

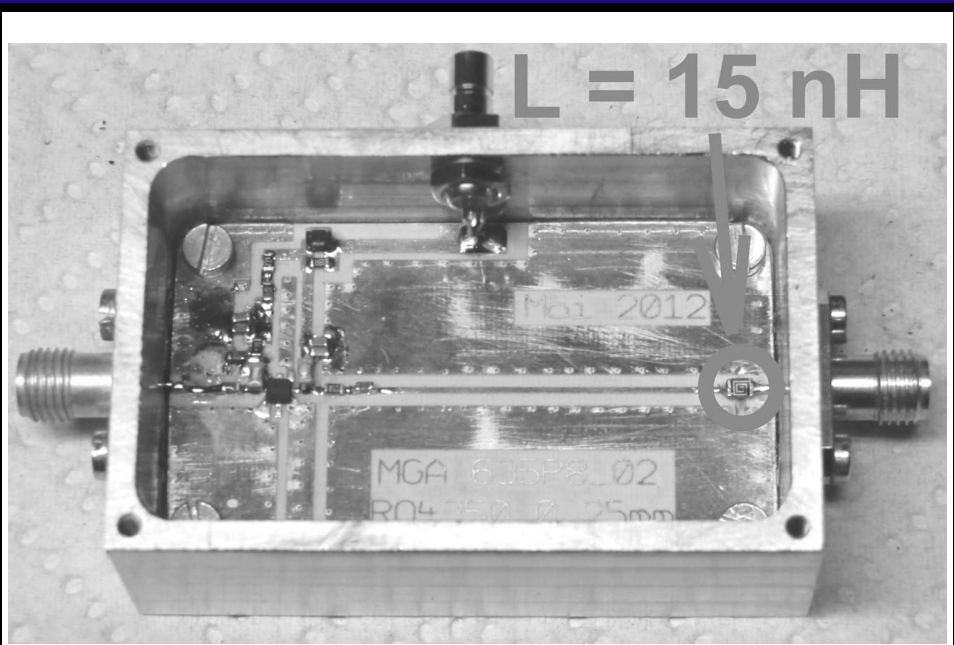


*A Publication for the  
Radio Amateur Worldwide*

*Especially Covering VHF,  
UHF and Microwaves*

# VHF COMMUNICATIONS

Volume No.45 . Winter . 2013-Q4 . £5.70



**A low noise preamplifier for the 70cm band with a  
gain of 25dB and a noise figure of approximately  
0.4dB**

*Gunthard Kraus, DG8GB*

Practical Wireless, the magazine that brings you Amateur Radio & so much more...

ISSN 0141-0857

# Practical WIRELESS

*Britain's Best Selling Amateur Radio Magazine*

## Enjoy the World of VHF every month!

Are you missing out on **Tim Kirby**  
**G4VXE's World of VHF?** You are if you're  
not reading *Practical Wireless* regularly!

Tim G4VXE has blown an exciting breath of new life in to his column as he explores the fascinating spectrum above 30MHz. It literally fizzles with enthusiasm and dedication and – as an extremely keen v.h.f. operator, enjoying the wide number of activities on the v.h.f., u.h.f. and microwave bands – Tim G4VXE writes a fully inclusive column. There's **something for everyone** in the *World of VHF*, whether you operate on f.m., s.s.b. a.m. or Morse and data modes. He proves – every month – how Radio Amateurs using relatively simple v.h.f. installations can work the DX!

However, as Tim clearly reports – there's much more to the *World of VHF* than chasing DX. Everything – from mobile and portable working to propagation reports – are enjoyed by Tim's growing band of readers around the globe. Tim's readers are a central part of the World of VHF team. So, join in and make sure you don't miss out!"

### Subscribe today!

- Never miss an issue
- Have it delivered to your door
- Subscribers get their copies before they reach the shops
- Avoid price rises
- Save £££s

To order a subscription please contact our subscription agency:

**Practical Wireless Subscriptions**  
Unit 8 The Old Silk Mill  
Brook Street, Tring  
Hertfordshire HP23 5EF

Please note: any cheques should be made payable to PW PUBLISHING LTD and CASH is NOT accepted by ourselves or Webscribe.

Orders taken on:

**01442 820580**

between 9am - 5pm. Outside these hours your order will be recorded on an answering machine.

FAX orders taken on:

**01442 827912**

Secure Internet orders can be placed at:

**www.mysubcare.com**

or via e-mail to:

**pw@webscribe.co.uk**

**PLUS REVIEWS, FEATURES AND ALL THE REGULAR FAVOURITES**

**Visit [www.pwpublishing.ltd.uk](http://www.pwpublishing.ltd.uk)**

**for up-to-date issue contents and more information**



# Contents

Andy Barter G8ATD	A brief history of VHF Communications Magazine	194 - 200
Gunthard Kraus DG8GB	A low noise preamplifier for the 70cm band with gain of 25dB and a noise figure of approximately 0.4dB	201 - 213
Sigurd Werner DL9MFV	Frequency Doubler and Sub-harmonic mixer for 122GHz	214 - 219
Gunthard Kraus DG8GB	Strong following wind for Sonnet Lite A book review	220 - 222
	Index of volume 45 (2013)	223 - 226
R. Lentz DL3WR	A Solid State Converter for 24cm Reprint from the first VHF Communications Magazine in 1969. It is interesting to see how technology has changed in 45 years	227 - 243
T Bittan G3JVQ/DJ0BQ	Antenna Notebook A reprint of the first of a series of articles by the original publisher. This article appeared in issue 3/1973	244 - 247
Gunthard Kraus DG8GB	Internet Treasure Trove	254 - 255

*This is the last issue of VHF Communications magazine. Low circulation, lack of articles and competition from the Internet have ended 45 years of continuous publication. Thank you to all subscribers and authors who have support this magazine over the years. Please read the article on the history of the magazine for more information.*

73s - Andy



**K M Publications**, 503 Northdown Road, Margate, Kent, CT9 3HD, UK

Telephone / Fax +44 (0)1843 220080, email : [andy@vhfcomm.co.uk](mailto:andy@vhfcomm.co.uk)

web : <http://www.vhfcomm.co.uk>



Andy Barter, G8ATD

# A brief history of VHF Communications Magazine

**Because this will be the last issue of VHF Communication Magazine published after 45 years of continuous publication I thought the history of the magazine would be of interest.**

---

## 1.

### How it started

---

The company UKW Berichte was founded in Germany by Hans Dohlus, DJ3QC in 1960 and the German magazine UKW Berichte was started edited by Terry Bittan, G3JVQ / DJ0BQ and Robert Lenz, DL3WR. The company supplied a wide range of amateur radio equipment and it is still a major supplier in Germany.

VHF Communication Magazine started in 1969 as the English version of the German magazine; Fig 1 shows the foreword of that issue. The cost of a subscription for the first year was \$3.00. There was already a lot of material to be presented to the English speaking readers with agents in 19 countries (three in the USA) ready to distribute the magazine and supply the many kits and products that had already been developed. One of the original agents, Christiane Michele, is still the French agent for VHF Communications Magazine and the original Span-

ish agent, Julio A. Prieto Alonso only retired as agent last year. The UK agent for the first few issues was Microwave Modules then various agents distributed the magazine in the UK including ARBBG, J Beam, VHF Communications, SOTA Communications and Ambit. In 1983 no UK agent was appointed and the magazine was distributed by UKW Berichte in the UK for the next 5 years. There were still 15 worldwide agents.

So many articles had already appeared in the German magazine that Issue 1 of VHF Communications Magazine contained a full index for the 1970 volume and issue 4/1969 had three pages of kits and Printed Circuit Boards available for projects described in the 1969 volume.

---

## 2.

### Tragedy

---

In 1984 a tragedy struck, Terry Bittan, one of the main driving forces behind the magazine was killed in a light aircraft accident. The announcement published in issue 1/1985 is shown in Fig 2. Terry's wife, Corrie Bittan took over as editor and advertising manager of the magazine with English translation by Colin Brock, G3ISB and his XYL. The magazine was produced like that for the next five years.



VOLUME 1 FEBRUARY 1969 EDITION 1

PUBLISHER: VERLAG UKW-BERICHTE  
Hans J. Dohlus, DJ 3 QC  
Gleiwitzer Strasse 45  
Fed. Republic of Germany

EDITORS: Robert E. Lentz, DL 3 WR  
Terry D. Bittan, G 3 JVQ  
DJ Ø BQ

## VHF COMMUNICATIONS

The first edition of VHF COMMUNICATIONS represents the birth of a new amateur radio magazine. However, VHF COMMUNICATIONS has not "appeared out of the blue" but is the international edition of the well known German language publication UKW-BERICHTE which has regularly appeared since 1960. The increased editorial team intends to forward the same ideals in both VHF COMMUNICATIONS and UKW-BERICHTE: To publish a magazine from radio amateurs for radio amateurs, specializing itself to the VHF, UHF and microwave technology.

The principle task of VHF COMMUNICATIONS is to provide exact and extensive assembly instructions for transmitters, receivers, converters, complete transceivers, antennas, measuring and auxiliary equipment etc., allowing them to be easily duplicated. The great advantage for our readers is that all the epoxy printed circuit boards and other specialized components, such as trimmers, coil formers, complicated metal-work, etc., are available from our representatives at moderate prices.

The ever increasing demands made on the efficiency and performance of amateur radio equipments as well as the continuously advancing technology resulting from this, makes it more and more difficult for the individual amateur to assemble his own equipment. Even though the turnover of amateur radio equipment manufacturers is steadily increasing, we feel that the majority of amateurs would prefer to build their own high-performance equipment if only the corresponding instructions and assistance were available. This is where we would like to help by providing detailed descriptions and supplying the special components. We believe that these ideals have been responsible for the success of the German language edition. We hope that our readers throughout the world will agree with us and help us to forward our ideals and the cause of amateur radio.

Vy 73, the publishers

DJ 3 QC

DL 3 WR

G 3 JVQ / DJ Ø BQ

Fig 1: The foreword of the very first issue of VHF Communications Magazine in 1969.



**Fig 2: The announcement of the death of Terry Bittan.**

With deepest sorrow we announce the death of the revered owner and head of our company, who was torn from our midst by a tragic accident.

**Terry D. Bittan**  
**G 3 JVQ, DJ Ø BQ**

We will greatly miss the enormous activity, care and scope of his ideas, and will strive to continue his work in his sense.

UKW-TECHNIK  
Verlag UKW-Berichte/  
VHF COMMUNICATIONS

Terry D. Bittan  
– The Staff –

Baiersdorf, the 17th of March 1985

### 3.

#### Publication in the UK

---

In 1988 Mike Wooding became the UK agent for the magazine and in 1990 when Corrie was looking for someone to take over the publication of the English maga-

zine Mike took over. Issue 4/1990 was the last magazine produced in Germany; Fig 3 shows the farewell message from Corrie. Mike had the German articles translated by a professional translator and the magazine was printed in the UK. He supplied the UK subscribers directly and most of the overseas readers via the established agent network. The cost of a subscription for 1991 was £12.00. During the 1990s the circulation of the magazine



## Contents

Hermann Hagn, DK 8 CI Dr. Andreas Ulrich	<b>The Initial Results of the Garching Amateur Radio-Astronomy Installation</b>	194 - 201
Dragoslav Dobričić, YU 1 AW	<b>An Unconditionally-Stable, Low-Noise GaAs-FET Pre-Amplifier</b>	202 - 218
Matjaž Vidmar, YT 3 MV	<b>Amateur-Radio Applications of the Fast Fourier Transform Part 2b (Concluding)</b>	219 - 229
Detlef Burchard, Box 14426, Nairobi, Kenya	<b>A Short-Wave Receiver PLL</b>	230 - 243
G. Tomassetti, I 4 BER S. Mariotti, IK 4 JGD	<b>A "New" Feed for the 3 cm Band</b>	244 - 247
Wolfgang Borschel, DK 2 DO	<b>Tropospheric Forward-Scatter Propagation</b>	248 - 249
Jochen Dreier, DG 8 SG	<b>Simple Improvements to the DK 2 VF Microstrip Directional Coupler</b>	250 - 253

### Farewell to our Readers

I regretfully announce that this will be the last edition of VHF COMMUNICATIONS to be published by Terry Bittan OHG. I would like to thank all our subscribers for their support during 22 years of the magazine's existence. I would also like to thank Colin (G3ISB) and his XYL for the effort of rewriting of the original UKW-BERICHTE articles into English. They are not professional translators, the work being sprung on to them following the tragic death of Terry Bittan in a light-aircraft accident six years ago. The detailed, and sometimes arduous, task of rewriting was undertaken in the spirit of a commitment to the constructional side of amateur radio and was therefore somewhat in the nature of a "labour of love" for G3ISB.

UKW-BERICHTE will continue to be published together with the sale of kits and parts associated with the articles and other ancillary equipment. Past editions of VHF COMMUNICATIONS are still available at reduced prices (see back cover page).

All subscriptions for VHF COMMUNICATIONS should now be sent to our UK representative **Mr Mike Wooding, 5 Ware Orchard, Barby Nr. Rugby, Warks CV23 8UF, Great Britain.**

I wish both you and the relaunched VHF COMMUNICATIONS all the very best for the future,

with sad 73s,

**Corrie Bittan, editor**



**UKWberichte** T. Bittan OHG · Jahnstr. 14 · Postfach 80 · D-8523 Baiersdorf  
Tel. 09133-47-0 · Telefax 09133-4747 · P SchKto Nürnberg 30455-858

**Fig 3: The farewell message from Corrie Bittan.**



## SPECIAL ANNOUNCEMENT

DUE TO EARLY RETIREMENT  
VHF *COMMUNICATIONS* MAGAZINE  
IS ON THE MARKET FOR A NEW  
PUBLISHER

The publishing of VHF Communications Magazine is suitable as a one-person business, or as an addition to an already existing business.

The last issue KM Publications will publish will be 4/1999, hence we are looking for the business to be purchased on or before December 31st this year, to ensure continuity of the magazine.

If you are interested in this exciting business opportunity, please contact us at the address below for further details, or email us at:

business@vhfcomm.co.uk

**Fig 4: The sale announcement from Mike Wooding.**

peaked at about 2200 copies, Mike set up a web site and acquired all of the back issue stock from Germany. Mike continued publishing the magazine until the end of 1999 when he wanted to retire; the announcement shown in Fig 4 was included as a flyer in issue 3/1999. At that time I was a subscriber, when I saw the flyer I thought that it would be an ideal job for me because I wanted to semi-retire and work from home.

#### 4.

### New UK Publisher

Issue 4/1999 was the last one produced by Mike; Fig 5 shows his farewell message. I had watched Mike produce issue 4/1999 so in early 2000 I started to produce my first issue of the magazine. The production method was interesting:

- Articles arrived from Germany on CD as text and picture files
- The article text was sent to a professional translator who produced English text that needed careful editing to correct some strange translation of technical terms. That was a big learning curve for me and one that I hope I have got better at over the years
- The articles were prepared for publication using Desk Top Publishing software and printed on bright white paper using a laser printer that I bought as part of the deal with Mike.
- These printed pages were sent to the printer in Rugby for printing with finished magazines returned to me in Luton
- The magazines were then posted to subscribers worldwide

In 2000 there were about 1200 subscribers and the subscription price was £20.00. Over the last 14 years that has fallen to the current 400 subscribers with a subscription price of £22.80.

When I purchased the publishing rights from Mike I also purchased all of the back issues, they arrived in a Transit van full to the gunnels. I spent some time sorting them out and arranging storage so that I could find any issue that was required. During 2000 and 2001 I sold quite a lot of back issues including complete sets of all the available printed magazines. I then set about filling the gaps by acquiring copies of all the magazines ever printed and scanning them to produce a library of every issue that is now available on DVD. As the magazine transferred to full computerised production the back issues of magazines from 2002 are in digital format rather than scanned images.

As subscriber numbers fell, the magazine production had to be changed to reduce





*Krystyna & Michael Wooding*

## Your old publishers




---

### Goodbye

---

It is something of a sad time for us, saying goodbye to the magazine and to you all, many of whom we have come to know personally over the last 10 years.

However, we are leaving you in the very capable hands of Andy Barter, who has been a subscriber of VHF Communications for many years.

Andy has been sitting in with us during the publication of this, our last issue. He now has a very good knowledge base of how the magazine has been produced by us over the last ten years, and I am sure he will maintain the high standard that you all expect.

We anticipate that we may have some small involvement over the coming year with the magazine, if only to give Andy technical support with the preparation and production.

Krystyna and I wish to thank you all for the continued support you have given us over our ten years as publisher

We would also like to thank Eberhard Smolka and his staff at UKW-Berichte, the sister and founding publication of VHF Communications. We know that Eberhard will be giving Andy the same support that we have enjoyed and wish them both a successful partnership.

So that's about it. We shall now fade into the sunset and enjoy the time we have gained back.

88 from Krystyna

and

73 from Michael



costs. The articles are now initially translated by computer producing similar results to the professional translator at a fraction of the cost. The translated text still needs editing to make sense of the technical details and where possible the original author is invited to proof read the result before publication. The printing process is now all electronic with a CD being sent to a different printer and printed magazine produced. The biggest cost increase has been postage; finally in 2012 the postage was changed from Royal Mail to a mailing company with a significant drop in postage costs.

During the 14 years that I have been publishing the magazine I have tried to keep the quality of the content a high as possible. Subscribers told me that the quality of some of the images, especially detailed circuit diagrams, was not very good. In September 2009 one subscriber, Andrew Holme, sent an email making that point but also said he had a solution. True to his word he helped me find a way to use a vector graphic format for the images that dramatically improved the quality.

A continuing problem for a magazine like VHF Communications Magazine is to keep a supply of good articles to publish. In the early days that was not a problem because all of the articles came directly from UKW Berichte. UKW Berichte started to change the format of their magazine with more adverts and more space around the articles. That meant that I had to find articles from elsewhere to fill the pages of the magazine. Some very interesting articles came from the subscribers but slowly that supply has dried up and a competition run in 2013 to try and stimulate more articles has failed with only three articles submitted. No votes have been received from subscribers to select the winners of the competition so Franco Rota who sponsored the competition will choose the winners.

---

## 5.

### The future

---

I have tried to find someone who wants to take over the magazine but that search has failed. Joe Kraft who publishes Dubus magazine wants to publish the English translations of the UKW Berichte articles, more about that below. With nobody wanting to take over publication of the magazine, sadly I am the person who has to say enough is enough and close the magazine. The magazine has been operating below the break-even point since 2011 with no sign of that situation improving. A survey of subscribers showed that an electronic version of the magazine was not viable so this is the last issue of VHF Communications Magazine.

The proposal by Joe Kraft to publish the English translation of UKW Berichte articles was initially acceptable to Eberhard Smolka who now runs UKW Berichte and produces the German magazine. When I tried to confirm the proposal Eberhard has failed to respond to any of my communications (email, telephone and post) so I cannot guarantee that the articles will appear in Dubus in future but if you do not already subscribe to Dubus magazine it is a very interesting magazine and needs support to stop it going the way of VHF Communications Magazine.

I will keep the VHF Communications Magazine web site running for as long as there is some demand. I will move it to a new host during 2014 to control the cost. It will still contain the full index of the magazine and back issue will be available as they are now in printed form if they are available or on DVD.

Thank you to all subscribers for your support over the years.

Best 73s - Andy



Gunthard Kraus, DG8GB

# A low noise preamplifier for the 70cm band with a gain of 25dB and a noise figure of approximately 0.4dB

This design was presented at the 2012 VHF meeting in Bensheim, it described the development of low noise LNAs for the frequency range from 1 to 1.7GHz. The lecture was published in expanded form in VHF reports. It documented the current state in development of low noise MMICs. The approach for a successful design was demonstrated using a model amplifier. Measurements confirmed the good simulation results. The performance of the circuit at low frequencies was also tested.

## 1.

### Overview

The properties of modern MMICs, from the article mentioned above [1] for a 1 to 1.7GHz amplifier, are briefly given below for the 1 to 1.7 GHz amplifier. The advantages are:

- Input and output are matched for 50Ω
- Noise figures are below 0.5dB even at frequencies below 500MHz
- More than 20dB gain up to 2GHz.
- Minimal external circuitry.

The author struggles with the following disadvantages:

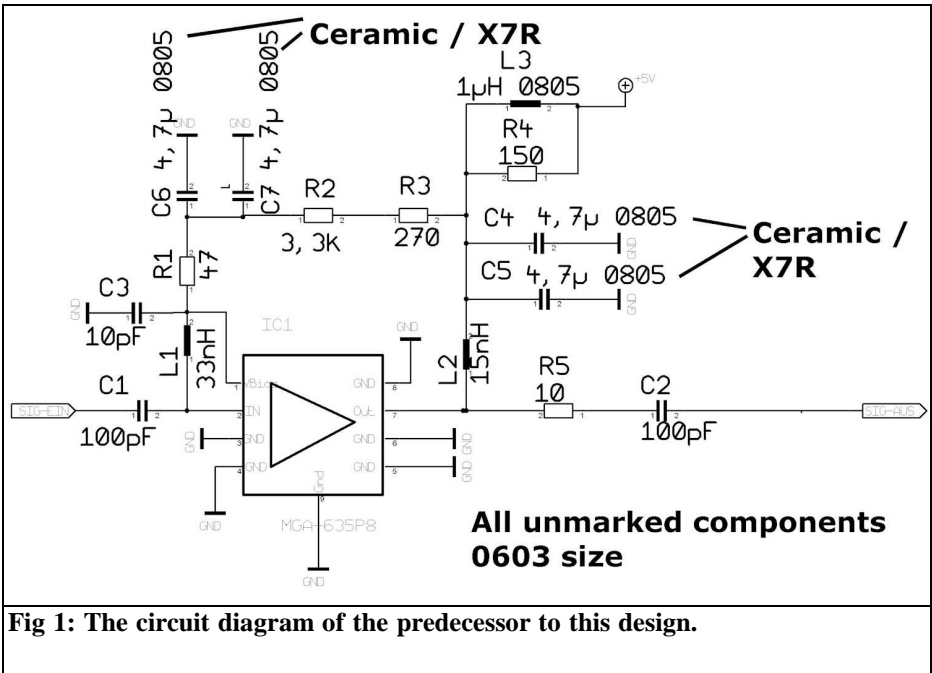
- The dimensions are now tiny and only tiny solder pads are used instead

of connecting pins.

- The common ground is a small spot of solder in the middle of the underside of the package.
- The layout design requires very high accuracy; tracks and connection pads on the IC are typically 0.25mm with a maximum width of 0.5mm
- The supporting components must be SMD size 0603 (1.25 x 0.75mm) or less to work.
- The cut-off frequencies of the components are so high that stability control is necessary even when operating below 1GHz and up to 10GHz therefore appropriate measures must be taken.
- The operating point must be carefully controlled and very carefully stabilised partly due to the high currents (often over 50mA per device). The supply voltages are decoupled even more carefully and for a broadband

The thickness of the PCB was reduced, for all applications, to 0.25mm due to the extended frequency range; this prevents the emergence of unwanted modes of the signals on the strip lines. The time for vias made from silver plated tubular rivets is over - now you have to have Printed Circuit Boards professional made.

The LNA development described in [1] was very successful; therefore, a step



**Fig 1: The circuit diagram of the predecessor to this design.**

down in frequency has been examined for the possibilities of use on the 70cm band. This is more difficult, because the manufacturer of this MMIC only gives usage data above 1GHz therefore the MGA635-P8 documentation for the properties at low frequencies (e.g. noise parameters) is very, very poor. So, a request list was formulated and checked how far it can be met:

- Noise figure: maximum 0.4dB
- Gain (S21) at least 20dB
- Absolute stability (k greater than 1 up to 10GHz)
- The output reflection S22 should be as low as possible (-20dB at 438MHz = dream value).

**2.**

**The circuit development**

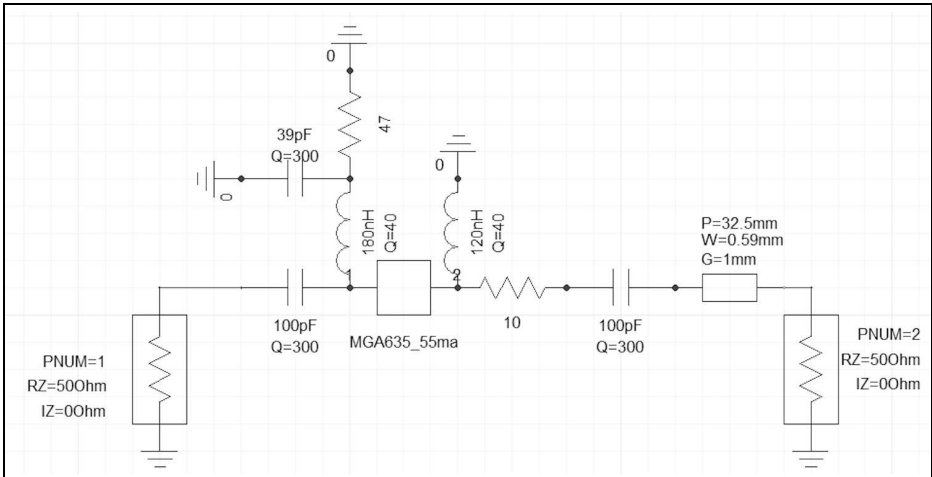
The LNA for 1 to 1.7GHz (Fig 1) and the

PCB layout were used. A cascode GaAs-pHEMT amplifier and bias circuit are inside the MMIC device. Pin 1 sets the operating point of 55mA through the bias circuit with a resistor ( $R_{bias} = R1 + R2 + R3 = 3.6k\Omega$ ). The generated bias feeds the first gate on pin 2 via L1. The inductor L2 on pin 7 forms the load resistance of the second stage.

A major problem of the HEMT components is stability at low frequencies - their tendency to oscillate. So a simple trick is used: with decreasing frequency the 50Ω value of R1 is presented more and more to the input pin 2. This is effective and prevents oscillation. The way this works:

- The reactance of L1 decreases with decreasing frequency, but the reactance of C3 increases. So at some point  $R1 = 50\Omega$  is the only thing active at the input pin 2.

The circuit was adjusted for noise at 438MHz using ANSOFT Designer SV. The values of L1, L2 and C3 were gradually changed using the simulation

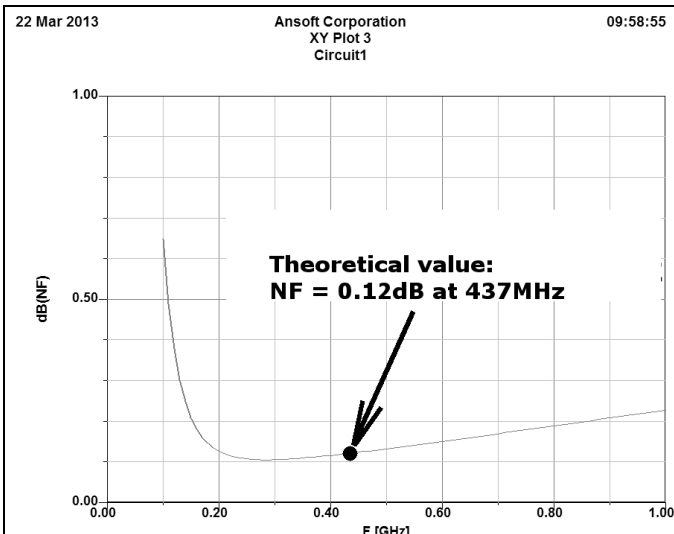


**Fig 2: The simulation circuit diagram for Ansoft Designer SV. It offers no great mystery for the optimisation of noise figure and stability.**

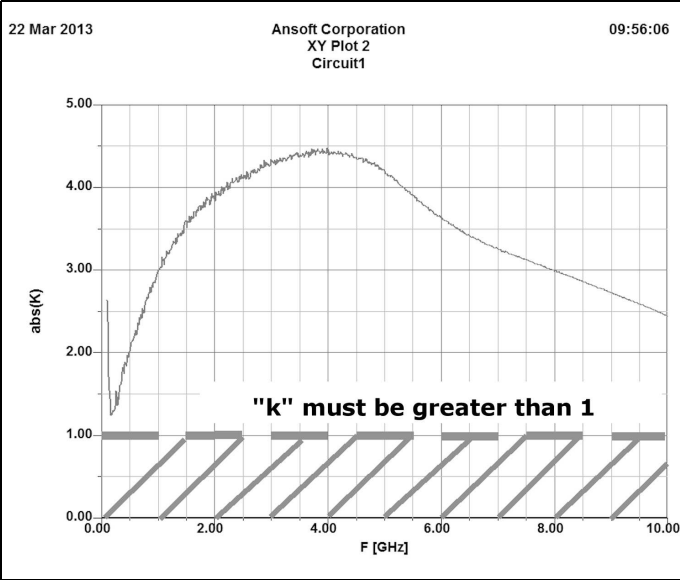
results for the noise figure, "NF in dB", and under a permanent control of the stability.

The intention was to create the minimum noise at 438MHz and to optimise the noise figure NF. The minimum value achieved was considerably lower than 0.4dB (simulation result: NF = 0.12dB) with L1 = 180nH / L2 = 120nH and C3 = 39pF. Up to 10GHz, a small resistor of

10Ω in the output circuit gave sufficient stability (fitted closed to the output pin of the MMIC). The output micro strip line (more correctly: "Grounded Coplanar Waveguide") with a width of 0.59mm and a "gap" of 1mm on each side and a length of 32.5mm should not be omitted from the simulation. The final simulation results were obtained using the simulation schematic shown in Fig 2 with the noise data as shown in Fig 3. This is a



**Fig 3: These noise levels would be a dream but are they realistic?**



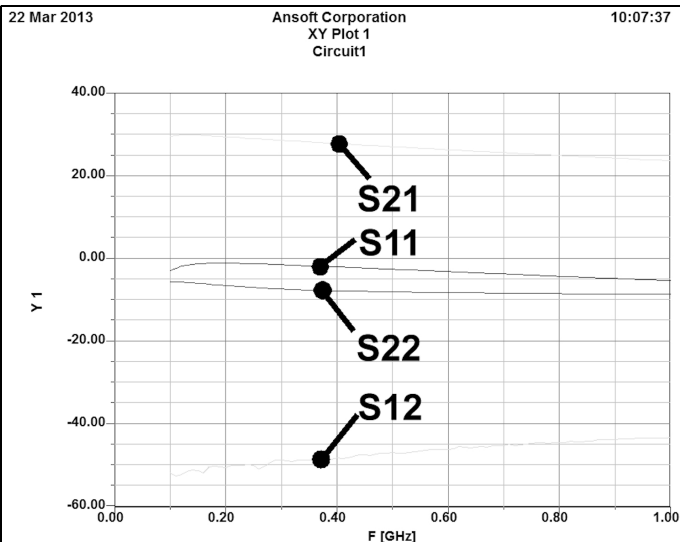
**Fig 4: No stability problem up to 10GHz.**

dream, of course it must actually be checked using a prototype to see if this is true. Finally, no noise data is contained in the S parameter file for this frequency range so the simulation program simply used a linear decrease of the noise figure with decreasing frequency!

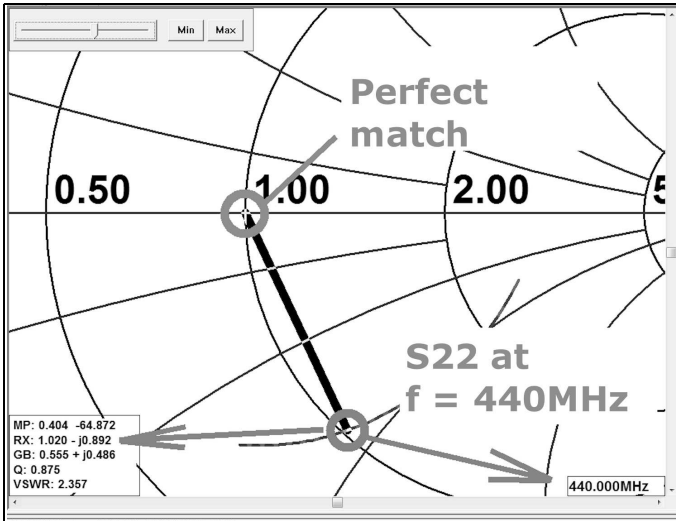
The required stability ( $k$  greater than 1 to 10GHz) was no problem as shown in Fig

4 and the simulated S parameters for this frequency range gives no cause for concern (Fig 5).

No extra development work was necessary for the board because the version developed for the 1.7GHz version could be used. The material is the “flame retardant version” of the familiar and proven Rogers material RO4003 called



**Fig 5: You can be satisfied with these simulated S parameters up to 1GHz.**



**Fig 6: The diagram for S22 at the required frequency shows that correction is needed (see text).**

RO4350B and in stock at the circuit board manufacturer [2] in the desired thickness of 10 mil = 0.254mm. To produce such a thin PCB with countless vias in perfect quality a Professional PCB manufacturer is necessary but the supplier [2] was very cooperative and is therefore recommended.

The Board size is 30 x 50mm with the bottom surface as a continuous ground plane (a matching milled aluminium case is used). Input and output use SMA connectors and the +5v power supply uses an SMB female as usual.

The central ground connection on the underside of the MMIC package requires its own 0.6mm wide ground island with 6 vias. All other ground planes on the PCB are carefully separated having enough vias. Actually, that's old hat, but it is purely and simply to give "neutral point grounding" that is recommended at low frequencies to avoid a tendency to oscillate. By the way: all vias have a diameter of only 0.3mm.

More on the Board follows in Chapter 3.

### 3.

#### Improvement of output reflection S22

First start a new Ansoft simulation for the frequency range from 200 up to 600MHz and display result of the S22 S parameters as a Smith chart (Fig 6). There is something very pleasing:

The 32.5mm long 50Ω line at the output moves the phase of S22 just so far that the S22 point for 440MHz is almost exactly on the reactance circle that runs through the centre of the chart. That means that S22 can be improved with a small additional inductance between the end of the line and the SMA output connector to compensate the capacitive reactance of S22 at this location.

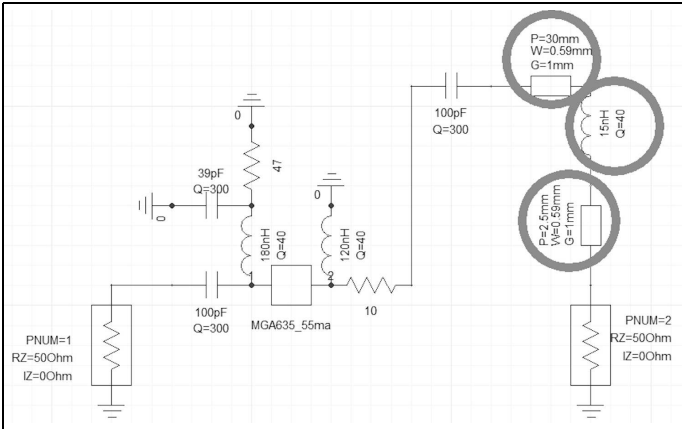
Thus the chart centre (perfect match) comes close.

A small interim calculation is required:

According to Fig 6 for the point "f = 440MHz", Ansoft designer SV gives a normalised impedance of:

$$Z = 1.101 - j0.892$$

This results in a capacitive reactance of



**Fig 7: These modest changes will do the trick.**

$$X_c = (50\Omega) \times (0.892) = 44.6\Omega$$

The required inductive reactance gives an inductance of

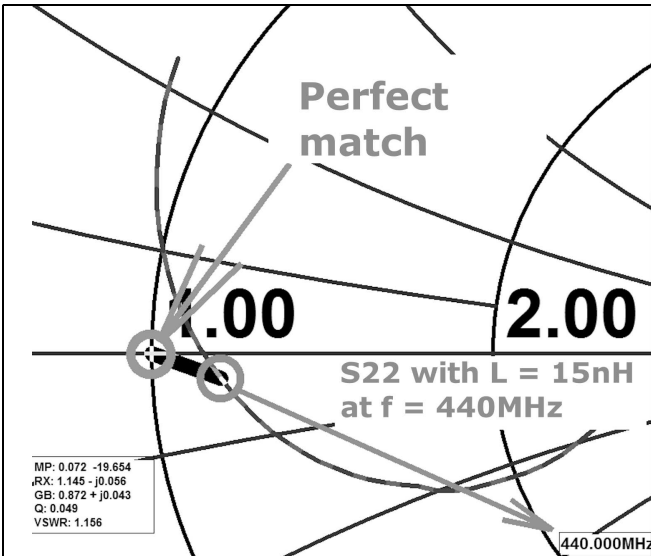
$$L = \frac{44.6\Omega}{2 \cdot \pi \cdot f} = \frac{44.6\Omega}{2 \cdot \pi \cdot 440\text{MHz}} = 16.1\text{nH}$$

This is something that cannot be bought "off the shelf", the closest standard value chosen was 15nH and the simulation diagram corrected accordingly is shown in Fig 7. The connection point for the SMD inductor is as close as possible to

the output SMA connector. A 30mm long section of 50Ω line from the MMIC is connected to the 15nH inductor followed by the remaining 2.5mm of line up to the SMA connector.

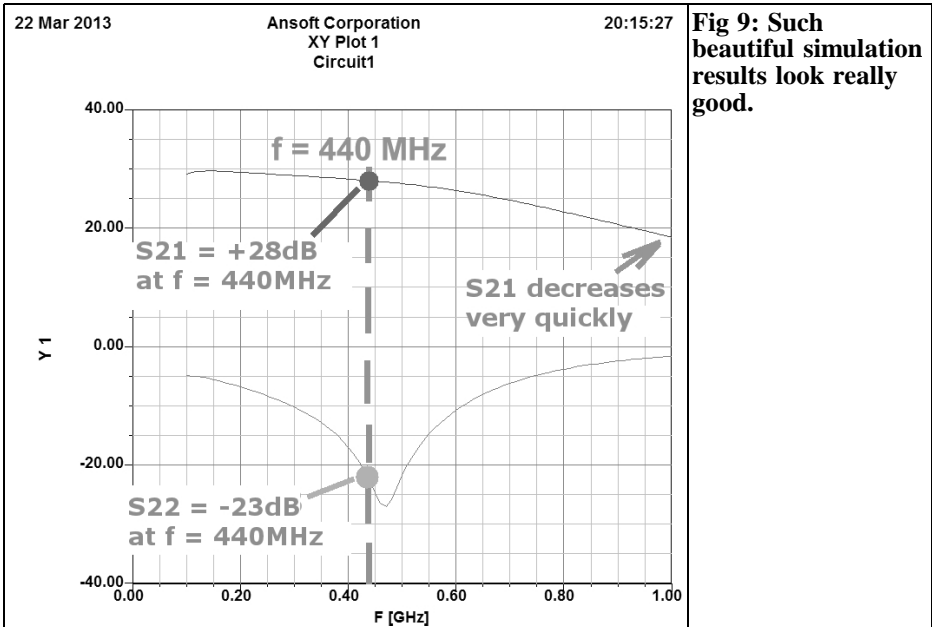
It is worthwhile to analyse the result (Fig 8) and looking at the the Smith chart you can see that it has landed not far from the chart centre for a perfect match.

You should not miss the result for S22 as a Cartesian chart together with S21 (Fig 9). The comparison with Fig 5 is very interesting showing the matching. But,



**Fig 8: The changes give almost the ideal matching point.**

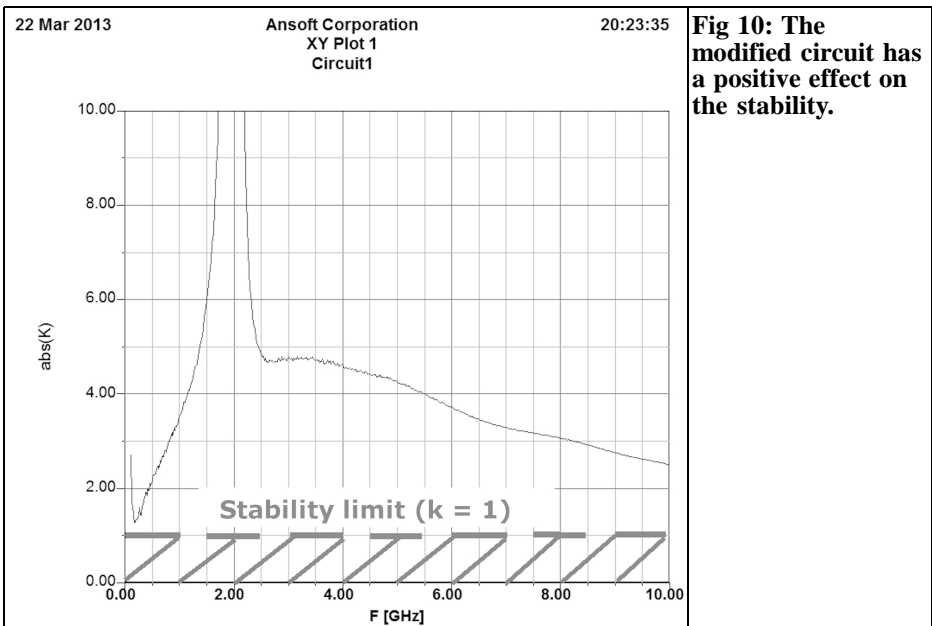




**Fig 9:** Such beautiful simulation results look really good.

S21 will now decrease much faster with increasing frequency because of the inductance inserted in the output line since its reactance is also increasing. Therefore

the stability factor “k” should be checked very closely up to 10GHz so that there are no unpleasant surprises, however Fig 10 is reassuring.



**Fig 10:** The modified circuit has a positive effect on the stability.

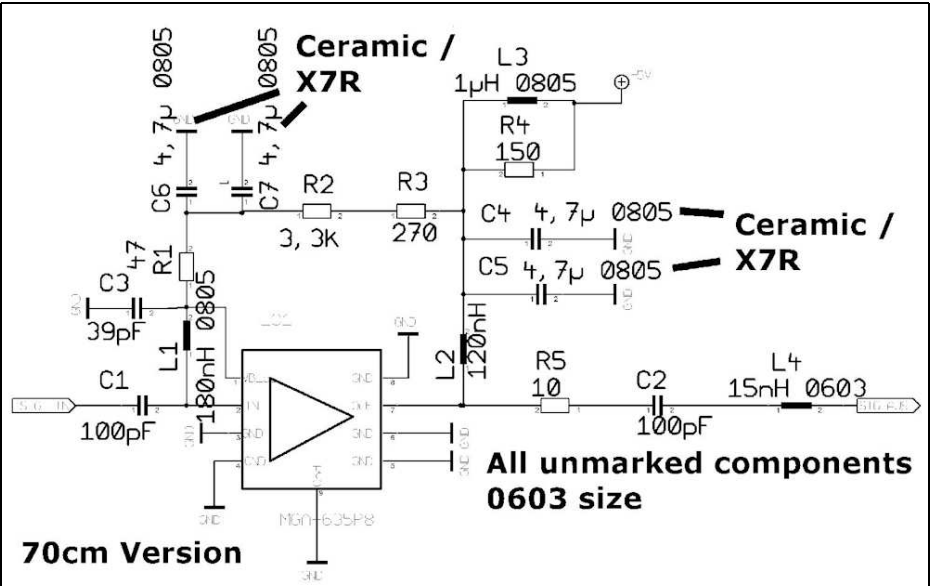


Fig 11: Who can spot the few changes from the 1.7GHz version?

#### 4. Measuring the S parameters of the prototype

Starting with the circuit diagram (Fig. 11) showing the changes from Fig 1 that

are minimal but extremely effective. This is followed by an almost identical board with a break in the output line after a distance of 30mm to insert the additional 15nH inductance. The revised layout is no problem (Fig 12), but the existing board can be used. A gap can be made on the original 1.7GHz version. A small piece of the conductor can be cut out

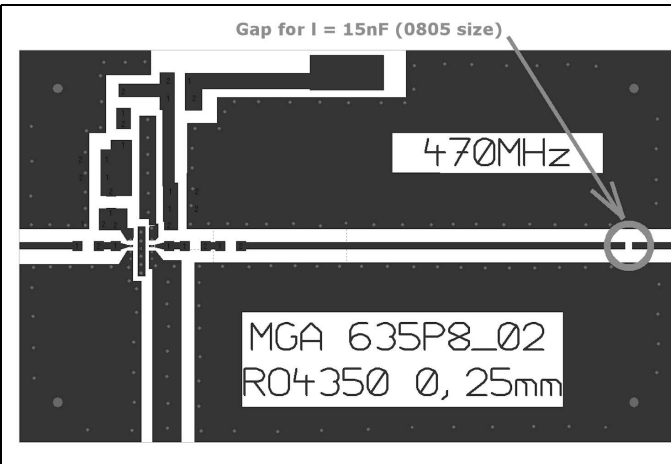
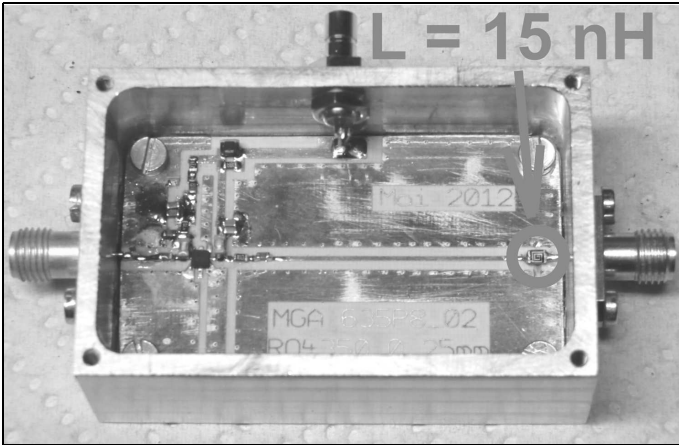


Fig 12: This is the only change to the previous PCB: a small gap for the additional inductor.



**Fig 13:** When you finally see this sight you know that you have done a lot of work to produce the finished prototype.

with a scalpel but this requires a warning: The copper layer of the Rogers RO4350B material does not adhere as well to the substrate as the previous RO4003 substrate so it is easy to remove the whole track with such an operation!

It is best done using a "Dremel" (small universal electric hand drill) with a small diamond cutting disc.

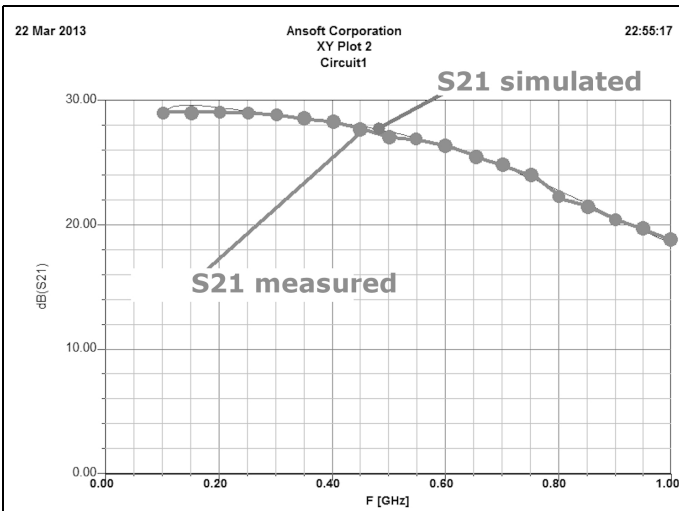
The finished board fitted into the aluminium housing, marked as a test Board and waiting for the Vector Network Analyser is shown in Fig 13.

The measurements were performed with an HP8410 true vector analyser and the associated S parameter test set (HP87-45A). A 20dB attenuator was used in front of the input for the S21 measurement to avoid clipping.

The graph of S21 can be seen in Fig 14 and it leaves no wish unfulfilled.

Convincingly, Fig 15 demonstrates the success of the measures to improve the output reflection S22, giving satisfaction.

It is advisable to disconnect the input of the DUT for the measurement of the output "Port 1" of the Network Analyser



**Fig 14:** Without measurements we do not know how the prototype works. S21 is as expected.



and to fit a  $50\Omega$  terminating resistor on the SMA socket instead. This results in a significantly more accurate result; because the transmitter output has more reflections than "little blue" (this is not only a joke, but a note on the blue paint of SMA termination made by Watkins Johnson. It is proven that Watkins Johnson together with the "Huber and Suhner" company are the front runners for making good devices with very low reflections over a wide frequency range).

One strange result is the shift of the "resonance peak" at low frequencies despite the use of the next standard value for the additional inductance (15nH instead of 16.6nH). This resonance frequency is lower by 20MHz.

For the measurement of S11 the amplifier output was separated from the analyser and connected to a "little blue" termination. Fig 16 shows the measurement of S11 at the amplifier input together with simulation. The result of 2.5 dB is not great but at least shows that theory and practice match.

Measuring S12 is more difficult due to the low amplitude but the measurement for a frequency of 440MHz is around the simulated value of approximately 45dB.

---

## 5.

### The noise

---

The precise measurement of small noise figures (NF about 0.4dB) for the first amplifier version last year (see [1]) proved to be a major hurdle for the basement workshop and it was completely dependent on the help of friends with appropriately high quality measuring equipment. In response to the article, there were some important tips and emails from readers who themselves have already struggled with the same problems. Therefore some experimentation and additional brooding suddenly

produced a solution to solve this task successfully.

Fig 17 shows an overview of the schematic for the slightly modified measurement setup from last year that suddenly delivered the desired results with sufficient accuracy using changed settings of instruments. The crucial difference is the 6dB precision attenuator inserted between generator output and input of the amplifier being measured. As a result, 6dB is added to the expected noise figure and that fits perfectly with the lowest output level range of the SKTU noise transmitter from Rohde and Schwarz with NF = 0 to 8dB.

The measurement is as follows using the practical setup shown in Fig 18:

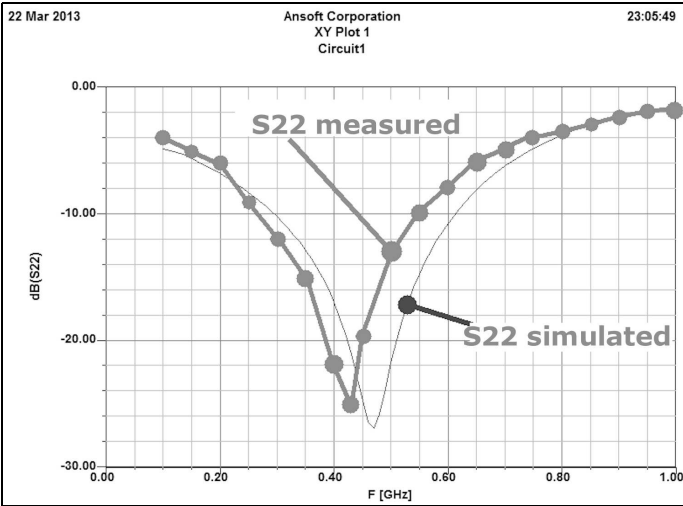
The HP8555 analyser is used as a measuring receiver to measure the power at  $f = 440\text{MHz}$  (scanning function switched OFF to get a selective level meter). Once the whole chain is in operation check the influence of the noise floor of the 20dB post amplifier in this manner:

Set the output level of the SKTU to Zero and remove the supply voltage from the amplifier being measured and determine that this decreases the indicated noise level on the spectrum analyser screen by more than 20dB. That should be enough to not distort the result.

Here we go with the measurement:

The amplifier to be measured is switched on again and the noise transmitter turned on. It is very nice to see how increasing the noise is displayed as a "marching point" on the screen. But to determine an increase by 3dB (then the LNA noise is exactly the same as the external input and displayed on the instrument of the noise transmitter), the following steps are required:

- Start with the noise transmitter output power set to "Null".
- The bandwidth of the spectrum analyser must be set to 30kHz to get a tiny and little "wriggling" point on



**Fig 15: S22 is hopefully satisfactory despite the small difference compared to the simulation.**

the screen (more decreasing bandwidth always gives a restless display). The video bandwidth is set on "b = 10Hz".

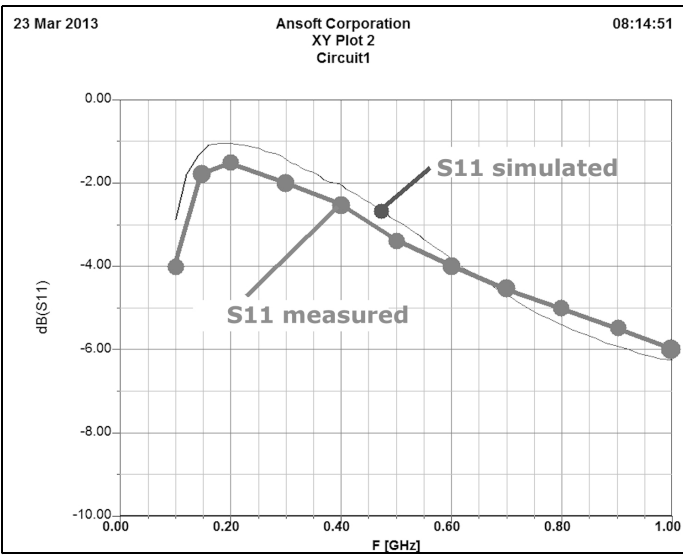
- Move this dot (with the help of a magnifying glass!) to be exactly in the centre of the screen.
- Increase the noise output level with one hand until the dot moves by exactly 3dB upwards (using a magnifying glass in the other hand to watch the analyser's screen!).

- Read off the indicated noise level on the SKTU instrument and subtract the 6dB of the attenuator.

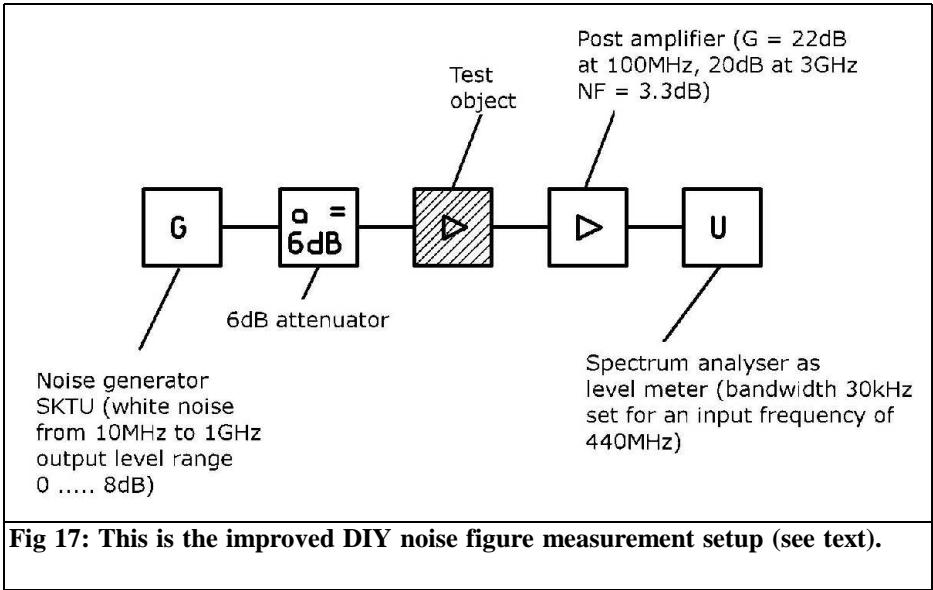
The exciting result as the average of 10 measurements:

NF approximately 0.38dB

That does not agree with the simulation but is exactly the noise figure of the 1.7GHz version that had a NF = approximately 0.3dB at 1GHz.



**Fig 16: S11 theory and practice are the same but by favouring noise adjustment means the values not quite the same.**



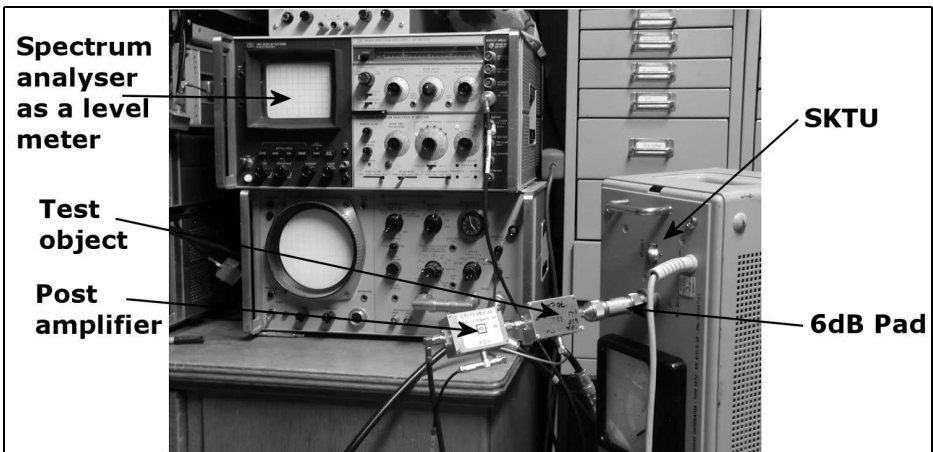
**Fig 17: This is the improved DIY noise figure measurement setup (see text).**

### 6. What does a professional quality measuring instrument give?

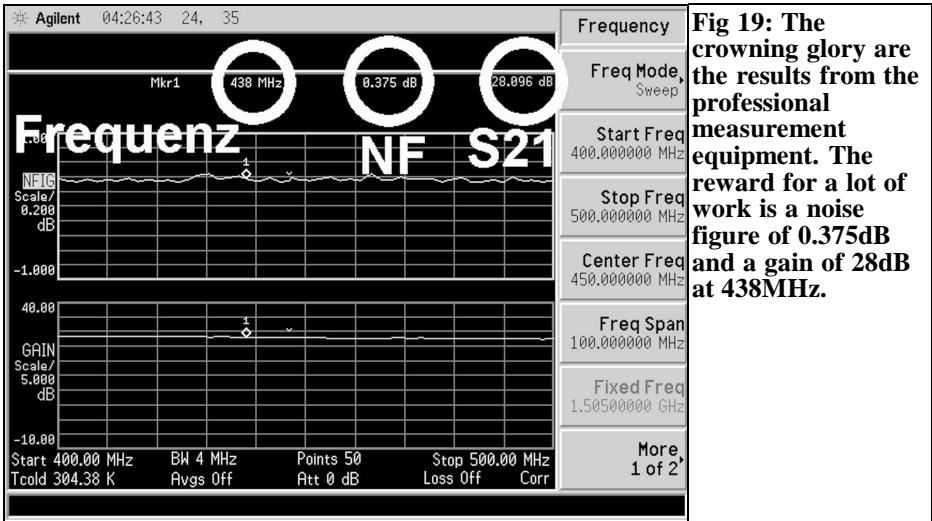
I was really happy with my own measur-

ement results but because the elderly meter results should be verified with the latest equipment with greater accuracy. Uli Kafka (from the electronics company Eisch, Ulm) was able to help again.

The following results were as follows and the comparison with Figs 14 to 16 is really worth while (again: thank you,



**Fig 18: This is what the noise measurement system looks like: however it is important to understand the operation (see text).**



**Fig 19: The crowning glory are the results from the professional measurement equipment. The reward for a lot of work is a noise figure of 0.375dB and a gain of 28dB at 438MHz.**

Uli):

With  $f = 438\text{MHz}$   $S11$  lies between  $-2.7\text{dB}$  (for an input level  $-20\text{dBm}$ ) and  $-2.5\text{dB}$  (with an input level of zero  $\text{dBm}$ ).

$S22 = -21\text{dB}$  with the minimum at  $f = 438\text{MHz}$  (the best fit to my measurement is not reached with  $-25\text{dB}$  at  $430\text{MHz}$ ).

The exact graph of  $S21$  (approximately  $28\text{dB}$ ) and the noise figure  $NF$  between  $400$  and  $500\text{MHz}$  is shown in Fig 19. The value of  $NF = 0.375\text{dB}$  at  $438\text{MHz}$  is very reassuring and convincingly confirmed the accuracy and reliability my own noise measurement described above. But it does have a considerably greater operation and calibration time.

$S12$  is where the simulation predicts (much less than  $-40\text{dB}$ ) and my own measurements gave the same result.

write that as a conclusion - but it does show the very fine line between simulation and prototype designs and encourages new projects.

Since this worked out so well is a  $144\text{MHz}$  version of the amplifier possible?

## 8. Literature

[1] Development of a preamplifier from  $1$  to  $1.7\text{GHz}$  with a noise figure of  $0.4\text{dB}$ , Gunthard Kraus, DG8GB.: VHF Communications Magazine, issue 2/2013 pp 90 - 101

[2] Board manufacturer in Munich: [www.aetzwerk.de](http://www.aetzwerk.de)

## 7.

### Summary

The electronics developer's life is full of surprises and there is no opportunity to be comfortable and relax. You could



Sigurd Werner, DL9MFV

# Frequency Doubler and Sub-harmonic mixer for 122GHz

**A passive frequency doubler for 122GHz using simple GaAs Schottky diodes is described below. The maximum output power of the CW transmitter is 4.3mW. The efficiency is between 5 and 7%.**

**A sub-harmonic mixer for 122GHz will also be presented. The attenuation of the mixer was measured as 16.5dB.**

- The efficiency of a frequency doubler is clearly superior to a tripler.
- There are no problems with the second harmonic of 80GHz that could possibly be propagated along the waveguide (the cut-off of a WR 8 waveguide is 74GHz).

This article is to motivate other "microwave enthusiasts" to try the interesting 2.5mm band.

---

## 1.

### Introduction

---

From the early to mid 1990s, Michael Kuhne (DB6NT) has shown that even frequencies beyond 100GHz can be successfully used by radio amateurs (e.g. [1]). The boards developed by him (using Rogers substrates) are popular to this day. After the so-called 2.5mm band (122.25 to 123GHz) was allocated it was mainly Philip Prinz (DL2AM) who carefully design many units (e.g. [2-3]). My special respect is for the Austrians (R. Wakolbinger, OE5VRL and W. Hoeth, OE3WOG) who made amazing equipment despite limited resources [4].

Their designs usually used a local oscillator frequency of about 40GHz. However I decided at an early stage to use 61GHz (DL2AM has also used this recently), for the following reasons:

---

## 2.

### Mechanical and electrical construction

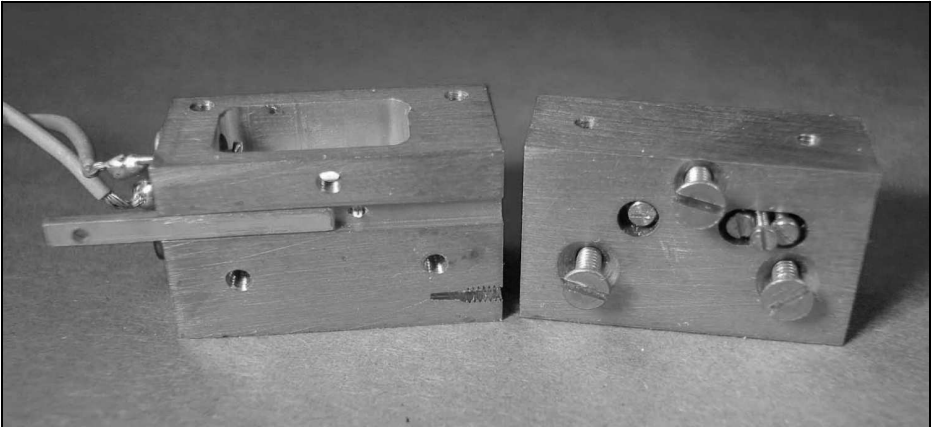
---

The typical dimensions of a milled housing made of brass are 24mm x 20mm x 20mm (L x W x H). The module is composed of 3 parts: two blocks that make up the waveguide (1 x 2mm) and a 5mm high cover. All metal parts are gold plated.

The simple block system is shown in Fig 1. The left block contains a 5mm deep cavity containing the quartz substrate and the low pass filter ( $Al_2O_3$ ). The right block forms the 4th wall of the waveguide.

The RF substrates used are 0.127mm quartz. An example of three structures is

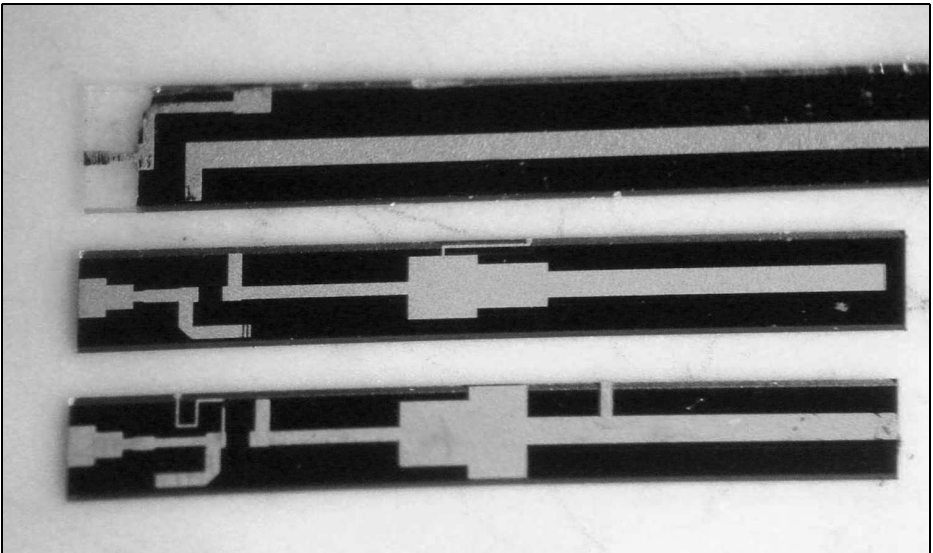




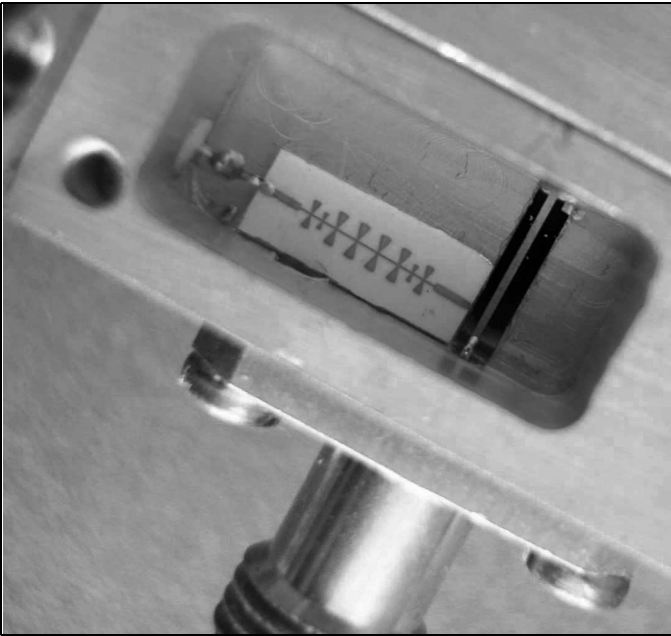
**Fig 1:** The block with the cavity is located on the left side. The slide and the slot (1.2mm v 0.5mm) for the substrate to pass into the waveguide can be seen on the right of the second block. There are three M2 fastening screws and clamping screw for the slide. There are three M1 adjusting screws to change the impedance of the waveguide.

shown in Fig 2 (nearly a dozen versions were tested). A "universal model" is at the top that must be matched with suitable

gold flags. The partially milled off metallisation on the bottom for use in a rectangular waveguide is clearly visible.



**Fig 2:** Three different quartz substrates (0.127mm) for RF management. The top one is a "universal" model that must be matched with gold flags. The metallisation is partially cut off on the bottom edge. The short stub blocks 122GHz signals. The long stub on the bottom two include the two additional sections.



**Fig 3: The construction of the frequency doubler using the block technique. This shows: the 1.85mm connector, the strip line on a quartz substrate (the diode is hidden in the opening to the waveguide). The low pass filter (on a white substrate) is used for the DC return.**

The short stub is for blocking the 122GHz signal ( $\lambda/2$  at 61GHz). The structures of the two other versions were created with an RF simulation program.

As for in the upper element, the bottom metallisation must be taken away for a distance of 0.5mm. This is done with a hand mill and a 0.4mm diamond grinder viewed under microscope. This part of the stripline (far left) extends into the waveguide. The quartz substrates are 1 to 1.3mm wide and contain the typical stubs and the return of direct current.

The diode is attached with silver conductive adhesive over the 200 or 250 $\mu$ m wide 'gap' (in the area of the waveguide). The structures of the two other substrates were calculated with a mixed 3D/2D-simulation program (CST Studio suite). I created SPICE models for the diodes used. The semiconductor used were Schottky diodes (flip chip versions) that are exclusive to GaAs. The preferred diode comes from Virginia Diodes (VD, W band), but several other types from M/A-COM Tech (e.g. MA46H146 and MA4E1317) have been tested successfu-

lly.

The low pass filter for the intermediate frequency and the DC return consists of 0.254mm  $Al_2O_3$ . Additional technical details are included in the previous work [5].

---

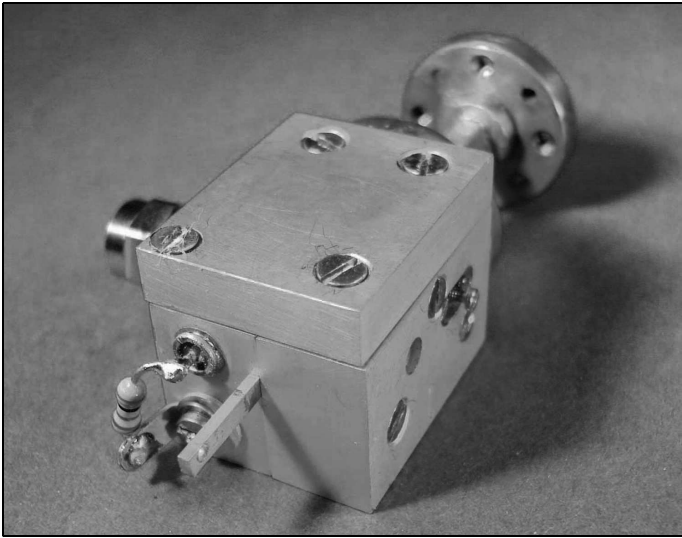
### 3.

## Measurements

---

Performance measurements were performed with a W band sensor by Hughes (75-110GHz) that was calibrated at 122GHz (calibration by DJ1CR) and a waveguide taper (W to F band).

An HP432A power meter was used as a display device. Later the measured values were verified with a calorimeter (MDW from ELMIKA). An HP spectrum analyzer and harmonic mixer (90-140GHz) by Hughes was also used with a variable attenuator for V band (Hughes) and F band (custom microwave).



**Fig 4: A working doubler module showing the fixed resistor to set operating point of the diode.**

An "old" UHF measuring receiver from Rohde and Schwarz did good service with its switchable attenuator to 80dB.

#### 4.

### Frequency Doubler

Fig 3 illustrates the construction of the frequency doubler module. A 1.85mm connector feeds the 61GHz signal onto the quartz substrate. The diode (not visible) is located in the gap to the waveguide. The low pass filter ( $Al_2O_3$ ) is the return DC path and is connected with a bonding wire to the quartz substrate. The operating point of the diode is determined with an external variable resistor and later replaced with a fixed resistor on the outside of the housing.

The W band diode (VD) was tested first. The simple  $50\Omega$  strip line on the quartz substrate must be matched to the diode (from data about  $8\Omega$ ). This is done by applying small "gold" flags on the strip line.

4.3mW at 122GHz were obtained with a

driving power of approximately 80mW at 61GHz. 50mW still gave 3.4mW. This corresponds to an efficiency of 5% to 7%. The M/A-COM diodes resulted in 3dB worse results in the test environment.

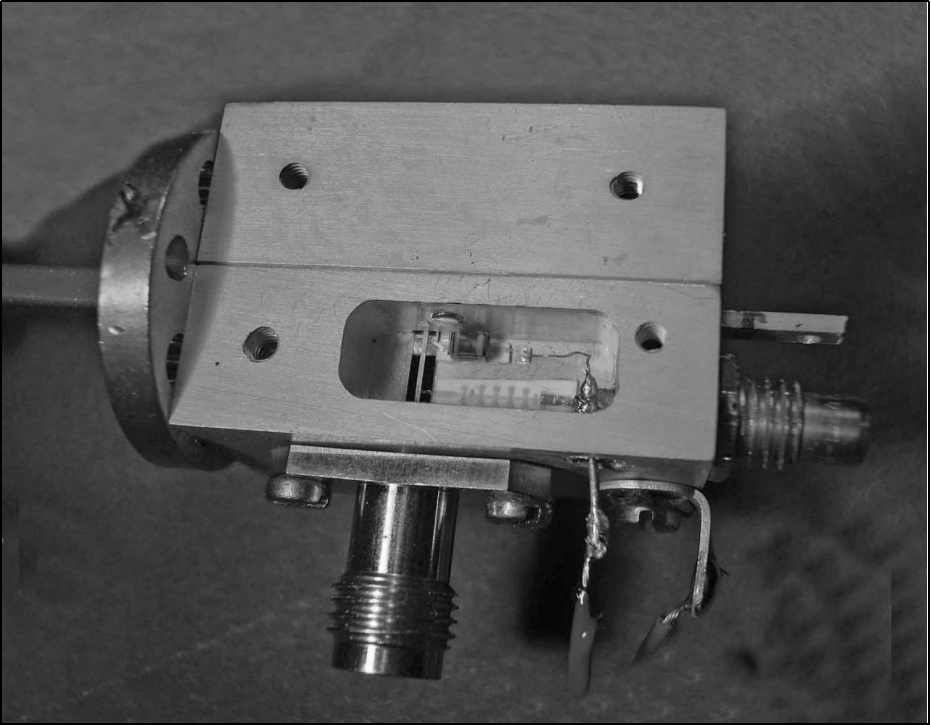
Other variants of the stripline were tried, for example the versions created by computer simulation (see Fig 2). Disappointingly they required re-adjustment of the matching but no better performance was achieved.

A prototype in the gold plated milled housing is shown in Fig 4.

#### 5.

### Sub harmonic mixer

A sub harmonic mixer module was developed using the principles of the doubler. A 10nF ceramic capacitor was integrated into the low pass filter (IF branch). Only the diode made by Virginia Diodes was used. A DC bias for the diode (Fig 5) meant that a relatively high LO drive was unnecessary.



**Fig 5: The sub-harmonic mixer for 122GHz. The LO is fed through the 1.85mm connector (at the bottom). The RF connection is via the waveguide and the IF output is through the SMB connector (right). The diode is in the cavity with bias fed using the socket next to the LO input.**

The RF frequency of 122250.24MHz and the LO frequency of 61053.02MHz were chosen so that an IF of 144.24MHz. The assembly shown in Fig 6 was used to measure the mixing attenuation. An RF signal of  $300\mu\text{W}$  was generated and reduced by a variable 10dB attenuator. The  $30\mu\text{W}$  signal,  $-15.2\text{dBm}$ , at 122250.-24MHz was fed using WR-8 waveguide into the mixer. The resulting low power IF signal was fed to a measuring receiver or a spectrum analyser. The optimum performance of the LO was approximately 13dBm. The mixing attenuation was measured as 16.5dB.

This value could not be reduced using the simulated RF substrates. The use of mixing diodes that are designed for higher frequencies (e.g. by Teledyn)

should achieve at least 12dB but this has not been tried yet.

---

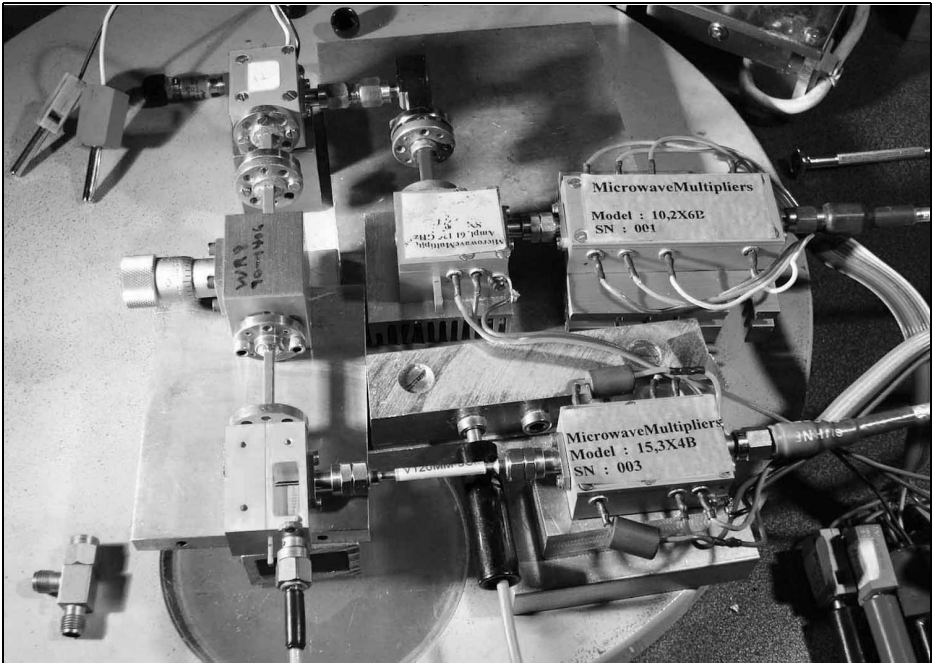
## 6.

### Thanks

---

I am extremely grateful to the employees of Rohde and Schwarz, Munich. This project would have been impossible without their help in creating the quartz substrates. Dr Hechtfisher (DG4MGR), W. Hohenester and K Beister deserve a particularly mention.

I would also like to thank M. Münich (DJ1CR), MPI for plasma physics who not only calibrated my measuring equip-



**Fig 6: The measuring arrangement for determining the mixing attenuation. The sub harmonic mixer (bottom left) was matched under a stereo microscope. The LO power is introduced using a quadrupler (bottom right) and the RF signal is fed in via a variable waveguide attenuator. The coax cable feeding the IF signal to the measuring receiver or spectrum analyser can be seen at the bottom of the picture.**

ment but also with many "small gifts" to complete my project.

Finally I owe J Ehrlich (DF3CK) for lots of good advice.

## 7.

## References

[1] Transverter for 145 to 241GHz, Michael Kuhne, DB6NT, Dubus Technik IV, pp 376-383

[2] 122GHz Transverter with new multiplier, Philipp Prinz, DL2AM, Dubus 2/2006, pp 8-18

[3] 50% more output on 122GHz, Philipp

Prinz, DL2AM, CQDL 2/2012, pp 2-3

[4] Rudi Wakolbinger, OE5VRL and Wolfgang Hoeth, OE3WOG, Microwave meeting in Hohenbachern 2011, personal communication

[5] Oscillator for 122GHz: Frequency multiplier from 61GHz and amplifier. Sigurd Werner, DL9MFV, VHF Communications Magazine 3/2013, pp 130-135



Gunthard Kraus, DG8GB

# Strong following wind for Sonnet Lite

## A book review

**It is sometimes odd! For years you work closely with the program "Sonnet Lite" developing microwave strip line circuits as well as lots of patch antennas - with joy and success. But then a reader reply arrives that changes everything!**

---

### Description

---

The reader reply casually mentioned (thanks, Christian!): "by the way do you know the book - Introduction to antenna analysis using EM Simulator - by a couple of guys called Kogure from Japan?" "At the time of purchase you can get the extension code for the Sonnet Lite "Plus" version 13.55 that uses 64MB of RAM, supplied for free".

At that time the maximum allowed memory with Sonnet Lite was 32MB so this mail had an electrifying effect and I immediately raised an Internet order to Amazon. The book was supplied promptly (Fig 1) and thrown out of the box for a look. This look extended over a period of several hours because it was fascinating!

In addition to a very clear and easy to understand presentation of antenna basics (including Maxwell's equations, but without too heavy mathematics) followed in

that context by the history of the development of the Sonnet simulation by Heinrich Hertz for the exploration of electromagnetic waves. It is astounding and perfect: the authors simulate not only the

The book cover features the title in large, bold, black letters. Below the title, the authors' names are listed. At the bottom, there are four circular icons: the first shows a wave pattern, the second shows a circular antenna structure, the third shows a radiation pattern, and the fourth is a portrait of Heinrich Hertz.

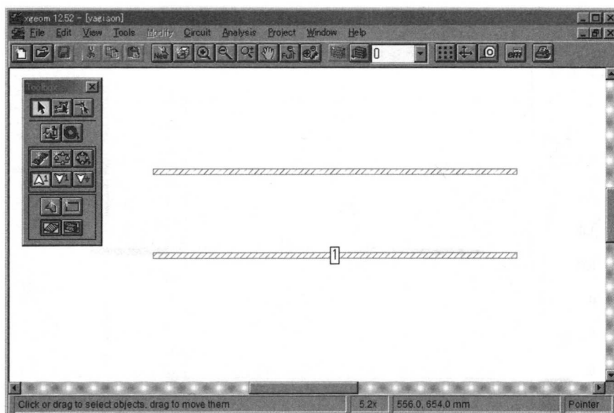
## INTRODUCTION TO ANTENNA ANALYSIS USING EM SIMULATORS

Hiroaki Kogure, Yoshie Kogure, James C. Rautio



DVD included!

**Fig 1: For people who use Sonnet Lite, this is a book where you can find everything about the working with the program.**



**Figure 1.36** Draw the second element and we have a complete Yagi antenna. The spacing is 55 mm.

**Fig 2: I can't believe that something with a planar Simulator can work on simulations of a dipole!**

Hertzian waves but also a dipole, a Yagi antenna, a bow tie antenna as well as loops, quads and other wire antennas successfully with Sonnet! I compared with the 4NEC2 simulator for wire antennas to check the planar EM simulation of Sonnet applied to wire antennas. The result is correct and Fig 2 shows the example of the Sonnet output for the dipole.

The following topics are covered in the chapter "Wire Antennas":

- Antennas on substrates
- Travelling wave antennas
- Antennas for RFID systems
- Determination of antenna Characteristics by using EM Simulator
- Practical antennas

If you are looking for a "log-periodic antenna" or an "Ultra Wide Band Antenna" or a "UHF RFID tag antenna" or similar searches then go to the extensive index at the back of the book and you will find what you want.

Fig 3 with the simulation input serves as appetisers to investigate a meander ante-

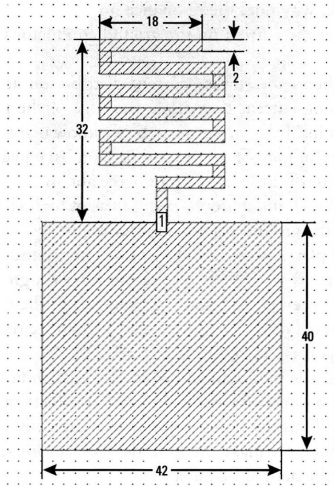
enna that is often found in mobile phones. Everything is always precisely described as well as the Sonnet settings.

Therefore: this book is really indispensable for the dedicated Sonnet Lite antenna developer.

However, the usual "thorns amongst roses" are there and here are two:

- Unfortunately Sonnet Lite still locks when simulating the antenna's far field or the indicative diagrams. You will have to purchase a genuine full version for these... or find a friend who has something available in the workplace.
- The addition of 64MB is only available when you buy directly from the Publisher "Artech House". There are offers available on the Internet at up to \$30 under the official selling price (well over \$100).

If you are tempted by the more favourable offer - then you will discover that the new book only includes the Sonnet version 13.53 from last year. The approved main memory was a somewhat annoying 16MB! Unfortunately, a warning email



**Figure 8.28** Monopole model with a ground patch on a substrate, roughly estimating what might happen in a real cell phone.

**Fig 3: It is amazing what is possible today: simulation of a meander antenna as used in a mobile phone.**

from Christian explaining this difference arrived at the same time as the book was delivered. Well, then I have just the 32MB of main memory from the currently available version of 13.55.

Here the exact information of the book:

- Title: Introduction to antenna analysis using EM simulation Simulator
- Authors: Hiroaki Kogure, Yoshie Kogure, James A. Rautio
- ISBN-13: 978-1-60807-157-9
- ISBN 10: 1-60807-157-X
- Publisher: Artech House Boston / London

(Incidentally: The co-author James A. Rautie is President of Sonnet software and his support and tips surely contributed much to the high quality of the book).





# Index of Volume 44 (2013)

Article	Author	Edition	Pages
<b>122GHz Band</b>			
Oscillator for 122GHz: Frequency multiplier from 61GHz and amplifier	Sigurd Werner, DL9MFV	2013/3	130 - 135
Frequency Doubler and Sub-harmonic mixer for 122GHz	Sigurd Werner, DL9MFV	2013/4	214 - 219
<b>23 cm Band</b>			
Development of a preamplifier from 1 to 1.7GHz with a noise figure of 0.4dB	Gunthard Kraus, DG8GB	2013/2	90 - 101
A Solid State Converter for 24cm. Reprint from the first VHF Communications Magazine in 1969	R Lentz, DL3WR	2013/4	227 - 243
<b>3 cm Band</b>			
ATV Transverter for conversion of the 23cm band to the 3cm band	Michael Klerkx, PA0MKX	2013/1	2 - 9
<b>70 cm Band</b>			
A low noise preamplifier for the 70cm band with gain of 25dB and a noise figure of approx 0.4dB.	Gunthard Kraus, DG8GB	2013/4	201 - 213
<b>Antenna Technology</b>			
Antenna Notebook. A reprint of the first of a series of articles by the original publisher	T Bittan, G3JVQ/DJ0BQ	2013/4	243 - 247
<b>Fundamentals</b>			
Extremely Low Noise Preamplifiers require Low Loss Antenna Cables. Wideband Directional Coupler for VSWR Measurement on Receive Systems. Reprint from 3/1983	Michael Martin, DJ7VY	2013/3	181 - 189
Directional couplers - made to measure. Reprint from 4/1984	Harald Braubach, DL1GBH	2013/3	174 - 180
Operational Transconductance Amplifiers (OTA)	Aristotles Tsiamitros	2013/3	148 - 162
<b>Measuring Technology</b>			
AGC test switch, part 2	Henning C. Weddig, DK5LV	2013/1	20 - 27
A vector measurement system for the X band (8 - 12GHz) based on an automated slotted waveguide	Massimo Donelli	2013/2	73 - 81
A Sensitive Thermal Power Meter. Reprint from issue 4/1983	Carsten Vieland, DJ4GC	2013/2	118 - 123

**Miscellaneous**

Internet Treasure Trove	Gunthard Kraus, DG8GB	2013/1	62 - 63
A useful coax latching relay control circuit	Marty Singer, K7AYP	2013/1	51 - 60
Counterfeits	Andre Jamet, F9HX	2013/1	50
Updating the AX.25 network in Slovenia Radio transceivers for the new Non-Flawless Protocol Network	Majaz Vidmar, S53MV	2013/2	106 - 117
An interesting program: DOS programs (e.g. PUFF) on Windows 7	Gunthard Kraus, DG8GB	2013/2	102 - 105
The RTL-SDR Working with a USB stick	Dirk Muller, DB6FM	2013/2	82 - 89
Modern beacon design	Wolfgang Schneider DJ8ES	2013/2	66 - 72
Internet Treasure Trove	Gunthard Kraus, DG8GB	2013/2	125 - 126
An interesting program: Today PUFF 2.1 for Windows 7: now on DC	Gunthard Kraus, DG8GB	2013/3	136 - 147
The RTL-SDR Working with a USB stick. Part 2 continued from issue 2/2013	Dirk Muller, DB6FM	2013/3	163 - 173
Internet Treasure Trove	Gunthard Kraus, DG8GB	2013/3	190 - 191
A brief history of VHF Communications Magazine	Andy Barter, G8ATD	2013/4	194 - 200
Strong following wind for Sonnet Lite. A book review	Gunthard Kraus, DG8GB	2013/4	220 - 222
Shortwave & IF Modules			
VLF receiving with an Active Magnetic Antenna and PC sound card interface, part 2	Gunthard Kraus, DG8GB	2013/1	28 - 49
Internet Treasure Trove	Gunthard Kraus, DG8GB	2013/4	254 - 255

A complete index for VHF Communications Magazine from 1969 to 2013 is available on the VHF Communications Magazine web site - <http://www.vhfcomm.co.uk>. The index can be searched on line or downloaded in pdf of Excel format so that it can be printed or searched on your own PC. If you are not connected to The Internet you can write to K.M. publications for a printed copy of the index that will cost £2.50 plus postage.



## Why not keep your magazines tidy with the new style Blue Binder



VHF Communications Blue Binders have been available for many years. The supplier used for many years closed down so a new supplier was found to produce the binders at beginning of 2010. These binders are the same size as the previous version but have a number of new features:

- They still store your magazines safe and tidy. Each Blue Binder holds 12 magazines.
- The magazines are held in the binder using a wire clipped into slots at the top and bottom of the binder and positioned in the centre page of the magazine. This means that individual magazines can be added or removed easily.
- The new binders have the logo and name embossed on the spine.
- The new binders have three place markers embossed on the spine to take self adhesive date labels. A strip of date labels from 2009 to 2015 is supplied with each binder.

**See the advert on page 252 for the half  
price sale of Blue Binders**



## VHF Communications Back Issues Available

Year	Q1	Q2	Q3	Q4
2013	Y	Y	Y	Y
2012	Y	Y	Y	Y
2011	Y	Y	Y	Y
2010	Y	Y	Y	Y
2009	Y	Y	Y	Y
2008	Y	Y	Y	Y
2007	Y	Y	Y	Y
2006	Y	Y	Y	Y
2005	Y	Y	Y	Y
2004	Y	Y	Y	Y
2003	Y	Y	Y	Y
2002	Y	Y	Y	Y
2001	Y	Y	Y	Y
2000	Y	Y	Y	Y
1999	Y	Y	Y	P
1998	Y	Y	Y	Y
1997	Y	Y	P	Y
1996	Y	Y	Y	Y
1995	P	Y	Y	Y
1994	Y	Y	Y	Y
1993	Y	P	P	P
1992	Y	Y	Y	Y
1991	P	P	P	P
1990	P	P	P	P
1989	P	P	P	P
1988	P	P	P	P
1987	P	P	P	P
1986	P	Y	Y	Y
1985	Y	Y	Y	Y
1984	Y	Y	Y	Y
1983	P	P	Y	Y
1982	P	P	P	P
1981	P	L	P	P
1980	P	P	P	P
1979	P	P	P	P
1978	P	P	P	P
1977	P	P	P	P
1976	P	P	P	P
1975	P	P	P	P
1974	Y	P	P	P
1973	P	P	P	P
1972	P	P	P	P
1971	P	P	P	P
1970	P	P	P	P
1969	P	P	P	P

**Key:** Y = Available as "real" magazines P = Photocopy

- Single issues from 1969 to 2011, £1.00 each plus postage
- Single issues from 2013 volume, £5.70 each plus postage
- Complete 2013 volume, £19.60 plus postage
- Back issue DVDs available for the 70s, 80s and 90s magazines, £20.00 plus postage, see advert
- Back issue DVD for the 00s (2000 - 2009) magazines, £35.00 plus postage, see advert
- **Complete VHF Communications Magazine collection, £85.00 plus postage, see advert**

**K M Publications, 503 Northdown Road, Margate, Kent, CT9 3HD, UK.**

**Tel / Fax +44 (0)1843 220080**

**Web site <http://www.vhfcomm.co.uk>**



R. Lentz, DL3WR

# A Solid State Converter for 24cm

Reprint from the first issue of VHF Communications Magazine in 1969. It is interesting to see how technology has changed in 45 years.

**The following article has been written more extensively in order to discuss the problems encountered in conjunction with diode mixer and varactor diode multiplier stages. We hope that the article will be informative and also of interest to those readers who do not intend to build the converter or only wish to copy some particular portion of the design**

## 1.

### Introduction

The following 24cm converter is exclusively equipped with silicon semiconductors and can thus be operated from a 12V source. Since the total current drain is only 20mA, the converter can be run from the batteries of a transistorised portable transceiver. This and the fact that the unit only weighs 380g (13oz) makes the converter extremely attractive for field day and operation from mountain sites, where no AC line facilities are available or desired.

The mechanical assembly is extremely simple and requires no precision metal work. The carefully cut chassis plates can be soldered together on the work bench, after which it is merely necessary to drill a few holes and to commence assembly.

In spite of its simplicity, the transistorised 24cm converter is technically advanced, which is indicated by the measured noise figure of 9.5dB

The frequency range of 1296 - 1298MHz is converted to 28 to 30MHz with the aid of the 84.533MHz crystal. Slight variations from this frequency range are possible by use of a different crystal frequency. A conversion to a first IF of 144 to 146MHz is, however, not recommended because the low noise figure will not be achieved. Due to the design of the described converter - no RF stage, mixer diode with conversion loss and a sensitive preamplifier - the absolute sensitivity of the converter is essentially determined by the absolute sensitivity of the IF preamplifier. This can be calculated as follows:

$$NF_{tot} = NF_{mix} + \frac{NF_{IF} - 1}{PG_{mix}}$$

Whereby:

- $NF_{tot}$  is the total noise figure
- $NF_{mix}$  is the noise figure of the mixer diode
- $NF_{IF}$  is the noise figure of the IF preamplifier
- $PG_{mix}$  is the power amplification of the mixer stage

i.e. a conversion loss of 6dB means  $PG_{mix} = 0.25$

Thus a lower absolute sensitivity of the

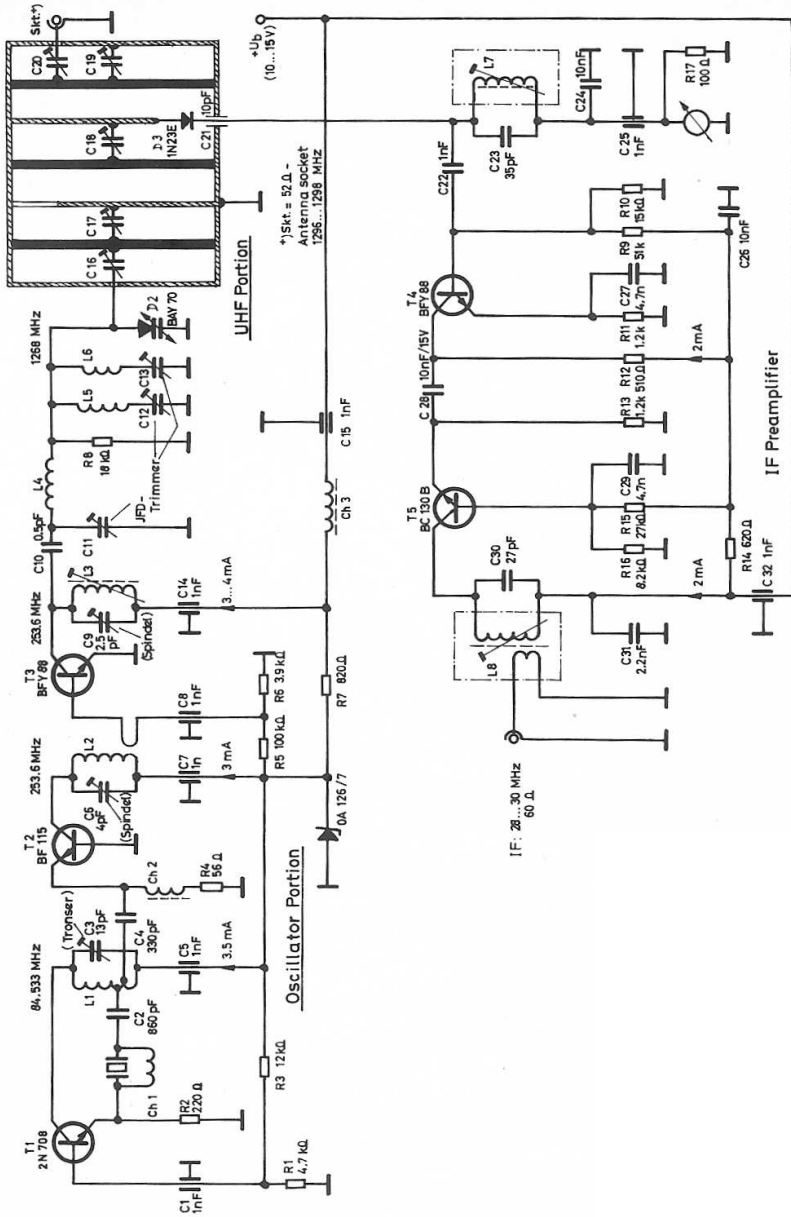


Fig 1: Circuit diagram of the DL3WR 24cm converter.



IF preamplifier obtained by using a higher first IF has the effect of increasing the total noise figure by multiplying itself with the conversion loss of the mixer diode:

The UHF portion of the converter, i.e. the three resonant line circuits and the mixer diode, is based on a circuit given in QST [1]. A similar design was also given in an article in UKW Berichte [2].

This UHF portion was modified by C. Sondhauss, DJ2LI for capacitive coupling, the provision of a varactor quintupler and otherwise equipped with tubes. Due to the low noise figure obtained with tubes in the 30MHz range, the absolute sensitivity was so great as to allow a total noise figure of 7.7dB.

Unfortunately the DJ2LI converter was never published but the UHF portion and the varactor quintupler have been taken over by the author in the described converter.

We would also like to mention the 24cm converter published in the Telefunken Taschenbuch [3] which possesses two grounded grid amplifier stages and a tubed mixer with the Telefunken tube 8255, an improved version of the EC88. The sensitivity of the IF amplifier (HF receiver) has practically no effect on the total noise figure with this rather extensive circuit and a first IF of, for instance, 145MHz could be used. The absolute sensitivity of the converter is 9.5dB.

---

## 2.

### Circuit Description (Fig 1)

---

#### 2.1. General details

The converter consists of three main sections: the oscillator portion, the UHF portion and the IF preamplifier. The oscillator portion commences with an overtone crystal oscillator at a frequency of 84.533MHz which is followed by a

tripler stage, multiplying the oscillator signal to 253.6MHz and a subsequent buffer amplifier stage. The amplified signal at a level of more than 10mW is then fed to a varactor quintupler, whose output signal of 1268MHz is decoupled via a resonant line transformer and passed to the mixer diode. The overtone crystal frequency is thus multiplied a total of 15 times.

The input frequency of 1296 - 1298MHz is capacitively coupled from the input connector to the input resonant line and is also inductively fed to the mixer diode.

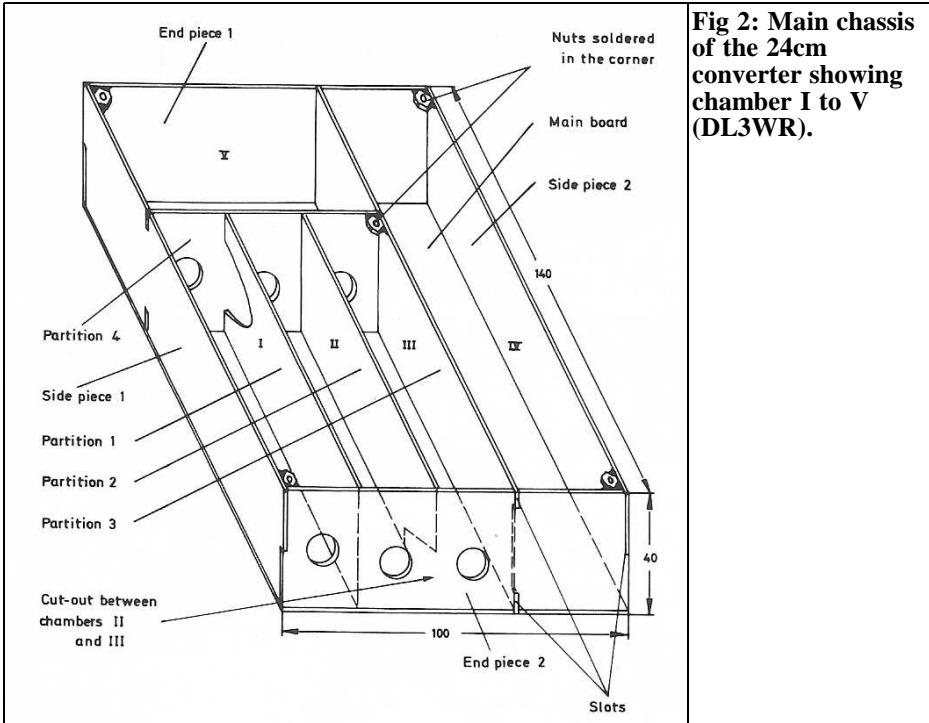
The intermediate frequency generated in the mixer stage is passed to a cascode preamplifier circuit. As is well known, it is necessary for the cascode circuit to have the first stage in a common emitter and the second stage in a common base configuration. No use has been made of selective links between the two stages (RC link).

#### 2.2. Circuit details

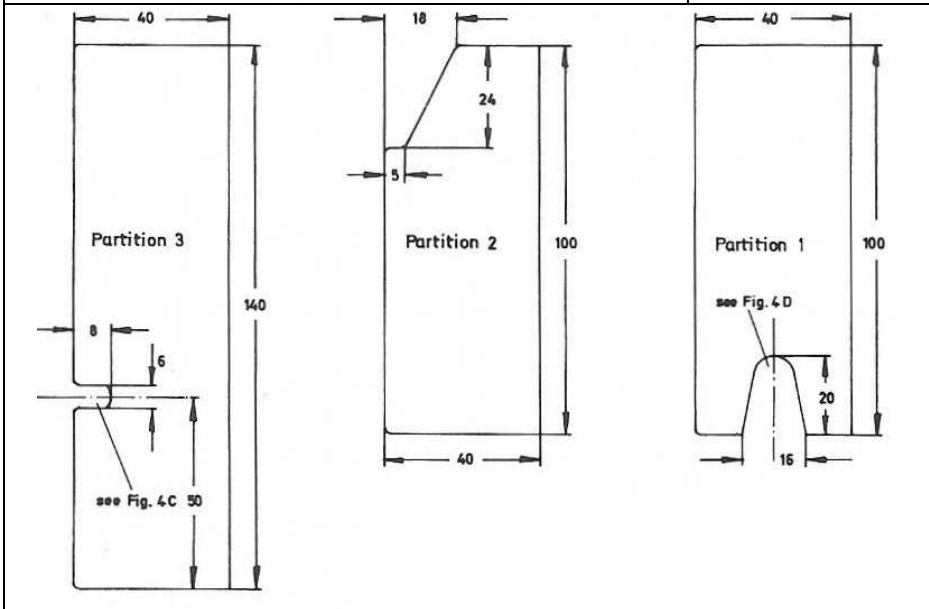
##### 2.2.1. Oscillator portion

The oscillator operates in a common base circuit and the crystal holder capacity is neutralised by choke Ch1. The coil tap on L1 for the feedback and coupling out of the signal is adjusted for the maximum drive to the tripler transistor (maximum collector current). L1 has not been provided with an alignment core in order to increase the frequency stability and the appropriate trimmer C3 is an air-spaced type. Transistor 2N708 (BSY19), 2N914 (BSY21), 2N918 or even the LF types such as BC108, BC130 etc. can be used in this stage.

A transistor BF115 in a common-base configuration is used in the tripler stage and operates in class C. A resistor in the emitter circuit compensates for slight variations of the operating point and drive conditions. This resistor also adjusts the angle of current flow to the most favourable value for the drive level (highest harmonic content).



**Fig 2: Main chassis of the 24cm converter showing chamber I to V (DL3WR).**



**Fig 3: Mechanical dimensions of partitions 1, 2 and 3 of the 24cm converter. Material given in Table 1.**





The oscillator and tripler are operated with a stabilised voltage, obtained by use of 7 volt Zener diode. This is extremely necessary for reasons of frequency stability and also ensures a constant drive to the subsequent buffer amplifier stage.

Only a transistor with a high transit frequency and a low retroaction can be used for the 253MHz amplifier stage and a BFY88, BFY90 or 2N3478 with a transit frequency of 900MHz and a retroaction of 0.23pF (due to integrated insular screening) was chosen by the author. This transistor may only be used in a common emitter configuration. The transistor is adjusted for class B operation via a voltage divider fed from the stabilised operation voltage so that the collector current just commences to flow under no-signal conditions. This adjustment results in the highest output power at low input levels. When matched to 60Ω, this stage will provide an output power of 12mW at 12V operating voltage which was sufficient to obtain a diode current of up to 2mA across the varactor quintupler of the described converter.

The quintupler is high-impedance fed via capacitor C10 and the matching is made with inductance L4 and trimmer capacitor C11. The idler circuit comprising L5 and C12 is aligned to the 2nd harmonic 507.2MHz and the idler circuit with L6 and C13 to the 3rd harmonic 760.8MHz. Tubular glass trimmers were used in the prototype converter which had the disadvantage of being somewhat expensive but other trimmer capacitors with the corresponding capacity values should be equally suitable.

A commercial varactor diode BAY79 manufactured by Telefunken, which was contained in a special holder, was used by the author. The junction capacitance is 5pF at a reverse voltage of 2V and the breakdown voltage is 35V. These specifications are also met with the currently available Telefunken diode BAY70, which should be connected using short leads between the junction of compo-

nts L4, L5, L6, R8 and C16 and ground (see Fig 5).

### 2.2.2. UHF portion (Fig 4)

The three coaxial circuits of the UHF portion are slightly shortened half-wave ( $\lambda/2$ ) circuits. The voltage lobe is thus in the centre of the lines where they can be capacitively shortened and tuned. The oscillator frequency is fed at a somewhat lower impedance to a point approximately half-way towards the cold-end where it is also capacitively coupled. The oscillator frequency transformer is coupled via the cut-out between the two resonant lines (see Fig 2 and 5). The mixer diode is also to be found in a similar cut-out in the partition between the input circuit and the secondary of the transformer. The thick end of the diode protrudes into the IF preamplifier compartment and is blocked for UHF frequencies by a homemade 10pF plate capacitor (see Fig 4) This excellent conception of the author of publication [1] has solved the critical coupling and mounting problems encountered with mixing diodes. The UHF portion was so easy to tune that no modifications have been made on the basic design.

Measurements carried out by C. Sondhaus, DJ2LI have shown that the diode series 1N23 offered no lower noise figure at 1.3GHz than 1N21 types. The author uses a 1N23E diode which is operated with a current of 0.8 to 1.2mA. This current is then indicated on a meter shunted for 2mA f.s.d.

### 2.2.3. IF preamplifier

The input of the IF preamplifier must be so dimensioned to allow both the mixer diode its optimum IF impedance of 300 to 500Ω and the most optimum source impedance of the input transistor, whereby the input impedance of the transistor acts as the terminating impedance for the diode and the impedance of the (current carrying) diode as the source impedance for the transistor. Since these impedance values lay in the same order of magni-

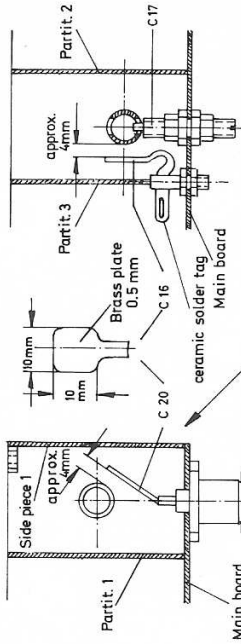


Fig. 4.c: Sectional View B-B C16 and C17 in UHF-Portion

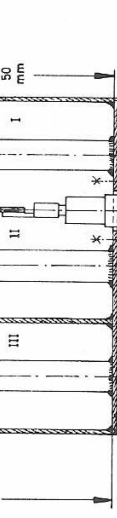
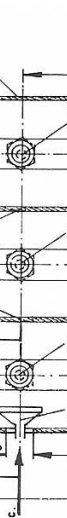
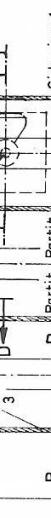
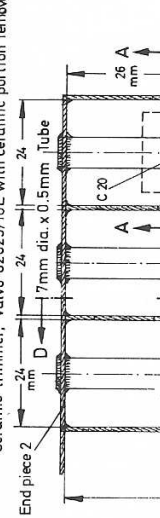
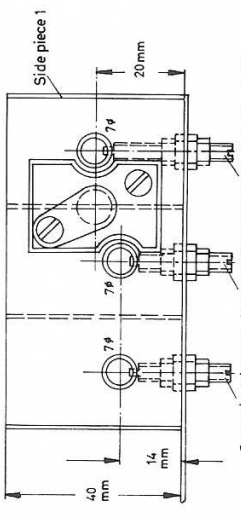
Fig. 4.b: Sectional View A-A Skt.1 and C20 in UHF-Portion

Fig. 4.e: Sectional View D-D Cut-out in Partit. 2

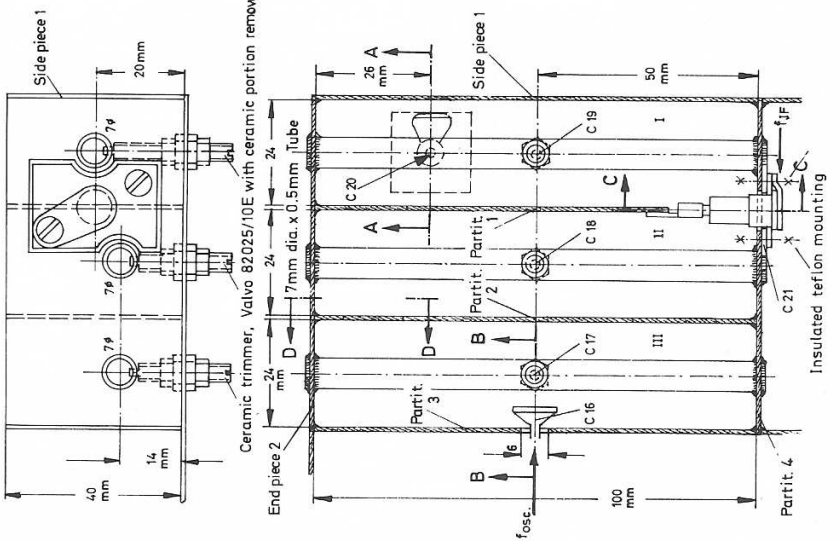
Fig. 4.d: Sectional View C-C Mounting of the Mixer Diode

Fig. 4.a: (left hand drawing) UHF Portion of the DL 3 WR 1296 MHz Converter (Chambers I, II and III)

4-699\*



4-699\*





ude, a transformation process was not used. It could, however, be possible that a more exact matching at this point would improve the absolute sensitivity.

The input circuit should possess a highest possible unloaded  $Q$  since all equivalent resistances at this point have an adverse effect on the noise figure. In extreme cases it may be advisable to form inductance  $L7$  in a different manner and to additionally isolate the base voltage divider from the critical high point of the first circuit with a RF choke.

The  $L/C$  ratio of the first IF stage has, in conjunction with the UHF blocking capacitor  $C21$  and the transistor input capacitance, been so chosen that the circuit is damped to a  $Q$  of 3 by the output impedance of the diode and the input impedance of the transistor. This corresponds to a band width of approximately 10MHz. The alignment is thus uncritical and it is only necessary to alter the tapping on inductance  $L8$  to modify the converter to receive wideband signals such as FM or amateur television transmissions.

In the case in question, the output circuit was aligned to a bandwidth of approximately 3MHz, which is valid for a termination of  $60\Omega$ . A greater bandwidth can be obtained by using a lower transformation ratio (more turns on the secondary).

The transistor BFY88, BFY90 or 2N3478 is also used in the input stage of the IF preamplifier where the major portion of the sensitivity is determined (see Section 2.2.1.). Transistors having a lower transit frequency such as BF173, BF224 and BF115 would also be suitable but with a slightly lower absolute sensitivity. Since silicon planar transistors such as BC130 or BC108 possess transit frequencies of approximately 250MHz, these types can be used in the less critical second stage of the cascode circuit. The large retroaction capacity does not have any adverse effect in this circuit.

### 3.

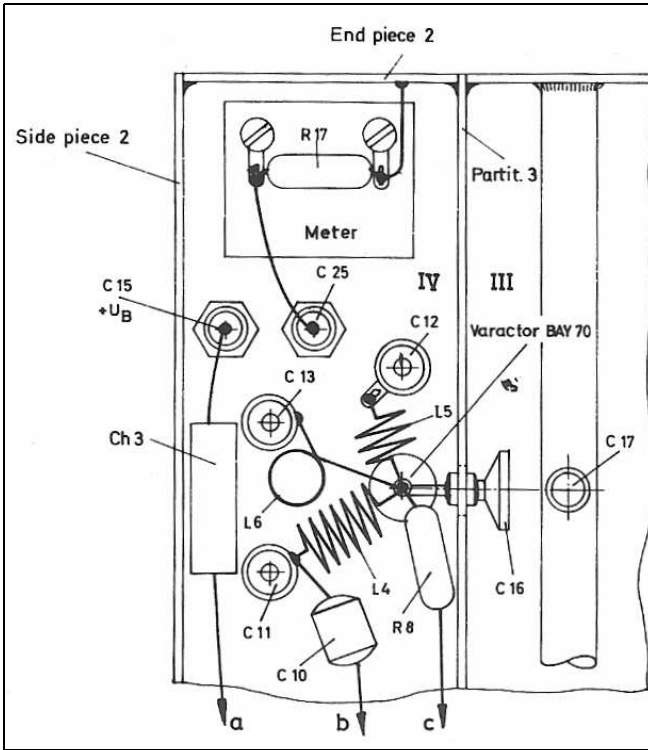
## Mechanical assembly (Fig 2 to 10)

### 3.1. Main chassis including UHF portion and varactor multiplier

The converter is built-up on a glass fibre reinforced 1.5mm epoxy board with a copper coating on both surfaces. This material can be easily processed at home and can be simply soldered with the aid of a small soldering iron. The exception to this assembly is the UHF portion whose wall pieces and partitions are made from brass plate and the inner conductors from brass tubing. This is to ensure that RF current at the ends of the inner conductors and around the cut-outs in the partitions 1, 2 and 3 can flow freely. The brass plate is 0.5mm thick.

Since it is impossible to use bent chassis portions when assembling on printed circuit boards, the already tailored metal pieces are soldered directly on to the non-drilled main board, which later forms the upper side of the converter. The walls are provided with slots to enable the assembly to be simplified and to give more support before soldering. Fig 2 shows the assembly of the main chassis, Fig 3 the mechanical dimensions of the partitions and Fig 4 the UHF portion of the converter with the corresponding mounting instructions. Table 1 contains all details regarding the casing pieces and mechanical accessories.

The assembly is commenced with the innermost partition 2 so that the maximum space is available for further soldering. After soldering the side, end and partition pieces to the main chassis, the UHF input socket Skt1 is soldered on the inside after having drilled the corresponding hole. It is also possible to screw the socket but care must be taken that a good ground contact is made inside the coaxial circuit. When using printed circuits



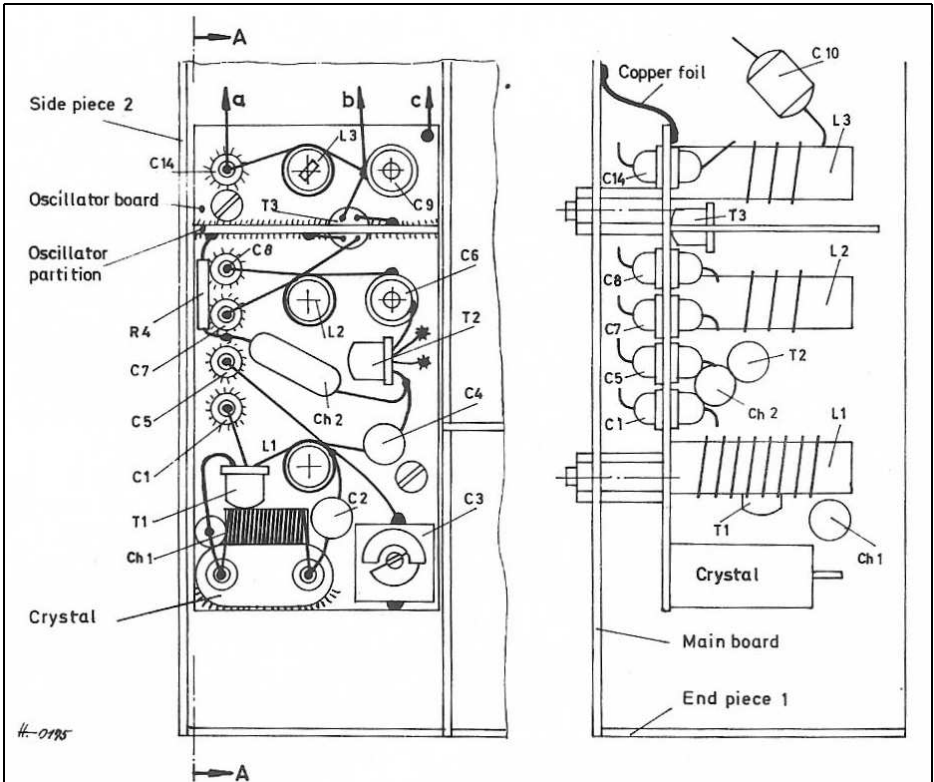
**Fig 5: Mechanical assembly of the varactor multiplier in chamber IV.**

coated on both surfaces it is important that the ground points are made on the correct side.

The next item to be mounted is the coupling flap C20 which is soldered to the inner conductor of the UHF input socket Skt1 (see Fig 4B). The three inner conductors, which have been drilled through with a 5mm hole are now placed into end piece 2 and partition 4 to find the hole position for the tuning trimmers which are located directly under the centre holes of the inner conductors. The three holes can now be drilled into the main board. It is now possible to mount the trimmer capacitors C17, C18 and C19 which are then soldered on the inside surface. The spindles of the trimmer capacitors are now removed, placed into the centre holes of the inner conductor and the spindles once again screwed in until they sit in the centre hole of the

inner conductors. The inner conductors are now adjusted so that the spindles are not touched and then soldered.

Following this, it is necessary to drill a hole in the main board for the ceramic soldering tag, on to which the coupling flap C16 is mounted (see Fig 4C). The solder tag receives the flap instead of the original tag and is installed into the converter. The holes are now drilled in the main board for the three trimmers of the varactor quintupler (see Fig 5), for the four feed-through capacitors and for the low-capacity IF feed-through (see Fig 8). The cut-out for the meter should also be prepared (see Fig 5). The contact spring of the mixer diode is now soldered into the cut-out in the first partition and the plate for capacitor C21 prepared for mounting. It is now possible for the converter chassis to be silver plated. In the prototype converter the cover and the



**Fig 6: Mechanical assembly of the oscillator portion in chamber IV. Sectional view A-A (see Table 1).**

sub-chassis were not silver plated

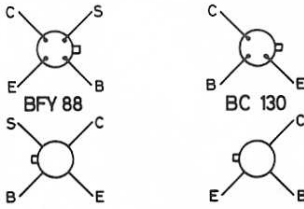
The solderable feed-through capacitors are now soldered to the inside of the converter and the IF feed-through pressed into place.

The varactor multiplier is mounted in chamber IV beside the coupling flap, in order to obtain the shortest possible connections to the resonant line transformer. The star point of the circuit is the hot end of the diode, there being no connecting leads. The three inductances are arranged in different directions in order to obtain a decoupling effect. The resistor R8 should be as low as possible and its value can be varied to establish the most optimum value. See Fig 5 for further details.

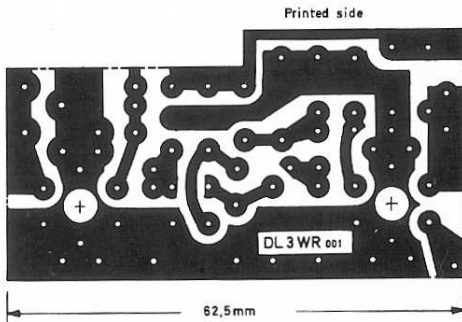
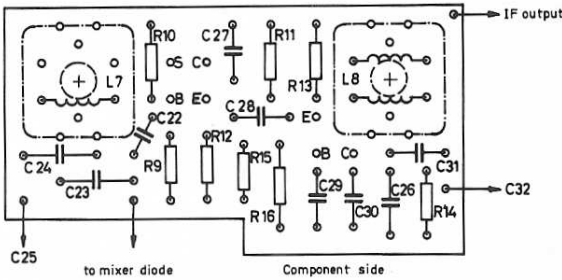
The oscillator portion, excluding quintupler, and the IF preamplifier represent individual sub-assemblies and are separately assembled, pre-aligned and thereafter mounted on to the main chassis.

### 3.2. Oscillator portion (Fig 6)

This separately assembled sub-assembly comprises the crystal oscillator, the tripler and the 253MHz buffer amplifier stage. It is built up on a small printed circuit board, which is copper coated on both surfaces (see Fig 6). A partition made from the same material, into which transistor T3 is mounted, separates the input and output of the 253MHz amplifier stage. Of course, brass plate could also be used for this sub assembly, and with enough experience, be modified into



**Fig 7: IF preamplifier of the DL3WR 24cm converter.**

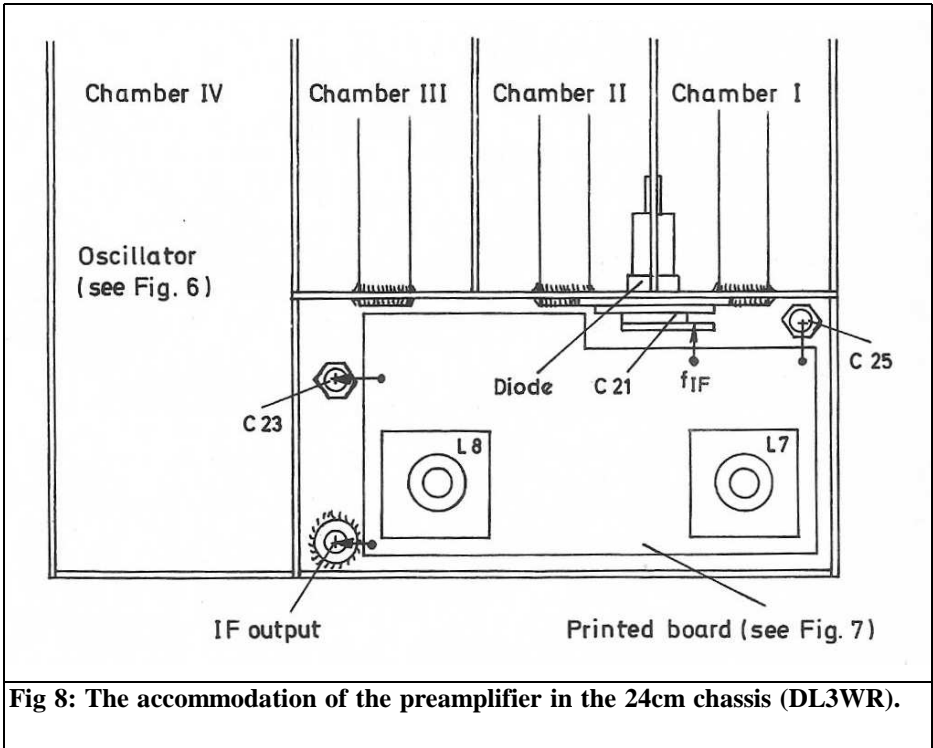


a printed circuit board.

The order of assembly for this sub-assembly is briefly described as follows: Saw the plate and screening piece to size, drill all the necessary holes, solder on the partition and then solder the feed-through capacitors into place. (The upper side of the printed circuit board is used as ground for all RF ground points). Solder two screws (approximately 15mm long) to suitable positions on the printed board and drill the corresponding holes into the converter chassis, where the oscillator board is later to be mounted with the aid spacing pieces. The crystal is now solde-

red to the mounting plate with the connecting wires facing upwards. A crystal holder was not used because the crystal need not be exchanged, and because contact difficulties should be avoided. The trimmer capacitors and the already wound coil formers are now mounted. The connection points of the crystal, feed-through capacitors and the trimmers offer enough possibilities for mounting the additional components, and for this reason the transistors have not been provided with sockets.

The neutralisation inductance Ch1 of the crystal is soldered directly on to the base



**Fig 8: The accommodation of the preamplifier in the 24cm chassis (DL3WR).**

of the crystal, which is accessible from above. The resistor R1, R3, R5, R6 and R7 as well as the Zener diode are all mounted under the chassis and connected to the lower ends of the feed-through capacitors.

The transistor T3 of the 253MHz amplifier stage is mounted with its connecting leads facing upwards in a cut-out in the oscillator partition (see Fig 6). The emitter and screening connections are soldered directly above the cut-out to ground. This ensures that the transistor is firmly held, that the base connection is on one side for the joining to the lowest be soldered on the other side to the trimmer C9.

After mounting the oscillator board into the converter chassis, a 5mm wide thin copper foil strip is soldered between the upper surface of the oscillator board (at the base of C9) to the converter chassis

(ground point of the varactor diode). The last feed-through capacitor of the oscillator portion C14 is connected to the external feed-through capacitor C15 located in front of the meter via a wideband choke. It is pressed into the corner so that the operation of the varactor diode is not disturbed (see Fig 5). Finally C10 is soldered between the high point of the 253MHz circuit and the first varactor trimmer C11.

### 3.3. IF preamplifier portion (Fig 7 and 8)

This sub-assembly is built up on a printed circuit board which is shorter than chamber V of the converter to enable enough room for the IF feed through and for the feed-through capacitor C32. The longest side has a 33mm by 5mm cut-out to allow enough room for the plate capacitor C2 with its two plastic screws



holding the mixer diode and for the feed-through capacitor C25.

The largest components on the printed circuit board are the two 15 by 15mm large and 26mm high aluminium screening cans of L7 and L8. The arrangement of the components and the printed conductor lanes is shown in Figs 7 and 8.

This sub-assembly is also mounted with two screws soldered to suitable positions and with spacing pieces to the main chassis. The mounting point is sufficient at this frequency for the ground connection and the only connections that are required after assembly is to the mixer diode, i.e. to the plate of capacitor C21, to C25, C32 and to the IF feed-through.

Finally the two feed-through capacitors for the diode current (C25 and another one not given in the circuit diagram which is to be found before the meter) would be connected to another. Capacitors C15 and C32 are also joined together.

A solder tag is fixed to a screw of the IF preamplifier and is used as a ground point. A coaxial cable is now connected to this point and to the IF feed-through. Finally a two core cable is connected to ground and capacitor C32.

The converter is now fitted with a cover made out of a single coated printed circuit board. The nuts soldered to the corners of the converter and to the corner of the compartment of the primary resonant line, are now used to hold the cover in place. The printed circuit is mounted with the conducting surface facing outwards and grounded only via the five screws. This is sufficient to avoid any detuning of the converter and thus ensuring that no outside influences affect the operation of the sensitive UHF circuits. If it is desired to make the converter "air-tight", this can be made with copper foil, a rubber padding and a solid iron cover or by sealing all surfaces in a professional manner.

### 3.4. Coil data

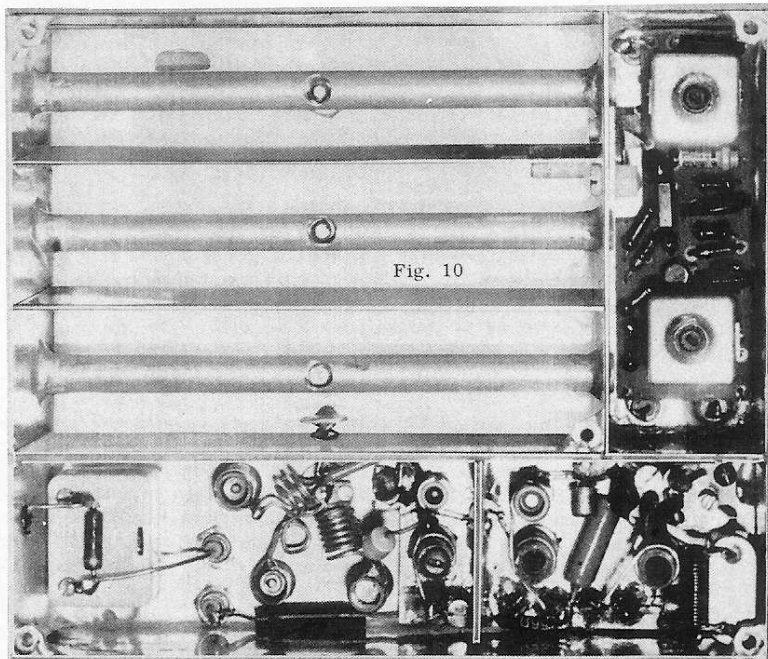
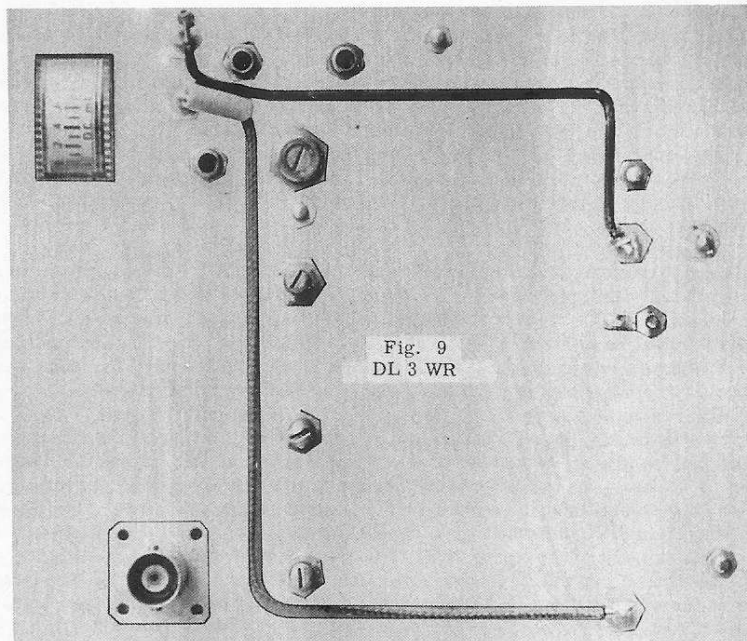
- L1 9 turns of 1mm dia. (18 AWG) silver plated copper wire on a 6mm former without core. Spacing between turns approximately 1mm. Feed-back and tapping point on the 2nd turn.
- L2 2 turns, wire and former as L1. Spacing between turns approximately 2.5mm. Decoupling winding 1 turn of 0.5mm dia. (24 AWG) enamelled copper wire.
- L3 3.5 turns, wire and former as L1 except with SW core. Spacing between turns 1mm.
- L4 6.5 turns of 1mm dia. (18 AWG) silver plated copper wire wound on a 6mm former, self-supporting and close wound.
- L5 3 turns of 1mm dia. (18 AWG) silver plated copper wire wound on a 6mm former, self-supporting with approximately 1mm spacing between turns.
- L6 1.5 turns of 1mm dia. (18 AWG) silver plated copper wire wound on a 6mm former, self-supporting.
- L7 0.5 $\mu$ H (approximately 10turns).
- L8 1 $\mu$ H (approximately 14turns) tapping approximately 3 turns.
- Ch1 18 turns of 0.5mm dia. (24 AWG) enamelled copper wire on a 4mm former, close wound, self supporting.
- Ch2, Ch3 50 $\mu$ H wideband choke, uncritical.

## 4.

### Alignment of the converter

The first alignment after adjusting the operating points of transistors T1 and T3 is the adjustment of the crystal oscillator. When not oscillating, a collector current of approximately 2mA will flow. A VHF







receiver de-tuned to 84MHz can be used for a coarse frequency check. Attention!! the 7th harmonic of the crystal (125.3MHz) is in the tuning range of trimmer capacitor C3. The oscillator should not oscillate at any other frequencies. If this is the case, the neutralisation coil should be changed if the oscillation is at the lower end of the tuning range the number of turns should be increased and vice-versa for oscillations at the higher end

The alignment is made with the tripler connected, which should pass approximately 3mA collector current after the alignment when coupled optimally to the 253MHz amplifier stage. The coupling to L1 and the value of R4 can be varied if necessary. The multiplier stage with transistor T2 is aligned for the maximum collector current of T3. T3 is finally carry out a power measurement, approximately 12mW should be measure at the third stage.

After installing the above sub-assembly it will be necessary to realign L3/C9, which will have been detuned by the quintupler. This is carried out with the aid of the absorption circuit and by adjusting the core of inductance L3 until resonance is found. During this alignment, the absorption circuit is taken further and further from the converter.

The two trimmers of the UHF resonant line transformer are now carefully aligned, whereby both trimmers should be equally turned (with the prototype converter of the author, the pistons of these two trimmers and that of the input circuit, protruded a little into the holes of the resonant lines). The task of this alignment is to find a position of the trimmers where a diode current of approximately 1 to 2 $\mu$ A flows. This is measured by disconnecting the built-in meter and by connecting a sensitive  $\mu$ A meter in its place. If the oscillator portion is correctly aligned, the unaligned quintupler will supply enough harmonic power to enable a noticeable small diode current.

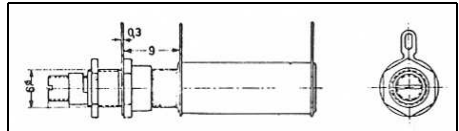
The next alignment is the adjustment of the quintupler, whereby the resonance of L3/C9 must always be corrected because it is effected by trimmer capacitor C11. The alignment of the quintupler is correct, if the diode current is at least 1mA and if no rapid variations of diode current are noticed on carefully rotating trimmers C11, C12 and C13. It is also necessary to readjust the coupling flaps of the primary circuit C16 and the UHF resonant line transformer during this alignment process. The ideal means of carrying out this alignment is with the aid of a spectrum analyser which can be simply connected to the input socket of the converter. However, a lecher line can be used to measure the wavelength of the voltages across the idler circuits and the UHF resonant line transformer. The correct wavelength is indicated by a dip in the diode current. The lecher line is either capacitive coupled with the open end or inductively coupled at the closed end. In the first case, the first dip found by varying the position of the short is at a  $\frac{1}{4}$  wave ( $\lambda/4$ ), whereas with inductive coupling it is at  $\frac{1}{2}$  wave ( $\lambda/4$ ).

The alignment of the UHF circuits is extremely critical but can be easily carried out with the aid of the M4 screw thread. If the required diode current is not achieved, the stabilised voltage of the oscillator and quintupler can be modified to 9 or 10V after the most optimum alignment of all stages has been completed. If on the other hand a too higher diode current is found, this can be corrected by shifting the operating point of the 253MHz amplifier transistor stage T3 towards class C operation (R5 can be removed in this case).

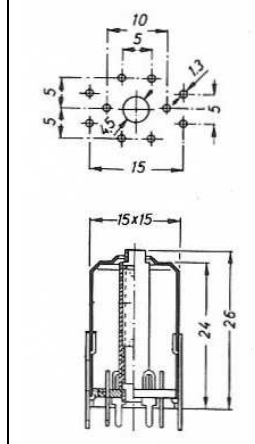
The alignment of the IF amplifier is limited to the checking of the operating points of T4 and T5 which should have a collector current of 2mA and checking for any instability (load input with 500 $\Omega$  and the output with 60 $\Omega$ ). After having correctly aligned the diode current, the IF preamplifier is aligned for maximum noise in the shortwave receiver (10



metres). The alignment of the output stage is clearly heard, whereas the alignment of the first stage of the preamplifier can just be seen on the S meter. The input circuit of the converter is coarsely tuned by aligning it to the oscillator frequency (dip on the meter) and by making 2 turns in an outwards direction. The resonance point will now be found near this point. The resonance point is found by connecting a correctly terminated antenna or terminating resistor and tuning for the maximum S meter reading (maximum noise). An exact noise alignment and noise matching can only be carried out with the aid of a noise generator (The coupling flap C20 is approximately 5mm from the inner conductor).



**Ceramic tubular trimmers.**



**Screening cans as used in the IF preamplifier.**

**Componets List (Fig 2)**

**Resistors**

R1	4.7kΩ	R6	3.9kΩ	R11,R13	1.2kΩ
R2	220kΩ	R7	820kΩ	R12	510kΩ
R3	12kΩ	R8	18kΩ	R14	620kΩ
R4	56kΩ	R9	51kΩ	R15	27kΩ
R5	100kΩ	R10	15kΩ	R16	8.2kΩ
				R17	100kΩ

All resistors rated at 0.25W.

**Capacitors**

C1, C5, C7, C8, C14, C15, C25, C32 0.001μF feed-through capacitor

C2	820pF ceramic capacitor (disc or tubular)
C3	13pF trimmer
C4	330pF ceramic capacitor
C6	4pF trimmer
C9	2.5pF ceramic capacitor
C10	0.6pF ceramic capacitor
C11	1 to 10pF glass tubular trimmer
C12	0.7 to 5pF glass tubular trimmer
C13	0.5 to 2pF glass tubular trimmer
C16,17,18,19	coupling flap see Fig 4A/4C
C20	coupling flap see Fig 3A/4B
C21	approximately 10pF see Fig 4A
C22	0.001μF
C23	35pF
C24,26,28	0.01μF ceramic capacitor disc or tubular
C27,29	0.047μF ceramic capacitor disc or tubular
C30	27pF ceramic capacitor disc or tubular
C31	0.022μF ceramic capacitor disc or tubular

**Semiconductors**

T1	2N708, 2N918
T2	BF115, 2N918
T3	BFY88, BFY90, 2N3478
T4	BFY88, BFY90, 2N3478
T5	BC130, BC108, 2N3398, SK3020
D1	Zener 7V P <sub>tot</sub> = 250mW
D2	Varactor: C <sub>j</sub> = 5pF at U <sub>r</sub> = 2V (see text)
D3	Mixer diode: IN21A..F or IN23 or Microwave Associates

**Other components**

1	Crystal 84.533MHz HC-6/U with soldering leads
1	Meter 1mA, resistance 100Ω
1	BNC socket UG-1094/U
1	Ceramic feed-through

**5.**

**Notes**

An examination of the pass-band curve and an amplification measurement could, unfortunately, not be carried out. Howe-

**Table 1: List of the required cabinet pieces including accessory parts. (see Figs 2 to 8).**

Amount	Fig	Designation, Material, Processing, Surface	Dimensions
1	1	Main board, glass-fibre reinforced epoxyd 1.5mm board with copper coating on both surfaces	140 x 110mm
1		Cover, glass-fibre reinforced epoxyd 1.5mm board with single copper coating	140 x 110mm
1	2	Side piece 1, glass-fibre reinforced epoxyd 1.5mm board with copper coating on both surfaces	140 x 40mm
1	2	Side piece 2, material and dimensions as for side piece 1 .	
1	1	Rear piece 1, glass-fibre reinforced epoxyd 1.5mm board with copper coating on both surfaces	110 x 40mm
1	4a	Rear piece 2, 1mm brass plate	110 x 40mm
1	3	Partition 1, 0.5mm brass plate	100 x 40mm
1	3	Partition 2, 0.5mm brass plate	100 x 40mm
1	3	Partition 3, glass-fibre reinforced epoxyd 1.5mm board with copper coating on both surfaces	140 x 40mm
1	4A	Partition 4, 0.5mm brass plate	75 x 40mm
1	4A, 4D	Capacitor board (C21), 1mm brass plate	27 x 17mm
1	4A, 4D	Foil (dielectric of C21), 0.2mm thick teflon	30 x 20mm
1	4A, 4D	M3 screws, 10mm long, nylon	
1	4A, 4D	Contact spring for mixer diode removed from an EL 34 tube socket (Octal)	
3	4A	Inner conductor, 7mm brass tube,	104mm long 0.5mm wall thickness
1	4A, 4B	Coupling flap for input 0.5 mm brass plate	
1	4A, 4C	Coupling flap for quintupler, 0.5mm brass plate	approximately 25 x 10mm
1	4C, 5	Ceramic solder tag, 8mm high	
6		Base board for the oscillator portion, glass-fibre reinforced epoxyd 1.5mm board with copper coating on both surfaces	70 x 30mm
1	6	Partition for oscillator portions, same material as the base board	30 x 25mm
1	7	IF preamplifier board, 1.5mm pertinax epoxyd board with single copper coating	62 x 24mm
1	4A, 4D	Leaf spring for mounting mixer diode	
4		M3 screws, 15mm long with nuts	
5		M3 screws, 8mm long, the nuts are soldered	



ver, no fall-off of the noise level can be noticed within the 2MHz bandwidth. The S meter indication of the noise level however indicates an amplification of approximately 26dB.

The author would like to thank the amateurs Claus Sondhaus, DJ2LI and Hans von Ellen, DJ1VO for their kind theoretical and practical assistance in the planning, assembly and alignment of this converter and for the 24cm QSOs in the vicinity of Ulm, Western Germany.

---

## 6.

### References

---

- [1] H.M. Meyer Jr.: A crystal-controlled 1296MHz Converter, QST 46 (1962), No. 11, pages 11 to 15.
- [2] D. Seidel: Ein Konverter für das 24cm Band, UKW-BERICHT 4 (1964), H 1, pages 18 to 24.
- [3] Die Röhre 8255 bei Frequenzen über 1GHz, TELEFUNKEN-Taschenbuch 1967, Technischer Anhang, pages 51 to 55.



*T Bittan, G3JVQ / DJ0BQ*

# Antenna Notebook

**A reprint of the first of a series of articles by the original publisher. This article appeared in issue 3/1973**

---

**Since articles on VHF/UHF antennas tend to be rather neglected nowadays it was thought that a regular series of antenna articles would be of interest.**

---

## 1.

### Circular Polarisation

---

The basic fundamentals of circular polarisation were given in [1] and [2]. This article aroused interest in this type of polarisation, also in commercial VHF communications and mobile radio circles. Recent measurements over a 200km path of rolling countryside has shown that the circular polarisation exhibited an additional gain of 12dB over the same antenna when switched to linear polarisation. The measured gain over this distance, and a distance of 275km have shown that the reduced path loss of circular polarisation using the author's homemade 10 element crossed Yagi provided a gain of 22 – 24dB over a vertical dipole. In the case of the 275km path, the other station was using linear (vertical) polarisation. Experience gained by DK4MV with a group of eight five element crossed Yagis has shown that circular polarisation does not show any special features for communication with linear polarised stations up to about 200km, after which a considerable improvement is noticeable,

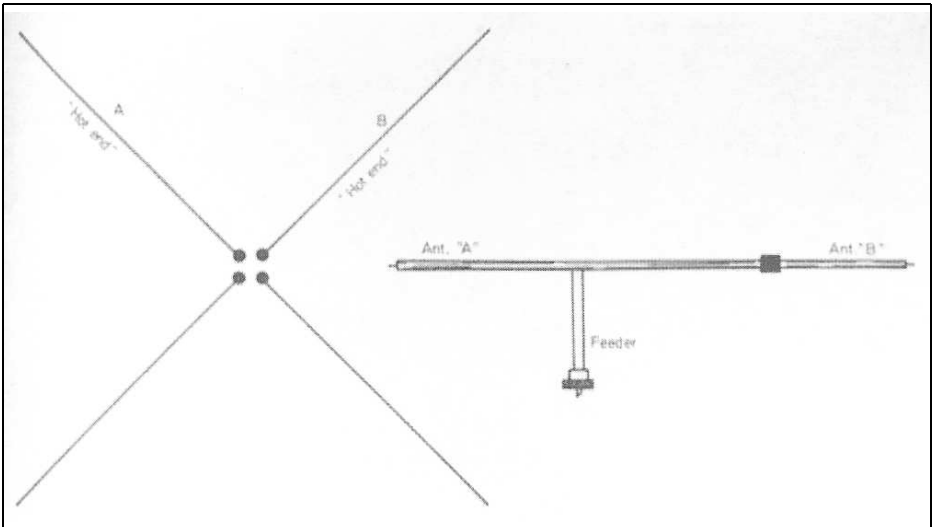
However, if the location of the station or partner is poor, the gain of circular polarisation over linear polarisation will be noticed immediately, even with local stations.

#### 1.1 Clockwise or anticlockwise?

For communications with linearly polarised stations, it is immaterial whether clockwise or anticlockwise polarisation is used. However, due to the growth of circular polarisation, and this trend will most certainly continue, it is important that a common standard polarisation is agreed.

Clockwise circular polarisation is usually used in commercial practice where an extra degree of isolation is not required between two systems. For this reason, the author would like to forward clockwise polarisation for amateur transmissions in the VHF, UHF and microwave bands. The designation clockwise or anticlockwise is the rotation direction as seen from behind the antenna looking in the direction of radiation. A crossed dipole, for instance, transmits clockwise circular polarisation in one direction and anticlockwise circular in the other. However, the direction of transmission is known in the case of a Yagi antenna.

The question is now how do we know whether we are transmitting clockwise or anticlockwise circular polarisation? This indeed is a problem that is not too easily

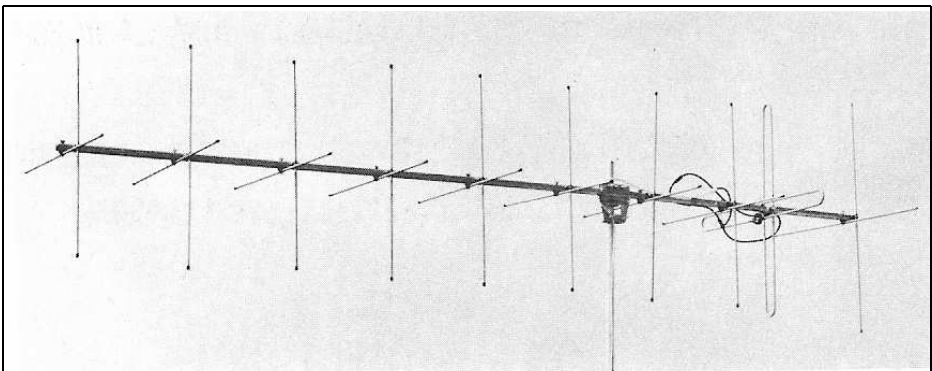


**Fig 1: Connection of a crossed Yagi to obtain clockwise circular polarisation.**

to explain. Anyway, let us assume a crossed dipole as seen from behind. The crossed dipole (or Yagi) should now be mounted so that the two “hot ends” (to which the inner conductor of the coaxial cable is connected) point upwards in the form of a “V” as shown in Fig 1. The asymmetrical phase line is now connected so that the shorter arm “A” is connected to dipole half “A” and the longer arm “B” to dipole half “B”. The resulting circular polarisation will be circular cloc-

kwise.

Of course, the same can be done in the shack if two equal lengths of coaxial cable are fed to the shack. In this case, it is possible to select either the vertical or horizontal antenna separately, or connect the phase line to both antennas to obtain circular polarisation. Since the author’s introductory article on circular polarisation appeared in [1], the manufacturers of the J-Beam MOONBOUNCER antenna



**Fig 2: Photograph of the J-Beam Moonbouncer.**

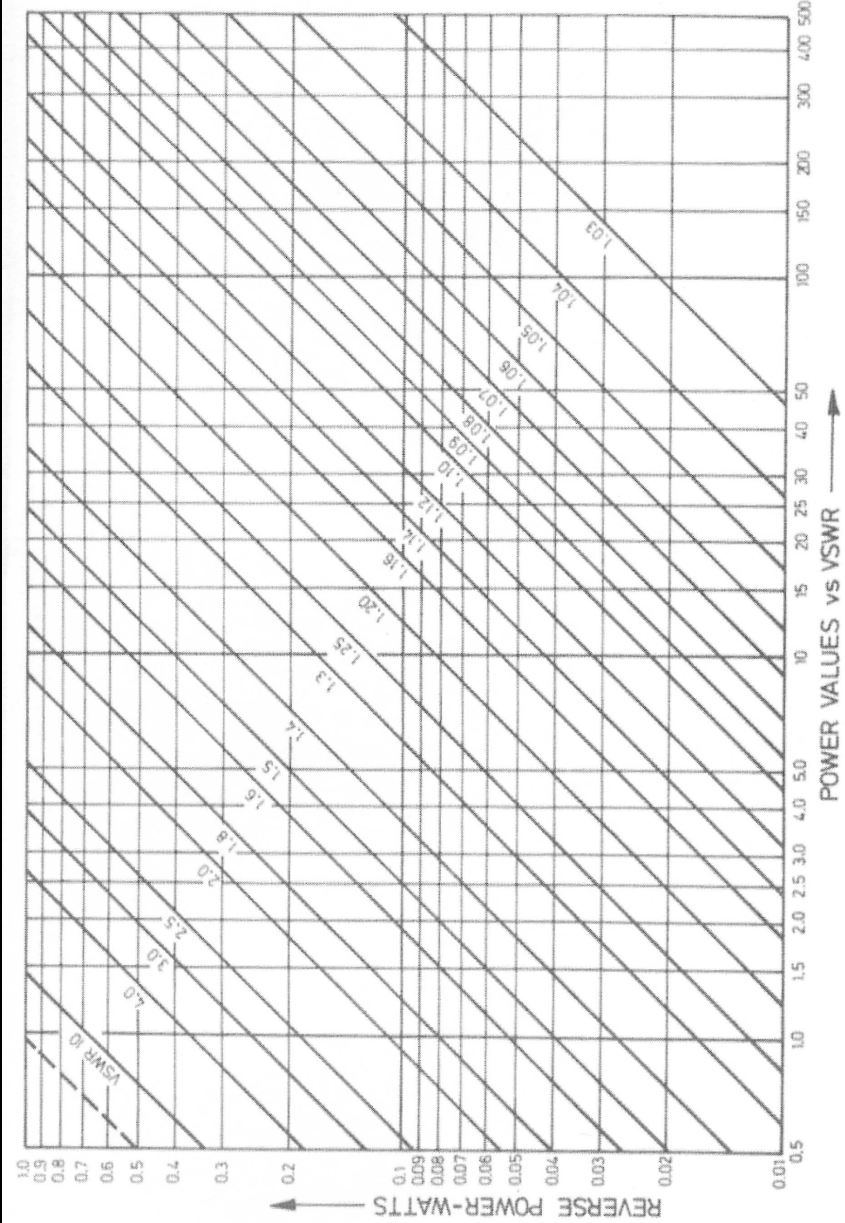


Fig 3: Power loss as a function of the VSWR.





have changed their range of crossed Yagis so that they are similar to the author's G3JVQ Twister as described in [1]. This means that the new range of antennas have the two dipoles of the crossed Yagi directly adjacent to another. Therefore the information given in this article is also valid for the new range of MOONBOUNCER antennas, which now comprise crossed Yagis of five, eight and ten elements. Of course, it is also valid for any other homemade antennas constructed similar to the "Twister".

If only circular polarisation is to be used, it will be advisable to mount the crossed Yagi so that the elements are mounted diagonally in the form of an "X". This ensures that the mast has the least effect. However, this will not be possible if the polarisation is to be switched.

Fig 2 shows a photograph of the new ten element crossed Yagi of the MOONBOUNCER series of J-Beam antennas which has now been reduced in length from 4.92 metres to 3.65 metres.

---

## 2.

### Power losses due to standing waves

---

Ever since reflectometers have become readily available to the amateur there has grown a completely exaggerated relationship between the standing wave ration and the performance of an antenna. The author knows of several amateurs who would return antennas to the manufacturer if the SWR was 2.1:1 instead of their minimum permissible 1.1:1. When it is considered how much output power is actually reflected by the antenna and when this is correlated to the output power, it will be seen that it will probably not be measurable at the receive end let alone be audible. This is also assuming that the power is actually lost, which is not true.

Let us assume the following with aid of Fig 3: Given are an output power of 5W, as well a "terrible" standing wave ratio of 2:1. It will be seen in Fig 3 that the reverse power is 0.5W so that the "lost" power is of this value and 4.5W will be radiated. It is know that the power must be doubled or halved to produce a power ratio of 3dB. In our case, the power ration is 1.11 for a 2:1 standing wave which is in the order of 0.5dB loss. The power loss for a SWR of 1.5:1 is only 0.17dB. This means that standing wave ratios of less than 1.5:1 are completely satisfactory.

The above information is, of course, based on the SWR at the antenna and not that measured in the shack at the end of a long feeder [3]. The author does not wish to underestimate the importance of low standing wave ration, but wishes them to be seen in their correct perspective.

---

## 3.

### References

---

- [1] T Bittan: Circular Polarisation on 2 Metres, VHF Communications 5 (1973), Edition 2, Pages 104 – 109
- [2] Dr A Hock: Theory, Advantages and Type of antenna for circular polarisation at UHF, VHF Communications 5 (1973), Edition 2, Pages 110 – 115
- [3] J Strum: Standing Wave Ratio and cable attenuation, VHF Communications 3 (1971), Edition 2, Pages 85 - 88



## Result of the 2013 article writing competition

This competition was announced in issue 4/2012 as one way to stimulate new articles for the magazine. It was sponsored by Franco Rota, the Italian agent for the magazine.

The response has been very disappointing with only three articles submitted to the competition. The articles were:

- ATV Transverter for conversion of the 23cm band to the 3cm band by Michael Klerkx, PA0MKX
- A useful coax latching relay control circuit by Marty Singer, K7AYP
- A vector measurement system for the X band (8 - 12GHz) based on an automatic slotted waveguide by Massimo Donelli

The number of articles submitted was disappointing. The voting response has been even more disappointing. No votes have been received so Franco Rota has been asked to adjudicate the result of the competition.

The result is:

- Franco has decided because there were only three entries the fairest solution is to split the total prize between all three entrants. The total prize is €25 worth of components from R F Elettronica so each of the three competition entrants can claim €75 worth of components.

The winners have been contacted with detail of how to claim their prize.



# DUBUS Magazine

*for Techniques and DX on VHF/UHF/SHF*

DUBUS is an A5 sized magazine, published quarterly, now in it's 42<sup>nd</sup> year of publication. Each issue of about 130 pages contains technical articles for bands from 6m to light-wave, with the focus on 144 MHz to 24 GHz.

In addition, articles about propagation and reports about DX-QSOs are also published.

In the past few years the following authors contributed articles:

**AD6IW, CT1DMK, DB6NT, DC0DA, DD8BD, DF5AI, DG7YBN, DJ5HG, DK7ZB, DL2AM, F1JRD, F5FLN, G0KSC, G0MRF, G3WDG, G4DDK, GM3SEK, GW4DGU, HA8ET, IW2ACD, I3OPW, K1JT, KE4PT, KF2YN, KH6/K6MIO, LZ1AG, OM6AA, ON4KHG, RW3BP, S57UUU, SM5BSZ, VK2ZRH, VK3OE, VK3XDK, VK6APH, VK7MO, W1GHZ, WA2ODO, W2PED, WA6KBL, YU7EF, YU7XL, and many others.**

We invite you to download a free sample copy (issue 4/2012, PDF, 16 MB) from:

[www.bit.ly/14tWuOf](http://www.bit.ly/14tWuOf)

Currently DUBUS has subscribers from over 50 countries and as this is the final issue of VHF Communications Magazine, I hope you might like to subscribe to DUBUS Magazine in 2014. 73 de Joe, CT1HZE / DL8HCZ (Publisher)

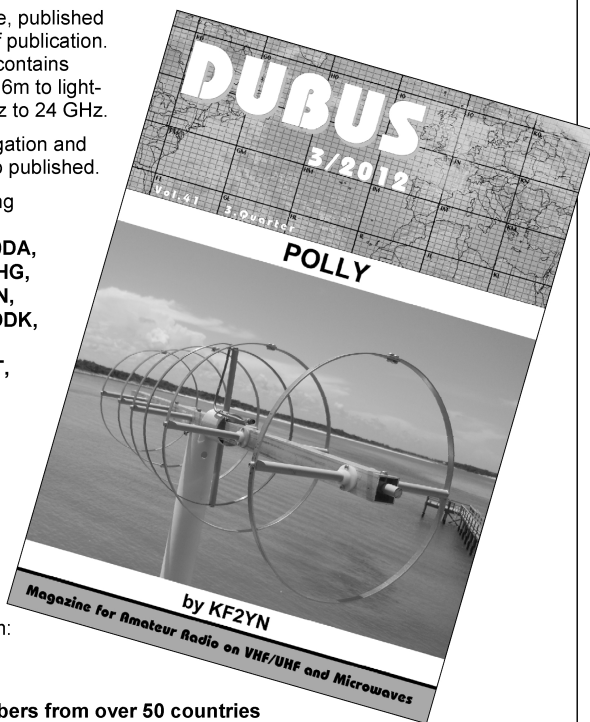
More information about the magazine, content, and subscription details are on

**[www.DUBUS.org](http://www.DUBUS.org)**

Subscription rate for any country from Europe is 25 € (or 22 GBP) per year.

Subscription rate for any country outside Europe is 30 € (or 40 USD) per year (airmail).

Orders please to: [DUBUS@t-online.de](mailto:DUBUS@t-online.de) or  
 DUBUS, Gruetzmuehlenweg 23, D-22339 Hamburg, Germany  
 Payments via bank transfer to  
 Verlag Joachim Kraft, IBAN DE92200100200207354201, BIC PBNKDEFF  
 oder via PAYPAL (in €) to: [funktelegramm@t-online.de](mailto:funktelegramm@t-online.de)





## Amateur Television Quarterly

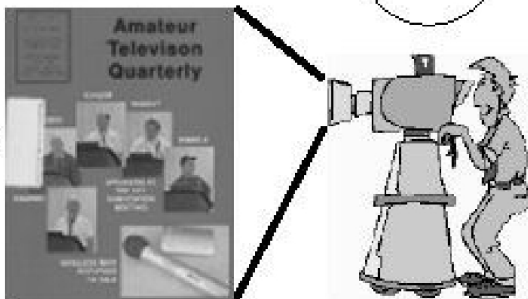
Great articles on :

ATV  
BALLOONING  
ATV PROJECTS  
Antenna Design for ATV  
SSTV  
ATV ACTIVITIES  
Digital ATV  
ATV On The internet  
WorldWide ATV Coverage

USA \$20.00 year  
Canada \$22.00 year  
DX \$29.00 year (US \$)

Don't miss another issue.  
Subscribe Today!

VISA  
M/C  
AMEX



Write or check webpage TODAY for more information!

Mike Collis, P.O. Box 1594, Crestline, CA 92325

<http://atvquarterly.com>



## The UK Six Metre Group

[www.uksmg.com](http://www.uksmg.com)

With over 700 members world-wide, the **UK Six Metre Group** is the world's largest organisation devoted to 50MHz. The ambition of the group, through the medium of its 56-page quarterly newsletter 'Six News' and through its web site [www.uksmg.com](http://www.uksmg.com), is to provide the best information available on all aspects of the band: including DX news and reports, beacon news, propagation & technical articles, six-metre equipment reviews, DXpedition news and technical articles.

Why not join the UKSMG and give us a try? For more information contact the secretary: Dave Toombs, G8FXM, 1 Chalgrove, Halifax Way, Welwyn Garden City AL7 2QJ, UK or visit the website.



Welcome to CQ-DATV Magazine  
CQ-DATV is free eBook format publication focused on ATV, but lots of the constructional projects have Amateur Radio applications. There is no membership, logins, or email required.

***www.cq-datv.mobi***

**CQ-DATV**   
*Issue 6* dot.MOBI  
**Out Now**



British Amateur Television Club

Supporting the ATV community  
worldwide

-  Live video streaming portal
-  Online members shop
-  Award winning CQ-TV magazine
-  Members on-line forum
-  Visit [www.batc.org.uk](http://www.batc.org.uk)





## End of Magazine Sale of Blue Binders



A few Blue binders are still in stock at the time that issue 4/2013 was published. These are being offered at half price, so if you need more binders order them now because when they are gone, they are gone forever.

This means that the binders are £3.25 each. Postage for single binders are:

UK - £2.20, Surface mail - £3.25, Airmail to Europe - £3.40, Airmail outside Europe - £5.10

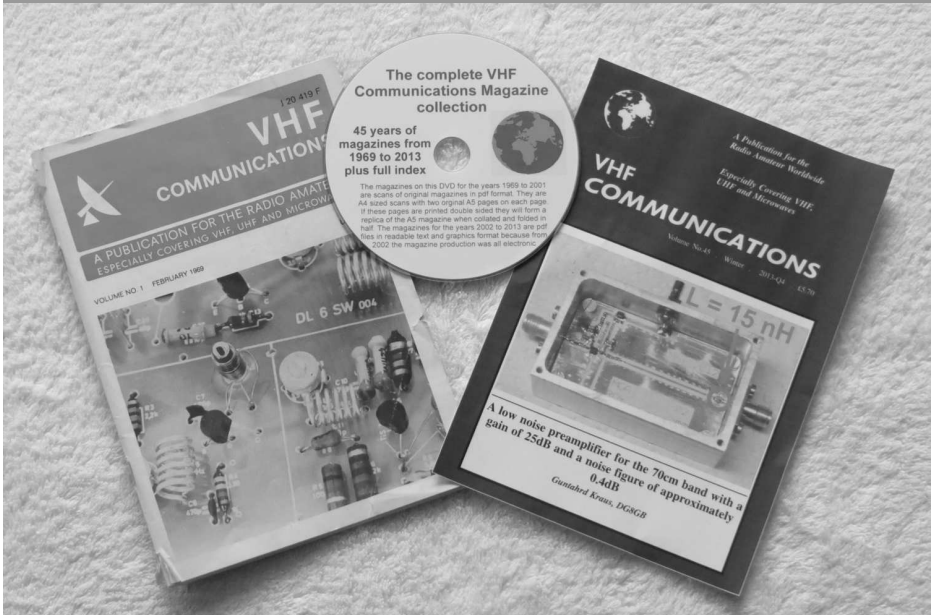
If you want more than one binder the postage will be more than these prices, please email - [andy@vhfcomm.co.uk](mailto:andy@vhfcomm.co.uk) - for an accurate postage price before placing an order. Orders received for multiple binders but insufficient postage will not be honoured.

Orders can be sent with full payment to the PayPal account - [vhfcomms@aol.com](mailto:vhfcomms@aol.com) - or by sending a cheque in UK pounds made payable to K M Publications to:

K M Publications, 503 Northdown Road, Margate, Kent, CT9 3HD, UK



# The Complete VHF Communications Magazine collection



VHF Communications Magazine is closing after 45 years of continuous publication. This DVD contains all of the magazines published - 180 magazines - so it is a valuable source of information. For those subscribers who have collected the magazines over the years this is a convenient way to fill any gaps in your collection and takes up much less space than the full 180 magazines.

The magazines on this DVD for the years 1969 to 2001 are scans of original magazines in pdf format. They are A4 sized scans with two original A5 pages on each page. If these pages are printed double sided they will form a replica of the A5 magazine when collated and folded in half. The magazines for the years 2002 to 2013 are pdf files in readable text and graphics format because from 2002 the magazine production was all electronic. A full index for the magazines is also on the DVD as a pdf document.

The DVD is £85.00 plus postage. Those people who have already purchased the Bumper DVD that contains magazine up to 2009 can purchase an upgrade to the full Complete collection for £2.00 plus postage (proof of original purchase will be required).

Postage prices are: UK - £0.50, Surface mail - £2.20, Airmail to Europe - £2.70, Airmail outside Europe - £3.30.

Orders can be sent with full payment to the PayPal account - [vhfcomms@aol.com](mailto:vhfcomms@aol.com) - or by sending a cheque in UK pounds made payable to K M Publications to:

K M Publications, 503 Northdown Road, Margate, Kent, CT9 3HD, UK



*Gunthard Kraus, DG8GB*

# Internet Treasure Trove

---

## Microwave antenna design calculator download

---

This calculator from Q-par has been around for a long while but it has been updated for the new operating systems and technical development. It is a fine thing!

Address: <http://www.q-par.com/capabilities/software/microwave-antenna-design-calculator>

To help with operation there is a short tutorial available from this link:

Address: <http://www.q-par.com/capabilities/software/microwave-antenna-calc-instructions>

---

## Wideband antennas - a historical perspective

---

This is from the same company as the previous item but a different topic. It is interesting to see how everything developed and where it might go. Not only interesting for specialists.

Address: <http://www.q-par.com/corporate/marketing/wideband-antennas-an-historical-perspective-article.pdf/view>

---

## Antenna theory

---

Here you'll find not just one but many pages in an online tutorial. Very nicely done and really an extensive "toolbox".

Address:  
<http://www.antenna-theory.com/>

---

## Historical Varian ads

---

For a change, something to relax and entertain after some stressful electronics. You will find a series of light hearted old advertisements each consisting of a full page cartoon. Each page depicts the former company Varian is involved in an historic event like "Waterloo", "The Trojan horse" or "Attila", etc.

Really great - you have to look, just scroll down the page to find the links ( you can download the small collection as a PDF file)

Address:  
[http://www.microwaves101.com/encyclopedia/history\\_varian\\_ads.cfm](http://www.microwaves101.com/encyclopedia/history_varian_ads.cfm)





---

## Advanced Microwave circuits and systems

---

A great thing: textbooks are often rewritten for the Internet and available to download for non-commercial use. A good example of this is this English language work on Microwave circuits and systems.

It is worth browsing; for the developer, it is beautiful. Individual pages/graphs can be printed out for future use.

Address: <http://www.intechopen.com/books/advanced-microwave-circuits-and-systems>

---

## Technical articles / Orban microwaves

---

This company has updated its range of interesting technical articles. (A note: the most cited article about Patch antenna basics comes from here). A quick check of the homepage will give a surprise.

Address:  
<http://www.orbanmicrowave.com/technical-articles>

---

## Radio Electronics.com

---

This sentence is the introduction to this website and it says it all: "Resources and Analysis for Electronics Engineers". And that's true, because you can dig here for hours, download and read.

Address:  
<http://www.radio-electronics.com/>

---

---

## Remcom

---

This company has an emphasis on a wide range of information on the Internet. The only recommendation: please go to the link under "Applications" as well as under "Resources" to have a look.

Address: <http://www.remcom.com/>

---

## A transformer based 1.8GHz low IF receiver for 1V in 0.13 $\mu$ m CMOS

---

This is a look at what can be fitted on a chip these days and what some developers can produce. You never stop learning...

Address:  
[http://www.chipmuenk.de/papers/2006-RFIC-Hermann-Transformer\\_based\\_receiver-Paper.pdf](http://www.chipmuenk.de/papers/2006-RFIC-Hermann-Transformer_based_receiver-Paper.pdf)

---

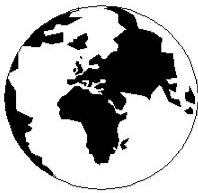
## Low cost Horn antennas for 23cm EME

---

This is a really interesting article about the construction of such a horn antenna with many pictures and details of the construction as well as detailed measurement results. Even if you do not want to make this antenna it is worth studying.

Address: [http://erewhon.superkuh.com/library/Electromagnetics/Low-Cost%20Horn%20Antennas%20for%2023-cm%20EME\\_%20Full\\_%20Thomas%20Henderson%20WD5AGO\\_%202011.pdf](http://erewhon.superkuh.com/library/Electromagnetics/Low-Cost%20Horn%20Antennas%20for%2023-cm%20EME_%20Full_%20Thomas%20Henderson%20WD5AGO_%202011.pdf)

---



# VHF COMMUNICATIONS

*A Publication for the Radio Amateur Worldwide*

*Especially Covering VHF, UHF and Microwaves*

Volume No.45

Winter

Edition 2013-Q4

**Publishers**

KM PUBLICATIONS,  
503 Northdown Road, Margate,  
Kent, CT9 3HD, United Kingdom

Tel: +44 (0) 1843 220080  
Fax: +44 (0) 1843 220080

Email:  
andy@vhfcomm.co.uk

**Editor**

Andy Barter G8ATD

**VHF  
COMMUNICATIONS**

The international edition of the German publication UKW-Berichte is a quarterly amateur radio magazine, especially catering for the VHF/UHF/SHF technology. It is owned and published in the United Kingdom in Spring, Summer, Autumn and Winter by KM PUBLICATIONS.

The 2013 subscription price is £22.80, or national equivalent. Individual copies are available at £5.70, or national equivalent each. Subscriptions should be addressed to the national representative shown in the next column. Orders for individual copies of the magazine, back issues, kits, binders, or any other enquiries should be addressed directly to the publishers.

**NOTICE:** No guarantee is given that the circuits, plans and PCB designs published are free of intellectual property rights. Commercial supply of these designs without the agreement of the Author and Publisher is not allowed. Users should also take notice of all relevant laws and regulations when designing, constructing and operating radio devices.

© KM  
PUBLICATIONS

All rights reserved. Reprints, translations, or extracts only with the written approval of the publishers

Translated by Andy Barter, G8ATD with the assistance of Bing

Printed in the United Kingdom by: Printwize, 9 Stepfield, Witham, Essex, CM8 3BN, UK.

AUSTRALIA - Mark Spooner c/o, W.I.A. SA/NT Division, GPO Box 1234, Adelaide, SA 5001, Australia Tel/Fax 08 8261 1998

BELGIUM - UKW-BERICHTE, POB 80, D-91081 BAIERSDORF, Germany. Tel: 09133 7798-0. Fax: 09133 779833. Email: info@ukwberichte.com Web: www.ukwberichte.com

DENMARK - KM PUBLICATIONS, 503 Northdown Road, Margate, Kent, CT9 3HD, UK. Tel: +44 1843 220080. Fax: +44 1843 220080. Email: andy@vhfcomm.co.uk

FRANCE - Christiane Michel F5SM, Les Pilets, 89240 PARLY, France  
Tel: (33) 03 86 44 06 91, email christiane.michel.s5m@orange.fr

FINLAND - KM PUBLICATIONS, 503 Northdown Road, Margate, Kent, CT9 3HD, UK. Tel: +44 1843 220080. Fax: +44 1843 220080. Email: andy@vhfcomm.co.uk

GERMANY - UKW-BERICHTE, POB 80, D-91081 BAIERSDORF, Germany. Tel: 09133 7798-0. Fax: 09133 779833. Email: info@ukwberichte.com Web: www.ukwberichte.com

GREECE - KM PUBLICATIONS, 503 Northdown Road, Margate, Kent, CT9 3HD, UK. Tel: +44 1843 220080. Fax: +44 1843 220080. Email: andy@vhfcomm.co.uk

HOLLAND - KM PUBLICATIONS, 503 Northdown Road, Margate, Kent, CT9 3HD, UK. Tel: +44 1843 220080. Fax: +44 1843 220080. Email: andy@vhfcomm.co.uk

ITALY - R.F. Elettronica di Rota Franco, Via Dante 5 - 20030 Senago, MI, Italy. Fax 0299 48 92 76 Tel. 02 99 48 75 15  
Email: info@rfmicrowave.it Web: www.rfmicrowave.it

NEW ZEALAND - KM PUBLICATIONS, 503 Northdown Road, Margate, Kent, CT9 3HD, UK. Tel: +44 1843 220080. Fax: +44 1843 220080. Email: andy@vhfcomm.co.uk

NORWAY - WAVELINE AB, Box 60224, S-216 09 MALMÖ, Sweden. Tel: +46 705 164266; GSM: 0705 16 42 66, email info@waveline.se

SOUTH AFRICA - KM PUBLICATIONS, 503 Northdown Road, Margate, Kent, CT9 3HD, UK. Tel: +44 1843 220080. Fax: +44 1843 220080. Email: andy@vhfcomm.co.uk

SPAIN & PORTUGAL - KM PUBLICATIONS, 503 Northdown Road, Margate, Kent, CT9 3HD, UK. Tel: +44 1843 220080. Fax: +44 1843 220080. Email: andy@vhfcomm.co.uk

SWEDEN - WAVELINE AB, Box 60224, S-216 09 MALMÖ, Sweden. Tel: +46 705 164266; GSM: 0705 16 42 66, email info@waveline.se

SWITZERLAND - KM PUBLICATIONS, 503 Northdown Road, Margate, Kent, CT9 3HD, UK. Tel: +44 1843 220080. Fax: +44 1843 220080. Email: andy@vhfcomm.co.uk

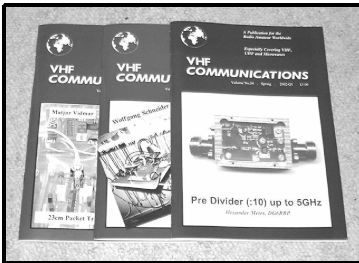
UNITED KINGDOM - KM PUBLICATIONS, 503 Northdown Road, Margate, Kent, CT9 3HD, UK. Tel: +44 1843 220080. Fax: +44 1843 220080. Email: andy@vhfcomm.co.uk

U.S.A. - ATVQ Magazine, Mike Collis, WA6SVT, P.O. Box 1594, Crestline, CA, 92325, USA,  
Tel: (909) 338-6887, email: wa6svt@atvquarterly.com

ELSEWHERE - KM PUBLICATIONS, address as for the U.K.

**Web: <http://www.vhfcomm.co.uk>**

**ISSN 0177-7505**



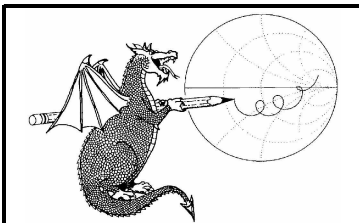
## Back Issues

Available either as photocopies or actual magazines. Issues from 1/1969 to 4/2011 are £1.00 each + postage. Issues from 2012 are £5.40 each or £19.60 for all 4 issues + postage. See web site or page 34 of issue 1/2013 for back issue list. The complete VHF Communications Magazine collection is available on a data DVD, see the advert on page 253.



## Blue Binders

A new style binder was introduced in 2010 with an embossed spine. These binders hold 12 issues (3 years) and keep your library of VHF Communications neat and tidy. You will be able to find the issue that you want easily. Binders are £6.50 each + postage. (UK £2.20, Surface mail £3.25, Air mail to Europe £3.40, Air mail outside Europe £5.10).



## PUFF Version 2.1 Microwave CAD Software

This software is used by many authors of articles in VHF Communications. It is supplied on 3.5 inch floppy disc or CD with a full English handbook. PUFF is £20.00 + postage. (UK £2.20, Surface mail £2.90, Air mail to Europe £3.20, Air mail outside Europe £4.50)



## Compilation CDs

Two CDs containing compilations of VHF Communications magazine articles are available. CD-1 contains 21 articles on measuring techniques published in the past few years. CD-2 contains 32 articles on transmitters, receivers, amplifiers and ancillaries published over the past few years. The articles are in pdf format.

Each CD is £10.00 + postage. (UK £0.50, Surface mail £2.20, Air mail to Europe £2.70, Air mail outside Europe £3.30)



## VHF Communications Web Site [www.vhfcomm.co.uk](http://www.vhfcomm.co.uk)

Visit the web site for more information on previous articles. There is a full index from 1969 to the present issue, it can be searched on line or downloaded to your own PC to search at your leisure. If you want to purchase back issues, kits or PUFF there is a secure order form or full details of how to contact us. The web site also contains a very useful list of site links, and downloads of some previous articles and supporting information.

**K M Publications, 503 Northdown Road, Margate, Kent, CT9 3HD, UK**  
**Tel / Fax +44 (0) 1843 220080, Email: [andy@vhfcomm.co.uk](mailto:andy@vhfcomm.co.uk)**



## HF, RF and microwave electronic components

Over 4000 items always ready in stock  
shipped all over the world

[www.rf-microwave.com](http://www.rf-microwave.com)

**DIODES:** Schottky, varicap, PIN, zero bias.

**MIXER:** balanced, active and passive.

**TRANSISTOR:** IF, RF, power.

**GaAs-FET:** low noise, power.

**IC:** wide band MMIC amplifiers,  
logarithmic amplifiers, IF demodulators  
for AM-SSB-FM receivers.

**PLL and prescaler** for synthesizer.

**Regulators, RF power modules.**

**CONNECTORS:** SMA, N, BNC and others

**CABLES:** teflon, semirigid, handyform.

**CAPACITORS and INDUCTORS.**

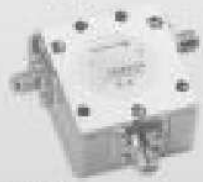
**FERRITE CORES:** wide availability of  
toroids, binoculars, beads, rods, AMIDON.

**FILTERS:** IF, helical, saw, gigafil.

**Terminations, attenuators, circulators,  
switches, power splitters, VCOs,  
metallic boxes, RF transformers.**



Visit  
the **SURPLUS** section  
to find many  
special offers  
at affordable prices



**ROGERS**  
CORPORATION

Multiplier and step-recovery diodes.  
Power PIN diodes up to 1KW.  
Noise diodes and noise sources.  
Microwave prescaler dividers.  
12Ω and 25Ω cables for matching of  
power FET, 35Ω cables for power  
splitters and Wilkinson combiners.  
ATC100 high Q RF power capacitors.  
Teflon laminates, ROGERS, RO4003.  
Dielectric and puck resonators.  
DC blocks, RF-microwave absorbers.  
Fingers, Gigatrimmers, beam-lead.



Amidon



Special and hard to find  
RF components



RF elettronica di Rota Franco - Via Dante, 5 - 20030 Senago (MI) - ITALY

Tel: +39 (0)2 99487515 Fax: +39 (0)2 99489276 E-mail: [info@rfmicrowave.it](mailto:info@rfmicrowave.it) Web: [www.rf-microwave.com](http://www.rf-microwave.com)