



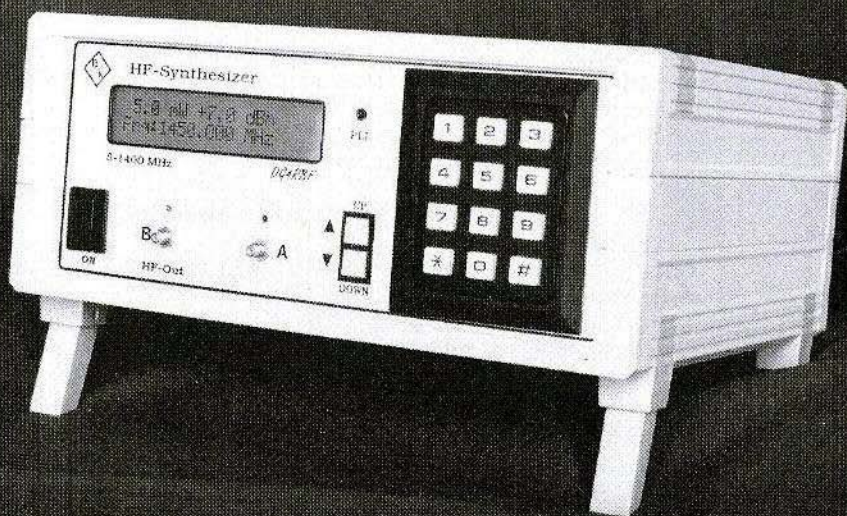
*A Publication for the  
Radio Amateur Worldwide*

*Especially Covering VHF,  
UHF and Microwaves*

# VHF COMMUNICATIONS

Volume No.30 . Autumn . 1998-Q3 . £4.75

Bernd Kaa  
DG4RBF



HF Synthesiser 5 to 1450 MHz

# BOOKS FOR ENGINEERS AND SERIOUS AMATEURS

## MICROWAVE FIELD-EFFECT TRANSISTORS

### Microwave Field-Effect Transistors

By Raymond S. Pengelly

703 pages of data on GaAs FET devices and circuits! Basic information on fabrication, packaging and performance is followed by circuit design data on amplifiers, oscillators, switches, multipliers, mixers, phase shifters and other functions. The most complete book for design using GaAs FETs. **Order NP-8 \$89.00**

## Transceiver System Design for Digital Communications

### Transceiver System Design for Digital Communications

By Scott R. Bullock

A thorough summary of radio system design for digital communications. Draws on developments driven by military systems, but presents them as fundamental information essential for commercial wireless communications system development. 432 pages. **Order NP-7 \$54.00**

## Transmission Line Transformers

### Transmission Line Transformers

By Jerry Sevick, W2FMI

Professionals and amateurs alike can use this unique resource, a modern classic that answers the questions, "How do they work?" and "How do I build them?" Guanella and Ruthroff configurations are described, with performance verified by hundreds of measurements on balanced, unbalanced and balun types. The best book ever on this subject! **Order NP-9 \$34.00**

## OSCILLATOR DESIGN AND COMPUTER SIMULATION

### Oscillator Design and Computer Simulation

By Randall W. Rhea

Understand oscillator design and operation! This book presents a unified approach to design, using a wide variety of active elements and resonator types — bipolar transistors, FETs or MMICs with crystal, L-C, SAW, coaxial, microstrip or other resonators. Strong coverage of basic concepts with many design CAD models and circuit examples. **Order NP-1 \$64.00**

## HF FILTER DESIGN AND COMPUTER SIMULATION

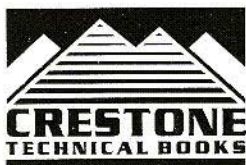
### HF Filter Design and Computer Simulation

By Randall W. Rhea

Filters for the practicing engineer who actually *builds* filters! Includes lumped element, coaxial, helical, dielectric resonator, stripline and microstrip types. Thorough review of filter principles with practical information on topologies, transformations, component effects and matching. Especially good for the design and realization of microstrip filters. **Order NP-2 \$59.00**

**Order by telephone, fax, mail or our Web site!**

We accept payment by VISA, MasterCard and American Express or check drawn on a U.S. bank. Shipping charges are — U.S.: \$5.00 for the first item, \$1.00 for each additional item; Canada: \$10.00 first item, \$2.00 each additional item; Other countries (Air express): \$32.00 first item, \$10.00 each additional item.



**CRESTONE TECHNICAL BOOKS**

Div. of Noble Publishing Corporation

2245 Dillard Street • Tucker, GA 30084 • USA

Tel: (770) 908-2320 • Fax: (770) 939-0157

www.noblepub.com



---

# Contents

---

Leif Asbrink SM5BSZ	Computer-Assisted Design of High-Gain Yagi Aerials	130 - 145
Henk Medenblik B.Sc. PE1JOK	A State-of-the-Art 13cm Amateur Television Transmitter; Part-2	146 - 158
Bernd Kaa DG4RBF	HF Synthesiser 5 to 1450 MHz Part-2 (conclusion)	159 - 181
Carl G. Lodström SM6MOM	Measurements on Ceramic Resonators	182 - 186

---

*Owing to lack of space part-6 of Gunthard Kraus's article 'Design and Realisation of Microwave Circuits' will be held over until issue 4/98 ... Mike*



**KM Publications**, 5 Ware Orchard, Barby, Rugby, CV23 8UF, UK

Telephone: (0)1788 890365; INT: +44 1788 890365; FAX: (0)1788 891883

Email: [michael.j@vhfcomm.co.uk](mailto:michael.j@vhfcomm.co.uk)

WWW: <http://www.vhfcomm.co.uk>



Leif Asbrink, SM5BSZ

# Computer-Assisted Design of High-Gain Yagi Aerials

For some time now many radio amateurs have had the option available of designing antennas with the aid of computers as a standard application.

Computer programs with automatic optimisation can also be obtained, and are frequently used by radio amateurs. However, designing the optimum antennas for a special application is still anything but simple

---

## 1. INTRODUCTION

---

Unfortunately, the optimisation programs available at present have a problem - they are not convergent. The optimum antenna which the computer finally discovers depends on which antenna has been pre-set as the initial antenna. A more convergent method is set out in this article. This method is even fully convergent if used on long Yagis or groups of long Yagis.

Naturally, it depends on the intended application which antenna is optimum. Thus, normally, the best transmission

antenna is the one which supplies maximum radiation in a specific direction. It is thus the antenna with maximum gain. However, in many cases the optimum transmission antenna is the one which permits the greatest possible output in various directions, without generating BCI or TVI.

A very good signal / noise ratio (S/N) is desirable at the receiver. The signal, S, is proportional to the gain, but it often makes more sense to reduce the noise, N, instead of increasing S. The noise can be thermal, due to ohmic losses, or can stem from side lobes which indicate noise sources.

The method which is set out here can be used to find the optimum antenna for many different situations.

Since the early sixties, I have had a preference for the 2m band. In the country, where there is practically no interference fog generated by people, this band is something special: the ground, the sky and the antenna have the same temperature, while the noise temperature of the receiver is considerably lower. The optimum antenna here for



both reception and transmission operation is the one with maximum gain.

The antenna which provides maximum gain for the given number of elements is certainly of more than theoretical interest, it is the practical solution to my problem: how can we assemble a competitive EME station, in spite of restrictions on antenna size?

---

## 2. THE YAGI MODEL

---

In 1967, Roger F.Harrington published an article with the title: "Matrix Methods for Field Problems" [1]. A few years later, computer programs based on Harrington's methods came on the market. I use such a program, compiled by D.C.Kuo and B.J.Strait [2].

This program is very widely used and can operate with arbitrarily bent wires. The speed suffers, of course, and the inputs required are rather complicated. However, the program already constitutes a more efficient version of earlier programs [3, 4].

To simplify matters and save time on calculation, I have modified the program to the extent that all it will accept are geometric configurations which stem from groups of Yagi antennas.

I know of no other geometrical configuration which can hold its own with the excellent performance data from this class of antennas. Although the article which follows deals exclusively with Yagi antennas, the principles can natu-

rally be transferred to other types of antenna. But no further reference will be made to this.

The model functions in the following way. All those elements which make up the complete antenna system are conceptually broken down into a series of short sub-sections or segments which are connected to one another. It is assumed that the current in each element runs linearly from one end to the other. This leads to delta functions for the current, which means a common impedance matrix can be calculated:

With this matrix it is possible to calculate the current in each segment if a voltage is applied in the middle of the radiator. The currents can then be used to calculate the impedance of the feeding point, the radiated field patterns and the ohmic losses.

James L.Lawson, W2PV [5], has published a simplified method. Since only one element per segment is specified, this method is very fast. Although it is not explicitly stated, it is assumed that the current distribution is the same on all elements. So the impedances can be taken from tables. If the computer-assisted development of antennas is still not clear, it would make sense to read the article by W2PV first.

---

## 3. CALIBRATION OF MODEL

---

If the program from Kuo and Strait is used to calculate the model, the result obviously depends on the number of functions which are specified per ele-

Number of Functions	Gain (dBd)	Impedance (Ohms Re, Im)		Number of Functions	Gain (dBd)	Impedance (Ohms Re, Im)	
3	9.500	31.914	-29.833	3	9.500	31.914	-29.833
5	10.687	22.834	-16.526	5	10.687	22.834	-16.526
7	11.272	15.946	-4.913	7	11.272	15.946	-4.913
9	11.486	12.770	3.575	9	11.486	12.770	3.575
11	11.491	11.243	9.669	11	11.491	11.243	9.669
13	11.390	10.461	14.212	13	11.390	10.461	14.212

**Table 1:**  
Gain and Impedance of Chen and Cheng 6-Element Yagi, Calculated with 3 to 13 Triangular Expansion Functions for the Current on each Element. All segments of one Element were made equal.

**Table 2:**  
The Specifications correspond to those for Table 1, but the Element Lengths were first multiplied by a Correction Factor prior to Computer Modelling.

ment. This can be illustrated using a very critical antenna configuration, the optimised 6-element Yagi from Chen and Cheng [6] (Table 1).

On the basis of Table 1, it appears that about 21 functions would be needed for each element to obtain an acceptable level of accuracy. Even with a Pentium processor, it would take far too long to do the calculations for an EME aerial of medium size in this way. The error which arises because not enough functions are included can be compensated for by corrections to the element lengths. After prolonged experiments, the following correction factor was established:

$$1 + \frac{0,766}{(M+1)(M+2)} - \frac{R}{\lambda} \cdot [3,744 - \frac{6,24}{\sqrt{M}}]$$

M is the number of functions for the current on each element, and  $R/\lambda$  the element radius in wavelengths. If all element lengths are multiplied by the

correction factor before any further calculations using the Kuo and Strait program, we obtain the results shown in Table 2.

Table 2 shows that the error which arises because too few functions are specified can be eliminated by means of a simple correction factor. Since all elements are of approximately the same length, a corrector summand would give similar results. But the use of a correction factor seems more appropriate, since the effect of there being too few segments per element for shorter elements is less significant when the segments are smaller as well.

A further correction is required for Yagi antennas. This necessary correction has been empirically determined [7]. It states that all theoretically determined element lengths are too long by one and the same amount of the element thickness. My explanation for this "final effect correction" is that the theory of it is based on the fact that the current at



the tips of the elements is precisely zero - although this is not quite true.

A small current flows from the cylindrical area of the element onto the flat end surface of the element, and then into the air, through a very small capacity at the tip of the element against infinity. The elements of the model must thus be slightly shortened to compensate.

As an initial estimate, it was assumed that the section of the element to be removed must have approximately the same area - and thus the same capacity against infinity - as the flat end of the element.

There are certainly other bases for an empirical correction of the element length. Thus approximations are used in the calculation method which could cause errors which are eliminated again using these corrections. The decisive point is the high correlation between the model and the experimentally determined radiated field patterns and impedance values, even for long Yagi antennas with a very high Q, if the corresponding corrections are carried out.

---

#### 4.

### OPTIMISING GAIN

---

Normally, VHF amateurs would compare an optimised-gain Yagi with a Yagi with a specific boom length which has more gain than all other Yagis with the same boom, or with a shorter boom.

This task can be replaced if we pose a significantly simpler problem - for a given element diameter, we have to find a Yagi with N elements which gives

more gain than all other designs.

The model is used to calculate the gain, to do which the element lengths and the positions of the initial antenna are altered until no further improvement can be made. Various calculation methods are used here which are available for defining this problem, and it emerges from this in the end that the antenna finally obtained depends on the antenna originally pre-selected.

Thus, for example, it is assumed in [8] that the reason for this lies in the fact that the gain "hypersurface" has many maxima, and that it is thus impossible to determine whether a specific maximum is the best possible.

I have another opinion on this - the reason for the difficulties is simply that the gain "hypersurface" is too flat for the extremely small rise in the gradient to the global maximum to be determined using the methods previously used.

It is true that the antenna with maximum gain can also be determined using traditional methods, with sufficient computational accuracy and adequate computing time; but to be satisfied with a gain increase of 0.1dB per iteration step [8] would surely not be enough.

In computer programs, the gain is normally calculated by means of numerical integration of the radiated fields pattern. The integral supplies the mean value for the power density radiated in all directions.

The directive efficiency is then the power density in the forward direction divided by the mean power density.

The gain is finally obtained as the

efficiency multiplied by the directive efficiency.

The efficiency,  $\eta$ , is the power radiated, divided by the sum of the power radiated and the thermal output caused by ohmic losses.

The key to a convergent optimisation method is thus to work on the radiated field pattern, instead of considering only the gain.

The optimisation program uses the antenna calculation package as a sub-program, CALC.

The inputs required for CALC are as follows:

- N = Number of elements
- D = Element diam. (the same for all)
- $P_1$  = Length of first element
- $P_2$  = Length of second element
- $P_{N+1}$  = Co-ordinates of 2nd element
- $P_{N+2}$  = Co-ordinates of 3rd element
- $P_{2N-1}$  = Co-ordinates of Nth element
- K = Number of identical Yagis which are stacked

$X_j, Y_j$  is the stacking configuration of Yagis for all  $j$ 's between 1 and K.

The result obtained using CALC is a radiated field pattern in steps of, for example,  $2^\circ$ . The radiated field pattern can be a two-dimensional configuration of  $90 \times 180$  elements, which consists of 16,200 complex numbers. Each number stands for an electrical field strength in a specific direction.

Now, to obtain the gain all these numbers must be squared, weighted and added up, which gives us the power density. The power density in the forward direction is then divided by this value, and the result is multiplied by the

efficiency.

These calculations naturally take time, but a lot of time can be saved here by another sequence of operations.

The radiated field pattern for a Yagi group can be very closely approximated as the radiated field pattern of a half-wave dipole, multiplied by the H-diagram of the Yagi, and further multiplied by the radiated field pattern which would be obtained for the corresponding stocking of isotropic radiators.

For the optimisation procedure, this means that the CALC sub-routine very often has to be run with other parameters for  $P_i$  in each case. Alterations to  $P$  relate to the H-diagram of the Yagi alone. Everything else essentially need be calculated only once, and stored as a weighting factor,  $W_k$ .

In the H-diagram, HK is a configuration of, for example, 90 complex values for 0 to 180 in 2-degree steps. The formula for the gain then gives us:

$$G = \eta \cdot H_0^2 / (\sum W_k \cdot H_k^2) \quad (1)$$

summed from 0 to  $180^\circ$ .

Re-formulated:

$$G = 1 / \sum B_k^2 \quad (2)$$

with

$$B_k = \frac{H_k}{H_0} \cdot \sqrt{\frac{W_k}{\eta}} \quad (3)$$

The problem is now different, in that we are no longer looking for the maximum gain but for the least square sum for the squares of the numbers in array B.





The CALC sub-routine has been suitably re-written to give B as the result, with P as the initial parameter. All other parameters are kept constant.

This now gives us a well-known problem - the non-linear "least squares method", according to which B has to be approximated to 0.

If you read about this in mathematics textbooks, you will soon discover that this method has a bad reputation. You probably can find a minimum, but as a rule you can not be sure that no better minimum exists. But this is precisely the problem for which the procedures for Yagi optimisation have become well-known!

Of course, the least squares method is a special case for Yagi antennas. In my experience, it will provide only a few minima, irrespective of the original design from which we begin. You simply seek out these minima and then select the best.

---

## 5. THE NON-LINEAR LEAST SQUARES PROBLEM

---

If you are not interested in mathematical relationships, you can simply skip this section. A comparison of various methods was published by the US Department of Industry National Physical Laboratory [9]. Corresponding Fortran programs are available in the NPL Algorithm Library.

The method with which I work is very linear. I do not know how it comes off

in comparison with other methods in relation to the speed of processing and its ability to find a minimum for a poorly defined problem, but I start from the assumption that my method is not especially good.

The least squares method looks like this:

Find a point  $x^1$ , which minimises  $F(x)$ :

$$F(x) = \sum_{i=1}^m |f_i(x)|^2$$

where  $x$  is an array with the dimension  $n$  and  $m > n$ .

$X$  describes the antenna and is the parameter  $P$ , which contains the data for element lengths and positions. For the  $N$ -element Yagi problem,  $n = 2N - 1$ .

$F(x) = 1/\text{gain}$ ,

Minimum  $F(x)$  means maximum gain.

$f_i(x)$  is  $B$  as in formula (2), the standardised electrical Fraunhofer region multiplied by a weighting function. The real sections and imaginary sections of  $B$  correspond to different values of  $i$ . If we calculate  $B$  in  $2^\circ$  steps from  $1$  to  $179^\circ$ , we obtain 89 complex values corresponding to  $i = 1$  to 178.

If  $x$  is altered at any time by only one element value,  $x_k$ , calculating  $F(x)$  anew gives us the corresponding change in the  $m$  point of the Fraunhofer region.

This route is inefficient but simple, and leads to  $J(x)$ , the  $(m \times n)$  Jacobi matrix of  $f(x)$ , the  $i$ th row of which is:

$$\Delta f_i(x) = (\delta f_i / \delta x_1, \delta f_i / \delta x_2, \dots, \delta f_i / \delta x_n)$$

For the case where all  $f_i$ 's are linear

functions of  $x$ , we have the least squares method, and  $x^+$  can be found in one step using standard procedures.

If the linear least squares computing routine is applied to the solution of the non-linear Yagi calculation, the result is a long way from the original antenna. Moreover non-linear effects are at work which cause the gain to decrease instead of increasing.

If a further  $n$  rows are added to  $J(x)$ :  
 $\Delta f_{i+1}(x) = (\alpha, 0, 0, \dots, 0)$ ,  $\Delta f_{i+2}(x) = (0, \alpha, 0, \dots, 0)$ ,  $\Delta f_{i+n}(x) = (0, 0, 0, \dots, \alpha)$ , a new  $x$  with the steepest descent for  $F(x)$  ("steepest descent solution") comes out of the linear least squares solution for this new non-linear problem if  $\alpha$  is large enough.

If we repeat the procedure and reduce  $\alpha$  step by step, the non-linear problem can certainly be solved. To prevent false minima from being obtained due to numerical difficulties, you should alternate between different ways of calculating  $J(x)$ . I use four different computing routes:

In the first computing path,  $J^1(x)$  is calculated with every  $x_j$  which goes in a positive direction.

For the second option,  $J^2(x)$  uses new  $X$  variables, which are linear combinations of the original  $X$  variables. The linear combinations are the eigenvectors of the  $J^1(x)TJ^1(x)$  square matrix.

In the third method,  $J^3(x)$  is calculated for every  $x_j$  which goes in a negative direction.

In the fourth method,  $J^4(x)$  is calculated correspondingly to  $J^2(x)$ , using  $J^3(x)TJ^3(x)$ .

It is not necessary to calculate  $J(x)$  anew for each iteration. If the non-linearity is monitored, it is a simple matter to establish when  $J(x)$  must be calculated anew.

An appropriate name for this Yagi optimisation method is the "brute force method".

The option of obtaining  $J(x)$  from the differences between complete calculations is very inefficient, but nonetheless good enough when the efficiency of modern computers is taken into account. The way in which the least squares problem is solved is probably another reason for this name.

## 6.

### ELEMENT DIAMETER AND OHMIC LOSSES

It is very important for Yagi models to take the ohmic losses into account, especially if very thin elements are used, because a Yagi with optimised gain takes the form of a superdirective antenna.

"Superdirectivity" means that the currents within the antenna itself are very high, and that the radiation levels in the different parts of the antenna more or less cancel each other out in all directions - naturally considerably less in the forward direction, and in contrast more to the sides. In this way, we obtain the desired radiated field pattern.

The near field is considerably stronger, since nothing is deleted in the immediate vicinity of the antenna.



Diam (mm)	Element positions and lengths (mm)						Gain (dBd)	1dB BW (MHz)	Impedance	
	Re, Im (Ohms)									
0.001	0.0	4.5	719.0	1532.2	2381.0	3191.5	11.7799	0.043	0.002	-2.3
	1034.9	1033.2	1002.1	993.0	989.5	994.5	-2.85		503	22.8
0.01	0.0	3.5	718.5	1532.5	2380.6	3192.3	11.7800	0.048	0.001	-2.5
	1034.8	1033.5	995.4	984.6	980.6	986.3	-2.47		73.6	4.2
0.1	0.0	3.6	714.4	1528.0	2378.1	3188.3	11.7805	0.075	0.001	-0.93
	1034.8	1033.4	985.5	972.2	967.1	974.3	-1.33		8.6	-4.0
1	0.0	68.3	744.7	1558.5	2406.5	3216.7	11.7794	1.2	0.26	-16.96
	1035.7	1002.4	968.5	951.5	945.2	954.1	9.32		1.05	-16.96
10	0.0	79.7	747.8	1562.9	2411.8	3221.0	11.7804	2.1	0.34	-8.76
	1035.9	991.4	933.4	909.2	900.6	913.1	11.04		0.42	-8.76
20	0.0	100.9	758.5	1574.5	2423.2	3231.8	11.7811	3.1	0.52	-7.77
	1034.7	975.5	914.0	886.3	876.7	891.0	11.49		0.56	-7.77
60	0.0	113.1	764.8	1582.9	2431.9	3238.3	11.7827	4.9	0.63	-2.90
	1034.5	952.3	862.4	826.7	814.9	833.5	11.70		0.64	-2.90

**Table 3: Dimensions and Performance for 6-Element Yagis, optimised for Max gain without ohmic Losses. For each Antenna, Gain, Impedance and Efficiency are calculated with and without ohmic losses, Upper and Lower Lines for each entry in the Table.**

A superdirective antenna is very sensitive with regard to metal components in the near field, and so you should be very careful about selecting the locations for the installation and erection of highly-optimised antennas.

“Superdirectivity” also means that the antennas store energy, which causes the antenna to have a high Q and a low band width.

The half-wave element can store more energy with the same currents if the element is thinner.

The magnetic energy is  $LI^2$  and the inductance per unit of length is higher for a thinner conductor.

A higher value is obtained for Q with thin elements, and at the same time the band width is reduced.

Table 3 lists a series of 6-element antennas which have been optimised without ohmic losses. Antennas are listed with ideal “superconductors” and with ohmic losses.

Antennas which have been optimised without the ohmic losses being taken into account have low impedances and high levels of current. The convergence of the optimisation procedure is very slow and the optimum is very flat. If ohmic losses are disregarded, the gain is thus independent of the element diameter.

Diam (mm)	Element positions and lengths (mm)						Gain (dBd)	1dB BW (MHz) (Ohms)	Imp Re, Im	Eff (%)
	0.0	486.2	1024.1	1828.8	2669.0	3459.2				
2	0.0	486.2	1024.1	1828.8	2669.0	3459.2	11.43	3.0	8.80	94.02
	1021.7	979.3	989.5	940.3	933.7	943.5				
4	0.0	448.3	983.6	1786.1	2629.9	3426.6	11.56	3.3	6.71	96.21
	1021.7	965.4	951.2	929.6	921.9	932.5				
6	0.0	425.9	960.8	1763.3	2609.1	3408.9	11.62	3.5	5.82	97.14
	1027.1	960.1	945.0	921.8	913.2	924.6				
8	0.0	408.7	944.2	1748.8	2594.5	3396.4	11.65	3.6	5.24	97.66
	1021.6	954.2	939.8	915.2	906.3	918.1				
10	0.0	395.8	933.5	1737.3	2584.4	3387.1	11.67	3.6	4.86	98.01
	1021.5	949.2	935.1	909.6	900.2	912.4				
20	0.0	352.4	900.2	1706.5	2554.6	3360.0	11.71	4.1	3.79	98.80
	1020.9	928.9	916.3	887.2	876.6	890.5				
60	0.0	284.4	855.8	1666.8	2515.8	3321.8	11.75	5.5	2.61	99.45
	1020.6	895.9	865.0	828.0	815.1	833.2				

**Table 4: Dimensions and Performance for 6-Element Yagis, optimised for Max gain with ohmic Losses included.**

These antennas do not have reasonable characteristics except for diameters exceeding 10mm if the losses are taken into account.

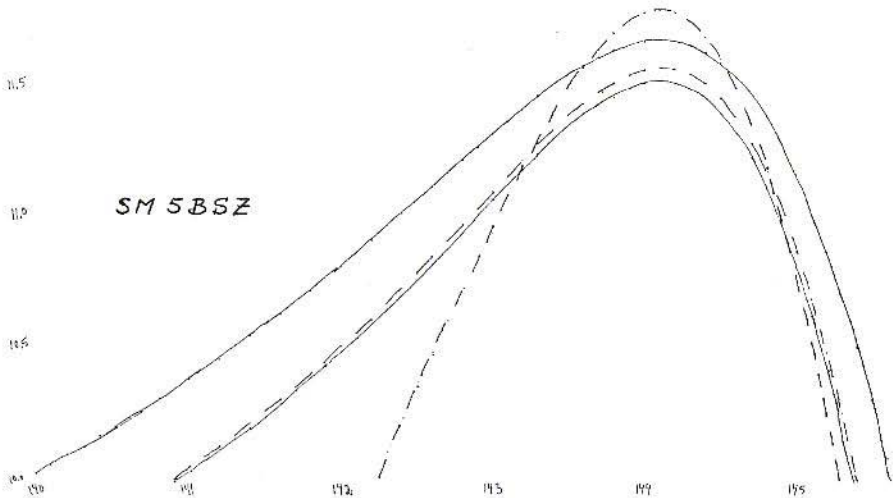
Table 3 shows that it is necessary to bring ohmic losses into the optimisation procedure. I would even make the assumption that such disregard is the main reason for convergence problems in the optimisation of Yagi antennas. To make it possible to calculate the ohmic

losses approximately, a resistor was positioned in the middle of each element.

The resistance value in Ohms was assumed to be  $0.44/d$ , where  $d$  is the element diameter in mm.. The 0.44 value is an experimentally determined value, which was obtained from trials using coax resonators, the Q values of which were measured.

Element Positions (mm)	0	519	1120	1963	2634	6511
Element Lengths (mm)	1007	957	925	910	920	910

**Table 4: Chen and Cheng 6-element Yagi adopted for 144.1 MHz and 10mm Element Diameter**



**Fig.1: Comparison of Gain (through Dipole plotted against Frequency of a 6-Element Antenna from Chen and Cheng with a 6-Element Antenna optimised in accordance with the Brute Force Method.**

**The 1dB Gain Bandwidth is drawn in. (Solid lines = with Ohmic losses; Dotted lines = loss-free antennas).**

The formula appears variously as  $k/d$  or  $k/d^2$  in the literature. The formula  $k/d$  is correct, and gives reasonable values for the losses with element diameters between 5 and 10mm.

Table 4 gives the optimised data for 6-element antennas with aluminium elements with varying diameters where  $f = 144.1$  MHz.

It can be recognised from Table 4 that the rule printed in the ARRL manual: "Avoid element diameters of less than 4mm!" is thoroughly well founded. The specifications in the VHF Handbook (Orr, 1956), in contrast, are of doubtful validity. It has proved to be impossible in all cases, with both thick and thin elements, to obtain a good gain value in the forward direction.

Thin elements have a high Q value. But it is a deceptive conclusion to believe that a high Q value automatically leads to high gain. On the other hand, it is impossible to obtain high gain from a small antenna without obtaining a high Q level [10].

If the elements are somewhat thicker than usual, a slightly higher gain value is obtained on a somewhat shorter boom.

This is especially important for those designing Yagis for relatively high bands, at which low atmospheric temperatures make low losses especially important.



Initial ( $G = 12.24\text{dBd}$ , $\text{Re}Z = 7.6\Omega$ , $\text{Im}Z = -15\Omega$ , $\eta = 97.0\%$ )								Position
0	0.654	1.099	1.851	2.603	3.138	3.760	4.513	Length
1.003	0.956	0.948	0.929	0.912	0.866	0.902	0.923	
False Optimum, 7-elements ( $G = 12.39\text{dBd}$ , $\text{Re}Z = 5.8\Omega$ , $\text{Im}Z = -21\Omega$ , $\eta = 96.5\%$ )								
Position	0	0.456	0.983	1.787	2.646	2.730	3.517	4.334
Length	1.018	0.941	0.944	0.921	0.909	1.049	0.906	0.920
Long Optimum ( $G = 13.06\text{dBd}$ , $\text{Re}Z = 5.5\Omega$ , $\text{Im}Z = -29\Omega$ , $\eta = 96.1\%$ )								
Position	0	0.467	0.992	1.797	2.663	3.553	4.442	5.274
Length	1.018	0.932	0.944	0.920	0.908	0.901	0.901	0.917
Short Optimum ( $G = 12.43\text{dBd}$ , $\text{Re}Z = 21\Omega$ , $\text{Im}Z = -156\Omega$ , $\eta = 97.2\%$ )								
Position	0	0.342	0.472	1.026	1.807	2.658	3.527	4.344
Length	1.018	0.766	0.953	0.939	0.921	0.910	0.907	0.921
Optimised $50\Omega$ ( $G = 12.42\text{dBd}$ , $\text{Re}Z = 50\Omega$ , $\text{Im}Z = 0\Omega$ , $\eta = 97.2\%$ )								
Position	0	0.364	0.487	1.011	1.802	2.658	3.528	4.346
Length	1.019	0.922	0.953	0.942	0.921	0.910	0.906	0.920
Nice, Near Optimum ( $G = 12.39\text{dBd}$ , $\text{Re}Z = 50\Omega$ , $\text{Im}Z = 0\Omega$ , $\eta = 98.2\%$ )								
Position	0	0.409	0.702	1.254	2.011	2.849	3.706	4.508
Length	1.013	0.961	0.958	0.934	0.919	0.909	0.906	0.920

**Table 6: Dimensions of Original Antennas in accordance with Design of Longsomboon et al. [8] and those with Brute Force Method Optimised Antennas (dimensions in metres,  $f = 144.5\text{ MHz}$ , Element Diameter  $5.2\text{ mm}$ ).**

## 7. COMPARISON WITH RESULTS OF PREVIOUS PUBLICATIONS

The simple and straightforward brute force method, as described above, has been used to improve the design of Chen and Cheng [6]. This design was optimised for loss-free elements with a

diameter of  $10\text{mm}$  [6]. The dimensions of these antennas are listed in Table 5 for  $f = 144.1\text{ MHz}$ .

The optimisation was carried out with and without ohmic losses, and the results produced those antennas with  $10\text{mm}$  elements which can be found in Tables 3 and 4.

The theoretical gain is shown in each case as a function of the frequency for the original and final antennas in Fig.1.

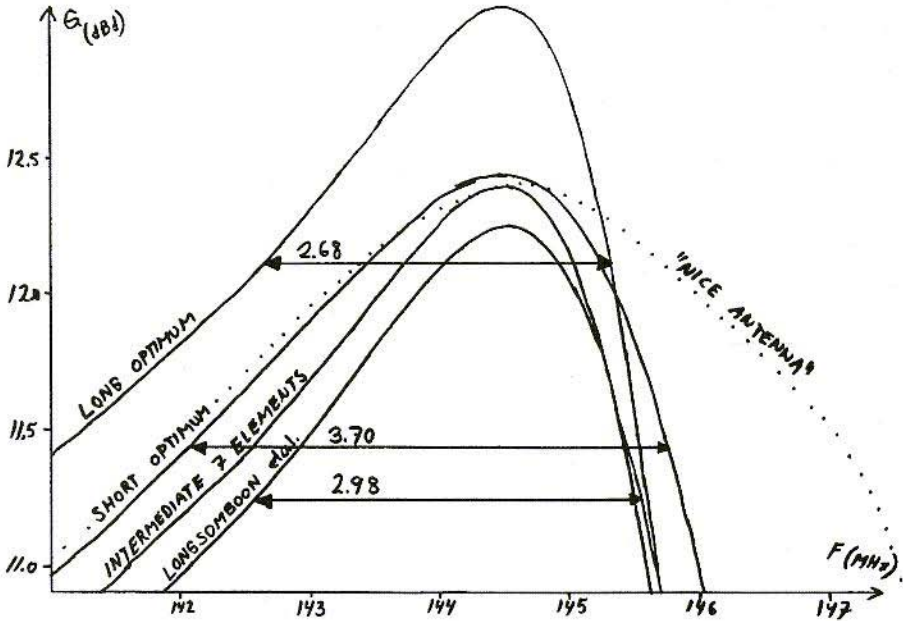


Fig.2: Comparison of an 8-Element Antenna from Longsomboon with one optimised by using the Brute Force Method. The 7-Element Version of the Interim Result is also plotted.

*Lang-optimierte Antenne* = Long-optimised antenna, *Kurz-optimierte Antenne* = Short-optimised antenna, *Als Zwischenergebnis* = As interim result, *Von = By, Nette Antenne* = Pretty antenna

The gain value from Chen and Cheng is 13.356 or 11.26dB, and is thus lower than mine, which is 11.56dB.

The YO program, version 1.00, from K6STI, gives 11.50dB for the 10-mm. Chen and Cheng design, so the value from Chen and Cheng is thus too low.

It is very probable that the difference between the individual antennas was calculated very precisely, even if there is a certain uncertainty concerning the absolute gain value.

For loss-free antennas - shown as a continuous line in Fig.1 - the increase in

gain is 0.22dB for a boom length of 3.22m, as against 3.51m. in the Chen and Cheng design. Expressed in terms of gain per boom length, the improvement is 15%, or 0.6dB.

If ohmic losses are also taken into account - shown as a dotted lines in Fig.1 - the increase in gain is 0.16dB, and the gain per boom length is improved by 7.5% or 0.3dB.

The reason for the significant improvement, as against the design from Chen and Cheng, can be found in the fact that at that time the element intervals were



optimised first for fixed element lengths, and only then were the element lengths optimised for fixed intervals. Obviously, simultaneous matching of element lengths and intervals is more flexible and thus better suited to finding the real optimum.

Another optimised antenna is presented by Longsombloom, Green and Cashman [8]. In this antenna, which uses elements only 5.2mm thick, I have included the ohmic losses in all calculations. In Fig.2, the gain is plotted against the frequency, and the dimensions are given in Table 6.

If we start with this antenna as the original antenna, the brute force method gives a false optimum, which comes out with an element smaller than the original antenna of Fig.2 and Table 6. The iterations are continued until no further improvement is possible, which is the case if the unused element is short enough to have no further influence.

If we remove the very short element, the 8-element antenna with a false optimum becomes an optimised 7-element Yagi. If we now add a director, in a normal position in front of this 7-element Yagi, we obtain a new "initial antenna".

If we use the brute force method to optimise this antenna again, we obtain a "long-optimised antenna" (Fig.2, Table 2). The increase in gain, compared to Longsombloom's design, is 0.8dB. This comparison is naturally inappropriate, since the antenna has become considerably longer.

For long Yagis, the optimum antenna which can be realised in practice is the best antenna for a specific boom length,

and not the antenna with the smallest number of elements.

However, the antenna referred to above is the optimum 8-element Yagi for an element diameter of only 5.2mm. Slightly more gain can be obtained if the element diameter is increased and / or the aluminium elements are replaced by copper elements.

Another "initial antenna" is obtained if a normal director is positioned 0.1m in front of the antenna radiator, with a false optimum, and the unused element is removed. The brute force method then gives a Yagi described as a "short-optimised antenna" in Table 2 and Fig.2.

A comparison with Longsombloom's design shows an increase in gain of 0.19dB - i.e. about 4% - an increase in band width of 25%, and a simultaneous reduction in the boom length, of 4%. Attempts to insert additional elements between the existing ones did not succeed. Thus, for the initial antenna with an inserted ninth element, we kept obtaining the "short-optimised antenna" with only eight elements.

---

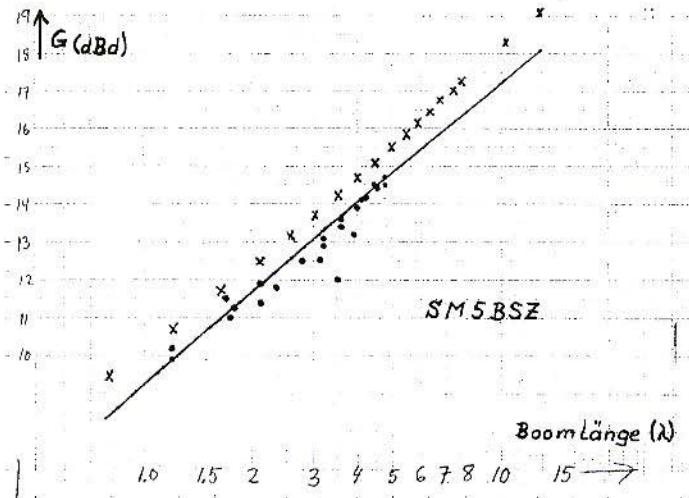
## 8. CHECKING IMPEDANCE AND OTHER CHARACTER- ISTICS

---

The optimisation procedure encompasses the simultaneous minimising of various functions of antenna geometry.

Naturally, we are free to introduce still





**Fig.3: The Gain of a Yagi Antenna at 144 MHz plotted against the Boom Length. Dotted and Dashed Lines as per [11], the Line of Crosses corresponds to the 50Ω Design using the Brute Force Method**  
*Boomlänge = Boom length*

more terms into the sum of the squares. If we provide these terms with suitable weighting factors, it becomes possible to influence the contribution made by these terms to the sum of the equations.

Two obvious factors which can be added to  $F(x)$  are  $c_z(\text{Re}(Z)-50)^2$  and  $c_z \cdot \text{Im}(Z)^2$ .

These terms are zero if the 50Ω base point is resistive. The optimisation will thus always go in the direction of 50Ω antennas.

For the case in which we wish to have only a small reduction in gain for an impedance of 50Ω, only a very low value is required for the coefficient  $C_z$ .

Different values for  $C_z$  lead to various compromises between gain and base point resistance.

The 50Ω antenna in Table 2 was developed in this way. The gain reduction amounts to only 0.01dB, and the frequency range is approximately 7% narrower.

A further term which I would like to add to  $F_u(x)$  is  $c \cdot (\text{ohmic losses})^2$ . The reason for this is that I would like to provide a certain safety margin for the deterioration of the characteristics due to ohmic losses, small errors in the theory (model errors) and changes in the element surfaces due to ageing / corrosion.

With the help of the weighting factors,  $C_z = 0.005$  and  $C_1 = 10$ , with which I prefer to work, I can obtain an approximate optimum value using the brute force method. For this "pretty" antenna, the gain is only 0.04dB below the maximum with a boom which is just 4% longer.

These alterations make it possible to reduce the losses by 35% and to increase the band width by 39%!

Should antennas be designed for bands other than 144 MHz, the equations for maximum G/T or for any other value combination can be appropriately altered.

It is thus possible to calculate any antenna geometry you wish with this model.

## 9.

### GAIN TO BOOM LENGTH RATIO IN YAGI ANTENNAS

A large number of calculations were carried out using the "pretty" parameters referred to above, for antennas with varying numbers of elements and with varying stocking configurations.

A uniform diameter of 10 mm. was selected for all calculations.

Thus, for example, the 8-element design gave a gain of 12.47dBd with a 4.387m long boom.

Fig.3 shows the gain for this antenna, and for a pair of others [11] with different boom lengths.

The "pretty" antennas referred to above are on average approximately 0.5dB better than typical EME antennas with boom lengths of 3 to  $5\lambda$ . For extremely long or short boom tubes, the gain is approximately 1dB above the normal line for good antennas [11].

For over two years, I have been operating a quadruplet of 14-element cross-

Yagi antennas which were calculated in accordance with the above procedures. I am very satisfied with the results. Likewise, good positions in EME contests demonstrate that these antennas, perfected to a high degree, do also actually function in practice.

The assembly naturally requires great care and precision.

## 10.

### LITERATURE REFERENCES

- [1] Roger F.Harrington: Matrix Methods for Field Problems Proc. IEEE, vol. 55, no. 2, Pp. 136-149, February, 1967
- [2] D.C.Kuo and B.J.Strait: Improved programs for analysis of radiation and scattering by configurations of arbitrarily bent thin wires Syracuse University, Syracuse, New York Manuscript
- [3] H.H.Chao and B.J.Strait: Computer programs for radiation and scattering by arbitrary configurations of bent wires Scientific Report no. 7 on Contract F19628-68-C-0180, AFCRL-70-0374, Sept. 1970
- [4] D.C.Kuo and B.J.Strait: A program for computing rear fields of thin wire antennas Scientific report no. 14 on Contract F19628-68-C-0180, AFCRL-71-1463, Sept. 1971
- [5] James L.Lawson, W2PV: Yagi antenna design: performance



calculations

Ham Radio, Jan. 1980, Pp. 22-27

- [6] C.A.Chen and D.K.Cheng:  
Optimum element lengths for  
Yagi-Uda arrays  
IEEE Trans. Antennas Propagat.,  
Vol. AP-23, pp. 8-15, Jan. 1975
- [7] L.Asbrink: The best 6-element  
Yagi antennas  
VHF Communicatons, no. 3/82,  
Pp. 106-109
- [8] N.Longsomboon, H.E.Green and  
J.D.Cashman: Numerical  
optimisation of Yagi-Uda arrays  
Monitor-Proceedings of the IREE  
Australia, Nov. 1977
- [9] P.E.Gill and W.Murray:  
Algorithms for the solution of the  
non-linear least squares problem  
NPL Report NAC 71, 1976
- [10] R.L.Fante: Maximum possible gain

for an arbitrary ideal antenna with  
specific quality factor

IEEE Trans. Antennas Propagat.,  
Vol. 40, pp. 1586-1588, Dec. 1992

- [11] Rainer Bertelsmeier, DJ9BV:  
Gain and Performance Data of 144  
MHz Antennas  
DUBUS-magazin, no. 3,  
Pp. 181-189, 1988

---

## 11.

### INTERNET ADDRESS

---

Leif Asbrink's computer program for  
antenna design can be called up on the  
Internet:

[http://ham.te.hik.se/homepage/sm5bsz/  
index.htm](http://ham.te.hik.se/homepage/sm5bsz/index.htm)

"SM5BSZ Homepage"

# PUFF version-2.1

## MICROWAVE CAD SOFTWARE

### Complete with full handbook

# £23.50

**Shipping UK £1.50; Surface £3.00; Air £5.00**

KM Publications, 5 Ware Orchard, Barby,

Nr.Rugby, CV23 8UF, UK Tel:

(0)1788 890365 Fax: (0)1788 891883

email: [sales@vhfcomm.co.uk](mailto:sales@vhfcomm.co.uk)



*Henk Medenblik, B.Sc., PEIJOK*

# **A State-of-the-Art 13cm Amateur Television Transmitter Part-2**

In this second article of the 13cm ATV transmitter project, a dual audio carrier module and video baseband processing main board will be described. This audio carrier module is capable of generating two independent PLL controlled audio carriers which can be tuned between 5.5 MHz and 8 MHz in 10 kHz steps. The video baseband board, which also will be described here, carries this audio module and the VCO/PLL unit from the previous article.

---

## **1. THE AUDIO SUBCARRIER MODULE**

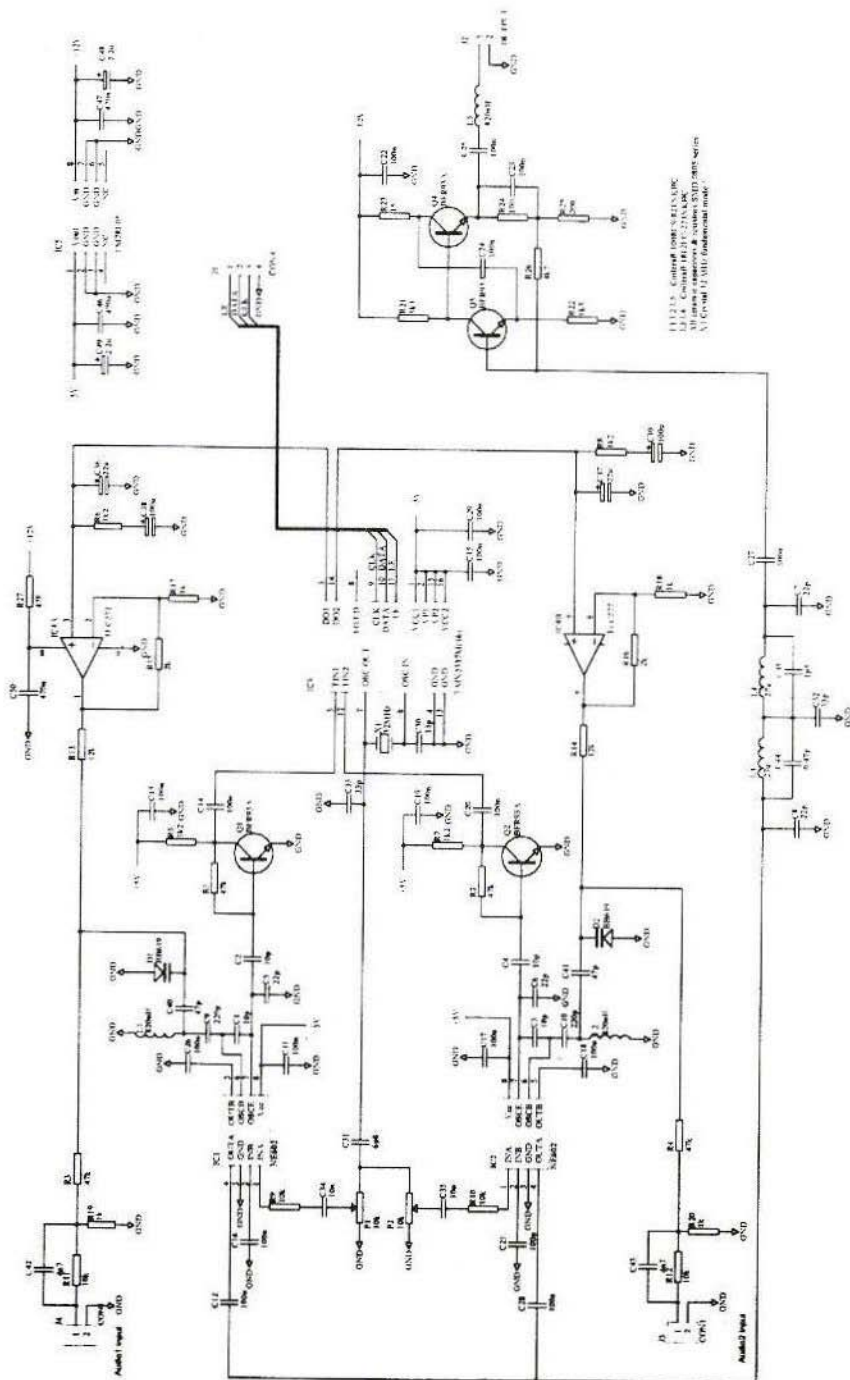
---

The audio carrier unit consists of two VCOs operating in the 37.5 - 40 MHz range. A 32 MHz crystal oscillator signal downconverts the VCO signals to the 5.5 - 8 MHz range. The VCO and mixer functions are fulfilled by two

NE602 active Gilbert cell mixer ICs. With the given frequency range of the VCO a compromise has been made between spectral purity of the mixing process and available tuning range.

In Fig.1 the schematic of the audio carrier unit is given. As can be seen a National Semiconductor LMX2337 dual PLL IC is used to stabilise the VCO signals. The internal crystal oscillator of the LMX2337, which is used for the internal reference frequency, is also used for downconverting the VCO signals to the desired frequency range of 5.5 - 8 MHz. The frequency of this oscillator is set at 32 MHz by the external crystal. Note that this crystal operates in fundamental mode (parallel resonant).

A point of discussion during the development process was the fact where both signals had to be combined to create the dual carrier system. As is well known, improper combination of the signals will lead to intermodulation products around the two carriers. One way to overcome this problem is by using a very linear amplifier which amplifies both signals.



**Fig.1: Circuit Diagram of the Audio SubCarrier Module**

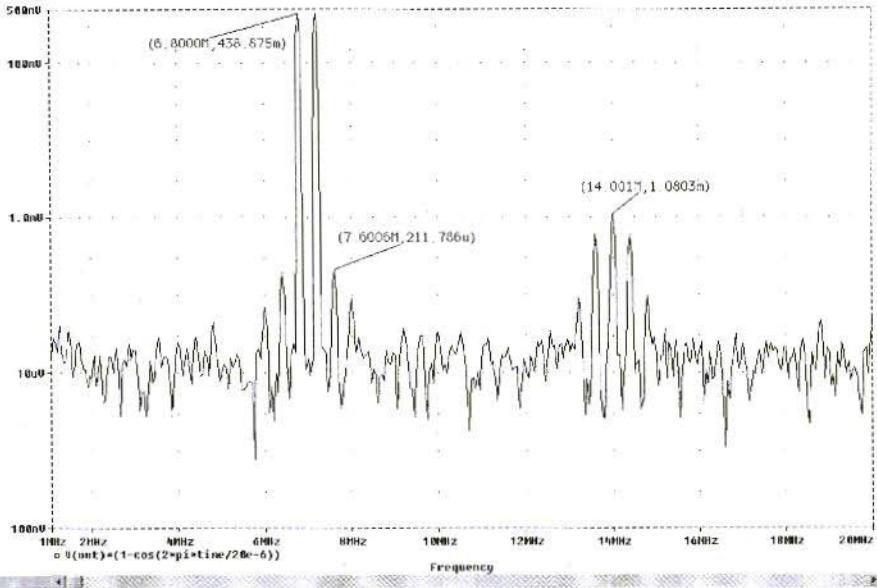


Fig.2: PSPICE Simulation of Intermodulation Levels between Two Carriers

These signals come from the mixer outputs after being filtered from harmonics, where the resultant signal is amplified by this special amplifier. Because the impedance levels of the NE602 mixers are quite high (1.2kW) and because we want a voltage

swing at the output with a low driving impedance, a special amplifier design is needed. This resulted in a two stage double feedback amplifier which acts as a voltage amplifier. The output impedance of this amplifier is approx. 50W at a driving impedance of 1.2kW and a

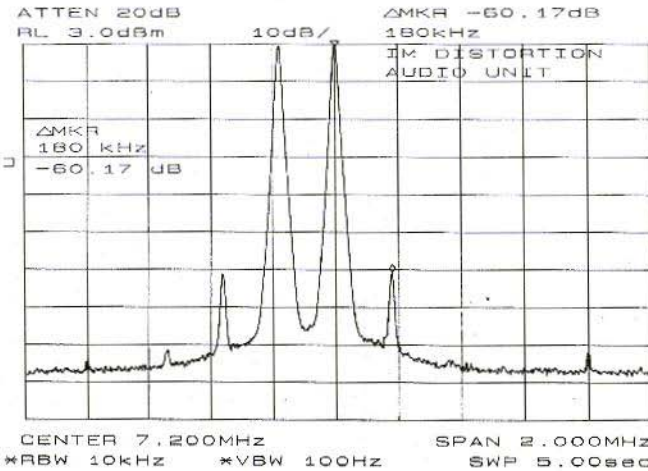


Fig.3: Practical Measurement of IM Products between Two Carriers



voltage gain of 10dB. This linear amplifier approach works very well to keep the IM products low.

A simulation with PSPICE tells us that IM products will be below -60dBc at output levels of +3dBm per carrier. In Fig.2 this result is shown. In Fig.3 a real practical measurement is given. Finally the output levels of the unit are adjusted by two trim pots which both influence the LO level for the mixing process and thus both output levels.

The loop bandwidths of the both PLLs are determined by the components C36,C38,R6, C37,C39, R8, the VCO constants and the phase detector gain. With the values suggested this bandwidth is set at approximately 3 Hz. This low bandwidth is chosen because it should be possible to modulate the VCOs with the incoming audio signals. Finally a simple 50ms pre emphasis network is added to compensate the 50us de-emphasis at receiver side. This network is formed by components R11,R19,C42 and R12,R20,C43.

---

## 2. CONSTRUCTION OF THE AUDIO SUBCARRIER MODULE

---

A special PCB has been developed to construct the audio subcarrier unit. To keep crosstalk and other unwanted interference to a minimum some redesigns of this PCB were necessary. This resulted in a PCB with one side full copper and the other side tracks. Because it was not

possible to implement all tracks at one side some wires at the ground plane side were needed. An attempt to implement these wires as tracks inside the ground plane gave bad results for spectral purity.

In Fig's.4a & b the PCB layout is shown and Fig's.5a & b show the component overlay. Nearly all resistors and capacitors are 0805 SMD shape except for the electrolytic types of the loop filter. Please check for the right polarity of the SMD electrolytics because the black band indicates the positive lead.

Correct function of the VCO range can be ascertained by measuring the required voltage range to give the necessary frequency range. A voltage range of approx. 4-8 volts should result in the given frequency range of 37.5 - 40 MHz. If not than C3 and C10 (both 10pF) can be decreased/increased to give the desired results.

---

## 3. THE BASEBAND VIDEO MODULE

---

The baseband PCB filters the incoming video signal, corrects the amplitude response with a pre-emphasis network and amplifies this signal to the required level before it is modulated to the VCO.

The filtering is necessary to prevent interference of high frequency video components with both audio subcarriers. A seventh order Cauer filter with a cut-off frequency of 5 MHz and a group

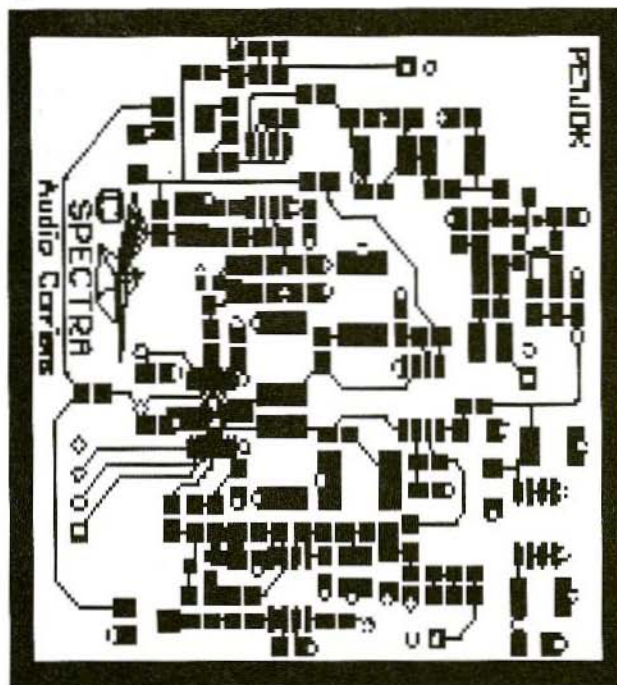


Fig.4a:  
Audio SubCarrier PCB  
Layout - Top Side  
Actual size: 59 x 64mm

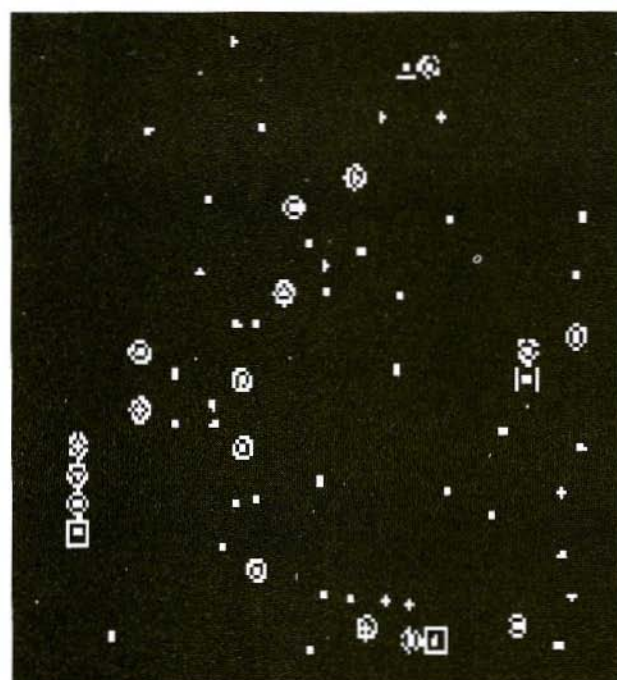


Fig.4b:  
Audio SubCarrier PCB  
Layout - Bottom Side  
Actual size: 59 x 64mm





delay equaliser are doing the job. The basic concept of this filter was first presented by DL2OU. The version described here is rearranged and simulated with the purpose of removing the need for a lot of tuning inductors.

The schematic of the original video filter is given in Fig.6. It consists of a 7th order Cauer filter cascaded by a 3-section group delay equaliser network. A group delay equaliser is necessary to prevent shifting of colours inside the picture. Because the specifications of the filter are very exact and because of the specific non-practical component values used in the original design, tuneable inductors are needed.

Some capacitance values are realised by a combination of several values. High Q values of both inductors and capacitors are necessary to prevent unwanted extra insertion loss around the cut-off frequency. Because of the low working frequency this leads to the usage of core-inductors.

The original filter was constructed with Neosid coils and styroflex capacitors. To bring this filter into the modern age I tried to simplify the original design and tried several computer simulations and breadboard trials. My first trial began with rounding the inductor values to the closest practical value and optimising capacitors for best performance of amplitude and group delay response. The resulting schematic is shown in Fig.7. Fig's.8a and 8b show simulated performance of both versions of the filters.

As can be seen, theoretical differences are kept to a minimum, also the influence of Q values was performed. It seemed that a Q of more than 60 is a

minimum requirement. Therefore I came to the conclusion that modern SMD inductors could not be used because they give Q values around 20-30. An axial inductor with core gives Q values of 60-100. Therefore the modified version of the filter uses axial core inductors. I tried inductors from Coilcraft (90 series) with measured Q values of over 80 and +/- 5% tolerance. Well known Siemens types should perform with their Q of approx. 60 although tolerance is bad (+/-10%). Finally I built and measured prototypes of both filters. Figures 9a,b and 10a,b give their measured responses.

Both filters seem to perform well as can be seen. A last problem with the modified filter version is component tolerance. I have to confess that performance of the original and the modified filter depends on tolerance of component values. Therefore the original filter requires tuning with sophisticated measurement equipment. The modified version depends fully on tolerances of component values. Therefore minimum tolerances are preferred. To give some insight of expected differences I made a Monte Carlo analysis with a tolerance of +/- 5% of component values. This result is given in Fig.11.

On the PCB of the baseband unit one can choose to implement either version of the filter.

The video baseband processing is completed with two Maxim video OpAmps and a pre-emphasis network. Note that this network is designed for a 75W load. This is implemented by a 75W resistor in parallel with the relatively high impedance of the video potentiometer

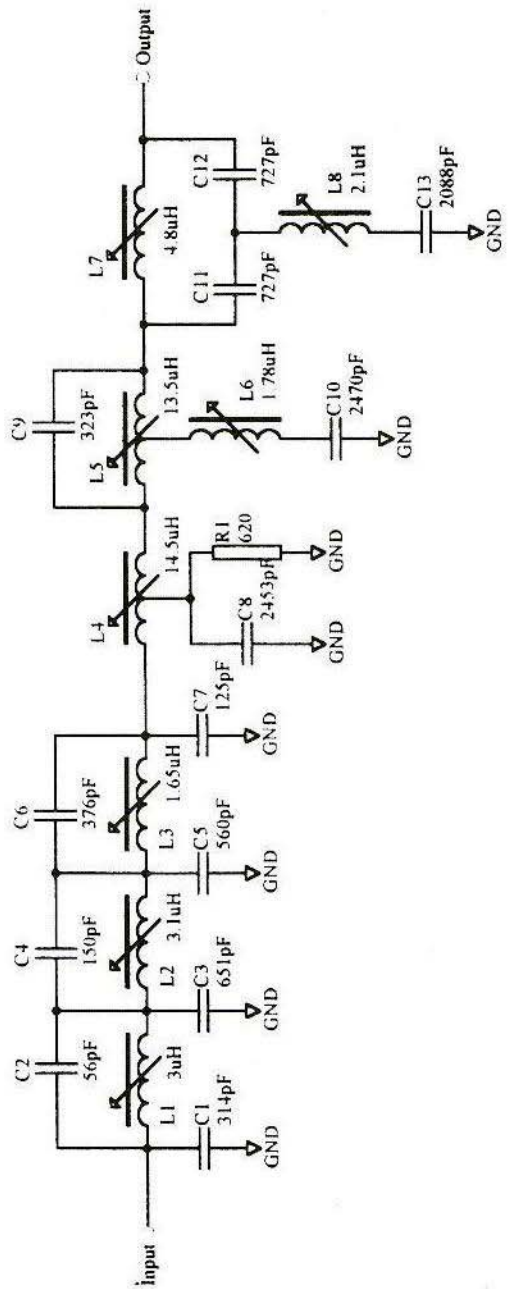


Fig.6: Original Circuit Diagram of the Baseband Video Filter

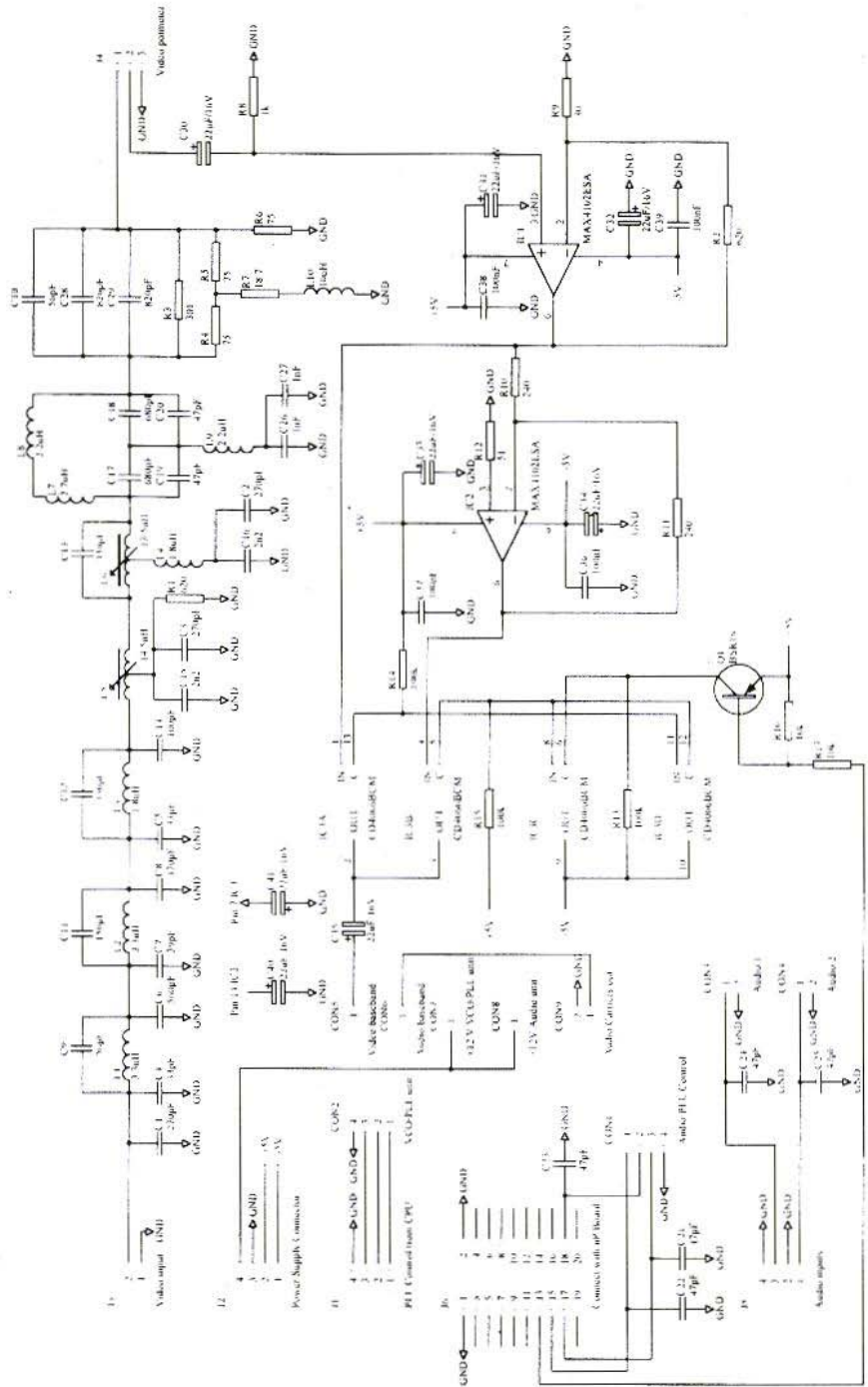
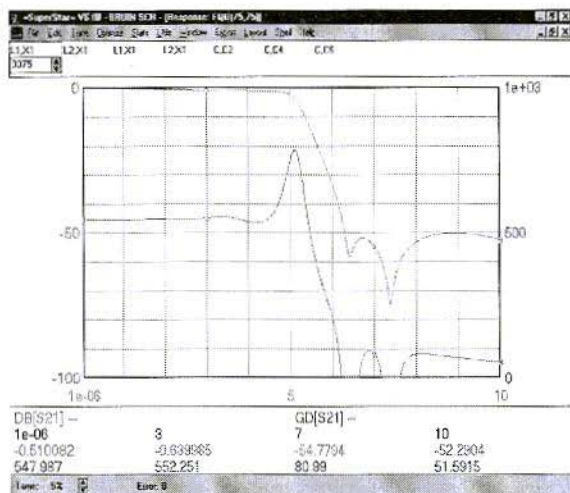
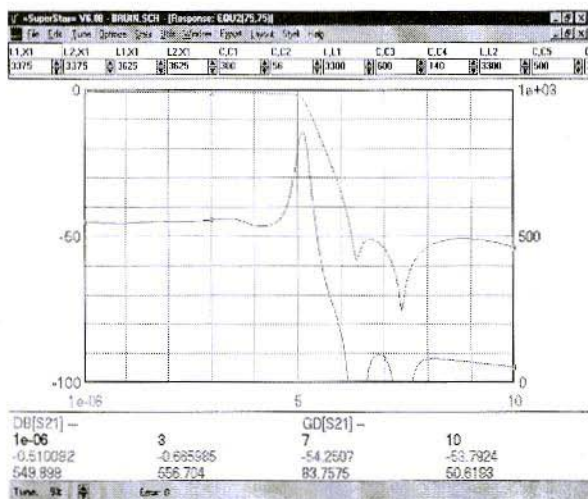


Fig.7: Final Circuit Diagram of the Baseband Video Module



**Fig.8a: Simulated Performance of Original Video Filter by DL2OU**



**Fig.8b: Simulated Performance of the Modified Video Filter**

(1kW). The first MAX4102 is used to amplify the baseband video and the second is used as an inverter.

A 4066 CMOS switch IC allows for software control of the video polarity.

The final PCB is designed to carry both the audio subcarrier unit and the VCO/PLL unit.

## 4. CONSTRUCTION

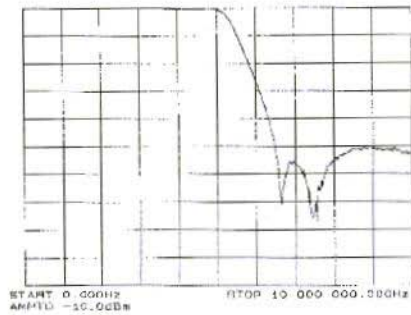
The layout and component overlay of the baseband PCB are given in Fig's.12a & b and Fig's.13a & b. Note that a fully metalised bi-layer PCB with solder mask and components are available by Spectra BV, Holland. The component placement shown here is for the modified video filter. However, placement of the original version is possible and therefore some component pads are optional.

The VCO/PLL unit and audio subcarrier unit have to be shielded with 2cm high screens, which can be soldered on the reserved spaces. The control lines to the audio unit and the audio inputs itself are decoupled with 47pF capacitors on the reverse side of the baseband PCB. They are needed to decouple HF which otherwise could result in unwanted de-programming effects of the PLL during operation.

This board forms the base of the 13cm ATV transmitter. In the next issue a

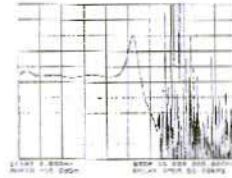


REF LEVEL 0dB  
-20.00dB



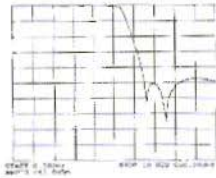
**Fig.9a: Measured Amplitude Response of Original Filter**

REF LEVEL 0dB  
-20.00dB



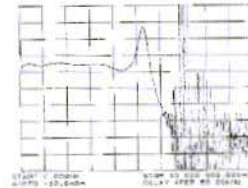
**Fig.9b: Measured Group Delay of Original Filter**

REF LEVEL 0dB  
-20.00dB



**Fig.10a: Measured Amplitude Response of Modified Filter**

REF LEVEL 0dB  
-20.00dB



**Fig.10b: Measured Group Delay of Modified Filter**

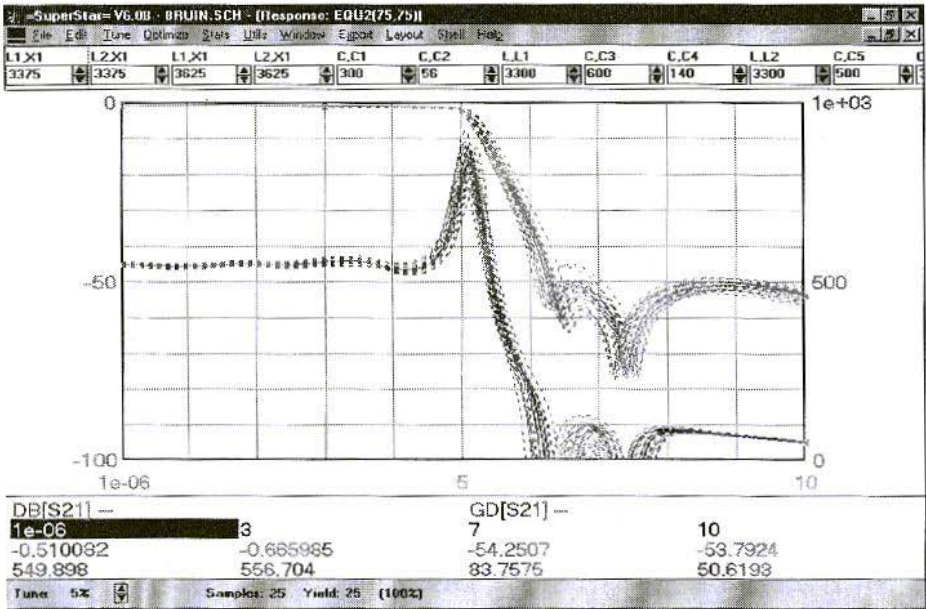
micro controller board with text inserter will be presented which controls several functions of the unit described here. Also a 1.5 Watt Power Amplifier and power supply circuit will than be presented.

---

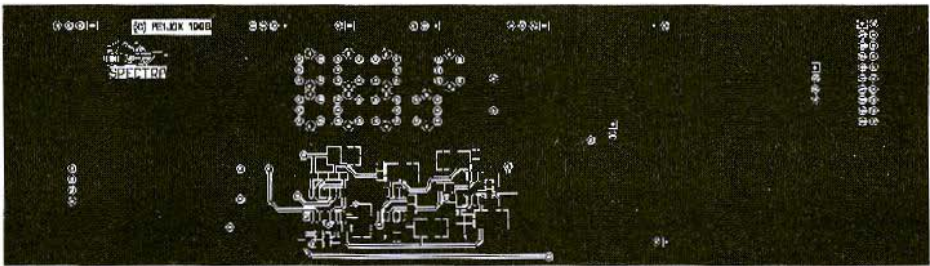
## 5. REFERENCES

---

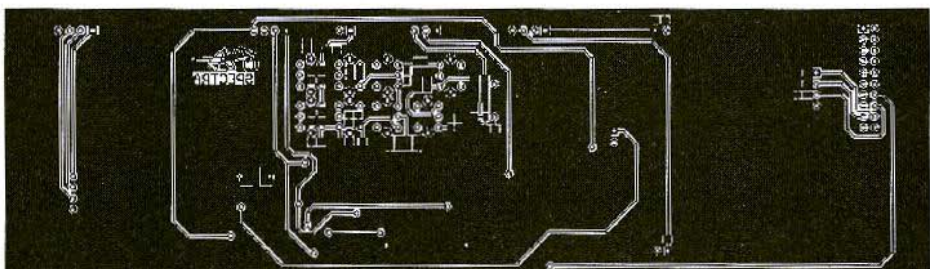
Groeplooptijd gecorrigeerd video filter, Repeater 1/1997



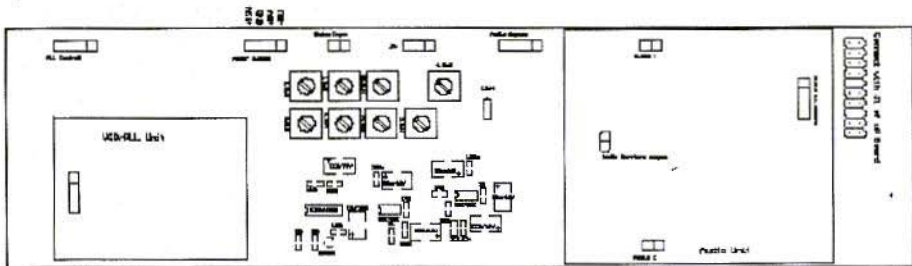
**Fig.11 : Simulated effects on +/- 5% Component Tolerances for Modified Video Filter**



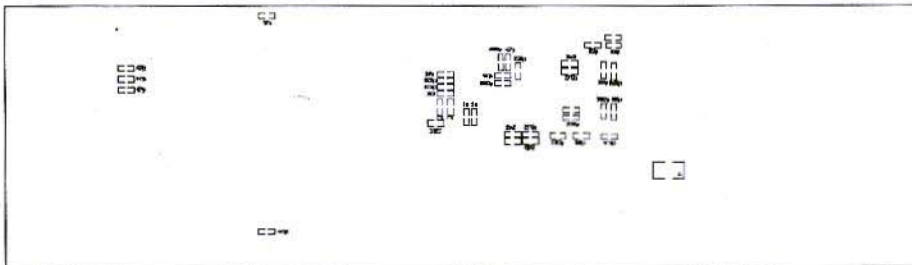
**Fig.12a: Video Baseband Module PCB Layout - Top Side**  
Actual Size: 215 x 61mm



**Fig.12b: Video Baseband Module PCB Layout - Bottom Side**  
Actual Size: 215 x 61mm



**Fig.13a: Video Baseband Module PCB Component Overlay - Top Side**  
Actual Size: 215 x 61mm



**Fig.13b: Video Baseband Module PCB Component Overlay - Bottom Side**  
Actual Size: 215 x 61mm

*To be continued*

## **PUFF 2.1 UPDATE**

**AVAILABLE NOW**

**£11.50 + £1.00 shipping**  
**(credit card orders +5%)**

**KM Publications, 5 Ware Orchard, Barby, Nr.Rugby,  
CV23 8UF, UK \* Tel: (0)1788 890365**

**Fax: (0)1788 891883 email: sales@vhfcomm.co.uk**





Bernd Kaa, DG4RBF

# HF Synthesiser 5 to 1450 MHz

## Part-2 (conclusion)

### 3.2.1. Assignment of Ports

The back-lit LC display is connected to port 1. A 16-digit or 20-digit LC display with 2 lines can be used. The display is driven in 4-bit mode through the data circuits (D4-D7).

Table 1 shows the connections.

The 3-conductor bus for controlling the PLL-IC is connected to port 3:

P3.5 = Clock [CLK]

P3.4 = Data [DA]

P3.3 = Enable [EN]

A normal matrix keyboard is used, with 3 x 4 keys, connected to port 4 through 7 lines (P4.0-P4.6):

Pin-3 (P4.0) = Left-hand column (1, 4, 7, \*)

Pin-4 (P4.1) = Centre column (2, 5, 8, 0)

Pin-5 (P4.2) = Right-hand column (3, 6, 9, #)

Pin-6 (P4.3) = Line 1 (top) (1, 2, 3)

Pin-7 (P4.4) = Line 2 (4, 5, 6)

Pin-8 (P4.5) = Line 3 (7, 8, 9)

Pin-9 (P4.6) = Line 4 (bottom) (\*, 0, #)

Port line P1.3 is responsible for the A/B band switching (pin-4 at K1).

For the future, it was even possible to foresee connecting an attenuator which could be digitally switched from 0 to dB in 10dB stages through three control lines, e.g. of the JFW50P-176 type.

In a basic setting, you can choose whether the existing "Up/Down" keys should be used to control the optimal attenuator or to select the frequency.

The following lines are used in addition:

ATT-10dB = P3.0

ATT-20dB = P3.2

ATT-40dB = P4.7

It should be mentioned, as a special feature, that two of the analogue inputs AN0 and AN1) are programmed as digital inputs for the "Up/Down" keys.

To be able to use these inputs digitally, you need two additional pull-up resistors (R28/R27). When the keys are activated, the inputs are pulled to earth.

AN7 (AD converter 7) is an 8-bit AD

Display	FunctionK1	Port	Comment
Pin 1	Earth	Pin 9	---
Pin 2	+5V	Pin 10	---
Pin 3	Contrast	---	---
Pin 4	RS	Pin 1	P1.0 Register Select
Pin 5	RW	Pin 2	P1.1 Read/Write
Pin 6	E	3	P1.2 Enable
Pin 7	D0	---	---
Pin 8	D1	---	---
Pin 9	D2	---	---
Pin 10	D3	---	---
Pin 11	D4	5	P1.4 Data Line
Pin 12	D5	6	P1.5 Data Line
Pin 13	D6	7	P1.6 Data Line
Pin 14	D7	8	P1.7 Data Line

Table 1

converter, which is programmed for the voltage range 0 to 1.25V. It is used for power setting (band A).

AN6 (AD converter 6) is an 8-bit AD converter, which is programmed for the voltage range 0 to 1.25V. It is used for power setting (band B).

AN5 (AD converter 5) is programmed for 10-bit width, and thus covers a voltage range of 0 to 5V. It is used to read in the Y axis during wobbling.

The ZN426E 8-bit DA converter, which controls the PIN-diode controller of the HF section, is controlled through port 5 (P5.0-P5.7).

### 3.2.2. Serial Interface

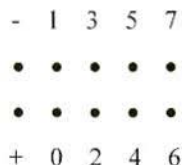
Transistor T2, wired up as an inverter, represents the simple serial interface, and is controlled by P3.1 (TxD).

The serial interface is used to transmit

data to a PC during wobbling, so that they can be graphically displayed using a corresponding program.

K5 provides access to the data bus, so that nothing stands in the way of any future expansion. This connection is not used at present.

All double-series pin-strips are connected according to the following diagram:



A separate "Reset" key could be connected to [K6]. However, this is not needed here, as an automatic "Reset" pulse is generated when you switch on (C6 / 1µF).

### 3.2.3. Assembly and Commissioning



### of Micro-Controller Assembly

When the board layout was being drawn up, it was ensured that no through-plating was needed on the processor connections. This makes it possible to use boards produced at favourable prices.

A double-sided epoxy board 1.5mm thick is used (Figs. 17 and 18). All through-plating can be created using simple sections of wire.

The micro-controller assembly was kept universal, so that it can also be used for other applications if an appropriate program is written.

First, all the necessary through-plating is created by means of short sections of wire.

#### Micro-controller assembly list:

- 1 x SAB80C535N16
- 1 x PLCC68 holder
- 1 x 27C12 (120ns)

#### with DG 4 RBF synthesizer program

- 2 x 28-pin-precision holder
- 1 x 62256 (100ns)
- 1 x 74HC573
- 1 x ZN426E
- 1 x LM358N
- 1 x 7805 regulator
- 1 x BS170
- 1 x BC548 B
- 1 x 18.432 MHz crystal
- 1 x BAT42
- 2 x 1N4148

#### 0204 series resistors:

- 1 x 680 $\Omega$
- 20 x 1k $\Omega$
- 1 x 2.2k $\Omega$
- 1 x 10k $\Omega$

- 1 x 33k $\Omega$
- 2 x 47k $\Omega$
- 2 x 220k $\Omega$
- 2 x 22nF, ceramic
- 1 x 10nF, ceramic
- 4 x 100nF, ceramic
- 2 x 1 $\mu$ F, tantalum
- 1 x 4.7 $\mu$ F, tantalum
- 1 x 10 $\mu$ F, electrolytic
- 1 x LCD dot matrix module  
16 x 2 or 20 x 2
- 1 x pressure key field matrix 3 x 4
- 1 x covering frame for keyboard
- 1 x 3V lithium battery
- 2 x keys (Up/Down)
- 1 x 1 x 10-pin strips;  
2.54mm spacing
- 5 x 1 x 2-pin-strips;  
2.54mm spacing
- 4 x 2 x 5 pin-strips;  
2.54 mm. spacing
- 1 x pin 1 x 1)

Then you can begin to equip the board (Fig.19), taking the usual precautions against static charging. Even the BS170 transistor is sensitive to static charging!

If IC holders are called for, precision holders which can be soldered on both the top and the bottom faces for through-plating absolutely must be used. Make sure that all connections on assemblies which act as through-plating are soldered to the top and bottom faces of the board.

For the first function test of the micro-controller assembly, the LC display, the keyboard and the "Up/Down" keys must be connected up, as a minimum.

### 3.2.4. Fault-Finding

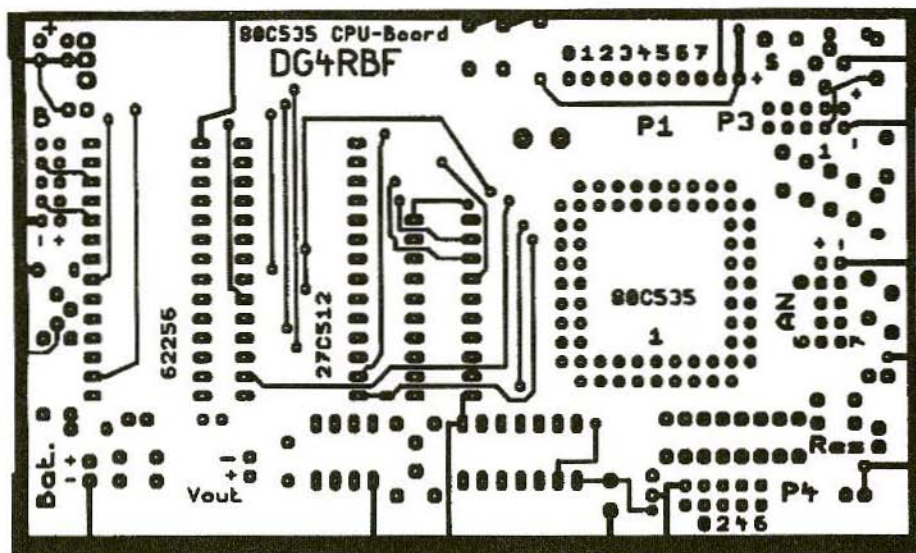


Fig.17: Layout of Top Face of CPU Board

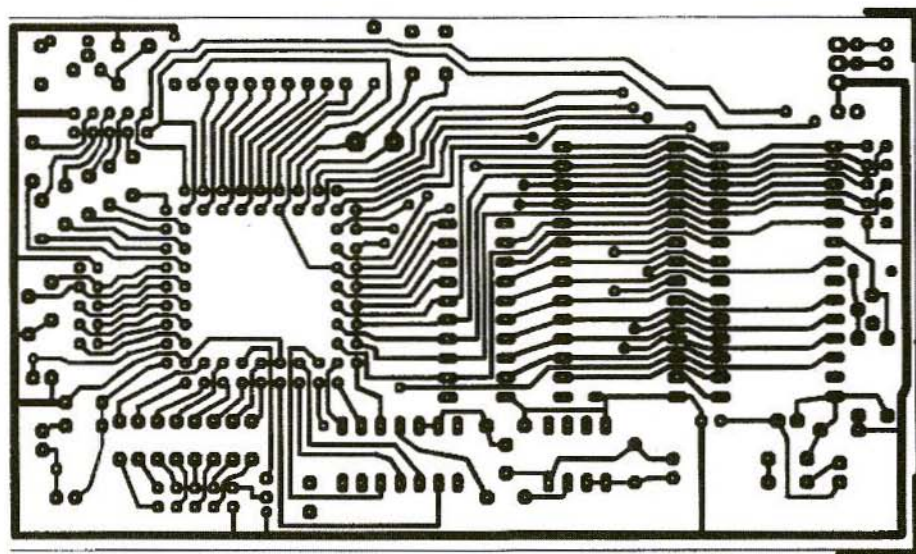


Fig.18: Layout of Bottom Face of CPU Board

Should the micro-controller assembly not function first go, here are a few helpful hints.

Check the following points with an

oscilloscope:

- Is the internal oscillator working?

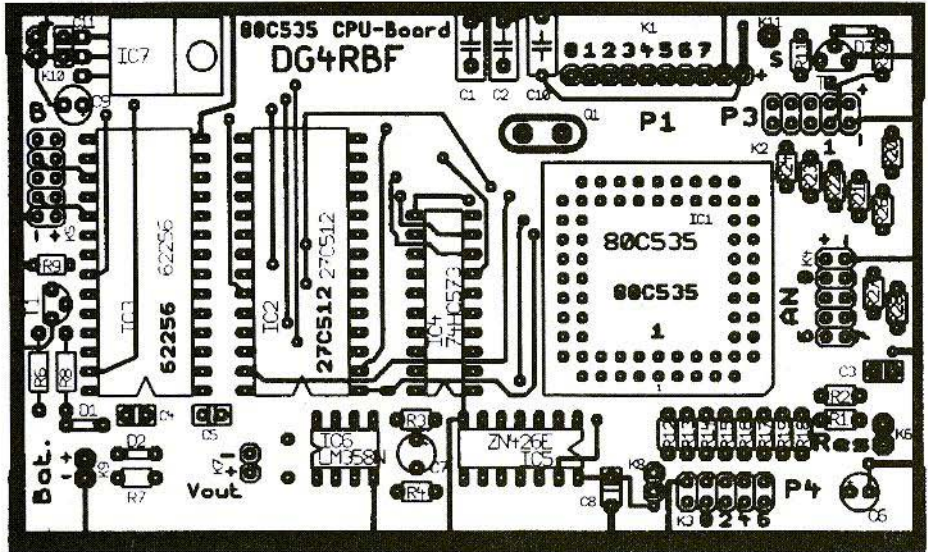


Fig.19: Component Overlay of CPU Board

- Is an ALE signal present at pin-50 (square wave signal)?
- Have all lines on the address and data bus TTL levels?

Should the processor not start up, the fault could also lie in a defective reset capacitor (C6 / 1 $\mu$ F).

Check whether the RAM9IC3) has been switched into the active condition by means of the "Chip Enable" line (pin-20 ). T1 must earth the "Chip Enable" line.

### 3.2.5. Bus Driver for Processor Port

If a port on the processor is used to switch or control external equipment, you should remember that a port can not supply much current, and could therefore be damaged.

To protect the processor, a bus driver

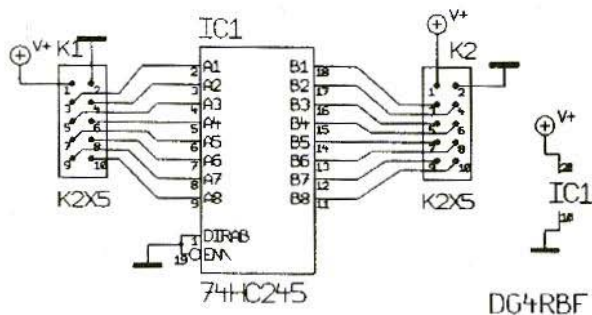
should be wired in between (Fig.20). For this, a universal bus driver is looped into the line. The driver for 8 port lines consists only of a 74HC245 IC, with plug contacts at the input and output (Fig.21 and 22). The power is supplied directly through the line into which it is looped (e.g. ribbon cable).

It is best if the driver is plugged into port 3 and cuts through the lines of the ribbon cable, which do not have to be buffered (P3.1 / P3.6 / P3.7).

Thus three inputs of the bus driver are free, to which P4.7 and P1.3 can then be wired up.

Thus the 3-conductor bus, the three control lines of the attenuator and the band switching line are buffered through the bus driver.

### 3.3. The VCO Assembly



**Fig.20:**  
**Simple Bus Driver**

The VCO used is the broad-band VCO DBINV-012, developed by Dr.-Ing. Jochen Jirmann for the spectrum analyser [1].

A few modifications have been made for use in the HF synthesizer.

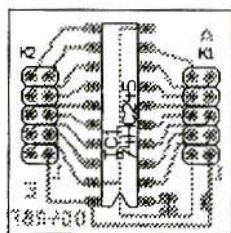
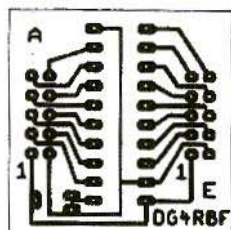
**Fitting a power controller:**

The output power of the VCO should be constant over the entire frequency range as far as possible. This was brought about by adding a power control (ALC).

For this purpose, the small supplementary circuit in Fig.23 is mounted externally on the VCO housing, and a slight circuit change is made.

The few elements making up the additional control circuit can be assembled on a breadboard, or the small board layout in Fig.24 can be used.

**Circuit change:**



**Fig.21:**  
**(Left) Bus Driver Layout**

**Fig.22:**  
**(Right) Bus Driver Board Components**

Replace AT42085 driver transistor with an MAR8, with a subsequently wired PIN-diode which is regulated by the control circuit (Fig.25)

Insert a small circuit to detect the power at the VCO output (Fig.26).

The 3 resistors and the capacitor are SMD components and can be mounted "floating" on the board. The control voltage this generates is fed through a feedthrough capacitor out to the control circuit.

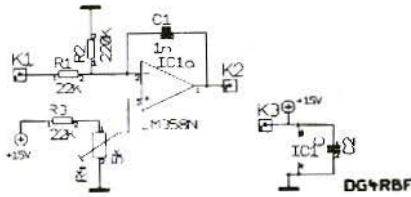
This expansion provides usable power control (see also Fig.27).

**3.4. The Wobble System**

The HF synthesizer can also be used as a slow-scan wobble system.

Wobble measurements can then be carried out in the 5 - 600 MHz and 600 - 1,450 MHz ranges.

The smallest wobble band width is



**Fig.23: Power Control for VCO**

127.5 kHz / division (or, to put it another way, 1.275 MHz from the “Start” frequency to the “Stop” frequency).

Thus relatively narrow-band filters can also be measured (see also Fig.28).

The wobble curves for the two bands (A, B) have no power breaks and are sufficiently straight (Figs. 29 and 30).

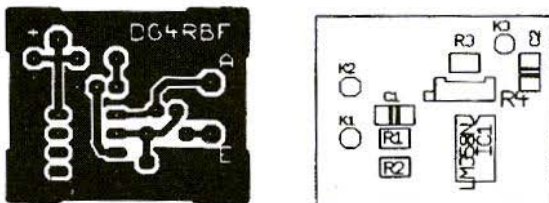
**3.4.1. Functioning Principle**

255 steps are calculated from the “Start” and “Stop” frequencies entered. The PLL is then programmed to the individual frequency calculated, using the micro-controller.

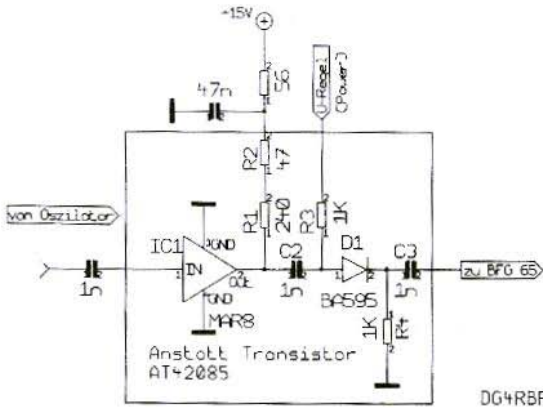
A diode detector is used to convert the HF at the output of the test piece connected up into DC voltage, which is fed to the AD converter (AN7) in the micro-controller. The AD converter is programmed to 10-bit width, so that it can process input voltages from 0 to 5 Volts.

Thus the micro-controller has all the data required for graphic evaluation available in digital form.

The data obtained in this way are fed through the serial interface at 9600 Baud to a PC, evaluated by an appropriate program - namely HF-

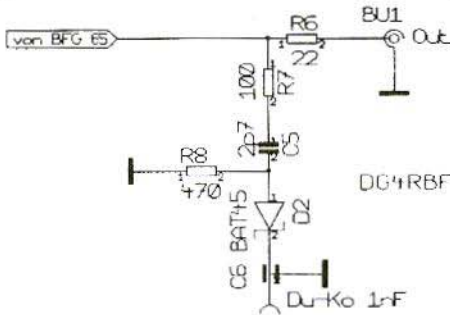


**Fig.24: Layout and Component Overlay of Control Circuit**



**Fig.25: Changes to VCO as per DB1NV**

*Von Oszillator* = From oscillator,  
*Zu* = To,  
*Anstatt* = Instead of,  
*U-Regel* = Switch-over control



**Fig.26: Power Detector for VCO**  
*Von = From, Zu = To,*  
*Regelschaltung = Control*  
*circuit*

WOBB - and graphically displayed.

This program is structured in a similar way to the PC-PLOT program with which the spectrum analyser is already familiar, and which evaluates the data

from the image memory (DB 1 NV), displays them graphically with many additional functions, and can print them out.

In this connection, see also the description of HF-WOBB.

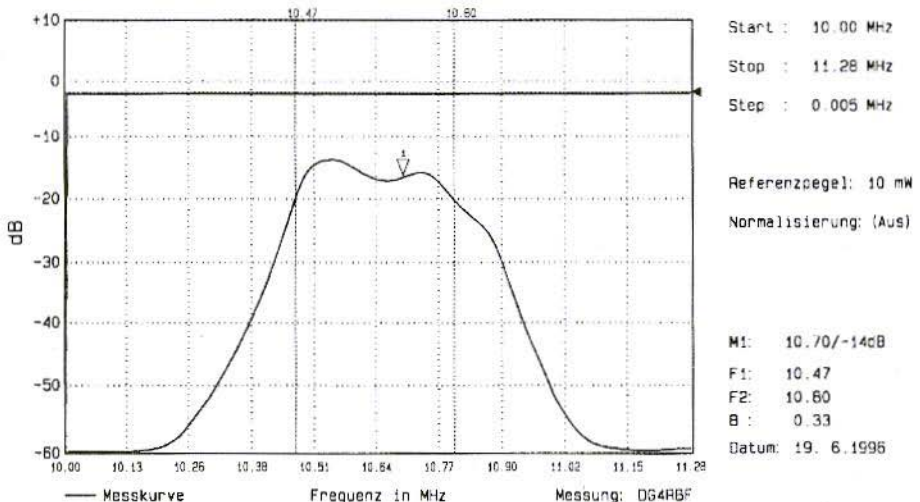
Since the PLL has to be re-programmed 255 times during wobbling, a wobble cycle lasts app. 23 seconds.

If large wobble steps are required, the PLL naturally needs some time to engage.

In addition, time is also taken up by data transmission and by the calculation of the scalers.

An additional "Delay" function can also be wired in for switching on, using key [6], "On" and "Off".

### Test Object: VCO-012 (with MAR8) regulated/unregulated

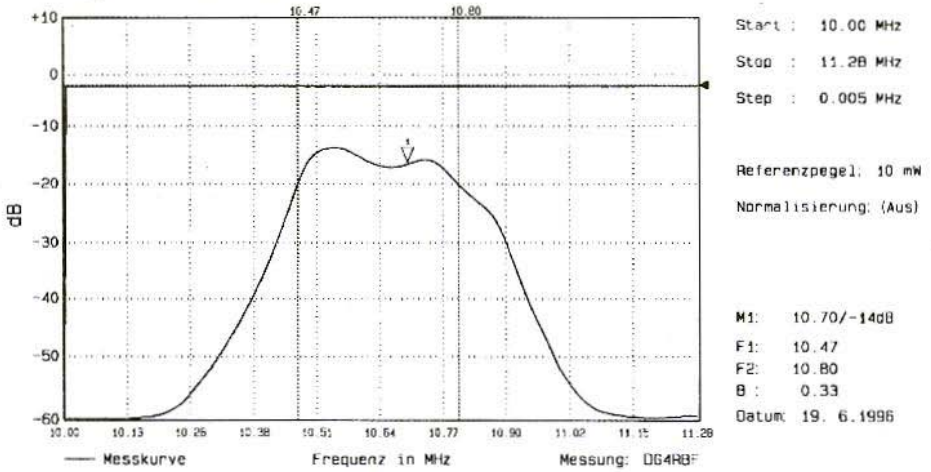


**Fig.27: Power Control Measurement Curve**  
*Referenzpegel = Reference level, Normalisierung = Standardisation,*  
*Datum = Date, Messkurve = Measurement curve,*  
*Frequenz = Frequency, Messung = Measurement*





**Test Object: Ceramic Filter**

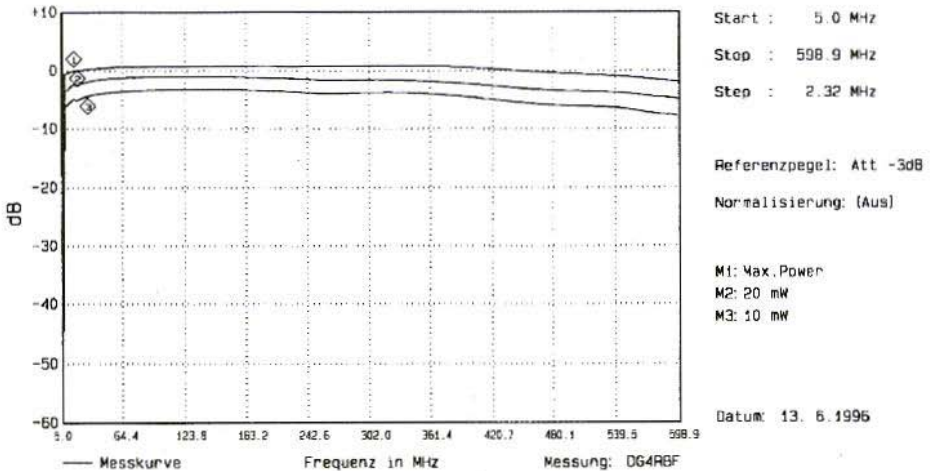


**Fig.28: Example of a Narrow-Band Wobble Measurement:**

**Ceramic Filter 10.7 MHz**

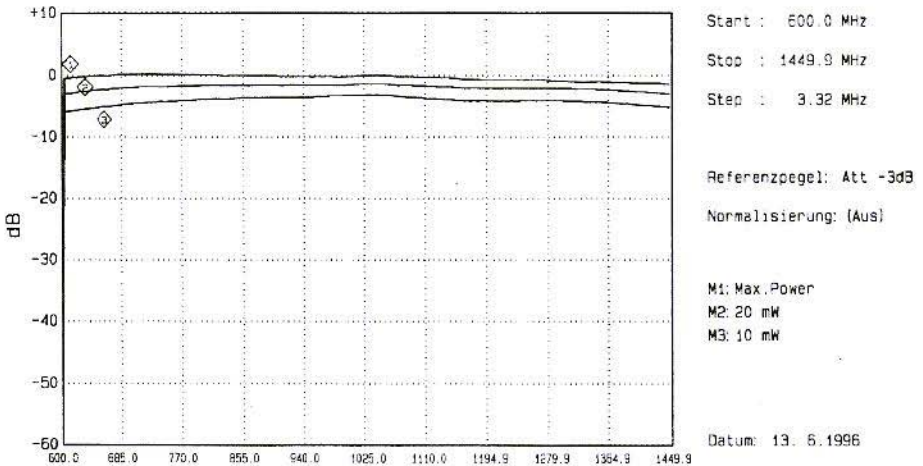
*Referenzpegel* = Reference level, *Normalisierung* = Standardisation,  
*Datum* = Date, *Messkurve* = Measurement curve,  
*Frequenz* = Frequency, *Messung* = Measurement

**Test Object: Wobble Curve Band (A)**



**Fig.29: Sufficiently Linear Power Curve over Band A**

*Referenzpegel* = Reference level, *Normalisierung* = Standardisation,  
*Datum* = Date, *Messkurve* = Measurement curve,  
*Frequenz* = Frequency, *Messung* = Measurement

**Test Object: Test Object: Wobble Curve Band (A)****Fig.30: Wobble Curve Output Power Band B**

*Referenzpegel* = Reference level, *Normalisierung* = Standardisation,  
*Datum* = Date, *Messkurve* = Measurement curve,  
*Frequenz* = Frequency, *Messung* = Measurement

If “Wobble Delay” is switched on, then an additional waiting loop - 25 ms. - is activated for wobble steps exceeding 0.5 MHz, which means that the PLL is given a little more time to engage and that the wobble process therefore takes about six seconds longer.

To allow a little scope for future expansion here, port 1 of the PLL-IC (pin-12), which is still free, has been programmed in such a way that it is at high level during the wobble process. This would make it possible, for example, to reduce the PLL’s engagement time during wobbling.

The HF power is not controlled during wobbling!

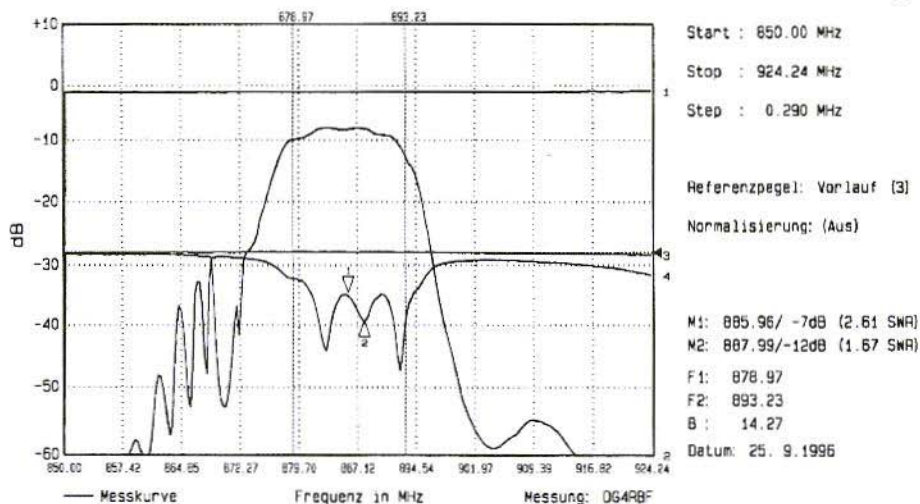
**3.4.2. Logarithmic Representation**

A wobble measurement is logarithmically represented as a rule, and should have as great a dynamic range as possible.

There are two options for logarithmic evaluation:

The first, and more elegant, way to do this is to use a high-value diode detector, with a logarithmic converter wired up subsequently, and to feed the DC voltage thus obtained to the AD converter.

The MCW 3000 HF-mW meter from Procom has proved an excellent piece of equipment for this area. It has a high-value diode detector and a very good logarithmic converter, with a dynamic range of up to 70dB. If this equipment



**Fig.31: Measurement Curve Band Filter with 60 dB Wobble Measurement**

#### Dynamic Range

*Referenzpegel* = Reference level, *Normalisierung* = Standardisation,  
*Datum* = Date, *Messkurve* = Measurement curve,  
*Frequenz* = Frequency, *Messung* = Measurement

is used as detector and logarithmic converter, a wobble measurement dynamic of app. 60dB can be obtained with a measurement power of 10mW (Figs. 31 and 32).

When connecting the logarithmic DC voltage to the AD converter, keep the following points in mind:

A voltage divider should be placed at the input of the AD converter to set a voltage of max. 5V.

The DC output earth of the mW meter must NOT be connected to the synthesizer earth, since otherwise an earth loop will be created which will influence the mW meter with the high measurement sensitivity.

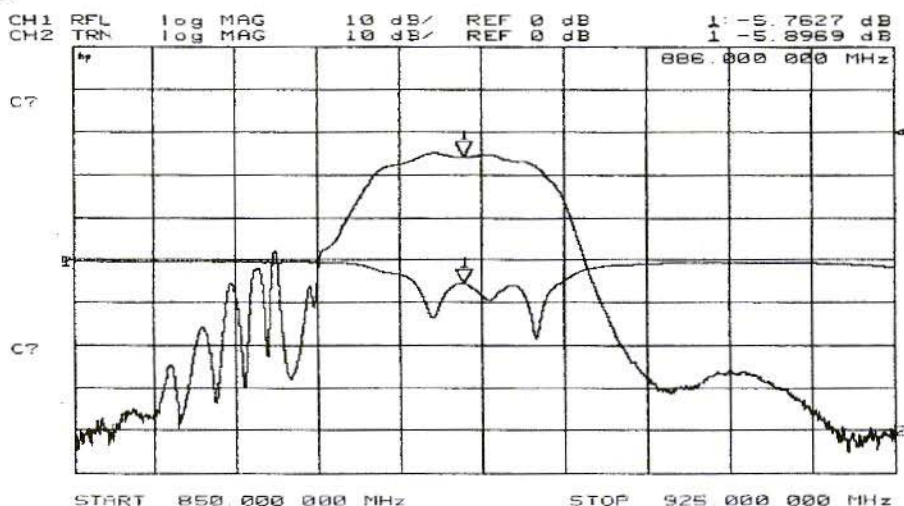
The DC voltage is fed in a coax cable to the synthesizer, but does not connect the cable earth with the synthesizer earth.

The second option is more favourably priced:

Use a home-made diode detector with a wide dynamic range - e.g. with an ISS99 diode, as described in [2] and [3], and subsequently wire up a simple DC voltage amplifier (Fig.33). The amplifier increases the voltage to 5 V and then feeds it to the AD converter. The HF-WOBB software then carries out the necessary logarithmic conversion.

The second option can give a dynamic of app. 30dB (Fig.34).

#### 3.4.3. Matching Measurements



**Fig.32: Comparison with Fig.31 - Here, Measurement using HP Network Analyser**

If we now expand the system by adding a directional coupler, we can also carry out matching measurements of filters, aerials, etc.

Incidentally, assembling a directional coupler on your own is a lot simpler with the wobble system of the synthesizer, since the frequency response, coupling attenuation and sharpness of directivity can easily be measured.

The HF-WOBB program is already orientated towards matching measurements, since the coupling attenuation, which is dependent on the frequency, can be compensated for through the standardisation function.

it is also possible to determine the voltage standing wave ratio, using the measurement cursor, since the reflection attenuation in dB can also be displayed as a VSWR.

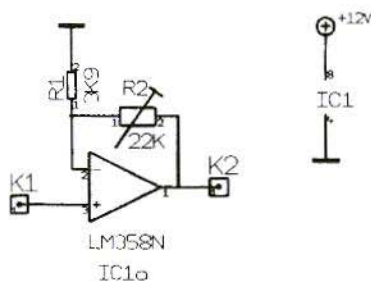
In this connection, see Fig.35. It shows

the matching (SWR) of the filter which was measured in Fig.31 using the wobble system.

This also has a strong influence on the optimising of DIY aerials.

Fig.36 shows how a matching measurement can be made for a home-made 70cm double-quad aerial with app. 10m. of coax cable:

Curve (1) is the forward motion, curve



**Fig.33: Simple DC Voltage Amplifier for Software Logarithmic conversion**



### Test Object: Filter 886 MHz (Software Log.)

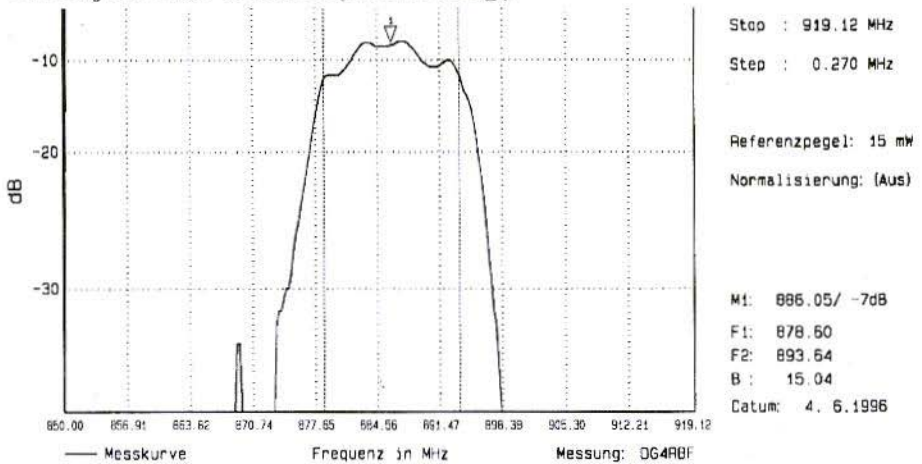


Fig.34: Logarithmic Conversion Software; Dynamic Range app. 30 dB  
*Referenzpegel* = Reference level, *Normalisierung* = Standardisation,  
*Datum* = Date, *Messkurve* = Measurement curve,  
*Frequenz* = Frequency, *Messung* = Measurement

(2) is the reverse motion, with a 50Ω moving load, and curve (5) shows the matching of the aerial (the distance between (1) and (2) is the sharpness of directivity of the directional coupler).

It can very easily be seen from this measurement curve that the aerial is optimally matched between 419 MHz and 428 MHz. The quad elements must therefore be shortened to be correctly matched for the 70cm. amateur band.

### 3.5. The Local Oscillator (LO)

No new additional circuit was designed for the LO, since many usable versions have already been published.

Most frequency synthesising systems for converters and GHz transmitters can be used, with some small changes.

The author, for example, uses a universal frequency synthesising system for GHz transmitters [4].

If a crystal is used at 117 MHz and if the stripline filter (1,278 MHz) is shortened by app. 1.5 - 2mm, an output frequency of 1,404 MHz can be obtained.

The local oscillator from W.Schneider [5] is likewise suitable. Here you need only the oscillator with the multiplier stages. The mixer with the MMIC's is not fitted.

## Test Object: Band Filter 886 MHz (Matched)

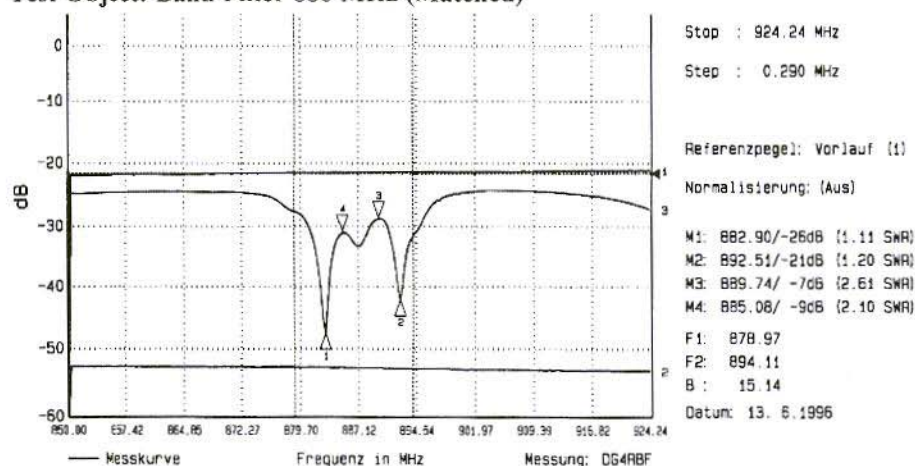


Fig.35: Matching Measurement (SWR) of a Filter

*Referenzpegel* = Reference level, *Normalisierung* = Standardisation,  
*Datum* = Date, *Messkurve* = Measurement curve,  
*Frequenz* = Frequency, *Messung* = Measurement

#### 4. DESCRIPTION OF SOFTWARE

The operational software for the HF synthesizer has been prepared with great care. It is stored in the equipment's EPROM.

When the HF synthesizer is switched on, the program responds with a brief running text, and then checks whether any data have already been stored.

If no set-up data are present, you are requested to enter the crystal frequency of the TCXO and the LO frequency.

Before you can carry out any power settings, you must first run through the two calibration programs, as described under "Putting HF section into operation".

The equipment is operated through a key field with the keys 0-9, the two special keys (\*) and (#), and the "Up/Down" keys.

The (#) key is used as a "Return" key. The (\*) key is normally used as the decimal point.

The selected frequency can be entered directly from the main window of the menu.

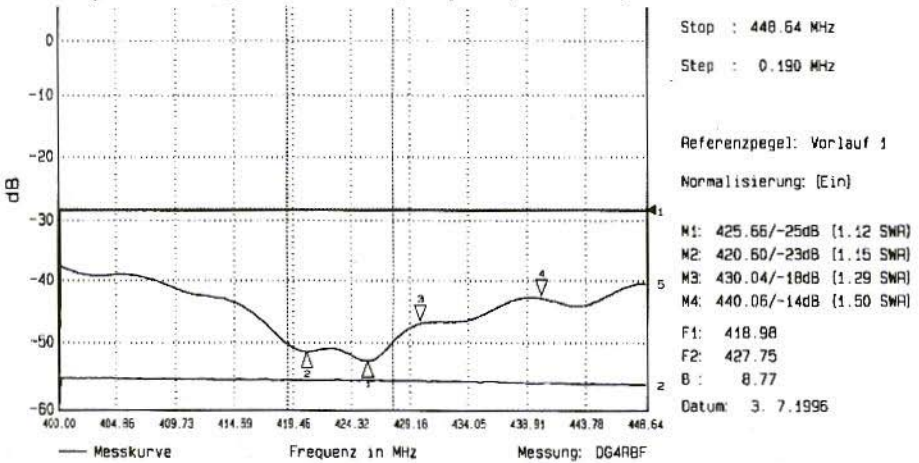
You can enter, for example, 600.000 MHz in two different ways:

- 600\*000: the star is used as the decimal point
- Or 0600 000: here the decimal point appears automatically after the fourth digit of the display

If you make a mistake and enter the wrong value, press the star key twice to delete the incorrect entry.



### Test Object: 70cm Quad Antenna (Frequency too low!)



**Fig.36: Matching Measurement of a Home-Made Aerial**  
**Referenzpegel = Reference level, Normalisierung = Standardisation,**  
**Datum = Date, Messkurve = Measurement curve,**  
**Frequenz = Frequency, Messung = Measurement**

The frequency entered is checked for validity, and is accepted only if it lies within the range of 5 - 1,450 MHz. Since the lowest frequency raster is 5 kHz, any input which diverges from the 5 kHz raster is automatically corrected.

If you press the "Return" key (#), you will find yourself in the menu, and you can then scroll forward and back using the "Up / Down" keys. To execute the selected menu item, press "Return" again (#). If you wish to alter the set power again - for example, because you have connected a 50Ω adapted load - simply press the star key, and the power value is reset.

The diagram "Operational Summary of Software" (Fig.37) gives a good picture of the software menu structure.

In addition to the main menu, there are also a set-up menu and a wobble menu.

#### 4.1. Explanation of Individual Menu

##### Items: Main Menu

##### **POWER:**

Enter the output power here in mW. If you enter 0.00mW, the PIN-diode controller is set to max. attenuation.

##### **STEP:**

The frequency can be adjusted in pre-selected steps, using the "Up / Down" keys. These frequency steps can be set here.

##### **SETUP:**

This takes you into the set-up menu.

##### **WOBBLE:**

This takes you into the wobble menu.

##### **END:**

Back to the main window.







## 4.2. Set-Up Menu

### **CRYSTAL:**

You can enter the crystal frequency of the reference oscillator here. The frequency is set in kHz - for example, 12800 kHz.

### **LO FREQUENCY:**

You enter the frequency of the local oscillator here in MHz - e.g. 1404.000 MHz.

### **BAND CHANGE:**

Here the frequency is set at which the switch has to be made between band (A) and band (B) - e.g. 600 MHz.

### **CALIBRATE POWER:**

Here the various power stages are gone through at one frequency, and the voltage obtained on the power detector is stored in the RAM.

The program pre-sets a specified power.

Then use the "Up / Down" keys to set the PIN-diode controller in such a way that the displayed power level also appears in reality at the HF output of the synthesizer.

Use [# = "Return" to store the setting. The program will move to the next power stage. If you press the star key [\*] instead of [#], the value is not stored.

The program runs through the following power stages: 0 / 0.5 / 1 / 2 / 3 / 4 / 5 / 6 / 7 / 8 / 9 / 10 / 12 / 14 / 16 / 18 / 20 / 22 / 24 / 26 / 28 / 30mW.

### **FREQUENCY RESPONSE:**

Here various frequency steps are gone

through, and the voltage which is shown on the power detector at 10mW is stored in the RAM. The program automatically sets the pre-selected frequency.

Here you need only use the "Up / Down" keys to set 10mW at the HF output of the synthesizer and confirm this using [# = "Return"].

If you press the star key [\*] instead of [#], the value is not stored.

The program runs through the following frequency steps: 5 / 10 / 20 / 50 / 100 / 140 / 200 / 250 / 300 / 350 / 400 / 430 / 500 / 550 / 600 / 650 / 700 / 750 / 800 / 850 / 900 / 950 / 1000 / 1050 / 1100 / 1150 / 1200 / 1250 / 1300 / 1350 / 1400 / 1450 / 1451 MHz.

### **END:**

Back to the main window.

## 4.3. Wobble Menu

### **START WOBBLE:**

You can use this to start the wobble process. The wobble range is pre-set by the start and stop frequencies.

### **START FREQUENCY:**

Here you enter the start frequency as a four-digit number in MHz; for 5 MHz, enter 0005 MHz. Errors can be deleted by pressing the star key. The frequency entered is checked for validity and is accepted only if it is equal to or exceeds 5 MHz and is smaller than 1450 MHz.

### **STOP FREQUENCY:**

Here you enter the stop frequency, also as a four-digit number, in MHz; for 600 MHz, you enter 0600 MHz. You can delete errors by pressing the star key. The frequency entered must be equal to



or exceed the start frequency, and must not exceed the band limit which is displayed in the entry window.

**END:**

Back to the main window.

---

## 5. CONFIGURATION

---

Specific basic configurations are already stored, and can be activated through "Reset" if a specific key is pressed at the same time.

Hold this key down for app. 3 seconds. When you release the key, the function activated by it is displayed in the LCD display.

The following configurations are possible:

**Key 1** = dBm ON (default setting)

The power specification is also converted into dBm and displayed.

**Key 2** = dBm OFF

The dBm display is switched off.

**Key 3** = Test Mode Max. Power

Here the pin-diode controller is set to max. power for test purposes (this function is deleted again when the synthesizer is switched off).

**Key 4** = Att ON (attenuator ON)

The UP / DOWN keys can now be used to set an attenuator.

The "dBm OFF" option also makes sense in combination with this function, since it can be used to select whether the attenuation set with the UP / DOWN keys is included in the dBm display, or whether the attenuation should be displayed only in the dB steps (- 10dB / - 20dB / - 30dB...).

**Key 5** = Att OFF (default setting)

The UP / DOWN keys are again used to set the frequency in pre-selected steps.

**Key 6** = Wobble delay ON / OFF

(ON = default setting)

With this key, the waiting loops for wobbling with large frequency steps are switched on and off.

If "wobble delay" is set to ON, the next time it is pressed the delay function is switched off, and vice versa.

**Key 7** = Max. wobble power ON

Wobbling is always carried out at max. power. If you use this setting, make sure the output stages are not saturated.

**Key 8** = Max. wobble power OFF

(default setting)

Wobbling is carried out at the power set.

**Key 9** = Short information on version

**Key 0** = Delete setup

The set-up data entered are deleted. The default settings are used once more.

This does not delete the calibrations!



## 6. POWER SUPPLY

As with many high-frequency circuits, here too the quality of the power supply plays an important role.

So as not to impair the signal quality unnecessarily, you must pay great attention to the following points:

- There should be good direct contact between the tinplate housings of the individual assemblies. This avoids earth loops which lead to an increase in the noise base.

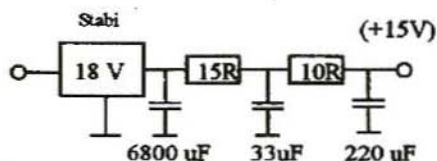
The following layout has proved itself. Mount the stabilisers on an aluminium backplate of the housing and bring the tinplate housings of the assemblies into direct contact with this earth-plate.

- The + 5 Volts power supply for the CPU should be generated from a separate transformer. It makes sense in terms of data security if the voltage for the micro-controller assembly is supplied with a slight delay in switching on (0.5 to 1 sec.).

- The transformers should be at least 25cm from the tinplate housings of the assemblies, since otherwise 50-Hz heterodyne effects of the signal become noticeable (perturbing radiation from transformer!).

To keep out of the way of this problem, we use (for example) a remote power pack. Here transformers, rectifiers and filter electrolytic capacitors are in a separate power pack housing. The DC voltages are then fed to the HF synthesiser through a multi-wire cable.

- The power supply for the broad-band VCO should have as little noise as possible! If a normal fixed voltage controller is used, it is absolutely necessary to have an RC module wired up subsequently.



The significant reduction in the noise base brought about by such simple RC filtering is shown by the print-outs of the signal at 1,400 MHz (Fig's.38 and 39). Or special low-noise circuits are used, as described in [6].

## 7. HF-WOBB PC PROGRAM

HF-WOBB is a program which was specially written for the HF synthesiser, and makes it into a slow-scan wobble system.

HF-WOBB is programmed entirely in graphics mode, and has "3-D keys", together with "3-D switch fields with LED's", which can very easily be activated using the mouse or the keyboard.

HF-WOBB receives the data from the synthesiser, which are transmitted from the micro-controller assembly during the wobble process, through the serial interface. It takes charge of the data preparation and provides a neat graphical representation, with frequency axis and dB lines.

## Test Object: HF Synthesiser (without RC Module)

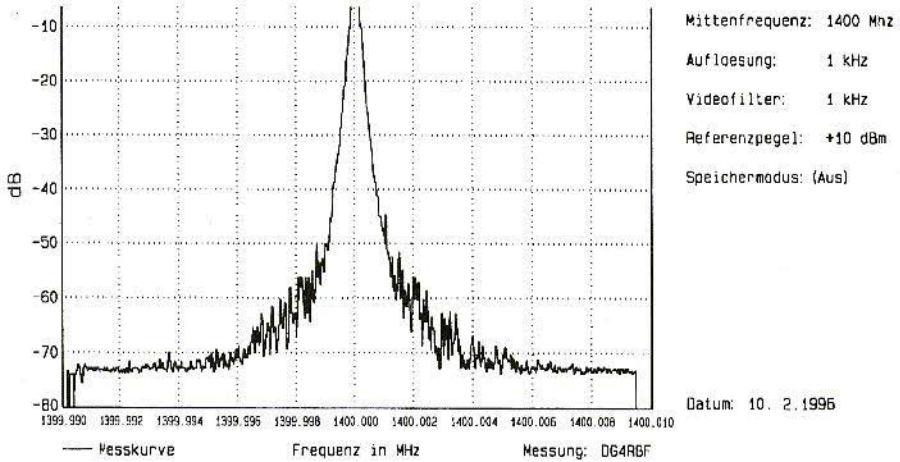


Fig.38: Signal of HF Synthesizer with Noise Base

Darstellbreite = Representation width, *Mittenfrequenz* = Medium frequency, *Auflösung* = Resolution, *Referenzpegel* = Reference level, *Speichermodus* = Memory mode, *Aus* = Off, *Messkurve* = Measurement curve, *Frequenz* = Frequency, *Messung* = Measurement, *Datum* = Date

## Test Object: HF Synthesiser (with RC Module)

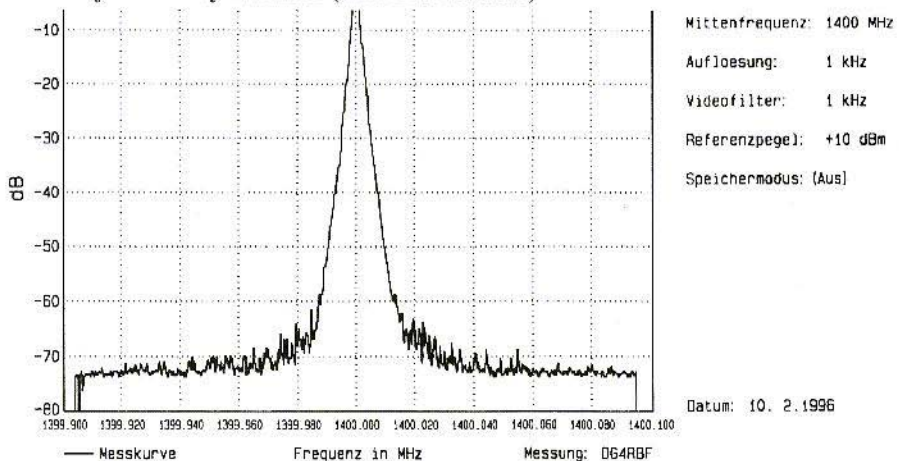


Fig.39: Decrease in Noise Base due to RC Filtering of Operational Voltage

Darstellbreite = Representation width, *Mittenfrequenz* = Medium frequency, *Auflösung* = Resolution, *Referenzpegel* = Reference level, *Speichermodus* = Memory mode, *Aus* = Off, *Messkurve* = Measurement curve, *Frequenz* = Frequency, *Messung* = Measurement, *Datum* = Date

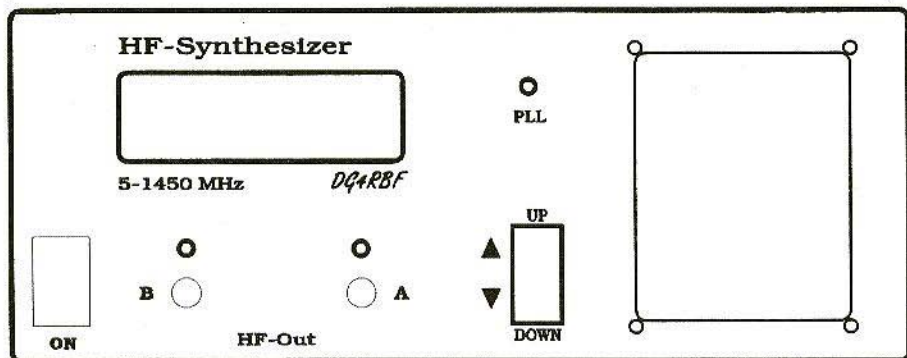


Fig.40: Example of Front Panel Design

The basic settings are given in a configuration file (HF-WOBB.CFG). Thus, for example, the horizontal dB lines can also be individually matched. This makes it possible to use other logarithmic converters as well, or to work with the software logarithmic conversion.

Here are a few sample characteristics.

- Up to 9 read-in curves can be superimposed.
- Curves stored in a selectable file.
- Frequency axis with scaling.
- dB scale individually matchable.
- Software logarithmic conversion possible.
- Standardisation function for reference line can be hooked up.
- Curves can be provided with up to 5 markers.
- Three types of markers are available: universal rectangle marker, measurement marker - triangle pointing upwards,
- measurement marker - triangle pointing downwards.
- Conversion and display of ref. attenuation in SWR possible.
- Superimposition of curve numbers on edge selectable (1-9).
- Freely positionable zero line for dB calculation of measurement markers.
- Touch-ON option for measurement markers. This makes it possible for measurement markers to be fed directly along the curve, as with expensive professional systems.
- Two vertical measurement lines with frequency and band widths, displays possible (very helpful for specifying band widths of filters).
- Superimposition of data during positioning of measurement cursor and measurement lines.
- Print-out for matrix printers and ink jet printers possible, but also:
- High-resolution graphics print-out for laser printer and plotter (HPGL).

- HPGL files for graphics and text programs such as - for example - Word or Coral Draw.
- Integration of a separate HPGL emulation program possible. This can make it possible to obtain a high-resolution print-out for matrix printers and ink jet printers as well.
- Can also be run on simple PC AT286 with a 640-KByte main memory and simple VGA graphics cards with 640 x 480 dots.

---

## 8. CONNECTION TO COMM-PORT OF PC

---

In order to bring the data from the HF synthesiser to the PC, we need only a 2-pin-line (data and earth). The best thing is to use a telephone line or a thin coax cable. Since the data are transmitted serially, there is absolutely no problem even if the lines are several metres long.

Connection to 9-pin-port:  
Data (R x D) pin-2 and earth pin-5

Connection to 25-pin-port: Data (R x D) pin-3 and earth pin-7

---

## 9. MECHANICAL STRUCTURE

---

When all the assemblies have been fully assembled and tested and are ready to function, they still have to be built into an appropriate housing. The prototype

was incorporated into a plastic shell housing from Bopla.

Fig.40 gives an example of how the front panel design and legends can be laid out.

The required power pack is mounted in a remote housing, as described under 6.

The voltage can be fed in, for example, through a SUB-D plug and socket connection at the back of the apparatus.

---

## 10. APPENDIX

---

Here are a few technical data regarding the VNA25:

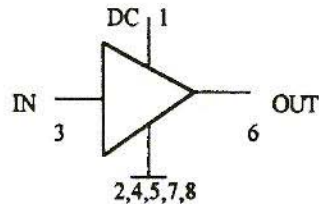
Freq. (GHz) / gain (dB) typ. / max. output (dBm):

0.5 - 0.8	/ 14.0	/ + 18.0
0.8 - 1.0	/ 17.0	/ + 18.5
1.0 - 2.0	/ 18.0	/ + 17.5
2.0 - 2.5	/ 16.0	/ + 17.0

Operating voltage: + 5.0V DC

Current consumption: typ. 85mA (105mA max.)

Pin-configuration:





## 11. LITERATURE REFERENCES

- [1] Dr. Ing. Jochen Jirmann, DB1NV: Broad-Band VCO's in Microstrip Technology  
VHF Communications 4/92,  
Pp. 194-203
- [2] Carsten Vieland, DJ4GC: Diode Detectors in 50Ω Broad-band Technology  
VHF Communications 2/88  
Pp. 111-125
- [3] Wolfgang Schneider, DJ8ES: VHF, UHF, SHF Measurement Technology using a PC  
Part 2: mW-meters from Short Wave to SHF  
VHF Communications 4/96,  
Pp. 206-214
- [4] Gerd Wehrhahn, DD9DU: CQ-DL 1 / 1986
- [5] Wolfgang Schneider, DJ8ES: VHF, UHF, SHF Measurement Technology using a PC  
Part 4: HF Measurement Position up to 1.4 GHz  
VHF Communications 3/97,  
Pp. 152-166
- [6] Volker Esper, DF9PL: Highly Stable, Low-Noise Power Supply  
VHF Communications 1/93,  
Pp. 19-37
- [7] Peter Baier, DJ3YB: Frequency Synthesis Circuits based on Mobile Radio Module PMB 2306  
VHF-UHF Congress 1994 Munich
- [8] Siemens Data Sheets: PMB 2306, PMB 2313, PMB 2314

## The Parabolic 24cm Preamplifier

**A fully weather-proofed very high-quality preamplifier covering 1200 MHz to 1360 MHz. Mounted in a sealed diecast enclosure with weatherproof N-type sockets for input and output. DC powered via the output socket for remote mast-head mounting.**

**GAIN >40dB across the band**

**NOISE FIGURE <1.6dB**

**£135 + £7.50 post and packing**

**KM Publications, 5 Ware Orchard, Barby, Nr.Rugby,  
CV23 8UF, U.K.**

**Tel: 01788 890 365; Int: +44 1788 890 365**

**Fax: 01788 891 883; Int: +44 1788 891 883**

**ALL MAJOR CREDIT CARDS ACCEPTED - above prices +5%**

Carl G. Lodström SM6MOM - KQ6AX; lodis@pressebo.com

# Measurements on Ceramic Resonators

---

## 1. BACKGROUND

---

Recently I designed some filters based upon ceramic resonators. After modelling the filters in *SuperStar Pro*, I came up with frequencies for the resonators, as well as the capacitances they should be coupled with.

Expecting no problems I went ahead and ordered samples from a few leading manufacturers of ceramic resonators here in the US. They arrived and one supplier even had a list of the frequencies they had measured up on the samples. I now know that a spread of  $\pm 5$  MHz is pretty good in my range of 1600 to 1700 MHz. The resonators are 6 x 6mm size, about 7mm long and made of a  $\epsilon_r=38$  material. This gives a  $\lambda/4$  shorted coaxial resonator with  $Z_0 = 9.4\Omega$  and an unloaded Q of about 600.

I assembled my filter and it did not look good. It was way off in frequency for one thing!

Something was very wrong. I proceeded to measure the resonant frequencies of the resonators with a Vector Network Analyser. The problem immediately arose: how do one measure these resonators? A call to each supplier revealed that they too used Vector Network Analysers and measured the frequency by sticking a little wire, the centre pin of the connector in a test fixture, into the hole in the middle of the resonator. From the non-metallized end of the resonator. They then pushed the resonator up on the pin until the capacitive coupling got large enough for the response to cut through the middle of the Smith Chart. Then they moved the marker to this point and read off the frequency.

I built a little fixture and repeated the feat. Now I observed that the frequencies from the two suppliers did not agree with each other or with my measurements!





## 2.

### THE PROBLEM

---

I modelled the fixture with resonator in *SuperStar Pro* and found the capacitance had to be in the vicinity of 0.15pF for to give this much coupling, also enough for to pull the resonator down by at least 15 MHz! The thickness and length of the wire also mattered. For a thinner wire; more length is needed, but more inductance is introduced as well. And the other way around. The method is not very 'scientific'.

Then the resonators should be fitted with little tabs soldered into the holes. The capacitance of this I found lowered the frequency by 6 MHz and required another kind of test fixture with a little fork instead of a wire. The resonator tab is now slid in between the prongs of the fork. More possibilities for errors!

Several tours of samples and trials followed, the 'theoretical' frequencies from *SuperStar Pro* were tweaked by +15 MHz, more samples were ordered and time was fleeting fast. It became more and more obvious that another method for to measure the resonators was needed. Not only did it take a long time to wait for samples, although one can grind down (up in frequency) the resonators on a sandpaper, but in the meantime one may loose the market for the filters.

Obviously it is too much load on the resonator with 0.15pF. The equivalent circuit for a 1650 MHz resonator is 8.04pF and 1.16nH with 7.2k $\Omega$  in parallel.

Transtech, a subsidiary of Alpha Industries (e-mail: transtech@alphaind.com) has a nice Design Guide program on a disk (and probably on their web site as well) that calculates these resonators as well as "puck" resonators, cavities and tuning screws.

---

## 3.

### SOLUTION

---

It dawned on me that some kind of transformer was needed. The VNA needs to see a low impedance, and the resonator needs to see a high one. A  $\lambda/4$  transmission line, or even such an "antenna" might do it! I fired up *SuperStar Pro* again and put in a slab line kind of transmission line. It is a round wire above ground. I found that the method ought to work just fine with a 43mm wire for my ~1650 MHz resonators. I built one fixture and it worked just like predicted! The pull is now only about 0.5 MHz. The resonator can have a tab or not, it does not matter, the coupling wire is so far from the open end that it does not matter. Neither do the resonator need to be positioned with any accuracy. When you get a reading on the VNA, that's it! A sweeper with a directional coupler for S11 will do just as well as the Smith Chart on a VNA, saving about \$65,000... It's even easier. Now you are in business!

I realised that the solution I came up with may be of general interest, so I decided to write this article. I am

probably not the only one who have had these problems!

A 1dB dip in S11 should be more than sufficient for detection, the wire length and coupling capacitances for this are listed below for some frequencies and a 0.1mm diameter wire: (Notice, the coupling capacitance is in fF!  $10E^{-15}$ ).

f (GHz)	C (fF)	l (mm)
0.5	1.0	1.5
2.0	2.5	3.0
3.5	17	8
5	4.1	3.3
2.7	2.3	148
74.1	49.5	37.1
29.6	24.7	21.2

The diameter of the wire is not important, but it got to be small! I used a 0.1 mm wire, although =SS= claims that a 0.05mm wire would give considerably more sensitivity => even less coupling needed. But 0.1mm is good enough though since the values above gave less than 1 MHz pull.

The length is by no means critical either. The little loop the resonator creates on the Smith Chart goes in from the periphery, and the diameter of it follows the resistance circles, so it is

largest at  $180^\circ$ , but large enough to be seen (in a S11 plot as well) over  $\pm 120^\circ$ . The values above gives the exact length for the listed frequencies.

In reality the wire radiates and has skin effect losses as well, so the loop does not have its base at the periphery of the Smith Chart (S11 is not 0dB outside resonance), but it can be read without problems anyway.

In the simulation model shown in Fig.1, a  $100^\circ$  line corresponds to the connector body for rotation of the Smith Chart plot to the one observed on the VNA. There is the wire probe and a "fake" resistor. The resistor helps to simulate the radiation losses. The *SuperStar Pro* program will not run without an output anyway, so I connected the resistor to this  $50\Omega$  output. You can see a 6fF capacitor coupling to the resonator.

#### 4. SUMMARY:

A method for measuring the self resonant frequencies of (ceramic) resonators has been described.

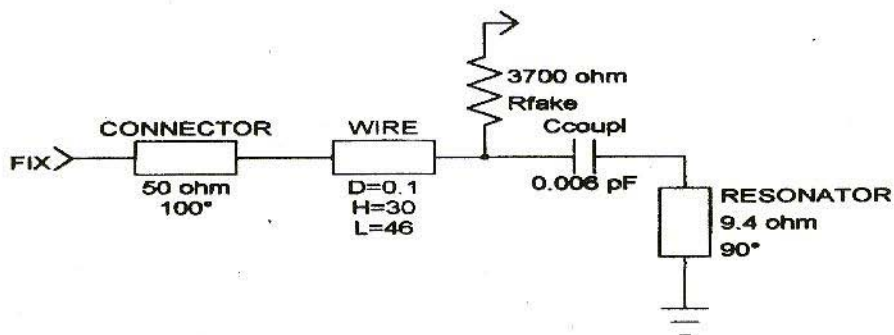
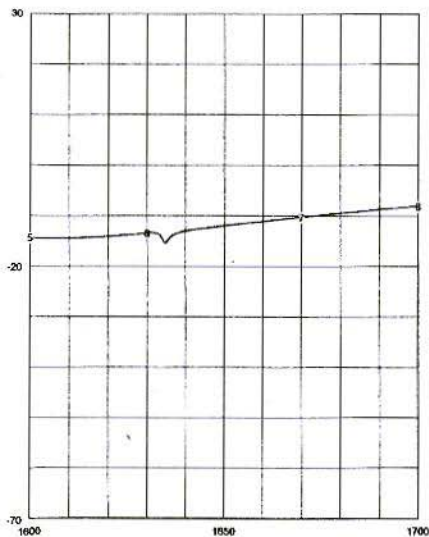
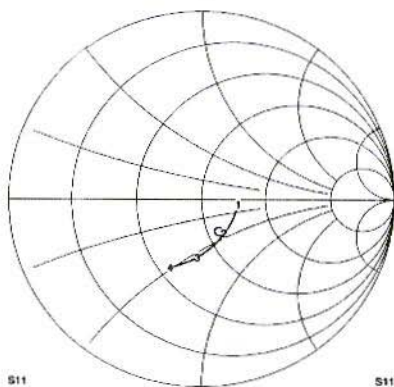
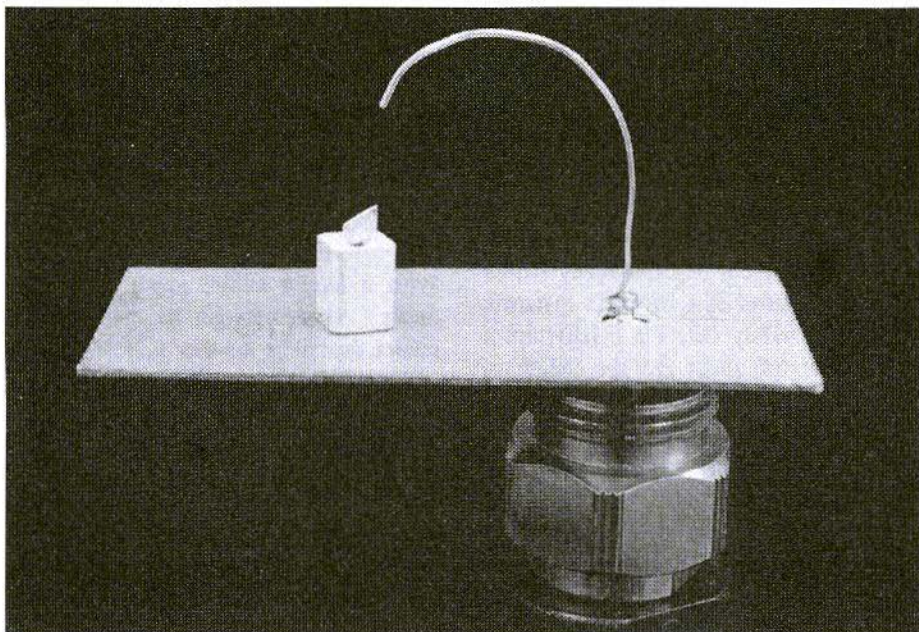


Fig.1: The *SuperStar Pro* Model



S11		S11	
1600	1630	1670	1700
-14.4017	-13.4639	-10.2268	-8.05699
-14.4017	-13.4639	-10.2268	-8.05699

S11			
1600	1630	1670	1700
-14.4017	-13.4639	-10.2268	-8.05699
0	0	0	0

Fig.2: The SuperStar Pro Simulation



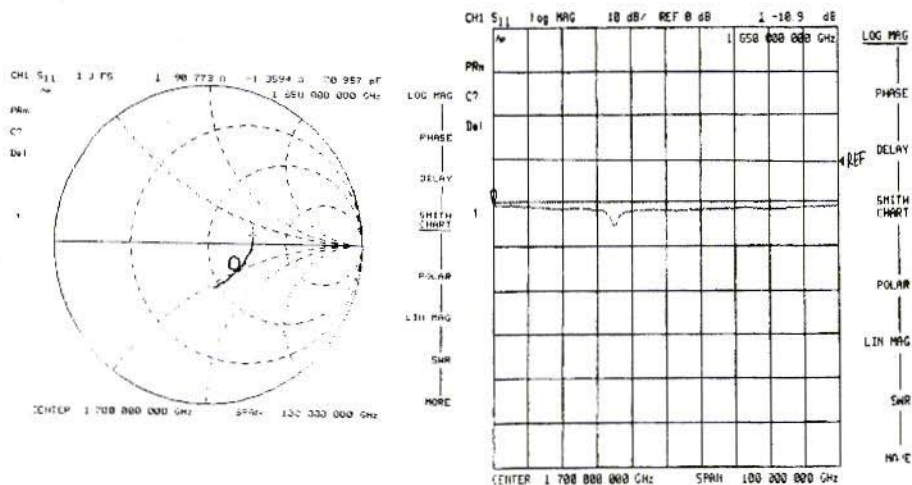
It is sensitive, simple and accurate, as well as at least magnitude of order faster than the prevalent method. It even lends itself to automated sorting.

It is most likely applicable to other kinds of resonators as well, i.e. helices in helix filters. A  $\lambda/4$  transmission line, with an open end, can easily be assembled for just about any frequency with a lab cable instead of a wire, for instance. If one can safely detect a 0.1dB dip, a 50Ω cable (of about 2/3 the length of the wire) should work also with 10 -

15fF coupling to a resonator like the ones I use.

Pull is then about -1 MHz. Although a ( $\lambda/4$  coaxial cable does not have the high Zo of a thin wire, it still transforms a high impedance of the open end (and it's diminutive loading) to a low impedance at the other end.

With a longer cable, much lower frequency resonators can be measured. A quartz crystal is another animal. It may still get pulled too much!



**Fig.3:** Actual measured values, to which the model was “tweaked”. The S11 plot to the right has a vertical range from -70 to +30dB. About 11 - 12dB return loss is observed due to radiation and skin effect losses.

# VHF Communications Back Issues

Back issues of VHF Magazine are available

Issues available:

- 1, 3, 4/1975 \* 3/1976
- 1, 2/1978 \* 1, 3/1979
- 1, 4/1980 \* 1, 2/1981 \* all 1983 to 1987
- 1, 3, 4/1988 \* 1, 2/1989 \* 1/1990 \* all 1992 to 1996

Price includes shipping for Air Mail add £0.75 per order +5%

*A complete set of available issues to 4/1996 plus shipping at cost*

Units, 5 Ware Orchard, Barby,  
 Rugby, CV23 8UF, UK  
 Tel: 01827 890365 Fax: (0)1788 891883  
 Email: [info@vhfcomm.co.uk](mailto:info@vhfcomm.co.uk) Secure WWW Form   
<http://www.vhfcomm.co.uk/saleform.htm>

**SEE SPECIAL OFFER INSERT**

# THE G8OZP RANGE OF MICROWAVE KITS FOR AMATEUR TELEVISION

## ASSEMBLED GUNNMOD2 3cm ATV TRANSMITTER PCB & KIT

Gunnmod2 PCB forms the heart of a compact, fully featured FM. Gunn diode PAL, SECAM, or NTSC Amateur Television Transmitter with 5.5, 6.0 or 6.5 MHz intercarrier sound. The PCB is suitable for most types of 3cm and other frequency Gunn oscillators up to 25mW (up to 300mW Gunn oscillators may be used with the addition of one extra transistor). The single 3 by 2 inch quality PCB incorporates a stable, adjustable Gunn diode modulator with video pre-emphasis and adjustable deviation, together with a stable intercarrier sound generator with selectable pre-emphasis, audio limiting, input level control and output filtering. The PCB requires a single 10 - 15V DC unregulated supply and consumes only 20mA, excluding the Gunn diode. This makes it ideal for portable or mast head use.

- PCB with full instructions - you supply components, Gunn Osc, case, connectors, etc..... £ 7.50**  
**Kit with full instructions - you supply Gunn Osc, case, connectors, etc (Note 1)..... £ 25.00**  
**Kit with Gunn oscillator - you supply case, connectors, etc. (Notes 1 & 2) ..... £ 35.00**

*Note 1:* Please state 5.5 MHz, 6.0 MHz or 6.5 MHz audio sub carrier frequency. (6 MHz standard) *Note 2:* At present Gunn oscillators are good tested surplus units. Gunn oscillators are WG16 square flange mounting, 8 - 12mW output and pre-tuned to 10.340 GHz, other frequencies at request. 8 - 12mW oscillators, when equipped with a suitable antenna and a low noise RX are capable of providing line-of-site transmissions well in excess of 100Km. With minor modifications this TX may be used to transmit data.

## 3cm LNB's

Low Noise Block receive converters have been the main contributive factor that has opened up the 3cm band to ATV and other modes. With the low receive noise figures now available, transmissions are no longer restricted to clear line-of-sight paths. Test transmissions have conclusively shown that over the horizon transmissions by various propagation modes are now possible. None line-of-sight transmission by means of scatter from rain clouds has also been achieved. Equipped with suitable antenna systems, etc., operation well in excess of 100km is readily achievable. Integral feed horn types will fit directly on to standard offset satellite dishes with a 38 - 40mm mount.

- Brand new with integral feed horn 0.7dB noise figure ..... £ 50.00**  
**Brand new with integral feed horn 1.0 - 1.2dB noise figure..... £ 45.00**  
**Brand new with integral 20dB antenna 0.8db noise fig. .... £ 60.00**  
**Brand new 22mm circular input 0.7db noise figure ..... £ 55.00**  
**Brand new 22mm circular input 1.0db - 1.2db noise figure ..... £ 50.00**

All LNB's. are fully tested with the local oscillator at 9.0GHz  $\pm 0.01\%$  (this is often better than original). Other local oscillator frequencies available by request. Horizontal or vertical polarisation is selected by applying either approximately 13 or 1BV DC.



## ASSEMBLED DOVE ATV TUNEABLE IF / RECEIVER KIT

The Dove ATV Tuneable IF/RX forms the ideal heart of an ATV receiving system for either 24cm (see note) or the higher bands when used in conjunction with a suitable Low-Noise-Block Converter. It is designed as a compact easy to construct unit that requires no adjustment, setting up, or alignment. The kit contains all board mounted components and full instructions. The only other requirements are a case, power and output connectors, four potentiometer controls (all 10k lin) and a switch (SPST). The unit has been designed on a flexible modular concept. Plug-in modules are being developed which include: a fully tuneable sound demodulator, plus single and multichannel synthesisers. Unprocessed DC-coupled baseband output is provided for expansion into data reception or multiple subcarrier demodulation. An AGC output is provided for signal strength, etc. A divided by 256 local oscillator signal is also available.

Size:	105mm wide x 97mm deep x 50mm high
Power:	11 - 14v DC @ 400mA
Frequency Range:	925 - 1800 MHz
Sensitivity:	-57dBm (300µV)
Audio Subcarrier:	6 MHz
Video Bandwidth:	25 Hz to 3-5.5 MHz Variable
Video Outputs:	1V P-P Composite Unprocessed Baseband
Audio Output:	1.5 W into 4Ω minimum
Controls:	Main Tuning, Volume, Video Gain, Video Bandwidth, LNB Power ON/OFF
LNB / Preamp Power:	12V DC Switched
Connections:	RF Input F-type, all others 0.1" pitch (supplied)
Mounting:	Fixing pilot hole in each corner

*NOTE: When used as a 24 cm Receiver unless the signal is a strong local one a preamp will be required.*

**DOVE RECEIVER KIT..... £ 57.00**

## 24cm HEMT GaAsFET ATV PREAMP

Satellite receivers are basically tuneable IF units which require, for satisfactory operation, input signal levels of many millivolts. In a satellite installation most of the RF gain is provided by the dish mounted LNB. This means that if used on the 24cm band, unless they are used only for local working, they will require a high-gain pre-amp at the front end to compensate for the gain normally provided by the LNB. This 24cm low-noise, high-gain pre-amp is designed specifically for ATV use, but may be used on any modes if required. Micro striplines plus Helical band pass filter make alignment very simple and greatly reduces the possibility of interference from out of band signals.

1dB noise figure HEMT GaAsFET front end, 40db gain.

12 - 20V DC supply via coax. (from satellite RX etc.) or separate feed if required. Sturdy tin plate enclosure. High quality BNC connectors. Very simple to align.

*Note:* This kit contains some surface mount components. TX/RX switching is not included

**Complete Kit..... £ 77.50**  
**Fully assembled, aligned & tested..... £ 90.00**

**Shipping charges at cost**

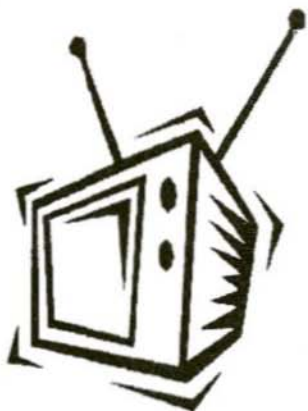
**Credit Card orders +5%.**

**KM Publications, 5 Ware Orchard, Barby, Nr.Rugby, CV23 8UF, U.K.**

**Tel: (0)1788 890365**

**Fax: (0)1788 891883**

**E-mail: [vhfsales@vhfcomm.co.uk](mailto:vhfsales@vhfcomm.co.uk)**



**Interested in the  
Technical Side  
of Television?**

# B.A.T.C.

*Over four decades of Television Service*



**CQ-TV Magazine is for you,  
packed full of practical and  
easy to build circuits for the  
Radio Amateur and Video  
Enthusiast.**

**For details, contact the BATC at  
Grenehurst, Pinewood Road,  
High Wycombe, Bucks,  
HP12 4DD, England**



**Internet <http://www.batc.org.uk>**





## COMPLETE KITS & PCB's

KIT	DESCRIPTION	ISSUE	No.	PRICE
DG4RBF-003	HF Synthesiser 5 to 1450 MHz, TCXO	2&3/98	-----	£135.00
DG4RBF-004	HF Synthesiser 5 to 1450 MHz, Processor	2&3/98	-----	£125.00
DG4RBF-005	HF Synthesiser 5 to 1450 MHz, Bus Driver	2&3/98	-----	£ 12.00
DG4RBF-006	HF Synthesiser 5 to 1450 MHz, Regulator for VCO	2&3/98	-----	£ 12.00
HF-WOBB	Software for PC: HF-WOBB	2&3/98	-----	£ 55.00
KOMBI	EPROM HF-SYNTH + Software HF-WOBB	2&3/98	-----	£ 85.00
DC8UG-007	5W PA for 13cm	3/94	06938	£286.00
DJ8ES-019	Transverter 144/28 MHz	4/93	06385	£143.00
DJ8ES-019mod	Transverter 50/28 MHz	2/95	06392	£143.00
DJ8ES-020	Hybrid Amplifier for 144 MHz	1/94	06387	£179.00
DJ8ES-021	13cm FM ATV Exciter	2/94	06388	£ 67.00
DJ8ES-022	28/432 MHz Transverter Oscillator	2/95	06395	£ 59.00
DJ8ES-023	28/432 MHz Transverter Converter	2/95	06396	£114.00
HF-MESS	PC Software for the DJ8ES projects	TBA	-----	£ 32.50
OE2TLZ 001	PreMixer for 23 and 13cm	1/97	-----	£115.00
YT3MV	Low Noise L-Band Aerial Amplifier	2/92	06358	£ 29.80
PCB	DESCRIPTION	ISSUE	No.	PRICE
DG4RBF-003	HF Synthesiser 5 to 1450 MHz, TCXO	2&3/98	-----	£ 18.00
DG4RBF-004	HF Synthesiser 5 to 1450 MHz, Processor	2&3/98	-----	£ 17.00
DG4RBF-005	HF Synthesiser 5 to 1450 MHz, Bus Driver	2&3/98	-----	£ 5.00
DG4RBF-006	HF Synthesiser 5 to 1450 MHz, Regulator for VCO	2&3/98	-----	£ 5.00
DC8UG-PA	5W PA for 13cm	3/94	06936	£ 19.25
DC8UG-NT	Power Supply for the PA	3/94	06937	£ 7.75
DJ8ES-019	Transverter 144/28 MHz	4/93	06384	£ 17.75
DJ8ES-020	Hybrid Amplifier 144 MHz	1/94	06386	£ 17.25
DJ8ES-021	13cm FM ATV Exciter	2/94	-----	£ 18.50
DJ8ES-022	28/432 MHz Transverter Oscillator	2/95	-----	£ 16.50
DJ8ES-023	28/432 MHz Transverter Converter	2/95	-----	£ 16.50
DJ8ES-027	Milliwatt Meter for the PC	4/96	-----	£ 13.50
DJ8ES-028	0.9 - 1.5 GHz Synthesiser for the PC	1/97	-----	£ 13.50
DJ8ES-029	Interface Card	3/97	-----	£ 15.00
DJ8ES-030	VCO with PLL	3/97	-----	£ 15.00
DJ8ES-031mod	Mixer / LO	2/98	-----	£ 15.00
DJ8ES-032	Pin Diode Controller	3/97	-----	£ 15.00
DJ8ES-033	A/D Converter with Detector	4/97	-----	£ 15.00
DJ8ES-034	Direct Mixer with Logarithmic Display	4/97	-----	£ 15.00
HF-MESS	Software for the DJ8ES PC projects	TBA	-----	£ 32.50
OE2TZL-001	PreMixer for 23 and 13cm	1/97	-----	£ 15.00

Minimum Shipping charge £6.75 \* Credit Card orders +5% \* Address data at bottom of Contents page



# VHF COMMUNICATIONS

*A Publication for the Radio Amateur Worldwide*

*Especially Covering VHF, UHF and Microwaves*

Volume No.30

Autumn

Edition 1998-Q3

## Publishers

KM PUBLICATIONS,  
5 Ware Orchard, Barby, Nr.Rugby,  
CV23 8UF, United Kingdom  
Tel: +44 1788 890365  
Fax: +44 1788 891883

Email:  
michael.j@vhfcomm.co.uk

## Editor

Mike Wooding G6IQM

## VHF COMMUNICATIONS

The international edition of the German publication UKW-Berichte is a quarterly amateur radio magazine, especially catering for the VHF/UHF/SHF technology. It is owned and published in the United Kingdom in Spring, Summer, Autumn and Winter by KM PUBLICATIONS.

The 1998 subscription price is £18.00, or national equivalent. Individual copies are available at £4.75, or national equivalent each. Subscriptions should be addressed to the national representative shown in the next column. Orders for individual copies of the magazine, back issues, kits, binders, or any other enquiries should be addressed directly to the publishers.

**NOTICE:** No guarantee is given that the circuits, plans and PCB designs published are free of intellectual property rights. Commercial supply of these designs without the agreement of the Author and Publisher is not allowed. Users should also take notice of all relevant laws and regulations when designing, constructing and operating radio devices.

## © KM PUBLICATIONS

All rights reserved. Reprints, translations, or extracts only with the written approval of the publishers

Translated by: Inter-Ling Services,  
62 Caldecott Street, Rugby,  
CV21 3TH, UK

Printed in the United Kingdom by:  
Cramphorn Colour Printers Ltd.,  
15c Paynes Lane, Rugby.

AUSTRALIA - W I A. South Australia Division, GPO Box 1234, Adelaide, SA 5001, Australia. Tel/Fax: 8 8522 4859

BELGIUM - UKW-BERICHT, POB 80, D-91081 BAIERSDORF, Germany. Tel: 09133-77980. Fax: 09133-77983. Postguro Nbg. 30445-858.

DENMARK - KM PUBLICATIONS, 5 Ware Orchard, Barby, Nr.RUGBY, CV23 8UF, UK. Tel: +44 788 890365. Fax: +44 788 891883. Email: vhfsubs@vhfcomm.co.uk

FRANCE - Christiane Michel F5SM, SM ELECTRONIC, 20bis Avenue des Clairons, F-89000 AUXERRE, France. Tel: (86) 46 96 59

FINLAND - KM PUBLICATIONS, 5 Ware Orchard, Barby, Nr.RUGBY, CV23 8UF, UK. Tel: +44 788 890365. Fax: +44 788 891883. Email: vhfsubs@vhfcomm.co.uk

GERMANY - UKW-BERICHT, POB 80, D-91081 BAIERSDORF, Germany. Tel: 09133-77980-Fax: 09133-77983.

GREECE - KM PUBLICATIONS, 5 Ware Orchard, Barby, Nr.RUGBY, CV23 8UF, UK. Tel: +44 788 890365. Fax: +44 788 891883. Email: vhfsubs@vhfcomm.co.uk

HOLLAND - KM PUBLICATIONS, 5 Ware Orchard, Barby, Nr.RUGBY, CV23 8UF, UK. Tel: +44 788 890365. Fax: +44 788 891883. Email: vhfsubs@vhfcomm.co.uk

ITALY - ADB ELETTRONICA di Luchesi Fabrizio IWSADB, Via Vecchia Romana 266, 55100 ANTRACCOLI (LUCCA), Italy. Tel: 0583 952612 Fax: 0583 91109

NEW ZEALAND - Judith Holland, AUCLAND VHF GROUP Inc., P.O. Box 10 138, AUCLAND 1030, New Zealand. Tel: 0 9 412 7659

NORWAY - WAVELINE AB, Box 60224, S-216 09 MALMO, Sweden. Tel: +46 40 16 42 66. Fax: +46 40 15 05 07. GSM: 0705 16 42 66. e-mail: waveline@algonet.se <http://www.algonet.se/~waveline>

SOUTH AFRICA - KM PUBLICATIONS, 5 Ware Orchard, Barby, Nr.RUGBY, CV23 8UF, UK. Tel: +44 788 890365. Fax: +44 788 891883. Email: vhfsubs@vhfcomm.co.uk

SPAIN & PORTUGAL - JULIO A. PRIETO ALONSO EA4CJ, Donoso Cortes 58 5<sup>a</sup> -B, MADRID 15, Spain. Tel: 543 83 84

SWEDEN - WAVELINE AB, Box 60224, S-216 09 MALMO, Sweden. Tel: 040 16 42 66. Fax: 040 15 05 07. GSM: 0705 16 42 66. e-mail: waveline@algonet.se <http://www.algonet.se/~waveline>

SWITZERLAND - KM PUBLICATIONS, 5 Ware Orchard, Barby, Nr.RUGBY, CV23 8UF, UK. Tel: +44 788 890365. Fax: +44 788 891883. Email: vhfsubs@vhfcomm.co.uk

UNITED KINGDOM - KM PUBLICATIONS, 5 Ware Orchard, Barby, Nr.RUGBY, CV23 8UF, UK. Tel: +44 788 890365. Fax: +44 788 891883. Email: vhfsubs@vhfcomm.co.uk

U.S.A. - GENE HARLAN, ATVQ Magazine, 5931 Alma Drive, Rockford, IL 61108, USA. Tel: Toll free USA only: 800 557 9469, Elsewhere: +1 815 398 2683; Fax: +1 815 398 2688. Email: atvq@aol.com

ELSEWHERE - KM PUBLICATIONS, address as for the U.K.

WWW: <http://www.vhfcomm.co.uk>

ISSN 0177-7505

# AFFORDABLE SOFTWARE FOR PRO AND AMATEUR

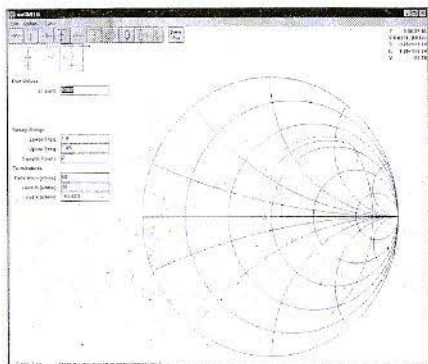
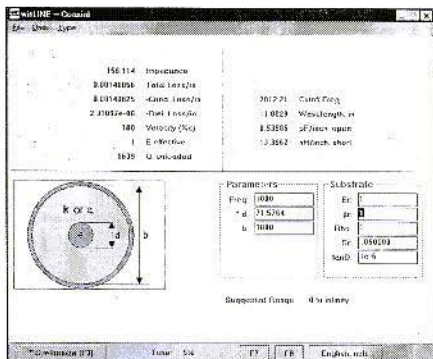
## winLINE

Transmission line impedance calculations for all sorts of lines: coaxial, stripline, microstrip, plus rectangular lines, eccentric lines, trough lines, wire-above-ground plane, and many others. Computes impedance, loss, inductance, capacitance and other parameters. Uses data from *Microwave Transmission Line Impedance Data*. For Windows.

Order NP-11 \$195.00

***Microwave Transmission Line Impedance Data***  
by M.A.R. Gunston

Order NP-10 \$54.00



## winSMITH

The best electronic Smith Chart around! "Build" a ladder network of up to nine elements (L, C, R, transmission line or transformer) and use the chart to tune values until the match is perfect. Written for stand-alone operation, but makes a perfect addition to the book *Electronic Applications of the Smith Chart*. For Windows.

Order NP-5 \$79.00

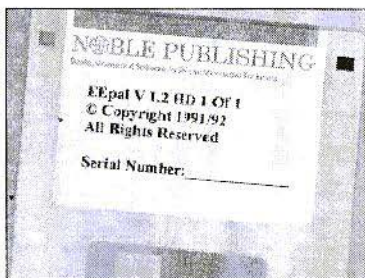
***Electronic Applications of the Smith Chart***  
by Philip Smith

Order NP-4 \$59.00

## EEpal

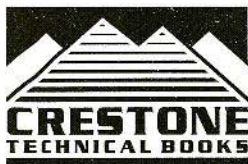
The "Electrical Engineer's Pal" is loaded with useful data and utilities for the active designer. Includes units and conversions, materials and component data, scientific calculator with higher math functions, pads, filters, matching, and more. Has a notepad and calendar, plus a phone list with an autodialer. All this is topped off with a list 1800 EE suppliers! Runs in DOS or a DOS window.

Order NP-20 \$195.00



**Order by telephone, fax, mail or our Web site!**

We accept payment by VISA, MasterCard and American Express or check drawn on a U.S. bank. Shipping charges are - U.S.: \$5.00 for the first item, \$1.00 for each additional item; Canada: \$10.00 first item, \$2.00 each additional item; Other countries (Air express): \$32.00 first item, \$10.00 each additional item.

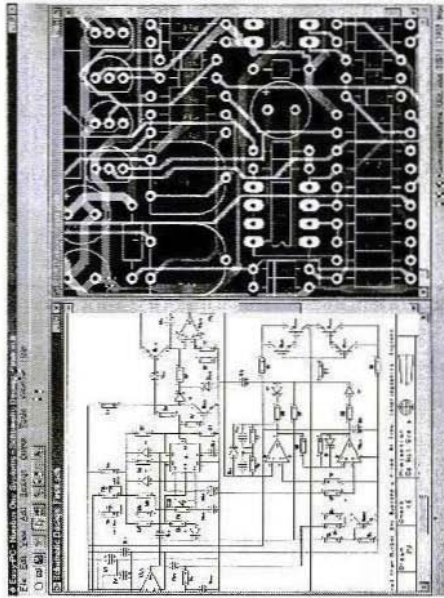


**CRESTONE TECHNICAL BOOKS**

Div. of Noble Publishing Corporation  
2245 Dillard Street • Tucker, GA 30084 • USA  
Tel: (770) 908-2320 • Fax: (770) 939-0157  
www.noblepub.com

# New Easy-PC

*Professional CAD  
for Windows 95 and NT*



- Produce Complex Designs Faster
- Revolutionary Time Saving Features
- Dramatically Improve productivity.
- Track and Component Editing - a dream!
- Full links to our Analogue, Digital and Electromagnetic Simulators.
- NO pin, net or layer limits!
- Powerful, high speed Shape based Autorouters available.
- Very Competitive Pricing.

## Number One Systems

UK/EEC:

Ref: VHFCOM, Harding Way, St. Ives, Cambridgeshire, PE17 4WR, United Kingdom

Tel: 01480 461778 Fax: 01480 494042

Ref: VHFCOM, 126 Smith Creek Drive, Los Gatos, CA 95030

Tel/Fax: (408) 395-0249

International: +44 1480 461778 / 494042

<http://www.numberone.com>

Ask for demo disc or download  
working demo from web site