



*A Publication for the  
Radio Amateur Worldwide*

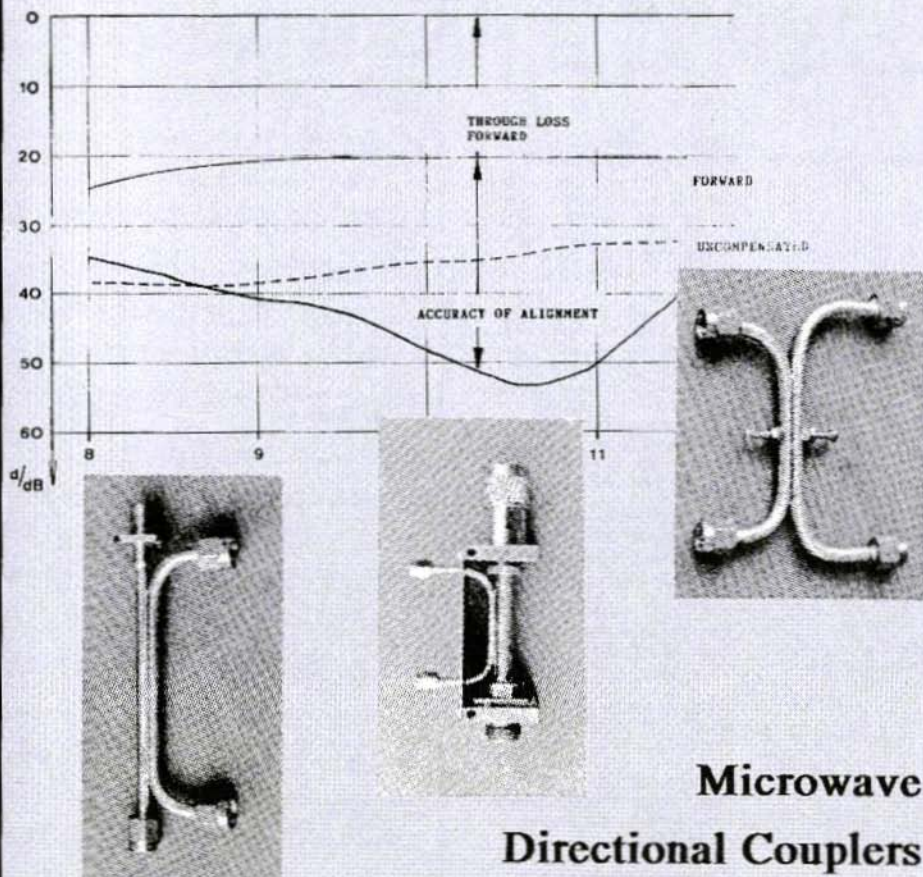
*Especially Covering VHF,  
UHF and Microwaves*

# VHF COMMUNICATIONS

Volume No. 24 . Autumn . 3/1992 . £3.50

## DJ4GC

### X-BAND DIRECTIONAL COUPLER



**Microwave  
Directional Couplers**



# VHF COMMUNICATIONS

*A Publication for the Radio Amateur Worldwide  
Especially Covering VHF, UHF and Microwaves*

Volume No. 24 . Autumn . Edition 3/1992

Published by: KM PUBLICATIONS,  
5 Ware Orchard, Barby, Nr. Rugby,  
CV23 8UF, United Kingdom.

Publishers: KM PUBLICATIONS

Editors: Mike Wooding G6IQM  
Kim Wooding

Advertising Manager: Mike Wooding G6IQM

## VHF COMMUNICATIONS

The international edition of the German publication UKW-BERICHTE is a quarterly amateur radio magazine especially catering for the VHF/UHF/SHF technology. It is published in Spring, Summer, Autumn and Winter in the United Kingdom by KM PUBLICATIONS.

The 1992 subscription price is £12.00, or national equivalent per year. Individual copies are available at £3.50, or national equivalent each. Subscriptions, orders of individual copies, advertisements and contributions to the magazine should be addressed to the national representative, or - if not possible - directly to the publishers.

Back copies, kits, as well as the blue plastic binders are obtainable from your national representative or from KM Publications in the U.K.

All rights reserved, reprints, translations, or extracts only with the written approval of the publishers.

Translated by: Mr. A. Emmerson  
G8PTH, 71 Falcott Way,  
Northampton, NN2 8PH, U.K.

Printed in the United Kingdom by:  
Apex Printers, 1 Avon Industrial  
Estate, Butlers Leap, Rugby,  
CV21 3UY.

Please address your orders or enquiries to your representative.

## REPRESENTATIVES:

A U S T R I A - Verlag UKW-BERICHTE, Terry D. Bittan, POB 80,  
D-8523 Baiersdorf, West Germany. Telephone: (0133) 47-0.  
Telex: 629 887. Postgiro Nbg: 30455-858. Fax: 09753 4747.

A U S T R A L I A - W.L.A., P.O. Box 300, South Caulfield, 3162 VIC,  
Australia. Telephone: 5285962.

D E L G I D M - UKW-Berichte, P.O. Box 80, D-8523 Baiersdorf,  
West Germany. Tel: 09133-47-0. Postgiro: Nbg. 30455-858.  
Fax: 09133-4747.

D E N M A R K - HALSKOV ELECTRONIC ØZTLX,  
Sigerstedt gamle Skole, DK-4100 RINGSTED, Denmark.  
Telephone: 53-616162 (kl.19-22). Giro: 7 25 68 00.

F R A N C E - Christianne Miché F5SM, SM ELECTRONIC,  
20 bis, Avenue des Clapiers, F-89000 AUXERRE, France.  
Telephone: (89) 46 96 59.

F I N L A N D - Peter Lytz OH2AVP, Ylikarantienkuja 5 A 9,  
SF-02360 ESPOO, Finland.

S R A T, PL 44, SF-00441 HELSINKI, Finland. Telephone: 358(0)5625973.

G E R M A N Y - UKW-Berichte, P.O. Box 80, D-8523 Baiersdorf,  
West Germany. Tel: 09133-47-0. Postgiro: Nbg. 30455-858.  
Fax: 09133-4747.

G R E E C E - C+A ELECTRONIC, P.O. Box 25070, Athens 100 26,  
Greece. Telephone: 01 52 42 867. Fax: 01 52 42 537

H O L L A N D - KM PUBLICATIONS, 5 Ware Orchard, Barby,  
Nr. Rugby, CV23 8UF, U.K. Telephone: 0788 890365.

I S R A E L - Doron Jacobi 4ZARG, P.O. Box 6382, HAIFA,  
Israel 31063.

I T A L Y - ADB ELETTRONICA di Lucchese Fabrizio IWSADB,  
Via del Cantone 714, 55100 ANTRACCOLI (LUCCA), Italy.  
Telephone: 0583 952612.

L U X E M B O U R G - TBLICO, Jos. Faber LXIDE,  
5-9 Rue de la Fontaine, ESCH-SUR-ALZETTE, Luxembourg.

N E W Z E A L A N D - EM Zimmerman ZI IAGQ, P.O. Box 31-261,  
Miford, AUCKLAND 9, New Zealand. Telephone: (9) 486 2744.

N O R W A Y - HENNING THEG RADIO COMMUNICATION LA4YG,  
Kjellerveien 30, 1370, ASKER, Norway. Postgirokont: 3 16 00 09.

S O U T H A F R I C A - HI-TECH BOOKS, P.O. Box 1142, RANDBURG,  
Transvaal 2125, South Africa. Telephone: (011) 886-2020.

S P A I N & P O R T U G A L - Julio A. Prieto Alonso EA4CI,  
MADRID-15, Donoso Cortés 58 5<sup>a</sup>-B, Spain. Telephone: 543.85.84.

S W E D E N - Lars Pettersson SMAIVE, Pl. 1254, Smögården, Talby,  
S-17500 ODENSBACKEN, Sweden. Telephone: 19-50223.  
Postgiro: 914379-3.

S W I T Z E R L A N D - Terry Bittan. PSchKto. ZÜRICH 80-54, 849-8.

U N I T E D K I N G D O M - KM PUBLICATIONS, 5 Ware Orchard,  
Barby, Nr. Rugby, CV23 8UF. Telephone: 0788 890365 & 0788 561281.  
Fax: 0788 890365

U S A - WYMAN RESEARCH INC., RR#1 Box 95, Waldron,  
Indiana 46182, USA. Telephone: (317) 525-6452.  
HENRY RUH, ATVQ MAGAZINE, 1545 Lee Street, Suite 73,  
Des Plaines, IL 60018, USA. Tel: (708) 293 2269. FAX: (708) 291 1644.

© KM  
PUBLICATIONS

ISSN 0177-7505

# Contents

---

|   |   |           |
|---|---|-----------|
| Carsten Vieland<br>DJ4GC                                    | Microwave Directional Coupler with<br>high Front-to-Back Ratio made from<br>Semi-Rigid Circuits | 130 - 139 |
| Jean-Jacques Noel<br>F6ILR<br>Daniel Caudroy<br>F6BXC       | A Digital Slow-Scan Television<br>Transmit Coder  | 140 - 150 |
| R.A.Formato, Ph.D.<br>KIPOO                                 | VHF/UHF Sloping Vee Antennas  | 151 - 157 |
| Dr.-Ing. Jochen Jirrmann<br>DB1NV                           | Operating Electronic Equipment in the Car   | 158 - 164 |
| Eugen Berberich<br>DL8ZX                                    | A Logarithmic Detector,<br>Manufactured using Integrated Modules                                | 165 - 168 |
| Jean-Pierre Morel<br>HB9RKR<br>Dr. Angel Vilascca<br>HB9SLV | Doppler Radar in the 10 GHz Amateur Band  | 169 - 181 |
| Detlef Burchard, Dipl.-Ing                                  | MES-Fetishism!  | 183 - 188 |

---



**KM Publications**, 5 Ware Orchard, Barby, Rugby, CV23 8UF, U.K.

Telephone: U.K: 0788 890365; INT: + 44 788 890365. FAX: 0788 890365



Carsten Vieland, DJ 4 GC

## Microwave Directional Coupler with high Front-to-Back Ratio made from Semi-Rigid Circuits

It is already one of the truisms heard at amateur radio tests that directional couplers can be used to measure the matching of aerials or other consumers. In their inevitable attempts to dismantle the mysterious boxes, mainly of Japanese or American manufacture, those seeking enlightenment encounter a structure made of sheet metal and wire, the mysterious working mechanism of which remains obscure, even after

lengthy meditation in the wilderness.

Upon recognising, for instance, that current is flowing at one end of the strapping and not at the other, even a hard-bitten natural researcher of the stamp of a Georg Simon Ohm would drop the voltmeter in despair.

In spite of the apparent simplicity of the mechanism, home-made units are usually only partially successful. At any

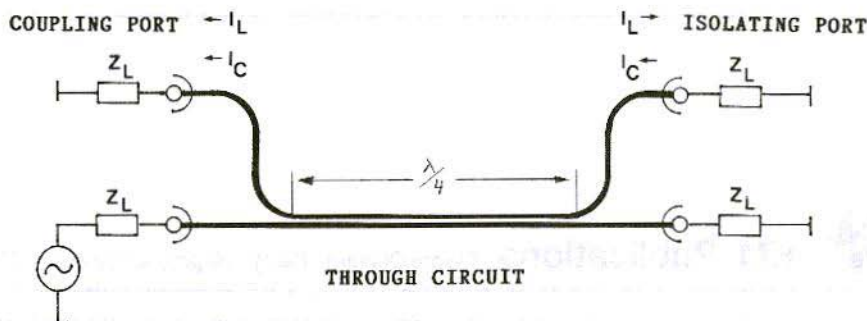


Fig.1: Coupler with Ports and Signal Devices

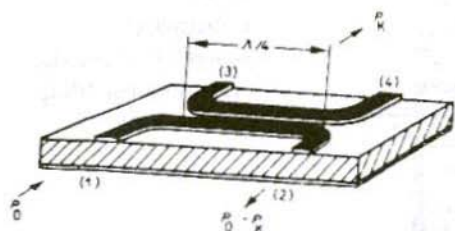


Fig. 2: Printed Directional Coupler on the basis of strip-lines.

rate, the longed-for high accuracy of alignment (the difference between the forward motion and backward motion lines) is not present. In the GHz range at any rate, only a few daring radio hams have succeeded in using lathes to create structures of a quality which could be paraded before a knowledgeable visitor. It is the purpose of this article to present a mechanically simple, but electrically high-quality home-made solution, based on fixed sheath cables.

## 1. WORKING MECHANISM

The essential mystery of a directional coupler lies in the correct impedance of the main line and secondary line, together with the correct joining of these lines regardless of impedance.

A directional coupler is a kind of repeater in which, in contrast to the transformer, in addition to the magnetic coupling, a capacitive coupling of the same value exists between the main line and the secondary line. If all main line and secondary line impedances coincide (50

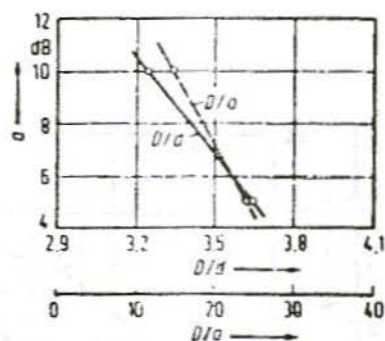
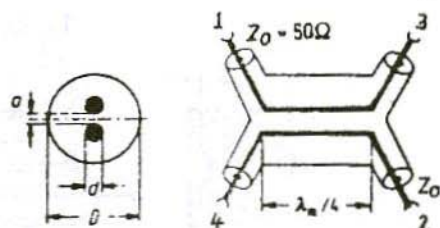
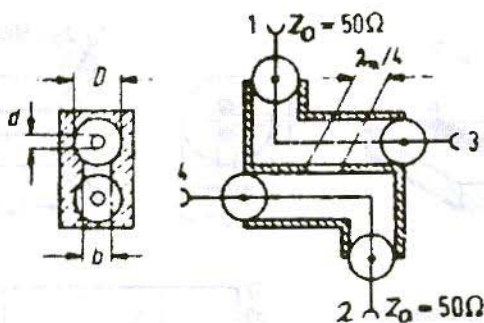


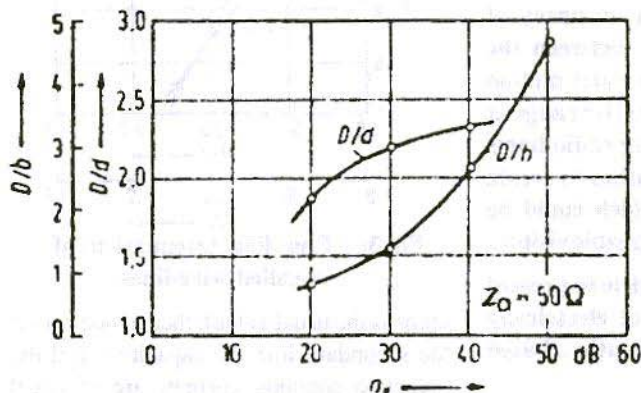
Fig. 3: Coupling Attenuations of so-called wire-lines

ohms is the usual value), then at one end of the secondary line the capacitive and the inductive coupling currents are of equal size and of the same phase, and thus reinforce each other. At the other end of the so-called secondary line, the phase angle between the two partial currents is 180 degrees, and they thus cancel each other out. Here a signal is transmitted only if a wave is flowing along the main line in the opposite direction, i.e.: if a standing wave is present as a result of mismatching by the user (Fig. 1).

Such strong directional relationships can be obtained only if a high degree of symmetry exists between the two wave components (referred to more simply as currents) due to the maintenance of the impedances. Thus, for example, for an accuracy of alignment of only 20dB, the power delivered at the uncoupled end of the secondary line has to constitute only



**Fig.4:**  
Influence of  
geometry of coaxial  
system on coupling  
attenuations



one per cent of that at the other end. Mismatching, even of the terminal resistance (wave sump) of the secondary line results in internal reflections, which lead to standing waves within the coupler and also impair the accuracy of alignment.

Home-made units constructed using sheet metal techniques usually require considerable mechanical engineering resources and industrial products from the high-tech range have to be purchased new with no price discounts.

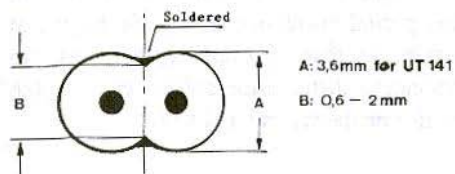
In principle, directional couplers can be constructed using coaxial technology, on the basis of strip line (Fig.2) or sandwich technology. CAE and CAD software are usually used for dimensioning nowadays.

2.

## CABLE COUPLER

The so-called wireline, which is available by the metre or centimetre, and which makes it possible to manufacture couplers with largely freely selectable data, has gained a certain degree of acceptance. Unfortunately, this decidedly expensive material does not permit the tidy installation of plugs and sockets, but is designed for integrated circuit technology.

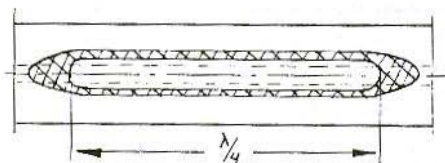
The most frequent application of this interesting component lies in 3dB couplers with two outputs in opposition of phase (Fig's.3 and 4).



**Fig.5: Structure of a Directional Coupler made from Fixed Sheath Cable**

A somewhat unconventional solution to the impedance problem lies in the use of additional longitudinally slit fixed cover cables as main and secondary lines. Here the manufacturers have already taken steps to ensure that the circuit is laid out in accordance with the impedance.

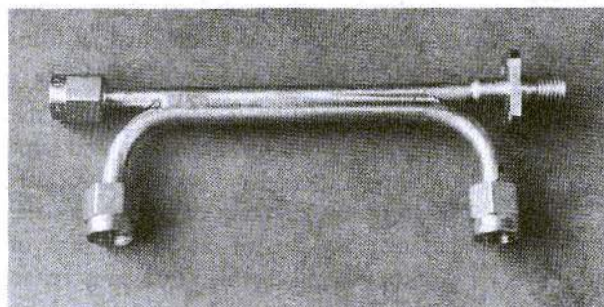
For a directional coupler made from individual semi-rigid circuits (Fig.5), the coupling area consists of a longitudinal slit (Fig.6) on the two circuit covers. The cable sections should first be bent at the planned



**Fig.6: Filed longitudinal slit**

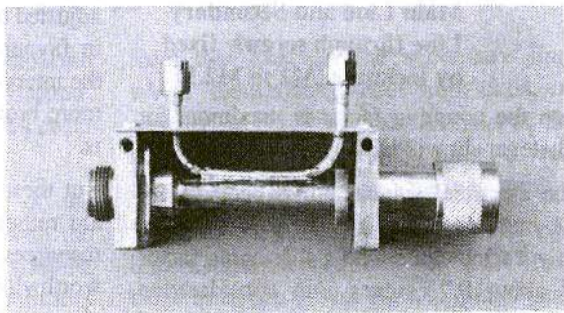
lengths and then worked on with a smooth-cut file. To avoid "hillocks" on the worked surface, the straightness of the filing work should be checked repeatedly. Once matched to one another, the cable covers are longitudinally pre-tinplated, made smooth again, and then soldered (Fig's.7 and 8).

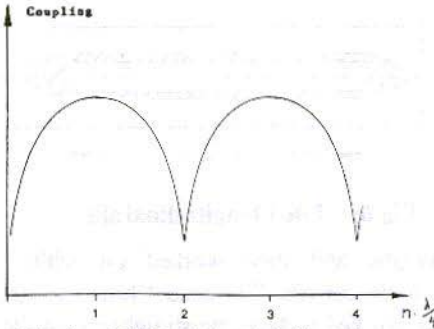
The wider these slits are, the stronger the coupling is. In addition to the width, the length of the openings contributes to the strength of the coupling (Fig.9). If the lengthwise dimension of the coupling area amounts to a quarter of the wavelength,



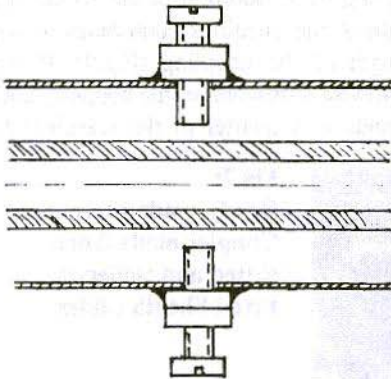
**Fig.7:  
Ready-made Directional Coupler made from slitted and soldered Fixed Sheath cables**

**Fig.8:  
High-Power version from DK1VC**





**Fig.9: Main Curve of Coupling between Main Line and secondary Line, plotted against Length of Coupling Distance**



**Fig.10: Transverse section of Capacitive compensation on Main Line and Secondary Line through screws fixed by locknuts (M2 to M2.5)**

then the coupling factor is maximum for whatever slit width has been selected.

The electrical wavelength is decisive for the individual type of cable. In practice, only Teflon cable with a shortening factor of about 0.7. comes into consideration here. For an effective wavelength of

$\lambda/2$  or its whole-number multiples, the partial currents cancel each other out again, so that, theoretically at least, no inductive disturbance exists between the main and the secondary lines.

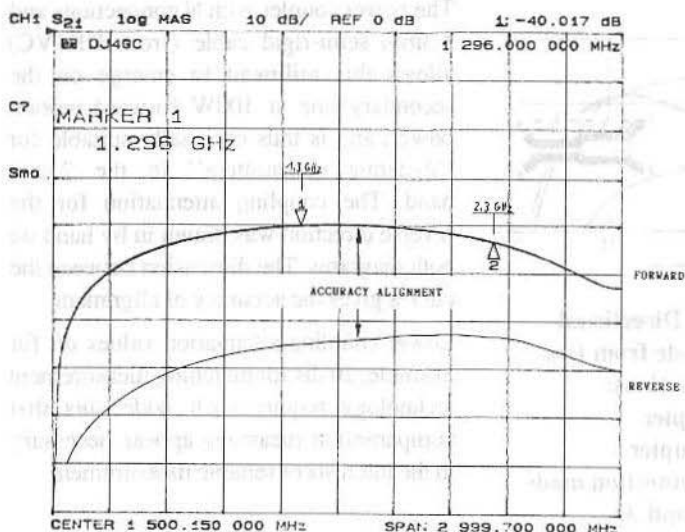
## 2.1. Compensation for faults

Wide coupling slits are required for the strong coupling which is frequently desired. Because of the impedance interference in the coaxial system, which can then no longer be ignored, the internal reflection on the measuring lines increases. The line impedance no longer coincides with the impedance of the other line sections or with that of the covers, which has an adverse effect on the accuracy of alignment. As long as the coupling distance is short by comparison with the wavelength, the capacitive electric stress for the internal conductor, which is too low as a result of the incomplete cable cover, can be selectively compensated. In practice, one or more screws can be attached as trimmers (Fig.10).

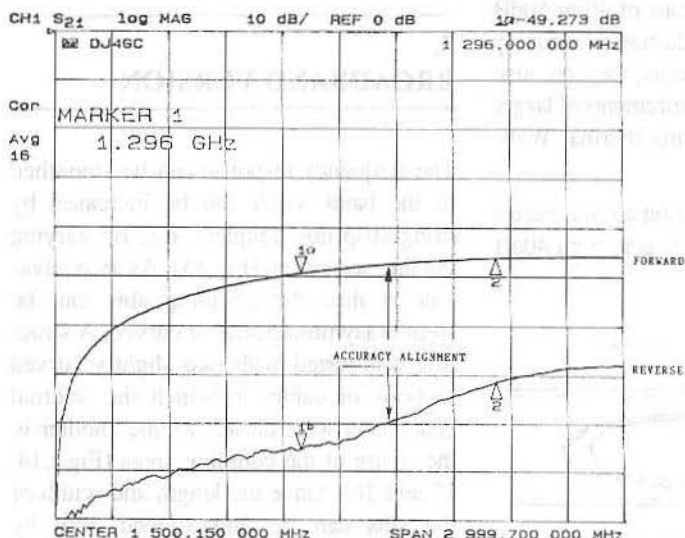
The compensation is carried out at the optimum accuracy of alignment, and happily it is a broad-band operation. Adjustments of this kind may offend the purists, but they are carried out in the best of circles, even in the high-frequency range itself. The accuracy of alignment can be adjusted to values which can exceed 40dB in favourable circumstances. The shorter the intervals between the trimmers are, the more broad-band the compensation effect is.

But these compensating measures, which are rather costly in terms of mechanical resources, could be considered as being worthwhile only if high accuracy of alignment is really of importance.





**Fig.11:**  
Functional Plot of  
the UT141 Coupler  
from Fig.7



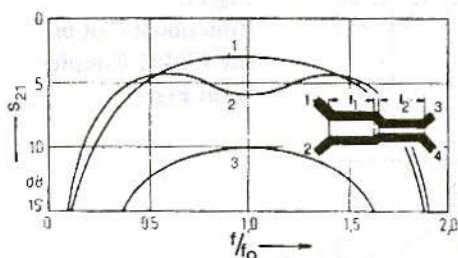
**Fig.12:**  
Functional Plot of  
the High-Power  
Coupler shown in  
Fig.8

No compensation is required to measure the forward motion power of a transmitter, because the faults are of a very small order of magnitude.

During compensation, the SWR of the main line is initially optimised, with the help of as good a standard joint as possible. In the second stage, the signal return loss

from this joint on the secondary line, which theoretically does not exist, is adjusted in practice, with the help of the adjusting screws positioned there, to values as low as possible, or ideally to zero.

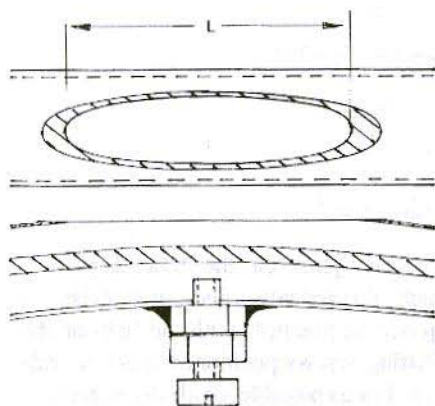
The frequency responses recorded for two uncompensated couplers by SSB-Electronic (tnx) are shown Fig's.11 and 12 and



**Fig.13: Broadband Directional Coupler made from two Coupling Sections:**  
 1) 3dB Coupler  
 2) 10dB Coupler  
 3) Series connection made from 1) and 3)

show coupling attenuations of 40 or 50dB in the 23-cm. band. In addition to accuracy of alignment measurements, they are also suitable for precise measurements of larger transmission circuits using thermal Wattmeters.

Thus 10W in a transmission circuit creates 1mW at the measurement gate with 40dB coupling attenuation.



**Fig.14: Two views of the filed coupling slit for the Broadband Coupler**

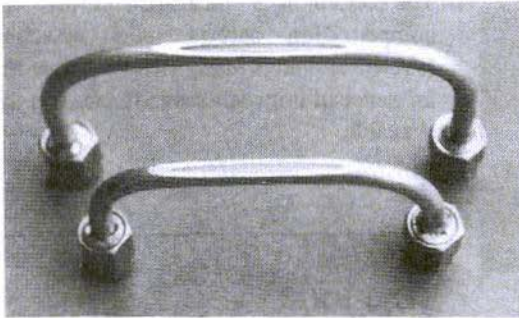
The power coupler with N connections and 8.3mm semi-rigid cable (from DK1VC) allows this milliwatt to emerge on the secondary line at 100W forward motion power, and is thus especially suitable for "dynamic transmitters" in the 23cm. band. The coupling attenuation for the reverse direction was drawn in by hand on both diagrams. The dimension between the curves gives the accuracy of alignment.

Lower coupling attenuation values of, for example, 20 dB for matching measurement technology require such wide slits that compensation measures appear necessary in the interests of reliable measurement.

### 3. BROADBAND VERSION

The frequency response can be smoothed or the band width can be increased by using strip line couplers, e.g. by varying the line separation (Fig.13). As an equivalent to this, the coupling slits can be formed asymmetrically or curved. A structure was tested with two slightly curved sections of cable, in which the internal conductors were closest to one another in the centre of the coupling areas (Fig.s.14, 15 and 16). Since the length and width of the slits can be dimensioned only by high-frequency experience and guesswork, and not by means of software, the values provided give only approximations on the way to even broader band widths.

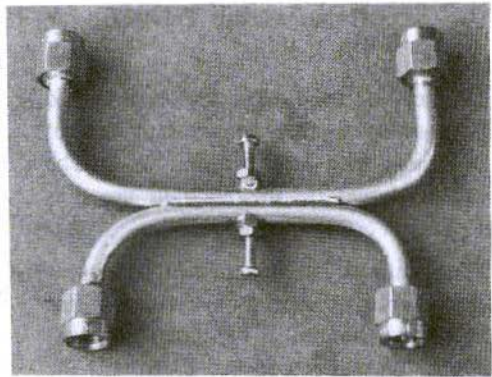
The readings (Fig.17) show that this solution can be applied over a range of approximately 1 to 4 GHz. However, it would seem that lengthening the coupling slit from 23mm to approximately 27mm



**Fig.15:**  
Prepared Cable sections for  
Broadband Coupler

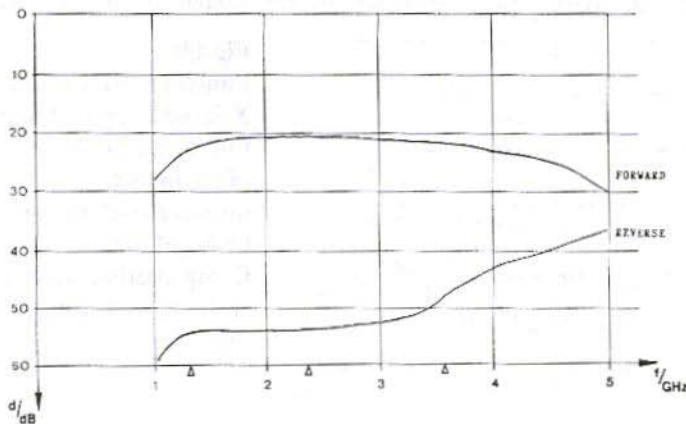
Slit length: 23mm  
Max slit width: approx. 2mm

**Fig.16:**  
Ready-made Directional  
Coupler with Screw  
Trimmers

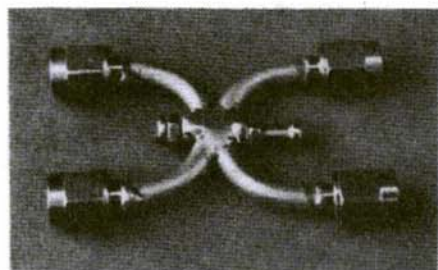


would tend to make the drop at 1.3 GHz less pronounced. Because of the strong coupling, compensation of the capacitive electric stress for the internal conductor, which is too low, is required in the interests of high accuracy of alignment.

Accuracy of alignment values of over 40dB can be adjusted for, even with only one M2 screw as a trimmer in each case, though this was sacrificed once again in favour of broader band widths (three amateur radio bands). If several screw



**Fig.17:**  
Functional Plot of  
the Broadband  
Coupler from  
Fig.16

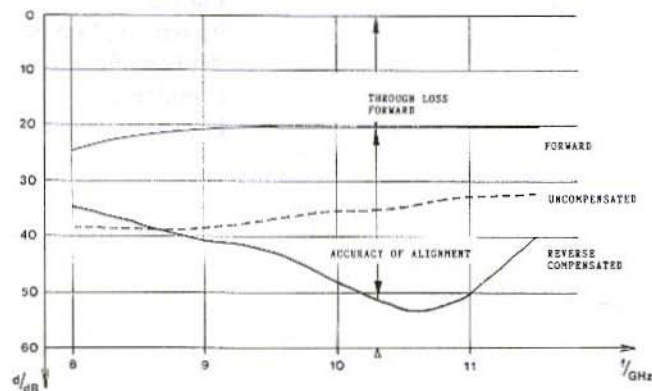


**Fig.18: Directional Coupler with Compensation Trimmers for the X-Band**

trimmers are used on each side, it should be possible to increase the accuracy of alignment with even broader bands. The values shown on the diagram are thus dependent on compensation.

The accuracy of alignment at high frequencies can be increased at the expense of that at low frequencies. If the gates are transposed, the readings remain essentially the same.

Even for the X-band, the technique seems very efficient. With a coupling slit length of 6mm (Fig.18), the range between 8 and 12 GHz can be covered and, at least over the range which is interesting for amateur radio, an astonishing accuracy of alignment of 30dB can be adjusted for (Fig.19).



**Fig.19: Functional Plot of the X-Band Coupler from Fig.18; the accuracy of alignment measured before the fitting of the Compensation Screws is shown as a dotted line**

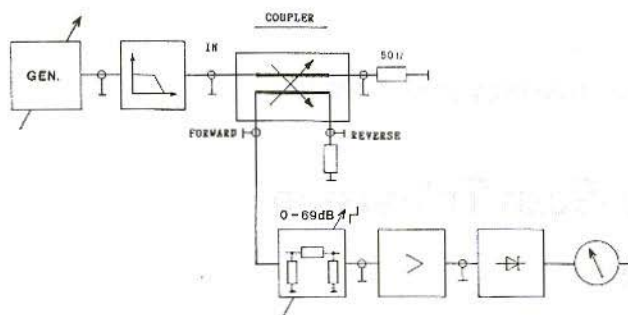
The return loss measured before the compensation screws were attached (shown in dotted lines) clearly shows the influence of impedance interference on the slit cable.

#### 4. TEST RIGS

The optimising and calibrating of the aforementioned directional couplers imposes certain requirements on measurement technology. For use within one band only, it is, of course, possible to carry out a test or a compensation, using a transmitter and a simple detector or receiver.

Network analysers provide an extremely convenient system for broad-band measurements, even if they are also complicated and difficult to obtain. Two "hard copies" produced in this way are reproduced here.

An electrical rig giving almost equivalent values using modular 50 ohm components should be referred to here (Fig.20). It makes it possible to measure the broad-band coupler and the X-band coupler. The accuracy of the output meter has no



**Fig.20:**  
**Basic set-up of**  
**measuring Equipment**  
**for determining**  
**Forward Attenuation**  
**(Through-Loss) and**  
**Return Loss**

influence on the result, since it should merely always recognise the same level. The detector or thermal output meter must, if necessary, maintain a limiting sensitivity of approximately  $-50\text{dBm}$ , by means of broad-band preamplifiers.

The low pass filters after the generators are of great assistance in measuring high accuracy of alignment, since otherwise errors could be introduced due to harmonics. The quality of the  $50\text{ ohm}$  joints, the coaxial transitions and the fact that the capacitive electric stress for the internal conductors can be balanced by screw trimmers only to a limited extent, set limits on the road to couplers which are always accurately aligned.

The goal could be considered as having been achieved if a return loss of more than  $30\text{dB}$  could be obtained with quite a broad band.

The author hopes to have been of some assistance, and provided some ideas on

how you can make these high-frequency components yourself, as they are scarcely obtainable otherwise.

## 5. LITERATURE

- (1) M.Kummer: Principles of Micro-Wave Technology  
VEB Verlag Technik, Berlin 1986
- (2) Meinke-Gundlach:  
High-Frequency Technology  
Pocketbook 4th edition, 1986,  
Springer-Verlag
- (3) Käs-Pauli: Micro-Wave Technology  
Franzis-Verlag Munich, 1991
- (4) K.Weiner, DJ 9 HO:  
UHF Data, Part 1



*Jean-Jacques Noel F6ILR and Daniel Caudroy F6BXC*

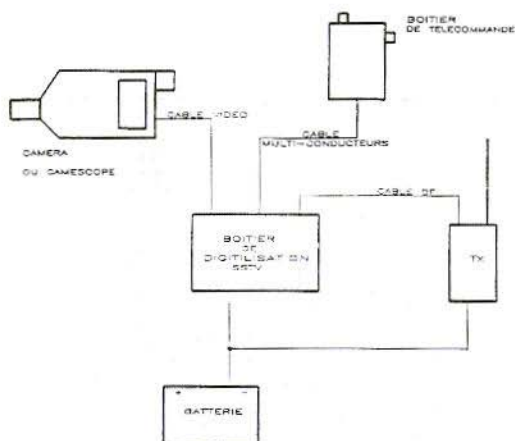
## A Digital Slow-Scan Television Transmit Coder

This article describes a digital Slow Scan Television encoder, which will allow you to send SSTV via your usual portable transmitter from any portable location or from your shack, as the unit operates from 12V DC. The unit is complete, in that all that is required is a video source and a transmitter to enable you to transmit SSTV.

The project was the result of extensive collaboration and testing between Jean-Jacques and Daniel during the winter months, with a great deal of indoor operation and mobile from a moving car and a moving bike using two prototype models. The specifications were found to be easily maintained with construction and the units conformed to our original schedule:

- portable, requiring between 8V and 15V DC supply
- small size; 30 x 165 x 120 mm

- usable as a fixed station or mobile
- quite light; approximately 400gm
- selection of high (32 seconds) or low-definition (8 seconds) monochrome picture modes
- manual (single-shot) or automatic (continuous) selection of 'snatched' picture(s)
- visual (LEDs) and audible (buzzer) indication of completion of scan
- controls can be located on the main case, or on a remote hand-held unit
- the contrast of the transmitted picture can be altered by a potentiometer on the control panel
- the video input can be from any standard composite video source, i.e: camera, computer, VCR, etc.



## The Principle of Portable SSTV Operation

### 1. CIRCUIT DESCRIPTION

The circuit diagrams of the complete unit are shown in Fig's. 1a and 1b. The composite video input signal is initially passed through a 2MHz band-pass filter to remove the HF and colour components of the signal. The NE592 (U15) is a signal amplifier, which lifts the filtered video to a level of 2 volts peak-to-peak for the A-D input of the Analogue-to-Digital-to-Analogue (AD-DA) converter U7 (UVC3101 or UVC3130). The video signal from U15 is also fed to the Sync Separator device U16 (LM1881), which receives its clock signal from the monostable U17B (4528).

A free-running oscillator is designed around U1A (74LS123) and produces the fast clock sampler, HR. A crystal-controlled is configured around U6 (4060) which produces, after the necessary division the slow picture-sampling clock, HL, either 4800 Hz for low-definition and 2400 Hz for high-definition transmissions, which is selected by U12A (4053).

When switch S2 pressed the picture transmission cycle is activated. U5 (74LS157) clocks the address counters U3 and U4 (both 74LS393) at video frame rate, the 20ms controlling pulse being generated by U2 (4013). The video signal is digitised by U7 and then routed by the tri-state buffer U8 (74LS366) to the memory devices U9 and U10 (43256), which have been switched to write by U2 (4013).

When switch S2 is released the 'snatched' picture is locked in the memories (in manual picture 'snatch' mode the video source can now be removed if desired), buffer U8 goes to a high impedance state, U2 switches U9 and U10 to read and the address counter clock U5 is switched to the selected SSTV rate, the sync pulses generated by U1B (74LS123) being corrected for the selected speed (i.e: 8 or 32 seconds) by U2( 4013) before being fed to U5.

The stored digital image in the memories is read back into U7 for conversion back into an analogue signal at the selected SSTV speed. The analogue output from U7 is routed to the frequency converter U13 (NE566), which is configured to operate in the range 1200 to 2400 Hz. The extreme ends of the range are adjustable by two 10-turn potentiometers, one for 1500 Hz 'Black' and the other for 2300 Hz 'White'. U12C injects the Sync signal of 1200 Hz, which is adjusted by means of a third 10-turn potentiometer, under the control of U11 (4528).

Finally, the output signal is filtered by U14 (741) and presented to the output socket, BF, for connection to the transmitter's microphone input.

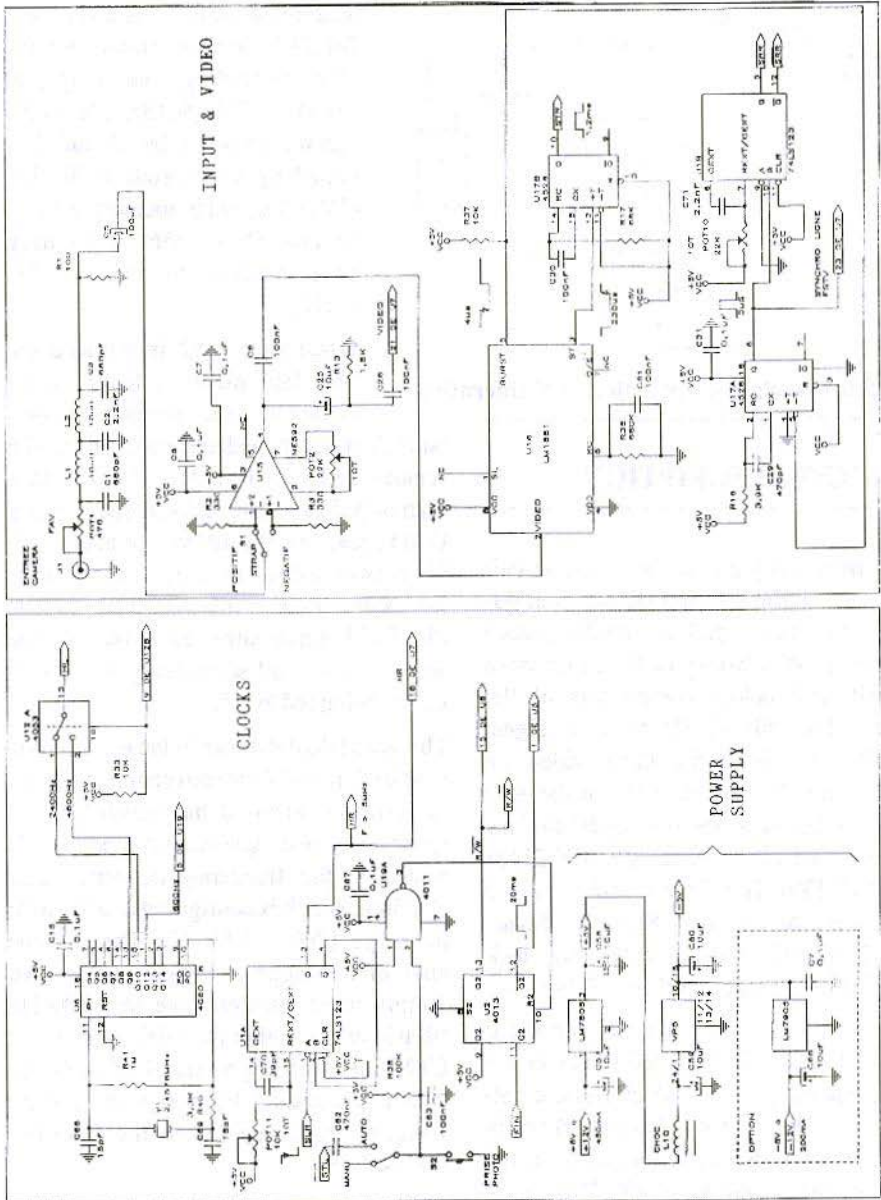


Fig.1a: Circuit Diagram of the Clock, Power Supply and Input stages



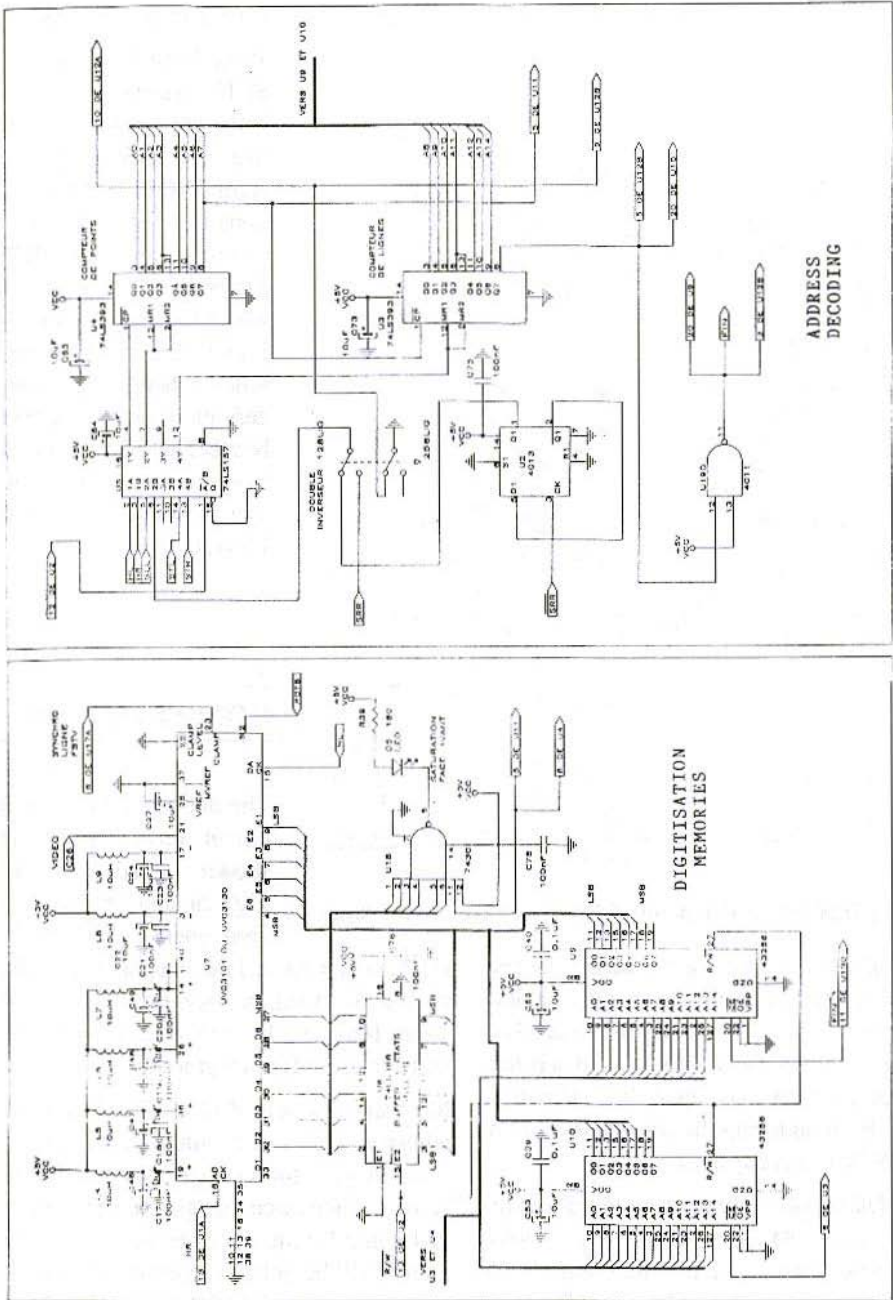


Fig.1b: Circuit Diagram of the Address Decoding and Digitisation and Memory



VP5 will be required to generate the -5 volt rail.

There is no design for an SSTV receive converter here, the authors' use either the DK3VF system from VHF Communications 1/86, or the F1JMG system from radio REF March 1990, both of which are suitable for the 8 and 32 second modes utilised here. The low-definition could of course be received on an original high-persistence tube system, such as was used 15 to 20 years ago!

## 2. CONSTRUCTION

The double-sided printed circuit board layout is shown actual size in Fig's.2a and 2b, with a component overlay in

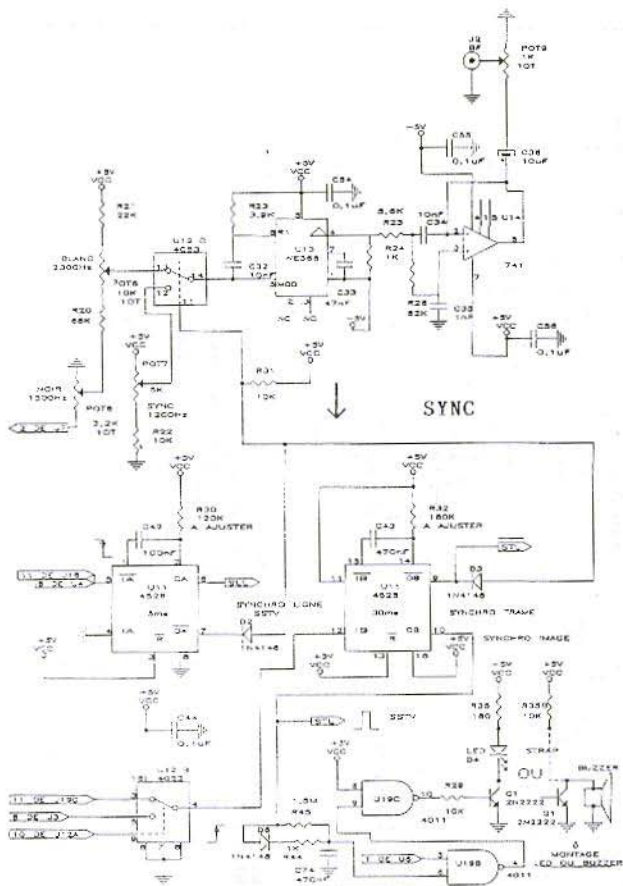


Fig.1c: Circuit Diagram of the Synchronisation stages

An LED (D4) or a buzzer indicates the end of transmission of a picture and a saturation LED assists the setting of the level of the input video signal. However, it is better where possible to adjust the saturation level by monitoring the transmission with an SSTV receive system.

The DC supplies are quite straightforward. If you have +8 to 15 volts and -8 to 15 volts available, then simple 7805 and 7905 regulators will suffice. However, for portable operation, or where only a +8 to 15 supply is available, the DC-DC converter

Fig's.3a and 3b. All the integrated circuits should be fitted in sockets, as many of them have to be removed during the adjustment and set-up procedure.

Resistors R30 and R32 at U11 should be adjusted-on-test, as should R16 and R17 at U17, to give the correct pulse-widths as shown on the circuit diagrams. The values of L4 and L9 are not critical, 15 or 22uH values will be quite acceptable. All potentiometers are upright 10-turn types. Strap S1 should be fitted to suit your video input signal polarity, either positive or negative

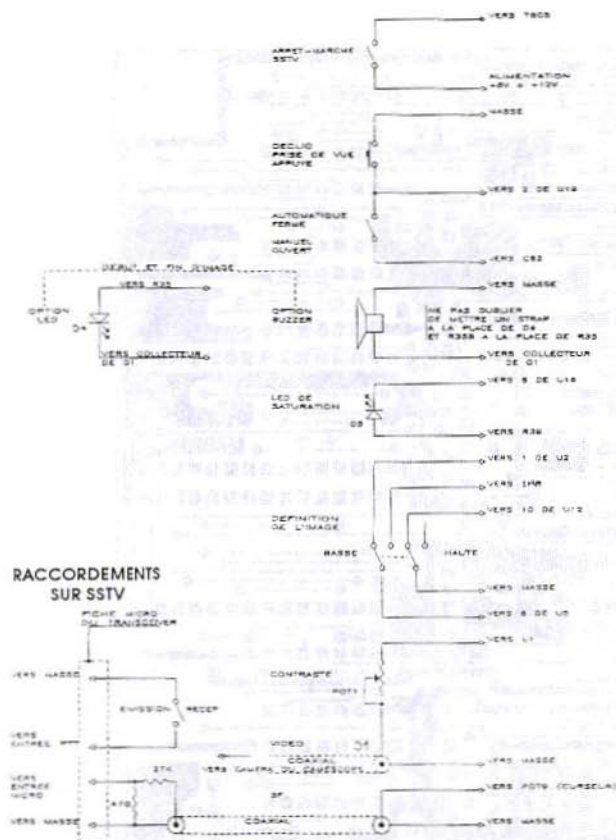


Fig. 1d: Control Interconnection details

going. Please also note the orientation of input capacitor C5, according to the polarity of the input video signal.

As mentioned earlier, the 'snatch' switch S2, the on/off switch and the manual/automatic switch may be located on a unit remote from the main case and can thus be wired in place using 1.5 to 2 metres of coaxial cable terminating in a 5-pin plug, with a matching socket on the main unit. The video gain potentiometer can also be mounted on the remote unit, or on its own at the camera. The supply regulators are mounted at the edge of the printed-

circuit-board so that they can be bolted to the metal case for heat-sinking. Please note that if a 7905 regulator is used, then its case must be insulated from the chassis.

### 3. ADJUSTMENTS AND SET-UP

Remove U8, U9, U10 and U11 from their sockets and adjust POT11 so that the frequency of the clock signal at pin-18 of U7 is 5 MHz. Set POT10 to approximately half way and adjust POT9 for maximum signal at the output socket, BF.

Solder a strap across pins-7 and 8 of the U11 socket (still with the ICs removed from the circuit) and adjust

POT7 for a frequency of 1200 Hz at the output socket. remove the strap and set POT8 to approximately half way. Strap together pins-12, 13, 15, 16, 17 and 14 of U19, connecting the strap to pin-14 first (again with the ICs still removed from the circuit board). Adjust POT6 for a frequency of 2300 Hz at the output socket.

Connect the six used outputs of U9 to +5 volts (pin-28). Adjust POT8 for a frequency of 1500 Hz at the output socket. Repeat the last two adjustments as they interact with each other, until both frequencies are correct.

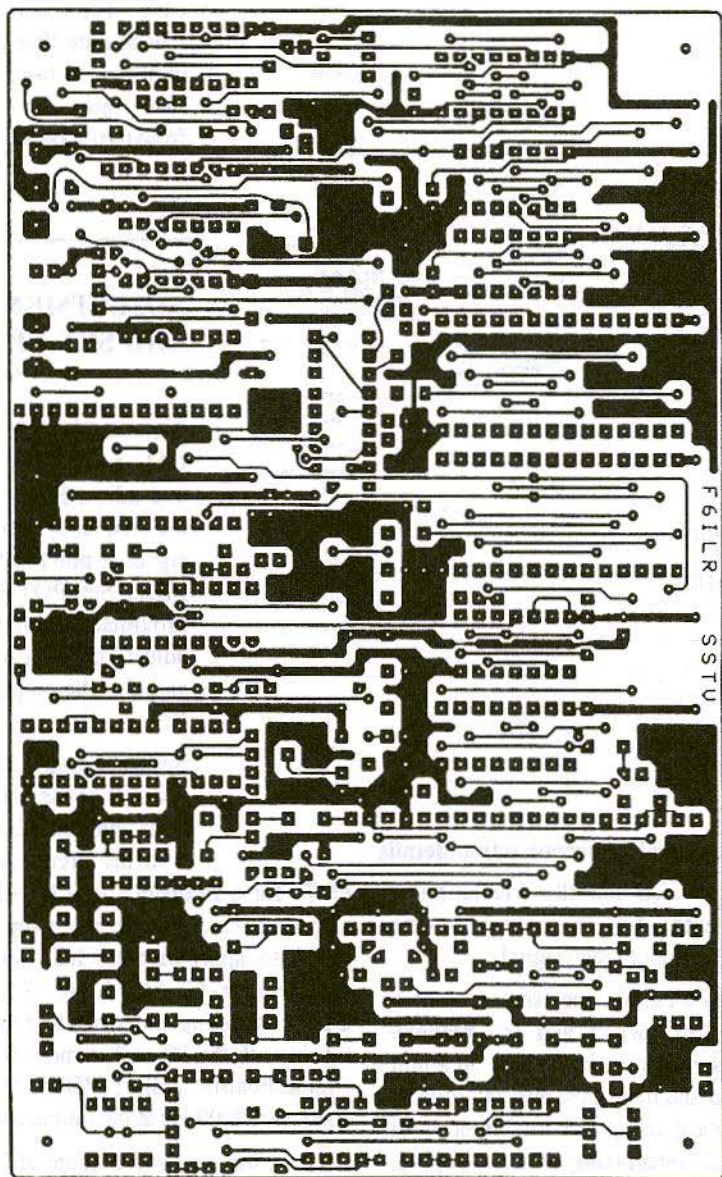


Fig.2a:PCB Layout Track side (actual size)

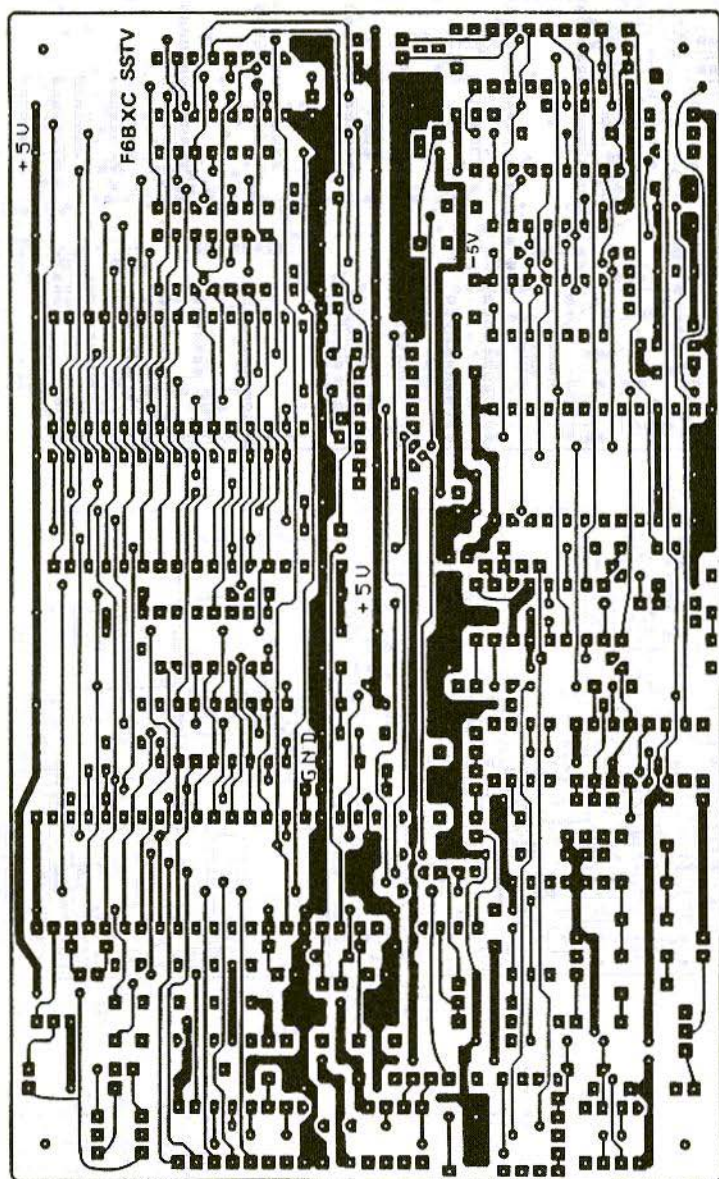


Fig.2b:PCB Layout Component side (actual size)

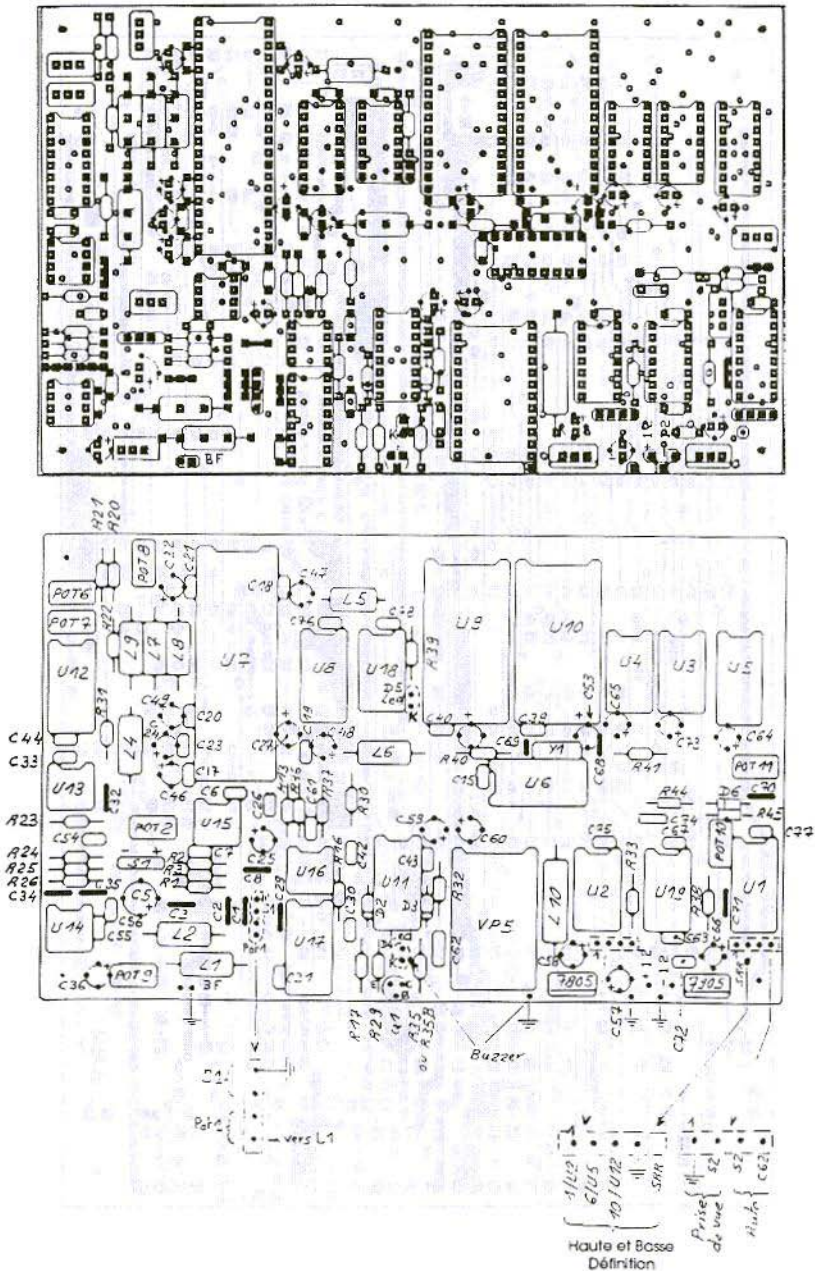


Fig.3: Component Layout



Fit U11 in its socket and ensure that the 128-line low-definition mode is selected.

Adjust the values of R30 and/or C12 to give a positive-going pulse with a pulse width of 5ms +/-0.2ms at pin-6 of U11. Adjust the value of R32 to give a pulse width of 30ms (or more) at pin-10 of U11. Please note that the pulse only occurs every 7.5 seconds.

Fit U8, U9 and U10 into their sockets, set the input saturation control POT1 to maximum, connect a video source and press S2. Adjust POT2 so that the saturation LED illuminates just before the transmitted picture starts to distort due to overload.

Adjust POT10 to centre the picture on the receive screen, if the picture is too wide or narrow, then slight adjustment of POT11 will correct this.

That completes the set-up procedure and the unit should now transmit good-quality 8 second or 32 second black and white picture.

## 4. COMPONENT LIST

### 4.1 Integrated Circuits

|          |                          |
|----------|--------------------------|
| U1       | 74LS123                  |
| U2       | 4013                     |
| U3, U4   | 74LS393                  |
| U5       | 74LS157                  |
| U6       | HEF4060                  |
| U7       | UVC3101 or UVC3130       |
| U8       | 74LS366                  |
| U9, U10  | 43256 or 20256 (32k x 8) |
| U11, U17 | 4528                     |
| U12      | 4053                     |

|     |               |
|-----|---------------|
| U13 | NE566         |
| U14 | UA741 (8-pin) |
| U15 | NE592         |
| U16 | LM1881        |
| U18 | 7430          |
| U19 | 4011          |

### 4.2 Transistors and Diodes

|            |        |
|------------|--------|
| Q1         | 2N2222 |
| D2, D3, D6 | 1N4148 |

### 4.3 Regulators

|        |   |
|--------|---|
| LM7805 |   |
| LM7905 | (if + and - supplies available)         |
| VP5    | (or any DC-DC converter outputting -5V) |

### 4.4 Chokes

|          |  |
|----------|--|
| L1 to L9 | 10uH   |
| L10      | 50 turns 0.2mm diameter on 4mm ferrite 15mm long |

### 4.5 Resistors 1/4W

|          |      |          |      |
|----------|------|----------|------|
| R1       | 100  | R35, R39 | 180  |
| R2, R3   | 330  | R44, R24 | 1k   |
| R13      | 1.5k | R40      | 3.3k |
| R16, R23 | 3.9k | R25      | 5.6k |
| R22, R29 | 10k  | R31, R33 | 10k  |
| R35, R37 | 10k  | R21      | 22k  |
| R17, R20 | 68k  | R26      | 82k  |
| R38      | 100k | R30      | 120k |
| R32      | 180k | R36      | 680k |
| R41      | 1M   | R45      | 1.5M |

### 4.6 Potentiometers

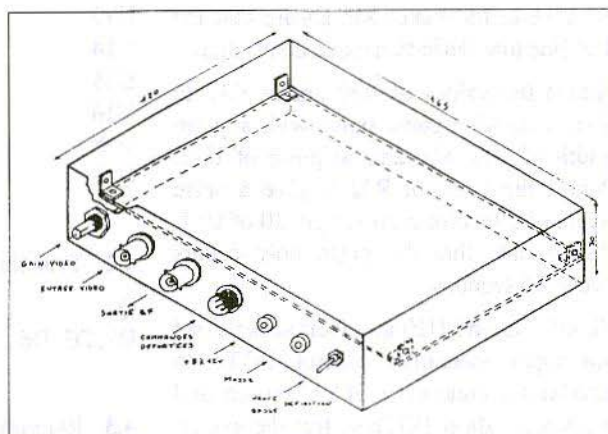
|      |      |
|------|------|
| POT9 | 1k   |
| POT8 | 2.2k |



|             |      |
|-------------|------|
| POT7        | 4.7k |
| POT6, POT11 | 10k  |
| POT2, POT10 | 22k  |

#### 4.7 Capacitors Ceramic

|          |       |
|----------|-------|
| C68, C69 | 15pF  |
| C70      | 39pF  |
| C29      | 470pF |
| C1, C3   | 680pF |
| C2, C71  | 2.2nF |
| 25 off   | 100pF |



#### 4.8 Capacitors Metalised Polyester

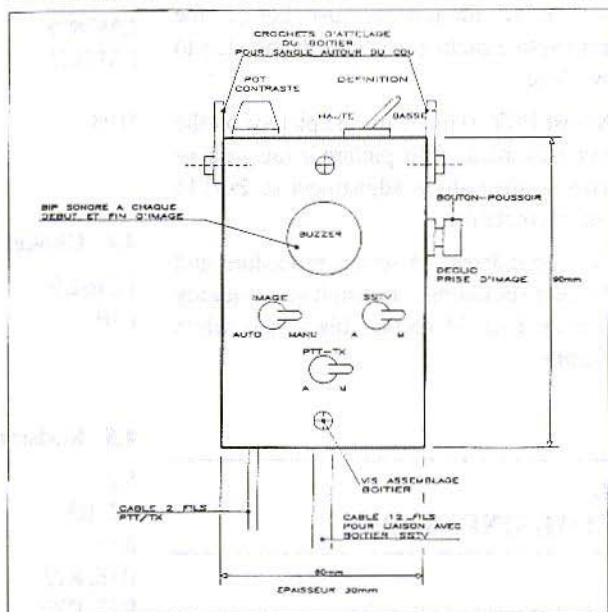
|                |       |
|----------------|-------|
| C35            | 1nF   |
| C32, C34       | 10nF  |
| C33            | 47nF  |
| C61, C30, C42, |       |
| C56, C55       | 100nF |
| C62, C43, C74  | 470nF |

#### 4.9 Capacitors Electrolytic

|        |                  |
|--------|------------------|
| 19 off | 10uF 25V Tant    |
| C5     | 100uF 16V Radial |

#### 4.10 Miscellaneous

|                         |            |
|-------------------------|------------|
| Y1                      | 2.4576 MHz |
| Crystal                 | 1          |
| high-luminosity Red LED |            |
| 5V                      | BUZZER     |



**Fig.4: Mechanical details of Main Enclosure and optional Remote hand-Held Control unit**

## 5.

### LITERATURE

- 1) Radio REF March 1990
- 2) The Slow Scan Companion, BATC
- 3) Radio Plans No. 42, January 1988
- 4) VHF Communications 1/86.





Richard A. Formato, Ph.D., K1POO

## VHF/UHF Sloping Vee Antennas

What comes to mind when you think of VHF/low-UHF antennas? Whips, Yagis, log-periodics,... right? These are the typical answers, and they are certainly among the most common antennas in those bands. The Sloping Vee is inconspicuously absent. But the Vee happens to be a superb antenna, especially at shorter wavelengths. Yet it is not well known or widely used by amateur operators on the higher frequencies.

The Sloping Vee is inexpensive, mechanically and electrically simple, easily transported and installed, and, most importantly, it provides excellent gain-bandwidth performance, particularly for single-band operation.

Sloping Vee antennas also provide the added bonus of inherent polarization diversity because the radiating elements are inclined wires.

A Sloping Vee consists of two radiating wires diverging from the antenna feed point. A schematic diagram appears in Fig.1, and a typical installation is shown in Fig.2.

Note that Fig.1 is a perspective view (both resistors R are at the same height Ht).

These non-inductive resistors terminate the radiating elements. The resistance value is 1/2 the antenna input resistance, and the power rating is typically 10 to 20% of the maximum antenna input power. The resistors absorb incident energy that has not been radiated into space, thereby suppressing reflections which would otherwise generate standing waves and create strong resonances. The resistors are connected by a shorting wire to complete the current path.

Since the Sloping Vee is a balanced radiating system, any unbalanced feed line (such as coaxial cable) requires the use of a

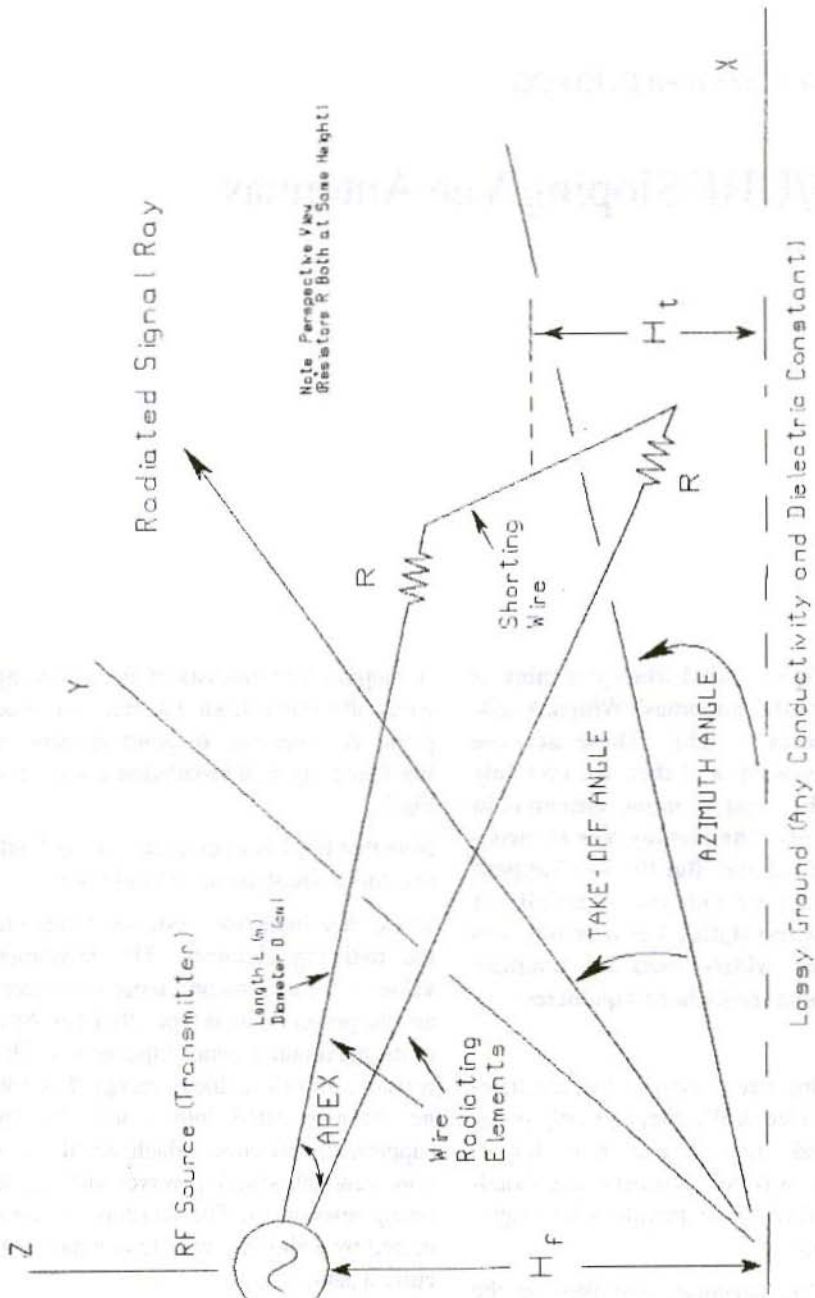


Fig.1: Sloping Vee Antenna Schematic Diagram



balun. The balun should have the lowest possible insertion loss and flattest possible response over the Vee's operating frequency range. As an engineering rule-of-thumb, the Vee is considered a "600 ohm" antenna, meaning that its input resistance is somewhere in the vicinity of 600 ohms. To match a 50 ohm feed system, a balun is required with a 12:1 impedance ratio (square of the turns ratio). In practice, the "600 ohm" antenna may actually turn out to be a 400 ohm or even a 900 ohm system, which, of course, changes the balun requirements.

To get an idea of how good a Vee can be, the three plots in this article show computed vertical radiation patterns for a 6-meter Sloping Vee. The antenna, which has not been optimised, provides very robust performance. The design frequency range is the 6-meter amateur band (50 to 54 MHz). It is assumed that the antenna will be deployed over average ground with an electrical conductivity of 0.002 mhos/meter and a relative permittivity (dielectric constant) of 8.

The antenna parameters are as follows: radiating element diameter, 0.32cm; apex angle (angle between wires at the feed point), 15 degrees; feed point height above ground, 6m; terminating resistor height above ground, 8m. This Vee has an input resistance of 455, 446, and 437 ohms at frequencies of 48, 52 and 56 MHz, respectively.

Taking the average value of 446 ohms as representative, each terminating resistor should have a value of 223 ohms (in practice, 200 or 250 ohms is close enough). Since the computed input resistance varies only 4% between 48 and 56 MHz, this design should provide essentially flat VSWR from 50 to 54 MHz.

The plots are total power gain in dBi (dB relative to an isotropic radiator). To convert to dBd (dB relative to a dipole), subtract 2.15 (the gain of a half-wave dipole in free space is 2.15dBi). Note that total power gain includes both horizontal and vertical radiated fields, as well as antenna radiation efficiency. Patterns were computed at 48, 52 and 56 MHz for three radiating element lengths (20, 40 and 60 meters) as annotated on the curves. These radiation patterns are in a vertical plane bisecting the elements (zero azimuth angle). They are plotted on linear scales which provide a more detailed view than polar plots.

The results in Table 1 summarise key computed performance parameters.

L is the radiating element length in meters. Gmax is the main lobe maximum gain in dBi. Angle is the take-off angle for maximum gain (degrees above the horizon). 3dB BW is the approximate main lobe beamwidth in degrees between points 3dB down from the maximum gain. 1st SL (dBi) is the first sidelobe level in dBi, and 1st SL (dB//Gmax) is the first sidelobe level relative to the maximum gain ("dB down" from the main lobe).

It is evident that this simple antenna exhibits exceptionally good performance. With the largest element (60m long), the main lobe gain varies from 16.3 to 18dBi between 48 and 56 MHz. Maximum gain for all lengths occurs at take-off angles between 9 and 12 degrees, which is a suitable range for long-distance links. The take-off angle can be controlled by adjusting the radiating element lengths and feed point and termination heights. As expected, the shortest element (20m) provides the lowest gain, but even its performance is very respectable (7.7-9.3dBi).

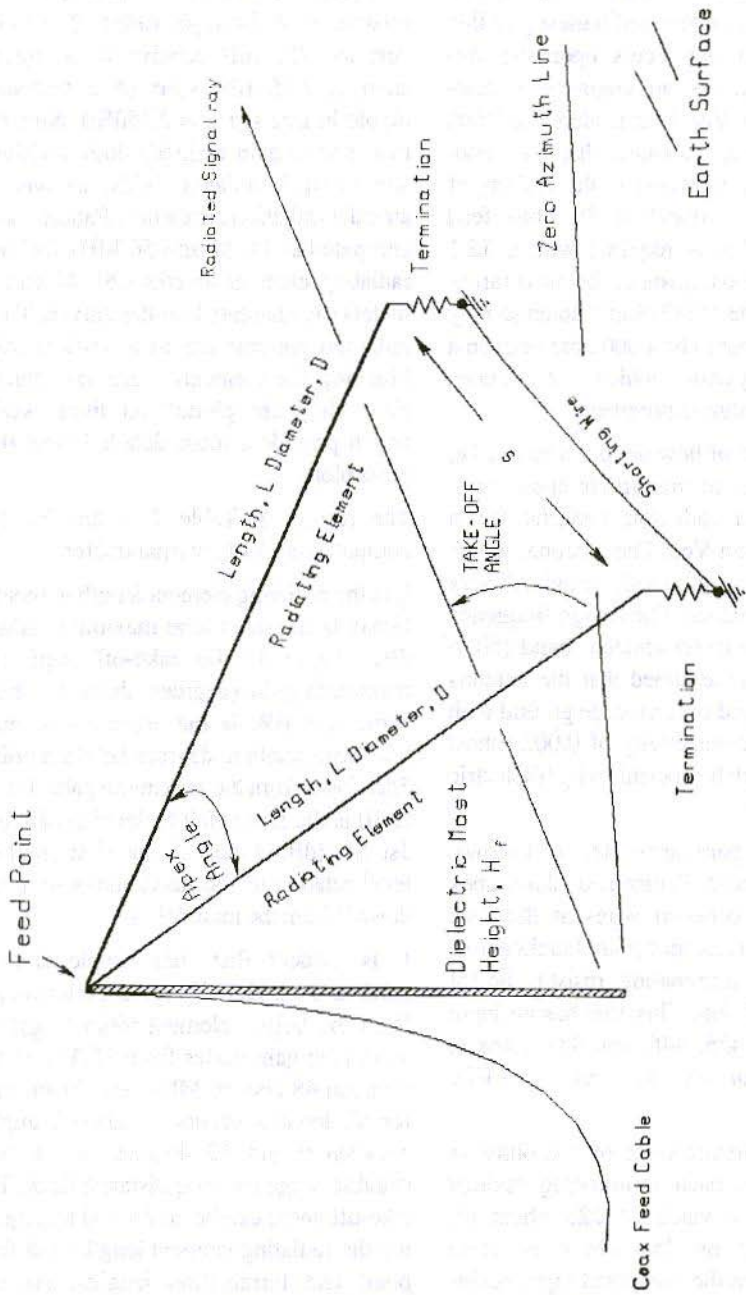


Fig.2: A Typical Sloping Vee Antenna Installation

**Table 1: Key Computed Performance Values**

| L<br>(m)           | Gmax<br>(dBi) | Angle<br>(deg) | 3dB BW<br>(deg) | 1st SL<br>(dBi) | 1st SL<br>(dB//Gmax) |
|--------------------|---------------|----------------|-----------------|-----------------|----------------------|
| Frequency = 48 MHz |               |                |                 |                 |                      |
| 20                 | 7.7           | 12             | 12.6            | 0.5             | 7.2                  |
| 40                 | 13.3          | 11             | 12.0            | -2.3            | 15.6                 |
| 60                 | 16.3          | 11             | 10.6            | -1.1            | 17.4                 |
| Frequency = 52 MHz |               |                |                 |                 |                      |
| 20                 | 8.5           | 11             | 11.9            | 1.9             | 6.6                  |
| 40                 | 14.2          | 10             | 11.0            | -1.5            | 15.7                 |
| 60                 | 17.2          | 10             | 9.9             | 0.3             | 16.9                 |
| Frequency = 56 MHz |               |                |                 |                 |                      |
| 20                 | 9.3           | 10             | 11.0            | 3.3             | 6.0                  |
| 40                 | 15.0          | 10             | 10.4            | -0.9            | 15.9                 |
| 60                 | 18.0          | 9              | 9.5             | 1.8             | 16.2                 |

This design example shows how well the Sloping Vee performs at VHF/UHF. As the example illustrates, the physical size of a high gain Vee can be large. But its dimensions are not so imposing, after all, when they are compared to the size of a yagi providing the same gain. Of course, at higher frequencies, the shorter wavelengths result in much smaller designs.

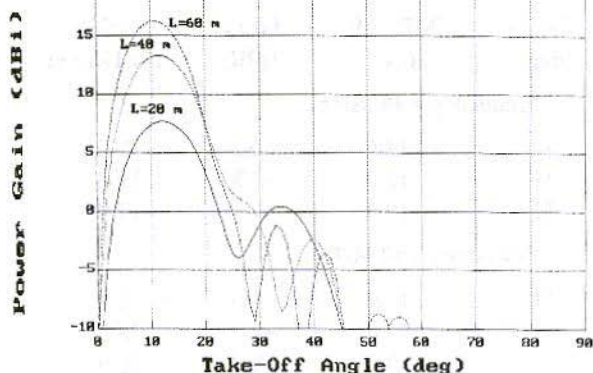
Another advantage provided by the Vee is simple installation. The three different size antennas in the design example could be deployed in a variety of places, for example, between trees, hung from a building or other structure, and so on; the range of possibilities is limited only by your imagination. Most antennas do not provide the installation flexibility that the Vee does. About the only caveat to bear in mind is that, like any antenna's, the Vee's performance is influenced by nearby metallic structures. If they are too close to the radiating elements, parasitic effects may become a problem.

If you want to experiment with VHF/UHF Vee's, the following U.S. companies are sources of materials. The radiation patterns in this article were computed using IBM-compatible PC software available from Phadean Engineering Co., Inc., P. O. Box 611, Shrewsbury, MA 01545-8611. Phadean provides inexpensive (\$10 to \$30) antenna design software (SASE for a list of programs and prices). A Sloping Vee modelling program is essential to designing a good antenna. It is the only way to investigate performance trade-offs as various antenna or ground parameters are changed.

Non-inductive film power resistors for terminating a Vee are available from Power Film Systems, Inc., Yellville, AR 72687. 7 x 9 stranded phosphor-bronze cable is an excellent wire for the radiating elements. It is especially useful if the Vee will be installed and removed frequently (does not kink or tangle). It's available from Astro Industries, Inc., Dayton, OH

## 48 Mhz SU Pattern

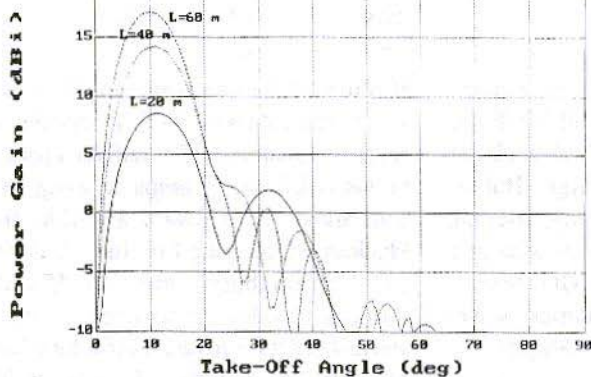
S=.002, EpsR=8, D=.32cm, Hf=6m, Ht=8m



Fig's.3, 4 and 5:  
Performance plots  
for 48MHz, 52MHz  
and 56Mhz

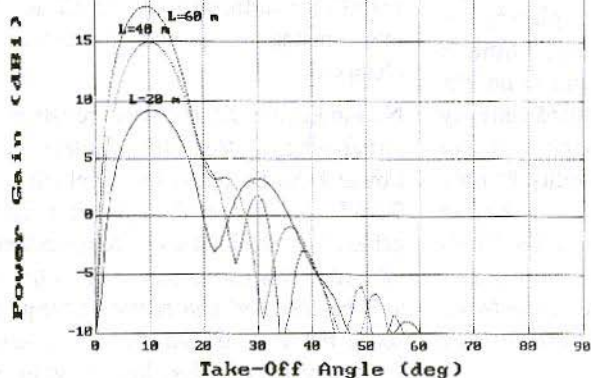
## 52 Mhz SU Pattern

S=.002, EpsR=8, D=.32cm, Hf=6m, Ht=8m



## 56 Mhz SU Pattern

S=.002, EpsR=8, D=.32cm, Hf=6m, Ht=8m





43432. If a non-metallic mast is desired or required, a very strong, non-bending, thick-wall fibreglass tubing called EXTREN 500 is available from J. T. Ryerson Co., P. O. Box 1111, Boston, MA 02103. The phosphor-bronze wire and EXTREN are quite expensive (about \$2 and \$4 per foot, respectively). Since most amateurs will not want to spend that much (and it is recommended that they do not), this information is being provided for completeness.

The Vee's electrical performance is the same whether an exotic stranded cable or a plain single-conductor wire is used. The main difference is convenience. As far as masts go, "masts of opportunity" (trees) provide the same results as fancy dielectric

ones, with somewhat less convenience perhaps, but probably more fun! And, finally, to wind those baluns, toroidal ferrite cores are available from Radio Kit, Inc., P. O. Box 973, Pelham, NH 03076.

I will be happy to answer questions on the material in this article, and I am especially interested in user feedback from anyone experimenting with VHF/UHF Vee's. I can be reached at Phadean Engineering Company at the address above, telephone (508) 869-6077.

## REFERENCES

Phadean Engineering Co., Inc., Post Office Box 611 (MO), Shrewsbury,

**CAMTECH**   
**ELECTRONICS**

21 Goldings Close, Haverhill  
 Suffolk, CB9 0EQ, England  
 Tel: 0440 62779 Fax: 0440 714147

- |                  |   |
|------------------|---|
| <b>TXV4000</b>   | 24cm Low cost Video transmitter, excellent miniature VFO design, 400mW output, 12V DC input, Ready assembled and cased transmitter.   |
| <b>TXV4001</b>   | 24cm Two channel PLL video transmitter module, 400mW output, 26 MHz bandwidth. 12VDC input, complete built and tested surface mount assembly.                               |
| <b>PAI001</b>    | 24cm Power amplifier module to compliment TXV4000 series transmitters, 2.5 Watt output, 12V DC input.   |
| <b>LHA2001</b>   | 24cm Pseudomorphic HEMT ultra low noise GaAsFET preamp, outstanding performance using 0.15dB noise figure PHEMT! Supplied in weatherproof IP65 enclosure with N connectors. |
| <b>CV7001</b>    | 24cm Down Converter, 40MHz IF output, 27dB Gain, 1dB Noise Figure. Complete built and tested surface mount assembly.  |
| <b>MI9001</b>    | Phase Lock Loop module based on Plessey SP5060 IC. Complete synthesiser on a single PCB, includes regulator and loop filter components.                                     |
| <b>VIDEOIF</b>   | Camtech's complete video IF card demodulator, IF at 40MHz with 6MHz sound demodulator all on a single Euro card PCB.  |
| <b>ASG+VOGAD</b> | Intercarrier sound modulator board for TXV4000 series transmitters, enables you to transmit sound with your video pictures.   |

**Specialist 24cm ATV suppliers, RF, Telecoms and Microwave design consultants + PCB CAD and prototype/small volume manufacturing service.**



*Dr.-Ing. Jochen Jirmann, DB 1 NV*

## Operating Electronic Equipment in the Car

Many radio amateurs carry blithely on connecting radio apparatus and other electronic equipment to the car network and are surprised when various forms of interference occur. If you are unlucky, your new radio may not survive being directly connected to 12V. Even specialists usually know very little about the special operating conditions applying to cars and what electronic loads vehicle electronics are designed for. Safe operation of electronic units in a car calls for a precise knowledge of the network's behaviour, so that adequate counter-measures can be taken.

---

### 1. THE ON-BOARD SUPPLY VOLTAGE

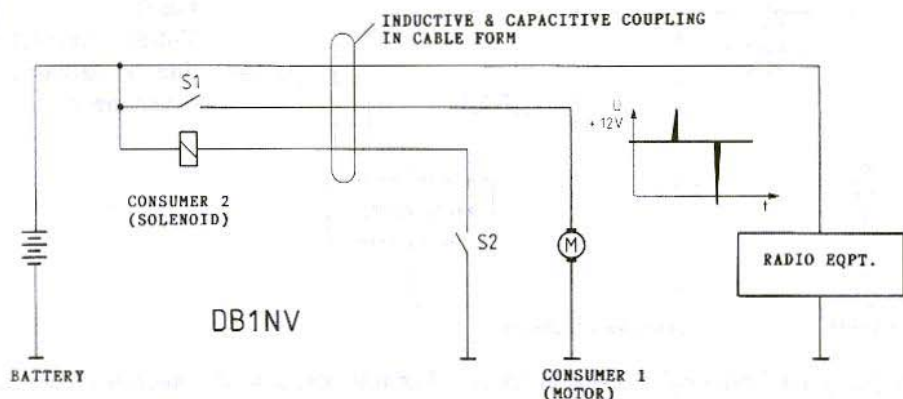
---

As is generally known, the on-board network of a vehicle has a supply voltage of 12V for cars (or 25V for big lorries). The statically measurable voltage lies

between approximately 11V when the battery is almost discharged and about 14.5V with the engine running and a low supply system loading. Cold starting can bring the battery voltage down to 6V, as a great deal of current is extracted by the starter - between 200 and 400A. Even if radio equipment is not required to function under these conditions, it should be established that the control, e.g: a micro-processor, does not trigger a reset and, for example, forget the frequency selected. The engine electronics of a car, such as the ignition control and the injection control, naturally also have to carry on working at 6V.

On older cars with mechanically controlled generators, static voltages greater than 15V can also arise. Modern AC generators regulate their output voltage to 14.2 +/- 0.2V. This is necessary for the use of maintenance-free lead batteries, so that, on the one hand, the battery will be fully charged, and on the other hand no loss of water will occur through over-charging. The output voltage of the generator usually also has a slightly negative temperature





**Fig.1: Occurrence of Negative and Positive Interference peaks.**

coefficient, in order to match it more closely to the charging characteristics of the battery.

## 2. INTERFERENCE

A number of interference factors are superimposed on the static voltage, which can be broken down as follows:

Rectification of the alternating voltage generated in the DC generator, using a three-phase bridge rectifier, generates a voltage ripple of from 100 to 200mVss at six times the three-phase frequency. With the 12-pole generators normally used, interference frequencies arise in the kilo-Hertz range, the well-known "dynamo whistle". As will be shown again later, the filter action of the lead battery on such interference frequencies is limited.

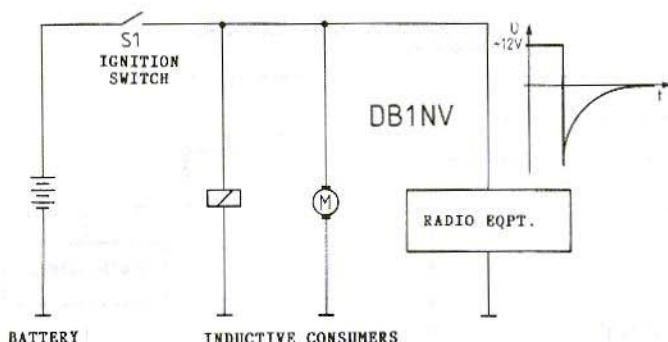
Switching on powerful consumers generates short-term voltage breaks. Periodically switching consumers, such as, for

example, electronic ignition equipment or electrical petrol pumps, are particularly likely to cause interference.

The cut-off peak for inductive consumers, in particular for electro-magnets, can generate positive and negative spikes, as shown in Fig.1. The magneto coupling interference, e.g: when the cooler fan or the air-conditioning compressor is switched on, is particularly energy-rich.

Should a part of the network (e.g: the ignition network) with inductive consumers be separated from the remainder of the on-board network, this can even lead to voltage reversals! Fig.2 shows such interference factors operating.

Should the generator suddenly lose power under high current load, e.g: due to a loose connection on the battery, an energy-rich voltage peak arises, with an amplitude which is a multiple of the on-board network voltage and a duration of from 100 to 200ms. The energy content depends on the load condition of the generator when the load disconnection takes place. The duration depends on the time constant with which the energising field decays in



**Fig.2:**  
Voltage reversal  
due to Inductive  
Consumers

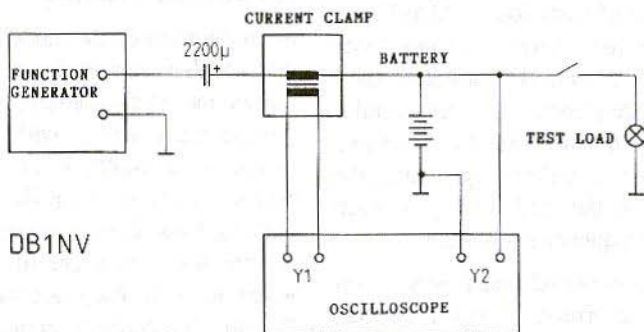
the generator. This kind of interference is described as "load dump".

### 3. THE AC CHARACTERISTICS OF A CAR BATTERY

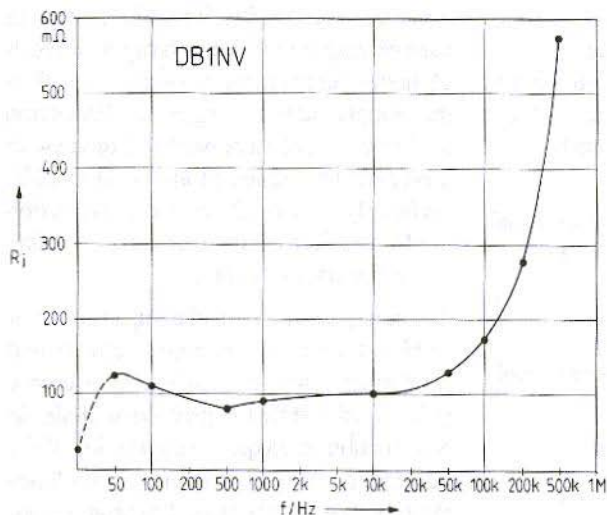
You often hear radio amateurs advising someone to supply the radio equipment direct from the battery terminals, so as to obtain an operating voltage which is as "clean" as possible. But experience has demonstrated that many interference couplings can not be controlled by this procedure. So the AC characteristics of a car battery were examined more closely, which brought some surprising facts to light.

For this research, the internal resistance was measured on a car battery which was about 5 years old. The unit in question was a 12V/63Ah battery, with a cold test current of 300A. Fig.3 shows the test rig: a function generator coupling an alternating current into the battery through a 2200uF capacitor, with the alternating voltage at the battery terminals and the alternating current being measured by the oscilloscope (through a current clamp). The results are shown in Fig.4. An additional connectable load of 5A (some light bulbs) was also available as a check.

Surprisingly, it turned out that the internal resistance of the battery in the low-frequency range is 100mΩ and in the high-frequency range, at 1 MHz, we even obtained 1Ω. The internal resistance is hardly dependent on the load.



**Fig.3: Measurement of Dynamic Battery Internal Resistance**



**Fig.4:**  
Internal Resistance of 5  
year old Battery plotted  
against Frequency

Battery type: 12V/63Ah  
Cold test current: 300A

As a check, the static internal resistance of the battery was again determined, by means of voltage failure while a load was being connected. Here a value of about 25mΩ was obtained.

Theoretically, the internal resistance of this type of battery is about 8mΩ when new, as can be determined from the following approximation:

$$R_i = (2100...2400) / I_{KP} \text{ m}\Omega$$

where  $I_{KP}$  = cold test current.

This equation can be found in (1). The significantly higher reading can be traced back to the considerable age of the battery. But working lives of 5 to 6 years are no longer unusual for today's batteries and charging technologies.

It can be seen from the measurements obtained that the screen effect of the battery for higher-frequency interference is somewhat modest, so that protective and anti-interference measures have to be taken on the consumer (the radio equipment).

#### 4. PROTECTIVE AND ANTI- INTERFERENCE MEASURES ON THE RADIO EQUIPMENT

Small electronic consumers are nowadays usually powered through special voltage regulators, which are on offer from various manufacturers under the name "car regulator" or "automotive voltage regulator", and which, apart from the usual characteristics of integrated voltage regulators, such as excess temperature protection and short-circuit protection, have the following advantages:

- Safe operation up to an input-output voltage difference amounting to 0.2V; this ensures stable output voltage, even for cold starting.
- No destruction if input voltage is reserved; thus the equipment is protected, not only from the aforementioned voltage reversal, but also from false polarity.

- No destruction due to over-voltages of up to 80V; the regulator switches itself into high- $\Omega$  mode when a voltage peak occurs at the input, and thus protects itself.

Unfortunately, the current load of the usual types of regulator, such as, for example:

- LM 2930 (5V or 8V, 0.15A) National Semiconductor
- LM 2925 (5V, 0.75A) National Semiconductor
- TLE 4260 (5V, 0.75A) Siemens
- L 4091 (5V, 0.4A) SGS-Thomson
- L 4920 (adjustable, 0.4A) SGS-Thomson

is so slight that, at best, they can power only a receiver. But they are suitable for producing auxiliary voltages, as they require no further protective measures.

For radio equipment, the discrete building-in of protective functions is required, which also makes it possible to obtain adequate current carrying capacity. The input wiring consists of the following elements:-

False polarity protection circuit: a silicon diode, switched parallel to the 12V input, with a current carrying capacity of a few Amperes, e.g.: a 1N5401, clips negative

input voltages arising for a short time. In case of long-term false polarity as a result of faulty connections, a safety located in the supply line is triggered. Protection against transients: a powerful Z-diode with a breakdown voltage of about 20 to 25V, preferably a special transient protection diode, restricts positive peaks to a value which the circuit can bear.

The low pass filter for the suppression of ripple effects in the on-board network and for further "slurring" of the interference pulse restricted by the protective diode. In order to obtain adequate suppression of the interference frequencies lying in the kilo-Hertz range, either high longitudinal inductances or large case capacitances are required. Since the longitudinal inductances are traversed by a full operating current, limits are set here by the format.

Inductivity values of from 500uH to a few milliHenries are normal. Be careful not to wind the coil round a ferrite core without an air gap. The operating current will saturate the coil and thus render it almost ineffective. Iron-powder toroidal cores or normal transformer cores with an air gap are more suitable.

Provided the leakage field of the coil does not cause interference, a simple rod core (ferrite rod) can also be used. However, in

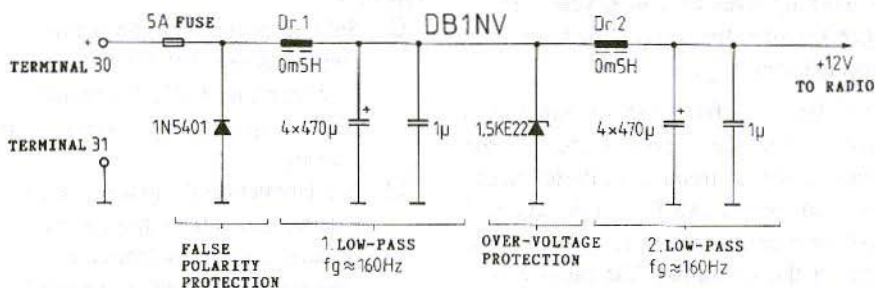


Fig.5: An Anti-Interference Filter for operating Radio Equipment in a Vehicle



order to obtain an adequate low pass effect, capacitors must be used in the range above 1000uF.

In this application, a capacitor characteristic which is scarcely known to the normal amateur gains in importance: the equivalent series resistance or ESR.

Whilst for an ideal capacitor the impedance falls towards zero as the frequency increases, with a real electrolytic capacitor it pushes towards a minimum of approximately  $10m\Omega$  the ESR. This resistance can be interpreted as the internal resistance of the capacitor supply lines and coatings.

For the electrolytic capacitor to be able to short-circuit the low-frequency interference factors effectively, the capacitance is less important than the ESR.

So for the electrolytic capacitors we either use logic system component types, which are produced for the lowest internal resistance, or we connect several small electrolytic capacitors in parallel, which also reduces the ESR.

Through experiments of this type, the author has established that over-age capacitors from the do-it-yourself shop often have much higher ESR's than new units.

A two-stage filter is usually more effective and also easier to fix up than a single-stage filter with correspondingly large inductors and capacitors.

For a better screen effect against high-frequency interference, it is recommended that foil capacitors of approximately 1uF be connected in parallel to the electrolytic capacitors.

## 5.

### EXAMPLE OF AN ANTI-INTERFERENCE FILTER

An anti-interference combination used by the author for a duoband mobile radio unit is shown in Fig.5.

After a fuse, the false polarity protection diode to earth is connected. An LC low pass filter, consisting of a 500uH inductor and a 2000uF capacitor forms the first filter stage, with a limiting frequency of about 160 Hz. The coil is wound around an iron-powder toroidal core and dimensioned in such a way that it is not saturated by the maximum operating DC, which is 4A.

If you want to save time on calculating and winding, you can make use of radio interference suppression coils, which are obtainable from several manufacturers. Make sure that you do not use any current-compensated ferrite coils, which easily become saturated.

The capacitor of the first low pass is actually four individual electrolytic capacitors, each of 470uF, plus a high-frequency block-off capacitor of 1uF. The transient protection diode (type 1.5KE22) is connected here. It is relieved of the task of clipping short interference peaks by the first filter.

A second similar low pass follows the transient protection diode. At its output, the DC voltage can be distributed to the individual stages of the radio equipment.

This circuit is intended as an example and can be modified according to application.

6.

## FURTHER POSSIBLE INTERFERENCE FACTORS IN THE ON-BOARD SUPPLY SYSTEM

In spite of careful filtering of the radio equipment operating voltage, interference often becomes apparent, in the form of extraneous noise. The origin usually lies in an earth circuit. The radio equipment has an earth connection, on the one hand, through the on-board network, and on the other hand through the screening of the aerial cable and the aerial base which is screwed to the bodywork. Since the two earth potentials are not necessarily the same, but may differ by a few tenths of a volt, compensating currents traverse the radio. On their path through the radio, they can be coupled up into the modulator or phase-locked-loop stages and become audible.

A recommended remedy is first to check whether any connections on the earth path

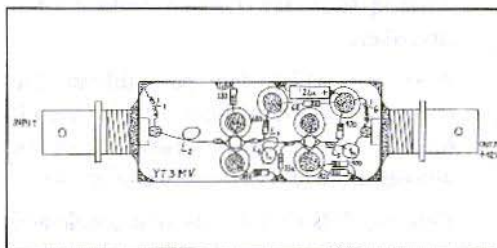
are corroded, specifically in the car (in order to prevent the potential difference from arising) and in the radio equipment, in order to reduce the coupling in of the interference currents into sensitive stages. Should nothing help, the only possibility remaining is to wire the earth feed to the radio equipment with a coil and thus block the interference factors.

As can be seen, the unfortunately frequently circuit-linked interference effects on the operation of a radio in a car can be taken in hand through appropriate measures at low cost. And many kinds of damage to equipment can be explained once the peculiarities of the car's on-board network are understood.

7.

## LITERATURE

- (1) Vehicle Technology Pocketbook  
Robert Bosch GmbH, Stuttgart 1984



Very low noise aerial amplifier for the L-band as per the YT3MV article on page 90 of VHF Communications 2/92. Kit complete with housing Art No. 6358 DM 69. Orders to KM Publications at the address shown on the inside cover, or to UKW-Berichte direct.



Eugen Berberich, DL 8 ZX

# A Logarithmic Detector, Manufactured using Integrated Modules

Inspired by the article on "Short-Wave Reception using the Principles of the Thirties" (1), I myself undertook some experiments with the technology of logarithmic demodulation.

---

## 1. DESCRIPTION

---

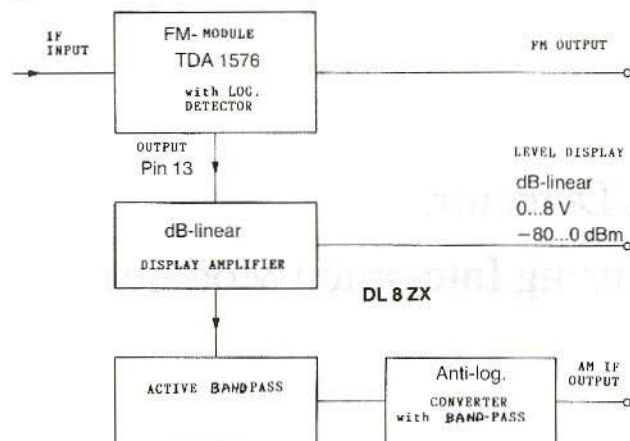
By contrast with (1), I use a special module as logarithmic detector, the TDA 1576 FM IF amplifier. This has an accurate logarithmic level detector - more precisely, an amplitude modulation detector with a logarithmic level procedure. This module is normally used as a dB-linear field strength indicator, as an FM IF amplifier with phase discriminator, and for other functions. I supplemented this module with a band-pass and an antilogarithmic

circuit. The block diagram (Fig.1) shows the individual stages of the amplitude modulation detector.

The demodulated signal actually has a distorted curve (see Fig.5 in (1)) and it is now appropriate to transform the distorted curve form into a slightly tidier sine-form. An antilogarithmic circuit is suitable for this; for example, the ICL 8049 from Intersil. However, problems in obtaining this meant I could not use it at first, which compelled me to build up the circuit from separate elements (Fig.2).

The antilogarithmic circuit was simultaneously intended to act as an integrator (C1). Its band-pass behaviour leads to an improvement, and it provided really good results with regard to minimal distortion effects from the non-linear distortion factor (signal-noise ratio).

The output signal, with a logarithmic curve form, is converted via an amplifier to a



**Fig.1:**  
**Block Diagram of an AM Receiver with Logarithmic level Output**

level of 0 to 8 volts, and can be displayed by means of an oscilloscope or simply using an S-meter (functions like a spectrum analyser).

The polarity of the logarithmic output (pin-13 of TDA 1576) must be matched to the antilogarithmic unit to obtain a clean linearisation. A capacitive coupling separates off the direct voltage fractions. The low-frequency signal level, which remains the same, allows the antilogarithmic circuit to work within the same level range all the time. No amplitude adjustment is needed, because of the special characteristics of the logarithmic detector, as already mentioned in (1).

(e.g. AD 811 from Analog Devices) for the construction, in order to obtain greater thermal stability. The level indication circuit was taken from the wiring diagram of an automatic telephone receiver (PKI BSA 51).

### 2.1. Equalisation of resistances

Without a high-frequency signal, offset equalisation is carried out through R1. The output level should be set to precisely zero volts. With R3, the output level at a 223 mV input level (corresponds to 0 dBm at 50 Ohms) is equalised to +8 volts. These two equalisation steps reciprocally influence each other and must therefore be repeated several times.

The non-linear harmonic distortion factor should be equalised through R2, R4 and R5. Here the equalising is done to produce optimal antilogarithmic characteristics.

If the ICL 8049 is used, R4, R5 and C1 are eliminated. Equalising points are marked \* on the wiring diagram.

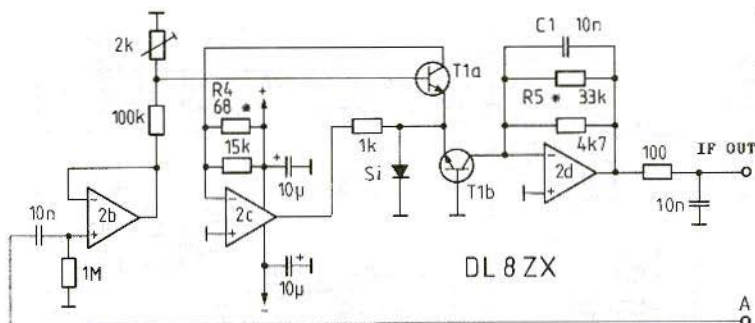
In Table 1 the non-linear harmonic distortion factors are listed in accordance with the logarithmic demodulation, at 30% and

## 2. ASSEMBLY INSTRUCTIONS

A circuit was constructed as per Fig.3 in the hook-up. A breadboard was used, with an earth plane for screening (e.g. Vero Eurocard no. 03-29891).

It is advantageous to use a dual transistor





**Fig.2:**  
**Antilog Circuit**

80% amplitude modulation each time, and with and without CCITT filtration.

Appropriate input amplifiers can increase the sensitivity. However, the input stages must operate in a linear fashion, as there are no regulation steps.

### 3. POSSIBLE APPLICATIONS

The naturally high sensitivity of the module used makes it possible to construct a long-wave or medium-wave straight-circuit receiver with a co-ordinated ferrite aerial as the only selection. The suppression of neighbouring signals described in (1) resulting from the logarithmic demodulation can be well observed here.

Fig.4 shows the circuit extension to the medium-wave receiver without oscillator. It operates largely without singing points.

With a suitably co-ordinated input circuit, this circuit is also suitable for the reception of time sign and

normal frequency transmissions (DCF 77.5 kHz).

Where greater selectivity is required, a second, co-ordinated resonant circuit can be constructed.

At my location in Nuremberg, the medium-wave receiver could even pick up SDR 1 on 576 kHz, as well as the German radio service, at any time of day, in spite of the powerful local transmitters such as B1 and AFN.

### 4.

| HF Level<br>dBm | 80% AM |        | 30% AM |        |
|-----------------|--------|--------|--------|--------|
|                 | CCITT  | Normal | CCITT  | Normal |
| 0               | 5.0    | 6.9    | 3.8    | 5.3    |
| -10             | 4.2    | 6.2    | 3.7    | 5.3    |
| -20             | 6.4    | 9.4    | 3.6    | 4.8    |
| -30             | 5.1    | 7.7    | 3.8    | 5.3    |
| -40             | 5.9    | 8.1    | 3.6    | 4.7    |
| -50             | 5.5    | 7.9    | 3.8    | 5.3    |
| -60             | 4.8    | 6.9    | 3.6    | 4.9    |
| -70             | 3.8    | 6.0    | 3.1    | 4.3    |
| -80             | 4.3    | 6.5    | 5.0    | 8.3    |

**Table 1: Non-Linear Harmonic-Distortion factor in % at 1kHz, measured without Band-Pass Filter**





*Jean-Pierre Morel, HB 9 RKR and Dr. Angel Vilaseca, HB 9 SLV*

# Doppler Radar in the 10 GHz Amateur Band

## Part-1

For years, a large selection of commercial intruder detectors has been available, based on the Doppler principle and operating in the micro-wave range. We wondered whether the simple 10 GHz transceiver with Gunn elements, which was so successfully used some years ago in the amateur radio world, could perhaps be used in Doppler radar equipment, similar to that used by the police to measure vehicle speeds on the roads.

As it turned out, we were able to obtain some surprisingly accurate readings with decidedly simple circuits! If developed a little further, the equipment could even be used to track aircraft and measure their distance and speed.

If you want to, you can, for example, monitor the speed of your neighbour's car electronically at any time! So now read on!

---

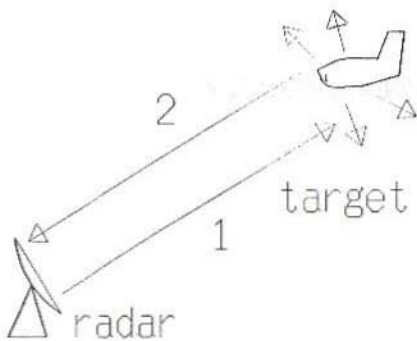
### 1. THE RADAR PRINCIPLE

---

Radar is an artificial word made up from the initial letters of "Radio Detection And Ranging", which points immediately to the principle involved - determining the presence and the direction of a "target" with the assistance of radio waves and measuring how far away it is. For this purpose, the radar equipment's target must be irradiated with radio waves, which should be as strong as possible (Fig.1).

A small part of the high-frequency energy reaching the target is absorbed by it. The majority is scattered in many directions, and a small part is reflected back to the radar equipment. We know this from EME radio traffic (Fig.2).

If the radar equipment receives an echo from a specific object in the area on which



**Fig.1: The Radar principle: the waves transmitted by the Radar set (1) are scattered in many directions by the target; a fraction is reflected back to the Radar**

it is trained, then there must be a target in this specific direction. This is called detection.

If we now measure the time elapsing between the transmission of the radar signal and the receiving of the echo, we can calculate the distance to the object - knowing, of course, that the radio waves are being propagated at the speed of light.

$$R = c * t/2$$

where:

R = Distance from radar to target

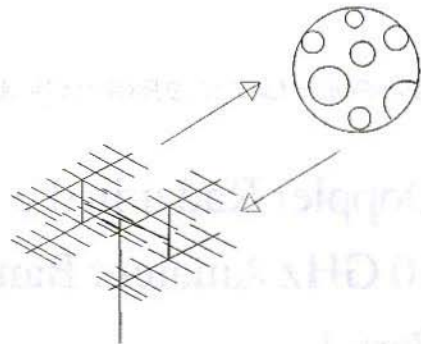
t = Time taken for signal to travel there and back

c = Speed of light (approx.  $3 \times 10^8$  m/s)

This is called ranging.

We can distinguish between two types of radar equipment:

- Pulse radar
- CW radar



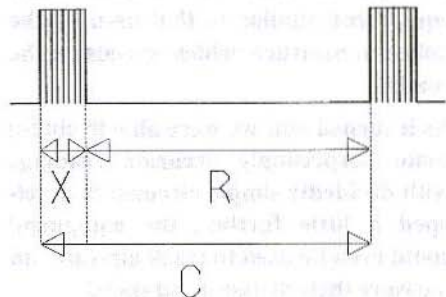
**Fig.2: EME Mode, based on the same principle as Radar**

### 1.1. Pulse radar

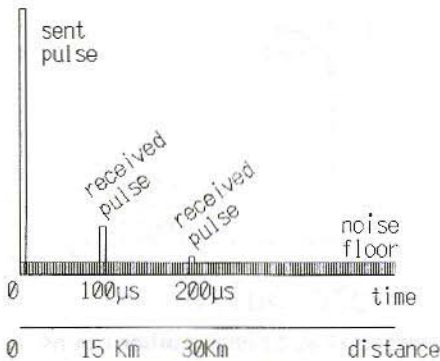
Pulse radar always transmits short pulses and listens to the echoes in between pulses. The pulse duration is typically in the approximate area of one per-thousandth of the reception time. For the descriptions in Fig.3, the so-called pulse-width repetition rate is thus:

$$X/(X + R) = 10^{-3}$$

The reception time is set in such a way that the transmission pulses have time to reach targets at the limit of the equipment's



**Fig.3: Pulse-width Repetition Rate: each cycle, C, consists of a Transmission Time, X, and a Reception Time, R**



**Fig.4: The echoes received from a Transmission Pulse**

range and then return. A longer reception time would not make sense, as echoes coming in even later would be weaker than the receiver's limiting sensitivity. It is thus time to transmit a new pulse (Fig.4).

The pulse repetition frequency (PRF) is a very important parameter in radar technology (Fig.5). For the radar measurement of short distances, a high pulse repetition frequency is used because the echoes are already arriving shortly after the pulse has been transmitted. For large distances, on the contrary, the echoes need more time, so that a low PRF is indicated. In practise, the repetition frequencies lie between one and several kHz.

The briefer the pulse duration, the higher are the accuracy and the resolution of the distance measurement. Short pulses allow several targets close to one another to be differentiated (Fig.6a), whereas with longer pulses they appear as only one target (Fig.6b).

A magnetron is ideally suited to the generation of microwave pulses with high energy at a low pulse-width repetition rate.

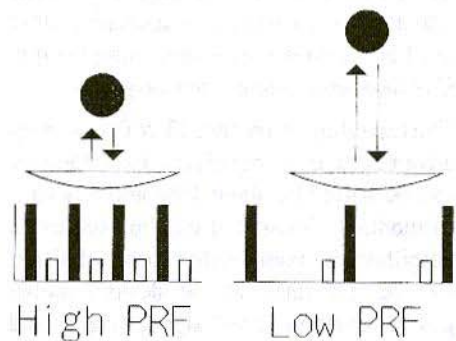
It has therefore been used for this since the 'forties, with a typical pulse-width repetition rate of about 1 part per thousand. The peak power can attain several megawatts.

But the transmission pulse duration can not be reduced indefinitely because, as the pulses become shorter, the reflected energy per pulse is reduced, and thus, of course, the energy of the echo. It must also be taken into account that shorter pulses have a greater signal band width.

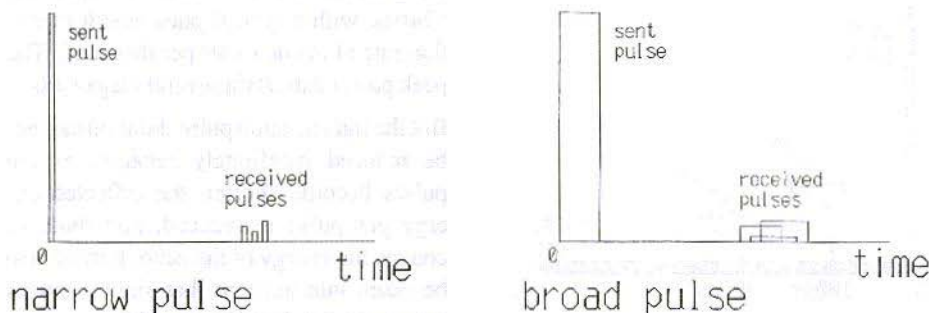
## 1.2. CW radar

CW stands for continuous wave. As the name indicates, the transmitter is continuously switched on, but the frequency is switched between two or more values. The time between two frequency switchings must be sufficient for the signal to reach the target and return (Fig.7).

It has probably become clear that CW radar has nothing to do with the amateur radio meaning of "CW" as telegraphy mode.



**Fig.5: The Pulse Repeat Frequency must be matched to the distance to be measured: high for short range and low for long range**



**Fig.6: If the Transmission Pulse is short, targets close to one another can be differentiated. With long pulses, on the other hand, the echoes overlap**

## 2. PRINCIPLE CONSIDERATIONS

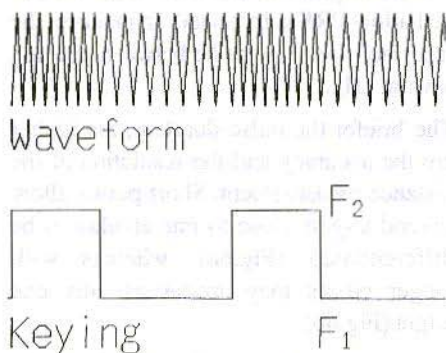
The pulses from the classic pulse radar can be replaced by bursts on one frequency, with continuous wave transmission on another frequency in between. It is not all that simple to switch the frequency of a magnetron, except with special models. So several magnetrons must be used and must be switched at high power, which is also not a trivial matter. Although continuous magnetrons do exist (for example, those used in micro-wave ovens), using them in CW radar equipment is not easy either.

The travelling-wave tube (TWT) has many advantages in comparison. Its frequency can be varied by about 10% and it is easy to modulate because it can be used as an amplifier. So complicated forms of signal can be generated at the desired output power, even in small signal stages, and they are then much cleaner than if an attempt is made to modulate a magnetron accordingly (Fig.8).

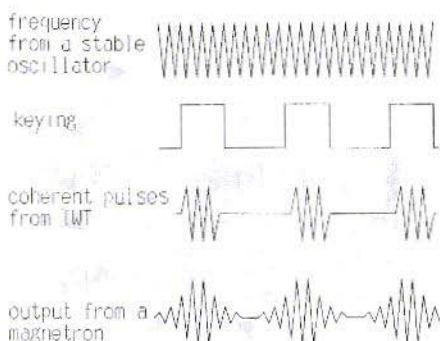
With a travelling-wave tube, for example, coherent pulses can also be generated. Since the returning echoes are then also

coherent, special filtering techniques can be used in the receiver which increase the signal-to-noise ratio or the range width. The disadvantage of the travelling-wave tube is that it can not generate the extremely high levels of power which characterise a magnetron.

For the radio amateur, of course, there is no question of using magnetrons, because in general they are much too powerful. One exception covers the types which are used in micro-wave ovens. They are cheaper than a 4CX250B, easily obtainable and also, if you buy a complete (old)

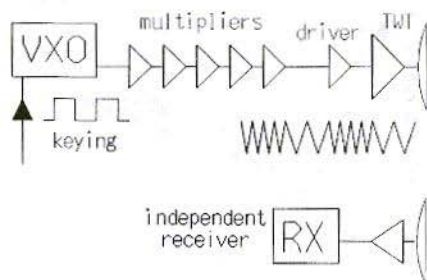


**Fig.7: Waveforms of a Continuous Radar**

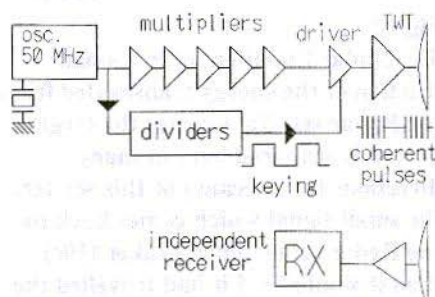


**Fig.8: Comparison of Output signals from a Travelling Wave Tube and a Magnetron (only a few waves are shown out of the thousands in every pulse)**

oven with them, equipped with a power supply and with cooling. With some comparatively simple modifications, the frequency can be moved to the 13cm



**Fig.9a: Continuous Radar with FM**



**Fig.9b: Pulse Radar with Coherent PCM**

amateur band and many hundreds of Watts of energy can be re-routed to an aerial. That would certainly be an interesting project (8). Switching the aerial between transmission and reception would, of course, not be exactly simple if you wanted to avoid baking the receiver input to a crisp.

Anyone who has the good fortune to get hold of a travelling wave tube amplifier can certainly also use it to carry out very promising experiments in the field of radar technology, as demonstrated by Fig's.9a and 9b.

For those amateurs who are really "poor" (i.e: lacking money, not spirit), the Gunn diode oscillator would seem to offer the only possibility for radar experiments. The obvious mode is CW, although we have read (1) that Gunn diodes can be forced into an intermittent high-powered mode if they are pulsed at an operating voltage which is higher than usual. But we did not investigate this type of misuse.

The lower microwave frequencies, such as the 23cm band, can be used for radar experiments, and normal ready-made FM transmitters probably can too.

The only problem would be switching the aerial between transmission and reception. You can certainly not switch a mechanical relay at a level of several kHz. So you would have to switch to a separate aerial for the receiver.

It should also be mentioned that the first radar sets operated in the VHF range, which could still be done today in principle. Even the short-wave range is used for radar, because there you can see "over the horizon" (remember the Woodpecker!).

## 2.1. The Radar Equation

We shall now carry out a theoretical study to determine the range width. The range width depends on the power received - more precisely, on the signal-to-noise ratio in the radar receiver.

We shall make use of the following values:

|           |   |
|-----------|---|
| $P_E$     | Transmission power (W)                                |
| $P_R$     | Received power (W)                                    |
| $\lambda$ | Wavelength (m)  |
| $R$       | Distance from radar to target (m)                     |
| $A$       | Reflected wave cross-section area of target ( $m^2$ ) |
| $G$       | Aerial gain   |

The power reflected back per solid angle unit is:

$$P_1 = \frac{P_E * G}{4 \pi} \text{ (W)}$$

At the target, at a distance,  $R$ , from the radar, the power density is:

$$P_2 = \frac{P_E * G}{4 \pi R^2} \text{ (W/m}^2\text{)}$$

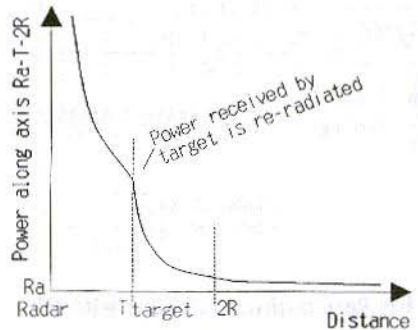
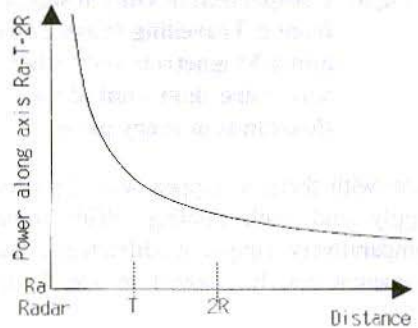
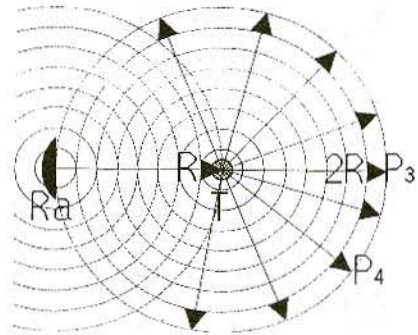
The target reflects a power,  $P_3$ , which is proportional to  $P_2$ :

$$P_3 = A * P_2 \text{ (W)}$$

$A$ , the radar back scatter cross-section, is a measure of the target's capability of reflecting radar waves. In warplanes, this value is made as small as possible.

$P_4$  is thus the back-scattered power per solid angle unit:

$$P_4 = \frac{P_3}{4 \pi} = \frac{A * P_2}{4 \pi} = \frac{P_E * G * A}{(4 \pi R)^2} \text{ (W)}$$



**Fig.10:**

**The Radar Equation: only a small fraction of the energy transmitted from the Radar set,  $R_a$ , reaches the target,  $T$ , and is scattered here in many directions (a). Because of this scatter, the small signal which comes back to the Radar set is much weaker (10c) than it would be if it had travelled the entire distance - namely  $2R$  - in free space (10b)**





Finally, the following power density returns to the radar aerial:

$$P_s = \frac{P_E * G * A}{(4 \pi R)^2} * \frac{1}{R^2} = \frac{P_E * G * A}{(4 \pi)^2 * R^4} \text{ (W/m}^2\text{)}$$

The aerial gain depends on its equivalent cross-section,  $A_e$ :

$$G = \frac{4 \pi A_e}{\lambda^2}$$

For a level wave front, the aerial therefore behaves like an absorbent aperture with a surface,  $A_e$ , of:

$$A_e = \frac{\lambda^2 * G}{4 \pi}$$

The signal supplied by the aerial to the receiver is thus  $P_s * A_e$ , which means that:

$$P_R = \frac{P_E * G * A}{(4 \pi)^2 R^4} * \frac{\lambda^2 * G}{4 \pi} = \frac{P_E G^2 A \lambda^2}{(4 \pi)^3 R^4}$$

If  $P_R$  is the smallest signal usable for the radar set, then the maximum range width,  $R$ , can be read off from the following equation:

$$R^4 = \frac{P_E * G^2 * \lambda^2 * A}{(4 \pi)^3 * P_R}$$

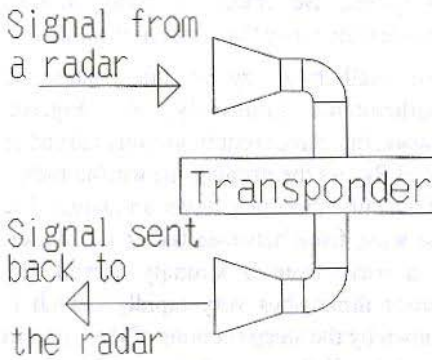
The range width itself is thus the fourth power root of the fraction to the right of the equals sign. The problem in constructing radar sets for large range widths becomes clear here. The range width is proportional to the fourth power root obtained from the transmission power! So if, for example, you want to double the range width, then if

everything else remains the same you must increase the power by a factor of sixteen!

We shall now try to understand the mathematics intuitively. As Fig.10a shows, the wave front is strongly curved at point Ra. As the distance grows, the radius of the curve becomes larger and larger, i.e. the wave front becomes flatter and flatter. If a wave front is strongly curved, the power diminishes very rapidly, which is shown by the steep sections of the curve in Fig.10b. If the wave front now becomes flatter and flatter, the power diminishes less and less, and thus the curve in Fig.10b becomes less and less steep.

At a great distance from the transmitter, the wave front is almost perfectly flat, so that the wave can cover great distances while losing almost no power. The power which transports the wave moves in only one direction.

Now what happens if an obstacle (radar target) is in the way? Right - the target scatters the waves in all directions again (Fig.10a), so that once again the propagation behaviour seen at point Ra returns. There is again a very steep fall in the (small reflected) power (Fig.10c). The power which strikes the target is proportional to  $\frac{1}{R}$ . The power which reaches the radar receiver is thus proportional to  $\frac{1}{\sqrt{R}}$ , or to  $\frac{1}{R^2}$ . In certain cases, this very high attenuation can be circumvented by building a transponder into the target. Whenever the transponder receives a signal from the radar, it amplifies it and loads it with information - such as identification and flying height - and then transmits the signal back to the radar set. The power received is then proportional to the fourth power root derived from  $R$  (Fig.11). It is clear that we can not make use of this possibility.



**Fig.11: The Transponder Principle**

The radar equation also shows that the 4th power also applies to the receiver sensitivity. The sensitivity has to be improved by a factor of 16 if the range width is to be doubled.

The smallest signal which the receiver can evaluate can also be expressed as the input noise power,  $N$ , for a given signal-to-noise ratio, SNR:

$$P_R = N * SNR$$

The radar equation then becomes:

$$R^4 = \frac{P_E G^2 \lambda^2 A}{(4 \pi)^3 N * SNR}$$

The noise power,  $N$ , contains a fraction received from the aerial and a fraction generated in the receiver. The latter has many sources, among others the thermal noise. This can be very closely approximated by using the thermodynamic law:

$$N = k * T * B$$

where:

- $k$  is the Boltzmann constant:  
1.374\*10<sup>-23</sup> W/Hz/K or Joule/K
- $T$  is the temperature of the object (K)
- $B$  is the receiver noise band width (Hz)

Now, we still haven't got the noise factor,  $n$ , which expresses the factor by which the receiver noise exceeds the minimum noise power established by the thermodynamic law. The total noise power is thus

$$N = n * k * T * B$$

Now we can write out the radar equation in a more comprehensive form:

$$R^4 = \frac{P_E G^2 \lambda^2 A}{(4 \pi)^3 * SNR * nkTB}$$

The numerator still contains the reflected power,  $P_E$ , and the received power,  $P_R$ , has been resolved in the denominator.

As the final factor, we would now like to introduce the power losses between the generator and the aerial, as well as between the aerial and the receiver. The sum of these losses,  $L$ , comes into the denominator of the radar equation:

$$R^4 = \frac{P_E G^2 \lambda^2 A}{(4 \pi)^3 * SNR * nkTB * L}$$

This should suffice for our purposes, and we shall now use this radar equation to estimate the range width of our experimental radar set-up (Fig.12). Let us assume the following values for our 10 GHz blow-through mixer with Gunn elements:



$$\begin{aligned}
 P &= 10\text{mW} = 10^{-2}\text{W} \\
 G &= 20\text{dB (or more)} = 100 = 10^2 \\
 &\text{thus: } G^2 = 10^4 \\
 \lambda &= c/f = 3 * 10^8 / 10 * 10^9 = 30\text{mm} \\
 &\text{thus: } \lambda^2 = 10^{-3} \\
 A &= 1\text{m}^2 \\
 (4\pi)^3 &= 1.98 * 10^3 \\
 \text{SNR} &= 10\text{dB} = 10 \\
 n &= 20\text{dB} = 100 \\
 &\text{(not exactly state of the art!)} \\
 T &= 290 = 2.9 * 10^2 \text{ K} \\
 B &= 8 \text{ kHz} = 8 * 10^3 \text{ Hz}
 \end{aligned}$$

This is an adequate band width, for if the Doppler frequency reaches 8 kHz, that corresponds to a target speed of 459km/h.

$$L = 6\text{dB} = 4$$

We now introduce this value into the above radar equation and we get:  $R = 140\text{m}$ .

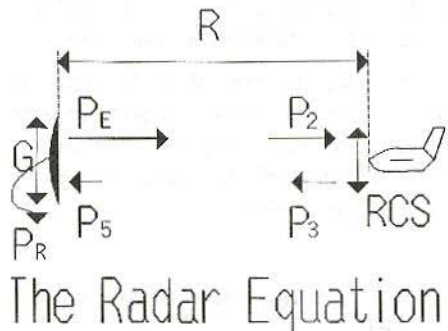
That might appear somewhat optimistic for the minuscule transmission power, but we shall find out by practical experiments. Initially we want to try and increase our range width on paper. If we had a hypothetical receiver without noise and without losses, only the thermal noise would remain and, with  $\text{SNR} = 1$ , we would obtain  $n = 1$  and  $L = 1$  from our radar equation, if the other parameters remained unaltered, giving  $R$  as 1.12km!

With a modern receiver and small power losses, the range width will thus lie somewhere between the extremes 140m and 1km.

We can now lay the receiver aside and juggle with the other parameters instead:

#### a) Increasing Aerial Gain

With a reflector diameter of 160cm, we would obtain a gain of about 40 dB, i.e. a hundred times the earlier figure, so that the



## The Radar Equation

Fig.12: The most decisive values from the Radar Equation

range width is multiplied by ten:  $R = 1400\text{m}$ . Disadvantage: targeting with a large aerial is very much more difficult.

#### b) Using lower frequencies

This makes the wavelength bigger - for example about 10 times as big if we use the 23cm band. The range width is increased by the square root of 10 = 3.16. Thus  $R = 440\text{m}$ . Disadvantage: as we are still calculating on 20dB gain, the aerial becomes correspondingly larger!

#### c) The last possibility - increasing the transmitter power

Unfortunately increasing the transmission power by ten only increases the range width by the fourth power root of 10, which is 1.77. So a range width of 140m becomes 249m at a transmission power of 100mW, or 442m at 1W, or 787m for 10W, and so on.

A super 3cm radar set with a transmission power of 10W from a travelling-wave tube and a 1.6m parabolic antenna could have a range width of between 7km and 30km, depending on the quality of the receiver.

A 23cm radar set with a transmission power of 100W and an antenna gain of

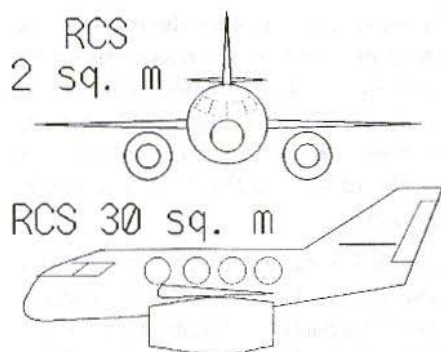
20dB (super long Yagi) would have a range width of between 4km and 30km.

So we can see that it is theoretically possible to track aircraft - especially large aircraft - and measure their speed. Now it's time to deal with the radar backscatter cross-section (RCS).

## 2.2. Radar Backscatter Cross-section (RCS)

The higher the RCS value, the greater the range width. All range widths given above are based on an RCS value of  $1\text{m}^2$ . It is clear that, for example, a Boeing 747 has a much higher RCS value. Moreover, it is immediately clear that the RCS value is always variable, depending on the orientation of the target relative to the wave front of the radar signal (Fig.13).

The RCS value is also dependent on the shape of the target. Flat surfaces act like mirrors and reflect the waves very well. Sharp edges, slots and points can act as aerials and reflect the microwave energy received. Multiple reflections take place in



**Fig.13: The Radar Backscatter cross-section, RCS, depends, among other things, on the orientation of the target**

cavities or intersecting surfaces, and the incoming wave can be reflected to the radar set (Fig.14).

But the RCS value is not dependent on the size and shape of the target alone. The material it's made of also has an influence. Metal reflects much better than, for example, plastic or composite materials. Certain materials which absorb microwaves are used to reduce the RCS value of warplanes, as is special shaping (remember the stealth bomber). Some aircraft optimised in this way should allegedly have an RCS value no greater than that of a seagull!

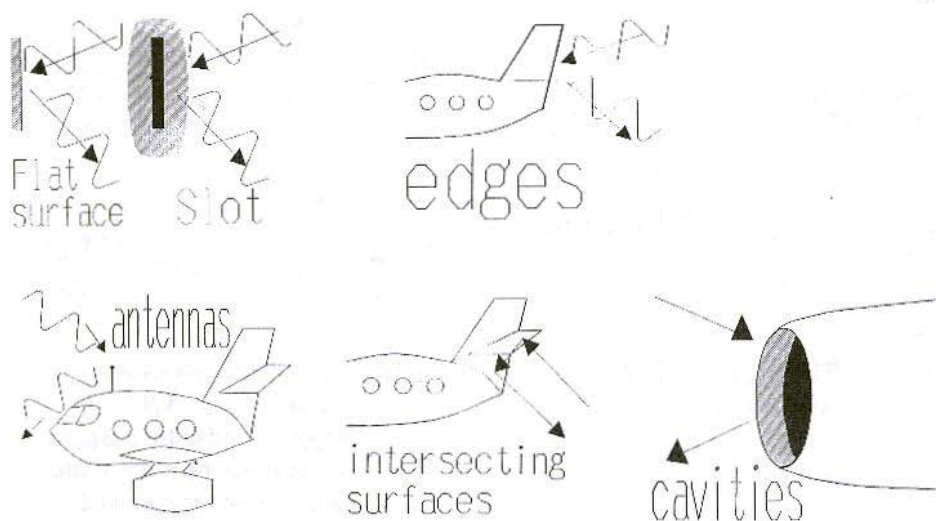
If we now target a large (civilian) aircraft with an RCS value of  $50\text{m}^2$ , the theoretical range width of our radar will be multiplied by the fourth power root of  $50 = 2.6$ . So the original range width of 140m becomes about 400m.

Now here are a few examples of RCS values:

|              |   |
|--------------|---|
| Human being: | $0.1 - 1.9\text{m}^2$                                     |
| Seagull:     | $0.01\text{m}^2$  |
| Fly:         | $0.00001\text{m}^2$                                       |
| Aircraft:    | $0.5\text{m}^2$ (head-on)<br>$20\text{m}^2$ (sideways-on) |

A more precise RCS value can be calculated only for simple surfaces (flat surfaces, spherical surfaces and the like). A multiform object can be seen as a combination of many simple shapes. Some of them will be good reflectors, others bad. To the radar set, such objects appear as a collection of bright spots between dark spots.

Depending on whether the waves from the various reflecting part-surfaces finally reach the radar receiver more in phase or more in opposite phase, the target is bright or dark, the RCS value large or small. If any of the structures of the target at all is in



**Fig.14: Certain structures of a Radar target can reflect particularly well, especially if their dimensions are of the order of magnitude of the wavelengths used; this creates particularly bright spots in the Radar image**

resonance with the radar wavelength, this produces a particularly bright spot, because the reflection is particularly effective.

It should now no longer come as a surprise to find that the RCS value of a moving target is continually varying in practise, because the phases of the wave fractions reflected are continually being superimposed on each other. Variations in the propagation conditions in the atmosphere, which are expressed as fading with changing strength and time constants, also play a part. Each individual radar echo will thus have a different intensity. There will be an average value, with a random scattering around it.

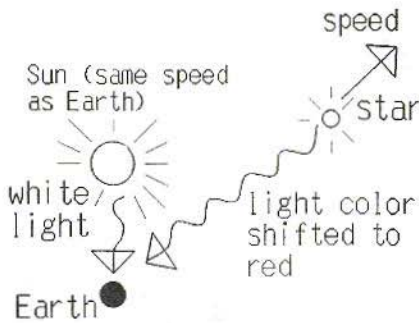
Thus, when signals are processed in the receiver of a pulse radar, a number of successive echoes must be determined in

order to increase the accuracy of the process.

### 2.3. The Doppler effect

The Doppler effect is familiar to everyone since rail and road traffic became widespread. This effect has become very important in astronomy (Fig.15), as the so-called red shift of spectra, on the basis of which their speeds and distances can be calculated on the cosmic scale.

The Doppler effect affects all electromagnetic waves, and this includes microwaves. Here it can even be measured quite handily. The frequency shifted by the Doppler effect can be calculated using the following formula - with the proviso, of course, that the speed of the object is small in comparison with the speed of light:



**Fig.15: The Doppler effect in Astronomy**

$$f' = f * (1 - (v/c))$$

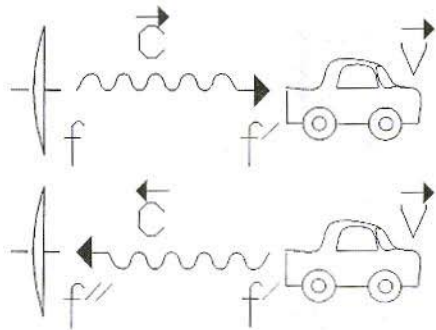
- $f'$  = the frequency received  
 $f$  = the frequency transmitted  
 $v$  = speed of object  
 $c$  = speed of light

But we must remember that this formula is based on the assumption that the frequency,  $f$ , is generated by the moving object itself, not by the observer.

#### 2.4. Doppler radar

In a Doppler radar system, the output frequency,  $f$ , is generated, not by the moving object, but by the radar set. When it encounters the moving object, a Doppler frequency shift has already taken place. This displaced frequency,  $f'$ , is reflected back to the radar set and undergoes a second Doppler shift. The reception frequency,  $f''$ , thus includes a double frequency shift (Fig.16).

$$f'' = f * (1 - (2v/c))$$

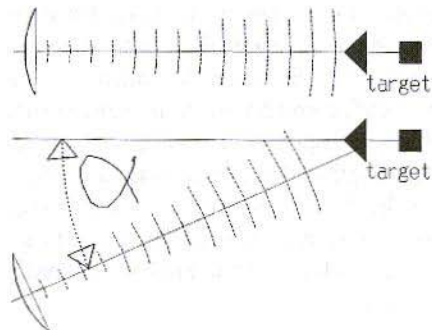


**Fig.16: The Doppler effect in its dreaded form. With Doppler Radar the Doppler Effect is doubled when the return signal is received**

The Doppler frequency,  $f_d$ , is the difference between  $f$  and  $f''$ , i.e. the total value of the frequency shift which the original frequency,  $f$ , has undergone due to the Doppler effect.

$$f_d = f * 2v/c \quad \text{oder} \quad v = f_d * c/2f$$

As we can see from this formula, the speeds of the target,  $v$ , and the Doppler frequency,  $f_d$ , are directly proportional to



**Fig.17: The Alpha Angle must be taken into account in the calculation of the speed**



| Doppler Frequency Hz | Speed m/s | Speed km/h |
|----------------------|-----------|------------|
| 0                    | 0         | 0          |
| 10                   | 0.146     | 0.526      |
| 50                   | 0.731     | 2.633      |
| 100                  | 1.463     | 5.266      |
| 200                  | 2.956     | 10.532     |
| 500                  | 7.315     | 26.33      |
| 1000                 | 14.63     | 52.66      |
| 2000                 | 29.26     | 105.32     |
| 5000                 | 73.15     | 263.3      |

**Table.1: Doppler Frequencies and Speeds for a Transmission Frequency of 10.25 GHz**

one another. We can also see why it is particularly easy to deal with the Doppler effect in the micro-wave range. For speeds which arise in practise, Doppler frequencies are in the low- frequency range. Table 1 gives some examples of this, based on the assumption that the transmission frequency of our radar set is 10.25 GHz.

As we see, an interesting speed range can be covered using a handy receiver range width. The Doppler formula was averaged to obtain the figures for the table. Multiplying the frequency by  $1.463 \times 10^{-2}$  gives the

speed in m/s. The factor for the speed in km/h is  $5.266 \times 10^{-2}$ .

So far we have been assuming that the target is moving directly towards or away from the radar set. But in practise this is extremely rare. There is almost always an angle, alpha, between the direction of propagation of the radar waves and the direction of motion of the target (Fig. 17).

The Doppler equation must therefore be expanded as follows:

$$f_d = \frac{f \cdot 2v}{c} \cdot \cos \alpha$$

or

$$v = \frac{f_d \cdot c}{2f \cdot \cos \alpha}$$

If the radar set is standing at the side of the road and the target is picked up when it is a few tens of metres away, cos alpha is so close to 1 that the term can be ignored for practical purposes. If the alpha angle is  $33.5^\circ$ , cos alpha = 0.83. The speeds listed in Table 1 would need to be multiplied by 1.2 in such a case.

## **BRITISH AMATEUR TV CLUB**

**THE CLUB FOR ANYONE INTERESTED IN AMATEUR TELEVISION**

**FAST SCAN, SLOW SCAN, STUDIO WORK, ETC. 2500 MEMBERS WORLDWIDE**

**QUARTERLY JOURNAL - CQ-TV - WHICH FEATURES CONSTRUCTION PROJECTS, ATV NEWS, REGULAR FEATURES AND PCB & COMPONENT OFFERS TO MEMBERS. ANNUAL MEMBERSHIP ONLY £9.00**

**BATC, GRENEHURST, PINWOOD ROAD, HIGH WYCOMBE, HP12 4DD, UK**

# KM PUBLICATIONS

## BOOKS:

|   |          |         |
|---|----------|---------|
| UHF COMPENDIUM, Pts.1&2 and 3&4                   | each     | £ 23.00 |
| KL.Weiner DJ9HO                                   | the pair | £ 40.00 |
| A PRACTICAL GUIDE TO PACKET OPERATION IN THE U.K. |          |         |
| Mike Mansfield G6AWD                              |          | £ 7.95  |
| AN INTRODUCTION TO AMATEUR TELEVISION             |          |         |
| Mike Wooding G6IQM & Trevor Brown G8CJS           |          | £ 5.00  |
| THE ATV COMPENDIUM                                |          |         |
| Mike Wooding G6IQM                                |          | £ 3.50  |
| THE INTERNATIONAL VHF FM GUIDE                    |          | £ 1.75  |
| THE RADIO LISTENERS GUIDE                         |          | £ 2.95  |

P&P please add £1.00 for U.K., £2.00 for Overseas surface, £7.50 for Air Mail

## CAD & DESIGN SOFTWARE (PC):

|                                     |  |         |
|-------------------------------------|--|---------|
| 'PUFF' with Handbook (Caltech)      |  | £ 15.00 |
| Motorola/SM6MOM-W64 PUFF supplement |  | £ 11.00 |
| Siemens S-parameters                |  | £ 9.50  |
| Philips S-parameters                |  | £ 14.50 |
| HP AppCad/HP                        |  | £ 16.50 |

P&P please add £2.50 for U.K. and Surface Mail, £6.00 for Air mail

|  |             |         |
|--|-------------|---------|
| EASY-PC PCB CAD                          |             | £121.00 |
| EASY-PC PROFESSIONAL ADVANCED PCB CAD    | ****NEW**** | £235.00 |
| PULSAR Digital Circuit Simulator         |             | £235.00 |
| ANALYSER III AC Linear Circuit Simulator |             | £235.00 |

Additional Component Library sets for Easy-PC, Pulsar & Analyser III each £ 50.00  
Prices include U.K. VAT and P&P. Overseas customers please Phone/FAX prices.

## C+A ELECTRONIC & RADIO KITS

KITS FOR THE ENTHUSIAST, PROFESSIONAL ENGINEER & RADIO  
AMATEUR: TRANSVERTERS, TRANSMITTERS, RECEIVERS,  
AUDIO UNITS, ALARM SYSTEMS, MEASURING EQPT., ETC., ETC.

SEND £1.50 FOR A FULL CATALOGUE AND PRICE LIST

KM Publications, 5 Ware Orchard, Barby, Nr.Rugby, CV23 8UF, U.K.  
Telephone: 0788 890365 Fax: 0788 890365 Cellphone: 0860 857434





*Detlef Burchard, Dipl.-Ing., Box 14426, Nairobi, Kenya*

## MES-FETishism !

A new structural element is as good as the manufacturers have made it. It can be used as well as its characteristics are known. The manufacturers have made some of the characteristics known in the technical data, and you can discover others yourself through tests and measurement. Radio amateurs are in the fortunate situation of not having to generate any equipment which can be reliably mass-produced. They can thus "extract" more from a structural element by dimensioning the stages individually. All circuits referred to in this series of articles are, in one way or another, "not worst case designed", but can be copied, with similar characteristics, if the basic circumstances are considered analogous.

It is only recently that the MES-FETs have appeared as new stars in the semi-conductor firmament: brought into the world in 1984 - from Texas Instruments (S 3000), 1986 - from Telefunken (CF 300) and 1988 - from Siemens (CF 139). Their differences are not as great as the advertisements would have us believe. And so, if the CF 300 is

the basic model here, then what has been said is also true, where applicable, to the products of the two other companies, including the SMD formats.

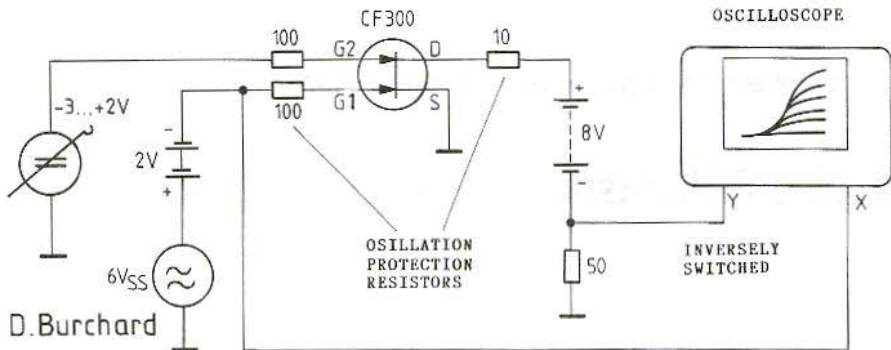
The selection of the operating point is described first. This differs considerably from the manufacturer's suggestions, but in the end makes the circuit as simple as for a GaAs triode.

---

### 1. CHARACTERISTICS

---

The curve  $ID = f(UG1S)$  gives information on the transmission behaviour at low frequencies, and can be obtained relatively simply in a test rig as per Fig.1 and displayed on an oscillograph. With the parameter UG2S, we obtain, for example, a set of curves such as Fig.2 for CF 300, IDSS group B. Because of the high limiting frequency of the MES-FETs, these curves continue to apply far beyond the VHF range, even if they can not be measured so easily there.



**Fig.1: Test Rig for obtaining Characteristic Curves**

Every value of  $UG_{2S}$  has its own S-form characteristic.  $UG_{2S}$  clearly has the highest level of current which can flow within the transistor. At about half of the maximum current, the characteristic curve has a turning point, at which, according to the laws of mathematics, the gradient is steepest. Around the turning point, the characteristic curve is approximately linear. The linear range is rapidly extended with values higher than  $UG_{2S}$ . The gradient at the turning point also increases, but not to anything like the same extent as the

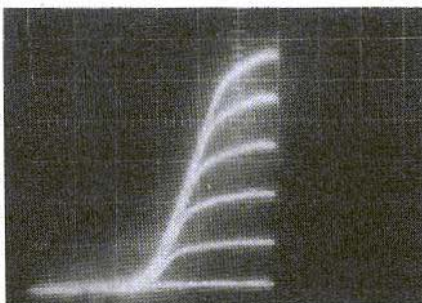
increase in the current and the linear range. The manufacturer's recommendation to set  $UG_{2S}$  to +2V and then adjust in a current of 10mA by means of  $UG_{1S}$  leads to an operational point on a bent section of the curve.

Ever since field effect transistors came into existence, their quadratic characteristic curve has been praised, because it promises freedom from cross-modulation and inter-modulation. This is due to the fact that these modulations are proportional to the third derivative of the  $I_D$  curve. Thus the curve must have the form

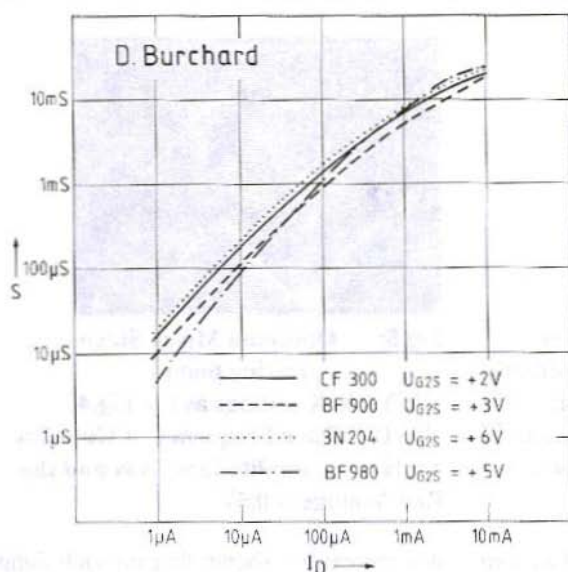
$$1$$

which includes purely linear and quadratic curves. Current FET circuits have thoroughly measurable cross-modulation and inter-modulation. Doubts are also voiced concerning the quadratic characteristic curves. A book (3) which to a large extent is accepted as the Bible of high-frequency technology even gives an exact characteristic curve for MES-FETs. It runs as follows:

$$2$$



**Fig.2:  $I_D = f(UG_{1S}, UG_{2S})$   
Characteristic Curves**  
X:  $UG_{1S}$ , 1V/div, 0-point in centre  
Y:  $I_D$ , 10mA/div, 0-point on lowest line  
Parameter:  $UG_{2S}$ , -3, -2, -1, 0, +1, +2V



**Fig.3:**  
Gradient Plotted against  
Drain Current for four  
different Dual-Gate FETs

and basically contains no quadratic elements. If we think of a few mathematical principles, then it becomes clear that it is always possible to find a parabola (and thus a quadratic curve) which coincides with a measured crooked curve at three points. If you want coincidence at still more points, then you have to turn to complicated potential functions like equation (2). What really happens involves the measurement of the gradient over a wide range of the drain current, as has been done for Fig.3. Unfortunately, some mathematics are once again required for the interpretation.

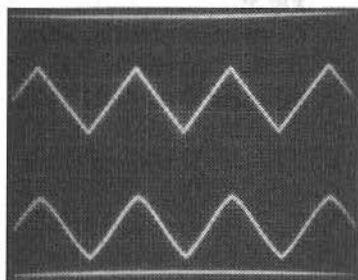
The amplification is proportional to the gradient if the load resistance or the feedback from the active element is sufficiently small. Thus in practise we measure the gradient instead of the amplification and convert. Another possible way of obtaining information on the functions, together with their derivatives, is to measure distortions which arise when there is an undistorted sine signal at the input. The

process can be read up in Meinke/Gundlach (3rd edition) (2). Unfortunately the new, fourth edition no longer refers to this interesting type of characteristic curve analysis. The process can also be used at high frequency. Even being restricted to the first derivative (gradient, Fig.3) still allows interesting information to be obtained. The diagram shows the relationship between the first derivative and the basic function with logarithmic axial distribution. In this diagram exponential functions and some potential functions are formed as straight lines, namely

and

All type (3) functions appear as straight lines ascending at under  $45^\circ$ , and  $m$  is not shown, while  $n$  indicates a parallel displacement. Those of type (4) are represented with an incline, which is

A quadratic characteristic curve ( $n = 2$ ) is indicated here with an incline of 0.5 (26.6 degrees), a linear one ( $n = 1$ ) with an



**Fig.4: Minimum Drain Current Distortion values at optimally selected operating point**

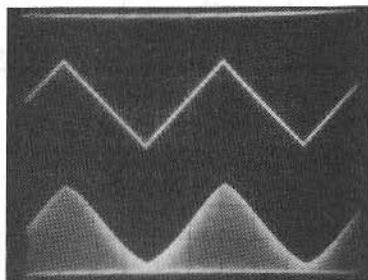
**Y1: UG1S, 0.5V/div, 0-point line above  
Y2: ID, 10mA/div, 0-point line below  
X: 0.2ms/div**

incline of 0 and a cubic one ( $n = 3$ ) with an incline of 0.67 (33.7 degrees). It can now be seen at a glance that for all the FETs investigated below 100uA an exponential function represents the closest approximation to the actual curve. Between 100uA and 1mA a cubic relationship is preferable, and only above that does a range which can be referred to as between quadratic and linear exist.

There is an interesting analogy with the long-forgotten "vapour" tubes. There the residual current law applied at low levels of current - an  $e$  function; at higher levels of current the space charge law applied - a potential function with the exponent 1.5, i.e: between linear and quadratic!

## 2. OPERATING POINTS

We would like to obtain a characteristic section which is as long and as straight as possible for a linear amplifier. The previ-



**Fig.5: Optimum Mixer Stage operating point**

**Y1, Y2 & X settings as for Fig.4.  
The Oscillator Frequency at Gate-2 is 20kHz, the amplitude is 3V<sub>ss</sub> and the Bias Voltage is 0.5V.**

ous section has shown that no such thing exists in the natural state of the case. Using MES-FETs, by selecting suitable UG2S values, we can ensure that the curve, bent to one side, bends back, and a straight characteristic section arises. The operating point then selected is in the middle of this straight section of the curve (to be mathematically correct, at the turning point of the S-shaped total curve). This point can also easily be found from the measurement technology point of view. There are several criteria.

The amplification is greatest here. Symmetrical limitation takes place at high modulation. When the modulation alters, there is no change in the average current value, which remains the same if there is no rectifier effect. There is a minimum of even-numbered harmonics.

There is a specific value of UG2S at which the circuit is particularly simple, namely  $UG2S = 0$ . G2 is directly linked with the source. There are no more components required than would have been needed for a circuit with a GaAs triode. But here we



obtain an amplifier with excellent linearity, as shown by Fig.4. The drain current can be modulated to approximately  $\pm 70\%$ , with the peak compression at about 10%. This gives a starting point for the later 1dB compression point of the amplifier. The input voltage may go up to  $1V_{SS}$ , the average drain current is 14mA, the initial potential at G1 amounts to  $-1.3V$ , and it can be generated at a source resistance of  $93\Omega$ .

A mixer can also be used in similar fashion, as Fig.5 shows. Of course, according to my experiments, there are no good mixers with  $UG2S = 0$ . The selection of  $UG2S = UG1S$ , which could also contribute to the reduction of the number of components, does not work well. CF 300 mixers can be obtained from Althaus (1) and Reuschle/Shah (4), but clearly measure from other standpoints. The setting found here works in quasi-linear fashion up to an input voltage of  $1.3V_{SS}$ . If the demands for linearity are not too great, you can, for example, use it as an AM modulator in a signal generator.

---

### 3

## LOAD RESISTANCES

---

The modulation capability of an amplifier stage can also be limited by an unsuitably selected load resistance. Obviously the optimum would be achieved if the drain voltage falls just to the turnover voltage at maximum drain current, i.e: double the stand-by current. If we assume a stand-by current of  $V$ , a turnover voltage of  $3V$  and the operating point in Fig.4, resistance should not exceed  $330\Omega$ . This is astonish-

ingly low, and permits a voltage amplification of only 6.6 for G1 after D. The gradient has been assumed to be  $20mS$ . In reality, it is somewhat less than the specification sheet for the same drain current states, but it gives a high G2 voltage. It can be more advantageous for a voltage amplifier to select an operating point with a smaller current ( $UG2S$  negative), for the gradient falls back less rapidly than the optimum load resistance rises. Fig.3 includes the fact that reducing the current to  $1/10$  brings the gradient down to  $1/4$ . The voltage amplification rises to 16.5.

There are other aspects worth noting at the output of a MES-FET. The second gate takes the form of a Schottky diode and should never become conductive. It lies opposite a point on the channel which receives a potential of about  $2/3$  of the drain source voltage. A high G2 voltage, as recommended by the manufacturer, thus also increases the turnover voltage.

With a drain voltage of less than  $5V$ , the output capacitance increases steeply, at about  $1pF/V$ . Should such an alteration result in connected circuits being impermissibly mismatched, or in cross-phase modulations, then the load resistance should be reduced again. That may well be necessary in a 10.7 MHz intermediate frequency amplifier!

---

### 4.

## SCATTERING OF OPERATING POINT

---

Setting to  $UG2S = 0$ , together with the turning point in the characteristic curve, is



bound to lead to different stand-by currents for different examples. All examples from group B, which were purchased at three different times, always displayed operating points with stand-by currents between 12 and 16mA. Anyone for whom this is too high can go back to group A, and will obtain currents of 10mA. Or if a higher output voltage is desired, group C can be selected, which will lie at approximately 20mA. But then the permissible power loss is reached at a drain voltage of 8V.

Naturally, UG2S can also be selected as a value deviating from zero in each IDSS group, so as to make possible a desired drain current and setting to the turning point of the characteristic curve. MES-FETs make it possible to match the characteristics of the active element to the circuit!

## 5. LITERATURE

- (1) M.Althaus (1990): Mcteosat Converter in Compact Format  
VHF Communications, 1/90, pp. 53-59
- (2) H.Meinke and F.W.Gundlach (1968): High Frequency Technology Pocketbook 3rd edition, Chapter L 39, pp. 818 - 819 Springer-Verlag, Berlin
- (3) Meinke and Gundlach (1986): High Frequency Technology Pocketbook 4th edition, Chapter G, p. 19 Springer-Verlag, Berlin
- (4) R.Reuschle and H.Shah (1989): Applications for Satellite Receivers Funkschau, no. 21, 1989, pp. 61 - 65 Franzis-Verlag, Munich

Announcement: Change of Title: Commencing with the JULY issue  
The 'BUYERS & SELLERS DIGEST' will be published as

# Radio Amateur Advertiser

Now indicating clearly the content, plus the FREE ADVERTISING SERVICE to the RADIO/ELECTRONIC enthusiast

There cannot be a more economical service than FREE ONE for advertising those surplus items,

No obligation to subscribe to the magazine to participate  
**in this FREE SERVICE**

AVAILABLE BY SUBSCRIPTION ONLY . RATES (inc postage)

12 monthly issues: UK £12.00 - EUROPE: £18.00 - REST OF WORLD: £22.00

For further information 9" x 4" S.A.E. Introductory sample copies available at £1.00 inc postage (Note may not be current issue)

**BUYING OR SELLING IS EASY WITH  
FREE PRIVATE ADS**


Technology Partners, PO Box 6, South Shore, Blackpool FY4 4YG



# The cost of a Phoenix Aerial is in material

*Phoenix Yagi Aerials are born of practical experience, built of high grade materials and designed for performance. They may cost a little more but look at the gains.*



◆ 5 year Warranty ◆ High gain, low noise *and* upgradeable ◆ High quality Mil Spec. feeder cable with 'N' termination and moulded connection to the driven element ◆ HE 9, 10 Gauge aluminium boom and stainless Steel fixings - STRONG and RESISTANT TO CORROSION ◆ Easily assembled and ready for immediate use - NO ADJUSTMENTS ◆ Unique Encapsulated matching system, protected from the atmosphere ◆ UK manufactured 

| Model                | ☆<br>50/3    | 70/5         | 144/7        | 144/14        | 144/18        | 432/16       | 432/29        | ☆ ⊗<br>434/8V |
|----------------------|--------------|--------------|--------------|---------------|---------------|--------------|---------------|---------------|
| No. of elements      | 3            | 5            | 7            | 14            | 18            | 16           | 29            | 8             |
| Design Freq. - Mhz.  | 51           | 70.2         | 144.3        | 144.3         | 144.3         | 432.2        | 432.2         | 434           |
| Gain - dBd.          | 6.1          | 7.5          | 10.3         | 14.2          | 16.4          | 15.8         | 17.8          | 11            |
| YSWR at design Freq. | <-----<      |              |              | < 1.2:1       |               | ----->       |               |               |
| Boom Length - metres | 2.4          | 2.8          | 2.8          | 6.9           | 9.7           | 2.9          | 5.9           | 1.6           |
| Boom sections        | 1            | 1            | 1            | 3             | 3             | 1            | 2             | 1             |
| <b>Prices £</b>      | <b>85.00</b> | <b>79.00</b> | <b>79.00</b> | <b>129.00</b> | <b>149.00</b> | <b>85.00</b> | <b>121.00</b> | <b>59.00</b>  |

All prices include UK Vat and packing.  
Carriage £ 11.75 inc Vat for overnight delivery - UK mainland only.

**Other New Products**  
**Include:-** Vertical Colinears for 6m, 4m, 2m, & 70cms. Active Receiving Antenna for 50 khz. to 30 Mhz.

**Future Products include -** 1296 Mhz. Antennas, HF Yagis and Verticals

☆ New Products ⊗ Extended boom for vertical mounting

For further details of these and other Phoenix products, contact the address below for a free catalogue UK only or 3 IRC's abroad.

**\* Overseas distributors required \***

PHOENIX SMD., AMATEUR PRODUCTS DIVISION, PHOENIX HOUSE, PO BOX 1526,  
WINCANTON, SOMERSET, BA9 9YA, UK.

☎ UK 0963 34992 Int.+44 963 34992 Fax: 0963 34360



# TIMESTEP



## HRPT System

Noise-free digital HRPT transmissions from NOAA, with a ground resolution of just 1.1km, allow images to be received in incredible clarity. Rivers, lakes, mountains, cities and even small towns can be seen on good days. Fishermen will appreciate the increased resolution of sea surface temperatures.

Image processing, including variable and histogram contrast equalisation combined with full colour editing, gives the best possible results from any image. Colour enhancement allows sea surface temperature and land details to stand out in high contrast. Any number of colour palettes can be saved for future use. The sophisticated mouse-driven software allows all five bands to be saved and displayed on nearly all VGA and SVGA cards right up to 1024 pixels, 768 lines and 256 colours.

Zoom to greater than pixel level is available from both a mouse-driven zoom box or using a roaming zoom that allows real time dynamic panning.

Sections of the image may be saved and converted to GIF images for easy exchange.

Latitude and longitude gridding combined with a mouse pointer readout of temperature will be available late in 1991.

Tracking the satellite is easy and fun! Manual tracking is very simple as the pass is about 15 minutes long. A tracking system is under development and expected by the end of 1991. A 4-foot dish and good pre-amplifier are recommended. The Timestep Receiver is self-contained in an external case and features multi-channel operation and a moving-coil S meter for precise signal strength measurement and tracking. The data card is a Timestep design made under licence from John DuBois and Ed Murashie.

Complete systems are available, call or write for a colour brochure.

USA Amateur Dealer: Spectrum International, P.O. Box 1084, Concord, Massachusetts 01742. Tel: 508 263 2145

### TIMESTEP WEATHER SYSTEMS

Wickhambrook Newmarket CB8 8QA England Tel: (0440) 820040 Fax: (0440) 820281





## VGASAT IV & MegaNOAA APT Systems

### 1024 x 768 x 256 Resolution and 3D

The Timestep Satellite System can receive images from Meteosat, GOES, GMS, NOAA, Meteor, Okean and Feng Yun. Using an IBM PC-compatible computer enables the display of up to 1024 pixels, 768 lines and 256 simultaneous colours or grey shades depending on the graphic card fitted. We actively support nearly all known VGA and SVGA cards. Extensive image processing includes realistic 3D projection.

### 100 Frame Automatic Animation

Animation of up to 100 full screen frames from GOES and Meteosat is built in. We call this 'stand alone animation' as it automatically receives images, stores them and continuously displays them. Old images are automatically deleted and updated with new images. The smooth animated images are completely flicker-free. Once set in operation with a single mouse click, the program will always show the latest animation sequence without any further operator action.

### NOAA Gridding and Temperature Calibration

The innovative MegaNOAA program will take the whole pass of an orbiting satellite and store the complete data. Automatic gridding and a 'you are here' function help image-interpretation on cloudy winter days. Spectacular colour is built in for sunny summer days. Self-calibrating temperature readout enables the mouse pointer to show longitude, latitude and temperature simultaneously.

### Equipment

#### Meteosat/Goets

- 1.0M dish antenna (UK only)  Yagi antenna
- Pre-amplifier  20M microwave cable
- Meteosat/GOES receiver
- VGASAT IV capture card
- Capture card/receiver cable
- Dish feed (coffee tin type)

#### Polar/NOAA

- Crossed dipole antenna
- Quadrifilar Helix antenna (late 1991)  Pre-amplifier
- 2 channel NOAA receiver  PROscan receiver
- Capture card/receiver cable

Call or write for further information.

USA Education Dealer. Fisher Scientific, Educational Materials Division, 4901 W. LeMoyné Street, Chicago, IL 60651.

Tel: 1-800-621-4769

USA Amateur Dealer. Spectrum International, P.O. Box 1084, Concord, Massachusetts 01742. Tel: 508 263 2145



### TIMESTEP WEATHER SYSTEMS

Wickhambrook Newmarket CB8 8QA England Tel: (0440) 820040 Fax: (0440) 820281



# practical Wireless

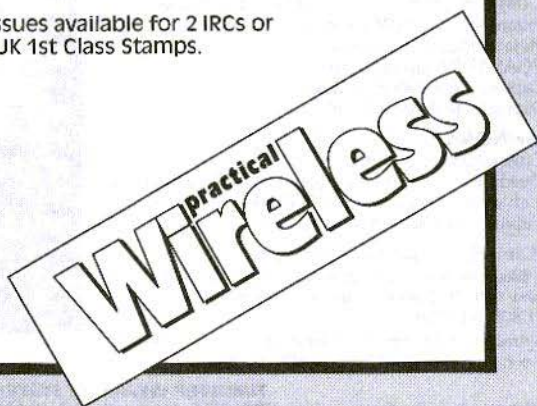
## Britains best selling amateur radio magazine

- ★ Practical Home-brew Projects ★
- ★ Regular Antenna Designs ★
- ★ Amateur TV & Packet Radio ★
- ★ News & Views ★
- ★ CB High & Low ★
- ★ Reviews ★

Published 2nd Thursday each month.  
Subscriptions, £19 - UK, £21 - Europe,  
£22 - Rest of World.

Sample issues available for 2 IRCs or  
6 UK 1st Class Stamps.

PW Publishing Ltd.,  
Circulation Dept.,  
Enefco House,  
The Quay, Poole,  
Dorset BH15 1PP.  
Tel (0202) 678558.





## Plastic Binders for VHF COMMUNICATIONS

- Attractive plastic covered in VHF blue
- Accepts up to 12 editions (three volumes)
- Allows any required copy to be found easily
- Keeps the XYL happy and contented
- Will be sent anywhere in the world for DM8.00 + post and packing

Please order your binder via the national representative or directly from UKW-BERICHTE, Terry Bittan OHG (see below)

The elder editions of VHF COMMUNICATIONS are still obtainable for reduced prices from the publishers of UKW-Berichte.

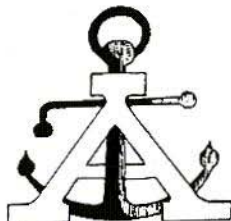
| Subscription                    | Volume       | Individual copy |
|---------------------------------|--------------|-----------------|
| VHF COMMUNICATIONS 1992         | each DM38.00 | each DM10.00    |
| VHF COMMUNICATIONS 1991         | each DM35.00 | each DM10.00    |
| VHF COMMUNICATIONS 1990         | each DM27.00 | each DM 7.50    |
| VHF COMMUNICATIONS 1988 to 1989 | each DM25.00 | each DM 7.50    |
| VHF COMMUNICATIONS 1986 to 1987 | each DM24.00 | each DM 7.00    |
| VHF COMMUNICATIONS 1985         | each DM20.00 | each DM 6.00    |
| VHF COMMUNICATIONS 1980 to 1984 | each DM16.00 | each DM 4.50    |

(Edition 3/1982 no longer available)

Individual copies out of elder, incomplete volumes, as long as stock lasts:

|  |              |
|--|--------------|
| 1, 2, 4/1972 * 2, 4/1973 * 1, 3/1974 * 1, 2, 3, 4/1975 | each DM 2.00 |
| 3, 4/1976 * 1, 4/1977 * 1, 2/1978 * 1, 2, 3/1979       | each DM 2.00 |
| Plastic binder for 3 volumes                           | each DM 8.00 |
| Post and packing minimum charges                       | DM 14.00     |

# ANCHOR SURPLUS LTD



The Cattle Market  
Nottingham .UK

NG2 3GY

Tele (0602) 864902 or 864041

FAX (0602) 864667

EUROPE'S LEADING GENUINE  
GOVERNMENT SURPLUS DEALER

Our 3 Acre Depot in Nottingham carries the Largest Stock  
of Genuine Surplus Electronics in the UK

SIGNAL GENERATORS £20 to £2000

OSCILLOSCOPES £40 to £4000

UPX6 Cavities for 23cm with 3 x 2C39 Tubes..£50

AF & RF Test Equipment always available

RF Power Amps HF to MicroWave

Valves...Coax..Plugs..Sockets..Meters..Cabinets..Insulators

RF Millivoltmeters...Power Meters...SWR Couplers

Digital Frequency Counters..Prescalars..Modulation Meters

The List is Endless...and Ever Changing

If you can...Pay us a Visit...You will be amazed !!!

If you can't Visit us...the please either Write or Telephone  
for up to the minute Stock Information and Prices.

Our Immediate Delivery MAIL ORDER SERVICE  
is Second to none.

Send a 30p SAE marked "Electronics News" for the next  
issue of our Newsletter

YOU TO CAN DISCOVER ANCHOR  
1000's ALREADY HAVE.

VISA

