

February, 1952

40 Cents

45c in Canada

QST

devoted entirely to

amateur radio

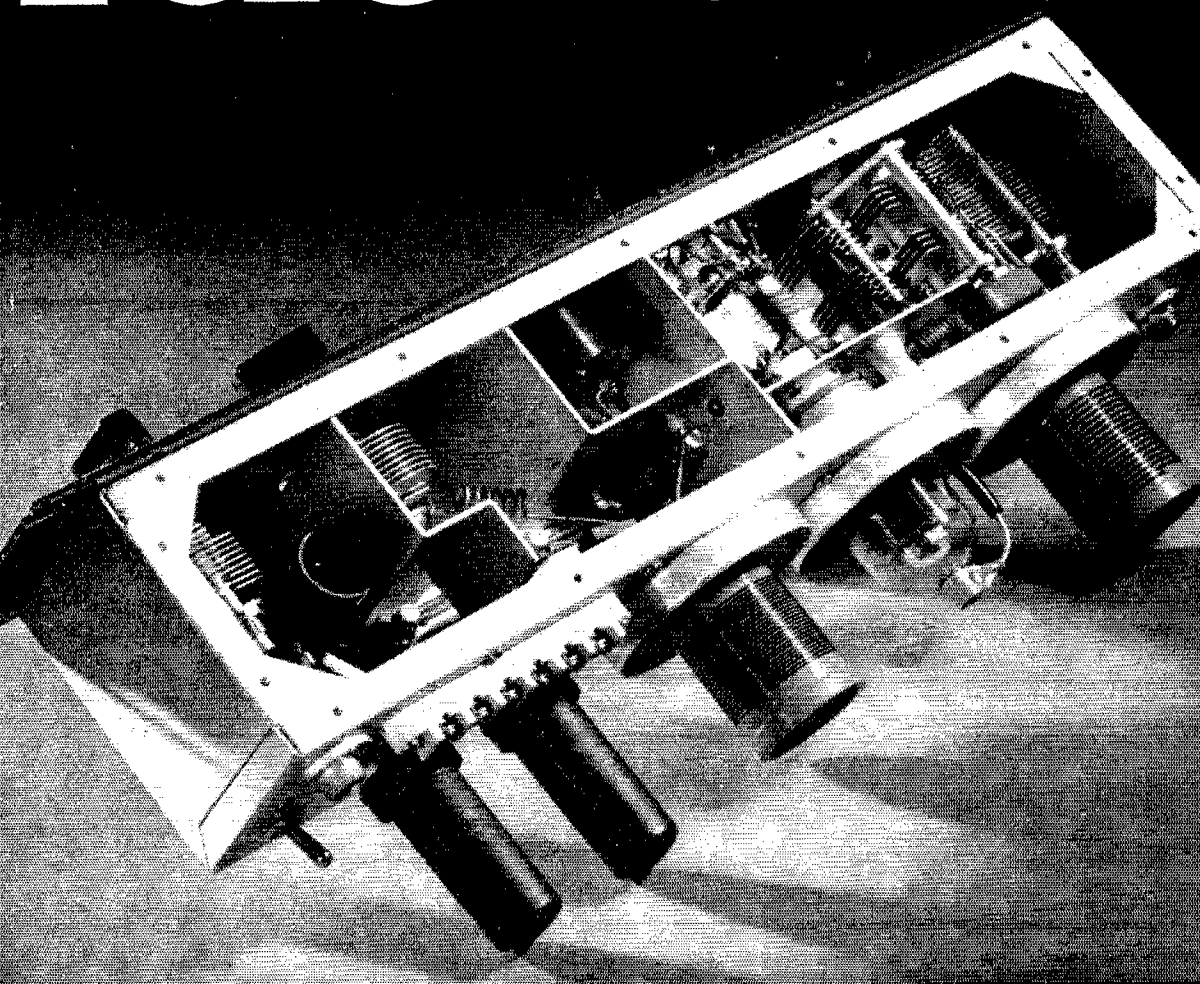

This Month! — THE NEW 6146 BEAM TETRODE IN A COMPACT SHIELDED RIG

E-V MOBIL-MIKE



SELECTED for Hallicrafters-Built SCR-399

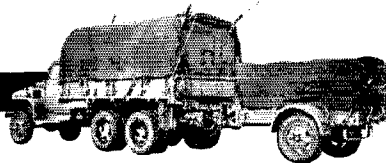

Again E-V serves in vital communications! The 600-D Dynamic Microphone (T-50) is standard equipment on the famous SCR-399. It insures high intelligibility speech transmission—helps get the message through clearly. It is an example of E-V research-engineering that, over the years, has created such fine electro-acoustic products for military and civilian use.

E-V 600-D MOBIL-MIKE

- Substantially Flat Frequency Response
- High Articulation—Less Listener Fatigue
- More Usable Power Level
- Extra Rugged—Withstands Toughest Use
- Accoustalloy Diaphragm
- Light Weight (8 oz.)

Electro-Voice

Experienced Staff and
Complete Laboratory
Facilities for Original
Research-Engineering

404 CARROLL ST. • BUCHANAN, MICH. • Export: 13 E. 40th St., New York 16, U.S.A. Cables: Arlab



MICROPHONES • PHONO-PICKUPS • HI-FI SPEAKERS • SELF-TUNING TV BOOSTERS

GET DOUBLE VALUE

from this
v-h-f twin!

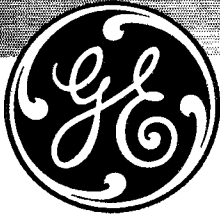

12AT7

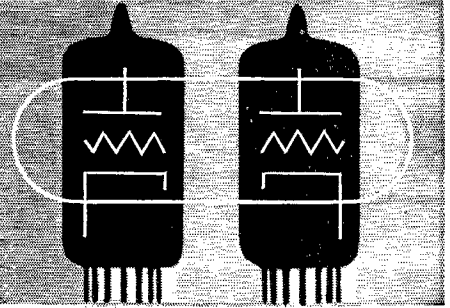

9-pin miniature twin triode

● **TWO TUBES IN ONE!** Both 12AT7 triodes are independent units with their own terminals. In converter work, one section of the tube will serve as mixer, the other as oscillator. For buffer-doubler use, one section will drive the other; or the two can be hooked up together as a push-pull final.

TWO EXTREMES OF SERVICE . . . and many applications in between! R-f (up to 300 mc) is one job the 12AT7 handles capably. Audio is another, for here the tube's high gm means high voltage gains of from 55 to 60.

TWO CLASSES OF USERS find the 12AT7 an exceptionally big "assist". For the newly licensed technician, the tube is an economy means for getting on the air on 1¼ meters. The novice welcomes the 12AT7 for audio. All amateurs like the tube's flexibility of application—compact size—high gain—low receiving-tube price!

YOUR G-E TUBE DISTRIBUTOR will be glad to supply further facts and quote you price in dollars and cents. See him today! *Electronics Division, General Electric Company, Schenectady 5, New York.*

G-E MILESTONE:

U-H-F AND S-H-F FOR HAMS!



ACTUAL SIZE, 21,000-MC WAVE

● Looking ahead to the time when the ultra-highs and super-highs will carry ham traffic, G-E engineers pioneered transmission-reception in the extreme upper range of the spectrum. On April 29, 1946, W2RYT and W2RMA of Schenectady opened the 2,300-mc, or 1/8-meter band. On May 18 of the same year, W2RDL and W2UKL of Schenectady opened the 21,000-mc, or 1/70-meter band. New performance horizons, new knowledge, new experience—these, gained by G. E.'s many electronic "firsts", become advanced design and plus value in General Electric tubes you buy!

ELECTRONIC TUBES OF ALL TYPES FOR THE RADIO AMATEUR

GENERAL



ELECTRIC

166-1B2

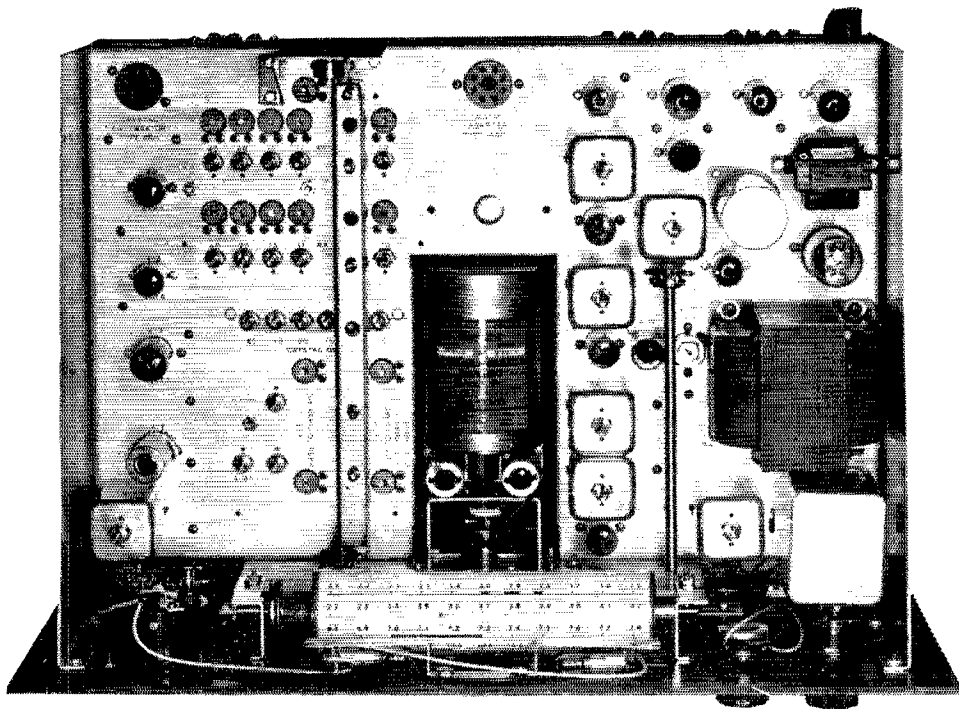

Characteristics of the 75A-2's VFO

The 70E-12 VFO, designed specifically for the Collins 75A-2 amateur receiver, appears in the center of this topside chassis view. Engineered and constructed to have the precision of a fine watch, it must meet the following test specifications:

Calibration — 750 cps

Temperature 25° to 60°C — 500 cps

+ 10% line voltage — 100 cps

Shock and vibration — 30 cps

The average frequency stability is .05% and, under normal operating

conditions, a much higher order of stability is obtained. For example, after initial warm-up, units have held within .004% over a 24-hour period.

The hermetically sealed 70E-12 features a new two-tube circuit which has a triode-connected 6BA6 as isolation between the tuned circuit and the oscillator amplifier, another 6BA6.

This circuit assures improved stability, unaffected by variations in tubes. An OA2 voltage regulator is used in the 70E-12's plate supply.

A precision-ground leadscrew, mounted in two ball bearings, provides true linear tuning with a very high degree of accuracy.

FOR THE BEST IN AMATEUR RADIO, IT'S . . .

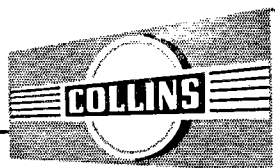

COLLINS RADIO COMPANY, Cedar Rapids, Iowa

11 W. 42nd St., NEW YORK 18

1937 Irving Blvd., DALLAS 2

2700 W. Olive Ave., BURBANK

PUBLISHED, MONTHLY, AS ITS OFFICIAL ORGAN, BY THE AMERICAN RADIO RELAY LEAGUE, INC., AT WEST HARTFORD, CONN., U. S. A.; OFFICIAL ORGAN OF THE INTERNATIONAL AMATEUR RADIO UNION

STAFF

Editorial
A. L. BUDLONG, W1BUD
Editor

HAROLD M. McKEAN, W1CEG
Managing Editor

GEORGE GRAMMER, W1DF
Technical Editor

DONALD H. MIX, W1TS
BYRON GOODMAN, W1DX
Assistant Technical Editors

EDWARD P. TILTON, W1HDQ
V.H.F. Editor

RICHARD M. SMITH, W1FTX
C. VERNON CHAMBERS, W1JEQ
Technical Assistants

ROD NEWKIRK, W9BRD/1
DX Editor

ELEANOR WILSON, W1QON
YL Editor

WALTER E. BRADLEY, W1FWH
Technical Information Service

Production
RALPH T. BEAUDIN, W1BAW
Production Manager

DOROTHY C. ARCHER
Assistant

Advertising
LORENTZ A. MORROW, W1VIG
Advertising Manager

Circulation
DAVID H. HOUGHTON
Circulation Manager

RALPH T. BEAUDIN, W1BAW
Assistant Circulation Manager

OFFICES

38 La Salle Road

West Hartford 7, Connecticut

TEL.: 3-6268 TWX: HF 88

Subscription rate in United States and Possessions, \$4.00 per year, postpaid; \$4.25 in the Dominion of Canada, \$5.00 in all other countries. Single copies, 40 cents. Foreign remittances should be by international postal or express money order or bank draft negotiable in the U. S. and for an equivalent amount in U. S. funds.

Entered as second-class matter May 29, 1919, at the post office at Hartford, Connecticut, under the Act of March 3, 1879. Acceptance for mailing at special rate of postage provided for in section 1102, Act of October 3, 1917, authorized September 9, 1922. Additional entry at Concord, N. H., authorized February 21, 1929, under the Act of February 28, 1925.

Copyright 1952 by the American Radio Relay League, Inc. Title registered at U. S. Patent Office. International copyright secured. All rights reserved. *Quedan reservados todos los derechos.* Printed in U.S.A.

INDEXED BY
INDUSTRIAL ARTS INDEX

— CONTENTS —

"It Seems to Us . . ."	9
Painless Shielding for the Plug-in Coil Transmitter-Exciter <i>George Grammer, W1DF</i>	10
Military Amateur Radio System	16
Feed-Back	16
A Radio-Control System for Models <i>Harry W. Lawson, jr., W2TTZ</i>	17
TVI Went Thattaway! or I'm Back in the Hamshack Again <i>Keith S. Williams, W6DTY</i>	20
Simplified Adjustment of the T and Gamma Matches <i>Frederick Q. Gemmill, W2VLQ</i>	23
United States Naval Reserve	24
A Battery-Operated 2-Meter Portable Station <i>Laurence LePage, W3QCV</i>	25
W2ZXMM/MM — "Captain Stay-Put" <i>Harry Paston, W1DJV</i>	29
How To Wire a Transmitter . . . <i>Byron Goodman, W1DX</i>	30
Happenings of the Month	33
Hints and Kinks	37
An Inexpensive Sine-Wave Audio Oscillator <i>C. Vernon Chambers, W1JEQ</i>	38
In QST 25 Years Ago This Month	39
The Wavelength Factor . . . <i>Yardley Beers, W2AWH</i>	40
Fundamental Teletypewriter Operation <i>A. J. Sabel, W4SQF</i>	48
Quist Quiz	47
Silent Keys	47
The World Above 50 Mc.	48
18th ARRL International DX Competition	50
How's DX?	51
A Mobile Installation for 10 and 11 Meters <i>George J. Gabert, W9JIM</i>	54
YL News and Views	60
Correspondence From Members	61
Operating News	62
With the AREC	66
Station Activities	69

hallicrafters

new communications "TOOL" for industry!

the *littlefone*[®]

2-WAY FM RADIO-TELEPHONE

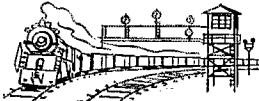

RAILROADING

FREIGHT HANDLING

WAREHOUSE OPERATIONS



RANCHING & LARGE FARMS

MINING (Above & Below Ground)

PIPE LINE INSPECTION



ROAD BUILDING

SHIPPING (Dock Operations)

CONSTRUCTION

CIVIL DEFENSE

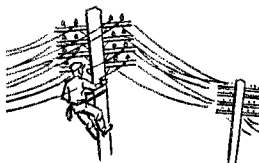

TELEPHONE

A new Hallicrafters product—the "littlefone"—is now ready for thousands of important uses in hundreds of industries.

This light, rugged, dependable radio-phone will be offered through Hallicrafters distribution organization—by the men who know communications best.

USES OF "LITTLEFONE" CHALLENGE YOUR IMAGINATION!

There are literally thousands of industrial uses for the "littlefone" radio—anywhere where powerful, dependable, "on the move" contact is required.

AMONG THE MORE
IMPORTANT
PRESENT USES ARE:

LUMBERING

POLICE & FIRE CONTROL

DISASTER EMERGENCIES

FACTORY INSPECTION

FORESTRY CONTROL

INTER-CITY BUSES

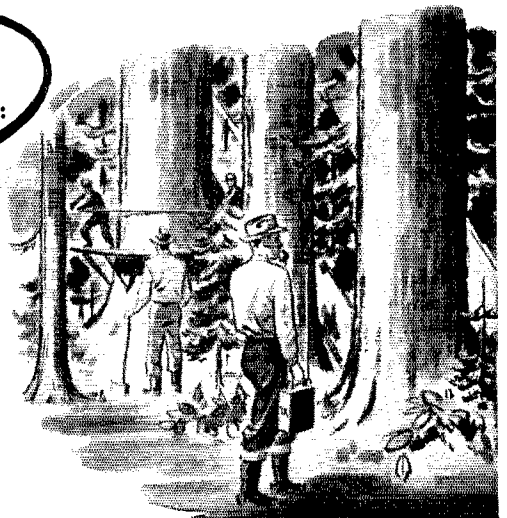

hallicrafters *littlefone*

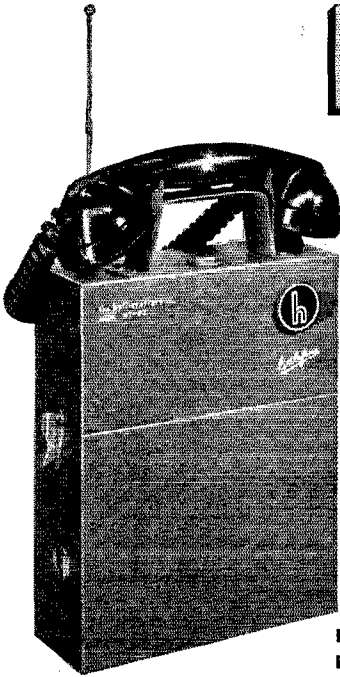

HAND CARRY

HT-21 (25-50 Mc.)
HT-22 (150-174 Mc.)

- FULL TWO-WATT ANTENNA OUTPUT*
- Weighs only 14 pounds!
- Complete, self-contained 2-way radio-telephone station!
- Powered by Dry, or Wet Rechargeable Batteries (can be recharged from car battery or 117 Volts AC)
- Rugged, weatherproof
- 22 sub-miniature tubes!

*On 25-50 Mc. • One-Watt output on 150-174 Mc.

10 lb. lower powered models
also available



CENTRAL STATION

HT-23 (25-50 Mc.) HT-24 (150-174 Mc.)

Same performance and specifications as the "Littlefone" Hand Carry.

- AC-operated Central Station
- Audio-amplifier, providing one watt of audio for loudspeaker
- Power consumption is 35 watts
- Plugs in any AC outlet (117 Volts)

Where one or more extra stationary receiving stations are desired, Hallicrafters economical S-81 receivers may be added.

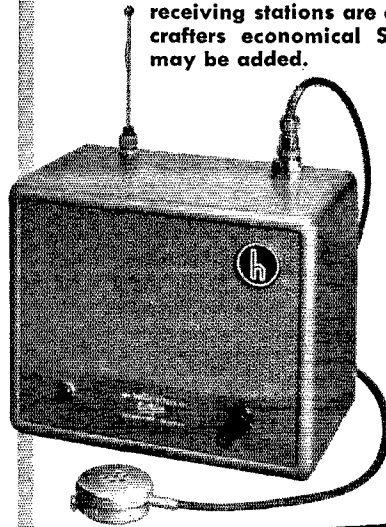

hallicrafters

"The Radio Man's Radio"

World's Leading Manufacturer of Precision
Radio and Television — Chicago 24

Section Communications Managers of the ARRL Communications Department

Reports Invited. All amateurs, especially League members, are invited to report station activities on the first of each month (for preceding month) direct to the SCM, the administrative ARRL official elected by members in each Section. **Radio Club reports are also desired by SCMs for inclusion in OSM.** All ARRL Field Organization appointments are now available to League members. These include ORS, OES, OPS, OO and OBS. Also, where vacancies exist SCMs desire applications for SEC, EC, RM, and P.A.M. In addition to station and leadership appointments for Members, *all amateurs* in the United States and Canada are invited to join the Amateur Radio Emergency Corps (ask for Form 7).

ATLANTIC DIVISION			
Eastern Pennsylvania	W3BXE	John H. DuBois	4105 E. Elbridge St.
Maryland-Delaware-D.C.	W4OMN	James W. John	29 Fawcett St.
Southern New Jersey	W2UCV	Lloyd L. Gainey	Hoffman Ave. & Marlton Pike
Western New York	W2SJV	Edward Graf	81 King St.
Western Pennsylvania	W3KWL	Ernest J. Hlinsky	509 Beechwood Ave.
CENTRAL DIVISION			
Illinois	W9KOL	H. F. Lund	3135 S. 5th St.
Indiana	W9DCA	Clifford C. McGuyer	1321 South Governor St.
Wisconsin	W9RQM	Keno W. Goetsch	929 S. 7th Ave.
DAKOTA DIVISION			
North Dakota	W0VKP	Everett E. Hill	406 South 8th St.
South Dakota	W0RRN	J. W. Sikorski	1900 South Menlo Ave.
Minnesota	W0MNC	Charles M. Bove	1611 1/2 E. Lake St.
DELTA DIVISION			
Arkansas	W5DRW	Dr. John L. Stockton	P. O. Box 302
Louisiana	W5GHF	Robert E. Barr	Box 446
Mississippi	W5JHS	Norman H. Feehan	P. O. Box 491
Tennessee	W4AFT	D. G. Stewart	Ala. Hwy. Drive
GREAT LAKES DIVISION			
Kentucky	W4KKG	T. W. Lyle, jr.	R. R. 3
Michigan	W8DLZ	Norman C. MacPhail	1340 Giddings, S.E.
Ohio	W8AJW	John E. Siringer	2972 Clague Rd.
HUDSON DIVISION			
Eastern New York	W2IIJ	Stephen J. Neason	794 River St.
N. Y. C. & Long Island	W2ORU	George V. Cooke	88-31 239th St.
Northern New Jersey	W2NKD	Thomas J. Ryan, jr.	1082 Anna St.
MIDWEST DIVISION			
Iowa	W0PPP	William G. Davis	3rd St.
Kansas	W0ICV	Earl M. Johnston	624 Roosevelt
Missouri	W0GBI	Clarence I. Arundale	1018 South Jefferson Ave.
Nebraska	W0KJP	Guy R. Bailey	133 North 38 St.
NEW ENGLAND DIVISION			
Connecticut*	W1HYF	Roger C. Amundsen	Rt. 4
Maine	W1PTL	Orestes R. Brackett	Goodrich St.
Eastern Massachusetts	W1ALP	Frank L. Baker, jr.	91 Atlantic St.
Western Massachusetts	W1EOB	Victor W. Pronoff	702 Rogers Ave.
New Hampshire	W1INC	Norman A. Chapman	98 South St.
Rhode Island	W1CIH	Roy B. Fuller	17 Ledge Road
Vermont	W1FPS	Raymond N. Flood	2 Marlboro Ave.
NORTHWESTERN DIVISION			
Alaska*	KL7BK	Jack Walden	Box 879
Idaho	W7IWIJ	Alan K. Koss	2105 Irene St.
Montana	W7KGI	Edward G. Brown	421 Yellowstone Ave.
Oregon	W7MQ	J. E. Roden	519 N.W. Ninth
Washington	W7CZY	Laurence Sebring	Route 2, Box 384
PACIFIC DIVISION			
Hawaii	KH6RU	John R. Sanders	c/o Mackay Radio & Tele- graph Co. Inc., Box 2993
Nevada	W7BVZ	Carroll W. Short, jr.	1608 Arizona St.
Santa Clara Valley	W6LZL	Roy I. Cousin	7 Englewood Ave.
East Bay	W6JZ	Ray H. Cornell	909 Curtis St.
San Francisco	W6ATO	R. F. Czolkowitz	243 Colon Ave.
Sacramento Valley*	W6CKV	Willie van de Kamp	Rt. 1, Box 492A
San Joaquin Valley	W6FYM	E. Howard Hale	741 E. Main St.
ROANOKE DIVISION			
North Carolina	W4DLX	J. C. Gresham	1832 Logie Ave.
South Carolina	W4ANK	T. Hunter Wood	1702 North Rhett Ave.
Virginia	W4HF	H. Edgar Lindauer	Route 1, Box 431
West Virginia	W8JM	Donald B. Morris	303 Home St.
ROCKY MOUNTAIN DIVISION			
Colorado	W0IOZ	M. W. Mitchell	1059 Uinta St.
Utah	W5SP	Leonard P. Zimmerman	House 4
Wyoming	W7HNI	A. D. Gaddis	P. O. Box 786
SOUTHEASTERN DIVISION			
Alabama*	W4RTI	Wm. H. McGowan, jr.	302 Massey Bldg.
Eastern Florida	W4FWZ	John W. Hollister	3809 Springfield Blvd.
Western Florida	W4MS	Edward J. Collins	1004 E. Blount St.
Georgia	W4ZD	James P. Barn, jr.	25 First Ave., N.E.
West Indies (Cuba-P.R.-V.I.)	KI4DJ	William Werner	565 Ramon Flovet
Canal Zone	KZ5AW	Everett R. Kimmel	Box 264
SOUTHWESTERN DIVISION			
Los Angeles	W6BSR	Samuel A. Greenlee	1701 Sepulveda Blvd.
Arizona	W7MID	Jim Kennedy	4511 N. 8th St.
San Diego	W6YYM	Mrs. Elton White	3677 Wiertman St.
WEST GULF DIVISION			
Northern Texas	W5BKH	William A. Green	1834 University Blvd.
Oklahoma*	W5GVV	Jesse M. Langford	3905 W. Oklahoma, Ct.
Southern Texas	W5FJF	Dr. Charles Fermaglich	618 Medical Arts Bldg.
New Mexico	W5NXE	Robert W. Frevin	2255-46th St.
MARITIME DIVISION			
Maritime (Nfld. & Labr. att.)	VE1DO	A. M. Crowell	69 Dublin St.
ONTARIO DIVISION			
Ontario	VE3IA	G. Eric Farquhar	16 Emerald Crescent
QUEBEC DIVISION			
Quebec	VE2GL	Gordon A. Lynn	R. R. No. 1
VANALTA DIVISION			
Alberta	VE6MI	Sydney L. Jones	P. O. Box 373
British Columbia	VE7US	Wilf Moorbo se	37 Regina Ave.
Yukon			
PRAIRIE DIVISION			
Manitoba	VE4AM	A. W. Morley	26 Lennox Ave.
Saskatchewan	VE5HR	Harold R. Horn	1044 King St.

* Officials appointed to act temporarily in the absence of a regular official.

**SOLID
AS A
ROCK**



PRs STAY PUT! In aircraft, in the marine, in broadcast and point-to-point, in police and military installations . . . in fact, wherever frequencies MUST be in channel . . . you will find PRs on the job. PRs for commercial service are precision made . . . low drift cut for the utmost in stability . . . with temperature coefficient less than 2 cycles per megacycle per degree Centigrade . . . cali-

brated within .005 per cent of specified frequency . . . contamination and moisture-proof . . . weight less than 3/8 ounce. Power output is exceptional, both for fundamental and harmonic oscillators. Since 1934 PR has become a standard of excellence for crystal controls . . . in all fields — commercial, amateur and industrial. It's no wonder that amateurs prefer PRs in their rigs at all frequencies.

PR

Crystals



USE **PR** AND KNOW WHERE YOU ARE

PETERSEN RADIO COMPANY, INC.
2800 W. BROADWAY • COUNCIL BLUFFS, IOWA

THE AMERICAN RADIO RELAY LEAGUE, INC.,

is a noncommercial association of radio amateurs, bonded for the promotion of interest in amateur radio communication and experimentation, for the relaying of messages by radio, for the advancement of the radio art and of the public welfare, for the representation of the radio amateur in legislative matters, and for the maintenance of fraternalism and a high standard of conduct.

It is an incorporated association without capital stock, chartered under the laws of Connecticut. Its affairs are governed by a Board of Directors, elected every two years by the general membership. The officers are elected or appointed by the Directors. The League is noncommercial and no one commercially engaged in the manufacture, sale or rental of radio apparatus is eligible to membership on its board.

"Of, by and for the amateur," it numbers within its ranks practically every worth-while amateur in the nation and has a history of glorious achievement as the standard-bearer in amateur affairs.

Inquiries regarding membership are solicited. A bona fide interest in amateur radio is the only essential qualification; ownership of a transmitting station and knowledge of the code are not prerequisite, although full voting membership is granted only to licensed amateurs.

All general correspondence should be addressed to the administrative headquarters at West Hartford, Connecticut.



Past Presidents

HIRAM PERCY MAXIM, W1AW, 1914-1936
EUGENE C. WOODRUFF, W8CMP, 1936-1940

.....

Officers

President GEORGE W. BAILEY, W2KH
1 East 79th St., New York 21, N. Y.

Vice-President WAYLAND M. GROVES, W5NW
P.O. Box 586, Odessa, Texas

Vice-President FRANCIS E. HANDY, W1BDI
38 LaSalle Road, West Hartford, Connecticut

Secretary A. L. BUDLONG, W1BUD
38 LaSalle Road, West Hartford, Connecticut

Treasurer DAVID H. HOUGHTON
38 LaSalle Road, West Hartford, Connecticut

.....

General Counsel PAUL M. SEGAL
816 Connecticut Ave., Washington 6, D.C.

Assistant Secretaries JOHN HUNTOON, W1LVQ
RICHARD L. BALDWIN, W1KE HARRY PASTON, W1DJV
38 LaSalle Road, West Hartford, Connecticut

DIRECTORS

Canada

ALEX REID VE2BE
240 Logan Ave., St. Lambert, P. Q.
Vice-Director: William W. Butchart VE6LQ
10740 107 St., Edmonton, Alta.

Atlantic Division

ALFRED C. HECK W3GEG
515 Cedar Ave., Sharon, Pa.
Vice-Director: Charles O. Badgett W3LVF
725 Garden Road, Glenside, Pa.

Central Division

WESLEY E. MARKINER W9AND
844 N. Galena Ave., Dixon 7, Ill.
Vice-Director: Charles F. Reberg W9MVZ
3900 W. 10th Ave., Gary, Ind.

Dakota Division

GOODWIN L. DOSLAND W0TSN
Moortead, Minn.
Vice-Director: Alfred M. Gowen W0PHR
325 S. Menio Ave., Sioux Falls, S. D.

Delta Division

JAMES W. WATKINS W4FLS
220 N. Howell Ave., Chattanooga, Tenn.
Vice-Director: George S. Acton W5BMM
Plain Dealing, La.

Great Lakes Division

JOHN H. BRABH W8SPF
417 Ford Bldg., Detroit 26, Mich.
Vice-Director: Harold E. Stricker W8WZ
247 W. 5th St., Marysville, Ohio

Hudson Division

JOSEPH M. JOHNSTON W2SOX
423 Monmouth Ave., Bradley Beach, N. J.
Vice-Director: George V. Cooke, Jr. W2OBU
88-31 239th St., Bellerose 6, L. I., N. Y.

Midwest Division

WILLIAM J. SCHMIDT W0OZN
306 S. Vassar, Wichita, Kansas
Vice-Director: James E. McKim W0MVG
1404 S. Tenth, Salina, Kansas

New England Division

PERCY C. NOBLE WIBVR
37 Broad St., Westfield, Mass.
Vice-Director: Frank L. Baker, Jr. W1ALP
91 Atlantic St., North Quincy 71, Mass.

Northwestern Division

R. REX ROBERTS W7CPC
837 Park Hill Drive, Billings, Mont.
Vice-Director: Karl W. Weingarten W7BG
3219 N. 24th St., Tacoma 7, Wash.

Pacific Division

KENNETH E. HUGHES W6CIS
810 W. Orange Ave., So. San Francisco, Calif.
Vice-Director: Richard F. Czelkowitz W6ATO
243 Colon Ave., San Francisco 12, Calif.

Roanoke Division

WILLIAM H. JACOBS W4CVQ
Route 6, Raleigh, N. C.
Vice-Director: Gus M. Browning W4BPD
135 Droughton St., S. E., Orangeburg, S. C.

Rocky Mountain Division

FRANKLIN K. MATEJKA W0DD
P. O. Box 212, Estes Park, Colo.
Vice-Director: Ramon S. Walker W0WPF
P. O. Box X, Brush, Colo.

Southeastern Division

LAMAR HILL W4BOL
104 Myrtle, Cochran, Ga.
Vice-Director: Ernest W. Barr W4GOR
911 Rosemary Ave., SW, Atlanta, Ga.

Southwestern Division

JOHN R. GRIGGS W6KW
10412 Don Pico Rd., RFD 2, Spring Valley, Calif.
Vice-Director: Walter R. Joos W6EKM
1315 N. Overhill Drive, Inglewood 3, Calif.

West Gulf Division

A. DAVID MIDDLETON W5CA
9 Kay Road, Tlajeras, N. M.
Vice-Director: Frank E. Fisher W5AHT/AST
104 E. 11th, Pawhuska, Okla.

"It Seems to Us..."

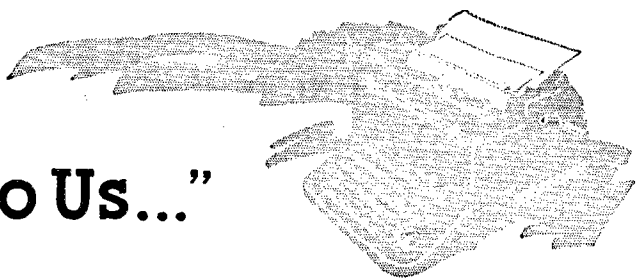

RACES

As detailed in "Happenings" and "Operating News" elsewhere in this issue, FCC has now released proposed rules for a new Radio Amateur Civil Emergency Service. These are the long-awaited regulations to govern the furnishing of civil defense communications by amateur radio. It is our fervent hope that the rules will be made final substantially as proposed and in as short a time as possible, and any minor kinks left for ironing out later.

We need to get moving! Too much steam has been lost from amateur interest in civil defense work by the tardy development of national planning and regulations. If these rules can be finalized promptly after February 15th, it will largely complete the picture for amateur participation.

RACES will be an entirely new service, operating in the amateur bands, yet almost indistinguishable from regular amateur network operations. They'll be amateur calls, amateur frequencies, amateur equipment for the most part, and largely amateur procedure. Then why RACES? Because it actually gets civil defense communication "on the books" in the form of authorized networks and stations, facilities that can continue operation in the event of war after normal amateur activities are shut down. It is foresight, inspired by lessons previously learned the hard way, to get the policy set and paper-work out of the way in advance, so that the operating machine can function with full effectiveness right at the start should it be needed.

All this means to the individual amateur the same as previous developments in the field have indicated: join the AREC, get aligned with your Emergency Coördinator, and be prepared to do your part in providing your community with emergency communication in the event it is needed.

TVI COMMITTEES

Not to be lost sight of in the bustle of preparation for civil defense communication is George Turner's milestone article in January *QST*, "FCC's Plan for Handling TVI." If perchance you missed it, get it out and acquaint yourself now with the proposed program.

The Commission has placed its blessing on a procedure which amateurs have found a useful tool in tackling TVI problems and

which we have been urging among clubs post-war — the formation of TV interference committees. Dallas and Dayton have demonstrated how effective this procedure can be. The committee approach can do the same for your city or community. And the encouraging part of FCC's announcement is that final solutions to many individual cases will be made easier with the agreement by major TV receiver manufacturers to install low-pass filters or other suitable remedies when adequate investigation shows the fault to lie with the receiver.

The call is clear — every community should have a TV interference committee. Certainly every amateur radio club should have one, or in larger cities participate in a council-style city-wide body. Each such committee to be formed, as well as each one already in existence, should get itself squared away with the FCC Regional Manager having jurisdiction — see the January story for names and addresses. While the committee will not in any manner have authority to act for FCC, it is quite possible that local engineers may follow the practice of turning over to the committee for preliminary investigation — and, it would be hoped, solution — such complaints as the office might receive. The ultimate aim is that the committee will produce such satisfactory results and become so well known in its community that any complaints from the public will be directed to it and not to FCC.

The technical hotshot in your club or community isn't necessarily first choice for your committee. You'll want him on it, of course. But we've learned that this job calls for 90% public relations and 10% engineering. While hardly cut-and-dried, the technical solutions to a TVI problem are pretty well established. Dealing with the public, and especially with a portion of it which may be temporarily irate, is a task for which no one can write specifications as to procedure. So the "front" man for your committee doesn't have to know a clamp tube from a reactance modulator to do his job well, if he knows how to deal in personalities. Pick him accordingly.

After your committee is set up and aligned with the FCC Regional Manager, the operating procedure is pretty well spelled out step by step in the January *QST* article. But the first step — formation of the committee — is up to you. Start today!

Painless Shielding for the Plug-in Coil Transmitter-Exciter

The New Type 6146 Tube in an All-Band 90-Watt Outfit

BY GEORGE GRAMMER,* W1DF

THERE is a certain monotony in the way in which the 807 injects itself into transmitter design. Except for flea-power sets, it doesn't make much difference what sort of rig is under consideration — the tube always seems to fit in logically somewhere along the line. With the introduction of the Type 6146, it could be that we have a new candidate for ubiquitousness. For besides somewhat higher ratings this new beam tetrode has a lot more versatility, including the ability to work at frequencies where the 807 is not a very good performer.

One useful feature of the new tube is that it is physically small. Mere size, as such, may not always be important; however, the type of construction used in the transmitter shown here would not have been possible with an 807 for the simple reason that there are no standard shield cans tall enough to fit it. In most cases, of course, the small size is more important for electrical reasons — leads both inside and outside the tube are shorter, making for better performance at the higher frequencies.

The 6146 is better described as a larger version of the 2E26 than as a redesigned 807. Its base connections are the same as those of the 2E26, the structure is similar, and it has the three cathode leads that are useful in reducing cathode-lead inductance for better v.h.f. performance. One of the most valuable characteristics of the new tube, in our opinion, is its ability to work well over a large range of plate voltages. It can be driven to the maximum plate current of 150 ma. even at 300 volts on the plate, and the maximum c.w. input rating (ICAS) of 90 watts can be used with any voltage from 600 to 750. This leaves the user free to choose any one of a number of economical power-supply combinations, depending on whether the tube is to be used

* Technical Editor, *QST*.

• The transmitter described in this article illustrates the use of standard parts to obtain complete shielding with plug-in coils, reducing set and lead radiation of harmonics in the television range to negligibility. Pi-network tank circuits are used in a compact three-stage layout ending in a 6146 beam tetrode. The final stage can be operated at any voltage from 300 to 600, delivering outputs from 25 to 65 watts.

as the final amplifier or as a driver for a higher-power stage.

The transmitter illustrated is set up to use the maximum c.w. input rating of 90 watts at a plate voltage of 600. This voltage was used not only because it is unnecessary to go any higher, but also because 600 is the maximum rating for plate-and-screen modulation. A single plate transformer will suffice for the whole set. As an exciter, it can be operated from as little as a 300-volt 200-ma. supply, running an input of 45 watts to the amplifier with an output of 25 to 30 watts.

Owners of prewar *Handbooks* may recognize the style of construction, since it was used in an exciter that was quite popular in its day. While the basic idea leads to a compact design, compactness as such is not the primary object in the present case. The important feature is that complete shielding, with accessibility for coil changing, is obtained without resorting to special shield construction. The coils are enclosed by standard can-type shields with friction bases — an idea that, if not as old as the hills, certainly dates back to the first manufactured communications-type superhet, the Hammarlund Comet Pro. With the exception of the plug-in coils and the tubes, everything is shielded by the $3 \times 4 \times 17$ -inch chassis and its bottom plate, which does not have to be removed except in case servicing should be required. The 6146 has a shield similar to those used for the coils (I.C.A. type 1549), with holes drilled above and below the tube to allow air circulation. The other two tubes, 6AG7s, are metal and therefore more or less self-shielding.

Circuit Notes

The complete circuit is given in Fig. 1. Two 6AG7s are used to give excitation for the 6146 in all bands from 3.5 to 28 Mc. The tube labeled "oscillator"

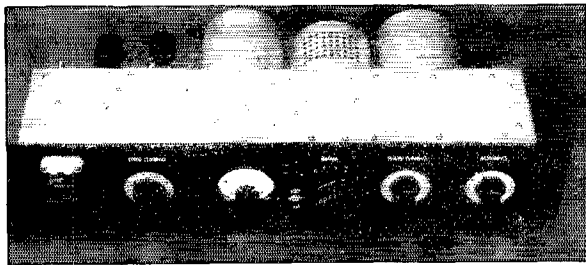

A compact and completely shielded low-power transmitter using a 6146 as the final amplifier. It can be used at an input of 90 watts on c.w. or 67 watts for plate-modulated 'phone. The unit is mounted on a $3\frac{1}{2}$ inch rack panel.

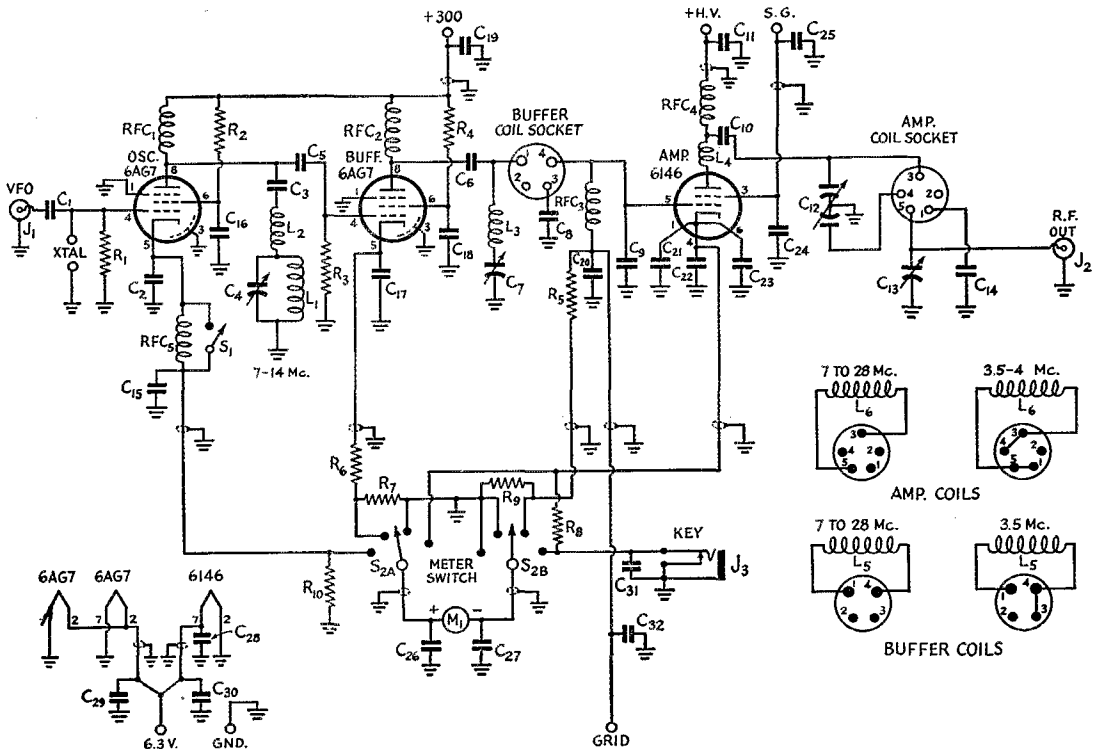

Fig. 1 — Circuit diagram of the transmitter.

- C₁, C₃, C₅, C₈ — 470- μ fd. mica.
- C₂ — 150- μ fd. mica.
- C₄, C₇ — 140- μ fd. variable (Millen 19140).
- C₆, C₉ — 100- μ fd. silver mica.
- C₁₀ — 0.001- μ fd. mica, 1200-volt working.
- C₁₁ — 470- μ fd. mica, 1200-volt working.
- C₁₂ — 100- μ fd. section variable, 1000-volt spacing (National TMS-1001).
- C₁₃ — 325- μ fd. variable (Millen 19325).
- C₁₄ — 470- μ fd. silver mica.
- C₁₅ to C₃₂, inc. — 0.001- μ fd. ceramic, midget size.
- R₁, R₃ — 47,000 ohms, $\frac{1}{2}$ watt.
- R₂ — 47,000 ohms, 1 watt.
- R₄ — 15,000 ohms, 1 watt.
- R₅ — 27,000 ohms, 1 watt.
- R₆ — 150 ohms, $\frac{1}{2}$ watt.
- R₇ — 2.2 ohms (2 \times shunt for 0–25 milliammeter).
- R₈ — 0.24 ohm (10 \times shunt for 0–25 milliammeter).
- R₉, R₁₀ — 100 ohms, $\frac{1}{2}$ watt.
- J₁, J₂ — Coax connectors, chassis type.
- J₃ — Closed-circuit jack.
- RFC₁ to RFC₄, inc. — 2.5-mh. r.f. choke (National R-100S).
- RFC₅ — 2.5-mh. r.f. choke (Millen 34300–2500).
- L₁ — 13 turns No. 22, diameter 1 inch, length 1 inch.
- L₂ — 16 turns No. 30 d.c.c. on $\frac{1}{2}$ -watt resistor.
- L₃ — 6 turns No. 14, diameter 5/16 inch, length 1 inch.
- L₄ — 8 turns No. 18, diameter $\frac{1}{4}$ inch, length $\frac{5}{8}$ inch.
- L₅, L₆ — See coil table.
- M₁ — 0–25 d.c. milliammeter (Simpson Model 125).
- S₁ — S.p.s.t. toggle.
- S₂ — 2-pole 4-position wafer switch, non-shorting (Centralab 2505).

is used as such (the circuit is of the harmonic-generating type) when the transmitter is crystal controlled, but with separate VFO input it becomes either an amplifier or frequency multiplier. The second 6AG7, the "buffer," is also either an amplifier or frequency multiplier.

There are a few circuit tricks in this unit that were adopted as a matter of necessity. We wanted to drive the amplifier on its output frequency on all bands, at least from a 7-Mc. crystal, and this requires three stages altogether if the job is to be done in a reasonably satisfactory manner. On the other hand, two plug-in coils represent enough of a chore in band-changing, and besides the chassis was not large enough to take more than two, with shields. Coil switching in the first stage was considered, but there was not enough room inside the chassis without excessive crowding, nor was there much panel room available for another control.

- R₇ — 2.2 ohms (2 \times shunt for 0–25 milliammeter).
- R₈ — 0.24 ohm (10 \times shunt for 0–25 milliammeter).
- R₉, R₁₀ — 100 ohms, $\frac{1}{2}$ watt.
- J₁, J₂ — Coax connectors, chassis type.
- J₃ — Closed-circuit jack.
- RFC₁ to RFC₄, inc. — 2.5-mh. r.f. choke (National R-100S).
- RFC₅ — 2.5-mh. r.f. choke (Millen 34300–2500).
- L₁ — 13 turns No. 22, diameter 1 inch, length 1 inch.
- L₂ — 16 turns No. 30 d.c.c. on $\frac{1}{2}$ -watt resistor.
- L₃ — 6 turns No. 14, diameter 5/16 inch, length 1 inch.
- L₄ — 8 turns No. 18, diameter $\frac{1}{4}$ inch, length $\frac{5}{8}$ inch.
- L₅, L₆ — See coil table.
- M₁ — 0–25 d.c. milliammeter (Simpson Model 125).
- S₁ — S.p.s.t. toggle.
- S₂ — 2-pole 4-position wafer switch, non-shorting (Centralab 2505).

In consequence, the oscillator plate circuit is a permanent tank covering the range 7 to 14 Mc. with a single tuning condenser. When the output is on 28 Mc. the buffer 6AG7 doubles that band and C₄L₁ therefore is tuned to 14 Mc. When the output is on 21 Mc. the buffer 6AG7 becomes a tripler and C₄L₁ is set to 7 Mc. For 14-Mc. operation the second 6AG7 becomes a doubler again and C₄L₁ is again tuned to 7 Mc. This is so far quite straightforward. However, for 7-Mc. output the buffer 6AG7 has to operate on 7 Mc. and, since there is no special shielding between the grid and plate circuits, it is likely to break into self-oscillation if its grid circuit is also tuned to that frequency. Consequently, it is necessary to detune C₄ far enough from resonance so that oscillation cannot occur, but not so far that resonance at 14 Mc. is approached. Since the second 6AG7 gets far more excitation than it needs, this detuning does not affect its output.

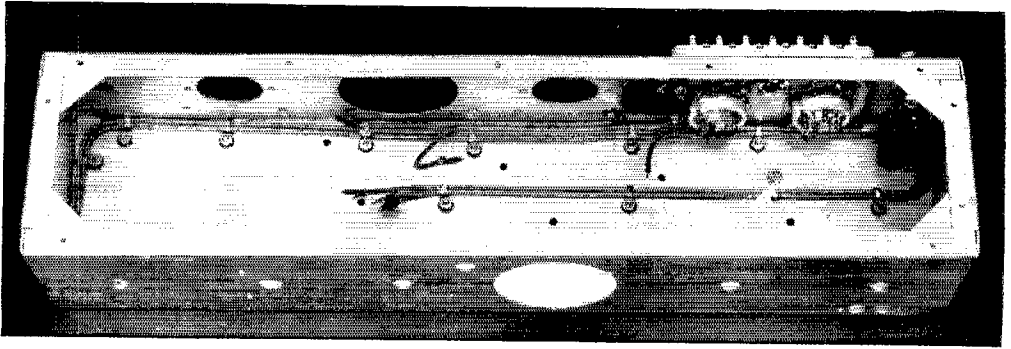

The shielded power wiring should be installed before the r.f. components are permanently mounted, including the ceramic by-passes across the ends of the shielded wires. The wires running along the center of the chassis go to the heater and grid choke of the final amplifier. The two that follow the chassis corner at the left are from the oscillator and buffer cathodes to the meter switch.

On 3.5 Mc. the 6AG7 is in no danger of self-oscillation because its grid circuit cannot be tuned anywhere near that band. It gets excitation simply by brute force across the low impedance represented by C_4L_1 at this frequency. The excitation is ample, the only point to watch being that C_4L_1 should not be tuned to a harmonic of the 3.5-Mc. operating frequency, since such tuning will reduce the buffer's output.

This system saves a good deal in constructional complications and works well, but it does require care in adjustment, particularly when operating on either 7 or 14 Mc. On the latter band the second 6AG7 can take off if C_4L_1 is tuned to 14 instead of 7 Mc. However, if the proper condenser settings are used there is no danger of self-oscillation. For utmost safety, a shield partition can be installed between the buffer tank condenser, C_7 , and the oscillator coil, L_1 , extending across the chassis close to the center of the 6AG7 buffer. This was subsequently tried in this unit and was found to stabilize the buffer to such an extent that it was impossible to make it self-oscillate on any frequency in either the 7- or 14-Mc. bands.

A pi network is used to couple the buffer to the final amplifier. This circuit has the advantages, for interstage coupling, outlined last month.¹ C_9 is the fixed output condenser shunting the grid of the 6146. It not only suppresses grid-circuit harmonics very effectively but also stabilizes the amplifier to prevent self-oscillation at the operating frequency. A value of 100 $\mu\text{fd.}$ was found necessary for this purpose, along with careful pruning of the buffer plate coil. Like all beam tetrodes of high power sensitivity the 6146 tends to take off without neutralization unless stabilized by other means; in this case, no means for neutralizing was available without sacrificing other circuit features we wanted to retain. C_7 is the tuning control for the buffer plate circuit. The coupling to the amplifier grid is determined by the L/C ratio in the buffer plate circuit, and is set at an average value for each band by the size of the plate coil. On the 3.5-Mc. band an additional output capacitance,

C_8 , is connected in the circuit by means of a jumper in the coil form, so that proper coupling can be secured with a plate coil of reasonable size.

The amplifier output circuit also uses a pi network, designed for working into coaxial line. It was impossible to use a variable inductance as discussed last month,¹ so the loading control is a variable condenser, C_{13} . Although the harmonic suppression in the TV range is not as good, by actual test, as could be secured with a series-resonated fixed output condenser, it is still quite a lot better than could be obtained using the same components connected as a conventional parallel-tuned tank and provided with the customary link winding. The various amplifier plate coils specified have been carefully adjusted to work, with the range available in C_{13} , into flat lines of 50 to 75 ohms characteristic impedance. At the lower frequencies C_{13} has just about enough range to do the job. On the 3.5-4-Mc. band, where an additional capacitance C_{14} has to be connected in, it is necessary to use two tank coils to secure proper amplifier loading. One, for 3.5 to 3.75 Mc., is adjusted to give the full 90 watts input for c.w. operation. The other is adjusted to give the maximum 'phone input of 67.5 watts over the 3.75- to 4-Mc. range.

Buffer and Amplifier Coil Table

Coils wound on 1½-inch diameter forms (National XR-4 and XR-5)

	Wire Size	No. of Turns	Turns per Inch	L, $\mu\text{h.}^*$
Buffer coil, L_5				
3.5-4 Mc.	26	42	28	48
7 Mc.	22	25	20	18.4
14 Mc.	18	10	10	3.5
21 Mc.	18	5	10	1.34
27-30 Mc.	18	3½	10	0.86
Amplifier coil, L_6				
3.5-3.75 Mc.	18	23½	16	14.5
3.75-4 Mc.	22	25½	20	18.7
7 Mc.	18	17½	12	8.3
14 Mc.	18	10½	8	3.25
21 Mc.	16	6½	5	1.36
27-30 Mc.	16	4½	5	0.84

* Measured values with coil unshielded.

¹ Grammer, "Practical Applications of Pi-Network Tank Circuits for TVI Reduction," QST, January, 1952.

The amplifier plate tuning condenser, C_{12} , a double-section unit, has both sections in parallel for the 3.5-Mc. band but uses only one section for all other bands. The two are connected together by a jumper in the 3.5-Mc. coils. This arrangement makes the tuning at the higher frequencies less critical than it would be if a single-section condenser of the same maximum capacitance were used.

Parallel plate feed is used in all three stages. This permits grounding the variable condensers directly to the chassis, and also takes the d.c. off the plug-in coils so there is no shock hazard in hand-changing.

Miscellaneous Features

L_2 , L_3 and L_4 are small coils used for parasitic suppression. The 6146 has an advantage over the 807 in this respect, since its shorter leads raise the parasitic frequency and a relatively small coil can be used in the plate lead to kill it. In this transmitter the plate return circuit, with L_4 as specified, resonates between 110 and 120 Mc., well out of the TV band, and thus does not boost harmonic output in the TV range. With the 807, a coil that tunes the plate return circuit to 80 Mc. or below usually is required for suppressing parasitics. The writer prefers this plate-coil method — when it can be used without setting up damaging resonances — to the grid choke and screen resistor combination, which tends to increase the harmonic voltage in the grid circuit as well as to increase the feed-back at the operating frequency through the grid-plate capacitance of the tube.

The 6AG7, like all high-sensitivity tubes, is only too willing to generate parasitic oscillations, and it was necessary to use small coils in both the grid and plate circuits of the buffer to suppress them in that stage. Connecting L_3 as shown, rather than in the plate lead itself, was found to

reduce the harmonic output of the stage (in the TV band) by a large factor.

The meter circuit is arranged so that the cathode currents of any of the three stages can be read, and also the grid current of the amplifier. The meter is a 0–25 milliammeter with shunts (wound with resistance wire on half-watt resistors as forms) to increase the range to 50 ma. for measuring the buffer current, and to 250 ma. for measuring the amplifier current. The screen and control-grid currents are of course included in the reading along with the plate current, but do not represent an important fraction of the total. The values of resistance for the multiplying shunts are for the particular make of milliammeter specified, and do not necessarily apply for other instruments. The proper values can be found in any case by following the method described in the measurements chapter of the *Handbook*.

A key jack is connected in the amplifier cathode circuit. It could be connected in any of the three cathodes, or the keying can be done in an external VFO if desired. In the event that any tube other than the amplifier is keyed, some provision must be made for holding the amplifier input to a safe value during key-up periods. The constructor can use any system he prefers for this purpose, since the screen lead is brought out separately and a lead is also brought out from the “hot” side of the amplifier grid leak to operate a clamp tube or other type of automatic protection system. (A clamp tube alone will not hold the plate current of a 6146 to a safe value without excitation; a VR-75 should be connected between the clamp-tube plate and the 6146 screen.) The currents taken by the other two tubes, with a 300-volt supply, are held to within ratings by the choice of screen-dropping resistors and cathode resistors, with no excitation applied.

The d.c. and heater wiring in the transmitter

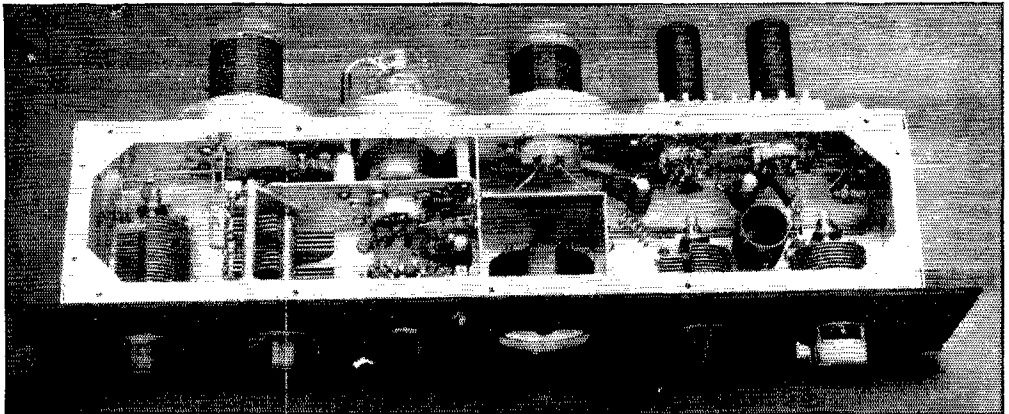

Bottom view of the transmitter completely wired. The oscillator plate coil, L_1 , is between the two variable condensers at the right. The amplifier circuit occupies the left-hand portion of the chassis in this photograph. The bracket on which the amplifier socket is mounted is supported at one end by the plate tank condenser and at the other by a partition that shields the amplifier section from the oscillator-buffer section. The amplifier plate choke is mounted on the chassis between the tube-socket bracket and the chassis wall, just below the plate-lead terminal. The meter is enclosed by a right-angle shield to prevent stray harmonic pick-up that might cause radiation through the meter hole in the panel.

is all shielded, as indicated by the symbols in the circuit diagram, and the shielded leads are bypassed at the ends using the technique described in *QST* some time ago.² The effectiveness of this method of lead filtering is attested by the fact that we have been unable to detect any trace of interference radiated from the set and the external supply leads, even with the transmitter and a TV receiver side by side and with a TV signal so weak that the receiver will just barely hold sync.

Construction Pointers

The layout of the unit is pretty well shown by the various photographs. The actual makes of parts are given in the caption for Fig. 1 in many cases where physical size and shape are important, and if a substitution is made it should be determined beforehand that that particular part will fit.

A chassis 3 inches high and 4 inches deep does not provide much scope for a soldering iron when a fair number of parts has to be fitted in. However, the assembly job is not really difficult if it is planned out in advance. Without such planning it may tend to be impossible.

The secret of easy assembly is to do practically all the wiring before the parts are mounted, and to drill *all* the necessary holes in the chassis beforehand. A separate subassembly is used for most of the amplifier circuit. This should be built before any of the chassis wiring is started, as should also the shield partition to which one

² Grammer, "By-Passing for Harmonic Reduction," *QST*, April, 1951.

Pre-wired amplifier assembly. The ungrounded lead from the coupling-network output condenser is left free until the permanent lead is run in (through the hole in the lip at the right) from the buffer tank coil to the grid prong on the amplifier socket. The shielded leads for the screen grid and the hot filament connection (Pin 7) are connected after this assembly is permanently installed.

The metal plate holding the tube socket is mounted to the rear frame of the tank condenser, using holes already present in the condenser frame for the mounting screws. The plate blocking condenser mounts on the upper screw holding the rear stator section of the condenser, after removing the nut supplied with the condenser. The shielded lead shown here goes from the cathode to the meter switch.

end of it mounts. The latter must have small cutouts on its inner edge to allow the shielded wiring, which is all laid flat on the chassis, to pass through. When the amplifier assembly has been made, temporarily mount it by means of the condenser mounting studs, then fit the shield partition in place and use it as a template to determine the right positions for the mounting holes in the chassis. Make the right-angled shield for the meter and use it as a template for its mounting holes similarly. At this stage it is a good idea to mount all the parts temporarily, both to make sure that everything fits properly and to study the layout a bit to determine just how the wiring should go. It will save time in the end if a wiring plan for the shielded supply leads is sketched out at this point.

To start the job, mount the 6AG7 sockets, the terminal strip, the crystal-VFO switch, S_1 , the amplifier plate-lead by-pass condenser, C_{11} , and the coaxial connector, J_1 , for VFO input. Temporarily mount the meter switch, S_2 , and also RFC_2 and RFC_4 . Then, starting from the terminal strip and the cathode terminals on the tube sockets, run shielded wires to the proper points. In each case mount the disk ceramic on the end of the wire at the starting end, lay the wire exactly where it is going to be on the chassis, determine the proper length, and then trim and finish it off, but do not solder anywhere except at the starting point. (The switch and chokes have to be removed before the amplifier assembly can be put in place and before some of the other work can be done.) Then take out the switch, install the amplifier assembly and shield partition temporarily, along with RFC_3 , and run in the shielded screen and grid leads, again connecting only at the starting ends. The leads can be held down to the chassis by using soldering lugs as miniature clamps. When all the wires are in place, spot solder the shield braid to each lug. When all the shielded wiring is in (including the leads from S_2 to the meter), remove the temporarily-mounted parts and finish off all the wiring, including installing small parts, around the 6AG7 sockets.

At this stage the amplifier coil socket should be mounted — with the mounting ring on the outside of the chassis, since the socket prongs may interfere with the amplifier assembly if the ring is inside — and leads soldered to it for later connection to C_{12} . Mount J_2 and wire it to the amplifier coil socket. Then install the amplifier assembly, the meter switch, and J_3 , and complete the wiring to the latter two. After this RFC_3 can be mounted permanently and its wiring finished, and then the wiring of the entire amplifier circuit may be completed. RFC_4 can be installed by making use of the chassis hole through which the amplifier tube projects.

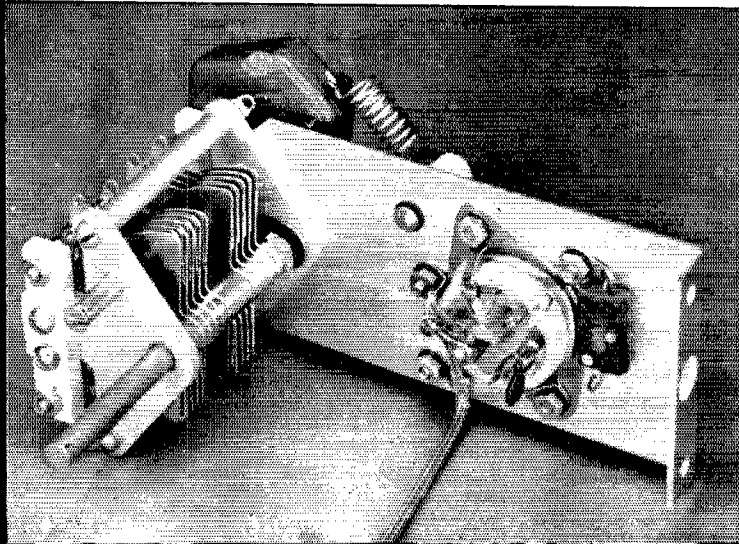

The rest is quite straightforward, since it involves only parts in the oscillator and buffer circuits that are easily accessible. The buffer coil socket has to be mounted after the amplifier assembly and shield partition are finally in place, because it interferes with installation of the partition.

Power Supply

For operation at maximum ratings the power supply should deliver 600 volts at approximately 150 ma. and 300 volts at 50 ma. A single transformer of the type designed to give a d.c. output voltage (through the filter) of 600 at a current of 200 ma. or so will suffice. The 300-volt output can be obtained by using two VR-150s in series, with a dropping resistor that will allow a bleed current of 10 ma. or so to flow through the VR tubes. The total current taken by the two 6AG7s varies between extremes of 30 and 50 ma., depending on the frequency and whether or not the tubes have grid excitation.

Under operating conditions the screen voltage for the 6146 should be around 200 volts. It is advisable to get this voltage through a dropping resistor from the 600-volt plate supply, rather than from a fixed voltage source. A resistance of 35,000 ohms is about optimum for either c.w. or plate-modulated 'phone. If a clamp tube is used for c.w. work with a VR-75 as recommended earlier, the dropping resistor should be reduced to 25,000 ohms.

If the transmitter is to be used as an exciter at lower plate voltage, it is recommended that the 6AG7s still get their voltage from VR-150s as described above. The screen resistor for the 6146 should be reduced to a value that will put about 200 volts on the screen under operating conditions. With a 400-volt plate supply this requires 10,000 ohms, and with a 300-volt supply a 5000-ohm resistor is about right. Both these values are for cases where the VR-75 is not used. The VR-75 will of course introduce an additional drop of 75 volts.

Operating Notes

As stated earlier, the amplifier output circuit has been designed to match into either 50- or 75-ohm resistive loads. If the antenna does not use coaxial feed, then a coax-coupled antenna tuner or matching circuit should be used, and the set-up should be adjusted to make the standing-wave ratio on the coax link come as close to 1 to 1 as possible. If this is done the amplifier tank coils specified in the table will allow adjusting the load on the tube, by means of C_{13} , to the rated value. The simplest way to adjust the s.w.r. is to use a resistance bridge such as is described in the *Handbook*. Matching circuit design also is discussed in the *Handbook*. Without some means for measuring the s.w.r., loading becomes a rather hit-or-miss proposition and rated input can be achieved only by trial and error settings of C_{13} . In every case, of course, C_{12} should be adjusted for minimum plate current, since this condenser is the one that keeps the circuit

resonant at the operating frequency.

Providing the line s.w.r. is low, there should be no difficulty in setting the plate current to 150 ma. in all bands except 3750-4000 kc., using a 600-volt plate supply. In the 3750-4000 kc. range the amplifier coil inductance is chosen to load the tube to 112 ma. for the maximum plate-modulated 'phone rating. On any frequency, the loading decreases when the capacitance of C_{13} is increased; i.e., the higher the capacitance the lower the plate current, C_{13} being tuned to resonance. If for some reason the proper full-load plate current cannot be secured at any setting of C_{13} , increasing the inductance of the tank coil, L_6 , will decrease the loading and lowering the inductance will increase it.

In the circuit coupling the buffer to the amplifier grid there is an optimum value for L_5 that will result in maximum amplifier grid current. The specifications given for L_5 in the coil table represent, in general, an inductance somewhat different than the optimum value, particularly at the higher frequencies. The reason for this is that, for a given capacitance at C_9 , the amplifier grid circuit is more effectively loaded (with improved stabilization) if the impedance step-down from the buffer plate to the amplifier grid is made as large as practicable. Under these conditions maximum power is not delivered to the amplifier grid. The coil specifications given are based on a compromise that allows the amplifier to get sufficient driving power with amplifier stabilization. It is easily possible, for example, to more than double the grid current at 28 Mc. by reducing C_9 to about 50 $\mu\text{fd.}$ and adjusting L_5 to the optimum value. However, with these constants the amplifier may oscillate when tested, without excitation and without load, with a plate input equal to the maximum rated plate dissipation. This is undesirable, even though under normal operating conditions the amplifier is perfectly under the control of the drive.

It is a good idea to make the no-excitation no-loading test if means are available for reducing the input to the rated plate-dissipation value of 25 watts. This requires reducing either the screen voltage or, preferably, the plate and screen voltage proportionately together. There should be no change in plate current, or any sign of grid current, at any combination of settings of C_7 , C_{12} and C_{13} . If there is grid current at some setting of C_7 but no marked dip at any setting of C_{12} , remove the buffer tube from its socket. If the grid current disappears when this is done it is a good indication of parasitic oscillation in the buffer stage (assuming that C_4L_1 is not inadvertently tuned to the same frequency as the buffer plate circuit, as mentioned earlier), and it may be necessary to add a few turns to either L_2 or L_3 to cure it since the parasitic circuits may vary somewhat with slight differences in layout and wiring.

In the oscillator and buffer stages, pulling out the crystal should cut off the amplifier grid current completely (this test should be made

with the amplifier plate and screen voltages off, unless some form of no-excitation protection is provided) and the oscillator and buffer currents should be approximately 20 and 30 ma., respectively, with a 300-volt supply. These currents should not vary with settings of C_4 and C_7 , except for the "taboo" combinations mentioned earlier. With the crystal operating, the plate currents of these two tubes will not differ greatly from the no-excitation values (the buffer current is around 25 ma.) although they show the usual resonance dips. The one exception is the buffer current on 7 Mc., which is in the vicinity of 10 to 15 ma. in normal operation.

On all bands the resonance setting of C_7 is in the low-capacitance third of the scale. A 50- μmf . condenser can be used instead of the 140- μmf . unit shown.

For c.w. operation of the 6146 a grid current of 2.5 to 3 ma. (through the 27,000-ohm grid leak) is sufficient for maximum output at full ratings. In our experience with plate-and-screen modulation a somewhat lower value of grid current—slightly under 2 ma.—gave best linearity at 100 per cent modulation, using the maximum ICAS 'phone ratings.

Those who are used to the 807 will find that the 6146 has considerably different operating characteristics with respect to plate-current behavior. When an 807 is used with a screen-dropping resistor the off-resonance plate current does not rise a great deal above the normal operating value of 100 ma. Tuning off resonance with the 6146 will send a 250-ma. meter off scale, if the grid excitation is normal, so a little more care must be used to keep the plate circuit resonated. The proper tuning procedure is to adjust C_4 and C_7 for a grid current of about 3 ma., with the 6146 plate and screen voltages off, and then set C_{13} at maximum before applying plate and screen voltage. With power on, swing C_{12} rapidly to find the plate-current dip. Then decrease the capacitance of C_{13} gradually, keeping C_{12} at the plate-current dip with each change, until the plate current approaches the rated value. Check the grid current at this point and if necessary readjust C_7 to bring it back to 3 ma., and then make the final adjustments to the plate circuit for the desired plate current. The tube works just as efficiently at 30 Mc. as it does at 3.5, and the measured output of the transmitter is about 65 watts on all bands at the 90-watt input rating.

A coax connector is provided for VFO input, and when a VFO is used the oscillator cathode should be shorted to ground for r.f., by means of S_1 . The VFO should be of the type having a length of coax as part of its tuned output plate tank circuit, and the VFO output frequency should be in the 3.5-Mc. band.

Harmonic Radiation

Although the harmonic radiation in the TV bands from the transmitter itself and the external

(Continued on page 112)



M. A. R. S.



Refiling of messages not received over military circuits involves a reprocessing of the message headings. Since it is desirable that this refiling procedure be standardized throughout MARS and also that it conform to Joint Army, Navy Air Force Publication (JANAP), the Chiefs, MARS, have developed and authorized the following conversion processes:

MARS Form

A6USA DE WAR NR 7
 NM 102213Z
 FM WAR WASHDC (CITY, APO, OR OTHER GEO-
 GRAPHIC INDICATOR)
 TO JAMES SMITH 813 BROWN STREET ALEX-
 ANDER CALIF
 GR 6 BT
 WILL BE HOME EASTER SIGNED GINNY BT

MARS to Amateur Form

W6PQB DE W6USA
 NR7 K4USA CK6/4 WASHDC 5R13P FEB 10
 TO JAMES SMITH
 813 BROWN ST.
 ALEXANDER CALIF BT
 WILL BE HOME EASTER BT SIGNED GINNY

It will be noted that the amateur call letters of the originating station have been substituted for the military call sign, the time has been converted from Greenwich Civil Time to the appropriate zone time (in this case Eastern Standard Time) and the signature has been detached from the text. The converted group count therefore will be the count of the original message text decreased by the signature and associated word(s). This count is shown followed by the slant sign (/) and the group count of the original message.

Amateur to MARS

An example of authorized refile from amateur circuits to MARS channels follows:
 A9USA DE WAR NR12
 ZOF STLOUISMO
 NM — 170030Z
 FM WAR WASHDC
 GRNC BT

NR 2 W6FOO CK5 TARFU CALIF 6P MAY 16
 TO JOHN DOE 1801 GREEN ST EAST ST LOUIS ILL
 BT
 DEAR JOHN I MISS YOU BT MABEL BT

Beginning with the preamble the original transmission becomes the text of the refiled message; the signature also becomes part of the text although the long break (BT) is retained. ZOF is a military procedure signal meaning "Relay (or pass) to ———." The new date time group indicates the time the message was refiled and the "from" line shows the station which introduced the nonmilitary message into the MARS channel. A MARS service message would refer to WAR's number 12 dtg 170030Z.

In the event that A9USA or a subsequent MARS station finds it expedient to reconvert the message back to amateur form for relay to East St. Louis all reference to military handling would be deleted. Example:

W9LJL DE W9USA
 NR2 W6FOO CK5 TARFU CALIF 6P MAY 16
 TO JOHN DOE 1801 GREEN ST EAST ST LOUIS ILL
 BT
 DEAR JOHN I MISS YOU BT MABEL

FEED-BACK

In the caption for the circuit diagram of the Novice amplifier, January 1952 *QST*, Fig. 1, page 26, the values for RFC_1 and RFC_2 are missing. Both are 2.5 mh. RFC_1 is a National R50, RFC_2 a Millen type 34101.

A Radio-Control System for Models

Proportional Control for Precision Maneuvers

BY HARRY W. LAWSON, JR.,* W2TTZ

THE author's interest in radio control, which is fairly recent, stems from the helpless feeling experienced while watching a friend's free-flight model plane meet the inevitable. The control system to be described here was designed in an effort to improve on the simple on-off control with a minimum of complexity. It is a first model and improvements are in order, particularly in the matter of weight. A complete tally, including batteries, for a two-channel two-control unit for model plane use, resulted in a weight of 33 ounces. Although not prohibitive, it can and should be trimmed down considerably.

At present this system is installed in the four-foot two-masted sailing schooner shown in the photograph. Since weight was no problem here, wet cells and a small vibrator supply were used. Some of the mechanical linkages are still in the process of development, since machine tool facilities are lacking at present. Two channels are used, providing full control of rudder and sails independently. An auxiliary motor is also provided and operated by a limit switch on the sail control mechanism. Two quarter-wave 6-meter vertical antennas are provided by the mainmast sidestays.

Circuit

The basis for this control system, which gives "proportional" control in contrast to the "sequential" or simple "neutral-right-neutral-left-

* 18 Relda St., Plainview, L. I., N. Y.

neutral" of an escapement system, is a square-wave signal. When the positive peak has the same duration as the negative peak, the control is in the neutral position — longer positive time than negative time moves the control in one direction, depending upon the ratio of the two times, and vice versa. The amount of movement is dependent only upon the ratio of the times and not of the signal strength.

The system can best be illustrated by the simplified diagram of Fig. 1A. With a square wave coming in, condensers C_1 and C_2 charge to equal voltages, and the net voltage to ground is 0 at the center of R_1 . If the value of R_2 is adjusted so that the current from B_1 through Ry_1 is just equal to the current from B_2 through the relay and tube, the net pull of the relay will be zero. Thus the relay will not make contact.

When the ratio of the incoming signal is changed, as in Fig. 1B, C_1 and C_2 will not charge equally. In the case shown, C_1 will charge to a higher value than C_2 . The point on R_1 where the net voltage to ground is 0 will now be somewhere toward C_2 , and if the arm is in the center of R_1 , the grid of the tube will be positive with respect to ground. The plate current from B_2 will exceed the steady current from B_1 , and the relay armature will be pulled down as shown. Closing the contact energizes the motor and it turns the control surface and the arm of R_1 , driving the arm down toward the C_2 end. When the arm reaches the point on R_1 where the voltage to

◆

The radio-control system of W2TTZ is used to operate the rudder and sails of this four-foot two-masted sailing schooner. Full proportional control is obtained, permitting setting to any desired position.

◆

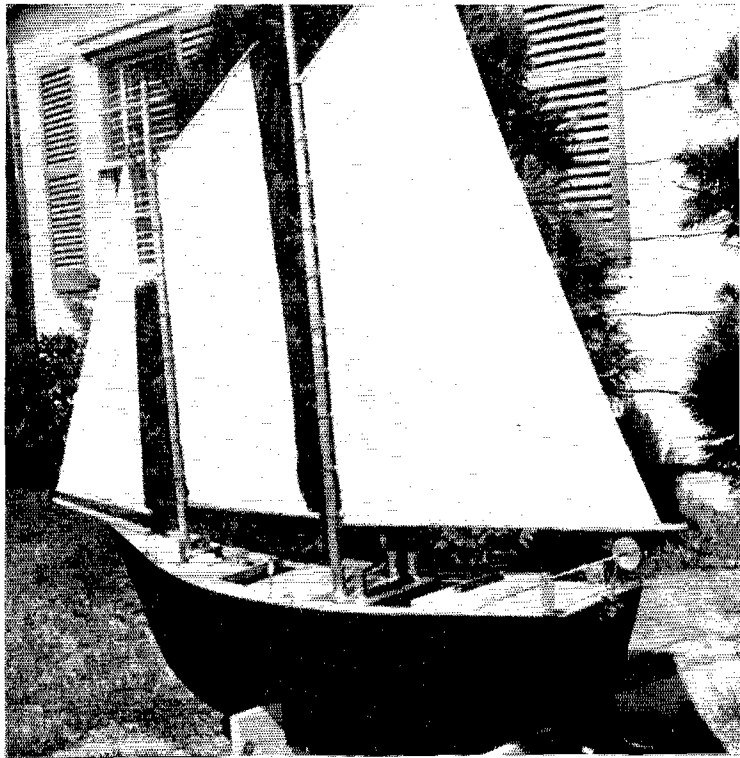

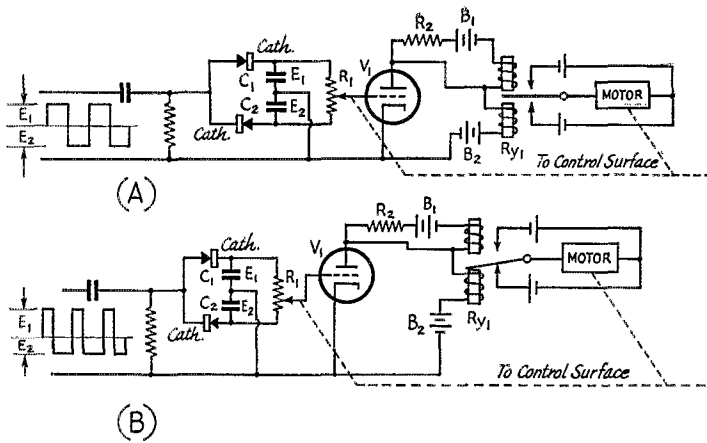

Fig. 1 — The basic diagram of the control system. With a symmetrical square-wave signal applied, the motor is not energized, as shown at A. When the signal is varied (as in B, for example) the control tube, V_1 , allows one relay to close and energize the motor until it has driven R_1 (and also the controlled surface) to a new position that depends upon the shape of the signal.

ground is 0, the relay will open and the motor will stop. The control surface and the arm of R_1 will now remain in this position until the shape of the input signal is changed.

It is obvious, of course, that if the square-wave signal had been modified in the opposite direction, the current from B_1 would exceed that from B_2 and the relay armature would be pulled up. The motor would then rotate in the opposite direction until the arm of R_1 reached the point on the resistor where the voltage to ground was 0.

The setting the motor drives the arm of R_1 to depends only upon the *shape* of the signal and not its amplitude, and accurate and resettable control is obtained at the model by controlling the signal shape at the transmitter. In the practical circuit, audio-stage limiting on strong signals helps to keep the peak-to-peak voltage constant,

and weak signals show up only as reduced error sensitivity rather than lack of control. The sensitivity of the system can be defined as the number of discrete positions of the controlled surface, and an ideal system would have an infinite number and hence be perfectly smooth. This particular system, as built and used, is capable of approximately 20 positions between each extreme position.

The Receiver

The complete circuit diagram of the receiver is shown in Fig. 2. A triode-connected 1U4 is used in the superregenerative-detector circuit, followed by a 1U4 audio amplifier. The output of the audio amplifier is applied to the pulse-width discriminator, where 1N34 germanium crystals are used for the rectifiers. The signal from the

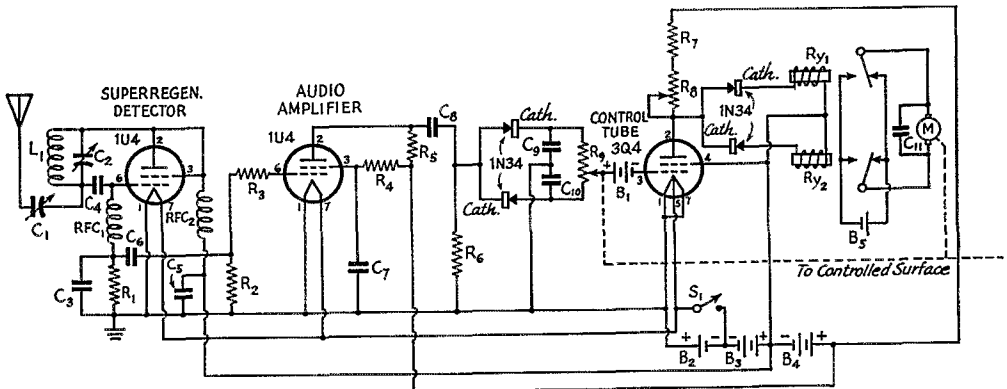

Fig. 2 — Wiring diagram of the 50-Mc. radio-control receiver.

C_1 — 7-45 μ fd. ceramic trimmer.

C_2 — 50- μ fd. midget variable.

C_3 — 150- μ fd. ceramic.

C_4 — 47- μ fd. ceramic.

C_5, C_6 — 0.01- μ fd. disk ceramic.

C_7, C_8, C_9, C_{10} — 0.25- μ fd. 200-volt paper.

C_{11} — 0.1- μ fd. 200-volt paper.

R_1 — 0.47 megohm.

R_2 — 10 megohms.

R_3 — 0.1 megohm.

R_4 — 2.2 megohms.

R_5, R_6 — 1 megohm.

R_7 — 10,000 ohms.

R_8 — 10,000-ohm miniature potentiometer.

R_9 — 1-megohm linear potentiometer, midget. All resistors $\frac{1}{2}$ watt unless otherwise specified.

L_1 — 6 turns No. 12, $\frac{1}{2}$ -inch diam., 1 inch long.

B_1 — 7 $\frac{1}{2}$ volts (5 Mallory bias cells in series).

B_2, B_5 — 1.5-volt flashlight cell.

B_3, B_4 — 67 $\frac{1}{2}$ -volt miniature B battery.

M — Supermite motor. See text.

RFC $_1, RFC_2$ — 10- μ h. r.f. choke.

Ry $_1, Ry_2$ — 8000-ohm sensitive relay (Sigma 4F).

S $_1$ — Toggle switch.

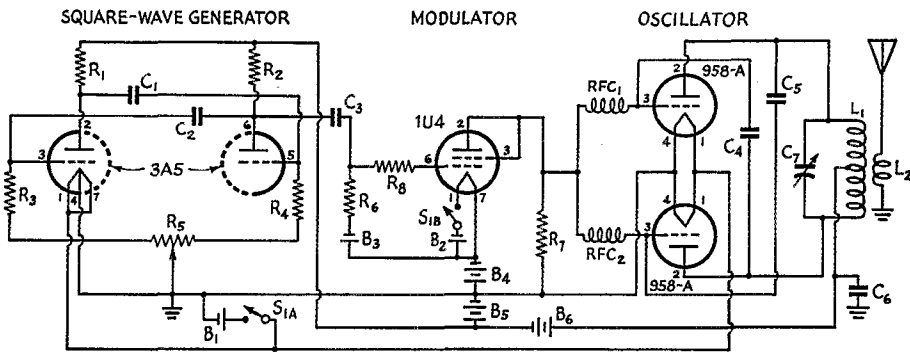

Fig. 3 — Wiring diagram of the 50-Mc. radio-control transmitter.

- C_1, C_2 — 0.001- μ fd. mica.
- C_3 — 0.25- μ fd. 400-volt paper.
- C_4, C_5 — 47- μ fd. ceramic.
- C_6 — 0.01- μ fd. disk ceramic.
- C_7 — 50- μ fd. midget variable.
- R_1, R_2 — 22,000 ohms.
- R_3, R_4 — 0.1 megohm.
- R_5 — 1-megohm linear potentiometer.
- R_6 — 1 megohm.

- R_7 — 22,000 ohms.
- R_8 — 0.1 megohm.
- L_1 — 6 turns No. 12, $\frac{5}{8}$ -inch diam., 1 inch long.
- L_2 — 2-turn loop on center of L_1 .
- B_1, B_2 — 1½ volts.
- B_3 — 6 volts.
- B_4, B_5, B_6 — 67½ volts.
- RFC_1, RFC_2 — 10- μ h. r.f. choke.
- S_1 — D.p.s.t. toggle.

discriminator is fed to a 3Q4 control tube. For want of a good polarized relay, two sensitive non-polarized relays are used in the plate circuit.¹ These relays are fed through 1N34 crystals to provide polarization. Although the two relays are a little on the heavy side, their use permits the use of only one motor-drive battery. As shown, approximately 0.3-volt differential is required at the grid of the 3Q4 for relay operation.

Motive power for the controlled functions is furnished by miniature permanent-magnet field electric motors.² These motors are excellent for model work, since they weigh only 1½ ounces. Gearing may be something of a problem, although a lead-screw movement is satisfactory. Since the duty cycle of the motor batteries in this system is quite low compared with pulsed electromechanical systems, longer battery life can be expected.

Transmitter

The transmitter diagram is shown in Fig. 3. Two 958-As are used in the push-pull Hartley circuit and, in our particular set-up, they feed into a quarter-wave vertical antenna. These low-powered tubes are satisfactory for ship-model control, but it might be necessary to use more power when controlling a model aeroplane. The modulator consists of a 3A5 multivibrator to generate the square waves, and this signal is used to grid-modulate the oscillator. A triode-connected 1U4 is used as the modulator. To simplify connections and give good response, the 1U4 modulator is direct-coupled to the oscillator.

¹ Small polarized relays are both expensive and scarce. Some are available, manufactured by Sigma, Carpenter (British) and Barber-Coleman. The Barber-Coleman Micro-positioner has good vibration characteristics, since it was designed for aircraft-control use. Its sensitivity can be increased to below the 100-watt level, depending upon the vibration-stability requirements.

² The "Supermite," made by Motoys, Inc., 11 West 42nd St., New York 18, N. Y.

This requires separate batteries B_2 and B_4 for the modulator. The linear potentiometer, R_5 , varies the shape of the signal and thus controls the position of the controlled surface on the model.

Operation

The construction of the receiver and transmitter is best left up to the individual, since it will vary with the application (aircraft or boat) and with the parts on hand. Shock mounting of the receiver, whether by rubber-band suspension or other means, is quite important in any flying or gas-powered model. Proper connection of R_9 in the receiver will be obvious when the system is given a dry run, since the motor rotation should be in the direction to reduce the voltage between ground and the arm of R_9 .

To adjust the receiver, apply the voltages and adjust R_8 until both relays are open. Optimum control-tube and relay operation is characterized by equal minimum grid differential voltages in either direction (positive or negative) to operate the relays. To obtain this setting, use a 1.5-volt battery, a potentiometer and a reversing switch from the arm of R_8 to ground. Make fine adjustments on R_8 , the relay spring tensions and contact spacings, until the relays close with equal voltages. Closing with 0.5 volt is the maximum permissible voltage — closing with 0.1 volt represents excellent performance.

The receiver is adjusted for normal super-regenerative operation, tuning the signal with C_2 and adjusting C_1 for best sensitivity.

In marine use, good operation at $\frac{1}{4}$ mile can be expected with this equipment. Model plane operation would entail use of a better (and horizontally-polarized) antenna and higher power, to offset the blind spots more apt to be encountered.

One question will be immediately apparent to the model plane fan — what happens during loss

(Continued on page 118)

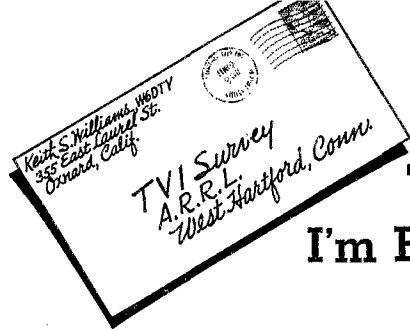

TVI Went Thattaway! or I'm Back in the Hamshack Again

BY KEITH S. WILLIAMS,* W6DTY

AFTER reading the editorial in October *QST* I decided to write something concerning the TVI situation at this QTH. My operation has been confined to 80- and 40-meter c.w. and 75-meter 'phone. Those are my favorite bands. Therefore, my TVI has been of the 80/40 variety; however, some of my procedures and methods may be as effective for 20/10 as they have been for the lower-frequency bands.

The local TV picture: Oxnard is located on the beach approximately 50 miles due west of Los Angeles. We are approximately 60 miles from the L.A. TV transmitters, with seven TV channels being received here. They are Channels 2, 4, 5, 7, 9, 11 and 13. Incidentally, there is a range of mountains between us and the L.A. stations. The Channel 8 station, which is also received (on a now-and-then basis), is in San Diego, about 150 miles away. Average signal strength here for the seven L.A. stations is 150 microvolts-per-meter, with Channel 5 the strongest and Channels 2 and 7 the weakest. In the absence of interference, good pictures are the rule on all channels. Most antennas are of the stacked-array variety, Vee-cones, Yagis, Arrows, etc. Very few people use boosters. TV set population is heavy. In this town of 30,000 I would estimate 70 per cent of the homes have TV. With the exception of Channel 8 (San Diego), all TV stations are at one location, so that one antenna array, pointed toward Mount Wilson, suffices for all channels.

My experience with TVI dates from the summer of 1948, when the first TV owner pounded on my front door to horrify me with the announcement that my brass pounding was knocking out his pictures. At that time the TVI problem had me flabbergasted, and I considered suicide as the only solution. Since then, however, I have built and rebuilt and rebuilt some more and have arrived at some highly satisfactory solutions. During the last year my TVI problem has been practically nonexistent, although I am surrounded by a forest of TV antennas and have one of my own.

Many fellows still think that 80- and 40-meter rigs cause no appreciable TVI. How wrong can you be, I ask? The old-style 80/40 rig can murder TV in very fine style. Some of the gang would be amazed at their harmonic strength in the TV channels from the old 807 rig on 80-meter

c.w. Of course, in a primary TV service area the problem would be considerably reduced, but in this fringe-fringe area it doesn't take much of a harmonic to wreck a TV channel, where the TV signal strength may be on the order of 25 microvolts.

The following items have been found necessary in order to be able to check in on a traffic net in the middle of the evening:

1) Shielding. This is of primary importance. The rig must be completely enclosed. Chassis must have a solid bottom cover. Use solid shielding on all stages except those in which a great

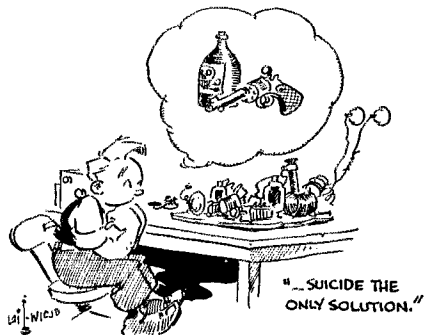

deal of heat is liberated. Shielding for an 813, for instance, may be fine-mesh copper screen. Contrary to popular belief, transmitter stages can be run totally enclosed in many cases, with no ventilation. As an experiment, I enclosed an 807 driver with solid shield . . . no openings at all, no ventilation. The shield enclosure was just large enough to enclose the 807 tube and its tank coil. The tube ran at 700 volts and 90 ma. and, needless to say, the shield box was a miniature bake oven. The same 807 operated continuously for over a year at my shack with no troubles, and it is still in use at W6HVJ and going strong.

2) Filtering. Very important for all leads leaving the shield enclosures. The ideal situation is to have as few leads leaving the shield as possible. This means mounting power supplies on the same chassis with the stages they operate. Key leads, microphone leads, meter leads, etc., should be filtered where they leave the unit. Effective filters here consist of 30 turns of No. 22 enamel, close-wound (air), in series with the lead, by-passed to chassis at each end with midget 500- μ fd. mica¹ condensers. For high voltages, those TV

* 355 East Laurel St., Oxnard, Calif.

¹ The new ceramic disk-type condensers are also excellent for high-frequency by-passing. See Grammer, "By-Passing for Harmonic Reduction," *QST*, April, 1951. — Ed.

high-voltage filter condensers make nice by-passes. Naturally, in all cases the filters must be inside the shielding and not in an r.f. field. For 80 and 40 meters the main 110-volt power lead only needs a line filter. It doesn't seem necessary

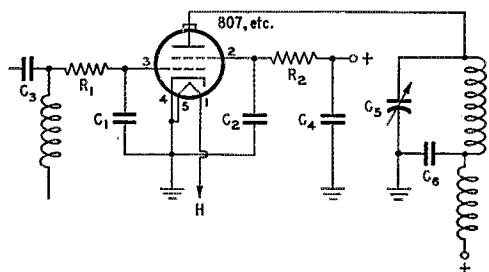

Fig. 1 — Recommended treatment of a tetrode stage. All grounds are one point on the chassis, as close as possible to the cathode pin.
 C_1, C_2 — 5- or 10- μ fd. disk ceramic.
 C_3 — Normal grid-coupling condenser.
 C_4 — Normal screen by-pass condenser.
 R_1, R_2 — 47-ohm composition resistor. $\frac{1}{2}$ -watt rating for 807s and smaller tubes.
 C_5 — Plate-tank tuning condenser, grounded as described in text.
 C_6 — 0.002- μ fd. mica.

to filter each power supply lead inside the chassis.²
 3) External leads should be shielded. Coax cable with appropriate fittings makes good keying leads between rig and key. Two-conductor shielded wire makes good meter leads. Not wishing to go to the trouble of shielding meters, I have found it very effective to mount meters in the open on a separate panel and plug them into appropriate circuits by means of plugs and jacks. The jacks are filtered inside the shielding. While shielded meter leads are to be preferred, I have found that in most cases unshielded leads can

² Particularly if all of the wiring is done with by-passed shielded wire, as described in the reference in Footnote 1. — Ed.

³ But give some consideration to the path the harmonics take in getting back to the cathode. In many cases the condenser should be insulated from the chassis and the rotor returned to the underside of the chassis by a heavy lead running through a hole in the chassis. This permits returning the condenser directly to the cathode. See Goodman, "How To Build a Transmitter," *QST*, Dec., 1951. — Ed.

be used providing the meter jacks are filtered. While it's nice to have continuous meter indications, it isn't really necessary, and once the rig is tuned up the meters can be unplugged if there is evidence of harmonic radiation from the meter leads or meters. I have never found it necessary to unplug the meters, however, even when using unshielded leads.

4) Cathodes should be grounded to the chassis as directly as possible, using heavy conductor. There are other ways of keying a rig or obtaining bias without making use of the cathodes, and it has been my experience that harmonic troubles can be considerably increased by even short cathode keying leads or the use of cathode bias. The ideal situation for 80 and 40 is to use a beam power tube in the final, driven as lightly as possible by very low-power exciter stages, with the cathodes of all stages strapped directly to the chassis. The oscillator and driver stages can be keyed in the plate-screen lead and the final stage uses a clamp-tube/VR-tube screen control.

5) Control-grid, screen-grid by-passing to cathode: All control grids and all screen grids should be by-passed directly to cathode right across the tube socket, using 5- to 10- μ fd. ceramic condensers. This is in addition to normal by-passing. See Fig. 1.

6) All screen-grid tubes should have low-resistance suppressors right at the control-grid and screen-grid socket pins, ahead of all other circuit components except the by-passes mentioned in Item 5. Forty-seven ohm $\frac{1}{2}$ -watt carbon resistors are very satisfactory.

7) Wherever possible, the frame and rotor of plate tank condensers should be directly grounded to the chassis, and the tube plate connected to the hot end of the tank through a short, heavy conductor. A convenient and effective way of managing this is shown in Fig. 1. For higher-powered stages, a vacuum condenser directly from plate to cathode is good; however, in most cases, the grounded-rotor plate tank circuit is effective in by-passing harmonics that may appear in the plate circuit.³

8) Tuned harmonic traps in plate circuit should be avoided, at least on 80 and 40. It has been my experience that, while a trap may be

Fig. 2 — Keying circuit used at W6DTY.

- C_1 — Normal screen by-pass condenser.
- C_2, C_3 — 100 μ fd.
- R_1 — 0.47 megohm.
- R_2 — Screen-dropping resistor.

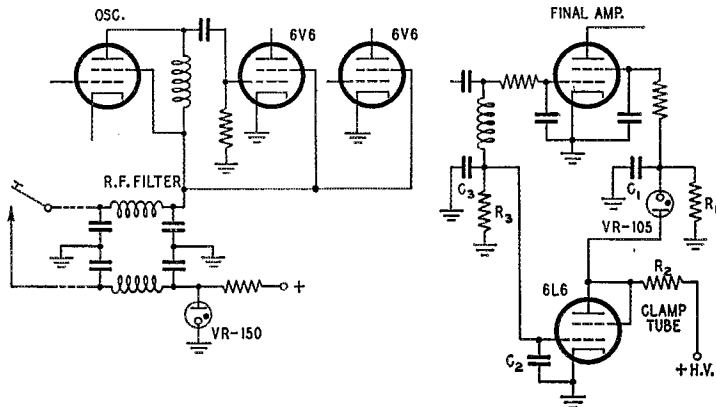



"MY NEAREST NEIGHBOR
DOESN'T KNOW WHEN I'M ON THE AIR!"

tuned to reduce harmonic trouble on one TV channel, it may increase harmonic trouble on another channel at the same time.

9) Use a separate antenna tuner, and couple it to the rig by means of link coils and coax link line. The antenna tuner should be built on a metal chassis of fair dimensions, and regular coax fittings should be used for the link line. On 80 and 40 I have not found it necessary to shield the antenna tuner, although it probably wouldn't hurt a thing to do so.

10) Eliminate key clicks. This is important, as severe TVI can be caused by clicks. And just because you have no audible clicks on the broadcast band, don't assume you have no clicks at TV frequencies. By far the most effective method for eliminating key clicks is to key the oscillator or other low-power stage in the plate or screen circuit and use a clamp-tube/VR-tube combination on the final screen circuit, as shown in Fig. 2. Using this method you can dispense with the old key-click filters, making for cleaner keying all the way around, and you won't have clicks, even smack alongside your sigs on 80 or 40.

11) Do not use triodes in the rig. They require too much drive. Use a beam-power final and drive it as lightly as possible consistent with reasonable output. Use an excitation control somewhere in the driver section. A wire-wound potentiometer in a driver-tube screen is very fine business; adjust excitation to the final for normal output to the antenna *but no more!* Do not reduce excitation by detuning a driver stage off resonance. A detuned r.f. amplifier can sometimes produce ruinous harmonics in the TV channels. Keep everything tuned on the nose. Granted this may make for a lot of knob twirling as you scoot around the band, but it can help materially to keep you off the Milton Berle show.

12) Use shielded internal wiring in the rig, bonding the shield to the chassis at frequent intervals.⁴

13) Use large *C* to *L* ratios in tank circuits. At an early stage of the game (TVI-wise), I had an unshielded crystal oscillator operating on 40 meters, driving an exciter and push-pull 812

⁴ Here, and also under Item 3, the shielding should not need to be extended beyond the transmitter proper if the leads have been adequately filtered and by-passed. It may help in many cases, but only because the job wasn't done properly in the first place. — *Ed.*

final. Harmonics in the TV and f.m. bands were fearful to behold. I was amazed at the reduction in harmonic strength that resulted from peeling turns from the crystal-oscillator plate coil and running the tuning condenser farther in. The same thing was done on all subsequent stages, and the harmonics were further reduced, some disappearing altogether.

14) If a power supply external to an r.f. chassis is used, the interconnecting leads should be completely shielded. This means using multi-conductor shielded cable, with fittings at the ends that will maintain the shielding.⁴

All the above may sound like a lot of labor . . . and it is if you're trying to fix up an existing rig. But if you're building a new rig from scratch, it's no more difficult than building a rig without TVI precautions, and it sure pays off. Using the above methods, the only TVI I have had is that caused by front-end overload at the TV set due to my fundamental. This has only occurred on two or three TV sets, very, very close to my station, and is easily cured by using a high-pass filter at the TV set. My nearest neighbor, with his TV antenna 25 feet from my 40-meter dipole, doesn't know when I'm on the air . . . and he does *not* have a high-pass filter.

P.S.: None of this dope is new. It has all appeared, in one form or another, in *QST*. But notice — my TVI has been knocked off *at my transmitter* — not at the TV receivers!

Strays



Dick Hauff, W3SCY, who earned his license at the age of ten, made a most unusual entry into the ranks of on-the-air amateurs. He was originally assigned the call W3RVU. Trying his hand at 40 c.w., Dick had several contacts and then was dismayed to work a station who also signed W3RVU! The "other" W3RVU turned out to be YL Verna Resch of Temple, Pa., and both ends of this contact assured the other that each had really been issued the call sign. A hurried letter to FCC brought quick results: a duplication had been made and Verna, being the first licensed, was allowed to retain her W3RVU while Dick was given W3SCY. The young gentleman is a sixth-grade pupil in Trappe, Pa., and also a Cub Scout. His mother is W31NL and dad is well known as W3GHS.

Simplified Adjustment of the T and Gamma Matches

Getting a Low S.W.R. by Reactance Cancellation

BY FREDERICK Q. GEMMILL,* W2VLQ

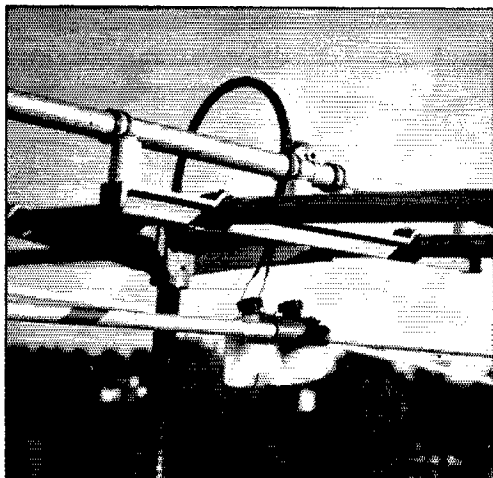

The variable condensers are mounted in plastic drinking cups to protect them from the weather. Metal straps mount the assemblies to the ends of the T bars.

SOME time ago the writer put up a commercial 3-element close-spaced 20-meter beam using 95-ohm Twinax line to drive the T match. No combination of T-section lengths could be found which would match, and no combination of director, antenna or reflector lengths improved the situation beyond an s.w.r. of about 3 to 1. While it is entirely possible that the right combination happened to be missed, walking up and down the roof adjusting antenna elements lengths is not to be indulged in unnecessarily.

A study of the articles on impedance matching that have appeared in *QST* from time to time suggested that tuning out the residual reactance at the T match might help matters. With the s.w.r. meter inserted between the transmission line and the antenna, and with tuning capacitors in series with each terminal of the T match, only a few minutes were required to adjust the T-match bars to a 95-ohm load with an s.w.r. of less than 1.1 to 1.

The writer later had a chance to check W0STC's 10-meter 3-element beam, which uses a Gamma match. Here again it was found that a variable capacitor would tune out the inductive reactance of the matching section, reducing the s.w.r. from a previous minimum of 4 or 5 to 1 to less than 1.1 to 1. Considerable improvement in performance resulted, and the strength of the field about the matching section was noticeably

greater, as measured with a one-turn loop and flashlight bulb field-strength indicator.

The capacitors used to tune out the residual inductive reactance in the balanced T match at W2VLQ were midget variables having a capacitance of 140 μf d. Greater plate spacing probably would be required for high power, but there have been no arc-overs with 160 watts input. Weather-proofing was solved by mounting the condensers in plastic drinking cups, as shown in the photograph. The bottom surface was drilled for the condenser shaft, and two metal washers were used to get a watertight seal around the shaft bushing. An extra nut was used inside the cup to make a suitable surface for tightening. A heavy copper strap fastened under the outside shaft-bushing nut was used to attach the assembly to the T match, mounting it so that the condenser shaft is vertical. The tuning knob keeps water off the shaft and the end of the shaft bushing. The cup sheds water, although the bottom is open to the weather.

A Convenient Maxwell Bridge

In making adjustments as described an s.w.r. bridge is indispensable, and the Maxwell bridge circuit shown in Fig. 2 has been found to be especially convenient since it is only necessary to throw a switch to change the direction of power flow through the bridge. The addition of R_2 makes the bridge a symmetrical device for either position of the switch S_1 . R_1 and R_2 must

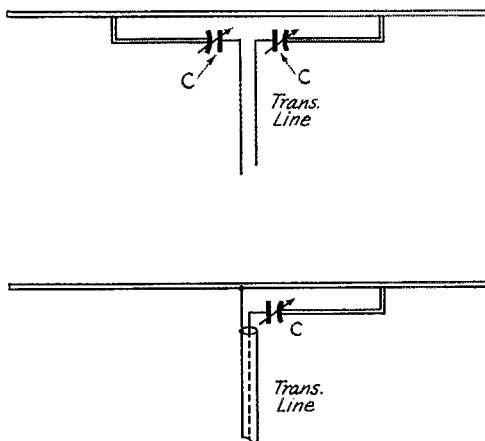

Fig. 1 — Using variable condensers to tune out inductive reactance inherent in the T match (above) and Gamma match. Condenser C should have a maximum capacitance of about 140 μf d. for use at either 14 or 28 Mc.

* 82 Wyatt Road, Garden City, N. Y.

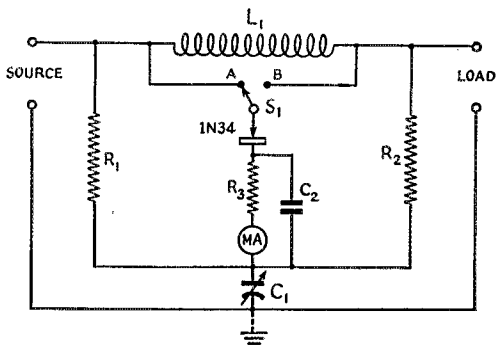

Fig. 2 - Maxwell bridge with reversing switch. This arrangement eliminates the necessity for interchanging the source and load terminals when using the bridge for obtaining a null indication when making adjustments to matching sections.

C_1 — 140- μ fd. variable.

C_2 — 560- μ fd. mica.

R_1, R_2 — 120 ohms, 1-watt carbon.

R_3 — 2700 ohms, $\frac{1}{2}$ -watt carbon.

L_1 — 14 turns No. 20, diameter $\frac{1}{2}$ inch, length $\frac{7}{8}$ inch (B & W Miniinductor No. 3003).

MA — 0-1 milliammeter.

be equal, and the capacitance of S_1 must be small so as not to disturb the bridge balance. The capacitance of the milliammeter to ground is in parallel with the adjustable capacitor C_1 and hence reduces the high-impedance limit at which balance can be obtained. A load-impedance range of 39 ohms to 250 ohms is obtained with the constants given in Fig. 2.

While the addition of R_2 reduces the sensitivity to unbalance, it in no way affects the actual balance position. With S_1 in position A, the source voltage is adjusted for a full-scale reading of 100 divisions. On switching to position B, the meter will read less than one division when the bridge is balanced for a given load resistance. The meter deflection with S_1 in position A is proportional to the source voltage and the deflection with S_1 in position B is proportional to the reflected wave. Unfortunately, there is a voltage drop across L_1 so that the transmitted wave on the transmission line is less than the source voltage. As a result, this bridge will not read true s.w.r. without applying a correction factor, but from a practical point of view this limitation is not significant since a null indication is sufficient for obtaining the proper matching adjustments.

In the construction of such a bridge the usual precautions should be taken with respect to stray capacitances and to avoid coupling between the rectifier circuit and the other parts of the bridge carrying r.f. current. The writer used a sloping-panel meter case which, although not overburdened with excess room inside, was the most convenient ready-made chassis shape available. The variable capacitor is mounted on the top surface above the milliammeter, the input and output terminals are at the sides, and the switch is on the front, just below the milliammeter. The meter itself is on the sloping front, but is mounted on $\frac{3}{4}$ -inch spacers to make more room inside and to reduce its capacitance to the case.



U. S. N. R.



The salty ham call W3SEA is assigned to a Naval Reservist (W. F. Egli of Ridley Park, Penna.), while W2GOB is held by a former Navy radioman (Roy Butler of Fair Lawn, N. J.).

A group of radio amateurs whose active military service assignments are concerned with the Naval Reserve Electronics Program hold an informal ham get-together on 7 Mc. at 2300 EST each Friday. The frequency 7250 kc. is the center of activity, with the gang spreading out between 7225 and 7275 kc. for individual rag chews.

A recent survey indicates that more than 1500 radio amateurs are members of the Naval Reserve and the Marine Corps Reserve. In addition, there are 509 amateur radio stations at activities of the Naval Reserve and the Marine Corps Reserve. These stations have the distinctive "K" calls (K1NRA, K0NAA, K6NR, etc.).

An SCR-299 mobile communication van was in operation on the amateur bands, both 'phone and c.w., at the 1951 New Mexico State Fair held at Albuquerque. Over 600 messages were handled for visitors to the week-long affair. The van was moved to the Fair site from Naval Reserve Training Center, El Paso, Texas (K5NRE). That activity cooperated with personnel of Naval Reserve Training Center, Albuquerque (K5NRX), in making the exhibit a success.



During the recent South Dakota Hamfest, James W. Fowley, W0CRY, was presented with the Armed Forces Communications Association medal for his many years of meritorious activity in communications work. Lieut. William Spanke, USA, W9CQU, made the presentation — the first time an amateur has received the award. For many years a member of the Naval Reserve, W0CRY is now associated with Organized Surface Division 9-208 at Naval Reserve Training Center, Sioux Falls (K0NRU). (Photo courtesy W0HSH)

**SWITCH
TO SAFETY!**



A Battery-Operated 2-Meter Portable Station

A Versatile Transmitter-Receiver for Portable or Mobile Service

BY LAURENCE LEPAGE,* W3QCV

IN contemplation of a motor trip through New England last summer, the writer developed a strong desire to take along a small portable rig operating on 2 meters, his favorite band. This idea also had Civil Defense aspects, and the little rig about to be described appears to have great potential in this application. Operation is possible on dry batteries, a vibrator supply in the car, or a combination of a vibrator supply and small non-spillable batteries, carried as a separate unit.

Believing that special circuits aimed at extreme light weight and low drain would be a source of trouble, the rig was designed along conventional lines, except that everything was handled in miniature. The general appearance is shown in the photographs. Housekeeping had to be very neat and compact. Everything is mounted on the U-shaped front of a Hammerloid-finish box (Bud CU-2110), measuring 10 by 6 by 3 inches.

Both transmitter and receiver are built on miniature aluminum chassis (Bud CB-1628) measuring 3 by $6\frac{1}{8}$ by $1\frac{1}{4}$ inches. This is an open-ended chassis from which approximately $\frac{1}{2}$ inch was removed from the length dimension to fit inside the box. In the photographs showing the back removed, the transmitter chassis is at the bottom, the receiver above it. The modulator is on a cut-down chassis approximately 3 inches square, mounted on end in the upper left corner.

Transmitter Circuit Details

All tubes are $1\frac{1}{2}$ -volt filament-type miniatures or acorns. The oscillator uses one half of a 3A5 dual triode, working on the third overtone of an 8-Mc. crystal.¹ It was decided to avoid a 48-Mc. stage, a potential source of TVI trouble on Channel 10 in the Philadelphia area, so the second stage triples to 72 Mc. It was felt that an audio pentode like the 3A4 might not work well at 144 Mc., so it was used as the tripler to 72 Mc., coupling capacitively back to the second half of the first 3A5 for doubling to 144 Mc. A very low-powered rig could stop right there, but we added a 3A5 operating as a neutralized push-pull amplifier on 144 Mc. While the book says that this tube is good only up to 40 Mc., it appears to perform admirably and without apparent loss of life expectancy.

It will be noted from the circuit diagram that each stage has a metering point for initial

• The usefulness of a low-powered 2-meter station is greatly enhanced if the rig is designed so that it may be carried to spots that are inaccessible by car. The little rig described here by W3QCV can be operated from dry batteries, a vibrator supply for mobile operation, or a separate wet-battery portable kit.

tune-up. In the operating set-up of the complete rig only the driver and final stages are metered, being connected to an 0-1 milliammeter with a selector switch. Because of the space problem the temptation to use one of the new miniature meters was great, but their sensitivity is poor. It was therefore decided to use a good 2-inch meter, so that careful tuning of the transmitter would always be possible. This is important if the most is to be had out of so small a rig. With 150 to 180 volts on the plates the final delivers enough power to burn out a 2-volt 60-ma. pilot lamp, connected to the antenna coil through the coaxial fitting, if it is left on for extended periods.

Modulator

The modulator uses a carbon microphone and a 6-volt battery, coupled through a miniature transformer to the grid of a 1S4 speech amplifier, transformer coupled to a pair of 3Q4s as push-pull modulators. A temptation to simplify this

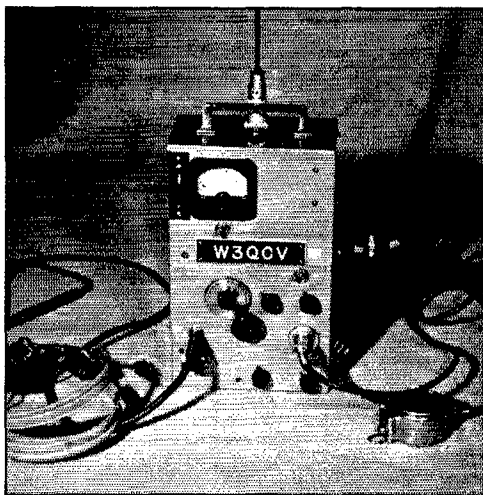

Transmitter and receiver of the W3QCV portable are housed in a box only 10 by 6 by 3 inches in size.

* 27 Love Lane, Ardmore, Penna.

¹ Tilton, "Overtone Crystal Oscillator Circuits," *QST*, April, 1951, p. 56.

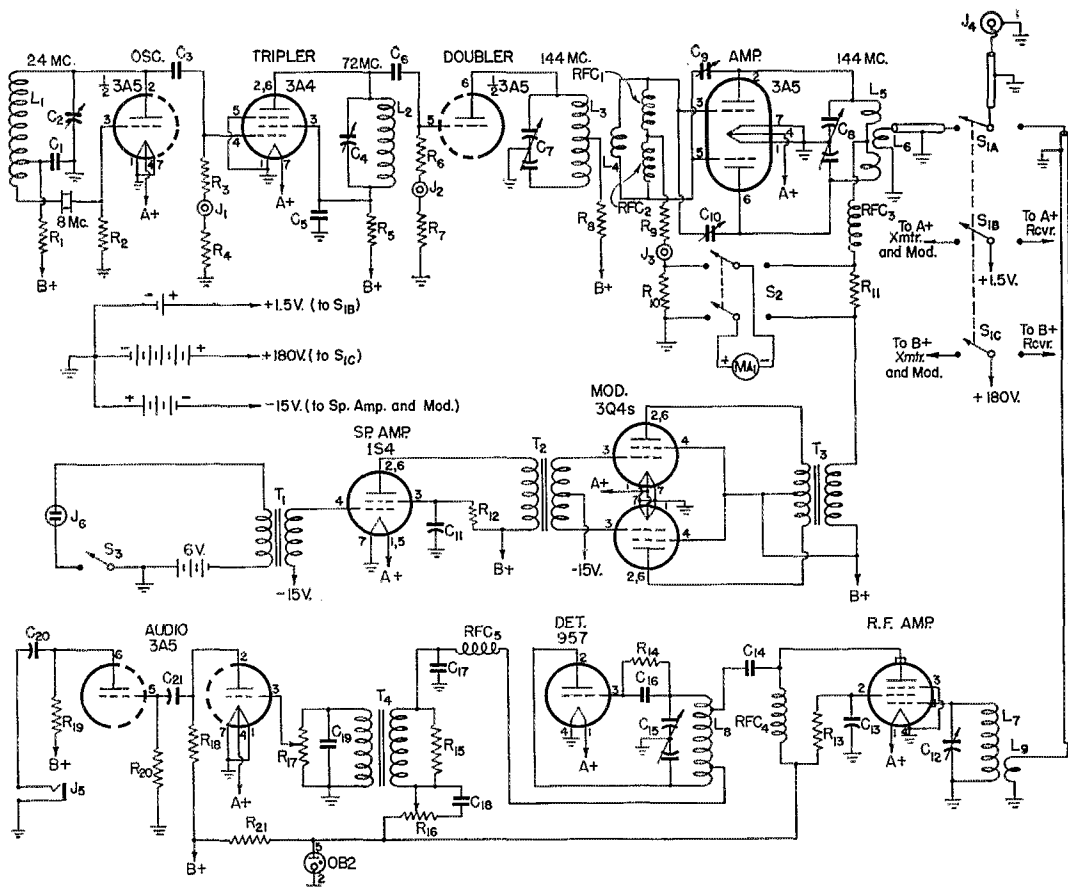

Fig. 1—Schematic diagram and parts list for the 2-meter portable station.

- C₁ — 170- μ fd. mica.
 C₂, C₄, C₁₂ — 50- μ fd. mica trimmer.
 C₃ — 22- μ fd. ceramic.
 C₅, C₁₉ — 0.001- μ fd. mica.
 C₆, C₁₄, C₁₆ — 50- μ fd. ceramic or mica.
 C₇ — Miniature butterfly variable, 2.5-7 μ fd. (Johnson 9MB11) with one stator and one rotor plate removed.
 C₈ — Miniature butterfly variable, 2.7-8.75 μ fd. (Johnson 9MB11).
 C₉, C₁₀ — Neutralizing capacitors, 2-7 μ fd.
 C₁₁ — 0.01- μ fd. paper.
 C₁₃ — 50- μ fd. (special for use with National XLA socket).
 C₁₅ — Miniature butterfly variable, 2.1-5.27 μ fd. (Johnson 5MB11).
 C₁₇ — 0.002- μ fd. ceramic or mica.
 C₁₈ — 0.1- μ fd. paper.
 C₂₀, C₂₁ — 0.05- μ fd. paper.
 R₁ — 4700 ohms, $\frac{1}{2}$ watt.
 R₂ — 3000 ohms, $\frac{1}{2}$ watt.
 R₃ — 0.33 megohm, $\frac{1}{2}$ watt.
 R₄, R₇, C₁₀ — 2200 ohms, $\frac{1}{2}$ watt.
 R₅, R₈ — 220 ohms, 1 watt.
 R₆ — 58,000 ohms, $\frac{1}{2}$ watt.
 R₉, R₁₂ — 10,000 ohms, $\frac{1}{2}$ watt.
 R₁₁ — 5 ohms, $\frac{1}{2}$ watt.
 R₁₃ — 0.1 megohm, $\frac{1}{2}$ watt.
 R₁₄ — 10 megohms, $\frac{1}{2}$ watt.

- R₁₅ — 30,000 ohms, $\frac{1}{2}$ watt.
 R₁₆ — 50,000-ohm potentiometer.
 R₁₇ — 0.5-megohm potentiometer.
 R₁₈, R₁₉ — 22,000 ohms, $\frac{1}{2}$ watt.
 R₂₀ — 1 megohm, $\frac{1}{2}$ watt.
 R₂₁ — 4700 ohms, 1 watt.
 L₁ — 14 turns B&W Miniductor No. 3003, tapped at 3 $\frac{1}{2}$ turns.
 L₂ — 5 turns No. 18, $\frac{3}{8}$ -inch diam.
 L₃ — 6 turns No. 16, $\frac{3}{8}$ -inch diam.
 L₄ — 3 turns No. 18 enam. around middle of L₃.
 L₅ — 4 turns No. 14, $\frac{1}{2}$ -inch diam., $\frac{1}{4}$ -inch space at center.
 L₆ — 2-turn loop of push-back in middle of L₅.
 L₇ — 3 turns No. 14, $\frac{1}{2}$ -inch diam.
 L₈ — 4 turns No. 14, $\frac{1}{2}$ -inch diam. B-plus tap 1 $\frac{1}{2}$ turns from low end; r.f. tap $\frac{1}{2}$ turn from grid end.
 L₉ — 2-turn loop of push-back in cold end of L₇.
 J₁, J₂, J₃ — Tip jack.
 J₄ — Coaxial antenna socket.
 J₅ — Open-circuit 'phone jack.
 J₆ — 2-pin microphone connector.
 RFC₁-RFC₅ — Small single-layer r.f. choke (Ohmite 7-144).
 T₁ — Single-button microphone to one grid (UTC Ouncer 0-1).
 T₂ — Single plate to two grid (UTC Ouncer 0-7).
 T₃ — Modulation transformer (Stancor A-3812).
 T₄ — Single plate to one grid (UTC Ouncer 0-5).

modulator will result in a beautiful carrier poorly modulated. The writer went all through this, starting with a one-tube modulating system.

The 3Q4s require 15 volts of negative bias, while the 1S4 calls for only 7 volts. This intro-

duced bias complications, until it was found that there was hardly any loss in output or quality when 15 volts was applied to the 1S4. The Burgess K10E hearing-aid battery, measuring little more than a one-inch cube, handles this

well, and fits neatly into the top or the case.

Receiver

The receiving circuit is a straightforward superregenerator, and no originality is claimed for it. A 959 acorn pentode r.f. amplifier is capacitively coupled to a 957 acorn triode superregenerative detector. A miniature transformer coupled the detector output to a 3A5 dual triode, providing two stages of audio amplification. High-impedance headphones are used and received signals are frequently sufficiently strong to be heard clearly when the 'phones are laid on the table. It is entirely practical to wire the headphone jack onto the output of the first audio stage and use a small 'speaker in the plate circuit of the second audio stage, in place of R_{18} .

Except for the constant necessity for compactness, there are no particular construction or wiring problems involved in the receiver. Placement of the r.f. and detector tubes is important. To provide shielding the r.f. tube is mounted horizontally on a small vertical aluminum plate, with the grid prong pointing toward the rear end of the chassis, permitting direct connection to the r.f. input coil. National type XLA sockets were used for both acorn tubes. This socket has small 50- μ fd. by-pass condensers that can be inserted within the socket itself. The detector tube is mounted upside down under the chassis, so that its circuit leads are as short as possible, and to isolate it from the r.f. stage.

The B supply to the receiver was originally fed through a dropping resistor, cutting the voltage to about 100, at which point maximum receiver sensitivity was achieved. However, when a vibrator supply was tried it was found that the output voltage varied with the speed of the car motor, so an OB2 regulator was squeezed into a corner of the receiver chassis to stabilize the detector voltage.

Construction

All parts are mounted on the front of the case or on the chassis,

◆

Rear view of the 2-meter portable station. The transmitter section is at the bottom with the receiver chassis in the middle. The modulator is on a small chassis at the upper left. The large cables are coaxial lines for the antenna and microphone circuits.

◆

so that removing the back involves no wiring complications. Even the 6-terminal power fitting is mounted on the flange of the front panel. The socket has two mounting lugs; one of these is bolted to the front panel flange, while a small brass nut is soldered to the back of the other flange. A square piece is cut out of the back section (see photo) of such size and location as will fit neatly around the socket, leaving the flange with the soldered nut inside. A matching hole in the side of the back section permits screwing the socket tightly to the case when it is closed.

The modulator chassis is bolted with two 6-32 machine screws and nuts to the front panel, in the top right-hand corner, viewed from the front. A small space must be left for the back of the case to fit inside the flanged edge of the panel. The transmitter and receiver chassis are held to the front panel by their respective condenser and potentiometer lock nuts.

The send-receive switch is a telephone-type key switch equivalent to a double-throw four-pole switch. The connections are: (1) antenna to receive or transmit; (2) A-plus to receiver or transmitter; (3) B-plus to receiver or transmitter and modulator. The fourth set of contacts is not used. Microphone current is applied through the push-to-talk switch, though it could be handled with the remaining set of contacts if desired.

A double-pole single-throw switch is mounted on the front panel for power control. This was added later for convenience, as was also a crystal socket on the front panel. It may be asked why the 6-pole power plug, to which reference has already been made, since a 4-pole plug would appear to be adequate. The reason for this was to facilitate mobile hook-up, with a vibrator supply for the high voltage.

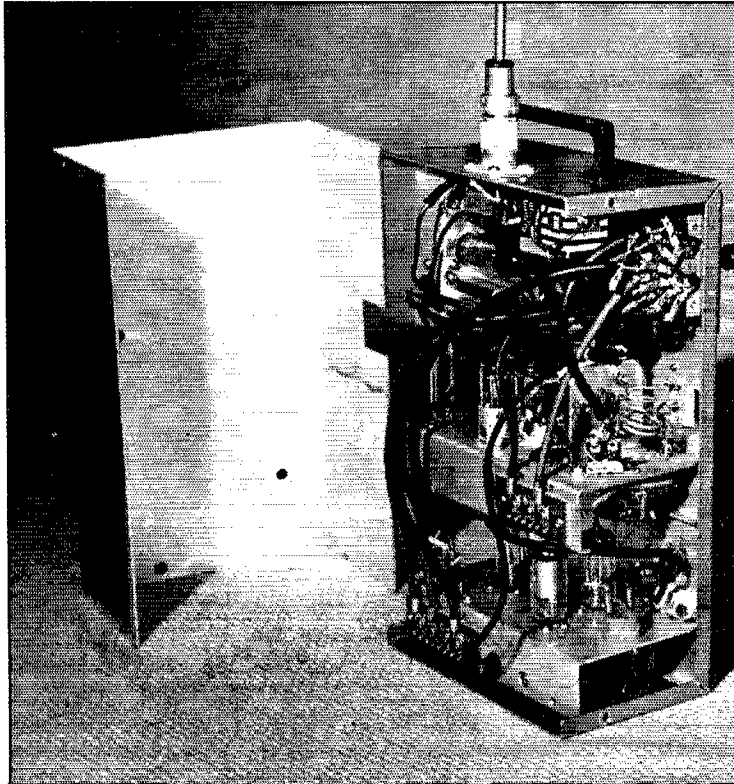

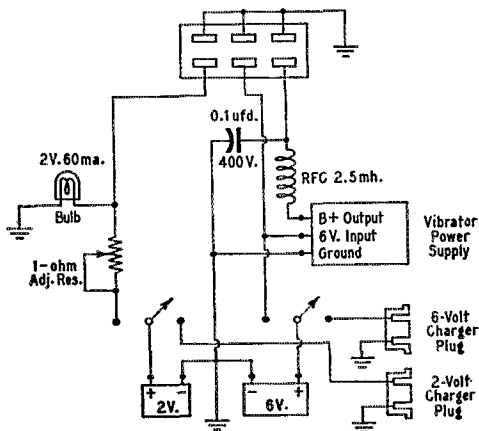

Fig. 2—Details of the wet-battery portable power supply. The 1-ohm variable resistor should be adjusted so that the voltage at the transmitter tube filaments is 1.4 volts. It is then necessary to make provision for dropping the receiver filament voltage to the same value independently. This was done by inserting another small variable resistor (about $1\frac{1}{4}$ ohms is needed) in the receiver filament circuit. This is shorted out when the unit is operated from dry batteries.

Antennas

A quarter-wave rod of brass $\frac{3}{16}$ inch in diameter was filed at the end to solder into the center conductor of a coaxial fitting. With a rubber grommet to center the rod this makes a very suitable ground-plane antenna for strictly portable operation. However, the rig has served well as a net station in simulated emergency operation, using a three-section collinear array on the roof of the local Red Cross Headquarters. This array is fed with 300-ohm line, but results have been good enough so that no special coupling provision is made for balanced feed. The same coupling system is also used when the rig is used for mobile operation.

Batteries and Power Supply

A Burgess type 4F $1\frac{1}{2}$ -volt battery makes a good filament supply, but two of them in parallel will last more than twice as long. As these batteries are relatively long-lived and inexpensive, no attempt has been made to tie into the car battery when the rig is used mobile. A separate 6-volt microphone battery is used as insurance against vibrator hash troubles. It gives long service and is usable down to 3 or 4 volts without noticeable loss in modulation. For B supply Burgess type B30s (four required) are recommended. These will give fairly long service, particularly if used for short widely-separated transmission periods.

To conserve dry batteries a portable power supply has been constructed using a small vibrator put out by Electronics Laboratories, Inc., Indianapolis, Ind. Two non-spillable batteries are used, Willard types ER40-6 and 20-2, 6-volt 40-ampere hours and 2-volt 20-ampere hours respectively. Batteries and vibrator are mounted in a Bud CC-1097 metal carrying case, with han-

dle on top and removable front and back panels. Holes $1\frac{1}{8}$ inch in diameter are punched in the cabinet so that the condition of the batteries, as indicated by red, white and green balls, can be observed without removing them from the case.

The cabinet is a perfect fit for the 6-volt battery, which rests on a pad of sponge rubber at the bottom of the case. The 2-volt filament battery is supported on a small bracket on the side of the cabinet just above the 6-volt unit. On the other side the vibrator supply fits in nicely on end, leaving enough space at the top for two switches, a pilot light and a pair of polarized sockets for connection to external chargers. Fig. 2 shows the wiring. A Mallory type 6-AC-4 is used for charging the 6-volt battery and a home-built charger, consisting of a 6.3-volt filament transformer and a Selectron type 5M1 rectifier, charges the filament battery.

Mobile Operation

"Pixie," as the rig is now known, is giving good service as a mobile rig. Another vibrator supply of the type used in the portable unit mentioned above is installed in the trunk compartment. This supply is rated at 200 volts at 75 ma., but its output voltage drops to about 180 under the load the rig imposes. A simple rack which latches onto the car radio grill holds the rig in a convenient location. The A and microphone batteries are strapped under this rack, while the B-plus comes from a cable running under the floor covering from the luggage compartment. B-minus is a ground to the dash.

The antenna for mobile operation is a coaxial type made from aluminum tubing. The supporting tube is a push fit into a socket that is bracketed to the skirt and rear bumper of the car. This socket is made of sheet brass bent to form a sleeve. The transmission line terminates in a coaxial fitting at this point and is readily coupled to a mating fitting on the end of a permanently-installed line of 72-ohm coax. This goes down through a rubber-grommetted hole in the skirt, up under the rear left fender, through a hole that was already there to carry lighting wires. It was easy to get into the passenger compartment from the trunk without drilling, and to bring the transmission line up through the grommet of the steering wheel column. Thus the only drilling consisted of two $\frac{1}{8}$ -inch holes for the antenna mast bracket and the $\frac{3}{8}$ -inch grommetted hole for the coax in the rear skirt. With this rig, "Pixie" can be installed or dismantled in a matter of two minutes, leaving little or no trace when removed.

Adjustment and Operation

In operation the little portable is similar to a fixed-station rig. The receiver r.f. stage is broadbanded, but it can be adjusted with an insulating screwdriver from the front panel. A friction-type tuning dial using a $1\frac{1}{4}$ -inch dial plate and a friction drive from a standard National or Bud dial of this type tunes the receiver.

The oscillator and tripler circuits are screw-

(Continued on page 118)

W2ZXMM/MM — “Captain Stay-Put”

ONE of the truly great epics of the sea was enacted as the New Year began. Battered by high winds of gale velocity and mountainous waves from the worst storm to hit the European coast in the past half century, the Isbrandtsen Line cargo ship *Flying Enterprise* started listing so badly that the skipper, Captain Henrik Kurt Carlsen, ordered the ten passengers and forty crewmen to abandon ship. Captain Carlsen chose to remain with his ship, radioing that he would stay aboard “until she is towed to port or sinks.” The long ordeal of this heroic sea captain is now familiar to all of you.

The master of the *Flying Enterprise* will not only go down in history as a great ship captain, but as an amateur radio operator, W2ZXMM, who in the true spirit of the amateur carried on emergency communications despite the odds. (The 37-year-old skipper from Woodbridge, N. J., is an active maritime mobileer, his 'phone signal well known on the ten-meter band.) To maintain communications he rigged up a battery-powered transmitter and a temporary antenna.

Captain Clayton McLaughlin of the Isbrandtsen Line in New York City early in this historic battle against the sea indicated to us that Carlsen was using amateur radio equipment. Subsequently, with the aid of Joseph Meyers, manager of operations of the National Broadcasting Company news department in New York City, word was received from NBC newsmen in England that Carlsen had been using amateur radio to maintain his communications. The Navy Department reported that escorting ships used channels in the 2.7-Mc. band. As *QST* goes to press, we are unable to ascertain the frequency on which Captain Carlsen had been operating.

Carlsen was licensed as W2ZXMM in 1949. His shipboard transmitter ran 1 kw. on c.w., 800 watts on 'phone, with a 50-watt rig operating 3.5 to 144 Mc. also available. A 3-element rotary beam was used for ten meters. Current was supplied to the station by a 2-kw. motor generator.

The valiant master, dubbed “Captain Stay-Put” by the British press, is a member of the ARRL and the Maritime Mobile Amateur Radio Club. He obtained his berth as master of the *Flying Enterprise* in 1948.

Just two years ago, Carlsen figured in another dramatic incident at sea. On January 4th, while the *Flying Enterprise* was off the Virginia Capes, the child of one of the passengers became seriously

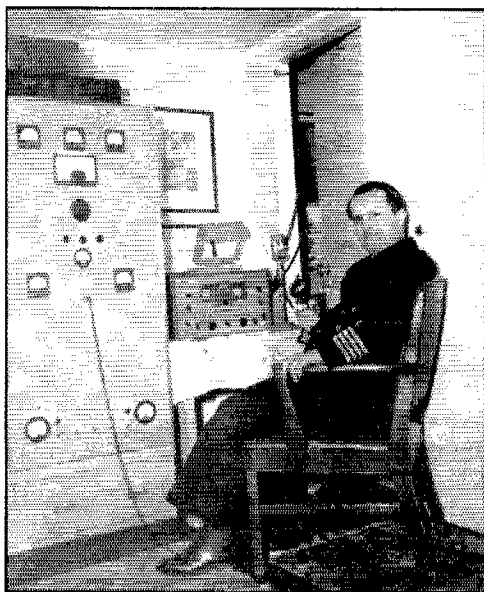

Captain Henrik Kurt Carlsen operating W2ZXMM/MM.

ill. The skipper put his maritime mobile station on the air and obtained medical advice from a doctor through an amateur in Minneapolis. Following administration of the proper drugs, the child recovered sufficiently to be out of danger.

Edgar D. Collins of the League's advertising department has sailed with the Captain and confirms his intense interest in amateur radio.

A radio message and cable were sent to the heroic skipper from League Headquarters, the cable saluting him on behalf of the amateur radio operators throughout the world. — H. P.

Captain Carlsen, safe in England after the unfortunate loss of his ship, when asked by newsmen “Would you have stayed [on the ship] if you hadn't had a ham radio with you?” said “I think it would have been rather a risky business.”

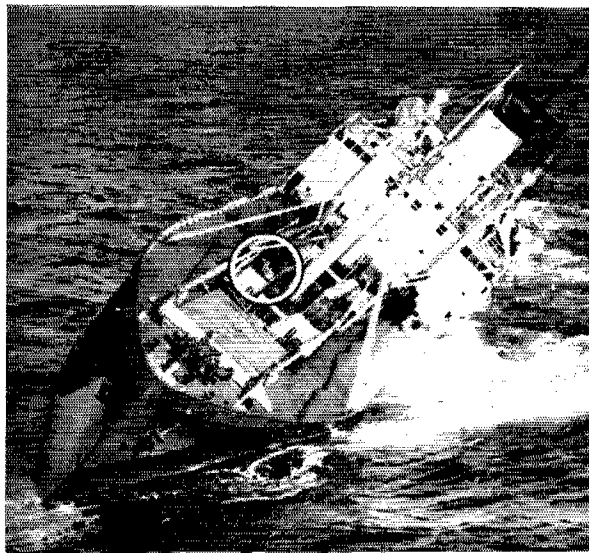

Air photo of the badly-listing *Flying Enterprise* with Captain Carlsen on deck (circle). — *Wide World photo*

How To Wire a Transmitter

The Basic Techniques of Radio Wiring†

BY BYRON GOODMAN,* W1DX

ONE'S first attempt at wiring a piece of radio gear is somewhat similar to one's first efforts at golf or skiing — the result is not likely to be mistaken for the work of a professional. But, fortunately, the rig will probably work, and the stations that hear your signals won't know that the rig isn't wired as neatly as a Bell Telephone switchboard. As a matter of fact, how well you wire your rig depends almost entirely on your pride and your experience — you will need both to come up with a good job. It is the object of this article to point out a few of the principles and considerations that are involved.

Obviously, the most elementary type of wiring is one where the small components are laid in haphazardly and the unclipped wires are run to the necessary points, while connecting wires between large components are placed in the most convenient way. This will work for anything from power supplies up through audio equipment to r.f. circuits. You find it in many broadcast and TV receivers. It's called "point-to-point" wiring, and it usually looks like a rat's nest. Some of the better jobs, of course, clip unnecessarily-long leads and try to lay the long wires out of the way, but the result is still something that will never carry the Tiffany label. At the other end of the scale you find the "quality" wiring that is used in the better test equipment and gear built for the Government. Every component seems to have a proper place, and there isn't a hodge-podge of crossed wires. A nice wiring job like this, or any other, isn't an accident — it is the result of careful planning.

Since point-to-point wiring is "just doing what comes naturally" — provided you can follow a wiring diagram and know a little about soldering

— most of this article will be taken up with the quality approach. There is, however, one simple trick that will dress up point-to-point wiring, and we'll tell you about it later.

Soldering

On the off chance that you haven't done much soldering, a short discussion of it is in order. In the early days of radio, many rigs were put together by wrapping the wires around binding posts that were provided on each component, but "them days is gone forever," and it is only in an emergency that one would build a rig without soldered connections.

Soldering requires a clean hot iron (actually it's copper), some solder and flux, and two or more wires or terminals that are to be soldered. The wires furnished with resistors and condensers are usually already tinned, as are the terminals on sockets and other components, so soldering is made easier and faster, because tinning allows the solder to flow freely over the wires when they are heated. Bare copper or brass (and insulated wire) must be cleaned or scraped before it is soldered, to expose shiny clean metal. Flux is used in soldering to prevent oxidization of the metal by the heat, and if you don't use flux-cored solder you must provide yourself with a can of rosin-base soldering paste, to be spread thinly on the metal to be soldered, before the iron is applied. Radiomen take a dim view of acid-base fluxes, because they have the reputation for corroding the joint and adjacent wires after a year or two. If you must use acid fluxes, be sure to remove any residue immediately after soldering.

We can't tell you what soldering iron to buy for your first one, any more than we can tell you how to select a wife or an automobile (and for the same reasons). However, you will probably wind up with an iron in or around the 100-watt class, or a soldering gun. A 60- to 100-watt iron will be

† Two earlier "how-to" articles in this series were "How to Lay Out a Transmitter," and "How To Build a Transmitter," in the July and December, 1951, issues. — *Ed.*

* Assistant Technical Editor, *QST*.

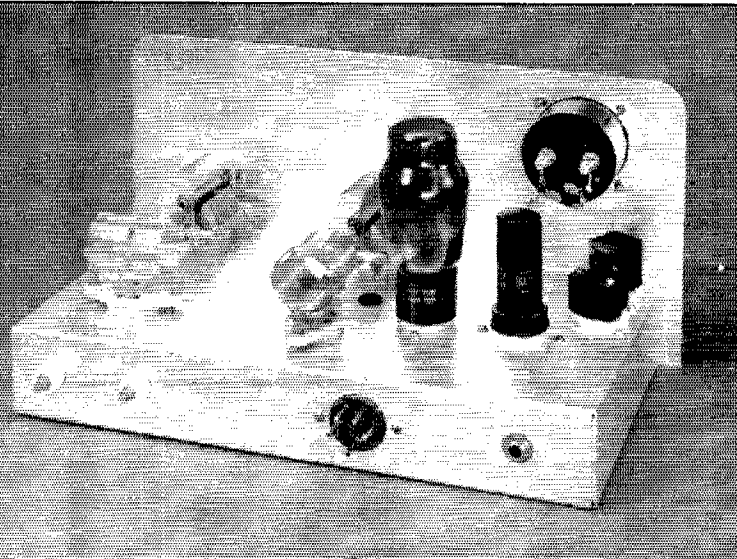

◆
With most of the wiring under the chassis, it is a simple job to keep a rig looking neat above the chassis.
◆

QST for

satisfactory for all but the heaviest work (such as soldering to large masses of brass or copper, where it won't be able to supply enough heat), and the soldering gun has the advantage that where you are working slowly and sporadically you don't have to worry about the tip burning out. The gun or the iron will have a small-enough tip to enable you to get into some of the small places where a larger iron won't fit. As you develop skill, you will probably want a small "pencil" iron for very light work and a heavy iron for the big stuff. However, you can use a 100-watt iron for heavier-than-normal work by adding the heat from a small alcohol blow-torch during the soldering process.

The soldering-iron tip should be kept clean at all times, with a thin coat of shiny solder on it. Wiping it with a rag or steel wool will do this for you. If the tip becomes pitted or irregular after some time, file it smooth again and re-tin it. Tinning instructions usually come with the solder and with the iron, so they won't be repeated here. The iron must be hot and shiny when soldering, because if it is dull and dirty it won't transmit the heat to the work.

Apply the hot iron right next to the joint to be soldered, and touch the joint with the flux-cored solder. The solder will melt and flow over the joint, provided the joint is already tinned or has been cleaned properly. Don't hold the solder against the iron — you may get a sleeve of solder but no real bond. It won't take long to get the hang of soldering — soldering a few pieces of scrap wire will give you the "feel" better than a thousand words could. Just remember that there are two enemies to good soldering: dirty surfaces, and an iron that isn't hot enough or clean enough. When the solder is flowing over the work, remove the iron and the solder and watch the surface of the molten solder. After a few seconds, the bright shine of the molten solder will suddenly change to a duller finish — this indicates that the solder has cooled and hardened. In a good soldered joint, the solder will flow freely over the work and seem to combine with it, leaving no visible joint. Anything less than this should be suspect, and wiggling the wires (after cooling) will usually show that you have acquired a "cold" joint or a "rosin" joint that has made no bond. Resist any temptation to blow on the joint before the solder has set — let nature do the cooling.

Sometimes the flux will flow over the work and leave a thin film after cooling. This film will injure nothing but it doesn't look neat, and it can be wiped off with a rag or brush while it is still warm.

When soldering a wire to a terminal, you have two choices. You can thread the wire into the terminal and then wrap it around the terminal once or more before soldering, or you can simply solder the wire as it lies in the hole of the terminal. The first, or "wrap-around" type of connection, is the one insisted upon in most high-grade commercial equipment, because the solder is not depended upon for the mechanical support but only for the electrical connection. It is recommended for any mobile equipment or anything likely to receive any shock or vibration. On the other hand, it is more difficult to replace components when this type of connection is used and, for experimental work, the simpler type of connection will work satisfactorily and will also speed up your work somewhat.

Your choice in wire lies between solid and stranded. The high-quality equipment usually calls for stranded wire, on the theory that if one or two strands break you still have a connection left. Solid wire is a little easier to work with in some instances, and for amateur work there isn't much choice. Whenever there is to be any flexing of a wire or wires, however, the stranded wire should be used, since it will take the bending better over a long period of time. Solid conductor is generally preferred for r.f. work, but this is probably as much superstition as anything else, since we have never heard of anyone finding r.f. that refused to flow along a stranded conductor.

Any bare wire that runs far enough to offer the chance of hitting another wire under vibration should be covered with any of the many "spaghetti" or insulating tubings that are available, or it should be anchored so that it cannot possibly touch another conductor or the chassis. The insulating tubing has no electrical effect that you will be able to measure.

When wires are run through a hole in the chassis, for any of a dozen reasons, a rubber grommet should be used in the hole to furnish some insulation (for a single bare wire) or to prevent chafing of the insulation on an insulated wire. Insulated bushings of polystyrene or ce-

◆
Like the man said (in a previous article), it is the wiring under the chassis that clutters up a piece of radio gear. But placing the components at right angles, as in this example, will minimize the effect.
◆

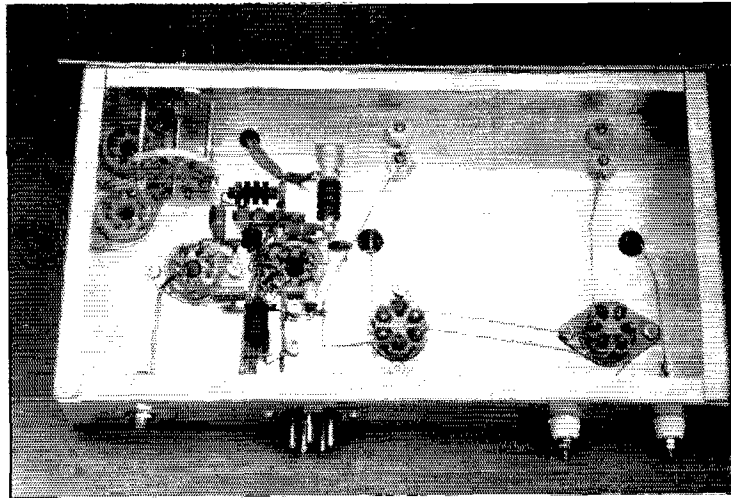

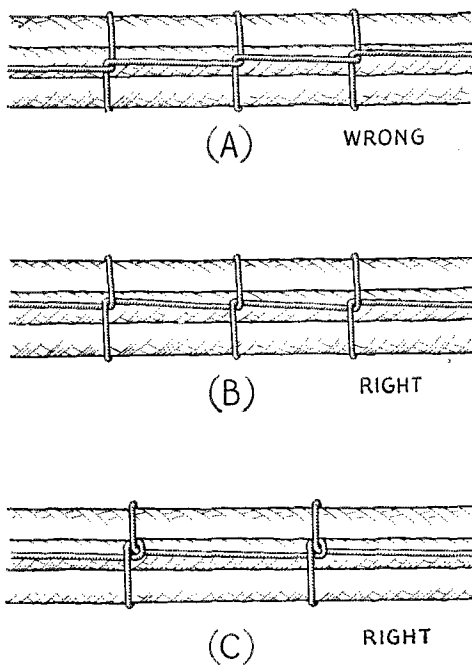

Fig. 1 — Methods of lacing cables. The example at A is wrong because it is not self-tightening. B shows the usual method — C is a little fancier and will take a little longer to do.

ramic are also available, and their use is recommended where the voltage is higher than 400 or 500.

Shielded Wire

If you use shielded wire, as recommended in *QST* for TVI reduction,¹ parasitic dissuasion or anything else, you will find that it pays to be careful in handling the shield braid. You can unravel it with a scribe or an ice pick, but be careful to cut off every wisp of the braid back from the tip of the wire, to prevent inadvertent grounding of the wire. After peeling the braid back a half inch or so, wrap the braid with 2 or 3 turns of No. 22 tinned wire and run a slight coating of solder over it, to anchor the ends of the braid and finish off the braid neatly. Or you can just run a narrow collar of solder around the braid. When soldering to braid, do it quickly, so that you won't melt through the insulation underneath.

Incidentally, ordinary shield braid will only hold down electrostatic pick-up in audio work — it offers but little protection against low-frequency magnetic fields. The best way to lick them is to keep your wire close to the steel chassis and as far from the magnetic field as possible.

Ground Connections

The best ground on a chassis is one that is welded or soldered directly to the chassis. You can solder to a steel chassis if you clean the chassis

¹ Grammer, "By-Passing for Harmonic Reduction," *QST*, April, 1951.

until it is shiny, and then use a very hot iron. It is hard to do a neat job. You can only solder to an aluminum chassis with special aluminum solder and sufficient heat, but here again it is difficult to do a neat job. However, the next best ground is a soldering lug with teeth in it (usually called a "star" or "Shakpruf" lug) that will bite into the metal of the chassis. There are times when a good ground to the chassis is not vital, as when "link" interstage coupling is used, but it is good practice to get into the habit of making good grounds to the chassis at all times. Whenever the chassis is used to conduct current, as in capacity-coupled stages, the chassis connections should be good ones. It is also good practice to make all of the grounds for any one stage (whether link- or capacity-coupled to the next) to a single soldering lug that makes good connection to the chassis. If they won't all fit on one lug, at least fasten the two or more lugs to the chassis with the same screw. And don't fall into the trap of thinking that a lug on one side of a chassis and one on the other, held down by the same screw, means that you have only one ground point for those two lugs. That is true only in d.c. and low-frequency work — at r.f. they represent two different grounds, since r.f. flows only on the surface of a conductor.

Dressing It Up

Back at the start we promised a trick on making your wiring look neater, so here it is. And don't laugh if it sounds too simple — try it, and you'll see what we mean. The secret is this: lay in the components parallel to the chassis sides. A lot of old hands do this automatically, without stopping to think why, but you will find upon examination that even the worst "rat's nest" can be dressed up by following this simple rule. If you still don't believe it, take a good wiring job where this has been done, and put a few of the components in at an angle — you'll see the difference.

There are other tricks, too, but we believe that that one is the key to the whole thing. Another trick is to make generous use of tie points and terminal boards, so that components can be laid in side by side (parallel to a side of the chassis, of course). Wherever possible, avoid stacking the components one above the other, to sidestep "peeling off" components to get at the bottom one. If you can't avoid stacking the components, at least make their leads accessible so that the bottom one can be snaked out from under the others. Proper use of tie points and terminal boards permits unsoldering a component or a wire without disturbing the other leads on that particular point.

The third and last trick to neat wiring is to run the long and loose leads around the edges of the chassis or as laced cables across the center of a chassis. In commercial work the laced cables are usually made up beforehand, but this is usually unnecessary in amateur work, and the wires can be laced after they are in place and the equipment has been given a rough check. Ordinary grocery

(Continued on page 114)

Happenings of the Month



"RACES" RULES PROPOSED

On December 19th the Federal Communications Commission released its long-awaited proposals for regulations governing civil defense communications to be furnished primarily by amateur radio under the name "Radio Amateur Civil Emergency Service," or "RACES." This action logically, if belatedly, follows the announcement nearly a year ago that portions of the amateur bands had been cleared for use by amateurs in c.d. communications even in the event of war.

RACES will be a brand-new service. It is of course closely allied to the amateur service; in fact, the proposed regulations are to be Sub-Part B of our present rules. Wherever they might be found incomplete, present amateur rules apply. The text of the proposal is of considerable length; the Headquarters has sent copies to ARRL administrative and interested field organization personnel, as well as clubs, and here we shall cover only the highlights. Any comment must be filed with FCC by February 15th. See your SEC or club secretary if you want to make a detailed study of the proposal.

RACES licensing and operation is based on organized networks under the direction of community or area civil defense authorities. There must be a complete communications plan in existence, and a copy on file with FCC. A key man in the local set-up is the Civil Defense Radio Officer, who must hold a commercial 1st or 2nd license, or an amateur license except Novice or Technician; must be qualified in the technical and administrative fields; and must have been cleared by local authorities for loyalty and integrity. He, primarily, organizes the networks, sets their drill and test schedules, and in general supervises all operations. He must endorse each amateur application before the Commission will issue a RACES station authorization. He is responsible to the director of civil defense, or to the intermediate communications officer if there is one.

Station authorizations will be issued upon application using FCC Form 480, endorsed by the radio officer, to a person who holds an amateur station license with operator privileges other than Novice or Technician. Normally the term will be concurrent with that of the amateur li-

¹ Abbreviations here show first a numeral indicating bandwidth in kc., then a letter showing type of modulation (A for amplitude, F for frequency or phase), and then another numeral showing type of emission (1 for telegraphy, 2 for tone-modulated telegraphy, 3 for voice, 4 for facsimile). For example, 6F3 is frequency-modulated telephony, bandwidth 6 kc.

² Subject to the priority of the Loran system of radionavigation in this band and to the geographical, frequency, emission and power limitations contained in Section 12.111 of Rules Governing Amateur Radio Station and Operators.

cence. If the station is inactive for a period longer than three months, the authorization is to be surrendered. Multiple units under the same call are provided for; i.e., a home station and additional portable or mobile units may be operated under the same authorization and call sign, plus a supplementary numeral to identify multiple units (e.g., WIABC/1 for a home or other fixed station, WIABC/2, etc., for additional fixed or portable or mobile units).

While only amateurs of General-Conditional Class or higher may obtain station authorizations, Novices and Technicians may participate in civil defense activities as operators, except on c.w. circuits. Provisions are also made for participation of commercial licensees, generally according to qualifications.

The c.d. earmarked portions of amateur bands are usable with various types of emission, as follows:¹

Frequency Band	Authorized Emission
28.55-28.75 Mc.	0.1 A1, 6 A3, 6 A4, 6 F3
29.45-29.65 Mc.	0.1 A1, 1.1 F1, 6 A3, 6 A4, 40 F3
50.35-50.75 Mc.	0.1 A1, 2 A2, 6 A3, 6 A4, 6 F3
53.35-53.75 Mc.	
145.17-145.71 Mc.	0.1 A1, 1.1 F1, 2 A2, 3 F2, 6 A3, 6 A4, 40 F3
146.79-147.33 Mc.	
220-225 Mc.	

Additional assignments "for use only by authorized stations or units of such stations which are operated under the direct supervision of duly designated and responsible officials of the civil defense organization" are:

Frequency Band	Authorized emission
1800-1825 kc; 1875-1900 kc. ²	0.1 A1, 6 A3
1900-1925 kc; 1975-2000 kc. ²	0.1 A1, 6 A3
3500-3510 kc.	0.1 A1, 1.1 F1
3990-4000 kc.	0.1 A1, 1.1 F1, 6 A3, 6 A4

The Commission makes it quite clear that this is a temporary service and that if the need for its existence disappears, authorizations may be cancelled before their normal expiration date. RACES shares frequencies with the amateur present, but otherwise has no effect on present normal amateur operations.

EXTRA CLASS LICENSES

On December 7th FCC released a Notice of Proposed Rule Making which in effect grants the Amateur Extra Class ticket without special examination either in code or advanced theory to applicants who hold or can qualify for at least a General Class license, and who submit evidence of having held an amateur license during or prior to April, 1917. December 21st was the final date for filing comment; on the 27th the Commission made the rule final.

It is difficult to tie this action into FCC's announced objectives in creating its Extra Class

license in the first place, "exceptional proficiency . . . a very real target for those among the amateurs in whom pride of superior ability and accomplishment would constitute a spur to special endeavor," and "an incentive to all amateurs to become highly proficient in all phases of the radio art." However, the Commission indicates that it feels recognition should be given early pioneers not necessarily on the basis of proficiency but of seniority.

The amended rules are paragraph (a) of § 12.21:

(a) *Amateur Extra Class.* Any citizen of the United States who either (1) at any time prior to receipt of his application by the Commission has held for a period of two years or more a valid amateur operator license issued by the Federal Communications Commission, excluding licenses of the Novice and Technician Classes, or (2) submits evidence of having held a valid amateur radio station or operator license issued by any agency of the United States Government during or prior to April, 1917,

and the following new paragraph, with old paragraph (d) becoming (e):

(d) An applicant for Amateur Extra Class operator license will be given credit for examination elements 1(C) and 4(B) if he so requests and submits evidence of having held a valid amateur radio station or operator license issued by any agency of the United States Government during or prior to April, 1917, and qualifies for or currently holds a valid amateur operator license of the General or Advanced Class.

FCC has now released a study guide for the Amateur Extra Class written examination, consisting of nearly 300 questions to indicate its scope. These example questions, together with suitable answers, appear in the latest edition of the ARRL *License Manual*, just coming off the press.

SERVICEMAN ACTIVITY WAIVER

Because so many amateurs are in the armed forces and unable to get on the air to accumulate sufficient hours of operating time to apply for renewal of their tickets, there has been in effect a waiver of the activity requirement for such persons in service. This waiver has now been extended to include licenses expiring during the year 1952.

F.C.D.A. COMMUNICATIONS CONFERENCE

Designed to evaluate and provide answers for technical and practical problems posed in planning civil defense communications, a users-industry-government conference was held in Washington the week of December 10th under the sponsorship of the Federal Civil Defense Administration. Nearly 100 representatives of federal, state and local governments, national organizations, industry and commercial services, took part in the discussions. The amateur service was represented by ARRL Vice President and Communications Manager F. E. Handy, WIBDI, and National Emergency Coördinator George Hart, WINJM.

In fields relating to amateur activities, the conference committees endorsed the proposed set-up for a Radio Amateur Civil Emergency Service and urged a speed-up in the machinery to put it into effect. It was recommended that the

military be asked to review the earmarked frequencies for a limited number of additional channels near 3.9 Mc., so long as this would not delay implementation of the plan as so far approved.

Operationally, there is no limit as to what equipment may be used in c.d. communications, but as a prerequisite to the Federal Government matching funds provided by states and communities for purchases of civil defense material, communications equipment presently must meet technical standards much more stringent than is customary in the amateur service. Looking to the future, a resolution was adopted suggesting the drafting of additional equipment specifications reflecting practical requirements for RACFS that would warrant matching funds.

The Existing Radio Services Committee included amateurs high among the services "so affected by a major disaster as to make the communications facilities appropriate for inclusion in c.d. activities." ARRL emergency coördinators and other officials in the League field organization are receiving more detailed information about the conference and its tangible effects on amateur planning and participation.

LEAGUE REQUESTS POSTPONEMENT OF 7-MC. BAND PLANNING

As reported in December *QST* (page 38), the Federal Communications Commission combined the ARRL request for f.s.k. teletype privileges in 7250-7300 kc. with others for 'phone on 40 meters and teletype for all bands below 27 Mc., in a notice soliciting general comment. This action, the League's Executive Committee concluded after study, made a complex problem out of a comparatively simple one, to the extent that ARRL comment could not be made by the stipulated filing date, January 2nd. As a result, the League requests an extension of this date to June, to permit completion of the Planning Committee's study and later consideration by the Board of Directors at its meeting in May. The text of our request follows:

FEDERAL COMMUNICATIONS COMMISSION

In the Matter of

Amendment of Section 12.111 of Part 12, "Rules Governing Amateur Radio Service."

Docket No. 10073

REQUEST FOR EXTENSION OF TIME

(*American Radio Relay League*)

I.

Pursuant to Paragraph 3 of the Notice of Rule Making Proceedings in Docket No. 10073, released November 1, 1951, the American Radio Relay League, Inc., files these comments.

II.

The League is eager to assist the Commission by furnishing comprehensive and detailed comment on the issues listed in its Notice. However, for reasons which will be detailed hereinafter, the League finds itself unable within the time indicated in the Notice to appraise and comment adequately on the various issues which the Commission has inter-related for consideration with our own proposal for f.s.k. teletype privileges in 7250-7300 kilocycles. This being so, it is requested that additional time for the date of filing be authorized. For its own part, the League would contemplate a date subsequent to the annual meeting of

A Letter to TV Receiver Manufacturers

In mid-December the American Radio Relay League addressed the presidents of principal television receiver manufacturing companies commending their action in agreeing to apply suitable remedies to receivers found by FCC to be deficient in design or construction when interfered with by amateur stations, and pointing up the need to prevent this problem on the design table and drafting board rather than in the field, especially in view of the imminence of opening the u.h.f. TV bands. The letter follows:

Dear Sir:

As you may know, the operation of an amateur radio station frequently interferes with the reception of television signals. Broadly speaking, the causes of such interference fall into one of two categories: spurious radiations from the transmitter, or receiver defects such as susceptibility to overload and lack of adequate selectivity. Thanks to an intensive development program aimed at eliminating transmitter difficulties, the radio amateur has succeeded in devising methods for solving his part of the television interference problem. In many cases the interference still exists, however, due to receiver deficiencies.

For some months now the Federal Communications Commission has been endeavoring to obtain assurances from manufacturers that suitable remedies will be applied without cost to the customer when interference patterns exist in sets of their make because of inadequate design or construction. The Commission has now announced substantial progress in this campaign. As information, I enclose copy of an article appearing in the January issue of *QST*. The industry deserves a bouquet for its cooperation in taking the first step — discharging its obligation when the customer's receiver is found at fault.

Yet at best this is only a remedy for a past miscalculation when TV was in its infancy. There still remains the obligation to provide, in normal design processes, adequate protection in current and future models against transmissions not in the television channels themselves. Recognition of this fact becomes especially important since we stand on the verge of opening u.h.f. channels for an expanded television service. TV receivers — and converters — designed for u.h.f. will bear the same responsibility for performance as their predecessors, with perhaps a slightly greater problem in interference rejection. The mistakes which have led to much needless interference in v.h.f. television — mistakes that, we feel certain, have occurred principally because of lack of awareness of the problem, rather than inability to cope with it — should not be repeated in the u.h.f. field. Your engineering group can provide the appropriate answers, once it is brought to their attention that solutions must be found.

In this connection you will be interested in the attached copy of my letter of May 1st to the RTMA. I understand the subject is receiving active consideration by the RTMA Committee on Television Receivers.

Action must be taken now to ensure that models of television receivers and converters for either v.h.f. or u.h.f. channels will incorporate adequate selectivity characteristics and protection against transmissions not in the television channels themselves. If the ——— TV Corporation would like to conduct cooperative tests on interference susceptibility of your engineering or pilot models, our laboratory facilities and engineering experience in this specialized field are gladly offered.

Sincerely yours,

A. L. BUDLONG
General Manager

its Board of Directors, now expected to be early May, 1952, where final recommendations on some of the issues presented by the Commission's notice will be made as the result of studies now in progress. A final filing date not earlier than June 2, 1952, is suggested therefore.

III.

So that the Commission may better understand a request for what may seem an unusually lengthy deferment, we explain briefly why the nature of the problem will take some months of study by the Board, and reference to some of the problems which arise and need study in any consideration of the matters covered by the Notice, other than that proposed by the League.

1) *The Board's current study.* As the Commission knows, the ARRL Board of Directors follows the practice each year of examining and re-examining matters of special amateur interest. At its regular meeting in May, 1951, the Board discussed the possibility of requesting opening part of the 7-Mc. amateur band to A3 emission. It quickly became apparent that there were many factors, several indeterminate at the time of the meeting, which would need careful study and thorough consideration before any sound and intelligent action could be taken. The Board, therefore, assigned to its Planning Committee, one of its standing committees, a study of this question looking to a report and recommendation sometime in the early part of 1952, on which the Board could base its final study and conclusions. As it happened, then, the League was already engaged in a study of the more difficult questions posed in the Commission's Notice when the Notice was released. The Planning Committee has not yet completed its report, however, and the Board will not finally act on the matter until after further study of its meeting in May. At that time the League expects to have gathered data sufficient to enable filing of suitable comment.

2) *The needs and desires of amateur radio operators.* Past expressions of amateurs, in sizeable polls of opinion conducted by the League, have indicated that a substantial majority feel that opening part of the 7-Mc. band to A3 emission would be detrimental to amateur interests. However, amateur interests and needs change rapidly; the most recent expression of opinion by amateurs on this highly controversial matter was four years ago and the Board feels that a current appraisal is needed. Numerous members of the League's Board are now engaged in a canvass of opinion in their respective areas of the country. Adequate comment by the League on the Commission's present Notice must await the results of such canvass, so that there may be a more general expression of amateur sentiment on this question.

3) *Effects of the Atlantic City allocations table.* At the present time, international regulations (Cairo, 1938) permit sharing between broadcasting and amateur on the frequencies 7200-7300 kilocycles in other regions outside the Americas. Under the Atlantic City allocations table broadcasting in these other regions is allocated exclusive use of half the amateur band, from 7150-7300 kilocycles, and shared use with amateur for an additional 50 kilocycles, to 7100 kilocycles. Such an allocation portends considerable effect on present amateur operations in the 7-Mc. band. Adequate comment by the League on the Commission's present Notice requires careful appraisal of this problem, as well as knowledge of such implementation schedule as may have been evolved by the Extraordinary Administrative Radio Conference, just ended.

4) *Worldwide displacement effects.* Amateur stations in other parts of the world, on the long-distance bands such as the one under discussion, customarily conduct their voice operations outside the portion of such bands available for A3 emission in the United States and Canada. At the present time, with no U. S. or Canadian voice operation in this band, foreign voice operation, both elsewhere in the Americas and in other parts of the world, is only moderate in amount and is distributed generally throughout the band. If, however, U. S. and Canadian amateurs were permitted to use voice here, it is possible there would be a marked influx of new foreign voice stations, and almost certainly a shift of all such foreign operation to the remaining portion of the band, affecting its utility for c.w. purposes. Adequate comment by the League on the Commission's present notice requires careful appraisal of these factors.

5) *Informal liaison with Canada.* It has been the custom for many years for Canada to provide her amateurs with

frequencies for A3 emission which not only encompass those available to U. S. amateurs but to extend somewhat beyond the U. S. limits. In its consideration of this whole subject, it is the hope of the League's Board that some informal indication of what allied action Canada might take can be developed through its Canadian member. As this will be a considerable factor in any evaluation of some of the questions the Notice poses, adequate comment by the League must await its further exploration.

6) *Laboratory project needed.* It is the opinion of the League that comment on question No. 6 in the Notice, if it is to be of any substantial value, will require the inauguration of a special laboratory project, which the League is prepared to undertake provided the extension is granted.

7) *Development of Novice operation.* The new Novice Class of license recently made available by the Commission is attracting many newcomers to amateur radio. The low-frequency assignment for Novice use, 3700-3750 kilocycles, is already becoming badly crowded and considerable interference exists. While there has not been sufficient experience with Novice operations to permit conclusions to be drawn at this time, it is possible that the Commission or the League may soon be disposed to propose additional lower frequency privileges for the Novice; it is conceivable that part of the 7-Mc. band would be more desirable for this purpose than expansion of the present 3.7-Mc. segment. Further experience under the new rules permitting Novice operation is desirable so that our Board may be able to appraise this factor properly.

IV.

These are the major problems which need study before intelligent comment can be made on the Commission's present Notice, a study which, as stated, is already in progress. The League hopes the Commission will be disposed to defer the final date for comment, as requested, so that continuance and completion of the League's present study will permit an adequate appraisal.

AMERICAN RADIO RELAY LEAGUE
PAUL M. SEGAL
Its General Counsel

A. L. BUDLONG
Secretary
December 17, 1951

RULES CHANGES

On January 3rd FCC announced two actions aimed at relieving its administrative-licensing load: (1) removing the requirement that a Conditional Class licensee must appear for examination if he moves into a General Class area or if the FCC establishes a new quarterly examining point within 125 miles of his location, and (2) removing the four-month limit on operation at a temporary location.

So if you are a Conditional Class (old Class C) licensee and move to a location within 125 miles of a quarterly examining point, you no longer have to worry about taking the exam again. FCC docs say, however, that if you get put on quiet hours because of citations for BCI or TVI or other unwarranted interference, it may call you up for the General Class examination.

The second action saves you a series of applications for modification if you are, for example, in military service and moving from one post to another every six months or so. So long as you have a permanent address you should have that shown on your license as the fixed station location and then operate as you wish in various portable or temporary locations. You must follow the notification procedures, of course, as specified below.

FCC asks that amateurs who have applied for

(Continued on page 114)



Hints and Kinks

For the Experimenter



BANDSPREADING THE "COMMAND" TRANSMITTERS

IF YOU use one of the "Command" series transmitters as the VFO in your station, you may be interested in having a bit more bandspread than that obtained with the original. In the case of the BC-458, remove the iron slug from the oscillator coil and replace it with a large brass slug. Now adjust the slug so that when the dial is set at 6.7 Mc. the oscillator frequency is actually 7 Mc., and when the dial is set to 7 Mc., the oscillator frequency is 7.3 Mc. This works out to 10 kc. per dial division. To make the dial direct-reading simply add 300 to the dial reading to get the actual frequency.

For the BC-457, glue the iron slug from the BC-458 onto the bottom of the slug in the oscillator coil, and adjust so that when the dial is set to 4 Mc. the oscillator is actually tuned to 3.8 Mc. With this arrangement, tuning the dial from 4 Mc. to 4.2 Mc. results in tuning the oscillator from 3.8 Mc. to 4 Mc., again resulting in a convenient 10-kc.-per division arrangement for use in tuning the 75-meter 'phone band. — *George Young, W5KQD*

[Editor's Note: While this system may work out well in practice, it should be pointed out that no provision is made for correcting the tracking error in the amplifier stage caused by the change in oscillator tuning rate. Over the limited range involved, however, the error may not be serious enough to cause trouble.]

ANTI-SKID TREATMENT FOR BUGS

THE tendency for a bug to slide across the smooth top of the operating table can be cured easily without resorting to unsightly rubber pads, screws, etc., and without marring the finish of the finest table. Merely rub a small piece of beeswax on the rubber feet of the bug and it will stay in place as though fastened down. This will work on surfaces as smooth as glass. If beeswax is not available, the wax coating from an old paper condenser will do as well. — *William J. Wright, W5KYK*

CURE FOR MAGNETIZED SCREWDRIVERS

THE annoyance of working with an accidentally magnetized screwdriver may be eliminated easily by following this simple procedure. Place the business end of the screwdriver inside a quarter pound spool of No. 20 or smaller wire. Momentarily connect the free ends of the spooled wire across a 2- to 10-volt a.c. source and quickly withdraw the screwdriver. — *Neil A. Johnson, W2OLU*

IMPROVED TUNING RATE FOR RECEIVERS

IF you have sharpened the selectivity of your receiver to keep pace with the increased occupancy of the ham bands, you'll probably feel the need for a slower tuning rate. The sketch in Fig. 1 shows one way to attach a vernier dial to the

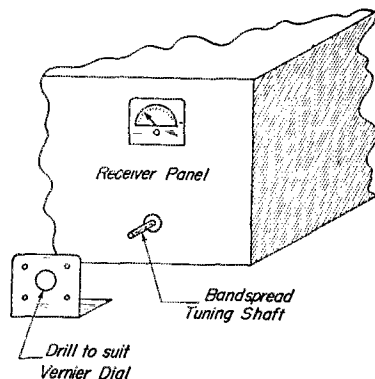

Fig. 1 — Here's the easy way to add that vernier dial to the bandspread tuning shaft of your receiver.

bandspread tuning condenser of your receiver without drilling into the panel. An angle bracket is formed to fit under the front edge of the receiver so that the vernier dial can be applied. Most receivers are heavy enough to hold the bracket in position without additional support, but if necessary, small self-tapping screws can be passed through the horizontal lip into the bottom plate of the receiver. — *Robert J. Morrison, VO6VB*

CHECKING CRYSTAL FREQUENCY

THE method described below is a simple way to determine the approximate fundamental frequency of an unknown quartz crystal. It is especially useful in checking surplus crystals, many of which are unmarked, or at best marked only with a channel number.

Connect the crystal in series with the antenna to a receiver that tunes the proper range. A BC-453 (Q5-er) can be used to check low-frequency units, and the station communications receiver for the rest. Turn up the gain of the receiver until the background noise is heard plainly, and tune until a definite "ping," or a change in noise level is heard. This occurs at the fundamental only. The method is not accurate enough to depend on for more than a rough check, but it does eliminate the need for construction of a separate oscillator just to find the approximate frequency of the crystal. — *Arthur C. Erdman, W8VWX*

An Inexpensive Sine-Wave Audio Oscillator

A Simple Unit for Audio Checking or Code Practice

BY C. VERNON CHAMBERS,* WIJEQ

At one time or another many of us have tuned up a 'phone transmitter by using the "shout, whistle and watch-the-plate meter" system. There can be no denying that this method of adjustment has resulted in many good sounding 'phone signals. On the other hand, the throat-and-eye test is neither adequate nor convenient for trouble shooting made necessary by audio equipment defects or deficiencies. Audio-circuit tests are best made with the aid of a steady, stable input signal and an oscilloscope. Very often it is the more simple instrument — an audio oscillator — that is not available.

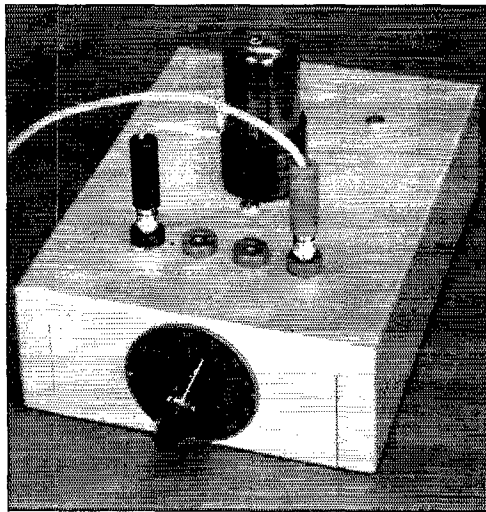

Simple audio oscillator using a twin triode. Tip-jacks are used as the output terminals and the variable attenuator is located on the front chassis wall.

The simple one-tube oscillator shown in the accompanying photographs can be built from a handful of parts in less time than it would take to drive across town to the friend who owns a commercial model. It incorporates the features useful in 'phone transmitter testing — sine-wave output, low output impedance, and a wide range of attenuation. The cost of new parts is less than ten dollars.

The wiring diagram, Fig. 1, shows that one half of a Type 6SN7GT tube is used in a Colpitts circuit. This section oscillates at approximately 450 cycles and the sine-wave output voltage is

fed to a cathode-follower circuit employing the second half of the twin triode. A variable attenuator and two ladder-type voltage dividers are included in the output circuit. Each divider reduces the output voltage by a factor of about 10 to 1. The maximum undistorted peak voltage obtainable from the unit is approximately 1.5 volts.

This particular oscillator-output combination was selected after several other circuits had been tested. The Colpitts was favored because it requires only a single triode tube, thus leaving the second half of a dual triode for use as a buffer and impedance transformer. Furthermore, the Colpitts will generate a good sine wave even when an inexpensive interstage transformer — iron core included — is used as the inductor for the frequency-control circuit. With the other circuits tested, it was necessary to employ both sections of the 6SN7GT for the oscillator or else to use a fairly high-inductance filter choke from which the core had been removed.

The frequency of oscillation is determined by the inductance of the winding that is normally the secondary of T_1 and the effective capacitance of the series-connected capacitors, C_2 and C_3 . The junction of these two capacitances is connected to the cathode of the oscillator triode. Resistor R_2 provides a d.c. ground return for the plate circuit of the oscillator and also serves as a cathode-isolating resistor for the audio frequency. Output from the oscillator is coupled to the cathode follower by means of the primary winding of T_1 .

The cathode-follower circuit uses the variable attenuator, R_3 , as the bias resistor. Audio output is coupled through C_4 to the fixed attenuators.

The heater and plate-supply requirements for the unit are 6.3 volts a.c. at 0.3 amp. and 150 volts d.c. at 7.5 ma.

Construction

The top and bottom views of the oscillator show the parts mounted on a $5 \times 7 \times 2$ -inch chassis. The layout may be made to suit the tastes of the individual, but the types and values of C and L for the oscillator tank circuit are critical factors, and the specified transformer and capacitors should be used if at all possible. If substitutions are made the waveshape and output voltage of the oscillator should be checked with an oscilloscope. When checking with the 'scope, first observe the waveform at the grid of the cathode follower. If it is not a good sine wave the probable trouble is in the tank components,

* Technical Assistant, QST.

OSCILLATOR

CATHODE FOLLOWER

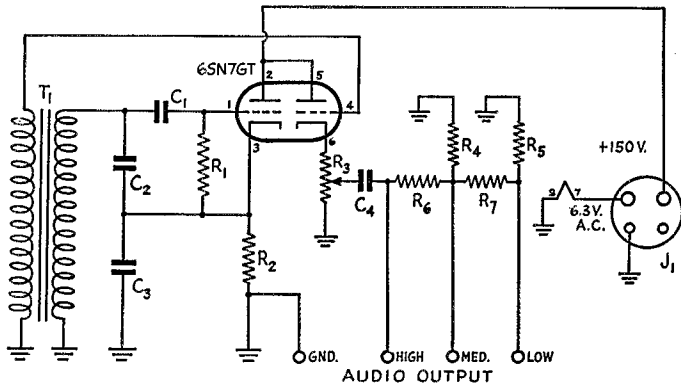

Fig. 1 — Wiring diagram of the audio oscillator.
 C₁, C₄ — 0.1- μ fd. 600-volt tubular.
 C₂ — 0.04- μ fd. 600-volt tubular (Sprague TM-14).
 C₃ — 0.03- μ fd. 600-volt tubular (Sprague TM-13).
 R₁ — 1.0 megohm, $\frac{1}{2}$ watt.
 R₂ — 10,000 ohms, $\frac{1}{2}$ watt.
 R₃ — 5000-ohm potentiometer.
 R₄, R₅ — 4700 ohms, $\frac{1}{2}$ watt.
 R₆, R₇ — 47,000 ohms, $\frac{1}{2}$ watt.
 J₁ — 4-prong male plug.
 T₁ — Interstage transformer, 1:1 ratio (Stancor A-4711).

particularly capacitors C₂ and C₃. The circuit is quite critical as to the *type* used and even may refuse to oscillate with the common cardboard-cased paper tubulars. If a sine wave is obtained at the grid of the output tube, the 'scope should then be connected to the high-output terminal. If the output appears to be clipped, it is necessary to reduce the input to the cathode follower. This can be done by lowering the oscillator cathode resistance, R₂. The turns ratio of the interstage transformer also is important. A ratio other than 1 to 1 will result either in excessive drive for the output tube or a reduction in output voltage.

The output cable for the oscillator is made

from a length of Belden type 8885 shielded wire. One end of the cable is terminated with a pair of insulated 'phone tips and the output end of the lead is soldered to a set of alligator clips.

Chapter 9 of the *Handbook* explains how a simple audio oscillator can be used for checking a 'phone transmitter. It can also be used for trouble shooting in receiver audio circuits or any other purposes — such as code practice — for which a fixed-frequency audio oscillator is useful.



February, 1927

... With deep regret, *QST* announces the resignation of John M. Clayton, 1DQ, assistant technical editor. He goes to New York City to become assistant secretary of the Institute of Radio Engineers.

... Ross A. Hull, oa3JU, honorary federal secretary of the Wireless Institute of Australia, has associated himself with ARRL Headquarters and is in charge of Information Service.

... The Old Man returns with pointed comments. He decries "Rotten Reasons" for some to believe that the average amateur's interest in his hobby is tending to wane.

... The Colpitts circuit is discussed by Technical Editor Robert S. Kruse in the third of his "How Our Tube Circuits Work" series.

... 2EB of Jamaica, Long Island, will test with a power of one kilowatt on 5 meters at scheduled periods for the benefit of Australian and European observers.

... "An Airplane Transmitter" by R. S. Briggs, 1BVL and G. H. Browning, describes a 70- to 120-meter range rig for aeronautical use employing UX-201-A tubes throughout.

... Robert H. Marriott writes on the new Loftin-White magnetic-electric coupling circuit.

... Hammarlund announces a two-plate screw-type neutralizing condenser, adjustable from 2 to 50 micro-microfarads.

... A ready-made quartz crystal mounting is now available, offered by General Radio of Cambridge.

... In DXing circles, Austria, Madagascar, Iceland, the Madeiras and the Leewards are rare countries reported on the air.

... Canadian 3VS gives interesting observations on the effect of the aurora borealis on short waves and 8BAD adds his opinions concerning peculiarities of short-wave fading.

... IBIG, winner of the Traffic Trophy, and ne5AO, "on top of the world" in Canada's far north, are described.

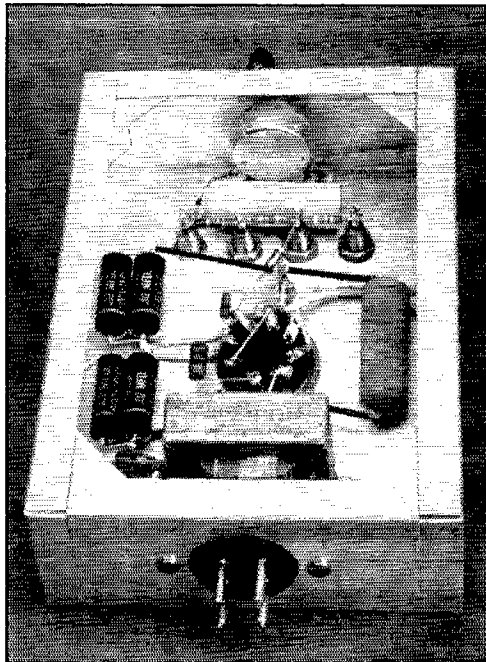

This bottom view of the test oscillator shows the interstage transformer mounted to the rear of the tube socket. Resistors for the ladder-type attenuators are supported by the terminals of the output jacks. The power plug is mounted at the rear of the chassis.

The Wavelength Factor

Influence of the Antenna on the Choice of Wavelength for Best Communication

BY YARDLEY BEERS,* W2AWH

GOOD radio operating always requires detailed knowledge of the properties of all wavelengths available and the intelligent choice of the one best suited for a particular purpose. At the present time two general problems facing the amateur fraternity require particular consideration of this subject: (a) selection of the best band for Civil Defense nets, and (b) the development of the microwave bands, which is stimulated by the recent establishment of Technician Class licenses.

Superficially, the selection of a band for Civil Defense and the development of the microwave bands appear unrelated questions. However, the same reasoning may be applied to both, although with completely opposite conclusions. It will be shown partly in this article and partly in others to follow that, except for ionospheric communication, there is every advantage in placing mobile operation on the longest possible wavelength, while the u.h.f. and microwave bands are suited for fixed-station operation partly because of the necessity for using high-gain antennas with narrow beam widths and partly because of the complexity of the apparatus required to exploit the chief advantages of these very short waves.

At the lower frequencies the choice is based primarily on the ionospheric properties of the various bands, as these are by far the most important. However, at frequencies greater than 50 Mc. — as well as in ground-wave operation at lower frequencies, where the ionosphere plays no part — the principal factors governing the choice of a band are instrumental: that is, the characteristics of the transmitter, receiver, and especially the antennas, although there are also some effects produced by the lower atmosphere. For sky-wave operation at the lower frequencies the instrumental effects are also present, of course, but to a large extent are obscured by the ionospheric ones. The purpose of this article is to review these instrumental effects in the hope of aiding the solution of the problems mentioned above. Ionospheric effects at the lower frequencies will not be discussed; those readers whose main interest is in sky-wave communication may nevertheless find some of the topics to be of value.

Most of the instrumental factors are very familiar by name. A list of the more important ones follows:

- Transmitter power.
- Type of modulation.

* Associate Professor of Physics, New York University, University Heights, N. Y. Mail address: 4 Ploughman's Bush, Riverdale 71, N. Y.

• The choice of the optimum wavelength for a given type of communication — fixed station to mobile, fixed to fixed, etc. — is considered objectively, based on known principles of antenna operation. The conclusions that logically follow may be surprising to many amateurs, especially those not familiar with the "effective area" concept.

Although the discussion here and in subsequent articles principally deals with v.h.f. and u.h.f., the low-frequency man will find it of considerable interest, too.

Gain and efficiency of the transmitting antenna.

Gain and efficiency of the receiving antenna.

Noise figure of the receiver.

Bandwidths of the r.f., i.f., and a.f. portions of the receiver.

Gain of the receiver.

Overload properties of the receiver.

Type of demodulation.

Relative frequency stability of the transmitter and receiver.

There remains one more item, which although familiar to engineers and physicists who have worked on microwaves, is not widely known in amateur circles: the equivalent area of the receiving antenna, which is a measure of the effectiveness of the receiving antenna in intercepting radiation. As one would expect, the equivalent area is related to the gain, and whenever anything is done to increase the gain, the equivalent area increases in proportion. However, gain is not the only consideration. The equivalent area also depends, as we shall see, on the wavelength. The gain of the transmitting antenna and the equivalent area of the receiving antenna are the two most important instrumental factors in the selection of an optimum wavelength, and therefore these will receive special attention.

The Antenna Factors

Before going any further let us define a few terms to prevent confusion. Not all of the power supplied to a transmitting antenna is radiated. Some of it heats up the metal conductors of the antenna. The ratio of the total power radiated to the total power supplied is the *efficiency* of the antenna. The radiated power, however, is distributed over many different directions. The ability of the antenna to concentrate its radiated

power in a preferred direction or directions is called the *gain* of the antenna. More quantitatively, the gain of an antenna is specified with reference to a standard antenna. It is the ratio of the power radiated (per unit solid angle) in the preferred direction, by the antenna in question, to the power radiated in the preferred direction by the standard antenna. It is assumed, of course, that the total power radiated in all directions is the same for both antennas.

The definitions of efficiency and gain of receiving antennas are similar. The efficiency is the ratio of the power supplied to the input terminals of the receiver to the total power extracted from the radiation. The gain is the ability of the antenna to discriminate in favor of signals coming from a desired direction or directions over signals coming from other directions and is usually specified numerically with respect to a standard antenna. As a result of the so-called "reciprocity theorem," the directional properties of a given antenna are the same when it is used as a receiving antenna as when it is used as a transmitting antenna. Therefore, the numerical values of the gain are the same for both applications.

Two types of antennas are used as a standard for the specification of gain. One of these is an imaginary antenna which would radiate equally well in all directions, called an "isotropic" antenna. The other is a half-wave dipole, which has zero radiation along its axis and a maximum in the plane at right angles to the axis. The power radiated (per unit solid angle) in the directions of maximum radiation of a half-wave dipole is 1.64 times (2.1 db.) that radiated in any direction by an isotropic antenna radiating the same total power. Therefore, gains expressed in terms of the isotropic antenna may be expressed with respect to a half-wave dipole by dividing by 1.64 (or subtracting 2.1 db.). In the present article the isotropic antenna will be used as a standard.

With these definitions in mind we shall explain why the equivalent area of a receiving antenna depends upon the wavelength. Let us suppose that we have a receiving antenna of some definite type — for example, a three-element broadside array — pointed at a transmitter. Then suppose that the wavelength of the transmitter is doubled, keeping the efficiency and gain of the transmitting antenna and the power of the transmitter the same. No longer will our receiving broadside array operate correctly. We must double both the element length and the spacing. In doing this we do not change the directive properties nor the gain. Nevertheless, the array "looks bigger" to the transmitting antenna and therefore is

¹ Although this formula is simple to write and to apply, its proof involves a lengthy application of advanced electromagnetic theory. A proof may be found in Chapters V and VI of *Microwave Transmission*, by J. C. Slater, McGraw-Hill Book Company, New York, 1942. However, Slater's results are not in the form of our equation, which more recently has been widely used in other books. Slater defines a quantity "the absorption area," which is equal to our "equivalent area" divided by the gain, and he proves that this is equal to $\lambda^2/4\pi$ for antennas of all types.

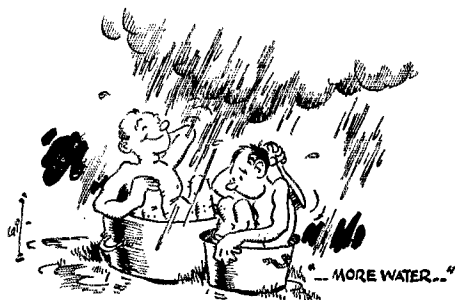

more effective in intercepting the radiation, just as a large pan will collect more water in a rain-storm than a small pan.

We shall defer a precise definition of equivalent area to a later article. When this is done, there is a very simple formula¹ relating the gain, G , the equivalent area, A , and the wavelength, λ :

$$A = \frac{G\lambda^2}{4\pi} \quad (1)$$

This formula is general and applies to antennas of all types. It shows, as we expected, that A is proportional to the gain and also that A increases with the square of the wavelength. If, as in our example, we double the wavelength and keep the gain constant, the equivalent area and therefore the strength of the signal would increase by a factor of 4 (or 6 db.); or if we increase the wavelength by a factor of 3, the received signal increases by a factor of 9 (or 9.5 db.). Equation (1) shows also, since G is a pure ratio, that A has the same units as λ^2 , which are square meters, square centimeters, or possibly square feet. These are, of course, units of geometrical area. This gives still further significance to the concept of equivalent area.

Finally, in the case of large broadside arrays, horns, and parabolic-mirror antennas, the effective area is between 40 and 100 per cent of the actual geometrical area of cross-section of the antenna. Therefore, the effectiveness of these antennas for receiving depends primarily on their geometrical areas. For example, if we replace a large broadside array by another one having the same area but operating at twice the wavelength, to operate correctly the new array requires elements of twice the length and twice the spacing, and therefore will have approximately one quarter the number of elements. Because of the smaller number of elements the gain will be reduced and the beam width will be greater. In order that Equation (1) will be satisfied we conclude that the gain must have been reduced by a factor of 4, and in general we may conclude that for antennas of the types mentioned having constant area the gain varies inversely with the square of the wavelength. It can be inferred that much of this reasoning also applies to end-fire and linear arrays, except for the fact that with them there is no related geometrical area that may be so clearly identified with the equivalent area.

It may be concluded that the effectiveness of

a receiving antenna—that is, its equivalent area—(a) increases with the square of the wavelength if the antenna has constant gain, and therefore the wavelength from this point of view should be as long as possible, while (b) it is independent of the wavelength if the antenna is a directional array of constant geometrical area.

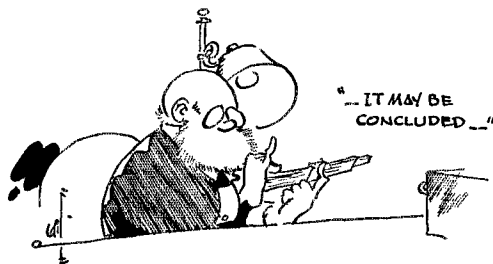

The Transmitting Antenna

While the strength of the received signal depends on the equivalent area of the receiving antenna, its dependence upon the properties of a high-efficiency transmitting antenna is through the gain. Therefore, many of our previous arguments have to be reversed when applied to transmitting antennas. As long as the transmitting-antenna gain is constant, there is no advantage of any wavelength over another so far as the transmitting antenna is concerned. But, if we are limited to a definite size—or, more exactly, a definite area—we see that the wavelength should be as short as possible because the gain varies inversely with the square of the wavelength.

However, if we attempt to operate with antennas of very high gain we must expect that as the gain increases the beam width will become narrower, and for certain purposes it may become so narrow as to give difficulty. For example, a parabolic mirror antenna 3 feet in diameter operating in the 3300-Mc. band (9 cm. wavelength) would have a gain of approximately 800 (or 29 db.) and a beam width of approximately 7 degrees between the extreme directions at which the power gain is one-half maximum. The difficulties in general coverage operation without prearranged schedules, using an antenna with a beam width of only 7 degrees, may be seen by comparison with the following angles: The New York City limits (not including suburbs) would subtend an angle of 15 degrees from Philadelphia (75 miles away) and 7 degrees from Boston (180 miles away). Also, Los Angeles and San Francisco differ in direction as "viewed" from New York by 7 degrees.

Some alleviation could be obtained by using an antenna with greater vertical directivity than horizontal. However, there is a practical limit to usable vertical directivity because of errors in

² If θ is measured in radians and if λ and d have the same units, the constant 2.3 is replaced by 1.22. Readers who have taken a college course in elementary physics will then recognize this formula as that for the half angular width of the central maximum of the diffraction pattern of a circular aperture.

alignment, unevenness of the ground, and atmospheric effects. This writer would guess that a vertical beam width of 10 degrees and a horizontal width of 45 degrees would be the most narrow beam that could be tolerated in operation without prearranged schedules. In the case of parabolic mirrors and horns, the beam width, θ , in degrees, is given approximately by a simple formula:

$$\theta = 2.3 \frac{\lambda}{d}, \quad (2)$$

where the wavelength, λ , is expressed in centimeters. This formula applies to antennas of circular cross-section, strictly speaking.² In this case d is the diameter expressed in feet. However, little additional error is introduced if the formula is applied to antennas of rectangular cross-section. In this case d represents the dimension in feet corresponding to the plane in which θ is measured. Thus for the horizontal beam width, d would represent the width of the antenna. Probably the error in this formula is not greater than 25 per cent for antennas which are adjusted correctly. More accurate formulas would take into consideration the exact shape as well as other details neglected in the present article.

Table I gives the approximate dimensions of parabolic mirror or horn type antennas which according to Equation (2) would have a horizontal beam width of 45 degrees and a vertical beam width of 10 degrees for three amateur bands of interest. In all three cases the gain is about 135 (or 21 db.).

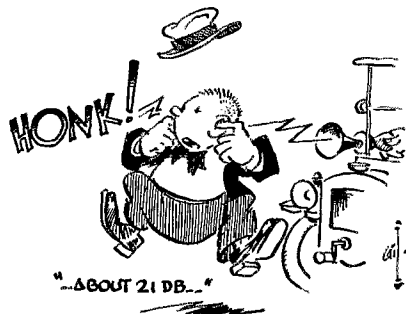

The upper limit on the size of an antenna depends upon the financial resources and mechanical skill of the builder. Undoubtedly, the following figures can be or have been exceeded, but it is unlikely that antennas larger than those indicated would be built often. A mirror or horn 5.7 feet by 1.7 feet is of practical size, but ones 16 feet by 3.6 feet would be too large for convenience. Therefore, the 1215-Mc. band is probably the lowest frequency where antennas of this type and beam width would be used. However, because of its open construction a broadside antenna 16 feet by 3.6 feet and having about 40 half-wave elements for the 420-Mc. band is within the possibility of practical construction. Such an antenna would have approximately the same equivalent area and gain, but it would be bi-directional and therefore it is to be presumed

TABLE I

Frequency (Mc.)	Wavelength (cm.)	Height (ft.)	Width (ft.)
220	136 (4.5 ft.)	31	7
420	72 (2.4 ft.)	16	3.6
1215	25 (0.82 ft.)	5.7	1.25

that the major lobes would be somewhat narrower than 45×10 degrees. By adding a group of elements to act as reflectors the array could be made unidirectional, but then the gain would be somewhat greater and the beam width somewhat smaller than 45×10 degrees. This could be corrected by reducing the cross-section of the antenna slightly. The adjustment of an antenna with 40 elements is, of course, a problem but not an insurmountable one. These arguments tend to indicate that an antenna of the minimum usable beam width and maximum gain for general coverage operation is within the realm of practical possibility for the 420-Mc. band. At the same time it may be inferred that such an antenna for 220 Mc. would be too large for the resources generally available.

Of course, it is the combined performance of the transmitting and receiving antennas which is significant in the choice of a wavelength. This subject will be summarized a little farther on. For the moment, however, we shall consider some antennas of types that are of principal interest at the longer wavelengths.

Dipoles, "Super-Gain" Antennas, and Unorthodox Antennas

As mentioned previously, the gain of a half-wave dipole is 1.64 relative to an isotropic antenna. Its equivalent area then may be calculated by substituting this value into Equation (1). Since by definition the length is one-half wavelength, we may conclude that the equivalent area depends upon the geometrical size of the antenna. Thus the properties of the half-wave dipole are not in contradiction with any of the ideas we have considered.

If we now consider what happens if we replace a half-wave dipole by one considerably shorter, we shall encounter a situation which is very different in several respects. The radiation pattern of a "short" dipole in free space is similar in general to that of the half-wave dipole, having a zero along the axis and a maximum in the plane at right angles to the axis. However, in detail the pattern is slightly different, resulting in a gain of 1.5 (or 1.7 db.) instead of 1.64 (or 2.1 db.). Thus the gain of the short dipole is 0.91 (or minus 0.4 db.) relative to the half-wave dipole. If we substitute the value $G = 1.5$ into Equation (1), we find for the equivalent area

$$\frac{1.5\lambda^2}{4\pi}$$

while for the half-wave dipole we would have the factor 1.5 replaced by 1.64. However, we are no longer required by definition to change the

length of the dipole every time we change the wavelength, and therefore we conclude that with the short dipole both the gain and equivalent area are independent of the geometrical size. Furthermore, it would appear that by replacing a half-wave dipole by one very much shorter we still have an antenna that is 91 per cent as effective in both transmitting and receiving! This conclusion is difficult to believe, although to a large

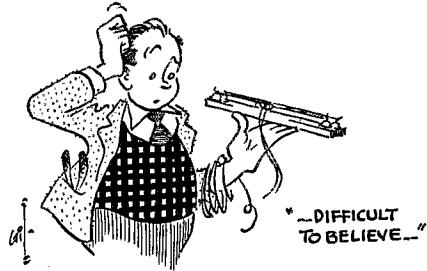

extent it is true. However, this situation requires us to consider a matter that we have been able to overlook up to now: the efficiency.

A transmitting antenna is characterized by a quantity called the radiation resistance, referred to a point which is usually taken at the center of a dipole or, in the case of long-wire antennas, at a current loop. The radiation resistance is defined in such a way that when its value is multiplied by the square of the current flowing at that point one obtains the radiated power. This impedance is quite real in the sense that it may be measured by an impedance bridge connected to the antenna. The value of the radiation resistance and the measured current will vary with the choice of reference point, although the changes in the resistance and current are interrelated in such a way as to keep the power constant. Therefore, by itself the value of radiation resistance has little meaning; only when it may be compared with other resistances in the output circuit does its value have significance. These other resistances include the plate resistance of the final amplifier, losses in the final tank, antenna coupler, transmission line, and the radiator itself. By consideration of the impedance step-up properties of the intervening circuit, the equivalent series resistance at the reference point due to each of these may be determined. If the radiation resistance is high compared with the total of these other equivalent resistances, the efficiency is large; if it is low in comparison, the efficiency is poor. If the antenna is used for receiving, the efficiency (and also the noise figure) will depend in a similar fashion upon the comparison of the radiation resistance with the total equivalent resistance resulting from portions of the input circuit as far as the grid of the first tube.

It is true that the voltage developed across the terminals of a perfect voltmeter connected to a short dipole will increase in proportion to the length of the dipole. However, the radiation resistance also varies with the square of the length in order to keep the available power and there-

fore the equivalent area independent of the length, as required by our formula. Therefore, as we decrease the length of an already "short" dipole while keeping the wavelength constant, the radiation resistance will drop until it becomes comparable with or even smaller than the equivalent resistance of the rest of the circuit, with a deterioration of efficiency.

Some countermeasures may be taken against this loss in efficiency. On the one hand, we may load the antenna in various ways to raise the radiation resistance. On the other hand, losses may be reduced by using heavy conductors in the antenna and elsewhere, and components of high quality. From the widespread success of 4-Mc. mobile stations with 10-foot antennas operating against the car body as ground it may be concluded that dipoles of a twenty-fifth and possibly one-fiftieth of a wavelength can be made of sufficiently great efficiency to be practical.

The effect of low antenna resistance and these countermeasures combine to make the circuit very selective, necessitating retuning for very slight changes in frequency. In itself this is not always a disadvantage, since it may result in the suppression of unwanted signals in receiving and suppression of unwanted harmonics in transmitting. However, the design of the coupling circuit may depend in an important way upon parasitic capacities and the L/C ratio in the antenna coupler, factors that ordinarily have little effect. Also, in transmitters very high voltages may be developed across the variable condensers with the result that these may have to have higher voltage ratings than usual with transmitters of the same power. The coils must be of low-loss construction, and changing inductance by shorting turns will

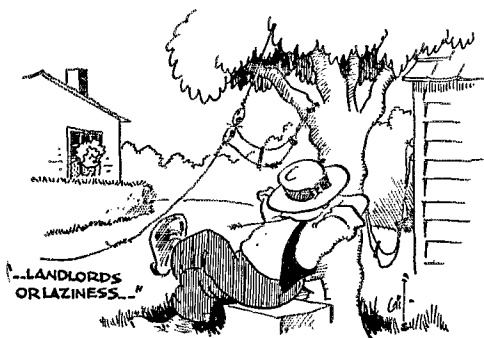

result in a serious loss of efficiency. Finally, the performance will be affected by rain and swaying in the wind.

Advanced antenna theory indicates that it is possible to build antennas of any desired gain with arbitrarily small size, or at least of much smaller size than is in accord with present practical designs. However, Chu has shown³ that as the size is reduced the radiation resistance of these "supergain" antennas falls, with the result of reduced efficiency and bandwidth. Therefore,

while high-gain antennas of small size may exist in theory, the theory also predicts that they will be of limited practicality. Although the short dipole perhaps is not included in the definition of a "supergain" antenna, its behavior as described above is completely in accord with that of antennas of this type.

Incidentally, the reasoning of the previous paragraphs justifies theoretically the success of the many unorthodox antennas put up by amateurs because of lack of adequate space, unsympathetic landlords, or laziness. The requirement that a dipole or a long-wire antenna be cut exactly to "resonance" is to a large extent superstition.

The Antenna Factors Summarized

The combined effects of the transmitting and receiving antennas as dependent upon the wavelength may be summarized conveniently by considering three cases which correspond more or less exactly to most situations likely to be encountered. In the following it is assumed that a mobile station would use a dipole, or at any rate an antenna of very little gain. The question of efficiency will be neglected.

1) *Both antennas having constant gain.* This situation is likely to be encountered at any wavelength when both stations are mobile, and almost inevitably also by fixed stations at low frequencies. In this case the effectiveness of the transmitting antenna will be independent of wavelength, while the equivalent area of the receiving antenna will increase with the square of the wavelength. Hence in this case the wavelength should be as long as possible.

2) *Both antennas of constant size.* This is the situation encountered normally with fixed v.h.f. and microwave stations. The equivalent area of the receiving antenna will be independent of the wavelength while the gain of the transmitting antenna will increase inversely with the square of the wavelength. Therefore, the wavelength should be as short as possible, provided that the beam widths do not become too narrow. According to the considerations of Table I, we may conclude that the most favorable antenna factors for general coverage operation would be realized in the 420-Mc. band under practical conditions. For point-to-point operation on prearranged schedules, much higher frequencies would be desirable.

3) *Station A having antenna of fixed gain, while Station B has antenna of fixed size.* This might be encountered with a fixed station with a rotary beam antenna in communication with a mobile station. When Station A transmits, the gain of the transmitting antenna and the equivalent area of the receiving antenna are both independent of the wavelength. When Station B transmits, the gain of the transmitting antenna varies inversely with the square of the wavelength, but this is compensated exactly by the equivalent area of the receiving antenna, which varies directly with the square of the wavelength. Thus in both cases there is no over-all dependence upon the wave-

(Continued on page 116)

³ I. J. Chu, *Journal of Applied Physics*, Vol. 19, page 1163 (1948).

Fundamental Teletypewriter Operation

Signaling Systems and Basic Circuits

BY A. J. SABEL,* W4SQF

WHILE radio communication to the average amateur classifies itself into two means of "thought transfer" — communication by 'phone and c.w. — within the last few years there has been a growing interest in a new form of ham communication, namely, radio teletypewriter communication. Unfortunately, unless one has had experience with the commercial or military application of RTTY, there is a rather vague understanding of the principles involved. However, the circuits and equipment used represent no unorthodox approaches. Circuitry, while perhaps not so familiar as that used in c.w. and 'phone equipment, is standard and well-defined. It is merely the combination of low-frequency (a.f.) circuits with high-frequency circuits used every day. Assuming the reader is an amateur with an average background, the following should not be difficult, nor should the principles involved be too unfamiliar. Since the scope must be limited, the individual phases will not be delved into too deeply.

Communication by c.w. makes use of transmitted signals which are broken up, or keyed, in accordance with a prearranged code. The code normally consists of short pulses (dots), long pulses (dashes), single spaces, letter spaces and word spaces, the only object of the single spaces being the separation of dots and dashes. Communication by teletypewriter, or "printer," is also based on a "code." There are several differences, however, which should prove interesting. In contrast to the Morse code in which the symbols vary in time length from a single dot (letter E) to five dashes (numeral 0), all TTY symbols are of the same over-all length. This standard length of time is divided up into seven standard units or blocks, as shown in Fig. 1. In the simplest teletype system, the dark spaces indicate time blocks during which a signal is being transmitted (called "mark"), while the empty blocks indicate time units during which no signal is transmitted (called "space"). In comparing teletype code with Morse code, it can be said that the former consists of dashes (or perhaps more correctly, dots) of various lengths, and spaces of various lengths. Five of these unit blocks (those numbered in Fig. 1) designate the letter (or other character). It can be seen, for instance, that the TTY code for the letter A is a sequence of two mark units followed by three space units; the code for the letter N consists of two space units, followed by two mark units, and another space unit. In the TTY code, there is no equivalent for the space between letters as in Morse code. But, as indicated in Fig. 1, the starting of a new letter is indicated by the "transmission" of a space,

while the end of each letter is indicated by a mark. This "stop" mark is slightly longer than the standard unit mark. For 60-w.p.m. transmission, each mark or space unit is 22 milliseconds long, while the stop mark is 1.43 times this length, or 31 milliseconds. Thus all characters have a total time length, including the start and stop units, of 163 milliseconds. While a transmission speed of 60 w.p.m. is more or less standard, it can be raised or lowered. Actually, in the preferred systems, discussed later, a signal is transmitted during the space block, as well as during a mark block, a different frequency (audio or r.f.) being used for each (two differently polarized voltages in the case of wire lines).

Keying of the characters and conversion of the received pulses into mechanical movement of a type-carrying anvil are accomplished in the tele-

CHARACTERS	U.C.	L.C.	SELECTING					STOP
			1	2	3	4	5	
A	—							
B	?							
C	:							
D	\$							
E	3							
F	!							
G	&							
H	STOP							
I	8							
J	'							
K	(
L)							
M	.							
N	,							
O	9							
P	0							
Q	1							
R	4							
S	BELL							
T	5							
U	7							
V	:							
W	2							
X	/							
Y	6							
Z	"							
BLANK								
SPACE								
CAR. RET.								
LINE FEED								
FIGURES								
LETTERS								

Fig. 1 — The "five-unit" teletypewriter code.

* Capt., SC., 1018 Columbia Drive, Alexandria, Va.

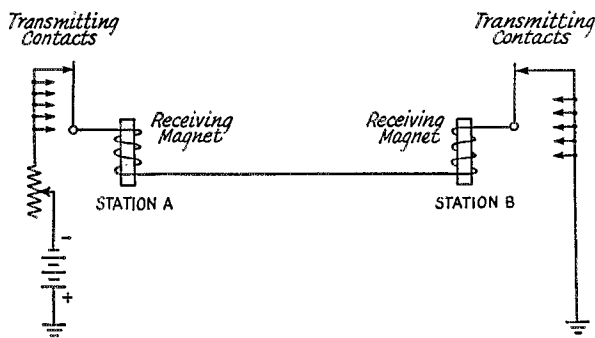

Fig. 2 — Simplified neutral type of control.

printer machine. The machines are used instead of the keys and sounders used in regular line telegraphy. Each machine consists of a transmitting keyboard and a receiving and printing mechanism. Depressing a key on the printer keyboard releases the transmitting mechanism and automatically keys the correct series of pulses over the line to the receiving printer. The receiving printer translates the received impulses into a mechanical action so that the printing portion of the machine may select and print the proper character. Each key of the transmitting portion of the teleprinter sends a different sequence of pulses and the receiving portion at the other end of the line will react to this difference in sequence by printing a different letter or numeral, or perform some other standard function, such as returning the carriage, etc. The teleprinters transmit any one of the 26 letters of the alphabet and 24 different characters and numerals. In addition, the functions of carriage return, line feed, letter shift, figure shift, space, blank, signal bell and motor stop can be performed by pressing a key for each. There are specialized versions of a standard keyboard in existence which substitute special symbols in place of standard letters or numerals. Among these is the weather-symbol machine used in weather-forecast work.

In wire teleprinter operation are two basic types of operation, known as "polar" and "neutral." Each has its own merits. In present amateur systems, standardization is imminent and the neutral system is being considered very favorably, although no decision has yet been reached. Briefly, a neutral system is one where the operation of the selector magnets or relays is independent of the direction of current flow through the windings, so either terminal of the battery or rectifier supplying them can be connected to the line. (It is standard practice to ground the positive side of the supply and apply the negative side to the line, however.) Signaling is accomplished by interrupting the current flow at specific intervals in accordance with the transmitted sequence of mark or space impulses. The result is a current, no-current type of operation,

where the interval during which current flows is the mark and the no-current interval the space. This system is shown in simplified form in Fig. 2.

In polarized operation, shown in Fig. 3, the principal difference is that marking or spacing conditions are obtained by reversing the polarity of the applied voltage, rather than by interrupting the line circuit. While the neutral system is easiest and cheapest to install and maintain, polarized operation is preferred for use over long lines because it is not affected to any considerable degree by the distributed capacitance and inductance of the line. In amateur work, the only line involved is from the machine to the transmitter and receiver so that line characteristics are usually not a consideration.

Application to Radio Communication

In applying radio teletype to radio communication, the principles of operation are unchanged. However, in the preferred systems, it is necessary to convert the d.c. pulses normally applied to the line to a form suitable for use with the system selected. Two systems are in most common use. In one of these systems, the d.c. marking and spacing pulses are used to key a relay that causes an audio oscillator to alternate between two standard frequencies — 2975 cycles for space and

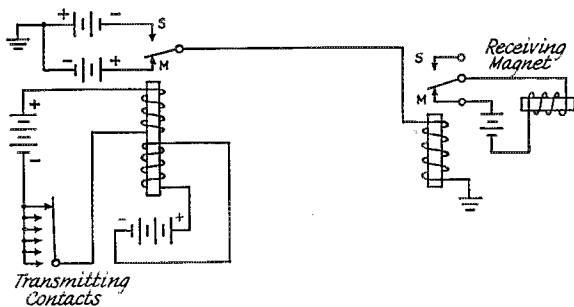

Fig. 3 — Simplified polar-type teletype circuit.

2125 cycles for mark. The two tones are then used to modulate the carrier of a regular 'phone transmitter. This system is known as "a.f.s.k." (audio-frequency-shift keying). Better signal-to-noise ratio and an increase in the effective power of the transmitter is obtained with the second system, known as "f.s.k." (frequency-shift keying). In this system, the carrier is not modulated, but its frequency is shifted by the same number of cycles as in a.f.s.k. Then, the b.f.o. in the receiver is adjusted to produce the audio beats of 2975 and 2125 cycles in the audio output of the receiver. The desired change in carrier frequency is usually accomplished through the use of a reactance modulator working on the oscillator, as in other f.m. systems.

A block diagram of the converter used at the receiving end of the circuit to change the audio tone back to d.c. pulses to operate the receiving

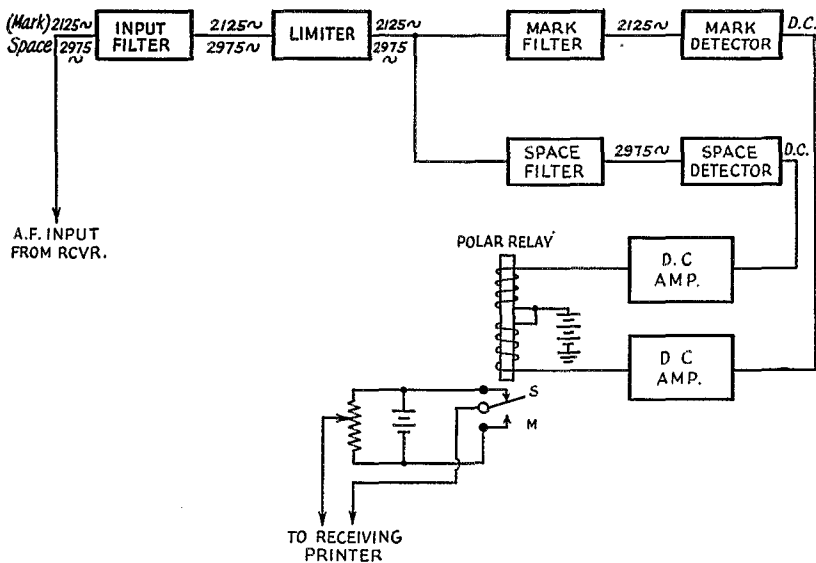

Fig. 4 — Block diagram of converter system for f.s.k. and a.f.s.k.

printer is shown in Fig. 4. The two audio tones are fed into a filter that passes the two frequencies but excludes noise frequencies outside the pass-band. The signal then passes to a limiter that holds the output constant over a wide range of signal-strength variations. The signal is then fed into two sharp filters, one passing 2975 and the other 2125 cycles. Thus the two audio tones are divided into two separate channels. Each signal is then rectified, and the d.c. pulses stepped up in d.c. amplifiers to the level needed to operate the

polarized relay controlling the receiving printing mechanism.

This, in brief, describes the more important principles involved. There are, of course, many refinements which often make it possible to operate printer service over circuits where other types of communication could not be carried out reliably. It is hoped, however, that this will serve to answer some of the questions that arise in the mind of the average ham when he hears RTTY mentioned.

Quist Quiz

A tells his friend B that the receiver he bought is no good — that the b.f.o. is noisy and he doesn't know what to do except to return the receiver. He knows the b.f.o. is noisy because when he turns it on the receiver noise increases. B tells him not to return the receiver, that it is a simple job to reduce the b.f.o. voltage and reduce the noise. Which course should be followed?

(Please turn to page 122 for the answer)

Strays

W2 QSL Bureau Manager Hank Yahnel, W2SN, had "practically nothing to do" in 1951. He handled only 55,075 cards. His record high was 105,050 in 1949 followed by a mere 90,780 total in 1950. Poor DX conditions may explain the decrease in volume. Or could it be by this time almost everybody has worked everybody else?

Silent Keys

It is with deep regret that we record the passing of these amateurs:

W1FMV, Arthur Gray, Orange, Conn.
 W1GZ, Nestor W. Stolba, Fitchburg, Mass.
 K2AW, J. Charles Hauff, Bronx, N. Y.
 W2JID, Lloyd Moore Peterson, Fayetteville, N. Y.
 W2WUH, B. A. Gorrell, Jackson Heights, N. Y.
 W2ZMJ, Vernon Whiting, Bronx, N. Y.
 W5QIV, Raymond Bell, Plano, Texas
 W5TA, Raymond Collins, Dallas, Texas
 W7BQW, Dennis A. Price, Dayton, Wash.
 W8HRF, Carl H. Ludwig, Lorain, Ohio
 W8SGB, Raymond E. Stukey, Lancaster, Ohio
 W9AQQ, Donald E. Martin, Aurora, Ill.
 W9DFZ, William J. Bender, Alexandria, Ind.
 W9DFC, E. J. Kunz, Randolph, Wis.
 W9MGG, Ray V. Zimmerman, Aurora, Ill.
 W0CZR, Francis A. Nelson, Denver, Colo.
 W0JB, John Raymond Derby, Denver, Colo.
 W0SJQ, Henry F. Kirk, Mendota, Minn.
 W0TLN, Herbert Erickson, Minneapolis, Minn.
 VE2AA, George A. Awcock, Drummondville, Que.
 VE3BNQ, A. S. Whetham, Hamilton, Ontario
 VK2HI, Perce G. Feeny, Sydney, N. S. W.



The World Above 50 Mc.

CONDUCTED BY E. P. TILTON,* W1HDQ

WAS it tropospheric bending or sporadic-E skip? This question always comes up whenever 2-meter DX beyond a few hundred miles is reported. There is good reason for argument, too, as both types of propagation seem to have been involved in our several instances of 144-Mc. communication over distances of 1000 miles and more in this country. Now we have a report from New Zealand that looks like another point for the ionosphere. It is also the first instance of near-record DX to be reported outside this country. Watch out, 2-meter record holders!

The month of December in the Antipodes corresponds to our June, so it is the peak month for sporadic-E DX on 50 Mc. for the VKs and ZLs. At 7:41 P.M. New Zealand time on Dec. 15th, ZL3AR, Ashburton, New Zealand, worked VK2AH, Ryde, New South Wales, on 50 Mc. VK2AH then shifted to 144.16 Mc., and his signal came through S6, so ZL3AR changed to 146.19 Mc. and was received in Australia S8. Two-way contact was established at 7:45 P.M., and continued until 7:52. The distance is approximately 1230 miles.

There are several points of interest here, and they check with experience in this country. The distance, for example: all our 2-meter DX that has looked like sporadic-E skip for sure has been over distances of 1200 miles or more. The contact came when 50 Mc. was open for the same path. As we've had no indication of tropospheric communication on 50 Mc. over distances beyond about 400 miles, it appears that *E_s* opened this path, just as it seems to have done when 2 and 6 have been open simultaneously in this country. The path in this VK-ZL QSO is of interest. Note that Ashburton is in the east-central portion of New Zealand's South Island. The hop to Australia crosses the Southern Alps, a backbone ridge of mountains nearly comparable to our Rockies in height. Not the sort of terrain you'd be likely to cover by tropospheric bending. The latitudes and distances are not unlike hops from Portland to Amarillo, or Los Angeles to Omaha. Those would be nice DX on 2 in these United States!

The closing weeks of 1951 were not unkind to 50-Mc. enthusiasts in this country. W5SFW, Amarillo, Texas, found the band open every week end for five in a row through Dec. 16th, with some other openings scattered in between. W5FXN, Austin, caught W7QLZ on the night of the 2nd and worked W0MZJ, W4FBH, W4RBK, W9MPH and W9ZHL on the night of the 18th. W8UZ, Columbus, Ohio, worked W5SFW on the

9th and heard him and W5MJD working other W8s and 9s. George also had a productive session with the W1s on the evening of the 16th, as did W8s LPD GZ and NQD. W6GCG, San Mateo, Calif., worked W0SZU/5 at Ft. Bliss, Texas, on the evening of the 15th.

2-Meter Standings

Call			Call		
States	Areas	Miles	States	Areas	Miles
W1HDQ	16 6	650	W5SWV	7 2	—
W1LZY	15 6	750	W5FBT	6 2	500
W1MNF	14 5	570	W5FEK	6 2	500
W1DJK	13 5	520	W5IRP	6 2	410
W1BCN	13 5	500	W5ONS	5 2	950
W1CTW	12 4	500	W5FSC	5 2	500
W1KLC	12 4	500	W5JLY	4 2	650
W2BAV	21 7	1175	W6ZL	2 2	1400
W2NLY	18 6	750	W6WSQ	2 2	1390
W2PAU	16 6	740	W6PJA	2 2	1390
W2AZL	16 6	—	W6EXH	2 2	183
W2DFV	13 5	350	W6ZEM/6	1 1	415
W2CET	12 5	405	W6GGM	1 1	300
W2DPB	12 5	500	W6YYG	1 1	300
W2QED	12 5	365	W8WJC	21 7	775
W2FHJ	12 5	—	W8BFQ	21 7	775
W2QNZ	12 5	—	W8WRN	19 7	670
W2BVU	12 4	260	W8WXV	18 8	1200
W2ORI	8 6	570	W8UKS	18 7	720
W3NKM	19 7	660	W8EP	17 7	—
W3RUE	18 7	760	W8WSE	16 7	830
W3QKI	16 7	820	W8RAX	16 7	500
W3KWL	15 7	560	W8BWX	15 6	655
W3LNA	14 7	720	W8FQK	13 7	—
W3GKP	14 6	650	W8CYE	12 6	—
W3OWW	13 6	600	W8CPA	12	— 650
W3KUX	12 5	575	W9FVJ	20 7	790
W3PGV	12 5	—	W9UCH	20 7	750
W3LMC	11 4	400	W9SUV	19 7	—
W4MKJ	16 7	665	W9EQC	18 7	820
W4HHK	15 6	660	W9BOV	15 6	—
W4JDN	13 6	—	W9WOK	15 5	690
W4JFV	13 5	830	W9AFT	14	—
W4IKZ	13 5	650	W9NFK	12 7	690
W4JFU	13 5	720	W9UIA	12 7	540
W4OXC	13 7	500	W9GTA	11 5	540
W4CLY	12 5	720	W0IHD	15 6	725
W4JHC	12 5	720	W0NFM	14 7	660
W4OLK	12 5	720	W0EMS	13 5	1030
W4FJ	12 5	700	W0ZJB	12 7	1097
W4LRR	5 2	900	W0WGZ	11 5	760
W5JTI	14 5	670	W0HKY	8 3	—
W5QNL	10 5	1400	W0JHS	7 3	—
W5MWW	9 4	570	VE3AIB	12 6	600
W5AJG	9 3	1260	VE1QY	11 4	900
W5ML	9 3	760	VE3BOW	8 5	520
W5ERD	8 3	570	VE3BQN	7 4	540
W5YX	7 4	—	VE3TN	7 4	480
W5VY	7 3	1200	VE3BPB	6 4	525
W5CVW	7 2	560	VE3DER	6 4	450
W5ABN	7 2	450	VE3EAH	5 4	380

*V.H.F. Editor, QST.

These December openings seem to surprise many of the 6-meter gang, though they shouldn't. Years of experience have shown that we have a winter sporadic-E season, as well as a summer one. It's not as long, and the openings are not usually so widespread, but there are always some good DX chances in December and January. One cannot escape the feeling that many interesting opportunities are lost for want of activity in the right places in these winter sessions. On Dec. 16th, for example, there were all the indications that double-hop work should have been possible from the East, if there had been somebody in business in northwestern W7.

The band was open most of the day, and well into the evening. Conditions were good enough so that W1CTW, Arlington, Mass., was able to work W8s NQD GZ UZ LPD, W9MFH, W0QIN, and VE3AET, with 8 watts input to a portable transmitter-receiver unit designed for civil defense communication! (This rig, now being duplicated in quantity in the Boston area, will be appearing soon in *QST*.) Your conductor was hearing Ohio, Indiana, Wisconsin, Minnesota, and South Dakota simultaneously, and the Middle West stations were hearing W7s on 28 Mc. We've worked plenty of double-hop DX in summer openings when conditions appeared less favorable.

W3OJU, Washington, D. C., comments on the frequent reception of VE9RA and VE9RB, the Canadian beacon stations just outside the low edge of the band. Though these transmitters are of moderate power, and use omnidirectional antennas that keep their effective radiated power well below that of most 50-Mc. ham stations, Rick hears them often, even when there is no indication of DX activity otherwise.

The tremendous coverage of the high-powered station on 49.8 Mc. has demonstrated that the average 50-Mc. amateur is a lot closer to DX conditions at all times than we have realized heretofore. Even taking the large difference in power and antenna between that station and the usual amateur layout into consideration, one has only to listen to the signal regularly to realize that a ham station running safely inside the legal power limit might also be heard over similar distances fairly often. If we who have 50-Mc. gear would put it on the air regularly in all seasons, instead of when we just happen to feel like it, all of us would find life on 6 a lot more interesting. It is nothing less than the *duty* of those of us who have a real and continuing interest in the 50-Mc. band to make better use of it than we have been. Let's get going *now* — don't wait until next May!

Here and There on the V.H.F. Bands

The choice of crystal and multiplier frequencies to be used in a crystal-controlled converter should be made with local TV channels in mind, unless one is prepared to do a TVI job on the stages involved. W2OWQ reports that he made large black bars on Channel 4 with the line-up (the 6BQ7 job for 144 Mc.) described in *QST* for September, 1951. The second half of the first 6J6 triples to 63.5 Mc., in the video portion of Channel 4. Running the stages at the lowest possible input, and some care in shielding and by-passing can get rid of the



W0ZJB.....48	W4IUJ.....38	W8BFQ.....39
W0BJV.....48	W4BEN.....35	W8LPD.....37
W0CJS.....48		
W5AJG.....48	W5VY.....47	W9ZHB.....48
W9ZHL.....48	W5GNQ.....46	W9QUV.....48
W9OCA.....48	W5JTI.....44	W9HGE.....47
W6OB.....48	W5ONS.....44	W9PK.....47
W0INI.....48	W5ML.....44	W9VZP.....47
	W5JLY.....43	W9RQM.....47
W1HDQ.....47	W5JME.....43	W9ALU.....47
W1CLS.....46	W5VV.....42	W9QKM.....46
W1CGY.....46	W5FAL.....41	W9ULA.....45
W1LLL.....44	W5NHD.....41	W9UNS.....45
W1KHL.....44	W5FSC.....41	
W1HMS.....43	W5ELD.....40	W0QIN.....47
W1LSN.....42	W5HEZ.....38	W0DZM.....47
W1EIO.....41		W0NFM.....47
	W6WNN.....48	W0TFX.....47
W2RLV.....45	W6UXN.....47	W0KXF.....47
W2BYM.....44	W6TMI.....45	W0JOL.....44
W2IDZ.....43	W6IWS.....41	W0JHS.....43
W2AMJ.....42	W6OVK.....40	W0PKD.....43
W2MEU.....42		W0HVW.....42
W2FEL.....41	W7HEA.....47	W0MVG.....41
W2GYV.....40	W7ERA.....47	W0PI.....41
W2QVH.....38	W7BQX.....45	
	W7DYD.....45	VE3ANY.....42
W3OJU.....45	W7JRG.....44	VE3AET.....35
W3NKM.....41	W7BOC.....42	VE1QZ.....32
W3MQU.....39	W7JPA.....42	VE1QY.....31
W3JVI.....38	W7FV.....41	XE1GE.....19
W3RUE.....37	W7CAM.....40	
	W7ACD.....40	
W4FBH.....46	W8NSS.....46	
W4EQM.....44	W8NQD.....45	
W4QN.....44	W8UZ.....42	
W4FWH.....42	W8YLS.....41	
W4CPZ.....42	W8CMLS.....41	
W4FLW.....42	W8RFW.....41	
W4MS.....40	W8LBH.....39	
W4XOC.....40		
W4FNR.....39		

Calls in bold-face are holders of special 50-Mc. WAS certificates listed in order of award numbers. Others are based on unverified reports.

trouble, or the alternative crystal-multiplier line-up described in September, 1950, *QST* and the 1951 *Handbook* can be employed. A shift in the intermediate frequency used will also frequently do the trick.

Organizing for civil defense communication is developing v.h.f. activity in many communities where there was no interest heretofore. W7OWF writes that the Richland, Wash., hams have decided to use the 144-Mc. band and are now in the process of getting ready for their first plunge into v.h.f. work.

About the middle of November, newspapers and several weekly news magazines carried stories of the first two-way communication between Cedar Rapids, Iowa, and Washington, D. C., by means of lunar reflection. Signals had been bounced from the moon before, of course, but these stations actually communicated by this means. Right away we began to receive letters asking why hams weren't doing it, too. The answer lies in the nature of the equipment involved. The frequency was 418 Mc.; the power output 20 kw. Huge high-gain arrays were used, and the receivers employed a degree of selectivity that few of us would care to attempt. Lunar communication may yet be accomplished by amateurs (144-Mc. signals have been received by that means, by hams, though we cannot disclose details at this writing) but don't expect to do it with a 5-element array and a 522. It is just within the realm of possibility on 144 Mc. with the legal amateur power limit, the biggest antenna system you can build, and receiver selectivity measured in *cycles*!

December came to an exciting close for 2-meter operators of several southern states. On the morning of Sunday, the 30th, W4HHK, Collierville, Tenn., was surprised to hear a Texas W5 working W5TTI, Jackson, Miss. Paul fired up immediately, and between 10:30 and noon he worked W5s AXV and BDT, Austin, W5QIO, Beaumont, and UB, San Antonio, Texas. Returning from work after midnight, Paul found the band still open and Texas stations coming through.

W4KQC, Tuscaloosa, Ala., worked W5s AJG CVW AXV ML NEY QFD AQS and DCV on the night of the 30th. W5ML, Oil City, La., knocked off W4s LRU and KCQ of Tuscaloosa, and FSW and FIG of Birmingham, as well as a long string of Texas and Mississippi W5s. None of these distances would be considered extraordinary in the warmer months, but 2-meter DX of 600 miles or more is big news in midwinter.

What was perhaps the first two-way radioteletype communication on 220 Mc. is reported by WICTW. W1KNW, Arlington, Mass., and W1WB, Belmont, made it two-way on 220 on Dec. 16th. The spot-frequency net in the Boston area is still going strong, with several stations ganging up on 222.7 Mc. each Sunday night at 8 p.m. An effort is being made to round up the Technician licensees to augment the 220-Mc. group.

To promote v.h.f. interest in Montana, W7MBV, Geraldine, Mont., is publishing a monthly paper called "Montana VHF." It is a nonprofit venture produced by mimeograph. Operating news, constructional hints and short articles are solicited. Subscription is 50 cents a year. Volume I No. 1 contains an impressive list of Montana stations now working on 6 and 2. To this list may soon be added W7JRG, formerly of Sheridan, Wyoming, now working in Billings, Mont. If Ken does as well in Montana as he did just a few miles south of the border, the other 50-Mc. stations in the state will have to look to their laurels. Montana is the one remaining state that nobody east of the Alleghenies has ever worked on 6.

Utah is also a distinct rarity, a condition that may be corrected by W0FKY. Formerly W4LVA, Harold is now operating on 6 in Grand Junction, Colo., only a short distance from the Utah border. He plans to do some portable work on the Utah side this coming spring and summer. Hal had an interesting opening to W7 and VE7 on Dec. 27th.

W5ML, Oil City, La., says he is having a hard time finding activity on any of the v.h.f. bands during the winter months, but there is a lot of v.h.f. talk on 75! He and W5DXB fired up on 420 Mc. and had a fine circuit on that band, but they couldn't attract any others. Their gear is ready to go at any time, however, if there are other interested parties.

In the midst of the usual complaints of low wintertime activity it is refreshing to hear that one area has experienced an upsurge. Rochester, N. Y., and vicinity is showing real progress, particularly on 144 Mc., according to W2ZHB. A factor in this coming alive is certainly the WAR certificate offered by the Rochester V.H.F. Group. This award, details of which were given in June, 1951, *QST*, page 54, has been issued to 15 operators in Toronto, Buffalo and Lockport. One Rochester operator, W2YUE, has just completed his required 25 contacts with an input of one watt. The V.H.F. Group is sponsoring a series of "WAR Nights," beginning February 19th and 22nd, during which the Rochester area stations will be out in force to give everyone a chance to round out his total.

Despite lack of any recent DX openings, activity is at an exceptionally high level. Several Novices have appeared on 2, and new stations are showing up in the rural areas of Western New York. W2SPU/2 is in operation from a 1900-foot elevation near Moravia, and though he is 75 miles from Rochester his signal is a steady S9.

More radioteletype reports continue to come in. W9TQ, Milwaukee, rewired his keyboard, and then got acquainted with the polar relay and its functions, with the help of W9SKF. A selenium rectifier power unit is now supplying the 120 volts d.c. needed for the printer magnets. His AFSK system should be working and the set-up ready for attended operation by the time this appears in print. Auto-call operation will follow shortly thereafter.

W9LEE, Westboro, Wis., reports continued success through early December in daily 2-meter skeds with W0BBN, Grand Marais, Minn., at 0745 and 2100. Signal-strength variations over this 190-mile path appears to follow a 10-day cycle. W9LEE recently finished a new 6BQ7 converter (September, 1951, *QST*) that is giving excellent

results. W9JBF, Wausau, and W9DSP, Chippewa Falls, also join in the skeds with W0BBN.

At least two hams in Portsmouth, N. H., would like to remind the fellows to the south that there is 2-meter activity in their state. WITTT and WILMD are doing their best to interest others in 2-meter operation, but they would have better luck if they could point to regular contacts with the Massachusetts gang. They are active on 2 nightly and would be glad to keep skeds with interested parties in any direction.

As you read these lines most of us will be in the process of recovering from a big week end of v.h.f. activity — the 5th Annual V.H.F. Sweepstakes. Once again we will have seen that concerted effort by many radio clubs and individuals can turn out a surprising number of 6- and 2-meter operators, even in the midst of winter conditions. Almost without exception we will have made contacts that would not have been possible again before next summer, but for the incentive afforded by the contest.

The week end of operating fun will have been an end in itself, but it can serve a much more important long-term purpose if we choose to make it do so. Not many of us want to do that much hamming every week end, but almost all would like to be able to make contacts on the bands of our choice more often than we do. Coordinated operating programs, a few regularly-kept schedules, and a resolution to transmit as well as listen could help to maintain a considerable portion of the activity that our v.h.f. contest always thaw out.

Eighteenth Annual ARRL DX Contest

'Phone: Feb. 1st-3rd, Feb. 15th-17th;
C.W.: Feb. 29th, Mar. 1st, 2nd, Mar. 14th-16th

Amateurs everywhere are invited to take part in the 18th Annual ARRL DX Competition. There will be two week-end periods devoted to c.w. participation and two to 'phone. Special certificate awards will be given to the highest-scoring c.w. and 'phone stations for each country and each continental U. S. A. and Canadian ARRL section entered in the contest. Operators outside the U. S. and Canada will attempt to work as many W, K, VE and VO stations as possible. Exchange of serial numbers will be required. Complete rules and details on scoring appear on page 36 of January *QST*.

The contest periods will be divided for c.w. and 'phone as follows: first 'phone period will begin on Feb. 1st at 7:00 P.M. EST and end on Feb. 3rd at 7:00 P.M. EST. The second 'phone period will be scheduled during the same hours from Feb. 15th to 17th. The first c.w. period will begin at 7:00 P.M. EST on Feb. 29th and end at 7:00 P.M. EST Mar. 2nd. The second 'phone period will be scheduled during the same hours from March 14th to 16th.

Though not necessary for entry in the contest, ARRL will supply convenient report forms upon request. You may make up your own forms following the samples shown in last month's complete contest announcement. If you request report forms from Headquarters, please indicate whether you plan to enter the c.w. section, the 'phone section, or both.

How's DX?

CONDUCTED BY ROD NEWKIRK,* W9BRD/1

How:

It's here again! It didn't take as long to roll around as we thought it would, did it? We mean, of course, our annual DX jamboree, the 18th ARRL International DX Competition.

As seems always to be the case, we'll wager many of the gang allowed procrastination to force them into much last-minute antenna erection and selectivity-sharpening. Are you ready for the zero hour?

Although the general outlook is for spotty h.f. conditions, this factor may not cut scores greatly. The top-layer guys seem to have the habit of exerting extra effort in one way or another to compensate for punk propagation possibilities. We expect the last drop will be squeezed from our lower-frequency bands unless Ten and Twenty should suddenly experience a remarkable renaisance. By this means the long-wire contingent may have a chance to crack back at night for 10- and 20-meter rotary beam shortcomings.

From whichever angle you intend to tackle this activity—big score or new countries or other—may luck be with you. You'll undoubtedly need your share!

What:

Twenty the Terrific has been hard at work earning its new reputation, Twenty the Terrible. Nevertheless, it occasionally forgets itself and turns red hot for short unpredictable periods. K2BU found ZD2DCP (14,082), VP8AO (002), VQ2AB (008), VS7NG (068) and ZP5BA (020) to his liking. Ken runs 400 watts to 812As VQ2JG (VF0), VQ3BNU (060), EA9AC (105), FD8AA (067), FY7YB (012), 9S4s AL (041) and AR (030) assisted W3MDE to reach 126 W8UPN finds the band hottest around breakfast time. Newt wrapped up VP1NW/2 on Grenada (095), VQ2s GW (017) WS (100), VQ4DO (060), VP8AP (080), SP3PF (020), VU2s EJ (010) JG (050), FD8AA (017), FF8AG (020), OQ5RA (015), KB6AQ (021), JA7FH (024), ZE3JP (035), ZS3s Q (033) and R (044) XE1SA took time out from his QSL manager duties to snare VK9XK (127), OA4A (020) and a JA2 While stamping out TVI in the new QTH, W9HUZ encountered HZ1HZ (100), FF8AC (065) and some VQ specimens W1APU got up on the right side of his bed to work PX1AA. He was pleased to hear G6QB inform him that the PX1 was a DL4 and all okay MP4KAE (045), EA8s BE (064), BF (020), AP2K (037), XZ2EM (029), VS7NG (072), ZD6DU (050), F9QV/JC (093) on Corsica, VK1WO (094) of Macquarie and FD8AB (022) enhance W5ASG's log. Bill has it that FD8AA is FD8AB's boss on the job in Lome From WHCP we hear that VS7ES arranges to be on 14,064 kc. daily at 7:30 p.m. EST. Join the chorus PFC Bud Rugel, awaiting his DL4 permit, hears interesting stuff in Boeblingen, Germany: LZ5LL (190), UH8KAA, UF6KLF, UD6BM, UA9OM and UG8KAA W9NN found time to work VR2BW, VQ4HJP (020) and KT1OC (001) while new neighbor W9WEA broke the ice with OX3CG In Carolina, W4KE had success with FQ8AE (070), HC2KB, OQ5RA, CR7s AF CI, an SP3 and VQ4 A vertical dipole fan, W3MFW

has something to show for it: EA0s AB AD (070), VS6CG (065), TF3s AG AR SF, VK9XK (010), ZB2A, ZD2HAH, IS1FIC (096 t7), F3AT/FF8, IIRC/Trieste, VQ4BB (040), YS10, YU3AB, VP5BF of T.&C. and ZB1GKU VK1BS (055), VU2s CP (035) NH (057), IS1CNG, VP8AU (002), VQ4s CM FCA, VP2AF, KB6AQ (112), FB8BB (020), ZD1AN and 4X4RE spiced up the collection at W8TKX Almost anything else on the air lately can be found in this roster provided by W5KUC and the West Gulf Division DX Club: A.M. — CK1YP on Formosa, CR8AE (040), EQ3UD (019), F7S5P (050) at SHAPE Hq. in Paris, FK8AH (090), FF8AB (010), FN8AD (115), FR7ZA (115), GC5s OM (040) OU (025), GD3GBG (059), HZ1s AB (055) AR (020) FH (082) TL (185), HH2LD (020), KB6AF (030), KT1LM (060), W2BXS/KJ6 (020), LZ1RF (008), MI3LK (121), OY3IGO (050), OE13SC (132), SP5-KAB (020), ST2GL (021), SU1s GO (040) HJ (060) XY (008), TF3s MB (010) NA (040), UA9FR (078), UO5KAA (089), VQs 2AT (035) 4AO (062), VRIAA (070), VS1s EO TA (035), VQ8s AD (016) CB (018), VU2s BC (060) CB (105) CR (097) CS (070) EC (030) EH (045), YI3s BZL (060) ECU (035) EFE (060), YU8 1AG (011) 1AD (015) 3FMC (030), YO3s AF (053) RD (040), LB6XD (030) of Jan Mayen, ZA1A (040), ZB1HF (085), ZDs 1AJ (009) 4AB (080) 7AB (045), APs 2N (120) 4A (050), 3V8AN (087), 4X4s BA (005) DE (029) DF (060) DK (022), 9S4AL (059); P.M. — AG2AG (008), CT3s AA (045) AN (050), CRs 5AD (070) 7BC (014), EA9AP (002), ET3Q (010), FF8AB (030), GC2FZC (084), DU1DO (052), KM6AX (095), KW6AR (100), M13US, OQ5s CP VN, VQs 4RF 4MS (030) 4ERR (023), VP2s 2MD (003) of Montserrat in the Leewards, 8AS (030), ZK1AB (035), ZDs 4BD (040) 1FB (150) 2FB (050), ZP6CM (073), ZS3s K (070) Q (025), FF8AF (040) and 8W4AF in Yemen. How do you like that F7S5P moniker?

With the twenty 'phone adherents, we note that CR6s AL (350) AV (351), EA8AX (318), ZP9CM (145), KT1DD (352) and CR7SF (235) were made welcome by W5ASG XE1AC gave the key a rest to modulate for HC8-MM (370), I1YAK/Trieste (195), OK1HI (145), Y03RI (125), KT1PU (370), FR7ZA (388), MI3BH (186), VU2FH (125), YI3BZL (172) and 3A2AP W8TKX knows when to switch to 'phone; Bud couldn't find these countries on c.w. — HI6EC (172) and ZP4BB (340) CR7s AD (140) CF (152), FA8CF (345), OQ5DZ (145), PZ1WK (375),

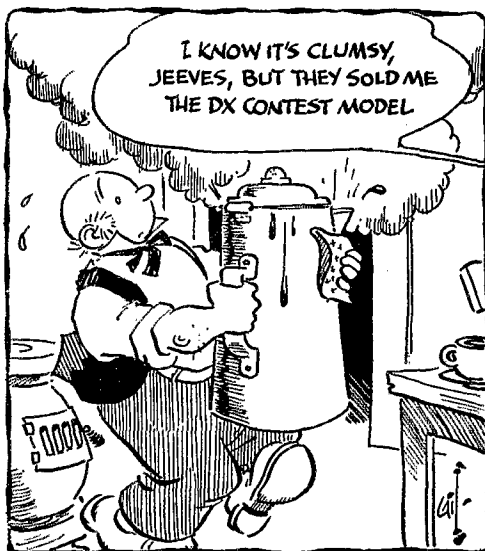

* New Mailing Address: Effective immediately, please mail all reports of DX activity to DX Editor Newkirk at ARRL Headquarters, 38 La Salle Rd., West Hartford 7, Conn.

160 FLASH!

On Dec. 31st at 6:45 A.M. CST W9CVQ and ZL1AH achieved two-way contact on 1.9-Mc. c.w. Tests are continuing.

VP2DB (150) of the Windwards, VQs 1RF (360) 2DW (160) 2JG (145) 5AU (148) and ZE1JX (355) put good signals into Illinois, according to W9BAE. W8UPN grabbed VP5BF (190) of Turks Isle as well as TF3MB (095) The *D X Bulletin* by W5KUC points out CS3AB (320), CRs 4AD (380) 6CC (188) 6AJ (295) 7SF (235), CN8FI (350), EL5A (330), EQ3FM (350), FQ8AI (380), GD3ENK (320), HC8GI (165), HR1LH (250), HZ1s TL (185) AB (320), ISUS (390), JY1XY (350) in Jordan, KJ6AP (294), KT1DD (352), MD2JB (389), MI3s LV (350) NA (310), MP4KAF (352), TA3AA (350), VPs 2AF (296) 3HAG (150) 7NM (190), VQs 2DT (324) 4RF (379) 8AL (360), YU1AV (145), ZPs 7AW (120) 9CM (145) and ZS2MI (350) on Marion.

Forty is having a tough time filling the shoes of twenty during wee hours but it's trying. W9HUZ found KM6AX (7040), VK9XK (010), VP8AI (010), OHs 2RB (021) and 5NK (013) available. KV4AQ answered W8FRD's 6L6 and W9ESQ ran off with CN8BJ, OX3GD and VR2AS. W2DOD is easily recalled as ex-8DOD. Elmer hit the band for YN1OC, YO2BU, YI3ECU, MD2PJ, LX1FB, ZK1AZ, EA9AP, EA8BF, VP8AP, OQ5RA, ZE2JN and VQ4HJP with a BC-459. All on the lower 35 kc. of the band. W4QCW raised FA8DA, KG6-FAA, VPs 5BN 7NW 9AL, TI2PZ and YV5AL. YU2AKL and 4X4RE didn't take Bob's bait. The *D X Bulletin* adds ZS3K (010), FQ8AG, F9QV/FC (040) and ZD6DU (030). W2BXS/KJ6 interrupted W8IQS in Flint.

Even inveterate traffic men take a whack at eighty DXing at this time of the year. A spark or two may fly when a rare one pops up near a net frequency but that's life for you. Most of the stuff is found in the lower 30 or 35 kc. FA8BG was W8FRD's 4th continent on 20 watts. FA9RZ and KS4AQ came back to W4KE while XE1SA was working KH6PL. Even the Novices are getting into the act. Here is WN4TKD snagging KS4AQ and WN4TRP getting CO7AU and KP4PZ. Don't tell us only 4th call area WNs can work DX! VE1JD has this 3.5-Mc. situation down pat. Here is his low-edge listing: Gs 2BJY 3AAM 3BKf 3FGT 5DQ 5JU 5UM 5VB 6QX, DLs 1EL 1VU 4MF 7AH, PA6s LB OA NG, EIs 2S 9J, OK1AWA, SM4GL, GT4QY, FA8RJ, YN1AA, EA4CN, ON4HC, M7AT, CT1SQ, 3A2AG and VP5BF. OQ5BC and PX1AA were two big ones that got away.

There are a lot of frustrated ten-meter beams sitting around unless our mailbag has a leak. On 'phone, the *D X Bulletin* lists EA8AX (28,305), ZD1SW (500), MI3DW (355) and MD2AM (350); FF8AE (005) was on c.w. Also on A1, VK9XK was chased down by W9HUZ while W4KE worked HC2KB, CR6BC and CR7AG.

W1BB keeps us informed of progress in the DX tests on one-sixty. In what was evidently the first transatlantic of the season, VE1EA and G3PU swapped reports in late November. W1BB clicked in mid-December with GW3ZV. At Christmas time W1BB hooked GW3FSP, G5JU and G6GM; W9CVQ also struck oil by working GW3FSP and G5JU on December 23rd. All hands were in there digging for ZL1AH (1900.5) whose signals were only at times audible.

Where:

DX stations or DX-working stations should keep in mind a few things when preparing their QSLs. It's downright tragic to receive a rare card that doesn't bear the necessary data for DXCC accrediting. The QTH of the confirming station, the call signs of the confirmer and confirnee, the year and date of QSO; these items are just about the bare minimum. There should be no doubt that the card is a confirmation rather than a "heard" card. If confirming a 'phone contact it should state so. Not necessary for DXCC but highly desirable are entries of signal report, time (local or otherwise) of QSO and the frequency band used. KW6AR will act as QSL manager for Wake Island henceforth. His address: Ivan C Lundblom, CAA, Wake Island.

AP2K (QSL via DARC)
 CS3AB Lagens MATS, Terceira, Azores, APO 406, % PM, New York, N. Y.
 DL4IE Capt. A. W. Borgia, Hq. EUCOM Sig. Div., APO 403, % PM, New York, N. Y.
 EA8BF (ex-EA8MC) Manuel Censalmor, Box 8, La-guana, Tenerife, Canary Islands
 EA0BH (EA4BH, QSL via URE)
 HB9LA Pierre Essinger, 10 Chemin de la Bateliere, Lausanne, Switzerland
 IO1MD/Trieste Giuseppe Glessi, Strada per Longera N. 179, Trieste
 JA7FH APO 75, % PM, San Francisco, Calif.
 KB6AQ % PAA, Canton Island
 KB6AT U.S.P.O. X3010, Canton Island
 KM6AX Box 24, Navy 3080, FPO, San Francisco, Calif.
 LB6XD (QSL via NRRL)
 KT1OC (W7IOC) Henry B. Poole, jr., % American Legation, Tangiers
 MP4KAF Box 54, Kuwait, Persian Gulf
 OQ5PE (QSL via OQ5RA)
 OX5EL Eigel Larsen, Danish Leigthaus Service, Loran Station, Fredericksdahl, Greenland
 PX1AA (QSL via DL4 QSL Bureau)
 ST2EB (QSL to VQ5AU)
 VP1NW/2 (QSL via VP1AA)
 VP7NW (QSL via W3MAI)
 VS9MA 4037746 S.A.C. West I, % RAF Unit Trans-mitting Station, Ryian, Aden Command, Aden
 XE4PK (QSL via XE1SA)
 YI3EFE (QSL via G3EFE)
 ZD2FFB Brewer, % P&T, Enugi, Nigeria
 ZP7AW % American Embassy, Asuncion, Paraguay
 ZP9CM (QSL via ZP5BA)
 3A2AK (QSL to F8BS or F9LQ)
 3A2AP (QSL via DL4 QSL Bureau)
 8W4AF Director of Harbourage, Port of Mocha, Yemen

For these we owe W1RWS, W3QLC, W4CYY, W5KUJ, W6BES, W8UPN, W9CFT, W9HUZ, W8TKX and W5-KUC's *D X Bulletin* a large vote of thanks.

Tidbits:

New prefix assignments have been announced as follows: AMA-AOZ — Spain, JYA-JYZ — Jordan, JZA-JZZ — Netherlands New Guinea, 3WA-3WZ — Viet Nam, 4XA-4XZ — Israel, 4YA-4YZ — Organization of International Civil Aviation, 5CA-5CZ — French Morocco, 9AA-9AZ — San Marino, 9NA-9NZ — Nepal, 9SA-9SZ — Saar. Call signs grow more weird by the day! From W0DEI we hear VQ5AU has taken a portable rig along on a hunting trip to last through several months. Operation on 20, 40 and 80 c.w. is intended. He'll be using the call ST2EB. Surprisingly enough, we receive questions on how to go about applying for DXCC after accumulating the necessary

Cold and remote, this cluster of buildings housed the equipment of LB5ZC on Jan Mayen, operated late last year by Bjorn Augdahl. LA5ZC. (Photo courtesy W1FH)

QST for





YUIAD runs 150 watts to an 814 and has worked over 150 countries, 71 on 'phone. He uses separate dipoles for each band and has a ground plane for 28 Mc. You may have worked him under his former call, YUICAE.

100 QSLs. Nothing complicated. Just mail your cards to ARRL Hq. for the attention of W1RWS. Enclose therewith a checked-off Countries List. You'll facilitate things for John by stacking the cards in Countries List order. Never fear, they'll be returned. Don't neglect to take all precautions in the mail, too. Also, as there is a certain average percentage of QSLs in everybody's collection that do not qualify for DXCC credit, we suggest you wait until 102 or 103 cards are on hand. That may eliminate extensive correspondence and delay of your award. By the way, DX Century Club rules in detail are available to anyone upon written request The "buddy system" and "phone-to-c.w. QSOs for 'phone DXCC credit get a good going-over in a letter from W3MFW QSLs for OQ5AA were being printed in Belgium and the resulting delay caused distress for OQ5RA. Andy will get these underway as soon as possible Arie Bles, PK4DA, possibly the best known DXer and v.h.f.-er in the Indonesian area, is leaving that base in March. He will stop over in Australia for a bit and then will head for this country, expecting to reach San Francisco in early May. He desires to visit as many amateurs and clubs as he can. When his itinerary is better established we'll pass along the pitch. This via W1HDQ W8DAW perspired at length for a Cyprus QSL and then received three at once. It was ever thus. ZC4TF has pulled the switch for leave in the U. K. and anticipates reassignment to another rare-DX spot soon W1AW (Chas) received word that VR5GA now awaits a ZL1 label in Auckland and wants to thank the W and KH6 boys for their cooperation and good fellowship on the air during his Friendly Islands sojourn One of the old British stand-bys is on the move. George Elliot, G5LI, is to set up camp in Montreal where he will take on another engineering job. Some pretty stiff competition coming right into our own back yard! We'll give you G5LI's new VE2 call as

◆
 This gathering in Rabat included French Morocco DXers (front, l. to r.) CN8s EG EQ MZ and AQ; (rear) CN8s EY CP MR BR and CR. CN8MZ and CN8BI are inspectors of DPPT which corresponds to our own FCC. The former is also president of the AAEM society. (Photo courtesy CN8EG)
 ◆

soon as available. Needless to say, George will thereafter be open for business looking for old on-the-air pals W0ELA wasn't able to carry through his plans for VS4/VSS hamming on his recent Far East junket but he did get on the air while visiting the VS6 gang. "I was amazed at the absence of W signals on the 14-Mc. band. Throughout my entire stay in Hong Kong, I heard only three W stations." Clyde will try again next spring to put Borneo, Brunei and Sarawak on the air and conditions by then should be improved. "On the trip just completed covering a total distance of nearly 25,000 miles, I had the opportunity to meet many very fine DX men who are not only good radio men but also leaders in their communities. It should be mentioned that their hospitality could not possibly be exceeded anywhere." Ex-J2NG is now studying at Ohio State U. and will remain in the States until next summer. J2NG was widely worked during the prewar period and Harry would appreciate hearing from the Old Gang personally or by mail. Write: Harry Yoned, 950 River Road Dorm., Columbus 10, Ohio W9KXX, assisting W9CFT at the W9 QSL Bureau, finds Illinois and Indiana DXers receiving about 80 per cent of incoming pasteboards there. Perhaps the Wisconsin mob makes it up in quality John Van Lear, who used to operate at VE7AKO, holds the call FP8AE and has intentions of using it this summer. He didn't make St. Pierre last year as planned The operators of YJ1AB (1947) and VR1G (April, 1951) are sought by W5ASG. Guess why Zoölogists, botanists, geologists and archeologists will descend on the Mexican islands of Revillagigedo in an expedition that was to have left in December. XE1FK will be along to man the key of XE4PK "on all bands, 'phone and c.w." It is doubtful that this will constitute a new one for the Countries List but the station is the first to be licensed with the XE4 prefix. A VFO rig running up to 200 watts will do the job. All cards sent via XE1SA will be answered; SWL cards must be accompanied by reply coupons WIA's *Ama-aur Radio* quotes an English source to say that UP5A, UP3PA and UM8KAA are now the only U.S.S.R. stations permitted to QSO foreign countries. The reason for the general ban is obscure at this writing although it is thought to stem from Russian monitoring of illegal transmissions by U stations. This will make DXCC no easier to obtain! Ex-PK1MJ is back in Holland after having lost his entire radio installation in leaving the Indies. He'd like to hear from some of his old contacts who may write: Rudy de Neef, 5 Floris Grijp straat, The Hague, Holland. W0TKX discovered that OX5EL is ex-OY5EL and also that MD2JB is getting set to close down. Bob could use some tracing data on JA0IJ, ST2MN and ZD1AN A friendly group at the U. of Minn. is gathering equipment to hit the air. They would be W0s FID SZM, KH6s AFV OJ and ex-DL4HU. W0FID has just assembled the required cards for DXCC from his home location in Rochester HE9R "calls" are held by Swiss SWLs. HE9LAA is the only transmitting HE9 to our knowledge There is doubt about the status of some of W2BXS/KJ6's QSOs. He may have rolled up some of them while on board ship. These would be taboo for DXCC, you know W5KUC, who puts out the dandy bulletin for the West Gulf group, has a new ham in the family. The XYL's studious efforts netted her the call W5UCQ. She really digs in on that bulletin, too.

◆◆◆

Jeeves wonders if it's true that the U.S.S.R. hams now use iron wire in their Sterba Curtains.



A Mobile Installation for 10 and 11 Meters

Converter and Remotely-Controlled Transmitter from Surplus Gear

BY GEORGE J. GABERT,* W9JM

AFTER giving considerable thought to a mobile transmitter and receiver, we made up a set of standards as to what our 10-meter mobile rig should be like. We decided that the transmitter should have a VFO so as to be able to QSY to any part of the band, that all tuned circuits of the transmitter should be ganged to the VFO for one-dial control and easy tuning, and that it should be possible to set the VFO to any frequency with a reasonable degree of accuracy. The converter was to be made as compact as possible with the transmitter controls built into the same housing. The receiver was to be provided with an S meter, as an aid in giving signal reports, along with a good noise silencer. We proceeded to lay out and build our mobile equipment and, as the following description shows, we followed out this set of standards. Although the equipment, built chiefly from surplus parts and units, is modest, the results have far surpassed all expectations.

The equipment consists of two units, aside from the power supply. The first is a control unit mounted on the dashboard, immediately above the car's b.c. receiver. The second is the transmitter mounted on a shelf over the rear fender well of the author's station wagon. The control unit houses the converter and also remote controls for the transmitter, including frequency control for VFO operation. Thus all necessary controls are grouped at one point, which is a decided convenience.

* 834 North Third Ave., Sturgeon Bay, Wis.

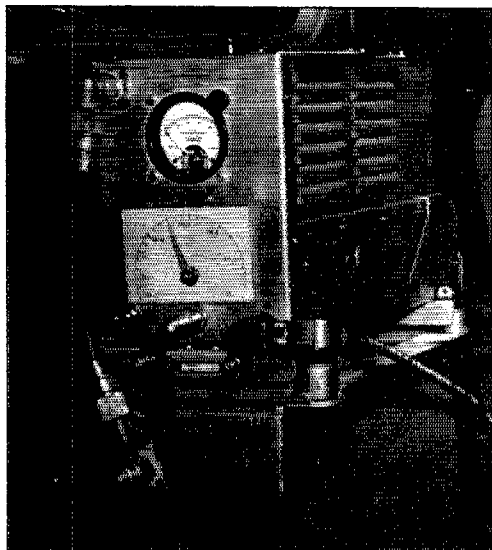

• W9JM describes here the mobile equipment with which he made the first mobile WAS — all on 10 meters. The VFO rig, a revamped Command transmitter, is remotely controlled from the dashboard. While you may not wish to duplicate the installation in all details, you will find many interesting and useful ideas that you can apply to your existing equipment.

The Converter

The housing for the control unit is a metal box $6\frac{1}{2}$ inches long, $4\frac{1}{2}$ inches high and 3 inches deep, although a standard box approximating these dimensions would serve as well. The circuit of the converter is shown in Fig. 1. It consists of a 6AK5 tuned r.f. stage, a 6BA7 mixer, and a 6C4 h.f. oscillator. The converter feeds the b.c. receiver by capacitive coupling through a short length of high-impedance coax cable. A toggle switch, S_1 , shifts the b.c. input from the converter to the antenna for broadcast reception. The converter covers the range of 26,900 to 29,700 kc. The tuning of the three stages is ganged through the use of a triple-unit tuning condenser. The oscillator plate voltage is regulated. A relay, controlled by the push-to-talk switch at the microphone, removes plate voltage from all but the h.f. oscillator during transmissions. The arrangement not only keeps the h.f. oscillator running to minimize frequency drift, but by tuning about 50 kc. away from the transmitter frequency, the transmitter can be heard with an S3 signal, permitting accurate monitoring.

The converter is built into the left-hand side of the control unit. The coils used are wound on slug-tuned forms. This makes the circuits easier to line up for tracking. The tuning dial and gears

◆
The transmitter is mounted over one of the rear fender wells of W9JM's station wagon. The revised Command unit is fitted with a new panel and a homemade calibrated dial is substituted for the original. The antenna relay is in the small box underneath. At the bottom of the panel, the cable at the center goes to the microphone. At the right is the flexible shaft for the remote VFO tuning control. A pair of surplus right-angle gear units avoids the necessity for a sharp bend in the control cable.
◆

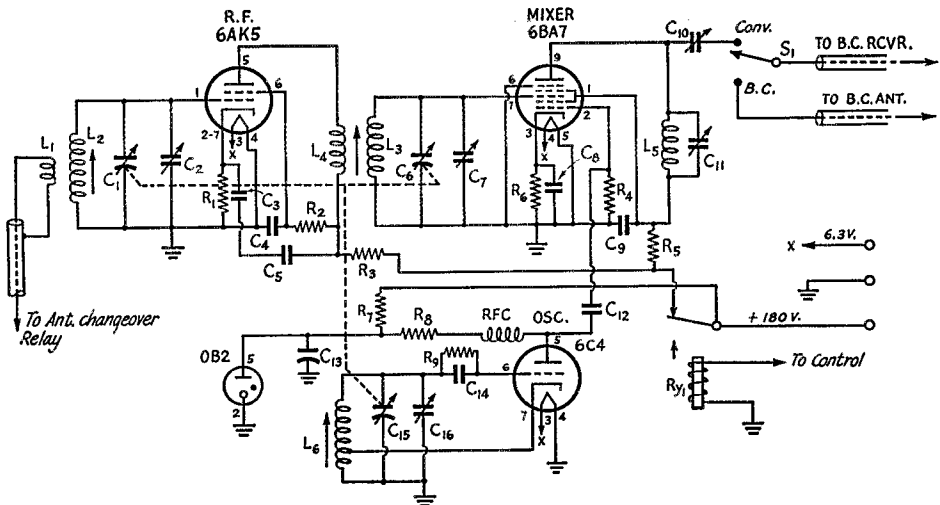

Fig. 1 — Circuit diagram of the mobile converter for 10 and 11 meters.

- C₁, C₆, C₁₅ — Triple-unit variable, 11 μ fd. per section (Bud LC-1845).
- C₂, C₇, C₁₀, C₁₁, C₁₆ — 30- μ fd. mica trimmer.
- C₃, C₄, C₅, C₈, C₉ — 500- μ fd. ceramic.
- C₁₂ — 10- μ fd. ceramic.
- C₁₃ — 0.01- μ fd. paper.
- C₁₄ — 50- μ fd. mica.
- R₁, R₆ — 100 ohms, $\frac{1}{4}$ watt.
- R₂ — 47,000 ohms, $\frac{1}{4}$ watt.
- R₃ — 10,000 ohms, $\frac{1}{4}$ watt.
- R₄, R₉ — 22,000 ohms, $\frac{1}{4}$ watt.
- R₅ — 1500 ohms, $\frac{1}{4}$ watt.
- R₇ — 35,000 ohms, $\frac{1}{2}$ watt.

- R₈ — 75,000 ohms, $\frac{1}{4}$ watt.
- L₁ — 13 turns No. 26 d.s.c., $\frac{1}{2}$ -inch diam., close-wound on Millen 69046 iron-slug form.
- L₂ — 2 turns No. 32 d.s.c. below L₁ on same form, windings spaced $\frac{1}{8}$ inch.
- L₃ — 12 turns No. 26 d.s.c., $\frac{1}{2}$ -inch diam., close-wound on Millen 69046 iron-slug form.
- L₄ — 9 turns No. 32 d.s.c. below L₃ on same form, windings spaced $\frac{3}{16}$ inch.
- L₅ — Midget broadcast r.f. coil to tune to 1600 kc. with C₁₁ — approx. 360 μ h.
- L₆ — 12 turns No. 26 d.s.c., $\frac{1}{2}$ -inch diam., close-wound on Millen 69046 iron-slug form, tap at 4 turns from ground end.
- R_{Y1} — S.p.d.t. relay (12-volt).
- S₁ — S.p.d.t. toggle switch.

for the converter control, as well as similar items for the VFO remote tuning control, were taken from the control box of a BC-450A and the condenser drive gears for the converter are from the Command receiver itself.

A very useful adjunct to the receiving system is the addition of an external S-meter connected in the b.c. receiver circuit as shown in Fig. 2. The meter is mounted in a small case on top of the control unit and is used not only for checking incoming signals, but also to set the VFO to the

frequency to the receiver's calibration. The converter dial was calibrated with a 100-kc. standard. Those who are not familiar with the process of lining up a superhet are referred to the ARRL *Handbook* chapters dealing with receivers and mobile equipment.

In adjusting the coupling between the converter and the b.c. receiver input, the coupling condenser, C₁₀, should be set so that maximum response of the received signal shows on the S-meter without disturbing the tuning of the

The control panel includes the converter whose dial is to the right. The dial to the left is the remote VFO tuning control. The switch in the upper right is for turning filaments and relay circuits on and off and switching the VFO to low voltage while setting frequency. The toggle at the center switches the b.c. input from the converter to the antenna. The third switch turns the converter on and off. The dial lamps are homemade, using grain-of-wheat bulbs.

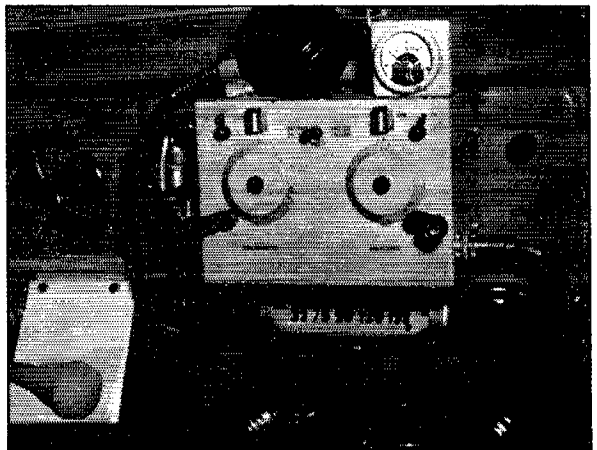

Voltages to ground measured with a
20,000-ohms-per-volt meter

Oscillating plate	150
Doubler plate	275
Doubler screen	160
Final plate	500
Final screen	200
Modulator plate	500
Modulator screen	410
Doubler bias	- 90
Final bias	- 80
Modulator bias	- 42
Modulator plate current	54 to 59 ma.

b.c. receiver input circuit. The latter can be checked by varying the r.f. trimmer in the car-receiver antenna circuit while switching back and forth between the antenna and the converter. The correct adjustment for C_{10} is one that makes it unnecessary to readjust the antenna trimmer of the b.c. receiver for maximum signal whether the converter is switched in or out. Each change of C_{10} will require readjustment of C_{11} to keep the output circuit tuned to the i.f. which, in this case, is 1600 kc.

Transmitter Circuit

The transmitter is a converted BC-458A. The revised circuit is shown in Fig. 3. A 14-Mc. high- C Hartley VFO drives a 12A6 doubler and this stage drives the 1625 final on 10 and 11 meters. The plate voltage of the VFO is regulated by the VR-150. Inductive coupling is used throughout and the tuning condensers are ganged to a single control. R_{y1} is the antenna change-over relay. It also shorts the input of the converter in the transmitting position. The winding of this relay is in series with the dynamotor negative high-voltage lead, so that the relay is operated automatically whenever the dynamotor is turned on or off. The negative terminal of the dynamotor should not be grounded except through the winding of this relay.

The audio section consists of a carbon micro-

phone, a 12SF5 speech stage and a 1625 modulator. Since no information could be found on the operation of the 1625 as a Class A amplifier, a test circuit was set up using variables to get the plate current to remain steady. Bias for the modulator tube is obtained from the voltage drop across the winding of the changeover relay, R_{y1} . An audio gain control was not found necessary. If desired, some change in audio output can be obtained by altering the microphone battery voltage. In this instance a single No. 2 flashlight cell, mounted in the FT-234A connector box, proved to be adequate for the WE F-1 microphone.

A milliammeter is provided in the plate circuit of the final amplifier for checking resonance and loading. Power input to the final amplifier is held to 30 watts.

A rather novel innovation is an arrangement for reducing VFO power for frequency setting.

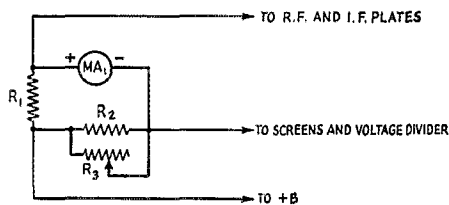

Fig. 2 — Circuit of the S-meter added to the car receiver.

R_1 — 270 ohms.

R_2 — 330 ohms.

R_3 — 1000 ohms, variable.

MA_1 — D.c. milliammeter, 1-ma. scale.

In the upper left of the control-box panel is a three-position switch. In one position, the switch turns on all filaments and sets up the relay circuits ready to be operated by the push-to-talk switch on the microphone. In a second position, these same circuits are held closed, but the relay of Fig. 4 is operated. This switches the high voltage off, but switches the low-voltage tap supplying the VFO to the positive terminal

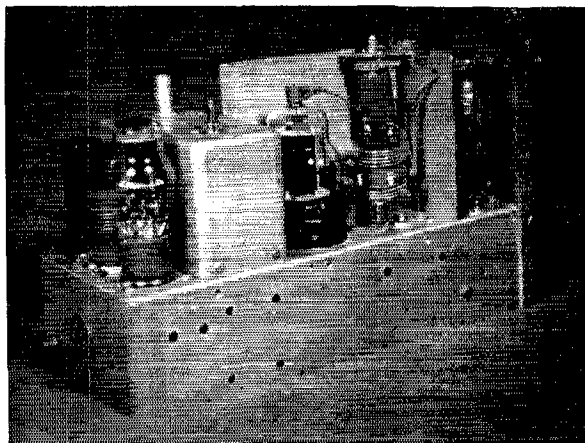

The r.f. section of the transmitter. Across the rear are the doubler tube, the doubler coil and the oscillator tube. The oscillator coil and padder condenser are in the box. In front of the box are the final-amplifier tube and tank coil, the antenna tuning condenser and the VR tube.

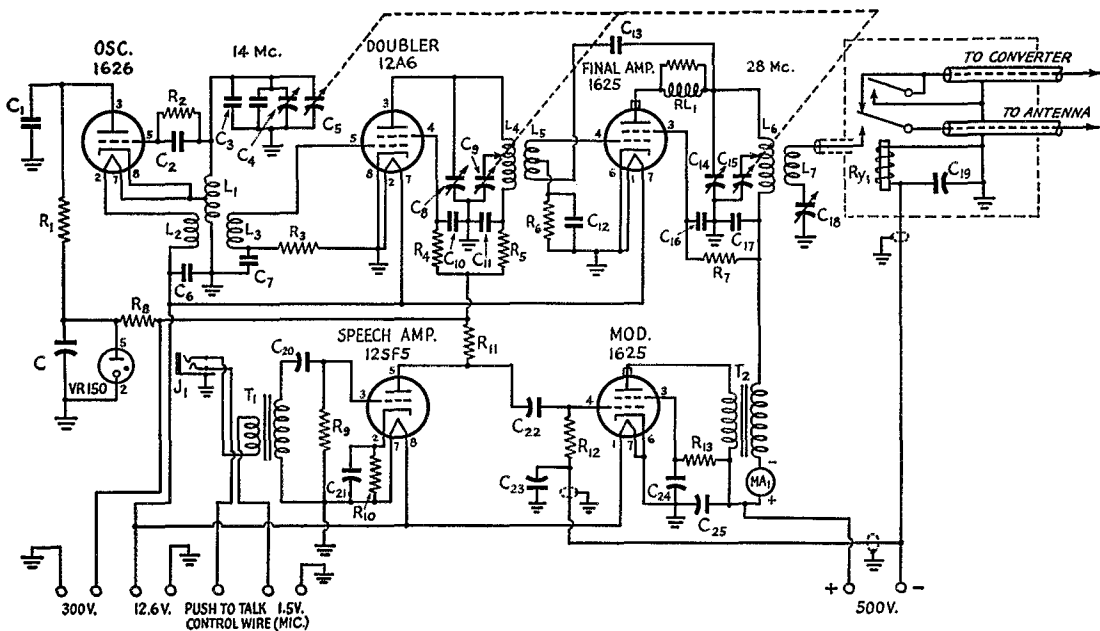

Fig. 3—Circuit of the 10-meter mobile rig, rebuilt from a Command transmitter.

- C — 10- μ fd. 250-volt electrolytic.
- * C₁, C₇, C₁₂ — 0.05 μ fd. (triple unit).
- * C₂ — 180- μ fd. mica.
- * C₃ — 3 μ fd.
- * C₄ — Oscillator padder.
- * C₅ — Oscillator tuning condenser (see text).
- * C₆ — 0.006- μ fd. mica.
- C₈ — 25- μ fd. midjet variable.
- C₉ — Doubler tuning condenser (see text).
- C₁₀, C₁₁ — 0.005- μ fd. mica.
- * C₁₃ — Neutralizing condenser (plates opened to half original capacitance).
- * C₁₄ — Final-amplifier padder (see text).
- * C₁₅ — Final-amplifier tuning condenser (see text).
- C₁₆, C₁₇, C₁₉, C₂₀, C₂₂, C₂₄ — 0.01- μ fd. paper.
- C₁₈ — 100- μ fd. variable.
- C₂₁ — 8- μ fd. 50-volt electrolytic.
- C₂₃ — 25- μ fd. 50-volt electrolytic.
- C₂₅ — 0.03- μ fd. paper.
- * R₁, R₁₃ — 20 ohms, $\frac{1}{4}$ watt.
- * R₂ — 51,000 ohms, $\frac{1}{4}$ watt.
- R₃ — 0.1 megohm, $\frac{1}{4}$ watt.
- R₄ — 40,000 ohms, $\frac{1}{2}$ watt.
- R₅ — 1000 ohms, 1 watt.
- R₆ — 30,000 ohms, $\frac{1}{2}$ watt.

- R₇ — 20,000 ohms, 5 watts.
- R₈ — 3000 ohms, 10 watts.
- R₉ — 0.5 megohm, $\frac{1}{4}$ watt.
- R₁₀ — 2000 ohms, $\frac{1}{2}$ watt.
- R₁₁ — 20,000 ohms, 2 watts.
- R₁₂ — 0.25 megohm, $\frac{1}{2}$ watt.
- L₁ — 8 turns No. 18, $\frac{3}{4}$ -inch diam., $\frac{5}{8}$ inch long, tapped 4 $\frac{1}{4}$ turns from ground end.
- L₂ — 4 $\frac{1}{4}$ turns interwound from ground end of L₁ to tap.
- L₃ — 8 turns No. 32 on $\frac{1}{2}$ -inch form inside L₁L₂.
- L₄ — 5 $\frac{1}{4}$ turns No. 18, 1-inch diam., $\frac{1}{2}$ inch long.
- L₅ — 10 turns No. 32, 1-inch diam., tapped at center, wound below L₄ on same form. windings spaced $\frac{1}{4}$ inch.
- L₆ — 4 $\frac{1}{2}$ turns No. 16, 1-inch diam., $\frac{5}{16}$ inch long, tapped at approx. 3 $\frac{1}{2}$ turns from ground end.
- L₇ — 3 turns No. 16, $\frac{1}{4}$ -inch diam., $\frac{1}{4}$ inch long.
- J₁ — 3-circuit microphone jack.
- MA₁ — D.c. milliammeter, 100-ma. scale.
- * RL₁ — Parasitic suppressor.
- Ry₁ — Antenna changeover relay with shorting contact, 200-ohm winding (taken from BC-442A antenna box).
- T₁ — Modulation transformer, 10 watts (Stancor A3871).
- T₂ — Carbon-microphone-to-grid transformer.
- * Parts salvaged from Command transmitter.

of the receiver supply through a dropping resistor, R_1 . This places about 50 volts on the plate of the oscillator so that the VFO can be set without blocking the receiver or putting a signal on the air. R_1 can be adjusted, if desired, to limit the VFO signal strength to the maximum reading of the S-meter, so that the needle of the meter will not be knocked against the pin. The third switch position is the "all-off" position.

Converting the Transmitter

In converting the Command transmitter, it is advisable first to remove all wiring, coils and variable condensers, except the oscillator padder in the compartment on top of the chassis. This condenser is used as the oscillator padder, C_4 in

Fig. 3. Fixed condensers can remain in their original locations. The original oscillator tuning condenser, the one under the chassis and to the rear, is remodeled to make a dual unit serving as C_5 and C_9 . Starting at the rear of the condenser, the last stator plate is removed. Then the next five plates toward the front are left in. Then, all remaining stator plates, except the last three at the front are removed. (Actually it is not necessary to remove all of the stator plates mentioned so long as the correct rotor plates are removed. Extra stator plates may be seen in the bottom-view photograph.) The space between the two sections of stator plates is measured and two pieces of $\frac{3}{8}$ -inch polystyrene rod are cut to fit exactly between the two sections. This

The audio section occupies the right side of the chassis. The speech-amplifier tube is toward the front, followed by the modulation transformer and the modulator tube.

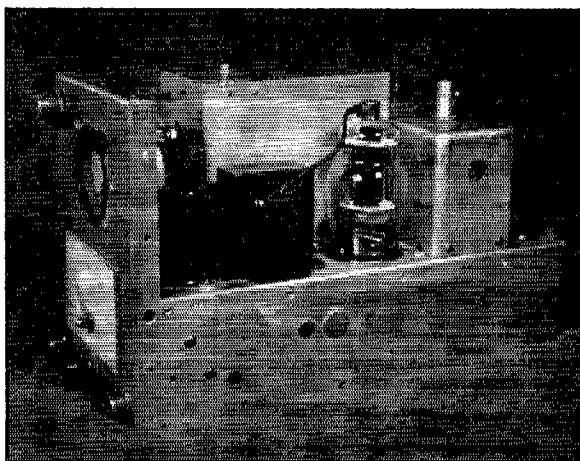

will make the poly pieces about $1\frac{1}{4}$ inches long. The rod should then be drilled end to end with a $\frac{3}{16}$ -inch hole. Then a section about $\frac{3}{8}$ inch long is cut out of the stator rods, at the center of the space between the two stator sections, dividing the stator into two parts. The drilled poly rods are slipped over the ends of the stator rods to again join the two sections together, this time insulated from each other. (See bottom-view photograph.)

The rotor is revamped by removing the first plate and the last plate, then leaving four at the rear and two at the front, and removing all plates in between. The plates of both rotor and stator can be easily removed by clamping a piece of $\frac{1}{8}$ -inch bar iron in a vise and holding the stator spacer bar or shaft against the iron

consists of two sections revolving independently. The main final tuning rotor (rotor of C_{15}) is shown in Fig. 5A. This is made from the rotor of the original final tuning condenser and it operates in the original manner from the tuning control. The second section of the rotor is shown in Fig. 5B. This part is made from the rotor of the original amplifier padder, since this condenser is not otherwise used. After cutting the shaft off flush at the bearing cone, it is cut off again at a length of $\frac{3}{8}$ inch. This shaft is then drilled out on a lathe so as to make a bearing fit over the $\frac{3}{16}$ -inch diameter portion of the rotor shaft of A. When the condenser is reassembled, the rotor of B can be moved by hand to set the padder capacitance without disturbing the setting of the tuning rotor. To hold the padder rotor in place after it is once set, it is provided with a locking piece that fastens against the front end of the plate of the condenser frame with a screw in the adjustment slot. This piece also is shown in Fig. 5B.

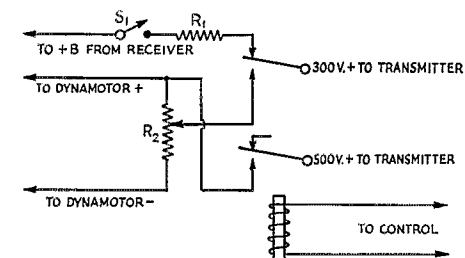

Fig. 4 — Circuit of the arrangement for reducing voltage on the VFO while setting frequency.

R_1 — Adjusted to give desired signal in receiver.

R_2 — 25,000-ohm potentiometer.

S_1 — Installed in control unit (see text).

piece. Then the plates will drop out with a few taps of a hammer. In removing the rotor from the frame, care should be taken to avoid losing any of the small bearing balls.

The final-amplifier tuning condenser — the one toward the front in the original version — is revamped into two sections, one serving as C_{15} and the other for C_{14} . The stator is altered by removing one stator plate at the rear, leaving the next three, removing two at the front and leaving the next three plates. The remainder of plates in between are removed and the sections insulated as described previously for the oscillator-doubler condenser.

The operation on the rotor requires some machine work, but even if it is necessary to have this done in a shop, it should cost little if any more than a new condenser. The new rotor

The reconstructed final tuning condenser is mounted where the padder condenser was formerly located, using the same mounting holes. Since the oscillator tuning condenser remains in its original position, the flexible driving shaft coupling the two condensers must be shortened. Before cutting the shaft, mark the length and flow in a good penetration of solder at the place to be cut. This will hold the wires of the shaft so that they will not spring apart after cutting. In removing the excess shafting from the sleeve, cut the shafting at about a half inch from the sleeve. Then, by pulling some of the inner wires out, the remainder should be loose enough to be removed without difficulty. The sleeve is then resoldered to the shafting after drilling the sleeve out to a push-in fit. The soldering is done after both condensers are mounted, and the shaft fitted onto the condensers and pinned. An extension shaft is fastened to the front end of the tuning shaft to reach to the front panel, with a spline attached to couple into the flexible shaft going to the control on the dashboard. Another

shaft is fitted to the tuning-dial gear extending to the front panel with a pointer attached, as shown in the bottom-view photograph.

The 12A6 doubler tube is placed in the socket formerly used by the 1629 and the doubler coil is placed in the socket used for the crystal in the original circuit. The oscillator coil is replaced with one wound on a smaller form. Moving the final condenser back makes it possible to mount the speech-amplifier and voltage-regulator tubes, the meter and the microphone transformer at the front of the chassis. The final tank coil is placed at the edge of the chassis, just forward of the 1625 final-amplifier tube. The modulation transformer is placed in front of the modulator tube. An L-shaped shield separates the final amplifier and the audio components and no trouble has been experienced from r.f. in the audio.

In rewiring the transmitter, it is advisable to cable all filament and plate wiring. No. 16 bare wire was used in all r.f. circuits and any lead longer than two inches is supported by polystyrene stand-off insulators cemented to the chassis or other convenient spot. All cables from the dynamotor to the transmitter and control unit are shielded and the shielding used as the ground connection between the various units. No switching circuits are shown, since each constructor usually prefers his own. Switches are shown where necessary to make the circuits complete.

Tracking of the transmitter circuits is obtained by tapping the tuning condensers of the doubler and final amplifier across a portion of the coil. The taps are quite critical. The tracking of the doubler stage is adjusted first with the plate and screen voltage off the final amplifier. Low voltage can be used while the circuits are being lined up. A milliammeter is connected in the plate circuit and the stage being adjusted is resonated with the padder at the high-frequency end of the band. Then the gang is tuned to the low-frequency end of the band and the circuit again resonated with the padder. If the capacitance of the padder must be increased to maintain resonance, the tap should be moved farther up on the coil. If the padder condenser must be decreased, move the tap in the opposite direction. When the tap is placed correctly, the stage should stay in resonance across the entire band without readjustment of the padder.

It is very important that the antenna resonate near the center of the band. Antenna resonance can be checked by a grid-dip meter coupled to

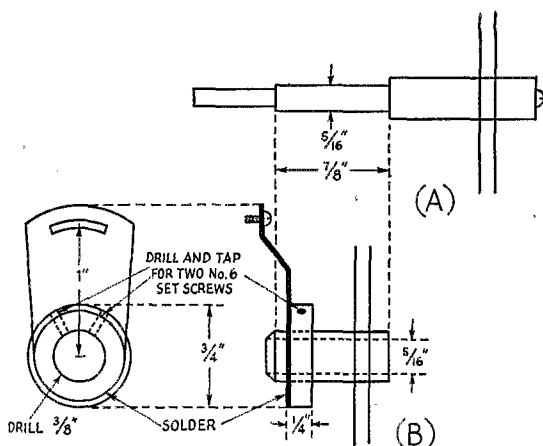

Fig. 5—Sketches showing the alterations on the rotor of the final-amplifier tank condenser. The original shaft is turned down to 5/16-inch diameter as shown after rotor plates have been removed. B shows how a piece of the original padder rotor is drilled to fit the shaft of A and then fitted with a locking device.

a link coil connected to the antenna, by observing the rise in plate current of the final amplifier while tuning the transmitter across the band, or with the aid of an antenna-current indicator. The antenna either should be cut or extended until the 29,200-kc. point is found. On 11 meters, a length of antenna must be added. This was accomplished by removing the metal ball tip and threading the top end of the antenna. The extension then can be screwed on. A new ball tip was made to screw onto the end of the antenna or to the extension for 11 meters, depending upon which band is in use.

A 12-volt power system is used for the transmitter because of less voltage drop through the wiring. A relay is used to change the batteries over from a parallel charge connection to a series connection whenever the filaments of the transmitter are turned on. No trouble has been experienced with run-down batteries or a stalled car. The dynamotor is a PE55 and is installed in the engine compartment along with the extra battery.

The results obtained with this 30-watt compare very favorably with home rigs running many times the power. We have had over 560 contacts, many lasting hours. We have also had many foreign contacts, and at this juncture I would like to say a word to those foreign amateurs who enjoy making contacts with W mo-

(Continued on page 118)

Bottom view of the transmitter showing the revamped tuning condensers. The microphone transformer is in the compartment at the front.

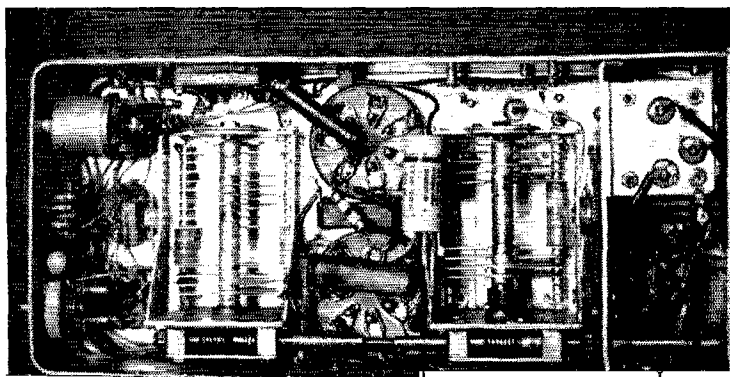

YL NEWS and VIEWS



CONDUCTED BY
ELEANOR WILSON,* W1QON

WHY are there more licensed YLs now than ever before? Currently, of course, the new Novice Class license is the greatest stimulus. Those who formerly despaired of ever meeting the requirements for the Class B license have deemed the Novice ticket their opportunity.

And today, more women are seeking ways to occupy their leisure more constructively. What other hobby offers better chance to release energy and a variety of talents to such advantage?

Commendably, YLs already licensed are offering not only incentive but also are giving generously of their time and effort in encouraging and helping those interested to obtain licenses.

There are other reasons, but what does all this mean? . . . More QRM? More feminine rag-chewing? Perhaps. But most important, it means a greater reserve of operators who will have the time to monitor the bands and keep frequencies in use, who will participate in organized operating activities, who will be immediately available for emergency work.

Surely, then, these new YLs should be welcomed heartily, and it is hoped that they will attract more of their kind to our hobby.

* YL Editor, QST, 318 Fisher St., Walpole, Mass.



For years Viola Grossman, W2JZX (*extreme right*), has been energetically and systematically attracting other YLs to ham radio. Since 1941, under various auspices, Vi has taught code, theory, and operating procedure to over a thousand women. Most of the YLs in her current classes, held in conjunction with the Nassau Radio Club, have become Novices or Technicians.

Believing that her "radio babies" would benefit from closer association, Vi initiated the Long Island Unit of YLRL in June, 1951. She is shown with (l. to r.) WN2-KEB, WN2BXT, and WN2KDP, also officers of the Unit, which has a current registration of sixty-five, most of whom were Vi's students at one time. Unlicensed YLs are also invited to attend meetings, and many have become interested enough to enroll in the code classes.

Keeping Up with the Girls

Answering an appeal for watermelons for a cancer patient, W4GTM helped relay the word on 40 c.w., which resulted in speedy delivery of the melons. . . . Several times a month W2OWL operates W2GTE, the American Red Cross amateur station in N. Y. C. . . . W8GEN finds that she can be a busy senior in high school and a very active amateur at the same time. Carol feels that her day isn't complete unless she gets in a QSO on 40, 80, or 160 c.w. using a rig she built herself. . . . For the benefit of W4HWR's many W friends, her current address is 36 Swakleys Drive, Ickenham, Middlesex Drive, England. Hilda is eager to see all that G-land has to offer during her stay there. . . . One night a week W2BNC takes her turn as NCS of the New York State Slow-Speed Net. . . . W7JFM will be found working 75 mobile in Oklahoma City while her OM, W7HAZ, is attending CAA school there. . . . ZS6WJ holds an SM certificate verifying her contacts with all seven SM districts. Ella found the certificate a bit different—it's actually a square of linen on which is painted the map of Sweden shown divided into the various sections. . . . Listen for ZS5BP and ZS5KG—they are two very active YLs. . . . Formerly of Miami, W4LKM is now on the air from Falls Church, Va. Annette's neighbor, W4JKZ, is training women operators in conjunction with the local civil defense program. . . . Two new YLs in Cincinnati are W8HDB and W8HBO. Louise is on 40 c.w. and Frances is on 10

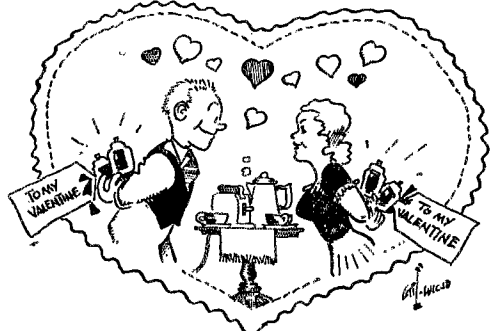

'phone. W3PMT/8, W8SKZ, and W8TPZ are other YLs from the same city. . . . WNTPWY is just ten years old! . . . KH8TI and W6EWW are members of MARS. . . . W6ATT (ex-W7OYO) and W6EPN are at Loma Linda with their OMs, while the latter, also licensed, study at the College of Medical Evangelists. . . . W5NWR has started a 75 'phone Southern States Rag Chewing Net for YLs which meets Tuesday and Thursday each week at 9:00 A.M. CST on 3830 kc. The object of the net is to promote acquaintance among YLs, and all YLs within working distance are invited to check in whenever possible. To date W5s NWR NES PTR RTT RWX SBN MZI LGY and OTU have participated. . . . In addition to her duties as a science teacher at St. Theresa's Academy in Boise, Idaho, and her activity on 10, 20, 75 and in various nets, including MARS, Sister Charlotte, W7MUT, has been directly responsible for the recent licensing of five amateurs. . . . Unfortunately, both ZS5MT and ZS5NE are hospital patients. . . . W9BBQ is now residing in the Sixth District. . . . W1MCW ceased DXing long enough to tune up on 75 'phone for the first time during the YLRL contest and consequently gave some of the girls a Maine contact. . . . W2PVS finds mobile operation (on 10) offers the least interference from the "doorbell, telephone, and kids". . . . W5MJU is active in the Oklahoma Emergency and the North Texas-Oklahoma Traffic Nets. . . . W2BIV proudly reports that his secretary, W2QGK, is doing a grand job in the AREC. "Without her help our AREC would not be where it is". . . . A student at State Teachers College at Oneonta, N. Y., W2GFK has regular schedules with her mother, W2EEO, and her father. Sylvia uses c.w., but her parents reply on 'phone so that her classmates can understand at least one side of the QSO. . . . W2WOW was elected president of the Ladies Auxiliary of the Rochester Amateur Radio Association. . . . David Earl Beringer, born November 11, 1951, died November 22, 1951. "Davey" was the son of Earl, W9RCB, and Louise, W9JTX.

(Continued on page 118)



Correspondence From Members -

The Publishers of *QST* assume no responsibility for statements made herein by correspondents.

GRANDFATHER CLAUSE

1926 National Bank Bldg.
Detroit 26, Mich.

Editor, *QST*:

The proposed amendment would grant special privileges to persons of doubtful qualification. The state of the radio art in April, 1917, was so low, and the qualifications for an amateur radio operator's license or station license at that time so trivial that it would be possible for an amateur licensed in April, 1917, to continue as a licensed amateur of the lowest qualified class to this date with no increase whatsoever in his knowledge of the radio art or his ability to utilize present-day radio technique.

It is contrary to public policy to grant privileges reserved for properly qualified persons whose only claim is "ancient privilege." For example, an aviator who flew an aircraft prior to April, 1917, is not automatically granted the privilege of flying a modern multi-engine aircraft in today's crowded airlines.

— Geo. H. Goldstone, W8MGQ

2223 Bennett
Dallas, Texas

Editor, *QST*:

I suggest that all licensed amateurs who served in the Revolution (1776) also be included in the Extra Class without code or written examination.

— Geo. C. Becker, W5EVI

Chicago, Ill.

Editor, *QST*:

They're in an awful rush to get this through without it being printed in *QST*. Wonder who the fossil is that got a B ticket in the magic month of April 1917 and now wants to get the highest class without taking exam like run-of-the-mill amateur riff-raff.

I thought the Extra Class was for persons who could demonstrate a high degree of ability — now it is to be for persons who demonstrate a high degree of ability and others who think age is proof of ability.

Why not wait five years on this and if one of the big boys wants the Extra Class put it up to a vote of all the Extra Class amateurs and see if they want to invite him into their group without passing any exam? They no doubt would just consider him qualified by vote of the majority — the democratic process, y'know.

— I. R. Evans

1546 Spruce St.
Berkeley, Calif.

Editor, *QST*:

It should be noted that the ARRL operates as one of its activities an "Old Timers' Club" for the express purpose of giving recognition to those individuals with amateur activity of 20 years or more. I contend that this honor is adequate and suitable, that recognition by fellow amateurs is more appropriate than recognition by the FCC, and that handling of such honors has been conducted in a fair and suitable manner.

— Guy Black, W6RLB

THE 7-MC. PROPOSALS

86 Whitney Road
Medford 55, Mass.

Editor, *QST*:

I am emphatically in favor of extending 'phone to all present DX portions of all bands. Due to unbearable crowded conditions on 20- and 80-meter phone, at least 75 per cent of these bands should be assigned to 'phone operation. Why should foreign amateurs be given nearly clear frequencies while we are mired in QRMM.

— Allan S. Dewar, W1RBH

P. O. Box 251
Loma Linda, Calif.

Editor, *QST*:

The only chance that the man with the low-power rig has is to work c.w. and the 40-meter band is the only good year-around c.w. band that we have.

Therefore my own sentiments are: Whatever you do don't let those 'phone men get into the 40-meter band, or for that matter don't give them anything more than what they already have.

— Maurice J. Blais, W6BBV

114 Idlewild Drive
Winston-Salem, N. C.

Editor, *QST*:

Regarding editorial in December *QST*, I am for 7-Mc. 'phone. I request you do all possible to obtain a portion of this band for 'phone use.

— Lewis Kanoy, W4DCW

7128 Patricia Lane
Houston, Texas

Editor, *QST*:

Unless it is necessary to open the 40-meter band to 'phone to keep the band for amateur use, I am opposed to this change.

— Harold C. Myers, W5SHD

12937 Memorial
Detroit 27, Mich.

Editor, *QST*:

I want to voice my humble opinion on the 40-meter 'phone situation. We've got the foreign 'phone and broadcast in the band now and nothing can be done about it. That's OK with me. It makes operating a little more difficult which should increase our skill. However, if the band was opened to our own 'phone boys I'm afraid the band would be ruined. For my money, 7 Mc. is the only band and let's keep it like it is.

— Jack W. Norland, W8GNA

1213 N. Sylvania Ave.
Fort Worth, Texas

Editor, *QST*:

I want to register against 'phone use for forty-meter band.

— South Texas Emergency NCS, W5RIJ

740 Vogel Place
E. St. Louis, Ill.

Editor, *QST*:

Heard 'phone to be put on seven megacycles. This is to let you know there are strong objections on my part and the many stations handling traffic and using only c.w.

— Fred W. Dezonis, W9EBX

Portal, N. D.

Editor, *QST*:

For goodness sakes, let's not recommend to the FCC that part of the 40 band be made available for the 'phone boys. Some of us are still c.w. operators, and let us have a little space for some good old c.w. operation.

We have enough foreign stuff in 40 now. Let's keep the U.S.A. 'phone boys off the 40 band.

— W. C. Hoel, W0DMK

AFF Board 1
Fort Bragg, N. C.

Editor, *QST*:

I understand that the FCC is considering a new amateur radio rule making to authorize radiotelephone operation in 100 kc. of the amateur 40-meter band.

I am opposed to any such change. I operate my amateur radio station W4KE on both c.w. and 'phone on all author-

(Continued on page 180)



Operating News



F. E. HANDY, WIBDI, Communications Mgr.
JOHN E. CANN, WIRWS, Asst. Comm. Mgr., C.W.
GEORGE HART, WINJM, Natl. Emerg. Coordinator

J. A. MOSKEY, WIMY, Deputy Comm. Mgr.
L. G. MCCOY, WICP, Asst. Comm. Mgr., Phone
LILLIAN M. SALTER, Administrative Aide

"RACES" a Challenging Development. The new proposed Radio Amateur Civil Emergency Service rules are discussed briefly under "Happenings of the Month." This development, to assist in integrating amateur facilities into civil defense, follows the general pattern discussed in this section, April '51 QST. Announcement of the proposed FCC rule-making follows close on the heels of the government-industry-users FCDA conference of December 10th-15th in which ARRL represented the amateur service. RACES rules would in no way change present requirements and privileges for amateur operation. A new Sub-Part B is designed to provide for continued civil defense operations, in designated subbands, in the event normal amateur operation should have to be suspended because of intensification of the national emergency. It is a way in which selected amateurs who can measure up can operate in controlled fashion to render a public civil defense service. Full text of the proposed RACES rules has been printed and distributed to field officials, including all ARRL Emergency Coordinators.

In RACES we find a responsibility that every licensed amateur should meet. It is a matter of self-preservation for all citizens to do their part in some branch of civil defense. It is in the tradition of amateur radio to render public service by fulfilling communications requirements in emergency. This time the service bears the name *radio amateur*. May we suggest that it is not a time for us to be flattered at the implied compliment, but rather to gird ourselves to get into RACES at the first opportunity. We must show we can do a responsible job when given the chance. *How* we embrace opportunity *individually* will determine the standing of our service in the future. We must accept the challenge.

After determination of this proposal it will re-

quire time for Washington to inform state and regional Federal Civil Defense Administration officials of the detailed provisions. Continuing ARRL recommendations are:

- 1) that amateurs all become registered with the AREC;
- 2) that SECs and ECs work closely with and become part of their respective civil defense councils, accept posts as Radio Officer and Communications Officer as these may be proffered, looking to implementation of the RACES plan, and;
- 3) that individual amateurs and EC groups so demonstrate their local radio plans, and participate in any civil defense drills in responsible fashion as to be ready for individual application and RACES authorizations, just as early in '52 as the proposed rules are evaluated and adopted.

Pointers for Novice Operation. One of the Novice QSOs noted while taking part in the recent "SS" drew the number "52," indicating that these newcomers to amateur radio were stepping right along in that week-end activity. A thoughtful letter from WN8IDP has some meaty material that may be of value not only in contests but in everyday operation. Here are some of his pointers:

- 1) To eliminate the string of —•••— following an exchange of report, power, antenna, name, QTH, etc., **always ask a question** not related to ham radio. (Occupation, vacations, articles, equipment, families . . . no limit to the subject.)
- 2) Be sure to use the ending symbols AR, K, and SK properly. So many place SK after the call instead of after the transmission. (ARRL has an Operating Aid, sent gratis on request, that gives the proper definition and examples of use of each of the ending signals.)
- 3) Be sure you have a good antenna and are loading it.
- 4) Don't worry either about receiving equip-

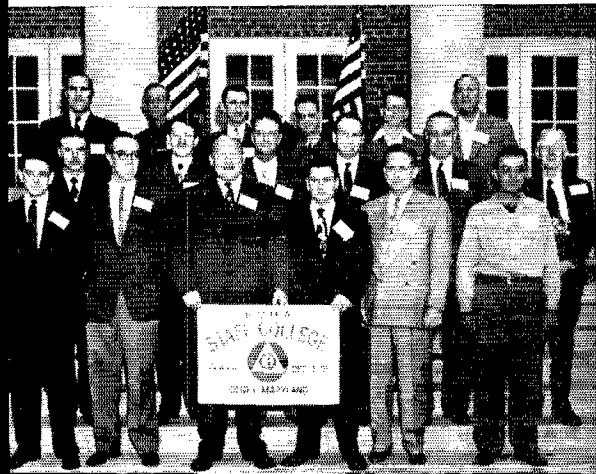

Out of a total attendance of 57, six state, three county and six city civil defense organizations were represented by amateurs at a special communications course for civil defense given at the FCDA Staff College in Olney, Md., Dec. 3rd-8th. ARRL and the Red Cross were also represented. A few (marked with an asterisk) remained for the FCDA communications conference held at the same place the following week. *Front row, l. to r.:* W1LKF, W1BDI*, W8EVD, W8EOK, W4HHJ/W5EGY, W5DCV*; *middle row, l. to r.:* W3RJQ, W3NPO, W7KGL, WINJM*, W3SLG, W4LHP*; *top row, l. to r.:* W8ZYG, W5AMT, W8HDI, W7KX*, W8RUO, W6EE.

QST for

ment, the operating technique you develop is what counts. Learn to lose some interfering signals at zero beat. Become "tone conscious;" this often permits successful copy through QRM.

5) Having contacted the station, it is not necessary to make three times three calls at the end of each QSO. Make it a one times one except when calling initially to insure the chance for the receiving operator to tune you in.

6) It is often quicker to listen for a CQ instead of calling for a CQ . . . obtaining crystals spaced about 10 kc. apart will make it possible to answer close to the frequency of the calling station.

7) Reserve the thoughts of voice operation until you get that General Class ticket. Keep the code speed coming along.

8) When the QRM is at a peak and QSO opportunities less, spend some time copying a selected QSO in progress to help your code speed. Pick a strong station going just a *wee* bit faster than comfortable for you to receive.

9) Don't be discouraged because you are limited to 75 watts. Power is less a consideration than the propagation conditions. Keep track of your states worked and have fun with low power.

Sportsmanship. W7NRB (PAM Washington) would like to see presented some claimed results accomplished on 100 watts or less; we agree they would prove interesting. Low power results are popular. One club just completed a successful low-power contest among its membership. W7NRB writes his sincere belief that The Old Man would find it revolting to hear some of the boys on 20 meters, each running a "cool gallon," having a *two-hour* rag chew at the amazing distance of eight blocks! VQ3HJP in Tanganyika writing of his successful work in the BERU contest wrote "Hordes of Ws called DX stations after their CQ BERU . . . and, as an example, blotted out MD5KW. . . ." DX should never be *that* scarce, that we cease to have patience and courtesy in operating. It is this attitude that drives some respectable amateurs to follow other paths in amateur work perhaps? On the contrary it is heartening to see the sportsmanship in helping a Novice make his first QSO when he has the jitters, or to see the loving care and pains to get a message through accurately under adverse conditions.

In working DX it is considered unsporting to call stations *exactly* on their frequency! Where many stations are zero beat, few or none at all can be read and the DX listens elsewhere. Also, anyone zero beat with the DX will prevent others from hearing any reply. Then, always move *further* from the DX station's frequency if you don't raise him, before sending a CQ. Nothing is *less* sporting than to deliberately prevent others from working the DX you cannot raise. This is, by the way, one of the quickest methods of purchasing a one-way ticket on the road to unpopularity.

Best DX for February and March! ARRL's 18th International DX competition is scheduled, rules were completely detailed in January *QST*. More-than-the-usual advance notice has been

sent overseas to invite members of other amateur societies to participate fully this year. Given good conditions we should find plenty of new DX thrills and contacts available . . . whether or not we end up with really impressive scores!

How one operates should always be much more important to the participant than what the score is. We urge all to avoid the type of operating that constitutes a bludgeoning or discourteous method of trying to get contacts. The calling of long loud frequent and insistent CQs is not as productive of DX for Ws, as a rule, as listening and calling the DX *at the right time* with break-in to minimize unnecessary calls. It is hoped that all operation will be in conformance with the ARRL DX Operating Code. Copies of this as printed Operating Aid No. 5 are available on request. The points were gotten up as a cross-section of DX-operating amateurs' opinion, both domestically and internationally, and aimed at discouraging those poorer practices that have driven some hams from DX. Contest suggestions: (1) Make calls *short*. (2) Observe frequency band limits applicable, on penalty of disqualification. (3) Keep signals clean — no clicks, feed-back or splatter, etc. (4) Make *reports* honest as well as the power figures given as the first and latter section of serial number exchanges. (5) Be guided by tuning instructions, such as 15 U, 20 D, etc., indicating when given the kc. up or down from a frequency. (6) Call DX *only* after it signs \overline{SK} , sends QRZ? or calls CQ. The loser in this DX fray is the chap who doesn't get in on the operating fun. We can hope for good propagation conditions! *Here's luck and DX in the competition.*

— F. E. H.

ARRL ACTIVITIES CALENDAR

Jan. 5th: CP Qualifying Run — W6OWP
Jan. 12th-13th: V.H.F. Sweepstakes
Jan. 12th-27th: Novice Round-up
Jan. 17th: CP Qualifying Run — W1AW, W7TQD
Jan. 19th-20th: CD QSO Party (c.w.)
Jan. 26th-27th: CD QSO Party ('phone)
Feb. 1st-3rd: DX Competition ('phone)
Feb. 3rd: CP Qualifying Run — W6OWP
Feb. 5th: Frequency Measuring Test
Feb. 15th-17th: DX Competition ('phone)
Feb. 15th: CP Qualifying Run — W1AW, W7TQD
Feb. 29th, Mar. 1st-2nd: DX Competition (c.w.)
Mar. 7th: CP Qualifying Run — W6OWP
Mar. 14th-16th: DX Competition (c.w.)
Mar. 17th: CP Qualifying Run — W1AW, W7TQD
Apr. 5th: CP Qualifying Run — W6OWP
Apr. 12th-13th: CD QSO Party (c.w.)
Apr. 15th: CP Qualifying Run — W1AW, W7TQD
Apr. 19th-20th: CD QSO Party ('phone)
May 4th: CP Qualifying Run — W6OWP
May 14th: CP Qualifying Run — W1AW, W7TQD
June 6th: CP Qualifying Run — W6OWP
June 7th, 8th: V.H.F. Contest
June 19th: CP Qualifying Run — W1AW, W7TQD
June 21st-22nd: ARRL Field Day

BRASS POUNDERS LEAGUE

Winners of BPL Certificates for November traffic:

Call	Orig.	Recd.	Del.	Rel.	Total
W3CUL	307	1557	1502	326	3692
KG6FAA	1503	885	328	557	3273
W6KYV	276	1386	424	956	3042
W0TQD	2	933	917	8	1860
K6WAE	12	655	645	5	1317
W4PL	10	655	567	79	1311
W9JUJ	52	645	594	20	1311
W6CE	10	570	557	3	1140
K4WAR	210	396	370	26	1002
W6BAM	39	421	341	76	877
W0ZJO	10	346	290	53	699
K0FAE	32	324	307	22	685
W5GZK	14	334	328	5	681
W6GYH	14	324	268	74	680
W7CZY	9	336	327	6	678
W9EGQ	4	313	304	11	632
W7IOQ	38	261	264	32	595
W1EMG	2	283	254	25	564
W9RUF	52	277	188	37	554
W1SJO	26	258	130	126	540
W5MN	3	251	218	30	507
W4PJJ	3	250	229	21	503
W5PTV	10	269	216	7	502

Late Reports

W0TQD (Sept.)	9	1105	1057	24	2195
W0TQD (Oct.)	6	764	734	15	1519
W9ILH (Sept.)	16	615	561	54	1246
W9ILH (Oct.)	7	336	280	56	679
K6GAA (Oct.)	75	242	204	38	559

The following made the BPL for 100 or more *originations-plus-deliveries*:

W6RIQ 260	VE1YV 118	W7BA 102
W7NRB 199	VE1MK 109	W2COU 101
W9NZZ 183	W1MX 107	W9DGA 100
W6BSD 134	W1SS 107	
W0PGX 121	W9TT 104	Late Reports
W5RIM 120	W8CPB 103	K6FAJ (Oct.) 112

A message total of 500 or more or 100 or more *originations-plus-deliveries* will put you in line for a place in the BPL. The Brass Pounders League is open to all operators who qualify for this monthly listing.

TRAFFIC TOPICS

With a lot of civil defense and GI traffic floating around these days, many traffic handlers feel called upon to decide the question of importance, or priority, of the various types of messages they handle.

Actually, we ought to stop reading the texts of messages we handle. It's none of our business, really. We have never used a priority system in amateur message handling, except occasionally to insert the word "rush" or "urgent" in the preamble, after the check. ARRL has always avoided trying to set up any such priority system because of the difficulties involved in questions of who classifies the message, who can change the classification, and what to do if an obviously unimportant message comes through with a high priority classification. Still, we amateurs (most of us, anyway) are handling traffic because of the satisfaction we get out of rendering a service. Our service is purely voluntary, and we'll b'gosh handle traffic or refuse to handle traffic strictly in accordance with our own personal views on what is important and what is not important—so reasons the majority.

We are not proposing a solution to this problem, but only making some observations. To begin with, the handling operator is not necessarily a good judge of the importance or urgency of any message he is handling, since the text may contain meanings not obvious to him. A message of greeting from a GI in Korea to his mother in the States may be, and invariably is, considered of greater importance than a message to Washington reporting participation in the Simulated Emergency Test, but in the final analysis the former earns the gratitude of a mother, the latter the respect of a government agency. The gratitude would still be there if the message were delivered a day later, but the respect diminishes sharply with the passage of time, and may even turn into contempt.

The armed services during the last war usually had classification officers in their message centers to set precedent ratings on outgoing messages. Even so, the tendency was to overclassify, and in many cases, the system used came close to breaking down. We amateurs who handle traffic provide the communication; someone else provides the contents of that communication and that someone, if anyone, should indicate its importance. As far as we are concerned, whether the text reads "having a fine time, wish you were here" or "am perfectly okay, Mom, don't worry," we ought to stop reading the messages we handle and give them *all* our best service.

— * * * —

During September the traffic count of the Transcontinental 'Phone Net members (reporting) in the Eastern areas totalled 4134. The October count will be very much larger, since the overseas traffic has been very heavy during the past few weeks. The net operates daily, including Sundays and holidays on 3970 kc. 1830 to 2030 local time.

— W2LMB, Area 2 Director

— * * * —

A total of 266 nets is listed on the new multilith Net Directory which is now in the hands of key emergency and traffic personnel and is available upon request to any others. This 12-page production includes a list of nets alphabetical by name, by state and then by frequency from low to high. The last two pages constitute a directory and routing guide for the National Traffic System. The Directory shows a registration of 163 'phone nets and 111 c.w. nets (some nets operate both 'phone and c.w. sections). Of the 'phone nets, 85 (about one-half) are in the 3.8-4.0 Mc. band; of the c.w. nets, 98 (almost all) are in the 3.5-3.8 Mc. band. The 'phone nets hold 467 sessions per week, the c.w. nets 542 sessions. These data may be of interest.

We are not naive enough to assume that there are no errors in the Directory, or that all nets are included. If your net is not included, or is incorrectly listed, please give us complete and correct information. It may be possible to get out a supplement later in the year.

— * * * —

National Traffic System. QRM, especially from high-powered commercial stations from south of the border, seems to be the main topic of discussion among the NTS nets. It appears that 3870 has become a popular hangout for two of these stations, disrupting the normally smooth operation of the three area nets. RN6 has experienced considerable difficulty with another commercial station on their 3640 frequency.

ARRL has funnelled protests on these and other such matters through proper diplomatic channels, and there is some justification for hoping for a measure of relief in the near future. Meanwhile, we hope nets affected will not "break and flee," but rather shift their center of operation the two or three kilocycles necessary to work through the interference. While doing so, keep us posted on any developments along this line so that our information on the strength, identity, frequency and type of operation of these commercials in the amateur bands will be up to date.

Net	Sessions	Traffic High	Low	Av.	Most Consistent
1RN	21*	217	32	1	13 Conn., E. Mass., Vt.
2RN	59	333	20	0	6 NYS
4RN	44	311	15	0	7 E. Fla., S. C.
RN5	44	364	95	0	8 Ark.
RN6	50	834		0	17 I. A., S. D.
8RN	44	109	14	0	2 Mich.
9RN	24	269	27	2	11 All
TEN	22	672			Nebr., Ia., Kans.
TRN	44	62	8	0	2 Ont.
EAN	22	318	35	11	14 All 100%
CAN	22	362	30	3	16 9RN
PAN	22	502	49	8	23 RN6
TLCN (Ia.)	22	241	31	0	11
QIN (Ind.)	74	951	45	0	13

* Out of 44 sessions held.

Second Regional Net: Certificates have been issued to W2DJF, W2NAI and W2WCL. The 1830 session of 2RN has been well attended, with increasing attendance from NLL. A bulletin issued under date of November 14th outlined plans for the winter season.

Fourth Regional Net: QRM from the commercial radio-telephone station on 3670 often makes it impossible for the 4RN representative to EAN to find the NCS. Plans are being made to send more than one station to EAN when the load gets heavy.

Fifth Regional Net: Certificates have been issued to W5s MWE PCQ RIQ and RWJ. W5RIQ has taken on the job as editor of a monthly RN5 news letter, and does a fine job. The net will conduct week end sessions the last two weeks in December.

Sixth Regional Net: RN6 has changed frequency to 3615. Pressure of SCM duties has necessitated W6JZ's resignation as Manager.

Eighth Regional Net: W8DXX is the new 8RN Manager, replacing W8SCW who resigned to become Manager of EAN. W8ELW is Assistant Net Manager.

Tenth Regional Net: W8SCA wants to give up the Managership by February 1, and negotiations are under way to choose his successor.

Thirteenth Regional Net: VE1HT has earned a Regional Net Certificate. The Maritime Section has become a full participating member of TRN through the efforts of VE1HT and VE1OM.

Eastern Area Net: EAN has maintained its high operating standards under W8SCW. The November report was the last submitted by W2CLL, who leaves EAN as one of the most efficient nets in the East.

Central Area Net: A Saturday night session started in December with W9LKK as NCS. Commercial QRM makes operation difficult.

Pacific Area Net: W0ZJO reports that at last he is getting some help on PAN. W6CE is back on the job and will help out on PAN.

ELECTION RESULTS

Valid petitions nominating a single candidate as Section Manager were filed in a number of Sections, as provided in our Constitution and By-Laws, electing the following officials, the term of office starting on the date given.

Ohio	John E. Siringier, W8AJW	Dec. 14, 1951
Eastern New York	Stephen J. Neason, W2ILI	Dec. 14, 1951
North Dakota	Everett E. Hill, W0VKP	Dec. 20, 1951

In the Eastern Pennsylvania Section of the Atlantic Division, Mr. John H. DuBois, W3BXE, and Mr. William H. Wiand, W3BIP, were nominated. Mr. DuBois received 195 votes and Mr. Wiand received 178 votes. Mr. DuBois' term of office began November 24, 1951.

ELECTION NOTICE

(To all ARRL members residing in the Sections listed below.)

You are hereby notified that an election for Section Communications Manager is about to be held in your respective Sections. This notice supersedes previous notices.

Nominating petitions are solicited. The signatures of five or more ARRL full members of the Section concerned, in good standing, are required on each petition. No member shall sign more than one petition.

Each candidate for Section Communications Manager must have been a licensed amateur for at least two years and similarly a full member of the League for at least one continuous year immediately prior to his nomination.

Petitions must be in West Hartford, Conn., on or before noon on the closing dates specified. In cases where no valid nominating petitions were received in response to previous notices, the closing dates are set ahead to the dates given herewith. The complete name, address, and station call of the candidate should be included with the petition. It is advisable that eight or ten full member signatures be obtained, since on checking names against Headquarters files, with no time to return invalid petitions for additions, a petition may be found invalid by reason of expiring memberships, individual signers uncertain or ignorant of their membership status, etc.

The following nomination form is suggested: (Signers will please add city and street address to facilitate checking membership.)

Communications Manager, ARRL [place and date]
38 La Salle Road, West Hartford, Conn.

We, the undersigned full members of the
..... ARRL Section of the
Division, hereby nominate
as candidate for Section Communications Manager for this
Section for the next two-year term of office.

Elections will take place immediately after the closing dates specified for receipt of nominating petitions. The

ballots mailed from Headquarters to full members will list in alphabetical sequence the names of all eligible candidates.

You are urged to take the initiative and file nominating petitions immediately. This is your opportunity to put the man of your choice in office.

— F. E. Handy, Communications Manager

Section	Closing Date	SCM	Present Term Ends
Connecticut	Feb. 1, 1952	Walter L. Glover	Apr. 14, 1952
San Francisco	Feb. 1, 1952	R. F. Czeikowitz	Apr. 14, 1952
San Joaquin Valley	Feb. 1, 1952	E. Howard Hale	Apr. 15, 1952
Oklahoma	Feb. 15, 1952	Frank E. Fisher	Resigned
Alberta*	Feb. 15, 1952	Sydney T. Jones	May 1, 1952
Utah	Feb. 18, 1952	Leonard F. Zimmerman	Dec. 20, 1951
Louisiana	Mar. 14, 1952	Robert E. Barr	May 31, 1952
Manitoba*	Apr. 1, 1952	A. W. Morley	June 15, 1952
Nevada	Apr. 1, 1952	Carroll W. Short, jr.	June 15, 1952
Virginia	Apr. 1, 1952	H. Edgar Lindauer	June 15, 1952
Eastern Mass.	Apr. 1, 1952	Frank L. Baker, jr.	June 15, 1952
Ontario*	Apr. 1, 1952	G. Eric Farquhar	June 15, 1952
Idaho	Apr. 1, 1952	Alan K. Ross	June 17, 1952

* In Canadian Sections nominating petitions for Section Managers must be addressed to Canadian Director Alex Reid, 169 Logan Ave., St. Lambert, Quebec. To be valid such petitions must be filed with him on or before the closing dates named.

DX CENTURY CLUB AWARDS

HONOR ROLL

W1FH.....244	W0YXO.....237	W2BXA.....230
W8HGW.....241	W6ENV.....235	W3KT.....230
W3BES.....240	G2PL.....233	W3GHD.....230
W6VFR.....237	W3CPV.....232	

RADIOTELEPHONE

W1FH.....212	XE1AC.....205	W9RBI.....187
PY2CK.....208	LU6AJ.....202	W1NWO.....187
VQ4ERR.....207	W8HGW.....197	W2BXA.....186
	W1JCX.....190	

From November 15 to December 15, 1951, DXCC certificates and endorsements based on postwar contacts with 100-or-more countries have been issued to the amateurs listed below.

NEW MEMBERS

G3BNC.....126	F9QU.....107	OE5CA.....101
W2ABM.....114	ZS6RI.....106	G8JO.....100
W6JTB.....112	HB9BJ.....108	W5QN.....100
HB9AO.....111	KH6DQ.....108	OZ4KX.....100
HB9KU.....109	W7PGX.....105	GM8AT.....100
HB9EI.....109	DL3HZ.....102	YS1O.....100
W0MJM.....108	11BCB.....101	W5NTT.....100
	CT3AA.....101	

RADIOTELEPHONE

G3FNN.....131	G3BNC.....114	VE3AOL.....100
	W4NDE.....109	

ENDORSEMENTS

W1ME.....221	GM3AVA.....161	SM5WJ.....136
W8JIN.....221	W8EYE.....161	W6KEK.....132
ZL1HY.....212	W1HA.....160	W9NZZ.....131
F8BS.....212	W5CEW.....160	W41YT.....130
W2CYS.....194	W4NNH.....160	W6ETJ.....130
LA7Y.....193	OE2NB.....153	W8MFB.....125
W4BRB.....191	W3FLH.....151	W8AE.....124
W2HMJ.....191	11XX.....150	1A5S.....122
W8BKP.....186	W1LZE.....150	SM3ARE.....121
HB9EU.....182	ON4FQ.....150	W4LYV.....121
W8UDR.....181	G3BL.....145	W0TKX.....120
LU7CD.....180	CA3BZ.....142	ZS3K.....112
G2MI.....180	TA3GVU.....141	G3BXN.....110
W0EYR.....180	W3JYS.....140	W3LVF.....110
ZS6BW.....180	W6KYG.....140	W2EQS.....110

RADIOTELEPHONE

ZL1HY.....170	W8HUD.....140	F8SK.....120
W3JNN.....161	W4OM.....132	LA7Y.....115
ZL2GX.....160	W8DMD.....121	SM5WJ.....113
GM3AVA.....150	W2JY.....120	W8BFQ.....110



With the AREC

Your Communications Manager and NEC spent two weeks at the FCDA Staff College at Olney, Maryland, in early December, one week to absorb some general information on the broad subject of civil defense and a second week to participate as ARRL representatives in a communications conference consisting of representatives of local and state governments, the federal government, manufacturers and national organizations. ECs and other AREC officials will have received further details concerning the facts absorbed during both weeks, but we think it appropriate to make a few comments in this column to acquaint all amateurs with the thinking and attitudes of people concerned outside of amateur circles.

Voluminous notes and mimeographed and printed material acquired during the first week's session of lectures on general civil defense subjects (with emphasis on communications) will testify that we were exposed to a broad and somewhat extensive education on the subject. If we learned nothing else, we learned one thing very well — that there is a terrific amount of information of a background nature which the average civil defense communicator needs but does not have; and that includes us amateurs. In the communications picture alone, we of the amateur service are sometimes prone to close our eyes to two basic premises underlying our participation: (1) That radio facilities are required to back up wire facilities and to provide communication between points where such facilities are not available, and (2) that ours is not the only radio service involved. The first premise is fairly obvious if you stop to think about it, and the second is an eye-opener. Of the 99 persons listed in the rosters of the various committees into which the Conference divided itself, 32 were representatives of state government civil defense, and 23 represented national organizations which had radio communication as their only or primary concern. Eighteen different such national organizations were represented, including ARRL. In addition there were 16 representatives of the federal government, 12 of local (city) government, 10 manufacturers and six commercial communications services (mostly AT&T). The Conference started with a full day of orientation and indoctrination into the problems to be considered. The second day the group was divided into seven committees, each to undertake a detailed study of one or more specific aspects of the radio communications problem in civil defense. These committees worked all day long, and sometimes far into the night, to accomplish their desired objectives and come up, at the end of the week, with some recommendations and conclusions which would be useful to FCDA in compiling its communications manual and formulating its future policies. Despite the fact that your two Headquarters representatives could not be everywhere at once, amateur radio was well represented in all committees, and recommendations and conclusions coming out of these committees at the end of the Conference all considered the rôle of the amateur a significant one, generally speaking. The status of the

proposed Radio Amateur Civil Emergency Service came in for a good bit of discussion, and recommendations that regulations for this service be finalized at an early date.

At the termination of the Conference, when we were collecting the frazzled ends of our nerves in preparation to returning to our respective occupations, one of our colleagues asked us if the extent to which the amateur figured in civil defense communication was not a little more than slightly disturbing to us. Our reply was that of course the amateurs could to the job expected of them; but it's going to take some doing, fellows.

— . . . —

Six mobile units of the Birmingham Amateur Radio Club assisted at the wreck of two crack passenger trains on the Southern Railroad near Woodstock, Alabama, on November 25th. Other stations of the Alabama Emergency Net acted as control and contact points for the mobiles. SCM W4RTI organized the Alabama Emergency Net, with the help of W4FGT, to arrange hospital accommodations, notify relatives and handle inquiries about persons on the trains. Five mobile units went to the scene of the wreck, while another went to the fire tower on Double Oak Mountain to act as a relay station. The call-letter license plate on the mobile unit assisted materially in getting past the state highway patrol lines; however, some trouble was experienced in getting railroad officials to recognize the ability of these amateurs to relay communications, although only two telephone lines were in use.

As a result of the experience, the sheriff deputized 11 amateurs so that recognition would be forthcoming immediately in any future emergency. Additionally, public agencies which might be involved in an emergency were given the telephone numbers and addresses of six AREC officials so that amateur assistance can get under way immediately. A probably incomplete list of those who participated includes W4s EBD EJC FGT KNW KXX KZY NS OLG RTI and SDX.

— . . . —

On November 14th the Kings County AREC supplied communications for civil defense during the simulated atom bomb burst at the Williamsburgh section of Brooklyn. In spite of many difficulties we maintained communication with our mobiles over the complete length of Brooklyn. W2BIV operated through control from W2WDM/M pending the installation of fixed equipment. During the drill, a photographer was stricken with a heart attack. W2BUU/M at the scene relayed the information to W2PQK/M, thence to W2BIV. W2BIV contacted W2QGK who called the police and an ambulance was dispatched. The net relayed the information 30 seconds before the e.d. authorities could report it by other means.

The drill revealed several weak spots in mobile communications which will be remedied.

— W2BIV, EC Kings County, New York

— . . . —

"Operation Airevac," to provide communication for the Civil Air Patrol during a simulated emergency, took place on Sunday, November 18th. The AREC of Wayne County, Ind., first received notice on Wednesday, November 14th. Communication was desired by the CAP between the Richmond Airport and the Connersville and Winchester Airports. Also, between the Richmond Airport and Civil Defense Headquarters in Richmond. Seventy-five meter phone was used between the Richmond, Connersville and Winchester



The AREC of Richmond, Ind., under the leadership of EC W9ZMP, helped supply some of the radio communication in "Operation Airevac" last November 18th. Shown above is the 75-meter operating position at the Richmond airport with W9PSD at the mike and W9KQF assisting. At the far left of the picture, on the other side of the two unidentified CAP telephone operators, is the two-meter operating position, normally occupied by W9GQD. Amateurs set up transmitters and receivers at three airports and Civil Defense headquarters in Richmond.

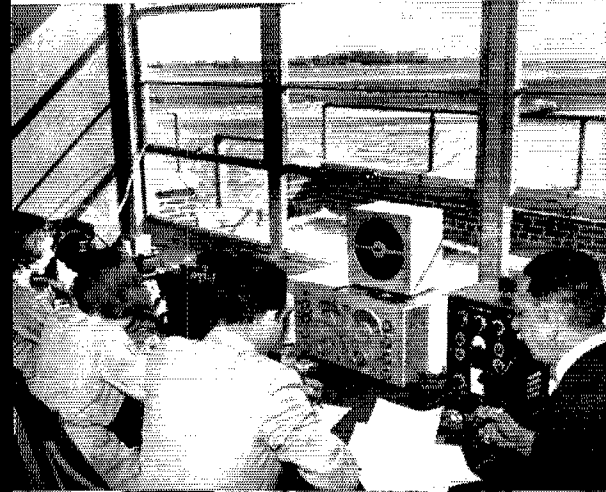

QST for

Airports. Two-meter 'phone was used between the Richmond Airport and Civil Defense Headquarters in Richmond. In addition a fixed 75-meter station was assigned as a stand-by station to help keep communication channels open for the lower-powered portable units at the three airports.

At 0540 on Sunday, air raid alert signals were sounded. All operating personnel proceeded to their assigned stations. Communication was established with W9NVA at Richmond Airport at 0615, with Connersville at 0625, with W9GJG at Civil Defense Headquarters at Richmond at 0630, and with Winchester at 0845. All departure and arrival reports were handed as received from CAP Headquarters. It was necessary on several occasions to use stand-by station W9MUR to relay messages to Connersville and to help clear a channel for the portable stations. The "all clear" signal was sounded at 1100. Communications were secured when all planes had returned to Richmond Airport at 11:30. Taking part were W9s CVU EZB GJG GOS GQD IFK KQE MGQ NVA PSD ZFR and ZMP.

— W9ZMP, EC Wayne County, Ind.

Amateur stations in Northern Vermont on November 14th provided a demonstration of civil defense communication facilities afforded through amateur operations. The audience heard both sides of each transmission via auditorium loudspeakers connected with receiving and transmitting apparatus operated before them. All transmissions were by voice. The actual demonstration continued for 16 minutes during which time 10 messages were received via seven stations. Wis AXN ETE KJG MMV OKH QQN RWX SEL TBG and TLI/1 participated.

— W1KJG

The Cuyahoga County AREC held its second Hidden Transmitter Hunt on October 8th. The transmitters on each band — 10, 75 and 80 meters — were located in Washington Park. The emergency net operated on 3650 kc., controlled by the County Net Control located at Cooley Farms. Approximately 225 amateurs used about 75 mobiles and 25 fixed stations to locate the hidden transmitter, which took about 35 minutes. The entire hunt was done with the cooperation of the Superintendent of Communications on the Cleveland Police Department and the Director of Civil Defense of the City of Cleveland.

Several letters have recently been received suggesting that we establish a frequency in each band which can be used for calling purposes to clear casual or random traffic of either a personal or emergency nature.

We think that this is a swell idea. In fact, we have thought so for quite some time. Back about the first of January, 1950, we decided that the National Emergency Net frequencies might be used for this purpose when no emergency existed, and this change was announced by a squib in *Traffic Topics* (February 1950 *QST*, page 56), and revised wording in the box which is printed in almost every issue of *QST* (page 57, same issue). This box has been running in *QST* since that time — in 16 issues, to be exact. It was last

printed in December 1951 *QST*, page 75, and will also be in this issue if room can be found for it.

Okay, if it's a good idea, let's use it. The best way to do this is to avoid use of those frequencies except for calling and making contact. Of course this is easier said than done, since our bands are crowded, and we cannot afford to leave any channels unused; but when you are stuck with traffic which for some reason or other cannot be put on a regular traffic net, try a directional CQ on one of the listed National Calling and Emergency Frequencies. If, at other times, you yourself will monitor one or more of these frequencies, you may be able to do a service for someone else who similarly has traffic. But remember — emergencies have priority!

CODE-PROFICIENCY PROGRAM

Twice each month special transmissions are made to enable you to qualify for the ARRL Code Proficiency Certificate. The next qualifying run from WIAW/WØTQD will be made on February 15th at 2130 EST. Identical texts will be sent simultaneously by automatic transmitters. Frequencies of transmission from WIAW will be 1885, 3555, 7130, 14,100, 28,060, 52,000 and 146,000 kc. WØTQD will transmit on 3534 kc. The next qualifying run from W6OWP only will be transmitted on Feb. 3rd at 2100 PST on 3590 and 7248 kc.

Any person may apply; neither ARRL membership nor an amateur license is required. Send copies of all qualifying runs to ARRL for grading, stating the call of the station you copied. If you qualify at one of the five speeds transmitted, 10 through 35 w.p.m., you will receive a certificate. If your initial qualification is for a speed below 35 w.p.m., you may try later for endorsement stickers.

Code-practice transmissions are made from WIAW each evening at 2130 EST. References to texts used on several of the transmissions are given below.

Date	Subject of Practice Text from December <i>QST</i>
Feb. 4th:	A Complete Portable 40-Meter C.W. Station, p. 11
Feb. 6th:	Some Novel Ideas for Bandswitching Mobile Converters, p. 16
Feb. 12th:	A Simplified Electronic Break-In System, p. 20
Feb. 14th:	A Practical Design for Your First Modulator, p. 22
Feb. 18th:	How To Build a Transmitter, p. 24
Feb. 22nd:	A Practical and Economic Approach to Medium Power, p. 29
Feb. 26th:	Compact Automatic Key Design, p. 42
Feb. 28th:	Technical Topics, p. 46

WIAW OPERATING SCHEDULE

(All Times Given are Eastern Standard Time)

Operating-Visiting hours:

Monday through Friday: 1500-0300 (following day)
Saturday: 1900-0230 (Sunday)
Sunday: 1500-2230

General Operation: Refer to page 75, October, 1951, *QST* (see also page 73, December, 1951 *QST*) for a chart showing WIAW general operation. This schedule is still in effect and is not reproduced herewith for space considerations. Mimeographed complete master schedules of all WIAW operation in EST, CST, MST, PST or GCT are available upon request.

On Saturdays and Sundays during which official ARRL activities are being conducted, WIAW will forego general-contact schedules in favor of participation in the activity concerned.

Official ARRL Bulletin Schedule: Bulletins containing latest information on matters of general amateur interest are transmitted on regular schedules:

Frequencies:

C.W. — 1885, 3555, 7130, 14,100, 52,000, 146,000 kc.
'Phone — 1885, 3950, 14,280, 52,000, 146,000 kc.

Times:

Sunday through Friday, 2000 by c.w., 2100 by 'phone.
Monday through Saturday, 2330 by 'phone, 2400 by c.w.

Code-Proficiency Program: Practice transmissions are made on the above-listed c.w. frequencies, starting at 2130 daily. Speeds are 15, 20, 25, 30 and 35 w.p.m. on Monday, Wednesday and Friday, and 5, 7½, 10 and 13 w.p.m. on Sunday, Tuesday, Thursday and Saturday. Approximately ten minutes of practice is given at each speed. Next certificate qualifying run from WIAW and WØTQD is scheduled for January 17th; from W6OWP, February 15th.

NATIONAL CALLING AND EMERGENCY FREQUENCIES

C. W.	'PHONE
7100 kc. (day)	3875 kc.
3550 kc. (night)	14,225 kc.
14,050 kc.	29,640 kc.
28,100 kc.	

During periods of communications emergency these channels will be monitored by stations of the National Emergency Net for personal-inquiry traffic. At other times, these frequencies can be used as general calling frequencies to expedite general traffic movement between amateur stations. Emergency traffic has precedence. After contact has been made the frequency should be vacated immediately to accommodate other callers.

The following are the National Calling and Emergency Frequencies for Canada: c.w. — 3535, 7050, 14,060; 'phone — 3815, 14,160 kc., 28,250 kc.

MEET THE SCMs

Clarence L. Arundale, W0GBJ, acquired his first license back in 1922, and since that time has held the calls 9CFK and 9GBJ besides his present call.

In addition to his duties as SCM of Missouri, he also is an active Official Relay Station, having held that appointment for the past twenty or more years. An enthusiastic participant in ARRL activities, he is a several-time winner for his section of both the ARRL QSO Party and the Sweepstakes. He holds RCC, WAS, WAC, OTC, DXCC (both prewar and postwar), and Public Service certificates, the latter having been issued to him for his work in the January 1949 Missouri blizzard. He is a present member of the Southwest Missouri Amateur Radio Club of Springfield, Mo., and for four years was its treasurer.



A combined den and ham shack houses the following equipment: Transmitting tube line-up consists of VFO/crystal, 6V6 doublers, 807 buffer, 100TH final (modulator and speech 57-2A5-p.p. 807s). Receivers are an SX-16 and an HF-10/20. Antenna in regular use is a 67-foot end-fed Zepp. Bands covered are 3.5-, 7-, 14-, and 28-Mc. c.w. and 28-Mc. 'phone.

A secondary hobby of SCM Arundale's is photography and he enjoys watching baseball and basketball games. His employer is McQueary Bros. Drug Co., for whom he works as head bookkeeper and office manager.

SOUTH DAKOTA WEEK END

In order to assist amateurs who need a contact with South Dakota for WAS, South Dakota hams will conduct another "South Dakota Week End" February 22nd and 23rd. Frequencies to be covered are 3695 and 3755 kc, and the Novice band; 7080 and 7225 kc.; 14,100 and 14,250 kc., and 28,050 and 28,900 kc. All stations will monitor 5 kc. on each side of these calling frequencies February 22nd from 8:00 P.M. to February 23rd 2:00 A.M. CST; they will cover the 10- and 20-meter frequencies February 23rd from 11:00 A.M. to 4:00 P.M. CST. South Dakota stations will answer to calls of "CQ SD."

BRIEFS

The Canadian Amateur Radio Operators' Association has received inquiries concerning the continued issuance of the "Worked All VE" award. WAVE certificates are still being issued and cards, together with the 25-cent fee, should be sent to Mr. Elton Culp, VE3AUQ, Club Secretary, C.A.R.O.A., 167 Sherwood Ave., St. Catharines, Ontario. Complete details concerning the requirements for WAVE were published on page 34 of May, 1951, QST.

Since publication of the 17th ARRL DX Contest results in October QST, the following errors have come to our attention: W6BYH's 'phone score of 2166 points (38 contacts, 19 multiplier) was omitted from the score tabulations; Leon was the 'phone winner for the San Joaquin Valley section. The 'phone score of East Bay section contestant W6UYX was listed in the c.w. section, but should have appeared in the 'phone section as number two score, 72,285 points. W6UYX, by the way, won the Northern California DX Club's 'phone cup award for his performance in the '51 DX Contest. The score for Wyoming section c.w. winner W7PGS was erroneously listed as 13,980 points instead of 49,980. The 429-point 'phone score of Ohio contestant W8ZJM was inadvertently listed in the c.w. results and his 32,943-point c.w. score was omitted. A typographical error made W0BBS's 'phone score third in Nebraska; high scorer in his section, Clyde actually made 6156 points. In both c.w. and 'phone tabulations, W0GUV's scores were credited in error to W0GUF. To all concerned, our sincere apologies for the slips.

Erratum: The 1026-point Class C Field Day score of

W3NNX/3, listed on page 126 of December QST, was credited in error to W3NXX/3.

Chess players who work 75-meter 'phone are sought by W4RIZ. The Smithfield, North Carolina, Chess Club already has a number of player-stations combining the two fascinating hobbies. If interested, write John S. Townsend, W4RIZ, Box 177, Smithfield, North Carolina.

WN8HUJ was erroneously issued the call WN8UJ. Until the mistake was corrected, he had the rare distinction of being the only "two-letter" Novice on the air!

HIGH CLAIMED SCORES — 1951 SWEEPSTAKES

The 18th ARRL Sweepstakes, held during the week ends of November 17th and 24th, was a bang-up affair that crammed the bands to overflowing with contest addicts SS'ng their way along and making contacts at a merry clip. No new records have come to our attention, but a large number of scores in the 100,000-or-over class were turned in and the highest over-all c.w. score, usually chalked up by an eastern station, this time came from a West Coaster. The W6s also retained the top positions they have been holding for many years in the 'phone section.

Listed below are the highest claimed scores received. The listings show score, number of contacts, and number of sections worked. All figures are claimed by the contestants and are subject to further checking. Final results will appear in an early issue of QST.

C.W.

W6BJU.....	191,250-1084-72	W3GRF.....	119,450- 685-70
W3BES.....	181,980-1011-72	W1NXX.....	118,998- 601-66
W3DGM.....	181,125-1050-69	W2FGF.....	118,925- 710-67
W4KFC.....	172,175- 972-71	W2PWP.....	114,885- 660-69
W6WIP.....	168,358- 952-71	W3PQB.....	114,713- 665-69
W8IOP.....	156,816-1100-72	W5KTD.....	112,988- 659-69
W9RQM.....	155,488- 893-70	W4TA.....	112,470- 654-69
W7PGX.....	149,975- 873-70	W0PHR.....	112,130- 648-69
W0TKX.....	148,390- 836-71	W3KT.....	111,825- 630-71
W7KEV.....	147,858- 839-71	W5ZD.....	111,510- 850-69
W3ALB.....	144,550- 826-70	W3LVF.....	110,831- 643-69
W3GAL.....	139,410- 780-72	W7FBD.....	108,990- 614-72
W4CKB.....	138,425- 802-70	W9NL.....	108,875- 650-67
W9OLU/4.....	138,173- 802-69	W9NH.....	108,416- 419-69
W5GEL.....	135,792- 947-72	W0BQT.....	107,440- 632-68
W4BGO.....	132,859- 752-71	W80YI.....	107,415- 651-66
W3JTK.....	132,770- 748-71	W4KFT.....	107,000- 630-68
W9FOI.....	131,750- 776-68	W2PJM.....	106,312- 609-70
W3FQZ.....	131,100- 761-69	W2HEH.....	106,225- 607-70
W8RSP.....	130,462- 750-70	W3PQA.....	105,910- 625-68
W8CBG.....	128,975- 737-70	W1LVQ.....	105,274- 630-67
W9WFS.....	128,188- 736-70	W3KDP.....	104,708- 610-69
W4SEY.....	127,500- 750-68	W0FZO.....	104,475- 813-70
W3GHM.....	125,848- 731-69	W9KZZ.....	103,845- 608-69
K2USA.....	125,387- 722-70	W3AEL.....	103,350- 638-65
W3VES.....	122,825- 723-68	W3DRD.....	100,567- 583-69
W3JTC.....	122,648- 711-69	W0FNC.....	100,300- 591-68
W6EPZ.....	122,580- 681-72	W6MHB.....	100,260- 558-72

'PHONE

W6QEU.....	116,208- 807-72	W7HAD.....	39,525- 255-62
W7PUM.....	98,153- 569-69	W5VIM.....	39,325- 242-65
W3LTU.....	82,360- 464-71	W6KJK.....	38,760- 287-68
W1ATE.....	82,080- 572-72	W1BFT.....	36,720- 230-84
W8UKS.....	80,730- 451-72	W1JEL.....	36,698- 316-59
W2MNR.....	73,015- 440-68	W8LIO.....	35,784- 251-72
W3DHM.....	67,824- 471-72	W3PWR.....	35,642- 251-71
W8REU.....	65,592- 460-72	W8LAX.....	35,604- 260-69
W4BRB.....	63,700- 367-70	W4KZF.....	35,400- 240-59
W2SKE.....	62,554- 454-69	W2KJH.....	34,540- 223-62
W4PJU.....	62,420- 362-69	W1BFB.....	31,616- 247-64
W0PRZ.....	59,400- 415-72	W0MIGV.....	30,940- 230-68
W6CHV.....	58,123- 347-67	W6KAEX.....	30,480- 256-60
W8AJW.....	54,075- 310-70	W5FAB.....	29,714- 225-62
W8VQD.....	51,984- 361-72	W1HRI.....	29,450- 190-62
W5RIY.....	48,100- 300-65	W0ECF.....	28,764- 214-68
W7EYD.....	48,500- 302-62	W7JUC.....	27,456- 215-84
W5MYI.....	45,402- 332-69	W4FV.....	27,132- 238-57
W5KC.....	44,020- 310-71	W8FTX.....	27,040- 189-84
W9ZTO.....	41,925- 258-65	W5HQR.....	25,600- 200-84

• All operating amateurs are invited to report to the SCM on the first of each month, covering station activities for the preceding month. Radio Club news is also desired by SCMs for inclusion in these columns. The addresses of all SCMs will be found on page 6.

ATLANTIC DIVISION

EASTERN PENNSYLVANIA — SCM, John H. DuBois, W3BXE — SEC: ISE, RM: BIP. Orchids to BES for the outstanding job done as SCM during the past fifteen years. This, in addition to being active in all phases of amateur radio, is even more noteworthy. Thanks, OMI Positions are open for EC in the following counties: Columbia, Lycoming, Montour, Northumberland, Pike, Snyder, Sullivan, Susquehanna, Tioga, Union, Wayne, and Wyoming. If you don't know your local EC, contact the SEC, or report into E. Pa. Emergency net on 3610 kc., Mondays at 8 p.m. Those interested in traffic should check into E. Pa. Traffic Net, 3610 kc. at 6:30 p.m. PVY reports that a joint meeting of the Hazelton, Carle, North Branch, and Schuylkill Clubs were held in Weatherly on Nov. 8th. This was high-lighted by a tour of the Tumsoil Tube Co. plant. A new kw. on 7 and 14 Mc. may have helped account for CUL's traffic total! CTJ's new location at Star Route, Ambler, is a welcome change from the S7 noise level at the old QTH. As customary, the antennas were erected before the furniture was moved in. With a full Activities Calendar scheduled for the coming season, this column should not lack material. Traffic: W8CUL 3692, AD 249, BIP 222, LQV 111, OML 67, ELI 47, QEW 23, ADE 20, HA 19, EAN 8.

MARYLAND-DELAWARE-DISTRICT OF COLUMBIA — SCM, James W. John, W3OMN — On Nov. 20th the Chesapeake Amateur Radio Club heard BYG speak on "Two Meter Converter Design and Construction," also "Noise Figure Measurement and Comparison." On Dec. 4th DWX covered "Predicting Propagation Conditions." On Nov. 9th OMN gave a talk to the Rock Creek Amateur Radio Association on antennas. The ARRL TVI film was shown at the Nov. 23rd meeting. The Capitol Suburban Radio Club met Dec. 7th at the QTH of GFF. On Nov. 24th the Washington Radio Club held a "clean up night" at PZA. On Dec. 8th 4NTZ talked about his most recent trip through the Caribbean Area. Slides of some of the DX met along the way were shown. A meeting for the Novices precedes the regular club meetings at WRC. A new network, known as "Ghost to Ghost," has developed in the District of Columbia Area. More than forty Certificates of Superlative Achievement have been issued since Nov. 1st. Further information and details are obtainable from NOL. KBE was subject to some malicious deprecation when his sky-wires were destroyed. NPQ attended the FCCA Staff College the first week of December. 1BDI and INJM also attended that week. HPIGD's XYL, who is in Baltimore, talked to the OM over EQK. EQK is trying to find the P.O. address of PX1AA. ONB has his TVI licked, thanks to PMA and his long-wire interlog. HZ1AB, formerly W3ASE, is in Saudi Arabia operating a BC-610 to a V antenna. His usual frequency is 14,300 kc. and he hopes to have a four-element beam on 28 Mc. before long. LZV received a citation from the FCC for hearing-aid interference. In order to expedite the processing of applications for AREC membership, please forward Form 1 directly to your local Emergency Coordinator or to PWB in the District of Columbia or PRL in the State of Maryland. Traffic: W3ECP 140, AKB 57, QZC 56, FWP 53, MCD 37, JZY 31, EQK 25, TT 23, NNX 21, NOE 15, BWT 5, CDG 5, ONB 5.

SOUTHERN NEW JERSEY — SCM, Lloyd L. Gainey, W2UCV — Twelve mobile units of the South Jersey Mobile Emergency Net participated in a full-scale civil defense drill in Delaware Township on Nov. 27th. Net Control Stations were set up in the Township Police Station and communications were furnished to all fire companies and emergency squads. 28 and 144 Mc. were used by the mobiles and the 144-Mc. fixed station net handled communications to all surrounding communities. PFG, president of the SJRA, has been appointed EC for Camden County. BQ gave a very interesting account of his early commercial radio operating days at the November meeting of the SJRA. The Gloucester County EC, VX, reports an interesting mobile drill held on the new state turnpike. The Mercer

County Emergency Net meets every Sunday at 9:00 p.m. EST on 147.15 Mc. and invites participation of all local 2-meter hams. ZI recently returned from a mobile vacation in W4- and W5-Land and reports working quite a bit of 75-meter DX running ten watts to his final. WOA has a mobile rig on 75 meters. GCU is working 800 meters with a BC-696 and really is getting out. PFG is finding it rather difficult to fit his 2-meter mobile rig under the dash on his new Pontiac. SPV passed out cigars the other day in celebration of the birth of his first jr. operator. Send the news along, fellows, and I'll be glad to include it in this column. Traffic: W2RG 118, K2BCG 112, W2ASG 14, ZI 2. **WESTERN NEW YORK** — SCM, Edward Graf, W2SJV — SEC: UTH, RM: RUF. NYS Net meets on 3615 kc. at 7 and 10-15 p.m.; NYSS on 3825 kc. at 8 p.m. daily. As this is my first report I ask the cooperation of all to assist me in maintaining the high standards established under previous SCMs. Your nets are in need of many more outlets for efficiently handling traffic; check in and give the section better coverage. UTH/PRL is your new SEC. If your county is not represented by an EC, contact him. UAC is in the Army at Pine Camp. GVH is a new call in Watertown. BGO attended a combined meeting of RAWNY and KBT, explaining amateur participation in c.d. ECs are CBA for Orleans Co., GHU for Jefferson Co., QXY for Saint Lawrence Co., and WQO for Warren Co. ICE is experimenting with "V" beams. A 2-meter net is in operation in Oswego Co. Contact ZHU for details. The RAWNY Hamfest was well attended. An interesting talk with slides on TVI was given by 1DBM and FCC exams were given by the engineer in charge, Paul Holloway. PPY is back in civvies after 11 years in the Navy. Speakers at KBT recently were Ed Sanders of WXXA, who spoke on problems of a broadcasting station; RPO, who described the WBEN-TV station; and RUC, who spoke on the conversion of the APQ-9 for outputs of 60 watts on 420 Mc. CIL demonstrated his reflecting telescope. John Williams, of the Rochester Weather Bureau, addressed the Rochester v.h.f. group on weather items of interest to v.h.f. men. NYS c.d. frequencies are 3509.5 kc., 730 p.m. Mon., Wed., and Fri., 9 a.m. Sun.; 3980 kc., 6:30 p.m. daily; 3970 kc., 9 a.m. Sun. FMH is in Florida for the winter. At the RAWNY meeting QWS spoke on radio commercial eliminators and TKO on auto generator regulators. SB reports that through the efforts of DGV the Northern Chautauqua ARA now meets at the USCG base at Dunkirk. G8J has returned from Alaska and now is living in North Syracuse. The Lockport Radio Club meets the last Saturday of each month in its new club rooms on the premises of RUI where members give code instruction evenings. RARA members gained knowledge from a talk given by FBA on amateur gadgets. The Rochester Emergency group did a grand job during the Brighton Blow-up. A special welcome to the Novices; let's hear of your activities. An amateur radio club, RA-DEES, has been formed at the University of Buffalo. Officers are FTO, pres.; VZX, vice-pres.; FTR, secy.; WUP, treas.; EGO, act. mgr. Traffic: (Nov.) W2RUF 554, COU 390, DJF 142, NAI 141, SJV 52, FCG 45, OE 40, PGT 28, UYG 5, (Oct.) W2OE 56.

WESTERN PENNSYLVANIA — SCM, Ernest J. Hlinsky, W3KWL — Congratulations to GEG on his election as Atlantic Division Director. Your SCM thanks those who so generously cast their ballots in his favor in the recent election for Vice-Director. Down Pittsburgh way the Steel City Amateur Radio Club station, KWH, again is heard. The first member of the Club to receive his Novice call is WN3SDV. NKM worked his 19th state, North Carolina, on 144 Mc. OMY is giving 420 Mc. a whirl. UUG is Net Control for the 20-meter YLRL net. GJY is back in the civilian ranks, and is heard on WPA Net with a flea-powered rig. UHN says he has to lick the TVI. From up Erie way QN reports that RTC is a new one on 28 Mc., with KKU doing a good job also. AAQ, POS, and QPP say the jr. operators are doing fine and big things are expected from them on the air soon. QN, the Erie EC, is doing big things with the civil defense program. In one of the recent drills those taking part were KKT, ODF, POS, QMY, NXK, LKJ, QMY, OIE, QPP, PIX, and PIY. The Boy Scouts are getting a break with QWL, who is helping them get their Radio Merit Badges. Erie's youngest Novice is WN3SLM. QZE says the Prep Radio Club again is showing signs of activity. UVD is working hard to become an advertising artist. LMM, EC for the Pittsburgh Area, is trying hard to keep things humming in the c.d. Incidentally, the section still is without the services of an SEC. The Western Pennsylvania Emergency Net is sponsoring a 10-meter Ground Wave Contest with prizes going to the most stations worked in the zones designated. Up the cold country way KUN still is doing a nice job as Alternate Control on WPA Traffic Net. The St. Marys Boys Club station, KYR, has been doing a nice job of traffic-handling these

past few months. LEV says he has converted two ARC-5 transmitters but now has TVI so he just pulled out one of the tubes in the p.p. final and lessened the TVI by 50 per cent. Around Mercer County way, the Mercer County Radio Assn, has revived the Pennsylvania-Ohio 2-Meter Net. From the grapevine we hear that Mr. Heim, the Club secretary, has passed his Novice exam and is awaiting his call. The new EC for Mercer County is KQA. Traffic: (Nov.) W3GEG 424, NRE 232, KYR 177, GJY 70, NUG 55, AAX 43, KUN 31, JSH 20, KWL 19, LEV 11, UHN 10, KNQ 4. (Oct.) W3KYR 6.

CENTRAL DIVISION

ILLINOIS — Acting SCM, H. F. Lund, W9KQL — SEC: QIZ. RM: BUK. PAM: UQT. New club officers: DeKalb: KCM, pres.; DRO, vice-pres.; HMM, treas. Springfield: GOJ, pres.; JSD, vice-pres.; MAE, secy.; UQT, custodian. The Quad City Club has new quarters at the Moline Airport. GSB works 20-meter mobile exclusively. CRD is going to 75-meter mobile to use his Advanced Class ticket. SKR is de-TVing the rig with a "dipper." The son-in-law of LQI is WN9OTT. AND and GNU have new HRO-TIs. The latter also is mobile with TBS-50 rig. The Chicago Area Council group is hard at work on the c.d. program with more mobiles needed. BA, JAC, JSQ, KUC, and MCB worked mobile with Scott AFB in a practice air raid. JGG is converting diathermy machine to kw. rig. OXZ is new president of the Quad City Club. NIU saw Miami and the APOCO Convention. BXX has returned to 7 Mc. sporting 7 watts to a 6AQ5 VFO. WN9OUW puts loading coils in each leg of a dipole so it will fit on his roof. JMG assists LCG with technical problems. Winnebago County, under the direction of EC HOA, scored 143 points in 45 minutes in the S.E.T. LQP reports the Franklin Park Area conducted a c.d. emergency test with 7 mobiles and 1 fixed station. The control station is located underground and was operated by EC FSS, assisted by his XYL, FZO. Mobiles were BWN, EUG, GQH, KKT, LQP, VEZ, and WPH. WVE reports he was heard on 144 Mc. by a VE3. GBT has a new 75A-2. All members of the Battin family of Elgin are now hams: father, OWD; mother, WN9OTO; daughter June, WN9OTM; and John, MEM. LIG's 10-year-old son passed the Novice exam and is sweating out his ticket. AND, JSP, and IVU all had birthdays the same week so the XYL of IVU gave them a birthday dinner. Also attending were FDL and HKI and families. LHQ and ZEN operate MKS when home on school vacations. DUA had equipment trouble during the S.E.T. However, BUK did an excellent job as unofficial alternate. 3GZH/9 is on the air from Springfield using 20 feet of wire in the basement for an antenna. New OBS is MBI of Coleta. Clare is active on 50, 144, and 420 Mc. Please watch the expiration dates on your appointments and send 'em in for endorsement. The North Shore Emergency Net has moved to 29.56 Mc., with 29.64 Mc. reserved for a calling frequency. ZKI cured his TVI when his final plate transformer went up in smoke. OLU now is at K4WOC. CZB completed remodeling his house and is back on ILN. OCW is mobile on 28 Mc. The St. Clair County Club contest was won by BPS. Second prize went to HIB, with BA finishing third. KQFAE makes BPL this month. Traffic: (Nov.) K9PAE 685, W9YX 196, MEM 105, SXL 75, CSW 72, KQL 69, YVY 48, BUK 44, WYZ 25, LAY 2. (Oct.) W9LH 679, YX 325, KRH 67, DOQ 55, QBH 17, YTV 10, LAY 4, LAX 3, DOR 2. (Sept.) W9LH 1246, YX 134, CSW 109, UQT 74, BUK 70, DOQ 60, YVY 10, LIN 7, FRP 4, DOR 2, IAY 2.

INDIANA — SCM, Clifford C. McGuyer, W9DGA — A newly-affiliated club is the Tippecanoe Amateur Radio Assn. of West Lafayette. OMD has 10-meter vertical. FJY has a Novice school. The Kokomo Club is planning a new club bulletin. ORZ is ex-2LXO at Anderson. New OPS are AZI, FZW, YNF, CGM, KDV, and GSY. New ORS is CWH. New OOs are QLW, RZS, and CGM. NTR is new at St. Meinrad. LHI, ex-CXC, is back on in Union City after an absence of 27 years. UIA is building a new transmitter for 28, 50, and 144 Mc. BXP has new 300-watt transmitter on 3.8-Mc. phone. HGV is recovering from an illness. CVN is building a new converter for 28 Mc. TT has crystals available for the RFN frequencies. New RFN members are UKV, OGH, BXP, and MDC. PBS has 20-meter vertical. RZS made a nice score in the 'phone 8S. NJR is building 10-meter mobile. AZJ worked 9GKH/6 on 28 Mc. Total QIN traffic for November was 951. CWH has a new break-in system. IGZ received his Advanced Class license. UDD maintained continuous contact with BKJ and FMJ for 225 miles from French Lick to Fort Wayne. RJY has a new antenna on the roof of the Red Cross Building. FMJ needs two states for 75-meter WAS. QIN now has a 4-p.m. net. MEA has a new all-band transmitter. DUK operates on the Novice frequencies. The Fort Wayne Radio Club now is 31 years old. UDD is chief operator at the Fort Wayne Police Department. PSD, GOS, and NVA are Asst. ECs for ZMP, of Wayne County. JWZ is on 7-Mc. c.w. CGM works on the MARS nets. TT is planning on RFN Novice net. MZE operates K5FBB while in the Air Force. Net Control Stations for IFN are CZO, FMJ, FZW, BNF, FSH, and VNV. New Novice class licenses in

Indiana are PPD, QAV, OWZ, and PFO. ZBK lost his 10-meter beam to the wind. QLW saw MKZ carrying his 10-meter beam down Washington Ave. in Evansville. EZS has new 10-meter beam. Traffic: (Nov.) W9UJ 1311, EGQ 632, TT 376, NZZ 269, LKX 233, TG 233, DGA 165, JBQ 139, JTX 123, NZW 120, QLW 99, BKJ 45, CVN 30, CWH 23, CGM 22, FZW 21, DOK 18, RCB 18, BDP 17, RZS 2. (Oct.) W9RZS 5.

WISCONSIN — SCM, Reno W. Goetsch, W9RQM — SEC: UFX. PAM: ESJ. RM: CBE and IQW. Phone Net (WIN) 3950 kc., 6 p.m. daily. C.W. Net (WIN) 3625 kc., at 7 p.m. daily; slow speed at 6:30 p.m. Net certificates (WIN) were issued to PYE, IJH, ITA, PYM, AXS, and BNN. LSK has 807 final with both VFO and crystal. IHW received Advanced Class ticket and is mobile on 75 meters with a TBS-50. DCARC elected as new officers: OVO, pres.; R. Rasmussen, vice-pres.; NKZ, secy.-treas. It looks like Point treats Waupaca as a result of the inter-club SS competition. WVR4 was represented in the SS by FZC, RLB, QJB, EWM, GKO, IZE, KJM, VHA, HRX, RQM, ZTO, IUG, FXA, HHE, and JBF. LEE continues daily skeds with #BBN on 144 Mc. at 0745 and 2100. JZS and ZBY are having transmitter trouble. NYS is on with indoor dipole at new QTH pending erection of tower. OOD worked 26 sections in the SS on 80-meter c.w. with a vertical 34-wave antenna. The Point Radio Amateur elected DFN, pres.; HQJ, vice-pres.; BCC, secy.-treas. KXK added the WFJS certificate to his collection. The Kenosha Club, which has applied for ARRL affiliation, has the following officers: GRX, pres.; JCV, vice-pres.; KCL, secy.-treas. TQ is busy with RTTY unit with manual operation for now and auto-call later. WN900I passed General Class exam. PES and EYV made a reappearance on 144 Mc. JBF still is holding skeds on 144 Mc. with LEE, DSP, NYS, EYN, and #BBN. FAN has new eighteen-element beam up for 144 Mc. Appointments renewed: TQ as OBS and SLZ as ORS. Despite TVI complications ERV continues 7-Mc. OBS skeds. After a long absence, SLZ is back on with an HRO-5 and a 50-watt hand-switching exciter. Madison AREC drills every Tuesday evening on 29,620 kc. with 10 to 12 mobiles. UFX is putting mobile equipment in new car. Tom Murphy, chief of communications for State Civil Defense, has appointed RUF as chief of Amateur Radio Service. A new call in Wausau is WN9PVR, the XYL of SBQ. Traffic: W9ESJ 400, CBE 216, IXA 115, IQW 91, ANM 44, FXA 30, DR 24, KZZ 23, LSK 20, SFL 10, ZGL 8, RQM 7, LHW 6, CFP 5, RSR 5, OVO 2.

DAKOTA DIVISION

NORTH DAKOTA — SCM, Everett E. Hill, W0VKP — IRRW was on the Voice of America Amateur Program, which was beamed all over the world. CGM reports 9 hams now in Mayville, with WN0FHB a new call there and 6 more Novices in training. PGO is on a 3.8 Mc. with 100 watts. FKP is on 28-Mc. phone. NAD now is back in Dickinson. PGO reports New England Boy Scout Troop and Scoutmaster all working on Novice class license program. Wiliston has formed a ham club. DM is Advanced Class and is on 3.8Mc. from Grand Forks. KMT is portable from Jamestown with 500 watts on all bands. WN0DAC, in Fargo, has formed a ham club to put HSB on the air. The Red River Amateur Radio Club, Fargo, has a new club-room and civil defense set-up in Fargo's Civil Defense Building. I wish to thank all for their congratulations and willingness to cooperate. I will be looking forward to a large number of applications for operating appointments. Traffic: W0LHB 16.

SOUTH DAKOTA — SCM, J. W. Sikorski, W0RRN — The Prairie Dog ARC, Vermillion, held regular meetings the 2nd Tuesday of each month. IZA has a new Viking. WUU has a VU addition to the family; CXM has a Jr. operator; and SDE has a pair of YLs. The South Dakota 160-meter Net meets Mon., Wed., and Fri. at 8 p.m. CST on 1905 kc. and the c.w. net has shifted from 3720 to 3600 kc. New club officers of SFARC are JLL, pres.; RRN, vice-pres. and secy.; and RWE, treas. The Black Hills ARC elected IWE, pres.; JLS, vice-pres.; CTI, secy.; FJZ, treas.; and QHK, act. mgr. After many years working 28-Mc. phone only, ZFE now is on 3.5, 7, and 28 Mc. CLS and DSK are Navy-bound. GWH is back in Sioux Falls after spending the summer as a customs official. UWO, HON, and DIY are completing 2-meter rigs — the first such activity in town. BQH now is located in Tea. Traffic: W0CXM 138, UVL 72, PHR 67, OLB 66, RRN 7, ZRA 7, GCP 5.

MINNESOTA — SCM, Charles M. Bove, W0MXXC — Asst. SCM, Jean Walter, 0KYE. SEC: BOL. RM: RPT. ITQ now is Net Control of the Tenth Regional Net. WEH soon will be back on the air on 28 Mc. ELA has returned from the Far East. HEO and SW arranged a small hamfest in Willmar. The gang from the surrounding towns and Minneapolis attended. CRO was the principal speaker, demonstrating the practical use of the antenlescope. This meeting was a huge success. BHA is active on 3.8, 7, and 28 Mc. BGJ is doing a dandy job as editor of the Marshall Club paper. WN0FFU is a new ham and also a member of the St. Paul Radio Club. The Mobile Amateur Radio

(Continued on page 74)

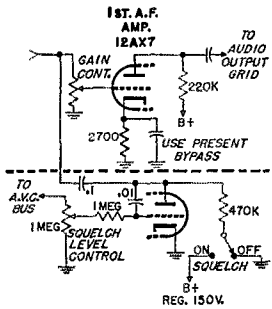

ONE phase of receiver operation that has been brought out by Civil Defense is the desirability of having provision for squelch on receivers used for stand-by purposes. With the receiver tuned to the spot-frequency of a C.D. net and running continuously for monitoring that frequency, the noise background of the receiver can be quite annoying. If a squelch circuit is added, this noise background can be reduced to a point where the no-signal background is not objectionable, but a signal opens

up the receiver to full output. The conventional circuit can be made to quiet the receiver completely but it is probably more desirable to leave a little background noise so that an operator can tell that the receiver is still functioning by merely listening carefully. This eliminates the possibility of the receiver going dead without the operator being aware of it.

A simple squelch circuit that serves the purpose is shown in the above sketch. This squelch has been used in a six-meter C.D. receiver which is to be described later in *QST*.

This circuit is an easy one to add to a receiver that has already been built and is in use, as it requires a minimum of change in the receiver. This circuit was tried out by adding it to a National NC-183. The first audio tube, a pentode, was removed and a 12AX7 double triode tube installed in its place. The use of a very high mu triode resulted in no noticeable loss of audio gain. The .01 capacitor is a ceramic disc mounted on the socket. The one megohm potentiometer could be a fixed resistor in locations that are not too noisy.

The .01 capacitor connects the grid and plate of the squelch tube together for audio frequencies making the tube virtually a diode. It can be looked at as a highly degenerative triode amplifier. This means that the plate resistance of this tube becomes very low — in the order of a cathode follower. The .1 mfd. capacitor places this low impedance of only a few hundred ohms across the .5 megohm gain control, shunting this control drastically. When sufficient AVC voltage is applied to the grid of the squelch tube, it is cut off and its impedance becomes extremely high, removing any shunting impedance from the gain control and opening the audio amplifier up to full gain.

Between 20 and 25 decibels reduction in background noise was obtained with the NC-183 which is sufficient for most purposes. It is important that the .1 mfd. capacitor be connected to a point of very low audio voltage to prevent distortion due to too much audio on the squelch grid. The advantage of this circuit is its simplicity, small number of parts and space required, and the ease with which it can be added to most any receiver.

DAVE SMITH, W1HOH



—IDEAL *for the* NOVICE

In addition to its many features, the TR-75TV has special design precautions to insure minimum interference to television. Special shielding and by-passing makes this transmitter ideal for fringe area operation or use in highly congested areas.

Look at these outstanding features of the TR-75TV:

- Simple enough for the beginner to assemble, sturdy enough for years of trouble-free operation.
- Uses the time-proven crystal oscillator final amplifier combination.
- Circuit permits use of 80-meter or 40-meter crystals to cover all bands.
- Plug-in coils eliminate trick circuits.
- Husky power supply employing a 5U4G rectifier delivers 500 volts d.c. to the final.
- Pi-network output simplifies loading of transmitter with all types of antennas; ideal for multi-band operation.
- All stages are metered using a meter which can be switched to oscillator plate, final grid and final plate.
- A terminal strip is provided to connect a modulator if radio-phone operation is desired at a later date. Eldico's MD-40/MD-40P Class B 6L6 modulator is designed expressly as a companion unit.

Over-all size with cover 17" x 10" x 9". Complete kit (less crystal) . . . not another bolt or wire to purchase, including a smartly styled shielded cabinet to minimize television interference. For 110-120 v, 50-60 cycles.

TR-75TV, complete kit with instructions \$59.95

EVERY ELDICO PRODUCT IS NOW AVAILABLE ON AMATEUR PRIORITY M-85

MD-40, MD-40P, MD-100 Modulator: The MD-40 delivers 40 watts of A.M. phone using 6L6 in class AB2. MD-40P is identical with self contained power supply. MD-100 delivers 100 watts of AM phone using 807's in AB2 with power supply. Each kit complete with components, tubes, crystal microphone, etc.
MD-40—\$34.95 MD-40P—\$44.95 MD-100—\$49.95

Grid Dipper and Antennascope: Two instruments no ham shack should be without. For complete details see our advertisement in December QST. Available both in kit or wired and tested. **GDO** Complete kit with instructions **\$29.50**, **GDO** wired and tested **\$43.00**

Antennascope. Complete kit with instructions **\$24.95**. Wired and tested **\$29.95**

2-Meter Mobile Receiver and Transmitter: Designed for mobile or fixed station operation. Ideal for amateur, Civilian Defense or CAP usage. Receiver complete superhet tuning 144 to 150 mc, with sensitivity of better than 1 uv for 6 db signal to noise ratio. Transmitter is crystal controlled 144 to 150 mc. 6AQ5's crystal and doubler stages driving 2E26 final up to 22 watts input; 6C4 speech amplifier for carbon microphone input; 6V6's modulators. Modified pi network output for ease of coupling to any type of antenna. **2-Meter Receiver.** Complete kit with instructions **\$59.95**. Wired and tested. **\$94.95**

2-Meter Transmitter. Complete kit with instructions **\$49.95**
 Wired and tested. **\$74.95**

Power Supplies for above. AC—**\$30.00**. 6VDC **\$45.00**

"Private Tutor" Amateur Novice Course **\$25.00**

"WE HAVE ELDICO PRODUCTS"

ACK RADIO SUPPLY CO.
 2205-3rd Ave. No.
 Birmingham 3, Ala.

ALLIED RADIO CORP.
 833 W. Jackson Blvd.
 Chicago 7, Ill.

ALMO RADIO CO.
 509 Arch St.
 Philadelphia 6, Pa.

WALTER ASHE RADIO CO.
 1125 Pine St.
 St. Louis 1, Missouri

GEORGE D. BARBEY CO.
 2nd & Penn Sts.
 Reading, Pa.

BLUFF CITY DISTRIBUTING CO.
 905 Union St.
 Memphis 3, Tenn.

CONSOLIDATED RADIO CO.
 612 Arch St.
 Philadelphia 6, Pa.

THE CRAWFORD RADIO
 King, Wm. & Hughson
 Hamilton, Ontario, Canada

DE MAMBRO RADIO SUPPLY CO.
 90 Broadway
 Providence, R. I.

M. N. DUFFY & CO.
 2040 Grand River Ave. West
 Detroit 26, Mich.

W. H. EDWARDS CO.
 94 Broadway
 Providence, R. I.

ELECTRONIC WHOLESALERS
 2345 Sherman Ave. N.W.
 Washington 1, D. C.

EVANS RADIO
 P.O. Box 312
 Concord, N. H.

FEDERATED PURCHASER, INC.
 911 So. Grand Ave.
 Los Angeles 15, Calif.

FEDERATED PURCHASER, INC.
 1115 S. Hamilton St.
 Allentown, Pa.

FEDERATED PURCHASER, INC.
 114 Hudson St.
 Newark, N. J.

FEDERATED PURCHASER, INC.
 701 No. Hampton St.
 Easton, Pa.

FORT ORANGE RADIO DISTRIBUTING CO., INC.
 904 Broadway
 Albany 7, N. Y.

HARRISON RADIO CORP.
 225 Greenwich St.
 (10 W. Broadway)
 New York 7, N. Y.

HARVEY RADIO CO., INC.
 103 W. 43rd St.
 New York 18, N. Y.

HATRY & YOUNG OF SPRINGFIELD, INC.
 169 Spring St.
 Springfield, Mass.

HATRY & YOUNG OF LAWRENCE, INC.
 262 Lowell St.
 Lawrence, Mass.

HENRY RADIO STORES
 211 No. Main St.
 Butler 1, Mo.

11240 W. Olympic Blvd.
 Los Angeles 25, Calif.

THE MYTRONIC CO.
 121 W. Central Parkway
 Cincinnati 2, Ohio

NEWARK ELECTRIC CO.
 323 W. Madison St.
 Chicago 6, Ill.

OFFENBACH & REIMUS CO.
 1564 Market St.
 San Francisco 2, Calif.

RADIO AMATEUR CENTER
 411 Hillsboro St.
 Raleigh, No. Car.

THE RADIO CENTER
 62 Craig St. West
 Montreal, Canada

RADIO ELECTRIC SERVICE CO. OF PENNA., INC.
 701 Arch St.
 Philadelphia, Pa.

RADIO ELECTRIC SERVICE CO. OF PENNA., INC.
 1042 Hamilton St.
 Allentown, Pa.

RADIO ELECTRIC SERVICE CO. OF PENNA., INC.
 916 Northampton St.
 Easton, Pa.

RADIO ELECTRIC SERVICE CO. OF PENNA., INC.
 3rd & Tainall Sts.
 Wilmington, Del.

RADIO ELECTRIC SERVICE CO. OF N. J., INC.
 513-515 Cooper St.
 Camden, N. J.

RADIO ELECTRIC SERVICE CO. OF N. J., INC.
 452 N. Albany Ave.
 Atlantic, N. J.

RADIO EQUIPMENT CO.
 821 W. 21st St.
 Norfolk 10, Va.

RADIO PARTS CO., INC.
 538 W. State St.
 Milwaukee 3, Wis.

RADIO PRODUCTS SALES CO.
 1237-16th St.
 Denver, Colo.

RADIO PRODUCTS SALES CO.
 1214-1st Ave.
 Seattle, Wash.

RADIO SHACK CORP.
 167 Washington St.
 Boston, Mass.

SREPCO, INC.
 135 E. 2nd St.
 Dayton 2, Ohio

WESTERN DISTRIBUTORS
 227 No. Santa Fe
 Salina, Kansas

WORLD RADIO LABS, INC.
 744 Broadway
 Council Bluffs, Iowa

**Buy THE X'MTR
you will USE
FOR YEARS**

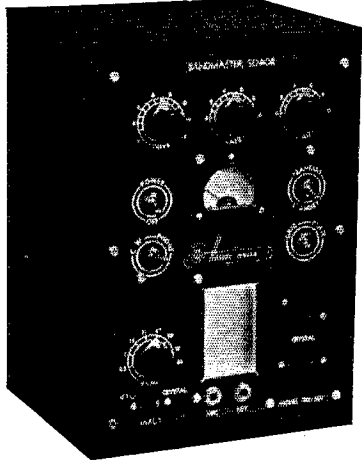

Harvey-WELLS

BANDMASTER

40 to 50 WATTS

THE WORLD'S MOST VERSATILE X'MTR FOR MOBILE OR FIXED OPERATION, NOVICE OR EXPERT

For Hams, Business Organizations, Government Dept's, Emergency Services and Civilian Defense.

BANDMASTER SENIOR . . .

A complete ready-to-go phone transmitter including new crystal-oscillator—vfo switching circuit—Phone or CW—100% break-in-operation—Eight bands: 80, 40, 20, 15, 11, 10, 6 and 2 meters—No plug-in coils—completely wired and tested. Tubes: 6AQ5 Crystal Osc., 6AQ5 Buffer Mult., 807 Final, 2-6L6 class B Modulators. Sturdy Steel Cabinet 12" x 8" x 8". **\$111.50**

BANDMASTER DELUXE . . .

The last word in a versatile small transmitter for home or commercial use. Thousands now in use in foreign countries for important applications and now adopted by many of our communities for civilian defense. Has built-in three tube preamplifier for use with crystal mike PLUS all the features **\$137.50** of the Bandmaster Sr.

REMEMBER—Your Bandmaster is protected by a continuing Technical Bulletin Service mailed regularly to all registered owners. It provides methods of adding new features as they are developed. No Bandmaster becomes obsolete or outmoded.

Send now for latest catalog

Harvey-WELLS ELECTRONICS, INC.

SOUTHBRIDGE, MASSACHUSETTS

Export Dept. 13 East 40th Street, New York

(Continued from page 70)

Corps of Hennepin County has a ground plane antenna 280 feet high. IJN now is located in Redwood Falls. SER now has a 32V-1. DZS has a new Collins 30K. The Minneapolis Radio Club elected the following: FDS, pres.; JNC, vice-pres.; BSI, secy.; and NYO, treas. #EA now is operating K6EA/θ at Bemidji. KYE, our Asst. SCM, is in the Vets Hospital after a serious operation. FJJ is a new ham at Duluth. KNN owns a new Viking. ZOB also has a new Viking. BZJ has a new Viking Shifter. EVD now has an 813 in his final. RA was the first to show the Duluth gang the '52 call-letter plates. EBX is a new ham at Virginia operating on 160 meters. QYZ is with his grandpa. AA has been working plenty of DX with his all-band antenna. ENJ is the new mayor of Floodwood. JVV still is going strong on 7-Mc. c.w. GKP is now 2 through 160 meters. NRV is building a Clapp oscillator. PQX is back from the Navy and on 28-Mc. mobile. MJJ has a 450-foot-long wire antenna now. Lil Dedon returned from Canada with greetings from the VE boys. Operations on the 80-meter c.w. net has been lagging this winter. Would like to see more of you take time to check into this net. The c.w. net meets evenings at 7 on 3795 kc. Traffic: W0ITQ 256, HEO 120, UCV 63, K6EA/θ 39, W0MXC 31, RXL 17, CWB 13, FIT 9, TKX 8, BUO 7, BBM 4, FTJ 4.

DELTA DIVISION

ARKANSAS — SCM, Dr. John L. Stockton, W5DRW — A TLC, at Case, has new Johnson Viking transmitter with VFO. ANR is QRL with MARS training program on the c.w. net at present. DFX helped secure watermelon juice via amateur radio for a patient in Florida in critical condition. BAB has been working 28-Mc. mobile. PUN has a new 10-meter antenna. MRD, RWJ, and ANR renewed certificates as ECs. It is almost time to begin considering who you want for your next SCM. WN5TLD now has his Technical Class license. STU has new VFO, and lacks Idaho for WAS. QIP has a BC-457 Command set, 60 watts. WN5TIC has an HT-6, 40 watts, and an HQ-129X. Traffic: W5RWJ 50, EA 42, DRW 37, QIP 34, STU 18, ANR 17, MRD 4, WN5TIC 4.

MISSISSIPPI — SCM, Norman B. Feehan, W5JHS — New calls reported in the State are TDP, TBI, TVI, and TUO. TUO has a pair of 35TGs running about 150 watts. TDP has a Viking. TBI has a Globe Champion. TVI has 32V-1. TVI keeps sked with his dad each morning on 75 and 80 meters. Ken works the high end of 80 meters and 4BOL, his dad, the low end of 75-meter phone. SMD has completely eliminated his TVI. 4MM/4 reports that GG and OOA are doing an FB job with their 75-meter mobile rigs. We regret to report the passing of NYF, who accidentally shot himself while hunting. The Hair Net, on 7159 kc., will take traffic for all points that are OKed by FCC, so why not drop in at 1 p.m. CST and give the fellows a shot at your traffic. RUT will have a new QTH somewhere in the Far East. Look for him on 14 Mc.; he will be looking for the Mississippi boys. Traffic: W5JHS 205, WZ 171, K5FBB 156, W5RIM 155, SSB/5 104, RUT 36.

TENNESSEE — SCM, D. G. Stewart, W4AFI — It is with deepest regret we note the passing of Doc Mitchell, W4EM, on Oct. 9th. He was an old-timer on the ham bands and held the highest respect of all who knew and worked him. AEE subdued his TVI from 500-watt unshielded transmitter by means of stubs. New appointee is NJE as EC for the Lewisburg Area. PMR acquired 1st-class radiotelephone license. AGC is reporting nice monthly traffic totals; he picks traffic up on QIN, TLJ, TCN, and regular skeds with 6CE. LUH is prodding around on 4 Mc. with brand-new kw. crusher. The Kingsport group recently completed a successful simulated emergency drill. PEN is back in the saddle again and can be heard on 4 Mc. regularly. ODR has traffic outlets to the armed forces at various points. Several of the Memphis group attended the radiological survey class conducted by the Memphis Civil Defense Organization. BAQ and HJK are building auto-call units designed by 3NL for use on 29-Mc. Net. When completed they will operate from whistled pulses from the calling station, cutting on the speaker and ringing a bell. AFI is building a new 4/125A final. KMH prepared new TCPN roster and it is available to net members on request. The Tennessee C.W. Net is in need of coverage for the larger towns. All who can possibly do so are urged to report into this Net and assist in keeping it rolling. Traffic: (Nov.) W4PL 1311, AGC 243, CXY 78, IIB 77, ODR 72, RMJ 29, AEE 22, RPT 16, BAQ 15, FEB 13, RHO 9, FLW 5, NDC 2. (Oct.) W4BAQ 58.

GREAT LAKES DIVISION

KENTUCKY — SCM, I. W. Lyle, jr., W4KKG — JYR is giving 7 Mc. a try. NBY reports in with a nice traffic total. PKT reports in on KYB and KYN. MGT, our SEC, also is a real traffic man. KZF made a nice score on phone in the SS. NZY has a new 75-meter mobile rig. RQV, in a TV fringe area, is hard hit. JUI is building new OO equipment. RYL has new 75A-2 and says it's a honey. TQC, Novice in Glasgow, passed his Class B exam. NEP

(Continued on page 76)

MALLOBY HAM BULLETIN

RECENTLY, we received a request from a fellow amateur for the solution of an interesting DC filter problem which involved cramming several Mfd's of filter capacity into a space already overcrowded with transformers, chokes and other components. His problem, and its subsequent solution, might prove helpful to other amateurs confronted with a similar dilemma. So we are passing along the story for what it might be worth.

Here was his problem: He had designed a 2-stage transmitter consisting of a harmonic oscillator and final amplifier, which required 2 complete DC power supplies. one delivering 700 volts for the plates . . . the other, 300 negative volts for bias and blocked-grid keying potential. His plans included making this rig completely self-contained with power supplies and RF stages mounted compactly on a single small chassis.

His problem arose when he discovered that it was impossible for him to arrange the other components of his transmitter to provide sufficient mounting area for the DC filter capacitance needed. The best he could do was an area roughly 2" square by approximately 5" in height in which to mount 4 Mfd's at 700 volts, and 8 Mfd's at 300 volts.

In pondering his problem, we thumbed through the latest Mallory Catalog looking for a capacitor which might fit his requirement. Frankly a solution didn't appear until we reached page 6. There we found the Mallory RM-265, a triple "e" separate section electrolytic. This capacitor looked as if it might have possibilities. Sure enough, it did the job!

The RM-265 is an electrolytic capacitor consisting of 3 separate 8 Mfd sections rated at 450 volts DC and is mounted in a single aluminum container measuring 1 $\frac{3}{8}$ " in diameter and 4 $\frac{1}{4}$ " in height. For this application, 2 of the 8 Mfd sections were connected in series to provide 4 Mfd of filtering at better than 700 volts, while the remaining 8 Mfd section was used as the bias supply filter.

The basic essentials of the power supplies he used are shown in the schematic diagram. Note in particular the 50,000 ohm 2 watt carbon resistors across the seriesed sections of the capacitor. These resistors are employed as voltage equalizers and should not be omitted.

This is one of many examples of how the complete line of Mallory quality parts can help you solve unusual problems. It would pay you to become familiar with the Mallory Catalog. It contains a wealth of special capacitors, controls, resistors and vibrators for unusual applications such as this one. Your authorized Mallory distributor will gladly supply you with a copy.

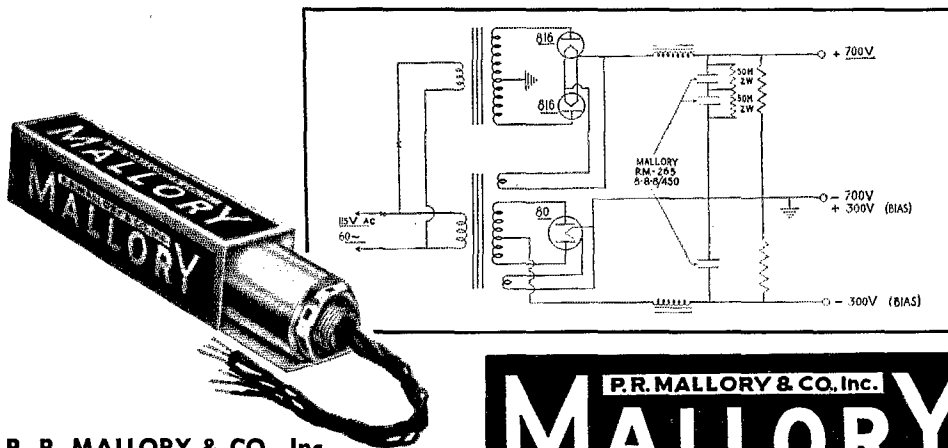

P. R. MALLORY & CO., Inc.
INDIANAPOLIS 6 INDIANA

P. R. MALLORY & CO. Inc.
MALLOBY

CHICAGO

Transformers Designed Expressly

For Today's Amateur Circuits

PLATE TRANSFORMERS

Pri. 115/230 Volts, 50/60 Cycles. Here they are—the top-performing plate transformers and matching filter reactors. They're conservatively designed, with ample insulation throughout. They operate with a temperature rise of 40° to 50°C at full load, 60 cycles, under CCS duty. Under ICAS conditions, the duty cycle is 15 minutes time on and 15 minutes time off, with same temperature rise applying as under CCS duty.

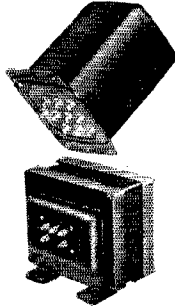

Catalog No.	Max. Pri. VA	Secondary A-C Load Volts	D-C Volts after filter	D-C Ma. CCS	ICAS
P-45	185	675-0-675	400	250	325
		575-0-575	500		
P-67	250	900-0-900	750	250	325
		735-0-735	600		
P-107	310	1150-0-1150	1000	250	350
		870-0-870	750		
P-1240	360	1425-0-1425*	1250	150	200
		600-0-600	400		
P-1512	550	1710-0-1710	1500	300	425
		1430-0-1430	1250		
P-2520	915	2820-0-2820	2500	300	425
		2260-0-2260	2000		
P-3025	1850	3450-0-3450	3000	500	700
		2850-0-2850	2500		

*Both secondaries may be rectified simultaneously

FILTER REACTORS

Catalog No.	Inductance in Henries	Max. D-C Ma.	D-C Resistance, Ohms	Insulation Volts RMS
R-67	6	700	35	10,000
R-105	10	500	40	9,000
R-65	6	500	35	9,000
R-103	10	300	40	7,500
R-63	6	300	35	7,500

SEND FOR FREE CATALOG TODAY!



You'll want the full details on CHICAGO'S New Equipment Line—the famous Sealed-in-Steel line that offers advanced engineering design to fit today's Amateur circuits. Full listings of Plate, Filter Reactor, Filament, Audio, Modulation units. Write for your FREE catalog today—or get a copy from your distributor.

WRITE NOW!

**CHICAGO Transformers are
the Choice of Leading Amateurs**



CHICAGO TRANSFORMER

DIVISION OF ESSEX WIRE CORPORATION

3501 ADDISON STREET • CHICAGO 18, ILLINOIS

handles his job as NCS of KYN in good style and daughter Susan, TAV, works in SS and DX Contests. THY and TPD are Novice Class licensees in Paducah. ALR has been called back to the Navy on active duty. SZL, a new ham in Glasgow, reports in for the first time. LXA, ex-Florida ham, now is in Harrodsburg. OXT sends in a nice long report. The U. of L. Radio Club, composed of many well-known amateurs, is real active and is becoming well known around town. ABEY finished new rig of 813s. SHD is rebuilding mobile rig to take to Camden, N. J., when he starts co-op work there. OXT also will go to Camden. TZT, Kentucky representative from Ft. Mitchell, has offered to sponsor the License Plate Bill in the Kentucky General Assembly. He will work with TUT on this. RRE got 1st-class radio ticket. OXN has a new HRO. PSE now is with Recordak Division of Eastman Kodak. PSJ is leaving for overseas work with Philco. KBR clears out trees for antenna room! VP has new Collins receiver and transmitter. PQJ is working on various types of oscillators. MRF reports in on KYR. OYH got his 1st-class ticket. CN has a new 813 rig. KMX, MOP, and OVG work mobile on the way to work and then work on mobiles all day! LNU has a new ham shack basement. All you Kentucky hams who haven't dropped a QSL to TUT backing up the license plate deal should do so at once. I would like to thank YAL for a lot of the dope in this report which he kindly furnished me, and also all of you fellows that wrote in this month. It makes my job easier and I know that Kentucky is on the map. Traffic: WAMGT 366, NBY 120, NWX 120, NEP 69, PRT 51, BXU 28, JUI 18, RQV 13, KKG 10, KZF 2.

MICHIGAN — SCM, Norman C. MacPhail, W8DLZ — Asst. SCM (o.w.); J. R. Peljan, 88CW, Asst. SCM (phone); R. B. Cooper, 8AQA, SEC; G.J.H. PAM; UTH, RMs; UKY, YKC, ELW. New appointments: ORS to IBB and QIX; OPS to EEF; RAI (8RN) to ELW; EC (Oakland County) to EAE. SCW now is the manager of the EAN, with ELW Assistant RM of the 8RN. SWG reports the Niles ARC officers are C.P.I. pres.; NLO, secy.; RAE, treas.; UPN act. mgr. ZIOP now is 8IOP at Buchanan. GJB reports a 32-station Great Lakes Emergency Net is operating on 1880 kc. every Tuesday evening at 7:30 EST with traffic outlets west and south. They would like more liaison with the BRNet and the QMNs. UGM now is the proud pappy of twin YL harmonies. WXO is recovering from a rough bit of oral surgery. MGQ, the perpetual builder, still is working on new modulator and final. EEF has a new NC-183. FGB says the Barien County Emergency Net is growing fast on 1890 kc. ILP reports the new officers of the Edison Amateur Radio Assn. are ZDK, pres.; VRB, vice-pres.; TMK, secy.-treas.; HLO, act. mgr. CPB is keeping daily skeds with VE8MC on 14 Mc. WNT has a new ranch-style home with a 42-foot tower atop. FFG is handling traffic with a 4-watter on QMN. SWG is doing the same with 9 watts. 1952 officers of the Hot Air Net are YLZ, pres.; IKX, vice-pres.; ZN, secy.-treas. The Grand Rapids gang is busy preparing for the midwinter hamfest. FX is building a new exciter. TZD is keeping daily skeds with 21HW, formerly 8PHO. DOI wants someone to invent a 28-hour day so he will have some time for traffic on QMN. EXZ reports DX on 7 Mc. at peak and several European QSOs on 3.5 Mc. ZEE is rebuilding for higher power. Thirty-five students completed the Grand Rapids Club's 12-week course in radio theory and code and now are waiting impatiently for the R's visit in January. The Michigan section leads the nation by almost two to one in the number of stations reporting traffic each month over the past year. Traffic: (Nov.) W8RJC 378, ELW 279, CPB 170, SCW 115, QBO 104, ZLK 102, SWG 67, SPT 50, IV 49, QIX 49, AQA 40, DLZ 35, DAP 31, ILP 34, TBP 31, WXO 31, LR 29, BVY 28, FX 27, HGY 24, TZD 22, IKX 21, DOI 9, TQP 9, WVL 9, YWF 8, MGQ 7, BJD 6, EXZ 2, ZEE 2, EEF 1, (Oct.) W8NZZ 255, ILP 75, CPB 49, TZD 34, GJH 14, GJB 13, QCZ 8, YWF 7, FFG 4, WNT 4.

OHIO — Acting SCM, John E. Siringer, W8AJW — SEC; UPB, PAM; PUN, RMs; DAE and PMJ. GAV is a new ORS. DBX has been appointed Manager of 8RN. Outo Liaison to 8RN are IB, DAE, YCP, FYO, and DSX, Monday through Friday, respectively. Our capable SCM, Carty, still is covering a good portion of the State on his lecture and information tours. It appears as though caller auto tags will not be issued until 1953, unless the OCARC is successful in its efforts to get clubs and c.d. organizations to contact NNC, committee head, who will bring the matter to the attention of the Registrar of Motor Vehicles. Information Bulletin No. 8-3, "Emergency Radio Communications," now is being issued by the Adjutant General's Department. HOM has erected a new 80-meter antenna. The second Hidden Transmitter Hunt staged by LYD, EC for Cuyahoga County, was equally as successful as the first, with 75 mobiles, 25 fixed, and three portable stations participating. DAE was active both week ends in the 8S. Wonder how many of you heard UKS knocking them off on 75-meter 'phone during the 8S. PUN now operates a 36-watt TVI-less rig during the P.M.s. DMJ, former de luxe DX man on 28 Mc., now is one of the State's more active 3.8-Mc. 'phone men. LBH is doing a revamping job and is back on all bands. Numerous compliments have

(Continued on page 78)



CRYSTALS

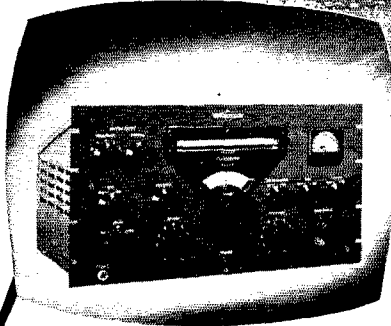

Supplying TODAY'S NEEDS

They're "anchors to the airwaves", these JK crystals which pinpoint the RIGHT frequencies. Like much of today's fine equipment, this Collins communications receiver prefers the JK H-9.

and DESIGNING TOMORROW'S

So new their possibilities remain comparatively unexplored, JK ultrasonic transducers have become the youngest pioneers in laboratory research. They are supplied in any cut desired.

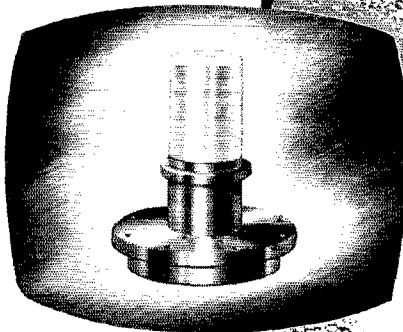

A MODERN THERMOMETER FOR OIL FIELDS

Deep in the oil fields, the JK ultrasonic transducer has found another dramatic application. It is used to measure temperatures far into the depths of the ground. When the signal changes frequency below the ground, the temperature is thus recorded. **WHATEVER** the crystal requirement, James Knights labs can furnish the crystal to do the job.

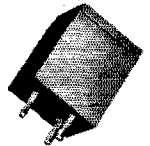

JK H-11



JK T-9



JK G-9



JK H-17

*Crystals
for the
Critical*

The
**JAMES
KNIGHTS
CO.**

**SANDWICH 6,
ILLINOIS**



**More Safety...Less Guesswork
When You Use
-PRECISION-
TEST EQUIPMENT**

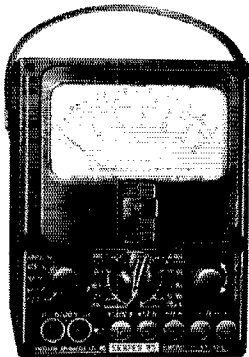

**Stay On The Air
With "PRECISION"
SERIES 85
AC-DC
Circuit Tester
(20,000 Ohms per Volt)
SELF-CONTAINED TO
6000 volts,
60 Megohms,
12 Amperes, + 70DB**

A compact, laboratory type, *high sensitivity* test set indispensable for test and maintenance of modern amateur communications equipment.

20,000 Ohms per Volt D.C. — 1000 Ohms per Volt A.C.

VOLTAGE RANGES: 0-3-12-60-300-1200-6000 A.C. & D.C.

CURRENT RANGES: 0-120 microamps; 0-1.2-12-120-MA;
0-1.2-12 Amps D.C.

RESISTANCE RANGES: 0-6000—600K—6 Meg—60 Megohms.

DECIBEL RANGES: From —26 to +70DB.

Complete with batteries and test leads..... **\$39.95**

PLUS superior physical features:

- ★ 4½", 50 microamps, Easy Reading Meter.
- ★ Heavy duty bakelite case 5½ x 7½ x 3".
- ★ Deep etched, anodized aluminum panel.
- ★ Recessed 6000 volt safety jacks.
- ★ Only two pin jacks for all standard ranges.

LC-1 LEATHER CARRYING CASE—Custom designed, top-grain cowhide case with tool and test lead compartment. \$9.50

See Series 85 and other famous "Precision" instruments, on display at leading radio parts and ham equipment distributors. Write for latest catalog.

Precision Apparatus Co., Inc.

92-27 Horace Harding Blvd., Elmhurst 13, N. Y.

been heard regarding the new QSL Manager, LJS. FJR, the teen-age whiz kid, claims that, what with the youngsters growing up, the teen-age net is dying, or rather, fading away. Only two bulletins were received this month. From the *Carascope* of the CARA we learn that the club officials for '52 are WAB, pres.; WRL, vice-pres.; APF, secy.; and ABO, treas.; that a club Christmas Party was held Dec. 14th; and that AREC is "going to town" in Franklin County. The *Shack Gossip* of the Toledo group informs us that several of the gang have been bitten by the 160-meter mobile bug; that AZB is attending school in Georgia; and that GRJ now is on 2 meters. Relected CWA officials are BF, pres.; BXB, vice-pres.; and FSP, secy.-treas. CACARC announces that the winners of the recent 10-meter ground-wave contest were AJW, FCX, and WML among the locals, with MXO and FSM tying for first place and UBY finishing third among the out-of-county stations. Reports still are arriving rather late so let's try to get them to the SCM a bit earlier. Traffic: W8DAB 250, 1B 226, ARO 197, YCP 61, WE 49, AL 23, DXO 23, EQN 22, QIE 20, PUT 14, BFH 12, AJW 10, RN 10, WAB 10, DMJ 9, LBH 5, PMJ 4, BUM 3, ET 1, FXJ 1.

HUDSON DIVISION

EASTERN NEW YORK — SCM, George W. Sleeper. W2CLL.— SEC: ILL. This is my last report of section activities. The need for a good rest and the increased amount of traveling incidental to my regular occupation have made it necessary for me to give up all ham activity for at least this winter and all of next summer. I take this opportunity to congratulate the section on its past and present splendid performance. Much has been accomplished. ARRL membership is increasing, clubs are growing, c.w. and 'phone nets have increased, and AREC is at an all-time high. The cooperation I have always received from each member is indicative of the strength and activity of the section. That cooperation has been much more than anyone could have hoped for. I know it is needless for me to say that it was with the utmost regret that my resignation was submitted. I have always been proud to be a member of our section, and even prouder to have had the privilege of serving as your SEC for 2 years and SCM for over a year. I am taking my vacation with the comforting knowledge that the section will continue to grow and become even stronger. The interest of the individual, plus the talents of the leadership appointees, assures that I am retaining the appointment as your Assistant Director in order to keep in touch with things and to continue to serve in a small way. Thanks to each of you for the help you have given me. I'm looking forward to my reactivation during the fall of 1952. Endorsements: AWF, GYV, GTI, PIE, LXP, ISG, IFF, WBH, PSH, SNN, and AAO as ECs; TYC as RM; EFU and BRS as ORS. Traffic: WBNC 364, PHO 203, TYC 88, EFU 76, HTH 39, GTC 33, BRS 1.

NEW YORK CITY AND LONG ISLAND — SCM, George V. Cooke, Jr., W2OBU — Asst. SCM, Harry Daniels, 2TUK. SEC: SYW. RM: TUK. PAM: YBT. The Brooklyn AREC nets show an average attendance of 95 per cent of all registered members participating in drills. For outstanding attendance and effort FTF, CLQ, BIV, PYX, YES, ZLK, JGD, THJ, WDH, and WDT received their Section Net certificates. Closer cooperation with e.d. officials in Suffolk is noted with Brookhaven, Smithtown, Huntington, and Islip Township organizing and setting up stations at strategic points and increasing their AREC memberships. In Nassau County, the C.D. Plan has been compiled and presented to the County C.D. for approval. Impetus is shown by increased personnel and the location of alternate stations for control on a local basis in a number of localities. KVG has been appointed EC in Queens and OG Alternate EC. In the Queens 2-Meter Net those having perfect attendance for the month were as follows: AVL, DGF, KVG, OG, and QFH. DVN and GIO operate PAG/2 at Flushing Hospital. KVG, OG, DVK, UNG, and DGF operate at Red Cross Rest Centers. WDP has been appointed Suffolk Alternate EC. EBZ and BNN now are operating on Liberty ships and sailing the high seas. The lure of the sea is calling BOC. GPK became the 100th member of the New York Radio Club at the same time AFG, ASA, CLD, IZN, KR, RAQ, and 9SM joined up. In the 420-Mc. band PAA, KRM, and PTO, along with CEP, are active on schedules in and around the Copiague Area. KAC, Tech. Class licensee, received his OES appointment. The Smithtown CD Radio Club and the Purple Bees are two newly-affiliated clubs in the section. A card from SJC tells of his cruise to Portugal, France, Greece, and Italy, where he met 11VL. The NYC-LI Phone Net, with YBT and PAM, operates on 3910 kc. Sundays at 1000 and now has 15 regular members and seeks stations in all parts of the section. Traffic, discussions of major topics, and net operation are the incentives for increased pleasure. YAU now is living in Philadelphia. UTB has moved to Seattle. JHF's little 2-meter rig is a neat package and would serve well in AREC planning. DIC, representing the TVI organization of N.Y., reports many cases of TVI cleared and agreements made with manufacturers for full cooperation in future cases. The Tu-Boro Club is pushing the Auto

(Continued on page 80)

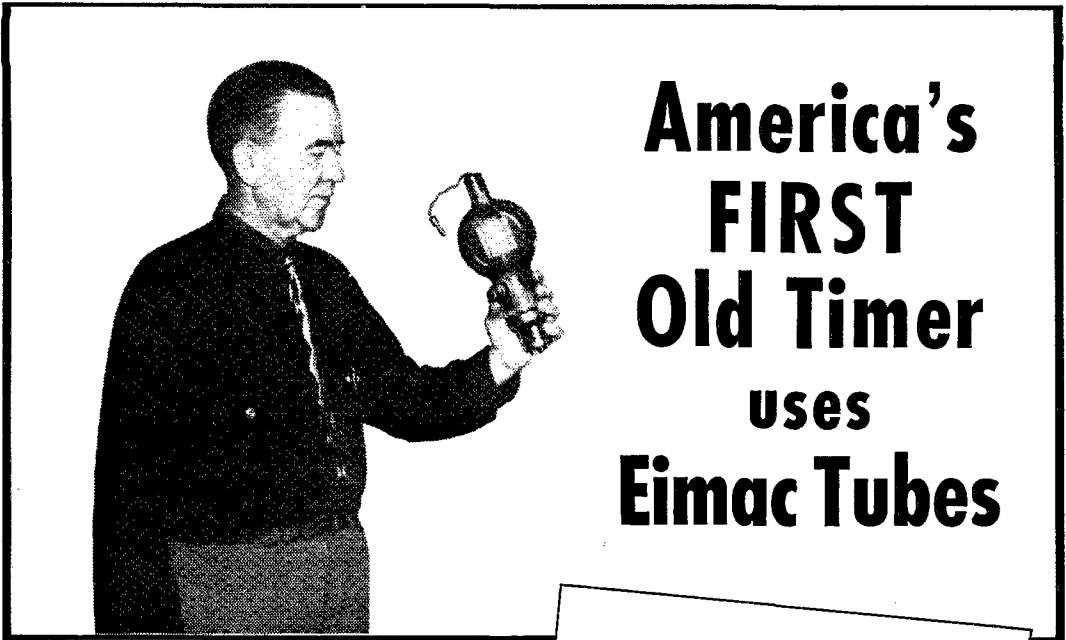

America's FIRST Old Timer uses Eimac Tubes

Irving Vermilya, W1ZE, an amateur radio operator since 1901, is witnessing the outstanding longevity of Eimac tubes. After more than a decade and a half of dependable service, two of his 300T's are still going strong — operating far beyond their guarantees.

Today Eimac offers a complete line of transmitting power tubes designed by the world's finest tube engineers to last longer and keep your rig on the air at least expense.

Mattapoisett, Mass.
September 10, 1951

Eitel-McCullough, Inc.
San Bruno, California

Gentlemen:

In 1935 I purchased three Eimac 300T (I believe you now call them 450T) tubes. Last night, after 16 years of almost continuous service (transmitter was on lease and used by the government during World War II), the first of these tubes gave up the ghost... the filament touched the grid. The other two are still going strong in my cool kilowatt rig. I believe this is the way to use tubes—let 'em loaf along.

At my age —61— I am a little reluctant to buy something that is going to last me another twenty years...but my ham activities would no longer be a pleasure without Eimac tubes. Would you please send me information on your modern version of the old 300T. I understand the new tubes will work right in the old sockets...without circuit modification and give still better service; and at the same time send me information on your tetrodes as I may want to modernize my rig while I have the opportunity.

Sincerely yours,
Irving Vermilya
Irving Vermilya
W1ZE

- Get the Eimac-published booklet, "The Care and Feeding of Tetrodes." It's loaded with valuable information, costs 25c. At your distributor's — or write:



EITEL-McCULLOUGH, INC.

SAN BRUNO, CALIFORNIA

Export Agents: Frazar & Hansen, 301 Clay St., San Francisco, California

2 New Mallard Products!

Now available at your jobber — two new MALLARD products designed for more enjoyable, more dependable mobile operation!

New MALLARD VFO

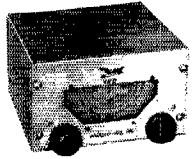

Designed primarily for mobile use — ideal for fixed stations too! Provides output on 160 and 40 meters more than adequate to drive transmitter to full excitation on all bands, 160 thru 10. Can be supplied with other output frequencies on special order for CD and similar applications.

FEATURES:

- ★ Plugs into xtal socket of any transmitter. ★ Voltage regulated — temperature compensated. ★ Nylon gear-drive dial accurately calibrated in Kcs. ★ Ample band spread. ★ Glare-free illuminated dial. ★ Power supply, available as optional equipment, supplies sufficient power for converter.

For more mobile QSO's — easier QSY while "in motion", get the new MALLARD VFO! Amateur Net.....\$59.95

New Mobile Transmitter

High efficiency, top quality components, skilled engineering — these characteristics best describe the new MALLARD MOBILE TRANSMITTER!

SPECIFICATIONS:

- ★ 30 watts on 75, 20 and 10 meter bands. ★ 2 xtal sockets with selector switch. ★ ECO socket. ★ Hi-level AM modulation 100% — Built-in speech clipper. ★ Plug-in coils for highest efficiency. ★ Antenna relay for push-to-talk. ★ Low impedance co-ax output.

New MALLARD MOBILE TRANSMITTER, with tubes and coils for one band, less mike and power supply. Amateur Net.....\$119.95

SINGLE BAND CONVERTER

Choice of mobile hams, everywhere, because of extra sensitivity — rock-like stability under adverse conditions of mobile operation. Available in three models for 75, 20 and 10 meter bands.

FEATURES:

- ★ Accurately calibrated nylon gear-drive dial with glare-free illumination. ★ Slug-tuned coils. ★ Low drain tubes. ★ Easy — plug-in — connections.

Models 75N, 20N, 10N, MALLARD CONVERTER, Amateur Net.....\$39.95

Mallard Hi-Q Loading Coils



Hi-Q 20 Loading Coil for 20 meter band. Plated 1/8" copper wire. Weatherproof plexiglas housing. Provision for exact inductance adjustment. Sturdy, efficient! Amateur Net \$8.95.

Hi-Q Loading Coil for 75 meter band: Two pie-wound coils for greatest efficiency. Plexiglas housing and Insulux-treater copper wire to resist moisture and fungus and maintain high Q. Easily installed, adjusted to exact inductance. Amateur Net \$7.95.



Adaptors available for installing Hi-Q Coils on non-standard mounts.

Prices subject to change without notice.



mallard mfg. co.

6025 NO. KEYSTONE AVE., CHICAGO 30, ILLINOIS

License Plate Bill and requested the FLIRC to start the ball rolling. The Queens 2-Meter Old Timers Net is going strong and more members are welcome. The net meets on 145.62 Mc. Mondays at 2100 with KVG as the NCS. The NLT Traffic Net, on 3630 kc. Mondays through Fridays at 1930, with TUK the OM, is steadily increasing its activity with higher traffic totals and members and desires more coverage in the Riverhead Area. All stations interested in the Slow Speed Training Net (NLT), please write or send a message to TUK requesting operating time and frequency. DUEP, Bronx EC asks two ABEC members for nets operating on 29.620 and 145.350 Mc. at 2100 in the Bronx. QOW has been appointed OPS. YSL and PAA are newly appointed OES. Traffic: (Nov.) W2VNI 231, EC 198, OBU 131, GP 80, JEQ 65, OJX 65, VVP 56, MQB 46, OUT 45, TUK 45, PZE 39, BGO 22, LGK 12, BIV 10, PR 10, DZK 8, QOW 5, DLP 4, JX 3, YBT 2. (Oct.) W2IGK 10.

NORTHERN NEW JERSEY — SCM, Thomas J. Ryan, jr., W2NKD — A committee of amateurs from all over the State has been formed to handle the job of composing a new Bill to be presented to the New Jersey Legislature when next they convene, to request our call letters on license plates. The general chairman of the committee is John McGrath, NUI, 1011 Avenue C, Bayonne. If you have a personal contact which you feel would be beneficial to the cause, please contact NUI. Four groups are working with NUI. MUP is Bill Revision chairman, assisted by UWK, UOU, and CGD. Publicity is being handled by ZBY and WN2BVS. DME is concerned with contacts in Trenton, and IIN is gathering information from each of the other 14 states which already issue call-letter plates. MMG is the general secretary of the entire committee. You will be able to keep in touch with the progress of the Bill by listening to Official Broadcast Stations in N.N.J. and S.N.J. The following stations will transmit news, written by ZBY, on the following bands: 75-meter 'phone — LOP, CXW; 80-meter c.w. — WN2AZP, NKD; 11-meter c.w. — WN2AZP; 10-meter 'phone — UOU, KLA, CGD, and ABX; 2 meters — EUI. The first of the committee meetings was held in the Bayonne Red Cross Dec. 3rd. Of interest lately around the section has been the new forms distributed by the Office of Civil Defense. The importance of these forms cannot be over-emphasized. The most important reason for their existence is to have each of the thirteen Area Amateur Radio Chairmen know what facilities are available for communication. You see, the c.d. radio organization in the State is broken down in the following manner: The State is divided into four Districts, the Districts into thirteen Areas. An Area comprises one or more counties. Your city is part of the county group, so that it is important that the Area office know what the set-up is in each city, for coordination purposes in time of emergency. Here in N.N.J. we have a group of unsung heroes who have done a tremendous job in helping us to police ourselves in staying on frequency within the bands, or helping us correct faulty procedure. I refer to the Official Observers. OUS, NIY, and GVZ send cards to offenders on each of our bands. We could use more OOs. How about applying for an appointment? OXL moved to Westfield. NIY got his 25-w.p.m. Code Proficiency certificate. ZEP mentioned that JN, on 3700 kc. nightly at 7, is gathering a large listening audience. New GSARA officers are K2BX, pres.; DME vice-pres.; LMB, secy.; YLS, treas.; and GUMI, chief engineer. LMB asks for listeners on 3970 kc. at 6:30 and 8:30 p.m. Maybe you can help deliver some of the enormous amount of G. I. traffic on the Transcontinental Phone Net (TCPN). CVW passed Class A exam. Traffic: (Nov.) W2CCS 257, LMB 198, WCL 122, ANG 47, EAS 44, ZEP 38, OXL 25, OUS 9, CJX 8, AWY 6, NIY 4, CFB 2. (Oct.) W2LMB 155, EAS 74, JKH 5.

MIDWEST DIVISION

IOWA — SCM, William G. Davis, W0PP — From the I reports received this month it seems that the only activity in Iowa is by the TLGN and Iowa 160-Meter 'Phone Net. The report on the 160-Meter Net was given by DIB. The Net meets on 1933 kc. at 6:30 p.m. seven days a week. The NCS is RWC, with BSG, BTX, BNS, and WKB as Asst. NCSs. They have contacts in Kansas, Minnesota, Nebraska, and Illinois. It is hoped that more reports will come in from this Net. The TLGN is up to its usual efficient operation. QVA is making up a monthly traffic report for TLGN, breaking it down to daily traffic, etc. AUL has new chrome-trimmed operating table. BDR has new Viking. CNK sports a Meissner Signal Calibrator. SEF now is using a Gammatron 24. ZYX left IFC for Ohio. FTF and YBK are back on duty with TLGN. CRP and YXE have opened a new TV store in Burlington. Part-time assistant is ENM, ex-9PIG. AEH is wintering in Phoenix. Don't forget the Agate. Otho. NWX reports the activity of the Ames club on a simulated emergency Oct. 14th. Those taking part were CFX, DDV, DEY, ZYX, and NWF. SEF, of Persia, also assisted. NFL is going to stick with c.w. for a spell. A nice report was received from DDV. Thanks for the reports, fellows. Traffic: (Nov.) W0SCA 462, NWF 277, QVA 158, YTA 83, BDR 76, NYX 44, DFD 25, DDV 6. (Oct.) W0NWF 94.

(Continued on page 22)

YOUR BEST SOURCE FOR ELECTRONIC COMPONENTS

Your Centralab Distributor (there's one near you) carries America's most complete line of controls, switches, ceramic capacitors and printed electronic circuits

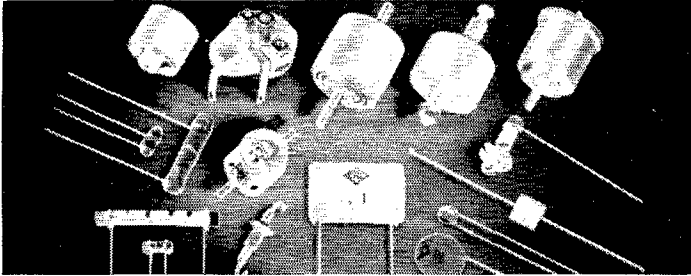

CERAMIC CAPACITORS with a wide range of ratings and in miniature sizes meet the exacting requirements of radio and television circuits. They offer high accuracy, low power factor, space saving and the most desirable temperature and humidity characteristics. This means freedom from service trouble not possible with older style condensers of moisture absorbing paper construction, or mica construction.

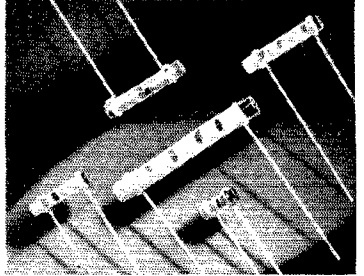

TUBULAR TC HI-KAPS temperature compensating ceramic capacitors. TCZ units show no capacity change over wide range of temperature; TCN's vary capacitance according to temperature.

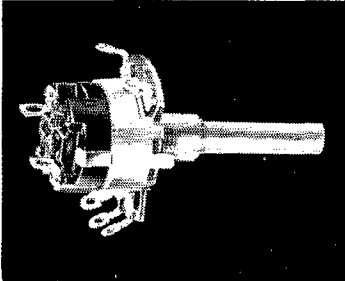

NEW BLUE SHAFT VOLUME CONTROLS available in all generally required sizes . . . plain and switch types. Factory-assembled and tested . . . ready to install.

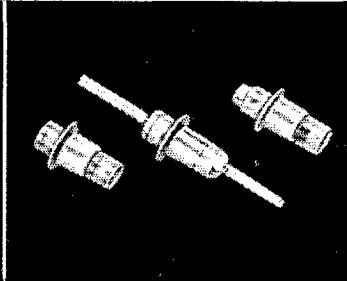

EYELET-MOUNTED FEED-THROUGH CERAMIC CAPACITORS are exceptionally small. Capacities range from 25 to 3000 mmf. Voltage rating, 500 V.D.C.W.

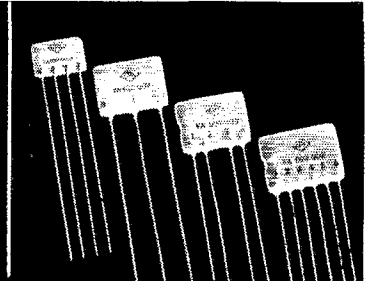

PRINTED ELECTRONIC CIRCUITS. Now available, everything from single value capacitors and resistor plates to complete 3-stage speech amplifiers.

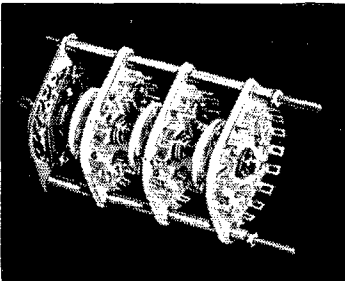

POWER SWITCHES are specially designed for transmitter, power supply converters and other medium duty power applications. Efficient up to 20 megacycles.

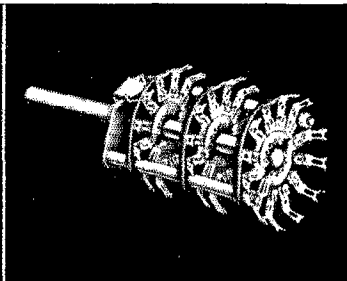

ROTARY BAND SWITCH is used primarily for band change and general tap switch applications. Made with Steatite or phenolic insulation.

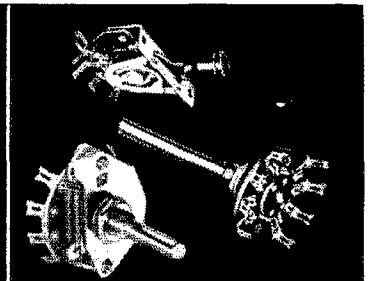

LEVER . . . SPRING RETURN . . . TONE SWITCHES. See your Centralab distributor for complete details on these switches — and the complete line of quality CRL parts.



These products are listed in Catalog 27. Just tell us you are a radio amateur—it will be mailed at once.

Centralab

Division of Globe-Union Inc.

912 E. Keefe Avenue • Milwaukee 1, Wis.

Deciding Factor

SAVES YOU MONEY

WARD

SPP-143

ACTUALLY SAVES YOU MONEY

HERE'S HOW!!!!

The WARD SPP-143 requires only one 15/16" hole for installation.

Installed in the same place as a standard radio antenna . . . no unsightly holes to refill when you trade-in your car. Merely replace with a standard auto antenna.

WARD's SPP-143 is available at your radio parts distributor. See him for the complete line of WARD amateur mobile antennas.

The WARD SPP-143 is a tapered stainless steel whip that can be adapted for all amateur mobile frequencies. Highest quality components throughout.

THE WARD PRODUCTS CORPORATION

Division of The Gabriel Co.

1523 EAST 45th ST. • CLEVELAND 3, OHIO

In Canada: Atlas Radio Corp., Ltd., Toronto, Ont.

KANSAS — SCM, Earl N. Johnston, W6ICV — Our RM, FDJ, sends a splendid report of QKS and QKS SS activities which shows 187 stations reported in with the 23 drills. NIY had a perfect attendance of 23, FDJ 22, MUY 18, YFE 16, FER 15, SGK 12, BLI 12, AHW 12, ZUA 8, and KSY 8. Eighty-four messages were handled. CKRC members of Salina furnished four mobiles for the Police Department on Halloween to help police the town. IYR moved to a new QTH in Salina and is temporarily using gutter on the house for antenna on 7 Mc. WN0FOG is the first Novice in Salina. MUY has new end-fed Zepp on 7 Mc., is building a new rig, and is redecorating the shack. PKD is building new 6-meter rig. WPL is new 75-meter station in Chanute with 807 clamp-tube modulation. WN0EOT just got his Class B license. DRB is getting back on the air with a pair of 814s, DNX, of Abilene, moved the shack to the second floor since the flood and is getting 75-meter mobile on the air. BEV, of Atchison, reports a new club there known as the Radio Amateurs of Atchison, with IWS, pres.; CWG, vice-pres.; and BEV secy.-treas. Meetings are held at the Maur Hill School the 1st and 3rd Sundays at 2 p.m. DRB, of Olathe, reports a new radio club there in the making. KVRC, of Topeka, had a chilli supper for OMs, XYLs, and harmonics Nov. 6th. WIT moved to a brand-new QTH and is rebuilding kw. rig with 4-250s in the final with 304TTLs for modulators. HOC has new bandswitching rig running 400 watts to a pair of 4E27s entirely de-TV'ed. Traffic: W0MUY 94, NIY 72, VBQ 66, FDJ 50, BET 32, KSY 30, WGM 30, YFE 30, BLI 22, KXL 11, AHW 10, ICV 10, SGK 9, LIX 8.

MISSOURI — SCM, Clarence L. Arundale, W0GBJ — VRF, the Missouri SEC, attended the Missouri Civil Defense Communications Advisory Committee Organizational Meeting Oct. 30th at Jefferson City. Harry Duncan, of the Missouri State Patrol, was appointed communications coordinator for the State. HARC met at the Red Cross Building on Nov. 16th. At this meeting the following officers were elected for the new year: VRF, pres.; UHB, vice-pres.; TFQ, treas.; and WHK, rec. secy. The SMARC furnished mobile stations to man the check-points for the Heart of the Ozarks Motorcycle Club's annual "Turkey Run." FNN/0 operated at motorcycle headquarters. EBE was control station operating at home, with the following mobiles at the check-points: DRP, YHL, DTF, FUM, HUI, and BUB. The course was very rugged and only 4 of the 12 starting motorcycle riders finished the run. The Motorcycle Club was highly pleased with the fine job done in handling check-point reports to headquarters. EMP, a new ham in the Kansas City Area, is on the air with a Viking I. KIK worked in the SS Contest on low power and is trying to whip TVI. ARH worked CR6BC to add a new country to his list. WAP has moved to Harrisonville and is back on the air with rebuilt rigs. CFL, GAR, and QXO have nice traffic reports this month. QXO's wife underwent an operation. BAF has a pair of 833As running a kw. on 75-meter 'phone. The XYLs of JUR and PUA are in the hospital. MON and Show-me Nets can use more stations in their respective nets. NDS now has a Collins receiver. Traffic: W0QXO 478, CFL 250, GAR 146, HUI 79, GBJ 56, BUL 40, FIR 32, EBE 22, CKQ 20, OUD 16, NNH 11, QMF 6, KIK 2, PTG 2.

NEBRASKA — SCM, Guy R. Bailey, W0KJP — Your SCM received a nice letter from AIN, who is with the Marines in Korea. UVU is doing a swell job as the new NCS on the 75-meter net. Eighty-eight stations are now on the net roll, with a daily average of 30 reporting. Let's all pitch in and keep Roy happy. IVW, in Auburn, OKI, in Bartlett, and ASI, in Halsey, are new 7.5-meter net members. KON reports the c.w. net going nicely with the following members: AUH, FJD, FMW, FQB, IXL, JDJ, KDW, LOD, LJO, and ZJF. Buzz is scouting for new members on the c.w. net. FQB has reduced power. He now has Lyseo 600 with 35 watts and gets out FB with no TVI on any band. FQB, KON, JDJ, and IXL are liaison stations from the c.w. net to TEN and CAN. JDJ reports SSN is coming along but needs more members. This is a fine opportunity for Novices and also for you old 'phone men to get that long-forgotten fist back. HI, TQD still is making BPL every month with his overseas traffic. Lyle lives on the TV fringe area and still is trying to get it out of his rig, but must be doing a good job with all that traffic. WN0FGK is a new reporter from Gering. Thanks, Mike, keep them coming. A new Novice in Omaha, EGM, is getting on with an HT-17. EUT reports that EXP lost his antenna in the recent snow-storm. CBI is back on his feet and is using a kw. to keep 75 meters stirred up in the west end. CTC is putting up 10- and 20-meter interlaced beam. Traffic: (Nov.) W0TQD 1860, KON 235, IAJ 150, JDJ 118, FQB 72, KJP 41, IXL 19, EGV 15, FGK 2. (Oct.) W0TQD 1519, FQB 27. (Sept.) W0TQD 2195.

NEW ENGLAND DIVISION

CONNECTICUT — Acting SCM, Roger C. Amundsen, G WIIYF — SJO makes BPL both ways for the second month. AW and NJM made it for October. STU is a new OPS. TRF, LWV, OGG, FSF, SXC, TJX, ILQ, ODW, RPQ, and SUZ all received new EC certificates. W2VMX.

(Continued on page 84)

WHEN YOU SPECIFY

ALSIMAG[®]

YOU SPECIFY

**THE BEST IN
HF INSULATION**

**Custom
Made
Technical
Ceramics**

FOR ELECTRONIC AND
ELECTRICAL USES

SOLD ONLY TO
MANUFACTURERS

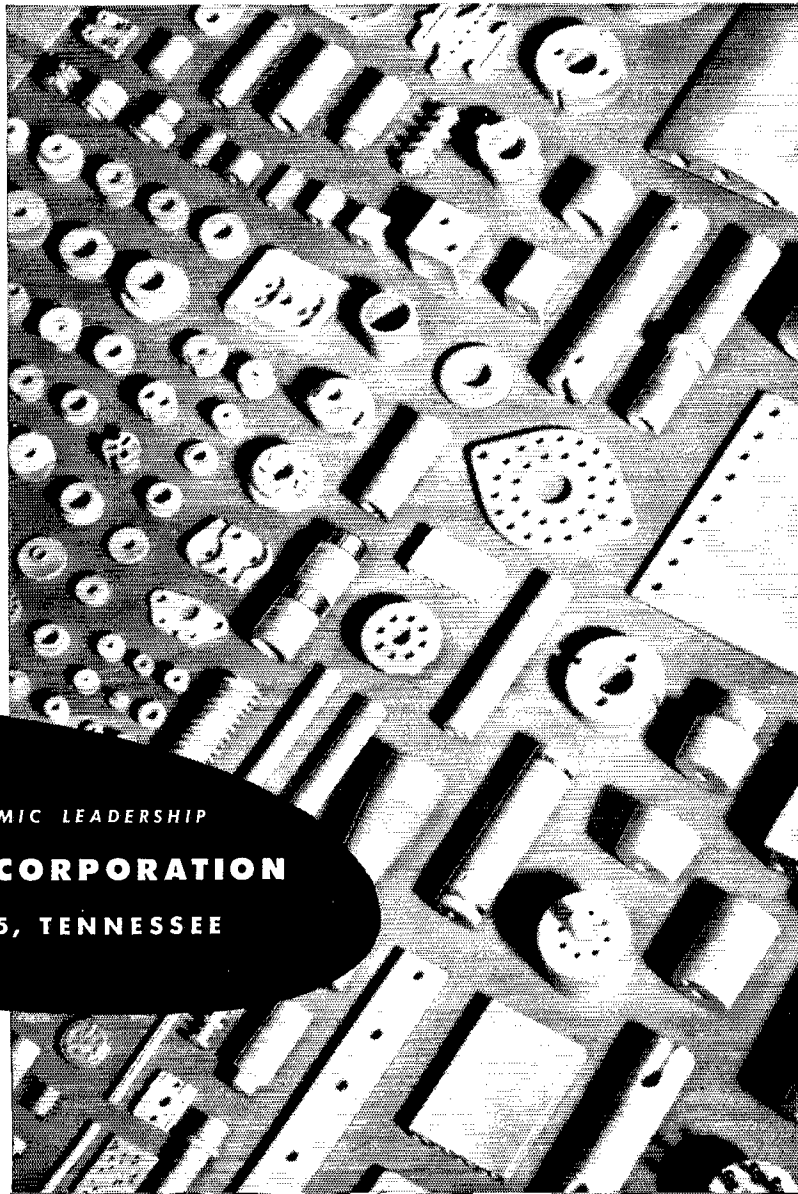

50TH YEAR OF CERAMIC LEADERSHIP

AMERICAN LAVA CORPORATION

CHATTANOOGA 5, TENNESSEE

HUDSON

Headquarters for

RCA TUBES
TEST EQUIPMENT
BATTERIES
PARTS



Hudson carries a complete line of RCA Tubes to meet every amateur, industrial and communications requirement. You can always depend on Hudson for the finest in electronic equipment.

One Call for All!

Largest stocks of all standard makes, the latest in Ham Gear — Transmitters, Receivers, Kits, Parts, Test Equipment, etc. . . . at LOWEST POSSIBLE PRICES. SAVE on everything at Hudson. One Call For All!

HUDSON

RADIO & TELEVISION CORP.

Formerly Newark Electric Co., Inc., of New York

Mail orders shipped within 24 hours to any part of the world.

UPTOWN: 48 West 48th St., New York 19, N. Y.

DOWNTOWN: 212 Fulton Street, New York 7, N. Y.

Phone: Circle 6-4060 Teletype: N. Y. 1 — 1299

operator at WIAW, rates Class IV OO. EFW and KZG still are busy with CAP. MHT is mobile on 28 Mc. Old-timer CDR is back on as JU. The CARA Banquet held Nov. 9th was well attended with 2100 scoring with his humorous and enlightening talk. RMW, PHT, and CTI from Norwalk, ODW, and SEC LKF were among the visitors. JEQ was speaker at the AREC of Norwalk meeting held Nov. 21st. RMS checks in to CPN. NUB again is active after a double fracture of the spine. RTB does a swell job as editor of *YLRL Harmonics*. QDT has moved to Texas. OAX is cooking on mobile and new furnace. HUM is busy on TLAP. BDI says the CN Party was a hum-dinger. He, with NJM and LKF, attended the FCDA Staff College near Washington Dec. 3-8. TJX runs a garage and hams at the same time. DAV is back on and soon will be effective again. NZM has resigned as EC. Nice to see all the Connecticut activity in the last PD scores. LHE has cured his TVI and reports new c.w. activity in the Stamford Area. It is not too early to plan to attend the New England Division Convention to be held in Springfield on June 14th. Here is one more reminder to check the date of your license expiration. While you do that, does your appointment certificate need endorsement, or do you have one? If not, drop me a line. The Danbury gang put on a c.d. demonstration of mobiles Nov. 30th. If you are not yet mobile, spring is just around the corner and that is the thing to be planning right now. KYF says he is building a kw. LWV has been aiding LKF in the eastern end of the State lining up EC appointments. He has more mobile stuff in his Olds than anyone I have seen. SLL and SLM, at Orange, are happy; the XYL just passed Advanced Class exam. Thanks for all the reports received and hope next month there are more. Traffic: WISJO 540, AYC 343, LV 187, HYF 180, HUM 162, KYQ 129, AW 126, TJX 124, BDI 81, STU 64, RWS 49, CTI 26, RFJ 21, GVK 19, VW 11, KV 8, RRE 8. (Oct.) W1HUM 58, KV 12.

MAINE — SCM, Orestes R. Brackett, W1PTL — SEC: IGW, RM: LKP. Net frequencies and time: Pine Tree Net — 3596 kc. at 1900 Mon. through Fri. Sea Gull Net — 3960 kc. at 1730 Mon. through Fri. Civil Defense Net — every Sun. 1045 to 1100 on 3995 kc., TO as NCS, also every Tuesday at 1930 on 3961 kc., FRS/1 as NCS. TBZ and Mable are at Bradenton, Fla., for the winter. We have reports that Mable has been notified that she has passed her Conditional Class exam, so look out, gang. TAU is sure putting out a fine signal on 28-Mc. ground wave in the evening. RUZ now has a 30-foot tower with beam which the boys on the Abusive Net put up for him recently. Among those present at the beam-and-tower-raising were ARV, ITH, TKV, FEE, and son Vincent who has just passed his Novice Class license, BAD, TFG, JOC, JTH, TGY, and BTL. BKU, formerly of Old Town and now at Freeport, expects to be back on the air soon. MJR is teaching school at Greenville and is putting out a very nice signal. An SGN certificate was issued to NIQ. SUK now is an ORS. A meeting of a proposed radio club for Aroostook County was held in Caribou. Those attending were SLL, TGH, HXQ, HUL, JSY, FDL, CNH, TMY, LYR, Alton Bridges, Clarence Benjamin, and Vernon Burgess. Traffic: W1LKP 162, PTL 74, OLQ 52, OHT 51, BTY 40, NXX 35, HXQ 31, SEJ 23, TO 23, EFR 14, S3N 14, HUL 13, KZK 13, AWN 10, FXA 9, NHT 9, QEK 8, KDE 6, RSC 5, W5-QCF/1 2.

EASTERN MASSACHUSETTS — SCM, Frank L. Baker, jr., W1ALP — New appointments: IF as EC for Peabody; MX as ORS, OPS, and OBS. Appointments endorsed: As ECs — MD, Hingham; MAN, Marblehead; AR, Belmont; KWD, Weymouth; DFS, Somerville; LPM, Natick; PKW, Reading; GJZ, Sherborn; QGJ, Woburn; BWII, Attleboro; LJT, Brockton; IPZ, Shirley; SH, Dedham; HYG, Dighton. As OPS: DHX, GOU, AAR, RP, and QGJ. As ORS: MEG and AAR. As OBS: DHX, MEG, WU, QHC, and AAR. As RM for 3.5 Mc.: JCK. As OBS: LJT, Helen Wright, of Brookline, passed the Novice Class exam. UGC, BDF, PH, and WNITWI are on 3.5 Mc. AJL is on 3.9 Mc. UIR, PZA, and KID are on 144 Mc. MCC is in West Africa. NLW is on 7 Mc. UDE is the XYL of KCP. UKQ is a new call. GGH, in Stoneham, is on 144 Mc. WE/7 now is living in Reno, Nev. SUE is on 1.8, 28, and 144 Mc. KLC has a 522 on 28 Mc. with 829B. WN1UE, New Bedford, gets into the Boston Area on 144 Mc. KMW is on 1.8-144 Mc. JOJ has another call, TKC. GAM and BL are on 28 Mc. UMA is Jack Lyons in Quincy, MA, M.I.T. Radio Society, puts out a monthly bulletin, *Sparks and Arcs*. WN1UJK is Luther Davis, sr. in Newton. A new club, the Arlington Amateur Radio Club, has been formed. Charter members are OEX, pres.; CTW, vice-pres.; LLY, secy.-treas.; BAQ, trustee, and GEO, KNW, NBI, FWQ, and THO. Meetings are held the 1st Tues. of the month. FHO is on 50 Mc. IPZ is in Region 9 c.d. net on 29 Mc. The Brockton Radio Club held a swap and auction. The Eastern Mass. Club had a talk and demonstration by the Telephone Co. on microwaves used on TV. Also a meeting was held at WBZ-TV with a talk by 2RYI. The Quapanawitt Radio Assn. had an auction with HXN and MW as auctioneers. The South Shore Club had an auction with AKY doing his stuff. The T-9 Radio Club had a Christmas party at ISX's QTH. The Braintree Radio Club held its

(Continued on page 86)

AMATEUR RADIO STATION
W2KOA
528 STERLING PLACE
GREENPORT, LONG ISLAND, N. Y.

Wincharger Corporation
Sioux City,
Iowa

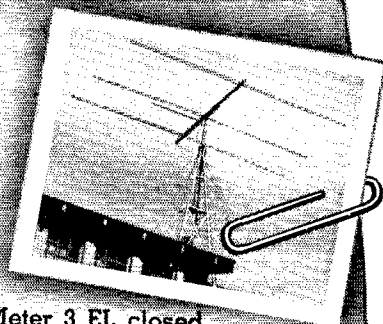

Dear Sirs:

Enclosed find a snapshot of a 10 Meter 3 EL closed spaced beam of home construction mounted on one of your 10 foot towers.

This tower was originally used as a support for a Wind Generator some years ago. Having served its purpose at that job, I was able to purchase it and put it to use as the picture shows.

It has been mounted as you see it for three years and during that time it has withstood all winds that we get out here on the extreme tip of Long Island.

Its most severe test being the storm of November 25, 1950, when winds reaching over 100 miles an hour were experienced and this storm lasted for 24 hours.

The 100 mile rate per hour was endured for the last 45 minutes of the storm, preceding that, winds from 60 to 85 miles were endured for 23 hours. Not even a guy wire damaged or broken!

In mounting this tower on the roof, no nails, bolts or lag screws were driven in the roof. If I may suggest, I would stress this advantage in the advertising of this tower.

In the process of adjusting the beam array, I, with a fellow ham have climbed all over the tower itself before it was really secure by the guy wires.

I have been noticing your ad's in various radio periodicals so I took the privilege to drop you a line regarding my tower and beam set up, of which I am very proud.

The tower, at its bottom horizontal braces also supports a prop pitch motor for rotating.

Thought you might be interested in this setup so couldn't resist writing.

WINCHARGER CORPORATION
Sioux City, Iowa

Yours Truly,

William Hamner

William Hamner

*from the desk of -
W0CXN
Thank you W2KOA
for this further unsolicited proof
of Wincharger tower superiority.
Very shortly you will see*

- **ELECTRONIC
DESIGN ENGINEERS**
- **TECHNICAL WRITERS**
- **DESIGN DRAFTSMEN**
- **PHYSICISTS**

Westinghouse

offers you

SECURITY AND OPPORTUNITY

EE's and ME's with over 3 years experience . . . a number of excellent positions are now available in our Electronic & X-ray and Air-Arm Divisions for work on:

- Broadcast Transmitters
- Power Line Carrier Communication Equipment
- Railroad Radio
- Radio Frequency Heating
- Medical and Industrial X-ray
- Commercial Radar
- Balancing Equipment
- Military Radar (ship, ground, airborne)
- Military Transmitters
- Specialized Electronic Equipment
- Fire Control Systems
- Automatic Pilots
- Guided Missiles

Check These Outstanding Benefits: Top pay, ideal working conditions, advancement on merit, graduate study opportunities, employee scholarships, paid re-location expenses, Baltimore location.

Send resume of experience and education to: Manager of Industrial Relations, Westinghouse Electric Corp., 2519 Wilkens Ave., Baltimore 3, Md.

YOU CAN BE SURE...IF IT'S

Westinghouse

monthly meeting. BDF has been on for 2 months with s.s.s.c. and has worked 69 stations, 23 states and VE3. JEO's rig is crystal filter p.p. 807s with 90 watts. EMG made BPL with lots of traffic from Germany and Japan. MX has skeds with LU2DN, ØUJL, ØDIC, CX3CN, and 3QZC. TIN is in Georgia. AAL is on 7 Mc. PKW reports that the Reading C.D. Net is on the 15th of the month at 10:30 p.m. on 28.6 Mc. QON is on 3.5, 3.9, and 28 Mc. 6YLR/1/MM, on 28 Mc., came into the Port of Boston and worked about 30 stations in no time flat. TYR is president of the Windy Net on 28 Mc. TAA has a new tower. RQZ, OMX, and SKP lost beams in a storm. KWD has the Weymouth Net on 28 and 144 Mc. at 7:30 p.m. Tuesdays. HYG gets on 3.9 Mc. a little. RP has new QTH in Waltham. JOJ is on 28- and 14-Mc. c.w. New Novice calls in Haverhill are UHX, UFO, TUJ, UHH, and UIB. RVJ and DOX now are mobile. The Gypsy Radio Club held a simulated disaster with the Red Cross with OLN and REI mobile and TOY, STA, SNZ, QQD, IWR, QZS, CCF, MTS, and Ray Bergeron on fixed stations. BWH is on c.w., 3.5 and 3.9 Mc., and has portable self-powered rig and a receiver on 44.76 Mc. for State Police. MAN has the following working with him on c.d. work; NEW, NLU, OLC, OPI, JIX, OFY, PRX, RNM, ALG, and ALT. AWA, our PAM for 50 Mc., reports the following stations on: DJ, NWL, CK, LIY, ATP, BPF, LSN, LJ, FCZ, CLS, FWL, and GJO. DID has 2 watts. EAB is on. MLS has 200 watts. The Wellesley Radio Society, newly-affiliated, has a monthly bulletin, *Dit's'n Daks*. TTY is editor. NWO worked FY7YB on 14 Mc. New Novices are Shaw Bridges, Bernie Stein, and Joe Schermerhorn. UG has a new steel tower with a beam for 14 and 28 Mc. PIW is on 28-Mc. c.w. WNITUG is going after Class B. The Newton emergency gang is becoming interested in 50 Mc. FUR plans \$29 for 144 Mc. SXD will have 522 for 829 output. HZR, Class A, has sked with VE3ACS on 3.5 Mc. BGW built a rig to use during TV hours. BHD renewed OBS and EC appointments. The Everett Amateur Radio Assn. station, TNI, is on 28 Mc. Fridays at 7 p.m., 29,560 kc. and 146.9 Mc., and conducts Novice classes. UMM is the call of one of the Muford twins. The South Shore Club had a civil defense night with G.E.'s c.d. picture and a talk by Mr. Comerford of Boston. MMH is mobile on 28 Mc. NEY, of Canaan, Conn., wants 7-Mc. sked. Traffic: (Nov.) W1EMG 564, SS 358, JCK 169, LM 142, MX 127, TY 105, NUP 65, THU 47, AAL 30, WU 21, DMS 20, PKW 12, AVY 7, NBS 6, DHX 4, CTR 3, QON 3, DWO 2, ALP 1, MD 1. (Oct.) W1JFS 34, QON 2.

WESTERN MASSACHUSETTS — SCM, Victor W. Paounoff, W1E0B — SEC: JYH, PAM: RDR. RM: BVR. WMN meets Mon., Wed. and Fri. at 7 and 10 p.m. on 3725 kc. The slow-speed net meets at 7:45 on 3725 kc. It's nice to hear from and about the new hams in our section. A hearty welcome to TZA and WNs TVJ, UBD, and UEO. Per GZ, Region 9 ARC now boasts 40 members and is seeking ARRL affiliation. COI would like to have his rhombic rotatable so that he could work Europe. BDV is helping to share the load on WMN NCS and 1st RN Rep. WNIUBD is congratulated on regular WMN attendance by BVR. How about some more of you new fellows trying the net? Your SCM met GVJ on a recent train trip to Washington. We had both been sold the same seat on the Pullman. RHU is busy preparing Geiger Counter for 1951 Science Talent Search. Good luck to you, Russ. JYH and RDR visited Worcester County RC. MUN has 20-meter beam back up. SDU and RO now hold Class A tickets. NZD, SHB, RO, IHI, and SDU attended Auction Nite at the Framingham Club. NZD brought back more than he took. Thanks to the unknown contributor for information about the "Grapevine Net." Region 2 CD boys are sending their traffic totals via radiogram through the net channels. It is suggested that NCS of the other regions collect the traffic totals from the gang in their nets and forward them to me. Traffic handled in c.d. and other training nets all count and certainly is evidence of our operation in the "Public Interest." Traffic: (Nov.) W1BVR 68, GZ 29, QJN 25, RHU 25, RDR 23, BDV 21, SWJ 11, GVJ 10, MOK 9, PKI 8, RRX 7, WNIUBD 7, W1CJJK 4. (Oct.) W1RHU 47.

NEW HAMPSHIRE — SCM, Norman A. Chapman, W1JNC — RM: CRW. The N. H. Net meets on 3685 kc., at 1900, Monday through Friday. New Novice tickets reported: UGP, UGS, UGT, UHT, UJL, and UNV. New General Class: UEC. The following appointments have been endorsed: Official Relay Stations: ANS, CVK, and IJB. Official Phone Station: GMH. Emergency Coördinator: SAL. QHS has been appointed an Official Observer, Class I. PBE now is employed at WXXL. PVF reports QSLs still pouring in from FP8AH contacts. You can find the following hams on the University of N. H. campus: SHJ, TMB, PVF, RUX and WNs UBH, UFU, UGR, UGU, and UHJ. Will see you at the N. H. QSO Party. Traffic: W1JNC 48, POK 38, QJX 26, PVF 2.

RHODE ISLAND — SCM, Roy B. Fuller, W1CJH — SEC: MIJ. RM: BTY. PAM: BFB. RIN meets Mon. through Fri. at 1900 on 3540 kc. The Southern R. I. Emergency Net meets Sunday at 1000 on 3960 kc. Pawtucket was active during the Nov. 4th c.d. test. AOP, BGA, CPV, OJE, REK, and PWS all participated. At Newport County Radio Club, Gilleran discussed long-range v.h.f. communi-

(Continued on page 88)

ALLIED High-Fidelity Components give you the most for your money

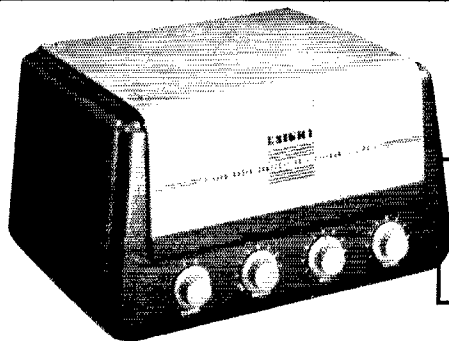

Judged top values by leading engineers and product research organizations

AMPLIFIER
± 1 db
20-20,000 CPS

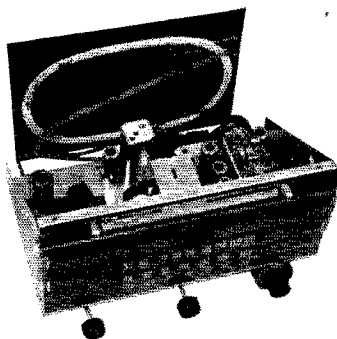

KNIGHT 20-WATT HIGH-FIDELITY AMPLIFIER

Check These Features: Built-in equalized preamp for magnetic cartridges; inputs for mike, record players with crystal cartridges, or tuners; inter-channel connection between preamplifier and main amplifier, for circuit switching at tuner; equalized hi-impedance output for direct connection to crystal recording heads; switch for selecting record player (thru preamp) or tuner; wide choice of output impedances. **One-year unconditional guarantee!**

Technical Specs: Response: + 1 db, 20-20,000 cps, at 10-watt level. Harmonic distortion, less than 2% at 20 watts; less than 4% IM at 18 watts. **Hum and Noise:** 80 db below 20 watts. 47,000-ohm magnetic cartridge input. **Speaker Outputs:** 4, 8, 16, 250 (70v), 500 ohms and equalized high-impedance for crystal cutters. **Tubes:** 6SN7, 6SL7, 6SC7, 2-6L6G; has 5U4G rectifier. **Controls:** Combined volume, on-off; bass; treble; phono-radio channel selector switch. **Case:** 14 5/8" wide, 8 3/8" high, 11 1/4" deep; two-tone gray Hammerloid finish. With tubes, instructions, and connectors. For 110-130 volts, 50-60 cycle AC. Shpg. wt., 27 lbs. **93-320.** Knight 20-Watt Hi-Fi Amplifier, *only* \$64.50

KNIGHT FM-AM TUNER CHASSIS

Features: FM circuit is drift-compensated. Separate tuned RF stages on both AM and FM. Built-in equalized preamp for magnetic cartridges. Separate high- and low-level output jacks, for connection to any amplifier. Has twin AC power outlets for amplifier and phono motor.

Technical Specs: Sensitivity: AM, 5 microvolts; FM, 10 microvolts with 180 kc bandwidth at 6 db down. **Controls:** On-Off Volume, FM-AM-Phono bandswitch, and Tuning. **Tubes:** 2-6BA6, 2-6BE6, 6SG7, 6SH7, 6AL5, 6C4, 6SQ7, 6SL7, 5Y3GT rectifier and 6U5 tuning eye. Supplied complete: Separate built-in antennas for FM and AM (provision for external antennas if desired); tubes, hardware, instructions. **Size:** 13 1/2 x 8 1/2 x 9". For 110-120 volts, 60 cycle AC. Shpg. wt., 16 lbs. **12H610.** Knight FM-AM Tuner, *only* \$79.50

SPECIAL VALUE HI-FI PHONOGRAPH SYSTEM

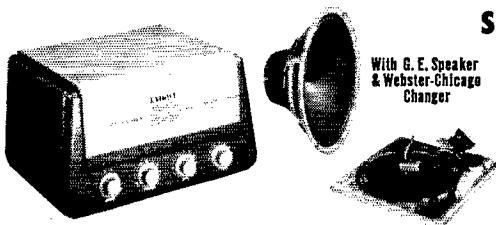

With G. E. Speaker & Webster-Chicago Changer

Here's the top buy in a really outstanding phonograph system that delivers brilliant record reproduction. The system consists of the fine value Knight 20-watt amplifier (described above), the General Electric S1201D high-fidelity 12" speaker (with 14.5 oz. Alnico V magnet), and the Webster-Chicago 106-27 3-speed record changer with plug-in heads and 2 G-E cartridges. Complete with all cables (no solder connections required), hardware and instructions. Shpg. wt., 57 lbs.

93-328. Hi-Fi Phonograph System, *only* \$126.85

1952 ALLIED CATALOG

Refer to your 212-Page ALLIED Catalog for all of your electronic needs, including the world's largest stocks of station supplies. Save time, effort and money at dependable ALLIED RADIO. If you haven't a copy of our latest 1952 catalog, write for it today.

FREE

ALLIED RADIO

ALLIED RADIO CORP., Dept. 15-B-2
833 W. Jackson Blvd., Chicago 7, Illinois

Ship the following:

93-320 12H610 93-328

Enclosed \$

Send Free 1952 ALLIED catalog

Name

Address

City Zone State

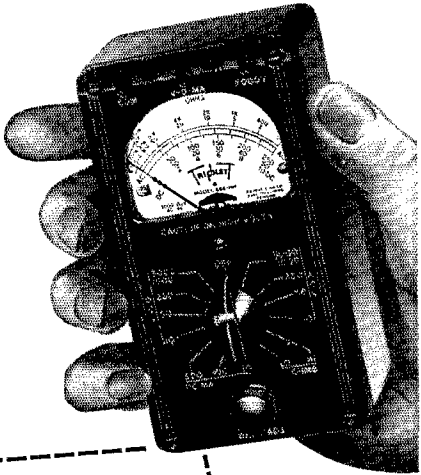

**Mighty
Midget**

of the Service World

Mighty Midget of all the V-O-M's! Slips into your pocket for making spot-analyses of D.C. and A.C. Voltage, Current, and Resistance. Has quick-reading scale, only one switch, 50" leads — alligator clips, banana-type jacks, self-contained snap-in type batteries, and plenty of ranges on the one-knob 14-position switch. Remarkable stability on voltage ranges. Completely insulated molded case. Get yours today! Triplet Electrical Instrument Co. • Bluffton, Ohio, U.S.A.

Model 666-HH Volt-Ohm-Milliammeter

ONLY \$24.50 AT
YOUR DISTRIBUTOR
(Price Subject to Change)

FOR THE MAN WHO TAKES PRIDE IN HIS WORK

Triplet

TRIPLET ELECTRICAL INSTRUMENT COMPANY • BLUFFTON, OHIO, U.S.A.

cations as demonstration by the Bureau of Standards. The Club has four mobile units operating on 3960 kc. TRX, TJR, OIK, and 4RUX/1. An actual emergency occurred during the Nov. 4th test, a plane crash with TJR standing by the scene with emergency communications until relieved by Naval personnel. Good Rhode Island participation was observed in the annual SS. Heard or worked were BFB, TRX, KHZ, LFE, BGA, BIL, KNE, TAT, TFX, TNX, and TNH. The NAARO held annual elections in November. New officers are KNE, pres.; NCX, vice-pres.; UEF, secy.; LWA, treas. TRX is building a new 813 final. JFF is on 144 Mc. and instructing a class of prospective hams. The newest Rhode Island ham reported up to this time is UEF. Would like to hear from new hams and report them here. Traffic: W1HLY 64, BBN 53, TNX 15, CPV 12, OIK 11, TRX 4.

VERMONT — SCM, Raymond N. Flood, W1FPS — AVP reports 13 hams active in Rutland, including Novices WNIUCC, Vern Richards; WNIUET, Martha Goodyear; WNIUHK, Jack Waite; and WNIUJO, Mary Van Wyck. of Middlebury. Vermont's YL hams are increasing. Ann, OAK, our busy RM, finds time to build a new rig. BJP has Lysco exciter and Workshop beam on 28 Mc. IT also is on 28 Mc. RLS and RWX are sporting new 75A-2s. PTB reports the passing on the West Coast of Harold White, ex-ICLL, formerly of Brandon. If any of you did not receive a copy of the SCM bulletin, *Green Mountain Static*, it's because your call and QTH are not in my files, so please keep me posted. Please fill out and return those c.d. forms that KJG sent you if at all possible. Traffic: W1RNA 183, AVP 81, FPS 75, IT 40, TXY 25, BJP 17, SPK 12, TAN 11, ELJ 6.

NORTHWESTERN DIVISION

ALASKA — Acting SCM, Jack M. Walden, KL7BK — A KL7MZ has resigned from ARR and moved to Portland, Ore., to go into business for himself. His active work as SCM will be greatly missed. MZ, the XYL, passed General Class exam just before leaving, so Nick will have trouble getting the rig at the new QTH. YG passed Advanced Class exam with flying colors. The Anchorage Club elected EC, pres.; PJ, vice-pres.; and BK, secy-treas. for the coming year. Anchorage XYLs are having gab-fest night of AARC meeting, so meeting attendance is increasing. ADA has been rotated to Texas. Many new faces and calls are evident in Anchorage as many W6s moved in with military units. Traffic: KL7PJ 46, YG 46, EH 28, AGU 26, AN 25.

IDAHO — SCM, Alan K. Ross, W71WU — Hayden Lake: EC FIS has been contacting QC, MER, and FCU to enlist their aid in helping the Weather Bureau river district offices communicate with Spokane in times of emergency during the spring run-off period April to June. Moscow: EC ELH is very busy with school, but managed to assist the local police on Halloween with three mobiles, NDT, GGH, and OLA, to keep the pranks to a minimum. Nampa: NBD has applied for ORS and OO appointments. He says he has a lot of time to monitor the bands. Meridian: MKS is new OPS and also has applied for OO. Boise: Visiting firemen at his shack were mobiles ACD, Shelley, and CUG, Stibnite. TGU, from Blackfoot, applied for ORS appointment in person and now is on the Gem and FARM Nets. CUG is moving from Stibnite and heading for California. Traffic: W7FIS 31.

MONTANA — SCM, Edward G. Brown, W7KGJ — BKB, of Anaconda, has returned to the air after about five years. George runs about 35 watts on 75-meter 'phone. JC, of South Bend, Wash., visited old friends in Billings on a return trip from the East. JRG is moving to Billings from Sheridan, Wyo. Ken will work at the local b.c. station. PAF has moved from Havre to Shelby. PYZ is a new call in Kevin. ISU is expected home from Korea any day. HJM is getting new 813 rig ready for net operations. The 160-meter net now is operating in North Montana. KUH is rebuilding. LBK is having antenna troubles but is almost ready to go. CT is putting the finishing touches on his new bridge. Skip conditions still are causing trouble for the net boys on both c.w. and 'phone. HZJ has applied for her license renewal. JGG is rigging 80- and 40-meter antennas and also has his 522 ready to go. New c.w. operators active in Great Falls are PYN and QAK. HQT is rebuilding 807 rig. Traffic is being handled between Sun River, Geraldine, and Great Falls on 50 and 144 Mc. MBV is editing a little paper, *Montana VHF*. Contact him for your copy. Traffic: W7KGJ 102, CVQ 40, CT 25, BNU 19, CPY 6, WN7PTW 1.

OREGON — SCM, J. E. Boden, W7MQ — PKN is interested in AREC program for Lakeview Area. AIZ has resigned as RACES Net Manager because of the pressure of business. RACES now meets at 6:30 p.m. PST each Monday for the 3993-kc. 'phone channel, and at 7 p.m. PST for the 3507-kc. c.w. channel. LVN reports that the official date for the OARA Convention at Eugene will be April 25, 26, 27, 1952. RWU has been transferred from Condon to Europe. DLX is new EC for Clackamas County. JLU is new OO, Class III and IV. JLU also is new ORS. ESJ reports that Oregon check-ins to RN7 are needed to take Oregon traffic, especially traffic for Portland. IEJ still is consistently trying to find check-ins for the RACES C.W. Net on 3507

(Continued on page 90)

RADIO SHACK APPLAUDS THE NEW **tapeMaster** GENUINE HIGH-FIDELITY 7 1/2" TAPE RECORDER FOR ONLY \$79.45 COMPLETE!*

*Tape Transport Mechanism with
Matching Fully-Wired Pre-Amplifier
and Bias-Erase Oscillator
with Push-Pull Supersonic Bias-Erase

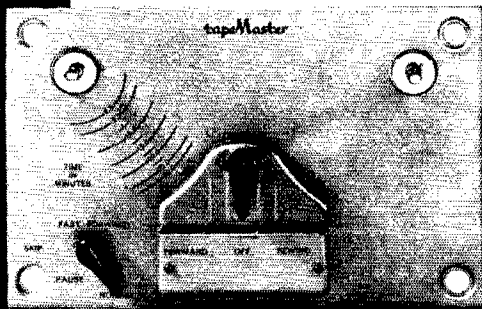

TAPEMASTER TH-21 TAPE TRANSPORT

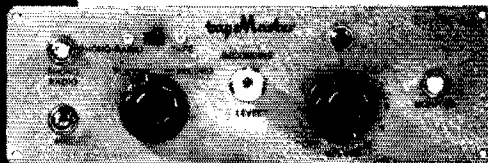

TAPEMASTER PA-1 PREAMPLIFIER

PLAY BACK THROUGH YOUR OWN AUDIO AMPLIFIER OR RADIO

At last! A dual track tape recorder worthy of HI-FI rating, at a price lower than \$80! Your TAPEMASTER includes the self-powered recording and playback pre-amplifier and the transport mechanism with the fine SHURE record-play-erase head. Transport plus pre-amplifier PLUS your own audio amplifier equals a professional tape recorder actually worth \$300-\$400. *Note:* units are furnished completely wired, with interconnecting cables — *no wiring* required.

CUSTOM INSTALLATIONS, OR PORTABLE!

Available in two compact separate units (illustrated) for custom installation, or installed in a rugged portable carrying case, TAPEMASTER offers the ultimate in flexibility. Features include: RTMA standard 7 1/2" per sec. tape speed; 70-8000 cps response; flutter less than 0.5%; fast forward; rewind 20:1 speed; handles 7" reel of type "B" tape — 1 hour dual track playing time; full monitoring; inputs for radio-phonograph and mike; outputs to amplifier and headphones; one knob mechanism control; push-pull supersonic bias and erase; neon level indicator. Preamp has master switch for selection of tape play-record, or radio-phonograph!

ORDER YOUR TAPEMASTER BY MAIL!

Note: TAPEMASTER uses "B" tape — coating facing out. "A" tape may be used after rewinding to face out.

Cat. No.	Type	Description	Size	Net
34-460	TH-21	Transport Mechanism	11x7x5 1/2"	\$48.95
34-461	PA-1	Matching Preamp.	10x3 1/2x5"	30.50
34-462	PT-121	Above in port. case	12x11 1/2x8"	89.95
34-088	B	1/4" Plastic Tape	1200 ft.	3.60
34-085	B	1/4" Paper Tape	1200 ft.	2.29
34-091	—	7" Plastic Reel	1200 ft.	.50

Write today for descriptive literature

Brilliant New Garrard 3-Speed Manual Player! Model "M", \$24



At long last — a magnificently engineered turntable for serious record players at a price all can afford! Metal base plate has the tone arm already mounted, ready for immediate use. Garrard's Model "M" has the identical 4-pole motor, weighted 10" turntable, triple-speed switch and jewel-mounted tone arm as the famous RC80 automatic changer! In addition it features automatic stop at the end of the record! Tone arm has plug in head adaptable to all crystal and magnetic cartridges. Hum-free, rumble-free AC operation. Overall: 16 1/2" L; 10" W; 4" below plate; 2 1/2" above plate. Complete, less cables: Net \$24. NOTE: Astatic turnover crystal for above, mtd. in head — \$5.10. G-E triple-play mag. cartridge — \$8.20.

RADIO SHACK

CORPORATION

167 Washington St., Boston 8, Mass.

As SEEN in QST

September 1951
page 41

V.H.F.

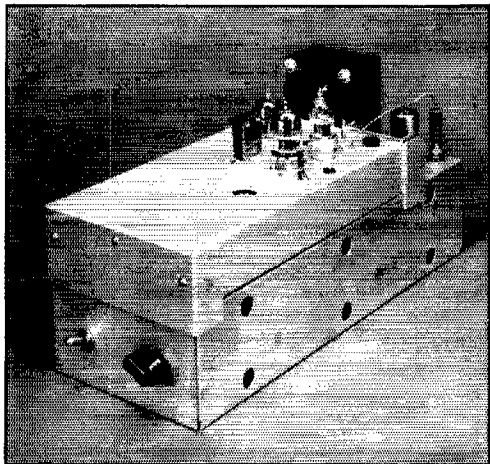

A Crystal-Controlled Converter for
220 or 144 Mc.

"THE WORLD ABOVE 50 MC."

is a mighty interesting place. QST
helps make it more so by the

19 articles, containing

38 diagrams, using

63 pages

in the past twelve issues telling you
about v.h.f. equipment and conditions.
More articles are coming. Don't miss
any!!!

QST and ARRL Membership

\$4 in U.S.A., \$4.25 in Canada

\$5 elsewhere

38 LA SALLE ROAD
THE AMERICAN RADIO RELAY LEAGUE, INC.
WEST HARTFORD 7, CONNECTICUT

kc. at 7 p.m. Mondays, but it seems that the Oregon c.w. boys are few and far between. Club officers for Baker are as follows: FFR, pres.; PWV, vice-pres.; and NQD, secy. New PARC officers are NGW, pres.; PAO, vice-pres.; DCJ, secy.; and HTS, act. mgr. JHF dropped his two final tubes (810s) and found that they would not bounce. GEJ and his XYL now are residents of Astoria, having moved from Newport. KL reports that all members of the Eugene Club are taking courses in First Aid, under c.d. PES is active on both 3.5- and 7-Mc. c.w. KL also reports that any information relative to the big Oregon OARA Convention at Eugene in April should be received from Leonard Kearney, 400 Howard Ave., Eugene, Club secretary. Traffic: W7II 232, APF 244, HDN 197, MQ 86, KPE 70, ADX 67, TH 67, AXJ 44, BUS 22, BDN 19, DHX 17, KTG 10.

WASHINGTON — SCM, Laurence M. Sebring, W7CZY — SEC: BTV, RM: FIX, PAM: NRB. The Capitol City Radio Club has installed the following officers for 1952: Don Ashley, pres.; Reuben Johnson, vice-pres.; Walter Draham, secy. LAG has a new 75A-2 receiver and is operating on 28-Mc. 'phone with a Lyisco rig, DRA now is in Virginia. The Spokane Radio Amateurs have over 50 mobile units on 29,600 kc. They drill each Tuesday. LEV passed Class A exam. BG is installing remote control from his living room for use during the winter. A trophy has been put up, to be won by the high man in a quiz contest among WARTS members. To become a permanent possession the trophy must be won three times. LFA is rebuilding a transmitter and is on c.w. only for the time being. JWE is mobile on 3.8 and 28 Mc. JFO and JKB check into WARTS. HCJ has a new harmonic. WAY is in San Francisco as chief operator at A6USA. KIX, GR, and CTS operate mobile on 3970 kc. The "wabbit" for the 29-Mc. loop gang is BA, hunted by CO, OYO, CBE, PGY, HRC, and KZP. JPC has new QTH on top of a hill in Kirkland. NWP is teaching his Boy Scout troop the code. AIB has new operating room in the basement. EQN put up new antenna for better reception — result, more QRM! KTL has a new 10-20-meter converter. ZU worked KG6DI in the SS. NJ, Seattle EC, reports five emergency nets in Seattle. BTV had his car wrecked going to see KX. IGM has a new Super-Pro. VE6ON visited RT for a few days. IHJ and IHK are vacationing in the South Pacific. DND has twelve-element vertical on 28 Mc. Traffic: (Nov.) W7CZY 678, IOQ 595, BA 351, NRB 210, TH 179, FRU 135, FIX 133, ETK 132, KIX 111, LVB 96, NWP 66, EVI 60, JPC 49, KCU 49, OEB 37, AIB 12, AVM 11, EVW 8, ZU 8, APS 7, LEV 7, PTC 5, KTL 3, BG 2, GAT 2, CWN 1. (Oct.) W7FIX 121.

PACIFIC DIVISION

HAWAII — SCM, John R. Sanders, KH6RU — HARC elected the following officers for 1952: EZ, pres.; RU, vice-pres.; GN, secy.; AN, treas.; ABI, WU, and AS, directors. The Honolulu Mobile Club held a fine beach picnic at Nanakuli. The 10-meter QRM was terrific! The Club has amended its Mobile-WAS Contest Rules to include 11 meters, but no contacts can be initiated from home rigs. The Inter-Island Net has moved operation to one hour earlier (2000 HST) than reported last month. New OBS, TS, therefore has moved his skeys to 1945 HST at 3950 kc., just preceding the net time. OA has transferred to KL7-Land and soon will be heard as BN from Anchorage. ADY took a trip to Guam. Another of our YLs, AFG, has gained Class A. Far Pacific Area: KG6FAA completed 186 'phone patches for the month. KB6AO has returned to Canton Is. after a prolonged visit to Honolulu. Far Pacific stations are urged to file activities reports by radio to the SCM. The mails are far too slow. Traffic: (Nov.) KG6FAA 3273, KH6ADY 19. (Oct.) KG6AAAY 559.

NEVADA — SCM, Carroll Short, jr., W7BVZ — Nevada State frequencies are 3660, 7225, and 29,360 kc. CX is on 160-meter 'phone trying to make his ART-13 sound like a 32V-2. He says it is some job! The Reno Club has many teen-agers trying for Novice Class licenses. JU took part in the SS trying for 80-meter WAS; he has 3 states to go. KEV and BKS participated in the c.w. SS and JUO in the 'phone SS. PFG, ex-KA1, W9, W8, KG6, and KH6, is on 3.8 and 28 Mc. from Hawthorne. KJQ moved next door to BVZ. That makes JUO, HJ, PGD, XSD, BHJ, JU, LGS, JLN, and KJQ all within 400 yards of your SCM. QRM — oh, brother! NWU is on 7 Mc. exclusively since his 10-meter converter went haywire. PST is back on 3.5-Mc. c.w. ODW moved to Montana. Traffic: W7JU 21.

SANTA CLARA VALLEY — SCM, Roy L. Couzin, W6LZL — Your SCM wishes to take this opportunity to wish all in the section the best of everything for the New Year. SCCARA elected the following officers: WGO, pres.; UTC, vice-pres.; QBO, secy.; FON, treas. New board members are NX and NKP. Members carried over are CFK, HC, and BPT. North Peninsula Electronics Club officers for the coming year are GXF, pres.; NVO, vice-pres.; MMG, secy.; LZL, treas.; FYK, act. mgr.; QIE, liaison officer. New calls include LKY and WN6OUX. New harmonics are announced at the homes of MVL and UXY. MMG shortened flat-top on all-band antenna and is getting better signal reports. LAD has a new receiver and can be heard on 7025 and 7075 kc. YHC has new three-element

(Continued on page 32)

HARVEY HAS THE GEAR YOU WANT!

FOR THE HAM WHO IS ALSO AN ENGINEER ACTIVE IN RESEARCH OR INDUSTRY HARVEY OFFERS THE

COSSOR DOUBLE BEAM OSCILLOGRAPH

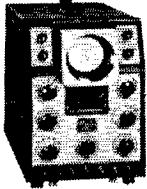

The most versatile laboratory instrument for quantitative measurements and waveform analyses in all electrical mechanical and marine engineering research and production. Sturdy construction. Simple to operate.

Model 1035, \$661.50

DOUBLE BEAM INDUSTRIAL OSCILLOGRAPH

Specifically designed for measurement of zero or very low frequencies and the photographic recording of transients requiring high photographic writing speed. Incorporates a 4" Diameter flat-screen tube.

Model 1049 \$925.00

Accessories for above include:

Model 1428 CAMERA \$245.00

Model 1429 MOTOR DRIVE

for same \$182.50

Model 1430 PREAMPLIFIER \$390.50

Descriptive literature and specifications available on request.

HARVEY carries the complete line of

BEST THERMOCOUPLES

both Standard and ULTRA HIGH FREQUENCY types



These units are electrically insulated from the heaters and tested to 100 volts D.C. Resistance tolerance are plus or minus 10%. Nominal output of 7 millivolts subject to sensitivity variation of plus or minus 12%. Current ratings can sustain 50% overload without damage.

STANDARD TYPES

5 to 1000 MA. Each \$ 7.50

1.25 MA \$36.00

2.5 MA \$29.00

ULTRA HIGH FREQUENCY TYPES

From 5 MA up. Each \$12.00

Write for descriptive literature and specifications.

ELDICO TR-75-TV



TRANSMITTER KIT

This is an ideal unit for the novice. Very simple to assemble. New, revised circuit to aid in the elimination of TVI. Uses 6L6 oscillator — 807 amplifier combination PI-network output. Husky power supply delivers 600 volts to the 807. Complete . . . including a punched chassis and shielded cabinet. Unbelievably low priced at . . . \$59.95

MD-40 modulator kit for above. . . \$34.95

MD-40P as above

but with power supply. . . \$44.95

COLLINS 75A-2 RECEIVER



Double-conversion superhet with sensational stability, calibration accuracy and sensitivity . . . all the good features of the 75A-1, plus many new ones. Price, complete with tubes \$420.; matching 10-inch speaker \$20.00.

Collins KW-1, 1kw. TRANSMITTER \$3,850. New Collins 32V-3 TRANSMITTER \$ 775. Place your order now for delivery.

Collins KW-1, 1kw. TRANSMITTER \$3,850. New Collins 32V-3 TRANSMITTER \$ 775. Place your order now for delivery.

IN STOCK FOR IMMEDIATE DELIVERY

MALLARD 10N, 20N and 75N

Mobile Converters \$39.95

MALLARD HI-Q 20 coil. \$ 8.95

MALLARD HI-Q 75 coil. \$ 7.95

SONAR SR-9 RECEIVER. \$72.45

SONAR MB-26 TRANSMITTER. \$72.45

A.C. POWER SUPPLY. \$30.00

Make HARVEY your Headquarters

for CD Emergency and CAP Communications Equipment, LF and VHF

. . . whatever your requirements may be

. . . from a 1½ volt cell to a 50,000 watt

gas engine driven generator. REMEMBER

. . . it will pay you well to ask HARVEY first.

IN STOCK... THE COMPLETE LINE OF



(Exclusive with HARVEY in the New York area)

Transformers for all applications — Military and Civilian — High Fidelity Audio Components, "Trijets" — Hermetically Sealed Midgets, Power Transformers, Replacements, Filters, Reactors, etc. . . . for the laboratory, industrial, servicing, public address and radio amateur fields. Complete stocks of all components are on hand for immediate delivery.

The TRIAD "HS" series of transformers incorporates hum-bucking coils and nickel-alloy multiple shielding for minimum pickup.

They are small in size, light in weight, rigidly supported and hermetically sealed. Note actual appearance of the "HS"

case, on left, and the telescopic view on the right which illustrates the construction of this particular type.

Write for latest catalog.

SUPERIOR POWERSTATS

Smooth, efficient voltage control, 0-135 volts output from 115 volt AC line. Models also for 230 volt input. Write for free literature. Models for table and panel mounting.

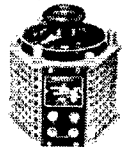

Type 20, 3 amp. \$12.50

116, 7.5 amps, table mtg. 23.00

116U, 7.5 amps, panel mtg. 18.00

1126, 15 amps. 46.00

1156, 45 amps. 118.00

VISIT HARVEY'S AUDIO-YORNIUM — Come in and visit our new Sound Department. . . all these items and many more on working display at all times.

Telephone **hrc** Luxembourg 2-1500

HARVEY

RADIO COMPANY, INC.

103 West 43rd St., New York 18, N. Y.

NOTE: In view of the rapidly changing price situation in both complete units and components we wish to emphasize that all prices are subject to change without notice, and are Net, F.O.B., N.Y.C.



*The Data
that Launched
Thousands of
Careers is
Yours FREE . . .
to show*

How

YOU CAN BE SUCCESSFUL in TV and ELECTRONICS

YOU can plod along for years, then something happens. Your earnings rise. You become more confident.

"Luck," "Contacts," some may say.

But in your heart, you will know the answer: "Training." And it all may have started the moment you filled out a coupon requesting a copy of a free booklet named "Your Future in the New World of Electronics."

From this data you get knowledge of where you stand in Electronics, an industry pleading for trained men.

More than \$7 billion in electronics contracts have been awarded for defense. Top manufacturers sold about \$3 billion worth of electronic merchandise in 1951. By 1960, radio-electronics should do no less than 10 billion dollars per year, excluding military orders.

Within 5 years, says the Chairman of the FCC, there will be 1,500 TV stations and in 10 years, 2,500. There are 14,496,000 TV sets and over 100,000,000 radios in operation. Countless positions must be filled.

To fill these posts, trained men are needed — men who somewhere along the line take time to improve their knowledge, their skills. Men who, today, perhaps, take two minutes to send for a booklet.

"Your Future in the New World of Electronics" shows you how CREI Home Study leads the way to greater earnings through the opportunities described above. An accredited technical school, CREI does not promise you a "snap." You must *study* to convert your ambition into technical knowledge.

Since its founding in 1927, CREI has provided thousands of professional radio men with technical educations. Leading firms choose CREI courses for group training in electronics at company expense, among them United Air Lines, and RCA-Victor Division. CREI alumni hold top positions in America's leading firms.

CREI courses, prepared by recognized experts, are practical and easily understood. You get the benefit of personal supervision by a CREI Staff Instructor, who *knows and teaches* you what industry wants.

At your service is the CREI Placement Bureau, which finds positions for students and graduates. Although CREI does not guarantee jobs, requests for personnel far exceed current supply.

Now is the time of decision. Neither luck nor contacts will propel you forward unless you have the skill to back them up. Only technical training can bring you increased earnings in this new Age of Electronics. Fill out the coupon and mail it now. We'll promptly send you your free copy of "Your Future in the New World of Electronics." The rest — your future — is up to you.

MAIL COUPON FOR FREE BOOKLET

CAPITOL RADIO ENGINEERING INSTITUTE

Dept. 162D, 16th & Park Rd., N.W., Washington 10, D.C.

Send booklet "Your Future in the New World of Electronics" and course outline.

CHECK FIELD OF GREATEST INTEREST

- TV, FM & Advanced AM Servicing
- Aeronautical Radio Engineering
- Practical Television Engineering
- Broadcast Radio Engineering (AM, FM, TV)
- Practical Radio Engineering

Name

Street

City.....Zone.....State.....

If residence school in Wash., D.C. preferred, check here

beam on 28 Mc, which weighs only 9 pounds. HRZ is going to San Mateo J. C. Mobiles on 28 Mc, between classes. QIE has stacked coax with ground plane antenna on 144 Mc, per Nov. QST. WN60UX has a 522 fired up on 144 Mc. HC reports MTN c.w. is doing fine and has a few WNs in now. WAE is doing a swell job as usual in the traffic department. NW is slowly getting back in the swing after a lengthy lay-off. QIE turned in a very fine report on the last emergency drill held in the vicinity of South San Francisco. Fine cooperation of those taking part made it a real success. They were CIS, FYK, GXF, UMK, QIE, K6NAQ, GYO, CDX, DCR, WIS, WSE, LfZ, DGK, and NVO. AEV, our SEC reports finding plenty of weakness in the e.d. structure but after visiting all the clubs in the section he hopes to iron out most of the difficulties. Traffic: K6WAE 1317, W6BPT 266, HC 93, NW 12.

EAST BAY — SCAM, Ray H. Cornell, W6JZ — Asst. SCAM, Guy Black, 6RLB. SEC: RVC. RM: IPW. A small measure of progress has been made in AREC organization. At the time this article is written, we have established one emergency net in the Concord-Walnut Creek Area operating on 28 Mc, under the guidance of TCU, EC for that Area. AKB and WGM have been appointed ECs for the Oakland and Vallejo Areas, respectively, and we can soon expect to see activity there. IPW has organized our section c.w. net in fine shape. We hope all you traffic-minded hams anywhere in the Bay Area will check into EBSN at 7 p.m. Mon. through Fri. on 3635 kc., where you will find HOR, IPW, and JZ alternating as NCS. When coverage warrants the net will be expanded into a Bay Area (tri-section) net "BAN." We hope eventually to come up with something as good as SCN and SSN in the southern part of the State. A PAM is needed to finish organization of the major activities in the section. OF put on a disaster drill Nov. 26th during the SS Contest. Mobile stations operating on 10- and 75-meter 'phone as well as on 40-meter c.w. at some distance checked in with little difficulty. Those participating were AWU, VDR, GDM, KZN, AKB, YDP, HOR, EXY, and WBLN. WHA is the new president of NBARA. HOR is recent ORS appointee. CGG lost his beam in a recent wind-storm. PYH is active again chasing DX. IKQ got married. TI is chasing newly-developed key clicks. CTL is developing new oscillator for VFO. EJA is rag-chewing with WN boys and having much fun. NGC submits a big OO report. RLB says the SS Contest was a rat race. FBY is getting out better with new antenna. ZA is developing tape-recording systems. AQN is installing Morrow converter. ZUI has three-element beam on 14-Mc. c.w. and a ground plane antenna on 7 Mc. At the November meeting of ORC, 15 members took the e.d. oath of office. Oakland C.D. Radio Center at Woodminster is very impressive. RCA Service Co. of Oakland will install special high-pass filters in RCA receivers if contacted by amateurs. Ask for Fred Carpenter. HOT has modulator trouble. There is no end of praise for the TV booklet furnished by IDBM. LRT is using 35 watts on 28 Mc. AOI is back on a 10-meter 'phone, also the aim of PKK and CTF. WN6NDU has worked a KH6 with legal novice power. JDO can be heard on 10- and 75-meter 'phone. VLF is home on leave from Korea. Traffic: W6IPW 110, JZ 59, HOR 24, NGC 14, YDI 10.

SAN FRANCISCO — SCAM, R. F. Czeikowitz, W6ATO — Phone JU 7-5561. SEC: NI, Phone PL 5-6457. Santa Rosa Area: EC: IEN. Asst. ECs: DLX, WOR, and HQN. The 2-Meter C.D. Net has drills and general ragchews on 145.35 Mc. Wednesday nights. A new control center now is complete at the Santa Rosa Junior College with an antenna 70 feet high. DTV is custodian for the unit. Mobile units participated in the annual Armistice Day Parade at Cloverdale, assisting the highway department in directing the parade units and highway traffic. At the November meeting were John Reinartz, K6BJ, and Frank Jones, W6AJF. John gave a talk on modulation and TVI reduction, assisted by Frank, CIS, Pacific Division Director, and ATO, San Francisco SCAM, also attended. The new rig of HQN is garnering DX. LGQ's 50-foot vertical withstood an 85-m.p.h. wind. LMR is a new member of the SCRA. UOV now commutes between Sebastopol and San Bruno, operating his new 500-watt 2-meter rig week ends. 28-Mc. enthusiasts WDM, DRX, LOU, DZM, LCZ, and EBI report the band conditions have been encouraging lately. ZKM has joined the merchant marine, while IEN is filling the secretarial post for the balance of the term. The Sonoma County Radio Amateurs meet the first Wednesday in the Tap Room of the Grace Bros. Brewery on Second St., west of the Freeway, Santa Rosa. Eureka Area: EC: SLX. Congratulations to the new officers of the Humboldt Amateur Radio Club: BJO, pres.; FCR, vice-pres.; BME, secy.; EQQ, treas.; ZZK, act. mgr.; and CNG, asst. act. mgr. Incidentally, CNG is the first WN6 in this area to exchange his Novice Class license for a General Class license. Many thanks to the HARC members for their fine hospitality to ATO, the SCAM, on the occasion of his visit at the November meeting. The Humboldt Amateur Radio Club meets the second and fourth Fridays in the YMCA rooms, rear of Mun. Auditorium, entrance on "E" St., Eureka. Marin Area: EC: KNZ. Tamalpais Radio Club EC: ZUB. In order to give this Area its fair proportion of space, it is earnestly

(Continued on page 94)



HENRY RADIO offers YOU:

LOW PRICES: You can't beat my wholesale prices.

FAST SERVICE: You get fast service. I have big stocks of Collins, National Hallicrafters, Hammarlund, RME, Johnson, Harvey-Wells, Lysco, Gonset, Morrow, Mallard, Eldico, Master Mobile, Hy-Lite, all other receivers, transmitters, parts at lowest prices.

BIG TRADES: I want trade-ins. I trade big. Tell me what you want—what you have to trade. Get my offer. I pay cash for receivers and transmitters too.

TIME PAYMENTS: Get what you want and pay by the month. I give you better terms because I finance all terms myself. Write for details.

SATISFACTION: Try any communications receiver ten days—if you return it your only cost is shipping charges. I want you to be satisfied. Ask any ham about Henry Radio.

PERSONAL ATTENTION: You get personal attention. Bob Henry, WØARA, runs the Butler store. Ted Henry, W6UOU, runs the Los Angeles store. Bob Henry can be reached nearly 24 hours a day, 7 days a week. Write, phone, wire or visit either store. Send us your orders and inquiries. Export inquiries solicited too.

Bob Henry
WØARA

Butler 1, Missouri
Phone: 395

HENRY RADIO STORES

11240 Olympic Blvd.
LOS ANGELES 64
BRadshaw 2-2917

"LARGEST DISTRIBUTORS OF SHORT WAVE RECEIVERS"

TVI is on the RUN!

Lick yours now with
the help of the
FCC Plan
and R. L. Drake
**Transmitter,
High Pass and
AC Line Filters**

**OM's, don't wait! Do your part
now by getting on the air and
cleaning up your harmonics.**

**The FCC and most TV receiver
manufacturers are ready now
to help you lick the television
interference problem. (See arti-
cle in January '52 QST)**

*R. L. Drake Transmitter, High Pass and
AC Line Filters are stocked by more
than 700 distributors throughout the
nation.*

THE R. L. DRAKE CO.
11 Longworth St., Dayton 2, Ohio

Write us for further information.

requested that the secretary or other appointed member of both the Marin and the Tamalpais Clubs please send the SCM items of club and individual doings each month. The Marin Radio Amateurs Club meets the second Friday in the Engineering Lecture Room, Marin College, Kentfield. The Tamalpais Radio Club meets in the new quarters of OZC on Vistazo near Centro East in Tiburon, P.O. Box 247. San Francisco Area: EC: BYS, Asst. EC: JWF. The S.F. Emergency Corps meets every Monday at 8 p.m. on 147.15 Mc. Congratulations to the new officers of the SFRC: CTH, pres.; BYS, vice-pres.; Harry Witzke, treas.; URA, secy.; and GGC, GHI, AHH, DZN, and WXV, directors. The Central California Council of Radio Clubs has set a July date in 1952 for the proposed Pacific Division Convention, and committees have been appointed. KAH lost his 10-meter beam in the Big Wind of Dec. 1st but has replaced it with a Workshop. GGC, from the San Francisco section, has been elected vice-president of the Central California Council of Radio Clubs. The San Francisco Radio Club meets the fourth Friday at 1641 Taraval St., and the High Frequency Amateur Mobile Society meets the second Friday at the Red Cross Building, 1625 Van Ness Ave., San Francisco. Traffic: W6JCG 22, KAH 7, ATO 5.

SACRAMENTO VALLEY — Acting SCM, Willie van de Kamp, W6CKV — Northern Area: Asst. SCM, Edward M. Cripps, 6YNNM, CFU and LIG are husband and wife. ASM is ex-BZZ. DDC has new modulator. HVB is heard on 160 meters. IIQ is chasing DX. IOI is going high power. FKI is holding down the fort for Mt. Shasta. AAR is inactive. Central Area: Asst. SCM, Willie van de Kamp, 6CKV, BJT, of Paradise, is the first Novice in this Area. IZC deserted radio for the jalopy. BHV is a new ham in Chico. OXG is talking 160-meter mobile. DPC is active again. GUV has good luck with the Carter system of modulation. AF is chasing DX on 14 Mc. CKV received a letter from SCM 6ZF-3ZF, who passes on his 73 and Season's Greetings to the SVS gang. Southern Area: Asst. SCM, Richard M. Hall, 6ZYV, JEJ finally received Advanced Class license and has 50-watt mobile on 2, 10, and 160 meters. MGR soon will be on 3.5 Mc. through the efforts of PIV. KFO writes while waiting for Advanced Class license. The SV traffic net, on 28.8 Mc., handles daily weather condition reports to the Weather Bureau. BVK has 160-through 2-meter gear in pickup truck for c.d. AP's son was wounded in Korea. KPV moved from Grass Valley to Sacramento. WSI moved from Applegate to Sacramento. BYB has returned to Sacramento. KME has a new antenna farm. Traffic: W6JDN 40, PIV 39, KRX 29, ZYV 26, JEJ 16, KFO 8, ILY 2.

SAN JOAQUIN VALLEY — SCM, E. Howard Hale, W6FYM — SEC: FYM, RM; JQB, ECs; BCL, CQI, EHN, RIP, GCS, GKX, HZE, JPU, and VRF. ORS; EXH; GIW, JQB, LRQ, and QUE, OBS; EXH, GRA, GS, GWQ, and OHT. OES: FYM, RJE, and UWY. OOs: FKL, HZE, and JQB. JAZOM/W5MIJ visited your SCM during November prior to returning to Japan. The recent gales in Northern California leveled several antennas, both TV and ham, among them those of EXH, AXI, WPV, and EQO. K6FAJ, at Edwards Air Force Base, now is operating 16 hours daily with traffic connections into a number of California nets. The Fresno Club made good financial gains during 1951, according to the report in their club bulletin. Skip, FKL has a swell new ham shack. JPU, Fresno County EC, sent a nice report of AREC activity there. A recent emergency test was held with one station set up on City Hall steps. BYH reports that the Delano Club was active in the SS Contest under the call EFV and garnered in excess of 85,000 points. JQB, section RM, reports by air that activity in SJVN has picked up considerably during the past two months. WN6GDI is a new call at Delhi near Turlock. Let's hear from the rest of your Novices in the section. Look on page 6 of QST for my QTH. Season's Greetings, gang, and keep up the good work during the coming year. Your FB reports are deeply appreciated by me. Traffic: (Nov.) W6EXH 135, JQB 68, GIW 38, AJE 20, QUE 20, BYH 13, HZE 8, GQZ 5, FYM 4. (Oct.) K6FAJ 178, W6JQB 144.

ROANOKE DIVISION

NORTH CAROLINA — SCM, J. C. Geaslen, W4DLX — SEC: ZG, PAMS; DLX and ONM. RM: AKC. Your SCM has been busy building a new basement this month so don't ride me if the news is short. Hi. Laying cement blocks doesn't leave much energy for hamming. The Mecklenburg Amateur Radio Society of Charlotte has purchased a new Viking rig and is on every week end to work the 75-meter mobiles. The call is BFB. OQQ has returned from a trip to Florida and really worked some DX with his mobile. A nice report was received from our RM, AKC. The N.C. c.w. net is going fine under his able direction. How about some more of you fellows getting down there on 3605 kc, and helping out? BDU has a new rig on 3.5 Mc. now and he says he is back in the old groove again. MVP has his 10-meter beam in the top of a 60-foot tree now and has the Wilmington gang drooling. MDA says he has a Novice about ready and sure enjoys the thrill

(Continued on page 96)



Hams Paradise!

Niagara, ONE OF AMERICA'S GREAT RADIO STORES

MORE AND MORE GREAT NAMES Come To Niagara

COMPLETE LINE OF ERIE RESISTOR Components

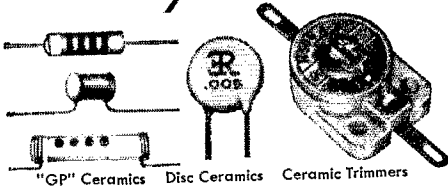

For Any and All By-Passing Requirements—Erie Ceramics

WRITE FOR FREE ERIE CATALOG



SW-54

\$49.95

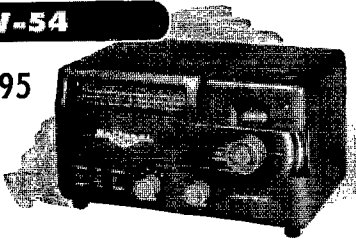

Sleek, Low-Priced, Beauty in a Compact General Coverage Receiver.

11" x 7" x 7"

NATIONAL SW-54 IN STOCK

WRITE FOR FREE LITERATURE

COMPLETE LINE OF



TOP CHOICE FOR 20 YEARS

Your Signal Stays Put WITH Bliley Crystals

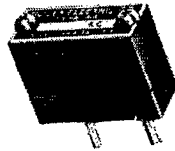

Popularly Used By

- HAMS
- AIRCRAFT
- INDUSTRIALS
- LABORATORIES, ETC.

WRITE FOR FREE BLILEY CATALOG

COMPLETE LINE OF WHEELER



SOUND POWERED PHONES

Up to 25 Miles without Batteries or Power Supply

The Finest!

12 Intercom Master Stations



WRITE FOR FREE WHEELER CATALOG

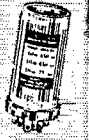

Niagara

RADIO SUPPLY CORP. DEPT. Q-2-2
160 Greenwich Street, New York 6, N. Y.

Digby 9-1132-3-4

NIAGARA'S GUARANTEE OF SATISFACTION
All items ordered must meet with full approval or your money back.

SIGNAL SPLITTER ELIMINATES ADJACENT CHANNEL AND HETERODYNE INTERFERENCE

THE McLAUGHLIN SIGNAL SPLITTER is used with receivers in communications services where reception is often jammed by unwanted signals normally impossible of elimination. Its versatile selectivity* will separate two carriers on the same "assigned" frequency . . . by as much as 60 db . . . when the frequency difference between carriers is but .005% (at frequencies of the order of 15 MC).

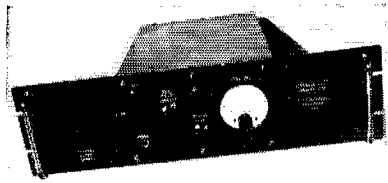

Essentially the **SIGNAL SPLITTER** is a selectable single-sideband converter, rejecting the side-frequencies containing the unwanted carrier and demodulating the message information in the remaining transmitted sideband.

However, more than a single-sideband receiver is required to eliminate interference . . . R-F intermodulation distortion must be kept at a minimum . . . otherwise, the distortion effects will produce new frequencies in both sidebands and little reduction in heterodynes will result. The measured intermodulation R-F distortion in **SIGNAL SPLITTERS** is below .01%.

Special miniature filters in hermetically-sealed metal cases . . . with maximum Q at the operating frequency . . . assure permanent selectivity.

SIGNAL SPLITTERS are available with bandwidths suitable for both CW and voice reception . . . from 100 to 5000 cycles plus and minus the signal carrier. We supply special **SIGNAL SPLITTER SYSTEMS** to services requiring greater bandwidths than the standard units. The maximum is four megacycles plus and minus the desired center frequency.

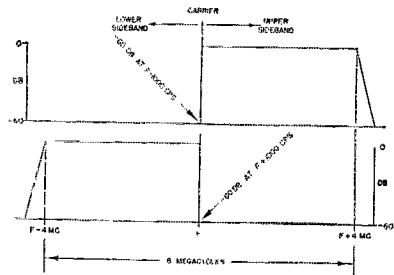

* U. S. Patents
2364863 2480870 2535442

Designing Receivers
for 30 years

J. L. A. McLAUGHLIN
LA JOLLA, CALIFORNIA
U.S.A.

Making **SIGNAL SPLITTERS** for 10 years

EXPORT: RCA International Division
RCA Building
New York 20, N. Y., U.S.A.

of putting another one on. Shucks, the Novices are coming so thick and fast your SCM has quit trying to keep up with them all. Hi. WN4TYR has a new antenna up and is doing fine in Charlotte. I hope we raise a good crop of c.w. men out of them. COO and 8AUB recently moved to Charlotte. Welcome, boys. The number of traffic reports was very surprising this month. Congrats, boys. Traffic: W4AKC 82, IMH 63, JPY 62, RRIH 39, REZ 30, BDU 28, OTE 17, EFV 9, ILJ 8, BBZ 4, DLX 4, LWU 4.

SOUTH CAROLINA—SCM, T. Hunter Wood, W4ANK—WN4UFP is a new ham in Hartsville who operates from the U. of S. C. and wants South Carolina contacts. DCE is Class I OO and ORS. The following SS Contest scores are reported: OGG 50,000, DCE 47,040. HCZ has new 750-wattter on 80-meter c.w. Ex-6YQS now is 4YQS and operates 75-meter mobile 'phone. CRY is in the service and stationed at Donaldson AFB, S. C. FFH, YQS, GWH, and ANK met for breakfast Dec. 2nd to plan a breakfast meeting monthly in the Charleston Area. Those interested, contact YQS. The SCM desires applications for ORS and OPS appointments, especially from net members. WNs, please register your address and call with the SCM. Traffic: W4ANK 251, FFH 32, FM 11, DCE 2.

VIRGINIA—SCM, H. Edgar Lindauer, W4FF—SEC: NAD, MWH, IA, NAD, PXA, and SDK are the hard-plugging RMs. QDX, a former RM, has been snatched by Uncle Sam for other duties in a West Coast QTH. Other recent casualties by the same route were LNL, NUU, LAP, CVO, KYD, PAS, NRO, and KVM. The SS Contest enjoyed heavy participation from this section, with KFC leading the flock of W4s. WN4TFX, the offspring of IA, passed the General Class test and is holding his breath until that coveted ticket arrives. Congrats, Phil, see you on the nets. KX is operating on borrowed equipment from EBH while assembling new rig. He returns after a 14-year lapse as 3KU. SDK is using K4AF-Pentagon for VN-NCS work on Thurs, while QRX for that 400 Globe King rig. TFX worked 19 states with single 6L6 18-wattter and bears the distinction of being the first Novice to submit an activity report to the SCM. NV also has a QTH in Wilmington using SB call sign. STM is an additional outlet to ESN. Many favorable comments are reaching us on the newly interesting *Virginia Section Bulletin*, very ably compiled and edited by KFC from good copy sent in by the gang. Keep it coming; he knows how to put it together. Thanks to 1BUD for his pat on the back for VFN found in the last issue. LNL's overseas QTH is Wheeler Air Field, Tripoli, at CN8FG on 3.5 and 14 Mc. Bill Stull, ex-LAP, can be heard as DL4JN and may surprise a QNT one of these days. TLR is the call of the new Red Cross station at Richmond. New appointments: As RM, SDK. As OBS, OGX. As OPS, OGX, NV, and QDX. As ORS, NAD. KSW, RYS, KX, and SDK. As Class I OO, SZY (ex-9ERU). 0PNQ and 6AVM visited KFC who, incidentally, worked his 80th country on 3.5 Mc. Traffic: W4SDK 489, PWX 201, MWH 129, FV 105, FF 58, NAD 54, QDX 53, KFC 47, NBA 38, PXA 38, NV 36, IA 32, KSW 20, IXL 11, LK 8, KX 7, WN4TFX 2.

WEST VIRGINIA—SCM, Donald B. Morris, W8JM—YPR maintains link between c.w. and 'phone nets Mercer Vocational Club station. GDX will cover the Blue field Coal Show. AUJ continues his fine traffic work. Congrats to Al Heck, 3GEG, formerly 8GEG, new Atlantic Division Director, GCZ, DFC, and GEP, new NCS on WVN, 3770 kc. MCR reports good results with new HRO-50. The Huntington Radio Club is reorganizing the AREC program. VPO is a new OBS. New hams are HNC, IHW, and HXG in the Bluefield Area. JM and BOK visited LBI and 8LFS. PZT has new coffee-can VFO which sounds like crystal. The following stations reported in to the c.w. net: AUJ, DFC, GCZ, GEP, YPR, BWL, FVQ, GGC, BWK, EZR, EUJ, EWM, PZT, EPK, GBF, GFV/4, and 4KTA for the month of November. WVF has a new location with more room for antennas. All members of the MARA code class passed the amateur test in Washington and are awaiting licenses. SGO, now 3SGO, is located in Cheltenham, Md. New Novice stations should give a WACWV to some West Virginia ham soon. Traffic: W8AUJ 292, MCR 84, YPR 50, DFC 17, GCZ 13, GEP 9, BWK 3.

ROCKY MOUNTAIN

COLORADO—SCM, M. W. Mitchell, W0IQZ—The El Paso Radio Club of Colorado Springs now is affiliated with ARRL. JMB is president and LZY secretary. PGX, with his crew of KHQ, EOQ, DYS, BRU, NDM, KV/0, RJJ, and local HQ, handled 167 in the c.d. test. CBSN (Colorado Slow-Speed Net) is getting off to a slow start. More members are needed in it. The Net meets at 1930 Mon. through Fri. on 3560 kc. ANK is on 160 meters. Lamar hams took part in the c.d. drill. JVR, with 20 watts and "V" beam, works all kinds of DX. DYS is OBS and is on 3560 kc. with bulletins at 1900. SFS has new Viking, as does SUP. DD is back on 75 meters. IC worked 87 sections in the SS. His new automatic keyer and Monitone which he built up are working PB. The Colorado Springs Club put on a transmitter hunt but the boys had trouble finding it because of reflection from the mountains. KHQ

(Continued on page 98)

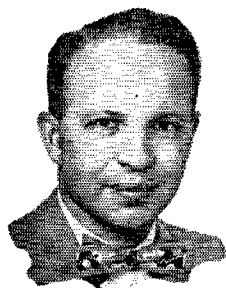

We Have the Most Satisfied Customers

Ask the fellows who deal with me. They'll tell you that WRL will allow you more for your present equipment — that WRL's large volume of sales means faster turnover and greater savings. Our customers know that we finance our own paper, eliminating all red tape. WRL buys more equipment — WRL sells more equipment. We offer the most personalized service anywhere. Deal With One of the World's Largest Distributors of Amateur Radio Transmitting Equipment. Special Attention Given to Foreign Orders Through Our Special Export Department. CABLE ADDRESS WRL1.

Leo I. Meyerson WØGFQ

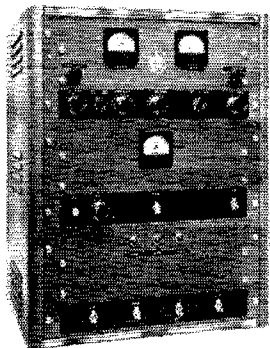

NEW WRL 400-B GLOBE KING TRANSMITTER

High Power — More Watts Per Dollar
Our newest model with increased power—420 watts Phone, 420 watts CW. Incorporates some of the latest TVI protective features. Efficient performance on all bands — 10 to 160 on phone and CW. Provisions for ECO. Complete with tubes, meters, and one set of coils. Low Down Payments.

KIT FORM
\$475.00

WIRE-TESTED
\$495.00

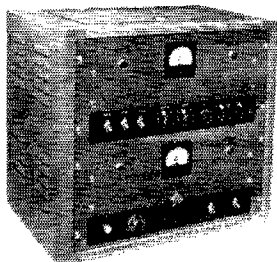

NEW WRL 165 WATT GLOBE CHAMPION TRANSMITTER

More Watts Per Dollar
R. F. Section a complete 165 watt XMTR. Provisions for ECO. Automatic fixed bias on Final and Buffer. Class B Speech Modulator. 165 watt input — 10 thru 160 meter bands. Complete with tubes, meters, and one set of coils. Low Down Payments.

KIT FORM
\$329.50

WIRED
\$349.50

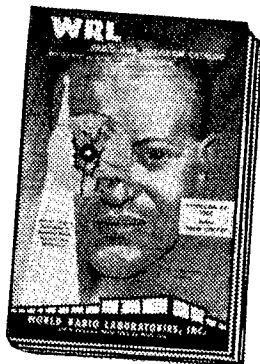

WRL 1952 CATALOG

IT'S NEW! IT'S FREE!
Send For Your Copy
— TODAY —

Contains everything new in radio and television. Jam-packed with bargains.

LIBERAL TRADE-INS
LOW DOWN PAYMENTS
PERSONALIZED SERVICE

GIANT RADIO REFERENCE MAP



Just right for your control room walls. Approximately 28" x 36". Contains time zones, amateur zones, monitoring stations. Mail coupon today and..... **25c**

CU ON 10-20 & 75 METERS

NEW LOG BOOK

For mobile or fixed stations. Spiral binding—turns up—lies flat. Full column log listing all FCC required info. Log will accommodate 1,525 stations. Front and back covers show "Q" signals, phonetic alphabet, and amateur international prefixes... **25c**



WRITE FOR DETAILED SPECIFICATION EQUIPMENT SHEETS

WRITE
WIRE

PHONE
7795

World Radio
LABORATORIES COUNCIL BLUFFS, IOWA



World Radio Laboratories, Inc.
744 West Broadway
Council Bluffs, Iowa

Q-2

Please send me:

- New Log Book
 New Catalog
 Radio Map
 Globe King Info
 Globe Champion Info
 Used Equipment List

Name _____

Address _____

City _____ State _____

TOP HAT RETAINERS

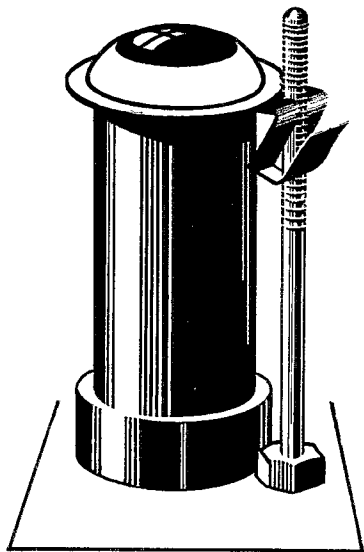

- EASY TO APPLY
- INSTANTLY RELEASED
- POSITIVE LOCKING ACTION

Securely holds tubes and other plug-in components in position.

They will not loosen under the most extreme conditions of shock or vibration.

Made in a variety of sizes to fit almost any type tube.

Recommended for use in Army, Navy and Air Force equipment.

Write for literature and prices.

TIMES FACSIMILE

CORPORATION

540 West 58th Street
New York 19, New York

1523 L Street N. W.
Washington 5, D. C.

is having speech amplifier troubles and is going to rebuild it again. Yours truly put up a 10-meter folded dipole in the attic which works out FB. The response to my request for more reports has been very heartening, with 4 letters and 8 cards received this month. The Greeley Club put on another one of its very fine annual hamfests recently with more than 100 registered. A very interesting demonstration of v.h.f.-controlled traffic lights was made and enjoyed by all. We wish to thank KHQ, PGX, LZV, and SGG for the newsy letters this month. Traffic: W0ZJO 699, KHQ 194, PGX 177, MOM 37, SGG 15, DYS 7, OWP 6.

UTAH — SCM, Leonard F. Zimmerman, W7SP — NUZ was elected president, PHR vice president, and OS� secretary-treasurer for 1952 of the Utah Amateur Radio Club. 7DAD/7 has moved to Sanday and is a new member of the MARS c.w. net. ZDX, 10-meter mobile NCS, is set up at a new QTH, 567 10th Ave., Salt Lake City. Welcome to WN7QDF who, we believe, is the No. 1 Novice licensee for Utah. KUX reports his new 304-TL rig is working FB and the TV receiver still works when he is on the air. The UARC 10-Meter Mobile Emergency Net has received spot frequency crystals and NMK has fixed up four walkie-talkies for use in conjunction with the emergency set-up. The Ogden Amateur Radio Operators Club initiated the Christmas season with a dinner dance held on Dec. 7th.

WYOMING — SCM, A. D. Gaddis, W7HNI — EC: LKQ, PAM: KFV. HX is in the hospital for a long rest. CBL is helping AMU to recuperate. ABO commutes from Gebro to Worland. HFV and MOD entertained IWW huntin' and hammin'. PKX is keeping Sheridan on 3.8 Mc. JRG is moving to Billings. MBL is on 3.5 Mc. MZV is working on 160-meter rig. LVU is constructing mobile rig. NOU still needs a new receiver. FLO, KFV, GOB, MWS, PKX, ATJ, HFV, NHC, IQQ, NOU, HPE, ABO, and HNI report in on the PE net 9:00 A.M. Sundays, 3920 kc. AEC needs expert help to exterminate beavers. Any ideas from the side-lines? Traffic: W7OSH 2.

SOUTHEASTERN DIVISION

ALABAMA — Acting SCM, William H. McGowen, jr., A4WRTI — SEC: ISD. Appointments: EBD as PAM of AENR. LEN has resigned as SCM and is moving to Indiana. We certainly hate to see Lewis leave and wish him lots of success in his new position. The Anniston Club gave a dinner for LEN at the Noble-Purefoy in Anniston on Nov. 26th. Those attending were GBP, GYD, LEN and his XYL, PHR and his XYL, HA, BA, and BCU, all of Anniston, and EBD, OLG, and RTI of Birmingham. Members of the Alabama Phone Net presented LEN with a fountain pen. AENP and AENR were alerted and both did a swell job after the tragic train wreck at Woodstock, Ala., on Nov. 25th. KVV did an exceptional job handling traffic and gathering information during the emergency. FGT and HFP served faithfully as NCS of AENP. OLG was NCS of AENR, with SDX, ECI, and GET relaying from mobiles RTP, KNW, EBD, NQK, FSV, and RTI, all at the scene of the wreck about thirty miles from Birmingham. FPB kept the two nets in contact. Sheriff Holt A. McDowell, of Jefferson County, commissioned eleven members of AENR as deputy sheriffs. PYU, formerly of Craig Air Force Base, paid a visit to FGT at Selma. AUP and ATF, of Montgomery, operate 160 meters almost every afternoon and would like to see more activity on 160 meters. Traffic: W4KIX 102, EJZ 95, BFM 22, SUF 5.

EASTERN FLORIDA — SCM, John W. Hollister, jr., W4FWZ — The Novices are really in there pitching and several of the OTs have been heard in there with them on 3.7-3.75 Mc. getting acquainted. My list of Florida WNs includes TWD, TRP, TEQ, TVQ, TEE, TWP, TYI, TFP, TOP, TRR, TKC, and TOO. Thanks to TWG for the calls of those I had missed on QSOs. WNs TKD and TWD are right open with the desire to form a WN traffic net and all we need is more with the same desire to get a section net going with pretty certificates and all. W4s JGD, in Jacksonville, and AXX, in Clearwater, have made some very complimentary remarks about the WNs they have worked. Well, the winter net skeds are in full swing and by the time this appears much new Christmas gear will have been broken in. Attendance with the K. of Kc. has materially picked up with the spirited old-faithfuls in full competition for the top brackets in the roll call. Those moving away from their old QTHs include EEP, at Jacksonville, PNS, at Clewiston, and CQX, at Tampa. The SS Contest pulled in some new contestants. Reporting were PJU and WN4TKD. Many others were heard. Here are some new mobiles in Broward County: 0GJQ, 3IMH, and 4OTG. There now are 12 mobiles there on 28 Mc. IM, at Ft. Lauderdale, and IEH, at Miami, urge closer cooperation among the other ECs in South Florida. (Mutual benefits, naturally.) IM has 17 AREC members. IEH is getting reorganized in Dade. LXX is new president of the Dade Club, which is putting on some lively programs. The *Miami Daily News* runs ham news bi-monthly! OZC is Assistant EC for Dade. SEA, at Madeira Beach specialized in holiday greetings to GIs. KJ, of New Port Richey, gave the Knights of the Kilo-cycle program by having Robert

(Continued on page 100)

LOOK STEINBERGS LOOK

SUPER SPECIALS

JACK BOXES

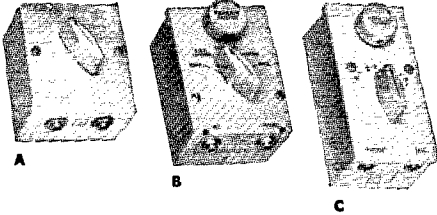

(A) BC-345. 3½" x 3" x 1½" aluminum, 2 standard open-circuit jacks, 3-position switch, 6-contact banana plugs and jacks.

(B) BC-1366. 4¼" x 3" x 2¼" aluminum, 1 standard open-circuit jack, 1 3-circuit mike jack, 150,000 ohm volume control, 5-position switch, 11-contact banana plugs and jacks.

(C) BC-213. 5¼" x 2¾" x 2¼" aluminum, 1 standard open-circuit jack, 1 3-circuit mike jack, 150,000 ohm volume control, 4-position switch, 8-contact banana plugs and jacks.

YOUR CHOICE 30¢

CONDENSER SPECIAL

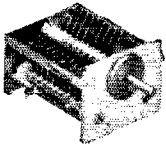

75 mmf, 4250 peak voltage, ceramic button insulation, adjustable spacing, straight-line capacity, precision construction, 3¼" long, 1¾" wide, shaft ¼" x 1", adjustable tension, double-bearing.. **89¢**

GRID BIAS CONTROL



2500 ohm, 25 watt Clarostat potentiometer, perfect grid-bias control for panel mounting, excellent heavy-duty P.A. speaker volume control, TV focus control, worth \$5.20 list, brand new..... **69¢**

PHOSPHOR BRONZE AERIAL



125 ft. of the finest aerial wire obtainable. 42-strand phosphor-bronze with linen center. Will not stretch, very high tensile strength, diameter approximately same as No. 14 copper, very flexible. Excellent for transmitting or receiving antenna, control cable, guy wire. Regular list \$4.95..... **90¢**

MINIMUM ORDER \$2.00. Send 20% deposit with COD orders. Please include sufficient postage or instruct us to ship by Express Collect. Overpayment will be refunded by check.

ELMAC-A54

Under-dash Mobile Xmtr.



VFO or Crystal control. Direct-reading. VFO on all bands—75, 20, 11, 10. • Plate modulation • Completely band-switching, fone or CW. • 50 Watts max. input. Power required: 300-500 V.D.C. at 250 ma., 6.3 V AC or DC at 4.5A. • Uses 3-6AG5, 6AR5, 6C4, 12AU7, 2-6L6G, 807, (included). • Only 7½" x 7½" x 12", 14½ lbs.

For carbon mike input..... **\$139.00**
 For Dynamic or crystal mike..... **\$149.00**
 Power Supply, 110 Volt AC..... **\$ 39.50**
 ELECTRO-VOICE 210 Mobile Carbon Mike..... **\$ 16.50**
 ELECTRO-VOICE 600D Mobile Dynamic Mike..... **\$ 23.10**

MALLARD MOBILE CONVERTER

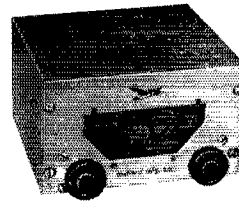

10 **\$3995**
 20
 75 **ANY MODEL**

A sensitive, stable one-band converter for peak performance! Wide band-spread with accurate calibration on a large, well-illuminated dial. Nylon gears; slug-tuned, 3 tubes.

Ht-Q, 20 coil to base load 96" whip..... **\$8.95**
 Ht-Q, 75 coil to base load 96" whip..... **\$7.95**

MASTER MOBILE UNITS

All-band center-loaded antenna for 75-20-10, specify coil wanted, less mount..... **\$8.75**
 100-96S. Stainless Steel 96" threaded whip.... **\$3.25**
 9-96T. Silicon-Chrome 96" threaded whip..... **\$3.75**
 100-60S-60". "All-Band" top section only..... **\$4.95**
 132. Tapered spring universal body mount..... **\$8.75**
 132X. Heavy-duty universal body mount..... **\$9.85**
 132J. Junior model universal body mount..... **\$4.17**
 140. Tapered spring bumper mount..... **\$6.55**
 140X. Heavy-duty bumper mount.. **\$7.65**
 140J. Junior model bumper mount. **\$4.17**



Steinbergs

633 WALNUT STREET • CINCINNATI 2, OHIO

Your order will receive my personal attention and will be shipped the same day order is received. We distribute all top-flight amateur lines... let us know what you need.
 73, Jule Burnett, W8WHE

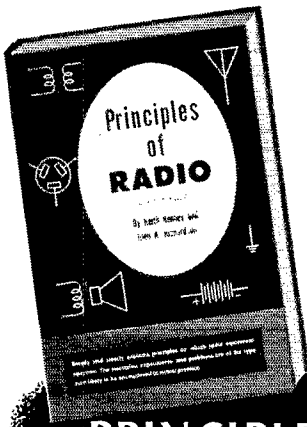

NOW!
Revised
Enlarged
Improved

6th
 EDITION

PRINCIPLES OF RADIO

By KEITH HENNEY, W1QGU, K2BH
 and GLEN A. RICHARDSON,
 Iowa State College

The bedrock of radio,
 clearly and simply explained.

Proved valuable and dependable in 5 previous editions, here is a new, revised, enlarged 6th edition of one of the most popular radio books ever published. Easier to understand and apply than ever before, this material has been tested and improved by men of wide experience. The resulting book is completely up-to-the-minute... a standby in a growing field.

- Many chapters extensively revised; many new chapters; more than half of illustrations are new; all problems completely rewritten, many added
- No math required beyond high school algebra
- The operation of radio equipment is clearly explained in simple English
- Covers the ground thoroughly, from DC, AC and magnetic circuits through FM, radar and TV
- Major emphasis is on operation of basic radio circuits, with many step-by-step examples
- All experiments have been worked out in the lab
- Offers characteristic curves of typical tubes, design equations, completely worked-out problems, etc.

1952. 655 pages \$5.50

Send coupon now for free 10-day examination

APPROVAL COUPON

JOHN WILEY & SONS, INC., Dept. QS-252
440 Fourth Ave., New York 16, N. Y.

On 10 days' approval, send Henney & Richardson's *Principles of Radio*. I will remit \$5.50 plus postage or return book postpaid. (Offer not valid outside U. S.)

Name

Address

City, Zone, State.....

SAVE POSTAGE — We pay postage if you enclose \$5.50. Money back on same return privilege.

Sims, who doubled for Forest Tucker during the filming of "Crosswinds" in central Florida. Traffic: W4PJU 503, PZT 214, LMT 59, RWM 32, WS 31, FWZ 6, IM 6, AXX 3, PNS 2.

WESTERN FLORIDA — SCM, Edward J. Collins, W4MS/W4RE — SEC: PQW. EC: PLE. DAO has returned to the air. NRX is building high power. QK is dusting off the rig. LUF is moving the rig into new studio. PQW has been QRL nets and E.C. works. RZV still clings to 28 Mc. NOX has been giving traffic a fit. TTM keeps 28 Mc. going but wants 3.8 Mc. PTK and his XYL visited Alabama and Tennessee hams. SZH is building 813 final. CNK is on again after a long absence. VR keeps up the 7-Mc. c.w. work. MUX is an early morning net man. AXP meets nets also. PAA keeps 14-Mc. skeds. PJP is getting ready to get on the air again. AGB did an FB job in the SS Contest. ODO is working on 50- and 144-Mc. gear. PLE reports considerable 2-meter interest over Edglin way. OKB is working on bandswitching rig. WN4TKL keeps plugging away on the Novice band. MS is putting mobile gear in operation again. BGO is doing an FB job on 3.8 Mc. I would appreciate hearing from more of the gang. Traffic: W4PQW 61, NOX 29, MS 3.

GEORGIA — SCM, James P. Born, jr., W4ZD — The new officers of the Confederate Signal Corps of Atlanta for 1952 are EJC, pres.; ORI, vice-pres.; EYQ, secy.; GLX, treas.; and EJJ, act. mgr. The Savannah Radio Club elected the following officers for 1952: KGP, pres.; FVI, vice-pres.; JIW, secy.-treas.; and RVG, act. mgr. Congratulations to the following Georgia clubs which recently affiliated with the League: The Macon Radio Club of Macon, the Camp Gordon Radio Club of Augusta, Confederate Signal Corps of Atlanta, and the Georgia Cracker Radio Club, a state-wide club. WN4UAU is a new ham in Thomaston. Our sympathies go to BOL and BQU, whose mother passed away recently. The following are active in the Brass Pounders Net: OSE, Net Control, FVY, LAJ, NS, PFF, RKK, TT, WB, K4WAR, and WN4TGM. The BPN Net meets every Saturday at 1930 EST on 3750 kc. Our RM, OSE, is forming a c.w. Novice net and request Novices interested to send him a radiogram or drop him a card at Box 672, Gainesville, Ga. This will be a net for Novice stations only. EJC is rebuilding. BOC now is on 50-Mc. 'phone and c.w. RZU has moved to Texas. LOR is building a new kw. His father now is UAT, PER, OOA, and PFA are attending Georgia Tech. LXE is rebuilding his kw. final on 3.85-Mc. 'phone. WN4TDY is a new ham in Chocopee and has worked 14 states with 25 watts. Traffic: K4WAR 1002, W4KGP 189, EJC 37, OSE 31, KXX 21, ZD 20, FBI 15, MTS 14, BOC 11, EYQ 11, LYG 10, FVY 6, WN4TGM 5.

WEST INDIES — SCM, William Werner, KP4DJ — SEC: BS. The WP4 Novice Net meets on 3735 kc. at 8 P.M. Tues. DJ pruned antennas to 3559, 7100, and 14,025 kc., respectively, for winter c.w. sessions. DV is working on bandswitching kilowatt. AZ is using cubical quad on 28 Mc. HZ is QRL building transmitter for sister. NI, PRARC committeemen CB and DJ conferred with RC and secured space on the main floor for club station KP4ID as NCS of P.R. Amateur Emergency Net of AREC. CH and OW keep 29.1-Mc. round table going every night. ES uses TBS50 instead of kw. on 3925-kc. net. GN, GP, BV, and DJ also are on 3925 kc. with TBS50s. EE's signal improved with a new 75 doublet. IT is operator at A4FAK, Tampa. FAA, Ramey AFB MARS call, was changed to AH2AB. KV4AA is building separate transmitters for 80 meters and other bands. WP4PW has a new HQ-129X. KE put 813s in his GO-9. CC has new 10-over-20 beams. DU reports into 3925-kc. net. CP has HC-610 working FB now. W4NRW /KP4 is using multiband off-center-fed antennas. MS's new 20-meter beam appears enormous on top of the house. KP4ZK and WP4PZ are a father-and-son team. JE reports on 3559-kc. AREC Net. W stations also are reporting into the 3559-kc. net at 8 P.M. Mondays. Anyone having 144-Mc. equipment ready for QSO, write DJ for introduction to others similarly equipped for schedules. Traffic: KP4DJ 6.

CANAL ZONE — SCM, Everett R. Kimmel, KZ5AW — SEC: FL, PAM: PC, RM: CG. Route Manager CG has the c.w. practice traffic net in operation weekly on 28,900 kc. at 2000R. After QNF the net reassembles on 'phone for criticism and post-mortems on the c.w. procedure used by members. AU, PC, RM, TB, and WZ are committeemen for the forthcoming CZARA hamfest. BT, on Stateside vacation, leaves the CZARA Bulletin without an editor. ML's oft-reported traffic-handling is no myth. Standing a recent noon traffic watch she was at the mike four hours, took 19 messages from the U.S.A., and put through two 'phone batches, but she couldn't get a Stateside station to take traffic for Denver. RL is having trouble making r.f. in the right places. Sky pilot LG's new and bigger church is finished. Next, he says, comes a bigger rig.

SOUTHWESTERN DIVISION

LOS ANGELES — SCM, Samuel A. Greenlee, W6ESR — SEC: KSK, PAM: PIB. RMs: DDE, FYW, LDR. Traffic nets operating within the section: Monday through Friday — Southern California Net (SCN), 3650 kc. at

(Continued on page 108)

HARRISON VALENTINE

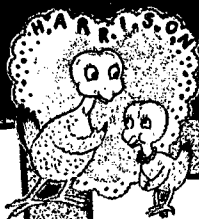

VALUES!

NEW ELMAC 50 WATT VFO XMTR



Here's the latest rig on the market! VFO or crystal control on all bands. Band-switching — 10, 11, 20, 75 meters. Additional switch position for 160, 40, or 8 meter coil. (Coil extra.) Use only two controls to QSY! Dial calibrated for all bands. Built-in pi antenna matching network. Push-to-talk! Needs 400 to 500V DC at 225 mls. plus filaments. Ideal for under-dash mounting or fixed station operation. Only 7 1/2" x 7 1/2" x 12". Wide. Rush your order for best delivery.

A-54 (for carbon mike) \$139.00
A-54H (for hi-imp mike) \$149.00



HARRISON HAS MALLARD!

Sensitivity—Stability—Slug-tuned coils—Accurately calibrated bandspread—ALL in the MALLARD Converter. Here's the newest thing to hit the mobile field. Tube line-up: 6AG4 oscillator, 6AG5 mixer, 6AG5 RF amplifier. Simple installation — only three connections — all plug-in! Attractive gray hammer-tone finish. Immediate delivery — order now! **\$39.95**

MALLARD BASE-LOADED COILS
For all 20 or 75 meter whips
HI-Q 20 — \$8.95
HI-Q 75 — \$7.95

HARVEY-WELLS BANDMASTERS

For Portable—Mobile—Fixed Station
Compact! Versatile! Modern! Ideal xmits for older timer or novice operator. (Covers Novice Frequencies: 80 CW, 11 CW, and 2-Meter Phone) 40 to 50 watts to 807 final — Phone or CW — Completely bandswitching — just turn knob to work 80, 40, 20, 15, 11, 10, 6 or 2 meters. 100% break-in operation. All controls and xtal sockets located on front panel for quick QSY — provision for VFO input.

YOUR INVESTMENT PROTECTED!

All Bandmasters remain modern as unique factory plan permits addition of all newly developed features to older models.

BANDMASTER SENIOR — Carbon Microphone Input \$111.50
BANDMASTER DELUXE — With pre-amp for crystal mike \$137.50
APS-50 Power Supply for 110V AC Operation \$39.50
DPS-50 Dynamotor Supply for 6V DC Operation \$75.00

110V AC IN YOUR AUTOMOBILE!

Terado's new Senior Model Inverter delivers 45 watts of 110-volt, 60 cycle AC from any 8-volt DC source! Ideal for your car, cabin, boat, house trailer, etc. Use for operating phonographs, lamps, electric shavers, motors, fluorescent lights, etc., etc., etc. Compact—only 2 1/2" x 2 1/2" x 4" long. Complete with cord and provision for plugging into cigarette lighter socket. Standard AC receptacle provided for output.

6V DC to 110V AC — 60 cycles **\$10.95**
Model No. 6-1160

SONAR TWO-METER RECEIVER

Covers 143.8 to 148.2 Mc. 9 tubes. Over-all sensitivity better than .5 microvolt. Compact, universal-mounting cabinet. Designed for best reception. Use any external speaker. Model SR-9 **\$72.45**

MOBILE ANTENNAS? HARRISON HAS THEM ALL!

MASTER MOBILE

Universal Body Mount — Model 132
Body Mount with Heavy Duty Spring — Model 132X \$9.75
96" Tapered Steel Whip for 10 Meters — Model 132K 9.85
All-Band Antenna with coil for 20, 40 or 75 5.25
Extra coils for above — 20, 40 or 75 — Specify 8.75
New High-Efficiency Coaxial Antenna for 2 Meters. Fits all Master Mounts. 12" Coax Lead. Model 114 3.30
9.95

PREMAX

New Universal Ball Mount with Spring — Model RS \$11.75
96" Shop-Tapered Stainless Steel Whip — AS-106 3.65
Base-Loaded 3.5 MC Antenna with Coil — BLS-386 7.94
Center-Loaded 3.5 MC Antenna with Coil — BXC-386 3.12

WARD

Roof-Top Antenna for 140 to 160 MC. Install entirely from outside. Includes 12' coax lead. Model SPP-18 \$3.96
Here's the antenna that you've been reading about! Single 55 1/2" whip for 10 or 2 meter mobile. Single hole mount. Fitting for coaxial connector. Full Instructions. \$13.50
Write for new Master Mobile and Premax catalogs.

NEW! RCA 6146

Big brother to the famous 2E26. Handles 90 watts to 60 MC AND 65 watts at 150 MC. Ideal for 2-meter mobile, fixed, or CD transmitters. **\$4.90**

TVI—Suppressed Johnson Viking

Here's America's BIG transmitter value! Harrison has it completely laboratory wired and tested, incorporating TVI preventive measures. Conservatively rated at 100 watts Phone or 125 watts CW OUTPUT! Push-pull 807 modulators! Covers 160-80-40-20-15-11-10 meters — entirely bandswitching — provision for VFO — xtal selector for 10 frequencies — all circuits modulator keying for break-in CW — coaxial output — 11" x 15" x 21" wide. Supplied complete with tubes and instruction book — ready to operate.

Johnson Viking I **Only \$308.50**
Wired, tested, complete!

Standard Johnson Viking I Kit as supplied by the factory. Complete with instructions, less tubes. \$209.50

NEW JOHNSON VIKING VFO KIT

A companion unit for the Viking I Transmitter — can also be used with any similar transmitter. Features accurate frequency calibration on all bands, 10 through 160 meters. High Stability — Cleanest Keying — Assembly so simple that it can be built in one evening. Cabinet finished to match Viking I. Send orders now.

Complete Kit, less tubes **\$42.75**
Wired Tested, with tubes **\$59.95**

KW AM MODULATOR — \$19.95

New Lysco Clampmaster provides efficient clamp type modulation of xmtrs using pentode or tetrode RF amplifiers. Will modulate rigs up to one KW input when properly adjusted in accordance with simple factory instructions.

- High Impedance Input — Use Xtal or Dynamic microphone.
- Simple installation — Only four wires to attach and one minor change in power amplifier grid circuit.
- Compact — Streamlined metal cabinet, 4" x 4" x 6" deep. On-off switch, gain control and pilot indicator.
- Low Drain — Requires only 300V at 20 MA and filament current. (Power can be taken from transmitter)
- Complete with Tubes — Uses 6S17 1st Speech, 6SN7GT 2nd Speech, and 6V6G Modulator.

Clampmaster 401 — Ready-to-use — **\$19.95**

GONSET CONVERTERS

New! Two-Motor Converter — 144 to 148 MC \$44.50
Tri-Band Converter for 75, 20, and 10 meters 47.80
6, 10-11, 20, or 75 meter converters. Your choice 44.75
Latest Model Gonset Noise Clipper 5.25
Universal Steering Post Mount for all Gonsets 3.90

NO SHORTAGES AT HARRISON!!

Racks! Panels! Cabinets! Harrison has a complete stock for immediate delivery — all sizes. Send orders NOW!



HARRISON

NEW YORK 7, N.Y.

225 GREENWICH STREET
(10 West Broadway, at Barclay St.)



LISTENING COMFORT

Modern, lightweight, durable—Telex
Headsets are easy on the ears . . .
No uncomfortable ear pressure
. . . Easily adjustable and
built for hard usage . . . Telex
Headsets effectively block out
background noises . . . 5 ft. standard
cord or special cord with built-in
volume control . . .

TWINSET*
Weighs only 1.6 oz.



C.A.A. Approved
Write today for
free folder — Or see
your Parts Jobber.

MONOSET*
Weighs only 1.2 oz.



TELEX hearing at its best
ELECTRO-ACOUSTIC DIV.—DEPT. D-12
TELEX PARK—ST. PAUL 1, MINN.
In Canada, Atlas Radio Corp., Toronto
*TRADEMARK
STANDARD OF THE WORLD FOR QUALITY HEADSETS

CODE SENDING
CODE RECEIVING
SPEED

HAVE SKILL, ACCURACY
SEND AND RECEIVE CODE this EASY —
FASTER WAY! The CANDLER SYSTEM
has developed expert Amateur and Com-
mercial Operators, and Code Speed Cham-
pions. In a few weeks you can pass the code
examination for license. You can send and
receive with amazing skill and speed, without
tension. Long hours of practice unnecessary
to acquire proficiency. The WAY YOU
LEARN is ALL IMPORTANT! By simple progressive lessons
Candler teaches you at home to send and receive as easily as
you talk or read — FAST, ACCURATELY. SEND Now For
FREE BOOK — explains how fine amateurs and radio-
telegraph experts learned code and developed skill and speed.

CANDLER SYSTEM CO.
Dept. 4-B, P. O. Box 928, Denver 1, Colo., U. S. A.
and at 52b, Abingdon Road, Kensington High St., London W. 8, England

2030 PST; Northern Counties Net (ZQJ), 3045 kc. at 1930 PST; American Legion Net (ALN), 3975 kc. at 1830 PST; Mission Trail Net (MTN), 3854 kc. at 1900 PST; El Capitan Net (ECN) — restricted-speed, c.w. — 3725 kc. at 1930 PST. It is suggested that you monitor one or more of these nets, become familiar with the procedure and "break" them with your traffic. Except for AREC, traffic-handling is the best insurance we have of securing sufficient good-will from the public to warrant our remaining on the air. Solicit messages from your neighbors. Keep them short and do your part in getting these messages on their way. Don't hold traffic over 24 hours — mail it, if necessary. BPL this month was made by KYV, CE, and GYH. VKY reports M/M off Korea (not hamming — Uncle Samming). KQS reports 6220-ft. high antennae, from his mountain cabin. QHX says 60 watts is a bit puny on 14-Mc. c.w. KYV received message by mail for Korea — in Arabic, yet. (Anybody got a Moslem bug?) BHG handles Official Bulletins on 147.5 Mc. on MCW and voice at 1800. CE has finished new VFO. HLZ proves traffic does move fast on 'phone. Anyone seen LYG's Christmas cards? (Wow!) CMN says he's QRL nets, clubs, and helping WNs. More skeds for GYH. The Mike & Key Club is reorganizing under a new prexy, DO, ex-DIO. LDR, RM, wants more outlets for SCN. EHA/EHB moved to W5-Land. BLY reports: VG is a grandpa; FGC, MDD, AXH, ECM, KJK, KH6, and UT/6 are new AREC members; FGC has a new Lyco transmitter; GJC will be JA7 soon. In the WW-DX Contest AM was assisted by KPC and UQQ on 'phone; ADP and W9SRB/3A2AB on c.w. FYW, RM, says ECN is going good; BRY, CMR, and ORW are new hams; WNs ORW and ORI are Mr. & Mrs. From DTY: AAI is on 7- and 14-Mc. c.w.; HVJ (XYL) is going strong on 7 Mc. WNs: NIE has a total of 416 stations worked; NJU, on 3 bands, has 10 states. PIB, PAM, reports things looking up. For precise frequency readings, contact CK, on 144 or 3.5 Mc. CFL is going 2400-Mc. mobile! (To QSO whom?) COZ reports the Citrus Belt Club threw a huge Christmas party and dinner; MGG is on 3.5 Mc.; SW is on 3.8-Mc. 'phone; LQR is on 7 Mc. and LGO on 144 Mc.; BXP now is VFO; KPD has a new 28-Mc. beam. Centinella Valley AREC held its third anniversary banquet on Dec. 11th. DLQ patched KG6ABI direct to his folks in New York. NTP reports WL on 28-Mc. mobile; CDB raises antenna mast by water pressure; GKM started a fad with his new console. KOY sent a newspaper write-up of W6GCDU's station. AREC Notes: Crescent Bay, Los Angeles, and Val-Area Nets staged a c.d. drill with 60 mobiles — field phones, etc., and tied in with commercial radio. Top brass was very impressed. Golden State, Whittier, San Bernardino Nets are integrating closely with c.d. in their jurisdictions. Whittier is standardizing 144-Mc. equipment. Long Beach mobiles were in the Armistice Day parade. Also reporting: BUK, EBK, EPL, FZO, FKO, IOX, NCP, YSK. Traffic: W6KYV 3042, CE 1140 GYH 680, LDR 179, CMN 140, LYG 117, HLZ 106, BHG 75, PMS 68, NCP 54, CK 50, MJA 48, FMG 30, FYW 29, BLY 27, QIW 14, VG 14, HOV 13, ESR 11, AM 10, COF 6, COZ 6, IGH 6, OHX 5, GEB 3, BUK 2, WN6NJU 2.

ARIZONA — SCM, Jim Kennedy, W7MID — Good conditions for the Sweepstakes and WAS Contests resulted in some nice scores run up by the Arizona gang on both 'phone and c.w. JGZ, who is our new Route Manager, reports good activity on the 3515-kc. c.w. net, which is handled by PKU on Mondays, MLL on Wednesdays, and by himself on Fridays, at 2000 MST. This is not a high-speed net, fellows, so check in often and get the hang of message form and net procedure. LVR reports ten stations on 50 Mc. in Tucson. Two simulated emergencies went off well there. OAP has a new Viking rig. JUY is a new mobile in Phoenix. MHE got a nice write-up in the local paper for his overseas traffic-handling work. Just two reports were received this month; not much with which to write a report. Traffic: W7BH 97, JGZ 57, PKU 40, LVR 14.

SAN DIEGO — SCM, Mrs. Ellen White, W6YYM — Asst. SCMs: Shelley E. Trotter, 6BAM; Richard E. Huddleston, 6DLN; Thomas H. Wells, 6EWU. SEC: NBJ, RM: IZG. ECs: DEY and IOK. New EC for San Diego County is IOK, Eddie Poe. IZG, RM for the section, reports that SSN is coming along nicely with good turn-outs by KIO, IYG, BAM, KFO, GTC, 7BH, 7PKU, and 7JGZ. CNQ is actively working with the Chula Vista C.D. Net. GMG reports an unusual traffic-handling job by BSD. A YL with a message for Korea gave it to BSD, as well as to two commercial services. The only one of the three to get through was that via amateur radio. It was given to the addressee, a B-29 pilot, by another B-29 pilot during an air-strike in Korea. The pilot doing the relay job picked the message up in Okinawa. Newest YL Novice in San Diego to receive her ticket is Carla Norris, WN6GJX. GMG expects to be signing a JA or KR call early in 1952. BAM accomplished quite a bit during November. He totaled 877 for BPL once again and worked FF8AC for a new country. On Dec. 3rd, the Imperial Valley Amateur Radio Station in Red Cross Headquarters in El Centro was dedicated. Direct contact was established with CXO at Red Cross Headquarters in San Francisco. Business houses and public utilities in the Valley were very cooperative in furnishing equipment, reports DLN. LVN now is instructing at the local telephone com-

(Continued on page 104)

WE CANNOT TELL A LIE!



We're Chopping Prices Way Down With "Surprise" Trade-In Allowances On Your Used Communication Equipment.



RECEIVERS

Constantly hacking away at high prices, Walter Ashe gives you bigger-than-ever "Surprise" Trade-In Allowances on your used (factory-built) communication equipment. This is your chance to save on that new equipment you've been wanting. Get your trade-in deal working right now. Wire, write, phone or use the handy coupon today.

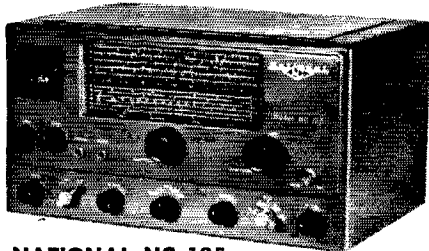

NATIONAL NC-125
Shpg. wt. 36 lbs.
Only \$149.50



NATIONAL SW-54
Shpg. wt. 10 lbs. Only \$49.95

NATIONAL NC-183
Shpg. wt. 64 lbs. Only \$279.00

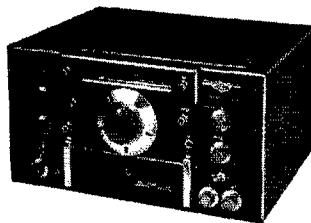

NATIONAL HRO-50T1
Shpg. wt. 88 lbs.
Only \$383.50

FREE CATALOG!

164 value-crammed pages of everything in Radio and Electronics for Industry, Schools, Laboratories, Radio Stations, Service Technicians and Amateurs.

All prices F. O. B. St. Louis
Phone: Chestnut 1125

Walter Ashe
RADIO CO.
1125 PINE ST. • ST. LOUIS 1, MO.

Walter Ashe Radio Co. Q-52-2
1125 Pine St., St. Louis 1, Mo.

O. K. Walter, Rush "Surprise" Trade-in-offer on my

for _____
(show make and model No. of new equipment desired)

Rush Free Copy of your new Catalog.

NAME _____ ADDRESS _____

CITY _____ Zone _____ STATE _____

ELECTRONIC ENGINEERS

Wide range of experience including design of wide band receivers, radar display systems, analogue computers, servo systems & CR oscillographs . . . thorough knowledge of RF circuits, wave shaping, pulse forming, triggers and gates (microwave techniques unnecessary).



A FEW KEY POSITIONS . . . Opening of our own manufacturing facilities creates permanent positions in research and development of vital, long-range products.

CONSIDER THESE ADVANTAGES . . .

- . . . Gracious country living, free from big-city pressures, provides a relaxing atmosphere in which you can do your best work . . . yet within easy reach of the cultural advantages of New York City.
- . . . Association with an established yet growing organization with few competitors in the field, where your merit and ability are given full consideration.
- . . . Unusual company-paid benefits . . . 40-hour week with considerable premium overtime . . . moving expenses paid.

TAKE ADVANTAGE OF THIS OPPORTUNITY NOW!

Address all inquiries to J. H. McCann

SPERRY PRODUCTS, INC.

DANBURY

CONNECTICUT

pany in El Centro. CQW is working DX by the bushel with a 40-meter vertical. New hams in the Valley are FTQ, GYL, KL7WF/6, and 61QL. FLD is busy building a 75-meter phone rig. Traffic: W6BAM 877, IZG 263, BSD 261, ELQ 238, KIO 33, GTC 17, FMZ 13, GMG 3.

WEST GULF DIVISION

NORTHERN TEXAS — SCM, William A. Green, W5BKH — Asst. SCM, Joe G. Buch, 5CDU, SEC: JQD. RMs: LSN and QHL. PAM: IWQ. Appointments were made to LEZ and KRZ as Asst. SEC, FNQ as EC, BAM as ORS, and IVG as OO. Congratulations to JQD who has another call in the family, TYX making it a five-call family. CMV, our EC in San Angelo, is cooperating with the c.d. on its Red Alert. AREC people of West Texas congregated on Lamesa for a hamfeed and discussion sponsored by the Lamesa AREC. Sorry to learn the station of the Pampa ARC went up in flames, with no insurance. Lubbock ARC has set up 3685 kc. as a secondary emergency frequency. An enjoyable social, picnic, and club meeting was held at Caddo State Park by the BTARC. The North/Oklahoma Phone Traffic Net is working under a rotating NCS system with the Texas end being carried by KRZ, HBD, SGR, IWQ, and EBW, each with an appointed alternate. Welcome to BAM, an old-time traffic man back with us. Known to have been participating in the Sweepstakes and renewing old acquaintances were BAM, SRQ, and VIM. Code practice for would-be hams is sent Mon., Wed., and Fri. nights at 7:00 p.m. on 3750 kc. by POG, IDZ, and SGR of the Sherman-Denison ARC. VIM has a new vertical colinear array on 28 Mc. LGY has a new stick holding up that antenna. CTM put in two weeks active duty with the Navy. POG has 100 watts on 144 Mc. and now wants somebody to talk to. Traffic: W5ARK 157, SQW 92, KRZ 82, BKH 72, HBD 81, PAK 69, EBW 47, IWQ 37, RHP 34, JOG 31, ONA 31, SGR 24, LGY 14, ASA 13, RJM 12, GZU 11, ROH 10, SRQ 10, BFA 8, BAM 6, QIP 4.

OKLAHOMA — SCM, Frank E. Fisher, W5AHT/AST — SEC: AGM, RM: OQD, PAMs: GZK and ATJ. WN5TFP received his General Class ticket 13 weeks after getting his Novice call. WN5TKC is awaiting his General Class ticket and sends in the first station activity report received here from a Novice. Thanks, Clarence. Keep up your reports. SLC swapped his Harvey-Wells for a Viking and more power. The Canton Radio Club, newly formed with QNK as prexy and ROZ as veep, has started a program of special aid for the Novice and has invited the Boy Scouts of Canton to its code classes. SWJ sends in a traffic report of work on 7 Mc. Wonder how many other stations handle traffic on 7 Mc. and do not report their activities. AGM, our SEC, has been appointed to the Advisory Counsel of the Oklahoma Civil Defense. Let's all get behind Claude in this important work and show the c.d. group what we can do. EHC and AGM are publishing a monthly bulletin on AREC which is appreciated by all. Well, fellows, this is the last report by AHT as your SCM. Being faced with a change in jobs and possibly a new QTH I cannot carry on to good effect as SCM or as Vice-Director of the West Gulf Division and have resigned both jobs. GVV will take over as Acting SCM until a successor can be elected. It has been a privilege and a pleasure to serve you and to work with you. I hope I shall be of service again in the future. 73 from FE, Traffic: W5GZK 681, MRK 270, OQD 147, MFX 51, MQI 51, JHA 50, AHT 46, FOM 40, EHC 16, SWJ 16, CKQ 13, OWG 4, WN5TKC 2.

SOUTHERN TEXAS — SCM, Dr. Charles Fermaglich, W5FJF — The DX Roundup meets on the 1st Monday of each month at 7:30 p.m. at the home of Bill Williams in Houston. Those present were IX, JWM, BDI, OFM, NMG, LXY, ADZ, OXI, NXX, and FJF. The boys gather around, have dinner, and discuss DX in general. One does not necessarily need to be a DX man to enjoy this meeting. There are no dues. Call ADZ or IX for further details. ADZ is planning to clamp-tube modulate a 304TL1 Brad is on 10-meter mobile. PY is doing an FB job as EC and also with TSGRC. EYV, who is communications chief for TSGRC, has a swell new lay-out at home and everything one could wish for at TSG. Hq. in Woodsboro. FXN wants to get the present QTH of DNN. He reports working 4FNR on 50 Mc. in November during the only opening. AQN and SU are partners in a large drugstore in Madisonville. Joe is looking for skeds with Houston, San Antonio, Waco, Austin, and Dallas. PDE is doing a nice job on 28 Mc. and we understand that he has a new 10-meter beam. TARC now is affiliated with ARRL. LM, DQF, ESL, and QGD are taking advantage of 10-meter openings. Construction is keeping PNP busy. IPT reports great activity among Temple hams on transmitter hunts. MN works sked with 8TQD at 7:30 a.m. PTV makes BPL practically every month. He has enlisted the Red Cross to visit hospitals, etc., and get messages which he is handling. The West Gulf Division DX Club is very active and KUC is doing an FB job in getting out the memorandum. Fellows, your SCM is making a New Year's resolution to be more active in tracking down the dope you fellows don't seem to want in print. How about dropping me a line before the 1st of each month and giving me the low-down on your friends and rivals. Let's all resolve

(Continued on page 106)

LEARN CODE!

SPEED UP Your RECEIVING with G-C

Automatic Sender

Type S
\$24.00 Postpaid in U. S. A.

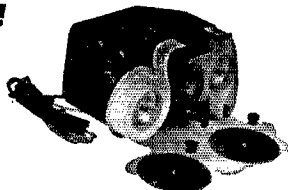

Housed in Aluminum Case. Black Instrument Finished. Small—Compact—Quiet induction type motor. 110 Volts—60 Cycle A.C.

Adjustable speed control, maintains constant speed at any setting. Complete with ten rolls of double perforated tape. A wide variety of other practice tapes available at 50c per roll.

GARDINER & COMPANY

STRATFORD

NEW JERSEY

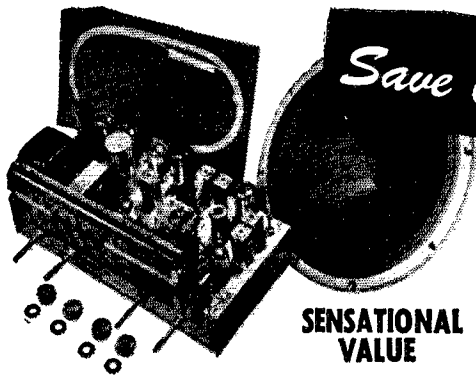

**SENSATIONAL
VALUE**

NEWARK'S FM-AM RECEIVER

Hi-fi FM-AM chassis featuring push-pull audio output. FM circuit is drift-compensated. Has full range bass-treble tone control and phono jack with built-in preamp for magnetic pickups. Chassis is complete with 12" PM speaker, built-in AM and FM antennas, 12 tubes (including rectifier), all hardware, and escutcheon. Size, 13½x9x9". Wt., 20 lbs.

96C034. SPECIAL PRICE.....\$69.50

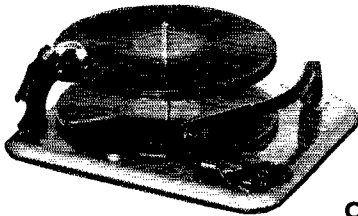

ONLY

\$17.88

G. I.

**3-SPEED
CHANGER**

Save on this lucky purchase that enables us to offer these fine, new record changers at less than manufacturer's cost! Made by General Instrument, these units automatically play all 3 sizes of records — 7", 10", and 12". Motor provides 3 constant speeds — 33½, 45 and 78 rpm. Tone arm uses crystal cartridge with single .002" needle to play both standard and microgroove records. Size: 12¾" wide x 12" deep x 5½" high. Requires 4½" above and 3¼" below. Wt., 12 lbs.

81G000. SPECIAL PRICE.....\$17.88

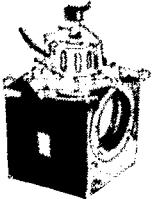

**"NORELCO" BASIC
TV PROJECTION
SYSTEM AT
NEW LOW PRICE**

Use this as the nucleus of your own projection TV system. Consists of Schmidt-type optical system and alignment assembly. Contains 3 optical elements: 6" spherical mirror with 200 mm radius curvature, aspherical corrector lens 4½" in dia., and plane mirror to "fold" the light beam. All factory pre-adjusted. Provide 8.6 linear magnification and numerical aperture of 10.62. Housed in black crackle finish case, 8½ x 8½ x 9". Overall size, 13½ x 8½ x 8½". Shpg. wt., 24 lbs.

81G500 SPECIAL PRICE.....\$6.95

Save ON THESE **NEWARK** values



NEW LOW PRICE! · GE CAPACITORS

While they last, Newark is offering these top-quality Pyranol-filled transmitting capacitors at less than manufacturer's cost! Conservatively rated at 1 mfd, 5000 volts. Porcelain insulators. Hermetically sealed in metal case, 3¼x4¼x4½". Complete with mounting brackets. All brand new units. Shpg. wt., 7 lbs.

54G004. SPECIAL PRICE.....\$4.95

HI-FI OUTPUT TRANSFORMERS

Save on these 50-watt output transformers — they're terrific values at the sensational low price of \$2.45! Match push-pull parallel or push-pull 6L6, 6V6, 807, and other tubes to 4, 8, 16 ohm voice coil; also 60 and 250 ohm line. Range: 30 to 50,000 cps. For use in high-powered PA amplifiers. 4000 ohms primary, P to P. Case, 4½ x 3½" dia. Shpg. wt., 7 lbs.

54G101. Special Price.....\$2.45

SMASHING TRANSFORMER VALUES

Power Transformer. Pri., 110 or 220 volts AC. Has two CT secondary: 140 volts at 50 ma for bias, and 2500 volts at 350 ma. Size, 6½ x 7½ x 8¾". Wt., 36 lbs.

54G104. SPECIAL PRICE.....\$8.95

Filter Choke. 6.5 hy @ 230 ma. 3000 volts insulation. Size, 5 x 7¼". Shpg. wt., 23 lbs.

54G102. SPECIAL PRICE.....\$2.95

Filter Choke. 4.2 hy @ 300 ma. 78 ohms. 2500 volts insulation. Size, 4½ x 3½". Wt., 9 lbs.

54G103. SPECIAL PRICE.....\$2.49

Driver Transformer. Matches PP 2A3 to most high power Class B modulator tubes. Secondary center tapped. Fully shielded with screw lug terminals. Inverted flange mountings. Size, 2½" wide, 4" long, 3½" high. Wt., 5 lbs.

54G111. SPECIAL PRICE.....\$2.25

Interstage Transformer. Matches PP triodes to PP 2A3 or similar. Has split pri. and sec. windings. Fully shielded. Lugs on bottom. Size, 4 x 3½" dia. Wt., 6 lbs.

54G112. SPECIAL PRICE.....\$1.25

**G. E. PYRANOL-FILLED
TRANSMITTING CAPACITORS**

No.	Mfd.	Volts	Size	Price
54G006	.2	600	4 x 2¾ x 1"	10 for \$3.50
54G007	.5	1000	3 x 1¾ x ¾"	10 for 3.25
54G002	.25	3000	1¼ x 2¾ x 3¼"	Each .59

Send for **NEWARK'S 160-PAGE CATALOG · No. 51**

The New Electronics Reference Book . . . Offering a Wide Selection of Electronics Equipment and Supplies for Amateurs and Industrial Users.

NEWARK ELECTRIC COMPANY

323 W. MADISON ST. · CHICAGO 6, ILLINOIS

▶ **FREE** ▶



To HI-FI ENGINEERS & HAMS

Diamond Needles.....\$10⁵⁰
PLUS POSTAGE

No doubt you have learned by now that the needle in your record player is not permanent. It is tipped with either sapphire or osmium metal which should be changed after about 20 hours of playing, in order to protect your valuable records.

This means that if you use your record player on an average of an hour a day these needles need replacing about every three weeks at a cost of between \$1.50 to \$3.50. Because of this frequent needle changing you have of course learned how to install a new one when required. Why not, then, retip your present replaceable needle with a genuine diamond, one that will give you at least 1000 hours of high fidelity, distortion-free record playing pleasure with the comforting assurance that your costly records will remain undamaged—particularly those long-playing micro groove records, so finely grooved and sensitive to a worn stylus?

Send us your replacement needle assembly now—today. Let us retip it with the highest quality genuine diamond stylus—exactly the same kind that we make for leading radio stations the country over.

Our diamond tips are unconditionally guaranteed and are made for LP or standard records. Send check or money order for \$10.50 plus 25c return postage with your needle assembly or complete cartridge if you cannot remove the replacement needle assembly (except Pickering non-replaceable type) to:

THE TRANSCRIBER COMPANY

Diamond Stylus Manufacturers

172-A Green Street, Boston 30, Mass.

our finest SPEED KEY

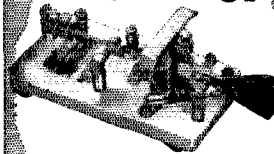

Complete pivot, contact tension and excursion adjustments; live

steel vibrator spring, vibrator damping wheel and carefully aligned 1/4" silver contacts assure perfect dots throughout speed range. Adjustable paddles for maximum operating comfort.

Heavy steel base and all machine parts beautifully chrome plated. Equipped with circuit closing switch; non-slip rubber feet. Weight 4 1/2 lbs.

Catalog No. 114-501
Amateur Net \$15.00



E. F. JOHNSON CO.
WASECA, MINNESOTA

to support our ARRL and local clubs. Traffic: W5MN 507, PTV 502, RTT 153, QDX 115, QFA 99, QEM 44, IZB 30.

NEW MEXICO—SCM, Robert W. Freyman, W5NXC—SEC: PLK. RM: NKG. PAM: BIW. PAM v.h.f.: FAG. The New Mexico c.w. net meets on 3705 kc. at 7 p.m. Monday through Friday. The phone net meets on 3838 kc. Sunday at 7:30 a.m. and on Tuesday and Thursday at 6 p.m. New officers of the Sandia Base Radio Club are DAH, pres.; CTG, vice-pres.; RVZ, secy. PLK has returned from an extensive trip eastward during which he had the chance to observe the N.Y.C. e.d. drill. Ben will be in Albuquerque until spring. IGO runs 200 watts on the 80-meter traffic nets with a TV set within two feet of the transmitter. Those who are QRT because of TVI, please note! OMR has been elected EC for the Los Alamos Area. The Albuquerque s.s.b. gang can be found almost any evening on the high end of 75 meters. QHB has 700 watts on s.s.b. NWH has a BC-610 on from Tucumcari. NUN also is active in the 75-meter phone net with 150 watts. QXO has 20 watts to a 6AG7 on 75 meters. TZB, ex-0UEB, now is active from Los Alamos with a new Viking. MYQ is active with 40-watt VFO all-band exciter on 7 Mc. PIZ has new 100-watt all-band VFO crystal controlled. QLY has a modulator. WNSTQB is a new Novice in Portales. Traffic: W5IGO 81, NKG 75, ZU 51, NXE 42, RMU 2.

CANADA

MARITIME DIVISION

MARITIME—SCM, A. M. Crowell, VE1DQ—SEC: FQ. EC: EK. RM: OM. FQ, our QSL Mgr., asks that you send in your large envelope for DX cards. DO NOT mail your OUTGOING cards to FQ for remailing. The QSL Bureau operates as a delivery service for the section in which it is located—providing you mail in your large envelope for YOUR cards. DO NOT mail your outgoing DX cards anywhere but to the country for which they are intended. PK is a new man in Campobello Island active on c.w. in the M.T.N. TN has moved to Selkirk. Man. HT is QNI M.T.N., T.R.N., E.A.N., V.T.N., and Q.U.E.N. TA built up a new 28-Mc. converter for mobile. VW rebuilt the rig with a view to reducing splatter. Angus operates ACU from the home QTH. We hear via the FRAC Bulletin that the N.B. fellows are thinking of going after the N.B. Highway Dept. for call-letter number plates for their cars. BM now is on from new QTH. GJ still is plugging 28 Mc. HB has been active from St. John. OL is back on, having returned from VE3-Land. LX now is A3. GU says the new all-band antenna is not so good. BI did an FB job of painting the F.D. masts. AAY is working with new 813 final. YW is active from U.N.B. residence. CM and ZK were quite active in the SS using the latter's rig. AAV reports new 10-meter converter. AM has a new QTH with a swell radio room. PF now is on the Lf. bands with c.w. The VO boys, headed by VO1T, furnished communications link during the Royal Embarkation at a time when heavy seas parted lines aboard M. V. Kipawo, from which the departure was being broadcast by C.B.C. Traffic: (Nov.) VE1YV 244, FQ 184, MK 184, OM 61, HT 42, EY 30, AAK 27, AL 10, XA 10, XH 9, GS 7, AAN 5. (Oct.) VE1TO 20, GS 9.

ONTARIO DIVISION

ONTARIO—SCM, G. Eric Farquhar, VE3IA—CJ, on a hunting trip, kept skeeds with TG, AYW, and DGZ. BV is the new call of DLO. Through the grape-vine we learn the annual dinners of the London and Ontario Phone Clubs were held recently. W.E. gets out with new vertical. Ferguson Lake, N.W.T., is the new location of DEP, who did a fine job as OO. The Ontario Section C.W. Traffic Net, with twenty stations reporting, turns out a nice traffic total. DGA is on with a new final. DGZ enjoyed his Florida vacation. Despite illness and transmitter trouble, ATR made a nice traffic total. Members of the Mohawk Club and HARC provided communications in November Red Cross Simulated Emergency Test. HO, BBW, CBJ, BFH, BFW, BOZ, KH, RM, AP, and 2SD, all members of the Ottawa Amateur Club, supplied communications link in motorcycle races. The Brockville gang staged a successful hamfest. The Ottawa annual banquet was termed the social event of the season. The Frontier Radio Assn., Windsor, appreciates the Red Cross Society's hospitality in making its building available for meetings. The Quinte Radio Club enjoyed a splendid talk on mobile communication given by BTQ. Monthly emergency tests are to be held by this emergency-conscious club. Congrats to NW upon his installation as a Kiwanis president. With many YLs and XYLs in attendance, the Kitchener-Waterloo Amateur Club's social evening was a happy occasion. VJ is newly-appointed ORS. AHA reports the 28,250-kc. Emergency Net is going great guns on Sunday evenings. BUR moved to the open spaces. MW is assembling mobile and fixed 2-meter gear. Traffic: (Nov.) VE3TX 118, IA 117, ATR 88, WY 87, IL 85, BUR 76, DGZ 66, BJV 47, AHA 44, GI 41, AYW 34, YJ 34, FQ 22, KM 18, TO 15, EAM 14, PH 14, SG 13, DIG 5, AVS 1. (Oct.) VE3IL 71, PH 36, AHA 32, BNQ 21. (Sept.) VE3IL 56.

(Continued on page 108)



Our 39th Year
QUALITY - PRICE
DEPENDABILITY

AC-DC VIBRATOR TRANSFORMERS
Operates from 6V Battery or 115V, 60 cycle line
P-3176—300V D.C. at 160 Ma 6.3 or 5V at 3 amps
6.3 V. at 4.5 amps.....\$8.82
P-3075—330V D.C. at 100 Ma 6.3 V at 4 amps..... 5.88
Both transformers are standard upright mounting.

Sarkes-Tarzian "Centre-Kooled" Power Rectifiers. Full Wave Bridge Rectifiers. Input 26V. Maximum Output 6-20V. DC.

D-17— 2A	5.44
D-18— 4A	7.30
D-19— 6A	7.84
D-20— 8A	9.46
D-21—12A	10.04
D-22—15A	17.05
D-23—22.5A	17.83

Write for bulletin on other stocks

Co-Ax Angles	Each	19¢
2 1/2 watt Argon bulbs	Each	19¢
10 for \$1.50		
1/25 watt Neons with leads	Each	8¢
Dubl Vee Antennas	Each	3.88
100 ft., 300 ohm lead.....	per 100 ft.	2.19
100 ft. stranded hook up wire	Each	79¢
100 ft. shielded wire	Each	99¢
Mallory #525 6 volt vibrators.....	Each	49¢
#14 enamel 100 ft. coil	Each	95¢
#12 enamel 100 ft. coil	Each	1.25
#10 enamel 100 ft. coil	Each	2.45

TV Conversion Kit including HVO-7 fly-back transformer (10"-24" tube). MDF-70 Deflection yoke (Cosine-Ferrite—10"-24" tube) and MWC-1 width-linearity control with AGC winding 13.63

DC to AC Converter. 6V DC-110V AC-60 cycles 40-45 watts. Will fit into cigar lighter of any car to supply power for portable radios, phonographs, electric shavers, fluorescent lites.... 9.95

VOLTAGE CONTROL PROBLEMS

POWERSTAT VARIABLE TRANSFORMERS are autotransformers of toroidal core design with a movable brush tap which rotates to deliver a continuously adjustable output voltage from a-c power lines. They are available as manually operated or motor-driven models. POWERSTATS feature excellent regulation, conservative ratings, standard mounting, smooth control and high efficiency. They are offered in 115, 230 and 460 volts; single and three phase; 50/60 and 400/800 cycle types in capacities of 405 VA 60 100 KVA.

5-WAY BINDING POSTS 5 methods of connection. Complete insulation, 30 amp. current capacity, 1000 v. working voltage. Captive head for convenience. Red or black color. 5 connections: 1. Permanent clamping. 2. Spade Lug. 3. Plug-in for Banana Plug. 4. Looping and Clamping. 5. Clip-Lead.



TYPE 1156



TYPE 116

Type	amps.	List Price
20	3.0	\$ 12.50
116	7.5	23.00
116G	7.5	18.00
1126	15.0	46.00
1156	45.0	118.00
1256	28.0	118.00

Binding Posts
DF30BC (Black)40
DF30RC (Red)40



TYPE 20



5-WAY BINDING POST

ISOLATION TRANSFORMER

Primary 115V 60 cycle
Secondary 105-115-125 Volts
at 350 Watts
Static shield. Equip. with primary cord & plug & secondary receptacle \$26.46
Perfect line stabilizer for T.V.

AMPLIFIER FOUNDATION CHASSIS

With 6" High Louvred Cover

5x10x3	\$2.48
6x14x3	2.75
10x12x3	3.45
10x17x3	4.13

STEEL CASES

Black Crackle Finish

4x4x2	\$.70
4x5x380
6x6x6	1.10
12x7x6	2.13
15x9x7	2.88

FT 243 XTALS

Brand New In The Following Frequencies

3245 Kc	
3655 Kc	Each
4110 Kc	\$.48
4780 Kc	
5235 Kc	

PLATE TRANSFORMERS

For Small Transmitters. DC Voltage Ratings are Approx. Values Obtained at Output of a 2 Section Choke Input Filter Using Mercury Vapor Rectifier Tubes. Pri. is for 115 V. 60 cy.

Type No.	Sec. Rms. Volts	Sec. DC Volts	DC Sec. M.A.	Dimensions			Price
				H.	W	D.	
P-3157	{ 660-660 } { 550-550 }	{ 500 } { 400 }	250	4 3/8	3 13/16	4 3/8	\$8.08
P-3158	{ 1080-1080 } { 500-500 }	{ 1000 } { 400 }	125 150	4 3/8	3 13/16	5	10.00
P-3159	{ 900-900 } { 800-800 }	{ 750 } { 600 }	225	4 3/8	3 13/16	5 1/2	9.70
P-3167	{ 1450-1450 } { 1175-1175 }	{ 1200 } { 1000 }	300	5 3/8	6 1/2	4	24.12
P-3168	{ 2100-2100 } { 1800-1800 }	{ 1750 } { 1500 }	300	5 3/8	6 1/2	4 1/2	30.58
P-4062	{ 2900-2900 } { 2385-2385 }	{ 2500 } { 2000 }	300	8 1/2	6 1/2	5 3/8	47.04

POLYSTYRENE ROD AND TUBING

ROD 12" LENGTHS			
O.D.	Price	O.D.	Price
1/8	\$.03	3/4	\$.80
3/16	.06	7/8	1.15
1/4	.10	1	1.55
5/16	.16	1 1/4	2.30
3/8	.21	1 1/2	3.30
1/2	.40	1 3/4	4.50
5/8	.57	2	5.90

TUBING 12" LENGTHS

O.D.	I.D.	WALL	PRICE
1/4	1/8	.062	\$.07
5/16	3/16	.062	.10
3/8	1/4	.062	.13
1/2	3/8	.062	.18
5/8	1/2	.062	.23
3/4	5/8	.062	.29
1	7/8	.062	.38
1 1/2	1 1/4	.125	1.13
2	1 3/4	.125	1.50

Both Rod and Tubing also available in 48" lengths to order.

If not rated 25% with order, balance C. O. D. All prices F. O. B. our warehouse New York. No order under \$2.00
We ship to any part of the globe.

LEEDS RADIO CO.

75 Vesey Street Dept. QS 2
COrtlandt 7-3440 New York City 7

FILAMENT TRANSFORMERS

Primary 115V., 60 cycles

P-2959—12.6V C.T. at 2 amp 2500V. Insulation.....	\$2.64
P-2962—25.2V C.T. at 1 amp 2500V. Insulation.....	2.64
P-2963—12.6V at 7 amp or 25.2V at 3.5 amp 2500V. Insulation.....	5.88
P-3041—5V C.T. at 3 amp and 6.3V CT at 3.6 amp 2500V. Insulation.....	4.06
P-3146—10V CT at 10 amp 3000V. Insulation.....	5.88

PERFORMANCE Not Size IS WHAT COUNTS

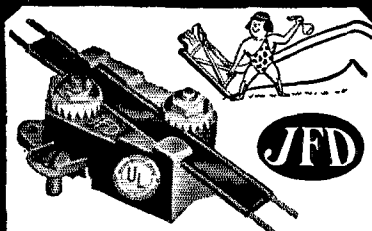

"LITTLE GIANT" LIGHTNING ARRESTER

PROTECTS
Against Lightning Hazards

No. AT 105

For ribbon-type and oval
jumbo twin lead.

\$1.25
LIST

ONLY JFD Lightning Arresters offer you these
exclusive patented features...

1. Strain-relief Retaining Lip prevents pulling or straining of lead against contact points.
2. You actually see positive contact made with lead-in wire.
3. No wire stripping or cutting.

Write for Form No. 84 showing the damage
lightning can do to a Television Installation.



MANUFACTURING CO., Inc.
6159L 16th AVENUE, BROOKLYN 4, N. Y.
FIRST in Television Antennas and Accessories



Founded in 1909
**RADIO TELEPHONY
RADIO TELEGRAPHY
RADAR & LORAN**

Courses ranging in length from 7 to 12 months. Dormitory room and board on campus for \$43.00 a month. The college owns KFAC, 5 KW broadcast station with studios located on campus. New students accepted monthly. If interested in radio training necessary to pass F.C.C. examinations for first-class telephone and second-class telegraph licenses, write for details.

PORT ARTHUR COLLEGE PORT ARTHUR
TEXAS
Approved for G. I. training

QUEBEC DIVISION

QUEBEC—SCM, Gordon A. Lynn, VE2GL—AO sends a nice report of doings observed while on his travels throughout the Province. AEN suffered a motor accident and will be laid up for two or three months. MB was a visitor to Montreal recently. AO lunched with LZ, who is quite active on 75 meters. RO, a sea captain, is back on 75 meters after a summer away. FM has changed QTH to Cap des Rosiers and will be back on the air shortly. ZV is very active on 75-meter 'phone and 40-meter c.w. from his new QTH in Quebec City. AJ5 has changed QTH to Levis and is very busy on 75-meter 'phone. XP gave a very interesting talk on audio at the November meeting of MARC. AGG is building the 813 rig described in July 1951 QST after having seen the original during his vacation at WIFTX. LQ helps keep PQN active as well as reporting into SSN and skeds WILM. JM is on 75-meter 'phone from Baie Comeau. AGA, at Valleyfield, also is on 75-meter 'phone. NW is back on 75-meter 'phone from Rapide Blanc with 150 watts into 1/2-wave center-fed antenna with 200-ft. feeders. AMI has 19 set on 75-meter 'phone from new QTH in Montreal. CD is active on PQN, NTS, and QEN and handles all traffic offering. SD holds up the Hull end of PQN. TA continues to sparkplug the QEN and is handling considerable traffic with the Pacific on 7 Mc, maintaining skeds with KGB stations. XR has changed QTH to Dorval and is looking for a spot to hang his skywire. Traffic: VE2CD 47, GL 42, SD 40, LO 29, AMB 28, AO 16, AGG 12.

VANALTA DIVISION

ALBERTA—SCM, Sydney T. Jones, VE6MJ—HM reports a very interesting trip to eastern Canada and the United States. IW is holding the fort for GK while he enjoys a visit to Portland. OC visited the big city and reported personally to the SCM on emergency activities in his district. LQ now has the necessary parts for a frequency standard and should give HM a good run in the next Frequency Measuring Test. NA operates portable from transmitter site. JP is building logarithmic compressor. EA is QRL rebuilding the rig for installation in new car. MJ plans on rebuilding the frequency meter using HRO dial for greater accuracy. MB seems to have resumed his nightly chat with HM. Don't forget, gang, to report your activities to your SCM for inclusion in this column. Civil defense plans call for organization on our part. Let's be ready. Register now with your local Emergency Coördinator and take an active part in c.d. affairs. PP has returned from a very successful trip to Europe, where he visited RSGB headquarters. VK plans on returning to the air waves very shortly. VS has been QRT for some time owing to the pressure of business. Traffic: VE6OD 86, MJ 21, YM 18.

BRITISH COLUMBIA—SCM, Wilf Moorhouse, VE7US—The BCARA had an "Open Forum" meeting which any interested ham was invited to attend. This was a chance for rank and file hams to see how the BCARA functions. Following the formal affairs there also was an "Open Forum" discussion on AREC matters with the SEC, etc., present. The AREC Net now is B.C.-wide with an NCS for the SE, SW, and Vancouver Island groups all combined into a full network. No ragchews, but smart check-ins, are invited. After all, an AREC net is for emergency uses and not for rags. A certain amount of so-called "regimentation" cannot be helped if AREC is to function. ASA has skeds on c.w. with SF. SW is heard again on the 5-P.M. net. WN stations give considerable QRM on the AREC frequency of 3755 kc. AA and NH moved to Chilliwack. Contact is being maintained with Vancouver and Duncan by TT on 144 Mc. ALL still is hunting for a signal on his 2-meter converter. Secret of the month! How does he rotate his 2-meter beam? Cowichan Valley is hoping to organize a club. DH and LP/7 still are active in Nanaimo. A new ham for the Kootenays is ACH. Traffic: VE7QC 59, AOB 8.

YUKON—Following is a report of VE8 activities written up by John W. Smith, VE8RY. BD is a new call heard locally. Congratulations, Bill, on getting your call and getting on the air. BK has received WAC certificate. CR is busy building a new rig with 813 final. KJ has obtained an AR77 and soon should be on the bands. CZ and AO are heard on 75-meter 'phone along with BN. RY and SW were the only two heard in the DX Contest. WJ, in Ft. Resolution, N.W.T., was worked on 7 Mc. PO, formerly VE6FA and now at Ft. Simpson, N.W.T., also is on 7 Mc. FI and SA also have been heard on the bands. WN has left for a new QTH in Quebec. Don't forget, gang, to pass along all the dope on your station activities either to CO or RY for inclusion in this column.

PRAIRIE DIVISION

MANITOBA—SCM, A. W. Morley, VE4AM—New appointments include ER as OBS and GV as OBS and OPS. Ex-BM now is signing TASF and ex-BN now is 4ET. GV has new all-band VFO-813 on both 'phone and c.w. CH is heard mobile on 75 meters. EH returned from a visit to GM-Land. PA finally put the rig in a rack. BJ is
(Continued on page 110)

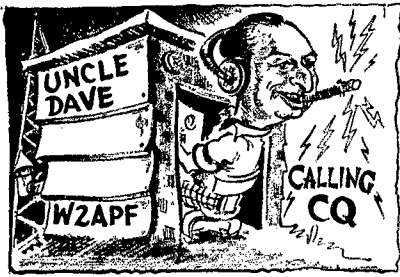

BARGAIN SPECIALS

T-45 lip microphones. Ea..... \$6.79
 J-38 transmitting keys. Ea..... .79
 Clarostat M60Z Volume Controls, 1/2 meg audio tapes. Ea..... .20
 The following Bud Radio items are either in shop-worn boxes, no boxes or discontinued items—ALL NEW.

BC-1633 variable condenser 100 mmfd per section, air gap .200 6300V..... \$14.50
 BC-1611 variable condenser 100 mmfd per section, air gap .200 7000V..... 6.38
 FA-781 fixed air condenser 100 mmfd air gap .144..... 3.00
 FA-545 fixed air condenser 75 mmfd air gap .238..... 4.00
 FA-783 fixed air condenser 150 mmfd air gap .078..... 3.00
 FA-785 fixed air condenser 100 mmfd air gap .100..... 3.00
 FA-786 fixed air condenser 100 mmfd air gap .238..... 4.45
 FA-5144 fixed air condenser 75 mmfd air gap .144..... 3.00
 FA-787 fixed air condenser 150 mmfd air gap .100..... 4.20
 FA-782 fixed air condenser 100 mmfd air gap .078..... 3.00
 FA-778 fixed air condenser 25 mmfd air gap .238..... 4.25
 FA-780 fixed air condenser 50 mmfd air gap .144..... 3.00
 MCL10 10 meter 1 kilowatt air wound coil 4.80
 MLS10 10 meter 1 kilowatt air wound coil 3.70
 AM-1340 adj. link coupling base unit for MLS series coils..... 4.63
 VCL10 10 meter 500 Watt air wound coil 2.00
 VLS10 10 meter 500 Watt air wound coil 1.85
 VLS15 15 meter 500 Watt air wound coil 2.08
 MLS20 1 kilowatt 20 meter air wound coil 4.45
 RCL40 fixed centre link 40 meter 150 Watt air wound coil..... 2.40
 MLA1 adjustable link ant. coil, 1 kilowatt for 80-40 meters..... 5.50
 ONS1 10 to 80 meter oscillator and buffer band switch assembly..... 3.58
 RLS10 150 Watt 10 meter coil air wound 1.65
 RCL10 150 Watt 10 meter coil air wound 1.67
 VLS20 500 Watt 20 meter coil air wound 4.58

NEW DEMONSTRATORS—The following receivers are new but have been in our shack as demonstrators:

1 S-40B..... \$ 89.95
 1 SX-71..... 179.50
 1 S-77..... 89.95
 1 SW-54..... 44.50
 1 Lyco No. 600..... 130.00
 1 Johnson Viking wired and tested less tubes..... 244.50
 1 S-72..... 107.95

Following test equipment is new, display samples, some slightly shopworn:

	Was	Now
1 Precision 847-P Volt ohm milliammeter wood portable case, 5000 and 1000 ohms per volts	\$ 59.75	\$45.00
1 Precision 847 Bakelite case 5000 and 1000 ohms per volt	55.00	42.00
1 Radio City Products 488-A VOM 20000 and 1000 ohms per volt in wood portable case,	59.50	40.00
1 Hickok 630 Voltage calibrator—used for calibrating voltages; on a scope.....	87.50	74.50
2 GE YMW-1 VOM in metal cabinet 20000 ohm per volt. Ea...	69.50	25.00

Calling All Hams!

Johnson Viking Kit..... \$209.50
 Johnson Viking, Wired and Tested, less tubes, crystal or mike..... 259.50
 Gonset Convertors, Model 3002 3-30..... 44.75
 Gonset Convertors, Model 3005 Tri-Band.... 47.60
 Gonset Convertors, Model 2000 6 meter..... 44.75
 Gonset Convertors, Model 3000 10-11 meter 44.75
 Gonset Convertors, Model 3000 20 meter.... 44.75
 Gonset Convertors, Model 3000 75 meter.... 44.75
 Gonset, Model 3001 noise clipper..... 9.25
 Gonset, Model 3006 steering post bracket.... 3.90

LYSCO MOBILE TRANSMASTERS

\$29.95

\$35.55

less tubes

with tubes

LESS TUBES

WITH TUBES

Model	Band	Tubes	Model
A129	10 meter	3-6AQ5	A129T
B129	10 meter	3-6V6GT	B129T
A114	20 meter	3-6AQ5	A114T
B114	20 meter	3-6V6GT	B114T
A175	75 meter	3-6AQ5	A175T
B175	75 meter	3-6V6GT	B175T
A140	160 meter	3-6AQ5	A140T
B140	160 meter	3-6V6GT	B140T

Lyso Model D11 grid dip master \$39.95

RECEIVERS

National NC-183 with speaker..... \$295.00
 National NC-125 with speaker..... 160.50
 National HFS with speaker and power supply 164.43
 Hallicrafters S-38B..... 49.50
 Hallicrafters SX-71 with speaker..... 219.45
 Hallicrafters S-76 with speaker..... 189.45
 Hallicrafters S-40B..... 99.95
 Hallicrafters S-53A..... 79.95
 Hallicrafters SX-62 with speaker..... 309.45
 Collins 75A2 with speaker..... 440.00
 Hammarlund HQ-129-X with speaker..... 214.00
 RME-50 with speaker..... 197.50

FORT ORANGE

Radio Distributing Co. Inc.

904 BROADWAY, ALBANY 4, N. Y., U. S. A.

AMATEUR HEADQUARTERS

Long Distance Phone: ALBANY 5-1594 . . . Cable Address: "UNCLE DAVE"

ELECTRONIC ENGINEERS

Permanent expansion program offers fine career opportunities with one of the leading companies in the industry.

Tung-Sol Electric Inc., Radio and Television tube manufacturers, is now interviewing qualified engineers for immediate job openings at excellent salaries with fine opportunities for advancement.

Experienced Engineers — If you have had experience in any phase of radio tube manufacturing including design, development, production, application or special problems involving glass technology, shrinkage control, etc., we would like to hear from you.

Trainees — We also have a limited number of openings in our training program for those men who hold a degree in electronics but have no experience in this field.

Write or apply in person to
PERSONNEL DIRECTOR

TUNG-SOL ELECTRIC INC.

200 Bloomfield Ave., Bloomfield, N. J.

MORE SIGNALS PER DOLLAR
From Money Invested in an Antenna

Self Supporting

STEEL TOWERS

For Rotary Beams, FM, TV

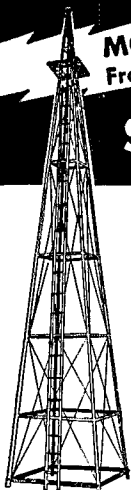

Width at
Base Equal
to 1/5 Height

Vesto Towers are available in a wide range of sizes to meet requirements of amateurs and commercial users alike. Note the low prices for these quality lifetime towers: 22'-\$94.75, 28'-\$115.75, 33'-\$135.75, 39'-\$157.75, 44'-\$178.75, 50'-

ATTRACTIVE—NO GUY WIRES!

- 4-Post Construction for Greater Strength!
- Galvanized Steel—Will Last A Lifetime!
- SAFE—Ladder to Top Platform
- COMPLETE—Ready to Assemble
- Easy to Erect or Move
- Withstands Heaviest Winds

EASY MONTHLY PAYMENTS
Up to 12 Months to pay

CIVIL DEFENSE DIRECTORS:

A Vesto Tower provides an ideal support for your air raid warning siren. Write for full details.

\$217.75, 61'-\$279.75, 100'-\$1060.00. Towers are shipped to your home knocked down, FOB Kansas City, Mo. 4th class freight. Prices subject to change . . . so order now! Send check or money order . . . or write for free information.

WRITE TODAY
FOR COMPLETE
FREE INFORMATION
AND PHOTOGRAPHS

VESTO CO., Inc.
20th and Clay
North Kansas City, Mo.

heard on 75-meter 'phone. DQ spent some time in the hospital in Winnipeg but now is recovered. Before going back north Harry visited friends in Winnipeg, Brandon, and Minnedosa. PC is recovering from a heart seizure, FG is new on 3.5- and 7-Mc. c.w. MW, of Brandon, now is 3CMW at Ottawa. A celebration at HT's honoring his father, who is 80 years young, was topped off with a QSO with BD who had a similar celebration going on honoring his grandfather, who was celebrating his 100th birthday. It was a real QSO. In another section of this issue you will see an SCM election notice. Think it over, fellows, and be prepared to act accordingly as yours truly will not be in the running this time because of pressure of other things. Traffic: (Nov.) VE4AM 89, HG 71, AL 27, JO 20, DQ 16, AT 14, QD 14, HT 11, CE 10, CI 7, HV 7, HS 6, LF 5, BD 3, GV 3. (Oct.) VE4AM 46.

SASKATCHEWAN — SCM, Harold R. Horn, VE5HR — The past year has been one of progress for the section. Two membership drives for ARRL and the newly-formed SARRL have been gratifying. GI will be pleased to accept memberships for either anytime. Help ARRL and SARRL so they can help you. We have just finished our demonstration for civil defense and although conditions were much against us we had a successful trial showing that amateur radio operators have a place in c.d. communications. Mr. Probe, Civil Defense Director, Saskatchewan, was well pleased with the efforts put forth from Fort Qu'Appelle and I also wish to thank those participating for their help and cooperation, and also GI for setting his equipment up on location at Fort Qu'Appelle. Thanks are extended to 4GU for his valuable contribution explaining propagation of frequencies to the school. KO is back on 75 meters with a new Commander. BH now is 4AL, JC is on 75-meter 'phone with an FB signal. RV is EC for the Cndworth Area and would like to hear from amateurs in that district. FY now is Squadron Controller, AFARS Saskatchewan Squadron. DS, DD, JW, and TD are new AFARS stations. My thanks to all for the cooperation received during the past year. Traffic: VE5TE 56, YF 47, HR 12, PJ 11.

COUNTY
RADIO CLUB



Old Boob is gone. Let's bow our heads.

He ignored this one essential.

He loved to run his kilowatt

Above true ground potential.

W-Strays

"Life's Little Reverses" department:

When Bob Uehlein of Rutherford, N. J., was studying for his ham ticket his code instructor was Jim Burns, W2NWT. And when Bob finally got his own license which call did FCC issue him? — why W2TWN!

W1TV and W1TVI both belong to the Malden (Mass.) Emergency Corps and the Malden Amateur Radio Association. They're good friends! — W1HKG

When the membership of the Radio Association of Western New York received word that member Bert Jones, W2CUU, had incapacitated himself by falling from a ladder while painting his house, they decided there was just one thing to do. Next Sunday twenty hams reported to the Jones' place and each carried a brush. Between the hours of 9 and 4 they painted the last of the house — all white, no trim.



Scotty Says

Hi. The Lysco Novice CW Transmitter is a buy! 40 watts input, built-in antenna coupler, AC power supply. Wired and tested, with tubes: \$109.95. Send for more details. Having trouble with QRM? Try Hallicrafters S-76 with its 50 Kc IF amplifier. I've tried it and it's swell! And don't overlook the Hi-Fi system for hams... offered for a limited time only at Bargain Price! Send your orders to me. CUL 73.

Duncan Scott, W2LAL

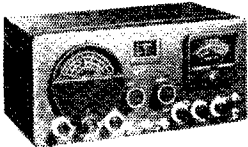

**HALLICRAFTERS
S-76
DOUBLE CONVERSION
RECEIVER
\$169.50**

ALL HALLICRAFTERS RECEIVERS IN STOCK

S-38B.....Net \$49.50 SX-62.....Net \$289.50
S-40B....Net \$99.95 SX-71.....Net \$199.50

R. L. DRAKE TVI FILTERS

HI-PASS RECEIVER TYPES

TV-300-50HP, 300 ohm
P12525.....Net \$3.50
TV-72-50HP, 72 ohm
P12600.....Net \$3.50

LO-PASS TRANSMITTER TYPES

TV-52-40LP, 52 ohm
P12526.....Net \$12.69
TV-52-20LP, 52 ohm
P12601.....Net \$12.69
TV-300LP, 300 ohm
P12602.....Net \$12.69

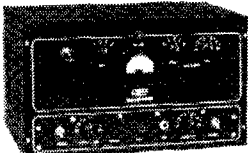

NEW LYSCO

Model 650
NOVICE XMITTER
40 Watt-Xtal Controlled
\$109.95

Model 600, TVI suppresses
Net \$143.95
Model 600S, With Clamp
Modulator Net \$189.95
Model 50, Ant. Coupler \$14.50
Model 500, Standard Net \$131.95
Model 500S, With Clamp
Modulator Net \$179.95



TEST INSTRUMENTS AND KITS



526



221

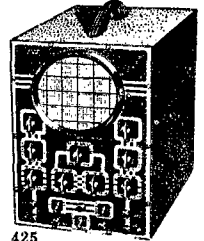

425

Eico Model 526K AC-DC Multimeter Kit..... Net \$13.90
Model 526, same but factory wired..... Net 16.90
Eico Model 221K Vacuum Tube Voltmeter Kit... Net 25.95
Model 221, same but factory wired..... Net 49.95
Eico Model 425K 5" Oscilloscope..... Net 44.95
Model 425, same but factory wired..... Net 79.95

All Other Eico Models In Stock

National



MULTI-BAND

TANK ASSEMBLIES



MB-40L



MB-150

Type MB-40L, Low power version of MB-150 Net \$12.90
Type MB-150, Tunes from 80 thru 10 meters... Net \$21.56



EXPERIMENTERS' MOTOR

Compact Induction Type AC Motor. Operates from 20-25 volts, 60 cycles AC. Motor speed 2400 RPM, with gear train driving 1/4" shaft at 24 RPM. Clutch dis-

engages motor from gear train when power removed. For intermittent operation with thermal cut-out. 2" x 1 3/4" x 3" overall, excluding 1/4" OD shaft extending 2 7/8". Clutch operates only when shaft is in horizontal plane. Four 9/32" mounting studs extend 9/16" from case. Shpg. wt. 2 lbs.

22723... SPECIAL

\$175

FREE

If you don't have our 1952 catalog yet, write today to Dept. VB

Remember, we're pioneers in Hi-Fi. For the latest dope get our new Hi-Fi Guide. It's yours on request. We are Authorized Distributors of all the foremost makes, including Magnecorder, McIntosh, Jim Lansing, Partridge, and all Standard Radio, TV, Electronic and Sound Equip't.



Special Hi-Fi Sale

Special for Hams! A Real High Fidelity "Package" at a bargain Price! For a Limited Time... Sale Ends March 1

HI-FI SYSTEM 1A

ESPEY 511-B AM-FM CHASSIS
WEBSTER 101-270 CHANGER
with GE triple-Play Cart.
UNIVERSITY 6200 SPEAKER

COMPLETE **149.50** with Plugs, Cables, etc.

Lafayette Radio



Radio Wire Television Inc.

NEW YORK 13, N. Y.
100 SIXTH AVENUE
REctor 2-8600

BOSTON 10, MASS.
110 FEDERAL STREET
HUBbard 2-7850

NEWARK 2, N. J.
24 CENTRAL AVENUE
MARket 2-1661

BRONX 58, N. Y.
542 E. FORDHAM RD.
FORDham 7-8813

LYSCO

MODEL 650 TRANSMASTER

FOR NOVICE or CW HAM

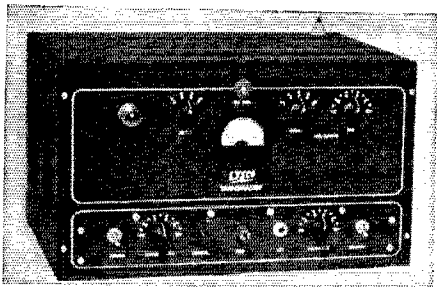

In usual LySCO tradition this New Model 650 Transmaster for the Novice or CW Ham is a sturdily constructed unit. It features: Complete break-in operation ★ Built-in antenna coupler with neon lamp resonance indicator for single wire operation on all bands, also 72 ohm coaxial output ★ Plug-in coils ★ Multimeter reads buffer grid or cathode and power amplifier grid or plate currents ★ Provisions for Model 401 Clamp Tube Modulator.

Tubes: 6V6-GT Crystal controlled oscillator — 6V6-GT Buffer-Multiplier — 6L6C Amplifier — 6V6-GT Dissipation Limiter — 5U4-G Rectifier.

Complete Wired and Tested **AMATEUR NET \$109.95**

See your Dealer — write for other LySCO Rigs

LYSCO Mfg. Co., Inc. • Hoboken, N. J.

THE RIGHT WAY...



OPEN WIRE TRANSMISSION LINE

- 1/10 THE LOSS
- LONGER LIFE
- EXCELLENT FOR FOLDED DIPOLE
- LOWEST PRICE

Type BC Fretline is made of No. 18 copperweld wire with no covering and has a higher tensile strength; otherwise it is the same as type A.

The surge impedance at 200 megacycles is 425 ohms. At 60 megacycles it is 495 ohms. The DC resistance is 5.163 ohms per 1000 feet at 25°C.

Type BC Fretline is made of No. 18 copperweld wire with no covering and has a higher tensile strength; otherwise it is the same as type A.

ASK YOUR DEALER OR WRITE Dept. Q-10

FRETCO

TELEVISION CO., INC.
1041 Forbes Street
Pittsburgh 19, Penna.

Painless Shielding

(Continued from page 16)

leads is down to the negligible point, even if the TV signal is very weak, the power coming from the output terminal naturally is not entirely free from harmonics. However, it is low enough so that in regions where the TV signal strength is enough to give a picture free from set noise, a coax-coupled antenna tuner should give enough suppression to prevent interference in channels harmonically related to the transmitting frequency. If the TV picture is very "snowy" a low-pass filter in the coax lead to the antenna coupler is likely to be necessary when the transmitting and TV receiving installations are close together.

Radio Control System

(Continued from page 19)

of signal? As shown, the control will remain in its last position when the signal is lost. This is not too serious for model boat operation, but it can be disastrous for aeroplanes. This situation can be alleviated by adding two bias cells to the discriminator, to provide a centering signal. This will decrease the sensitivity somewhat but not seriously. Depending upon the quench frequency of the detector, continued operation of the receiver will provide a signal that will bring the equipment close to center with no signal.

The speed of response with this system is remarkably good. It depends, of course, on the mechanical linkage between the motor and K_9 in the receiver, but aeroplane surfaces can be made to respond from one extreme to the other in about one second. In a low-friction system, it is possible for inertia to cause the motor to overshoot and even develop into an oscillator, but the addition of a slight amount of friction will overcome this.

Battery-Operated Portable

(Continued from page 28)

driver adjustments. The knobs at the lower right of the front-panel view are the doubler plate and final plate tuning adjustments. Some retuning of all circuits is usually required only when changing frequency by a considerable amount.

The writer has been amazed at the way this little rig performs. With the quarter-wave rod antenna a radius of some 10 miles can be covered from the home location, indoors on the second floor, while a simple folded dipole just above the roof produces a weak, though readable, signal at W3TF, Temple, Pa., some 50 miles distant. From the fifth floor of an office building in downtown Philadelphia, "Pixie," sitting by an open window and looking up into a stack of skyscrapers, provides excellent communication with W2FXFT, Merchantville, N. J., several miles across the river. With a small portable beam antenna mounted on a cottage at Saunderstown, R. I., last summer, several Cape Cod stations were worked at distances up to 50 miles.

THE RADIO AMATEUR'S HANDBOOK



1952

EDITION

AVAILABLE NOW

PRICE \$3.00 U.S.A. Proper

\$3.50 U.S. Possessions and Canada. \$4.00 Elsewhere

Buckram Bound Edition, \$5.00 everywhere

All Prices Postpaid

PUBLISHED BY THE AMERICAN RADIO RELAY LEAGUE,
INCORPORATED, WEST HARTFORD, CONNECTICUT

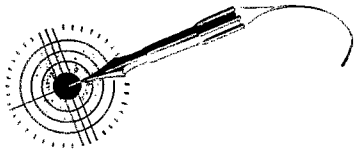

MISSILE TECHNICIANS

for FIELD TEST POSITIONS
in New Mexico "The Land of Enchantment"

★ ★ ★ ★

ON

GUIDANCE FLIGHT TESTING
SERVOMECHANISM
TELEMETERING TEST EQUIPMENT
AIRBORNE ELECTRONICS EQUIPMENT

★

IDEAL WORKING CONDITIONS

WRITE: FIELD TEST DIRECTOR
P. O. BOX 391
HOLLOMAN AIR FORCE BASE
NEW MEXICO

BELL *Aircraft* CORPORATION

Wiring a Transmitter

(Continued from page 32)

twine can be used for lacing the wires, or you can get fancy and acquire lacing twine from a friendly telephone man or acquaintance who works in a radio factory. Regardless of what you use for the job, you will find that lacing the wires results in a considerable improvement in the appearance. We won't guarantee that the piece of gear will work any better, but you won't object to showing the wiring to your severest friends and best critics.

If you have come along with us this far, you have probably already anticipated our conclusion, but here it is, anyway. The key to good wiring is patience, a little forethought, and a clean hot iron.

Happenings of the Month

(Continued from page 86)

modification for change of address from a permanent location to a temporary location should immediately write FCC in Washington withdrawing the application; and that amateurs who have applied for modification for change of address from one temporary location to another temporary location should immediately apply for another modification back to a permanent address, with a note requesting cancellation of the earlier modification request; and that amateurs holding license at a temporary location should, when they next move, apply for modification to change address to their permanent residence.

Changes in the amateur rules are as follows: Section 12.44 (b) is amended so that the first few words read:

A holder of a Conditional, Technician or Novice Class . . .

Section 12.45 (b) amended to read:

Whenever the holder of a Conditional Class amateur operator license is required by the Commission to restrict the operation of his amateur station in accordance with the provisions of Sections 12.152, 12.153 and 12.154 of this part, the necessity for those restrictions shall be considered sufficient grounds to require the holder of the Conditional Class license to appear for the General Class examination.

Section 12.91 (a) is amended by striking the last two sentences (beginning "An amateur station operated . . .") and replacing them with:

Additional advance written notice shall also be given in accordance with the foregoing whenever such operation away from the fixed station location designated in the station license exceeds one month, and for each additional month of such operation.

Section 12.93 (b) is amended to read:

The licensee of an amateur station who changes residence temporarily but retains a permanent residence associated with the fixed station location designated in the station license and moves his amateur station to a temporary location associated with his temporary residence, or the licensee-trustee for an amateur radio society which changes the normal location of its amateur station to a different and temporary location may use the station at such temporary location under the following conditions:

(1) Advance notice in writing shall be given by the amateur station licensee or licensee-trustee to the Commission in Washington, D. C., and, for each month of such operation, to the Engineer in Charge of the radio inspection district

(Continued on page 116)

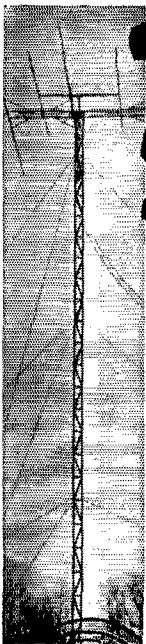

TOPS IN Masts AND Towers

- Amateur radio types
- TV-FM antenna masts
- Vertical radiators
- Micro-wave towers, etc.

From inexpensive TV antenna masts, to 400' guyed vertical radiators for commercial use, the makers of famous Trylon products offer a complete line — including special, built-to-order jobs. Write for details of any type.

Trylon Towers are made only by
WIND TURBINE CO.
West Chester, Pa.



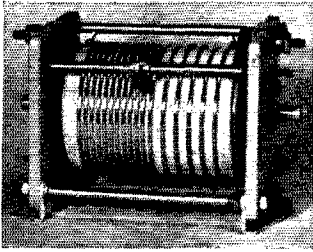

VARIABLE INDUCTANCE FOR TRANSMITTING APPLICATIONS

The JOHNSON 229-201 rotary inductor provides a new concept of flexibility in 100 watt transmitters. It may be used in a single ended amplifier to cover all amateur bands from 80 thru 10 meters. Used in antenna loading or phasing circuits, the 229-201 will furnish a relatively large value of continuously variable inductance.

229-201

Winding is #14 tinned copper wire and has variable pitch to insure smooth tuning at low inductance values. Maximum inductance, 10 microhenries. May be applied with unused turns shorted or open as desired. Positive rolling contact maintained by beryllium copper tension springs. The form and end plates are Steatite. Overall size; width 2½", length 4½", height 3".

229-201 - Amateur Net \$8.85

An amplifier such as this, with pi-network output tuning and utilizing a JOHNSON 229-201 inductor, can be expected to couple into unbalanced loads from 50 to several hundred ohms throughout the range 3.5 to 30 mcs. Overall plate circuit efficiency on the order of 70% may be expected.

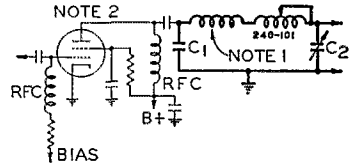

Note 1: Auxiliary inductor consisting of 7½ turns #14 wire 1 inch diameter self supporting; for improved 10 meter performance.

Note 2: 4D32, 4-65A, 807 parallel 807, 2E26 etc.

Write for data sheet 710 containing inductance curve and typical operating values for the 229-201, one of many JOHNSON inductors supplied for commercial applications.

E. F. JOHNSON COMPANY

WASECA,
MINNESOTA

Announcing

THE arrival of complete stocks of Hallicrafters, Johnson, Simpson, ICA, Bud, Lysco, Gonset, Master Mobile, National Co., Par-Metal, Stancor, Thordarson, Sangamo — — components and equipment — — as well as most every other quality amateur line.

Write Us Your Requirements

THE OVERBROOK COMPANY

Overbrook 81

Massachusetts

Signal

WIRELESS and TELEGRAPH INSTRUMENTS

SET THE STANDARD

For Speed Performance Service

• write for FREE catalog today!

Signal

ELECTRIC MANUFACTURING CO.
MENOMINEE, MICHIGAN

©1950, Signal Elec Mfg Co.

ATTENTION MOBILE HAMS

Complete mobile package — nothing else to buy. Outstanding mobile signals use motorola equipment — backed by years of communication equipment experience — World's largest producer of 2-way mobile equipment.

A mobile transmitter with a double feature FM or AM at flip of the switch, the MOTOROLA FMT-30-DMS (27-30 MC.). **\$130.00**

P-7253 spring base rear — mount antenna **\$24.75**

New Gon-set Tri-Band Spread Converter... **\$47.60**

MOTOROLA P-69-13 or 18-ARS receiver with special noise limiter for use with any converter having 1440-3000 KC..... **\$60.00**

3-30 famous Gon-set converter complete to connect to the P-69-13 or 18-ARS receiver. **\$44.75**

P-327-E Fire wall loud speaker.... **\$5.00**

The above comes complete with all necessary accessories and mounting hardware. Order direct or through the Motorola National Service Organization member in your area.

NOTE: This Receiver and Transmitter is equipment which has been returned from the field, modified and rebuilt for Amateur Service.

For further information write to:

MOTOROLA INC.

Amateur Sales Dept. QST — February
1327 W. Washington Blvd. Chicago 7, Illinois
Attention: Harry Harrison, W9LXX, Tel. Taylor 9-2200 Ext. 161

ASTATIC ACCOMPLISHES NEW HIGH SENSITIVITY IN A SINGLE BUTTON CARBON HAND MICROPHONE

THE MODEL 10M5



HERE is the resistance to jolts and abuse, to high temperatures and humidity, of a carbon mike, PLUS HIGHER SENSITIVITY. This

and other refinements make the new Astatic 10M5 the ideal unit for a host of applications. Write today for complete details.

THE Astatic CORPORATION
CONNEAUT, OHIO
BY CANADA: CANADIAN ASTATIC LTD., TORONTO, ONTARIO

EXPORT DEPARTMENT
401 Broadway, New York 13, N. Y.
Cable Address: ASTATIC, New York

in which the station is to be temporarily operated.

(2) Similar notice shall be given for each change in such temporary location, for the return of the station to the former permanent location, or for the establishment of a new permanent location; provided that additional monthly notices to the Engineer in Charge shall not be required when such operation takes place at the fixed station location designated in the station license held by the licensee.

(3) The notice of operation at a temporary location, as required under the preceding provisions of this paragraph, shall clearly identify the station call sign and licensee or licensee-trustee, shall indicate both the permanent and the temporary station location, shall indicate the address at which the licensee or licensee-trustee can be readily reached during such temporary operation, and shall show the reason why operation at that location is considered temporary rather than a change of permanent location.

Strays

At the December, 1951, meeting of the Quarter



Century Wireless Association held in New York City, Phil Rand, W1DBM (left), QST author and pioneer in the field of television interference elimination, gave a talk on this all-important topic. Accompanying him on the program with an amazing dem-

onstration of electronic test and measuring equipment developed for use by the blind, Bob Gunderson, W2JIO (right), editor of the *Braille Technical Press*, presented his bag of ingenious tricks. Bob's plea for financial support of the *Press* obtained spontaneous response from members present. ARRL President George W. Bailey, W2KII, was on hand as guest of honor. (Photos courtesy Bob Hertzberg, W2DJJ)



— . . . —
Television Interference, by Phil Rand, W1DBM, is now available in a revised second edition brought up to date to cover as completely as possible all aspects of the TVI problem. Over 20,000 copies of the first printing were distributed. Requests for the new expanded issue of the booklet should be mailed with 25 cents in coin to: Remington Rand, Inc., c/o Miss Anne Smith, 315 4th Avenue, New York 10, N. Y.

Wavelength Factor

(Continued from page 44)

length. Nevertheless, if the wavelength becomes too short the beam width of Station B will become so narrow that accurate orientation will become difficult.

By consideration of these cases we see a very definite group of conclusions: (1) portable and

(Continued on page 118)

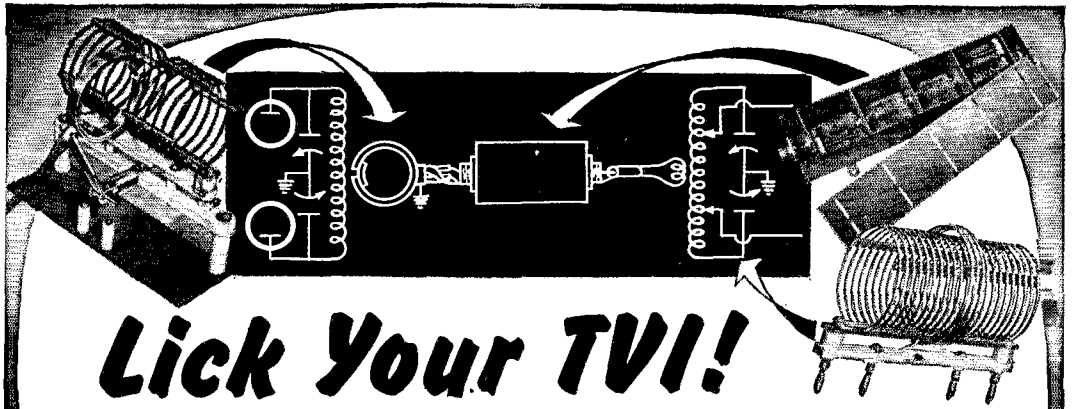

Lick Your TVI!

Most cases of TVI caused by harmonics and spurious radiations can be reduced to a negligible minimum.

In planning a new rig, the best bet, of course, is to use precision-made B&W components—from oscillator to final including antenna coupler. Filtering and shielding recommendations in our "Filter Facts" booklet show what to do, how to do it.

Should your present rig be

of fairly good design, a few minor changes as outlined in "Filter Facts" plus installation of B&W low-pass filters and Faraday shielded links will effectively throttle TVI. Many hams have proved it!

Send 15c today for a copy of "Filter Facts" giving details on how to lick your TVI and get silent rigs back on the air!

B&W Low-pass Filters, Models 52 and 75 Amateur net \$27.00.

B&W

BARKER & WILLIAMSON, Inc.

237 Fairfield Ave.

Upper Darby, Pa.

20
METER BEAMS

10
METER BEAMS

2
METER BEAMS

Attention
CD
OFFICIALS

Whether you are using Amateur frequencies or a special assigned frequency, HY-LITE assures you the finest in construction and performance. Send us your specifications and freq. for our quotation. • you're RIGHT with HY-LITE.

SEE YOUR DEALER OR WRITE
DEPT. 2-2 FOR PRICES

HY-LITE
BEAMS

HY-LITE
BEAMS

HY-LITE
BEAMS

HY-LITE
BEAMS

HY-LITE
BEAMS

HY-LITE Antennae INC

Makers of Fine Antennas for AMATEUR · FM · TELEVISION

242 EAST 137TH ST., NEW YORK 51, N. Y.

PIONEER CHASSIS PUNCHES

Cut ROUND · SQUARE · ANGULAR · KEYED HOLES

Type "CS"
Square Punch
cuts any
Size Larger
Square or
Angular Hole

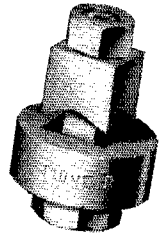

★
For mounting IF's, Terminal Strips, Sockets, Plugs, Meters, Controls, Xfmr's, Switches, Panel Lites, Etc.

■ SQUARES		● ROUNDS		Simple Hand Wrench Screw Action	
3/8	\$2.95	1/2	\$1.95		
1 1/8	\$3.25	3/8		1 3/8	
3/4	\$3.50	3/4		1 1/2	
7/8	\$3.85	1		1 3/4	\$2.60
1	\$3.95	1 1/8	\$2.30	1 1/2	\$2.95
		1 1/4		2 1/4	\$5.65
		1 1/2			
		● KEYED			
		1 1/4	\$3.50		

"AT YOUR FAVORITE DISTRIBUTOR"

PIONEER TOOL CO.

LOS ANGELES 16, CALIFORNIA

• WANTED •

RADIO COMMUNICATIONS

The United States Government has openings for radio operator-technicians who are interested in careers in radio communications and general electronics involving extensive overseas assignments.

Applicants should have the following technical qualifications: (A) Two years active radio experience in the design, construction, and maintenance of transmitting and receiving equipment and the ability to copy International code at fifteen words per minute, preferably on a typewriter. (B) Knowledge of radio wave propagation and practical design and construction of antennae.

The required personal qualifications are as follows: (A) Age, over 21 and must be able to pass a thorough physical examination. (B) Indicate a willingness to serve overseas extensively and in any location required.

Current starting salaries for non-supervisory radio operator-technicians range from \$3410 to \$4205 per annum. Salaries, leave, promotions, employee benefits, transportation and baggage allowances, cost of living differential allowances, etc., are in accordance with current government regulations.

Interested personnel are requested to write a brief application letter to Box 1136, Main Postoffice, Washington, D. C. Considerable duplication of effort will be avoided if the following outline is adhered to:

1. Experience and training.

a. Number of months radio training and type (college, service schools, technical and/or trade schools).

b. Number of years radio experience and type (military, merchant marine, commercial, government).

c. Amount of this experience in telegraphy and amount in construction or maintenance.

d. Present radiotelegraph code speed.

e. Present or past radio licenses, including amateur.

2. Marital status.

If your initial application appears promising, you will be sent full application forms upon which detailed information can be entered.

mobile operation should be placed at the longest wavelength feasible; (2) the 420-Mc. band is the band best suited (not utilizing ionospheric effects) for general coverage operation; and (3) the micro-wave bands are useful mainly for point-to-point operation on prearranged schedules. Although we have only considered the dependence of antenna properties on wavelength so far, it happens by chance that the other factors mentioned at the start of this article conspire almost unanimously to confirm these conclusions.

[Editor's Note: Propagation, types of modulation, and equipment limitations will be discussed in a subsequent article.]

Mobile Installation

(Continued from page 59)

Mobile stations. I would suggest that when they call "CQ mobile," they also state the frequency or frequencies on which they intend to listen and also that they select frequencies where there are openings.

The terrain here in Wisconsin is hilly and there are also many low, wet places. After numerous tests, we have come to the conclusion that best results are obtained from locations where the water table is close to the surface, even though these spots may not necessarily be at high elevation. We worked most of the stations for WAS as well as DX from comparatively low spots, offsetting the old idea that height is necessary for successful contacts. While we have noticed an improvement in signal reports over wet ground in this section, this condition may not hold true in other parts of the country.

YL News

(Continued from page 60)

YL-OM CONTEST

Sponsored by the YLRL, this contest will begin at 6:00 P.M. EST, February 23rd, and will end at 3:01 A.M. EST, February 25th. Any or all bands, both 'phone and c.w., may be used—schedules, crossband, and c.w.-to-'phone operation permitted. On 'phone call "CQ YL/OM contest." On c.w. YLs call "CQ OM/YL" and OMs call "CQ YL/OM." Exchange QSO number and state, U. S. possession, VE district or country. It has been suggested that the YLs on c.w. operate near the net frequencies of 3610, 7040, and 7105 kc. in order that the OMs may find them more easily.

Scoring: Count one point for each station worked (YL to OM or OM to YL only). Multiply by the total number of different states, U. S. possessions, VE districts or countries (except W/VE) worked. Each station, state, country, etc. will count once only, regardless of frequency band or mode of operation. A cup donated by W8UDA, and now held by W1BFT, will be awarded to the highest OM scorer. A cup donated by W1BFT, and now held by W6YYM, will be awarded to the highest YL scorer. These cups are awarded on a yearly basis, with a three-time winner obtaining permanent possession. Certificates will be awarded to second- and third-place winners. Logs must be post-marked not later than March 2, 1952, and mailed to Kay Barelay, W3LSX, 2022 Columbia Road, N.W., Washington 9, D. C.

Aside to YLs: Strangely enough, you never need much coaxing for this party—so no sermon on contest spirit this time!

DID YOU GET IT? IF NOT...

SEND NOW FOR B-A's 136 BIG PAGE FREE CATALOG



**INCLUDING
21 PAGES OF
DOLLAR-SAVING
BARGAINS!**

BURSTEIN-APPLEBEE CO.
1012-14 McGee St.
Kansas City 6, Mo.

FREE

Send your 1952 catalog to:

Name.....
Address.....
City.....State.....

BURSTEIN-APPLEBEE CO.



MAKE THIS YOUR HOME FOR IMPORTANT WORK UNDER IDEAL CONDITIONS

- TV RECEIVER DESIGN ENGINEERS
- ELECTRONICS ENGINEERS
- FIELD ENGINEERS
- TEST & INSPECTION ENGINEERS
- LAB. TECHNICIANS

NEEDED TO WORK ON: Radar, G.C.A., Mobile Radio, Auto Radio, Airborne Communication & Navigation Equipment, Television, Antennas, Microwave Equipment, Servo Mechanisms and Guided Missiles.

YOU BENEFIT AT BENDIX RADIO:
from high wages, a modern, air-conditioned plant, paid vacations and holidays, group insurance and a good chance for advancement.

Housing immediately available in the beautiful suburban and country areas that surround the Bendix Radio plant.

Write, Wire or phone
MR. E. O. COLE, DEPT. K

Bendix Radio

DIVISION OF BENDIX AVIATION CORPORATION
BALTIMORE-4, MD. Phone: TOWSON 2200

COMPLETE RADIO TRAINING!

Prepare now to accept a responsible position in Commercial Radio. New developments will demand technicians with thorough basic training, plus a knowledge of new techniques discovered during the war. Training open to high school graduates, or those with high school equivalency. Courses 6 to 18 months' duration in RADIO AND ELECTRONICS. Approved Veteran training in Radio. Write for Particulars.

VALPARAISO TECHNICAL INSTITUTE
DEPT. TN Valparaiso, Ind.

RADIO and TELEVISION

Over 30 years N.E. Radio Training Center. Train for all types FCC operators' licenses. Also Radio and Television servicing. FM-AM broadcasting transmitters at school. Send for Catalog Q.

MASS. RADIO SCHOOL

271 Huntington Avenue Boston 15, Massachusetts
Lic. by Comm. Mass. Dept. Educ.

Standard
Grey
\$16.75

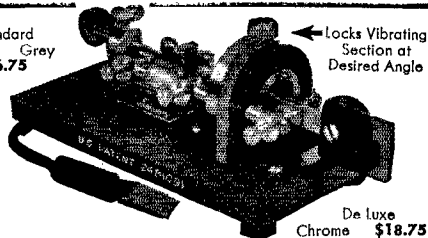

De luxe
Chrome \$18.75

Turn to position which gives you best control—Then see how your sending improves. See your dealer, or write for brochure. Try a Dow-Key on your rig 10 days—purchase price refunded if desired.

DOW-KEY CO., INC. WARREN, MINNESOTA
Canadian Distributors—Sparling Sales, Ltd.,
120 King St., Winnipeg, Canada

BUY OF A LIFETIME! TRIED AND PROVEN THE WORLD OVER

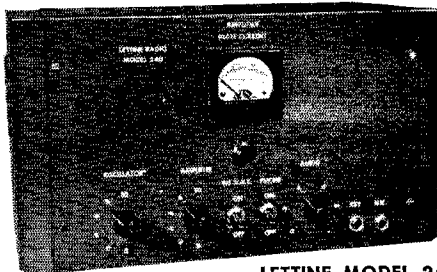

LETTINE, MODEL 240 TRANSMITTER WITH MOBILE CONNECTIONS AND A.C. POWER SUPPLY

This outstanding transmitter has been acclaimed a great performer throughout the world. It is excellent for fixed station, portable or mobile operation. Even if you have a transmitter of your own you can't afford to miss this wonderful buy, direct from our factory, ready to operate.

The 240 is a 40 watt Phone-CW rig for 160 to 10 meters, complete with: (8 x 14 x 8) cabinet, self contained A.C. power supply, MOBILE connections, meter, tubes, crystal and coils for 40 meters. Tubes: 6V6 osc., 807 final, 6S17 crystal mike amp., 6N7 phase inverter, 2 6L6's mod., 514G rect. Weight 30 lbs. TVI instructions included. 90-day guarantee. Price \$79.95.

\$25 deposit with order — balance C.O.D.

Coils for 80, 20 and 10 meters \$2.91 per set. Coils for 160 meters \$3.60. Equipped for CAP 2374 kc. \$84.95.

LETTINE RADIO MFG. CO.

62 Berkley St.

Valley Stream, N. Y.

MASTER MOBILE LEADS AGAIN

NEW COAXIAL CONNECTOR—At No Extra Price

For Nos. 132 Double Tapered Spring and 132X (Same—Heavy Duty Spring). Also for Nos. 126 (Standard—Straight Spring) and 126X (Same—Heavy Duty Spring).

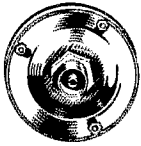

— ALL ASSEMBLED —
READY FOR
INSTALLATION

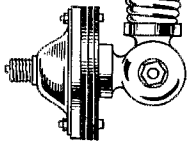

AMATEUR'S NET PRICES:

No. 132—\$8.75 No. 132X—\$9.85
No. 126—\$8.75 No. 126X—\$9.40

FITS ALL MASTER ANTENNAS
Famous Master Quality—Beautifully Finished

MASTER MOBILE COAXIAL CONVERSION KIT—For Quick Coaxial Conversion Connection where above Regular Master Mounts are now installed.

No. 118—Complete Kit

AMATEUR'S NET — \$1.95

FOR SALE AT LEADING JOBBERS

Master Mobile Mounts, Inc.

P. O. BOX 1817 · LOS ANGELES 36, CALIFORNIA
WAREHOUSE AND SHIPPING ADDRESS 1306 BOND STREET

**Superintendent of Airline Communications
Overseas Airlines**

**FREE HOUSING. PAYS OVER \$600
PER MONTH**

Must be thoroughly capable of planning and installing ground and aircraft radio equipment. Also must be well qualified radio technician capable of supervising radio repair shop. *Write:*

**S. A. A.
Trans World Airlines
Employment Manager
Kansas City 6, Missouri**

EASY TO LEARN CODE

It is easy and pleasant to learn or increase speed the modern way—with an Instructograph Code Teacher. Excellent for the beginner or advanced student. A quick, practical and dependable method. Available tapes from beginner's alphabet to typical messages on all subjects. Speed range 5 to 40 WPM. Always ready, no QRM, beats having someone send to you.

ENDORSED BY THOUSANDS!

The Instructograph Code Teacher literally takes the place of an operator-instructor and enables anyone to learn and master code without further assistance. Thousands of successful operators have "acquired the code" with the Instructograph System. Write today for full particulars and convenient rental plans.



INSTRUCTOGRAPH COMPANY

4709 SHERIDAN ROAD, CHICAGO 40, ILLINOIS

Correspondence

(Continued from page 61)

ized bands. It is my opinion that at present all c.w. and 'phone amateur frequencies are overcrowded. The only solution to the problem is either the assignment of additional amateur frequencies or perhaps through technical improvements at either the transmitting or receiving end which result in an effective reduction in the bandwidth of amateur radio signals. Any attempt to change the c.w. or 'phone assignments within the present bands is simply a matter of robbing Peter to pay Paul.

— Lloyd D. Colvin, W4KE

113 Waterloo Road
Southport, England

Editor, QST:

I feel that, as an European amateur, I must comment on the editorial in the December issue of QST and also on Mr. William Szabo's letter in the same issue.

In Great Britain and, I think, in all the countries of Europe in which amateur operation is officially permitted, no attempt is made by the various administrations to subdivide the amateur bands as regards to various types of emission allowed. There is, however, a voluntary band plan in existence sponsored by the Radio Society of Great Britain which ordains that 7000 to 7050 kc. shall be for c.w. only and this plan is, in general, very well observed. However, 'phone operation does take place between 7050 and 7300 kc.

As you say, the Cairo Convention of 1938 ordains that, outside the American Hemisphere, 7000 to 7200 kc. shall be amateur, with the remainder of the band occupied on a shared basis. At the time of day when European amateur 'phone stations are likely to be active in any quantity there are many other more powerful stations active, namely the broadcasting stations. According to a list of broadcasting stations published in England by a firm of technical publishers, there are six broadcasting stations between 7000 and 7050 kc., thirty-three between 7050 and 7200 kc. and no less than sixty-eight broadcasting stations between 7200 and 7300 kc. Almost all of these stations are in the European area. I am not suggesting that all these stations are on at the same time, although it is difficult to believe that such is not the case when listening on the forty-meter band any afternoon or evening and attempting to work a few amateur stations, either 'phone or U. S. In fact, forty meters is, under present-day conditions, impossible for 'phone contacts after dark and what c.w. can be worked must be in the gaps between competing propaganda stations between 7000 and 7050 kc.

As far as Europe is concerned, it is not the amateur who is causing QRM on forty meters. If and when sanity returns to the earth and the powers that be realize what a waste of the earth's wealth of energy is the propaganda broadcasting station, we may have less 'phone QRM on forty meters, but not before.

— F. H. P. Cawson, G2ART

1338 Washtenaw
Ann Arbor, Mich.

Editor, QST:

This question of 40-meter 'phone is sure full of dynamite. . . . Present 'phone frequencies on the 20- and 75-meter bands are jammed and the opening of 40 meters would do much to alleviate this situation. It would be especially valuable for the increasing number of 'phone nets. So many nets are now operating on 75 meters that the average ham has to be extremely careful in the early evening hours not to step on some net frequency. . . .

Keep up the good work. QST remains the most complete and comprehensively written ham publication on the market.

— Jerome S. Müller, WN8DP

1112 S. Wilmoore Drive
Albuquerque, N. M.

Editor, QST:

Let's keep 40 meters c.w., at least in the U. S.

— Bruce Butler, W5PXX

Stanwood Road
Mt. Kisco, N. Y.

Editor, QST:

. . . desirable to authorize the use of the 7-Mc. band for type A-3 emission. . . .

— Mr. & Mrs. James E. Taylor, W2OZH, W2EYK
(Continued on page 122)

HERE IT IS!

ALL YOU NEED TO KNOW!

The KEY to a Ham Ticket . . .

IF YOU HAVE BEEN WORRYING ABOUT HOW TO PASS THAT
FCC WRITTEN EXAM, YOU CAN STOP WORRYING NOW

All you need is a copy of the new ARRL License Manual, and a little of the same enthusiasm you had when you first decided to become a ham. A few additional hours looking through this book, and you'll be well on your way to getting that coveted ticket.

Here, in one compact manual, is all the info you will ever need for the written examination. Thoroughly revised, brought up to date, and containing the latest FCC regulations on the new Novice and Technician Class and other licenses, and many other pointers, with complete questions and answers, the ARRL 27th Edt. License Manual is available to help you over the hump.

THIS BOOK WILL BE OF MUCH HELP TO
YOU IN PREPARING FOR THE TESTS, AND
MASTERING THE REQUIRED KNOWLEDGE

Revised, enlarged, and
printed on slick paper

50¢ PER COPY
POSTPAID ANYWHERE
(No Stamps, Please)

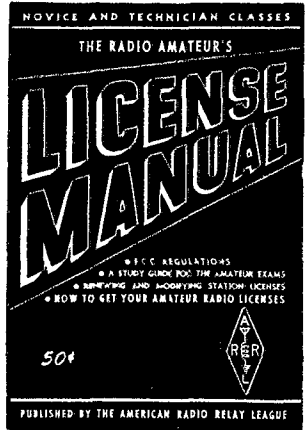

38 LA SALLE ROAD

THE AMERICAN RADIO RELAY LEAGUE, INC.

WEST HARTFORD 7, CONNECTICUT



RADIO COURSES

- RADIO OPERATING
- RADIO SERVICING
- CODE
- FM TELEVISION

Preparation for Civilian, Maritime, Army and Navy
license requirements.

Personal Counselling Services for Veterans
Write for Catalog T.Q.

YMCA

TRADE & TECH. SCHOOL 15 W. 63 St., N. Y. 23
ENdicut 2-8117

Send Easier, Faster and Better with
a **VIBROPLEX Super DeLuxe Key**

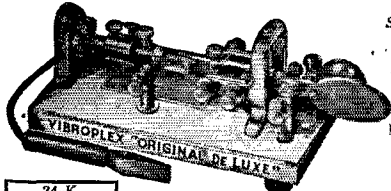

Semi-Automatic
Twice as Easy
as Hand Sending

Needs no extra
weights
for
slow sending

24-K
Gold-Plated
Base Top
\$29.95

ORIGINAL DELUXE
model illustrated

A finger-touch on lever button—it's that easy!
Transmits **SMOOTHLY! EASILY! PERFECTLY!** No special skill
necessary . . . no arm fatigue . . . no nerve strain. Anyone can use
it. The use of patented jewel movement assures a smooth, easy
action, easier operation and longer life. Needs no extra weights for
slow speed . . . there's no drag . . . no sacrifice of signal quality even
at slowest speed. Lets you send from dead slow to a speed beyond the
need of the most expert operator. Suits any hand. Order yours today
and enjoy keying at its easiest and best! Other models \$12.95 up. Left
hand models one dollar more. At dealers or direct. **FREE**
catalog.

Headquarters for **NEW** portables, all models
and styles of type. Also, **REBUILT** standard
and portable typewriters with **ALL CAPITAL**
letters and other styles of type. **Immediate**
delivery. **Get our prices before buying.**

THE VIBROPLEX CO., INC.
833 Broadway New York 3, N. Y.



*Turn "Pro" With
The Top Circuit*

YOUR AMATEUR EXPERIENCE MAY
QUALIFY YOU FOR A HIGH-PAYING
ELECTRONICS OR RADIO POSITION
WITH BENDIX RADIO.

These jobs open:

- LAB TECHNICIANS
- TECHNICAL WRITERS
- DRAFTSMEN
(MECH. & ELECT.)

BENEFIT FROM high wages,
modern, air-conditioned plant, paid vaca-
tions and holidays, group insurance and
a good chance for advancement. Housing
immediately available.

Write, Wire or Phone
MR. E. O. COLE Dept. L

Bendix Radio
DIVISION OF BENDIX AVIATION CORPORATION
BALTIMORE-4, MD. Phone: TOWSON 2200
*Makers of the World's Finest
Electronic Equipment*



NATIONAL

- **Proven**
- **Dependable**
- **Quality**

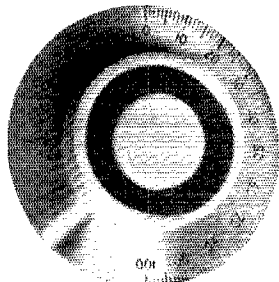

HRM KNOB

HRM KNOB



IFR (455kc)
IFS (1720kc)
I.F. TRANSFORMERS

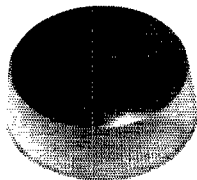

VD-16 KNOB

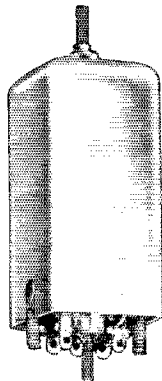

NEW COMPONENTS

Pictured above are some of the new items we have added to our line of quality components. They have been especially designed to meet new and changing needs in electronics and, like all National components, are made better than industry standards. Write for drawings and specifications.

National



NATIONAL COMPANY, Inc.
MALDEN, MASSACHUSETTS

722 Savannah Avenue
Wilkinsburg
Pittsburgh 21, Penna.

Editor, *QST*:

. . . Normal activity is now very bad between 7200 and 7300 kc. for use of Type A-1 emission in this band due to Type A-3 from foreign sources. Therefore the U.S.A. amateurs should be entitled to use the same type of transmission, namely A-3 in this same spectrum. . . .

— *Chris E. Hobson, W3AER*

4132 73rd Street
Jackson Heights 77, N. Y.

Editor, *QST*:

Some years back the amateurs made a proposal to ARRL in an orderly way for A-3 emission on the 7300-7000 kc. spectrum. A vote was taken and I believe, at the time, 20 per cent voted for A-3 emission.

A report came back to us in a form like this, "Insofar as ARRL is a believer in democracy and whereby the A-3 emission members did not vote 51 per cent in favor, there will be no consideration of A-3 emission. Keep after your directors." It caused a great dissension amongst the amateurs.

I was never taught in school as a child that this country was a democracy where the directors (commissars?) report back to ARRL (Moscow?) and decide whether the 20 per cent should be shot or die of starvation as in Russia.

I have always been taught that this country was a republican form of government whereby the minority has equal rights as the majority. Insofar as only 20 per cent, at the time, voted for A-3 emission I should think they would at least be entitled to 60 kc. of the 7000-7300 kc. spectrum; also, at present, over 400 amateurs have, in their possession, teletype machines. They could operate them in the evening without resorting to high power if they had the use of long-haul frequencies.

— *John Junginger, W2BDA*

[Editor's Note: In a Midwest town, so the story goes, the civic fathers were faced with the problem of setting a satisfactory speed limit on the town's main street. Fifty per cent of the residents thought the speed limit should be 30 miles an hour while the other 50 per cent thought the limit should be 40 m.p.h. The solution was simple. Half the people now drive down main street at 30 m.p.h., while the other half travel 40 m.p.h.]

Answer to QUIST QUIZ on page 47

Be grateful for a decent receiver. It is normal for the noise to increase when the d.o. is turned on, because the incoming noise is beating with the d.o., a perfectly natural effect. Reducing the d.o. voltage will make the receiver "mushy" on strong signals. The only way to reduce the noise is to decrease the bandwidth of the receiver or, in some few bad cases, to use a better first r.f. stage in the receiver.

GROUND RADIO OPERATORS and RADIO TECHNICIANS TRANS WORLD AIRLINES

First or second phone license required. Ground radio operators, able to type 35 wpm, needed at several domestic stations. Radio technicians needed Kansas City base and should have two years' experience radio repair. Write

TRANS WORLD AIRLINES
Employment Manager
Kansas City 6, Mo.

**Model
M-51**

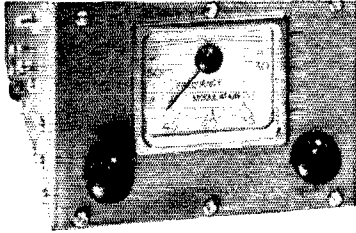

POLIC-ALARM MONITOR-RADIO

for emergency communications

USED BY HUNDREDS OF MUNICIPALITIES FROM BOSTON, MASS.. TO ALHAMBRA, CAL.

Says S. L. Grant, City Manager, Winchester, Virginia . . .

"I think you have a receiver that is well built, and I see no reason why it should not be in demand by all public works departments that have a transmitter available."



Users of FM 2-Way Radio Communications equipment throughout the entire nation, find Polic-Alarm and Monitorradio a welcome innovation to low-cost mobile communications radio .

5 Models For All Systems

- 6 VOLT MOBILE
- M-51
- Tuneable 30-50 MC
- M-101
- Tuneable 152-163 MC
- 115 VOLT AC-DC
- PR-31
- Tuneable 30-50 MC
- PR-8
- Tuneable 152-163 MC
- AIRCRAFT
- AR-1
- AM Tuneable 108-132 MC
- 115 Volt AC-DC

For Complete Information: See Your Jobber—Or Write Us Today

RADIO APPARATUS CORPORATION

55 N. NEW JERSEY ST., INDIANAPOLIS 4, IND., PHONE: ATLANTIC 1624

Evans Radio

"Your Friendly Supplier"

Service to hams by hams. Nationally accepted brands of parts, tubes and equipment. Trade-ins and time payments. Write W1BFT.

10 HILLS AVENUE CONCORD, N. H.



RADIO and TELEVISION ELECTRONICS

in all Technical Phases
New Classes (*Day & Evening*) Start
1st of Dec., Mar., June, Sept.

FREE PLACEMENT SERVICE FOR GRADUATES

For Free Catalog write Dept. ST-52

RCA INSTITUTES, INC.
A Service of Radio Corporation of America
350 WEST 4th ST., NEW YORK 14, N. Y.

DESIGN LAYOUT TECHNICIANS

For work on Radar, Loran, and other types of electronic equipment.

Cost-free employee benefits; good working conditions and opportunity.

Assignment in New York City. Apply:

RADIOMARINE
Corporation of America
75 Varick St., N.Y.C. T3
WA 5-3716

Quartz Crystals

Made to your specific specifications. Accurate to the minutest tolerance. Exacting in performance—with thorough dependability.

Whether one or a million, you get prompt shipment. Made by craftsmen with a quarter century experience.

Send us detailed description and quantity for prices.

MICHAEL STAHL, Inc.

215 Fulton Street

New York 7, N. Y.



HAM-ADS

(1) Advertising shall pertain to radio and shall be of nature of interest to radio amateurs or experimenters in their pursuit of the art.

(2) No display of any character will be accepted, nor can any special typographical arrangement, such as all or part capital letters be used which would tend to make one advertisement stand out from the others.

(3) The Ham-Ad rate is 30¢ per word, except as noted in paragraph (4) below.

(4) Remittance in full must accompany copy. No cash or contract discount or agency commission will be allowed.

(5) Closing date for Ham-Ads is the 25th of the second month preceding publication date.

(6) A special rate of 7¢ per word will apply to advertising which, in our judgment, is obviously non-commercial in nature and is placed and signed by a member of the American Radio Relay League. Thus, advertising of bona fide surplus equipment owned, used and for sale by an individual or apparatus offered for exchange or advertising inquiring for special equipment, if by a member of the American Radio Relay League take the 7¢ rate. An attempt to deal in apparatus in quantity for profit, even if by an individual, is commercial and all advertising by him, takes the 30¢ rate. Provisions of paragraphs (1), (2) and (5), apply to all advertising in this column regardless of which rate may apply.

(7) Because error is more easily avoided, it is requested signature and address be printed plainly.

(8) No advertiser may use more than 100 words in any one issue nor more than one ad in one issue.

Having made no investigation of the advertisers in the classified columns, the publishers of QST are unable to vouch for their integrity or for the grade or character of the products or services advertised.

QUARTZ—Direct importers from Brazil of best quality pure quartz suitable for wide range piezo-electric crystals. Diamond Drill Carbon Co., 119 World Bldg., New York City.

MOTOROLA used communication equipment bought and sold, W5BCO, Ralph Hicks, 204 E. Fairview, Tulsa, Okla.

QSL's: No. 101, \$5 up. Samples, 10¢, refunded when ordering. Griffith, W3PSW, 1042 Pine Heights Ave., Baltimore, Md.

SUBSCRIPTIONS. Radio publications a specialty. Earl Mead, Huntley, Montana, W7LCCM.

QSL's-SWL's. Meade W6KXL, 1507 Central Avenue, Kansas City, Kans.

5-Element 2-meter beams. Riverside Tool Co., Box 87, Riverside, Ill.

WANTED: Your surplus radio receivers, transmitters, ARC-1, ARC-3, ART-13. We buy anything. What have you? Tom Allen, 562 Atlantic Ave., Brooklyn 17, N. Y.

QSL's Taprint, Little Rock, Mississippi.

WANTED: Indices to QST volumes 6 to 19, both inclusive. Also "Pink Sheet" one-page supplement to October, 1919 "QST" announcing lifting of transmission ban, and April, 1919 8-page pamphlet entitled "Getting Together Again", mailed to League members before publication of "QST" resumed after World War I. Also complete files, odd lots, or single copies of Southern Edition QST's. Jan. 1936 to Dec. 1939, both inclusive, and Western Edition, years 1936 and 1941. Must have both covers and be in very good condition. Sumner B. Young, W0CO, Route 3, Wazayata, Minn.

QSL's: Uncle Fred QSL's. Three colors and up. Rainbow map QSL's. Special DX QSL's. Bargain QSL's. Samples rushed, 10¢. Uncle Fred, Box 86, Lynn, Penna.

QSL and SWL cards. Samples. WISOF, Minner, Candia, N. H.

REX Bassett, Incorporated can no longer deliver Amateur Crystals because of high volume high priority production for defense of our country. We don't like it any better than you do but we must help lick them first.

WANTED: Bargains in transmitters, receivers, test-equipment and miscellaneous gear. What have you? W5ZZ, 718 N. Broadway, Oklahoma City, Oklahoma.

WANTED: TG-29 telegraph repeater. I-193-A relay test set. W6ITH Moraga, Calif.

WANTED: TM 11-615A for SCR 609A and SCR 610A. D. E. Cartwright, W5UPB, P. O. Box 82, Lockland, Ohio.

FOR Sale: W.R.L. c.w. xmtr, Globe Champion with all coils 160-10 meters; \$75.00. Rack mounted ant. tuner with 2 r.f. meters, \$10 National rcvr, Model NC-46, A.C./D.C., \$35; New Lyco Model No. 129 xmtr, 10 meters, with Mallory Vibrapack, \$20; Lyco Model No. 50, ant. coupler, \$7.50. McMurdo Silver Model No. 903-903A wave meter with rectifier, meter, \$10.00. 2400 hour clock, \$5.00. 110 plate transformer, Model S-45, \$5.00. UTC file transformer, Model S-67, \$3.00. Hagen, 336 E. 34th St. NYC 16, N. Y.

WANTED: Tech manuals and instruction books. Will swap or buy. WIIBY, 12 Sunnyside Ave., Wellesley 81, Mass.

WANTED: Electro Importing, DeForest, Wireless Specialty, Marconi apparatus, Wireless Age, Electrical Experimenters, Marconiographs, Modern Electrics, Year Book of Wireless Telegraphy 1913, 1914, 1915. "Ultimate" Bug key, Collins "Wireless Telegraphy". Mundock 2-side tuning coil, early crystal detectors. Would like to contact other collector of early wireless apparatus or books. Louis Rizoli, W1AAT, 100 Bay View Ave., Salem, Mass.

QSL's, SWL's. America's Finest! Samples, 10¢. C. Fritz, 1213 Briargate, Joliet, Ill.

WANTED: TG-29 telegraph repeater. I-193-A relay test set. Also wanted: Teletype 1/40th HP synchronous motor. W6ITH, Moraga, Calif.

QSL's: SWL's? Modernistic? Cartoon? Rainbow-map? State-map? QSL samples, 20¢. Sackers, W8DED, Holland, Mich.

WANTED used good condition Ham marlund Super-pros. Keystone Electronics Co., 114 Manhattan St., Stamford, Conn.

FOR Sale: Collins 75A-1 receiver, complete. Perfect condition. \$280. A. H. Hardwick, W2VQ, Orange, N. J.

FOR Sale: 2, 6, 10 meter complete self contained transmitter phone and CW, in A-1 condition, 75 watts. Send for photo and complete description: \$150. Money back guarantee. Harvey-Wells TBS50C, also H. W. motor generator, all cables, control box, push to talk mike, a complete mobile set up. Price \$175. Money back guarantee. W1CPL.

WANTED: 8 Mc crystals for low ends of 2 and 6 meter bands. Korn, W2AMM, 1549 Richard St., Schenectady 3, N. Y.

WANTED: Collins 310B-3, perfect condition. W8YLA.

ELIMINATE TVI. Shield your rig. 26 gauge heavy plated bright steel. Perforated 75 #33 holes per in. Easily cut forms and soldered. Sheets 29" x 23" for \$3.50; live for \$6.50 postpaid. Sample dime in stamps. Republic Television, Inc., Dumont, N. J.

QSL's. Brownie, W3CJI (Richard Brown again in business. 433 Chestnut St., Emmaus, Penna.

SELL: Complete station. Johnson Viking, 6 months old, factory wired, factory de-TV'd, 4D32 final. Extra set tubes including 4D32. Eldico low pass. New Viking VFO. New D-104, push to talk.

Excellent HRO-7, extra coil. New Eldico antenna coupler. Vibroplex Original, year old. Cost \$800. Make offer. W7DKA.

SWAP or sell. Wire recorder 4 w. amplifier. Needs cartridge \$20, new. Gosnet 3-30. New G-E cavity oscillator for 2300 Mc with tube. ARC-5, 3-4 Mc, \$12. 6 w. Magmotor 400 V. 150 MA. \$5. VAC. capac. and others. Want: Tape recorder, Millen R-9R, W2DFI.

FOR Sale: low power transmitter, two receivers, back issues radio magazines, many tubes and parts. Very reasonable. Ernest Austin, 743 Erie Avenue, Chillicothe, Ohio.

CRYSTALS wanted for emergency nets. FT-243, twenty-five each, 7,400, 7,400 and 8,075. W4HFK, Collierville, Tenn. Box 325.

HT-19 xmtr less than 75 hours use. Like new. \$225 or best offer. W0DSV, Webster, Wis.

WANTED: WRL transmitter, Collins 32V2, Collins VFO, TBS-50, Gosnet. Box 382, Newark 1, N. J.

REQUIRE following fill-ins to complete file: May, June, July, 1951 QST; US Govt. Pr. Office Call Books; Commercial Stations 1922; Amateur Stations 1926. Large size radio Amateur Call Books Key: Winter (W); Spring (SP); Summer (SU), Fall (F); 1951 W, SU, F; 1950 SU, 1949, SP, SU; 1948, F; 1945 all; 1942 SU, F; 1936, all; 1935 SP; 1934, SP, SU, F; 1933, F; 1932, all; 1931, F; 1930, SP; 1929, W; 1928, SP, SU, F; 1927, W, F; 1924, W, SU, F; 1923 W, F; 1922, SP, SU, F; all earlier. Bob Willits, W1PN, Box 26, Hyannis, Mass.

WANT: ART-13, TCS-12, SCR-284A, BC654A, PE-103A, PE-104A, GN-45, BC-348, BC-342, BC-312, BC-221, RA-34, RA-20, RA-62. Test equipment, radar, technical manuals. Cash or trade. Arrow Appliance, 253 Union, Lynn, Mass.

NOVICE 80 meter xtals surplus FT243 holders. Guaranteed, \$1.25 postpaid. W9OVF, 1310 Laurel, Indianapolis, Ind.

SELL: HQ-129X, used one year, like new. \$150. Answer all letters. W9AEY, 416 N. Water, Watertown, Wis.

TOP Cash for HQ-129X receivers and others. We have reconditioned HQ-129X's with speakers at \$139 guaranteed clean as new. Positively A-1. Electronic Labs, 2444 D, Lincoln, Nebraska.

WANTED: Triband converter, mobile transmitting equipment. State price, condition. Edgar Cole, W9CAM, 920 N. Cedar, Colorado Springs, Colo.

BAV Area ham! Sell 60 w. 75 m. tone rig; MM2 scope; 6 m Gosnet conv., T19P56 transformer; 150 w. PS; 2 m transmitter. Write FJM, 5255 Summit Ave., San Jose, Calif.

LM15, TCS, MO-1 (3-8 mc) perfect shape. No power supplies. Also Telex code machine, complete with tapes; BC376H, dynamotor 115 dc to 110 ac 1.4 amps. all in perfect shape. Will swap individually or the lot for television or ham gear. All letters answered. W5RRO, P. O. Box 385, Reserve, La.

W6JQP will swap or sell radio correspondence course.

FOR Sale: HRO-M, in excellent condition. Complete with power supply 8 coils and speaker. \$135. W1HVR, 40 Hosmer St., Mattapan, Mass.

FOR Sale: Transmitters, power supply, cabinet, other items. Stamp for list. Samkofsky, 527 Bedford Ave., Brooklyn, N. Y.

FOR Sale: complete sets of QST for years 1932, 33, 34, 46, 47, 48, 49, 50. Also partial sets from 1930. Mrs. A. W. Brunner, 4476 23rd St., San Francisco 14, Calif.

SALE: BC-325 1 Kw. on c.w., Incl. modulator, sacrifice \$350. Phone FL 4-0082. Frank Ballard, W2WFF.

TRADE: Anniversary Speed Graphic, 4 x 5, f-4.7 coated, wide angle f-6.8, 90 mm. Graphic Gun, meter case-holders and accessories, Omega D. enlarger and accessories for Collins 31V1 or 2 and 75A or 2. Write for details to W0QLZ, 4112 Trenholm Rd., Columbia, S. C.

BARGAINS: New and reconditioned Collins, National, Hallicrafters, Hammarlund, RME, Millen, Gosnet, others. Reconditioned S38, \$29; S40A, \$69; SX43, \$119; SX71, \$149; SX42, \$199; SX62, \$199; NC57, \$69; NC173, \$139; NC183, \$199; HR050T, \$279; HR050T1, \$339; HO129X, \$139; HF-10-20, \$49; VHF152A, \$59; RME84, \$69; RME43; SX25, HR07, SP400X, Collins 75A1, others. Shipped on approval. Terms. List free. Henry Radio, Butler, Mo.

NEW crystals for all commercial services at economical prices; also regrinding or replacement crystals for broadcast, Link, Motorola, G-E and other commercial types. Over 10 years of satisfaction and fast service! Eidson Electronic Co. Phone 3-3901, Temple, Texas.

SELLING: 51-J-1 Collins receiver in brand new condition. Will accept best offer or \$25. Write Joe Tabor, W8AES, 19215 Westphalia, Detroit 5, Mich.

CODE practice oscillator, two tube deluxe A.C. model, pitch control, Mac-Key speed key, Trimm headpieces, Turner 33-D dynamic mike all for \$25. G. M. Clark, W2JBL, 22 Mulford Place, Hempstead, N. Y.

FOR Sale: Hallicrafters S-38B rcvr. Five months old, like new condition. Silvertone Precision thirteen tube communications rcvr with matching spkr, in fair condition. Best offer, sell or trade. W91NU.

SELL: New PE-103 Dynamotor in original and unopened oversea shipping crate, \$35. Will consider trade for Gon-Set Tri-band or 3-30 converter. W. M. Jackson, W4LZ, Box 51, Savannah, Tenn.

BOONTON standard signal generator, Model 78B; 190-230 meg. Make offer. Roberts, 603 Thorne St., Bridgeport, Conn.

DON'T fail! Check yourself with a time-tested Surecheck Test similar to FCC tests. Novice, \$1.50; Conditional and General, \$1.75; Advanced, \$2.00. Amateur Radio Supply, 1013 Seventh Ave., Worthington, Minnesota.

SELLING: My file of QST, 271 issues, from March 1922 to November 1949, at 20¢ each. Fhos. M. Catich, W6MGN, 1324 Harrison Ave., Fresno, California.

SELL: Transmitter in Bud enclosed rack, 1000 watts c.w. and F.M. 700 watts phone. New Meissner signal shifter, \$375. W2FOR, Seaford, N. Y. Wantagh 2-2996-M.

WANTED: 80 and 40 meter coils for National FB-7. W. Sponser, W3PLK/W1UKU, 363 Memorial Dr., Cambridge, Mass.

ATTENTION: Novices Thirty FT-243 80-meter crystals, each \$1.25; complete transmitter 40 watts, metered, tubes, power, key, antenna compact, \$37.50; BC454 revr 80 meters, power, controls, speaker, \$15; VHF-152 \$55; National 1-10, coils, power, \$35; Lyseo Dipmeter grid dipper \$30; transformer 700-0-700 at 400 milliamps, tapped primary, \$10; Diehl seisyms, FJ84-8, husky, new pair \$8; Electro-Voice clipper, separate power, \$12.50; Command transmitters 2.1-3, \$17.50; 7-9.1, new, \$14; frequency meters, calibration books, crystals, tubes, BC221-O, \$60, BC-221-AA, \$75; Everything guaranteed, F.O.B. Write: Wanted: Clean commercially made amateur radio equipment. W9DPL, Howard Seveid, 2431 East Riverside Drive, Indianapolis 23, Ind. Tel. Winthrop 2184.

BARGAINS: extra special Motorola P-69.13 Mobile receivers, \$29.50; Globe King, \$315; HT9, \$199; HRO-50, \$299; Lyseo 600, \$109; SP400X, \$249; HRO7, \$199; Collins 75A1, \$295; HRO-5T, \$175; Hallicrafters S-47, \$99; RME 2-11, \$99.50; RME-45, \$99; Meissner EX shifter, \$89.50; S-40A, \$69.50; VHF 152A, \$69; HF-10-20, \$59; SX-24, \$69; Globe Trotter, \$79.50; Meissner signal Calibrators, \$24.95; ME611 mobile transmitter, \$29; 90800 exciter, \$29.50; XE10, \$14.95 and many others. Large stock trade-ins. Free trial. Terms financed by Leo, W6GFO. Write for catalog and best deal to World Radio Laboratories, 740-44 West Broadway, Council Bluffs, Iowa.

AN/APR-4 COMPONENTS WANTED

In any condition. Also top prices for: ARC-1, ARC-3, APR-1, APR-5A, etc.; TS-34 and other "TS-" and standard Lab Test equipment, especially for the MICROWAVE REGION; ART-13, BC-348, BC-221, LAE, LAF, LAG, and other quality Surplus equipment; also quantity Spares, tubes, plugs and cable.

ENGINEERING ASSOCIATES

430 Patterson Road

Dayton 9, Ohio

WANTED Engineers and Scientists

Unusual opportunities for outstanding and experienced men.

These top positions involve preliminary and production design in advanced military aircraft and special weapons, including guided missiles.

IMMEDIATE POSITIONS INCLUDE:

- Electronic project engineers
- Electronic instrumentation engineers
- Radar engineers
- Flight test engineers
- Stress engineers
- Aero- and thermodynamicists
- Servo-mechanists
- Power-plant installation designers
- Structural designers
- Electro-mechanical designers
- Electrical installation designers
- Weight-control engineers

Excellent location in Southern California. Generous allowance for travel expenses. Write today for complete information on these essential, long-term positions. Please include resume of your experience and training. Address inquiry to Director of Engineering.

NORTHROP AIRCRAFT, Inc.
1029 East Broadway
Hawthorne (Los Angeles County), Cal.



2 GONSET METER CONVERTER

featuring
**SUPER-IMPOSITION
TUNING**

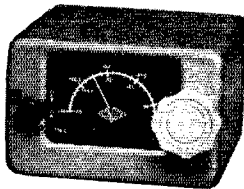

Ideal for



**FIXED-MOBILE
C.A.P.
EMERGENCY**

Freq. range 144-148.2 MC—Excellent sensitivity
44 to 1 vernier dial—Coax input—BC band output.
No images from commercial, police, taxi, etc.
3 tubes, 12AT7, 6CB6, OB2—Large bandwidth.

\$44.50 net

GONSET CO.

72 E. TUJUNGA AVE.

BURBANK, CALIF.



see your distributor or write direct

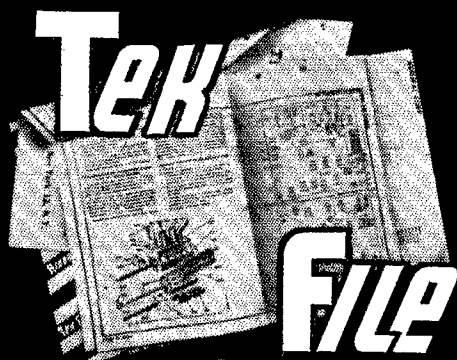

Complete RIDER TV information in new form. Individual manufacturer's complete, factory authorized data, boxed separately. Indexed for easy filing, quick reference... faster, easier, more profitable servicing! Only \$2.00 at your jobber's.



JOHN F. RIDER

Publisher, Inc.

480 Canal Street, New York 13, N. Y.

Designed for

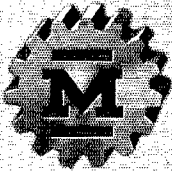

Application

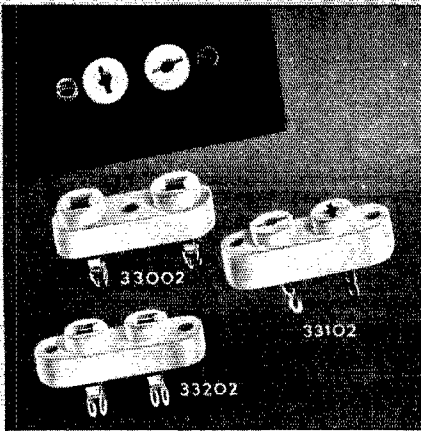

**Crystal Holder Sockets
33002, 33102, and 33202
Plus new 33302 for CR7**

In addition to the original 33002, 33102 and 33202 exclusive Millen "Designed for Application" steatite crystal holder sockets, there is now also available the new 33302 for the new CR7 holder. Essential data:

Type	Pin Dia.	Pin Spacing
33002.....	.125	.750
33102.....	.095	.500
33202.....	.125	.500
33302.....	.050	.500

**JAMES MILLEN
MFG. CO., INC.**

MAIN OFFICE AND FACTORY
**MALDEN
MASSACHUSETTS**



Index of Advertisers

Allied Radio Corporation.....	87
American Lava Corporation.....	83
American Radio Relay League, Inc.....	90, 113, 121
Ashe Radio Co., Walter.....	103
Astatic Corporation, The.....	116
Barker & Williamson, Inc.....	117
Bell Aircraft Corporation.....	114
Bendix Radio Division.....	119, 121
Burstein-Applebee Co.....	118
Candler System Company.....	102
Capitol Radio Engineering Inst.....	92
Centralab.....	81
Chicago Transformer Co.....	76
Collins Radio Company.....	2
Dow-Key Co., The.....	119
Drake Co., The R. L.....	94
Eitel-McCullough, Inc.....	79
Edico of New York.....	72, 73
Electro-Voice, Inc.....	Cov. II
Engineering Associates.....	125
Evans Radio.....	123
Fort Orange Radio Distributing Co.....	109
Fretco Television Company.....	112
Gardiner & Company.....	104
General Electric Company.....	7
General Radio Company.....	127
Gotset Company, The.....	125
Hallcrafters Co., The.....	4, 5
Harrison Radio Company.....	101
Harvey Radio Company.....	91
Heath Company, The.....	74
Harvey-Wells Electronics.....	128
Heath Company, The.....	93
Henry Radio Stores.....	84
Hudson Radio Television Corp.....	84
Hy-Lite Antennae, Inc.....	117
Instructograph Co.....	120
JFD Manufacturing Company.....	108
Johnson Co., E. F.....	106, 115
Knights Co., The James.....	77
Leeds Radio Company.....	107
Lettine Radio Manufacturing Co.....	119
Lysco Manufacturing Company.....	112
Mallard Manufacturing Company.....	80
Mallory & Co., Inc., P. R.....	75
Mass. Radio & Telegraph School.....	119
Master Mobile Mounts, Inc.....	120
McLaughlin, J. L. A.....	96
Millen Manufacturing Co., Inc., The Jas.....	126
Motorola, Inc.....	116
National Co., Inc.....	Cov. III, 71, 122
Newark Electric Co.....	105
New York YMCA Tr. & Tech. School.....	121
Niagara Radio Supply Corp.....	95
Northrop Aircraft, Inc.....	125
Overbrook Co., The.....	115
Petersen Radio Company.....	7
Pioneer Tool Company.....	117
Port Arthur College.....	108
Precision Apparatus Co.....	78
RCA Institutes, Inc.....	123
Radio Apparatus Corporation.....	123
Radio Corporation of America.....	Cov. IV
Radiomarine Corporation of America.....	123
Radio Shack Corporation, The.....	89
Radio Wire Television.....	111
Rider Publisher, Inc., John F.....	125
Signal Electric Manufacturing Co.....	115
Stahl, Inc., Michael.....	123
Steinberg's, Inc.....	99
Sperry Products.....	104
Telex, Inc.....	102
Times Facsimile Corporation.....	98
Transcriber Co., The.....	106
Trans World Airlines.....	120, 122
Triplett Electrical Instrument Co.....	88
Tung-Sol Electric, Inc.....	110
Valparaiso Technical Institute.....	119
Vesto Company, Inc.....	110
Vibroplex Co., The.....	121
Ward Products Company.....	82
Westinghouse Electric Corporation.....	86
Wiley & Sons, Inc., John.....	100
Wincharger Corporation.....	85
Wind Turbine Company.....	114
World Radio Laboratories, Inc.....	97



The Versatile

Variac

for S-M-O-O-T-H
VOLTAGE CONTROL

Variac

the original continuously-adjustable auto-transformer — has many advantages over any other type of manually-operated voltage control for a.c. use. Among its many features are:

The Type V-5MT

is one of the more popular for amateur use. On a 115-volt line it delivers 860 watts of controlled output from zero to 135 volts. Its no-load loss is only 9 watts. For 135-volt output connections its rated and maximum currents are 5 amperes. It is equipped with protective case around the windings, a 6-foot line cord with plug, a two-terminal convenience outlet and a line switch. It sells for \$25.00. If your remittance accompanies order, we prepay carrying charges to any point within the Continental U.S. At the moment we even have a few in stock!

Good Regulation — output voltage is substantially independent of load

Smooth Control — in very small steps the VARIAC can be set to any output voltage within its range

High Efficiency — very low losses both at no load and at full load

Linear Output Voltage — output voltage is continuously adjustable from zero to 17% above line voltage by a 320-degree rotation of the knob. The dial is calibrated to read directly in output voltage when the VARIAC is used on a rated-voltage line

Moderate Temperature Rise — less than 50 deg. C. for continuous use

Many Different Models — with power ratings from 170 watts to 25 kilowatts and for line voltages from 115 to 460



GENERAL RADIO Company

275 Massachusetts Avenue, Cambridge 39, Massachusetts

90 West St., NEW YORK 6 • 920 S. Michigan Ave., CHICAGO 5 • 1000 N. Seward St., LOS ANGELES 28

Send me a copy of the new VARIAC Bulletin per QST ad.

Name _____
PLEASE PRINT

Address _____
STREET CITY & ZONE STATE

Send for the New Variac BULLETIN with complete data on all Variacs. Fill in and mail this coupon.

New 1952 HEATHKITS

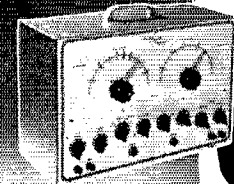

Heathkit
TELEVISION
GEN. KIT \$39.50

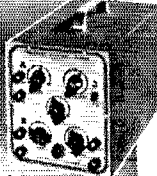

Heathkit
ELECTRONIC
SWITCH KIT \$19.50

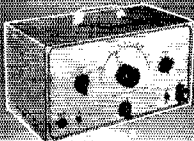

Heathkit
AUDIO GEN.
KIT \$34.50

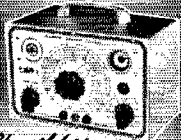

Heathkit
CONDENSER
CHECKER KIT \$19.50

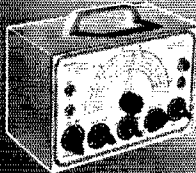

Heathkit
R. F. SIGNAL
GEN. KIT \$19.50



Heathkit
A.C. VOLTMETER
KIT \$29.50

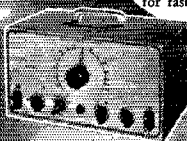

Heathkit
SQUARE WAVE
GEN. KIT \$29.50

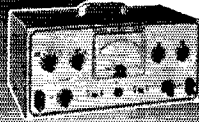

Heathkit
INTERMODULATION
ANALYZER KIT \$39.50

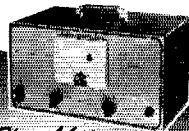

Heathkit
AUDIO FREQ.
METER KIT \$34.50

5" OSCILLOSCOPE KIT

- New "spot shape" control for spot adjustment — to give really sharp focusing.
- A total of ten tubes including CR tube and five miniatures.
- Cascaded vertical amplifiers followed by phase splitter and balanced push-pull deflection amplifiers.
- Greatly reduced retrace time.
- Step attenuated — frequency compensated — cathode follower vertical input.
- Low impedance vertical gain control for minimum distortion.
- New mounting of phase splitter and deflection amplifier tubes near CR tube base.
- Greatly simplified wiring layout.
- Increased frequency response — useful to 5 MC.
- Tremendous sensitivity .03 RMS per inch Vertical .6V RMS per inch Hor.
- Dual control in-vernier sweep frequency circuit — smoother acting.
- Positive or negative peak internal synchronization.
- Multivibrator type Wide Range Sweep Generator.

A brand new 1952 Heathkit Oscilloscope Kit with a multitude of outstanding features and really excellent performance. A scope you'll truly like and certainly want to own.

The kit is complete with all parts including all tubes, power transformer, punched and formed chassis, etc. Detailed instruction manual makes assembly simple and clear — contains step-by-step instructions, pictorials, diagrams, schematic, circuit description and uses of scope. A truly outstanding value.

MODEL O-7
SHIPPING WT. 24 LBS.

\$43.50

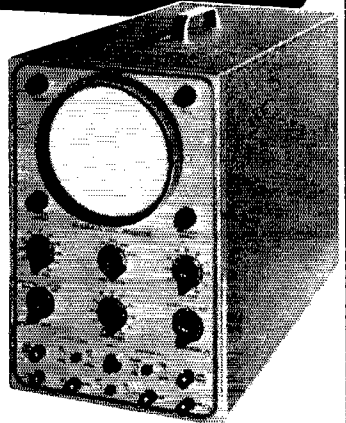

Heathkit VACUUM TUBE VOLTMETER KIT

- New styling — formid case for beauty.
- New truly compact size — Cabinet 4 1/8" deep x 4-1/16" wide x 7 3/8" high.
- Quality Simpson 200 microamp meter.
- New ohms battery holding clamp and spring clip — assurance of good electrical contact.
- Highest quality precision resistors in multiplier circuit.
- Calibrates on both AC and DC for maximum accuracy.
- Terrific coverage — Reads from 1/2V to 1000V AC, 1/2V to 1000V DC, and .1 to over 1 billion ohms resistance.
- Large, clearly marked meter scales indicate ohms, AC Volts, DC Volts, and DB — has zero set mark for FM alignment.
- New styling presents attractive and professional appearance.

The 1952 Model Heathkit Vacuum Tube Voltmeter! Newly designed cabinet combines style and beauty with compactness. Greatly reduced size to occupy a minimum of space on your work-bench. Covers a tremendous range of measurements and is easy to use. Uses only quality components including 1% precision resistors in multiplier circuit for greatest accuracy. Simpson 200 microamp meter with easy to read scales for fast and sure readings.

All parts come right with kit, and complete instruction manual makes assembly a cinch.

MODEL V-5
SHIPPING WT. 5 LBS.

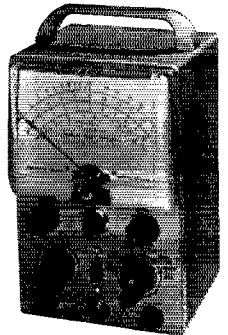

\$24.50

YOU SAVE BY ORDERING DIRECT FROM MANUFACTURER

SOLE AGENTS
RUCKE INTERNATIONAL CORP.
12 E. 40th ST.
NEW YORK, CITY 17 (10)
CABLE: ARLAB NY

The HEATH COMPANY

BENTON HARBOR 9, MICHIGAN

*great news
to hundreds who
want maximum
selectivity
at minimum cost!*

NC-125



*the only receiver
with the famed
select-o-ject
built in!*

**NOW AVAILABLE FOR
IMMEDIATE DELIVERY**

Covers 550 kc. — 36 mcs. in 4 bands. Voice, CW, NFM (with adapter). Edge-lighted, direct-reading scale. Amateur, police, foreign, ship frequencies clearly marked. National Select-O-Ject built-in (rejects any selected audio frequency 45 db — boosts 38 db). Three microvolt sensitivity (for 10 db signal/noise ratio on 10-meter band). 5-meter. AVC, ANL, ant. trimmer. Variable CW pitch control. Separate R.F. and audio gain controls. Volt. reg., stabilized oscillator. Jack for phono or NFM Adapter. Audio essentially flat to 10,000 c.p.s.

Now at last, you can get immediate delivery on the receiver that gives you more selectivity per dollar — the *only* receiver with the famed Select-O-Ject circuit built in! And that's only one of the many fine features that make the NC-125 tops in receiver value!

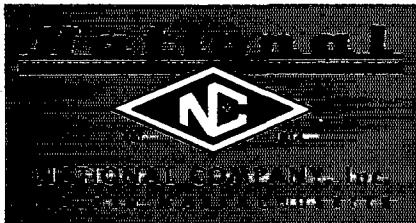

NC-125..... \$149⁵⁰*
NC-125TS (matching spkr.).... 1100

*Slightly higher west of the Rockies.

Still unmatched
in its class...

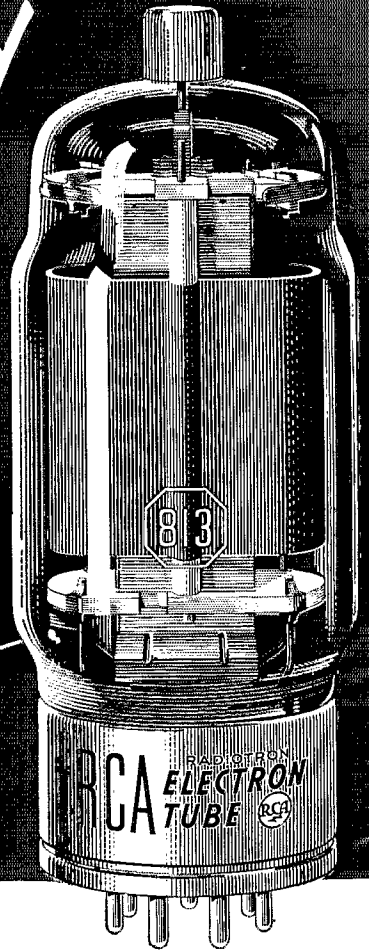
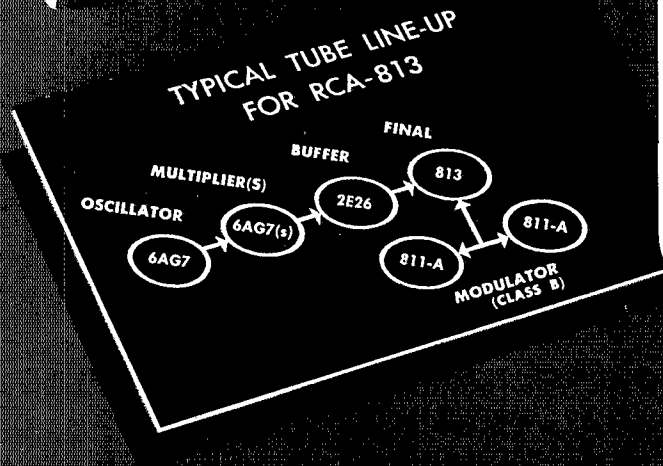

for price — power — performance

COMPARE an RCA-813 with any other tube in its class. Here's what you will find:

Economy—You get *more watts-per-dollar* input. You also save on the initial cost of the power supply because the 813 operates at relatively low plate voltage.

Power—A single RCA-813 easily takes an input of 500 watts on cw and 400 watts on phone. And, because it operates efficiently over a wide range of plate voltages, you can conveniently reduce power for local QSO's.

Performance—Because of its high power gain, the RCA-813 *beam power* tube can be driven to

full input at frequencies up to 30 Mc with a single RCA-2E26. High-level intermediate stages are not required . . . a big step toward the elimination of TVI!

In short, design that new, compact, efficient transmitter around a husky RCA-813 beam power tube.

Tubes for the Professional priced for the Amateur



The dependability of *commercially proved* RCA Tubes costs you no more. Buy genuine RCA Tubes and you buy the best. See your local *RCA Tube Distributor*.



RADIO CORPORATION of AMERICA
ELECTRON TUBES
HARRISON, N. J.