

QST



March, 1951

40 Cents

45c in Canada

devoted entirely to

amateur radio



for High Q Inductors...

For Maximum Stability... Permalloy Dust Toroids

The UTC type HQ permalloy dust toroids are ideal for all audio, carrier and supersonic applications. HQA coils have Q over 100 at 5,000 cycles... HQB coils Q over 200 at 4,000 cycles... HQC coils Q over 200 at 30KC... HQD coils Q over 200 at 60 KC. The toroid dust core provides very low hum pickup... excellent stability with voltage change... negligible inductance change with temperature, etc. Precision adjustment to 1% tolerance.

Inductance Value	Type No.	Net Price	Inductance Value	Type No.	Net Price
5 mhy.	HQA-1	\$7.00	70 mhy.	HQB-3	\$16.00
12.5 mhy.	HQA-2	7.00	120 mhy.	HQB-4	17.00
20 mhy.	HQA-3	7.50	.5 hy.	HQB-5	17.00
30 mhy.	HQA-4	7.50	1 hy.	HQB-6	18.00
50 mhy.	HQA-5	8.00	2 hy.	HQB-7	19.00
80 mhy.	HQA-6	8.00	3.5 hy.	HQB-8	20.00
125 mhy.	HQA-7	9.00	7.5 hy.	HQB-9	21.00
200 mhy.	HQA-8	9.00	12 hy.	HQB-10	22.00
300 mhy.	HQA-9	10.00	18 hy.	HQB-11	23.00
.5 hy.	HQA-10	10.00	25 hy.	HQB-12	24.00
.75 hy.	HQA-11	10.00	1 mhy.	HQC-1	13.00
1.25 hy.	HQA-12	11.00	2.5 mhy.	HQC-2	13.00
2 hy.	HQA-13	11.00	5 mhy.	HQC-3	13.00
3 hy.	HQA-14	13.00	10 mhy.	HQC-4	13.00
5 hy.	HQA-15	14.00	20 mhy.	HQC-5	13.00
7.5 hy.	HQA-16	15.00	.4 mhy.	HQD-1	15.00
10 hy.	HQA-17	16.00	1 mhy.	HQD-2	15.00
15 hy.	HQA-18	17.00	2.5 mhy.	HQD-3	15.00
10 mhy.	HQB-1	16.00	5 mhy.	HQD-4	15.00
30 mhy.	HQB-2	16.00	15 mhy.	HQD-5	15.00

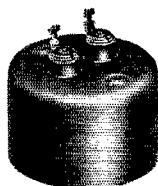

HQA, C, D
1½" Dia. x 1¼" High.

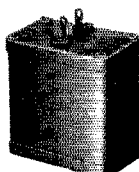

HQB
2½" L. x 1½" W. x 2½" H.



UNCASED TOROIDS
(Deduct \$1.50 for uncased units)

For Maximum Flexibility... The VIC Variable Inductor

The set screw on VIC units permits positive adjustment of inductance to plus 90% minus 50% from rated value. Revolutionary approach for tuned audio circuits. Q and I vs. screw adjustment for a typical coil are illustrated.

Type	Mean Hys.	List Price	Type	Mean Hys.	List Price
VIC-1	.0085	\$11.00	VIC-11	.85	\$14.00
VIC-2	.013	11.00	VIC-12	1.3	14.00
VIC-3	.021	11.00	VIC-13	2.2	14.00
VIC-4	.034	11.00	VIC-14	3.4	14.00
VIC-5	.053	11.00	VIC-15	5.4	16.50
VIC-6	.084	11.00	VIC-16	8.5	16.50
VIC-7	.13	14.00	VIC-17	13	16.50
VIC-8	.21	14.00	VIC-18	21	16.50
VIC-9	.34	14.00	VIC-19	33	16.50
VIC-10	.54	14.00	VIC-20	52	16.50
			VIC-21	83	17.50

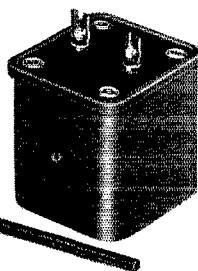

1½" L. x 1¼" W. x 1½" H.

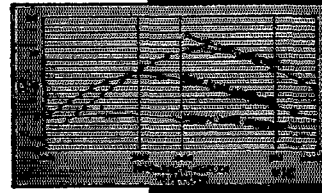
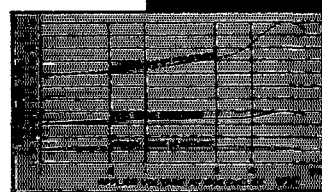
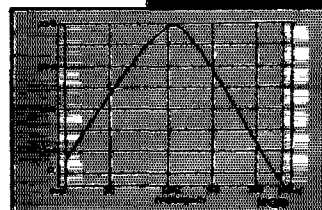
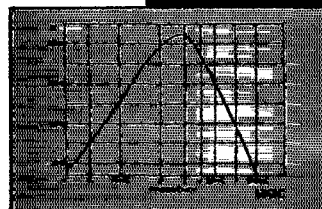
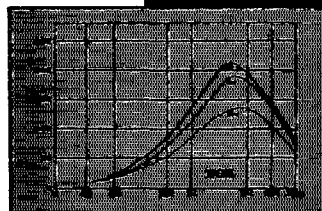
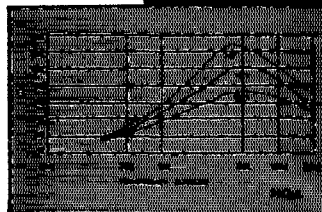

United Transformer Corp.

Write for catalog PS-408

LESS TIME SPENT CHASING TROUBLE

More time for rag-chewing

... that's your reward when you invest in these sturdy G-E triodes!

HAMS who use triodes know how easy they are to install and operate. Circuits can be less complex . . . neutralizing, once accomplished, is over and done with . . . minimum effort need be spent in knocking down parasitics in order to get a clean signal.

After firing up a pair of GL-810's or GL-8000's, your time can be devoted to mike and key while your repair-kit collects dust.

Exceptionally long-lived, these triodes! This means there are fewer of the annoying shifts in electrical characteristics that occur when tubes are nearing the end of usefulness. Heavy-duty 45-w filaments; large graphite anodes able to handle high momentary overloads; these extend tube life and ward off operating trouble.

The GL-810 and GL-8000 are versatile—both will serve in audio or r-f work. But the GL-810 is best as an a-f amplifier, needing only -60 v of grid bias when putting out 725 w of audio.

GL-8000 is an ideal r-f tube. A pair asks for only 16 w of drive when taking a full kilowatt's input on CW. And this is the CCS max input, with ICAS top rated at $1\frac{1}{2}$ kw. Plenty of power here!

The value-clincher is price. Either tube costs you *less than half* what most types of equal input sell for! Ask your G-E tube distributor today for the exact low figure. Or write for prices and data sheets ETX-150 and ETX-215 to Section A, Electronics Department, General Electric Company, Schenectady 5, New York.

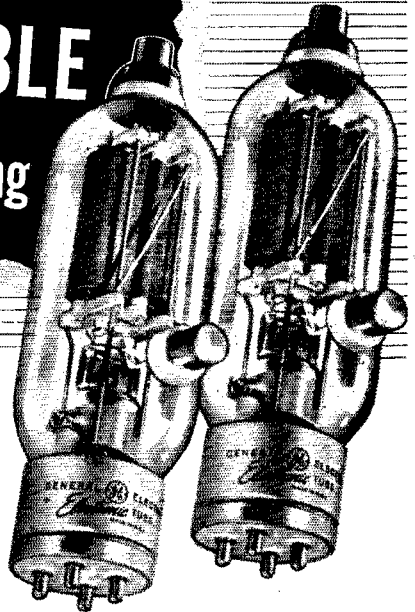

GL-810

GL-8000

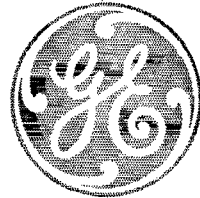

	GL-810	GL-8000
Filament voltage	10 v	10 v
Filament current	4.5 amp	4.5 amp
Amplification factor	36	16.5
Max ICAS input, Class C		
Telephony, per tube	500 w	500 w
Max ICAS input, Class C		
Telegraphy, per tube	750 w	750 w

ELECTRONIC TUBES OF ALL TYPES FOR THE RADIO AMATEUR

GENERAL  ELECTRIC

1B4-KA3



"like having a second right hand": W2IOP

First report from a 75A-2 user comes from Larry LeKashman, W2IOP, well known amateur operator who participates in contests in a big way.

For top performance, for scores that consistently rank with leaders in the country, Larry has long been an advocate of intimate familiarity with every piece of equipment in his shack.

A Collins 75A-2 amateur receiver was delivered to him just two hours before the start of the 1950 SS. Twenty-two hours later, after over 640 contacts in every state in the union, W2IOP had this to say:

"Its performance was like having a second right hand. Ease of handling coupled with unmatched performance made me feel like this receiver was an old friend. It was amazing to me that it was possible to feel so completely at home with this complicated unit in so short a period of time."

He added that "my own personal comments about the receiver can be summed up as 'terrific.' The crystal filter and noise



limiter were superb, and there was no indication of blocking at any time, even with the receiver running wide open alongside the transmitter."

The 75A-2 was designed specifically for the radio amateur. It reflects the same high standards of engineering and manufacturing which produce all Collins communications gear for the airlines and the Armed Forces. Order from your Collins distributor, and expect gratifying performance.

FOR THE BEST IN AMATEUR EQUIPMENT, IT'S . . .

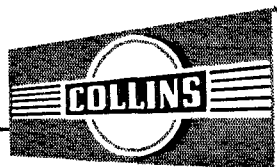

COLLINS RADIO COMPANY, Cedar Rapids, Iowa

11 West 42nd Street, NEW YORK 18

2700 West Olive Avenue, BURBANK

PUBLISHED, MONTHLY, AS ITS OFFICIAL ORGAN, BY THE AMERICAN RADIO RELAY LEAGUE, INC., AT WEST HARTFORD, CONN., U. S. A.; OFFICIAL ORGAN OF THE INTERNATIONAL AMATEUR RADIO UNION

STAFF

Editorial

A. L. BUDLONG, W1BUD
Editor

HAROLD M. MCKEAN, W1CEG
Managing Editor

GEORGE GRAMMER, W1DF
Technical Editor

DONALD H. MIX, W1TS
BYRON GOODMAN, W1DX
Assistant Technical Editors

EDWARD P. TILTON, W1HDO
V.H.F. Editor

RICHARD M. SMITH, W1FTX
C. VERNON CHAMBERS, W1JEQ
Technical Assistants

ROD NEWKIRK, W9BRD
DX Editor

WALTER E. BRADLEY, W1FWH
Technical Information Service

Production

RALPH T. BEAUDIN, W1BAW
Production Manager

NANCY A. PRICE
Assistant

Advertising

LORENTZ A. MORROW, W1VIG
Advertising Manager

F. CHEYNEY BEEKLEY, W1GS
Advertising Consultant

Circulation

DAVID H. HOUGHTON
Circulation Manager

RALPH T. BEAUDIN, W1BAW
Assistant Circulation Manager

OFFICES

38 La Salle Road

West Hartford 7, Connecticut

TEL.: 3-6268 TWX: HF 88
Subscription rate in United States and Possessions, \$4.00 per year, postpaid; \$4.25 in the Dominion of Canada, \$5.00 in all other countries. Single copies, 40 cents. Foreign remittances should be by international postal or express money order or bank draft negotiable in the U. S. and for an equivalent amount in U. S. funds.

Entered as second-class matter May 29, 1919, at the post office at Hartford, Connecticut, under the Act of March 3, 1879. Acceptance for mailing at special rate of postage provided for in section 1102, Act of October 3, 1917, authorized September 9, 1922. Additional entry at Concord, N. H., authorized February 21, 1929, under the Act of February 28, 1925.

Copyright 1951 by the American Radio Relay League, Inc. Title registered at U. S. Patent Office. International copyright secured. All rights reserved. *Quedan reservados todos los derechos.* Printed in U.S.A.

INDEXED BY
INDUSTRIAL ARTS INDEX

— CONTENTS —

"It Seems to Us . . ."	9
Hamming by the Touch System	10
A Two-Stage Linear R.F. Amplifier <i>Byron Goodman, W1DX</i>	13
An Electronic Lightning Calculator <i>Philip S. Rand, W1DBM</i>	17
Silent Keys	23
The "WWV-er" <i>C. Vernon Chambers, W1JEQ</i>	24
We Have New Regulations	26
Adjustable Dummy Antennas . <i>George Grammer, W1DF</i>	32
In QST 25 Years Ago This Month	33
An All-Band Mobile Station <i>William H. Rawson, K2AX</i>	34
United States Naval Reserve	37
Happenings of the Month	38
Substitute for Phillips Trimmers in Low-Power Bandpass Rig	39
Hams Aid Korean War Effort	40
The Deluxe Fixed-Portable Package <i>Gilbert L. Countryman, W3HH</i>	42
On the Air with Single Sideband	47
I.A.R.U. News	48
Technical Topics —	
Some Facts of Modulation	49
Operation SET — 1950 <i>George Hart, W1NJM</i>	52
How's DX?	55
Using the Pi-Section Antenna Coupler <i>John T. McWatters, W2CBK</i>	58
U.S.A. Calling	60
The World Above 50 Mc.	61
Hints and Kinks	64
Operating News	65
With the AREC	69
Station Activities	71
ARRL QSL Bureau	120
Hamfest Calendar	122

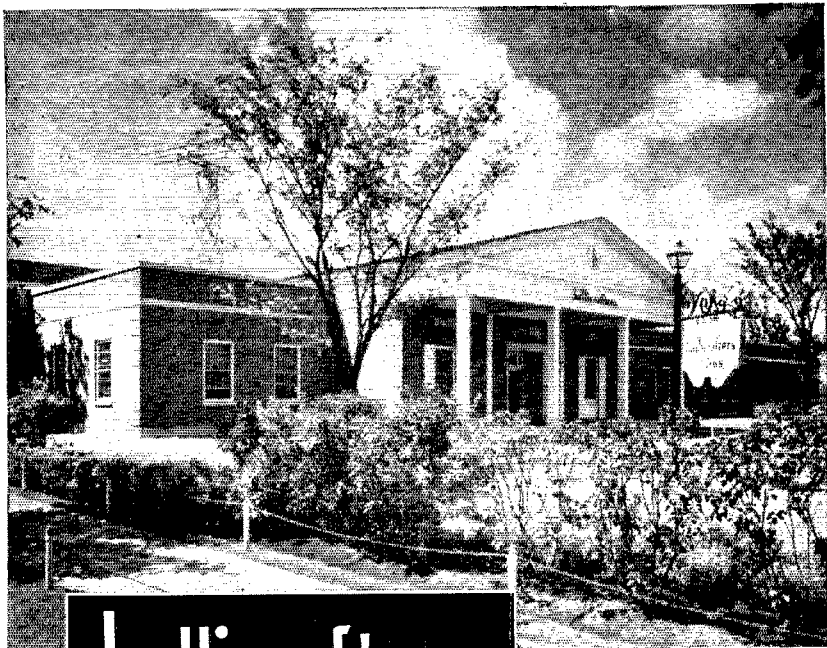

hallicrafters
"The Radio Man's Radio"

Hallicrafters Block Long Main Plant—Chicago, Ill.

*Precision
 Radio*

famous throughout
 the world . . .

Hallicrafters precision instruments have been sold in 89 countries, used by 33 governments. They are remembered by veterans, prized by experts, and preferred by radio amateurs throughout the world who want a radio that is all radio.

The BIGGEST "Ham Shack" in the World...

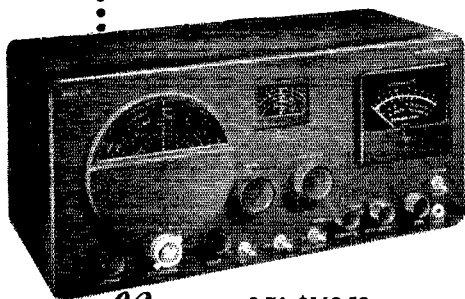

New S-76 \$169.50
 DUAL CONVERSION RECEIVER
 WITH 50-KC 1-F

SX-71. 11-tube Double conversion receiver. 538 kc to 35 Mc. 46-56 Mc. Crystal filter.....\$199.95.

From the block-long building above comes more Ham equipment than any place else in the world. Its elegant Georgian design gracefully conceals the modern precision laboratories and humming production lines within.

You've read about it, you've heard about it, now here it is—with the most wanted features, at the lowest possible price.

DUAL CONVERSION (1650 kc and 50 kc)—more usable selectivity than the best crystal.

GIANT 4-in. "5" METER—calibrated in microvolts and "S" units.

OTHER FEATURES: Four bands 538-1580 kc, 1720 kc to 32 Mc. Calibrated electrical bandspread. 5 position selectivity. Sensitivity 2 microvolts or better with .5 watt output. 9 tubes plus regulator, rectifier.

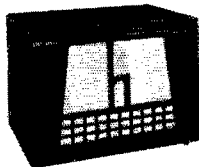

R-46 SPEAKER
 New 10" PM in Satin black cabinet. 80 to 5000 cycle range. 500-ohm matching transformer. 15" wide, 10 1/4" high, 10 1/4" deep....\$19.95

the hallicrafters co.

WORLD'S LEADING MANUFACTURER OF PRECISION RADIO & TELEVISION • CHICAGO 24, ILLINOIS

How to Make Friends

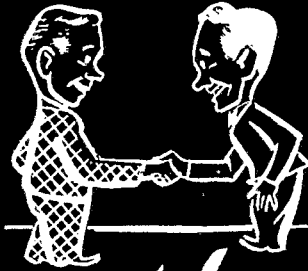

and keep them!



Many a beautiful friendship has been lost to a handful of kilocycles! More and more . . . under crowded present day band conditions . . . amateurs are learning IT PAYS TO STAY PUT . . . with PR Precision CRYSTAL CONTROL. Yes, PRs

pay off . . . with stable, trouble-free operation on spot frequencies . . . where you can make friends and keep them. Whether you operate phone or CW, or both, you will appreciate the fine dependability, high output, economical operation and hair-line accuracy of PR Crystals. They're UNCONDITIONALLY GUARANTEED, and your Jobber can supply you with the EXACT FREQUENCY YOU WANT (Integral kilocycle) WITHIN THE AMATEUR BANDS AT NO EXTRA COST, NO PREMIUM. Insist on genuine PRs!

20 METERS, Type Z-3, \$3.75 • 40, 80 AND 160 METERS, Type Z-2, \$2.75

PR

Crystals



USE **PR** AND KNOW WHERE YOU ARE

PETERSEN RADIO COMPANY, INC.
2800 W. BROADWAY • COUNCIL BLUFFS, IOWA

Section Communications Managers of the ARRL Communications Department

Reports Invited. All amateurs, especially League members, are invited to report station activities on the first of each month (or preceding month) direct to the SCM, the administrative ARRL official elected by members in each Section. Radio Club reports are also desired by SCMs for inclusion in *QST*. All ARRL Field Organization appointments are now available to League members. These include ORS, OES, OPS, OO and OBS. Also, where vacancies exist SCMs desire applications for SEC, EC, RM, and PAM. In addition to station and leadership appointments for Members, *all amateurs* in the United States and Canada are invited to join the ARRL Emergency Corps (ask for Form 7).

ATLANTIC DIVISION			
Eastern Pennsylvania	W3BES	Jerry Mathis	617 Crescent Ave.
Maryland-Delaware-D.C.	W3BWT	Eppa W. Darne	132 Tennessee Ave., N.E.
Southern New Jersey	W2ASG	Dr. Luther M. Mkitarian	500 Warwick Road
Western New York	W2CGT	Harding A. Clark	RFB 22
Western Pennsylvania	W3KWL	Ernest J. Hinsky	509 Beechwood Ave.
CENTRAL DIVISION			
Illinois	W9EVI	Lloyd E. Hopkins	27 Lynch St.
Indiana	W9RE	W. E. Monigan	1504 East Ewing
Wisconsin	W9RQM	Reno W. Goetsch	929 S. 7th Ave.
DAKOTA DIVISION			
North Dakota	W0JWV	Rev. Lawrence C. Strandenaes	St. Andrew's Church
South Dakota	W0NGM	J. S. Foasberg	509 Idaho Ave., S.E.
Minnesota	W0MXX	Charles M. Bove	1611 1/2 E. Lake St.
DELTA DIVISION			
Arkansas	W5DRW	Dr. John L. Stockton	P. O. Box 302
Louisiana	W5GHT	Robert E. Bar	Box 44
Mississippi	W5JHS	Norman B. Feehan	P. O. Box 491
Tennessee	W4AFI	D. G. Stewart	McAlice Drive
GREAT LAKES DIVISION			
Kentucky	W4KKG	I. W. Lyle, jr.	R. R. 3
Michigan	W8DLZ	Norman C. MacPhail	1340 Giddings, S.E.
Ohio	W8HGW	Leslie Misch	21380 Mastick Rd.
HUDSON DIVISION			
Eastern New York	W2CLL	George W. Sleeper	76 Fuller Road
N. Y., C. & Long Island	W2OBJ	George V. Cooke	23-41 239th St.
Northern New Jersey	W2NKD	Thomas J. Ryan, jr.	1082 Anna St.
MIDWEST DIVISION			
Iowa	W0PFP	William G. Davis	3rd St.
Kansas	W0ICV	Earl N. Johnston	624 Roosevelt
Missouri*	W0HUI	H. Glenn Lipscomb	400 Hderman Drive
Nebraska	W0EED	Scott E. Davison	433 North Nye Ave.
NEW ENGLAND DIVISION			
Connecticut	W1VIB	Walter L. Glover	Glover Ave.
Maine	W1VIV	Marlow W. Haskell	15 Hemlock St.
Eastern Massachusetts	W1ALP	Frank L. Baker, jr.	91 Atlantic St.
Western Massachusetts	W1EOB	Victor W. Paounoff	26 Denton Circle
New Hampshire	W1INC	Norman A. Chapman	98 South St.
Rhode Island	W1CIH	Roy B. Fuller	17 Ledge Road
Vermont	W1NLO	Burtis W. Dean	P. O. Box 81
NORTHWESTERN DIVISION			
Alaska	KL7IG	Charles M. Gray	Box 1237
Idaho	W71WU	Alan K. Ross	2105 Irene St.
Montana	W7KGJ	Edward G. Brown	421 Yellowstone Ave.
Oregon	W7MO	J. E. Roden	519 N.W. Ninth
Washington	W7CZY	Laurence Sebring	Route 2, Box 384
PACIFIC DIVISION			
Hawaii	KH6RU	John R. Sanders	60 Mackay Radio & Telegraph Co., Inc., Box 2993
Nevada	W7BVZ	Carroll W. Short, jr.	1608 Arizona St.
Santa Clara Valley	W6LZL	Roy I. Couzin	7 Englewood Ave.
East Bay	W6TTI	Horace R. Greer	414 Fairmount Ave.
San Francisco	W6AFO	R. H. Konowitz	24 E. Plon Ave.
Sacramento Valley	W6ZF	Ronald G. Martin	2638 13th St.
San Joaquin Valley	W6FYM	E. Howard Hale	741 E. Main St.
ROANOKE DIVISION			
North Carolina	W4DCQ	Herman P. Jolitz	P. O. Box 48
South Carolina	W4AZT	Wade H. Holland	P. O. Box 116
Virginia	W4FF	H. Edgar Lindauer	Route 1, Box 431
West Virginia	W8JM	Donald B. Morris	303 Home St.
ROCKY MOUNTAIN DIVISION			
Colorado	W0IQZ	M. W. Mitchell	1959 Uinta St.
Utah	W7SP	Leonard F. Zimmerman	House 4
Wyoming*	W7HNI	A. D. Gaddis	P. O. Box 786
SOUTHEASTERN DIVISION			
Alabama	W4LEN	Lewis C. Garrett	818 Maplewood Ave.
Eastern Florida	W4FWZ	John W. Hollister	3809 Springfield Blvd.
Western Florida*	W4MSS	Edward J. Collins	1003 E. Blount St.
Georgia	W4ZD	James P. Born, jr.	25 First Ave., N.E.
West Indies (Cuba-P.R.-V.I.)	KP4DJ	William Werner	563 Ramon Llovet
Canal Zone	KZ5AW	Everett R. Kimmel	Box 264
SOUTHWESTERN DIVISION			
Los Angeles*	W6IOX	Vincent J. Haggerty	1017 Indio Muerto St.
Arizona	W7MID	R. M. Canedy	451 N. 8th St.
San Diego	W6VYM	Mrs. Ellen White	3677 Wightman St.
WEST GULF DIVISION			
Northern Texas	W5BKH	William A. Green	1834 University Blvd.
Oklahoma	W5AHT/AST	Frank E. Fisher	104 East 11th St.
Southern Texas*	W5FJF	Dr. Charles Fermaglich	618 Medical Arts Bldg.
New Mexico*	W5BIW	Richard J. Matthias	P. O. Box 548
MARITIME DIVISION			
Maritime (Nfld. & Labr. att.)	VE1DQ	A. M. Crowell	Dublin St.
ONTARIO DIVISION			
Ontario	VE3IA	G. Eric Farquhar	16 Emerald Crescent
QUEBEC DIVISION			
Quebec	VE2GL	Gordon A. Lynn	R.R. No. 1
VANALTA DIVISION			
Alberta	VE0MJ	Sydney T. Jones	P. O. Box 373
British Columbia	VE7EB	Ernest Savage	4353 West 12th Ave.
Yukon	VE8AK	W. R. Williamson	P. O. Box 534
PRAIRIE DIVISION			
Manitoba	VE4AM	A. W. Morley	26 Lennox Ave.
Saskatchewan	VE5HR	Harold R. Horn	1044 King St.
GLENSIDE DIVISION			
			Washington 2, D.C.
HURON DIVISION			
			Minneapolis 7
SILYOAM DIVISION			
			Springfield
GULF DIVISION			
			Fountain City
JEFFERSON DIVISION			
			Grand Rapids
CREVELAND DIVISION			
			Elizabeth 4
MITCHELL DIVISION			
			Topeka
SPRINGFIELD DIVISION			
			Concord
EAST GREENWICH DIVISION			
			Burlington
BOULDER DIVISION			
			Los Gatos
OAKLAND DIVISION			
			San Francisco 12
SACRAMENTO DIVISION			
			Turlock
CLINTON DIVISION			
			Greenville
ANNANDALE DIVISION			
			Fairmont
DENVER DIVISION			
			Saltair
SALTIRE DIVISION			
			Gillette
ANNISTON DIVISION			
			Jacksonville
YENSCOLA DIVISION			
			Atlanta
URB. TRUMAN DIVISION			
			Rio Piedras, P. R.
GAMBOA DIVISION			
			C. Z.
SANTA BARBARA DIVISION			
			San Diego
ABIENE DIVISION			
			Pawhuska
HOUSTON DIVISION			
			State College
HALIFAX DIVISION			
			Burlington, Ont.
ST. GENEVIEVE DIVISION			
			Pierrefonds, P. Q.
EDMONTON DIVISION			
			Whitehorse, Y. T.
ST. VITAL DIVISION			
			Saskatoon

* Officials appointed to act temporarily in the absence of a regular official.

all the world's your neighbor with . . .

hallicrafters

long range

Portable

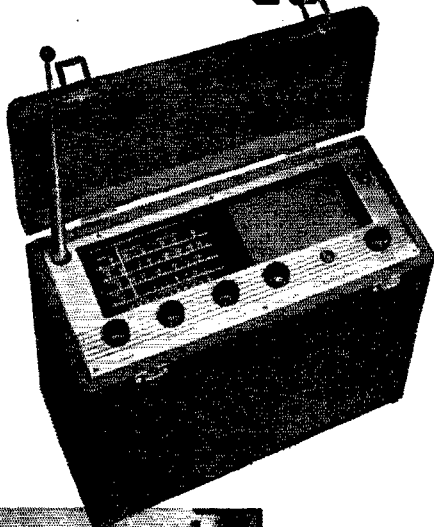

You'll always be in touch with the outside world wherever you go with this extra-sensitive, all-wave portable radio.

One stage r-f, two stages i-f amplification. Built-in loop antenna for broadcast, plus 61" collapsible whip for short-wave. Band-spread tuning knob for separation of short-wave stations. Sensitivity control combined with code (BFO) switch. Jack for headphones.

Brown leatherette cabinet, 14" wide, 12 $\frac{1}{4}$ " high, 7 $\frac{1}{4}$ " deep. Space inside for power cord and headphones. 8 tubes plus rectifier. Less batteries. For 115 V. AC or DC or battery.

LONG-WAVE MODEL S-72L. Marine beacons, aircraft ranges and towers 175-420 kc. Broadcast, short-wave 540 kc-12.5 mc. Price \$119.95

REGULAR MODEL S-72. 540 kc-30 mc. \$109.95



Plenty of sensitivity for far-distant stations, even where ordinary receiving sets fail.

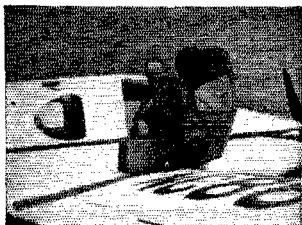

Long wave model gets airport towers and ranges—ideal for plane owners.

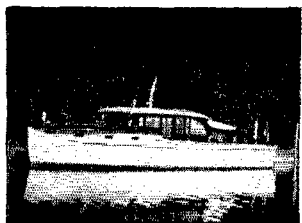

Long wave model gets marine beacons, gives rough "DF" bearings if ever needed.



THE AMERICAN RADIO RELAY LEAGUE, INC.,

is a noncommercial association of radio amateurs, bonded for the promotion of interest in amateur radio communication and experimentation, for the relaying of messages by radio, for the advancement of the radio art and of the public welfare, for the representation of the radio amateur in legislative matters, and for the maintenance of fraternalism and a high standard of conduct.

It is an incorporated association without capital stock, chartered under the laws of Connecticut. Its affairs are governed by a Board of Directors, elected every two years by the general membership. The officers are elected or appointed by the Directors. The League is noncommercial and no one commercially engaged in the manufacture, sale or rental of radio apparatus is eligible to membership on its board.

"Of, by and for the amateur," it numbers within its ranks practically every worth-while amateur in the nation and has a history of glorious achievement as the standard-bearer in amateur affairs.

Inquiries regarding membership are solicited. A bona fide interest in amateur radio is the only essential qualification; ownership of a transmitting station and knowledge of the code are not prerequisite, although full voting membership is granted only to licensed amateurs.

All general correspondence should be addressed to the Secretary at the administrative headquarters at West Hartford, Connecticut.



Past Presidents

HIRAM PERCY MAXIM, W1AW, 1914-1936
EUGENE C. WOODRUFF, W8CMP, 1936-1940

Officers

President GEORGE W. BAILEY, W2KH
New York, N. Y.

Vice-President WAYLAND M. GROVES, W5NW
Odessa, Texas

Secretary A. L. BUDLONG, W1BUD
West Hartford, Connecticut

Communications Manager FRANCIS E. HANDY, W1BDI
West Hartford, Connecticut

Treasurer DAVID H. HOUGHTON
West Hartford, Connecticut

General Counsel PAUL M. SEGAL
816 Connecticut Ave., Washington 6, D. C.

Assistant Secretaries JOHN HUNTOON, W1LVQ
RICHARD L. BALDWIN, W1KIE HARRY PASTON, W1DJV
West Hartford, Connecticut

DIRECTORS

President
GEORGE W. BAILEY, W2KH
1 East 79th St., New York 21, N. Y.

Vice-President
WAYLAND M. GROVES, W5NW
P. O. Box 586, Odessa, Texas

Canadian General Manager
ALEX REID, VE2BE
240 Logan Ave., St. Lambert, P. Q.
Alternate: William W. Butchart, VE6LQ
10740 107 St., Edmonton, Alta.

Atlantic Division
WALTER BRADLEY MARTIN, W3QV
1033 Arbutha Rd., Abington, Pa.
Alternate: Henry W. Wlekenhiser, Jr., W3KWA
1112 State Ave., Coraopolis, Pa.

Central Division
WESLEY E. MARRINER, W9AND
624 College Ave., Dixon, Ill.
Alternate: Charles F. Reberg, W9MVZ
3900 W. 10th Ave., Gary, Ind.

Dakota Division
GOODWIN L. DOSLAND, W0TSN
Moorhead, Minn.
Alternate: Alfred M. Gowan, W0PBR
325 S. Menlo Ave., Sioux Falls, S. D.

Delta Division
VICTOR CANFIELD, W5BSR
P. O. Box 965, Lake Charles, La.
Alternate: George S. Acton, W5BMM
Plain Dealing, La.

Great Lakes Division
JOHN H. BRABB, W8SPF
417 Ford Bldg., Detroit 26, Mich.
Alternate: Harold E. Stricker, W8WZ
247 W. 5th St., Marysville, Ohio

Hudson Division
JOSEPH M. JOHNSTON, W2SOX
423 Monmouth Ave., Bradley Beach, N. J.
Alternate: George V. Cooke, Jr., W2OBU
88-31 239th St., Bellerose 6, L. I., N. Y.

Midwest Division
LEONARD COLLETT, W0DEA
Civil Aeronautics Administration
Box 776, Joplin, Mo.
Alternate: Alvin G. Keyes, W0KTC
1201 Merchants Nat'l Bank Bldg., Cedar Rapids, Ia.

New England Division
PERCY C. NOBLE, W1BVR
37 Broad St., Westfield, Mass.
Alternate: Frank L. Baker, Jr., W1ALP
91 Atlantic St., North Quincy 71, Mass.

Northwestern Division
R. REX ROBERTS, W7CPY
837 Park Hill Drive, Billings, Mont.
Alternate: Karl W. Weingarten, W7BG
3219 N. 24th St., Tacoma 7, Wash.

Pacific Division
KENNETH E. HUGHES, W6CIS
810 W. Orange Ave., So. San Francisco, Calif.
Alternate: C. Porter Evans, W6BF
134 Dracena Ave., Piedmont 11, Calif.

Roanoke Division
WILLIAM H. JACOBS, W4CVQ
326 Circle Drive, Fayetteville, N. C.
Alternate: Gus M. Browning, W4BPD
135 Broughton St., S. E., Orangeburg, S. C.

Rocky Mountain Division
FRANKLIN K. MATEJKA, W0DD
P. O. Box 212, Estes Park, Colo.
Alternate: Ramon S. Walker, W0OWP
P. O. Box X, Brush, Colo.

Southeastern Division
LAMAR HILL, W4BOL
104 Myrtle, Cochran, Ga.
Alternate: William P. Sides, W4AUP
Fleming Road, Montgomery, Ala.

Southwestern Division
JOHN R. GRIGGS, W6KW
10412 Don Pico Rd., RFD 2, Spring Valley, Calif.
Alternate: Walter R. Joos, W6EKM
1315 N. Overhill Drive, Inglewood 3, Calif.

West Gulf Division
A. DAVID MIDDLETON, W5CA
9 Kay Road, Tlheras, N. M.
Alternate: Frank E. Fisher, W5AHT/AST
104 E. 11th, Pawhuska, Okla.

"It Seems to Us..."

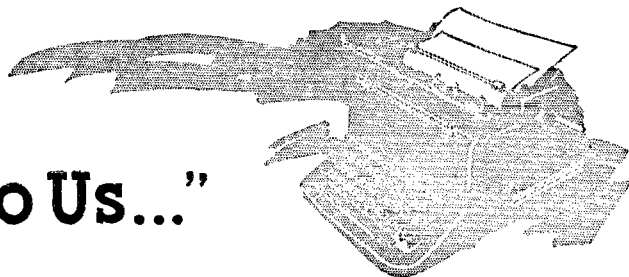

NEW ANTENNA RULES

If you live within a mile or so of an airport and have had some ideas for bigger and better antennas, we hope you got 'em up by February 15th. If not, you may have some headaches, mister.

We have reference to some new rules the Commission has just issued, effective February 15, 1951, concerning antenna masts and structures in the vicinity of airports; promulgated primarily for other services, they will henceforth apply also to amateurs.

Under the Communications Act, FCC has long had authority to "require the painting and/or illumination of radio towers if and when in its judgment such towers constitute, or there is a reasonable possibility that they may constitute, a menace to air navigation." In the past the Commission has had some brief rules covering this matter. A couple of years ago, it began an intensive study of the general problem, in collaboration with CAA, on the premise that its rules were out-of-date and inadequate to deal with a situation arising from increasing air traffic and rapidly-sprouting (or proposed) standard and TV broadcast towers, police installations, etc. In May of 1950 the Commission released a notice of intent to create an entirely new section of its rules which would contain rather elaborate specifications governing construction, marking and lighting of antenna towers and antenna supporting structures in the vicinity of airports. It appeared obvious from the context that these rules were designed strictly for commercial installations—the 200-foot b.c. verticals, 300-foot TV towers, and on up. However, the League examined the proposals carefully and, noting no specific exemption of amateurs was included, filed comment asking for exemption and documenting the request with illustrations of rather fantastic situations which would arise if the rules were to be applied to amateurs in their proposed form.

It was considerable of a surprise, therefore, when FCC made its rules final and said yes indeed, these rules will most definitely apply to amateurs as much as to any other station. Although minor modifications, in some re-

spects, reduce the number of outright fantastic examples if the rules are applied to amateurs, we think they are still going to result in some pretty silly situations, have a serious nuisance value to a considerable number of amateurs and prospective amateurs, and bring on a king-sized administrative headache to the Commission's staff.

The rules are complex, running to several pages of fine print in the *Federal Register*, and, when applied to amateurs at least, are apparently capable of several interpretations. The Headquarters is in process, at this writing, of attempting to determine exactly when an amateur will be affected and what he will be obliged to do. So far we don't have this dope from FCC (in some informal discussion with Commission personnel we found disagreement among even them on proper interpretation). What follows, then, is a brief discussion of the rules as we understand them at the moment, with revision possibly forthcoming later as the matter is given further study.

Only amateurs in the vicinity of airport landing areas are affected, although "in the vicinity of" may conceivably mean as much as ten miles in special cases. The rules say that an application for radio facilities (i.e., for a station license) must be accompanied by FCC Form 401A (revised) in cases where the proposed antenna structure will be more than 170 feet high or will exceed a height of one foot above ground for each 200 feet of distance from the nearest boundary of any landing area. We doubt if many hams contemplate 170-foot towers but the 1 for 200 ratio may involve quite a few of us. For instance, a prospective amateur 10,000 feet (roughly, two miles) airline from an airport will have to fill out the new form if he wants to construct a tower 51 feet or more in height; if he lives within a mile of the landing area, he won't be able to put up an antenna more than 26 feet above ground without application. For the time being, and until we get some of these things straightened out with FCC, you'd better make it a point to ask for Form 401A if you come within that 1/200 provision.

(Continued on page 104)

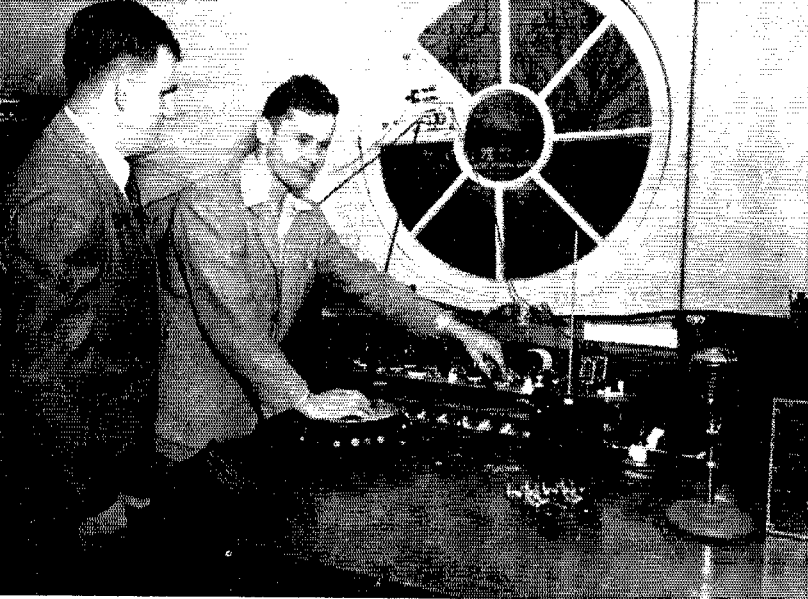

◆
 Instructor Gunderson stands by while student Bob Johnson adjusts the Institute's transmitter by auditory methods. The rig is the original model of a 5-band breadboard design built in the ARRL Lab in 1936.
 ◆

Hamming by the Touch System

A Day with Bob Gunderson, W2JIO

THE grounds of the Institute, just off Pelham Parkway, in the Bronx, look not unlike those of the numerous small colleges that dot the New York area. Only the occasional special warning signs to motorists set it apart. Even these seem largely unnecessary, for there are few more alert or competent pedestrians than the people who make up the student body and part of the faculty of the school we are about to visit.

We pick up W2JIO at his apartment on Waring Avenue, and he directs us as we drive around to Schermerhorn Hall, where the ham shack is located. "Go out to the wide street and turn right." We proceed as directed. "Okay, now turn down here to the right again . . . pull up there at the edge of the circle. Anywhere along here will do." All so matter-of-fact that, for the moment, we forget that the fellow who is conducting us around these busy streets has been blind since birth!

The same air of easy confidence is found wherever we go throughout the day. It shines in the face of the receptionist, Miss Frances Sievert, who finds time for a pleasant greeting as we come in the main entrance, though she is handling a considerable volume of incoming and outgoing telephone calls on her Braille switchboard. It is reflected in an eagerness to learn on the part of the dozen or so students we find working in the radio lab; the way they ply their "Mr. Gunn" with questions would gladden the heart of any teacher. But most of all, it is the motivating spirit of our host for the day.

Robert W. Gunderson, W2JIO, came to the New York Institute for the Education of the Blind in 1927. Before he had graduated he be-

came a teacher, starting a class in radio techniques for the blind, perhaps the first of its kind. Having demonstrated that he can do just about anything that can be handled by a person with normal sight, his highest aim in life is to convince other blind people that they can make their own way in a world of sighted folks, and to help them get started doing it. In the years since 1937 he has turned out more than 200 blind radio technicians, quite a few of whom are blinded World War II veterans. Some of these veterans came to the Institute in an almost hopeless state of mental depression, but they were quickly snapped out of it, and many of them are today holding down jobs in the radio and electronics field. Perhaps as important as the vocational training they receive is the knowledge that the blind, too, can get fun out of life. What better way than ham radio? If the New York area has a preponderance of the approximately 300 blind hams in the country, it is largely Gunderson's doing.

We follow Bob up three flights to the radio shack, marveling at the way he opens doors, switches on lights (for *our* benefit, of course), and otherwise makes himself perfectly at home in surroundings that have no special devices for the blind. The ham shack looks like any one of hundreds we've visited — no better, no worse. There is the usual clutter of gear and QSL cards. The haywire here and there looks just like your haywire, or ours. There is a breadboard transmitter by the window that savors a bit of the middle '30s — for good reason, Bob explains. "Principles haven't changed much since George Grammer described that rig in December, 1936, *QST*, and the open layout is easier to follow than

a schematic in Braille. With a small low-voltage plate supply it's just the thing for our boys to practice tuning up, and yet it puts out enough stuff to make some good contacts." The 5-band rig, complete with antenna coupler, is the original model built in the ARRL Lab more than 14 years ago, and it's still going strong!

There is a 522 for 2 meters, a pair of Command sets for c.w., and a snappy-looking multiband job in a steel cabinet. This one has us guessing, after Bob tells us that he built it himself. Those meters — what are *they* for? "Oh, I just stuck them in to make fellows like you feel at home!" He knocks the controls askew and proceeds to show us that it is possible to tune the rig quickly and easily without being able to watch the swinging pointers. There are lots of ways to measure current, voltage, or output — but that's getting ahead of our story. The meters also give Bob a chance to demonstrate a novel use for an instrument originally developed commercially as an electronic reader. It was a failure for its intended purpose, but Bob makes short work of spotting the position of the meter pointer with it. "It's a handy gadget for adjusting a TV set, too — not that it's much good to me to get the picture in sync!"

Now we walk across the campus to Boorman House, which houses the radio lab. This is a large basement room with perhaps half the space occupied by radio gear in various stages of being built or torn down. After years of burning our fingers, or pounding or drilling them, we find it a bit hard to believe that persons completely blind can be taught to handle all the operations that the construction of a modern transmitter or receiver entails. But here they are, doing all these things — with a varying degree of success and skill — but doing them, or learning to.

Handiwork in evidence today runs all the way from simple layouts that look for all the world like the first crystal set we built back in 1922 to multistage rack-and-panel units that stand up well under the most critical inspection. How is

all this done without schematic diagrams or layout drawings? The answer is found in thorough verbal instructions, transcribed in Braille if a record is necessary. This touch-system reading is the basis for much of the instruction; circuits are *described*, not drawn. "This audio transformer, Mr. Gunn — one side of it goes to control grid of the audio tube and the other to the socket ground lug. Is that right, Mr. Gunn?"

Soldering is one of the toughest jobs, and learning is almost certain to have its painful moments. The new quick-heating guns have helped a lot in this respect, but the boys must also learn to use the standard copper-tip method. Many burned fingers result, but major accidents are rare. Handling dangerous voltages is more of a problem. You can't sense the nearness of a 300-volt terminal in the way that you approach a hot soldering tip. Bob lets his students get a shock now and then, to teach them a healthy respect for high voltage, but the gear the boys use is designed to keep the shock possibilities far below lethal character.

The radio room is equipped with a code instruction table, complete with audio oscillator and up to 12 keying or listening positions. Copying code introduces another unconventional approach. Writing legibly at high speed is hard for the blind, and use of a typewriter involves still another skill to be acquired through much study and practice. Though Bob can take code on a mill at up to 45 w.p.m., he teaches students to dictate their copy, a method approved by FCC many years ago as a result of representations made by ARRL and organizations representing the blind.

At our request Bob furnished us with a list of some twenty blind hams who got their start in radio and their ham tickets as a result of his efforts at the Institute. We were going to run them at the end of this story, but when we re-read the words of W4PMO in a letter recently published in the Correspondence from Members section of *QST* we thought better of it. Writing

◆

A typical lab period at the New York Institute for the Education of the Blind. Students learn to do all the mechanical and electrical jobs encountered in the construction and maintenance of transmitters and receivers.

◆

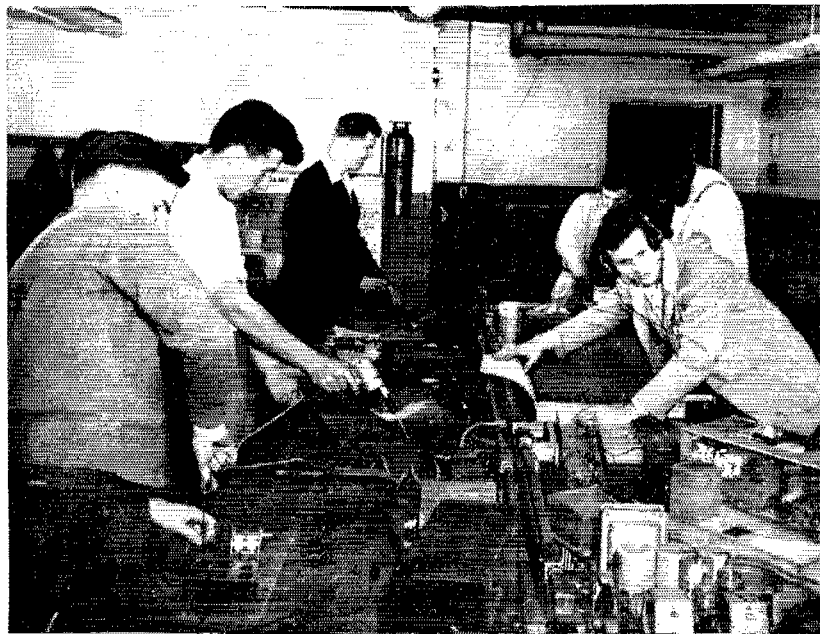

to protest modification of the amateur license requirements in favor of the blind, Dr. Lynn said: "Amateur Radio is the only major hobby I know of which a sightless person may enjoy on an equal footing with his seeing colleagues. Won't you let us keep this feeling of equality? We're proud of it!" So we will let those of our fraternity who do their hamming by the touch system remain anonymous unless they wish it otherwise. Perhaps you've chatted with several of them, and never knew.

— . . . —

This might be the end of our story, but it isn't. A while back we mentioned Gunderson's urge to help others along the road to independence via radio. One of the greatest barriers to the realization of this ambition is the lack of suitable literature in Braille. (Can you imagine getting started without recourse to *QST*, the *Handbook*, the *License Manual*, *How To Become a Radio Amateur*, and other printed texts?) The extent of technical literature in Braille is woefully inadequate. Years ago, through the cooperation of the Red Cross, the 1935 edition of the ARRL *Handbook* was done in Braille, but even this monumental task was none too helpful. Except for the simplest sort of drawing, Braille techniques are not adaptable to schematic presentation, and the numerous photographs are, of course, a total loss. Individual copies of the most useful sections of various ARRL publications have been transcribed in Braille by volunteer organizations at one time or another, but there has never been anything approaching a satisfactory quantity of properly prepared material available.

About a year ago Bob Gunderson was able to take the first step toward the accomplishment of his objectives in this respect. For years he had been planning a radio and electronics magazine for the blind. Braille texts are bulky; their preparation and distribution is a complex and expensive process, but Bob felt sure that he could do it with a little help. Then along came opportu-

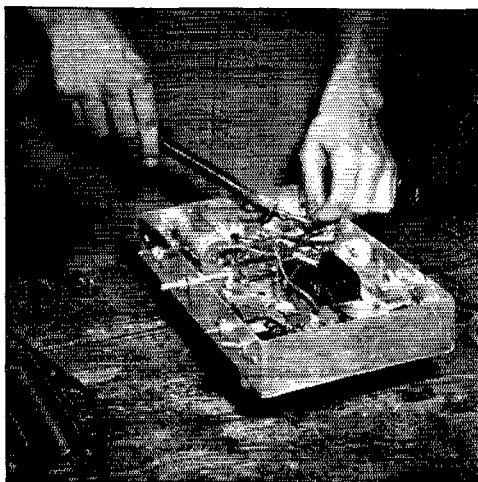

Soldering is no cinch when you can see. Would you like to try it blindfolded?

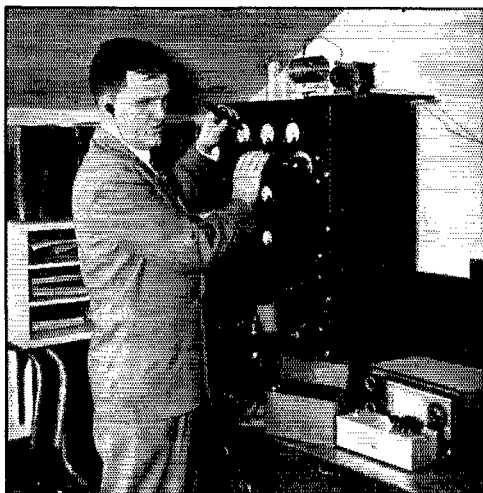

There are more ways than one to read a meter. W2JIO demonstrates the electronic-reader technique. Usually tune-up operations are done with simple audio adaptations of conventional measuring methods.

nity, in the form of an appearance on a national radio network program, Ralph Edwards' "This Is Your Life." The sponsors of the program financed the first issue of *The Braille Technical Press*, Robert W. Gunderson, editor. Bob and his devoted wife, Lillian, have kept it going since, but it has been a difficult and costly process.

At 50 cents a copy, the magazine is far from a money-maker, and Bob sends out any number of them free to fellows who can't afford the price. Here, we think, is a chance for hams to aid a worthy cause. Many send in money to ARRL each year to pay for *QST* subscriptions to be sent to worthy (and often unnamed) foreign amateurs. Would not these and others also be willing to provide a year of *The Braille Technical Press* for some worthy blind ham or ham-to-be? Can't afford \$6.00? Then how about paying for the mailing of one issue, or two? Send contributions direct to Robert W. Gunderson, W2JIO, The Braille Technical Press, Inc., 980 Waring Ave., New York 67, N. Y.

Some of the most popular items in the issues of *The Braille Technical Press* so far published have been descriptions of test equipment Bob has designed for use by blind hams and technicians. By substituting auditory methods for visual, he has made it possible for the blind ham to check the operation of his gear with surprising accuracy. Volt-ohmmeters, capacity checkers, field-strength meters, grid-dip oscillators, r.f. ammeters — name the gear you want, and Bob will produce an equivalent for the blind. Some of them, including a 100,000-ohm-per-volt test set, have features that make them of considerable interest to sighted workers as well as blind. An article describing these techniques is now in preparation. Watch for it in an early issue of *QST*.

— E. P. T. & H. M. M.

A Two-Stage Linear R.F. Amplifier

More Power for Your S.S.B. Signal

BY BYRON GOODMAN,* WIDX

IN the normal course of amateur work you don't run into linear r.f. power amplifiers unless you have a s.s.b. exciter that doesn't have as much power output as you would like. Practically all a.m. transmitters modulate at high level, in the output stage, so there really isn't much need for getting acquainted with linear amplifiers until you try s.s.b. Our receivers use a number of linear r.f. amplifiers, but these operate at low level in Class A, and unless we stop and think about them we might be inclined to say, "Nope, never had a linear amplifier in the shack."

Linear amplifiers, for either audio or r.f., can operate anything from pure Class A to pure Class B. Class A means that the tubes draw current during all of the excitation cycle, and is usually associated with no grid current and no change in average plate current. Class B means, in the strictest definition, that the tubes draw current during only one half of the excitation cycle, or they can be said to have an operating angle of 180 degrees. Nothing is said about grid current in the definition, but most practical Class B amplifiers draw grid current over a large portion of the half cycle. Class AB means operating between A and B — the subscript "1" means no grid current, and the subscript "2" means grid current during some part of the cycle. Thus Class AB₁ amplifiers will show some change in average plate current as the signal level is changed, but they never show grid current. Class AB₂ behave much the same but they draw grid current at some signal levels.

* Assistant Technical Editor, QST.

Because none of the vacuum tubes available has perfectly linear characteristics right down to zero plate current, one can't always be strict about the definitions. For example, a pure Class B amplifier would be biased right to cut-off, drawing no plate current with no signal. Actually, they are biased almost to cut-off, and at low signal levels they operate AB₁ or AB₂. This makes no practical difference — the point is just thrown in to deter anyone who might be too strict about the definitions. If you remember that the classification of the amplifier is made at or near full output, we won't get into any trouble with nomenclature.

The efficiency of a linear amplifier increases as you approach Class B operation, so most high-powered amplifiers are operated in AB₂ or B. Since they draw grid current, driving power is required, and it must be furnished undistorted if the amplifier is to be linear. On the other hand, the more inefficient Class A or AB₁ amplifiers require only enough driving power to overcome stray losses in the grid circuit, and their power sensitivity runs quite high. Thus they are quite suitable for low-powered stages where power economy is of little importance.

Probably any tubes can be made to operate satisfactorily as Class B r.f. amplifiers, but the driver problem is greatly reduced if zero-bias tubes can be used. When negative-bias tubes are used, such as any of the tetrodes and most of the triodes, the load on the driver changes as the signal swings in and out of the grid-current re-

◆

A two-stage linear amplifier for boosting the power level of a s.s.b. signal. The large knobs control the antenna coupling and output plate tuning. Meters indicate grid and plate currents of the output stage.

◆

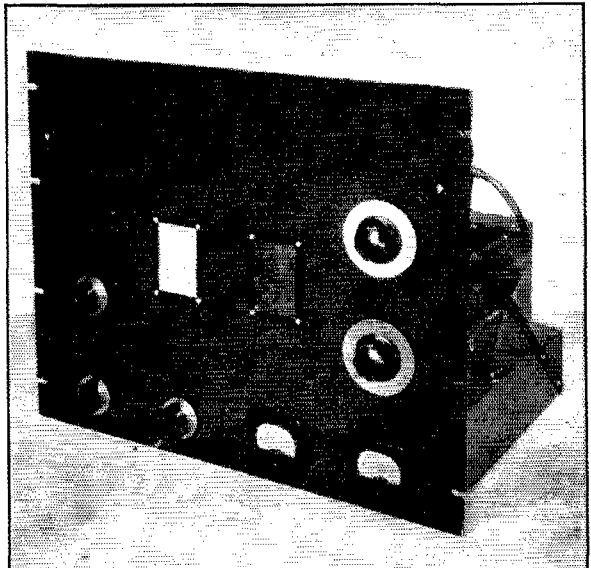

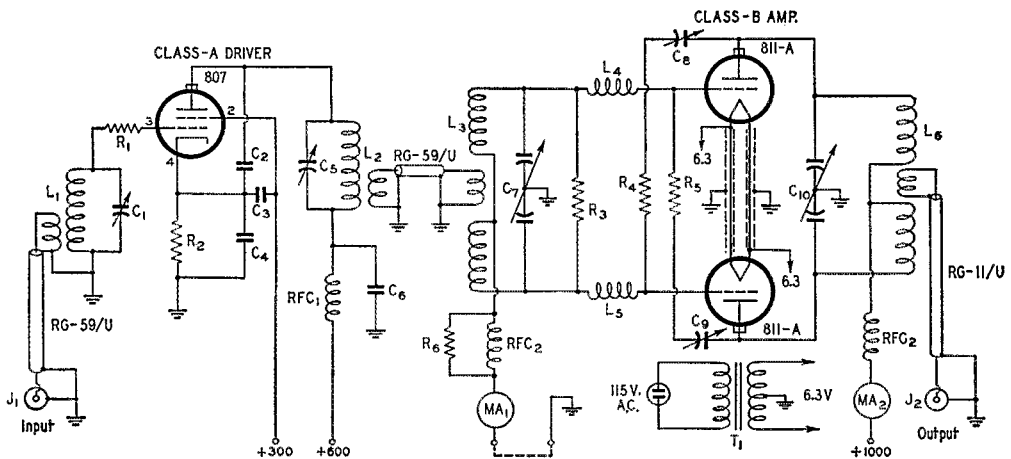

Fig. 1 — Wiring diagram of the linear amplifier.

- C₁ — 140- μ fd. variable (Millen 19140).
- C₂ — 13- μ fd. tubular, made of RG-58/U. Active length, 6 inches.
- C₃, C₄ — 0.005- μ fd. disc ceramic.
- C₅ — 140- μ fd. variable (Millen 22140).
- C₆ — 0.001- μ fd. 1200-volt mica.
- C₇ — Dual variable, 100 μ fd. per section (Millen 24100).
- C₈, C₉ — Disc-type neutralizing condensers with feed-through base (Bud NC-853).
- C₁₀ — Dual variable, 200 μ fd. per section, 0.077-inch spacing (National MC-200D).
- R₁ — 100 ohms, $\frac{1}{2}$ watt.

- R₂ — 680 ohms, 2 watts.
- R₃ — 2700 ohms, 4 watts (four 2700-ohm in series-parallel).
- R₄, R₅ — 20 ohms, 2 watts.
- R₆ — 1000 ohms, 1 watt.
- All resistors are composition, not wire-wound.
- J₁ — Input connector (Jones S-101-D).
- J₂ — Coaxial-line connector (Amphenol 83-1R).
- MA₁ — 0-50 milliammeter.
- MA₂ — 0-500 milliammeter.
- RFC₁ — 2.5-mh. 300-ma. r.f. choke.
- RFC₂ — 200- μ h. 75-ma. r.f. choke.
- RFC₃ — 5-mh. 300-ma. r.f. choke (National R300S).
- T₁ — 6.3-volt 10-amp. transformer (Stancor P-6308).

gion, and the driver is hard put to deliver an undistorted signal. With zero-bias tubes, the driven tubes draw grid current under any and all signal conditions, and the load on the driver is more nearly constant. When using negative-bias tubes, "swamping resistors" are used across the grid tank to offer a more nearly constant load to the driver. These resistors waste driver power, however, and it is nice to be able to avoid using them.

The 811-A is our choice for a Class B stage, since it can be used with from 1000 to 1200 volts on the plate with zero grid bias, and a pair will deliver from 180 to 250 watts peak in this plate-voltage range. On s.s.b., this amount of power output puts you on a par with a kilowatt a.m. 'phone, so far as useful power at a selective receiver is concerned, so it isn't any "sissy" thing.

The driver stage is logically something running Class A or AB₁, to minimize its drive requirements and offer maximum power sensitivity. It is hard to find a tube better suited for the purpose than the 807, since it is inexpensive and will deliver the required power. One 807 will drive a pair of 811-As with 1200 volts on their plates — if the 811-As are to be operated with a plate voltage of 1500 and a peak output of 400 watts, a pair of 807s is required.

The Circuit

The circuit of an amplifier like this doesn't look much different than the usual Class C amplifier arrangement, since the only real differences are in the operating conditions (bias and loading). It

can be seen in the wiring diagram, Fig. 1, that the 807 stage looks like any other, except that it uses cathode bias. A small resistor, R₁, in series with the control grid, and a coaxial plate-to-cathode condenser, C₂, are included to eliminate a tendency to oscillate at various and assorted frequencies, as can be expected of a tetrode running Class A. The 807 is link-coupled to the grid circuit of the 811-As, to confine the ground returns to their respective stages and to provide a simple means for adjusting the coupling. Since the over-all gain of a two-stage amplifier like this is quite high, it is advisable to return the ground leads within a stage to a single point, to reduce the chances for over-all feed-back.

In the 811-A stage, the chokes L₄ and L₅ were required to detune a v.h.f. parasitic that showed up, and R₆ knocked out a low-frequency one. The two resistors, R₄ and R₅, in the neutralizing circuit may seem a little unusual, but they were found necessary to kill a v.h.f. parasitic. Loading the grid circuit slightly with R₃ killed the last traces of instability. If all of these suppression devices make it sound like the amplifier is a hotbed of oscillations, just remember that this stage has considerably more gain than the usual Class C amplifier. Several of the parasitic oscillations could be killed easily by using grid-leak bias, but that isn't the way you operate a linear amplifier.

No filament by-pass condensers were used because they weren't found to be necessary. The filament wiring was done with shielded wire, however, and this adds a little filament-to-ground

COIL TABLE FOR TWO-STAGE LINEAR AMPLIFIER

Band	Turns	Wire No.	Diam.	Length	μ h.	Link	Spacing
L_1^*							
3.9	22 $\frac{1}{2}$	20 enam.	1	$\frac{3}{4}$	10	4	$\frac{1}{16}$
14	10 $\frac{1}{2}$	20 enam.	1	$\frac{3}{4}$	2.5	3	$\frac{1}{16}$
L_2^{**}							
3.9	25	20 enam.	1	$\frac{7}{8}$	11.2	4	$\frac{1}{16}$
14	11	20 enam.	1	$\frac{3}{4}$	2.5	3	$\frac{1}{8}$
L_3^{***}							
3.9	22	22 enam.	1 $\frac{1}{4}$	1 $\frac{1}{4}$	9.4	6	Adjustable
14	12	18 enam.	1 $\frac{1}{4}$	1 $\frac{1}{8}$	3.3	4	Adjustable
L_6^{****}							
3.9	22	16 enam.	2 $\frac{1}{2}$	2 $\frac{1}{4}$	20	3	Adjustable
14	8	0.15 tubing	2 $\frac{1}{2}$	3 $\frac{3}{4}$	2.3	3	Adjustable

* Wound on Millen 45004 plug-in form.

** Wound on Millen 45005 plug-in form.

*** National AR-16-40S and AR-16-20S. 75-meter coil shunted by 150- μ fd. mica condenser.

**** B & W 80TVL with 18 turns removed, and B & W 15TVL.

capacity. All of the non-r.f. leads were made with shielded wire, as has become the custom of many of us. Although it is probably not necessary in many cases, it seemed like a good idea here because of the possibilities for over-all feed-back.

Construction

The amplifier is built on a 13 \times 17 \times 3-inch aluminum chassis. A 15 $\frac{1}{4}$ -inch-high aluminum relay-rack panel is fastened to the chassis by the meters and two shaft bushings, and it is further reinforced by a pair of brass straps.

The grid coil for the 807 plugs into a four-pin socket mounted at the rear of the chassis and shielded by an ICA No. 1549 3-inch diameter shield can. The plate coil plugs into a five-pin socket mounted 4 inches above the chassis. The

platform for the socket also shields the plate condenser, C_6 . Another 3-inch diameter shield can protects the 807 plate coil. The plate by-pass condenser, C_8 , is mounted under the chassis near the 807 socket, and the "cold" lead from C_6 and L_2 is brought down to it in shielded wire. The coaxial condenser, C_2 , is made of a length of RG-58/U and drops down through the same chassis hole as does the shielded "cold" lead.

The grid coil for the 811-As is shielded by an ICA No. 29842 4 \times 5 \times 6-inch aluminum utility cabinet. To simplify coil changing, the cabinet is fastened to the chassis and a friction-fit cover is made from a piece of sheet aluminum. The inside lips on the top of the cabinet should be bent down to allow more room for the hand that changes coils.

The output tank condenser, C_{10} , is mounted on the chassis with aluminum brackets that also support the jack bar for the output coil, L_6 . The variable link mounts on the jack bar and is connected to the panel control through two flexible couplings and an extension shaft. A B & W 3-turn shielded link was used for the output link, but an ordinary link might serve just as well in cases where TVI precautions are unnecessary.

Adjustment

During the initial testing it is advisable to connect a milliammeter in the plate circuit of the 807, to check the static current of the tube. With

A rear view of the linear amplifier, showing the push-pull 811-A output amplifier and the 807 driver. The cover of the rectangular shield can slides off for access to the final grid coil. The round shield cans are for the 807 grid and plate coils.

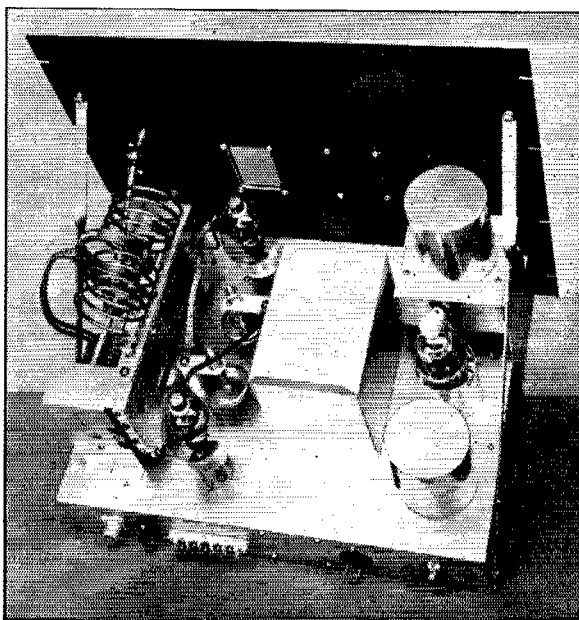

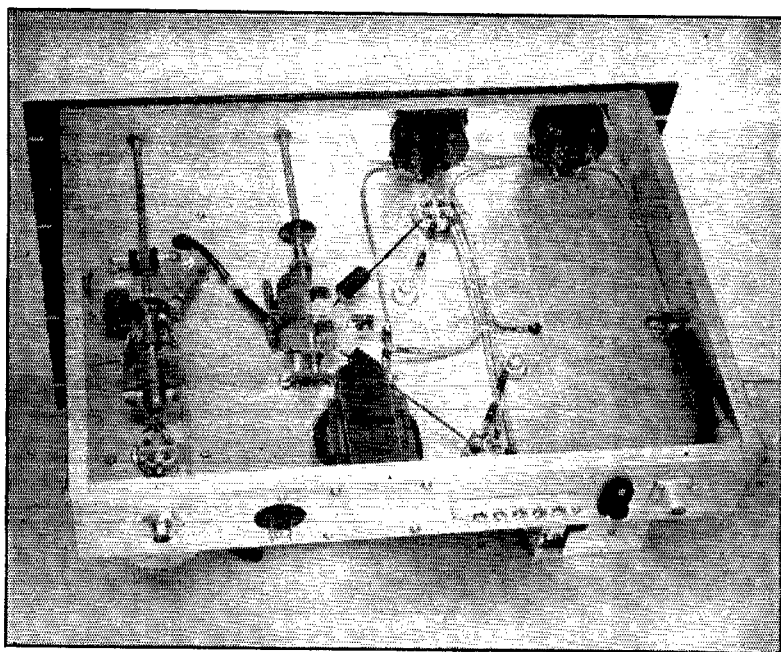

Underneath the chassis, showing all but r.f. leads in shield braid. The coils in the leads from the split-stator grid condenser are parasitic chokes.

600 volts on the plate and 300 on the screen, the plate current will run around 40 ma. If it differs from this value, it should be brought back by changing the cathode resistor, R_2 , or the screen voltage. If the available plate voltage is something other than 600, adjust the plate current for a static plate input of about 25 watts. With no input signal the screen current will be insignificant, and with maximum signal it will be only a few ma. The screen supply therefore has no great drain on it, but it should be "stiff" and not vary in output voltage. A low-level exciter stage is probably the best source for this voltage. Since the 600-volt plate supply will have practically a constant drain on it, the regulation of this supply is not important.

Couple a signal from the exciter in at J_1 and, with plate and screen voltage on the 807 but no plate voltage on the 811-As, resonate the circuits for maximum grid current in the 811-As. It should be easy to run this over 50 ma. without any change in the 807 plate current. Cut the excitation back to where the 811-A grid current is about 25 ma. and neutralize the output stage. You can use the "flick" in the grid current as C_{10} is tuned through resonance, but a more sensitive indication can be obtained by using a crystal diode and 0-1 milliammeter connected to J_2 . You may find an irreducible minimum feed-through current with a sensitive indicating device, but this is the neutralization point.

Couple a dummy load to J_2 and apply plate voltage to the 811-As. Couple an oscilloscope to the dummy load and apply a "two-tone" test signal¹ at the input. The 811-A no-signal plate current should run around 40 or 50 ma., depend-

ing upon the plate voltage. Adjust the two-tone signal amplitude for 10 or 15 ma. grid current and resonate all circuits. Then increase the excitation until the two-tone pattern just begins to flatten on the peaks. When using 1000 volts on the plates of the 811-As, this flattening should not occur until MA_2 indicates 160 ma. or so — with 1200 volts the current should run up to 190 ma. without noticeable flattening. If distortion occurs sooner, it indicates that the 811-A stage should be coupled more tightly to the dummy load, or that the 807 stage is not delivering enough drive. It will probably be found that the 811-A output coupling is at fault — if the link at L_3 is coupled closely the 807 should behave at all power levels. The 811-A grid current will be around 25 or 30 ma. when the pattern flattens.

When the linearity has been checked, turn off the power long enough to couple the antenna to the amplifier instead of the dummy load, and then couple the antenna to give the same plate current with the same excitation condition as before. You are then in business.

IS YOURS ON FILE WITH YOUR QSL MGR?

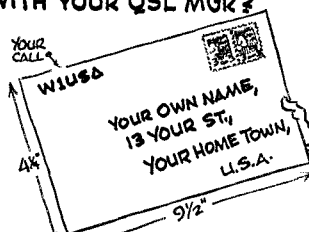

SEE PAGE 120

¹Reque, "Linear R.F. Amplifiers," *QST*, May, 1949, or the current *Radio Amateur's Handbook*.

An Electronic Lightning Calculator

A Measuring Instrument of All-Around Utility

BY PHILIP S. RAND,* WIDBM

THE ARRL Type A Lightning Calculator is well known and is used by electronic engineers as well as hams all over the world. It is essentially a cardboard *L/C* slide rule for calculating the sizes of inductances and the frequencies to which they will tune when combined with various amounts of capacitance. However, it cannot measure the actual inductance of a coil you have wound or purchased and it cannot determine the actual capacity of a condenser you want to use with the coil. The Electronic Lightning Calculator will perform both of these functions as well as many more.

The instrument to be described is about the most useful piece of apparatus a ham can have if he is one who likes to build his own gear. It combines the features of a general-purpose signal generator, 45 kc. to 85 Mc.; a calibrated condenser, 43 $\mu\text{mfd.}$ to 600 $\mu\text{mfd.}$; a vacuum-tube voltmeter; a condenser checker with a range of 2 or 3 $\mu\text{mfd.}$ to 500 $\mu\text{mfd.}$; and an inductance checker with a range of 0.05 $\mu\text{h.}$ to 110 mh.

In addition to the above, it serves to put 50-, 100-, 500-, or 1000-kc. markers on the ham bands for locating band edges, and for calibrating receivers, grid-dippers, wavetraps, etc. It is just the thing for lining up that 50-kc. or 85-kc. i.f. amplifier of a Q5-er as well as the old-fashioned 465-kc. i.f. strips.

How often have you wanted to match up two condensers for an s.w.r. bridge or a low- or high-pass filter for TVI, or even wondered whether that surplus mica condenser was 5, 50, or 500 $\mu\text{mfd.}$? Have you ever wanted to wind a coil of 0.37 $\mu\text{h.}$ for a low-pass filter for TVI or tell which of those surplus r.f. chokes was 1, 2.5 or

5 mh.? Have you ever wanted to know the relative *Q* of two coils of different construction?

If you have ever pondered any of the above questions, this simple instrument will give you the answers, and it only uses two tubes plus power supply. If you have \$600-700 to spend, you can stop reading here and buy a laboratory-type *Q*-meter; otherwise, read on and save some dough.

Circuit

The circuit, Fig. 1, comprises a bandswitching signal generator of the electron-coupled type with a calibrated condenser in its plate circuit, followed by a vacuum-tube voltmeter for reading the r.f. voltage across the unknown coil, which is connected to binding posts across the calibrated condenser. A small 300-volt 40-ma. power supply is built in, with an 0A-2 supplying 150 volts, regulated, to the screen grid of the 6AU6 oscillator. A second 6AU6 is used as a triode for the vacuum-tube voltmeter simply for convenience; a 6C4 might be better as it has a lower input capacitance, and it is very important to keep the minimum capacitance in the calibrated condenser circuit as low as possible. In this connection, parts should be placed so that leads are practically nonexistent, and the insulation on the binding posts, condensers, and sockets should be of low-loss material.

Construction

The chassis used is actually the front panel and top cover of the cabinet, securely bolted together with corner angles. On this "L"-shaped chassis are mounted all the components except the power supply, which is on its own little chassis. The front panel measures 9 by 15 inches

◆

Signal generator, *LC* checker, v.t. voltmeter — this instrument performs most of the functions of the commercial *Q*-meter. It uses four tubes, including rectifier and voltage regulator, and is not expensive to build.

◆

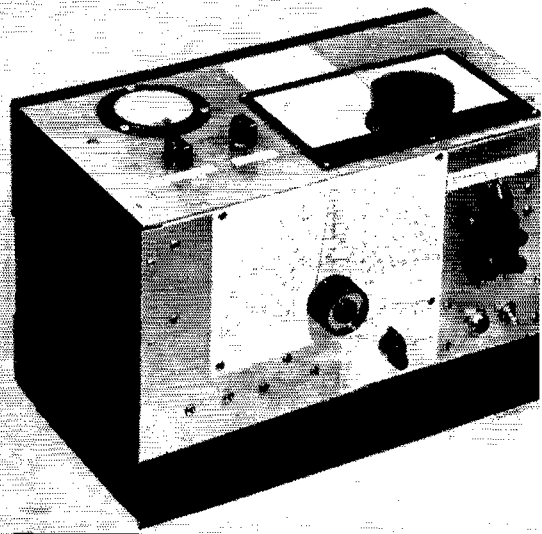

and the top cover 8 by 15 inches. The cabinet is a standard unit measuring 9 by 15 by 8 inches; most any cabinet will be satisfactory in this approximate size, providing the top can be removed for attaching to the front panel.

The tuning condenser of the oscillator is mounted horizontally on a small bracket with its dial on the front panel. The 6AU6 oscillator socket is mounted on a small 1-inch-wide aluminum angle so that the socket pins are adjacent to the terminals of the condenser. The band-switch is mounted directly under the tuning condenser, thereby keeping the leads to about $\frac{3}{4}$ inch in length. The seven coils for the various ranges are soldered directly to the switch contacts by means of No. 12 bus-bar, with the result that they circle the under part of the switch and yet are spaced from each other about $\frac{1}{2}$ inch.

The calibrated condenser is mounted vertically on the front panel with its dial on the top of the cabinet so as to bring its rear end, where the terminals are, to the same level as the 6AU6 oscillator socket, and spaced just to clear it. The 100- μf d. coupling condenser can then be attached with $\frac{1}{8}$ -inch leads. The four binding posts are mounted on the front panel as close as possible to the other side of the calibrated condenser. Another one-inch aluminum angle holds

the 6AU6 v.t. voltmeter socket and locates its pins adjacent to the "hot" binding posts.

The 1-ma. meter and its two pots are mounted on the top cover, in order to be readily visible when tuning the calibrated condenser. The power supply is wired up on a separate chassis and placed in a convenient spot inside the cabinet.

The dial on the oscillator should be easily read and calibrated in seven ranges. We purchased, therefore, a National type ACN, discarding everything except the velvet vernier mechanism and knob. A new longer pointer was fashioned out of lucite, and a larger scale was made of white cardboard, lettered in India ink, and then cemented on the panel with rubber cement. After calibration, this was covered with celluloid held in place with small screws at the corners. An ACN dial was used "as is" on the calibrated condenser, as only four ranges are used.

A small low-capacity single-pole single-throw wafer switch is mounted as close as possible to the two "hot" binding posts. It is used to cut in and out an additional 270- μf d. silver mica condenser for extending the range of the 15-300 μf d. calibrated condenser to 600 μf d. This is necessary in order to obtain a capacitance ratio of a little better than the 10 to 1 necessary for the inductance ranges of 0.1 to 1 μh ., 1 to 10 μh ., etc.

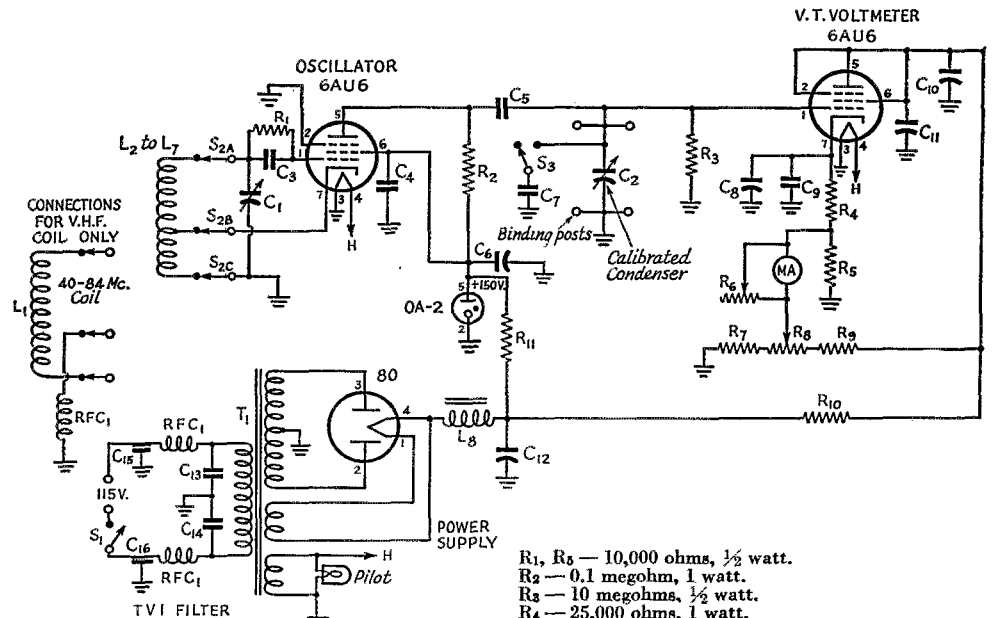

Fig. 1 — Circuit diagram of the electronic lightning calculator.

- C₁, C₂ — 15-300 μf d. variable (National FMS-300 or SEH-335).
- C₃, C₅ — 100- μf d. mica.
- C₄, C₉ — 0.001- μf d. mica.
- C₆, C₁₀ — 0.01- μf d. paper.
- C₇ — 270- μf d. silver mica.
- C₈ — 0.25- μf d. paper.
- C₁₁ — 8- μf d. electrolytic.
- C₁₂ — 20- μf d. electrolytic, 450 volts.
- C₁₃, C₁₄ — 470- μf d. mica.
- C₁₅, C₁₆ — 0.1- μf d. paper, feed-through type (Sprague Hypass).

- R₁, R₅ — 10,000 ohms, $\frac{1}{2}$ watt.
- R₂ — 0.1 megohm, 1 watt.
- R₃ — 10 megohms, $\frac{1}{2}$ watt.
- R₄ — 25,000 ohms, 1 watt.
- R₆ — 100-ohm potentiometer.
- R₇ — 350 ohms, $\frac{1}{2}$ watt.
- R₈ — 200-ohm potentiometer.
- R₉ — 50,000 ohms, 5 watts.
- R₁₀ — 1000 ohms, $\frac{1}{2}$ watt.
- R₁₁ — 15,000 ohms, 10 watts.
- L₁ to L₇, inc. — See Table II.
- L₈ — 10-hy. filter choke, 40 ma.
- MA — 0-1 d.c. milliammeter.
- S₁ — S.p.s.t. toggle.
- S₂ — 3-gang 8-position ceramic (Mallory 180-C).
- S₃ — S.p.s.t. rotary (ICA No. 1228).
- RFC₁ — V.h.f. choke (Ohmite Z-50).
- T₁ — Power transformer, 300 volts, 40 ma., with 5- and 6.3-volt filament windings.

A close-up of the top panel. The dial control is for the calibrated variable condenser, the scales being calibrated in capacitance and inductance. The chart at the top shows frequency settings for measuring inductance. The small knobs at the left are the v.t.v.m. controls.



Winding Coils

In winding the coils for the signal generator part of this instrument a minimum of 20 $\mu\text{fd.}$, including strays, and a maximum of 250 $\mu\text{fd.}$ of capacitance will just about provide an overlapping range if the coils are as shown in Table I.

Band	L	Frequency at		
		20 $\mu\text{fd.}$	250 $\mu\text{fd.}$	350 $\mu\text{fd.}$
1	0.18 $\mu\text{h.}$	84 Mc.	40 Mc.	
2	0.5 $\mu\text{h.}$	50 Mc.	14 Mc.	12 Mc.
3	5. $\mu\text{h.}$	16 Mc.	4.5 Mc.	3.9 Mc.
4	50. $\mu\text{h.}$	5 Mc.	1.4 Mc.	1.2 Mc.
5	0.5 mh.	1.6 Mc.	450 kc.	390 kc.
6	5. mh.	500 kc.	150 kc.	120 kc.
7	50. mh.	160 kc.	45 kc.	39 kc.

However, you will not realize the full coverage on the lower frequencies because the distributed capacitance of the larger layer-wound coils will raise the minimum capacitance up to 30 or 40 $\mu\text{fd.}$ This gives a bandsread effect. It would be safer to use a 17-335 $\mu\text{fd.}$ condenser such as a National type SE straight-line frequency, if possible. However, this has 270-degree rotation

Band	L	Wire Size	Diam.	Length	No. of Turns	Cath. Tap
1	0.18 $\mu\text{h.}$	No. 12	1/4"	7/8"	3	RFC
2	0.5 $\mu\text{h.}$	No. 12	3/8"	7/8"	7	2 t.
3	5. $\mu\text{h.}$	No. 26	3/8"	3/8"	38	6 t.
4	50. $\mu\text{h.}$	No. 28	1/2"	1 3/4"	126	20 t.
5	0.5 mh.	No. 32	1"	2"	230	40 t.
6	5. mh.	Four-pie r.f. choke tapped 1 pie from ground (Nat. R-100, 5 mh.).				
7	50. mh.	Two 10-mh. and one 30-mh. Miller RFC in series. (Cathode tap between the two 10-mh. chokes.)				

instead of the usual 180 degrees, so the dial would have to be made accordingly.

The coil-winding data are given in Table II. Bear in mind that the inductance in the switch and the leads affects the high-frequency coils, and that all coils should be pruned so that the oscillator covers the right frequencies. Coils other than those specified may be used if you already have them, so long as you can cover the right frequencies.

Oscillator Calibration

The same general techniques used in calibrating a VFO or frequency meter should be used in calibrating the signal generator portion of this instrument. There are many points that can be compared directly with WWV, using both fundamental and harmonics — for example, 50 kc., 100 kc., 250 kc., 500 kc., 1000 kc., 2.5 Mc., 5 Mc., 15 Mc., etc. Intermediate points can be obtained from a frequency meter or calibrated receiver. The 55- to 100-kc. range can be checked by spotting the 10th harmonic in the broadcast band, the 200- to 500-kc. range by checking the third harmonic, etc.

The points on the dial to nail down as closely as possible are the settings for measuring inductance. In my case, these are shown in Table III.

The only range that might give any trouble is the 71-Mc. range. This can be spotted accurately by first locating the tenth harmonic from 7.1 Mc. or the second from 35.5 Mc., etc., on some receiver that tunes that range — for example, TV Channel 4. Incidentally, the coil for the 71-Mc. range should be mounted on the coil switch adjacent to the wiper contacts, to keep the switch inductance to a minimum. It is doubtful that the 6AU6 will oscillate over much more than the minimum capacity end of the tuning range, but this will do no harm if it will cover from 40 to 80 Mc. since the next coil overlaps at this point.

The coils should be wound and roughly calibrated one at a time, starting with the highest-frequency coil. The inductance of each coil is

TABLE III

Signal Generator Frequency	Inductance Ranges
71 Mc.	*0.05 to 0.1 μ h.
22.5 Mc.	0.1 to 1 μ h.
7.1 Mc.	1 to 10 μ h.
2.25 Mc.	10 to 100 μ h.
710 kc.	0.1 to 1 mh.
225 kc.	1 to 10 mh.
71 kc.	10 to 100 mh.

* Binding posts shorted.

adjusted to cover the correct tuning range by spreading or squeezing the turns on the three highest ranges and by adding or subtracting turns on the others, or by adjusting the slugs if you use coils with slugs.

The cathode tap was adjusted for best oscillation on the higher-frequency coils, and set at somewhere between 10 per cent and 30 per cent from the ground end on the others. The 71-Mc. coil would not oscillate with the cathode tapped on the coil, but started up fine when a 50-Mc. r.f. choke was soldered to the cathode tap of the switch as indicated in the inset diagram in Fig. 1.

Calibrated Condenser

The next problem is to calibrate the variable condenser used for measuring small capacitances and inductances. This should not be done until the oscillator section has been finally calibrated, with the whole unit installed in its cabinet. The condenser calibration is no problem at all if you have access to a laboratory-type Q-meter, or have a friend that has. With the Q-meter, it is only necessary to connect the two instruments together with short, heavy leads and read the capacity on the laboratory instrument.

Lacking the Q-meter, you need an inductance of some convenient known value. We used, for example, a surplus r.f. choke marked 1 mh.,

5 per cent. The first thing to do is to determine the minimum capacitance of the condenser with the v.t. voltmeter, binding posts, and oscillator plate all tied on. To do this, connect the 1-mh. coil across the binding posts, set the condenser dial at minimum, and tune the signal generator until there is a sharp rise in the meter reading, indicating resonance. Note the frequency of the signal generator, and continue to tune higher in frequency to see if you get another kick on the meter. If not, then the first was the fundamental. This is one precaution you must take in an instrument as simple as this, because harmonics are present in the plate of the oscillator and will register on the meter at about half the strength of the fundamental. Therefore, always check to see if you have the highest setting of the signal generator that will give a meter reading. In checking inductances later on, always be sure that you have the highest capacity setting of the calibrated condenser and the highest frequency range on the generator that will give a meter reading.

Let us now suppose that the frequency of the signal generator was 710 kc. with the 1-mh. r.f. choke. By use of an ARRL Lightning Calculator, Type A, we can determine that the capacitance needed to resonate a 1-mh. (1000- μ h.) coil to 710 kc. is 50 μ mf. The capacitance thus determined will be the minimum of the condenser plus the distributed capacitance of the 1-mh. coil, which was about 9 μ mf. in the case of my coil. This must be subtracted from the capacitance calculated as above to get the true minimum to calibrate on the dial. On small single-layer air-wound coils you can ignore distributed capacitance as it will be very small.¹

We now proceed to locate the 100-, 150-, 200-, 250-, and 300- μ mf. points by looking up on the Lightning Calculator the frequencies at which a 1-mh. coil will resonate when tuned by

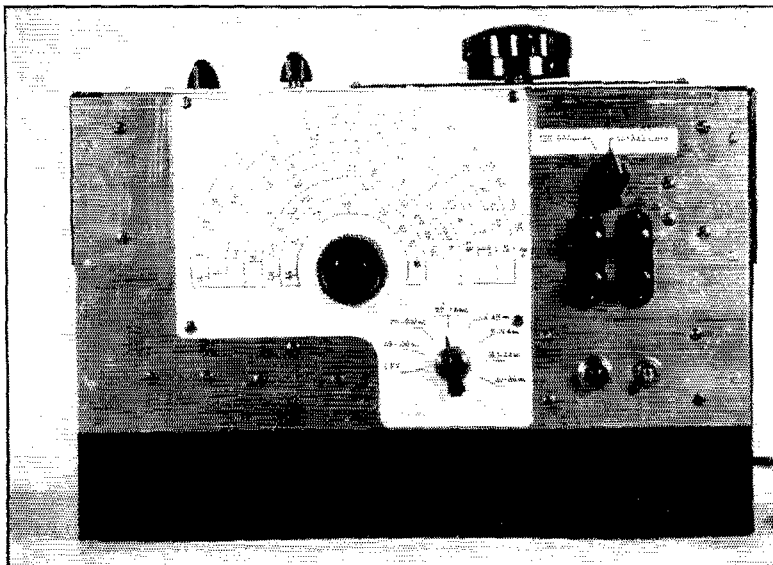

The oscillator tuning control is on the front panel; the calibrated dial is a home-made affair using a commercially-made drive. The switch for the two calibrated capacitance ranges is at the upper right, with the test binding posts just below it.

$\mu\text{mfd.}$	$\mu\text{h.}$	$\mu\text{mfd.}$	$\mu\text{h.}$
46	11.0	200	2.5
50	10.0	250	2.0
55.5	9.0	263	1.9
62.5	8.0	278	1.8
66.8	7.5	294	1.7
71.5	7.0	312	1.6
77	6.5	333	1.5
83.2	6.0	358	1.4
91	5.5	384	1.3
100	5.0	417	1.2
111	4.5	455	1.1
125	4.0	500	1.0
143	3.5	555	0.9
167	3.0	600	0.83

a 109-, 159-, 209-, 259-, and a 309- $\mu\text{mfd.}$ condenser. These frequencies are approximately 490 kc., 405 kc., 350 kc., 315 kc., and 290 kc., respectively, assuming your coil has the same 9 $\mu\text{mfd.}$ of distributed capacitance as mine, and also that it is 1 mh. The same procedure, of course, can be used for a coil of some other known inductance. The 10- $\mu\text{mfd.}$ points are now put in by dividing up the space between the 50- $\mu\text{mfd.}$ points with a pair of dividers, if you have used a straight-line capacitance type condenser. If you have used a straight-line frequency type of condenser, which is more desirable, it would be better to locate the intermediate points by the substitution method. Set the condenser at, say, the 100- $\mu\text{mfd.}$ point, with the 1-mh. coil on one pair of binding posts, and tune the signal generator to resonance as indicated by the meter. Next, connect a 10- $\mu\text{mfd.}$ mica condenser, 5 per cent type, to the second pair of binding posts and retune the calibrated condenser to resonance. To do this it will be necessary to back out on the condenser by 10 $\mu\text{mfd.}$ This will then give you a 90- $\mu\text{mfd.}$ calibration point. Continue in this fashion until you have all your 10- $\mu\text{mfd.}$ points plotted.

The next step is to calibrate the high-capacitance range; that is, with the 270- $\mu\text{mfd.}$ mica switched in parallel with the variable. First set the calibrated condenser at your highest calibrated point, somewhere around 320 to 330 $\mu\text{mfd.}$, and tune the signal generator to resonance on the meter. You now turn the switch to cut in the 270- $\mu\text{mfd.}$ mica and retune the calibrated condenser toward minimum until you find resonance again. You are subtracting 270 $\mu\text{mfd.}$ of variable capacitance to compensate for the 270 $\mu\text{mfd.}$ you added. The resonance point will represent the same capacitance as before, 320 to 330 $\mu\text{mfd.}$, and this is your minimum on the high

¹ In the event that a coil of known distributed capacitance is not available, manufactured transmitting coils can be used, the inductance being calculated from the manufacturer's data on the capacitance required to resonate at a given frequency. Or a "standard" can be made up from available coil material. For example, 22 turns of Barker & Williamson type 3905 or 3905-1 coil, with 2-inch leads to reach binding posts separated 1 inch, has a measured inductance of 16.4 microhenrys, a convenient value for use in calibrating. With coils of this type the distributed capacitance can be neglected. — Ed.

range. You now proceed as before and find the calibration points for 350, 400, 450, 500, 550 and 600 $\mu\text{mfd.}$, referring to the Lightning Calculator and filling in the 10- $\mu\text{mfd.}$ points later. Leave room on the dial to fill in the two inductance scales directly under each capacitance scale.

Calibrating the Inductance Scale

In calibrating the inductance scale it is only necessary to copy off the appropriate values from an ARRL Type A Lightning Calculator, and write them down on the dial directly under the capacitance calibrations already there. The actual relationship of the two calibrations depends on the frequencies you select for your signal generator settings. In my case, I thought it convenient to have 50 $\mu\text{mfd.}$ and 500 $\mu\text{mfd.}$ equal 10 and 1, or 1 and 0.1 respectively, so that meant I would have to use 71, 22.5, 7.1, 2.25 Mc., etc. This is shown in Table III. If you elect to do the same, you can use Table IV to calibrate your dial in inductance. The one calibration holds for all values of inductance, it being necessary only to refer to Table III to see whether 1 on the dial is 0.1, 10, or 100 $\mu\text{h.}$ or mh. Table III, incidentally, should be cemented on top of the cabinet.

V.T. Voltmeter

The v.t. voltmeter is conventional in design and has two variable resistors, one for controlling the sensitivity and one for setting the zero point. On the low-frequency ranges of the signal generator, the meter will read the r.f. in the plate circuit even without a coil connected to the binding posts; however, when you hit resonance, it may go off scale. If such is the case, simply turn down the sensitivity pot a bit. To measure external a.c. voltages, such as audio frequencies, be sure to use a blocking condenser to prevent any d.c. from reaching the meter, or it will read incorrectly. To make connections to the v.t. voltmeter simply throw the signal generator bandswitch to an open set of contacts (Position 8) or the "off" position, and connect the a.c. voltage to the binding posts. The meter, of course, must be calibrated from a known voltage source

A.C. Calibration		D.C. Calibration (Positive)	
A.C. Volts	Ma.	D.C. Volts	Ma.
5	0.06	1	0.02
10	0.14	2	0.04
15	0.24	3	0.06
20	0.33	4	0.11
25	0.42	5	0.12
30	0.52	10	0.24
35	0.62	15	0.34
40	0.72	20	0.48
45	0.82	25	0.58
50	0.92	30	0.76
55	1.0	35	0.84
		40	1.0

initially, and the sensitivity control must be at the same setting as when it was calibrated.

Table V gives an approximate calibration of the v.t. voltmeter when used to measure 60-cycle a.c. as well as d.c. It was calibrated for a.c. with a Variac, checking the voltage on a known v.t. voltmeter. It may be made to read higher voltages by calibrating the sensitivity control. The 60-cycle calibration is reasonably accurate when the meter is used on audio and low radio frequencies. The v.t.v.m. was calibrated for d.c. by connecting a d.c. voltmeter in parallel and applying d.c. voltages in small steps.

Use of Signal Generator

No attenuator is included in the oscillator circuit because it would have raised the minimum capacity of the calibrated condenser. However, an external one could be constructed, if desired. A short wire connected to one of the "hot" binding posts and brought near the receiver is usually enough coupling. On the high-frequency coils this may cause TVI, so be careful!

To get accurate 50-, 100-, or 1000-kc. marker points all across the ham bands, simply tune the signal generator to 50, 100, or 1000 kc., and zero beat one of its harmonics against WWV. Use just enough coupling between the signal generator and the receiver to give the desired signal strength at the marker points. In some of the higher-frequency ham bands it may be necessary to connect the wire from the binding post directly to the antenna post on the receiver.

Measuring Capacity

Most magic-eye condenser checkers sold in kit form work very nicely on condensers from 500 $\mu\text{fd.}$ up to 100- $\mu\text{fd.}$ electrolytics; however, it is impossible to tell a 25- from a 50- $\mu\text{fd.}$ condenser, much less to match a pair of 100- $\mu\text{fd.}$ micas.

This instrument fills the gap very nicely, measuring down to within the accuracy of your calibration. If you have used a straight-line-frequency type condenser, you should be able to measure down to 1 or 2 $\mu\text{fd.}$ In any event, any value up to 500 $\mu\text{fd.}$ can be measured by the substitution method. A coil is attached to two of the binding posts with the main calibrated condenser set at, say, 200 $\mu\text{fd.}$, and the signal generator is tuned for maximum meter reading. The unknown condenser is next attached to the other two binding posts and the calibrated condenser is tuned toward minimum to re-establish resonance. Let us say resonance is found at a reading of 156 $\mu\text{fd.}$; then the unknown condenser is 200 minus 156 or 44 $\mu\text{fd.}$

To Measure Inductance

An unknown inductance is connected across two of the binding posts and the signal generator is set at one of the frequencies listed in Table III. The calibrated condenser is now swung through its two ranges while looking for a resonance indication on the meter. If one is found, check to be sure that it is the one at the highest capacitance setting so that it will be the fundamental and not a harmonic. If in doubt, switch the signal generator to the next highest frequency range and repeat. When the highest resonance point is found, read the inductance off the dial, putting the decimal point in the correct place according to Table III. If no resonant point is found on the first range tried, then try a different range.

As noted in Table III, the internal inductance (binding posts shorted) is 0.05 $\mu\text{h.}$ In measuring very low values of inductance this minimum should be subtracted from the measured value. Check the internal inductance of your instrument by connecting a flat strap, not a length of wire, between the two binding posts.

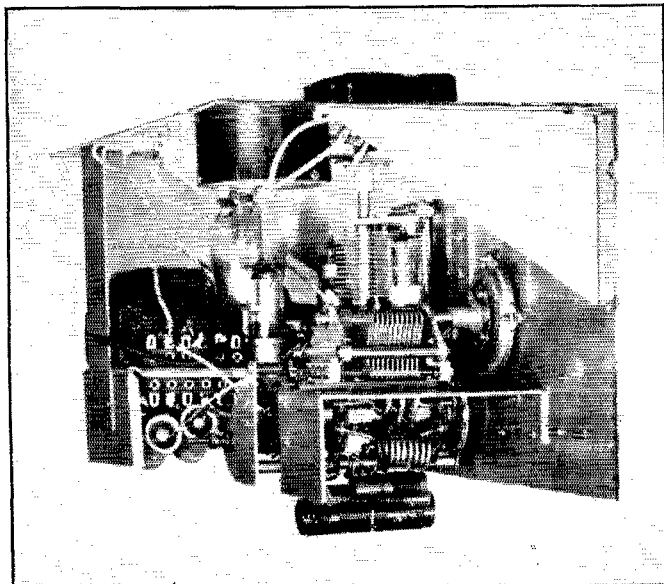

◆
As this inside view shows, the internal construction and wiring is not difficult. All parts are supported by the top and front panels, with the help of a few simple brackets. The power supply is at the left in this photograph.
◆

Measuring Q

Relative Q measurements can also be made on this instrument by observing the sharpness of the tuning of the calibrated condenser when tuning through resonance. The sharper the tuning, the higher the Q. Also, the higher the meter reading at a given frequency, the higher the Q. The actual Q can be determined with a good degree of accuracy by utilizing the following formula:

$$Q = \frac{f_1}{f_2 - f_3}$$

where: f_1 = resonant frequency giving a reference meter reading.

f_2 = frequency giving a reading of 0.7 of reference on high side.

f_3 = frequency giving a reading of 0.7 of reference on low side.

Let us suppose a given coil resonates at 7000 kc., f_1 , at some convenient setting of the calibrated condenser. Adjust the v.t. voltmeter sensitivity control until a 0.5 or 1 reading is obtained. Now tune the signal generator higher in frequency until the meter reading has dropped to 70 per cent of its former value. Suppose this frequency, f_2 , is 7035 kc. Now tune the signal generator lower in frequency until you again get a 70 per cent reading on the meter; suppose that this frequency, f_3 , is 6965 kc.

The Q of the coil is then:

$$Q = \frac{7000}{7035-6965} = \frac{7000}{70} = 100.$$

This value of Q will not be highly accurate, because of the loading effect of the 6AU6 plate, and the plate resistor, and also the difficulty of reading the dial accurately, the effect of which will vary with frequency. The higher the Q of the coil the greater the error, the reading always being low. However, it is accurate enough to tell the effect on the Q that various iron and brass slugs have, as well as coil forms, wire size, etc., for a given frequency. After all, that is the amateur's chief interest in Q. Another method to measure Q is as follows:

$$Q = \frac{C_1}{\frac{1}{2}(C_2 - C_3)}$$

where:

C_1 = the capacitance of the calibrated condenser at resonance.

C_2 = the capacitance of the calibrated condenser when tuned off to the high-capacitance side to give a 0.7 meter reading.

C_3 = the capacitance of the calibrated condenser when tuned off on the low-capacitance side to give a 0.7 meter reading.

Thus, if the coil tunes to resonance at 200 $\mu\text{fd.}$, and the 0.7 points are 198 and 202 $\mu\text{fd.}$, respectively, then:

$$Q = \frac{200}{\frac{1}{2}(202-198)} = \frac{200}{2} = 100.$$

This method is sometimes more convenient and easier to read.

Measuring Distributed Capacitance

To measure the distributed capacitance of a layer-wound coil, which is necessary if the true inductance is to be obtained, the following approximate formula is used:

$$\text{Distributed Capacitance} = \frac{C_1 - 4C_2}{3}$$

where:

C_1 = calibrated condenser reading at fundamental.

C_2 = calibrated condenser reading at second harmonic.

If, for example, C_1 is 300 $\mu\text{fd.}$, and C_2 is found to be 68 $\mu\text{fd.}$, the distributed capacitance is $\frac{300 - (4 \times 68)}{3} = \frac{300 - 272}{3} = \frac{28}{3} = 9.3 \mu\text{fd.}$

In making this measurement the fact that harmonics are indicated on the v.t. voltmeter is utilized. The calibrated condenser is set at some convenient value such as 300 $\mu\text{fd.}$, C_1 , and the fundamental frequency of the signal generator is resonated as indicated by a high reading on the v.t. voltmeter. The condenser is then turned toward minimum until the second harmonic is picked up as indicated by a second, but lower, v.t. voltmeter peak. The capacitance, C_2 , is now read off the dial and used in the above formula. The distributed capacitance for my 1-mh. 5 per cent coil turned out to be 9.3 $\mu\text{fd.}$ as shown.

Silent Keys

IT IS with deep regret that we record the passing of these amateurs:

W1DIX, Warren H. Allen, Rye, N. H.
 W1IVV, Clifford E. Henry, Mexico, Me.
 W1NNQ, John H. Sipple, Windsor, Conn.
 W2BGP, Clarence E. Onens, Gibbstown, N. J.
 W2TTE, ex-W8PFG, Joseph E. Opalka, Amsterdam, N. Y.
 W2UQE, William G. Follmer, Rochester, N. Y.
 W3DNZ, Charles J. Gundel, East Lansdowne, Penna.
 W4JOY, Arthur D. Thompson, Savannah, Ga.
 W6IBH, Clinton N. Terry, Sacramento, Calif.
 W6PSI, Lester I. Wiltse, Los Angeles, Calif.
 ex-W6SGD, Mrs. Kitty C. Aitken, Prescott, Ariz.
 W6YTM, Donald C. Wedemeyer, Alameda, Calif.
 W7AW, Iver V. Iversen, Seattle, Wash.
 W7QJL, Avery T. LeNoir, Mesa, Ariz.
 W9HFF, Carl E. Forster, Evansville, Ind.
 W9JZL, Elmer W. Everson, Evansville, Ind.
 W0QEG, Willard G. Hayes, Wray, Colo.
 VE3DIN, S. L. Ogilvie, London, Ont.
 VE3WK, Arthur G. Palmer, Toronto, Ont.

The "WWV-er"

A One-Tube Converter for 5 and 10 Mc.

BY C. VERNON CHAMBERS,* WIJEQ

EVERY once in a while someone pops up with one of those ideas that sets the rest of us wondering, "Why hasn't someone thought of this before?" And that was exactly our reaction when Joe Moskey, WIJMY, suggested a fixed-tuned converter, coupled to the i.f. amplifier of the receiver and ready to provide a WWV signal at the flip of a switch. Feeding the output of the converter directly into the receiver i.f. sounded particularly interesting because it meant that the WWV signal would be always there — when the right switch was thrown — regardless of the frequency to which the receiver was tuned.

The "WWV-er" — built for less than ten dollars — is a bandswitching converter designed to operate on 5 and 10 Mc. Amateurs residing in sections of the country where one or the other of these frequencies is not useful may wish to use another pair of frequencies. If a single WWV frequency can be depended on, it will be logical to do away with the bandswitching feature.

A selenium-type power supply is built into the converter. However, because of the low power consumption of the 6BE6 tube, it would be practical to operate the unit from the regular receiver supply. Incidentally, a saving of approximately \$3.50 will be realized by the elimination of bandswitching and the built-in supply.

The converter is as simple to operate as the stand-by switch on a receiver. Because the bandswitch is always set at one of the operating positions, it means that WWV can usually be heard merely by throwing the plate switch.

The Circuit

Fig. 1 shows the circuit of the converter. The Hartley oscillator employs C_7 , C_8 and L_2 as the frequency-determining components when the converter is tuned to 10 Mc. Capacitors C_5 and C_6 are connected in parallel with the oscillator tank by means of S_1 , when the unit is switched to 5 Mc. The oscillator operates on the high side of the 5-Mc. input signal and on the low side of WWV's 10-Mc. signal. In either case, the resultant i.f. is 456 kc.

The input circuit for the converter uses C_2 and L_1 at 10 Mc. and this combination plus C_3 and C_4 at 5 Mc. An isolating capacitor, C_1 , connected in series with the antenna coil, prevents accidental contact between the hot chassis and units external to the converter.

RFC_1 and capacitor C_{10} form the plate circuit for the converter. C_{11} is the output coupling capacitor and C_{13} is an r.f. by-pass for the shielded output cable.

The power supply employs a small selenium

rectifier in a half-wave circuit. C_{14} is a hash filter and C_{15} is the filter capacitor. Resistor R_3 serves as a filter component and also limits the output of the supply to approximately 100 volts. S_2 is the stand-by switch.

A.c. power is carried to the converter by means of a resistance line cord. The cord listed in the parts list is one of the few types that include the 360-ohm resistor called for by a single 6BE6. Use of a conventional a.c. line cord and a heater dropping resistor is not practical in this case because the resistor must dissipate almost 33 watts.

Construction

The chassis for the converter is $1\frac{3}{8}$ inches deep, $1\frac{3}{4}$ inches wide and $2\frac{3}{4}$ inches long. A $2 \times 4 \times 4$ -inch steel utility box is used as the cabinet with one of the box covers serving as the panel.

A rear view of the converter shows the tube socket mounted at the center of the chassis to the right of RFC_1 . Coil L_1 is mounted on a $\frac{1}{4}$ -inch bushing to the right of the 6BE6 and a feed-through bushing to the left of the coil accommodates the lead running from the top of the coil. Rubber grommets at the front corners of the chassis pass the leads to the toggle switches and a third grommet, located to the front and right of RFC_1 , takes care of the tube-to-choke connection. Capacitors C_1 and C_{12} are mounted on the tie-point strip at the rear of the tube socket and

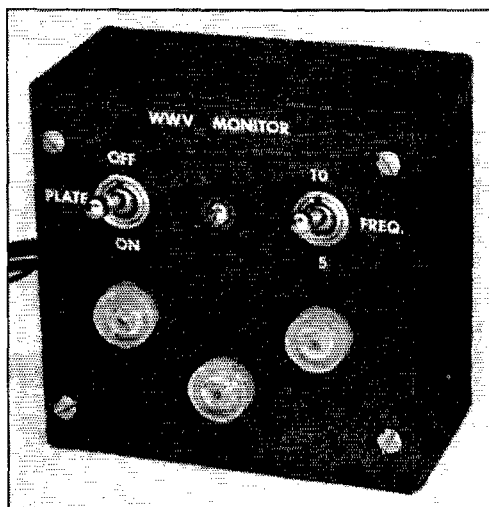

A front view of the "WWV-er." The plate switch at the left and the bandswitch at the right are the only operating controls.

*Technical Assistant, QST.

C_{11} is mounted between the strip and the top of RFC_1 . Holes are drilled along the rear wall of the chassis to permit adjustment of the variable trimmer capacitors.

The bottom view (see page 106) shows the oscillator coil, L_2 , at the left end of the chassis and the resistance cord terminated at a two-terminal tie-point strip at the right end of the base. Capacitors C_5 , C_7 , C_2 and C_4 are mounted in that order in a line running from left to right across the rear of the chassis. The mounting holes for the capacitors are $\frac{5}{8}$ inch in from the outside edge of the base. Fixed capacitors C_3 and C_6 are mounted directly across the terminals of C_4 and C_5 , respectively. The grid-blocking condenser, C_9 , is shown in a vertical position with the top end connected to C_7 and the 10-Mc. fixed padder, C_8 , lies flat against the rear wall of the chassis. A homemade clamp holds the filter capacitor, C_{15} , in place.

The panel layout has the toggle switches to the left and right of the selenium rectifier. The switches are $2\frac{1}{8}$ inches apart and $1\frac{1}{2}$ inches down from the top edge. National type XP-6 bushings provide insulation for 115 volts a.c. between the chassis and the panel. The heads of the machine screws which pass through the bushings are at chassis potential and are therefore covered with a set of XP-6 bushings which have been countersunk to clear the screw heads and then fastened in place with Duco cement.

Chassis and cabinet are more readily slipped together if the lower front mounting lip of the case is bent back flush with the bottom surface and if a $\frac{1}{2}$ -inch notch is filed in the lip at the left of the cabinet. The notch will provide clearance for the input and output cables which extend out from the left end of the chassis. When the unit is completely assembled, the cables pass through a 1-inch diameter hole punched in the left side of the cabinet.

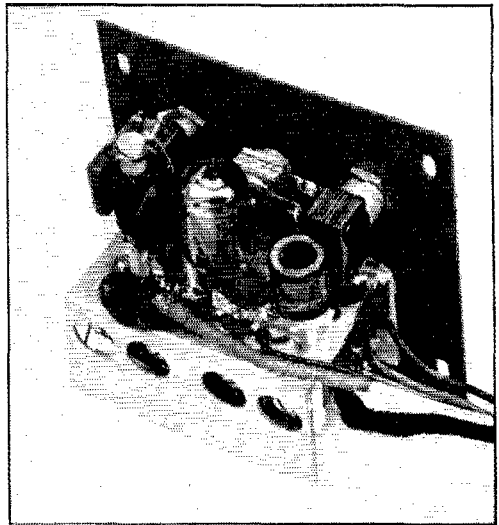

This rear view of the WWV monitor shows compactness without excessive crowding of the components.

Wiring of the converter is simplified by leaving the mounting and the wiring of the switches and the filter capacitor as the last operations. Leads approximately 6 inches long should be connected to the terminals of the switches before the latter are mounted. Care should be taken to prevent any of the components, other than the switches, from making contact with the panel and the shielded i.f. cable should be insulated from the chassis by means of friction tape. The resistance cord is connected with the heavy brown lead tied to the heater of the 6BE6 tube, the red lead to the chassis and the black lead to the selenium rectifier.

(Continued on page 106)

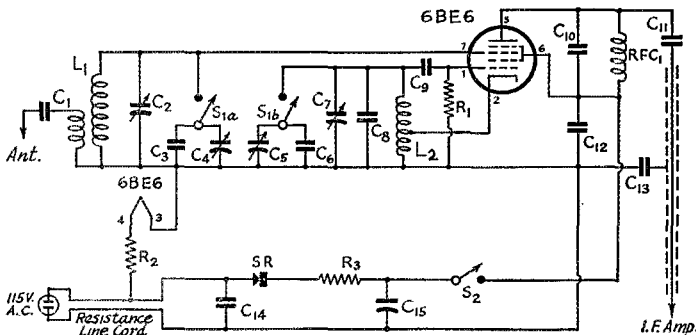

Fig. 1 — Circuit diagram of the WWV converter.

- C_1 , C_{11} , C_{12} , C_{13} , C_{14} — 0.01- μ fd. disc ceramic.
- C_2 , C_4 , C_5 , C_7 — 3-30 μ fd. mica trimmer (National M-30).
- C_3 , C_6 , C_9 , C_{10} — 100- μ fd. mica.
- C_8 — 22- μ fd. silver mica.
- C_{15} — 40- μ fd. 150-volt electrolytic.
- R_1 — 22,000 ohms, $\frac{1}{2}$ watt.
- R_2 — 360 ohms; see text.
- R_3 — 1000 ohms, $\frac{1}{2}$ watt.
- L_1 — 4.8 μ h.; 26 turns No. 24 enam. wire, $\frac{1}{2}$ -inch diam.,

- $\frac{3}{16}$ inch long. Link: 8 turns No. 24 enam. wire, close-wound over cold end of L_1 .
- L_2 — 3.6 μ h.; 20 turns No. 24 enam. wire, $\frac{1}{2}$ -inch diam., $\frac{3}{16}$ inch long. Cathode tap 7 turns from cold end. Note: L_1 and L_2 wound on National PRD-2 coil forms.
- RFC_1 — 1.0-mh. r.f. choke (National R-100S).
- SR — 20-ma. selenium rectifier (Radio Receptor Co. 8Y1).
- S_{1a} , S_{1b} — D.p.s.t. toggle switch.
- S_2 — S.p.s.t. toggle switch.

We Have New Regulations

*Docket 9295 Decided; 75-Meter 'Phone Expanded March 1st;
Novice and Technician Licenses Available July 1st*

ON January 31st FCC released notice of an action taken January 29th disposing of matters in Docket 9295 relating to revision of the amateur rules. You will recall that original proposals were made in April, 1949; that they caused considerable furore in amateur ranks and eventually resulted in the holding of an informal engineering conference in October of that year; that at said meeting the League presented a comprehensive document outlining its views as determined by the ARRL Board of Directors just previous to the meeting, and that this document became without qualification the unanimous view of those present or represented at the conference; that on November 17, 1949, the Commission issued an amended notice of proposed rule making which adopted most but not all of the conference recommendations; and that the League, still unable to accept some of the FCC proposals (as they differed from conference recommendations), requested oral argument which was held in Washington in June of 1950. The present action is the first one in Docket 9295 since that date.

In substance, the Commission affirms its proposals of November, 1949, and orders them into effect on March 1, 1951 (but Novice and Technician licenses will not become available until July 1, 1951, because of considerable administrative work required in setting up the licenses, and Extra Class licenses will not become available until January 1, 1952). Commissioners Henneck and Sterling filed a dissenting opinion at some length, among other things taking exception to FCC's action in establishing in its proposed form the language of now-famous § 12.0. Of course the majority opinion rules, so that we have the new Basis & Purpose section whether we or Commissioners Henneck and Sterling like it or not. The most that can be said is that the language of the originally-proposed § 12.0, which caused vehement opposition on the part of the League, was considerably "watered down" by the time it reached the amended proposal stage in November of 1949, and the language finally adopted is much closer to the ARRL recommendations concurred in by all participants at the informal engineering conference.

What effect does the Commission's action have on us? Quite a bit, and in many respects.

New License Structure

First of all is a complete revision of our present license structure. The Commission sets up six classes of amateur licenses as follows:

- Amateur Extra Class (new)
- Advanced Class (formerly Class A)
- General Class (formerly Class B)

- Conditional Class (formerly Class C)
- Technician Class (new)
- Novice Class (new)

The Amateur Extra Class license will become available to qualified applicants after January 1, 1952. Requirements will be two years' holding of an amateur operator license issued by FCC (i.e., since 1934), except that holding of Novice and Technician licenses will not count; passing a code test at 20 w.p.m.; passing the present written test on general theory and regulations, unless credit for it exists by virtue of having already passed it before an FCC examiner in connection with a currently-held license; and passing a new written examination in advanced radio theory and techniques, presumably considerably more difficult than the present Class A written exam. Privileges are all authorized amateur privileges although the Commission adds, somewhat ambiguously but perhaps in the nature of a prediction, "including such additional privileges in both communication and technical phases of the art which the Commission may consider as appropriately limited to holders of this class of license."

The Advanced Class license is simply a new name for Class A, and its requirements and privileges are the same. Advanced Class licenses still permit operation in the 75- and 20-meter 'phone bands, and the licenses may be renewed indefinitely, providing the holder can comply with renewal requirements. Class A will be renewed as Advanced Class without reexamination. New Advanced Class licenses will not be issued after December 31, 1952, however. The important point to note here is that after that date persons wishing to use the restricted 'phone bands, if they do not already hold an Advanced Class license, will have to qualify for the Extra Class license under requirements outlined in the preceding paragraph — and of course including the 20 w.p.m. code test. For holders of Advanced Class (Class A) licenses, the Extra Class presently confers no new privileges — and is in effect purely a "certificate of merit."

The General Class license is simply a new name for Class B, and the Conditional Class a new name for Class C. No substantive changes have been made in either class as to requirements or privileges.

New "Beginner" Licenses

The Technician Class license is a new one, becoming available July 1, 1951. Any citizen may obtain one by passing the present (Class B) written examination, both the element covering theory and the one dealing with regulations, and

a code test at 5 w.p.m. Examinations will be conducted along with others by FCC examiners according to the usual schedule; in addition, the license will be available by mail on the same basis that Class C now is — i.e., persons living more than 125 miles from the nearest quarterly FCC examining point, or disabled persons or those in the military service unable to appear. Privileges are all those available to amateurs above 220 Mc. It is a five-year license, renewable.

The Novice Class license is a third new one, also becoming available July 1, 1951. Any citizen, except a former holder of an amateur license (including, incidentally, those issued by military authorities in occupied areas such as Germany and Japan), may obtain one by passing a code test at 5 w.p.m. and an extremely simple written exam in regulations and theory. This exam may be taken at any FCC examining point or before a traveling inspector on the usual schedule, and like the Technician Class license is additionally available by mail to those more than 125 miles from an examining point, or disabled or in service. The exact scope of the written examination has not yet been set. The license is valid for one year and may not be renewed. It is expected that distinctive call signs will be issued. A Novice may use code in 3700-3750 and 26,960-27,230 kc., and code or voice in 145-147 Mc. His transmitter must be crystal-controlled, and the maximum input is 75 watts. By the end of the year the Novice must obtain another class of license (including passing the code test at 13 w.p.m.) or go off the air, and he may not again take the Novice exam.

Present examination credits are maintained — that is, the holder of a General Class license has to pass only the additional written examination for Advanced Class and is given credit for basic theory and regulations and the 13 w.p.m. code test. Similarly, future applicants for the Extra Class license, if they hold Advanced or General Class licenses, receive credit for basic theory and regulations and will be required to pass only the 20 w.p.m. code test and the new advanced exam on techniques. Credit will not be allowed holders of Conditional Class licenses or Technician licenses obtained by mail examination. Of course there is no credit accruing to a Novice Class license.

Frequency Changes

Effective March 1, 1951, the 75-meter 'phone band is expanded to 3800-4000 kc., restricted to Advanced Class (Class A) only, but of course available also to Extra Class licensees when that ticket is obtainable. Narrow-band frequency or phase modulation is moved to 3800-3850 kc. and made a permanent assignment. No change is made on 14 Mc., but the present 14,200-14,250 kc. n.f.m. privilege is made permanent. Similarly, the 10-meter n.f.m. assignment, 28.5-29 Mc., is made permanent, and of course n.f.m. may be used throughout the 'phone band because of wide-band privileges already existing above 29 Mc. On 50 Mc., n.f.m. is made available through-

out the entire band, whereas until now it has been limited to 51-52.5 Mc.

Renewals

Present renewal requirements undergo considerable change. Henceforth, renewal applicants must affirm that they have been actively operating at least 2 hours during the last 3 months of the license term, or 5 hours during the last 12 months of the license term. Operating time is determined as the total of that accumulated in the log between beginning and end of transmissions or QSOs. Such operation may now be on either voice or c.w. (or any mode), but the applicant must affirm that he can send and receive code at a speed not less than that originally required for the class of license being renewed — i.e., 13 w.p.m. for Advanced, General and Conditional Classes, 5 w.p.m. for Technician, 20 w.p.m. for Extra Class.

Heretofore it has been the Commission's practice, when issuing a duplicate license to replace one lost or accidentally destroyed, or a modified license because of a change to higher privileges or a change of address, to date the license currently so that it runs for five years more and is in effect a renewal. This practice now ceases, and such modifications or duplicates will bear the same expiration dates as the original license; therefore everyone will have to go through the renewal procedures described above every five years.

In a related action, the Commission separately has amended, also effective March 1st, Sections 12.22, 12.28, 12.45, 12.48 and 12.49 of our rules to make them editorially consistent as concerns the new names of the licenses, and to point out that, since examinations are now graded in the field offices, examinations taken by mail should henceforth be sent to the proper field office instead of directly to Washington.

There follows, first, the explanatory report and order, then the text of the new rules (with editorial liberties, to save space), third, the dissent filed by Commissioners Henneck and Sterling, and finally the new language of related sections changed for editorial consistency.

**Before the
FEDERAL COMMUNICATIONS COMMISSION
Washington 25, D. C.**

IN THE MATTER OF

AMENDMENT OF PART 12,
"RULES GOVERNING AMATEUR RADIO SERVICE".

DOCKET
NO. 9295

REPORT AND ORDER OF THE COMMISSION

BY THE COMMISSION: (Chairman Coy not participating; Commissioners Henneck and Sterling dissenting in part and concurring in part and issuing a joint statement).

On April 21, 1949, the Commission published a general Notice of Proposed Rule Making which set forth substantial changes in Part 12, "Rules Governing Amateur Radio Service". Numerous comments both for and against the proposed amendments were received, whereupon the Commission held an informal conference in its offices at Washington, D. C., during the period October 10 to 11, 1949. As a result of the comments made and discussions which occurred at the conference, substantial revisions of the proposed rules were made, and on November 17, 1949, a Further Notice of Proposed Rule Making and Notice of Provisional Designation for Oral Argument was issued. Following

a specific request by one of the amateur organizations a general oral argument was scheduled. On June 2, 1950, oral argument was heard by the Commission en banc.

In addition to stating the basis and purpose of the amateur rules, the amendments originally proposed provided for changes in the classification of amateur operator licenses which would eventually eliminate the three operator classifications now provided and substitute therefor six grades of amateur operator licenses, i.e., the novice, technician, conditional, general, advanced, and amateur extra classes of license; prescribed qualifications for these classes of licenses; amended the rule relating to renewal of license by providing, among other things, that the report of operation during the latter portion of the license term be specified in terms of operating time rather than number of communications; provided for changes in operator examinations in keeping with the new classes of licenses to be created, and restricted operation in certain frequency bands as to band width and modulation.

Following publication of the initial Notice of Proposed Rule Making the Commission received written comments from more than six hundred interested persons, including comments of some thirty-nine local, regional, or national amateur club and associations.

Because of the diversity of opinion expressed in the written comments, it was felt that by affording an opportunity for all interested parties to sit down with each other and the Commission's staff informally to discuss each of the specific rules proposed, these differences could be reconciled and each of the rules could assume the best possible substance and form. To a large extent these results were realized, and the further Notice of Proposed Rule Making thereafter issued reflected the discussions and agreements of the conference in a manner which, it was believed, would be generally acceptable to amateurs and which would also fulfill the Commission's statutory obligation in respect to the promulgation of rules and regulations.

In this further notice of rule making the Commission amended the proposed statement of the basis and purpose of the amateur rules in certain particulars, and in addition the proposed limitations of bandwidth, prohibition of wide-band frequency modulation, and further extension of narrow band frequency modulation were eliminated. Provision was made for continuance of the Class A type of operator license in a manner designed to accommodate current licensees. The proposed new Section 12.107, dealing with round table operation, was eliminated. The proposed requirement as to showing of operation during the license period as a prerequisite to renewal of license was modified.

Some forty or more persons and organizations filed initial or further comments following publication of the Further Notice of Proposed Rule Making.

At the oral argument held June 2, 1950, considerable support of the proposals, as revised, was expressed. The controversial portions of the argument related, primarily, to the statement of the basis and purpose of the amateur rules and the proposal to establish the amateur extra class of license. In addition, apparently because the underlying rationale was not clearly exposed, some objection was expressed to the proposed revision in the requirements for renewal of licenses and to the lack of a requirement for the re-examination of the holders of the technician class of license. However, the Commission was unable to determine, on the basis of the arguments, that further modifications should be made in the proposed amendments.

The disagreement with the proposed rule covering renewal of operator licenses was expressed, chiefly, on the ground that the present requirement, that application for renewal of license be accompanied by a showing of at least three communications by radiotelegraphy within the last six months of the license period, is sufficient. The theory underlying both the present and the proposed renewal requirements is that a certain showing of activity under the amateur license may be accepted as constituting a reasonable assurance that the licensee has maintained the skills which initially qualified him for the license. Accordingly, it is believed that a showing of operation in terms of actual operating time more accurately reflects this activity than would a mere showing of three contacts of indeterminate length.

The rules as to the technician class of license provide that an applicant may, if he resides more than 125 miles from the nearest examining point, is physically disabled, or is shown by certificate of the commanding officer to be in the armed forces of the United States at an Army, Navy, Air

Force, or Coast Guard station and, for that reason be unable to appear for examination at the time and place designated by the Commission, take the examination for the technician class of license before volunteer examiners. However, no provision is made for re-examination of the Technician Class operator when he changes residence and station location to within a regular examination area or when a new examination location is established within 125 miles of such licensee's residence and station location, as in the case of the Conditional Class license and the old Class C license. The reason for this difference lies in the comparative nature of the licenses. The technician class is designed for the experimenter or technician and the holder of the license is permitted to operate only on the higher frequency bands. Accordingly, it is believed that persons desiring this class of license would, primarily, be those who are truly interested in the radio art and who, because of the nature of their interest, are likely to be in fact qualified for the technician class of license whether examination for such license was conducted by an employee of the Commission or a volunteer examiner. Having this in mind and having in mind the administrative difficulties which are inherent in any requirement for re-examination, it is believed that to omit any requirement of re-examination in connection with the technician class of license is appropriate.

Objection to the proposal to create three new classes of amateur operator licenses was directed for the most part to the requirement of a code speed of 20 words per minute for the Amateur Extra Class license, on the grounds that this requirement would preclude many amateurs from obtaining this class of license. However, the new rules, in effect, provide a total of six grades of amateur licenses, including ones comparable to the present Classes A, B and C; hence, persons not able to attain the code speed required for the Amateur Extra Class will still be able to obtain other licenses commensurate with their skills and abilities.

Objection was also expressed to the proposed eventual elimination of the present Class A license, which heretofore constituted the highest grade of amateur license and was supposed to indicate that the holder thereof was particularly well qualified in amateur radiotelephony. This grade of license was established several years ago when certain bands of frequencies were originally made available for amateur radiotelephony and it was considered advisable to restrict use of these bands to amateurs who showed above-average qualifications in this phase of the radio art. In view of this, the Class A license has become identified with advanced radiotelephony while at the same time constituting the only incentive in the amateur license structure for advancement in radio skills. Inasmuch as amateur radio activity contemplates many phases of the radio art in addition to radiotelephony, it is desired that the holder of the highest grade of license shall be well qualified in more than one of its phases, regardless of whether he intends to restrict his activities to a particular aspect of amateur activity. Accordingly, the Amateur Extra Class of license is provided to eventually replace the Class A in the belief that the logical grade of license beyond the General Class should be one which will afford an incentive to all amateurs to become highly proficient in all phases of the radio art.

At the oral argument it was proposed that, if the Commission deems it necessary to provide the Extra Class of license, such license, should be subdivided into two classes; viz., radiotelephone and radiotelegraph. However, comments received in this proceeding seem to indicate that a schism now exists among the ranks of the amateurs in regard to amateurs who are proficient in radiotelephony and amateurs skilled in code operation. It is not the purpose of these rules to widen this breach in the ranks of the amateurs but rather to cement together the various techniques employed in amateur radio into one license to symbolize a radio man who is highly proficient in all amateur phases of the radio art. It further appears that the type of emission or technique used in the operation of the amateur radio station would be an illogical dividing line between the various classes of operator licenses because of the almost limitless types of emission or techniques possible to the amateur. Accordingly, careful study and consideration of this proposal leads to the conclusion that such a division of the Extra Class license would be undesirable.

It was also suggested at the oral argument that, in addition to the requirements proposed, issuance of an Amateur Extra Class of license be restricted to persons who have had at least ten or fifteen years operating experience as a licensed amateur. However, since skill in operating and in

radio technique depend to a considerable extent upon intensity of application this suggestion seems unnecessarily strict. Further, it is believed that a requirement of such lengthy experience, to some extent, would defeat the Commission's purpose in creating the Amateur Extra Class of license.

The basis and purpose statement evoked considerable comment and argument, largely upon the ground that the amateur body should seek its own objectives and request of the Commission such minimum regulation as would accomplish these objectives. However, since the Commission is charged, under the provisions of the Communications Act, with a positive responsibility to regulate the use of radio in the public interest, it may not, as suggested, shift that responsibility to others. Accordingly, the statement of the basis and purpose of the amateur rules is intended as a prospectus of the accomplishments which the Commission expects to result from the activities of a healthy amateur radio service functioning within the limits of rules shaped toward this end. Additionally, and of equal importance, is the fact that an expressed firm basis thereby will be afforded for future international negotiations affecting the Amateur Radio Service.

In view of the foregoing considerations and determinations, the Commission finds that the public interest, convenience, and necessity will be served by the adoption of the rules herein ordered. Accordingly, pursuant to the authority of Sections 4(i) and 303(b), (c), (g), (l), and (r) of the Communications Act of 1934, as amended, IT IS ORDERED, this 29th day of January, 1951, that:

1. The foregoing Report is adopted.
2. The rules set forth in the Appendix attached hereto are adopted and shall become effective on the dates specified therein.

FEDERAL COMMUNICATIONS COMMISSION

T. J. SLOWIE, Secretary

Released: January 31, 1951

Part 12, "Rules Governing Amateur Radio Service" is amended as hereinafter indicated. These rules will become effective March 1, 1951, except as otherwise indicated by footnote.

(1) A NEW SECTION 12.0 IS ADDED. AS FOLLOWS:

12.0 *Basis and Purpose.* These rules and regulations are designed to provide an Amateur Radio Service having a fundamental purpose as expressed in the following principles: (a) Recognition and enhancement of the value of the amateur service to the public as a voluntary noncommercial communication service, particularly with respect to providing emergency communications. (b) Continuation and extension of the amateur's proven ability to contribute to the advancement of the radio art. (c) Encouragement and improvement of the amateur radio service through rules which provide for advancing skills in both the communication and technical phases of the art. (d) Expansion of the existing reservoir within the amateur radio service of trained operators, technicians, and electronics experts. (e) Continuation and extension of the amateur's unique ability to enhance international good will.

2) A NEW SECTION 12.20 IS ADDED, AS FOLLOWS:

12.20. *Classes of Amateur Operator Licenses.*

Amateur Extra Class.¹

Advanced Class.² (Previously Class A)

General Class.³ (Previously Class B)

Conditional Class.³ (Previously Class C)

Technician Class.⁴

Novice Class.⁴

¹ This class of operator license will become available to qualified applicants January 1, 1952.

² This class of license is the same as the Class A with change of name only. It (and the Class A) may be renewed as long as the holder to whom it was issued meets the renewal requirements current at the time renewal is applied for. New Advanced Class (or Class A) amateur operator licenses will not be issued after December 31, 1952.

³ This class of operator license will become effective March 1, 1951.

⁴ This class of license will become available to qualified applicants July 1, 1951.

(3) SECTION 12.21 IS AMENDED TO READ AS FOLLOWS:

12.21. *Eligibility for license.*⁵ Persons are eligible to apply for the various classes of amateur operator licenses as follows:

Amateur Extra Class. Any citizen of the United States who at any time prior to receipt of his application by the Commission has held for a period of two years or more a valid amateur operator license issued by the Federal Communications Commission, excluding licenses of the Novice and Technician Classes.

Advanced Class. Any citizen of the United States who at any time prior to receipt of his application by the Commission, has held for a period of a year or more an amateur operator license issued by the Federal Communications Commission, excluding licenses of the Novice and Technician Classes. New Advanced Class amateur operator licenses will not be issued after December 31, 1952. However, Advanced Class (or Class A) licenses may continue to be renewed as set forth in Section 12.27.

General Class. Any citizen of the United States.

Conditional Class. Any citizen of the United States whose actual residence and amateur station location are more than 125 miles air line distant from the nearest location at which examinations are held at intervals of not more than 3 months for General Class amateur operator license; or who is shown by physician's certificate to be unable to appear for examination because of protracted disability; or who is shown by certificate of the commanding officer to be in the armed forces of the United States at an Army, Navy, Air Force or Coast Guard station and, for that reason, to be unable to appear for examination at the time and place designated by the Commission.

Technician Class. Any citizen of the United States.

Novice Class. Any citizen of the United States except a former holder of an amateur license of any class issued by any agency of the United States government, military or civilian.

(4) SECTION 12.23 IS AMENDED TO READ AS FOLLOWS:

12.23. *Classes and privileges of amateur operator licenses.*⁵

Amateur Extra Class. All authorized amateur privileges including such additional privileges in both communication and technical phases of the art which the Commission may consider as appropriately limited to holders of this class of license.

Advanced Class. All amateur privileges except those which may be reserved to holders of the Amateur Extra Class license.

General and Conditional Classes. All authorized amateur privileges except the use of radiotelephony on the frequency bands 3800 to 4000 kilocycles, and 14200 to 14300 kilocycles, and except those which may be reserved to holders of the Amateur Extra Class license.

Technician Class. All authorized amateur privileges in the amateur frequency bands above 220 megacycles.

Novice Class. Those amateur privileges as designated and limited as follows: (a) The d.c. plate power input to the vacuum tube or tubes supplying power to the antenna shall not exceed 75 watts. (b) Only the following frequency bands and types of emission may be used, and the emissions of the transmitter must be crystal-controlled: (1) 3700 to 3750 kilocycles, radiotelegraphy using only type A1 emission in accordance with the geographical restrictions set forth in Section 12.111(a)(2)(i). (2) 26.960 to 27.230 Mc., radiotelegraphy using only type A1 emission. (3) 145 to 147 megacycles, radiotelegraphy or radiotelephony using any type of emission except pulsed emissions and type B emission.

(5) SECTION 12.27 IS AMENDED TO READ AS FOLLOWS:

12.27. *Renewal of amateur operator license.* (a) An amateur operator license, except the Novice Class, may be renewed upon proper application stating that the applicant has lawfully accumulated a minimum total of either 2 hours operating time during the last 3 months or 5 hours operating time during the last 12 months of the license term. Such "operating time" for the purpose of renewal, shall be counted as the total of all that time between the entries in

⁵ For effective dates of the various classes of operator licenses, see footnotes 1 through 4.

the station log showing the beginning and end of transmissions as required in Section 12.136(a), both during single transmissions and during a "sequence of transmissions" as herein provided. The application shall, in addition to the foregoing, include a statement that the applicant can send by hand key, i.e., straight key or any other type of hand operated key such as a semi-automatic or electronic key, and receive by ear, in plain language, messages in the International Morse Code at a speed of not less than that which was originally required for the class of license being renewed. (b) The Novice Class license will not be renewed. (c) The applicant shall qualify for a new license by examination if the requirements of this section are not fulfilled. (d) The renewal application shall be accompanied by the applicant's amateur operator license, and also by his amateur station license if he holds one. (e) Application for renewal of an amateur operator license may be filed not earlier than 120 days prior to the date of expiration and not later than a period of grace of one year after such date of expiration. During this one year period of grace an expired license is not valid. A renewed license issued upon the basis of an application filed during the grace period will be dated currently and will not be back-dated to the date of expiration of the license being renewed. (f) Renewal applications shall be governed by applicable rules in force on the date when application is filed.

(6) SECTION 12.29 IS AMENDED TO READ AS FOLLOWS:

12.29. *License term.* Amateur operator licenses are normally valid for a period of 5 years from the date of issuance of a new or renewed license, except the Novice Class which is normally valid for a period of 1 year from the date of issuance. Modified and duplicate licenses shall bear the same date of expiration as the licenses for which they are modifications or duplicates.

(7) SECTION 12.42 IS AMENDED TO READ AS FOLLOWS:

12.42 *Examination elements.* Examinations for amateur operator privileges will comprise one or more of the following examination elements:

1(A) — *Beginner's code test.* Five (5) w.p.m.

1(B) — *General code test.* Thirteen (13) w.p.m.

1(C) — *Expert's code test.* Twenty (20) w.p.m.

2 — *Basic amateur practice.* Amateur radio operation and apparatus, including radiotelephone and radiotelegraph.

3(A) — *Basic law.* Rules and regulations essential to beginners' operation, including sufficient elementary radio theory for the understanding of those rules.

3(B) — *General regulations.* Provisions of treaties, statutes, and rules and regulations affecting all amateur stations and operators.

4(A) — *Advanced radiotelephone.* Technical, operational and other matter specifically applicable to the operation of amateur radiotelephone stations.

4(B) — *Advanced amateur practice.* Advanced radio theory and operation as applicable to modern amateur techniques, including, but not limited to, radiotelephony, radiotelegraphy, and transmissions of energy for measurements and observations applied to propagation, for the radio control of remote objects and for similar experimental purposes.

(8) SECTION 12.43 IS AMENDED TO READ AS FOLLOWS:

12.43 *Examination requirements.* Applicants for original licenses will be required to pass examinations as follows:

(a) Amateur extra class: Elements 1(C), 2, 3(B) and 4(B).

(b) Advanced class: Elements 1(B), 2, 3(B) and 4(A).

(c) General class: Elements 1(B), 2 and 3(B).

(d) Conditional class: Elements 1(B), 2 and 3(B).

(e) Technician class: Elements 1(A), 2 and 3(B).

(f) Novice class: Elements 1(A) and 3(A).

(9) SECTION 12.44 IS AMENDED TO READ AS FOLLOWS:

12.44 *Manner of conducting examinations.* (a) The examinations for all classes of amateur operator licenses, except Conditional Class, will be conducted by an authorized Commission employee or representative at locations and at times specified by the Commission. The examinations for Conditional Class, as well as Technician and Novice Class licenses, may be conducted in accordance with the provisions of paragraph (c) of this section under one or more of the following conditions:

(1) If the applicant's actual residence and proposed amateur station location are more than 125 miles airline distance from the nearest location at which examinations are conducted by an authorized Commission employee or representative at intervals of not more than 3 months for amateur operator licenses; or

(2) If the applicant is shown by physician's certificate to be unable to appear for examination because of protracted disability; or

(3) If the applicant is shown by certificate of the commanding officer to be in the armed forces of the United States at an Army, Navy, Air Force, or Coast Guard station and, for that reason, to be unable to appear for examination at the time and place designated by the Commission.

(b) A holder of a Technician or Novice Class license obtained on the basis of an examination under the provisions of paragraph (c) of this section is not required to be re-examined when changing residence and station location to within a regular examination area, nor when a new examination location is established within 125 miles of such licensee's residence and station location.

(c) Each examination for Conditional Class license, or for Technician, or Novice Class license under special conditions set forth in paragraph (a) of this section, shall be conducted and supervised by not more than two volunteer examiners, whom the Commission may designate or permit the applicant to select (not more than one examiner for the code test and not more than one examiner for the complete written examination). In the event the examiner for the code test is selected by the applicant, such examiner shall be the holder of an Extra Class, Advanced Class, or General Class of amateur operator license or shall have held, within the 5 years prior to the date of the examination, a commercial radiotelegraph operator license issued by the Commission or within that time shall have been employed in the service of the United States as the operator of a manually operated radiotelegraph station. The examiner for the written test shall be at least 21 years of age.

(10) A NEW SECTION 12.50 IS ADDED, AS FOLLOWS:

12.50 *Code test procedure.* The code test required of an applicant for amateur radio operator license, in accordance with the provisions of Sections 12.42 and 12.43 of these rules, shall determine the applicant's ability to transmit by hand key (straight key, or if supplied by the applicant, any other type of hand operated key such as a semi-automatic or electronic key) and to receive by ear, in plain language, messages in the International Morse Code at not less than the prescribed speed, free from omission or other error for a continuous period of at least 1 minute during a test period of 5 minutes, counting five characters to the word, each numeral or punctuation mark counting as two characters.

(11) SECTION 12.46 IS AMENDED TO READ AS FOLLOWS:

12.46 *Examination credit.* An applicant for a higher class of amateur operator license who holds a valid amateur operator license issued upon the basis of an examination by the Commission will be required to pass only those elements of the higher class examination that were not included in the examination for the amateur license held when such application was filed. However, credit will not be allowed for licenses issued on the basis of an examination given under the provisions of Section 12.44(c).

An applicant for Amateur Advanced Class operator license will be given credit for examination element 4(A) if within 2 years prior to the receipt of his application by the Commission he held Class A privileges or an Advanced Class license.

An applicant for any class of amateur operator license, except the Extra Class, will be given credit for the telegraph code element if within 5 years prior to the receipt of his application by the Commission he held a commercial radiotelegraph first or second class operator license issued by the Federal Communications Commission.

No examination credit, except as herein provided, shall be allowed on the basis of holding or having held any amateur or commercial operator license.

(12) SECTION 12.65 IS AMENDED TO READ AS FOLLOWS:

12.65 *License period.* The license for an amateur station is normally valid for a period of 5 years from the date of issuance of a new or renewed license, except that an amateur

station license issued to the holder of a Novice Class amateur operator license is normally valid for a period of 1 year from the date of issuance. Modified or duplicate licenses shall bear the same issue date and expiration date as the licenses for which they are modifications or duplicates.

(13) SECTION 12.111 IS AMENDED TO READ AS FOLLOWS:

12.111 *Frequencies and types of emission for use of amateur stations.* (a) Subject to the limitations and restrictions set forth herein and in §12.114 of these rules, the following frequency bands and types of emissions are allocated and available for amateur station operation as follows:

(1) 1800 to 2000 kc. [Same as at present — not repeated here in order to save space — *Ed.*]

(2) 3500 to 4000 kc. Use of this band is restricted to amateur radio stations as follows:

(i) 3500 to 4000 kc. using type A1 emission, to those stations located within the continental limits of the United States, the Territories of Alaska and Hawaii, Puerto Rico, the Virgin Islands and all United States possessions lying west of the Territory of Hawaii to 170° west longitude.

(ii) 3800 to 4000 kc. using type A3 emission and, on frequencies 3800 to 3850 kc. using narrow band frequency or phase modulation for radiotelephony, to those stations located within the continental limits of the United States, the Territories of Alaska and Hawaii, Puerto Rico, the Virgin Islands and all United States possessions lying west of the Territory of Hawaii to 170° west longitude, subject to the further restriction that type A3 emission, or narrow band frequency or phase modulation for radiotelephony, may be used only by an amateur station which is licensed to an amateur operator holding an Amateur Extra Class or Advanced Class license and then only when operated and controlled by an amateur operator holding an Amateur Extra Class or Advanced Class license.

(3) 7000 to 7300 kc. using type A1 emission.

(4) 14,000 to 14,400 kc. using type A1 emission and, on frequencies 14,200 to 14,300 kc, type A3 emission and, on frequencies 14,200 to 14,250 kc, using narrow band frequency or phase modulation for radiotelephony, subject to the restriction that type A3 emission, or narrow band frequency or phase modulation for radiotelephony, may be used only by an amateur station which is licensed to an amateur operator holding an Amateur Extra Class or Advanced Class license and then only when operated and controlled by an amateur operator holding an Amateur Extra Class or Advanced Class license.

(5) 26,960 to 27,230 Mc. using A β , A1, A2, A3, and A4 emission and also special emission for frequency modulation (radiotelephone transmissions and radiotelegraph transmissions employing carrier shift or other frequency modulation techniques), subject to such interference as may result from the emissions of industrial, scientific and medical devices within 160 kc. of the frequencies 27,120 and 27,320 Mc.

(6) 28.0 to 29.7 Mc. using type A1 emission and, on frequencies 28.5 to 29.7 Mc. using type A3 emission and narrow band frequency or phase modulation for radiotelephony and, on frequencies 29.0 to 29.7, using special emission for frequency modulation (radiotelephone transmissions and radiotelegraph transmissions employing carrier shift or other frequency modulation techniques).

(7) 50.0 to 54.0 Mc. using types A1, A2, A3, and A4 emission and narrow band frequency or phase modulation for radiotelephony and, on frequencies 52.5 to 54.0 Mc. special emission for frequency modulation (radiotelephone transmissions and radiotelegraph transmissions employing carrier shift or other frequency modulation techniques).

(8) 144 to 148 Mc. [and above, same as at present, not repeated here to conserve space — *Ed.*]

(14) SECTION 12.114 IS AMENDED TO READ AS FOLLOWS:

12.114 *Types of emission.* (a) Type A β emission, where not specifically designated in the bands listed in § 12.111 of these rules, may be used for short periods of time when required for authorized remote control purposes or for experimental purposes. However, these limitations do not apply where type A β emission is specifically designated.

(b) *Deleted.*

(c) The use of narrow band frequency or phase modulation is subject to the conditions that the bandwidth of the modulated carrier shall not exceed the bandwidth occu-

ried by an amplitude-modulated carrier of the same audio characteristics, and that the purity and stability of such emissions shall be maintained in accordance with the requirements of § 12.133 of these rules.

COMMISSIONERS FREIDA B. HENNOCK &
GEO. E. STERLING — DOCKET NO. 9295
DISSENTING IN PART AND
CONCURRING IN PART

We concur with Section 12.20 as it relates to the establishment of a Technician and Novice Class of license.

We concur with Section 12.111, paragraph (2) (ii) wherein it provides for authorization of 50 kc. of extra space for A-3 emission for the so-called 75-meter band (3800-4000 kc.). However, as indicated in the dissenting portion of this opinion, this is insufficient expansion to meet the growth of radiotelephony in the amateur service.

We dissent as follows:

Concerning Section 12.0, we do not intend to labor the point but we do feel that in view of the compromises effected in the desire for unanimity, the language agreed on by the amateurs at the Conference should be adopted in Section 12.0 without change. Since the Commission was seeking a reconciliation of the differences of opinion, it seems it could give a little itself for the purpose of arriving at the substance and form of the rules rather than adding language to this section as has been done in this case.

We object to Section 12.23 as it relates to the establishment of an Extra Class of operator's license without making provision for a "grandfather clause" so that the "old timers" may obtain this license and subsequent privileges it may authorize without examination. It is our opinion that the Commission in adopting the amateur extra class license as provided by Section 12.20 of the rules adopted on this date, which at some future date will confer special privileges to the holders of this class of license as anticipated by the language of 12.23, over and above those conferred on the holders of Class A licenses or subsequent holders of advanced classes of licenses, should in fairness to the "old-timers" in the amateur radio service, some of whom obtained their first license in 1912 when the first law was passed regulating radio communications, have provided a "grandfather clause" whereby the holders of these and Class B licenses for a period of many years could be accorded these additional privileges without the necessity of passing a technical and code examination at 20 words per minute. Traditionally, when the standards are raised in a trade or profession in which a license or certificate is required as the result of legislation, recognition has been given to those who have practiced in the art or trade for long periods of time.

It is the old-timers in the amateur fraternity who have been the backbone of the amateur service and will continue unless Federal regulation thwarts their interest and efforts. The amateurs who have for a long time rendered service to the public in providing emergency communications in times of national disasters as well as the gallant and meritorious services rendered in two wars for which they have been commended by high ranking military authorities should be recognized.

It has long been recognized by those experienced in the training and examination of radio operators that after one passes the age of 25 or thereabouts, it becomes increasingly difficult to improve one's code speed or to maintain a high code speed unless one is practicing it day by day. Many of these old-timers having qualified at either 10 or 13 words per minute for a license years ago have devoted most of their operation to radiotelephony and cannot pass a 20 word code test. Their service for renewals have been obtained generally at the present code speed of 13 words per minute or less, the only exception being those that have had several years as commercial operators or having operated extensively with radiotelegraphy. The rules have never required a specified code speed when obtaining service for renewal of license. It is our opinion that it would have been better to have adopted a class of license similar to the extra class of license issued several years ago, which could be taken voluntarily and it would attest to an advanced knowledge of theory and indicate a higher proficiency in code speed. Such a license, in our opinion, should not confer any extra privileges. To be eligible for this class of license, one would show a record of being an amateur licensee for ten years.

We object to Section 12.111 for the following reasons:

Section 12.111 of the rules adopted today should have
(Continued on page 108)

Adjustable Dummy Antennas

Pure Resistance Loads for Matching Your Line Impedance

BY GEORGE GRAMMER,* W1DF

WHEN a dummy antenna is required for transmitter testing, incandescent lamps for the most part serve very well. However, their resistance varies over a wide range with current, and they are therefore unsatisfactory when a load of constant, known resistance is needed — when, for instance, power output is to be measured or the transmitter coupling is to be adjusted to work into a matched line.

By using an impedance-matching circuit it is possible to make any resistor that has reasonably low reactance look like a pure resistance of the same value as the characteristic impedance of a transmission line. A simple s.w.r. bridge, used in the same way as for measuring s.w.r. on a line, will show when the circuit is properly adjusted. The only disadvantage is that the matching circuit can be set up for only one frequency at a time, which is not a very serious handicap.

Any resistor that will maintain constant resistance from no current to full current can be used in such a circuit provided its reactance is not too high. Low values of resistance are usually best in this respect, particularly those that are flat-wound. A resistor that we have found fairly satisfactory, and which has the virtues of high power-handling capability and cheapness, is the type used as the heating element in an electric iron. The element from a toaster may be equally useful. These units have a d.c. resistance of 12 to 14 ohms and can handle something over a kilowatt at 60 cycles. The resistance changes only a few per cent from room temperature to bright red heat. The apparent inductance is of the order of one microhenry, which is far from negligible but which does not constitute a limitation until the frequency is above 30 Mc. The resistance at radio frequencies is not known, but it does not matter. The matching circuit takes care of transforming it to the desired value.

Because the resistance is low, the heating element can be used in series with a resonant matching circuit at frequencies where the reactance of

the element can be neglected. A simple circuit that works well with coaxial line is shown in Fig. 1. The photographs show a dummy antenna unit which, having been constructed for lab use, includes an r.f. ammeter so the power can be measured, and mounts the heating element inside the chassis for protection against mechanical damage in handling. This unit has been tested with transmitters running up to a kilowatt input, on frequencies up to 28 Mc. At the latter frequency the resistance element shows distributed effects — i.e., the heating is greatest at one end and decreases along the length of the wire — but not of sufficient magnitude to affect its ability to dissipate the power satisfactorily. At 14 Mc. and below the heating appears to be uniform throughout the element.

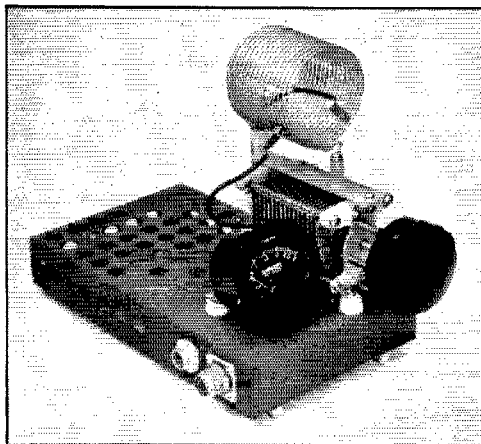

A dummy antenna for use with coaxial lines. The resistor, a replacement element for an electric iron, is mounted under the chassis for mechanical protection, and placed to the rear so the heat will not travel directly to the tuned circuit. Plenty of ventilation holes should be provided. Two types of coax fittings are used on this unit as a matter of convenience.

For occasional testing it is hardly necessary to go to the trouble of building up a special unit, since the resistor can simply be used as the load on an ordinary antenna coupler. However, it is desirable to mount the element itself in some fashion that will protect it, because the mica card on which the wire is wound is rather fragile; also, it must be kept away from anything that can be

damaged or set on fire by the heat. For use at the higher frequencies the leads to the element should be kept as short as possible.

The unit shown can be adjusted to 50 or 75 ohms over the range 3.5 to 28.7 Mc. An earlier model, which had leads about half as long between the resistance element and the tuned circuit, worked up to 30 Mc. Although the s.w.r. cannot be brought down quite to 1 to 1 at 30 Mc. with this later version, the mechanical layout keeps the circuit components fairly well isolated from the heat developed. A better arrangement for the 28-Mc. band, where the reactance of the element is large, is to connect the coil, condenser and resistor all in parallel. This gives good matching over the whole band with four active turns in the coil. The line is tapped across about two turns in such case. The series circuit is better at 14 Mc. and below.

*Technical Editor, QST.

There is some drift in the element with temperature, which it is believed is caused principally by a change in the inductance and distributed capacity with mechanical expansion of the wire. Depending on the power and frequency, the ammeter reading may change by as much as 20 per cent as the element comes up to temperature. This drift can be greatly reduced by placing the unit so that a small ventilating fan can blow air on the element from underneath. However, if the test periods are short the forced cooling can be omitted. For accurate power checks, the coupling at the transmitter should first be adjusted to give the proper loading, then the power should be turned off and the element allowed to cool down to about room temperature. On turning on the power again the ammeter reading should be taken immediately, before the temperature has risen to the point where the wire expands.

The circuit is adjusted in the same way as a coax-coupled antenna tuner — that is, by adjusting the taps and tuning so that an s.w.r. bridge inserted in the line to the dummy gives a null reading. The resistance looking into the dummy is then the value for which the bridge is designed, and the current shown by the r.f. meter can be used for calculating the power ($P = I^2R$). If the dummy is to be used for power measurement, be sure that the circuit adjustment brings about a complete null; a small discrepancy will not affect the usefulness of the unit as a load, but will cause the current to change in about the same percentage. The percentage error in power is about twice the percentage error in current. Also, once the circuit is properly matched the condenser should not be touched; adjustment of loading on the transmitter *must* be done at the

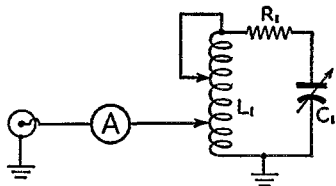

Fig. 1 — Dummy antenna circuit for coaxial line. The single coil works over the 3.5- to 28-Mc. bands by shorting turns.

C_1 — 200- μ fd. transmitting variable (National TMK-200).

L_1 — 15 turns No. 12, $2\frac{1}{2}$ inches diameter, 6 turns per inch (Barker & Williamson No. 3905-1).

R_1 — Electric-iron heating element.

A — R.f. ammeter, according to resistance and power.

NOTE: Circuit should be adjusted to have as low Q (high C) as possible. This broadens the tuning and reduces the voltage across the condenser. Approximate tap positions from grounded end of coil are as follows, for 75 ohms:

Band	Shorting Tap	Line Tap
3.5 Mc.	Open	$2\frac{1}{2}$
7 Mc.	5	2
14 Mc.	3	$1\frac{1}{2}$
28 Mc.	2	2

Tap adjustments are critical for perfect matching, but will usually hold over the entire band, condenser C_1 being properly tuned at each frequency.

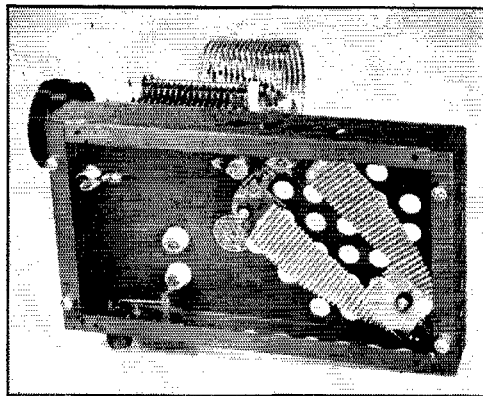

The heating element is mounted on metal pillars to center it vertically in the chassis space. The two outside mica pieces furnished with a replacement unit should be cut off to help keep the wire as cool as possible.

final amplifier, not the dummy antenna, if the ammeter readings are to mean anything.

Power measurements made in this way are practically as accurate as the accuracy of the r.f. meter permits. They are likely to be a bit disillusioning, though, if you have been used to "guesstimating" power output by the brightness of a lamp load!



March 1926

... The intricacies of shielding are authoritatively discussed by D. R. Clemons.

... The roster of U. S. amateurs now active on the air with crystal control includes 1BAY, 2WC, 4BK, 4BY, and 4XE.

... IARE has devised a convenient method of providing a "center tap" for filament transformers. He uses a pair of Christmas tree lamps in series across the secondary, tapping in at the junction of the lamps.

... Circuits and devices for multiplex short-wave reception are described by J. K. Clapp of M.I.T. The author predicts great possibilities for the system in handling traffic, measuring frequency, and observing receiving conditions.

... F. Cheyney Beekley, 1KP, has succeeded Edwin Adams as advertising manager of QST; Harold P. Westman, 2BQH, has joined the ARRL technical staff.

... In the interests of frequency stability, Rufus P. Turner, 3LF, presents a power amplifier for low-power oscillator transmitters.

... The "Who's Who in Amateur Wireless" section furnishes introductions to Dr. Lawrence J. Dunn, 2CLA, Brandon Wentworth, 6OI, and E. W. Thatcher, op at 8ZE.

... 1XU uses a glass toothbrush holder as a form for plug-in r.f. chokes.

... A. L. Budlong recommends the use of a "C" battery instead of a grid leak because of the improved detection of weak signals that results.

... Practical power-supply filters employing Ford coils are described by Charles Provins, 6DAO-6DBW.

An All-Band Mobile Station

A Simple Installation for 'Phone or C.W.

BY WILLIAM H. RAWSON,* K2AX

THE dream of almost every mobile enthusiast is an all-band arrangement that doesn't clutter up the auto too much and can be band-changed easily. The installation shown in the photographs is an outgrowth of meditation while auto-bound in a heavy rainstorm last Field Day, and it seems to meet those requirements. The transmitter puts a minimum of 12 watts into the antenna on all bands, 80 through 10, and is easy enough on the battery so that the average automobile generator will handle the situation. It is the design and work of Dal Akers, W2FL. It took him 30 hours to build. He studied the features of various mobile rigs described in past issues of *QST* and added some ideas of his own.

Circuit

As shown in Fig. 1, the rig starts with an 80-meter crystal in a modified Pierce circuit, using a 6BA6. The plate circuit operates either on the fundamental or the second harmonic, a 140- μ fd. condenser, C_3 , covering both without need for coil change. The band switch, S_1 , selects either one or both halves of a 12AU7, multiplying to 20 or 10. On 40, the 12AU7 is out of the circuit.

The output tube is a 2E26, which works into a pi-section matching network. The final coils are National type AR plug-in units, but alternatively could be made easily from B&W Miniductors and mounted on whatever plug bars are available.

The final plug-in coils are accessible through a plexiglas window, held by four wing nuts, in the front panel. Shown in the diagram, but installed

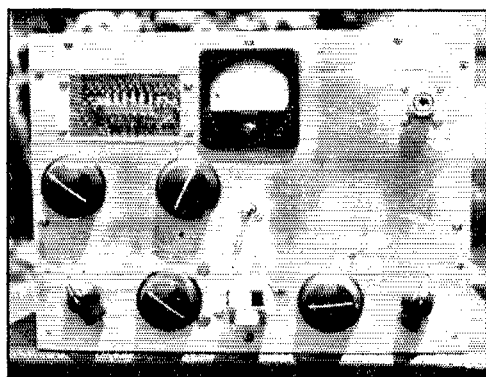

Front view of the all-band mobile rig, showing the opening for the final plate tank coil. The two upper controls are for the matching-network condensers. Along the bottom, left to right, are the bandswitch, oscillator tuning control, crystal socket, audio gain control, and 'phone-c.w. switch.

*107 Elm St., Dover, N. J.

after the front-panel photograph was taken, is an extra loading control — a 140- μ fd. condenser in parallel with one of 100 μ fd. If additional capacitance is needed to meet antenna requirements, it can be a fixed condenser secured on the coil itself.

The speech section starts with a war-surplus T-17 carbon microphone working into a single-button-to-grid transformer. The first speech tube is half of a 12AU7, the second half being a resistance-coupled amplifier. This second stage is transformer-coupled to drive a 6N7, cathode-biased, so that the 400 volts applied to the 2E26 also can be used for the 6N7. The modulator provides 100 per cent modulation with the gain control only slightly advanced. A 'phone-c.w. switch cuts the B-plus to the speech tubes and shorts the modulation-transformer secondary.

Construction

The entire unit is contained on a chassis bent from aluminum sheet, 10 by 6 by 2 $\frac{1}{2}$ inches. The panel is 10 by 7 $\frac{3}{4}$ inches, with a 0-5 ma. meter centered on it. The meter is shunted (R_{11}) to read 0-50 ma. for checking cathode current. A double-pole double-throw toggle switch is mounted under the meter to read grid or cathode current. The doubler stages are tuned by screw-driver adjustments brought to the front panel. The condensers and coils for them are subchassis mounted, near the 12AU7.

The speech section occupies one-half of the chassis, and the r.f. portion the other in the on-end rear-view photograph. All r.f. parts are under the chassis except the final-amplifier coil and associated condensers, and the shunt-feeding r.f. choke. A partition set back from the panel holds the pi-section network. The condensers are behind the partition, and the coil socket in front, mounted at right angles to the panel.

Control Box

Presumably operating controls, such as switches and jacks, could be mounted on the transmitter panel. It was decided, however, to put them in a control box mounted on the steering column. The wiring of this unit is shown in Fig. 2. A metal box, 4 by 5 by 3 inches, contains three 1 $\frac{1}{2}$ -volt flashlight batteries for the microphone, a three-way microphone jack (J_2), closed-circuit keying jack in the 2E26 cathode circuit, (J_3), a master switch (S_1), a toggle switch (S_2) to turn on the dynamotor independently of the press-to-talk switch on the microphone for c.w. work, a pilot light (I_1), and an octal socket (J_1) to receive the power-control cable from the transmitter. Wires also are brought out to connect to the power-distribution strip on the dyna-

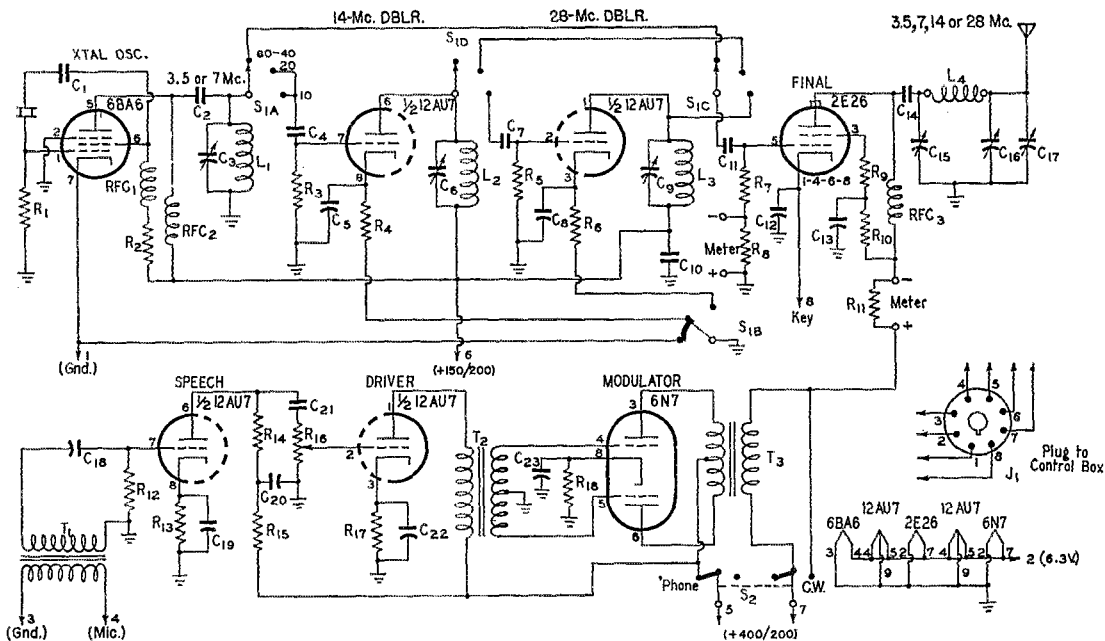

Fig. 1 — Circuit diagram of the all-band transmitter.

- C₁, C₁₄ — 0.001- μ fd. mica.
- C₂ — 0.005- μ fd. mica.
- C₃, C₁₇ — 140- μ fd. variable.
- C₄, C₇, C₁₁ — 50- μ fd. mica.
- C₅, C₈, C₁₂, C₁₃, C₂₁ — 0.01- μ fd. paper.
- C₆, C₉ — 25- μ fd. variable.
- C₁₀ — 0.002- μ fd. mica.
- C₁₅, C₁₆ — 100- μ fd. variable.
- C₁₈ — 0.1- μ fd. paper.
- C₁₉, C₂₂, C₂₃ — 25- μ fd. electrolytic.
- C₂₀ — 8- μ fd. electrolytic.
- R₁ — 47,000 ohms.
- R₂ — 56,000 ohms.
- R₃, R₅ — 33,000 ohms.
- R₄, R₆ — 300 ohms.
- R₇ — 22,000 ohms.
- R₈, R₁₈ — 220 ohms.
- R₉ — 100 ohms.
- R₁₀ — 15,000 ohms.
- R₁₁ — Meter shunt, 10 times.
- R₁₂ — 0.5 megohm.
- R₁₃ — 2200 ohms.
- R₁₄ — 0.1 megohm.
- R₁₅ — 5000 ohms.

- R₁₆ — 0.5-megohm volume control.
- R₁₇ — 560 ohms.
- L₁ — 17 μ h — 48 turns No. 24, $\frac{3}{4}$ -inch diam., $1\frac{1}{2}$ inches long (B & W 3012 Miniductor).
- L₂ — 4 μ h. — 16 turns No. 24, $\frac{3}{4}$ -inch diam., $\frac{1}{2}$ inch long (B & W 3012 Miniductor).
- L₃ — 1.3 μ h. — 8 turns No. 18, $\frac{3}{4}$ -inch diam., $\frac{3}{16}$ inch long (B & W 3011 Miniductor).
- L₄ — 3.5 Mc. — 60 μ h. — 60 turns No. 18, $1\frac{1}{4}$ -inch diam., $1\frac{3}{4}$ inches long (National AR-16-80).
- 7 Mc. — 15 μ h. — 28 turns No. 18, $1\frac{1}{4}$ -inch diam., $1\frac{3}{4}$ inches long (National AR-16-40).
- 14 Mc. — 4.2 μ h. — 14 turns No. 16, $1\frac{1}{4}$ -inch diam., $1\frac{1}{4}$ inches long (National AR-16-20).
- 28 Mc. — 1.2 μ h. — 8 turns No. 16, $1\frac{1}{4}$ -inch diam., $1\frac{1}{2}$ inches long (National AR-16-10).
- J₁ — Octal chassis-mounting plug.
- S₁ — 2-wafer 4-circuit ceramic rotary; S_{1B} modified to short.
- S₂ — D.p.d.t. rotary.
- T₁ — Microphone transformer.
- T₂ — Plate to Class B grids.
- T₃ — 10-watt universal modulation transformer.

motor panel. The box is mounted with a bracket taken from a flashlight holder bought for 20 cents at an auto parts store.

Power Supply

The wiring of the power-supply unit is shown in Fig. 3. The main unit is a Carter Magmotor that delivers 400 volts at 150 ma. Another Magmotor delivering 250 volts at 100 ma. is available, through the double-pole double-throw midget knife switch, *S*₁, for tuning or stand-by in case of failure of the other. The knife switch also changes over the starting relay, *R*_{Y1}, and the smoothing filter made up of *C*₁, *C*₂ and *L*₁. The starting relay is a type designed for use with sealed-beam headlights. It draws only 0.5 ampere. The dynamotor circuit is fused with a 40-amp. fuse, *F*₁, in a clip mounted on the relay.

The dynamotors and associated equipment are mounted on a single piece of heavy aluminum that is bolted to the under-hood firewall of the 1949 Ford. Number 10 wire is used in the contact circuit. A separate fused (*F*₂) line is brought directly from the battery for the transmitter heaters and starting-relay coil. Wires from the dynamotor panel to the control box are forced through the grommet along with the car's main wiring.

Transmitter Installation

The transmitter is mounted on a shelf centered against the inside firewall. The shelf was made by cutting a corner of a cast-aluminum junk cabinet (from an old BC-312 receiver). It takes up no more room than the heater, alongside which it is located, and does not interfere with leg room.

Receiving Equipment

A b.f.o. and noise limiter are built into the automobile receiver, an Automatic Radio Co. job made for Fords. The b.f.o. transformer had to be bolted outboard, but room was found in the chassis for the additional tube. When mounting things outboard on these receivers be sure that you have ample clearance since the power supply and audio components hang down behind the r.f.-i.f. unit. The b.f.o. switch and a 'phone jack are placed on the side of the receiver. The receiver is fed by a Gonset 3-30 converter.

Antenna Considerations

A 96-inch whip, bought for \$3.00 at an auto parts store, is mounted on the rear bumper guard with the two stand-offs supplied with it. It is fed with a half wavelength of RG-59/U coaxial on 10 meters. The coax can be fed all the way, forward

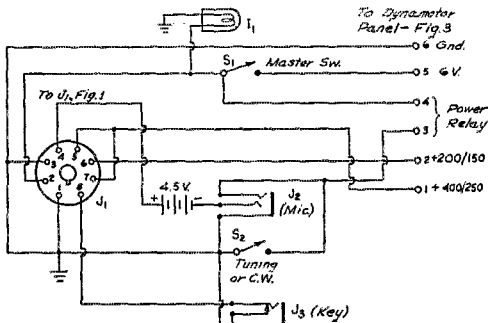

Fig. 2 — Wiring diagram of the control unit.

- I₁ — 6.3-volt dial lamp.
- J₁ — Octal socket.
- J₂ — 3-contact microphone jack.
- J₃ — Closed-circuit jack.
- S₁, S₂ — S.p.s.t. toggle.

to aft, in a 1949 or 1950 Ford without drilling a hole. It goes under the front seat, under the rear mat, under the rear seat and through a crack to the trunk compartment. A rubber plug on either side of the latter gives access to the outside. There's a gap just right for pushing the coaxial through to within a few inches of the bumper guard where rear fenders meet the back.

For receiving on 10 meters, a cheap 56-inch cowl-mounted antenna is used. On all other bands, the front antenna, fed by the 3-foot coaxial supplied with it, is used for transmitting, and the rear whip for receiving. The rear antenna, with the long run of coaxial, cannot be fed with any efficiency except as a quarter wave. The forward antenna, however, with just a short piece of coaxial, is simply a random-length antenna loaded by courtesy of the matching network.

A better system would be to have one antenna, and use a change-over relay. An 8-foot cowl mounted affair would do the trick. Expensive and hard-to-get, but eminently suitable, is the Ward DCF-4. The change-over relay should have other

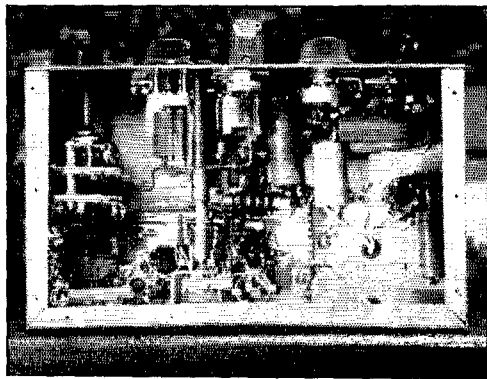

Bottom view of the all-band 'phone-c.w. mobile transmitter.

contacts to open the transmitter B-plus while receiving because the dynamotors coast.

Efficiency on the lower frequencies could be gained through a loaded antenna. The system employed here, though, is relatively simple, inexpensive, and it does work. For 80-meter work while parked, a horizontal extension can be stretched aft and rigged to the rear antenna with an insulator.

The 2E26 normally is loaded to 40-ma. plate current. The total plate-screen drain for the entire transmitter, with modulation, is less than 150 ma.

Adjustment

It is best to pretune the transmitter on the bench, preferably with the aid of a grid-dip meter. While only final grid and cathode currents are metered, once the previous stages are set at approximately the right place, and so marked, it is easy to get enough grid current so that all circuits can be peaked in the car, even when shifting frequencies.

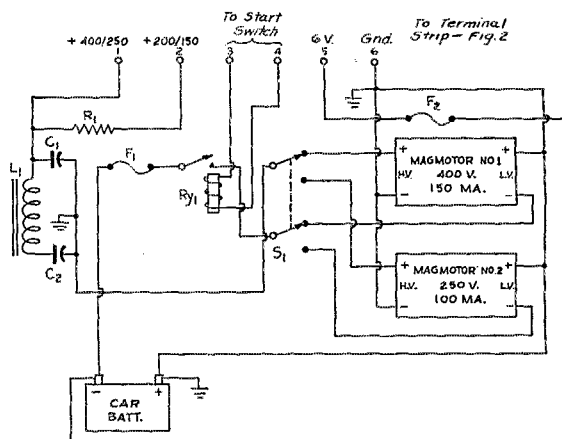

Fig. 3 — Wiring of the power-supply unit.

- C₁, C₂ — 8- μ fd. 450-volt electrolytic.
- R₁ — 3000 ohms, 50 watts.
- L₁ — 10 h., 150 ma.
- F₁ — 40-amp. fuse.
- F₂ — 15-amp. fuse.
- R_{y1} — See text.
- S₁ — D.p.d.t. miniature knife.

UNITED STATES NAVAL RESERVE

Amateurs on Active Duty

The following Naval Reservists are on active duty with the Navy:

W1FWS PSG; W7IWH MZB OYV SJC TXU WVE YEC YGW ZNE ZUT; W3ACM KIP; W4EFA IA.

W5BQT DWJ FPX GIC HKP HNW HYD ICS JKC KMN KPC LRA LUA MPI MRN MWT NCR NCS NOS NXM OBJ OCK ODO OM OSW PQU QNP RAE REQ RKI.

W6AME ARB BEU BQX BSY DXY ENE FMV FUG FWK GDV HXY IFE IMX JFX JSF JUW KQK KYF MCS MSG NCM QHW UYV UVM UJU VBU VGF VWF WPM WQI YPE ZDF; K8AW; K6HJB.

W7BKW BML DNG ESK GEV GHW IDU IQV JCU JEC JGT JPM KHO KQD KYY LJ LVW LXP MQM NCI NSE OAQ OV SQT.

W8BEZ BPU CBD DSD DXX ELW FJF FKI FOR VQO YAB ZAM ZBV ZDJ ZDT ZHM ZNG ZOH ZOY ZQM.

W9AKP AMT ANA ART AUB BHY BWI CHV CIK CND DTE DTO DYH DZR ECI EIZ FCD FDC GKP GMI HGR HF HN HSA IHV IML JOG LEN LLT LXX MTU NGM OQY RZW SGU TEG ULP WIB; K9AAD.

W0ADN BBL BCT BJG BYL CIQ COA CQK CRY CWM DJE DKV DYQ ECN ELS ELT EYU GBG GJS GMM GVW HDX HEY HKM HOC HZR IZH JRN JVB KIR LWY NZQ OPO OVD QGU RKS SHI SKF TLT TWB UJU VXM.

Reservists Invited To Visit U.N.

Naval Reservists who are in New York City on cruises or any other duty have been extended an invitation by Warren E. Austin, chief United States delegate to the United Nations, to obtain first-hand knowledge of the international organization by visits to both the U.N. Mission and U.N. Headquarters. Ambassador Austin advises that the Office of Public Information of the United States Mission to the U.N. would be happy to arrange briefing sessions for military personnel who might profit directly from orientation in U.N. matters. The U.N. Mission is located at New York and U.N. Headquarters at Lake Success, N. Y.

Here and There

Reservists who are considering application for appointment to the Naval Academy will be interested to learn that physics and plane trigonometry are no longer required subjects for entrance examinations or high school certificates. This change will be in effect for the examinations to be given this April. . . . Organized Electronics Company 12-4 (K6NAM) was activated on December 12, 1950, at San Luis Obispo, Calif., with Lieut. Cmdr. John D. Lawson, USNR, as commanding officer. Formerly Volunteer Company 12-20, it is the first organized electronics company in the Twelfth Naval District. . . . NDM, the radio station at Naval Reserve Training Center, Washington, transmits code practice for Naval Reservists each Wednesday starting at 2000 EST. Three ten-minute periods are transmitted on 3415 kc. at approximately 8, 13 and 18 words per minute respectively. Each period concludes with a drill message of 10 to 15 groups. Reservists who copy these drill messages are requested to send a copy on a postal card to Naval Reserve Radio Station, Naval Reserve Training Center, Naval Gun Factory, Washington 25, D. C. Separate competitions will be held for each speed group. Non-Reservists are invited to copy the transmission for practice purposes and to submit reports. However, competition is open only to Reserve or Regular Naval personnel. . . . Lieut. Cmdr. Edwin F. Jones, USNR, W2YJ, commanding officer of Volunteer Electronics Platoon 3-18, Plainfield, N. J., invites radio amateurs and other interested personnel to look over the unit's facilities. This platoon meets at W2YJ's QTH on Tuttle Road, Watchung, N. J., a suburb of Plainfield. . . . Clarence St. Andre, RMC, USNR, W18GC, is an instructor in the communication training program at Naval Reserve Training Center (K1NRP), Pawtucket, R. I.

Don't try to get by with too little output capacitance in the pi section. A quarter-wave antenna on 29 Mc. requires something over 100 μ fd. An 80-meter whip, loaded to represent an electrical quarter wave, would require in the neighborhood of 400 μ fd. As the loading increases, the required loading capacitance decreases up to the optimum point. The plate tuning capacitance consequently must be increased to maintain resonance. The tank coil, therefore, should be trimmed so that the condenser is not close to either extreme in the unloaded condition.

Of interest to new car owners, the installation requires a minimum of hole drilling. The bumper guard is replaceable in event of auto turn-in. The only other holes are in the firewall and, even there, use was made of existing knock-outs.

Summary

Good results have been had on all bands, but 10-meter 'phone thus far has been used mostly. There, reports have been consistently high — better than average for mobile. The probable answer is that there is ample voice gain so that 100 per cent modulation is assured. It is also important to make sure the available power is getting to the antenna, and not just loading up a length of coaxial.

Warning

Safety precautions cannot be overstressed in mobile work. Do your tuning while parked. Resist the temptation to look down at the meter while in motion. You'll never get out very well from inside a lead-lined box or concrete vault!

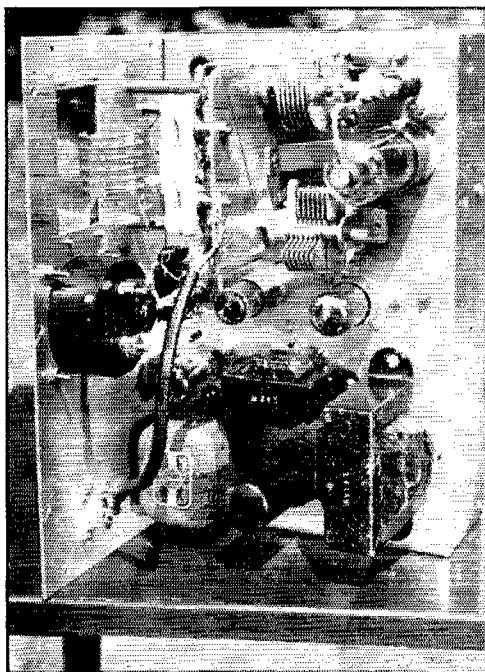

Rear view of the all-band mobile transmitter. The modulator is below and the r.f. unit at the top.

Happenings of the Month

F.C.C. NOTES

A couple of TV program digests recently carried a small item to the effect that an amateur had had his license suspended by FCC for interference to TV reception. That wasn't the case at all, and the League promptly hopped the editors. The facts were that the amateur in question paid no attention to routine FCC notifications of TV interference, did not answer them as required, made no effort whatsoever to investigate or clear up the interference, and disregarded silent hours when they were finally imposed on him. All of which illustrates the importance of responding to any such FCC notifications of interference as we may get, promptly and fully.

The "State-Local Government and Amateur Division" of FCC has a new name: Public Safety and Amateur Division. The Commission believes the new title more adequately describes its scope and work.

FCC has now made final, effective February 15th, its proposed rules governing construction and marking of antennas and masts, and insists they will apply to amateur stations despite a League request for exemption.¹ All the ramifications are not clear at this writing; see the editorial in this issue for a discussion of the matter.

At the end of the year FCC issued its sixteenth annual report² covering the year ended June 30, 1950. On that date there were 87,967 amateur station licenses outstanding, an increase of 6292 in one year, and 86,662 operator licenses, an increase of 5941. (A supplementary report shows 89,739 stations on October 31st, and unofficial figures show by year end we were well over the 90,000 mark.) This is approximately the same growth as in the previous fiscal year. Editorially, the report devotes a couple of pages to an FCC appraisal of the amateur service, a portion of which we quote to illustrate the esteem in which our service is held in Washington:

The amateurs, or "hams" as they prefer to be known, are internationally recognized and their ranks comprise persons in almost every walk of life. Some of them obtain a livelihood from employment in the radio industry, others from entirely unrelated fields of endeavor. However, they are all joined by a common interest in radio; an interest which is without pecuniary considerations and involves only personal aims. Many of them bring to the amateur service outstanding ability in one or more of the various phases of the art of radio communication. Through the exercise of their respective skills in designing, developing, constructing, and experimenting with radio equipment, developing communication techniques, and by providing scientific observation services as well as the usual handling of third party messages during the past year, they have demonstrated that the privileges which they have been granted have been well justified.

Also the amateur service has a high degree of national value. It constitutes a pool of self-trained radio technicians

¹ P. 26, *QST*, September, 1950.

² Available from Supt. of Documents, Government Printing Office, Washington 25, D. C., 40¢.

and operators upon which the country can draw in time of war and other national need. Further, special networking and other amateur activities have proved highly useful to the national defense program.

In our February issue we were able to insert a flash announcing those amateur frequencies which are earmarked for civil defense communications. The full text of the Commission's public notice of January 17th is reproduced on the next page.

Note to prospective amateurs in the Rocky Mountain states: The quarterly radio operator examinations at Salt Lake City, Utah, are now scheduled for March 21st, instead of the 14th as previously announced. The June 13th date remains okay, so far as is known at present.

ARKANSAS LICENSE PLATES

Special call letter license tags are now being issued through the State Revenue Department to be used by Arkansas amateurs in addition to the regular state plates. Under state motor vehicle laws no other form of car tag is permitted so Arkansas amateurs have obtained a concession from the State. The tags, costing \$1, will contain the call letters of the car owner, with "amateur radio" above and "Arkansas" beneath. The Fort Smith Radio Club was instrumental in obtaining this privilege.

Special call letter plates in lieu of the regular license tags are now being issued in Florida, Mississippi, Louisiana and the Canal Zone. ARRL headquarters, continuing to supply information on special call letter license plates to interested clubs and groups, would like to be kept informed on the progress being made in other states.

PORTABLE/MOBILE IN CANADA

Just as we go to press, an agreement in the form of a treaty has been concluded between Canada and the United States clearing the way for eventual authorization for U. S. amateurs to operate while in Canada — and vice versa. After the agreement is ratified, and after the Department of Transport on behalf of Canada and FCC on behalf of the United States have promulgated any necessary regulations, licensed radio operators of three categories will be permitted to use their equipment in either country: amateurs, civilian pilots, and land mobile (high-way radiotelephone) stations. Don't get your hopes too high for mobile in Canada this vacation season, however; ratification still has to be accomplished by the two countries — a process which will probably take several months, at least, in this country and possibly six months or more in Canada, according to CGM Reid.

Public Notice
January 17, 1951

**FREQUENCIES AVAILABLE FOR AMATEUR
PARTICIPATION IN CIVIL
DEFENSE COMMUNICATION**

The Civil Defense Administration has brought to the attention of the Commission the fact that licensed radio amateurs may be requested by the appropriate local Civil Defense authorities to provide civil defense communications or to supplement other existing communications systems for civil defense purposes.

The matter of permanent availability of specific frequency bands within the regularly allocated amateur bands for eventual use by amateurs in providing civil defense communications, after any suspension of normal amateur activity which may later be found to be necessary because of war or other national emergency, has been the subject of particular study by the Commission, the Civil Defense Administration and the Armed Forces of the United States.

After consideration of all factors known to be involved at this time, including frequency requirements of other radio services in time of war or other national emergency, certain frequency bands already allocated to amateurs have been selected for their retention and use for the purposes described in the preceding paragraph. The extent to which these bands meet the actual requirements for amateur participation in civil defense communications may be reviewed after a sufficient number of local communities have established appropriate civil defense plans, conducted communications drills or otherwise accumulated data which will permit such a review.

The frequency bands which will remain available for civil defense use by amateurs are tabulated herewith:

1800 - 2000 kc	50.35 - 50.75 Mc
3500 - 3510 kc	53.35 - 53.75 Mc
3990 - 4000 kc	145.17 - 145.71 Mc
28.55 - 28.75 Mc	146.79 - 147.33 Mc
29.45 - 29.65 Mc	220 - 225 Mc

In addition to the above bands, the band of frequencies 1750-1800 kc. will continue to be available for use by properly qualified amateurs and others to provide a Disaster Communications Service, but it should be noted that such a service is intended as a permanent one for use in a disaster occurring at any time, to assist in handling communications within or with a disaster area, whereas the frequencies listed above are designated for amateur use for the handling of such communications as may be required in the interest of civil defense.

This notice is primarily intended to make clear which portions of the regularly allocated amateur bands will continue to be available for amateur use to provide civil defense communications after any suspension of normal amateur activity. It is not intended to deal with the various other phases of the problem, such as eligibility for continuing operation in these bands, operating regulations and procedures, and other related matters. However, to the extent that knowledge of frequency availability is required for planning purposes, such planning may proceed on the basis of this announcement for the organization of civil defense communication networks.

Nothing herein should be construed to alter in any way the present availability of amateur frequency bands or the normal operation of amateurs in these bands as presently being practised in accordance with existing Commission rules.

WATCH YOUR EXPIRATION

Nearly one-half of present amateur licenses expire during 1951. Check the expiration date on yours now and arrange to apply for renewal sometime in the 120 days preceding expiration date. See the story on regulations in this issue for revised renewal requirements.

**Substitute for Philips Trimmers
in Low-Power Bandpass Rig**

IN the 6AG7-807 single-control transmitter described on page 11 of January *QST* the use of two Philips 3-30 μ fd. trimmers (C_5 and C_6) was specified in the construction of the plug-in bandpass couplers. Apparently these condensers, which are of foreign manufacture, are not presently available in this country because the former distributor is no longer in business. An entirely satisfactory replacement for these condensers is the ordinary 3-30 μ fd. compression-type trimmer available from most dealers and shown in the accompanying cut-away view.

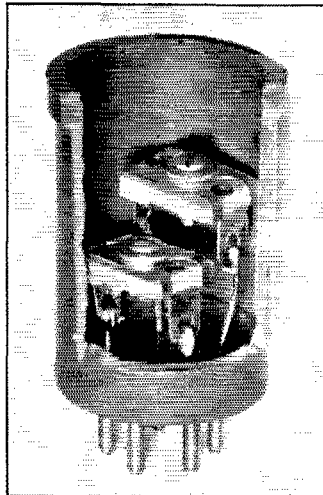

The compression-type trimmers are too large to permit them to be mounted side-by-side in the bottom of the coil form as the Philips trimmers were, but by soldering pigtail leads made of No. 16 tinned wire to the mounting tabs, a pair may be "stagger mounted" as shown in the photograph. The coils must be wound first, and their leads pulled through the pins in the base of the coil form. Before soldering, place one of the trimmers, with its newly-acquired pigtail leads, near the bottom of the coil form, slipping the pigtails through the proper base pins. Then place the second trimmer slightly above the first, pushing one against the inside of the form in one direction and the second in the opposite direction. This permits access to the adjusting screws of both trimmers, and accomplishes the desired result. As with the Philips trimmers, care should be taken to be sure that the "rotor" of the condenser is connected to the grounded side of the circuit.

— R. M. S.

V.O.A. PROGRAM SCHEDULE

An additional airing for the VOA amateur program is at 0915 GCT (4:15 A.M. EST), on the 6-, 9- and 11-Mc. bands, with Far Eastern relays on the 6-, 9-, 11- and 15-Mc. bands.

Hams Aid Korean War Effort

THE puzzled operations officer at one of our Air Force bases in Japan watched the planes coming back from Korea shortly after the war started.

"What's the matter?" he asked as the crews walked in from their planes. "You were supposed to land at Pusan."

"We couldn't," they explained. "There's a steam roller on the runway."

"Did you try to contact the ground there?"

"Yes, but we couldn't raise anybody."

The operations officer called the Far East Air Force Headquarters in Tokyo and explained about the steam roller. "We can't land any planes until they roll that thing away," he said. "And there are a lot of Americans waiting to get out of Korea."

Shortly afterward, a telephone rang in the Washington Heights, Tokyo, residence of 1st Lieut. Donald P. Dickinson. Lieut. Dickinson, who is assigned to the 71st Signal Service Battalion, was sitting in his upstairs bedroom at the controls of his amateur station, JA2DD. He answered the telephone:

"Are you still in contact with the ham station in Pusan, Lieutenant?"

"Yes."

"Then how about passing along the word to get a steam roller off the Pusan Airport so our planes can land?"

"Sure thing!"

In a few seconds Lieut. Dickinson started pounding the key of his Stancor 120-watt transmitter. The station in Pusan, HL1CD, came back with "Roger." A few hours later, the steam roller, which the South Korean police had placed on the runway to keep North Korean planes from landing, was moved away.

When the history of the first 48 hours of the Korean conflict is written it ought to include the story of the American amateur radio operators in Tokyo who held open a vital channel of infor-

• This inspiring report of amateur activity during the early days of the Korean conflict was prepared by the Signal Section, Far East Command. Our regular MARS department has been omitted this month to make room for this feature.

mation for General MacArthur's headquarters. They used their personal equipment and skill to keep open a hole in the fog of confusion and rumor which hung over Korea during these two hectic days.

The first Signal Corps ham to contact Korea after the fighting started was Capt. Joseph H. Ziglinski of Natrona, Penna., also assigned to the 71st Signal Service Battalion. Capt. Ziglinski, JA2KK, had been in contact with American-operated amateur stations in Korea many months before the conflict. He had often talked with people in the Korean Military Advisory Group and ECA. In fact, he had been talking with HL1US in Seoul the night before the Reds invaded. His two friends there, Francisco and Al, he recalls, were throwing a party and there was no hint of the fighting to come.

Before he signed off with Seoul that Saturday night he made a schedule to call them Sunday at noon. But he missed the sked and, instead, spent a leisurely afternoon talking shop with another Signal Corps ham, Maj. Myron A. Huebler of Los Angeles, Calif., also with the 71st Signal Service Battalion.

By the time Capt. Ziglinski returned to his home that afternoon in Grant Heights, Tokyo, an officer in the Intelligence Section of General MacArthur's headquarters was calling him by telephone. It was his first definite information of trouble in Korea.

"There's fighting in Korea," the officer said. "We need any kind of news or information you



◆
First Lieut. Donald P. Dickinson, 71st Signal Service Battalion, GHQ FEC, at the controls of JA2DD, Tokyo. Lieut. Dickinson hails from Murfreesboro, Tenn., and his JA signals are well known on the DX bands.
◆

can pick up from Korea on your amateur station. Can you help us?"

"Glad to," Capt. Ziglinski said. "I was just about to call a friend in Seoul. I'll see what I can do."

He turned on his Collins 120-watt transmitter and, using voice, called "CQ Korea." Almost immediately he got an answer from HL1CD in Pusan.

"This is Ray," the voice said. "And are we glad to hear from somebody in Tokyo! We're worried stiff about things here. What's the dope from up there?"

"Nothing right now," Capt. Ziglinski replied. "I'm trying to contact HL1US in Seoul. They're closer to the fighting. How about getting on your landline telephone, Ray, and calling Francisco and Al for me? Tell them I'll be looking for them on the 20-meter band. It's more reliable."

"Will do, Joe," Ray said. "But keep in touch with us, too. We want to know what to do down here."

"Okay, Ray," Capt. Ziglinski said. "Tell everybody to get on 20 meters. We'll all net there until this thing clears up."

Then he switched to 20 meters and began calling station HL1US. In a few minutes Francisco and Al answered him. But instead of the gay, party atmosphere of the night before they sounded excited and worried. "What do we do next?" they asked. "Things are getting hot here."

"Just stand by, that's all," Capt. Ziglinski said.

Then he patched in his telephone and called General MacArthur's headquarters to report he had a circuit if anyone wanted to talk to Korea.

For 31 strained hours he held the circuit with Seoul. During that time American officers with the Korean Military Advisory Group used the circuit to report on the progress of the Red invaders. As the fighting moved closer to Seoul, contact grew more difficult. Once there was a long silence and Capt. Ziglinski wondered what had happened.

Then a breathless voice said, "Jeez, hold off, Joe! We're under air attack." A moment later, Capt. Ziglinski heard the drone of planes. Finally, the voice in Seoul came back. "It's okay now. They got one of those Yaks and the others are gone."

HL1US stayed on the air until midnight Monday. The last words Capt. Ziglinski heard from the doomed station were, "Things are looking up!" He didn't learn until many weeks later that Francisco and Al had destroyed HL1US with hand grenades and caught one of the last evacuation planes from Kimpo Airfield. But, at the time, the air evacuation was a secret operation, and they could only drop a hint to Capt. Ziglinski back in Tokyo.

On the same Sunday evening, meanwhile, the intelligence officer had called Maj. Huebler at his home in Grant Heights and asked him to use his amateur station, JA2MA, to collect information from Korea. Maj. Huebler checked with Brig. General George I. Back, Far East Command sig-

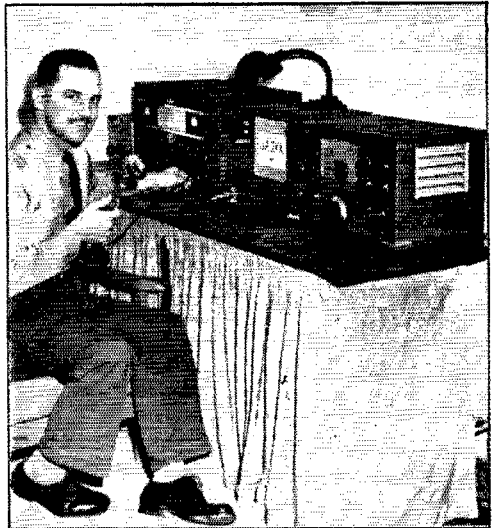

Capt. Joseph H. Ziglinski, 71st Signal Service Battalion, GHQ FEC, JA2KK, had his first taste of emergency work while operating his Stateside station, W3OLM, during the 1936 Allegheny River Valley flood.

nal officer, and got permission to organize a team of Signal Corps amateur radio operators to monitor broadcasts from Korea and send all their information to General Headquarters.

To organize the team, Maj. Huebler called a meeting of hams in the Tokyo area at his home that same evening. Most of the amateurs were Signal Corps officers, members of the 71st Signal Service Battalion, but there also were an Air Force officer and a Medical officer present.

They divided into two groups of about ten amateurs each, and each group worked in shifts so there would be not less than two operators scanning the ether at any time. They split the short-wave spectrum into two sections at 13 megacycles, one operator scanning the lower frequencies while the other covered the higher frequencies. One thing which helped the JA amateurs was their familiarity with the stations in Korea. They knew what frequencies would be the most likely spots to monitor and they knew at what times of the day and night and season these frequencies were best.

Capt. Ziglinski's station, JA2KK, became the key station in his group at Grant Heights, since he had the most elaborate equipment. He had three antennas — a folded dipole strung in his living room, a three-element beam antenna, and a 40-meter Zepp.

While he was working HL1US in Seoul late Sunday evening, Lieut. Dickinson in the other group at Washington Heights 15 miles away was monitoring. Suddenly Lieut. Dickinson heard HL1CD in Pusan trying to call Capt. Ziglinski. HL1CD was sending out the distress call, "QRRR." But his call was too weak. He was using 'phone and, as Lieut. Dickinson learned later, he had only a 20-watt rig.

(Continued on page 114)

The Deluxe Fixed-Portable Package

A Complete 40-Meter C.W. Station

BY GILBERT L. COUNTRYMAN,* W3HH

THE author's receiver-building efforts ceased along about 1927 when another audio stage with loudspeaker was added to the 0-V-1. Those Baldwins were too heavy for continuous wear. Since that time there has been a succession of factory-built and, more recently, surplus receivers. True, the idea of building a superhet arose many times, but never was it realized until a need developed for a completely portable receiver-transmitter that could be conveniently packed around on various trips that must be made, and one that would insure satisfactory communication at all times.

The photographs show the finished product, and the set really performs! The receiver section may not be quite as effective as a 51-J-1, but it is more compact! Inside the cabinet, which measures about 14 by 8 by 8 inches, are included an eight-tube superhet receiver covering the 40-meter band from 5 to 95 on the dial, a loudspeaker, a 40-watt transmitter complete with a pi-section antenna-coupling network that will load any antenna over 10 feet long, an a.c. power supply with regulated taps for the receiver, a key, 16 crystals, logbook, tools and pencil, 70 feet of antenna wire, and an a.c. line cord. There is also room for a headset if desired.

Circuit Details

The transmitter and power supply are pretty much standard. The circuits are shown in Fig. 1. The modified Pierce oscillator circuit is foolproof and is easy on the crystal. The 6AG5 provides sufficient drive for the 6L6 amplifier, but a 6AK5 will not drive the 6L6 to full output. Both oscillator and amplifier are keyed simultaneously.

The required output voltage from the power supply is obtained through the use of a condenser-input filter. The regulated tap at 105 volts is provided for the oscillators in the receiver.

*Cmdr. USN, Room 4303, Navy Dept., Washington, D. C.

Before designing the receiver, the receiver section of the ARRL *Handbook* and current articles on receivers were carefully studied. All circuits for mixer, oscillator, i.f., detector, etc., actually were tried out. The final circuit that evolved is different from most published circuits in some particulars. The circuit, broken into sections in Figs. 2, 3, 4 and 5, outperforms all other combinations that were tried.

Since the operation is confined to 40 meters, image response is not a serious problem with a 1750-kc. i.f. amplifier. Also, the ultimate in sensitivity is not a primary objective. Therefore, there is little practical value in the use of an r.f. amplifier stage, so it was foregone in the interest of simplicity and compactness.

Naturally, miniatures are used throughout. The 6BE6 mixer feeds a two-stage 1750-kc. i.f. amplifier using 6AK5s. If socket Pins 2 and 7 are wired together, 6BA6s can be substituted, depending upon which of the two types is available. A 6C4 in a Colpitts circuit is used in the high-frequency oscillator. The coupling is capacitive from the cathode of the oscillator tube to the injection grid of the mixer. The coupling condenser, C_{17} , is made by twisting insulated leads together for about an inch. The tuning of the oscillator is not ganged with that of the mixer, since the tuning of the latter is broad enough to require only occasional adjustment. As a matter of fact, since no r.f. gain control is provided, it is desirable to be able to detune the input circuit in case strong local signals start to block the receiver. The h.f. oscillator, as well as the b.f.o., are operated from the 105-volt regulated tap from the power supply, as mentioned previously. The changeover switching is arranged so that while the remainder of the receiving tubes are disabled during transmitting periods, both oscillators run continuously to minimize drift.

One section of a 12AU7 dual triode is used as an infinite-impedance second detector. (It should not be necessary to mention that a 12AU7 will

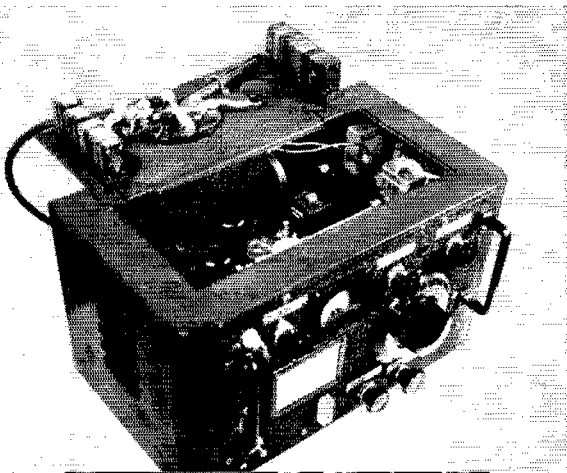

A 40-watt transmitter and superhet receiver in one package. The speaker and output transformer can be seen to the right. The key and spare crystals are mounted on the cover.

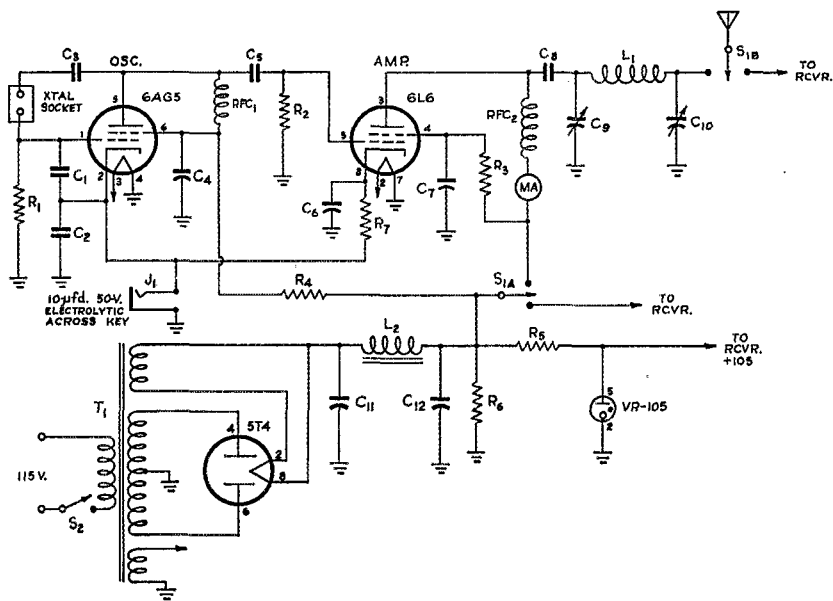

Fig. 1 — Circuit diagram of the transmitter and power supply.

- C₁, C₅ — 100- μ fd. mica.
- C₂, C₈ — 0.001- μ fd. mica.
- C₃ — 500- μ fd. mica.
- C₄, C₆, C₇ — 0.01- μ fd. disk ceramic.
- C₉, C₁₀ — 250- μ fd. midget variable.
- C₁₁, C₁₂ — 4- μ fd. 600-volt electrolytic.
- R₁ — 47,000 ohms, 1 watt.
- R₂ — 22,000 ohms, 1 watt.
- R₃ — 10,000 ohms, 1 watt.
- R₄ — 15,000 ohms, 5 watts, for 300 volt supply; 25,000 ohms, 10 watts, for 400-volt supply.
- R₅ — 6500 ohms, 10 watts, for 300-volt supply; 10,000 ohms, 25 watts, for 400-volt supply.

- R₆ — 0.1 megohm, 2 watts.
- R₇ — 300 ohms, 5 watts.
- L₁ — 20 turns No. 18, 1½ inches diam., 1½ inches long (6 μ h.).
- L₂ — 12-h. 150 ma. filter choke.
- J₁ — Open-circuit jack.
- MA — 100-ma. milliammeter.
- RFC₁ — 2.5-mh. r.f. choke (National R-50).
- RFC₂ — 2.5-mh. 125-ma. r.f. choke.
- S₁ — D.p.d.t. ceramic rotary switch.
- S₂ — S.p.s.t. toggle.
- T₁ — 400 volts r.m.s. max. each side of center, 150 ma.; 5 volts, 3 amp.; 6.3 volts, 4 amp.

not plug into a 7-prong miniature socket! The author found out the hard way!) This type of detector showed a big improvement over the usual diode. Because the infinite-impedance detector does not load the circuit the way a diode does, better selectivity can be obtained by using a regular interstage transformer in the output of the second i.f. stage, rather than a transformer designed to work into a diode.

Resistor R₂₇ is necessary only if the supply voltage under load exceeds 250 or 300 volts. R₂₆ drops plate and screen voltage for the 6AK6.

Since the receiver and transmitter each require considerable current, the high voltage is switched along with the antenna when going from transmitting to receiving and vice versa. This permits the use of a smaller power transformer with a saving in space and weight. It also eliminates the need for otherwise silencing the receiver while transmitting. One refinement to be added later is a tone oscillator, possibly of the neon-bulb type, which will be automatically turned on with the transmitter. While not essential, it will be a big help in sending, especially when using a bug.

Construction

Since they were already available, the receiver was constructed on an 8 × 5½ × 2½-inch

chassis, and the power supply and transmitter on an 8 × 5 × 2½-inch chassis. The two are bolted together and feed-through insulators used for the high-voltage and filament leads. A single 8 × 10 or 8 × 11-inch chassis could be used as effectively.

Power-supply components are under the chassis. Since this precludes mounting transmitting components in the clear space on top of the chassis, a small "U"-shaped aluminum subassembly was made and punched for the two transmitting tube sockets. It is spaced one inch from the chassis so that most of the transmitter components can be tucked underneath.

On the front panel, left to right at the top, are the antenna terminal, changeover switch (a d.p.d.t. ceramic rotary that switches high voltage and antenna between transmitter and receiver), a 100-ma. milliammeter and the two 250- μ fd. midget variable condensers in the pi-section tank. Below, there are a National chart frame with the receiver calibration and a Velvet Vernier dial that tunes the receiver h.f. oscillator.

In the bottom row, left to right, are the a.c. switch, crystal socket, mixer-grid tuning knob and the audio gain control under the tuning dial. Appropriate name plates dress up the 8 × 12 × ½-inch aluminum front panel. The two draw

handles are a surplus item and serve to protect the knobs, make it easy to withdraw the panel and chassis from the cabinet, and are convenient when carrying the rig which weighs only 26 lbs. fully loaded with all accessories. Four large rubber feet screwed to the underside of the cabinet protect the table top and raise the cabinet slightly, permitting easier operation of the controls along the bottom row.

There was not room on the panel for the 3-inch 'speaker nor space on the chassis for the output transformer, so they are mounted on the side of the cabinet and connected with a short length of Twin-Lead terminated in a Millen type 37412 plug that goes into a ½-inch crystal socket (Millen type 33102) mounted on the chassis, as indicated in Fig. 5.

Between the cabinet and the chassis on the right there is room to stow the a.c. line cord and spare tubes. The output transformer and 'speaker are mounted on this side of the cabinet so that they clear the chassis, and the 'speaker signals come out through the cabinet louvers. On the left is room for a 70-foot hank of receiver loop-antenna wire and insulators, logbook, and miscellaneous gear that may be needed.

Underneath the hinged top are mounted the key with a shaping condenser, two wood blocks drilled to receive 8 crystals each, and a b.c. receiver dial spring under which may be slipped such things as an aligning tool, pencil, etc. Originally, provision was made inside the rig for 3 crystals, switched from the panel. But this quantity was found to be inadequate, so a front-panel socket was installed and the spare crystals carried underneath the cabinet lid. The holes in the wood blocks are drilled small enough to hold the crystals securely when the top is closed. To permit quick selection of a proper crystal, the frequency in kilocycles and, under it, the receiver-dial setting for that frequency, are printed on a small slip of paper secured to the top edge of each crystal holder with Scotch tape.

Terminals on the rear apron include a 115-volt socket for the line cord and a small PL68 jack for

the key plug. Since a standard 'phone plug and jack are used for the headset, there is no chance of plugging 'phones or key into the wrong jack.

Wiring

If possible, beg, borrow or steal a soldering gun. On a compact job like this, soldering with a standard iron is rather difficult.

In an early model, components under the

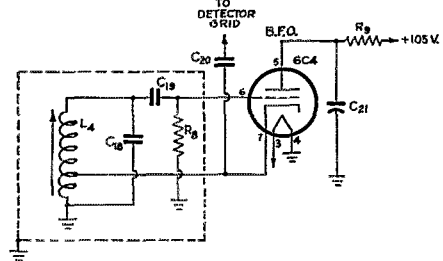

Fig. 3 — Circuit of the superhet b.f.o.

- C₁₈ — 270- μ fd. silvered mica.
- C₁₉ — 100- μ fd. mica.
- C₂₀ — Same as C₁₇ (see text).
- C₂₁ — 0.1- μ fd. paper.
- R₈ — 47,000 ohms, ½ watt.
- R₉ — 22,000 ohms, 2 watts.
- L₄ — See text.

chassis were placed on terminal boards and it looked very neat — just like a factory job. But the arrangement resulted in so much intercoupling that the idea was abandoned in the final version.

All leads must be run as directly as possible and ¼-inch ceramic cone stand-offs and terminal strips were used wherever necessary to support components such as resistors and by-pass condensers. It was found to be essential that all by-pass condensers associated with a given tube be grounded to one place on the chassis, preferably to a lug secured with one of the machine screws holding the socket in place. The i.f. cans should be arranged to get the most direct runs for the leads.

Receiver Coils

Adjusting the h.f. oscillator to cover the proper range is easy. A National XR50 form is wound full of No. 20 enameled wire. Plates are yanked from the 50- μ fd. tuning condenser and the slug in the coil form is adjusted until the oscillator range of 8750 to 9050 kc. is spread out over the entire dial. With the 1750-kc. i.f., the receiver will then respond to signals in the 7000- to 7300-kc. range. The coil slug is a great convenience when it comes to this part of the job.

Another National XR50 form was wound full of No. 30 d.c.c. wire with a tap one-third of the way up from the bottom and this is used in the b.f.o. circuit. It should hit 1750 kc. with the slug about halfway out. All b.f.o. components are mounted in a small coil shield 1¼ inches square and 2 inches high. The adjusting screw of the coil sticks out the top of the can and the grid, filament

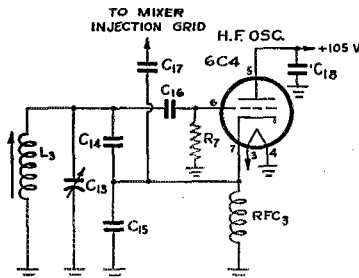

Fig. 2 — Circuit of the superhet h.f. oscillator.

- C₁₃ — 50- μ fd. double-spaced (approx. 15- μ fd. variation required — see text).
- C₁₄ — 330- μ fd. silvered mica.
- C₁₅ — 150- μ fd. silvered mica.
- C₁₆ — 100- μ fd. silvered mica.
- C₁₇ — See text.
- C₁₈ — 0.01- μ fd. disk ceramic.
- R₇ — 56,000 ohms, ½ watt.
- L₃ — See text.
- RFC₃ — 3.5-mh. r.f. choke (National R-50).

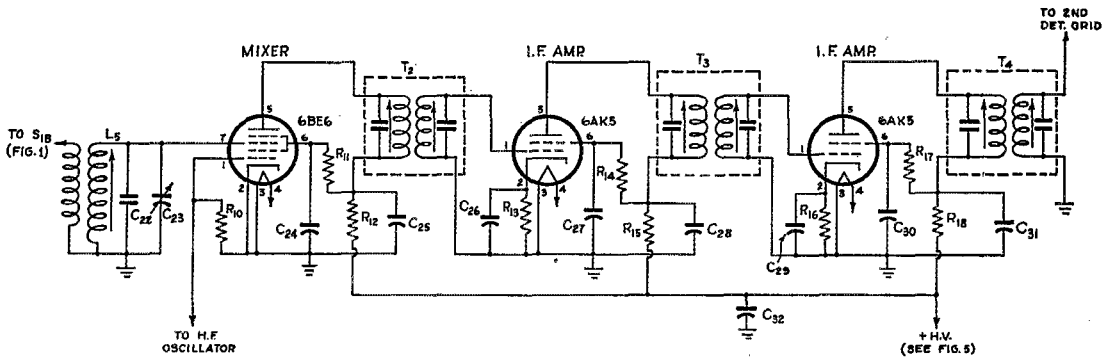

Fig. 4 — Circuit of the mixer and i.f. amplifier.

- C22 — 100- μ fd. silvered mica.
- C23 — 50- μ fd. air trimmer.
- C24, C25, C26, C27, C28, C29, C30, C31, C32 — 0.01- μ fd. disk ceramic.
- R10 — 47,000 ohms, $\frac{1}{2}$ watt.
- R11, R14, R17 — 22,000 ohms, 1 watt.
- R12 — 8200 ohms, 1 watt.
- R13, R16 — 220 ohms, 1 watt.
- R15 — 10,000 ohms, 1 watt.
- R18 — 12,000 ohms, 1 watt.
- L5 — See text.
- T2, T3, T4 — 1500-kc. i.f. transformer, retuned to 1750 kc., interstage type (Meissner 16-8091).

and cathode leads pass out the bottom and thence through holes in the chassis.

The i.f. transformers specified come pretuned to 1500 kc., but they may be readjusted to 1750 kc. Since the frequency of the oscillators can be changed readily by means of the tuning slugs in the coils, it is not necessary that the i.f. be exactly 1750 kc. If a strong local commercial signal hits the i.f., the i.f. can be reset to another frequency to avoid the interference.

The mixer coil is another National XR50 form wound full of No. 20 enameled wire. The antenna coil is of No. 30 d.c.c. wire wound over the bottom of the form between the ground lug and the regular coil-winding slot, secured in place with cement. This coil and the h.f. oscillator coil are mounted in $\frac{1}{4}$ -inch holes in the chassis with the coils underneath so that the slug adjustments may be made from the top.

Receiver Adjustment

Initial receiver adjustments may be made by any convenient method, depending upon what equipment is available. The entire rig can be

placed in operation with a grid-dip meter, another communications receiver or a signal generator with or without modulation. It is suggested that the receiver section of the ARRL *Handbook* be reviewed, particularly those parts dealing with adjustments.

A signal generator with modulation was used to align the i.f. amplifier, first removing the b.f.o. tube. The output of the generator cannot be connected to the mixer signal grid unless the latter is disconnected from the tuned circuit. The first i.f. transformer can, however, be adjusted by clipping the generator output lead to the lead from the cathode of the h.f. oscillator. If no signal generator is available, there are several alternatives. A grid-dip meter can be used as a signal generator. Since there is no modulation on the signal, the b.f.o. must be operating. Another receiver may be used to pick up the i.f. when a steady incoming signal beats with the h.f. oscillator. In this procedure, start from the front end of the receiver, using a short pick-up wire connected to the grid of each i.f. tube and the second detector in turn, working backward from the

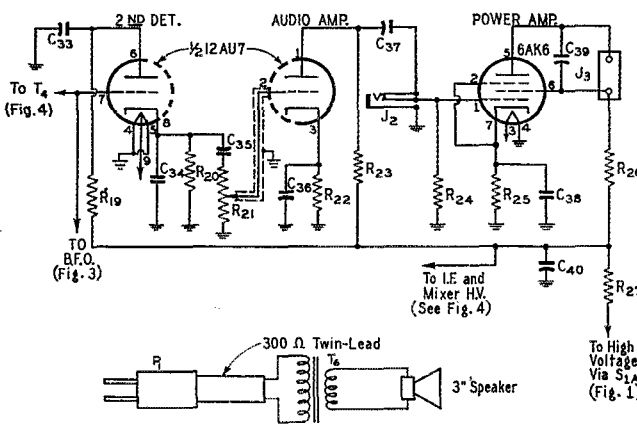

Fig. 5 — Circuits of detector and audio amplifier. Inset shows speaker connections.

- C33 — 0.5- μ fd. paper.
- C34 — 250- μ fd. mica.
- C35, C37 — 0.1- μ fd. paper.
- C36, C38 — 10- μ fd. 25-volt electrolytic.
- C39 — 0.02- μ fd. paper.
- C40 — 8- μ fd. 450-volt electrolytic.
- R19 — 33,000 ohms, 1 watt.
- R20 — 0.15 megohm, 1 watt.
- R21 — 0.5-megohm potentiometer.
- R22 — 680 ohms, 1 watt.
- R23 — 0.1 megohm, 1 watt.
- R24 — 0.27 megohm, $\frac{1}{2}$ watt.
- R25 — 470 ohms, 1 watt.
- R26 — 6800 ohms, 2 watts.
- R27 — See text.
- J2 — Double-circuit jack.
- J3 — Crystal socket (Millen 33102).
- P1 — Twin-Lead plug (Millen 37412).
- T6 — Output transformer: 7000 ohms to v.c.

latter. Tubes beyond the stage being adjusted should be removed. Tune the communications receiver to the i.f., of course, and trim the portable i.f. transformers to produce the loudest signals in the communications receiver. A grid-dip meter may be used for approximate adjustment of the i.f. transformers before they are installed. Then they can be peaked on background noise or signals, although this method will not usually result in as accurate an i.f. alignment as when a signal generator is used.

Operation

Operation of the unit is simplicity itself. Plug in the a.c. line and connect any antenna. If the transmitter is to be used, open the lid and plug in the key. Turn the switch to the receiving position and turn on the power supply. Within one minute the receiver is operating stably without appreciable drift. A strong local signal, loud enough to block the receiver, may be handled by detuning the input circuit to the mixer. Normally, of course, this control is peaked for maximum signal. Although this tuned circuit suppresses images effectively, its tuning is broad and may be disregarded, once set, for average signals anywhere in the band.

To send, plug in the proper crystal, turn the switch to the transmitting position, press the key and tune the pi-section input condenser, C_9 , for the usual dip in plate current. Adjust the loading with the output condenser, C_{10} , at the right, and then reresonate with the input condenser. Do not load the final beyond the point where a pronounced dip can be obtained with the left-hand condenser. Your antenna will be resonated at the input-condenser setting where the dip occurs. For a 300-volt supply, the rig can be loaded to about 40 or 50 ma., and to 90 or 100 ma. if a 400-volt supply is available for the plate of the 6L6 stage.

Now you are tuned up and ready to send. Unless your chosen frequencies are at opposite ends of the band, only minor trimming of the pi-section tank will be necessary when using different crystals.

Operation of the key when the lid is open surprisingly is not tiresome, except for protracted operation. When longer operating periods are

necessary, a bug is plugged into the key. When the hand key is used, the forearm rests on the right front corner of the cabinet.

So far as the results to be expected are concerned, on the first trial, using a 50-foot antenna 20 feet high at one end and 15 feet high at the other, the following stations were worked:

Call	Report	Distance (miles)
W1AKN	569X	450
W1SWD	579X	500
W2ZSA	579X	225
W3NQJ	469X	250
W4EEL	579X	350
W8BWD	579X	375
W8YOW	579X	300
W9IQY	569	650

These results were obtained while using a b.c. receiver transformer delivering only 280 volts to the plate of the 6L6. It has since been replaced by a transformer that delivers 400 volts and West Coast contacts are easily made when the QRM is not too bad and conditions reasonable.

The receiver really is hot and would be a credit to any fixed station. The 'speaker gives ample volume and the apparent volume is the same whether the headphones or the 'speaker is used. It is extremely stable, has negligible drift, has no image trouble, is exceptionally sensitive and the selectivity is remarkable, considering that no crystal or audio filter is used. For fixed-station use, an FL8 audio filter may be added between the receiver and the headset, if desired. ZLs and VKs pound in on the 'speaker in the early morning. A few DX contacts have been made since the 400-volt supply was installed, although the rig is primarily used for short and medium distances up to about 1500 miles. With the relatively low power, selection of frequencies that are reasonably free from QRM must be made, of course. The 40-meter band was chosen so that the rig could be operated 24 hours a day, 365 days a year. Forty is never dead.

The time and patience necessary to complete this unit and align it will be repaid a thousand-fold to anyone interested in continuous, dependable communication from various locations where 115 volts a.c. is available and where a wire can be thrown out the window.

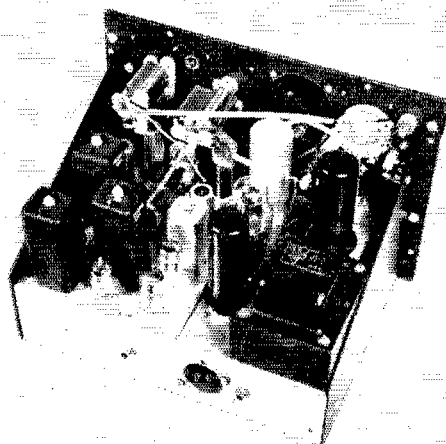

Inside view of the deluxe fixed-portable. The transmitter and power supply are to the right and the receiver section to the left. The 6AG5 oscillator is behind the 6L6. The first i.f. tube is between the cans. Shields are used over the oscillator and mixer tubes. On the rear edge, the 'phone jack is to the left and the key jack to the right.

On the Air with SINGLE SIDEBAND



THE 60-watt s.s.b. rig at PK4DA was finally finished, and Arie worked WAC on 20 with it. He was all set to provide an excellent Oceanic contact for the gang, but the recent announcement that Indonesia forbids amateur communication with other countries puts a damper on for a while. Here's hoping he will again be available in the near future!

The activity in England continues to grow. G3CU is on 14 and 3.7 with a phasing rig that ends up in an 829B and is working out well. G3FDG uses a crystal-filter job with p.p. 811s in the output stage on 80. G3FEL now uses a 257B in the final instead of the old 807, with a substantial increase in output. In G-land, the equivalent of our 3999 seems to be 3720 kc., according to G3CU.

The first s.s.b. station on in Vermont is W1AEA at Waterville, and he may have been the first on 160 meters with the stuff, too, although W1SCO in Farmington, Conn., has been on 160. In any event, there is one more state for you WAS chasers.

Just in case you think WAS on s.s.b. is far-fetched, you might be interested to know that Hoagy, W2SHN, had worked 100 different s.s.b. stations by the end of 1950, in 29 states and 4 Canadian provinces. He and W9PHV made a very close race out of their contest to be the first s.s.b. Century Clubber, j.g.

Bob at W2NJR had lots of fun with parasitics in his new 833A final, somewhat along the lines of last month's article by W1DBM, but he has the bottle tamed now. He uses full power when going after the W6s and W7s, but holds it down to about 250 watts peak for anything east of the Mississippi.

Ed at W4OFG, Bowling Green, Ky., got his start with a W2UNJ exciter driving a pair of 5D21s to around 750 watts peak, and when last heard from was working on a W1JEO crystal job driving an 829B, with voice-controlled break-in.

In San Francisco, Clyde at W6KNH uses a W1JEO rig on 75 followed by a 24G and a pair of 4-250As at a kilowatt peak, with stabilized screen and bias supplies, and has been working out well

We must apologize for having no more recent picture of Dick Long, W3ASW, than this year-and-a-half-old one, and we hope the S.S.B. Hall of Fame is able to wangle a slightly better one. Dick will rate high on their roster, because he was one of the first on 75 s.s.b., and has been a steady operator there ever since. He pioneered in the voice-control field, along with W3BOL and W4OLL, and he has been a steadfast champion of filter rigs. The present rig starts out with a W2KUJ voice compressor in the speech, a varistor ring modulator and a filter at 20 kc., and ends up with a pair of 811s. Other adjuncts in the shack are a panoramic adapter and a selectable-sideband receiver.

with only a short antenna. The nearest TV antenna is only 10 feet away, but there has been no trouble with TVI since a high-pass filter was installed at the receiver.

W3KPP continues to build up his roster of active 75-meter s.s.b. stations, and the list is now in its sixth edition and shows 75 calls. Among the new ones reported are VE5MA, W6BAY, W6GGM, W6WI, W0EPV, W0GK, and many new W2s and W3s.

Mark of W2ALJ has been sticking to 20 and seems to be doing right well in breaking in the DX on the tuning technique. Among the DX worked were YN4CB, HH5SS, ZD6HJ and H18WF. ZL2HP was worked while running 10 watts peak output and, to top that one, CN8EJ gave a report of "R5 with slight QRM" when the peak output was 7 volts across 52 ohms, or 1 watt! That should stand as mighty good low-power 'phone DX, until some *real* DX comes along! Taking a tip from the crystal-filter technique of W1JEO, Mark has been working on a selectable-sideband filter for his HRO-7, but it's a little crowded in the original filter unit, and all of the bugs haven't been worked out.

D. C. Bakeman, W0HKX, wrote an interesting thesis on s.s.b. for his M.S. at the University of Illinois. Since some of his experiments had a bearing on technical standards for amateur s.s.b., we are passing along his findings. For example, it was observed that attenuating all voice frequencies up to 500 cycles made little audible difference in intelligibility or volume, although some of the naturalness was destroyed. This is useful information if you have been worrying about the characteristics of your filter or phase-shift network not being too good at the low audio frequencies. The low-frequency burble you get on reception when the carrier reinsertion isn't exact was used as the criterion in some experiments on acceptable sideband rejection figures, and it was found that this burble was only barely noticeable when the sideband attenuation was 30 db. Thus 30 db. is probably a good minimum figure to shoot for in most instances. Permissible carrier-reinsertion tuning error was also studied, and it was decided that the naturalness of the voice had definitely disappeared at 50 cycles high (audio components made higher) and 20 or 30 cycles low, although it was still easily understandable. Since these observations are qualitative and opinionated, they cannot be taken as absolute standards, but they were the results of careful experiments and certainly represent something close to the order of magnitude of the effects.

— B. G.

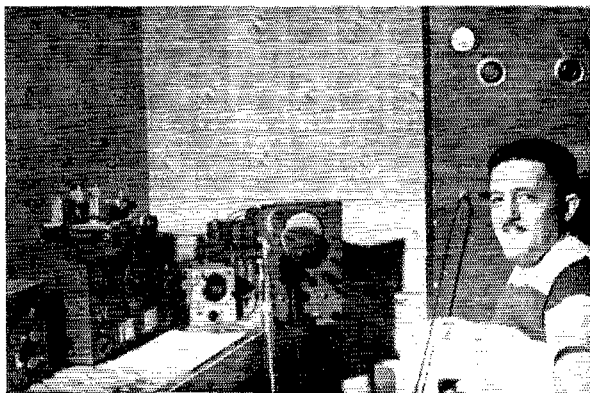

I.A.R.U. News



I.A.R.U. CALENDAR

Reporting I.A.R.U. events during 1950, the December Calendar notes the addition of four new sections to the Union and the deletion of two, bringing the membership to forty-two national societies.

The four new societies admitted to membership include the *Israel Amateur Radio Club*, the *Amateur Radio Club, India*, the *Technical Institute of Radio* (Syria) and, admitted in June, the *Union Congolaise des Amateurs de Radio* (Belgian Congo).

The Headquarters reports that the member-society in the Netherlands East Indies, N.I.V.I.R.A., must be considered nonexistent since all mail addressed to the society has been returned and none of the member societies has any information regarding the status of N.I.V.I.R.A. Since the I.A.R.U. Constitution allows only one representative society from each country, the *Newfoundland Amateur Radio Association* is being dropped from membership in the Union. Newfoundland became a province of Canada in 1949 and is now considered as being represented by the Canadian section of A.R.R.L. The Headquarters expressed regret in taking this necessary action and wished N.A.R.A. much success as one of Canada's outstanding amateur groups.

Two formal applications for membership, from the *Association des Amateurs Emetteurs du Maroc* (French Morocco) and the *Radio Club Dominicano* (Dominican Republic), were presented in the Calendar. The A.A.E.M. has a membership of 87, licensed amateurs accounting for 61 of these. The R.C.D. has a membership of 60, the entire licensed body of amateurs in that country.

The Calendar also disclosed that a total of 916 WAC certificates, 376 of which were for work on radiotelephony, were issued during the year. This figure continued the gradually decreasing trend since the peak year of 1948.

The Calendar took note of the twenty-fifth anniversary Congress held at Paris in May, full details of which were reported earlier in this column.¹

WAC CERTIFICATES

The I.A.R.U. continues to issue WAC certificates to qualified applicants. This award is available to amateurs who submit adequate proof of two-way communication with the six continental areas of the world (Asia, Africa, Europe, Oceania, North America and South America). Amateurs residing in countries represented in the Union by a member-society must be members of their so-

ciety to be eligible for a certificate. They should submit applications to their society which certifies the application to Headquarters. Applicants whose place of residence is in a country not represented in the Union must enclose a fee of fifty cents in U. S. funds (10 International Reply Coupons) with the application submitted directly to the Headquarters. An endorsement is available for radiotelephony but no band endorsements are made except in the case of the yet-to-be-achieved 50-Mc. WAC.

ARGENTINA

The *Radio Club Argentino* board of directors, together with about 150 other amateurs, met with President Juan Peron and high government officials in late 1950 for the purpose of exchanging expressions of good will and discussing radio legislation. This legislation was subsequently endorsed by President Peron and passed by the national parliament.

The activities of radio amateurs were declared to be in the national interest, in this legislation, which, among other things, provides for the possible assignment of a member of the *Federacion Argentina de Radioaficionados* to future delegations to international radio conferences.

REGION I BUREAU

The R.S.G.B. council has accepted in principle the invitation of the I.A.R.U. twenty-fifth anniversary Congress to establish a Central Bureau for Region I at R.S.G.B. headquarters. This bureau would represent the interests of the member societies in that Region,² costs not to exceed £500 to be borne by the R.S.G.B. for operating the bureau for one year.

At the request of the R.S.G.B., member-societies were asked in a special bulletin issued in November 1950 to submit their comments on this proposal.

FRANCE

The *Reseau des Emetteurs Français* has announced that the last part of the four-part DUF award announced in the September 1950 I.A.R.U. News will be issued to qualified applicants upon payment of a 700 franc (\$3.25 U. S. funds) fee to cover the cost of the elaborate certificate and accompanying medal. The first three parts are issued gratis. A.R.R.L. headquarters continues to handle applications on behalf of amateurs in the U. S. and Canada.

¹ See p. 49, Sept., 1950, *QST*.

² Europe, Africa, part of U.S.S.R.

• Technical Topics —

Some Facts of Modulation

CORRESPONDENCE we have had over the past few years indicates a rather widespread misunderstanding of the relationship between the envelope of an amplitude-modulated wave and the frequency spectrum occupied by the signal. In particular, there seems to be an impression that if by some means the output can be prevented from "hitting zero" on the downswing of modulation, the signal will be kept from "splattering," irrespective of what may happen to the modulation envelope in the process.

Unfortunately, it isn't so. The fact is that the zero axis has no greater intrinsic importance than the carrier level or the modulation up-peak or any other part of the amplitude swing in a modulated wave. To get perspective on this point it is necessary to go back to fundamentals.

Waveform Characteristics

A sine wave is the only type of wave that contains one and only one frequency. Any other kind of wave must consist of a "fundamental" sine wave upon which has been superimposed a number of other sine waves the frequencies of which are all integral multiples or "harmonics" of the fundamental. The thesis that any waveshape can be resolved into a combination of sine waves is not particularly obvious in the case of a complex wave such as that shown in Fig. 1, but must be accepted on the basis of mathematical proof that was given many years ago, plus the experimental fact that the individual components can be separated out by suitable equipment. The harmonic relationship of the components is fairly obvious; only frequencies that are exact integral multiples will "come out even" in one cycle of the fundamental frequency. This is necessary if each cycle of the complex wave is to be exactly like the preceding one.

Another fact of importance is this: The average value of the amplitude of any waveshape is zero. The average of all the amplitude values that the wave goes through above the reference axis is exactly equal to the average value of all the amplitude values below the axis. In the third cycle

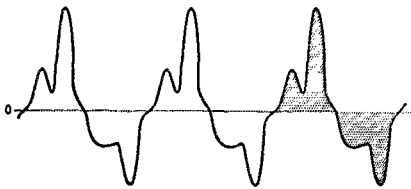

Fig. 1 — This and any other periodic wave can be resolved into a fundamental and series of harmonically-related sine waves. The axis of the wave is at the point where the total areas above and below are equal — i.e., the average positive amplitude is equal to the average negative amplitude and the algebraic sum is zero.

of Fig. 1, the total shaded area above the zero axis during the cycle is equal to the total shaded area below the axis. This means that the energy in the "positive" region is exactly the same as the energy in the "negative" region during each complete cycle.

The point deserves some elaboration. Fig. 2 represents a typical Class A amplifier grid-voltage plate-current characteristic with a sine wave applied to the grid about the operating point *O*. Because the characteristic is curved, the wave-

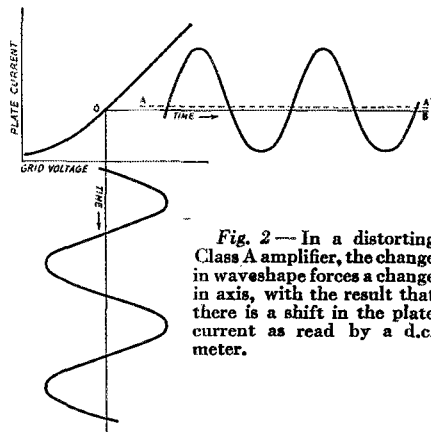

Fig. 2 — In a distorting Class A amplifier, the change in waveshape forces a change in axis, with the result that there is a shift in the plate current as read by a d.c. meter.

shape of the plate current, shown at the right, is not exactly the same as the waveshape of the voltage at the grid. If it were, the plate current would vary about the line *OB* as an axis, since *OB* represents the steady plate current determined by the operating point *O*. But in the actual waveshape of plate current the upper half-cycle is not the same as the lower half-cycle. Consequently, the axis must shift to a new position such as *AA'*, where the requirement that the average amplitude of the wave is zero is met. This changes the average plate current flowing in the amplifier and is the reason why nonsymmetrical (even-harmonic) distortion in a Class A amplifier always is accompanied by a change in d.c. plate current.

If the a.c. component alone is coupled out, as it might be by transformer or condenser coupling, the amplitude varies about the axis corresponding to *AA'* in Fig. 2. No other axis is possible, because if there were more energy on one side than the other per cycle, there would be a continuous flow of energy in one direction — i.e., the transformer or condenser would be transmitting direct current.

Note that it is the *average* amplitude that must be the same on both sides of the axis over one cycle. There is no restriction on the *peak* ampli-

tudes. It is perfectly possible to have a waveshape such that the peak amplitude on one side of the axis is very much greater than the peak amplitude on the other. Most speech waveforms are like that. Such a lack of symmetry is not the same thing as distortion in an amplifier or modulator, because no matter what the relationship between the positive and negative peaks the average amplitude of the wave as supplied to the amplifier or modulator is zero. Although such a waveshape necessarily contains more than one frequency, the component frequencies constitute the intelligence we wish to transmit. It is only a change in the waveshape that constitutes distortion — and introduces new harmonic frequencies that not only were not present in the original signal but are usually undesirable as well.

Fig. 3 shows a simple waveshape having unequal peaks. It consists of a fundamental and second harmonic combined in such a way that the positive peak greatly exceeds the negative peak. The axis of the wave is necessarily at the point where the total areas above and below it, in each cycle, are just equal.

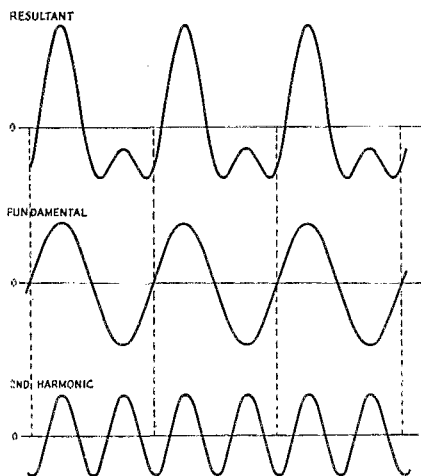

Fig. 3 — An example of a wave having a large positive peak and small negative peak. The average amplitude is still zero, since there are equal areas above and below the axis in each cycle.

Voice waves qualify as “waves” — that is, having cyclic variations in amplitude — because they do have definite, recurring waveforms for long-enough periods of time. If they did not, voice tones and sounds would merely be unrecognizable noise. For this reason it is possible to discuss modulation in terms of sine waves and combinations of sine waves. The simplest possible case, a single sine wave, is usually chosen for purposes of discussion. While extension to actual voice modulation would involve detailed consideration of many waveforms, such complexity is hardly justified since the principles that apply to one sine wave apply to any harmonic combination of sine waves.

Modulation and Overmodulation

In Fig. 4, the sine-wave modulating signal shown at A will produce, when applied in too-great amplitude to the modulated stage, the modulation envelope shown at B. This is typical overmodulation, with the output cut off entirely for part of the modulating cycle: As we all know, it results in a great deal of splatter. The outline of the upper edge of the modulation envelope is the waveshape of the audio signal that would be obtained from a perfectly linear detector.

Now if that same audio waveshape, Fig. 4C, is actually applied to the modulated r.f. stage and the audio gain is adjusted so that the wave is not modulated 100 per cent in the downward direction, the modulation envelope will have the shape shown at D. The upper outline in this pattern has exactly the same shape as the upper outline in the pattern of Fig. 4B. The modulated wave in D will cause exactly the same kind of splatter as the modulated wave in B. Furthermore, if the modulating signal of D is turned upside down, as in E¹ and then applied to give the modulation envelope shown at F, the splatter is again exactly the same, even though this wave is not modulated 100 per cent.

The reason lies in the fact that a modulated wave consists of a carrier and a series of side frequencies, the distribution of which is solely a function of the shape (not the amplitude) of the modulation envelope — i.e., the fundamental frequency and the harmonics necessary to make up the modulation envelope waveshape. If two modulated waves have the same envelope-outline shape, they both have exactly the same side frequencies. It does not matter whether these frequencies were actually present in the original modulating signal or whether they were generated in the process of modulation; the result is the same in either case. Also, it does not matter how they were generated, which is why the zero-output level has no special significance.

Those who doubt these statements can prove their truth for themselves. A signal of the type shown at C or E in Fig. 4 can be produced by feeding a sine-wave tone through an audio clipper, and by adjusting the clipping level one peak can be cut off at the same relative level as in the case of downward overmodulation. If the spectrums of the two modulated waves so produced are carefully explored with a receiver having a sharp crystal filter, it will be found that the number and relative amplitudes of the side frequencies will be the same in both cases. A test of this sort should be performed with a dummy antenna, of course, and an oscilloscope is necessary for checking the waveshapes. A tone of about 1000 cycles should be used so that the clipped part of the wave will stay as square as possible when passing through the subsequent audio stages. A high tone

¹ This “turning over” is merely a 180-degree phase reversal, and occurs in every amplifier stage where the signal is applied between grid and cathode and taken off between plate and cathode. It can also be brought about simply by reversing the terminals of one winding of a coupling transformer.

facilitates separating out the various sideband components in the receiver.²

When a sine wave is applied as a modulating signal to a perfectly linear modulated stage, the modulated wave has only two side frequencies. If there is distortion anywhere in the system, be

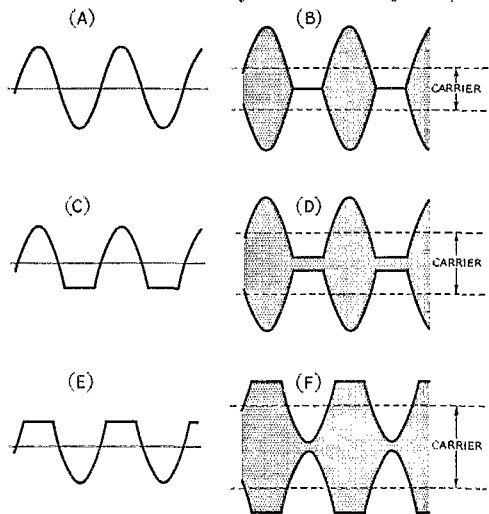

Fig. 4 — Examples of overmodulated and undermodulated waves that will produce exactly the same kind of splatter.

it in the audio amplifiers or in the modulated r.f. stage, the outline of the modulation envelope will not be a pure sine wave. The outline then consists of a combination of the original sine wave plus a series of harmonics, just as in any complex waveform. The harmonics appear as additional side frequencies when the signal is examined by the crystal-filter method, and if their amplitudes are large enough the signal also will appear to be "broad" when it is tuned in with normal i.f. selectivity. Distortion cannot be avoided completely, because no system is perfect, but it can be kept within tolerable limits. As has frequently been pointed out in connection with using speech clippers, distortion in the audio system can be prevented from doing any harm on the air by filtering out the high-frequency audio components generated by the distortion before they can reach the modulated stage. *Distortion in the modulated stage itself cannot be filtered out and invariably broadens the signal.*

Peak Manipulation

As an explanation of "supermodulation" it has frequently been suggested that the negative peaks are prevented from touching the zero axis while the positive peaks are allowed to extend consid-

² However, the tone cannot be too high, because the sharp corners in the waveform resulting from clipping (which represent very high-frequency harmonics) will not be passed through the audio stages either. In fact, it is only possible to approximate, through an audio amplifier, the waveshape that is very easily set up by downward overmodulation, particularly when the signal has to pass through a modulation transformer. This is the reason why distortion in the audio system seldom gives rise to as vicious splatter as the clipping that occurs with overmodulation.

erably beyond the normal 100 per cent upward modulation. By this means the signal is presumed to be kept "sharp" while putting a larger amount of power into the sidebands. In effect, the alternate half-cycles are in themselves half sine waves, but of different amplitudes.

The fallacy of this reasoning should be apparent from Fig. 5, where an actual sine wave is represented by the combination of the positive half-cycle and the negative half-cycle *A*. A half-cycle of somewhat lower amplitude, such as *B*, joined to the positive half-cycle does not make a complete sine wave, even though it may not appear to depart very far from it. But, *C* is also a half sine wave, and the combination of it with the positive half-cycle certainly bears no resemblance at all to a full sine wave. Either *B* or *C* combined with the positive half-cycle constitutes distortion of the original sine wave; both contain a series of harmonics of the fundamental frequency. *The greater the distortion, the larger the number and amplitudes of the harmonics; i.e., the wider the channel occupied by the signal.*

This type of operation is, in fact, comparable with the distorting Class A amplifier shown in Fig. 2. Amplitude modulation is somewhat analogous to Class A amplification, with the steady carrier replacing the steady plate current of the Class A amplifier.

The only possible benefit from such distortion, as O. G. Villard, jr., has pointed out,³ is that the harmonics will not be as bad as when the signal is clipped efficiently (as it is in Fig. 4, and would be in Fig. 2 if the grid signal were large enough to cut off the plate current at the negative peak), and that therefore such a modulation envelope will not cause as drastic interference in adjacent channels as the negative chopping that accompanies straight downward overmodulation. But the argument that the splatter won't be quite as

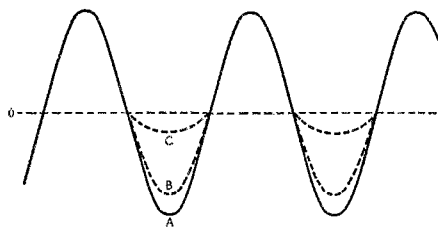

Fig. 5 — Combinations of half sine waves. Only the true sine wave (top half combined with *A*) has only one frequency; any other combinations consist of the fundamental plus harmonics.

bad is hardly a recommendation. To be worthy of consideration a system should be, at least theoretically, capable of distortionless modulation. A system based on distortion in the modulated amplifier is simply one that takes more spectrum space than is necessary.

It happens that in amplitude modulation it is impossible for the modulated stage to generate

(Continued on page 116)

³ Villard, "Supermodulation — An Explanation and Evaluation," *QST*, December, 1950.

Operation SET—1950

U. S. and Canadian Amateurs Turn Out for the Biggest Simulated Emergency Test Ever Held

GEORGE HART,* WINJMJ

CONGRATULATIONS are due the members of the Amateur Radio Emergency Corps who turned out for the 1950 Simulated Emergency Test in greater force than ever before! The number of reports received at Headquarters, the amount of publicity given by the nation's press praising the preparedness of the amateurs, and the quantity of traffic handled made 1949's figures, then records, seem small by comparison. The curve of our progress in emergency preparedness can readily be seen by the fact that in 1947, 54 ECs reported activity; in 1948, 93; in 1949, 127; and in 1950, 213! Here are some other statistics from reports on the 1950 Test which will be of interest:

Total Participation	Mobiles & Portables	Emergency Fixed	Messages to ARRL	Total Score
2290 AREC Members	1015	211	1473	22,228

Actually, 1840 messages were received at ARRL, which indicates that many groups participated who did not report. On the basis of the proportion of messages reported to messages actually received (1473/1840), we can arrive at a pretty close estimate of nationwide participation and adjustment of some of the above figures. Here's how it comes out:

Total Participation: 2861 AREC Members
Mobiles and Self-Powered Portables: 1268
Emergency-Powered Fixed Stations: 264

Figures don't tell the whole story, of course, and most ECs who reported, realizing this, supplemented their reports with complete and often voluminous details of the operation, starting with preliminary plans and finishing up with summaries. Great sheafs of newspaper clippings and photographs came along with reports of activity. In every respect, the 1950 SET was the greatest simulated emergency demonstration that we have ever held.

* National Emergency Coördinator, ARRL.

Let's be optimistic and estimate that some 300 AREC groups participated in the 1950 SET, as against about 200 last year. This 50% improvement is noteworthy; if we continue this trend, we'll reach close to 100% participation in only a few years. Right now, let's not get puffed up about our 1950 participation to the extent that we feel we can relax. On the contrary, 300 ECs active in the SET out of 1100 total ECs, while the best we have done so far, is still a long way from perfect. Shucks, fellows, we're just getting started. In 1950 we said we'd do better than in 1949, and we did. This year we're going to do better than we did in 1950. If your community is not represented in the listing below, don't pick up an axe and go looking for your EC. Where were *you*? Offer your EC your support, help him to line up other local amateurs behind a community emergency program. If, given the support of local amateurs, no action is forthcoming, *then* get the axe. The local club is an excellent place to form the nucleus of an AREC unit, but remember, emergency communication is a function of *all* community amateurs, whether or not they are club or ARRL members.

22,228 points were scored by the 213 participating amateur groups in the 1950 SET. This is the national score we have to shoot at for 1951. We would like to point out again, as we did last year, that the SET is not a contest and scores are not competitive among groups. If groups wish to compete with each other on a private basis, that is perfectly okay and may even help to promote a better turnout and performance. Naturally, the larger groups in big cities will have a higher point score than small groups, but the latter are just as significant an addition to the national total. Your 1951 score will be competitive with your 1950 score, and will serve as an indication of the progress you have made in a year's time. To some extent, progress indicated by figures is "paper" progress only. Here are the 1950 scores:

EC W9DJG explains the simulated disaster problem to a combined gathering of amateurs and officials of Civil Defense, Civil Air Patrol, Coast Guard, Red Cross, and Boy Scouts. The problem was a simulated air raid. This briefing took place in the Egyptian Radio Club building (W9AIU), which is also a disaster communications headquarters in the St. Louis area.

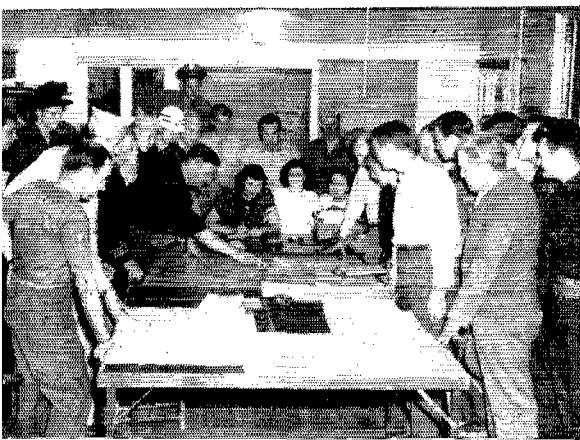

QST for

Adams County, Ill.	99	Green Bay, Wis.	104	Panora, Iowa	34
Albany, Ore.	64	Green County, Ill.	66	Passaic County, N. J.	55
Albany County, N. Y.	146	Groveland, Mass.	80	Pendleton, Ore.	101
Allegheny County, Pa.	237	Hamden, Conn.	103	Perryton, Texas	96
Ardley, N. Y.	48	Hamilton Area, Ont.	195	Phoenix, Ariz.	100
Athens County, Ohio	67	Hattiesburg, Miss.	44	Pittsburg County, Okla.	90
Atlanta Area, Ga.	101	Haverhill, Mass.	81	Pittsfield Area, Mass.	104
Auburn-Lewiston, Me.	108	Hempstead-Garden City Area, N. Y.*	—	Pittsylvania County, Va.	78
Augusta, Me.	72	Holyoke, Mass.	77	Plainfield, N. J.	99
Baltimore, Md.	248	Howard & Martin Counties, Texas	72	Pomeroy Area, Iowa	71
Benton & Franklin Counties, Wash.	139	Hughes County, Okla.	57	Providence, R. I.	81
Bergen County, N. J.	247	Huron County, Ont.	150	Quebec Area, Que.	198
Billings, Mont.	126	Iroquois County, Ill.	81	Racine, Wis.	101
Boone County, Ark.	53	Isabella County, Mich.	44	Ramey Air Force Base, P. R.	50
Boston, Mass.	98	Jackson, Tenn.	75	Rapid City, S. Dak.	116
Boulder City Area, Nevada	119	Joplin Area, Mo.	132	Richmond, Calif.	153
Bristol Area, Tenn.-Va.	78	Kankakee, Ill.	106	Rochester, N. Y.	258
Brookline, Mass.	102	Kansas City, Mo.	195	Russell County, Ga.	55
Broome County, N. Y.	115	Keeler Air Force Base, Miss.	161	Salina, Kans.	85
Burlington Area, Iowa	90	Kent County, Mich.	139	San Bernardino Area, Calif.	210
Calgary, Alberta	201	Kingsport, Tenn.	97	San Fernando Valley, Calif.	454
Canal Zone	127	Knox & Waldo Counties, Me.	56	San Juan, P. R.	170
Canton, Ohio	35	La Crosse Area, Wis.	59	Santiaç & Huron Counties, Mich.	69
Carlisle & Lonoke, Ark.	36	Lake County, Ind.	93	Saugus, Mass.	53
Centerville, Tenn.	29	Lancaster, Pa.	109	Schenectady County, N. Y.	162
Chattanooga, Tenn.	126	Lawton, Okla.	101	Sebastian County, Ark.	111
Chemung County, N. Y.	38	Lebanon County, Pa.*	—	Sedgewick & Harvey Counties, Kans.	170
Cherokee County, S. C.	15	Lethbridge, Alberta	61	Siloam Springs, Ark.	61
Chicago (Area C), Ill.	76	Lincoln, Nebr.	102	Sioux Falls, S. Dak.	64
Chittenden County, Vt.	76	Long Beach Area, Calif.	253	Snohomish County, Wash.	175
Cincinnati Area, Ohio	190	Los Angeles, Calif.	79	Southbridge, Mass.	85
Clearwater Area, Fla.	86	Louisville Area, Ky.	206	Southeast British Columbia	87
Cook County (Areas A-B-D-E-F-G), Ill.	318	Lubbock County, Texas	191	Spokane, Wash.	334
Cook County, Ill. (Area H)	163	Madison, Wis.*	—	Springfield, Mass.	109
Coos Bay Area, Ore.	119	McKean County, Pa.	89	Springfield Area, Mo.	166
Corpus Christi, Texas	118	Medford Area, Ore.	57	St. Clair County, Mich.	70
Corvallis, Ore.	100	Memphis Area, Tenn.	240	St. Johns-Iberville, Que.	51
Crescent Bay Area, Calif.	268	Mercer County, Pa.	87	St. Louis, Mo.	243
Cumberland, Me.	102	Meriden, Conn.	113	St. Paul, Minn.	139
Cuyahoga County, Ohio	216	Merrimac, Mass.	18	Stamford, Conn.	91
Danville, Ark.	29	Miami County, Ohio	72	Steubenville, Ohio	64
Davidson County, Tenn.	81	Middlesex County, N. J.	139	Stevens Point, Wis.	93
Davenport, Iowa	111	Midland County, Mich.	82	Straits of Mackinac Area, Mich.	143
Dedham, Mass.	83	Millinocket Area, Me.	69	Tacoma, Wash.	206
Delaware County, Ohio	47	Montgomery, Bucks & Schuylkill Counties, Pa.	55	Toledo Area, Ohio	262
Door & Kewaunee Counties, Wis.	92	Morgantown, W. Va.	52	Tompkins County, N. Y.	96
Dresden, Tenn.	44	Morris County, N. J.	199	Toronto, Ont.	355
Dubuque, Iowa	68	Mount Clemens, Mich.	92	Tulsa County, Okla.	139
Duluth, Minn.	96	Muscatine, Iowa	75	Twin Falls, Idaho	27
Dutchess County, N. Y.	68	Nassau County, N. Y.	392	Union County, N. J.	287
East Lyme, Conn.	36	New Canaan, Conn.	58	Vallejo, Calif.	135
Eau Claire, Wis.	105	New Hartford, Conn.	45	Waltham, Mass.	60
Elko County, Nevada	57	New London, Conn.	99	Washington, D. C.*	—
Erie, Pa.	152	New Port Richey Area, Fla.	29	Washington County, Ohio	78
Eureka, Calif.	82	Newport, R. I.	71	Washington County, Okla.	111
Evansville, Ind.	25	North Platte, Nebr.	118	Watchung, N. J.	24
Ewart & Osceola Counties, Mich.	24	Northampton, Carbon & Lehigh Counties, Pa.	183	Watertown Area, N. Y.	68
East Mesabi Range, Mich.	33	Northern Chautauqua County, N. Y.	76	Watertown Area, Wis.	31
Fairfield, Conn.	53	Northern Madison County, Ill.	161	Wausau, Wis.	215
Fairfield County, S. C.	10	Norwalk, Conn.	123	Webster, Mass.	23
Fargo Area, N. Dak.-Minn.	65	Oklahoma County, Okla.	134	West Long Branch, N. J.	18
Forest Grove, Ore.*	—	Onondaga County, N. Y.	152	Westfield, Mass.	31
Fort Knox, Ky.	55	Orlando, Fla.	61	Westmoreland County, Pa.	162
Fort Worth, Texas	195	Orleans & Essex Counties, Vt.	70	Wilmington Area, Ohio*	—
Franklin County (Southern), Me.	48	Osage County, Okla.	53	Windham County, Vt.	64
Franklin County, Ohio	142	Ossining-Scarborough, N. Y.	57	Windsor, Ont.	83
Fremont, Nebr.	110	Ottumwa, Iowa	70	Winthrop, Mass.	90
Gallatin County, Mont.	81	Outagamie County, Wis.	82	Yarmouth, N. S.	136
Garland, Texas	44	Oxford County, Me.	118	York & Adams Counties, Pa.	120
Genesee County, Mich.	197	Palo Alto Area, Calif.	103	Zanesville, Ohio	118
Glencoe Area, Ont.	53				
Granite City Area, Ill.	84				
Grant County, S. Dak.	42				

National total..... 22,228

* No point score reported.

Traffic

The local groups held their tests, but traffic nets and long-haul stations set up for the purpose took care of relaying the messages to their destinations — usually either ARRL or the American National Red Cross in Washington. The national emer-

gency frequencies of 3555, 3875, 7100, 14,050 and 14,225 kc. were indeed busy spots on the amateur bands during the week end of October 14th and 15th. Over 400 messages from local chapters were dispatched by amateur radio to Red Cross Headquarters in Washington, through the medium of

their three interconnected stations, W3PZA, W9DUA and W6CXO, assisted by local amateurs and club stations. These stations also handled some of the traffic destined to ARRL. Connecticut stations abounded during the week end to pick up any ARRL traffic for delivery, and they were kept busy! Several NTS regional and area nets held extraordinary sessions over the week end to assist with relay, particularly the First Regional Net which cleared much of the traffic for ARRL Headquarters. On Monday the regular traffic nets were in action and made short work of the remaining traffic so that the flow had died down to a mere trickle by Tuesday. Significant is the fact that the majority of the traffic in the 1950 Test was cleared up over the week end itself, leaving only "mopping up" operations for Monday and Tuesday. This contrasts to the experiences of previous years when Monday was as heavy a day for traffic as was Sunday. Mention should be made of the work of W3BHK, W4FF, W4KFC and W4LRI in assisting W3PZA, and of W9BUK in assisting W9DUA.

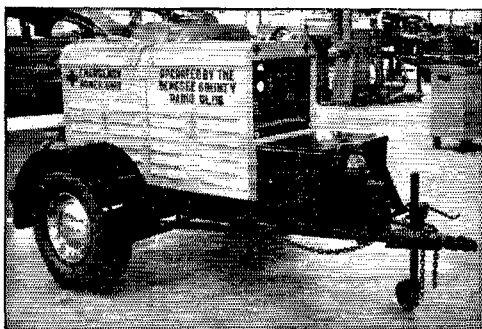

This 10-kw. generator, property of the Genesee County Radio Club of Flint, Mich., was an old relic before they got hold of it. In its rebuilt condition it is used on Field Days, in the SET, and to supply power for the entire Red Cross Headquarters building in which the club meeting rooms and the club station, W8ACW, are located.

On the West Coast the staff of W6CXO enlisted the aid of the Oakland Radio Club (W6OT) and the San Leandro Radio Club (W6BHY) in a joint activity designed at contacting each of 386 local Red Cross chapters via amateur radio and getting a reply back the same way. The amount of organizational preparedness and effort which went into this plan was tremendous, starting early in the summer and continuing until weeks after the SET. Each of the three stations (W6CXO, W6OT, and W6BHY) had a specific function during the test in order that the work load would be divided as evenly as possible. One hundred and seventy messages were sent to Red Cross chapters in the West Coast area and 170 replies received. In addition, the usual amount of traffic for American National Red Cross in Washington and ARRL was handled by the three stations which were in constant communication with each other by means of v.h.f.

links. A recapitulation compiled by San Francisco SEC W6NL and SCM W6ATO indicates that 453 messages were handled for the Red Cross and 237 for ARRL, and that the total number of handlings involved in receiving, transmitting and relaying these messages was 2317. A busy week end indeed, and the combined staff of the three stations which made this activity possible deserves a pat on the back: W6s AWU, BYS, JWF, NL, OBJ, PYH, TI, YDP, and ZB.

Eighteen hundred and forty are a lot of amateurs. That's how many we heard from at ARRL Headquarters, indicating their activity in the SET. We went to a lot of work to list them alphabetically, but there are just too many to print. You fellows who sent us messages know who you are and if you want to know whether your message was received drop us a line or radiogram—we can easily tell you, without digging through the stack.

Messages received at ARRL Headquarters, broken down by call areas, indicated that W2s sent us the greatest number of messages, but they were closely followed by the W0 and W9 areas. The W3s and W6s lagged behind considerably in this department. VEs made a surprisingly good showing. Here's the breakdown by call areas:

W1 — 198	W8 — 145
W2 — 237	W9 — 222
W3 — 63	W0 — 286
W4 — 156	VE — 87
W5 — 138	KP4 — 25
W6 — 82	KZ5 — 15
W7 — 136	Total — 1840

Publicity

One out of every three reports contained at least one newspaper clipping. Some contained a whole sheaf of them. In some cases the local AREC group rated a front-page spread (with headlines), in others a full page of pictures, and in some cases an insignificant item on one of the back pages. No activity that we hams have ever held rated the amount of publicity accorded the 1950 SET, and no activity has ever presented us in a more favorable light to the public. The degree of coöperation and coördination with local civic and relief agencies further enhanced the standing of local amateurs with their fellow citizens to the extent that in most places where a coördinated SET was held the amateurs are recognized as a vital factor in emergency communications, both for civil defense and peacetime disasters. The SET is probably responsible more than any single activity we have held in the past year for the high esteem in which we amateurs are now placed in the national civil defense picture.

Speaking of civil defense, many of the simulated tests held locally had to do with bombings, air raids and other facets of defense against enemy attack. This was a keynote of the times which made the 1950 SET all the more significant in the public eye.

(Continued on page 118)



CONDUCTED BY ROD NEWKIRK, * W9BRD

How:

Bring in three cups of coffee, Jeeves. Yes, you do! three—one, two, THREE! No, there's nobody here but us; what makes you ask?

... Ah!

Now go out and fill 'em up again. And while you're at it, for Pete's sake oil that squeaky shack door—it keeps calling "CQ TEST CQ TEST" every time you parade through it. And then go out and check the feeders again.

We're going to work something in this free-for-all if it takes all night and our remaining stock of 6L6s. . . .

[Tsk, tsk. It undoubtedly will.—Jeeves.]

What:

"Conditions generally poor but good in spots," comments W9HUZ. On *twenty*, the spots were good for VK1RF (14,058), JA3AC (14,082), UC2KAB (14,038), UF6AC (14,078), CR7BB (14,035), CT3AB (14,104), EK1AQ (14,082), FK58AA (14,090), FF8JC (14,038), FF8GP (14,066), HZ1KE (14,010), KX6AA (14,132), VP8AK (14,007), VS2CP (14,104), VU2FH (14,104), ZE1JS (14,070), MI3VG (14,050), and 4X4DF (14,022). . . . XE1AC is giving c.w. a whirl after lo these many years and doing nicely: IS1FC (14,110), OE1KF (14,105), UB5KAF (14,090), UM8KYS (14,095), FK8AH (14,102), and AP2Z (14,100). . . . WØEFK has been sitting in at JA2OM occasionally and reports hearing an AC4RN (14,020 t8). . . . A junior at Fairbanks High School, KL7AES was licensed about a year ago. Lloyd has 300 watts and a doublet and is breaking into the DX angle on items such as TF3KG, 4X4RE (14,006), and CN8EX (14,084). . . . OY3IGO (14,050) looks dandy in W4KFC's log and W8YGR hooked HC1JW (14,025) and chatty ZS3Q (14,020). . . . To remind the gang that Nebraska is still around, WØVDC specifics contacts with FK8AA (14,105), FO8AG (14,070), FQ8AC (14,040), VR2AA (14,090), VS1DZ (14,100), VU2BK (14,080), DUICE (14,060), ZE3JQ (14,040), and 9S4AX (14,090). Going through the book for more anti-TVI hook-ups is taking up the rest of Jim's spare time. . . . As a ray of hope for some, W5MPG reports QSLs from KB6AO, EK1MD, UN1AB, ZM6AA, FO8AB, PK4OO, HA5B, VP2GG, and VQ3BNU. This batch may have sparked Rex to capture HZ1AB (14,080), EQ3FM (14,048), CR6AQ (14,050), VQ6N (14,023), YU1CAF (14,043), and 4X4DE (14,038). We hear W5MPG has been loitering in the vicinity of Widener for a peep at W5ASG's ouija-board but he does okay without one. . . . One 3X3GG (14,034) at 1200 intrigued WØTKX. Bob has also been hearing VU2CP (14,055) at 0945 and V8TNG (14,040) at 1030, times being CST. LJ is just another Norwegian prefix reminds WØTKX. . . . LX1AS (14,060) is good for a fast QSL, finds W2JBL, MI3AB (14,095) and CR4AD (14,070) are among George's new ones. . . . "The band is beginning to open," cheers W5FXN with CR5AC (14,005), ZK1BC (14,050), ZE2KY (14,088), VP3MCB (14,118) and OQ5LL freshly logged. Jim is gunning for ZS2MI on Marion (14,005), FB8AA on Madagascar (14,040), CP5EK (14,022), and KW6AR (14,100). . . . With 203 confirmed, W4MR reports PK5AA, CR5AC, EA9BB and AR8AR QSLs. Al picked up and moved his entire outboard ham shack down the road a piece and contemplates considerable activity in the rebuilding department. So here's another approach to TVI solution—merely pack up and move away from it. . . . En route just short of two years, a ZP6 QSL reached W7JYZ. This may have caused him to grab the pump-handle and raise FQ8AE (14,039), EA6AF in the

Balearics (14,040), C9AA (14,010), and VQ2RG. . . . W1FPS reached 110 with ST2RD while W6BIL was finding ZK2AA, HR1AT, YS10, and VP5BF of the Caicos available. . . . The new 150-watter at 4X4BX netted Sam ZS3K, ZS8MK, LX1JW, VK1PG, VK1YG, MP4AMO of Bahrain plus the questionable ZD2LO and PX2MU. 4X4BX was hoping to stir up W/VEs with a new 10-meter rotary during the DX Test. . . . VR1C, UA9KFA, FF8AB, FA3VV, VQ2AB, OX3SF, EA8BC, VQ4AQ and two VK1s helped W8UPN break in his new 3-element twirler. . . . W2GVZ rattled off ZDIAR (14,004), ZDIAX (14,050), ZD2GAJ (14,057), AR8AB (14,012), CR4AF (14,022), and Y13BZL (14,012). VK1PG has been wheezing through on the long path during the afternoons when using 14,018 kc., notes Pat. . . . Here are some "Whens" from the WØFID archives, times being CST: VP1AA (0755), OA4J (0701), OA8A (0720), JA3AC (1735), OH6OH (1240), CN8EJ (1734), YS10 (0705), PJ5OK (1155), T2PZ (1217), T2DL (0700), KR6CP (1708), KG4AD (1800), VP7NM (1605-0745) and HK3AS (1415). . . . 120 watts and a simple ground-plane vertical helped W4CCKB to VQ2GW, ET9X, SVØUN, TF3SF, CT3AA, CR6AW, CR7BC, CR7CR, ZE3JJ, HZ1JD, AG2AG, PZ1AL, 3V8AJ, ZK1AB and LX1DC. . . . Out W6 way the So. Calif. DX Club's *DX News* lists ZDIIF (14,036), EA6AM (14,010) at 0710 PST, EA9AP (14,011), CR4AH (14,007), IS1CNQ (VFO), VK9MR (14,067), and OQ5LL (14,020) at 1300 PST. YI3ECU (14,127) at 0600 PST and EL2P (14,050) are two more good bets.

EAØAC has been all the rage on *twenty* 'phone as verified by XE1AC and John DeMyer. Look for him on 14,350 around 1700 CST. John also has been hearing about a VQ6BFQ on 'phone. . . . W4CCKB caught up with voicers VR1C, EL2R, 4X4CI and EA8MC. . . . EQ3FM (14,120-350), HZ1AB (14,210), VU2FH (14,150), and VQ4RF (14,350) will all receive QSLs from W5KUC. . . . "Stuck" at 213 countries, W2TXB has been after ZE1JE (14,170) and CR6AR, both modulated. . . . W8UPN scored with HPIEV, OA1C, YS1EC, HH5SS, HK4JO and VP6PV.

As for *ten*, may it rest in peace. Nevertheless, W5KUC managed ZS9F (28,420), ZS3O (28,200), and VR1E on Canton (28,400). . . . W8NØH is still at it: HB9MS, W5OEU/KW6, HC2OW, CR7IV, ZE2KH, ZP3AW, ZS7C, YN4CB and CR6AV were worked; MD2PJ was logged for future reference. . . . The DX Contest



* DX Editor, *QST*. Please mail reports of DX activity to W9BRD's home QTH: 1517 Fargo Ave., Chicago 26, Ill.

should stir up 28-Mc. activity a little but things are rough in this range. The activity listed was on 'phone.

Forty has been trying to make like twenty meters but seems to suffer from loads of ionospheric absorption during long skip. Anyhoo, W2WPP came up with CN8EJ (7009), CR7CI (7010), OE13GI (7008), EK1AO (7007), HA4SA (7004), HA5PC (7014), YO2BU (7016), YV5DO (7022), and VP5BM (7010) W3IAK cornered OX3BG, HK5HN, HC1JW, LA6U, and TA3FAS while W9ESQ collected CT2AV (7035), CT3AB, FQ8AC, VP8AJ, and FA9IO W6ZZ logged his 25,000th QSO (with W3KDD) and then went on to work ZS2Q (7009) and T2PZ (7015) The ZL2AL on 7120 kc. is old friend V86AH according to W6GTC and the 30-watter at W1SVL raised OH3NY and VP7NQ TF3MB, 4X4RE, and FA8DA bumped into W4CKB while W6BIL landed FO8AH In home territory, W9HUZ did well with W1FXA/KW6 (7018), CT1DJ (7023), OA4BG (7026), KG4AQ (7040), HK5CR (7015), HH2JC (7040), ZD4AB, and FK8AH Mentioned by W8YJE are HZ1KE (7009), FQ8AC (7015), and FFBAC (7010 t5e) TA3GVU made it WAC for W3OQJ's 45 watts, coming through on 7020 kc.

On **eighty**, W4KFC rattled the 'phones of c.w. men VP5BM of the Caicos (3505), YN1AA (3515), OH2NB (3517), FY7YC (3514), LU3EL (3516), and T12PZ (3505). Vic also worked 9S4AX (3525) and has 64 countries on the band W4CKB hooked the TI2 as well as OA4BG and DL3RM while W1SVL snared HB9MQ (3515) Wondering if he has the first Alaska-Europe 3.5-Mc. contact logged, KL7OK raised DL1QT. Any challengers? W9HUZ chatted with ZLs 1HM (3505) and 3JT (3533) and W9BRD startled the critics with a ZL4BO (3507) contact after an interminable number of ZL4BO QRZs W6ZZ adds ZL1DI (3527) and W8LM comments on the c.w. activity of DL6NU/MM and HB1HL/MM, heard from the North Atlantic. These two mariners report the band clogged with W/VEs nightly all the way over to the Continent W9AND made it 43 3.5-Mc. countries with SM6APB (3503), LU7AZ (3525), HR1AT and a YN1. Wes also lists as worked Gs 2Y8, 3CKL, 5CR, 5DQ, 5MR, 5VB, 5WP, 5YH, 6CM, 6QB, 6ZO, 8JR, VE8SF (3525) at the top of Hudson Bay, PA8IP, and ZL1BY. W9AND hears that ZD6RD will hit 80 c.w. directly and that W6CEM and W6AY are working into Europe consistently from the West Coast. ". . . Loud DX signals on 80 make some 80-meter non-DXers and DXers call them bootleggers . . . very poor policy," remarks Wes Bemoaning the lack of 80-meter activity by South Americans and casually mentioning a 160-minute WAC on the band, W4BRB lists the following eligibles: HZ1KE (3501, 3535) VP1AA (3501, 3515), VP5AL in Jamaica (3512), IIAIV (3511), VR2BX (3527), ZS3K (3513), KS4AC (3515), KS4AI, F9QV (Corsica), ZS6AL (3516), YO6CR, OH2NB (3515), FA8s IH, BG and DA (the latter a sure QSLer!). Gene also reports hearing W6CEM working Gs 5WP, 6ZO, 5VB, 8JR and 6CM at one sitting! W4CKB latched on to one FP8AM (3510).

Last but certainly not least in the spectrum analysis comes **one-sixty**. W1BB appears to be the first U. S. station to get

160 FLASH!

On January 21st W1BB worked HCLJW for the first U.S.A.-S.A. 160-meter QSO on record. W2UKS and W8BKH also worked HCLJW on this night. W1BB was successful in repeating his feat on the next evening although band conditions were somewhat poorer.

across the pond this season, working EK1AO at 0100 EST on January 7th. G6GM and G3PU were raised shortly thereafter while G2YS was heard VE1EA may have scored the initial 1951 North American trans-Atlantic, snagging EK1AO just before W1s EFN and BB did it. Clarry opened the 160-meter DX season on December 31st with a G6BQ QSO GD3UB wants the 160-meter gang to watch for him every Thursday from 2130 to 2300 EST W8HSW and W9PNE are reported to have worked EK1AO As of late January the following were being heard and worked on the low band: Gs 2PL, 2ACV, 3DIY, 3ERN, 3KP, 3SU, 5HB, 5KM, 5RI, 5UB, 5VB, 8NF, and GWs 3PSP and 3ZV.

Where:

The *Radio Emissoras de Madeira* has formed a QSL bureau for CT3-based cards. Ship yours to: REM QSL Manager, Alberto C. de Oliveira, CT3AA, Beco Chao da Loba, 8, Funchal, Madeira Though the QTH of QSL Manager 4X4BX has changed as listed below, the IARC QSL Bureau address remains the same — Box 4099, Tel-aviv, Israel.

CR5AC	Box 36, Bissau, Portuguese Guinea
ex-DL4FA	Lt. W. Snyder, O-2055167, 7966 EUCOM Det., APO 58, % PM, New York N. Y.
EA8AC	Dr. Juan Medem, P. O. Box 195, Santa Isabel, Spanish Guinea
EK1AQ	(ex-PA8AQ-PA8FA) S. J. Quast, 65 Rue de Foucauld, Tangier, Morocco
EQ3FL	Sgt. Murphy, APO 205, % PM, New York, N. Y.
ET1/2/6AC	(QSL to W2YEJ)
FUSAA	Rens Chevenin, Petecote Isle via Vila, New Hebrides
ex-KH6VP	Col. W. R. Shuler, K6CU, P. O. Box 5180, Metro. Stn., Los Angeles 55, Calif.
OE13BB	% QSL Bureau, APO 541, % PM, New York N. Y.
ex-PA8RU	(QSL via ZS6WW)
PJ3XA	(QSL via ARRL)
PJ5OK	(QSL via W8NKU)
PK1CI	(QSL via PAR1)
PK1HX	H. Wolvekamp, Dj Palm 8, Djakarta, Indonesia

Surely you've either worked or heard all four of these British DX stalwarts: far left: Art Milne, G2MI;

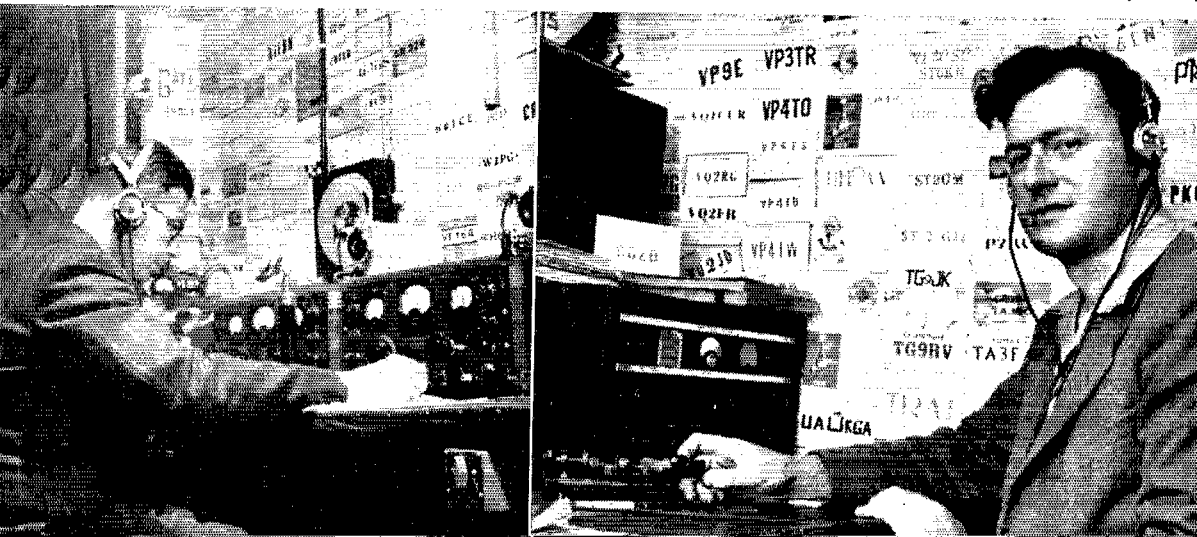

ST2TC (ex-ZC4TC) T. C. Christodoulides, International Aeradio Ltd., Anglo-Egyptian Wadi Halfa, Sudan
 VP5BP (QSL to VE3CJ)
 VQ9FD (QSL via VQ8AF)
 VR1B S. Silver, Tarawa, Gilbert-Ellice Islands
 VR1E E. A. Lemon, % PAA, Canton Island
 ex-VS1CW S. Clark, 11a Burley Wood, Leeds 4, England
 ZC4TF P. O. Box 451, Nicosia, Cyprus
 ZD1AX Box 221, Freetown, Sierra Leone
 ZD2GAJ Box 138, Lagos, Nigeria
 ZL2AL (ex-VR6AH) G. Merriman, 38 Fulford St., New Plymouth, N. Z.
 4X4BX Radio 4X4BX, Lydda Airport, Israel
 4X4RE R. Egon, P. O. Box 792, Haifa, Israel

W2s CTO GVZ, W3SEI, W5FXN, W6AM, W7JYZ, W8NOH, W9CFT, W9s CMO VDC, XE1AC, the So. Calif. DX Club and Mr. John DeMyer assisted in supplying the foregoing Who's-Where.

Tidbits:

Captured in mid-January by the Chinese Communist invaders of Tibet, Bob Ford, AC4RF, was bound and publicly paraded as a spy for Anglo-American interests. This sad news from an AP dispatch forwarded by W0EFK, now in Tokyo with Northwest Airlines VQ2AB opines that a VQ1 will hit the ether by summer and that VQ4KRL will engage in another radio-equipped treasure hunt ere very long. Let's hope the latter brings along a bit more power this time If you still need an FP8AA confirmation, W3BXE stands ready to oblige. He has QSL'd his St. Pierre QSOs thoroughly but figures some may have gone astray. Jack heard that a Canadian was assigned FP8AD and an American given FP8AE but these two tickets were never used. Completing the list, W6SAI and W3BVN held and used FP8AC and FP8AF, respectively W3SEI learned that VP5BM was to leave the South Caicos for a return to Kingston in February Meaning to give the Caymans a good representation in the latter part of the current DX Test, VE3CJ will put VP5BP on ten and twenty 'phone. VE3XZ may help keep the log growing while Noel grabs his forty winks. A 40-watt rig, an Eddystone 750 receiver and a 300-watt 60-cycle generator will produce the results W0TKX takes up the cause of some of the more remote of the OX gang who periodically get called to task for tardy QSLs. For instance, OX3SF has been at Aputiteq for over four years and the last plane service was in 1948, at which time the craft merely dropped supplies. The Greenland stations with APO addresses have good mail service but don't be too anxious for your cards from such settlements as Kangerdlugssuak, Angmagssalik, or Danmarsharbour—they're lucky to receive two-way postal service once or twice a year PK6XG is now signing PA0MOT and W9AND mentions the possibility of his making Dutch New Guinea his next stop. By the bye, Wes still handles the FY7YB logs but he must have a stamped self-address envelope for each QSL request. FY7 is the official label for French Guiana and 7YB says 7YA is the only other legit ticket-holder. Yet, FY8AC

and FY7YC are intermittently heard The ARAT (Amateur Radio Association of Trieste) is plugging for a distinctive prefix such as now adorns Sardinian and Sicilian calls. This will probably be IQ1 John DeMyer's log is also crammed with VR1 notes: VR1C is now Stateside and Tarawa's VR1B is building a new rig in pursuit of better W reports. VR1E has progressed from the 10-watt rig initiated last October to a 4D32 at 100 watts, modulated by 807s. The call VR1C may be kept active by newer Makin personnel VR6AC ran out of petrol for power; hence a temporary QRT. He asserts VR6AB is a no-good, in a letter to VE1PA via W9EET W1RWS was told by W6AM that VP8s AD, AR and AT emanate from So. Georgia; AP, Antarctica; AI, Falklands; AP, So. Orkneys; AC, AK and AO, So. Shetlands. Nobody at present is disturbing the bird life on So. Sandwich OQ5 hams intend to participate in the International Exhibition in Leopoldville to be held this year. WANKQ writes that they will operate OQ5AA on ten and twenty 'phone and c.w. and an individualistic QSL will verify the contacts. WANKQ is about to complete his second postwar DXCC, having made it once before as W8LCN. Say, who holds the record in this department? And who's going to make it ten, one for each call area? CM9AA is all hopped up to operate from FG8, PX and 8A2, according to John DeMyer. April may be the magic month A card to VQ2JN was returned to W2JBL marked "unknown" DL4FA moved to Orleans and mentions the possibility of obtaining an F7 call. The new French QTH is nifty for radio as compared to his former location deep in a Bavarian Alpine valley. "If people would all QSL, would still have a chance at a DL4 DXCC," laments ex-W0HZA Another "ex" guy is K6CU whom you'll recall readily as former KH6VP, W7BE, W6BC, and W3IWM. Bill gets lots of mileage in as an Army Colonel of Engineers. He's bent on sticking to a 125-watt power maximum while operating out of El Monte. (That's equivalent to running five watts in W9, Jeeves.) ETs 1, 2 and 8 AC were all operated at various spots in Ethiopia by W2YBJ during September through December last year. A 6V6 crystal oscillator driving a 6L6 at 10 watts fed single-wire antennae and an SX-72 did the sniffing. A total of 105 contacts was accumulated and all cards sent to K2AJ as requested have been answered. More stock is available for those still desirous of a confirmation PA8RU emigrated to South Africa and has some cards along for emergencies. Possibly another new ZS before long ZD2FAR knocked off until May, informs W7JYZ. Before pulling the switch, he wrote, "Sorry to tell you that ZD2LO is a pirate . . . all genuine ZD2 hams are three-letter, except ZD2S and ZD2G." F8BS is the only Frenchman to score with FUSAA thus far, finds W6AM. Further proof that conditions have been punk all over ZC4TC ran into complexities in getting on the air from Cyprus but Chris is now back at the old ST2TC stand as reported by W2CTO. Only military personnel may run Cyprus ham stations at present That YL DXCC pops up again. You can scratch Curacao off your feminine country list if you've hooked Miss PJ3XA We receive occasional queries anent the status of LU and CE

(Continued on page 118)

Left center: Jim Kirk, G6ZO; right center: Pete Solder, G5FA; far right: Ed Elliot, G5LI. (Photos by W2AIS)

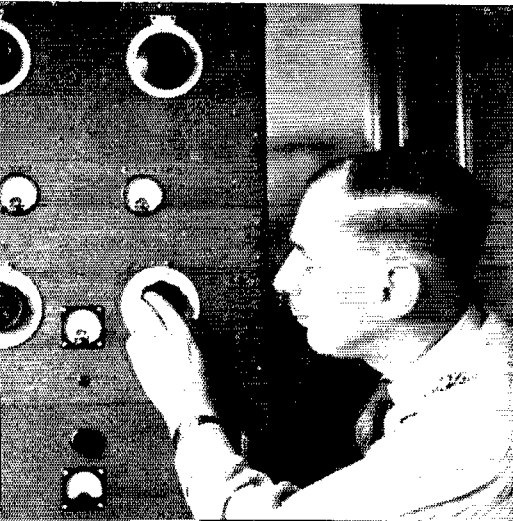

Using the Pi-Section Antenna Coupler

Proper Adjustments for Harmonic Reduction

BY JOHN T. McWATTERS,* W2CBK

THE pi-section antenna coupler, having capacitive shunt arms and inductive series arms, has certain advantages for coupling a radio-frequency amplifier to an antenna system which make it a very useful device. It is better than most other systems from a convenience standpoint for it allows an impedance match with roughly-adjusted coupling to the amplifier tank circuit, eliminating the need for swinging-link coils. Since the total inductance generally is divided between two coils, losses are probably less when turns are shorted out, and since each coil needs only one variable connection, tapping becomes simple and practical. Also, the device is symmetrical and compact and so can be mounted near the final amplifier, simplifying adjustments and saving steps. Furthermore, if the values of the coils and capacitors are properly selected, it can be made effective over a considerable frequency range and it will match a wide choice of

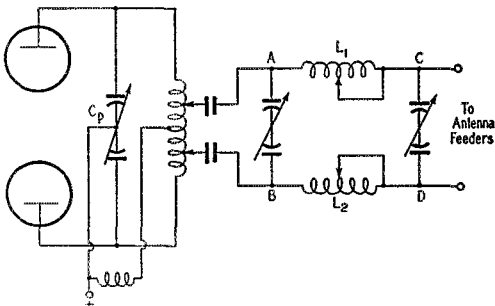

Fig. 1—Method commonly used in connecting a pi-section coupler to the output tank circuit.

impedances without a major rewiring job. Additionally, this type of coupling offers good attenuation to harmonic frequencies when it is adjusted and used correctly.

The latter statement may be the cause of some eyebrow lifting, since this system of coupling is in some disrepute for the simple reason that many of those using it have been plagued with harmonic-radiation troubles. In fact, this difficulty at one time caused me to try other systems of coupling. However, the efficiency and convenience of the pi-section coupler led to a serious attempt to make it do the job and at the same time to eliminate the evils generally associated with it. This has been done successfully and experiments with it have led to a theory of the cause of the trouble and a proved satisfactory tuning procedure.

*James St., Dryden, N. Y.

Why It Gives Trouble

In Fig. 1 is shown the common method of connecting the pi-section coupler between the final amplifier and the antenna system. Considering the loop impedance into the coupler between the points A and B, this looks good as a coupling system, even from a harmonic-radiation standpoint. However, when used as shown, a test generally will reveal strong second-harmonic radiation. How can this be? Well, first, of course, the harmonic must be generated and in the case of all Class C amplifiers this is a fact. Granted that they will be generated in the final, how are they passing through the coupler? Could it be that the antenna system is operating in a mode different from what it appears on paper? The answer is yes. The entire antenna system with both sides of the coupler and both feeders acting in parallel, in conjunction with the antenna proper, probably is operating as a Marconi-type antenna against ground. Let's take a look at Fig. 2 and study the voltage distribution on the final tank circuit at the fundamental and second-harmonic frequencies. Fig. 2A shows the distribution at the fundamental. Fig. 2B illustrates the distribution at the second harmonic. Fig. 2B shows that the second harmonic in the final tank appears in phase at the input of the coupler at points A and B in Fig. 1. Furthermore, since the system is directly coupled to the final tank, and since the *Q* of the antenna circuit operating against ground is generally low, the arrangement shown in Fig. 1 just can't help pouring out the second harmonic.

Don't let anyone tell you that a push-pull final will not generate harmonics. Perhaps not, but dollars to doughnuts they are there just the same, and the arrangement of Fig. 1 will radiate them. Use a push-pull amplifier by all means but do not depend on it to eliminate second-harmonic radiation. If you do not believe this, just ask the fellows who have received official notices. No doubt using plenty of capacitance in the final tank circuit is of considerable benefit and a step in the right direction, but this should not be depended on entirely. It will not do enough to permit the use of the direct-coupled system shown in Fig. 1 with safety.

Eliminating Harmonic Radiation by Inductive Coupling

To eliminate harmonic radiation, inductive coupling to the final amplifier, as shown in Fig. 3, was tried and the rotors of the capacitors were grounded. Since the capacitive coupling between the pick-up coil and the final tank coil can be made small by proper construction, the circuit

is effectively open so far as operating as a Marconi-type antenna against ground is concerned. However, harmonic radiation can still take place if the coupler is improperly adjusted. Instead of changing taps on the tank coil as indicated in Fig. 1, it is necessary to vary the coupling between the link coil and the final tank coil for the initial adjustment. After that the coupling can remain

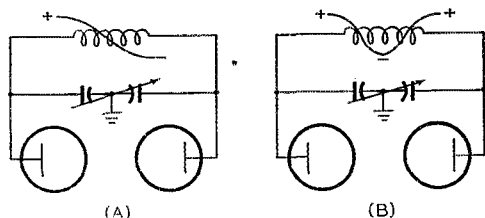

Fig. 2 — Voltage distribution at the fundamental is shown at A. In B is shown the distribution of any second-harmonic voltage present.

fixed for a given band and antenna system, since the loading can be adjusted with the coupler. If difficulty is experienced in obtaining enough variation in loading, it usually can be overcome by using a few more turns on the link coil and a looser coupling adjustment. The pick-up coil should not be of the usual swinging-link type but preferably a coil fixed in position, made so that it becomes part of the plug-in arrangement. If an electrostatic shield between the pick-up coil and the tank coil is impractical, capacitive coupling can be reduced by removing turns at the center of the tank coil, thereby providing greater spacing. The reduction in tank inductance can be compensated for beneficially by the use of a larger tank capacitance, possibly through the use of fixed vacuum capacitors. The pick-up coil should be mounted so that the coupling, once determined, will not be changed accidentally.

We now come to the really important part of the adjustment. At some setting of one of the coupler tuning capacitors, either C_1 or C_2 of Fig. 3, whichever is the more effective, the final amplifier should be loaded at a peak and changing the selected capacitor either way should result in a reduction of the final loading. Simultaneously, at this coupler-peaking adjustment, the final-amplifier plate capacitor should be adjusted so that turning it either way causes the plate current of the final to increase. This load on the final, arrived at in the above manner, should bring the plate current to the desired operating value, of course, and it will be necessary initially to adjust the position of the pick-up coil or the number of turns, or both, the value of L_1 and L_2 , and the ratio of C_1 and C_2 until the correct load obtains under the conditions outlined above. Generally it will be found that one of the capacitors of the coupler will be more effective in controlling the tuning than the other. The other capacitor will then be used to control the loading. *In no case should loading be adjusted by detuning.* Detuned

operation of the coupler is a sure invitation to harmonic radiation. The function of the inductances L_1 and L_2 is to bring the tuning range of the coupler roughly within the limits of C_1 and C_2 and the positions of the taps, which should be the same on each side, can be determined by experiment.

After the coupler has been adjusted as indicated above, the transmitter should be tuned to a frequency higher and also to a frequency correspondingly lower than that used for the initial adjustment and the final amplifier loading noted. The final plate current should fall about an equal amount each side of the adjustment frequency. The arrangement shown in Fig. 3, when properly tuned, works very smoothly and uniformly in the vicinity of the tune-up frequency and is excellent for those who use variable frequency control. After the above test has been completed, a check should be made on the air with other stations to insure absence of harmonic radiation, as with any other coupling system. If the procedure outlined has been followed, you can be pretty sure there will be none.

Some Further Refinements and Applications

A few additional remarks are in order in regard to harmonic reduction and matching. Some antenna impedances cannot be matched easily as they stand. One good antenna system to use with the coupler is an antenna that is a half wavelength long at the lowest frequency band used and fed with open-wire feeders at the center with the feeders close to a quarter wave in length for this lowest frequency band. The coupler is definitely at its best when it is connected to the feeders near a voltage peak. However, if the an-

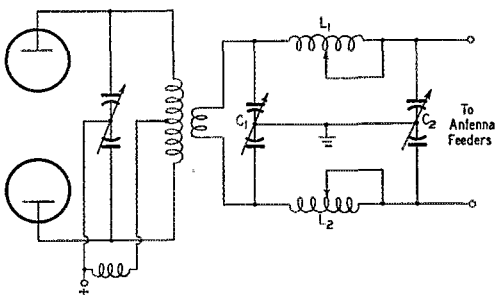

Fig. 3 — Recommended method of coupling filter to output tank circuit.

tenna impedance will not permit a match with good control of loading, it is possible to add inductance or capacitance in series with the feeders, external to the coupler, to make the antenna impedance appear as a matchable value. One scheme which looks good would be to add an inductance and capacitor in parallel in each feeder and tune these parallel circuits to an undesired harmonic. This will result in an added inductive reactance in series with the normal antenna-system impedance at the fundamental

frequency and will offer a high impedance at the harmonic frequency at the intended mode of operation and also when the antenna system is tempted to operate against ground.

This system of coupling also is an excellent way to couple an antenna to a receiver but it will generally be necessary to use a separate coupler for the receiver. I have found that optimum adjustment for the transmitter will not, in general, result in optimum receiver operation. I have experimented with a large number of coupling systems with receivers and have found the pi-section coupler to be as good as any and better than most.

Some Constructional Details

The value of the coupler inductances, L_1 and L_2 , of Fig. 3, are not too critical, nor do C_1 and C_2 need to be exceptionally large. The coils preferably should be air-wound to reduce capacitive coupling. In the couplers here, L_1 and L_2 consist of 26 turns of No. 12 wire, 2.5 inches in diameter. Each is tapped at the second turn from one end and then every four turns. Another arrangement used involves a slider mechanism which provides a tap for every turn and is probably a better system. However, the tapped coil has been satisfactory here. On the coils, taps are terminated by mounting standard coil plugs on polystyrene strips. A jack is connected to a piece of flexible copper braid to short out the required number of turns. C_1 and C_2 each are 95 $\mu\text{fd.}$ per section and have 0.08-inch spacing. These capacitors should not be too large if frequencies as high as 28 Mc. are to be covered. The values indicated provide a useful coupler range from 3.5–30 Mc. The coupling coils used have two turns fairly close-coupled for 3.5 Mc., while one turn almost at right angles to the final tank coil is used at 28 Mc. Probably for the 3.5-Mc. band, a larger coil with less coupling would be better from the viewpoint of reduced capacitive coupling. But this should give the reader some idea of the size of coils required.

The coupler should be completely shielded if it is placed in the transmitter rack. This can be accomplished readily by placing the coupler at the top of the rack with a shielding partition closely fitted across the rack beneath. An access door can be provided for coil-tap adjustment if desired. Even the leads out of the coupler can transfer a serious amount of harmonic energy if they are exposed to the electric field of the final amplifier tank. It is recommended that the leads into and out of the coupler, as well as the coupler itself, be shielded. Additionally, even less exposure will occur if the r.f. stages in the transmitter also are shielded. Again, it might be well to center-tap the antenna pick-up coil and ground the tap to the final-amplifier chassis. No filter system can be effective if it is being by-passed by stray coupling. Shielding should include any antenna relays used, and all leads to same.

To illustrate the point, I found that a transmitter running with a dummy load inside the closed transmitter rack, and not showing any

harmonic radiation a short distance away, immediately began to show an indication when the leads to the antenna were inserted a few inches into the rack. When these leads were shielded and the shield grounded to the rack, the harmonic indication disappeared. The electrostatic field at the second harmonic seems to be exceptionally strong in push-pull amplifiers.

Generally an earth ground is not effective because of the reactance of the ground lead at harmonic frequencies. The cabinet or the final-amplifier chassis seems to be a more effective ground.

When an antenna system has no direct connection to ground, as in Fig. 3, trouble is sometimes encountered from static antenna charges flashing to ground. One good cure for this is to connect a small radio-frequency choke between each feed wire and ground.



NAVAL RESERVE COMMISSIONS OFFERED

Civilians and enlisted members of the Naval Reserve may now apply for commissions as Reserve officers in numerous specialties. Both men and women are eligible.

General Requirements — Each applicant, whether he is on active or inactive duty in the Naval Reserve, or is a civilian, must be a citizen (if naturalized, for a period of at least 10 years, during which he has resided continuously in the United States); be physically qualified according to current medical standards, with minimum vision (which must in all cases be correctable to 20/20) as follows: (a) line officers for General Service — 15/20; (b) line officers for Special Service and Staff Corps officers — 4/20; must establish mental, moral and professional fitness for appointment to the Naval service; must have a college degree from an accredited college or university; in the case of women candidates, must not have a dependent under the age of 18 years.

Specific Requirements — Of particular interest to QST readers are the qualifications for the following programs:

Electronics Specialists. Open to men only, who are 19 or older but under 33. Candidates for ensign must have a degree in electrical, radio, or communication engineering, or a degree in physics with courses in electronics or wave propagation. Candidates for lieutenant (junior grade) must have, in addition, 5 years of practical experience in electronics maintenance, repair, or design (including graduate study or active military experience in related fields).

General Line. Open to men 19 years old and over, who have not reached the age of 27; and women 21 years old and over, who have not reached the age of 27. Educational requirements call for a baccalaureate degree.

Where to Apply — Personnel on inactive duty and civilians who are interested in applying for a commission should report to the nearest Navy Recruiting Station or Office of Naval Officer Procurement (address may be obtained from any Naval activity).

Reservists on active duty, or who have orders to report for active duty within 60 days, should submit a written request to the commanding officer of their permanent duty station briefly outlining their qualifications.



The World Above 50 Mc.



CONDUCTED BY E. P. TILTON,* W1HDQ

THE "summer soldiers and sunshine patriots" of the v.h.f. bands missed some good bets by not being on hand in January. Stepped-up interest and activity in connection with planning, building and testing for civil defense communication, the 4th Annual V.H.F. Sweepstakes, and one of the most widespread winter openings in the history of 50-Mc. work all combined to make a considerable dent in the midwinter quiet that customarily becalms the v.h.f. bands in some sections at this season.

In our emergency planning we are far ahead of our 1941 position in preparedness. The frequencies announced on January 17th tell us where we stand as to bands available. Work is going forward as we write that will provide a basis for more specific area planning. Meanwhile there is plenty of work to be done. There is a considerable reservoir of v.h.f. gear that can be turned to good use. Let's take stock to see what we have available, build more where needed, and be ready for any communications job that may come our way.

Perhaps as a v.h.f. operator you've not been closely allied with the ARRL Field Organization. Chances are that the Emergency Coordinator in your neighborhood may not even know of your facilities. You don't know who he is? Page 6 of each QST carries a list of ARRL Section Communications Managers. Get in touch with your SCM; he can give you the name of your local EC, if you do not already know him. The EC will sign you up for the Amateur Radio Emergency Corps and fit you into local plans. V.h.f. men and equipment will be in demand in many localities. It is up to us to see that neither asset is allowed to go unused.

V.H.F. Sweepstakes Highlights

As it has before, the club incentive in the V.H.F. SS thawed out a tremendous amount of wintertime activity. With the deadline for reporting not yet reached as we compile copy, it is not possible to report in detail as to results, but every indication is that the v.h.f. version of the Sweepstakes is keeping up its rating as a major ARRL operating activity. Well over 200 reports are on file as we write, with several club groups yet to be heard from.

Comment generally indicates that conditions were not too bad over most of the country, though certainly nothing extra. No band openings of any major character have been reported, and the widespread loss of antennas in the East appears to have held down some scores below previous

*V.H.F. Editor, QST.

levels. Activity reports vary all the way from W4FLW's "Spent 8 hours on 6 without hearing a signal!" to the phenomenal record of W2NLY, Oak Tree, N. J., who set an all-time record for V.H.F. SS competition with 213 contacts in 8 sections for 3400 points. This is the greatest number of contacts ever reported for one-band operation, and unless some of the siege guns of Eastern Pennsylvania or Southern New Jersey not yet accounted for top it, Jim will have the honor of being the first one-band operator to rack up the nation's top score. Whatever the outcome, the work is a noble effort!

2-Meter Standings

Call		Call	
States	Miles	States	Miles
W1HDQ....16	6 650	W5FSC.....	5 2 500
W1HZY....14	5 570	W5JLY....	4 2 650
W1MNF....14	5 570		
W1BCN....13	5 500	W6ZEM/6..	1 1 415
W1CTW....12	4 500	W6GGM....	1 1 300
W1KLC....12	4 500	W6YYG....	1 1 300
W2BAY....21	7 1175	W8WJC....	20 7 775
W2NLY....18	6 750	W8BFG....	20 7 775
W2PAU....15	6 740	W8WXX....	18 8 1200
W2DFV....13	5 350	W8UKS....	18 7 720
W2CET....12	5 405	W8EP....	17 7 -
W2DPB....12	5 500	W8WRN....	16 6 670
W2QED....12	5 365	W8RWW....	14 7 500
W2FHJ....12	5 -	W8WSE....	14 6 620
W2QNZ....12	5 -	W8FQK....	13 7 -
		W8CYE....	12 6 -
W3NKM....17	7 660	W8CPA....	12 - 650
W3RUE....16	7 780		
W3LNA....14	7 720	W9FVJ....	18 7 790
W3KWL....14	6 480	W9UCH....	18 7 650
W3GKP....13	6 610	W9EQC....	17 7 820
W3OWW....13	6 600	W9SUV....	17 7 -
W3KBA....13	6 -	W9WOK....	15 5 690
W3KUX....12	5 575	W9NFK....	12 7 690
W3PGV....12	5 -	W9PPE....	11 5 800
W3LMC....11	4 400	W9ULA....	11 6 540
		W9GTA....	11 5 540
W4HHK....15	6 660		
W4JDN....13	6 -	W9NFM....	14 7 660
W4IKZ....13	5 720	W9EMS....	13 5 1080
W4JFU....13	5 650	W9ZJB....	12 7 1097
W4CLY....12	5 720	W9IHD....	12 5 725
W4FJ....12	5 700	W9WGG....	11 5 760
W4MKJ....11	5 650	W9HXV....	8 3 -
W40XC....10	5 509	W9JHS....	7 3 -
W4JFV....9	5 880		
		VE3AIB....	12 6 600
W5JTI....14	5 670	VE1QY....	11 4 900
W5ML....8	3 725	VE3BQN....	6 4 540
W5ERD....8	3 570	VE3BFB....	6 4 525
W5VY....7	3 1200	VE3DER....	6 4 450
W5CVW....7	2 560	VE3BOW....	6 4 415
W5AJG....7	2 450	VE3EAH....	5 4 380
W5FBT....6	2 500		
W5FEK....6	2 500		
W5IRP....6	2 410		

Our two fair-sex winners are apparently again the tops in their respective sections. W2FHJ knocked off an even 100 contacts in 8 sections to hold the lead in the N.Y.C.-L.I. Section, and W8BFQ is resting at the head of the Ohio contingent with 70 contacts and a multiplier of 9, for 1260 points. Some other upper-bracket scores: VE3AQG — 94 in 4 for 752, W6AJF — 69 in 5 for 690, W6ZBS — 63 in 5 for 630, W4AO — 68 in 7 for 952, W1CTW — 117 in 5 for 1170, W2VRE — 92 in 7 for 1281. We hope to have individual winners for you next month. Club finals may have to wait a month longer.

That January 4th Opening

Long experience on 56 and 50 Mc. has taught us that sporadic-E skip openings may be expected in December and January, as certainly as in June and July. The winter sessions are not as frequent, nor are they usually as widespread as the summer ones, but this January 4th affair gave the best that summer has to offer a good run. From Nova Scotia to North Carolina, from Florida to Minnesota, and as far west as El Paso, Texas, the 50-Mc. band was open for a stretch of several hours. In some localities the skip pulled in as short as has ever been encountered in E_s work, almost overlapping the ground-wave range.

Many of the paths were more like aurora distances, but little or no distortion was observed, the signals being very strong and steady and perfectly readable on voice at all times. W1CGY, East Longmeadow, Mass., worked W1PWW, Bangor, Maine, less than 275 miles, a path never before covered except by aurora-reflected c.w. VE1QY, Yarmouth, Nova Scotia, worked W1GJO, Westminster, Mass., about 300 miles, and W1s CGY, LLL, NKZ and PNB, all inside the 375-mile mark. Jerry first heard signals coming through at 7:15 P.M. EST, and between then and 10:40 he worked five W1s, four W2s, seven W3s, two W4s, six W8s, and three VE3s. During this time TV channels 2-6 were jammed with signals to such an extent that identification of any one station was all but impossible. VE1s TR and TF, of Chester, N. S., covered much of the

same territory, and 1TR added W9VZP, Delavan, Wisc. He reported the band open from 7:45 to midnight EST.

VE3AET, Lansing, Ontario, checks on the 7:45 opening time, with W1PWW as the first signal logged. Reg was hearing TR, TF, QY and QZ continuously until 11:30, but W1PWW (who is geographically equivalent to VE1) was the only W signal heard. He says that the signals had all the customary E_s characteristics, and none of aurora, but it was the first time he'd ever heard VE1s on voice in the winter months.

Down in Pensacola, Fla., W4MS was busy from 6:25 to 8:55 P.M. EST, working W8CMS, Newton Falls, Ohio, W5s GVS, Enid, Okla., BDT, Austin, Tex., CUH, Durham, Okla., MJD, Amarillo, Tex., SFW, unknown location, LKP, El Paso, W0s UQM and LNW, Garden City, Kans., W5s EMY, Midwest City and ATJ, Hammon, Okla., and W0s QIN, Minneapolis and GPQ, Hutchinson, Minn. Thus it appears that double hop was at least possible, though no work over distances indicating double-hop transmission has been reported.

First West Coast 50-Mc. WAS

Though he worked his 48th state on 50 Mc. last July, it took W6OB until late January to get the necessary confirmations from all concerned. Special 50-Mc. Award No. 7 thus goes to John H. Flinspach, W6OB, the first such award to be issued to a 50-Mc. operator on either coast. The accomplishment of 50-Mc. WAS in such a geographical position is evidence of long and consistent effort. Our heartiest congratulations, Jack — several of us here in the East know well how hard you worked for it!

Here and There on the V.H.F. Bands

Buffalo, N. Y. — To cement the already close friendship existing between the v.h.f. operators of Western New York and those of Ontario, it has become a practice to hold an annual meeting shortly after the V.H.F. Sweepstakes. A feature of this year's session was the first awarding of the Sacrilegious Order of the Bathtub Plug. This

50-Mc. Aurora Dates Observed by VE3AET—1950

	1	2	3	4	5	6	7	8	9	10	11	12	13	14	15	16	17	18	19	20	21	22	23	24	25	26	27	28	29	30	31		
January																																	
February																						•	•	•									
March							•	•						•								•	•									•	
April	•	•	•	•	•	•												•		•									•	•	•		
May		•	•	•	•	•							•	•	•	•										•	•	•	•				
June		•			•			•	•															•						•			
July			•	•																													
August		•		•			•		•	•	•								•	•									•	•			
September			•	•	•	•												•		•			•	•	•								
October	•	•	•	•	•									•															•	•	•	•	
November										•	•												•		•	•	•	•	•				
December												•	•	•								•		•									

V.h.f. men who think of aurora as a rarity would do well to examine this chart, compiled from observations by VE3AET, Lansing, Ontario. It shows that aurora propagation was possible on 50 Mc. on at least 23 per cent of the days in 1950. The 27-day recurrence shows up clearly in this presentation.

honor (?) is bestowed on the hapless individual who, in the opinion of an award committee consisting of two American and two Canadian operators, pulls the biggest boner during the contest period. The badge of membership is a 5-inch metal disc on which the details of said boner are permanently inscribed. This medal is attached to a bathroom chain to which are appended the usual tub plug and an electronic device of some sort that will be indicative of the nature of the awardee's misdeed.

The badge must be worn at all v.h.f. meetings, and at other hamfests as required by the sponsors. An incentive to proper display of the incriminating side of the medal is the imprinting, on the reverse side, of an invitation to all within reading distance to partake of a round of refreshment at the victim's expense. The 1951 award was made to W2 —, who took off for the afternoon of Jan. 14th (second day of the contest) leaving his 2-meter transmitter on the air.

Guayaquil, Ecuador — The end of the 50-Mc. trail now looms for HC2OT. The project that took W5DNN to Ecuador is nearly completed, and HC2OT will be closed down in early March. Another assignment, still confidential, has been arranged, and Steve says it is in good 6-meter territory. World conditions permitting, another choice bit of DX may be available by spring. Meanwhile, this writer speaks for all 6-meter men in expressing profound appreciation for the lift that the consistent effort of HC2OT has given to 50-Mc. interest in the Western Hemisphere. Well done!

Hyannis, Mass. — If you have a 10-meter beam, have you tried it on 2? W1BCN reports that his 10-meter beam does quite well for horizontal work on 144 Mc., and W8UZ, Columbus, Ohio, has had similar results. As the bands are in fifth-harmonic relationship an antenna system for the lower band will usually load up on 2. The pattern will have a number of lobes, but the gain is likely to be appreciable compared to a horizontal 2-meter dipole.

Farrell, Pa. — The Mercer County Radio Association invites all 2-meter men to participate in their nightly gathering on the air at 10 P.M. The primary purpose is the handling of traffic, but a general get-together session follows.

Glens Falls, N. Y. — An example of what civil defense organization can do for v.h.f. activity is shown in the growth in the 2-meter population of Glens Falls in recent weeks. The Adirondack Radio Club now has its headquarters in the Red Cross building, and an application is on file for a club call for that location. W2s SFK, ERX, WFY, DV, BIW, DRZ, LWA and K2BU are active in the 2-meter net, meeting on Sunday evenings at 7:30. The first five stations also are equipped for mobile operation. The group reports into the Schenectady net on Thursday evenings.

Milwaukee, Wis. — To encourage daytime activity on 144 Mc., W9s TQ, KQM, LJV and PYM have skeds at 12:30 CST on Monday, Wednesday and Friday. W9s IMQ, Dundee, Ill., HDZ, Fond du Lac, and FPE, Willard, Wis., are on daily at 12:00, Monday through Friday.



Standings as of January 25th

W8ZJB.....48	W5ML.....44	W9ZHB.....48
W8BJV.....48	W5JLY.....43	W9QUV.....48
W6CJS.....48	W5ONS.....43	W9HGE.....47
W5AJG.....48	W5JME.....43	W9PK.....47
W9ZHL.....48	W5VV.....42	W9VZP.....47
W9NJT.....48	W5FAL.....41	W9ALU.....46
W6OB.....48	W5NHD.....41	W9QKM.....46
	W5GNQ.....41	W9RQM.....45
W1CLS.....46	W5FSC.....41	W9UIA.....45
W1HDQ.....46	W5HLD.....40	W9UNS.....42
W1CGY.....45	W5HEZ.....35	
W1LL.....44		W8QIN.....47
W1KHL.....43	W6WNN.....48	W8DZM.....47
W1HMS.....43	W6UXN.....47	W8NFM.....47
W1LSN.....41	W6IWS.....41	W8INI.....47
W1EIO.....40	W6OVK.....40	W8TKX.....47
	W6TMI.....40	W8KYF.....44
W2RLV.....45		W8JOL.....44
W2BYM.....44	W7HEA.....47	W8JHS.....43
W2LDZ.....43	W7ERA.....47	W8PKD.....43
W2AMJ.....42	W7BQX.....45	W8HVW.....42
W2MEU.....42	W7DYD.....45	W8MVG.....41
W2GYV.....40	W7JRG.....42	W8PLI.....41
W2QVH.....38	W7BOC.....40	
W2FHF.....37	W7JPA.....40	VE3ANY.....42
	W7FIV.....40	VE3AET.....32
W30JU.....45	W7CAM.....40	VE1QZ.....32
W8NKM.....41	W7KFM.....40	VE1QY.....31
W3JVI.....38	W7ACD.....35	HC2OT.....26
		XE1GE.....19
W4FBH.....46	W8QYD.....45	
W4EQM.....44	W8NQD.....42	
W4QN.....42	W8YLS.....41	
W4FWH.....42	W8CMS.....41	
W4CPZ.....39	W8LBE.....38	
W4OXC.....39	W8RFW.....37	
W4MS.....39	W8UZ.....37	
W4BEN.....35	W8WSE.....36	
W5VY.....47		
W5JTI.....44		

Calls in bold-face are holders of special 50-Mc. WAS certificates listed in order of award numbers. Others are based on unverified reports.

W9TQ is available for 2-meter skeds between 9:00 A.M. and 4 P.M. CST daily.

Hudson, Ohio — A converter capable of tuning from about 100 Mc. up can be very helpful in checking v.h.f. propagation conditions, particularly in areas where there is not extensive 2-meter activity. W8FKC checks the aircraft beacons on 110 to 118 Mc. as one example of signals that are on the air consistently. Normally their ground-wave range is small, but when they are heard at distances of 25 to 50 miles one can be sure that 2-meter conditions will be better than normal. Aeronautical charts are available that list the various stations and frequencies.

Greenwich, Ohio — From his location in North-Central Ohio, W8FQK is in a good position to hear what 2-meter activity there is in a radius of 100 to 200 miles in all directions. A list of some of the more frequently heard calls shows how the operating range on 144 Mc. has expanded in recent years. W9UCH, Ft. Wayne, and W9EGH,

(Continued on page 118)



Hints and Kinks

For the Experimenter



END SUPPORTS FOR TWIN-LEAD FOLDED DIPOLES

THE gadget shown in Fig. 1 solves easily the problem of providing adequate support for the ends of a folded dipole made of Twin-Lead. Three slots and one hole are cut through a sheet of 1/8-inch micalex or bakelite. The end of the Twin-Lead is laced through the slots. When a



Fig. 1—A sturdy end-insulator for folded dipoles made of Twin-Lead. In addition to providing secure anchorage for the end of the dipole, a convenient mounting place for a fixed mica condenser is available.

sharp pull is exerted on the other end of the Twin-Lead it becomes firmly wedged into the slots, which distributes the strain over the entire Twin-Lead rather than concentrating it on just one wire.

If desired, a mica condenser can be soldered across the end of the Twin-Lead without complicating the suspension problem. — *George Wragg, W1QFQ*

SHUNT-TYPE CLIPPING CIRCUIT

THE shunt clipper circuit shown in Fig. 2 seems to be a logical development for modulators having high internal impedance, such as 6L6s or 807s. It has several advantages over other systems. There is no series resistance element to subtract from the final-amplifier plate supply voltage, the clipper tube need only dissipate power on modulation peaks, and it may be adjusted to clip at less than 100 per cent modulation.

The resistor *R* shown in Fig. 1 may be an actual resistor, the plate resistance of the clipper tube, or the internal resistance of the bias supply. Its

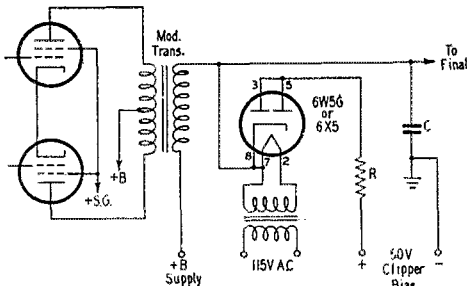

Fig. 2—A shunt-type high-level clipping circuit for use with high-impedance modulators.

purpose is to prevent sharp clipping and to form a "rounded off" negative peak. Condenser *C* is used to suppress the audio harmonics generated by the clipping action. A value of 0.005 μ f. should be satisfactory in most instances. The point at which clipping begins is determined by the bias voltage applied, and should be set with the aid of an oscilloscope to produce the desired results. — *Bill Rust, W2UNJ*

RAINSPOUT ANTENNA

MOST of us have worked fellows who claimed they were using a ten-watt rig and a rainspout antenna, but usually we consider ourselves a little above falling for such a line. In cases where outdoor antennas are prohibited by the landlord and indoor antennas are impractical, the system shown in Fig. 3 will often do the trick.

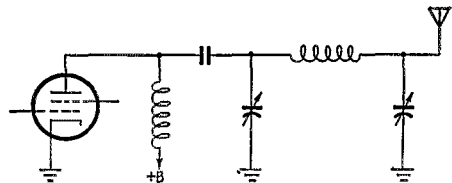

Fig. 3—Pi-section output tank circuit used to load W4RXP's rainspout antenna. *LC* values will depend on the output frequency, and may be taken from the *Handbook*.

Scrape a clean spot on the rainspout, and solder a feeder to it. In cases where "invisible" antennas are called for, No. 36 wire will do. Run the feed line to your shack window, and then use a pi-section tank circuit in the output stage of the transmitter. If the joints in the rainspout system are reasonably well soldered, you'll get results. If they are not, and are old and corroded, don't bother to try it, because serious TVI from stray rectification of the fundamental signal will probably result.

If your rainspout system looks good, try this stunt where all other antennas have failed. No, you don't have to prune or mount the spout on stand-offs! — *Albert L. Martin, W4RXP, ex-W1ORN*

SWITCH
TO SAFETY!





Operating News



F. E. HANDY, WIBDI, Communications Mgr.
 JOHN E. CANN, WIRWS, Asst. Comm. Mgr., C.W.
 GEORGE HART, WINJM, Natl. Emerg. Coördinator

J. A. MOSKEY, WIJMY, Deputy Comm. Mgr.
 L. G. McCOY, WIICP, Asst. Comm. Mgr., Phone
 LILLIAN M. SALTER, Administrative Aide

Operating Cautions. In view of continuing international tension certain self-imposed operating precautions become advisable. It is *very* wise always to curb our tongue and avoid scurrilous gossip about either our nation's politics or our amateur problems in order to retain prestige and respect for the amateur service. In times like these we owe it to ourselves to keep the general tone of our amateur work entirely above suspicion. It is definitely best to limit on-the-air discussions to amateur equipment and technique and personal matters.

Since a state of national emergency was declared by President Truman the Emergency Corps program has been stepped up; there has been a marked increase in interest in net operation and more and more amateurs are trying to find ways to help. Against the efforts of those trying to make amateur radio mean more to the nation, some few can thoughtlessly cause the fraternity harm by unnecessarily sounding off on the bands as political and military experts. Discussions on the military leadership and steps the nation will take are of dubious credit to the fraternity . . . more suited to the dinner tables . . . and amateurs who value their operating privilege have already helped the amateur service by asking the self-credited experts to leave the state-of-the-nation to be given to the world by others! Granted that we have free speech, there is most certainly a time and a place to say it and that place is *not* on the air. Let's try at all times to think before we speak and to keep on the subject of our own radio technique, as a matter of judgment and maintaining respect for our service. Help quiet this sort of talk if you hear it.

The following operating precautions may well be observed by every amateur who considers his amateur radio important!

- 1) Sign each transmission with your assigned call.
- 2) Do not permit unlicensed operators to use equipment.
- 3) Contact no unlicensed stations.
- 4) Follow each FCC regulation with scrupulous care.
- 5) Do not discuss any happenings that might have military intelligence or political significance.
- 6) Limit on-the-air discussions to radio technique and personal matters.
- 7) Watch for any possible signs of radio activity that do *not* belong in our bands, strange or subversive or suspicious. Report all such to the Field Engineering and Monitoring Division of the FCC without delay for any necessary study or investigation.

Listen First. How annoying it is when keeping a schedule with another amateur, or operating in a net, or even when having a proper-enough fraternal QSO or contact, to have another station

come right smack on the frequency and start to call or CQ. It is appreciated that where we share bands some QRM will occur . . . but sometimes it seems inspired! To *listen first* is a principle that should be followed by all *good* operators for the benefit of having a clearer channel.

Al Keltz, W2TXB, points this up when he writes, "In looking around the band you will find open spaces with few or no signals coming through at all. Am writing to ask that the VEs try to listen *first* to avoid parking on JAs that are doing such a tremendous service in handling hundreds, yes, thousands of messages for our American GIs. By listening first, needless QRM-ing of those JAs doing such a marvelous job with this traffic can be avoided."

On Delivery of ARL-Numbered Text Traffic. W4NNJ and W2EC call attention to the responsibility for expanding every ARL-Numbered Text message when delivering to addressees! It seems that this has not been done in some cases, and it hardly reflects credit on the operators or amateur service to fail to "spell out" such texts. The wording for numbered texts is given on the yellow sheet in the back of *every* logbook. May we invite every amateur to drop a card or message to ARRL for a free copy of this list (CD form 3) of "numbered texts" suited to emergency relief, anniversary and thank-you messages, and greeting and seasonal messages, so he will have this information if using other than the standard-type log. All messages to be delivered must at all times be put in proper form without official and unofficial ham abbreviations, numbered or otherwise, in the texts, if our message-handling efforts are to be understood and appreciated. Where a limited number of overseas amateur circuits have a heavy load of traffic from overseas personnel in uniform, it is perfectly proper that ARL-numbered texts be used to step up the efficiency of handling traffic. Please be sure to spell out the meaning in such texts when you deliver them. Thanks, Wade and Ferd, for calling attention to this!

RTTY Progress Report. The following news items will be of special interest to radioteletype-equipped amateurs around the country.

Vin Kenney, W2BGO, SEC N. Y. C.-L. I., has appointed John Williams, W2BFD, coördinator for amateur radioteletype operations in the five counties of N. Y. C.

The Stevens Tech. RTTY installation (147.96 Mc.) pictured on page 60 of Sept., 1950, QST was used to handle a large amount of emergency

traffic from the South Amboy, N. J., explosion area. This local group plans a station wagon, printer-equipped, with high-speed tape equipment in addition to its manual keyboard, permitting tape storage of traffic for retransmission or record.

W9TQ and W9DDG are planning a net between Sheboygan and Milwaukee and plan to have an unattended link to extend to Chicago.

On v.h.f., the N. Y. C. RTTY group use a.f.s.k., but on 27 Mc. true carrier shift (f.s.k.) can be used. This requires stable receivers as a drift of 100 cycles can make signals unprintable if noise conditions are not favorable. It is not true that printer is useful only for strong noise-free signals, however. On the contrary, W2BFD can demonstrate 100% perfect printed-record copy of signals from W2JAV with his signals almost inaudible a good deal of the time. To accomplish this takes a properly-built frequency-shift receiving converter with adequate limiting.

Efforts are being made to perfect a Washington to New York automatic printer amateur relay circuit. Some of the links are rather long for v.h.f. circuits and additional stations are welcomed to come up with RTTY and assist in the relaying. It is over 100 miles from the New York area to the first relay point, W2JAV, Hammonton, N. J. The circuit goes thence to W3LMC (Baltimore) and to W3PYW (Silver Spring, Md.). Points that can be reached from the Washington area are W4JCV (Leesburg, Va.) . . . other stations are at Richmond, Winchester, Reliance, and Front Royal.

We'll be pleased to chronicle other news from around the country along these lines if the RTTY operating gang will send it in. — *F. E. H.*

ELECTION RETURNS BY RTTY

Amateur radioteletype stations again handled the Westchester returns from White Plains to the New York City (WNYC) station this year. Amateur traffic filed at W2NUE (W2AUS' printer gear at the White Plains Court House) was received at W2QGH, Larchmont, where it automatically punched tape at the receiver. W2ISG, Mamaroneck, was set up with RTTY at W2PHO where the election data from 69 upstate districts were transmitted to W2QGH where they also punched tape. From W2QGH the transmissions went to W2SHE operating W2BFD's equipment, temporarily relocated in the N. Y. C. municipal building in lower Manhattan. The special ham circuits are reported to have led the professional wire services from a few minutes to an hour at different times. Extra amateur receivers were installed as a precautionary deal, since there was little or no pause to provide for any trouble shooting once the returns started to roll in. RTTY equipment controlled by amateurs and installed in the municipal building also played an important rôle in the storm of hurricane proportions that visited the New York area November 25th.

A.R.R.L. ACTIVITIES CALENDAR

Mar. 2nd: CP Qualifying Run — W6OWP
 Mar. 9th-11th: DX Competition (c.w.)
 Mar. 13th: CP Qualifying Run — W1AW, WØTQD
 Mar. 16th-18th: DX Competition ('phone)
 April 1st: CP Qualifying Run — W6OWP
 April 14th-15th: CD QSO Party (c.w.)
 April 19th: CP Qualifying Run — W1AW, WØTQD
 April 21st-22nd: CD QSO Party ('phone)
 May 5th: CP Qualifying Run — W6OWP
 May 16th: CP Qualifying Run — W1AW, WØTQD
 June 8th: CP Qualifying Run — W6OWP
 June 9th-10th: V.H.F. Contest
 June 19th: CP Qualifying Run — W1AW, WØTQD
 June 23rd-24th: ARRL Field Day
 July 8th: CP Qualifying Run — W6OWP
 July 19th: CP Qualifying Run — W1AW, WØTQD
 July 21st: CD QSO Party (c.w.)
 July 29th: CD QSO Party ('phone)

W1AW OPERATING SCHEDULE

(All Times Given Are Eastern Standard Time)

Operating-Visiting Hours:

Monday through Friday: 1500-0300 (following day)
 Saturday: 1900-0230 (Sunday)
 Sunday: 1430-2200

General Operation: Refer to page 61, September, 1950, QST, for a chart showing W1AW general operation. This schedule is still in effect and is not reproduced herewith for space considerations. Mimeographed complete master schedules of all W1AW operation in EST, CST, MST, PST or GCT are available upon request.

On Saturdays and Sundays during which official ARRL activities are being conducted, W1AW will forego general-contact schedules in favor of participation in the activity concerned.

Official ARRL Bulletin Schedule: Bulletins containing latest information on matters of general amateur interest are transmitted on regular schedules:

Frequencies:

C.W. — 1887, 3555, 7215, 14,100, 28,060, 52,000, 146,000 kc.

'Phone — 1887, 3950, 14,280, 29,000, 52,000, 146,000 kc.

Times:

Sunday through Friday, 2000 by c.w., 2100 by 'phone.
 Monday through Saturday, 2330 by 'phone, 2400 by c.w.

Code-Proficiency Program: Practice transmissions are made on the above-listed c.w. frequencies, starting at 2130, Monday through Friday. Speeds are 9, 13, 18, 25 and 35 w.p.m. on Monday, Wednesday and Friday, and 15, 20, 25, 30 and 35 w.p.m. on Tuesday and Thursday. Approximately ten minutes of practice is given at each speed. Next certificate qualifying run from W1AW and WØTQD is scheduled for March 13th; from W6OWP, March 2nd.

The station staff:

J. M. Powell, W1QIS, "imp"
 J. I. Barrett, W4KVM, "jim"



This quartet of League officials was snapped at a testimonial dinner tendered to Vic Paouloff, W1EOB, by the Hampden County Radio Club after his election to the office of SCM of Western Massachusetts. Left to right: Percy C. Noble, W1BVR, New England Division director; F. E. Handy, W1BDI, ARRL Communications Manager; W1EOB; Roger Corey, W1JYH, SEC and H.C.R.C. president. The results of the election were announced only a few minutes before presentation of the SCM certificate to W1EOB by W1BDI.

QST for

TRAFFIC TOPICS

W2EC tells us that he received, not so long ago, a telephone call from a father of a GI overseas from whom he had just received a message by amateur radio. The text was "sixty." Naturally, the father was somewhat confused, and Ferd was glad to be able to straighten him out. This is not the only instance of its kind, but just an example. On the surface, the onus would seem to be on the delivering station, but think a minute. The use of ARL texts is a device for speeding up handling of greeting-type traffic, but its usefulness is proportional to the common sense connected with its use. Whoever sent that message to the delivering station should have ascertained (ARL?) if the receiving station had a list of ARL texts. If not, *the text should have been sent in full*. Somewhere along the line of relays, someone in this case sent the message either in incorrect form or without first assuring himself that the station to whom he was sending it was familiar with ARL texts. The resulting unfavorable impression could have been avoided if a little care had been taken along this line.

Easter comes early this year — March 25th — and the Lawton, Okla., Easter Pageant therefore starts on March 24th. As last year, the Lawton-Fort Sill Amateur Radio Club is establishing a message center at the pageant site, and detailed plans are being worked out for the handling of the 2000-odd message originations expected. The Oklahoma Traffic Net (OLZ) will handle all local Oklahoma traffic except for Tulsa and Oklahoma City, which will be put on a teletype line to W5FOM at Fort Sill, thence to be transmitted to Tulsa and Oklahoma City amateurs on 75-meter phone. Traffic for Texas, Louisiana and New Mexico will be handled via W5FOG. Long-haul traffic to the East will be taken care of by K5WAH at Fort Sill. Other routes are being lined up for additional points; although a large percentage of the traffic is local, there are always visitors at the pageant from all 48 states, comprising from forty to fifty thousand people in all. In addition to handling some traffic, the Lawton-Fort Sill gang are assisting the Oklahoma Highway Patrol by patrolling the highway approaches and setting up portable stations at strategic points to call tow-cars, render first aid, etc. Anyone interested in providing a traffic outlet should contact the Secretary, Lawton-Fort Sill Amateur Radio Club, Box 892, Lawton, Okla.

National Traffic System News. We report the news we have, which includes most of the nets for the month of December. All net managers have been sent certificates, and issuance should be well under way. Activity in December was, of course, high, which has caused some of the net managers to be late in sending in their reports for this monthly summary. Our deadline is the fifteenth of the following month, fellows. If we don't hear from you by then, your chances of having your report included are slim. Here is a tabulation of traffic figures and other data for Dec.:

Net	Sessions	T/c.	High	Low	Average	Most Consistent Sect.
1RN	37	633	51	0	17.1	N.H. & W. Mass.
2RN	32	209	38	0	6.5	N.Y.C.-L.I.
8RN	36	189	22	0	5	Ohio
TEN	12	949	137	26	79	Minn., Nebr., Iowa
TRN	—	35	11	0	2	
CAN	21	1420	170	7	68	
PAN	21	1113	197	17	53	

That's the crop, gang. Those who aren't listed didn't submit any figures. Here's some additional dope on the various NTS nets:

First Regional Net (W1BVR, Mgr.): Western Mass. reported in 35 of the 37 net sessions reported (there were 44 sessions altogether). 1RN certificates have been issued to the following: W1s AYC, AZW, BBN, BTW, CRW, CTI, EOB, FGT, HLY, JCK, JLT, JYH, KRV, LKP, LV, NGV, NJM, NXX, ORP, PFU, QUA, QJM, RHU, RNZ, SAL, VB.

Second Regional Net (W2PRE, Mgr.): Although there are five sections in this region, they are now represented by only three section nets. W.N.Y. and E.N.Y. have long since combined, traffic-wise, and now a similar merger has been announced for the N.N.J. and S.N.J. nets. This has simplified the problem for 2RN, which is now operating normally except that attendance was lacking in the late session, which has now been discontinued temporarily.

Sixth Regional Net (W6JZ, Mgr.): Due to a change in work, W6CE has been forced to resign as manager of RN6.

We are sorry to see him go, but we know that Ray, W6JZ, will carry on the good work that has been done with the aid of California and Nevada traffickers.

Seventh Regional Net (W7CZY, Mgr.): Negotiations are under way for a new manager for RN7, since Larry has found it necessary to resign.

Eighth Regional Net (W8YCP, Mgr.): Conditions have been bad on the late session. Ohio has the best record of reporting this month, with 33 out of 36 sessions.

Ninth Regional Net (W4BAZ, Mgr.): No formal report, but JB says 9RN is doing a good job on one session per night, with all regions represented.

Tenth Regional Net (W0SCA, Mgr.): During December there was so much traffic on TEN that the two sessions were combined into one, lasting sometimes until after midnight. TEN was active 27 out of the 31 days, but NCS reports were received for only 12 days; due to the heavy traffic, prolonged sessions and the necessity for having relief NCSs, further figures were not available. There are also many outside QNIs. The Tenth Regional Net is for the relay of traffic within, into and out of the Tenth Region only. "Thru" traffic, except that originating within the Tenth Region, should be reported into your own regional or area net. However, Doc, W0SCA, says TEN will handle all traffic reported, if possible.

Thirteenth Regional Net (VE3BUR, Mgr.): Walt reports increasing activity in the Canadian Regional Net, although traffic continues to be light. VE1OM has been representing the Maritimes, where no regular traffic net is in existence. Representation to EAN has been regular.

Central Area Net (W9CBE, Mgr.): Representation from all regions and from EAN has been perfect during December, and liaison with PAN has also been 100%. CAN is a real bunch of traffickers.

Pacific Area Net (W7WJ, Mgr.): Illness has prevented W7WJ from carrying out his duties, so our report comes from W0ZJO, assistant manager. Attendance from both regions (RN6 and RN7) and from both other areas (EAN and CAN) was perfect during December, but Hal hopes for better conditions in 1951. W7NH is assuming increased NCS duties, which leaves W0ZJO free to act as QNB, often very badly needed. Resignation of both regional net managers and inability of W7WJ to be active have thrown a certain amount of confusion into the Pacific Area, but this is only temporary and will soon be cleared up.

Those YL traffickers who want to consort with members of their own sex can now have an opportunity to do so. The Petticoat Net, with W9JUJ as NCS and managed by W3MWD, meets at 1300 CST on 7200 kc. every Monday, Wednesday and Friday. The net is strictly slow speed and open to newcomers among the YLs and XYLs of the fraternity. A card or radiogram from any interested YL or XYL, addressed to W9JUJ, would be welcomed.

SUPPLEMENT TO NET DIRECTORY

The following list of nets will supplement and correct the listings on pages 58 and 59 of November 1950 QST, and the listings on pages 50 and 51 of January 1951 QST. It can also be used to supplement and correct the mimeographed net directory now in circulation. An asterisk (*) indicates correction from previous listing.

Name of Net	Freq.	Time	Days
Atlanta CW Net	7273.3	2111 EST	Sun.
Atlanta Emerg. Phone Net	29,600	2230 EST	Sun.
Atlantic Net	1895	1900 EST	Mon., Wed., Fri.
Buzzard Net (Texas)	144,038	0730 CST 1230 CST 1900 CST	Daily
Calgary Radio Emerg. Net (CREN)	29,258	1930 MST	Tue.
Caravan Club (Texas)	3990	1300 CST	Sun.
Chittenden County Emerg. Net (CCEN) (Vt.)	29,150 29,560	2000 CST 1900 EST	Sun. Mon.
Christian Fellowship Net (CFN)	3612	1900 EST	Tue.
Coastal Emerg. Radio Net (CERN)	7224	1900 EST	Thu.
Coastal Emerg. Radio Net (CERN)	146,800	1400 CST	Tue.
Codger Net	3870	1100 EST	Sat.
Delco Net (N. Y.)	3748	1830 EST	Mon.

Delaware Lehigh Emerg. Net (Pa.)	29,640	1000 EST	Sun.
Domestic Overseas Net (DON)	3700	2400 EST	Daily
Grand Rapids Emerg. Net (Mich.)	29,188	2100 EST	Mon.
Great Lakes Net	1885	1930 EST	Tue., Thu., Sat.
High Plains Net*	1995	1830 CST	Tue.-Fri.
Iroquois County AEC Net (Ill.)	3920	1230 CST	Mon.-Sat.
Jersey Net (JN)	3630	1900 EST	Mon.-Sat.
Kansas 75 Phone Net*	3920	0800 CST	Sun.
		1230 CST	Tue., Fri.
		2000 CST	Thu.
Kentucky Blue Grass Net (KYB)	3945	2000 CST	Daily
Ky. Corn Crackers Net (KYC)	3945	0800 CST	Mon.-Sat.
M.K. Ten Meter Emerg. Net (Mo.)	28,964	2100 CST	Wed.
Measabi Net (Minn.)	1895	1900 CST	Mon., Fri.
Monterey Bay Radio Club Emerg. Net (Calif.)	28,900	2030 PST	Mon.
Morris County Emerg. Net (N. J.)	147,000	1915 EST	Mon.-Fri.
Mt. Baldy Area AEC Net (Calif.)	28,326	1930 PST	Tue.
New Mexico Emerg. Phone Net	3885	0730 MST	Sun.
		1800 MST	Tue., Thu.
New York City-Long Island Traffic Net (NLI)	3710	1930 EST	Mon.-Fri.
N. Y. State 75 Meter Amateur Phone Emerg. Net	3920	0900 EST	Sun.
North Carolina Net (NCN)	3605	1900 EST	Mon.-Fri.
North Texas Net (NTX) *	3830	1900 CST	Mon., Wed., Fri.
No. N. J. Emerg. Phone Net	3900	1000 EST	Sun.
Oregon Emergency Net	3600	1900 PST	Daily
		2000 PST	
		2100 PST	
Pan-American Net	14,025	1430 EST	Mon., Wed., Fri.
Pony Express Net (Wyo.)	3920	0900 MST	Sun.
Rubber City Net (Ohio)	3625	1900 EST	Tue.
Sacramento Valley Net (Calif.)	28,800	1900 PST	Mon.-Fri.
San Diego Emerg. Net	3975	1000 PST	Sun.
San Diego Emerg. Net	29,500	1930 PST	Tue.
		2000 PST	
San Diego Emergency Net	146,000	1900 PST	Tue.
San Joaquin Valley Net (SJVN)	3525	1900 PST	Mon.-Fri.
Sky High Net (Colo.)	29,640	1930 MST	Wed.
South Dakota Phone Net	3885	0845 CST	Sun.
		1900 CST	Tue., Thu.
So. Jersey 10 Meter Mobile Net	29,560	1930 EST	Wed.
Transcontinental Relay Net (TCRN)	7042	0115 EST	Daily
Val-Area Net	29,112	2000 PST	Mon.
Vermont Net (VTN)	3740	1900 EST	Mon.-Fri.
Victor AEC Net (N. Y.)	29,520	1900 EST	Thu.
West Texas Net (WTX)	7150	1900 CST	Tue.
Westlake Radio Net	3950	1000 EST	Sun.
Whittier Emergency Net (Calif.)	3925	1900 PST	Thu.
Winkler County Texas Net	28,600	1900 CST	Mon.

Y.L.R.L. NOTES

The Young Ladies' Radio League announces the winners in its world wide QSO Party held last December. In the 'phone section Miriam Blackburn, W3UUG, tallied 11,180 points and has been awarded a silver loving cup for the top over-all score. Other leading 'phone scores were those of

W8TAB 8855, W4HWR 5400, W1FTJ 5145, W7HHH 5100. Dot Evans, W1FTJ, turned in the highest c.w. total, 2050 points, followed by W9JTX with 920 and W3MSU 760.

The Forty-Meter YLRL Net schedule has been changed; the gals now meet on 7220 kc. Wednesday at 3:00 p.m. EST.

YLRL continues to extend membership invitation to YLs the world over. Secretary-treasurer W4HWR will be pleased to answer requests for information about the organization.

BRASS POUNDERS LEAGUE

Winners of BPL Certificates for December traffic:

Call	Orig.	Recd.	Rel.	Del.	Total
KG6DI	191	1649	759	890	3489
W0ZFO	29	1633	1456	157	3275
W7IQQ	13	1394	305	1115	2827
W0TQD	2		2511	12	2525
KG6FAA	1133	630	493	137	2393
W6LSN	7	1022	1000	15	2044
W1CRW	423	672	598	62	1755
W3NHI	105	811	624	102	1642
W6GZU	11	693	651	38	1393
JA2MB *	506	414	0	414	1334
W8ZWM	29	611	590	21	1251
W8SUF	37	574	500	62	1173
W6GYH	31	543	231	311	1116
W6JZ	44	484	420	34	1032
JA3AC	403	296	296	0	995
W4WWT	15	488	452	20	973
W6CE	12	471	463	1	947
W7KGJ	68	440	430	7	945
W8SCA	43	463	431	5	942
K4WAR	627	168	122	17	934
W9ESJ	41	578	268	42	929
W7CZY	0	510	305	89	904
W9ILH	27	459	356	51	893
JA2KW					842
W0QXO	33	398	346	41	818
W8SG	5	401	367	32	805
W3GZH	64	359	353	7	783
W6AY	39	352	344	43	778
W6BAM	13	373	338	50	774
W8AUJ	12	392	346	19	769
W9CBE	5	379	360	14	758
W8RJC	45	345	344	11	745
JA2HQ					717
W6UTV	8	344	332	26	710
W7CT	10	349	333	14	706
W6JHS	114	281	275	6	676
W2VNJ	46	321	164	141	672
W2TYC	28	301	226	69	624
W8NOH	43	281	201	68	593
W0ITQ	17	284	203	87	591
W6HC	6	297	243	40	586
W4ANK	14	282	177	107	580
W8IB	43	271	188	73	575
W2BO	25	250	180	80	535
W1LKP	29	250	219	21	519
W7JJK	20	254	220	23	517
W5DRW	6	254	250	4	514
W1BBN	131	197	164	20	512
W0QAO	9	252	249	1	511
W1EMG	11	253	164	80	508
W1CRW *	17	246	215	28	506
W6BPT	11	245	231	14	501

The following made the BPL for 100 or more *originations-plus-deliveries*:

W7IE	331	W8DAE	140	VE3ATR	120
W7KGF	238	W4NZG	136	W8BDF	109
W6OXF	200	W8UKV	134	W8YKC	108
W9YLX	192	W5RIQ	133	W2RTZ	106
W8DZX	189	W6CMN	132	W0AII	105
W7LBK	175	W1RZG	129	W5QDF	101
W1RHU	147	W0RJR	125	W6SWP	101
K4AIR	141	W18FZ	121	W0FID	101

A message total of 500 or more or 100 or more *originations-plus-deliveries* will put you in line for a place in the BPL. The Brass Pounders League is open to all operators who qualify for this monthly listing.

* November Traffic



Compared to last month's splurge of emergency reports, there is little to report in the way of real emergencies this month. We are, however, glad to see the increasing zeal and interest with which local AREC organizations, under their ECs, are tackling the civil defense communications problems and the advance in the state of preparedness and participation therein, even though there are still a lot of question marks to be answered by Washington action.

The earmarking of frequencies within the amateur bands for civil defense purposes is as likely as not to cause a stampede to those frequencies by AREC units, and abandonment of all plans and presently-operating nets in order to "fit in" with what is presumed to be the plan for civil defense emergency communication. But let's stop and think about it a little.

In the first place, we must point out that we have other duties besides preparation for civil defense, and always have had them. We cannot drop one ball and pick up the other; we have to pick them *both* up. Our responsibility has not changed, it has just *increased*. Basically, there is little difference between an atomic bomb and a Texas City, or a South Amboy (except in magnitude), so our job is pretty much the same, but it is bigger, harder, more complex. This is not the time to forget the responsibilities we have always had and still have just because we have additional ones. Civil defense is a *big* job, but it's not the *only* job — and let's not forget it!

Secondly, the frequencies designated have not been allocated to civil defense, they have simply been earmarked for that purpose in the event of war. It does not mean that all other amateurs have to stay off those frequencies or that you and your civil defense AREC organization have to operate there. *Nothing is changed* about the amateur regulations. There are still a lot of question marks concerning what part we amateurs will play in civil defense. They have to be answered by the working out of detailed plans by the Civil Defense Administration and regulations by FCC. These studies are under way, but they will not be accomplished overnight. All we know right now is what frequencies we will use — and while this is of immense help to us in our planning of equipment under construction, we still do not know *how* and *for what* we are to use those frequencies. For the present, we must draw on logic and experience in whatever plans we make.

In consideration of all of the above, it would seem the wisest policy to equip ourselves to operate, for civil defense purposes, on the bands in which segments have been earmarked, but not necessarily within the segments themselves. If we are starting from scratch, we can select frequencies within those segments, but if we are already operating in those bands but not in the earmarked segments, it would not seem wise at this time to order new crystals to operate within the segments until more specific information concerning channel allocation within the segments is available.

Almost without doubt, the segments within the 10, 6 and 2 meter bands will be used for intra-community purposes. The 220-Mc. band will be useful for walkie-talkies and smaller hand-carried units. The segments within the 3.5-4.0 and 1.8-2.0 Mc. bands, small as they are, will probably be used only for medium-distance requirements, such as inter-community and perhaps inter-state contact for mutual aid purposes. If you are at present organizing locally on either of these bands, you may do well to consider the possibility of a move to one of the higher-frequency bands. All this is still conjectural, but it follows the line of logic whether or not it fits in with the planning you have already done.

We have been carefully studying literature on civil defense operations during World War II, with a view to pointing up its shortcomings and observing its good points, so that we may this time prepare to eliminate the former and emphasize the latter. No nostalgia here! We hope those days, or days like them, will never return; but we ought to get

as much benefit as we can out of the many lessons we learned then. Some of you fellows who were active then might do well to review your files of 1942, 1943 and 1944 *QST*.

At 1300 on Dec. 19th, VE1MK called the Swing-Shift Net with emergency traffic from part of Nova Scotia which was isolated due to storm damage. VE2AFV was the only station copying him at first and started taking his traffic with W2SZ (operated by W2CEV) acting as monitor, SSN shifted down 15 kc. and W2SZ took over as NCS on VE1MK's frequency. VE2AFV checked up with Red Cross and the local EC while W2SZ took traffic from VE1MK. This was relayed to W2VNJ who distributed it to SSN. The net closed at 1500, but a later schedule was made with VE1MK at which time the last message was taken and information was received that normal communication was being restored. Seven messages were handled, and all these were relayed immediately by SSN. — *W2CEV*

A surprise emergency arose in Pittsburgh on November 16th in which the AREC of Western Pennsylvania and surrounding vicinity were alerted and stood by at the request of the Red Cross. The occasion was a fire in the telephone company's building and it was feared for a time that the telephone lines might be put out of commission. Mobile W3AAX was put into action, with the aid of W3KXU, at Red Cross headquarters and contact was established with W3OMA, W3KSP, W3QPJ and W3LMM. Stand-by operation was also arranged with the Western Pennsylvania and Third Regional Nets. Operation continued for four hours, after which the Red Cross indicated no further need for the amateurs' services. A letter of thanks was sent to SEC W3OMA by the Disaster Director of the Pittsburgh Chapter, ARC. Those amateurs who participated were W3s AAX/M, CTN, GJY, KSP, LMM, NCD, NRE, OMA, ONB, PDJ, QPJ, QPQ, RFH, UHN, VNL and K3FMC.

A flood emergency at East Lake, Ohio, alerted and activated part of the extensive AREC organization of Cuyahoga County, Ohio, on December 2nd. EC W8PBZ alerted assistant EC W8NGW at 1242 to go to East Lake and set up communications from the police station for the Coast Guard Auxiliary. The net was in operation within a half hour with four mobiles, two portables and a number of fixed stations in the Cleveland area. One mobile was stationed above the water works dam at Willoughby, another with the Coast Guard men on the flats to relay river rise at that point, a third assembled dynamite to blow the ice and debris to prevent damming, and a fourth helped maintain police order, as there was only one police mobile in East Lake. The net also handled USCGA communications to its headquarters when the distance proved to be too great for the walkie-talkies the Coast Guard was using. Mobiles on the spot included W8s FOU, FOZ, DEP, SRU; portables in action were W8s SSW and FOU; fixed stations in the net were W8s BAG, DGK, EBZ, ERI, FBZ, QBF/8, RJF, SKG, ZJQ. W8PBZ was net control.

On November 16th a bad sleet storm in the Upper Peninsula of Michigan disabled telephone, teletype and telegraph lines. The Upper Michigan Emergency Net went into action, with W8TTY as the main contact to isolated Calumet. The net was in action for three days, during which time many official and personal-emergency messages were handled for the telephone company. Active amateurs in upper Michigan included W8s BY, GJX, HYQ, SCL, TTY, WNT, YLB, ZAZ.

A late report from the EC for Milford, Conn. (W1NZM) is worthy of mention as a supplement to the report of the "Great Land Hurricane of 1950" reported in the last issue. Milford, located on Long Island Sound between New Haven and Bridgeport, was particularly hard hit by the storm, and the amateurs did a wonderful job. Activity started at 1100 November 25th when W1NZM alerted his gang on 3960 kc., with W1s HYE, LLM, RMZ and SFI reporting in. Hourly schedules were kept to keep tabs on the communications situation. At 1400 W1KNM, who happened to be communications chairman of the local Red Cross, informed the EC that an emergency had been proclaimed by the Red Cross and that an emergency station had been set up at Red Cross headquarters. At 1530 the police in-

formed that an evacuation center on the shore was without means of communication with Red Cross headquarters. WIRMZ/mobile was dispatched and handled traffic for Red Cross headquarters to WINZM who relayed it to WILLM who phoned it to Red Cross headquarters. Since this was not too satisfactory an arrangement, later WIRMZ's 2-meter station was installed at the evacuation center and traffic was handled direct to Red Cross headquarters on two meters. W1RJA was dispatched to another evacuation center and established contact, also on two meters, from there. During the height of the storm, antennas were erected on the roofs at both places by W1s ILLM and KNM. Everything was cleared by 0120 November 26th. Other amateurs not mentioned above who assisted in various ways were W1s SFI and OPY.

MEET THE SCMs

Carroll Short, jr., W7BVZ, ex-W6BVZ, became interested in amateur radio in 1928, obtaining his license the following year.

An active LO-Niter and Field Day participant, Carroll is a member of the AREC and recently was appointed Assistant Director. Prior to his election as SCM of Nevada he was active in the capacity of Assistant SCM. He is a member and past-president of the Southern Nevada Amateur Radio Club.

In addition to WAS, RCC, Old Timer's Club, Code Proficiency (with 35-w.p.m. endorsement) and A-1 Operator Club certificates, Carroll treasures a certificate from the Southern Nevada Amateur Radio Club for working 25 Nevada stations and W.A.A.C. certificate No. 1 (Worked All Arizona Counties) awarded by the Old Pueblo Radio Club of Tucson, Arizona. He also possesses a Public Service certificate for his emergency communication work during the California Wind and Snow Storm of February, 1938.



Equipment in W7BVZ's front-room shack includes a BC-610E for use on all 'phone and c.w. bands from 160 through 10 meters. The receiver is an SX-28 with Q5-er (BC-453). On hand for emergency and mobile use are a BC-459 transmitter and a BC-455 receiver. Antennas used are a vertical half-wave on 40, also used as a quarter-wave on 80, and half-wave horizontals for 20 and 10.

Carroll is interested in amateur photography and likes to do a little hiking and swimming now and then. His working hours are spent as radiotelegraph operator for the City of Los Angeles Department of Water & Power. He usually doesn't wear the chin whiskers! Grown for a local celebration, they have long since been removed.

CODE-PROFICIENCY AWARDS

Have you received an ARRL Code Proficiency Certificate yet? Twice each month special transmissions are made to enable you to qualify for the award. The next qualifying run from W1AW/W0TQD will be made on March 13th at 2130 EST. Identical texts will be sent simultaneously by automatic transmitters. Frequencies of transmission from W1AW will be 1887, 3555, 7215, 14,100, 28,060, 52,000 and 146,000 kc. W0TQD will transmit on 3534 kc. The next qualifying run from W60W/P only will be transmitted on March 2nd at 2100 PST on 3590 and 7248 kc.

Any person may apply; neither ARRL membership nor an amateur license is required. Send copies of all qualifying runs to ARRL for grading, stating the call of the station you copied. If you qualify at one of the five speeds transmitted, 15 through 35 w.p.m., you will receive a certificate. If your initial qualification is for a speed below 35 w.p.m., you may try later for endorsement stickers.

Code-practice transmissions are made from W1AW each evening, Monday through Friday, at 2130 EST. References to texts used on several of the transmissions are given below.

- Date Subject of Practice Text from January QST**
- Mar. 8th: *A Single-Control Low-Power Transmitter*, p. 11
 - Mar. 8th: *A Single-Control Low-Power Transmitter*, p. 15
 - Mar. 14th: *The Case for Homemade Receivers*, p. 17
 - Mar. 16th: *A New Adventure in Ham Radio*, p. 21
 - Mar. 19th: *A Wide-Range Test Oscillator*, p. 29
 - Mar. 22nd: *V.H.F.; Why-How-When?*, p. 40
 - Mar. 28th: *The World Above 60 Mc.*, p. 42
 - Mar. 30th: *Operating News*, p. 46

DX CENTURY CLUB AWARDS

HONOR ROLL

W1FH.....236	W2BXA.....227	W0YXO.....224
W8HGW.....233	G2PL.....226	W3GHD.....223
W6VFR.....229	W6ENV.....225	W3CPV.....223
W3BES.....229	W6EBG.....225	

RADIOTELEPHONE

W1FH.....196	VQ4ERR.....186	W2BXA.....175
XE1AC.....190	PY2CK.....184	W9RBI.....175
LU6AJ.....189	W8HGW.....184	W1JCX.....172
	W6DL.....181	

From December 15, 1950, to January 15, 1951, DXCC certificates and endorsements based on postwar contacts with 100-or-more countries have been issued to the amateurs listed below.

NEW MEMBERS

G6YQ.....163	VE3BBR.....103	W5LV.....100
F8SK.....113	GM3EST.....102	W7AH.....100
ZB1AJX.....106	W8AE.....102	CO2BM.....100
DL1SC.....106	VE3RM.....102	W2LRW.....100
W5NUT.....106	W3KEW.....101	W1BIL.....100
W1CDX.....105	G3CSE.....101	W2BUY.....100
W6KPC.....105	W2CDP.....101	W2YTH.....100
W9UZS.....104	CE3AX.....101	

RADIOTELEPHONE

AR8AB.....133	HB9HM.....102	W6KPC.....101
W3BET.....128	CO7GM.....102	W2VWN.....100
W1KJU.....110	W2PPS.....102	W1FQX.....100
F8MY.....104	W1CLX.....101	

ENDORSEMENTS

G6ZO.....220	I1AY.....154	W8OCA.....120
W6ANN.....191	PA6IF.....150	W1NLM.....123
W4PN.....190	W6EAK.....150	W2WC.....123
PY2CK.....190	W8DAW.....150	W9CU.....121
W1LOP.....171	ZL3GU.....150	W9NZZ.....121
W6KUT.....170	W6ATO.....140	W4ZD.....120
W8CVU.....167	W8MPV.....134	W6BJU.....113
KP4CC.....163	W2GFV.....130	CP1AP.....111
ZS6BW.....161	W2PRN.....130	W8PNT.....111

RADIOTELEPHONE

W3LTU.....171	ZS6BW.....150	LU8CW.....120
W4EWY.....160	W5NMA.....130	W9JFF.....120
W4AZD.....150	CNEBA.....130	

• All operating amateurs are invited to report to the SCM on the first of each month, covering station activities for the preceding month. Radio Club news is also desired by SCMs for inclusion in these columns. The addresses of all SCMs will be found on page 6.

ATLANTIC DIVISION

EASTERN PENNSYLVANIA—SCM, Jerry Mathis, W3BES—EU bought BQ's rig and plans to make a memorial station at "W.A.D." Pa. this spring. Congrats to EAN on the birth of his first YL operator, PSH, OSE, and PDJ all got Class A tickets this month, making the membership of the ATARA 100 per cent Class A. OSE is on 3.85 and 14 Mc. PSH is on 14-Mc. 'phone. He also has a new mobile 28-Mc. rig. The D.O. Net meets every night from midnight till 4 a.m. on 3700 kc. QSP anywhere. Everyone is welcome. Traffic: W3NHI 1642, PDJ 210, BIP 202, PMG 27, QEW 23, QLI 3.

MARYLAND-DELAWARE-DISTRICT OF COLUMBIA—SCM, Eppa W. Darne, W3BWT—At the first December meeting of the Chesapeake Amateur Radio Club, Reuben Lee, transformer engineer of Westinghouse Electric, spoke on "The Amateurs Problem with Modulation Transformers and Side Band Splatter." This was followed by an informal question and answer period. Featured at the second December meeting was an illustrated talk, by Fred Marshall, of Bendix Radio Research, his subject being "A Miniature Microwave Signal Generator." The Washington Radio Club held an auction during its single December meeting on the 9th. Much valuable gear was found in new homes, so much being available that the auction lasted until nearly midnight. The Rock Creek Amateur Radio Association had a lecture on "Frequency Measurement" at its first December meeting. No second meeting for the month was held because of the Christmas holidays. The Capitol Suburban Radio Club held its Dec. 15th meeting at the University of Maryland, Building "R." Modulation indicators were discussed as well as a discussion on Civil Defense planning. The Baltimore Amateur Radio Communications Society held a Social and Smoker on Dec. 8th at Ed Nichols' Club basement. A business meeting was held on December 4th, along with an auction. The Dec. 18th meeting featured a speaker and refreshments. The Delaware Area has an Emergency Net that functions nicely under the guidance of Emergency Coordinator GZH. About 14 stations participate, and net meetings are held Sunday at 9:00 a.m. and Thursday at 9:00 p.m. using the frequency of the MDD net, 3650 kc. OFU is using a "Helical Hi-Pot Antenna," 175 feet of wire on a bamboo pole for 3.5 Mc., in his attic and gets out well with same. PJJ, Evelyn, of the Baltimore Area, has been doing some fine work on 28-Mc. 'phone. She keeps her receiver on the mobile frequency of 29,500 kc. constantly for anyone who wants to call for a contact. PSP is on 28-Mc. 'phone and c.w., all bands. Ken is working for his Class A ticket at present. VP is located in his new QTH in West Baltimore. Mr. and Mrs. HG made a trip to North Carolina recently. OPS is installing a mobile rig. QVW is a newly-licensed station in the Baltimore Area. OOT is working for his Class A ticket. QND has a new 28-Mc. beam and V.F.O. QYC is on 7 Mc. with 120 watts. QOM is building a TV receiver. FUZ has a new homemade de luxe kilowatt rig. NKY and PRL are building cubical quad antennas. GBB is on 1.7-Mc. 'phone. FDJ was active in the last SS Contest. NLS is in his new QTH, Belair Road, Baltimore, and gets out well on 7 and 14 Mc. with an indoor antenna. GZH has been appointed Official Bulletin Station. CJT has 70 watts on 1.7-Mc. 'phone and is on 3.5- and 7-Mc. c.w. OPO has a 1500-watt gas generator for emergency work and has a pair of 807s in final working on all bands. CDQ is on 7 Mc. LSX sticks to 7 Mc. for ragchews. IZL is busy with Civil Defense communications planning. CVE operates in the new "Transcontinental Relay Net." FQZ has p.p. 4-125As in his final and is on 3.5, 7, 14, and 29 Mc. Traffic: W3GZH 789, ECP 253, LZM 231, JZY 154, CVE 149, ONB 139, HUV 113, ADO 110, MCG 52, NNX 48, ARK 43, JHW 28, GUS 26, OFU 25, CJT 15, BWT 11, CDQ 3, FQZ 3, AKR 2.

SOUTHERN NEW JERSEY—SCM, Dr. Luther M. Mkitarian, W2ASG—A Bill is being introduced to the Senate and General Assembly of the State of New Jersey by the Hon. N. C. Smith, of Ocean County, for the issuance of

automobile license plates with amateur radio station call letters. It is understood by your SCM that printed copies of the Bill are available and that any suggestions from clubs or interested parties will be accepted for incorporation or revision. ORS is a proud "grandpappy." K2BG is a new ORS in Palmyra. ZI is back in the swing with net activities after a real vacation. ZVW is building a portable rig for his car and is high traffic man. Traffic: W2ZVW 210, ZI 80, ORS 51, RG 26, K2BG 21, W2ASG 17, HAZ 4.

WESTERN PENNSYLVANIA—SCM, Ernest J. Hlinsky, W3KWL—1950 was a successful year in your old Western Penna. section with such highlights as the winning of the SS by GJY for the third time; the outstanding work of your SEC, OMA, and his many ECs, who well proved their worth on several occasions such as Operations Comet and Operations Snowbound; the wonderful showing of activity among the various clubs; the swell cooperation of all club secretaries in keeping your SCM well supplied with material for this column; the outstanding performance of the v.h.f. boys, RUE, NKM, KWH, PGV, and LNA, and the activity of the boys of the Upper Ohio Valley Emergency Nets, the Western Penna. Traffic Net, and the Polecat Net. LSS says his mobile is working FB, and he is ready with two battery portables for emergency operation. LMM is trying to eliminate TVI. AER still is looking for the rare ones on 14 Mc. NLU and KKS are attending State College. OGI is working 7 Mc. with a 1625 final. DKL and PIV have new 10-meter beams. AU has been working 7 and 28 Mc. IYR handled weather and flood reports during the big storm. The Mercer County Radio Assn. has come up with the idea of using the 2-meter band as a traffic-handling outlet to all of Western Penna. The members have been reporting nightly at 10 p.m. on 144.3 Mc. after all regular nets have closed down. They request that all in the section active on 144 Mc. try and make that schedule. Heard on 144 Mc. each night is LNA with his 60-ft. high beam. LST sends in some highlights on the activity up Oil City way. MLG finally got his 144-Mc. gear working. RBB is doing nicely after several weeks in the hospital. Drop him a card, fellows. LST is very anxious to work many of you 144-Mc. boys. *The ATA News* tells us that a club discussion on The Radio Amateurs Position in Civil Defense will be held, with a panel for the forum being made up of OB, OMA, KWA, and NUG. Traffic: (Dec.) W3GEG 427, NCD 235, NRE 194, VNL 57, KWL 33, MIZ 18, AER 10, NCJ 7, IYR 4, QCN 3, LOD 2. (Nov.) W3GEG 231, OMA 111, LSS 95, NCD 81, LMM 41, NUG 40, MIZ 18. (Oct.) W3NUG 34.

CENTRAL DIVISION

ILLINOIS—SCM, Lloyd E. Hopkins, W9EVJ—UFF has been appointed director of communications for the Peoria Area by the Civil Defense office. LID is interested in our ILN Net. SGH is looking for 160-meter activity in the Chicago Area. KQL located bad choke in the power supply and now has an input of 750 watts. YIX, KJ, and BUK are making a valiant effort to revive *ILLNus*, the publication of ILN Net. ILH is back with the traffic gang and has a nice total. BIN is stationed at Camp McCoy. FGZ just completed his 12th year with the USAF, now at Selfridge Air Force Base, Mich. BPU is head of Civil Defense in Bloomington. TWMM returned from a trip to Florida; he reports TVI has dropped DeKalb activity to a new low. HOA, the new EC for Winnebago County, is doing a swell job with his bulletins regarding activity in that area. LIG managed to get the Starved Rock Radio Club paper, *Static*, going again. CMU reports improvement in his health; he is active on ILN. We welcome LIN back after an operation. TAL finds signals on various bands are definitely improving as far as quality is concerned. Our sympathy to TZQ, whose wife passed away. LQI is a new ham in Ashton. The Dixon Club officers are GNU, pres.; AUU, vice-pres. LDU is a new operator in Dixon. HUX reports Santa brought a new SX-71 for Christmas. Santa also dropped off an Eldico power supply for 813 to JJO. FRP filled out application for MARS. KJ finally licked his parasites. MEM, Elgin's 13-year-old ham, is going to town on 14 Mc. with his Millen exciter. GOJ passed Class A exam. New hams in the Springfield Area are MBA, MCE, LZS, LCF, MAE, and K9WA0. It is a pleasure to have AND, one of our section boys, as our new Director. Let's give him all the help we can. Thanks to many of the Illinois gang, hundreds of important messages were delivered from military personnel in hospitals in Japan. Letters and cards from many grateful families have been reported. Traffic: (Dec.) W9TLH 893, YIX 438, EDW 274, KQL 248, PEK 174, BUK 120, QN 85, KJ 75, SXL 41, JJO 34, FRP 27, BGN 25, PK 24, FKI 21, CMU 10, LIN 9. (Nov.) W9LIN 38.

INDIANA—SCM, W. E. Monigan, W9RE—SEC: PHV. PAM: BKJ. RMs: DGA, RMN, RCB. The Indiana

'Phone Net (HEN) has moved frequency to 3910 kc. to avoid QRMing the Missouri Net. The Evansville Police Department has loaned its surplus a.m. mobile sets to the Tri-State Amateur Radio Society. Approximately 15 cars will be equipped. JWZ is back on with 50 watts. LXW and LWX are new hams in Evansville. LXA has moved to Evansville from St. Louis. 8VGM gave a FB talk on s.s.b. HFF has joined the ranks of Silent Keys. YPF has TV antenna above his 28-Mc. beam. JTV vacationed in Florida. BBC is busy de-TVing his big rig. Looks as though Evansville soon will have two XYL operators. Mobile activity is increasing with good QSOs frequent. GQZ and HIW made Class A and are active on 3.85- and 14-Mc. 'phone. DHJ is on 3.5 and 144 Mc. from Crown Point. Good activity was shown in the Indiana QSO Contest. New officers of the Indianapolis Radio Club are FKX, pres.; PMM, vice-pres.; FZW, secy.; Clarence Pence, treas. 177 contacts were made by the Club station at the Hobby Show. FZW has new harmonic, the third. New officers of the Michiana Radio Club are YME, pres.; ZGC, vice-pres.; IDX, secy.; BCJ, treas.; EZS, act. mgr. UB is Club EC and is organizing Civil Defense for the South Bend Fire Department. Traffic: W9JTX 636, DGA 552, QLW 512, JUJ 436, TT 411, RCB 125, NZZ 70, BKJ 57, MKM 49, DOK 45, LZI 45, ZVF 32, DHJ 29, YME 14, RE 12, PMT 8, K9WAA 8, W9NH 3, YB 3.

WISCONSIN — SCM, Reno W. Goetsch, W9RQM — SEC: UFX. PAM: ESJ. RMS: CBE, LFK, CWZ. Nets: BEN, 3950 kc., 6 p.m.; WIN, 3625 kc., 7 p.m.; WIN slow speed, 3625 kc., 6:30 p.m. IXA has been working into the WIN, 9RN, CAN, and PAN Nets. IQM finally got a card from Vermont to complete WAS on 3.5 and 7 Mc. Because of the nature of his work, YYY has resigned as SEC. UFX is the newly-appointed SEC. Please direct all future EC reports and inquiries to UFX. IVE has been checking modulation and frequency for numerous 28-Mc. stations on ground wave. UIT worked ZL and KZ5 on 3.85 Mc. with n.f.m. during December. The Kewanee Emergency Corps meets each Sunday at 1300 CST, according to OVO, the EC. ILR registered with the AEC. TQ now is OES and is available for 144-Mc. schedules between 0900 and 1600 CST. NYS has a new YL jr. operator. The Blackhawk Radio Club elected KBT, pres.; FCY, vice-pres.; GVG, secy. A net certificate (BEN) has been issued to CIH. FPE reports 144-Mc. conditions during December equal to summer openings. Plan now to attend the annual WRA Hamfest in Wausau April 21st. IHW, new OBS, uses a pair of 813s with 811s for modulators at 450 watts. His MARS call is AF9IHW. CBE reports that 1424 messages were handled on the Central Area Net during December, or an average of 65 per net session. BVG and KZZ have been handling traffic between CAN and PAN Nets. RBI worked 37 states in the 10-meter WAS Test. The Door County Club elected LIK, pres.; OVO, vice-pres.; UIM, secy.-treas. GJK is working on a mobile rig. LIK has taken over maintenance of the Door County police radio. Traffic: (Dec.) W9SUF 1173, ESJ 929, CBE 758, IXA 470, IQM 95, HDZ 45, IQW 40, FXA 33, IVE 29, UIT 26, GWZ 18, NRP 17, CIH 16, MUM 11, BZU 9, OVO 7, RKT 5, ILR 4, GPU 3, ERW 2. (Nov.) W9FXA 33, MUM 9.

DAKOTA DIVISION

NORTH DAKOTA — SCM, Rev. Lawrence C. Strandenaes, W9JWY — The Goose River Valley 'Phone Net is now operating, according to report from OEL. It meets at 10:15 p.m. Tuesday and Thursday on 1991 kc. It is an emergency and ragchew organization and invites members, especially from Tralle, Steele, Cass, Nelson, and Grand Forks Counties. New officers of the Fargo Club include HIV, pres.; TDI, vice-pres.; CAQ, secy.-treas. JWY finally is on 160 meters, thanks to the help of HDI. HAI is going to school in Minneapolis, and IPC is attending television classes in Chicago. VSK reports that JWL is active on 28 Mc. and took part in the recent WAS Contest. CAQ purchased a new car and soon will have a mobile rig installed in it. All stations are urged to be active on at least one net. Get your portable or emergency gear built up and keep it in operation. Traffic: W9LHB 31, CAQ 29, OOI 6, JWY 5.

SOUTH DAKOTA — SCM, J. S. Fosberg, W9NGM — Asst. SCM, J. W. Sikorski, W9RRN. OAR and RWE are constructing clamp-tube modulators. With JLI as auctioneer, SFARC conducted an auction, the results of which brought a gleam to the eye of RWE, club treasurer. HDI visited the Sioux Falls Club and hauled considerable "loot" back to Mitchell. The Sioux Falls Club station, ZWY, is adding a modulator, for emergency use only, and seeing the handwriting on the wall, has formed a TVI committee composed of GWH, MPQ, and BLZ. The above report was written by Asst. SCM RRN. Traffic: W9PBR 96, RRN 6, CAR 3.

MINNESOTA — SCM, John B. Morgan, W9RA — Acting SCM, Charles Bole, 9MXC. Asst. SCM, Jean Walter, 9KYE. SEC: BOI. AIH now is using a new electronic keyer and also has received his WAC award. Paul works all bands on c.w. PDN left his job with N. W. Airlines and now is with the St. Paul Police Dept. Cliff now checks into the MSN. GHN is back in Moorhead. PVS is building a new hand-pass exciter. GHN and PVS are building a rig for Civil Defense. The Runestone Radio Club in Evansville had an

exceptional meeting in December. Attending this meeting were DAB, EUR, BQK, IGG, TSN, QEQ, and YBM. TSN, our Division Director, spoke on amateur affairs and YBM demonstrated the operation of his antennascope. FID earned his BPL certificate. AIH also made BPL. AIH received stecker for 30 w.p.m. UYJ is chairman of Civil Defense amateur communications in St. Paul. UJZ is EC for White Bear. UMK received a new 32V-2 Collins for a Christmas present. RXL received a dandy write-up in the *Duluth News Tribune* for handling Tokyo traffic. RJF and ITQ also had a write-up in the *Minneapolis Tribune* for handling overseas traffic. Forty-four stations report into the Minnesota 'phone net now. HBI has a new baby boy at his house now. 2HRW, ex-9RJV, and family are back in St. Paul to stay. SJR won a StAnvor transmitter and power supply as the grand prize at the Minneapolis Radio Club annual Christmas dinner. MRX now is mobile on 3.85-Mc. 'phone. BOL wants everyone to join the Emergency Corps. Write for application now! Bob's address is 1130 Delaware, St. Paul, Minn. Traffic: W9ITQ 591, RJF 285, KXF 216, AIH 199, EPJ 197, FID 156, HEO 128, BGY 46, MXX 46, ORJ 45, QYZ 32, MRX 28, RA 24, TKX 24, UCV 20, FIT 11, PDN 10, CWB 9.

DELTA DIVISION

ARKANSAS — SCM, Dr. John L. Stockton, W5DRW — ANR is building a mobile and is new EC for Alma. ASO took a vacation during January. EA has been getting out well with his 28-Mc. mobile. IJN has a new WRL-40-Trotter transmitter and is working 7 and 14 Mc. Our sympathy is extended to ONL on the death of his father. SI, HEE, and PYM visited the Little Rock Club meeting which had a big turnout. BUX and DSW were QRL with City Council meeting and couldn't attend the LR meeting. DRF is new EC. Our thanks again to AY, EA, and IOS for their efforts on the licensees deal. BAB and DRW had visits from 7BED, 5ICS, and LNW. IIV is new EC for West Memphis. RWJ has three-element beam for 28 Mc. and also is working some 160-meter 'phone. EGY has EC appointment for Texarkana. ANR is ORS, and FMF's certificate has been endorsed for ORS. MET works at KBRS and has been snagging DX such as FY8AC, VQ9FD, etc. The Camden Radio Club was organized with CPV, pres.; PZC, vice-pres.; PYU, secy.; and AQD, treas. The Little Rock Club is forming a 28-Mc. mobile emergency net. Traffic: W5DRW 514, FMF 231, LUX 134, MRD 84, EA 66, ONL 31, ICS 28, OXR 22, ANR 19, ASO 15, PYU 10, IGM 8, AQD 3, RWJ 2.

LOUISIANA — SCM, Robert E. Barr, W5GHF — AXU is operating controlled carrier on 3.85 Mc. at Alexandria. LV now has 120 countries confirmed on 14 Mc., running 120 watts. RIQ continues traffic and ragchew activity from Barksdale. The Ark-La-Tex Radio Club in Shreveport is receiving very enthusiastic support, with many interesting lecture programs by various professional men. RIQ beams the fact that the fellows in Utah and South Carolina, and in Asia have failed to QSL his contacts, thus blocking his WAS and WAC. NG meets HHT and bounce and TXN regularly, and is building a new 200-watt 813 c.w. job. The C.A.P. is holding simulated emergency drills, in conjunction with the hams in Baton Rouge, Alexandria, Opelousas, and surrounding area. HEJ and ZAB are going forward with civilian MARS net organization. QIX operates 28-Mc. mobile from Cotton Valley. FYZ is in Minden for his new QTH. BUZ, of Port Arthur, has been operating portable on the Sabine River in Louisiana. OXF originated 200 messages in December, chiefly from service men at Barksdale Air Base for service personnel at Ramey A.F.B., P.R. BSR got out a very nice letter to all Delta Division hams at the close of 1950, with a progress report for his year as Director. GHF works early morning traffic with the Transcon Early Bird Net. EVZ gets consistent 400- to 600-mile range with the 75-meter mobile. The latest ORS appointment is to RIQ. Traffic: W5RIQ 444, NG 391, OXF 312, GHF 112.

MISSISSIPPI — SCM, J. C. Wallis, W5DLA — Norman B. Feehan, JHS, is the new SCM for this section. On Dec. 9th and 10th the Pascagoula Club, NTG, had a group outing at Sweetmans Fishing Camp. Four low-power rigs were placed in operation on 3.85, 7, 14, and 28 Mc. Among those present were RWN, QNS, SFC, WA, RAR, RNB, LBY, HAV, DT, IBO, and DLA. New officers of the Jackson Club are OTD, pres.; RHE, vice-pres.; and RDA, secy. Those attending the Christmas blow-out at FFF's were ONY, OYA, PUG, RDA, RGH, RIO, PCD, PRY, and PNA. PRY, PCD, NPO, and PQJ are Class A and working 3.85-Mc. 'phone. PUG, also Class A, is working 3.85 and 14 Mc. with 750 watts A3. KP4LH was a recent guest of PFC. QMQ made Rag Chewers Club. FCH and EWD are active in CAP work. DEF is active in Rebel and RN5 Nets. DNS is pulse-modulating his 813s. CUU is working on his mobile rig. Traffic: (Dec.) W5JHS 676, DEJ 98, RKO 29, OMK 17, MGR 9. (Nov.) W5QMQ 48.

TENNESSEE — SCM, D. G. Stewart, W4AFI — Attendance has been good on both our section 'phone and c.w. nets, although skip conditions have made 'phone operation almost impossible at times. There has been a great deal of worth while traffic passing through ham channels recently and public reaction from recipients has been extremely good. Am sure those of you who had an opportunity to handle it

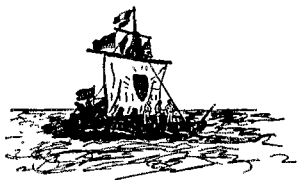

'Twas the Saturday before Christmas and — the XYL and I were window-shopping in historic Harvard Square and had just stopped in front of a bookstore window. Suddenly, a certain book in the window display caught my eye. I dashed into the store, bought it and gave it to the XYL. On Christmas Day, I was “greatly surprised” to receive as a present from my wife, a copy of the book, “Kon-Tiki.”

During the two following evenings, I read the book completely, ending up with a case of eyestrain that bothered me for two weeks more. The book was very interesting although the radio angle is not covered as completely as I had hoped, and it was not until the final chapter that I discovered what I considered the real reason for risking such a dangerous trip. I still think that “proving a theory” was just an excuse! Wahoo! LaHula!

There is a reason for my interest in the expedition described in this book. National Company supplied the radio equipment used on this unique trip including both transmitting and receiving equipment.

Some time before the expedition was to leave, we agreed to supply this radio equipment. The receiver was to be an NC-173 with precautions taken to make it as leak-proof as possible. Both B batteries (several hundred pounds of them) and hand-generating equipment were to be used. With about ten days notice, with the help of W1EHT and others, we set to work to build the three transmitters, modulators, battery box, control boxes, and connecting cables, with special emphasis on water-proofing. Cooperation was requested and received from other companies. Hytron supplied the 2E30 tubes, Workshops Associates supplied antenna equipment and Diamond Manufacturing Co. built the water-proofed connectors. Everything was water-proofed with aluminum welded joints and gaskets, including even the microphones and the toggle switches. Only one tube type, the 2E30 was used throughout in the transmitters and modulator. It was a rush job and we drew a sigh of relief when the units were finally completed and tested. Then, we crossed our fingers and waited.

After news of the safe landing of the crew was received, we were very happy to find that the radio equipment was still working right to the end. What pleased us the most was the fact that the NC-173, after lying on the bottom of the lagoon for a day or so soaking thoroughly in salt water, worked satisfactorily after it had dried out on the beach in the sun. Such an extended salt water dunking is a real rugged test for anyone's radio equipment, we think.

The book is interesting reading and I would recommend it as good reading to everyone. I wonder if other hams will get the same kick that I did out of the incident of “the ham in Colorado.”

CAL HADLOCK, W1CTW



have gained a great amount of personal satisfaction. This is good work, fellows, and affords us an opportunity to really render a service that is truly appreciated. Noticeably missing is a report from our most prolific traffic man, PL, who enjoyed a well-earned vacation in Florida. The transmitter procured for RLF through the efforts of MQV and the phone net is in operation on 28 Mc., affording hours of pleasure for Billy. Welcome to Route Manager NNJ from new QTH, and thanks for the extremely informative bulletin published and distributed in December. FLW and OGG activities were diverted by the arrival of new jr. operators. RMJ is operating on 28 and 3.5 Mc. FDF, chasing DX on 3.5 Mc., came up with OZAM. PMR is sporting a new five-inch 'scope, recently completed. AFI has new 75-meter mobile. Your SCM would be pleased to receive activity reports from Western Tennessee. Traffic: W4APC 470, NNJ 448, BAQ 326, LNF 79, FX 58, AFI 40, OGG 32, AEE 30, RMJ 30, FDF 21, OCN 20, LNN 19, DFR 15, NQJ 15, NDC 11, FHP 10, CXY 8, PMR 6, RDK 5, FLW 2, LUH 1.

GREAT LAKES DIVISION

KENTUCKY — SCM, I. W. Lyle, jr. W4KKG — FQQ is moving to East Lansing, Mich.; WWT is moving to Indianapolis. MDB has been appointed ORS. YPR says to pour the Tennessee traffic his way. MWX and CDA, as RMs, are lining up new stations for KYN, OXT, fairly new to the game, is a first-class operator. BXU and NWQ reports regularly to KYN. JYB is new ARTS president; MHV is new secretary. All hams, and hams to be, are extended a cordial invitation to attend meetings the second Saturday of each month at the Mayflower. QDI and RRN, YLs in Henderson, would like to hear from other Kentucky YLs. NUQ is on 144 Mc. with high-gain beam. DTI is new to Kentucky. RYB is working everything he hears with a 616 oscillator. KTZ is looking for West Coast schedules. K4WBG reports into KYN frequently. OYG says 160 meters is real fun. SFD does his ragchewing in the early A.M. KIV sticks to 60 Mc. MGT and his 32V-2 sound swell. RBV is in new location. NBZ, KMX, and LVP work on Southern Bell toll testboard. CDO passed the 100 countries rebuilt recently. MKJ is an ardent 144-Mc. operator. MIS rebuilds before he gets through rebuilding. FU still is knocking off that rare DX. FR is about ready to fire up on all bands. By the time you read this, ALR will be calling for all hands to raise his new 10-20 beam! KQI, our Great Lakes Asst. Director, thinks a 32V-2 might be just what he needs. SFS has 829B on 14, 28, 50, and 144 Mc. VP says that finding out what's wrong with people is sometimes easier than finding out what's wrong with a radio. BAZ is very busy these days on Trunk Line "J" and KYN. OGB and OGP are good traffic men. MQ is chasing DX in spare time. IPR finished new 20-meter beam just as the band went dead. Traffic: W4WWT 973, BAZ 203, MDB 166, MGT 145, YPR 107, MWX 77, KKG 51, CDA 32, OXT 25, BXU 18, NWQ 13.

MICHIGAN — SCM, Robert B. Cooper, W8AQA — Asst. SCM c.w., J. R. Beljan, R8CWC. SEC: GJH. RMs: UKV and YKC. PAMs: TTY and YNG. New appointments: EC for Berrien County goes to TOM and ORS to BDF. YNG and OAF received acknowledgment for their work on the Coast Guard Net. Sincere condolences to EXJ and BVY on their recent bereavements. SWF is making a slow recovery from bursitis but keeping his OBS schedules. NQ and CZK are making efforts to get their mobile equipment operative. Congratulations to the new officers of the Muskegon Club, who are FCZ, pres.; GSC, vice-pres.; and FDE, secy.-treas. ZWM made a very nice traffic total this month while NCSING DON along with K4USA. BDF, along with DSE and FX, worked some nice traffic deliveries from JA2MB. UKV also joins BPL this month, along with RJC and ELW. WXO reports the TVI program is in high gear. EXZ makes use of the TV set next door for his TVI corrective efforts. CLP reports the emergency planning for the club station of the MSC Radio Club. COW makes a very fine use of the activity report cards to keep a tally of traffic as the month is in progress. TIC reports a new r.f. section for TVI elimination but nothing new as the result of his experiments. DED reports GCW as a new Holland amateur. MGQ reports the loss of a 15-year-old RK-18. SPF has made a very nice showing on 3.85 Mc. and can be heard working into the nets. EXO and ZCH seem to be the only 144-Mc. activity in this area. BHL reports the installation of an amateur station in the Red Cross Headquarters and can be heard at 1500 Sundays on 3715 kc. RTZ/8 reports a visit to Headquarters while in N.Y.C. and makes BPL in the 2nd call area. I hope you will accord your new SCM the same spirit of cooperation you have so generously given me. The privilege of working with you has been more than repaid with many expressions of genuine "esprit de corps" which has made acquaintances that will be long remembered with the most pleasant of associations. Traffic: (Dec.) W8ZWV 1251, RJC 745, NOH 593, YKC 419, BDF 336, UKV 301, ELW 227, SCW 199, SWG 166, WXO 128, DAP 107, YNG 96, IV81, QBO 72, CLP 65, EXZ 65, UGD 60, AQA 48, OAF 46, WVL 44, DLZ 32, TIC 28, COW 26, AYV 25, TQP 23, DOI 20, FX 14, LLD 12, TTY 11, DED 7, BHL 3, MGQ 2. (Nov.) W8WXO 88, ELW 47, DOI 4, DUK 2.

OHIO — SCM, Leslie Misch, W8HGW — Asst. SCMs,

C. D. Hall, 8PUN; J. E. Siringer, 8AJW. SEC: UPB. PAMs: PUN and AJW. RMs: PMJ and DAE. Congratulations to IB, SG, DAE, and DZX on making BPL. It surely is nice having IB, ex-LFE, back in the fold. Bob, of 14-Mc. DX renown, received an ORS appointment in 1916. BN needs a consistent Youngstown outlet. DAE and FYW have handled considerable traffic for GIs in Japanese hospitals. LBH now is active on 420 Mc. DXO has received MM certificate Nr. 9; he needs one more QSL for DXCC and also one for WAS. TAQ will operate portable W5 while at school. The OCARC held its meeting on Jan. 13th at Columbus. YCP is celebrating the arrival of a YL harmonic. DZX suggests a slow-speed net to be known as BN SS. JFC scored 2262 in the 28-Mc. WAS Contest. PAU has a new 32V-2. GFE is a new operator in Mt. Healthy. ZJM is installing 14-Mc. beam on a new telephone pole. DGG reports the arrival of a baby girl. ICC has new NC-173. TZO is looking for c.w. schedules for checker or chess games. UZJ broke down the first week end of the SS. The following clubs were active in the OCARC in 1950: Delaware, Springfield, Akron, Dayton, Toledo, Piqua, Canton, Columbus, Mansfield, 89 Gang, Ohio Emergency Phone Net, Ohio River Valley Net, and the Dog House Net. UKS has invested in a 32V-2. Sam apparently is the top 3.85-Mc. DX man in the State. CPA and WRN still are busy on u.h.f. BAX is concentrating on 7 Mc. HAM is going to construct a sixteen-element beam for 144 Mc. Lake and Geauga County amateurs met to form an emergency net for the two counties. NEARC now is meeting at Fire Station Co. Nr. 40. NGW handled 4000 QSLs in his first month as W8 QSL Manager. SHI has reported to the San Diego Naval Station for active duty. YAC, a "fugitive" from TVI, is operating under cover from a new QTH with an attic antenna. BMC was presented with his third harmonic, a boy. EHW has a new 144-Mc. converter. JNF now is wearing a toupee and false whiskers — reason, back on the air. (Unconfirmed rumor). New West Park Radiop officers are NFD, pres.; SBB, secy.-treas.; ZEU and JNF, trustees. The Q6, published by the Springfield boys, indicates an active bunch. BLN is their outstanding 144-Mc. man. ETS, of Cleveland, passed away just before Christmas. Our sympathy to Josephine and the children. FOU can be added to the growing list of 32V-2 users. The closing date for news items is the 7th of the month. What say, gang, let's get those reports in before the deadline. Traffic: W8SG 805, IB 575, DAE 393, DZX 289, YCP 266, UPB 92, ARO 78, CBI 78, AJW 44, UZJ 40, TAQ 38, WAV 26, FJN 24, EQN 23, SFI 23, DXO 22, QLE 22, GDQ 17, WZ 15, AL 13, GZ 11, ZAU 9, FVR 7, LBH 7, DZO 6, BEW 5, EXI 5, EZE 5, WAB 3, RN 2, BUM 1.

HUDSON DIVISION

EASTERN NEW YORK — SCM, George W. Sleeper, W2CLL — SEC: NJF. YBK has moved to Somers and will organize AREC activities there. AAD is back on 144 Mc. with JPX and FAR. NJF is going to town with a ground plane. Antennas knocked down in the recent storms are slowly but surely going back up. The WARA gave a big Christmas party which went over with a bang. JIO gave an interesting lecture at WARA on auditory test equipment. DST is back after a very long absence. SQW is on the C.D. board for White Plains. WBH erected 60-foot tower for 20/10/2-meter beams. Congrats to SNN, recently married, but who takes care of the 75-meter net by having his parents operate. Congrats also to QJJ on having acquired an XYL. YVG's brand-new XYL is interested in obtaining a ticket. ZQX is QRL organizing club at W.P. High School. VRE is back on 144 Mc. and is very active in AREC. MZV is in the Army. PR is in charge of C.D. for Eastchester. ILL is in charge of communications for County Red Cross chapter. SUL really is doing a job with his AREC. We are looking for a ham in Putnam County. GTI is a real help to AREC for his work in N. Y. State C.D. N. Y. State C.D. advises that the Dept. PW has been authorized to start a state-wide ham net. HCM is coordinating all contact between State C.D. and ARRL in the section. HCM to CLL. All members of the section are urged to do their utmost to prove we are worth our salt. Appointments were made to FVP as ORS, JLI as EC for Dobbs Ferry, AWF as EC for the City of Albany, YBK as EC for Somers, and AAD as EC for White Plains. New SARA officers are GYV, pres.; UKA, vice-pres.; ZHI, secy.; YIK, treas. The technical committee of the Schenectady AREC completed propagation tests. 60 Mc. gets the job. PFU appeared on TV; subject, TV antennae! Traffic: W2TYC 624, LRW 238, DXY 61, BR5 65, CLL 34, GTC 27, NJF 16, NVB 5.

NEW YORK CITY AND LONG ISLAND — SCM, George V. Cooke, W2OBU — Asst. SCM, Harry Dannels, 2TUK. SEC: BGO. RMs: PRB, TUK. The AREC roster shows good progress in all counties of the section. In Brooklyn, with BIV as EC, 16 new stations have been added within a month; 53 stations are operating on the 10-meter net, of which 20 are mobile, with 6 of the fixed stations operating on emergency power. On the 2-meter net there are 6 stations, with more being added continually. Added to BIV's staff as Asst. ECs are DLP, ALJ, and DIR. Queens also continues to add stations in AREC, with 112 stations now listed. Newly-appointed aides to SYW, Queens EC, are AAG as Alternate, JSV as Assistant EC, and AVI, who has taken

(Continued on page 78)

A Special Announcement

Concerning NOVICE CLASS Operation

As explained on other pages of this magazine, the "Novice-Class" Radio Amateur was established by the Federal Communications Commission January 31, 1951. Examinations for novice-class licenses will begin July 1, 1951.

A new low-power transmitter-receiver SR-75, ideally suited for novice-class operation, was announced by Hallicrafters some months ago. Actual production was begun in January, 1951. The unit was formally introduced in these pages last month and by the time you read this announcement, initial deliveries will have been made to all Hallicrafters distributors.

Hallicrafters are proud to point out that in the SR-75 we have anticipated the needs of these new aspirants to the ranks of Amateur Radio. To nourish the dreams of the beginner (looking toward the future), as well as to pioneer in new refinements for the more experienced, has always been an essential part of the Hallicrafters creed.

The SR-75 is a complete one-package station suitable for semi-portable, emergency or novice-class use. For the benefit of those who missed our advertisement last month, its features are listed briefly: crystal controlled transmitter for 80, 40, 20, or 11/10 Meters; 10-watt input; pi-network output; built in keying relay. Receiver substantially the same as our S-38B; transmitting section uses separate oscillator plus receiver output tube with voltage-doubler rectifier.

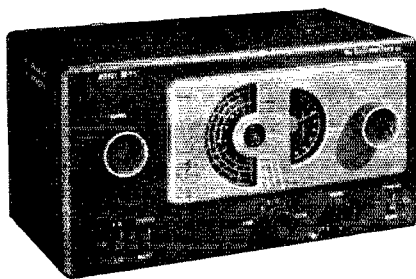

SR-75 • \$89.95

Yes, Hallicrafters are ready for the novices — with *good* equipment to get them started in the *right* way.

BILL HALLIGAN, JR.
Communications Sales Mgr.



over NCS on the 40-meter AREC net. A recent Staten Island AREC net drill was observed by the local Red Cross Chapter, with excellent results under the guidance of VKF, Staten Island EC, who reports that during the recent wind storm the AREC there was called to action when Oakwood Beach had to be evacuated because of flood conditions. Communications were maintained between temporary Red Cross Headquarters and area Headquarters, in addition to alerting the gang for possible Fire Department work should the alarm system fail. Those handling this job were GHK, NFH, GNX, MEF, EFA, WOZ, PZF, PRP, and VKF. In Staten Island there are 17 AREC members, with new members being added weekly. Drills are held Thursdays at 2000 on 29.492 Mc. Manhattan, with HF as EC, is developing AREC with a view to working in CD. The Knickerbocker Radio Club is well equipped with a panel truck for mobile work with a gas-driven generator installed. The over-all picture in the city shows plans for affiliation with the Fire Department with a fixed 10-meter station at Headquarters in each borough, with varying numbers of mobiles from 3 in Manhattan to 8 in Brooklyn. The need in the city for this project is 60 operators to man central offices and 30 mobiles throughout the five counties. ECs are requested to report to the SEC two or three days earlier each month. The NLI Traffic Net, operating on 3710 kc. at 1930 on Mondays through Fridays, is booming because of the new appointment of TUK as RM. Write TUK for full information. The UHF Club in Jamaica elected the following for the coming year: GRQ, pres.; NZJ, vice-pres.; ZXQ, secy.; OTA, treas.; with DYK and QPQ, delegates to FLIRC. Mid-Island Radio Club officers for '51 are as follows: CIG, pres.; Joe Desize, vice-pres.; YBT, secy.; ELT, treas.; KJY, sgt. at arms; OWP and FTF, trustees; CXG, publicity; and WFL, tech. chairman. The Tu-Boro Club has the following slate for '51: BOT, pres.; PFY, vice-pres.; HVD, treas.; LGK, secy.; JSV and AVI, delegates to FLIRC. Section Net certificates have been issued to LOL, DHN, PFY, and JSV. MZB and SJC have been called back into the Navy. RPZ now is located at NAS, Norfolk. ZPG is in Texas attending Radar School at Fort Bliss. RUZ is boning up on net procedure to join NLI Net. NFU worked for OBS appointment. QQD, Frank Bruce, is a professional wrestler. PF operated PK/KP4 from hotel room in San Juan using TBS-50. Watch for ZRR with his rig up at Cornell U. IN is the latest traffic man in Bronx. CLA operates on 2374 kc. with the CAP. EC reports TLAP is handling hundreds of messages from the Far East for GIs. VOS works NLI from IMX at M.I.T. RQJ cured TVI with 32V-2. Traffic: (Dec.) W2VNJ 672, BO 535, EC 358, RTZ 205, OBU 115, CLA 54, ZKJ 41, VKF 39, ZRR 36, BIV 30, TUK 24, IN 18, SJC 17, RQJ 16, IAG 15, BQP 11, KVG 7, PF 6, ESO 2, LGK 2. (Nov.) W2SJC 50.

NORTHERN NEW JERSEY — SCM, Thomas J. Ryan, jr., W2NKD — The Northern New Jersey Net has combined with representatives of the Southern New Jersey section to form the "Jersey Net" on 3630 kc. Mon. through Sat. at 1900. Net Manager is CGG. The Net offers statewide coverage. Traffic men are urged to join the Net. Listen on 3900 kc. every Sunday at 1000 to the N.N.J. Emergency 'Phone Net. AOW is Net Control. All counties in the section are represented. Along the same line, the following men have been designated as Civil Defense District Coordinators: Metropolitan, UWK; Northern, K2CM; Central, YLS; Southern, ZVW. Next month we will present the complete list of the Area Coördinators who comprise the organizations within each district. The new officers of the Morris Radio Club are YTH, pres.; FRB, secy.; GAX, treas.; FGN, comm. dir.; WKL, tech. dir.; K2AX, publicity. YOB passed Class A exam. BFP is operating @WAD at Iowa State U. VYB is new OO appointee. CBT is active on 2-meter Middlesex County Net and 75-meter 'phone N.N.J. Net. FWP is back on the air after three years' inactivity. FNO is the call of the newly-formed Dunellen High School RC. Its faculty advisors are BEP, QXC, and FQN, ex-1JBQ. New Dunellen call is FNQ, the fifteen-year-old son of QXC. What a chance for confusion when both FNQ and FQN are on 144 Mc. at the same time! 3LBF, of Wilmington, Del., now in Plainfield, is waiting for new W2 call. He works 3.5- and 7-Mc. c.w. COT is assisted in Maplewood by GXA and AXJ for emergency work. BEP received Class A exam. CCY and JMX are Assistant ECs for Roselle Park under LOP. CUI is a regular member of the Swing Shift Net on 7 Mc. TZF has PAV and SMK as Assistant ECs in Union City. The Garden State ARA held its annual dinner on Dec. 6th. Recent EC appointments are AGO, Bloomfield; BYH, Glen Rock; MSR, Ramsey; K2BX, Eatontown; WUD, Newark; KLA, Deputy Essex County EC. Endorsement for ORS went to CWK, of Highland Park. Traffic: (Dec.) W2CUI 312, CGG 255, LMB 165, WCL 93, ANG 45, AWY 36, NIY 16, LOP 9, CFB 7, OUS 6, COT 4, CWK 3, TZF 1. (Nov.) W2CCS 101, BUX 14, HIA 12.

MIDWEST DIVISION

IOWA — SCM, William G. Davis, W8PP — AZR reports the Sioux City Club has elected the following officers: AZR, pres.; YNW, vice-pres.; ENS, secy.; and UFL, treas. EOL, ENS, and YNW have returned from active military service. AEW has moved back to Sioux City. SVS lost his feed line to a steam shovel being used in construction work.

KUX is on active duty at Cherry Point, N. C., and in charge of the base ham station. AXE has volunteered for USAF. The TLON is losing a top traffic man, as QAO is moving to Wisconsin. GFX is the newest member of TLON. The Burlington Club is moving back to the NRTC for its meetings at the invitation of the Navy. All the training, test, and operating facilities will be available to them. YTA reports the first 'phone contact of his ham career. WMU says he's all settled on 3.85-Mc. 'phone now. NYX reports from Waterloo that the new Club president is MG. The Club is busy working out plans with the city for a disaster and communications center. The Des Moines Club is likewise busy under the able direction of John Moffitt. SCA is building a new c.w. rig using a 4-125. Doc is top traffic man again. Both the Iowa 'phone net and the c.w. net are busy moving traffic from the boys who have returned to Japan from the fighting front. When you read this report it will be time for you to consider who you want for your SCM and get nominations in accordingly. Traffic: W8SCA 942, QAO 511, YW 328, AUL 312, QVA 210, YTA 80, AK 37, KAH 29, WMU 26.

KANSAS — SCM, Earl N. Johnston, W8ICV — We are highly pleased with the increase of interest and activity in traffic nets, 'phone nets, AREC registrations, mobile stations, v.h.f. stations, and radio clubs. The Wichita Amateur Radio Club elected EVE, pres.; DMF, vice-pres.; DJB, secy.; GAV, publicity; DEB, pres.; with DMA and CQC representing WARC in the Federation of Clubs. The Central Kansas Radio Club's new officers are INW, pres.; BGW, vice-pres.; PKD, secy.-treas.; MUY, act. mgr. TDW says the Eldorado Club has two regular stations in AREC and one Official Mobile Unit. FRK is one of the latest newcomers to 144 Mc. MVG has completed a 4 over 4. YZX has a new rig on the air. AFW enlisted in the Air Force. ALD completed Viking transmitter with crystal on 160 meters and VFO via 459 and 696 on other bands. IPI, now in the Army, is stationed at Camp Atterbury, Ind. PWJ, now attending K. U., is Class A and is on the air with new Letting rig, CBO, a new ham in Olathe, is operating on 28 Mc. GZI is permanently located at Gardner. ZLW and WEV are new 3.85-Mc. 'phone arrivals from 28-Mc. 'phone. BSP and UA are Civil Defense officials in Olathe. DRB recently rebuilt. NI, of Topeka, is on with BC-610 and the highest indoor antenna in the locality on 3.85 Mc., up about 75 feet. UPU keeps regular schedule with his son-in-law, ABV, in Arlington, Va., on 14-Mc. 'phone. Traffic: W8WGM 217, FDJ 193, NIY 145, DRB 117, EQJ 87, FEL 54, TDW 34, ICV 19, LIX 16, HBL 15, JDX 15, BNU 11, FRK 6, KXL 5.

MISSOURI — SCM, Ben H. Wendt, W8ICD — HUI will serve as Acting SCM until an election has been held. Appointments and endorsements: DEA, KIK, and QXO as ORS; VRF as SEC; RCE, QXO, TPK, and IAC as EC; CNC as OBS; SOM as OPS; QXO as RM; PTG as OES. The HARC is looking forward to activity in the Civil Defense plans of Greater Kansas City. YVI reports emergency activity lagging because of work overload on the few available operators. Civil Defense plans are developing rapidly with amateur participation well represented. PLJ has his shack completed. QXO would like to see Iowa and Kansas participation in the Hit and Bounce Net. PTG is giving 50 Mc. a try since the wind eliminated the 144-Mc. beam. CEX is experimenting with push-pull supermodulation. ZZB is back on the air with high power. GEF is using an 829B for his 144-Mc. debut. 144-Mc. activity is gaining popularity in the S. E. Missouri Area. NIP is back on the air after having moisture trouble with the rig. Acting SCM HUI reports the following: DEA, Midwest Division Director, addressed the SMARC of Springfield on club affiliation at its December 20th meeting. HQM is back in the U. S. Naval Air Service, Ocean View, Va. EBE assigns new certificates to the mobile units. ARH reports 14 and 28 Mc. conditions very poor and he is moving to 50 and 144 Mc. WAP is handling traffic on 3.5- and 7-Mc. c.w. GCL was elected secretary of the Rolla Club. SMARC recently elected BHC, pres.; BPD, secy.; and CGJ, treas. Missouri 'phone net operates on 3.9 Mc. Mon., Wed., and Fri. at 1830. The daytime net meets Tues., Thurs., and Sat. at 1230. TPK is Acting Net Control Station. GBJ is rebuilding rig. Missouri 'phone net needs an outlet station in Northeast Missouri and St. Louis. Traffic: W8QXO 818, DEA 273, WAP 272, EBE 35, PTG 29, GBJ 8, GCL 4, YVI 4, SOM 3.

NEBRASKA — SCM, Scott E. Davison, W8OED — KDW has his BC-459 on 7 and 3.5 Mc. now. JED reports following members of EC: YNA, INR, TIP, F8J, YSK, QOU, CBH, ADK, EXJ, NVE, BFC, YMU, BXC, MHG, NBP, RGG, SAI, VQO, YWK, FMW, JDI, RCH, GXT, LOD, UJA, YDE, KDW, MHV, DCQ, VNA, IQ, APX, EUT, AQJ, COU, QHG, VQR, AGE, MJY, ZJF, KBR, GHM, TIF, YLC, IDR, NZ, and GWZ. A new call at North Platte is CZK. COU, EXP, EKP, and JED are sporting new HRO-50s. CBH is a 500-watter now. ZUT put up new rhombic. JGT has installed mobile unit for 3.85-Mc. 'phone. JED has a 522 rig on 144 Mc. RCH has a new 800-watter all-band using 810s for final. New officers of the NENRC are YSK, pres.; NVE, secy.; and ZUT, treas. YMU is Asst. EC for Omaha Area. Nebraska's 160 Emergency 'Phone Net lists the following members: YWK, AGE, BFF, BLM, BTB, CSW, GEQ, IDR, FMW, KBR, TIF, VQR, YSK, (Continued on page 78)

Be Sure of Your Installations — Get the *Aptitude-Tested* RG/U TRANSMISSION LINE CABLES

RG-5/U
APTITUDE RATING No. 8236

Frequency (Mc)	Attenuation per 100 ft
100.	2.65
200.	3.85
300.	4.80
400.	5.60

RG-8/U
APTITUDE RATING No. 8237

Frequency (Mc)	Attenuation per 100 ft
100.	2.10
200.	3.30
300.	4.10
400.	4.50

RG-11/U
APTITUDE RATING No. 8238

Frequency (Mc)	Attenuation per 100 ft
100.	1.90
200.	2.85
300.	3.60
400.	4.35

RG-54A/U
APTITUDE RATING No. 8239

Frequency (Mc)	Attenuation per 100 ft
100.	2.90
200.	4.20
300.	5.50
400.	6.70

RG-59/U
APTITUDE RATING No. 8241

Frequency (Mc)	Attenuation per 100 ft
100.	3.75
200.	5.60
300.	7.10
400.	8.30

For use with television antenna.

You know what you are doing when you use Belden RG/U Transmission Line Cables—they're aptitude rated. They are designed from the start to provide desirable electrical characteristics, and rigid manufacturing control assures constant, unwavering quality.

You can safely put Belden Wire to work for you, and know for sure how it will perform. You can know, too, that it will have the stamina to stay loyally on the job for years. For trouble-free installations, specify Belden Radio Wires.

Belden Manufacturing Company
4621 W. Van Buren Street
Chicago 44, Illinois

Belden 8238 RG-11/U

Belden 8239 RG-54A/U

Belden 8241 RG-59/U

RG-58/U
APTITUDE RATING No. 8240

Frequency (Mc)	Attenuation per 100 ft
100.	4.10
200.	6.20
300.	8.00
400.	9.50

For use with radio frequency transmission, video, test equipment, and pulse transmission.

Belden
Radio WIRE

The
Aptitude-Tested **LINE**

TIP. New officers of the Ak-Sar-Ben Radio Club are JKE, pres.; HZE, vice-pres.; QHG, secy.; and EAO, treas. JCK has a new 10-meter beam. GJI has new final for 28, 50 and 144 Mc. with 8266 p.p. and a new twelve-element 144-Mc. beam. His exciter for this final is 6AG7-6AG7-832-928! UJW uses HT-17 on 3.8 Mc. IAJ puts out a 300-watt wallow in his dipole on 3.5 Mc. EHF finds his kw. B8X is building self-tuned automatic exciter with motor tuning. UVC is building new rig. JKE operates 28 Mc. IDR has 518-ft. antenna on 160 meters with his 100TH rig. JJK has 60-watter DXing. Traffic: W0TQD 2525, AY 778, IXL 335, SAI 106, IAJ 79, CBH 78, FMW 46, DMY 42, KDW 36, RYG 26, ADJ 23, BLM 21, EUT 18, LJO 16, IDR 11, GEQ 10, YDE 9, YSK 9, JJK 1.

NEW ENGLAND DIVISION

CONNECTICUT—SCM, Walter L. Glover, W1VB—The December issue of *Connecticut Progress*, a four-page pamphlet with pictures, published by the State Development Commission, which is mailed monthly to all public officials in Connecticut, is devoted entirely to amateur radio. It deals mainly with AREC and especially the State Police set-up here, the first state in the United States to have such a network, so it states. This makes for good publicity and I assume much credit should be given to LKF, our SEC, for this job. It is possible there are extra copies. If anyone is interested, a card to LKF will give you the dope. The State Police stations have received their calls, which are TIA, TIB, etc. OJR is building a Clapp oscillator and 144-Mc. transceiver for EC work. RY is another casualty to TVI. NBP has two transmitters in his truck now, and expects to add a 144-Mc. job. CTI is on irregularly these days because of heavy work at the bank. A new operator at AW is Jim, 4KVM. AW has new 7-Mc. exciter. HRR is active on 160-meter 'phone. HYF thinks the 10-p.m. session of CN is slipping. How about it, fellows? Cannot check myself as it conflicts with TLAP. AOS has all the necessary gear for a 3.5-Mc. mobile, providing he ever gets time to mount it in his car. VB finally broke down and bought a TV set, so if you guys will get on channel 2 or 4, everything will be swell. Traffic: WINJM 392, AYC 287, LY 162, VB 160, AW 143, BDI 127, BVV 74, HYF 43, KYQ 43, GVK 28, CTI 26, NBP 23, VV 17, KV 15, OJR 14, RFJ 13, HRR 7, AOS 3.

MAINE—SCM, Manley W. Haskell, W1VV—Seagull Net, 3961 kc. at 1715, Mon. through Fri., PAM PTL as NCS. Pine Tree Net, 3596 kc. at 1900, Mon. through Fri., RM NGV as NCS. AEC Net, 3588 kc. at 1645, Mon. through Fri., QUA as NCS. Dogpatch Net, 29 Mc., Mon. at 2000, ROM as NCS. Maine V.H.F. Net, 146.8 Mc., Mon. at 2000, JUV as NCS. LKP and SFZ made BPL in good shape but QUA was 5 points short. BKU has a shiny new net certificate for work in the Pine Tree Net. LRG uses "Q" Signal sheets for instruction purposes. ITU and VV were in on monthly LO Party. QLU joined the gang on 3.85 Mc. with 350 watts. QUA yells that SWZ is a right good man on the PTN. The Eastern Maine Amateur Radio Club meets Tuesday nights at Bangor. PMY is secretary. The state meeting of Civil Defense was held at Augusta in December and the amateur was represented by SEC IGW and SCM VV. The annual W/VE QSO Party was held Jan. 4th on 3860 kc. at 2000 with VE2XO as M.C. AW was present and speakers included "Ed" Handy, C.M., and George Hart, NEC. Alex. Reid, VE2BE, Canadian General Manager, spoke for the VEs. The Portland Amateur Wireless Assn. elected ITU, pres.; CAP's Vice Carr, vice-pres.; RSX, secy.; JRS, treas.; and LNI, chief op. Silent Key: 1VV, Clifford E. Henry. Traffic: W1LKP 519, SFZ 285, QUA 172, LBJ 104, LRG 66, QQY 65, VV 62, BTY 60, PTL 59, HYH 53, SUK/SVM 34, RQR 25, TFY 24, ACW 21, ITU 19, AFT 18, PVY 11, BRQ 10, RPT 9, FV 6, KDE 6, QEK 6, GJ 5, SWX 4.

EASTERN MASSACHUSETTS—SCM, Frank L. Baker, Jr. W1ALP—SEC: BL, RM for 3.5 Mc.; JCK, RM for 7 Mc.; AQE, RM for 14 and 28 Mc.; AAL, PAM for 14-Mc. 'phone; LMB, Eastern Mass. Net meets on 3745 kc. New appointments: CCL as EC for Cohasset; RSE as EC for Whitman; SAI as ORS; OPS, and OBS; KBN and RRP as ORS; RRP as OO. The following had their certificates endorsed: UE, BHD, MRQ, JYJ, DDC, JYC, and MBQ, as ECs; BHD as OBS; MRQ, JYJ, BB, QZS, and LM as ORS. MRQ and BB as OPS. KBN participated in 28-Mc. WAS Contest. QVC and NIG are on 28 Mc. Active on 144 Mc.: EUW, SEN, SH, TEA, SAR, RUD, IPC, and AKD. CTW has been on 28 Mc. some. ALP and BL attended the meeting at State House on operational communications for Civil Defense called by Director Stokes, KWD, Weymouth EC, has more than 20 hams signed up in the Emergency Corps. Those present at the Eastern Mass. Net supper and meeting in Boston were QGL, SJX, JCK, ATX, BJ, RRP, FCT, PYM, QMJ, TY, CCF, ALP, DWO, and AXG. MEV works ZLs on 14-Mc. 'phone. MME has a rig on 28-Mc. in his car. KWD has 144-Mc. rig in his car. SAI is on 3.5-Mc. c.w. The South Eastern Mass. Amateur Radio Assn. of New Bedford elected WU, pres.; CTZ, vice-pres.; HSR, secy.; QX, treas.; LAZ, member of Board of Directors. MXG/MM writes from Houston, Tex., that he is on the S.S. L. V. Stanford and is on 28 Mc. DDC gets on 1.8-Mc. c.w. and 144-Mc. 'phone. MAN, Marblehead EC, has

OLC, IXO, PRX, and RNM working on emergency work. LYH is Asst. EC for Everett. MM will be on 3.5-Mc. c.w. soon. SS handled 58 messages from hospitals. EGH is trading. DMS built preselector with grounded grid. EGH is trading receivers. SWX is staying in Allston for a while. KBN has started 250-watt constant modulation final for 144 Mc. WU visited the South Shore Radio Club. FGT reports a new club in Foxboro, the Old Colony Amateur Radio Assn. QGJ is installing 7½-kw. Diesel electric plant. TGP is a new ham in Danvers. GW is building rig for u.h.f. frequencies. HWE has 3 antennas. JYJ has 'phone rig going for MARS Net. RGY got six new states in 28-Mc. WAS Contest. Newton emergency drill had BL, EK, ILX, LMI, RM, QPM, SQB, and PWV on. NSZ and PWV are Asst. Deputy Directors of Communications. OOP gave a talk at Eastern Mass. Club on "Possible Circuits for Civil Defense." The Brockton Radio Club had a demonstration on converting a BC-459. The T-9 Radio Club held a meeting at IPK's. MBQ has rebuilt rig for 144 Mc. and is building emergency rig for 3.85 Mc. QPY, TDS, RAI, and BNS are on 144 Mc. GOU gets on 28 Mc. with reduced power to cut out TVI. GYZ, Director of Communications of Quincy Defense Council, is calling a meeting of all hams to talk over plans. The Boston Emergency Net held a drill on 144 Mc. with Mr. Reardon, Radio Coordinator for the City of Boston, at MCR's QTH. Traffic: (Dec.) W1EMG 508, YU 287, LM 225, SS 221, PU 156, DMS 109, ZR 68, DWO 46, QJB 45, JCK 35, QKM 33, BGH 32, SWX/1 28, NWL 18, AVY 7, KBN 7, SDO/1 5, WU 4. (Nov.) W1FGT 130, QGJ 54, QKM 48, JFS 24, JYJ 22, BB 19, DWO 16, ILN 2.

WESTERN MASSACHUSETTS—SCM, Victor W. Paunoff, W1EOB—SEC: JYH. RM: BVR. Net frequency, 3725 kc., Mon. through Fri. at 7 p.m. and 10 p.m. Slow-speed net Mon. and Fri. at 6:30 p.m. The emphasis is on emergency nets and organization. JYH has ambitious plans and needs the support of all amateurs to make them click. New emergency net in Springfield meets Thursdays at 8 p.m. on 29.45 Mc. RDR is NCS. RDR is appointed Assistant SEC and has attended Civil Defense communications meeting in Boston. Springfield 144-Mc. net meets on Friday; see NLE. Agawam 144-Mc. net meets on Thurs.; see MNG. BVR reports obsolete police 38-Mc. equipment, one fixed, three mobile, being made available to Westfield AREC. Via QFB, 5 mobiles participated in test at Northampton. ICW is Director of Communications for Chicopee C.D. MOK is reorganizing the AREC in Chicopee. Worcester will have 3.5-Mc. c.w. training net, per RO. JYH and RDR gained many good ideas during visit to Connecticut SEC, who works in cooperation with state police system. CJK, SVW, and QJN are new on 144 Mc. in Holyoke. BDV is building receiver for 144 Mc. Emergency communications and organization are the most important things that face amateurs today. Start training yourself on any existing net. Start building equipment for the most likely frequencies to be used. Mobile equipment is especially important. See your EC now. ECs are: Adams, JAH; Fitchburg-Leominster, EHH; Holyoke-Chicopee, MOK; Northampton, QFB; Pittsfield, IZN; Southbridge, EFC; Springfield, NLE; Webster, LIB; Westfield, BVR; Worcester, RO. BVR spoke at the Hilltop Club in Worcester, along with EOB and JYH. 2BK1/1, a newcomer to Western Mass., is in Leicester. Traffic: W1RHU 341, RZG 181, BVR 164, EOB 161, 2BK1/1 98, 1JYH 88, GZ 82, JLT 69, GVJ 8, BDV 5, MOK 1.

NEW HAMPSHIRE—SCM, Norman A. Chapman, W1JNC—SEC: KYG. RM: CRW. The NHN meets on 3685 kc., 7:00 p.m., Monday through Friday. The NIEN meets on 3685 kc., 6:30 p.m., Friday, 3890 kc., Sunday, 1:00 p.m. The Concord Brasspounders presented ANH, Windsor, Vt., with certificate Nr. 10 for having successfully worked all ten New Hampshire counties. Who will be next? RHW is reported to be in Korea. RHP stopped in at W1AW to work the rig before taking off for Tripoli. AIJ is back on the air working 7 Mc. MMC is rebuilding and is expected to be on soon. BBH takes his new Class A ticket to bed with him. The Connecticut River Valley Net operates on 3890 kc., Sunday at 10:30 a.m. AXL is Net Control. NQ is doing a fine job as secretary of the Old Timers Club. The Concord Brasspounders elected the following officers: AOQ, pres.; CNX, vice-pres.; OZG, secy.-treas. Have you forwarded your League appointment certificates for endorsement? CRW makes BPL again. Traffic: (Dec.) W1CRW 1755, PFU 102, QJX 27, JNC 26, GME 23, MCS 9, RFP 6, JGI 3, POK 3, EWF 2. (Nov.) W1CRW 506, SAL 88, MCS 6, JGI 4, EWF 1.

RHODE ISLAND—SCM, Roy B. Fuller, W1CJH—RM: BTV. PAM: BFB. Rhode Island Net (RIN) meets Monday through Friday at 1900 on 3540 kc. Rhode Island traffic men handled the Christmas rush nicely although sometimes they were overworked. Outstanding is BBN's entrance into the select BPL (Brass Pounders League). This is the first time yours truly has issued a certificate for BPL since taking office. NAARO will inaugurate a two-meter net for emergency work and will drill Mondays after regular ten-meter emergency net drill. SZD is providing instructive sound movies at NAARO's regular meetings. All hams are cordially invited to view these interesting films. KXJ reports from Japan that he soon will be firing up JAGJ, so be looking for him on 14 Mc. I hope every ham in Rhode Island will devote some of his or her time to the

(Continued on page 82)

E-V MOBIL-MIKE



SELECTED for Hallicrafters-Built SCR-399

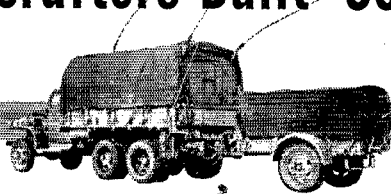

Again E-V serves in vital communications! The 600-D Dynamic Microphone (T-50) is standard equipment on the famous SCR-399. It insures high intelligibility speech transmission—helps get the message through clearly. It is an example of E-V research-engineering that, over the years, has created such fine electro-acoustic products for military and civilian use.



E-V 600-D MOBIL-MIKE

- Substantially Flat Frequency Response
- High Articulation—Less Listener Fatigue
- More Usable Power Level
- Extra Rugged—Withstands Toughest Use
- Accoustalloy Diaphragm
- Light Weight (8 oz.)

SEND FOR
CATALOG 110

Electro-Voice

404 CARROLL ST. • BUCHANAN, MICH. • Export: 13 E. 40th St., New York 16, U.S.A. Cables: Arlab

Experienced Staff and
Complete Laboratory
Facilities for Original
Research-Engineering



MICROPHONES • PHONO-PICKUPS • HI-FI SPEAKERS • SELF-TUNING TV BOOSTERS

For Civilian Defense or Amateur . . .



TR-1 Transmitter

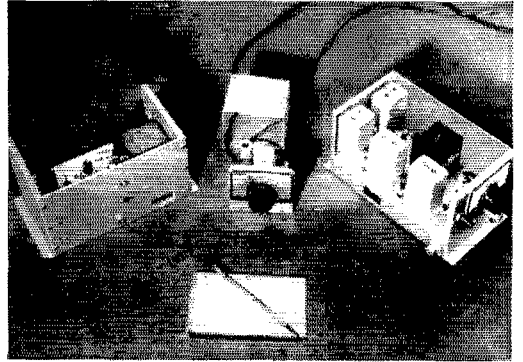

2-Mtr. Mobile Rcvr. & Xmtr.

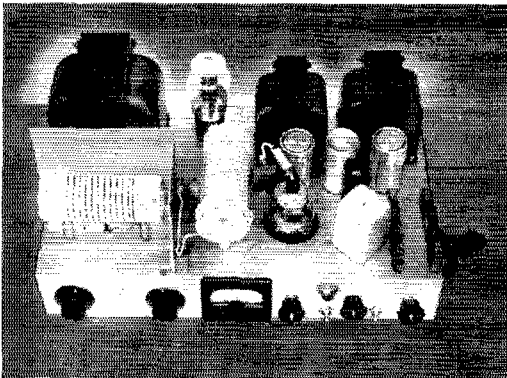

TR-75-TV Transmitter

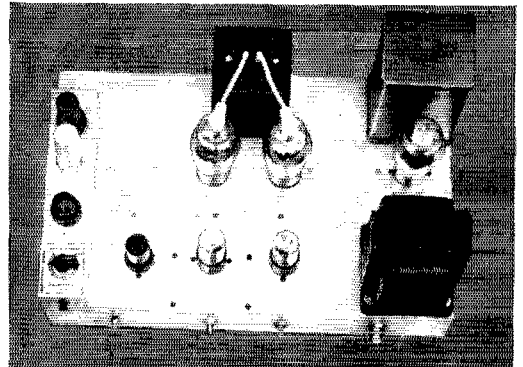

MD-100 Modulator

ELDICO'S FINE PRODUCTS CAN BE FOUND AT ALL THESE LEADING DISTRIBUTORS

Allied Radio Corp.
833 West Jackson Boulevard
Chicago 7, Illinois

Walter Ashe Radio Co.
1125 Pine Street
St. Louis 1, Missouri

Low Bonn Co.
67 South 12th St.
Minneapolis, Minn.

C & G Radio Supply
2502 Jefferson Ave.
Tacoma, Washington

Crawford Radio
King William and Hughson
Hamilton, Ontario

M. N. Duffy and Co.
2040 Grand River Ave., West
Detroit 26, Mich.

W. H. Edwards Company
94 Broadway
Providence 3, R. I.

Electronic Wholesalers
2010 14th St. N. W.
Washington 9, D. C.

Federated Purchasers, Inc.
1115 Hamilton Street
Allentown, Pa.

Federated Purchasers, Inc.
114 Hudson Street
Newark, N. J.

Federated Purchasers, Inc.
701 North Hampton Street
Easton, Pa.

Harrison Radio Corp.
12 West Broadway
New York 7, N. Y.

Harrison Radio Corp.
Jamaica Branch
172-31 Hillside Ave.
Jamaica, L. I., N. Y.

Harvey Radio Co. Inc.
103 West 43rd St.
New York 18, N. Y.

**Hatry and Young of
Springfield, Inc.**
169 Spring Street
Springfield, Mass.

**Hatry and Young of Mass.,
Inc.**
639 Essex Street
Lawrence, Mass.

**Hatry and Young of
New London, Inc.**
428 Bank Street
New London, Conn.

Henry Radio Stores
211 North Main St.
Butler 1, Mo.

Henry Radio Stores
11240 West Olympic Blvd.
Los Angeles 25, Calif.

Radio Amateur Center
Hillsboro Street
Raleigh, N. C.

Radio Equipment Co.
821 West 21st St.
Norfolk 10, Va.

Radio Parts Co., Inc.
538 West State Street
Milwaukee 3, Wis.

Radio Products Sales Co.
1214 1st Ave.
Seattle, Wash.

Radio Products Sales Co.
1237 16th St.
Denver, Colorado

The Radio Shack Corp.
167 Washington Street
Boston, Mass.

World Radio Labs., Inc.
744 West Broadway
Council Bluffs, Iowa

**ELDICO'S
CATALOG 51
AVAILABLE FREE
ON REQUEST
AT YOUR FAVORITE
DISTRIBUTOR**

ELDICO OF NEW YORK • DOUGLSTON, L. I., N. Y.

Greenwich, Conn., CD goes Eldico 100%



Signing the "Greenwich Plan." From left to right: Don Merten, W2UOL; C. E. McDougall, W1OTU; C. A. Pirro, W1AJ0; Henry N. Flynt, Director of Civil Defense in Greenwich, Conn. Equipment shown is Eldico's 2-meter receiver, power supply, and transmitter.

Eldico's business has been equipment designed to make amateur radio more enjoyable. Now — in a major expansion — Eldico is offering complete radio installations specifically designed for Civil Defense. Whether your requirement is a single mobile installation, or an entire CD system, Eldico is prepared to serve you.

A typical Eldico project is the complete Greenwich, Conn., CD radio installation. In that town, amateurs formed the Greenwich Amateur Radio

Club to serve the local Civil Defense organization. Under the able leadership of Charles A. Pirro, Jr., W1AJ0, CD Chief of Communications, and C. E. McDougall, W1OTU, radio aide, an Eldico mobile network is already operating in conjunction with other services. Greenwich has 11 Eldico 2-Meter crystal controlled mobile transmitters and receivers, and an Eldico master control station.

Whether the "Greenwich Plan" will be your community approach to CD, or some plan completely different, Eldico's complete line of equipment can provide a firm foundation for building. Remember that Eldico is the first organization anywhere to offer amateurs a fully integrated civil defense communications system, with or without engineering installation and maintenance. For full details wire, phone or write Donald Merten, President of Eldico, W2UOL. Orders will be filled on an "as received" basis unless defense order priorities are extended.

Signals of Distinction

WRITE
W2UOL
FOR FREE —
**TVI CAN BE
CURED.**

ELDICO
OF NEW YORK
INCORPORATED

1 DOUGLASTON PARKWAY • DOUGLASTON, L. I., NEW YORK • BAyside 9-8686

2 Extra Features*

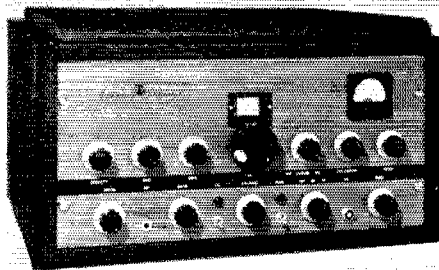

OF THE

JOHNSON VIKING 1

TRANSMITTER KIT

There are two things in which a Ham takes especial pride.

One is his signal. He wants it to be distinguished by a crisp, clean CW note and a well modulated, natural phone signal.

Another is the appearance of his rig. He likes to note the glow of approval — and sometimes envy — in the eyes of visitors to his shack as they see the neat, "professional looking" equipment.

These, then, are two Bonus Features for the Ham with the JOHNSON VIKING 1.

*1. Pride in Performance! 2. Pride of Possession!

For here is a rig that not only looks professional, but operates with that smooth convenience and dependable power that is usually found in only the most carefully designed and engineered commercial transmitters.

Here are other Outstanding Features of the VIKING 1:

- 115 Watts CW, 100 Watts AM Phone OUTPUT!
- Front Panel Bandswitching. No plug-in coils!
- Ten Position Xtal Switch For Rapid QSY!
- Provision For Optional VFO Input!
- Pi-section Output Stage. Loads many antennas without external couplers!
- Continuous Tuning Final Tank!
- All Stages Metered!
- Two Complete Power Supplies!
- 160, 80, 40, 20, 15 and 11-10 Meter Operation!

The VIKING 1 is furnished unassembled but complete in every detail including wiring harness, drilled and punched chassis and panel and all parts. Instructions are carefully detailed, profusely illustrated. Novice or old-timer alike can assemble and get brilliant performance from the VIKING 1.

Tubes required — RF tubes: 6AU6, 6AQ5, 4D32. AF tubes: 6AU6, 6AU6, PP807's. Rectifiers: 6AL5, 5Z4, parallel 5R4's.

Why not be proud of your rig? Own a "commercial in appearance", "commercial in performance" VIKING 1.

VIKING 1 Transmitter Kit

(less tubes, crystals, mike & key), Amateur Net Only \$209.50



E. F. JOHNSON CO., WASECA, MINN.

(Continued from page 78)

emergency program. If you wish to do so but don't know where to start, contact SEC Getter or myself and we will give you details on activities in your locality. Traffic: WIBBN 512, BTW 58, CPV 44, HRC 2.

VERMONT — SCM, Burtis W. Dean, WINLO — KJG is busy with CD communications for the State set-up. LYD has been appointed OBS. The following appointments have been endorsed: EC — ARA, ELJ, RNA, and SPK. OBS — SPK. ORS — ELJ. MEP is building all-band grid-dip oscillator. RHQ and TBC had their cars damaged in auto accidents. PTB's radio shop and ham shack were destroyed by fire. QHD is on 144 Mc. with 522. EKU is busy with TV. QQN is chasing TVI. QEG has Lyco 28.5-Mc. mobile rig. BJP, LTW, QNM, RNA, and SVT have signed up with CAP. HLL is back on the air after a long absence. FN reports into the VTN on 3740 kc. Now that we have the frequencies for the CD, Vermont hams will be busier than ever building emergency equipment and mobile rigs and participating in drills. Be sure to monitor WIAW for the latest dope on ham activities. Traffic: W1KRV 255, RNA 84, AVP 72, IT 43, AXN 35, ELJ 20, BJP 10, NLO 9, KJG 2.

NORTHWESTERN DIVISION

IDAHO — SCM, Alan K. Ross, W7IWU — Twin Falls: LNH is a busy gal these days; she is on the Gem Net and the PAN Net, keeps schedules with VETXA, W7ESJ, and W7ZU, and made BPL this month. Skip makes the Gem Net tough these nights. The FARM Net is doing nicely at 7 p.m. Burley: HAH has applied for AREC membership, as has CUG, at Subnite. Rupert: EC IEY has NGU and GFW as assistants. ENC, Weiser, and MXM, Idaho Falls, are proud recipients of jr. operators. Now that we have our frequencies for Civil Defense, we can plan or change our emergency gear accordingly. Watch QST for complete information. How about a 160-meter Idaho QSO Party? Let's set March 18th (Sunday) — all day and evening. Get on 160 and see how many of your friends, old and new, you can work. Would also appreciate letters from all who intend to be on. Traffic: W7NH 520, EMT 55, DMZ 42, FIZ 30, IWU 22.

MONTANA — SCM, Edward G. Brown, W7KGIJ — The North Montana Radio Club entertained 18 members of the Lethbridge Amateur Radio Club at its meeting Dec. 17th. The Lethbridge Club held Civil Defense meeting Jan. 13th and invited members of the NMRC to attend. Speakers from Calgary and Medicine Hat were there and plans for a Civil Defense set-up between Lethbridge and the northern part of Montana were discussed. CVQ reports NJO, BFW, GCV, ONI, IWI, CVQ, and LXX are active on the 160-meter 'phone net. MHQ has three-element beam on 50-ft. pole. IXL, NKE, and OIQ are on 144 Mc. OIQ, newly-appointed activities manager of the Gallatin Amateur Radio Club, reports that MHQ, ED, NKE, IKL, MKH, OIQ, and ODK are active on 28 Mc. NUS is active on 3.5- and 7-Mc. c.w. IXL, NKE, MKH, and ODK are students at Montana State College. KGF and LBK are interested in traffic work. LCM is having rig troubles. All Montana stations are invited to check into the state nets regardless of code speed. The slower operators are more than welcome. Let's have more action in emergency work and some reports to your SEC. Traffic: W7KGIJ 945, CT 706, KGF 279, LBK 184, CVQ 61, LCM 44, BNU 26.

OREGON — SCM, J. E. Roden, W7MIQ — PAB reports the following new officers of the Rogue Valley Club of Medford: LYY, pres.; OVO, vice-pres.; PAB, secy.; NOL, treas.; OFS, tech. advisor. MYI is teaching his mother the code and fundamentals. EJ is new AREC member and is located where hams are few and far between. LVN is contemplating 100-watt mobile. OIH is waiting for his Class B. OVO is new ORS. NOJ worked a ZL4 on 3.6 Mc. ITJ is a newly-licensed amateur in Oakridge. BSY is awaiting news from the FCC on his Class A ticket. BSY reports the loss of his 10-20-meter beam in a big wind storm. LZQ is going to Alaska with GAA pub. IGI now has new four-element 28-Mc. beam. FJY received Class A license. SO is keeping Albany-Salem 144-Mc. circuit hot. VW has a new tower with a Plumber's Delight. KQD has entered the Armed Forces. BSY is helping to set up C.D. plans for the Oakridge Area. BUS and NVE are busy with MARS activities and traffic-handling. HHH is new EC for Bend Area, ably assisted by her OM, GNJ. LWV is now residing in Grants Pass Area. ESJ lost his antenna recently but is back on with a louder signal than usual. AJN is assisting ESJ to build up OSN into a smooth-working Slow Speed Net. AIZ keeps busy helping to get Veteran Hospital traffic started and rolling. Traffic: W7AIZ 445, IE 331, HDN 239, FFJ 216, KP8 183, ESJ 172, HLF 153, GXO 113, IIV 107, AJN 99, OHX 78, MQ 67, GNJ 47, BSY 37, JVO 30, LVN 27, KTG 23, NGG 15, GUR 14, NOJ 13, FY 12, BDN 6, OBM 6.

WASHINGTON — SCM, Laurence Sebring, W7CZY — SEC: KAA. RM: JJK. IOQ handles overseas traffic only. JJK built a foot-locker-size portable to use when he receives his "greetings." ZU has been acting as NCS on RN7 part of the time. FLX has schedule with KCU and JZR. FRU is librarian at two libraries, which limits his operating time. JZR says that skip is wrecking things on 3.5 Mc. BX put up

(Continued on page 84)

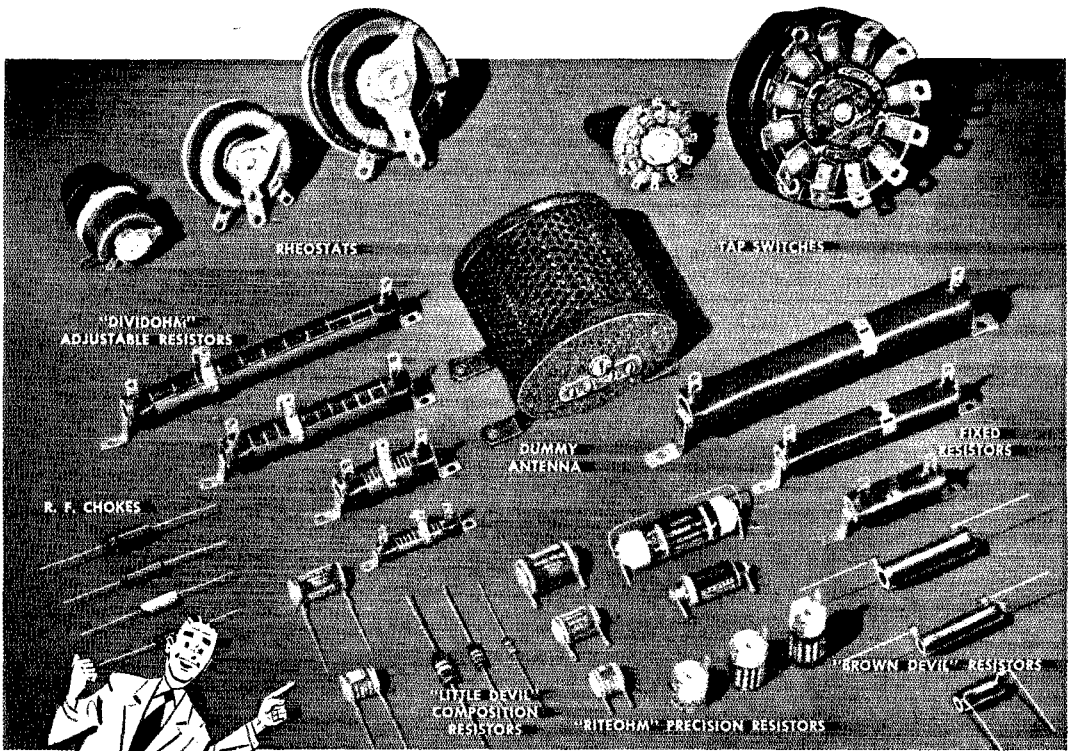

You Can't Beat **OHMITE** for **DEPENDABLE PERFORMANCE!**



When you see the Ohmite name on an electrical component, you can depend upon that part to give long, trouble-free service.

Every Ohmite product is designed and constructed to stand up under the most severe service conditions . . . to give extra performance . . . to withstand the effects of shock, vibration, temperature extremes, altitude, and humidity. And it is this extra performance Ohmite products give that so often makes the difference between satisfactory and unsatisfactory operation.

The Ohmite line includes ten sizes of close-control rheostats ranging from 25 to 1000 watts . . . fixed and adjustable wire-wound vitreous-enameled resistors from 5 to 200 watts . . . composition resistors, precision resistors, non-inductive resistors, tap switches, and R. F. and power line chokes . . . all in a wide selection of types and sizes. When you need dependable electrical components, play safe and specify Ohmite!

OHMITE MANUFACTURING CO.
4865 Flournoy St. Chicago 44, Ill.



Be Right with

**WRITE FOR
STOCK CATALOG**

OHMITE®

RHEOSTATS • RESISTORS • TAP SWITCHES • CHOKES • ATTENUATORS



**FIELD DAY...
EVERY DAY!**

Precision Series 85

AC-DC Circuit Tester

(20,000 Ohms per Volt)

**will help YOU to
STAY on the AIR**

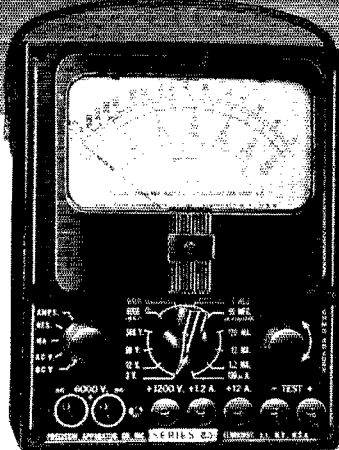

Self-Contained to

6000 volts, 60 Megohms, 12 Amperes, +70DB

A compact, laboratory type, high sensitivity test set indispensable for test and maintenance of modern amateur communications equipment.

20,000 Ohms per Volt D.C. — 1000 Ohms per Volt A.C.

VOLTAGE RANGES: 0-3-12-60-300-1200-6000 A.C. & D.C.

CURRENT RANGES: 0-120 microamps; 0-1.2-12-120-MA;
0-1.2-12 Amps D.C.

RESISTANCE RANGES: 0-6000-600K-6 Meg-60 Megohms.

DECIBEL RANGES: From -26 to +70DB.

Complete with batteries and test leads..... **\$3875**

PLUS superior physical features:

- ★ 4 1/2", 50 microamps, Easy Reading Meter.
- ★ Heavy duty bakelite case 5 1/2 x 7 1/8 x 3".
- ★ Deep etched, anodized aluminum panel.
- ★ Recessed 6000 volt safety jacks.
- ★ Only two pin jacks for all standard ranges.

LC-1 LEATHER CARRYING CASE—Custom designed, top-grain cowhide case with tool and test lead compartment. \$8.75 See Series 85 and other famous "Precision" instruments, on display at leading radio parts and ham equipment distributors. Write for latest catalog.

Precision Apparatus Co., Inc.

92-27 Horace Harding Blvd., Elmhurst 13, N. Y.

Export: 458 B'way, N. Y. City, U.S.A. Cables: MORHANEX
In Canada: Atlas Radio Corp. Ltd., Toronto, Ontario

a 10-meter vertical 40 feet high to help emergency coverage in the Tri-City Area. HWK checks in on WSN when TV service work permits. KCU has schedules with FTS, FTX, JZR, 4NOX, and 3NEH. AFS is on the air week ends only. CWN moved to a new location and likes it fine. LAN gives code practice on 3510 kc. from 1800 to 1845 EST on Tuesday, Thursday, and Sunday, starting at 4 w.p.m. and progressing to about 13 w.p.m. OZX is proud possessor of new ticket in Mt. Vernon. GAT has been appointed Assistant EC for Mt. Vernon. KWC, LVO, ILLR, MBY, MVR, LXP, KCZ, JVE, OQY, BLF, and KVA are all mobile in the Bellingham Area. LVB has big rig on the air at Sedro Woolley. KYD and NWP moved to Seattle. OZT is a new station at Walla Walla. GZK is the new president of the Walla Walla Club, with FMJ as vice-president, EMP as secretary-treasurer, LJK and GVC on the board of directors. The new clubhouse is nearing completion. LFA lives at Bothell and goes to school at the U. of W. Traffic: (Dec.) W7IOQ 2827, CZY 904, JJK 517, ZU 149, FIX 135, FRU 96, JZR 91, BX 82, HWK 82, KCU 77, AFS 41, CWN 17, DRA 17, ETO 11, EAU 7, KAA 6, DDQ 2. (Nov.) W7JJK 198.

PACIFIC DIVISION

HAWAII—SCM, John R. Sanders, KH6RU—Your new SCM appreciates deeply the honor you have bestowed and hopes to serve you to the best of his ability. Many thanks to the retiring SCM, HJ, whose beautifully-kept files made taking over the job so much the easier! New officers of the HARC are ABI, pres.; GG, vice-pres.; GN, secy.; AN, treas.; EZ, CM, and WU, directors. The Honolulu Mobile Club attempted a test case when QO got a ticket for operating in motion but the Prosecuting Attorney refused to prosecute and the case was thrown out of court. The Mobile Club drills Tuesdays at 7:30 p.m. on 28.5 Mc. IJ writes a good ham column for the Saturday Star Bulletin and has long done sterling duty as Asst. SCM. AAA has departed for duty at San Diego. ADY schedules Regional Net #6 with a TCS on 3.5 Mc., a good trick with present poor conditions. VE has 100 watts on 14 Mc. Traffic: KH6ADY 74, VE 6.

NEVADA—SCM, Carroll W. Short, jr. W7BVZ—SEC, JU, ECs: HJ, KOA, KTH, MBQ, JVV, JVO, and ZT, RM: PST, OPS: JUO, NWU had two TSOs with UA6FJ and received two QSLs; this with low power on 7 Mc. JU is working out PB with 60-watt mobile on 3.85 Mc. EEF is building a new rig. MEQ has new 25-watt rig on 28 Mc. KOH is expected back on 28 Mc. OBW is building a new 829-B final. OXX and ZT work American Legion Net, 3975 kc., each night at 7 PST and handle considerable traffic. VR has 100-ft. tower with three-element and stacked four-element 10 beams. OLF has 100 watts and three-element beam on 28 Mc. KOA and QYK are working on controlled-carrier rigs. JLV is QRL police radio and CAP. TFF has ideas about long wives and rhombics because of the open desert behind his new QTH. MBQ wants contacts on 160 meters. Contact your SCM mornings on 7225 kc. Traffic: W7JU 7, BVZ 2.

SANTA CLARA VALLEY—SCM, Roy I. Cousin, W6LZL—SEC: UTV, ECs: CLF, CER, QIE, IXJ, NOE, FTZ, FTG. Top news in the section is Civil Defense. A meeting recently was held by San Jose Area hams to decide on the type of equipment to be used for Civil Defense and emergency work. 144 Mc. definitely was decided upon; also the equipment will be designed so all units will be interchangeable to avoid confusion in case of need of replacement. Spares units will be on hand in case of failures. The South San Francisco gang is holding drills on 144 Mc. on the CD net with mobiles and fixed stations. CLF has been appointed EC for the Los Gatos Area. PBV is back on the air after three years overseas, having been VQ3HGE in Africa and MP4BAL, Bahrein Island. TVI still is giving the gang a bad time, but progress is being made toward its elimination. WOZ received a notification that a complaint was made against his station; also PBV and BPT are working for continued friendship with their neighbors. MMG is QRL except for a little mobiling. QIE is holding code and theory classes two nights a week at his ham shack. The North Peninsula Electronics Club meets the first and third Fridays of each month at Administration Bldg., Lindenville Housing Unit, South San Francisco. New officers for 1951 are ZXS, pres.; GXF, vice-pres.; VTR, secy.-treas. ZRJ is back on the air operating 3.5- and 7-Mc. c.w.; he also is active on RN6. Traffic: W6UTV 710, HC 586, BPT 501, PBV 42, ZRJ 30.

EAST BAY—SCM, Horace R. Greer, W6TI—Asst. SCM, Charles P. Henry, 6EJA. SEC: OBJ. ECs: AKB, EHS, NNS, IT, IDY, QDE, LMZ, OJW, RRH reports that his power transformer went out in the middle of the 10-meter WAS Contest and he had to put 1000 volts on 829B. JZ reports that he was QRL the first two weeks in December but still he reported a total of 1032 messages for the month. ITH is QRL press duties. WGM has new SK-71 receiver. BPC is going great guns on 14 Mc. PAK is back in town again. JFL has mobile rig in operation. The December meeting of the OCRC was held in San Francisco. MIZ was elected president for the first six months of 1951, with HC, vice-president, and ZZT, secretary. ZXK has new jr. operator. CML says c.w. is not a dead language; it really puts

(Continued on page 86)

ARE YOU QUALITY-CONSCIOUS?

New Centralab parts give you the advantages of Centralab leadership in electronic component research

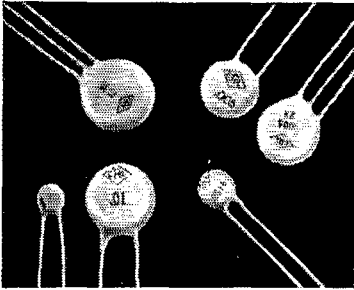

NEW! Centralab's new ceramic Hi-Kap capacitor line gives you discs and plates up to and including .1 mfd — tops in ceramics — your most permanent type capacitors.

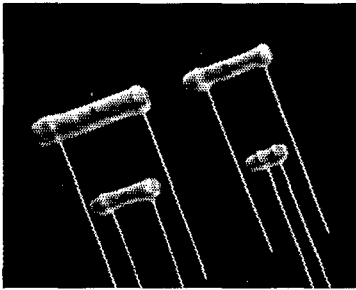

NEW! New BC Hi-Kap ceramic tubulars are now available in 48 different values. Best for r.f. by-pass and audio-coupling applications. For temperature compensating capacitors — ask for CRL's TC's.

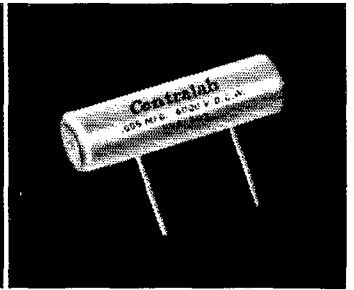

NEW! The best in ceramic stability, permanence and high-temperature characteristics in tubular form with ample external insulation. Pictured: CRL Cat. No. TV6-502 rated at .005 mfd. — 6000 V DC.

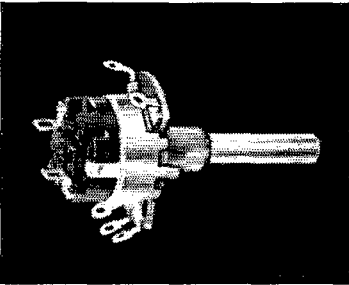

NEW! Centralab's new Blue Shaft Volume Controls are a complete line of all generally required sizes . . . plain and switch types. They're factory-assembled and tested . . . ready to install.

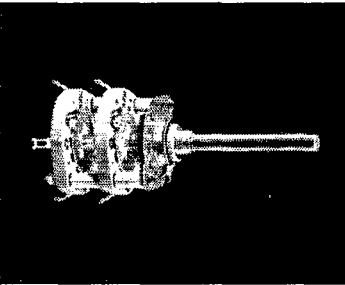

NEW! The famous CRL Ham Switch has a new look! It has heavier Steatite insulators — smoother action. You can't find a huskier amateur switch with a longer life . . . it's high quality at low cost.

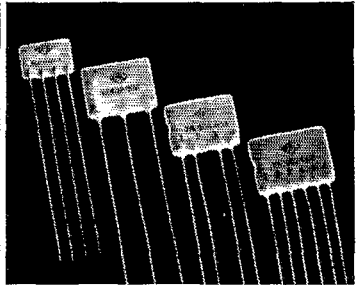

NEW! Now you can get CRL's famous Printed Electronic Circuits — everything from single valve capacitors and resistor plates to complete 3-stage speech amplifiers. Ask your local CRL distributor.

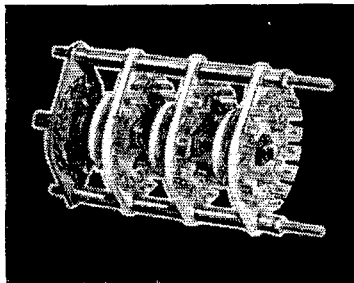

POWER SWITCHES are specially designed for transmitters, power supply converters and other applications. Efficient performance up to 20 megacycles.

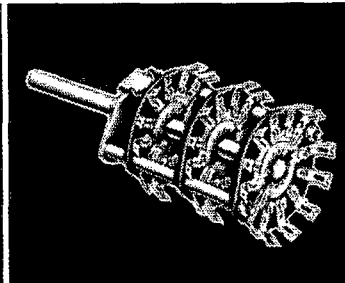

ROTARY BAND SWITCH is used primarily for band change and general tap switch applications. Made with Steatite or phenolic insulation.

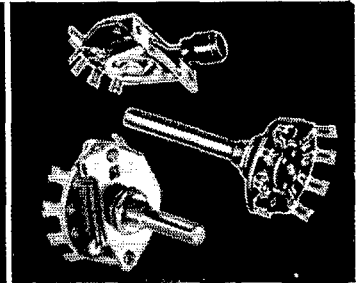

LEVER, SPRING RETURN, TONE SWITCHES. See your Centralab distributor for complete details on these switches — and all quality CRL parts.



The **NEW** products are listed in Catalog 27. Just tell us you are a radio amateur — it will be mailed at once.

Centralab

Division of Globe-Union Inc., Milwaukee

AMPHENOL

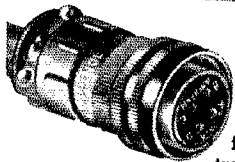

AN CONNECTORS

for power, signal and control circuits in aircraft and electronic equipment. AMPHENOL, by far the largest supplier of quality connectors, leads with the broadest availability listing of AN Connectors for all MIL-C-5015 shell styles and applications. AMPHENOL'S leading position is assured by a continuing development and tooling program.

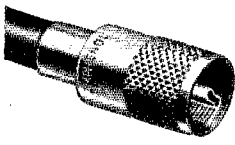

RF CONNECTORS

for instruments, test equipment and all types of industrial applications. Extensive research and manufacturing facilities have made AMPHENOL RF Connectors outstanding in design. They have longer leakage paths, lower loss resulting in outstanding performance.

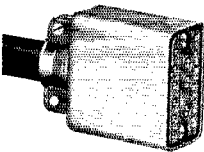

RACK and PANEL CONNECTORS

AMPHENOL Rack and Panel Connectors have eyelets inserted in the mounting holes for added strength, holes for wiring instead of the usual hooks on the male contacts, and interlocking barriers to prevent accidental shorting. Another AMPHENOL product of precision design!



AUDIO CONNECTORS

now standard for audio circuits on Signal Corps communication equipment. AMPHENOL'S superior design provides watertight lock and spring-loaded contacts which have low voltage drop and are self-cleaning.

AMERICAN PHENOLIC CORPORATION

1830 South 54th Avenue, Chicago 50, Illinois

- Send me the 48 page general CATALOG No. 74.
- Add my name to your mailing list for monthly information on currently new products and technical data . . . AMPHENOL ENGINEERING NEWS.

NAME _____

FIRM NAME _____

ADDRESS _____

CITY _____ STATE _____

traffic through. NQJ has new Collins rig. EY still is teaching two nights a week. NZG is on 3.85-Mc. mobile. The editor of SARO comes up with ten ways to kill an organization. 1. Don't go to meetings. 2. If you go, be late. 3. If it is bad weather, don't even think of going. 4. When you do attend a meeting, find fault with the president and other officers. 5. Never accept office. It is much easier to sit back and criticize. 6. If you should be appointed on a committee, don't go to the meeting. If you are not appointed, get peeved about it. 7. When your opinion is asked, reply that you have nothing to say; but after the meeting, tell everyone how things should be done. 8. Do nothing more than is absolutely necessary; but when others do the lion's share, tell everyone how the club is run by a clique. 9. Don't worry about paying your dues; wait until you receive two or three notices from the secretary. 10. Don't bother about getting new members; let the ones who do all the other work do that, too. Mission Trail officers: BPT, pres.; JZU, vice-pres.; UJL, treas.; RRH, secy.; and WGO, EC. KZF is Civil Defense Coördinator. The new officers of the Oakland Radio Club are as follows: AKB, pres.; VDR, vice-pres.; AXW, treas.; GDM, secy.; BF, board member at large; ZZT, EC; CCY, agt. at arms; AWU, chief; VMN, public relations. LDD and PB are working DX on 3.5- and 7-Mc. c.w. TVI really has the East Bay gang down in the dumps. Many seem to have lost interest in ham radio of late, but, gang, ham radio needs you and you need ham radio. Traffic: W6JZ 1032, YDI 45, RRH 35, IVD 2, TI 1.

SAN FRANCISCO — SCM, R. F. Czeikowitz, W6ATO — Phone: JU 7-5561. SEC: 6NL. Phone: PL 5-6457. *San Francisco Area:* EC: BYS. Again congratulations are due SWP for making BPL, handling traffic with Mountain C.W. and RN6 Nets. HJP has been assigned to the Air Inspector at Selfridge Air Force Base, Mich. The San Francisco Emergency Corps, under BYS, has both 28-Mc. f.m. and a.m. nets in operation in addition to the 144-Mc. net. The new 144-Mc. rigs are going into operation, with approximately 30 on the assembly line. The S.F. Radio Club held its annual Christmas Party. NL still works nights. RBQ is shielding "Old Betsy" with bronze screen. GGC, with his projector and screen, continues to provide far more than his share of entertainment for the SFRC. The officers of the SFRC were reelected for another term. The SFRC meets the 4th Friday at 1041 Taraval St. The HAMS Club meets the 2nd Friday at the local Red Cross Bldg., 1625 Van Ness Ave. *Marin Area:* EC: KNZ. Congratulations to the new president of the Marin Radio Amateurs Club, SG. The new program chairman is MRZ, while KYQ fills the prize committee spot. FIJ went to Oregon for his Christmas vacation. Join the Emergency Corps — phone KNZ. The MARC meets the second Friday in the Engineering Lecture Room, Marin College, Kentfield. *Sonoma Area:* EC: IEN. By the time this is being read, the Sonoma County Radio Amateurs Club will be in possession of a fine large electric coffee urn, acquired through the sale of vanilla by the members. FWD has received Class A license. He is moving to the Southland. The Club held a well-attended affair at Feters Hot Springs. DTV is working 144-Mc. mobile, while FWD worked Washington, D. C., with a 10-watt 3.85-Mc. mobile. WOR is fighting TVI, and has a 522 working on 144 Mc., as has WQE. In addition, WQE uses a BC-611 on 3.85 Mc. The Sonoma County Radio Amateurs Club meets the first Wednesday in the Tap Room of the Grace Bros. Brewery on Second St., west of the freeway in Santa Rosa. *Eureka Area:* EC: SLX. Our greetings and congratulations to the newly-elected officers of the Humboldt County Radio Amateurs Club: CWR, pres.; BJO, vice-pres.; Kelton Steele, secy.; BWV, treas.; LE and BME, directors. Social activities are the responsibility of FYY and YUH. The Christmas Party was well attended, and among those present were W6LE, KL7KE, W6FYY/HLI, DQA, WYP W6JSD/6, W6FYX, AEY, ZZK, YUH, EQQ, QBC, NAO, J8Y, BJO, BBN, FBK, SLX, YDR, BWV, BSM, BME, CWR, ZSE, ZHE, and QCS. The HARC meets the 2nd and 4th Fridays in the YMCA rooms, rear of Municipal Auditorium, entrance on "E" St., Eureka. *Guam Area:* Again KG6DI and KG6FAA handled a tremendous amount of traffic: KG6DI 3489 and KG6FAA 2393. Clark Cox also forwards the report of JA2MB, who in November handled 1334. KG6FAA schedules W5DAD for 'phone patches 2200 to 0000 GMT on 28.67 Mc., and W6TQD records traffic 0000 GMT on 14.09 Mc. From 0300 to 0700 GMT QRL schedules with Okinawa and Japan. Chief Operator T/Sgt. Parrish, in charge of amateur radio station JA3AC, Nagoya, Japan, is very active, and handling a large amount of traffic. Traffic: (Dec.) KG6DI 3489, KG6FAA 2393, JA3AC 995, JA2KW 842, JA2HQ 717, W6SWP 364, JCG 21, ATO 8. (Nov.) JA2MB 1334.

SACRAMENTO VALLEY — SCM, Ronald G. Martin, W6ZF — Asst. SCMs: Northern Area, 6YNM; Central Area, 6CKV; Southern Area, 6SUP. SEC: KME. ECs: Met. Sacramento, AUO; Walnut Grove, AYZ; Dunsmuir, JDN; Mount Shasta City, EWG; Paradise (Chico Area), HBM; Roseville, GHP. RM: PIV. OBS: AF, BTY, PAM. ZYV. QES: PIV, GHE. OOs: ZYV, YNM, BTY, GDO, YV. OPS: JDN. Nets: Sac. Emergency (city) AUO NCS. Sac. Valley Net, ZYV NCS. Mother Lode, UNT NCS. Tall Pine, 29.224 Mc., Wed. 8 P.M., YNM NCS. *Northern Area:*

(Continued on page 88)

Of **SPECIAL** interest to amateurs with
any of these mercury rectifier tube problems:

- ★ SHORT LIFE
- ★ HIGH VOLTAGE ARCING
- ★ LOOSE BASES AND CAPS
- ★ OVERHEATING
- ★ EXCESSIVE MERCURY, ETC. . . .

see it at
Booths 10, 11, 12
at the March
IRE Show

Another **NEW** Advancement
in Tube Design

BY **AMPEREX**

the 866-AX..an engineer's rectifier

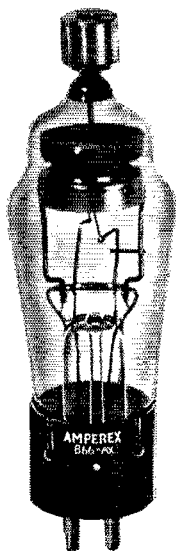

Amateur Net
\$2²⁵

Available at
better radio parts
distributors or direct.

Common mercury rectifier tube troubles are reduced to negligible factors with this new and **STURDIER** type, the Amperex 866-AX.

Note that the plate cap is **THREADED**, enabling accurate adjustment to open-end or ring type lug connectors.

This same plate cap, when tightened, fits the standard metal or ceramic type connectors.

The 4-pin UX phenolic base is amply ventilated, **REDUCING TEMPERATURE** at the bottom of the bulb.

The new Amperex 866-AX is directly interchangeable with all conventional 866 tubes.

Re-tube with AMPEREX

for steady — dependable power...and more of it!



AMPEREX ELECTRONIC CORP.

25 WASHINGTON STREET, BROOKLYN 1, N. Y.

In Canada and Newfoundland: Canadian Radio Mfgs. Ltd.
11-19 Brentcliffe Road, Leaside, Toronto, Ontario, Canada
Cable: "AMPRONICS"

CHICAGO

Transformers Designed Expressly

For Today's Amateur Circuits

PLATE TRANSFORMERS

Pri. 115/230 Volts, 50/60 Cycles. Here they are—the top-performing plate transformers and matching filter reactors. They're conservatively designed, with ample insulation throughout. They operate with a temperature rise of 40° to 50°C at full load, 60 cycles, under CCS duty. Under ICAS conditions, the duty cycle is 15 minutes time on and 15 minutes time off, with same temperature rise applying as under CCS duty.

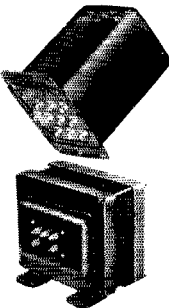

Catalog No.	Max. Pri.	Secondary A-C Load Volts	D-C Volts after filter	D-C Ma. CCS	D-C Ma. ICAS
P-45	185	675-0-675	400	250	325
		575-0-575	500		
P-67	250	900-0-900	750	250	325
		735-0-735	600		
P-107	310	1150-0-1150	1000	250	350
		870-0-870	750		
P-1240	360	1425-0-1425*	1250	200	260
		600-0-600	400		
P-1512	550	1710-0-1710	1500	300	425
		1430-0-1430	1250		
P-2520	915	2820-0-2820	2500	300	425
		2260-0-2260	2000		
P-3025	1850	3450-0-3450	3000	500	700
		2850-0-2850	2500		

*Both secondaries may be rectified simultaneously

FILTER REACTORS

Catalog No.	Inductance in Henries	Max. D-C Ma.	D-C Resistance, Ohms	Insulation Volts RMS
R-67	6	700	35	10,000
R-105	10	500	40	9,000
R-65	6	500	35	9,000
R-103	10	300	40	7,500
R-63	6	300	35	7,500

SEND FOR FREE CATALOG TODAY!



You'll want the full details on CHICAGO'S New Equipment Line—the famous Sealed-in-Steel line that offers advanced engineering design to fit today's Amateur circuits. Full listings of Plate, Filter Reactor, Filament, Audio, Modulation units. Write for your FREE catalog today—or get a copy from your distributor.

WRITE NOW!

**CHICAGO Transformers are
the Choice of Leading Amateurs**



CHICAGO TRANSFORMER

DIVISION OF ESSEX WIRE CORPORATION

3501 ADDISON STREET • CHICAGO 18, ILLINOIS

Tall Pine Net opened officially Nov. 29th, covering Dunsuir, Mt. Shasta, McCloud, Redding, Fall River Mills, and Klamath Falls, Ore. CFU is mobile on 28 Mc. with 829B. JDN has new 32V-2. YNM is civil defense communications coordinator for Dunsuir. DARC is building new club house which also will serve as headquarters for civil defense. OMR has been busy moving Mt. Shasta Club shack to new QTH. HRF and JDN helped Santa arrive at Mt. Shasta by using mobile rigs in conjunction with local broadcast station. **Central Area:** GERC held Christmas party at WVR in Orland. GERC officers for '51 are CKV, pres.; HNL, vice-pres.; ZNU, secy.-treas. CKV worked ICO on 160 mobile all the way from San Mateo. RQL and SYN are on 160. Marysville-Yuba City awakens with DGK, ZFG, and GCM on 160. **Southern Area:** MARS conducts code and theory classes Mon., Wed., Fri., 7 to 9 p.m. GCP from Long Beach moved into the section. PIV is back on RN6. JEQ is new ANCS for SVN on 29.4 and 28.8 Mc. MYT, in spite of illness, continues as MTN Sacramento outlet. SYN and ASE are on 160. ACH returned from Korea and will be on soon. QDT reached ultimate in high-power mobile with ART-13. SARC held Christmas Party at Capitol Inn. GDE and WLI are on 10 mobile. QKJ has new Colpitts VFO. Traffic: W6VPI 83, SUP 67, JDN 45, ZF 39, MYT 37, GDO 21, YNM 19.

SAN JOAQUIN VALLEY—SCM, E. Howard Hale, W6FYM—SEC: FYM. ECs: CQI, FIP, GCS, GJO, HIP, HZE, and JPU. ORS: GJP, HU, and GRO. OPS: GRO. OBS: EXH, GRO, and OHT. OES: PSQ and UWY. OOs: FKL and GRO. Newest CD appointees are GCS as EC for Tulare County, JPU as EC for City and County of Fresno, and FKL, of Fresno, as Official Observer. Any of you fellows interested in any CD appointment, please let me hear from you. I am happy to report the San Joaquin Valley Section C.W. Net now operates Monday through Friday at 7:00 p.m. on 3525 kc., and according to the organizer, JQB, the net handled 124 messages during its first two weeks of life. JQB did a marvelous job of organization of the net but is forced to give up activities because he now is working the night shift. He has turned the net over to GJP, of Taft, who is carrying on in FB style. Anyone interested in joining the SJVN on 3525 kc., contact your SCM or GJP. BYH is with CBS at Delano and sent an FB letter of Delano gang activities. Leon states that 10 hams besides himself work for CBS and live in Delano, all within 3 blocks of each other and all active. They are ARI, BRP, BVM, EFV, GNR, FHC, HYK, IDZ, M/J, and ZEK. GJP has put up new longwire with 6 full waves on 3.5 Mc. The Taft Amateur Radio Club has a code class with 10 prospective hams participating. No report was received from Fresno, Stockton, or Bakersfield at mail time. Traffic: (Dec.) W6LRQ 155, GJP 137, FYM 9. (Nov.) W6BYH 10, EFV 6.

ROANOKE DIVISION

NORTH CAROLINA—SCM, Herman P. Jolitz, W4DCQ—SEC: ZG. PAM: DLX. RM: AKC. AKC reports N. C. c.w. net now is active on 3605 kc. Mon., Thurs., Fri. at 7 p.m. AKC, LMH, IPY, JPY, NZG, REZ, RGH, SAL, and RXI are active members. The Atlantic Net, on 1875 kc. meets Mon., Wed., and Fri. at 1900. N. C. members are LWU, N/Q, PSD, PZ, RRE, and RWL. RRH reports activity on Atlantic and Great Lakes Nets. ENQ is building s.s.e. rig. IAG has new 400-watt. SDY is a new ham in Maiden. OXG has moved to W3. The Catawba Valley Club is building a new clubhouse and has elected PHZ, pres.; EQJ, vice-pres.; ENQ, secy.; REZ, treas.; and FFW, act. mgr. SEC ZG is visiting each applicant before appointing him to the EC ranks. If interested, contact Roy. ASQ and EYN are new ECs. FUA is Red Cross Director for emergency in the Charlotte Area. JPY visited DLX and DCQ over the holidays. DCQ was host to ZC6JM for several days during Christmas. SAJ is a new ham in Charlotte. SGD, an XYL, is a new ham in Fuquay. OM PZE has a time getting to the mike now. The Mecklenburg Amateur Radio Society elected EJE, pres.; OQQ, vice-pres.; CXS, secy.; CAY, treas. We hear that CAY is in the hospital. ROJ is back home after operating Mobile Aeronautical all over South America. NYN says a three-quarter pipe will not support a Dual 10 over 20. DCQ is unable to get on until late because of work at d.c. station. Traffic: W4NZG 440, IMH 318, AKC 76, RRH 60, REZ 45, RGH 39, JPY 37, IPY 29, CVQ 13, DCQ 11, RXI 8.

SOUTH CAROLINA—SCM, Wade H. Holland, W4AZT—The Greenville Amateur Radio Club had a very successful meeting with the local Civil Defense officials in early January. BSS renewed his OES, OPS, and EC appointments. ANK makes BPL this month. NEB is back in the Air Force. CSP/3 visited with GUZ and EZF recently. KVL has moved and will be off the air until he can install new antennas. AUL has AEC appointment for the Florence Area. Civil Defense records show 68 licensed hams in Greenville, 56 in Columbia, 35 in Charleston, and 10 in Spartanburg. Traffic: W4ANK 580, AZT 31.

VIRGINIA—SCM, H. Edgar Lindater, W4FF—NAD, our hardworking and capable SEC, plans to get in touch with all Virginia hams to arouse interest and activity in emergency communications organization. There should

(Continued on page 80)

Every Radio Amateur Can Participate in This

CIVIL DEFENSE PROJECT

THE one weak spot in the Civil Defense communication project is that all plans for *advance* alerting of C-D personnel and amateur operators depend on making individual calls over the telephone. This method is so slow that bombs could drop before the *advance* calls could be completed! People who failed to answer their phones at once would not be reached at all.

TELEPHONE CALLS ARE TOO SLOW: One answer is to use radio transmission, but up to this time, no adequate system was available. Now, such a system, known as the FTB Air-Raid Alert Alarm, has been developed, tested, and proved by Frederick T. Budelman of Link Radio Corporation, one of the leading manufacturers of emergency equipment.

The FTB system can be used 1) on any police, taxi, or other communication transmitter, or 2) on any amateur transmitter. The signaling device does not interfere with normal operation. At the receiving end, a simple alarm unit actuates white, yellow, and red signal lights. This unit can be attached to any suitable set without interfering with normal speaker reception.

Of essential importance is the fact that the FTB alarm meets the basic requirement of fail-safe operation. That is, it indicates immediately any failure at the transmitter or receiver.

A JOB FOR YOU: At this late date, there is not time to produce FTB units commercially, but they can be built and installed readily by radio amateurs, both for official Civil Defense use at existing emergency communication systems, and for local amateur organizations.

Accordingly, Mr. Budelman is making the complete information on the FTB Air-Raid Alert Alarm

available to the radio fraternity through RADIO COMMUNICATION Magazine. These data illustrated with detailed photographs and diagrams, will appear as follows:

FEBRUARY: How it Works. An overall description of the system, its application to amateur, police, and other systems, and the fail-safe method of operation.

MARCH: FTB Signaling Device. How to build and install it at any transmitter.

APRIL: FTB Alarm Unit. How to build and connect it to any type of receiver.

MAY: Fixed-Frequency Receiver. For the benefit of those who want to construct special receivers, the fourth article will show how to build a miniature fixed-frequency receiver to operate the FTB alarm unit.

This information will be supplemented with reports on actual installations for Civil Defense organization.

YOUR PLAN OF ACTION: Get the technical information on the FTB system at once by ordering a subscription to RADIO COMMUNICATION Magazine. Then study the details of the equipment so you can discuss its use with your local C-D authorities and with other operators who will be interested in setting up a special local system.

You will probably find that C-D funds are available to cover the expense of the equipment.

NO TIME TO LOSE: Your February issue of RADIO COMMUNICATION Magazine will be sent *the day your order is received*, so you can get started without delay. A coupon is provided here for your convenience.

RADIO COMMUNICATION

Published by Milton B. Sleeper

Serving Management & Engineering Since 1940

Radiocom Bldg., Great Barrington, Mass.

RADIO COMMUNICATION MAGAZINE
Radiocom Building, Great Barrington, Mass.

Please enter my subscription to start with the February issue, so that I shall have Mr. Budelman's complete series on the FTB Air-Raid Alert Alarm. I enclose:

- \$3.00 for 1 year (12 issues)
 6.00 for 3 years (36 issues) SAVE \$3.00

Name.....

Address.....

.....

Foreign, add \$1.00 per year — Canada 50¢

Nearly 5000 BANDMASTERS NOW IN USE AROUND THE WORLD

By Hams, Business Organizations,
Government Depts. and
Emergency Services

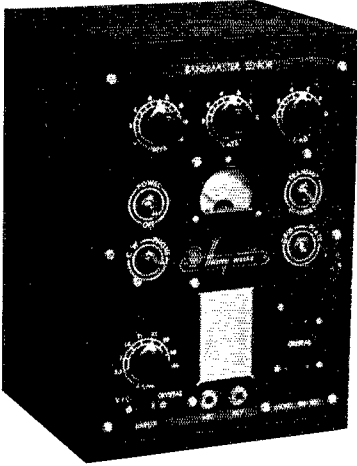

H-W BANDMASTER XMTRS
have **EVERYTHING** from
2 to 80 Meters

FOR FIXED OR MOBILE OPERATION
YOUR BANDMASTER

REMAINS MODERN BECAUSE—

It is **PROTECTED** by a continuous Technical Bulletin
Service mailed regularly to all registered owners:

AN INSURANCE POLICY

Which provides methods of adding new features to
your present **BANDMASTER** as they are developed.
In this way no **BANDMASTER** becomes obsolete or
outmoded.

3 BANDMASTER MODELS

JUNIOR	SENIOR	DELUXE
\$87.50	\$111.50	\$137.50

Simple inexpensive accessory kit converts Junior to
Senior. Built-in antenna changeover and push-to-talk
relay now available at small extra cost.

BANDMASTER POWER SUPPLIES

APS-50 for 110 A.C.	DPS-50 for 6 or 12 V.	VPS-50 6 V. Vibrator
\$39.50	6V—\$87.50 12V—\$54.50	\$29.75

SEE THEM AT YOUR SUPPLY HOUSE
Send Now for Latest CATALOG

Harvey-Wells Electronics, Inc.
SOUTHBRIDGE, MASSACHUSETTS

be a link to all parts of the State. K4AIR, Langley AFB, schedules Canal Zone on Mon., Wed., and Fri. NKV cranked up in 813 for more QSA and also is additional link between VN and VFN, giving PV and QDX needed assistance. QDX had antenna troubles; reason — the landlord chopped down supporting tree. KFC is sparking the boys' interest for 144-Mc. activities for useful work in local emergencies. PAS is on the mend in Naval Hospital, Norfolk. EMJ struggles with new gear and TVI. VE moved to Fort Belvoir as chief surgeon. CVO participated in lost plane search with K0FAN and W5QQI. PWF has a new jr. operator. LMY is attending N. C. State. OSU travelled to KG4-Land and brought back QSLs. KSW added additional crystals for 3670- and 3691-kc. QSYs. NAD's rig was augmented by Santa with a new desk, lamp, and typewriter. Military amateur activity via ARRL nets certainly has been on the increase, especially with traffic from the boys in hospitals in the Far East to their folks back home. New draftees also are finding ham radio valuable toward keeping home ties closer. Net certificates are being issued by Regional and Area Net Managers to those who deserve the honor. LRI is coordinating a going AREC gang with local area defense plans of Arlington County and surrounding areas. OWV writes from Philadelphia, where he is Navy operator, that he is Class A now and is on 3.85 Mc. each week end from home station. Traffic: W4FV 306, LAP 246, K4AIR 242, W4MWH 195, FF 145, NAD 124, QDX 104, SDK 91, MUP 71, PWX 65, KFC 64, NKV 52, KYD 38, CFV 25, JAQ 16, GR 12, CVO 10, IYL 10, PAS 7.

WEST VIRGINIA — SCM, Donald B. Morris, W8JM — WSL, through daily schedules with 7DND and 9JFF, located a blue parakeet and is training him for 28-Mc. 'phone work. BOK has submitted his cards for WAS; he finds work as MARA secretary is interfering with operations. ELX received new Vibroplex for Christmas. GBF reported into W. Va. Net running 1½ watts. DFC reports the new amateurs in Princeton are all active. AUJ made BPL again by his excellent traffic schedules. PZT, VCA, AUJ, BWD, UHK, and GBF held a small hamfest at Weston. MARA finds that a club bulletin increases interest in the club. JKN has left the v.h.f. bands for s.s.b. on 3.85-Mc. 'phone and reports success with low-power rig. NCS MCR, and the W. Va. 'Phone Net report good activity. ESQ has mobile 3.85- and 28-Mc. 'phone rig in his car. JM received a copy of Lee de Forest's new book, "Father of Radio," and recommends it to all amateurs. 3HJV is active 9 miles from Martinsburg and handles eastern traffic on the WVN, 3770 kc. EP is running tests on 420 Mc. YBQ reports success with cathode modulation. Get ready for the Annual W. Va. QSO Party. Rules in next issue. Traffic: W8AUJ 769, MCR 42, BWT 25, BWK 24, DFC 23, GBF 15, JM 10, BOK 7.

ROCKY MOUNTAIN DIVISION

COLORADO — SCM, M. W. Mitchell, W0IQZ — SEC: CJKHQ, PAM; KHQ, RMs: ZJC and LZV. ZJO makes BPL again with a grand total of 3275, the highest score yet! KHQ is new PAM. PGX was named communications chief for Bent County for the Civil Defense Organization. PNK has new mobile rig but is troubled with ignition and other car noises. IA had to move back into the house with lower power because the XYL didn't like being a radio "widdler." Bob Ainge, SWL from Great Britain, visited LZV in Colorado Springs. PSB has several in his radio club ready for ham exams. SFS has new modulator and e.o.p. PQZ is back in school at C. U. DZB is back in the Army. DD has superconverter built for mobile and plans to be on 144 Mc. with 100 watts. NIT is on 3.85 Mc. at Rocky Ford. HWH also is on 3.85-Mc. 'phone. Several hams in Denver, Laramie, and Cheyenne are holding regular schedules on 144 Mc. How about some of you Denver boys letting your SCM in on your 144-Mc. activities with a "lil ole report card" each month? That goes for any other area engaging in 144-Mc. activities in Colorado. Several have asked why there isn't more news in the Colorado section each month. The first reason is few cards are received with any news, and second, this column is limited as to the number of lines. Yours truly finally got the shields made and fastened down in the new WFO exciter. Traffic: W6ZJO 3275, IC 460, BYW 361, MOM 93, PNK 67, IA 66, LZV 36, OWP 5.

UTAH — SCM, Leonard F. Zimmerman, W7SP — The Ogden Amateur Radio Club elected the following officers for 1951: GPN, pres.; MOQ, vice-pres.; TAE, secy.-treas.; NAY and SSY, trustees. The Utah Amateur Radio Club elected RUX, pres.; NUZ, vice-pres.; and OOK, secy.-treas. UTM reports he has acquired a gasoline generator and his station is completely emergency powered in a moment's notice. OOK says she soon will be on at new QTH with new rig and lots of power. JPN rates Class I OO appointment and now is on 3.5-Mc. c.w. and 3.85-Mc. 'phone. The Bonneville 10-meter 'phone net, with NAY as NCS, reports coverage over Northern Utah and hopes to cover the entire State soon as an emergency net. Many of these stations are mobile. The old Utah c.w. net is experimenting with 144 Mc. as an alternate frequency to the regular 3.5-Mc. channel. Traffic: (Dec.) W7UTM 373, SP 11, OOK 4. (Nov.) W7UTM 148.

WYOMING — Acting SCM, A. D. Gaddis, W7HNI —

(Continued on page 92)

new!

1951 ALLIED CATALOG

COMPLETE • UP-TO-DATE

212 Value-Packed Pages



**YOUR BUYING GUIDE FOR ALL
THE NEWEST STATION GEAR . . .**



ALLIED Gives You Every Buying Advantage

- World's Largest Amateur Stocks
- A Real Break on Time Payments
- A Square Deal on Trade-Ins
- Fastest Service on All Orders
- Ham-to-Ham Personal Help

Your Buying Guide for Everything in Radio, Television and Industrial Electronics

You can depend on your *complete* ALLIED Catalog not only to meet *all* your station needs but to provide you with *everything in electronic supplies*—always at lowest prevailing prices. Your ALLIED catalog brings you the world's largest stocks of special tubes, parts, test instruments, audio equipment, recorders, radio and TV components. And ALLIED gives you the advantages of speedy delivery, expert personal help and lowest prices. Save time, effort and money—use the *only complete source* for all your electronic supply needs—dependable ALLIED RADIO.

ALLIED RADIO

833 W. Jackson Blvd., Chicago 7, Illinois

Everything for the Ham

FREE

**Send for
ALLIED'S
NEW 1951
CATALOG
No. 126**

Keep it handy



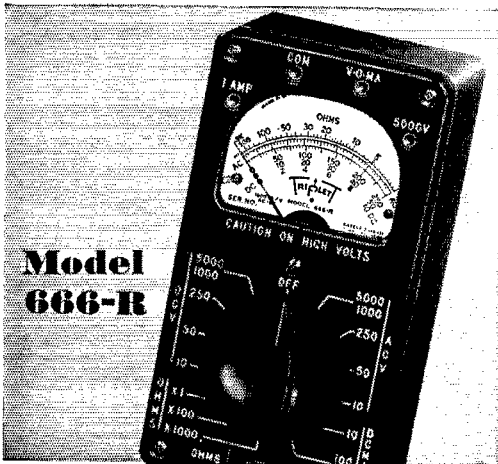

**Model
666-R**

A Basic Tool

POCKET-SIZE VOLT-OHM-MIL-AMMETER With Self-Contained Resistance Ranges to 3 Megohms.

Note the wide ranges of this compact design. Note controls, flush with panel. Enclosed selector switch keeps dirt out, retains contact alignment permanently. Resistors, shunts, rectifiers housed in molded base integral with switch; no chance for shorts. Resistors are precision film or wire-wound types, each in its own compartment. Inside view shows details. Batteries easily replaced—positive grip coil assures permanent contact.

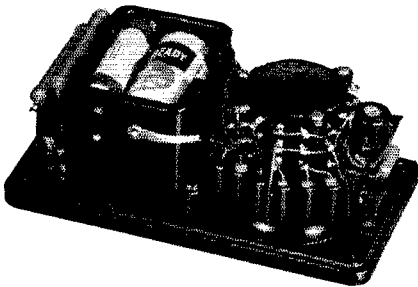

Only \$26.50—at your distributor

FOR THE MAN WHO TAKES PRIDE IN HIS WORK

Triplet

TRIPLITT ELECTRICAL INSTRUMENT CO., BLUFFTON, OHIO, U. S. A.

In Canada: Triplet Instruments of Canada, Georgetown, Ontario

RM, KUB, and HLA, of Cheyenne, are working with off-center-fed half-wave antenna using 300-ohm feed line. HDS is back from Clinic. GOH is on the air from his new QTH doing FB. AEC still is pounding the brass. ATJ is on 160-meter phone with nice signal. GS is chasing DX on the low end of 3.5 Mc. — working the world. MWS is reporting consistently on the Pony Express Net. NVX is waiting to tangle with FCC exam. FLO is having REA QRN. GSQ is back on the air on 14 and 28 Mc. AMU is working CAP and CARS. HX and AXG are keeping Basin on the air. CZG and JXJ are working overtime since JDB and KFY have left Laramie. JRG and HNI are preparing for 144-Mc. test. Traffic: W7HNI 12, JRG 10, GS 6, FLO 4, HLA 4, AEC 2, MWS 2, NVX 2.

SOUTHEASTERN DIVISION

ALABAMA — Acting SCM, Percy Sexton, W4HFL — ALEN is new SEC for Alabama. Anyone interested in emergency net should contact him. The Mobile Club has elected new officers for 1951. They are ISD, pres.; HFP, vice-pres.; LCK, secy.-treas. MI is building new shack at his new QTH, Cottondale. IMK is radio officer aboard *SS Conico Denver*. GOP has new mobile rig on 3.85 Mc. PZY now is 5SGL of Mississippi City, Miss. 5OZV now is 4RRZ of Mobile. AENB, c.w. net, still is active but needs new members. Those interested in AENB may obtain information from KIX, Montgomery. Recent additions to AENB are NQH, OPH, and RYY. New members of AENP are NLB, Dothan, and 9JZL/4, Mobile. OKJ is EC for Blount County. KCQ is building kw. rig for 144 Mc. OKJ is back from the Army and is expected to be back on 3.85 kc. OBV is getting mobile rig ready for 3.85 and 28 Mc. All future reports should be sent to your new SCM, LEN, at 818 Maplewood Avenue, Anniston, Ala. Let's all help LEN in every way possible to make the Alabama section one of the most outstanding during the next two years. Traffic: W4MVM 217, KIX 159, GJW 76, AENP 74, W4BFM 33, OAO 33, LEN 28, HFP 14.

EASTERN FLORIDA — SCM, John W. Hollister, W4FWZ — Enjoyable and inspiring reading is "Father of Radio," the autobiography of Dr. Lee de Forest. PL is staying at Fort Myers. AXY was elected MO of Knights of Kilocycle and LEP the SA. AXY nosed out AYZ, and are those calls confusing on the phone nets! One of them should go c.w. Don't forget, fellows, let me have your February traffic reports on fair traffic. Cleviston: PJU is reporting some nice groundwave work on 28 Mc., such as with KET, QCE, and RHX. George has 112 DX confirmations. PNS has been doing a nice job as QSP from 3675-kc. net to 3945-kc. net. Lake Wales: LJM has gone to Minnesota. Melbourne: RWE reports 72,910 points in the SS. We contest men had better watch him. Sarasota: LMT works Florida nets on 3945, 3910, and 3617 kc., 4RN on 3615 kc., MARS on 3307 kc., and Navy on 2200 kc., and that is a real netter. KRA is experimenting on spiral-wound fish-pole dipole ideas mainly for Marine installations. Stuart: NYB is a new member of the Fern and K. of Kc. Nets. It will soon be time for the Gator Net to reopen for the "summer" season on 7290 kc. Should we keep this frequency or change? What time? A later QNI also? Who do you want for net manager this year? OZC had it last season and still has it until new nominations are made. (We try not to impose on a fellow for more than one season unless by popular demand!) Flood me with answers to these questions and let's see how many have the same ideas and comments. Who is interested in Florida all-band QSO party and how should we hold it? Maybe KM or someone else will put up a couple of prizes. We will want interclub competition in on it also. Traffic: W4OGI 169, OCG 143, PEI 137, WS 111, LMT 79, KJ 68, FWZ 62, PJU 25, DES 16, PNS 13, NYB 1.

WESTERN FLORIDA — Acting SCM, Edward Collins, W4MS/RE — PBV and RCH are Class A. PLE has been working out an FB Civil Defense program. RYA has the best ground wave in the section. CQF has moved to 28 Mc. MEN is on all bands. PRV has joined the section from North Carolina. PRP has new HRO-50T. PLA keeps 28 Mc. hot nightly. SAW has new five-element wide-spaced beam. DAO is on 7 Mc. AXP visited Eastern Florida. LT keeps 3.85 Mc. going in fine style. HIZ is gathering 144-Mc. gear. FHQ has v.h.f. gear. BFD works 14 and 28 Mc. LRC has new QTH and tower. ROM has increased power. KJV has been heard aero-mobile. QK is reworking the RME-69. BQZ keeps schedules on 3.85 Mc. with home town. VR is our most consistent 7-Mc. man. PAA is giving him competition. PQW is experimenting with different types of modulators. NJB is going to 75 meters. MFF keeps Ft. Walton Area represented. RZV keeps 28 Mc. hot. BKQ works 3.85 Mc. MS has new HRO-50T. NOX has gone back to 14-Mc. c.w. SAW conducts code classes for SWLs. CNK has new type modulator to 1 kw. Traffic: W4AXP 52.

GEORGIA — SCM, James P. Born, jr., W4ZD — New officers of the Amateur Radio Club of Augusta are as follows: EZU, pres.; HRR, vice-pres.; LYG, secy.-treas.; OKL, act. mgr. The Kenneshooshee Radio Club of Marietta elected the following officers: KXT, pres.; Bill Baskin, vice-pres.; NEJ, secy.; Ray Pledger, treas. MCQ has moved to Birmingham, Ala. PBF has a new 24-hour clock as a result of Christmas. KWC snagged nice DX such as FK8, EA8.

(Continued on page 94)

HARVEY is HQ for CD emergency communications gear

We have all of the equipment and parts that you may need, whether for installation or construction, of an emergency communications station for operation on any of the designated bands . . . fixed station, mobile or portable. We carry complete stocks of the products of the nation's foremost communications equipment manufacturers . . . transmitters, receivers, tubes, speakers, transformers, AC power supplies for fixed stations, mobile power supplies for 6v. or 12v. operation, gas engine operated generators for 6v. DC or 110v. AC, antennas, meters, noise-cancellation and standard microphones (carbon, dynamic and crystal), etc. . .

Popular Priced ELDICO 2 Meter Equipment for fixed station and mobile operation

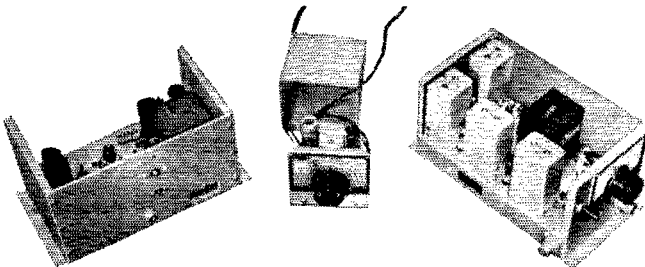

Crystal Controlled Transmitter

Designed for stable, trouble-free operation in the 144-150 mc bands. Couples to any co-ax fed 2 Meter antenna. Uses any power supply providing 300v. at 200 ma. Screw-driver adjusted tuning controls. 7 tubes. Components and tubes are standard for replacement ease. Co-ax connectors. 5½ x 9½ x 5½ in., with universal mounting flanges. Prices are less power supply.

TRANSMITTER, wired and tested\$74.95

TRANSMITTER, in kit form 49.95

Superhet Receiver

An excellent 10 tube receiver, sensitive, stable, selective. Highly efficient with precision vernier tuning over 144-150 mc. Exceptional signal-to-noise ratio. Minimized power requirements with total battery drain only 22 watts. Matching cabinet, same size as xmitter, with universal mounting flanges. Jones plug and co-ax connectors. Prices are less power supply and speaker.

RECEIVER, wired and tested.....\$94.95

RECEIVER, in kit form..... 59.95

For external local oscillator, add to above..... 5.00



TR-1 TRANSMITTER KIT

A conservative 300-Watt phone and c.w. rig 6V6-6V6-6L6-813, Class B 811 modulators. All bands, 80, 40, 20, 15, 11, and 10. Exciter broad band, single control PA tuning. Three power supplies delivering 1500 v.d.c. at 350 ma, 500 v.d.c. at 200 ma, and bias supply. Punched aluminum chassis, tubes, transformers, capacitors, resistors, antenna changeover relay, meter, wire, hardware and coils included. Electro-Voice 915 high level crystal microphone part of the package. Plug in the crystal and line cord and you're on the air. Shpg. Wt. 180 Lbs.....Only \$199.95



TR-75 TRANSMITTER KIT

Loafing along at 75 watts this is the c.w. man's buy of the year. Simple enough for the beginner to assemble. Punched chassis. Uses the time proven 6L6 oscillator-807 amplifier combination. Pi-network output. Husky power supply delivers 600 volts to the 807. Complete...including a punched chassis and a specially shielded cabinet to minimize television interference. Unbelievably low priced at\$44.95

Shpg. Wt. 80 Lbs.

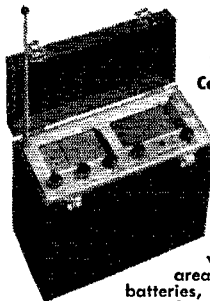

Hallicrafters S-72 Portable Communications Receiver

For vacations or year-round use. BC and ham use, 4 bands - 540 kc to 31 mc. Extra sensitivity for weak signal areas. AC, DC or batteries, whip or loop antenna. 8 tubes plus rectifier. Shpg. Wt. 16 lbs.....\$109.95

VISIT HARVEY'S AUDIOTORIUM — Come in and visit our new Sound Department... all these items and many more on working display at all times.

NOTE: In view of the rapidly changing price situation in both complete units and components we wish to emphasize that all prices are subject to change without notice, and are Net, F.O.B., N.Y.C.

Telephone:  Luxembourg 2-1500

HARVEY
RADIO COMPANY INC.

103 West 43rd St., New York 18, N. Y.

MUNICIPALITIES AND EMERGENCY SERVICES

are invited to consult us on any of their emergency radio communications equipment problems. Six members of our staff are fully qualified and licensed operators. Their services are available to you. No obligation, of course.

PREMAX

Civil Defense

Civil Defense and the vast communications problems it presents are on the minds of every patriotic ham these days. Nearly every community is planning an amateur radio operators to provide them with a large part of their Civil Defense communications services. Many of us are prepared with mobile gear, rigs with handles and emergency power.

A recent action of the FCC proposed frequencies on all amateur bands to 225 megacycles excepting 40 and 20 meters. This encourages us to further expand our emergency facilities and improve our equipment. Of course, mobile installations are of prime value and these frequencies on 160 and 75 are excellent for the very necessary point-to-point work.

Remember, too, that the Premax BXC or BXS center-loaded antenna is a natural for fixed portable operation since it is easily tuned against any convenient ground.

For the more permanent base stations at Civil Defense Headquarters, Premax offers straight verticals up to 35 feet to really lay down a signal — or perhaps the 17-foot center-loaded marine antenna suitably tuned to the operating frequency.

Ten meters, a mainstay in emergency communications, will require beams for point-to-point and, in a service which must be completely reliable, this indicates the use of commercial quality such as is built into Premax R8-6309 Rotary Beam.

Remember those mobiles, too. There's no substitute for the Premax RS Mount with stainless steel springs, coaxial backplate, positive lock and theft-resistant hardware.

Send for the Premax Catalog today and let us show you the type of antenna equipment around which you can build your emergency gear with complete confidence.

73,

T. STEWART W2TBD

PREMAX PRODUCTS

DIVISION CHISHOLM-RYDER CO., INC.

5102 HIGHLAND AVENUE • NIAGARA FALLS, N. Y.

and VP5 on 7 Mc. Congratulations to K4WAR with a traffic total of 934. Operators at K4WAR are RZN, LDM, 9JHU, and 3QXU. MCL has moved to Atlanta from Nashville, Tenn. JMU now is in Connecticut operating portable 4. PDR is building a p.p. 807-watt final. NLY has resigned as EC for Dougherty County to enter the armed forces. MUK is the new EC for Dougherty County. OTG is sporting a new TBS-50. KCM has moved to Atlanta from Richmond, Va. KPQ is building a new 28-Mc. beam. New appointments are as follows: KWC as OBS on c.w.; RPO, KWC, and KFL as ORS; KWC and HDC as OO. The following certificates have been endorsed: As EC — MMQ for Chatham County, CYC for Muscogee County, RPO for Paulding County, IMQ for Polk County, LXE for Bibb County, As ORS — MA, HYW, FKE, and MCM, As OPS — MCM, As OO — MCM, PDD now is in the Navy. We are all saddened to learn of the death of EYK. KOR has a new Monitone and is active in traffic-handling again. INO is in the Navy and is on the air from Chamblee. Traffic: K4WAR 934, W4HKA 28, KWC 25, MTS 11, KOR 8, ZD 8, HZG 4.

WEST INDIES — SCM, William Werner, KP4DJ — SEC: ES. HU renewed ORS appointment and is building 144-Mc. cascade converter. HF and AL renewed AREC membership. KD realigned the HRO and is building 50-Mc. rig. KB worked 100 countries and made WAC with 9 watts. HU, KD, and UW are active on 7 Mc. HZ received Class A license and is building 812 final for 3925 kc. ID, R. C. Headquarters, has new 80-meter Zepp and power-control circuits installed by DJ. MRAC's Christmas Party was well attended. The main topic of KP4s is 144 Mc. and many are preparing equipment for an island-wide net. HU reports T2PZ and YN1AA are consistent on 3.5 Mc. JA handles traffic with CO2WB and CO2GE daily on 14 Mc. CO2LY, Abuelito, is active again. COBMP schedules Hempstead for traffic. W2PF was visitor at MRAC and gave a talk on TVI problems of W hams. CO is heard on 3925 kc. again. Traffic: KP4DJ 18, IT 11, HU 5, KD 1, UW 1.

CANAL ZONE — SCM, Everett R. Kimmel, KZ5AW — New officers for CZARA are WJ, pres.; AU, vice-pres.; BD, secy.; and WA, treas. Retiring president RM, during whose year CZARA prospered mightily in membership and attendance, has constantly advocated having an activities manager. When the ballots were counted RM found himself elected to that very job. His first act was to revive the CZARA Bulletin, with BT as managing and production editor. MARS, USARCARIB, received enthusiastic support from KZ5 civilians. Liaison groups: For MARS, FL, CG, and AW. For Civil Defense, CG, PC, RM, WJ, and AW. W4KTW soon will be a KZ5. Route Manager CG schedules KV4AA daily and K4AIR tri-weekly. C.w. men, call Carl and give him YOUR schedules. He needs them for emergency traffic. Phone operators should do likewise. When you read this there still will be time to 'phone in your traffic. Gambia 6-295 or 6-161. Traffic: KZ5FL 33, CG 13 LR 12.

SOUTHWESTERN DIVISION

LOS ANGELES — Acting SCM, Vincent J. Haggarty, L W6IOX — Greetings! Your former able SCM, VTM, has resigned to move to Texas. In the interim I shall attempt to fill his boots. If you have not done so already, please file nominations for the election of a new SCM. In this transition period reports may be hurried and brief. Please excuse any errors or omissions. Reports were received from AM, AAE, AFR, BBG, BUK, CAJ, CE, CFL, CKO, CMN, COZ, CUF, DBY, DDE, EYH, FMG, FYW, GTJ, GYH, HLL, HYL, IOX, JQB, QLM, MU, NAZ, and SCN. CAJ is on a European tour now. GYH topped the section traffic-handlers. CE was runner-up in traffic but is curtailing his heavy traffic work. DDE joined MARS. QLM reports from the Mission Trail Net. BHG continues the fine OBS schedules. HYL asks those interested in a traffic net for major California cities to write him at 6151 West 77th St., Los Angeles 45. COZ reports on a successful Christmas party of the Citrus Belt Amateur Radio Club. Traffic: (Dec.) W6GYH 1116, CE 947, JQB 434, CMN 337, DDE 181, QLM 85, FMG 80, BHG 54, HYL 37, FYW 36, CKO 33, HLL 25, MU 20, AFR 11, AM 9, COZ 8, CUF 8, EYH 6, AAE 2, DBY 2. (Nov.) W6JQB 187.

ARIZONA — SCM, Jim Kennedy, W7MID — LVR has new Johnson 20-10 beam, and is on 50 and 144 Mc. with an 829B. The Tucson gang plans a dozen rigs for 144-Mc. emergency work, all to be interchangeable. KFS is mobile in 3.85 and 28 Mc. SDO is back on from new QTH on all bands. OUZ is on 7 Mc. in Tucson and OZO is on 7 and 14 Mc. LOM is in the Navy in Washington State. PZ is working lots of Europeans on 14 Mc. with his new three-element beam. JVK has TVI trouble on 3.85 Mc. MLL was loaned ten receivers by the Naval Reserve for his radio class. The Old Pueblo Club had an ARRL film on TVI. HYQ was heard checking into the 3815-kc. net from Bisbee. JMQ has moved to Colorado. In St. Johns, OWL is trying out a new vertical with good results. UKK is QRO to 150 watts. In Phoenix, KRW is chief engineer at KRIZ. PUM has new p.p. 304TL final. OXQ is a new call at Phoenix Union H.S. OZF is the call at West Phoenix H.S. We are saddened to report the death of QJL, of Mesa. LUK and OIF are putting

(Continued on page 96)

BOB HENRY, WØARA, OFFERS YOU:



LOW PRICES: I sell to you as cheap or cheaper than you can buy anywhere.

COMPLETE STOCKS: Collins, Hallicrafters, National, Hammarlund, RME, Millen, Harvey-Wells, Meissner, Gonset, Meck, Johnson, RCA, all other amateur receivers, transmitters, beams, TV, AM-FM, Polic-Alarm and Monitoradio, high fidelity amplifiers and speakers, test equipment, tubes, parts, etc. I can supply nearly any equipment shown in any catalog or advertisement and at lowest prices.

BEST TRADE-IN ALLOWANCE: Customers in all parts of the USA trade with me because I allow so much. Tell me what you have to trade and what you want. I also buy equipment.

TIME PAYMENTS: You can order anything on terms. I finance the terms myself to save you time and bother. Customers everywhere in the USA find my terms best. Write for details.

QUICK DELIVERY: Mail, phone, or wire your order. It will be shipped promptly. I can be reached nearly 24 hours a day, 7 days a week.

TEN-DAY TRIAL: Try any communications receiver ten days -- if you return it your only cost is shipping charges.

PERSONAL ATTENTION: The Butler store is run by Bob Henry, WØARA, and the Los Angeles store by Ted Henry, W6UOU. We make the deals ourselves. We finance the time payments ourselves. That way we have the lowest overhead and can do more for you. That's why YOU AND I CAN DO BUSINESS. Write, phone, or visit either store. Export orders solicited.

73,
Bob Henry
WØARA

Butler 1, Missouri

HENRY RADIO STORES

11240 Olympic Blvd.
LOS ANGELES 25
CALIF.

'WORLD'S LARGEST DISTRIBUTORS OF SHORT WAVE RECEIVERS'

Engineering at Work

NEW 10 METER MOBILE TRANSMITTING ANTENNA NEEDS BUT 1 HOLE FOR INSTALLATION!

Ward's SPP-143 transmitting antenna can be installed on cowl, fender or flat rear deck of any automobile without the necessity of drilling a series of unsightly holes. It is developed to use one $\frac{1}{8}$ " hole, that can easily be plugged or used to mount a Ward 8-Ball standard broadcast antenna. The short, standard $5\frac{1}{2}$ " rod reduces damage from overhead constructions. A special hook-up used by Ward engineers enables the SPP-143 antenna to match and in some factors exceed customary rear mounted whips. The new SPP-143 antenna is now carried by leading parts jobbers.

As an exclusive manufacturer of antennas, Ward concentrates on aerials. Being the oldest and largest manufacturer in the field, Ward has broad experience and engineering facilities. Whether you require one or thousands of special antennas, consult Ward for the answer.

THE WARD PRODUCTS CORPORATION
Division of The Gabriel Co.
1523 EAST 45th STREET
CLEVELAND 3, OHIO

only **WARD** OFFERS
ONE SOURCE FOR
SPECIAL COMMUNICATION
TV-FM-AM and AUTOMOTIVE
ANTENNAS

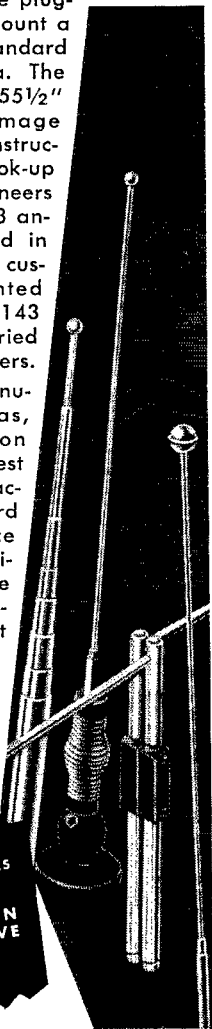

in lots of time in AREC and Civil Defense work. Nearly 50 of the local gang attended a recent meeting to register with the CD authorities and hear a talk by LUK. Traffic: W7OIF 47, MID 7, LVR 5.

SAN DIEGO—SCM, Mrs. Ellen White, W6YYM—Asst. SCMs: Thomas H. Wells, 6EWU, San Diego County; Shelley E. Trotter, 6BAM, Orange County. SEC: NBJ; ECs: San Diego County, VJQ; Orange County, DEY. RM: ELQ. During 1950 the AREC held nine simulated emergency drills. The total check in count for the year: Mobile and portable, 1175; fixed stations, 2349. Very pleased to report the appointment of Dave Hannah, NBJ, as SEC. BVI, at Costa Mesa, is a new OPS. IZG, active on SSN, has been appointed ORS. New officers for Orange County Amateur Radio Club are LDJ, pres.; RBA, vice-pres.; FCT, secy. For Soledad Amateur Radio Club: DWE, pres.; SKZ, vice-pres.; FAY, secy.-treas. BAM had a total of 774 in traffic to make BPL for December. ELQ had a near-miss with a traffic total of 497. DEY is busy organizing emergency activities in Orange County. FMZ is assisting 4PYQ in getting the U. S. Fleet Sonar School station, DCM, on the air. To quote IZG, "Sure having fun and meeting a swell bunch of guys since getting my ticket about one year ago. Owe it all to W6ELQ." One of the best club papers seen around in a long while is *The Hamgram*, voice of the Imperial Valley Radio Association. YYM/YYN have a new rig. The Aztec Radio Club of State College is moving to a better location on the campus. Traffic: W6BAM 774, ELQ 497, IZG 72, FMZ 32, FCT 27, BGF 8.

WEST GULF DIVISION

NORTHERN TEXAS—SCM, William A. Green, N W6BKH—Asst. SCM, Joseph G. Buch, 5CDU. SEC: AAO. RM: GZU. PAM: ECE. EC appointments were made to MQW, LQU, QQU, KJB, and LXE. GZU and LSN piloted this section to a very good traffic month. Several hundred messages were handled by 75-meter stations, most of whom had never handled traffic in volume before. Much of this traffic was from overseas, bringing happiness to the relatives of our boys now hospitalized. LSN, GZU, and QDF made BPL. 223 members now participate in the AREC program, with NWTEN leading in the Trophy Contest. HUU was appointed CD Communication Chairman in Amarillo. The Abilene ten-meter emergency net now is operative with K5NRC as NCS. AAO has new Federal transmitter dedicated to CAP and AREC activity, planning liaison with MARS to further our CD plans. FQT has organized a 160-meter emergency net. Contact him for enrollment. MARS activity is steadily increasing. New mobile rigs are being sported by LZV, MQF, JFT, MHE, CC, DM, and NAX. A transmitter hunt was held by CTARC, with NCD and SAT winning. Earl Brown, blind, but soon to become a ham, was presented with a receiver by AARC. AVA has a new rig, while Santa brought MQW a 32V-2, MDL a new shack, LUQ a beam, and PPS a 'phone patch. Traffic: W5LSN 2044, GZU 1393, QDF 340, GER 236, BKH 214, ARK 179, IWQ 148, LEZ 93, IGU 65, AWT 45, MAW 39, RH 26, EBW 18, PPS 18, HBD 16, ASA 13, GYW 10, ECE 8, LGY 8, RHC 5, CC 2, RUM 2.

OKLAHOMA—SCM, Frank E. Fisher, W5AHT/AST—SEC: AGM. RM: FOG. PAM: ATJ. PML cabled home from Seoul early in the month. Lee Kline, now 3HJV, reports into OLZ with a fine signal and provides quick service for eastern traffic. The Lawton-Fort Sill Club is making plans for the Easter Pageant. FOM has been revamped with a new central control panel and three operating positions. ATJ sent in a list of 144-Mc. stations active in the western half of the State: CUIH, Durham; ATJ, Hammon; FRB, Carter; LZ, Lone Wolf; CFN and KLIH, Hobart; HRZ, Sentinel; HXK, Watunga; WQ, Canton; GVS, Enid; and HZP, Pampa, Tex.; BFA, Borger, Tex. This looks like the beginning of a state-wide 144-Mc. net which IQW and ATJ have suggested. AGM reports increased AREC interest around the State. JFY now is with CAA in Oklahoma City. The Enid ARO held its annual guests were WQ, ROZ, JFQ, HQF, EAK, QQB, BKN, ELD, NEN, FME, LCN, and R. W. Webb, ROZ, at Canton, and PHR, at Bartlesville, are reporting into OLZ. OPEN also is gaining new members; HFN, of Frederick, and MRK, of Bartlesville, have reported in. PA is heard frequently on low-power c.w. Oklahoma City and Tulsa groups are reported actively working on the Civil Defense set-up. OWG received OPS and OPS appointments. Traffic: W5MRK 296, AHT 225, FOM 190, MQI 117, RIT 89, PCQ 87, QOD 71, FOG 60, MEZ 67, MEX 40, AAJ 39, OYP 28, ADB 12, EHC 10.

SOUTHERN TEXAS—Acting SCM, Dr. Charles Fermaglich, W5JFF—FIF is active on 3.85, 7, and 14 Mc. IQB is active on 3.85 Mc. with p.p. 807s. BEEX has a new 28-Mc. mobile rig with a motor-controlled VFO. MMK is on 3.85- and 28-Mc. mobile. BDI is putting up two 50' towers. ON is active on 144-Mc. emergency net. KFY is using new 144-Mc. beam of his own design and is building a new 144-Mc. preslector. JAK is active on 50- and 1.8-Mc. disaster net. FPH is on No. Tex. and So. Tex. Nets. MK, new MARS member, is Net Control Station for STEN, operating for the sole purpose of handling messages for

(Continued on page 98)

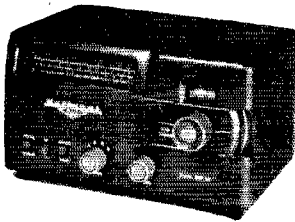

NEW! SW-54

Brilliant new superhet covering 540 kc — 30 mc. with built-in speaker, bandspread, best communications features. AC/DC. 12BE6, 12BA6, 12AV6, 50C5, 35Z5 tubes. Tops for voice, music, code. Only 11 x 7 x 7" SW-54\$49.95

**ORDER BY MAIL,
ORDER TODAY!**

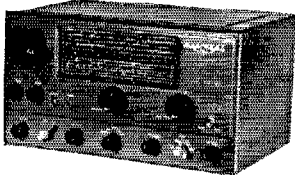

NEW! NC-125

9-tube superhet for hams and SWL's, covers 550 kc — 36 mc in 4 bands. Calibrated electrical bandspread on all ham bands. Select-O-Ject filter circuit. Less speaker. Phono input. NC-125\$149.50
NC-125TS 6" Speaker11.00

RADIO SHACK HAS 'EM



for **AT ONCE DELIVERY**

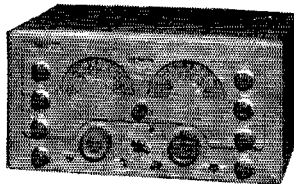

FAMOUS NC-183

14 tubes plus VR-150, 5U4G. Covers 540 kc — 31 mc, plus 48-56 mc. Phono input and push-pull 8 watt audio. Two tuned RF stages. 5 bands; bandspread. Speaker extra. NC-183\$279.00
NC-183TS 10" Speaker.. 16.00

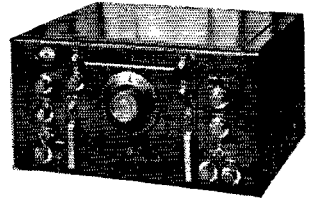

GREAT HRO-50

50-430 kc, 480 kc — 35 mc; supplied with AA, B, C, D coils, 15 tubes. 8 watt p-p output within 1 db 50-15,000 at phono output. Many accessories available. Speaker extra. HRO-50\$359.00
HRO-50TS 10" Speaker. 16.00

"PLAY AS YOU PAY" FOR 1/4 DOWN ON ANY NATIONAL RECEIVER!

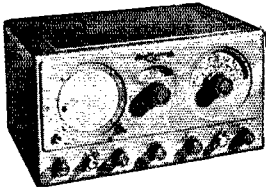

LAST CALL FOR NC-57!

NATIONAL has temporarily halted production of the NC-57 receiver and all others except the 4 sets above and the HFS due to shortage of parts. Radio Shack is fortunate to still have in stock A VERY LIMITED NUMBER OF NC-57's for immediate delivery. After they're gone there will be NO MORE! A superhet with one tuned RF stage. NC-57 covers 540 kc to 55 mc in 5 bands and has a built-in PM speaker. AC circuit with 7 tubes plus rectifier, featuring: CW osc., switch-selected CW, MVC, AVC, ANL; tone control; electrical bandspread on all bands. Tunes EC, SW, ham, police, fire, ship-shore. Order today!

NC-57\$99.50
\$24.95 down, while they last!

ORDER TODAY BY MAIL

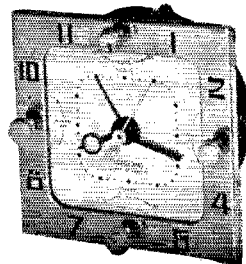
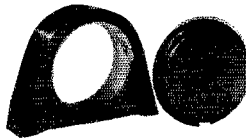
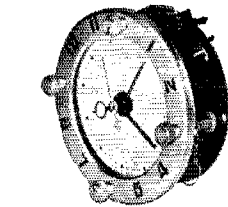

SESSIONS CLOCK TURNS RADIOS, APPLIANCES ON OR ON-OFF!

Convert your radio into an alarm-clock radio, or operate air-conditioners, lamps, TV, mixers, etc., at preset times, with a world-famous SESSIONS electric switch timer! Polished gold-colored metal rims (round or square) with raised numerals; red sweep second. AC operation; UL approved; kitten quiet; guaranteed. TWO TYPES: W26 — "on" only; W31 — "on" or "off" — sleep switch enables independent shut-off from 0-90 minutes. Both available round or square. Price includes mounting hardware (and matching bezel for round only).

Order No.	Preset Action	Net
W26 Round	"On" only	\$5.50
W26 Square	"On" only	5.50
W31 Round	"On" and "off"	6.50
W31 Square	"On" and "off"	6.50
Model 905	Wood Case*	2.50*

*For round models only; has metal back

The RADIO SHACK Corp.

167 WASHINGTON ST., BOSTON, MASS.

**NO OTHER MICROPHONES
OFFER YOU SO MUCH
FOR SO LITTLE!!!**

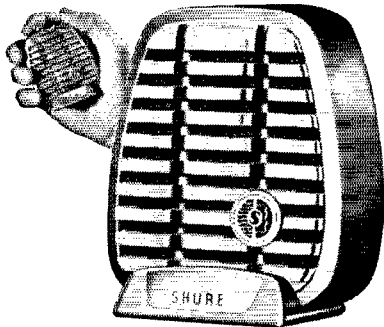

...The New Shure Controlled Reluctance

"HERCULES" Only \$15.00 List!

A revolutionary new hand-held magnetic unit that provides clear reproduction, high speech intelligibility, high output, and ruggedness—at an amazingly low price! A tough microphone that can be used indoors or outdoors—fits snugly in the hand, sits firmly on a desk without tipping over, can be placed on a stand. Metallic Green finish. Complete with stand adapter. Die-cast case, 2 3/8" wide, 3 1/4" high, 1 1/2" thick.

MODEL	CABLE	OUTPUT LEVEL	IM-PEDANCE	SHPG. WEIGHT	CODE	LIST PRICE
510C	7 ft.	52.5 db below 1 volt per microbar	High	1 1/2 lb.	RUTUF	\$15.00
510S (with switch)	7 ft.	52.5 db below 1 volt per microbar	High	1 1/2 lb.	RUTUS	\$17.00

...The New Shure Crystal

"REX" Only \$10.95 List!

A striking-looking low-cost crystal microphone. The "Rex" is a high output, hand-held microphone that fits snugly in the hand, sits firmly on a desk without tipping over, or can be placed on a stand. The "Rex" is recommended where good quality speech reproduction is required, and low cost is an important factor. Burgundy Red metallic finish. Complete with stand adapter. 2 3/8" wide, 3 1/4" high, 1 1/2" thick.

MODEL	CABLE	OUTPUT LEVEL	IM-PEDANCE	SHPG. WEIGHT	CODE	LIST PRICE
710A	7 ft.	50 db below 1 volt per microbar	High	1 1/2 lb.	RUDEL	\$10.95
710S (with switch)	7 ft.	50 db below 1 volt per microbar	High	1 1/2 lb.	RUDET	\$12.95

Controlled Reluctance Microphones Built Under Shure Patents. Crystal Microphones Licensed Under Patents of Brush Development Company. Shure Patents Pending.

SHURE

SHURE BROTHERS, Inc.

Microphones and Acoustic Devices

225 West Huron Street • Chicago 10, Illinois

Cable Address: SHUREMICRO

98

wounded servicemen in Japan. NIT is active on 3.85 and 7 Mc. JC is working lots of DX. PNP is on 3.5, 7, 14, and 28 Mc. LFW is clearing up the bugs in his rig. LMI is going strong on 28 Mc. The Port Arthur Amateur Radio Club is drilling 29.1-Mc. net. NNF has new 28-Mc. beam. The Orange Amateur Radio Club has much fine emergency equipment, including power supplies. NMY is very active on the air. The El Paso gang is busy with a new 28-Mc. net. GHI had a good score in the SS. RJP has moved to Marfa. PJB is building a new 829-B final. The El Paso Club is planning a club-house. JZR is building converters for each band. PHC and HYG did outstanding disaster relief work in recent ice and snow storm. LAK is on 3.5, 7, 14, and 28 Mc. with 125 watts in traffic net. YH is active on 7025 and 7050 kc. and would like to QSO former students of Ft. Arthur College. MZL is on 14-Mc. c.w. PXO is on 7- and 14-Mc. c.w. OPJ is on 28-Mc. 'phone. LAK has Class A and 3rd-class radiotelegraph tickets. QCH is making lots of contacts with low power. AEQ is active on No. Tex. Net, Ok. Traffic Net, STEB, and Winkler Co. Net. NIV is active on 28 Mc. Recent ARRL appointments are: NBK, NIV, KSW, and AQJ as ORS, ON, NBK, JTF, RFG, and RIE as OBS, NKM as OO, KFY and 9CQH as OES, IRP, FNY, RFG, and HBI as OPS, FNY, RHC, BAJ, GI, IPT, JBZ, DAJ, MCZ, EYV, ON, NHV, NMY, and JPC as FCS. Active members in Winkler County Net are AQE, FPH, HAF, JAK, MKZ, MZK, NJH, NNB, OAL, PVT, PWH, PXM, RCS, RIE, RXQ, RYO, SBB, and SDL. PIE, MKZ, and NNB are active on CAA 40-meter c.w. net. PTV is active on about 8 traffic nets. The Tumble Amateur Radio Club had an FB Christmas Party. LM is rebuilding. QGD is new MARS member. PNP has p.p. 814s and puts out a fine signal on 3.85 and 7 Mc. ESL is putting out on 7 Mc., along with some 3.85 and 28 Mc. UJD is in McCloskey General Hospital. DXD is 3.85-Mc. mobile. IPT is on 3.85 Mc. with 75 watts of clamp-modulated BC-457 and on 7 Mc. with 250 watts of p.p. 809s. OUG has been appointed OCS for Houston MARS Net, and still is operating 144 Mc. with CERN. RSJ is working 3.5-Mc. c.w., and is building a kw. around a 304-TL. QJS is working 3.85, 144, and 28-Mc. mobile with low power, c.w. and 'phone. MDZ is on 144 Mc., rebuilding 200-watt 28-Mc. TVI-proof rig. LLV will be on 14-Mc. 'phone. OKX is working c.w. on all bands with 100 watts. DFC is de-lousing the rig for Tennessee Valley Indians. IMN is on 7- and 14-Mc. c.w. with miniature portable rig running 17 watts to 6AQS, and worked 20 states and 7 countries in less than 4 months. FWC still is working 3.85, 28, 50, and 144 Mc. LLT is working 7-Mc. c.w. to keep his fist in trim. HJA is rebuilding new 7-Mc. c.w. rig. QE1LA visited the Houston Amateur Radio Club. BBK is rebuilding the modulator. BHO is installing 3.85-Mc. 'phone in the car. JN has only 696 on 3.85 Mc. NMG is working 14- and 28-Mc. 'phone. MN, regularly on 7155 kc., has schedule with 3CUL 5 A.M. daily. Traffic: W6MN 168, AQE 4, NIV 2.

NEW MEXICO—Acting SCM, Richard J. Matthias, W5BIW—SEC: PLK. RM: NKG. PAM: BIW. PAM v.h.f.: FAG. The 75-meter emergency 'phone net of New Mexico is now meeting on Tuesdays and Thursdays at 6 P.M. MST in addition to the regular 7:30 A.M. Sunday morning roll call. The frequency is 3885 kc. The c.w. net meets at 7:00 P.M. MST on 3705 kc., Mondays through Fridays. We are sorry that SMA has to be away at this time, but will carry on as best we can until he returns. Much activity already is under way regarding the coordination of amateur communications with the Civil Defense program. Contact the SEC or your local EC for information regarding this program. PIZ, in Albuquerque, is doing an FB job with his little Lettine transmitter 30 watts in, and is planning a new vertical Helical antenna on 3.85 Mc. PLK is temporarily moving to Albuquerque from Socorro. ST, in "lovely" Lovington, is plugging for a state get-together. Let's encourage him. FAG, in Socorro, has 250 watts on 144 Mc. with a beam 50 ft. high. His test schedules are 6:30-7:00 P.M. MST, Tuesdays and Thursdays. If you hear Hub, please send reports via the 'phone net, 3885 kc., or the c.w. net, 3705 kc. Traffic: W5QKJ 198, NKG 30, ZU 19.

CANADA MARITIME DIVISION

MARITIME—SCM, A. M. Crowell, VE1DQ—FQ has the highest traffic total this month. Recent calls appearing are JO, VG, AAH, and AAE, who will be on from Pugwash Jet. YV, of 3.8-Mc. 'phone fame, was a recent visitor to Halifax. YO, of Inverness, also did some visiting. BV is back from Northland Inspection with the D.O.T. KJ now is 20K. Listen first! Several times our nets have been QRMed by ill-timed calls which were NOT preceded by use of a receiver. Most recent trouble was on the Maritime 'Phone Net, 3830 kc. MK, YO, YV, and AAK have been quite active in AFARS work. DS has converted his TA12 to 28 Mc. LO has gone to sea as radio operator. Recently active on 3.8-Mc. 'phone were ET and HD. DQ says it still is possible to work a few ZS on 28-Mc. 'phone. Newfoundland: VO6B, of Northwest River fame, and VO6BF, of Goose Bay, have been putting out well on 14 Mc. VO1DX

(Continued on page 100)

Meissner

TRU SONIC

National
EST. 1914

American Beauty



CLAROSTAT

hallicrafters



Eimac
TUBES

THORDARSON

Jensen

AMPHENDL



Mueller



Rauland



DU MONT
GARRARD

AEROVOX



SPRAGUE

RAYTHEON



MALLORY

TRIPLET

Memo SILVER



B&W

OHMITE

LRC

Simpson

ASTATIC



Taylor Tubes

ALTEC
LANSING CORPORATION



JACKSON

Bliley
CRYSTALS



GREENLEE



SHURE

SANGAMO

ElectroVoice

HICKOK

TERMINAL

RADIO CORPORATION

Distributors of Radio & Electronic Equipment
85 CORTLANDT STREET
NEW YORK 7, N. Y. Phone: Worth 4-3311

FREE TO TV SERVICEMEN THE LAST WORD IN TV 'TENNA INSTALLATIONS



**BRAND NEW
AUTHORITATIVE
INFORMATIVE**

Simplified

TV-ANTENNA INSTALLATIONS

A fact-filled, pocket size reference manual edited by outstanding authorities. Packed with vital information on all types of antennas, helpful Hints, Do's and Don'ts, Dimension Guide, Channel Frequencies, Proper Feed Methods and many other subjects.

LIMITED QUANTITY

PUBLICATION PRICE 50c. AVAIL-
ABLE WITHOUT OBLIGATION
IF YOU WRITE IMMEDIATELY.

FREE!

MAIL THIS COUPON TODAY

SNYDER MFG. CO., Dept. F
22nd & Ontario Sts., Phila. 40, Pa.

Please send free copy of TV 'TENNA TIPS

Name.....

Address.....

City.....Zone.....State.....

has 500 watts to a 14-Mc. beam and the outstanding QRK from VO. VOIVI was in Ontario recently. The Annual NARA Convention was an outstanding success. VOIAG had his rig set up and had contact with 2X and II/M. Trophies were awarded IT and II by Mr. Crocker of the D.O.T. Traffic: VE1FQ 81, MK 62, OM 46, YV 46, AAK 21, YO 9, AAL 7, LO 8, VC 5, YC 5, ABJ 4, JS 4, YR 4.

ONTARIO DIVISION

ONTARIO — SCM, G. Eric Farquhar, VE3IA — Asst. SCM c.w., W. Guillot, 3BUR; Asst. SCM 'phone, E. Kimble, 3FQ. SEC: KM. With sincere regret we record the passing of WK, of Toronto. Art was active on 7 Mc., being the Toronto outlet for Ontario 40-meter net. He was one of the original members of the Wireless Association of Ontario. He did much work in the formation of the VE Operators' Association, which later became CAROA, where he served on the Executive Board. He thoroughly enjoyed traffic-handling and never faltered in one of the requisites of the game — cooperation. As Emergency Coördinator for Toronto on 7 Mc., he gave much valued assistance during the Winnipeg and Vanwagner's Beach emergencies. May those of us who had the privilege of knowing him personally and on the air be able to carry on his ideals so essential to our hobby, ever keeping in mind that WK was an outstanding operator and a fine fellow. Congrats to ATR, who made BPL on originated traffic. Attention is called to all VE operators of the national calling and emergency frequencies to which has been added Canada. See page 48 Jan. QST. VD completed extensive rearrangement of rig and shack. BSQ, a newcomer in Belleville, is welcomed. BUR has NTS certificates available for those qualifying in regional and area nets. BIK handled urgent traffic in connection with aircraft down near the Hudson Strait. A quick QSP five minutes later got emergency flight moving. JU made a VES's Christmas a happy one. The New Year's Party at Oakville, attended by fifty ham couples, was highly enjoyed. Traffic: (Dec.) VE3BUR 344, IA 291, ATR 209, WY 138, AYW 98, GI 91, NI 77, BMG 65, IL 52, BTQ 44, DH 34, AZH 32, YG 30, VD 21, APS 13, BTZ 10, KM 10, ADN 9, CP 7, BLY 3. (Nov.) VE3BMG 13.

ONTARIO QSO CONTEST

A QSO Contest, open to all Ontario amateurs sponsored by the Ontario 'Phone Club, will be held on Sunday, March 11, 1951, from 10 A.M. to 10 P.M. The purpose of the Contest is to enable c.w. and 'phone operators to become more familiar with both types of operating. Two awards will be made. The c.w. trophy will be known as the "Sparton Radio Trophy," and the 'phone award as the "Columbia Record Trophy." Both trophies, donated by Sparton of Canada, will be suitably engraved with the winner's call and the year of presentation. Permanent possession of the trophy will be given to the person winning it on three occasions. Following are the rules: Frequencies from 3500 kc. to 3750 kc. will be allotted for c.w. operation. 3750 kc. to 3800 kc. is allotted to mobile 'phone stations running a power of 100 watts and under. 3800 kc. to 3850 kc. will be used by any 'phone station using 101 watts and up. No multipliers will be used and one point for contact from 'phone to 'phone, 'phone to c.w. and vice versa, provided contacts are made in the portion of the band above designated. Any station may operate 'phone or c.w., provided his operation takes place in the proper portion of the band. Judges of the contest will be: C.w. — VE3HP and VE3DU. 'Phone — VE3YJ and VE3FQ. Contest logs should be forwarded to E. Kimble, c/o Sparton of Canada, Limited, London, Ontario, up to midnight March 31, 1951.

QUEBEC DIVISION

QUEBEC — SCM, Gordon A. Lynn, VE2GL — HM has two transmitters and three receivers at his St. Sauveur QTH, one a pair of 812s with 805 modulators 500 watts into Hammond 20-meter rotary beam, the other a converted Meissner 150-B on 75 into 1/2-wave center-fed flat top. Receivers are Collins 75A-1, HQ-129X, and SX-17. KS is rebuilding. CA now has schedule with VE2SX in Ft. Chimo, as well as VE3SF in Nottingham. WH is active on 160, 80, and 40 meters and schedules ZR daily. KG is back on 28 Mc. after trouble in the modulator and buffer stage. XB schedules AFARS Mon., Wed., and Fri. on 3785-kc. 'phone and Tues. and Thurs. on 3590-kc. c.w., both at 7:30. He is Squadron Controller for VE2 section AFARS and could use more VE2s in AFARS. If interested, drop him a card. AKJ is operating on 7 Mc. only with indoor antenna at new location. PQN continues to operate thrice weekly, with LO, AGG, CD, and 3BOZ most active. Other VE2s are invited to participate on 3570 kc. at 7 P.M. Mon., Wed., and Fri. BB

(Continued on page 108)

NOTHING... ABSOLUTELY NOTHING...



Beats a "Surprise" TRADE-IN

ALLOWANCE ON YOUR USED COMMUNICATION EQUIPMENT

In Exchange For One Of The New

NATIONAL RECEIVERS



©
EST. 1914

Values are better because trades are higher!
Take advantage now of the one and only "SURPRISE"
allowance on used, factory-built equipment. Remember,
there is nothing else to compare with it, absolutely nothing.
Wire, write, phone or use the handy coupon today.

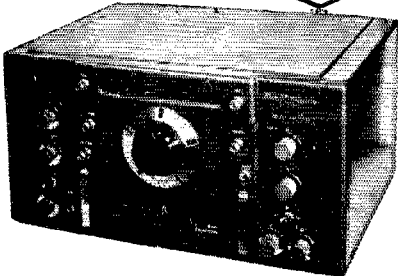

HRO-50—Shipping weight 80 lbs. Less
speaker. Only **\$359.00**. What do you
have to trade?

SW-54—Shipping
weight 23 lbs. Only
\$49.95. Buy this
amazing new SW-54
at a sensational sav-
ing. Trade used
equipment now.

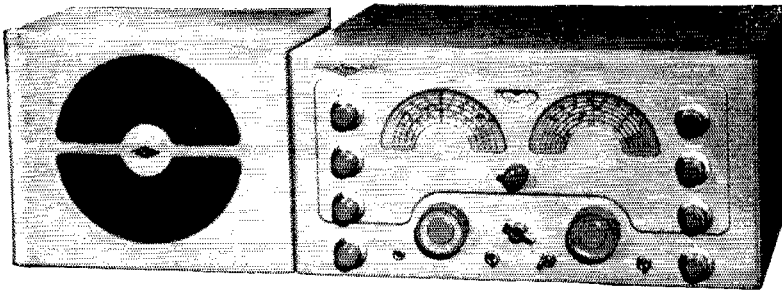
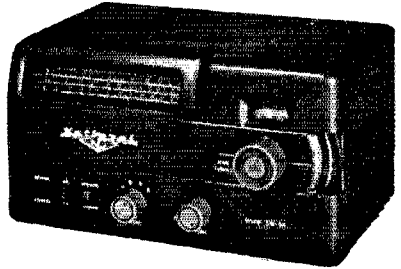

NC-183—Shipping weight 80 lbs. Only **\$279.00**.
Speaker for above in matching cabinet \$16.00.
Trade now where trades are higher ... at Walter Ashe.
All prices f.o.b. St. Louis Phone: CHEstnut 1123

FREE!

New 164-page
catalog. The
"Treasure Chest"
of values.

SEND
FOR YOUR
COPY
TODAY!

Walter Ashe Radio Co.
1125 Pine St., St. Louis 1, Missouri Q-51-3

Rush Special "Surprise" Trade-in offer on my.....
(show make and model No. of used equipment)

for NATIONAL Receiver.....
(indicate model No.)

Mail my Free copy of new 164-page Walter Ashe Catalog.

Name

Address

City Zone State

Walter Ashe
RADIO CO.
1125 PINE ST. • ST. LOUIS 1, MO.

NOW a really high-powered RADIO ENGINEERING LIBRARY

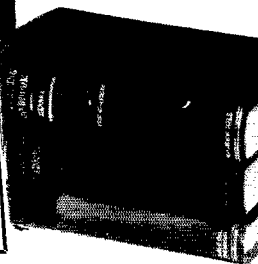
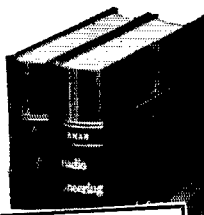

**NEW!
ENLARGED!
REVISED!**

Special Offer on This Complete Up-to-Date Set

Save \$4.50! These fine engineering books would cost a total of \$39.00 at our regular single-copy prices, if you bought them one or two at a time. Under this offer you can have the whole set at once and we'll pass along the saving in handling in a special low Library price of only \$34.50. In addition you may spread this over several installment payments as shown in the coupon below. Take advantage of these convenient terms to add these helpful books to your working library right away.

5 volumes, 3,921 pages, 2,770 illustrations

Eastman's FUNDAMENTALS OF VACUUM TUBES, 3rd Ed.

Terman's RADIO ENGINEERING, 3rd Ed.

Everitt's COMMUNICATION ENGINEERING, 2nd Ed.

Hund's HIGH-FREQUENCY MEASUREMENTS, 2nd Ed.

Henney's RADIO ENGINEERING HANDBOOK, 4th Ed.

What this library gives you

These books cover circuit phenomena, tube theory, networks, measurements, and other subjects — give specialized treatments of all fields of practical design and application. They are books of recognized position in the literature — books you will refer to and be referred to often. If you are a practical designer, researcher, or engineer in any field based on radio, you need these books for the help they give in hundreds of problems throughout the whole field of radio engineering.

EXAMINE THESE BOOKS 10 DAYS FREE

McGraw-Hill Book Co., 330 W. 42nd St., N. Y. C. 18

Send me RADIO ENGINEERING LIBRARY for 10 days' examination on approval. In 10 days I will send \$4.50, plus few cents for delivery, and \$6.00 monthly until \$34.50 is paid, or return books postpaid. (We pay delivery if first payment accompanies this coupon; same return privilege.)

Name.....

Address.....

City.....Zone.....State.....

Company.....

Position.....QST — 3-51

(This offer applies to U.S. only)

works nets on 3.5 and 7 Mc. PM has 100 watts to T55 on 3.5, 14, and 28 Mc. with NC-101X receiver. LD, in Shaw-bridge, is on 3.85-Mc. 'phone after years on 14 Mc. CO now is located in Pte. Claire and is on 3.85- and 14-Mc. 'phone. JG is on 14 Mc. with Hammond three-element rotary beam. XO did an excellent job as M. C. of International New Year's QSO Party on Jan. 4th, in which 75 VE and W stations participated. Traffic: (Dec.) VE2BB 136, CD 79, CA 37, AKJ 12, GL 6. (Nov.) VE2BB 76, XB 52, CD 49, AKJ 21. (Oct.) VE2BB 62.

VANALTA DIVISION

ALBERTA — SCM, Sydney T. Jones, VE6NJ — EO is building grid dip meter. LG is active in Civil Defense set-up. SS is working locals with his VFO. BW says it's hard when he has to buy parts now. WS has new mobile rig and puts out a good signal on 3.8-Mc. 'phone. PV and VJ are heard working 3.8-Mc. 'phone. That new jr. operator soon will be able to write for her ticket, eh Charles? HM is the proud owner of a new HRO-50. MJ finally connected with local telephone exchange. PE received an electric clock as a Christmas present. EA is building anemoscope. DR has moved his QTH to Cowtown and has been heard with faint signals. Civil Defense authorities have advised that ham radio definitely will be included in their plans. Details will be announced as soon as organization can be worked out. Contact your local Emergency Coordinator and register now. Those amateurs holding appointments are requested to report each month to the SCM items of interest for inclusion in this column. OC, at Himes Creek, and RF, at Grande Prairie, have been heard with good signals on 3.8 Mc. RU has been trying to contact his XYL in England but conditions have been poor. Traffic: VE6OD 86, EO 13, MJ 11.

BRITISH COLUMBIA — SCM, Ernest Savage, VE7FB — US has been appointed EC for South West B. C. Anyone interested should check into the emergency net on 3755 kc., Tuesday, Thursday, and Saturday at 1800 hours PST, 'phone or c.w. LF is back in town and intends to stay. The Victoria Short Wave Club's new officers are PO, pres.; MU, vice-pres.; DY, secy. The VSWG celebrated its 21st anniversary with a cake baked and decorated by Miss Nite Woods, AYL. Visitors to Victoria were 88Y, of Tuktoyaktuk; 78G, of Sidney; and 7JR, of Cariboo. EB has gas-driven generator in the trunk of his car to run his mobile gear. PY is in the Veterans' Hospital in Victoria. AKG has p.p. 807 clamp tube modulation. The North Vancouver Amateur Radio Club is very active and is looking for more North Shore members. ZF is looking for active u.h.f. stations in the Okanagan Valley. ALJ has a new addition to the family, a baby girl. JM is spending some time in Veterans' Hospital in Vancouver. Where is TF? RT has moved back to his old district and is on with clamp tube 807. US has junked clamp tube; he says it is no good for DX. I wish to say Happy New Year and all the best for 1951. Please write the SCM during 1951 with some news. Traffic: VE7XA 145, AOQ 60, FB 15, ZF 8, AKG 4.

PRAIRIE DIVISION

MANITOBA — SCM, A. W. Morley, VE4AM — PAM: MFA. DN has new ham shack in new QTH. NN's XYL has her ticket. IW was visited by his Dad, 5JS, and now has new 45-watt rig going. RO has two new Sterba curtains up for 28 Mc. HP is the proud possessor of a new HQ-129X. 5JI visited several VE4s on his trip East on a holiday. TJ is heard testing on 3.8-Mc. 'phone. QI is back on using a.m. modulation. 7BW, ex-4JF, wishes to be remembered to all. HT has p.p. 813s modulated by 811s on 3.8 Mc. The Manitoba 'phone net, on 3760 kc., now boasts 28 members. Traffic reports were not received from half of them, though. Traffic: VE4AM 201, HG 75, FA 74, GQ 24, DQ 21, CI 14, GV 14, HA 10, BD 8, GP 8, PA 8, DN 7, HT 4, GB 2.

SASKATCHEWAN — SCM, Harold R. Horn, VE5HR — Thanks, gang, for the honor you have given me as your new SCM. With your continued assistance and the good job DW has done, the further promotion of ARRL activities is assured. 5JX is the former 4FG. BE has left and will be VE6 at Barrhead. AJ is on 14 and 28 Mc. going great guns. YF went back to her first love, 3.5-Mc. c.w. FY confines his activities to AFARS. Congratulations to JV and OC on their promotions with CPR Communications. OC ended 1950 with a three-way QSO with 9X4AS and HZ1AB. The NSARC, with 5PA as home station, conducted a Boy Scout Rally with scouts at the shacks of YF, LY, JW, LE, BE, and 6MJ. JK is RCC member and received VHF Contest certificate for 1950. MV and AF are back on 3.8-Mc. 'phone running 125 watts to 813. IJ and JI are visiting VE3-Land for the winter. KQ has 600 watts on 14 Mc. FR, TE, SW, FG, and FS are new additions to the 'phone net. MA, with s.s.s.c. on 8995 kc., QSOs all U. S. call areas. LD is a new ham at Porcupine Plains. QP has QSL cards for you. Send in your envelopes. JI was lost in the North for a week while deer hunting. JV is QRT until spring, getting the D.K. gang a rest. Traffic: VE5MA 104, HE 85, YF 49, BH 18, EZ 12, DS 11, OC 11, GC 10, JK 9, TE 9, LL 8, PJ 7, FR 5, DN 4, SW 4, LY 3, PQ 3.

TVI TROUBLES?

Do what hundreds of smart amateurs are doing. Switch to a WRL Transmitter. Our new Globe King and Globe Champion incorporate some of the latest TVI protective features . . . can give you complete "screened job" for small additional charge.

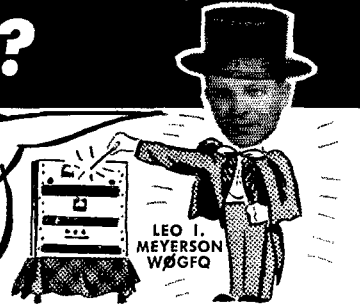

LEO I. MEYERSON
W0GFQ

NEW WRL 400-A GLOBE KING TRANSMITTER

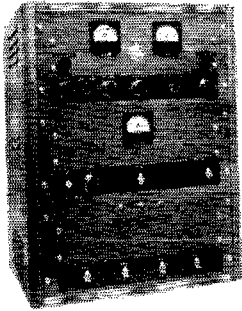

**HIGH POWER
MORE WATTS PER DOLLAR**
Our newest model with increased power—400 watts Phone, 425 watts CW. Incorporates some of the latest TVI protective features. Efficient performance on all bands—10 to 160 on phone and CW. Provisions for ECO. Complete with tubes, meters, and one set of coils.

KIT FORM WIRED-TESTED
\$439.45 \$459.45

Low Down Payments

WRL 150 WATT GLOBE CHAMPION TRANSMITTER

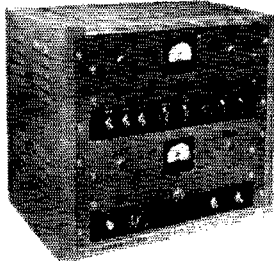

MORE WATTS PER DOLLAR
R.F. Section a complete 150 watt XMTR. Provisions for ECO, Automatic fixed bias on Final and Buffer, Class B Speech Modulator. 150 watt input—10 thru 160 meter bands. Complete with tubes, meters,

KIT FORM WIRED
\$279.00 \$299.00

LOW DOWN PAYMENT

Let me know what you have to trade, any make or model. I'll allow you more for your present equipment. WRL buys more equipment . . . WRL sells more equipment. Our large volume of sales means faster turnover, greater savings for you! We finance our own paper . . . no red tape!

LOW DOWN PAYMENTS
NAME YOUR TERMS
PERSONALIZED SERVICE

FREE



Send for the 1951 complete WRL catalog containing everything new in radio and television. Deal with the "World's Most Personalized Radio Supply House."



CU ON 20 - 10 & 75 METERS

GIANT RADIO REFERENCE MAPS

Just right for your control room walls. Approximately 28" x 36". Contains time zones, amateur zones, monitoring stations. Mail coupon today and . . . **25c**

GUARANTEED CRYSTALS IN HOLDERS Type FT-243 160 METER

1.8 to 1.825 1.875 to 1.9
1.9 to 1.925 1.925 to 2.0

\$1.25 ea.

80-40 METER
3.5 to 4.0 7.0 to 7.4
98c ea.

Please state frequency. We will come as close as possible.

NOW YOU CAN AFFORD TO OWN A BEAM 10 METER BEAM

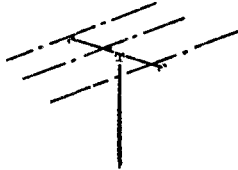

Plumber's delight 3 element beam quickly assembled; furnished with Gamma match. Extremely light; all aluminum construction; grounded antenna; very low priced. Furnished less mast and lead. Full instructions furnished

Narrow spaced **\$15.95**
Wide spaced **\$17.95**

Write for detailed XMTR specification sheets.

WRITE - WIRE

PHONE 7795

World Radio
LABORATORIES INCORPORATED
COUNCIL BLUFFS, IOWA



World Radio Laboratories, Inc.
744 West Broadway
Council Bluffs, Iowa

Q3

Please send me:

- Radio Map Globe King Info
 New Catalog Globe Champion Info
 List of Guaranteed Used Equipment

Name _____

Address _____

City _____ State _____

MOSLEY Handy and EFFICIENT

XTAL HOLDER SOCKETS — ADAPTERS

MOSLEY CRYSTAL & PLUG SOCKET. No. 51 • Single Socket. 1/2" spacing. For small pin crystal holders or any MOSLEY 2 wire plugs. Adapts for 3/4" large pin holder with MOSLEY 75-5 listed below. Mounts directly to metal chassis with non-rusting machine screws furnished.

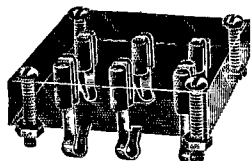
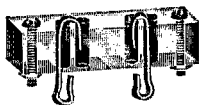

MOSLEY 3-GANG MULTI-SOCKET. No. 53 • For three holders or plugs with 1/2" pin spacing. Mounts on metal panel or chassis. Ideal for bandswitching exciter or as multi-antenna connection to TV set.

MOSLEY 6-GANG MULTI-SOCKET. No. 56 • Same as above but for six crystals or plugs.

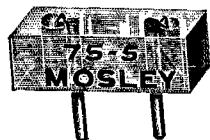

MOSLEY XTAL HOLDER ADAPTER. No. 75-5 • Receives 3/4" spaced xtal holder and fits standard 1/2" spaced sockets including MOSLEY 51, 53 and 56 above.

MOSLEY XTAL HOLDER ADAPTER. No. 5-75 • Same as above except adapts 1/2" spaced xtal holders for use in 3/4" sockets.

MAKE YOUR OWN HI-PERFORMANCE OPEN WIRE TRANSMISSION LINE AND SAVE!

An open wire feed line, using the right kind of spacers, has less loss than ordinary 300 ohm twin-lead. Easy to make with MOSLEY low loss, weather resistant components. Acrylic resin plastic with non-rusting hardware. Solderless.

Cat. No. 450-3, MOSLEY SPACER • Place 12" apart along line. Maintains constant 1" spacing. Threaded holes. Non-rusting screws.

Cat. No. 450-2, MOSLEY ANCHOR BAR • Holds open wire line securely. Use with screw-eye stand-offs of any size or shape. Maintains 1" wire spacing for constant impedance.

Cat. No. 450-1, MOSLEY SPLICER • For joining sections of open-wire line. Maintains line impedance.

See these and other fine MOSLEY electronic products at your dealer

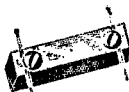

450-3



450-2

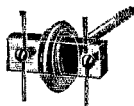

450-1

It Seems to Us

(Continued from page 8)

We can't tell you too much about the form at this time because it is in process of being revised. The old form would scare the wits out of any normal prospective ham, requiring as it does such things as the exact latitude and longitude of the proposed structure (in degrees, minutes and seconds), exact elevation above mean sea level, a map showing the exact location of the antenna site with reference to "nearby cities" and existing tall structures in the vicinity, whose height must be determined and indicated. We've already talked with the people at FCC who have the job of revising this form, pointing out the amateur aspects, and asking for some suitable provisions for amateurs who have to file to relieve them of any such chores when it is obvious their 40-foot 2 X 4s aren't going to disrupt aircraft flight operations; we'll have more information later.

So what happens to the application? Apparently it is used to determine whether the proposed antenna structure possibly may be a menace to air navigation, in which case it will require special study by an aeronautical group. Generally, towers 170 feet and less in height are exempt from such study; in practically all cases, therefore, we'd say only the complexity of filling out the forms is involved for the amateur (the present one has to be filled out in quadruplicate). But in certain instances where the proposed mast is along the line of an instrument approach runway, even at distances of several miles a pole only a few feet high may require attention and conceivably even marking and lighting.

We can't escape the feeling that somewhere along the line in the consideration of this matter at the Commission somebody overlooked the realities of amateur practice. No one, of course, wants to challenge deep and certainly warranted concern on the part of FCC over the possibility of radio towers of its licensees becoming menaces to air navigation. It's a fact, though, that we've simply never heard of any amateur whose poles represented such a hazard. Certainly the great bulk of amateurs put up their skywires in residential areas where surrounding buildings, trees, church spires — and TV receiving antennas — are as high or higher than our modest poles. We think the Commission should take this into account in the application of its rules. On this point, we still haven't given up hope.

We'll keep you posted.

CARL E. MOSLEY
W0FQY

MOSLEY

Electronics

2125 LACKLAND OVERLAND, MISSOURI

SWITCH
TO SAFETY!





HARRISON IS YOUR CIVILIAN DEFENSE HEADQUARTERS!

HARRISON
NEW YORK 7, N.Y.
225 GREENWICH STREET
(10 West Broadway, at Barclay St.)

LYSCO MOBILE TRANSMASTERS FOR 10-11, 20 and 75 METERS

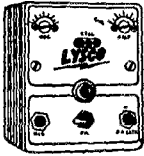

A new series of compact mobile transmitters featuring 25 watts power, clamp type audio for 100% AM modulation, streamlined drawn metal cabinet finished in black wrinkle, built-in antenna relay for push-to-talk operation, etc. Case 4" W x 4 1/2" H x 6". All controls and xtal socket on front panel for fast QSY! Coax output to 50-ohm line. Requires 300-500V DC at 25 MA., 6.3V at 1.35 amps. Use T-17 type microphone.

BAND	TUBES USED	MODEL - PRICE (with tubes)	MODEL - PRICE (less tubes)
10-11 Meters	3-6AQ5	A129T \$33.55	A129 \$29.95
10-11 Meters	3-8V6GT	B129T \$33.55	A114 29.95
20 Meters	3-6AQ5	A114T 33.55	B129 29.95
20 Meters	3-8V6GT	B114T 33.55	B114 29.95
75 Meters	3-6AQ5	A175T 33.55	A175 29.95
75 Meters	3-8V6GT	B175T 33.55	B175 29.95

STANCOR ST-203A MOBILE XMTR

Stancor's ever popular 10-11 meter transmitter. Mobile operation from dynamotor or vibrator supply—use AC pack for home or portable use. 6V6 Osc., 2E26 Final—conservatively rated 25 wattals 615 Speech Amp., Push-pull 6VE modulators for 100% AM modulation. Handy xtal switch, antenna loading system, and changeover relay. Attractive case finished in silver-gray hammetone novel spring fasteners allow instant removal. 8 3/4" W x 7 3/4" H x 6 3/4". Kit comes complete with instructions, less only accessories and tubes.

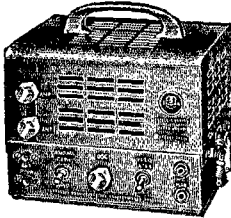

STANCOR ST-203A KIT — \$47.50
Wired model has been discontinued.

100-1000 KC CRYSTAL SCOOP!

Mounted dual frequency crystal to provide 100 KC or 1000 KC. Ideal for that frequency standard. Not war surplus. Fresh stock—famous manufacturer—fully guaranteed. Type SMC100 Regularly \$8.75. While a few last \$5.95



HOME & MOBILE EMERGENCY RECEIVERS

A new series of high-performance, emergency band FM receivers for home and mobile use—ideal for Police, Firemen, News Photographers, Reporters, Civilian Defense Workers, Emergency Auto Service Units, etc. etc.

HEAR: Police Calls — Fire Alarms — Bus Dispatchers — Petroleum Guards — Border Patrol — Railroad Communications — Ambulance Calls — Taxicabs — Forest Rangers — Ships-at-Sea — Mobile Telephone — Etc. etc.

BOTH TYPES FEATURE: • 5 tubes plus rectifier • Ratio Detector • Sensitive Superhet Circuit • Quiet When No Signal • 100 KC Selectivity • 5" Alnico V Speaker • Drift Compensation • Illuminated Airplane Type Dial • 10 Micro-volt Sensitivity • Other Outstanding Features.

MONORADIO

MOBILE FM RECEIVERS

Complete receiver comes in Gray Hammetone cabinet with provision for under dash or universal mounting. Built-in vibrator supply and speaker. VR tube added for extra stability.

Model M-101 Covers 152 MC to 162 MC Band \$72.50
High Frequency Antenna for use with M-101 (A-101) 7.50
Model M-51 Covers 30 MC to 50 MC Band 72.50
(Use Master Mobile 96" Whip with Model M-51)
Specify whether for 6 or 12 volt DC operation.

POLICE ALARM

For HOME or Fixed Location

Housed in attractive walnut finish plastic cabinet. Operates on 115 volts. AC or DC.

Model PR-31 for 30 MC to 50 MC Emergency Band \$44.95
Model PR-8 for 152 MC to 162 MC Emergency Band \$44.95

CIVIL AIR PATROL RADIO HEADQUARTERS

CAP COMMUNICATIONS OFFICERS: for fastest delivery of anything in electronic parts or equipment for your CAP installation, try Harrison first! Harrison Has the Lowest prices always

CAP TRANSMITTER

Here's LySCO's answer to the CAP transmitter problem. Identical in size and design to the 25-watt mobile xmtrs. Operates quies 300 to 500V DC plus filament power. Uses T-17 microphone or equal. Supplied less mike and crystal.

Model	Tubes Required	Filament Voltage
A-140	3 - 6AQ5	6.3V DC or AC
B-140	3 - 8V6GT	12 Volts AC or DC
C-140	3 - 12A6	

Your Choice **\$29.95** Less Tubes
Your Choice With Tubes **\$33.55**

GONSET CAP BAND CONVERTER

Use with any auto or home radio to receive CAP band signals. Covers 1600 KC to 4000 KC — aircraft, CAP, marine, 75-80 meter amateurs, etc.

MASTER MOBILE CAP Antenna for 2374KC Only \$44.74
(Use with any Master Mobile Mount) \$9.95

GASOLINE DRIVEN AC POWER PLANTS

KATO



• City type AC current for farms, camps, outposts, etc., regardless of location. Convenient! Economical!

• Ideal protection against power line failure for homes and industry. It pays to be prepared! Don't be without lights, heat, refrigeration, radio, etc.

• Standby transmitter power. Keeps your rig on the air during any emergency.

Famous KATOLIGHT, precision-engineered AC power plants are ruggedly designed to give long, dependable service. Low operating cost, easiest installation. Delivers 115 Volts, 60 Cycle AC and DC to charge batteries. Filtered and shielded. Conservatively rated — do not confuse with economy-type power plants. Use anywhere — boats, cabin trailers, fixed locations, etc.

500 Watts	(Hand Start Model)	\$172.80
500 Watts	(Push Button Start)	206.50
700 Watts	(Hand Start Model)	216.80
700 Watts	(Push Button Start)	250.40
1200 Watts	(Push Button Start)	325.60
2500 Watts	(Push Button Start)	431.20

Early Delivery All Models — Prices F.O.B. Minnesota
Other sizes to 25 KW — Write for literature.

110V AC IN YOUR AUTOMOBILE!

Terado's new Senior Model Inverter delivers 45 watts of 110-volt, 60 cycle AC from any 6-volt DC source! Ideal for your car, cabin, boat, house trailer, etc. Use for operating phonographs, lamps, electric shavers, motors, fluorescent lights, etc., etc., etc. Compact—only 2 1/2" x 2 1/2" x 4" long. Complete with cord and provision for plugging into cigarette lighter socket. Standard AC receptacle provided for output.
6V DC to 110V AC — 60 cycles Model No. 6-1160 \$10.95
JUNIOR MODEL — Identical to Senior Model except delivers 110 volts AC at 115 cycles (40 watts maximum). Ideal for AC-DC radios, lamps, etc. Model 6-110 Only \$8.95

MASTER MOBILE MOUNTS & ANTENNAS

Model	Description	Price
Model 132	MOUNTS (Tapped for 3/8" threaded stud)	
Model 132X	Universal Body Mount	\$8.75
Model 132S	Same with Heavy Duty Spring	9.25
Model 140	132 with Stainless Steel Spring	10.75
Model 140X	Bumper Mount	6.55
Model 142	Same with Heavy Duty Spring	7.65
Model 92	Bumper Mount — No Spring	3.25
	18" Adjustable Extension Bar	3.25
STAINLESS STEEL ANTENNAS		
100-96S	96" Whip 3/4" Stud for All Mounts	
105-96S	96" Whip, Plain end to fit 92 Ext.	5.25
	All Band Antenna with 20, 40, or 75 meter coil	4.50
	Extra Coil for 20, 40 or 75 meters. Each	8.75
	(Use All Band Antenna on 10 by shorting coil)	3.30

LOOK

POWER SUPPLY SCOOP!

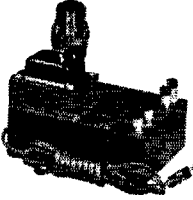

Utility power supply, 350 volts dc @ 50 Ma., 6.3 volts @ 2 Amp., black crackle chassis $6\frac{1}{4}$ " x 5" x 2". Has choke and 2-section filter, AC switch and line cord, a wonderful buy, less No. 80 rectifier, only..... **\$2.25**

PLATE TRANSFORMER



510-0-510 volt, 200 Ma. transformer, fully shielded, upright mounting, electrostatic shielding, $4\frac{1}{2}$ " high, 4" wide, 4" deep, 9 lbs. at less than half regular price. **\$3.95**

8/8/8 MFD. 500 V. D.C.

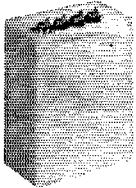

Triple 8 mfd. 500 working volt D.C. oil-filled condenser, common negative, solder terminals, hermetically sealed, 5 " x $3\frac{3}{8}$ " x $2\frac{1}{4}$ ". A one-time buy..... **\$1.95**

BC-348 RECEIVERS



EXCELLENT CONDITION

\$109.50

All prices F.O.B. Cincinnati
20% deposit on C.O.D. orders
73, Jule Burnett, W8WHE

Steinberg's

633 WALNUT STREET • CINCINNATI 2, OHIO

The "WWV-er"

(Continued from page 26)

Testing and Alignment

A check with a voltmeter should show 6.3 volts at Pin 4 of the 6BE6 socket and approximately 100 volts at the plate and screen prongs. If current is measured, the oscillator grid and the total cathode currents should be roughly 0.5 and 10 ma., respectively.

Any one of the usual systems for lining up a converter may be used with the WWV-er. It is advisable to start out with tight coupling to the first i.f. tube of the receiver and this is accomplished by stripping the braid from the receiver end of the output cable and then wrapping several loops around the grid pin of the tube. It is essential that the converter be first lined up at the highest frequency of operation. This means that capacitors C_2 and C_7 should be adjusted for maximum response to a 10-Mc. signal before the 5-Mc. trimmers, C_4 and C_5 , are adjusted.

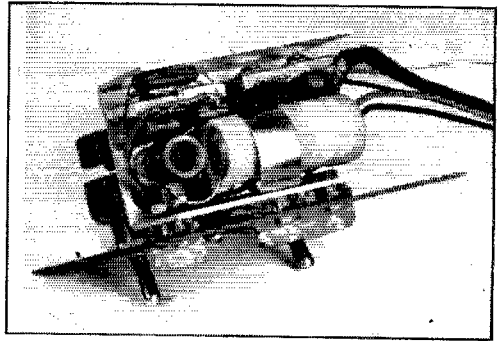

A bottom view of the converter showing the placement of the oscillator coil and the trimmer-type tuning condensers.

Coupling between the converter and the i.f. amplifier should be more critically adjusted after the r.f. circuits have been aligned. The loosest possible coupling is desirable because it has the least loading effect on the i.f. tube. However, the coupling should be tight enough to make the WWV signal stand out above all but the very loudest signal that may pass through the receiver. Should the gain characteristics of a particular receiver make tight coupling necessary, it is recommended that the i.f. transformer of the receiver be repeaked to compensate for any detuning that may have occurred.

We have been using the regular transmitter-receiver antenna with the WWV-er. Undoubtedly, there are locations where a few feet of wire will provide sufficient pick-up for the unit.

SWITCH TO SAFETY!





Our 28th Year

QUALITY - PRICE
DEPENDABILITY

SPOTLIGHT
on
VALUE

CRYSTALS

WORTH LOOKING INTO!

They are all perfect, all have been tested and the PRICE is out of this world.

FT-243 Type	DC-30 Type	
Frequency range 5675	4550 KC	5080 KC
8650 KC. Every 25 KC.	4950 KC	6450 KC
FT-241 Type	4970 KC	7010 KC
From channel 0-781	5570 KC	7810 KC
	5660 KC	7930 KC

We have a large quantity of other types of Crystals in Frequencies from 4000 KC to 9000 KC.

49¢
EACH

RAYTHEON Voltage Stabilizer

Precision built units provide maximum voltage stabilization with maximum variation in output voltage. We have models to meet practically every installation requirement. Guaranteed to deliver controlled output voltage to $\pm 1/2\%$.

For larger installations the 2000 Watt models operate on 95 to 130 Volt input, 60 cycle, single phase, output of 115 volt stabilized to $\pm 1/2\%$ or with input of 190 to 260 volt output of 230 volt stabilized to $\pm 1/2\%$.

No.	Output Capacity Watts	DIMENSION IN INCHES			Net Weight lbs.	Price
		L.	W.	H.		
VR-6110	15	5 3/4 x	2 1/4 x	3 1/2	4	\$ 16.00
VR-6101*	30	7 1/2 x	3 3/8 x	4 1/8	5	18.00
VR-6111	30	7 1/2 x	3 3/8 x	4 1/8	5	18.00
VR-6112	60	7 1/2 x	3 3/8 x	4 1/8	8	25.00
VR-6113	120	7 1/2 x	3 3/8 x	5 1/8	14	33.00
VR-6114	250	12 3/8 x	5 x	7 3/8	25	52.00
VR-6115	500	12 3/8 x	5 x	9 1/8	45	81.00
VR-6116	1000	14 1/8 x	13 3/8 x	9 5/8	92	135.00
VR-7B	2000	16 3/8 x	14 7/8 x	12 3/8	200	245.00

*Output 6.0 or 7.5 volts stabilized $\pm 1/2\%$.

We Carry A Complete Line of SUPERIOR Products. Powerstats, Voltage Regulators, Volt boxes.

If not rated 25% with order, balance C O D. All prices F. O. B. our warehouse New York. No order under \$2.00 We ship to any part of the globe.

LEEDS RADIO CO.

75 Vesey Street
COrtlandt 7-2612

Dept. QS 3
New York City 7

Watch MERIT FOR TV IN '51....

Try these MERIT Ham Units for your "Rig."
Make MERIT first choice for your transformer needs.

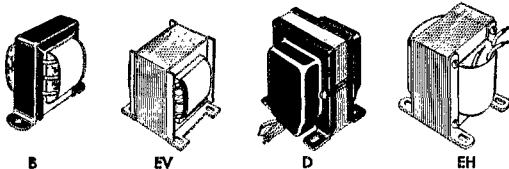

XMTR Rectifier Filament Type

Type No.	Sec. Volts	Sec. Amp.	Insul. Volts	Dimensions			Mtg.	
				H	W	D		
P-2940	2.5 c.t.	10	7500	3	3 $\frac{3}{8}$	2 $\frac{1}{4}$	B	\$3.15
P-3042	2.5 c.t.	10	10000	2 $\frac{7}{8}$	3 $\frac{3}{8}$	2 $\frac{1}{4}$	EH	3.45

XMTR Filament for Medium and High Power Popular Tubes

Type No.	Sec. Volts	Sec. Amp.	Insul. Volts	Dimensions			Mtg.	
				H	W	D		
P-2943	5 c.t.	20	2500	3 $\frac{3}{4}$	3 $\frac{1}{8}$	3	EV	\$6.00
P-2947	6.3 c.t.	6	2500	3	3 $\frac{3}{8}$	2 $\frac{1}{4}$	B	3.00
P-3146	10 c.t.	10	3000	3 $\frac{3}{8}$	3 $\frac{3}{8}$	3 $\frac{3}{8}$	D	5.55

Low and Medium Power Plates

Type No.	Sec. Rms. Volts	Sec. DC Volts	DC Sec. M.A.	Dimensions			Mtg.	
				H	W	D		
P-3175	550-550	400	150	3 $\frac{3}{8}$	3	3 $\frac{3}{8}$	D	\$5.70
P-3159	900-900	750	225	4 $\frac{3}{8}$	3 $\frac{1}{8}$	5 $\frac{1}{8}$	D	9.00
	800-800	600						
P-3167	1450-1450	1200	300	5 $\frac{3}{8}$	6 $\frac{1}{8}$	4	EH	22.35
	1175-1175	1000						

See Merit Catalog No. 5111 for other items.
Ask your dealer or write

MERIT
TRANSFORMER CORP.
4431 NORTH CLARK ST., CHICAGO 40, ILL.

New Regulations

(Continued from page 31)

provided for greater use of Narrow-band Frequency Modulation in all the bands authorized for type A3 emission. Long experience has shown that Narrow-band Frequency Modulation when used in the amateur service results in the elimination and in many cases a considerable reduction of interference to both broadcast and television service.

In many cases, it provides the opportunity to operate with radiotelephony where if Amplitude Modulation were employed and all requirements of the rules were being satisfied interference results to both broadcast and TV reception because of lack of selectivity in the front end of the receiver or blanketing or both, and the amateurs who work all day must remain off the air during TV program transmissions in their areas.

Narrow-band FM has for over a period of approximately 4 years been authorized in the major part of the 10-meter band (25.5 to 29.0 Mc.) but only in 50 kc. portion of the 20 and 75-meter band for experimental purposes; no deleterious results have been experienced as it concerns Amplitude Modulated signals in the 20 and 75-meter bands. In the light of this extensive experience with Narrow-band FM, it should be authorized throughout all the portions of the bands authorized for radiotelephony.

In view of the experiments that are now being conducted by amateurs with single side-band radiotelephony, a portion of each part of the bands authorized for radiotelephony should have been earmarked for single side-band experimentation. At some later date, based upon the results of the experimentation, additional space could be provided for such use and without any restrictions on the class of radio operator license held. In no case should this technique be limited to the holders of the amateur extra class license.

We are of the opinion that it would have been prudent to withdraw the proceedings in Docket No. 9295 for the following reasons:

Nearly two years have elapsed since the Commission initiated the Proposed Rule Making and nearly three years have elapsed since the original proposals of the American Radio Relay League (ARRL) were received by the Commission, which, in our opinion, led to the original Proposed Rule Making. The ARRL Board will have their annual meeting in May of this year and, no doubt, new proposals will be made to the Commission for modification of the rules, and other amateur organizations and individuals, no doubt will offer counter and new proposals if the amateurs are on the air at that time.

At the most the rules adopted today are only a patchwork job. There is a need to study and revise the rules in light of the present situation as it concerns advances in the art, trends and the problems relating to interference to other services. On December 15, 1950, the President declared a National Emergency. It is our opinion that in light of the critical international situation and faced with the possible necessity of closing down the amateur service except to the extent it may be used in the Civilian Defense, the proceedings should be dismissed and the efforts of the Commission's staff that can be utilized in administering the amateur service, taking into consideration the Commission's National Defense obligations, limited budget and shortage of manpower, should be devoted to the studies and administration of the part the amateur will play in National and Civilian Defense. It must be realized that many amateurs have been, and others will be, called into the military service and many are, and will be employed in agencies of the Government. The Commission already has taken action to suspend the renewal service required for amateurs, for the next year for those in the military service — this action is similar to that taken in World War II and the period immediately subsequent thereto.

The Director of Civilian Defense has recognized the potentiality of the well-organized and experienced amateur service in meeting the needs for communication during the emergency. "Because of their wide distribution throughout the nation, their proven ability to provide efficient communication in emergencies and the supply of equipment in the possession of amateurs, particularly mobile and portable apparatus, the amateurs provide an immediate reservoir of both experienced personnel and equipment to meet the needs of the Country in this hour of need. They should in sufficient numbers and by nationwide distribution be permitted to serve in this capacity without any change in their identity

(Continued on page 110)

CALL LETTER PLATES

Type A-18 -
For Your Car

W8ENH

A large, sturdy cast aluminum plate with satin-finished letters and border against

Type A-19 -
For Panel Mounting

\$3.20 POSTPAID

a black baked enamel background. Red, green, blue and gray -- 50¢ extra. Size - 2 $\frac{1}{2}$ " x 8 $\frac{1}{2}$ " with 1 $\frac{1}{2}$ " letters.

LAPEL BUTTONS

An attractive metal button with highly polished raised letters against a black background. Other colors 50¢ extra.

W9HKZ

KEYHOLE SIZE **\$1.10 POSTPAID**

Type A-26L With Screw Backing
Type A-26P With Pin Backing

SREPCO Inc.
STANDARD RADIO & ELECTRONIC PRODUCTS
134 S. Second St. DAYTON 2 OHIO Tel. TUlton 2174

CASH WITH ORDER
Allow three weeks for delivery.

THE RADIO AMATEUR'S HANDBOOK



1951

EDITION

AVAILABLE NOW

PRICE \$2.50 U.S.A. proper

\$2.75 U.S. Possessions and Canada • \$3.00 Elsewhere

PUBLISHED BY THE AMERICAN RADIO RELAY LEAGUE,
INCORPORATED, WEST HARTFORD, CONNECTICUT

RADAR, COMMUNICATIONS and SONAR TECHNICIANS WANTED

For Overseas Assignments

Technical Qualifications:

1. At least 3 years' practical experience in installation and maintenance.
2. Navy veterans ETM 1/c or higher.
3. Army veterans TECH/SGT or higher.

Personal Qualifications:

1. Age, over 22—must pass physical examination.
2. Ability to assume responsibility.
3. Must stand thorough character investigation.
4. Willing to go overseas for 1 year.

Base pay, bonus, living allowance, vacation add up to \$7,000.00 per year. Permanent connection with company possible.

Apply by Writing to:

**C-3, P.O. Box 3552
Philadelphia 22, Pa.**

Men qualified in RADAR, COMMUNICATIONS or SONAR give complete history. Interview will be arranged for successful applicants.

TVI? • BCI?

The R. L. Drake High Pass Filter at the TV Receiver — and a Low Pass or Half-Wave Harmonic Filter at your Transmitter will help keep you on the air. See our ads in Dec. 1950 and Jan. 1951 *QST*.

R. L. DRAKE CO.

11 Longworth St.

Dayton 2, Ohio

with appropriate security safeguards. If the staff has any additional time, it should be devoted to an over-all study of the amateur service for the reasons set forth in the following paragraph.

It is our opinion that the technical rules should be studied looking towards Standards of Good Engineering Practice so that if interference results to broadcast or television reception and a determination has been made that the amateur is complying with the rules with respect to suppression of harmonics and spurious emissions, the burden is not placed on him stay off the air when it can be shown that the addition of a high-pass filter connected to the front end of a TV receiver at a cost of approximately \$3.85 will eliminate the interference.

Much too often interference from other sources is blamed on the amateur service.

Moreover, the amateurs themselves have proceeded to place their own house in order by modernization of their transmitters in order to eliminate and suppress harmonics and spurious emissions. Even though they have done this to a degree normally not anticipated in the Standards of Good Engineering Practice for other radio services, interference still results mainly because manufacturers of TV receivers fail to provide proper selectivity in the front end of their receivers. This has led many amateurs, after spending considerable money to place their transmitters on a high engineering standard as it concerns suppression of harmonics and spurious emission, to canvass their neighborhoods to determine the extent they are interfering with TV reception and in many cases at their own expense voluntarily purchasing and installing for the owner of the TV receiver a high-pass filter, a device which could be built into the TV receiver by the manufacturers at a very low cost and often prevent interference originating from sources other than the amateur transmitters.

There are several related problems including the policy the Commission should adopt when TV viewers insist upon protection from interference in "fringe" areas or in any area outside the protected service area, a policy similar to that taken on December 1, 1949, when it relieved the operator of type approved diathermy equipment of the burden of eliminating "IF" interference to TV and other receivers.

The rules adopted permit radiotelegraphy to be used throughout all the bands below 29.7 mc, including those authorized for radiotelephony and it is only by courtesy that radiotelegraphy is not employed generally in these radiotelephony bands. The rules should prohibit the use of radiotelegraphy in any part of the radiotelephony bands below 29.7 mc. Just because amateur radio was once all telegraphy, there is no need to avoid facing up to the reality of the situation as it exists today.

The use of radiotelephony for both fixed and mobile use, particularly the latter has increased year by year on the part of the amateur, as it has in all the radio services including safety services such as marine, aviation and the military service.

At one time portable operation was confined mainly to the VHF and UHF bands. Due to the resourcefulness of the amateur, equipment and radiators have been developed which permit mobile radiotelephony to be used in the lower bands with a high degree of efficiency. Because of the speed in exchange of communications we find an increasing use of radiotelephony in regular and emergency communications, both in the fixed and mobile amateur stations. Accordingly, it would be appropriate to consider this trend and determine if it would not be to the interest of the amateur service to provide a wider allocation in the 3.5-4 and 14.0-14.4 mc bands for type A-3 emission.

Since the majority have moved to adopt Docket No. 9295, it is our opinion that the amateur service should continue to operate under the present rules with the changes in Section 12.20 as it relates to the establishment of the Technician and Novice class of license and the additional 50 kc of space provided for radiotelephony in Section 12.111 unless for reasons of national security restricted operation becomes necessary.

When peace and tranquillity come again to our Nation, the staff could then devote its efforts to revising the rules on the basis of recommendations made by amateur organizations and interested parties to participate, looking towards the adoption of rules that will meet the situation at that

(Continued from page 112)

NOW! A Better Frequency Standard Crystal

THE JK G-9

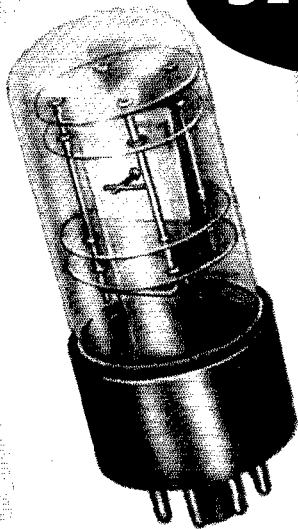

ACTUAL
SIZE

- ★ Absolute Hermetic Sealing
- ★ Dependable Vacuum
- ★ Higher Q
- ★ No Supersonic Reflections
- ★ Greater Stability

JAMES KNIGHTS takes pride in presenting the JK G-9, first of a series of new crystals employing a glass envelope for absolute hermetic sealing. A dependable vacuum can be maintained, resulting in higher crystal Q and absolute freedom from the effects of supersonic reflections.

Although now available only in limited quantities and only in the 90 to 200 KC range, it is planned to use this mounting on higher frequencies.

Excellent thermal insulation is afforded by the glass and vacuum, utilizing the principle of the thermos bottle. In oven operation, for instance, a thermostat cycle of several degrees will result in a change of only a fraction of a degree at the crystal—providing stability never before possible!

LESS CRYSTAL "AGING"—Greater cleanliness is achieved in the new JK G-9 because glass is not porous and does not de-gas as does metal. Temperatures that would be destructive to the characteristics of a crystal are necessary for complete de-gassing of metal holders, whereas clean glass holders are relatively easy to de-gas. Because no fumes are emitted by the sealing operation, crystal "aging" is substantially reduced.

With minimum power dissipation, as employed in modern oscillator design, the new JK G-9 provides a new standard of stability plus years of trouble-free precision operation.

JK
CRYSTALS

The James Knights Company
SANDWICH, ILLINOIS

Specify JK for civilian,
military or amateur use!

SPECIAL TUBE SOCKETS

For high power tubes Gates has designed several very attractive tube sockets.

← To the left, a socket for the Eimac 3X2500 tube.

To the right, a socket for such tubes as the 889R, 891R, →
892R and others.

Available in small or large quantities at proportional prices.

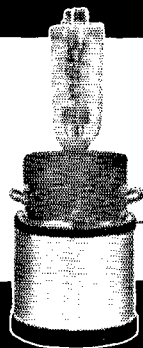

GATES RADIO COMPANY

Manufacturing Engineers Since 1922
QUINCY, ILLINOIS, U. S. A.

Telex Headsets Keep QSO's Q5

CAA
APPROVED

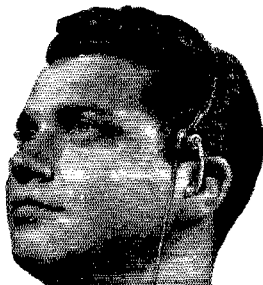

THE TELEX TWINSET

The Twinset is easy on the ears! No pressure whatsoever, background noise blocked out. It clips sharply at 3000 cps adding another Q5'er to your receiving setup. Mighty relaxin' for hours of traffic, DX, or just plain rag chewing.

The Twinset weighs only 1.6 ounces, completely eliminates fatigue and discomfort.

Write for free folder on the Twinset today . . . or see your Parts Jobber.

TELEX Dept. Y-21-10
TELEX PARK
ST. PAUL, MINN.

In Canada, ATLAS RADIO CORP., TORONTO

Standard of the World for Quality Headsets

LEARN CODE!

SPEED UP Your
RECEIVING
with G-C

Automatic Sender

Type S

\$24.00 Postpaid in
U. S. A.

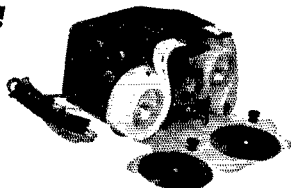

Housed in Aluminum Case. Black Instrument Finished. Small—Compact—Quiet induction type motor. 110 Volts—60 Cycle A.C.

Adjustable speed control, maintains constant speed at any Setting. Complete with ten rolls of double perforated tape. A wide variety of other practice tapes available at 50c per roll.

GARDINER & COMPANY
STRATFORD NEW JERSEY

time, and they would, no doubt, take into consideration new electronic and communications devices stemming from our latest defense effort.

Section 12.22. Application for amateur operator license. The application for any new amateur operator license, including application for any change in operating privileges, shall be submitted in person or by mail to the district field office of the Commission at which the applicant desires his application to be considered and acted upon, which office will make the final arrangements for conducting any required examination. If the application is for a license which is obtained upon successful completion of an examination by volunteer examiners under the special provisions of Section 12.44(c), the application shall be submitted to the district field office which supplied the examination material. Applications for renewal or modification of license, or for duplicate license, when no change in operating privileges is involved, shall be filed directly with the Commission at its Washington 25, D. C. office.

Section 12.23. Who may operate an amateur station. An amateur radio station may be operated only by a person holding a valid amateur operator license. Such station may be operated by the licensee only in the manner and to the extent provided in his amateur operator license. Persons other than the station licensee, when operating such station, may operate it only to the extent and in the manner authorized to the licensee of the station and not exceeding the operating authority of such person's own amateur operator license. When an amateur station is used for telephony, the station licensee may permit any person to transmit by voice, provided during such transmission call signs are announced as prescribed by Section 12.82 and a duly licensed amateur operator maintains actual control over the emissions, including turning the carrier on and off for each transmission and signing the station off after communication with each station has been completed.

Section 12.45. Additional examination for holders of Conditional Class Operator licenses. The Commission may require a licensee holding a Conditional Class of operator license to appear for a General Class license examination at a location designated by the Commission. If the licensee fails to appear for the General Class examination when directed to do so, or fails to pass such examination, the Conditional Class operator license previously issued shall be subject to cancellation and, upon cancellation, a new license will not be issued for the Conditional Class privileges.

Whenever the holder of a Conditional Class amateur operator license changes his actual residence or station location to a location where he would not have been eligible to apply for a Conditional Class license in the first instance, or whenever a new examining location is established in an area within which the holder of a Conditional Class amateur operator license would not have been eligible because of such examination location, to apply for a Conditional Class license, such holder of Conditional Class license shall appear within 4 months thereafter at an examining location and time designated by the Commission and be examined for a General Class license. If, under such circumstances, the licensee fails to appear for the General Class examination, or fails to pass such examination, the Conditional Class license previously issued shall be subject to cancellation and, upon cancellation, a new license will not be issued for the Conditional Class privileges.

Section 12.48 Grading. Code tests are graded as "passed" or "failed," separately for sending and receiving tests. Failure to pass the required code test for either sending or receiving will terminate the examination.

Seventy-four percent is the passing grade for written examinations. For the purpose of grading, all elements, other than elements 4(A) and 4(B), required in qualifying for a particular license will be considered a single examination, and elements 4(A) and 4(B), will be considered as separate examinations.

Section 12.49. Eligibility for re-examination. An applicant who fails examination for amateur operator privileges may not take another examination for such privileges within 30 days, except that this limitation shall not apply to an examination for a General Class license following an examination for a Conditional Class license.

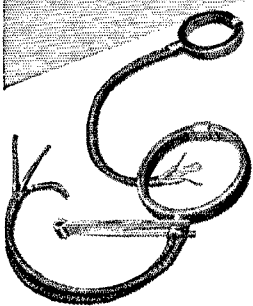
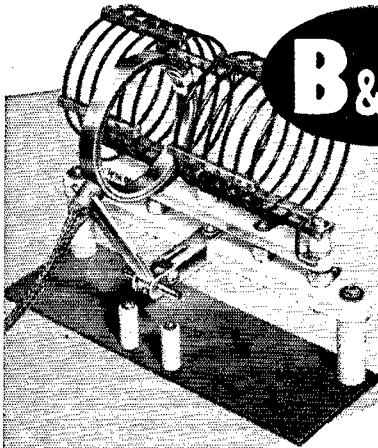

B&W FARADAY SHIELDED LINKS

... for reducing TV and BC interference

B&W Faraday Shielded Links are highly effective in reducing harmonic or spurious signal radiations, normally transferred by capacity coupling, and which are always present with an open wire link. They're easily adapted to all conventional link-coupled circuits and with external antenna units, or in conjunction with harmonic suppression filters of either the low-pass or band-pass type. Available for B & W Series HDVL, TVL, TVH, and BVL coils. Write for Bulletin 605.

BARKER & WILLIAMSON, INC.

237 FAIRFIELD AVE.

UPPER DARBY, PA.



Can You See Your Future in Television . . . Electronics?

CREI Home Study qualifies you for better paying jobs in essential industry, or the Armed Forces

"Technicians may soon be as scarce as certain tubes," says an informed industry spokesman as growing military demands cut sharply into available skilled personnel. Now is certainly the time to get into electronics! In this essential industry you're assured—if qualified—of a lifetime career. And if you're headed for the Armed Services, your technical electronics ability will set you apart from the crowd—put you in line for supervisory work at extra pay in vital radar, navigation, or communications units.

CREI's practical home study training is recognized by industry and the military as outstanding. It starts with basic principles and goes step-by-step through advanced TV, communications, and industrial techniques. For detailed proof, send for booklet. It can lead to promotion, more money, and a lifetime career. Act now!

CAPITOL RADIO ENGINEERING INSTITUTE

Dept. 163C, 16th & Park Rd., N. W., Washington 10, D. C.

Send booklet "Your Future in the New World of Electronics" and course outline.

CHECK FIELD OF GREATEST INTEREST

{	<input type="checkbox"/> TV, FM & Advanced AM Servicing	<input type="checkbox"/> Aeronautical Radio Engineering
	<input type="checkbox"/> Practical Television Engineering	<input type="checkbox"/> Radio-Electronics in Industry
	<input type="checkbox"/> Broadcast Radio Engineering (AM, FM, TV)	
	<input type="checkbox"/> Practical Radio Engineering	

Name

Street

City Zone State

If residence school in Washington, D. C., preferred, check here

MAIL COUPON FOR FREE CATALOG!

CUT HOLES FAST IN RADIO CHASSIS

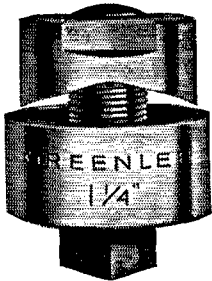

WITH A GREENLEE RADIO CHASSIS PUNCH

Eliminate tedious reaming and filing. Just turn GREENLEE punch with an ordinary wrench and make clean, accurate holes in a hurry. There's a GREENLEE for each of these sizes: $\frac{1}{8}$ " ; $\frac{3}{16}$ " ; $\frac{1}{4}$ " ; $\frac{5}{16}$ " ; 1 " ; $1\frac{1}{16}$ " ; $1\frac{1}{8}$ " ; $1\frac{1}{4}$ " ; $1\frac{1}{2}$ " ; $1\frac{3}{4}$ " ; $1\frac{7}{8}$ " ; $2\frac{1}{4}$ ". Also GREENLEE Knockout Punches and Cutters for conduit and meter holes up to $3\frac{1}{2}$ ". Write for facts. Greenlee Tool Co., 1863 Columbia Avenue, Rockford, Illinois.

TOOLS FOR CRAFTSMEN

GREENLEE



CIVILIAN DEFENSE IS ON 2-6-10 METERS

HY-LITE IS READY — ARE YOU?
COMPLETE CATALOG D-51 ON REQUEST

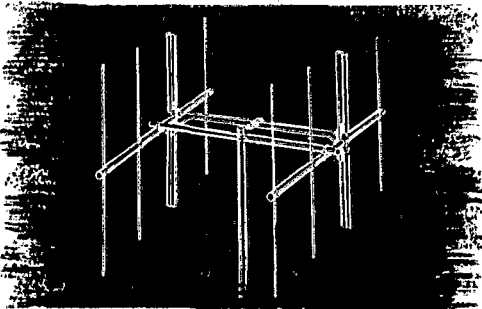

YAGI 2 METER BEAMS AVAILABLE NOW

4E2 4 Element 2 Meter with Folded Dipole.

8E2 Consists of 2-4E2 units and "Q" Bars, Boom and all necessary hardware. **\$20.50 Net**

16E2 Consists of 4-4E2 units, "Q" Bars, Booms and all necessary hardware. **\$41.00 Net**

**\$875
NET**

HY-LITE Antennae INC.

Makers of Fine Antennas for AMATEUR · FM · TELEVISION

242 East 137th St., New York 51, N. Y.

Hams Aid Korean War Effort

(Continued from page 41)

Realizing that Capt. Ziglinski was too busy to pick up the call, Lieut. Dickinson called in on c.w. and told HL1CD to drop down 10 kilocycles in frequency and use c.w. instead of radiotelephone. He knew that with a weak signal c.w. could carry better than voice. HL1CD followed his instructions and the two stations established a second important circuit between Tokyo and Korea.

Wild rumors were then circulating in both Tokyo and Korea and the chief mission of Capt. Ziglinski and Lieut. Dickinson was to help pass more accurate information back and forth. There was a strong fear of an amphibious landing at Pusan at that time, and once there was a report that a landing had actually taken place 30 miles north of Pusan. Lieut. Dickinson was making reports to Brig. General Back every ten minutes and in between reports he forwarded messages from and to high officials in Japan, including Maj. General F. E. Partridge, Fifth Air Forces commander.

Lieut. Dickinson's contact with the weak 20-watt station in Pusan rested on his three-element rotary beam antenna on 20 meters. And even though his contact was by code, he could measure the rising distress and worry which hung over the Pusan station. The Americans there were huddled in a guarded compound, wondering at what minute guerillas might attack them. At times their landline to Seoul went out, and then Lieut. Dickinson relayed their messages to Seoul through Capt. Ziglinski's contact with HL1US.

Fellow hams came over at intervals to give Capt. Ziglinski and Lieut. Dickinson a chance to eat nap during the long hours of night. Major Huebler helped Capt. Ziglinski at the controls, and Capt. Robert K. Slaven of the 71st Signal Service Battalion sat in for Lieut. Dickinson at Washington Heights. The wives of the four amateurs helped get them over the stretch with coffee and sandwiches.

After the men were called back to their military duties, they continued to listen-in on Korea in their off-duty time. There were still many personal messages from Americans in Korea to their relatives in the United States which had to be relayed.

In 1936 Capt. Ziglinski received an ARRL Public Service Certificate for his work during the Allegheny River Valley flood. He stuck it out in his home, with the flood waters lapping through the living room, handling rescue messages over his Stateside station, W3OLM.

For Lieut. Dickinson, it was his first emergency operation, and it hit within less than a year after he got his amateur license. He went on the air with JA2DD in August 1949. His father, Maj. Donald C. Dickinson, a SC officer on duty at Fort Mason, Calif., was one of the first licensed amateurs in the United States. It makes Lieut. Dickinson a combination Army "brat," Signal Corps "son," and second-generation "ham."

BENDIX RADIO DIVISION



ELECTRONICS AND RADIO POSITIONS NOW OPEN CAPITALIZE ON YOUR AMATEUR EXPERIENCE

● LABORATORY TECHNICIANS

Opportunity to associate with Bendix scientists in laboratory development of high power radar and communication electronic gear. Requirements include working familiarity with electronic components and basic circuits. Salaries from \$3100 to \$3800.

● TECHNICAL WRITERS

Knowledge of radar fundamentals required. Work closely with engineers to gather material for instruction and maintenance manuals. Base salaries from \$3400 to \$4300.

● ELECTRONICS ENGINEERS — at all salary levels. Research and Production Design.

● TEST AND INSPECTION ENGINEERS

Practical knowledge of radio, radar or TV manufacturing processes. Good knowledge of radio fundamentals essential. Base salaries from \$3900 to \$5880.

● FIELD ENGINEERS

Supervise installation and maintenance of radio and radar equipment. Factory training will be given. Base salaries from \$4200 to \$6900 per year. 25% bonus for time spent overseas. Traveling and living expenses paid by Bendix. Insurance plan.

ALL BASE SALARIES QUOTED ABOVE INCREASED UP TO 30% DUE TO SCHEDULED 48 HR. WEEK.

HOUSING IS NO PROBLEM IN BALTIMORE

EXCELLENT GROUP INSURANCE AND FAMILY HOSPITALIZATION AND SURGICAL BENEFITS

MODERN LABORATORIES — AIR-CONDITIONED PLANT

ATTRACTIVE RETIREMENT PLAN FOR SALARIED PERSONNEL

Write now stating personal experience record:

**J. Siena, Engineering Personnel Supervisor
Bendix Radio Division, Bendix Aviation Corp.
Baltimore 4, Maryland**

AMATEURS SPECIAL

One 814 transmitting beam tetrode.....\$3.50

Two 1616 high vacuum rectifiers.....\$.75

All three in special offer at
\$3.75 F.o.b.

The **OVERBROOK COMPANY**
Overbrook 81, Mass.

EASY TO LEARN CODE

It is easy and pleasant to learn or increase speed the modern way — with an **Instructograph Code Teacher**. Excellent for the beginner or advanced student. A quick, practical and dependable method. Available tapes from beginner's alphabet to typical messages on all subjects. Speed range 5 to 40 WPM. Always ready, no QRM, beats having someone send to you.

ENDORSED BY THOUSANDS!

The **Instructograph Code Teacher** literally takes the place of an operator-instructor and enables anyone to learn and master code without further assistance. Thousands of successful operators have "acquired the code" with the **Instructograph System**. Write today for full particulars and convenient rental plans.



INSTRUCTOGRAPH COMPANY

4709 SHERIDAN ROAD, CHICAGO 40, ILLINOIS

ATTENTION

MOBILE HAMS

Complete mobile package — nothing else to buy. Outstanding mobile signals use Motorola equipment — backed by years of communication equipment experience — World's largest producer of 2-way mobile equipment.

A mobile transmitter with a double feature FM or AM at flip of the switch, the MOTOROLA FMT-30-DMS (27-30 MC.). **\$130.00**

P-7253 spring base rear — mount antenna **\$22.50**

New Gon-set Tri-Band Spread Converter **\$47.60**

MOTOROLA P-69-13 or 18-ARS receiver with special noise limiter for use with any converter having 1440-3000 K.C. **\$60.00**

3-30 famous Gon-set converter complete to connect to the P-69-13 or 18-ARS receiver. **\$39.95**

P-327-E Fire wall loud speaker **\$5.00**

The above comes complete with all necessary accessories and mounting hardware. Order direct or through the Motorola National Service Organization member in your area.

Note: This Receiver and Transmitter is equipment which has been returned from the field, modified and rebuilt for Amateur Service.

For further information write to:

MOTOROLA INC.

Amateur Sales Dept. QST — March
1327 W. Washington Blvd. Chicago 7, Illinois
Attention: Harry Harrison, W9LIX, Tel. Taylor 9-2200 Ext. 161

Get antennas up in the air THE MODERN WAY

No other mast matches Tylon for ease of erection, safety, durability or ease of antenna change or adjustment!

SAFE—EASY TO CLIMB

Made of sturdy steel rods hot dipped galvanized for durability—double-welded for safety. Climb it like a ladder! Comes in 10-foot sections for heights to 60 ft. Costs no more than a pole installed. Handles 10-meter beams, rhombics, doublets, etc. Weighs only 2 lbs. per foot.

Write for FREE FOLDER

WIND TURBINE CO

240 E. MARKET STREET
West Chester, Pa.



Technical Topics

(Continued from page 51)

an amplitude that is less than zero. On the other hand, it is easily possible to handle an amplitude greater than twice the carrier amplitude. This situation seems to be confused with the distorted type of modulation described immediately above, but the two things represent entirely different cases. An upward modulation peak that is greater than twice carrier amplitude, accompanied by a downward peak that is not as large as the carrier amplitude, does not represent distortion if the modulation envelope is simply reproducing the waveform supplied by the audio modulator. The average amplitude of the modulation-envelope waveform will still be zero. With such a modulating waveform, the average carrier level, as checked by the plate milliammeter in plate modulation, by the receiver S-meter or, most truthful of all, by a modulation monitor using a linear rectifier, does not change when the transmitter is modulated. This invariability of the carrier level in a linear rectifier is characteristic of proper operation of all pure amplitude modulation systems except those in which the carrier level is intentionally varied at a syllabic rate (controlled carrier). With this exception, a change in the carrier indication with modulation inevitably means distortion and broadening of the signal, because the lopsidedness is arising in the modulated amplifier. — G. G.

How's DX?

(Continued from page 57)

stations now operating in territory encompassed by the VP8 prefix. We regret that confirmations from such stations cannot be accredited for DXCC as such would be contrary to the provisions of DXCC rule No. 7. For more specific details, as in the case of LU1ZA, we refer you to September, 1949, QST (p. 65) Persistent lobbying by the 4X4 gang has resulted in the projected assignment of 3.5- and 7-Mc. frequencies for their use. Since acquiring the first Israel DXCC membership, 4X4BX has changed QTH and is rebuilding to an 813 final Single-letter calls are now official in many of the British colonies and territories. VQ2E and VS9E will have fun convincing people they're on the legit, being the first singletons in their countries From the DX News of the So. Calif. DX Club we excerpt that LA2FB will be operating on Svalbard, call letters not specified; QSL direct only. Nobody has been or will be operating from Jan Mayen for the present; a ham is in the area but has no gear along. New item: FK8AD brands FUSAD a phoney and the boys are having quite a time getting FW8AA properly enthused about the whole thing. YJ1AA operates the commercial set-up at Port-Vila and VR1F is reported QRT for a while W6FID would like a line on ex-EL7A and W5FXN learns that TQ8AE is quite a philatelist.

— * * * —

In the course of the 17th International DX Competition we discovered, or rediscovered, an old but infallible Hint & Kink. To keep your bug from "walking" around the operating table merely spill a "coke" thereon and allow to dry. (Works fine on logs and pencils, too.)

SWITCH TO SAFETY!



Astatic's Synabar Model DR-10 Unidirectional Cardioid Crystal Microphone

ASTATIC'S Synabar Microphone uses a special sintered metal to cancel out 15 db front to back, making it, for practical purposes, dead to sound from the rear. Excellent frequency range, from 50 to 10,000 c.p.s., is further enhanced by a Response Selector switch, which provides choice of ideal pick-up characteristics for either crisp voice or general voice and music. The Synabar's crystal element has a special METALSEAL protection against moisture or dryness. A high impedance microphone, it has an output level of —54 db. It has a satin chrome finish, is furnished with detachable cable connector and 20 feet of single conductor shielded cable, and is available in models with or without off-on switch.

DR-10List Price \$37.25

DR-10-S*.....List Price 39.95

*With off-on switch

**Now Available
For Immediate
Delivery**



Astatic Crystal Devices
Manufactured Under Brush
Development Co. Patents

THE
Astatic
CORPORATION
CONNEAUT, OHIO
IN CANADA CANADIAN ASTATIC LTD., TORONTO, ONTARIO

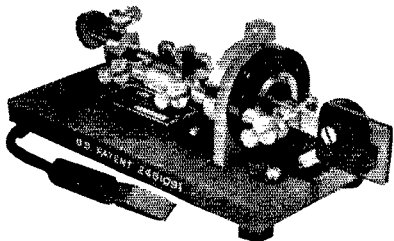

Entire **Dow-Key** vibrating section rotatable through 45° clockwise.

Turn to position which gives you best control — Then see how your sending improves.

- Firm dot making, no flutter, no split dots
- 1/8" pure silver contacts
- Nickel silver springs
- Knob, paddle, insulating ring: Red Lucite
- De Luxe—chrome mirror finish base
- Standard—chrome parts on platinum grey wrinkle

Soon to be on sale at your distributor's. Buy now direct from factory.

Send check, money order, or order C.O.D. Prices net F.O.B. Warren, Minn. or Winnipeg, Canada.

Standard Grey..... **\$16.75**

De Luxe Chrome..... **\$18.75**

THE DOW-KEY COMPANY

WARREN, MINNESOTA

Canadian Distributors — Sparling Sales, Ltd., 120 King St.,
Winnipeg, Canada

BUY OF A LIFETIME! TRIED AND PROVEN THE WORLD OVER

LETTINE MODEL 240

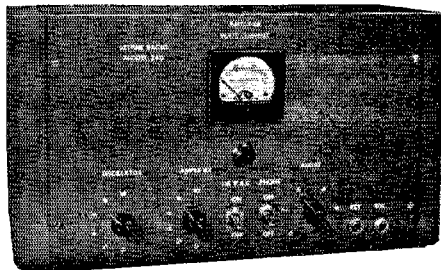

This beautiful transmitter originally sold for \$98. Buy it direct from our factory for only \$79.95, complete with instructions for TVI reduction. Even if you already have a transmitter of your own, this rig makes an excellent standby. You can't afford to miss this opportunity.

The 240 is a complete 40 watt Phone-CW rig, working all bands from 160 to 10 meters; complete with (8 x 14 x 8) cabinet, self contained power supply, meter, tubes, crystal and coils for 40 meters. Tube line-up 6V6 osc., 807 final, 6SJ7 mike amp. 6N7 phase inverter, 2 6L6 mod., 5U4G rect. — weight 30 lbs. — 90 day guarantee. PRICE **\$79.95** \$25 deposit with order — the balance C.O.D.

Coils for 80, 20 and 10 meters, \$2.91 per set. Coils for 160 meters \$3.60.

LETTINE RADIO MFG. CO.

62 Berkley St.

Valley Stream, N. Y.

New **LYSCO**

MOBILE TRANSMASTERS

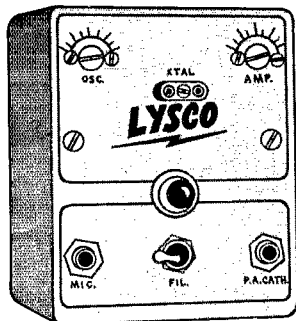

25 WATTS
MINIMUM
PEAK POWER
CLAMP TYPE
MODULATION
TUNING ADJUST-
MENT FROM
FRONT PANEL

DIMENSIONS:
4" W x 4½" H
x 6 D

A new addition to the famous LySCO Amateur Mobile Units. A new modern design in rounded drawn case, black wrinkled finish.

Mod.	Band	Tubes	Mod.	Band	Tubes
A129	10-11M	3-6AQ5	A114	20M	3-6AQ5
B129	10-11M	3-6V6-GT	B114	20M	3-6V6-GT
A175	75M	3-6AQ5	B175	75M	3-6V6-GT

Power requirements: 6.3 V AC/DC 1.5 Amps.
300 to 500 V 125 MA.

AMATEUR NET \$29.95

Less Tubes, Microphone, Power Supply

BUY **LYSCO** EQUIPMENT AT LEADING DEALERS—OR WRITE FOR LITERATURE ON OTHER **LYSCO** EQUIPMENT

LYSCO MFG. CO., INC.

Main Office
1401 CLINTON STREET
HOBOKEN, N. J.

Plant No. 2
EAST RUTHERFORD
NEW JERSEY

50 Mc.

(Continued from page 63)

Goshen, Ind., come in regularly, though they are about 140 and 160 miles, respectively. W4JDN, Erlanger, Ky., 150 miles, is heard frequently on his sked with W8BFQ. W8s BBO, AMW and DQR in Toledo are regulars, as is W8ID in Tiffin. To the north, W8DUL, Ypsilanti, and W8GJF and W8DX, Detroit, are heard often, and from the easterly direction W3LNA, Greenville, Pa., is the most frequently heard DX.

Santa Cruz, Calif.—The mountainous paths from the Fresno area to Los Angeles and Santa Cruz have been covered fairly frequently on 144 Mc. since the first work last summer, according to W6GGM. W6EFS, at Armona, near Fresno, is working in both directions. There is an increase in 2-meter mobile activity as a result of emergency planning, and quite a few new stations are appearing on 2. Some of these new operators apparently do not appreciate the value of good receivers in 2-meter work, however. W6GGM copies a number of fellows in the region between Oakland and San Jose who appear to be unaware that they are being heard at all outside of the local working radius.

Amateur TV in Dallas, Texas

Add another to the list of amateur TV stations. On January 19th, W5MSB, the club station of the Amateur Radio Club of the Texas Trade School, Dallas, made its first TV transmissions. The station is on 435.2 Mc. with 12 watts output, feeding a corner-reflector antenna system. The flying-spot scanner is being used at present, with camera equipment under construction. Participating in the construction and operation of the station are W5s RGL, PAZ, MPU, SHA and QHI.

S.E.T.

(Continued from page 54)

Comments

We wish it were possible to reproduce here the highlights of the many fully-documented SET reports which have been received from ECs throughout the United States, Canada and possessions. They certainly deserve it for the extended effort, time and even money poured into this all-out effort to demonstrate to the nation that we amateurs mean business and that we are prepared for whatever part we will be called upon to play along emergency communications lines. Those of you who are located in the areas covered by the list above are indeed fortunate to have found a qualified leader who takes it upon himself to organize local amateurs into a coordinated emergency communications organization. Let's keep the ball rolling in those areas, and let's *get* it rolling in areas which are not represented above. Here are a few significant com-

(Continued on page 180)

MORE SIGNALS PER DOLLAR
From Money Invested in an Antenna

Self Supporting

STEEL TOWERS

For Rotary Beams, FM, TV

ATTRACTIVE—NO GUY WIRES!

- 4-Post Construction for Greater Strength!
- Galvanized Steel—Will Last A Lifetime!
- SAFE—Ladder to Top Platform
- COMPLETE—Ready to Assemble
- Easy to Erect or Move
- Withstands Heaviest Winds

(We will supply stress diagrams for your building inspector)

EASY MONTHLY PAYMENTS

Up to 12 Months to Pay!

All Vesto Towers are available on a special monthly payment plan which requires only 1/8 down. Write for free details.



Width at
Base Equal

to 1/5 Height

IMMEDIATE DELIVERY

on all 7 popular sizes. Note the low prices for these quality lifetime towers: 22'—\$84.75, 28'—\$104.75, 33'—\$123.75, 39'—\$144.75, 44'—\$164.75, 50'—\$192.75, 61'—\$259.75, 100'—

\$974.75. Towers are shipped to your home knocked down, FOB Kansas City, Mo. 4th class freight. Prices subject to change . . . so order now! Send check or money order . . . or write for free information.

WRITE TODAY FOR COMPLETE FREE INFORMATION AND PHOTOGRAPHS

The VESTO Company

101 Main St. Parkville, Mo.

6-ELEMENT 10-METER ARRAY

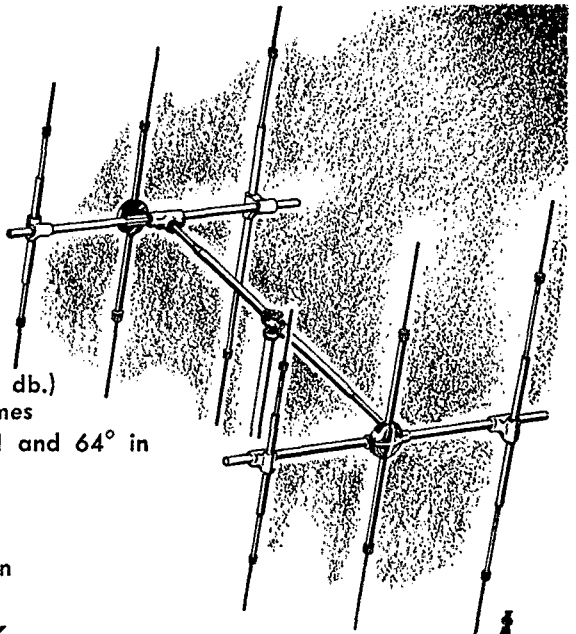

Very high gain (conservatively rated at 7.6 db.)
effectively multiplies transmitter power 6 times
Highly directional pattern—68° in vertical and 64° in
horizontal planes
High front/side and front/back ratios
Matches 52 ohm coax
Lightweight, durable, commercial construction
Mounts on any standard 1½" pipe

Ask for **WORKSHOP Model 29X**

THE **WORKSHOP ASSOCIATES, Inc.**

Specialists in High-Frequency Antennas

135 CRESCENT ROAD NEEDHAM HEIGHTS 94, MASSACHUSETTS



BAMBOO ANTENNA POLES

Carefully selected top quality imported heat treated bamboo poles, length 24/26 feet, butt diameter approximately 2½ inches, top diameter ¾", wall thickness ¼". Light yet sturdy. Stands weather better than wood. Good dielectric qualities. Ideal for radio masts. Price \$7.50 per pole f.o.b. New Orleans. Can be shipped C.O.D. via Railway Express.

DART EXPORT CORPORATION

533 NBC Building New Orleans 12, La.

COMPLETE RADIO TRAINING!

Prepare now to accept a responsible position in Commercial Radio. New developments will demand technicians with thorough basic training, plus a knowledge of new techniques discovered during the war. Training open to high school graduates, or those with high school equivalency. Courses 6 to 18 months duration in RADIO AND ELECTRONICS. Approved Veteran training in Radio. Write for Particulars.

VALPARAISO TECHNICAL INSTITUTE

DEPT. TN Valparaiso, Ind.

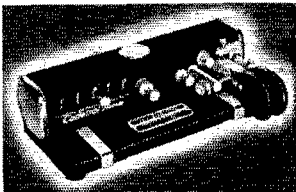

Codetrol

A NEW STANDARD FOR SEMI-AUTOMATIC CODE \$22.50

BERNARD H. BREEDLOVE

299 Marietta Street N. W. Atlanta 3, Georgia

Here is a key engineered for CW. Beautifully machined and finished, the Codetrol has the feel you've been looking for. You know it's right with the first dot. No whip, no lag, no crawl. Clean signals, sharp cutoff. Stabilized double-pivoted suspension with silky smooth Flywheel Action without runaway sensitivity. Don't be a slave to your key.

Write for free folder or order today.

COMMUNICATIONS for KON-TIKI

During the 101 days and nights of drifting across the Pacific the balsalog raft worked amateurs in W, VE, KH, OA, ZL, KZ, LA, keeping schedules with several of them.

From Peru to Raiora, drenched by rain and sea water, baked by the tropical sun, Kon-Tiki's radio equipment did not fail.

We are proud that Hytron tubes did their part in keeping LI2B on the air.



HYTRON RADIO & ELECTRONICS CORP.

SALEM, MASSACHUSETTS

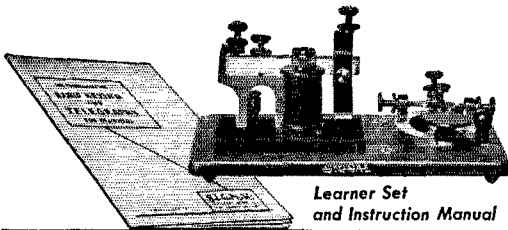

Learner Set
and Instruction Manual

Learn Telegraphy & Wireless the EASY Signal Way!

It's fun! And, you can learn keying fundamentals and codes quickly and easily with Signal's new booklet — "Radio Keying and Telegraphy for Beginners." Signal's professional-type practice keys and two-way learner sets are also available at student prices. Mail 15c (stamps or coin) today for your instruction manual and equipment catalog.

Signal ELECTRIC MANUFACTURING CO.
MENOMINEE, MICHIGAN

DISCOVERED — The finest screw-holding screwdriver ever made for ban or home workshop use. One size grips firmly to insert or remove 4-40's to 1/4" stove bolts, any type head. Just push button on shank with thumb to expand wedge-shaped precision spring steel blades firmly against walls of screw slot. Hollow-ground tips really hold securely. 6" blade, Tenite handle. \$1 postpaid. LYMAN (WIPEN). Box Q, Goshen, Conn.



ENGINEERS

ELECTRONICS RESEARCH AND
DEVELOPMENT
IN BALTIMORE, MARYLAND

Career Positions

for TOP ENGINEERS and ANALYSTS in

Radar Pulse, Timing and Indicator Circuit Design • Digital and Analogue Computer Design • Automatic Telephone Switchboard Design • also Electro-Mechanical Engineers

Experience in servo-mechanism, special weapons, fire control, and guided missile design.

Recent E.E. graduates and those with at least one year electronics research and development work will also be considered.

Salary commensurate with ability. Housing reasonable and plentiful. Submit resume outlining qualifications in detail. Information will be kept strictly confidential. Personal interviews will be arranged.

THE GLENN L. MARTIN COMPANY
Employment Department
Baltimore 3, Maryland

ments taken at random from the big stack of reports received here:

"We received the utmost cooperation from all who took part and thanks have been given to all concerned. This being my first attempt at such an undertaking I was somewhat afraid of a hitch developing, but . . . the wonderful cooperation received resulted in a good job." — *VE6EO, Asst. EC Lethbridge, Alberta*

"The lesson learned by us by this test is that we need more practice and more portable and mobile equipment." — *W3GJA, EC Lancaster, Pa.*

"I believe this was one of the largest emergency tests ever held in this area." — *W6VRF, SEC Mo.*

"Broadcast listeners with short-wave bands on their receivers listen in and say they get more encouragement and information from listening to the amateurs in the different towns than they do from local broadcast stations during approaching storms." — *KP4DJ, EC San Juan, P. R.*

"It would seem that the results of this Test would prove the value of retaining amateurs in their present status in any crisis, national or otherwise." — *W7HJ, EC Boulder City, Nev.*

"It is our opinion that your request for a separate message from each participant is silly and only adds to the confusion of so much traffic." — *W8QVA and W8LAC, ECs Burlington, Iowa*

"The boys get 'smoother' all the time, but we still find bugs." — *W8HKD, EC San Bernardino, Calif.*

"This test . . . under simulated disaster conditions is another service of the amateur radio operator given to his city or county." — *W1JFF, EC Newport, R. I.*

"Our drills are now much better attended than they have been in the past. Guess the AREC has a big job ahead." — *W8TUR, EC Hempstead-Garden City, N. Y.*

"Much good was done in the way of getting all local agencies together and making them realize the good that can be had by a well-organized communications net manned by amateurs." — *W6JKY, EC Garland, Tex.*

A.R.R.L. QSL BUREAU

(*Bold-face type indicates recent change of address*)

- W1, K1 — S. R. Baker, jr., W1JOJ, Box 232, Ipswich, Mass.
- W2, K2 — H. W. Yahnel, W2SN, Lake Ave., Helmetts, N.J.
- W3, K3 — Jesse Bieberman, W3KT, Box 34, Philadelphia 5, Penna.
- W4, K4 — William M. Rowe, jr., W4JDR, 2430 Connally Drive, East Point, Ga.
- W5, K5 — L. W. May, jr., W5AJG, 9428 Hobart St., Dallas 18, Texas
- W6, K6 — Horace R. Greer, W6TI, 414 Fairmount St., Oakland, Calif.
- W7, K7 — Mary Ann Tatro, W7FWR, 513 N. Central, Olympia, Wash.
- W8, K8 — Walter Musgrave, W8NGW, 1204 East 188th, Cleveland 10, Ohio
- W9, K9 — John F. Schneider, W9CFT, 311 W. Ross Ave., Wausau, Wis.
- W0, K0 — Alva A. Smith, W0DMA, 238 East Main St., Caledonia, Minn.
- VE1 — L. J. Fader, VE1FQ, 125 Henry St., Halifax, N. S.
- VE2 — Austin A. W. Smith, VE2UW, 6184 Jeanne Mance, Montreal 8, Que.
- VE3 — W. Bert Knowles, VE3QB, Lanark, Ont.
- VE4 — Len Cuff, VE4LC, 238 Rutland St., St. James, Man.
- VE5 — Fred Ward, VE5OP, 899 Connaught Ave., Moose Jaw, Sask.
- VE6 — W. R. Savage, VE6EO, 329 15th St., North Lethbridge, Alta.
- VE7 — H. R. Hough, VE7HR, 1785 Emerson St., Victoria, B. C.
- VE8 — W. R. Williamson, VE8AK, Box 534, Whitehorse, Y. T.
- KP4 — E. W. Mayer, KP4KD, Box 1061, San Juan, P. R.
- KZ5 — C.Z.A.R.A., Box 407, Balboa, Canal Zone
- KH6 — Andy H. Fuchikami, KH6BA, 2543 Namaau Dr., Honolulu, T. H.
- KL7 — Box 73, Douglas, Alaska

DEPENDABLE PERFORMANCE

December 13, 1950

"I've tried half a dozen different microphones only to come back to my original Turner 22X purchased before World War II.

I've worked 180 countries on phone and have many compliments on my quality with this unit. During the war it was stored in my attic where temperatures sometimes reached 125° F.

If my other equipment held up like the Turner 22X I would have saved plenty of money."

George E. Bourne
W8BI

It's the inbuilt quality of the Turner 22 that makes it a faithful performer year after year. Try it, compare it! Buy it for your rig.

Write for Free Microphone Literature

In Canada: Canadian Marconi Company, Toronto, Ontario

Export: Ad. Auriema, Inc., 89 Broad St., New York 4, N. Y.

THE TURNER COMPANY

917 17th Street, N. E.

Cedar Rapids, Iowa

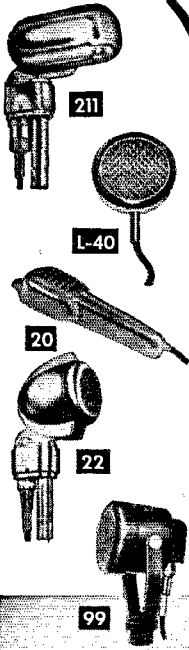
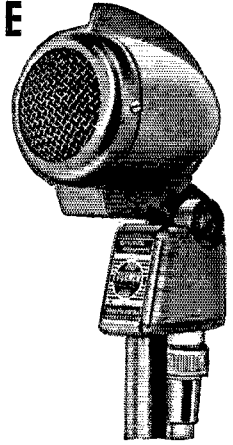

Microphones by **TURNER**



Crystals licensed under patents of Brush Development Co.



Whether you're in the Armed Services or in Industry ELECTRONICS TRAINING PAYS OFF

with interesting jobs and higher earnings

CREI Residence School Training offers
Quick promotion in uniform—as well as profitable civilian careers!



In or out of the armed services, the best jobs go to the men with technical training. With electronics knowledge you're prepared for the future, whether you're headed for a berth in the Armed Services or a career in essential industry. Because of the critical shortages that exist today in the electronics field, the *qualified* technicians and engineers can practically choose their own jobs. Because of the dependence of modern armies, navies, and air forces upon electronics — for radar, communications, and navigation — the man with even limited electronics knowledge can get ahead quickly in uniform. In case of call to active duty before completion of your CREI course, you're still way ahead, since it is easier for the Services to complete *your* electronics training than start from scratch with an untrained man.

At CREI you work with modern equipment — over 18,000 sq. ft. of class rooms, TV and radio studios, transmitters, control rooms, and labs. You're grounded in the fundamentals required for work in guided missiles, TV, com-

munications, and other electronics fields. CREI's experience in training thousands for the Army, Navy, and Coast Guard in World War II, coupled with pioneering background in technical education and close industry connections, assure you of the best in technical preparation. New classes start twice a month. To insure *your* training, act right now. Send today for free catalog.

Residence School Approved for Veterans
For most veterans, July 25, 1951 is the deadline
DON'T DELAY!

FOR FREE CATALOG, MAIL COUPON NOW!

CAPITOL RADIO ENGINEERING INSTITUTE

16th St. & Park Rd. N.W.
Dept. 333C, Washington 10, D. C.

Please send free Residence School Catalog.

Name

Street

City

Zone

State

Veteran Non-Veteran Age

Send details about Home Study Courses



NATIONAL

- **P**roven
- **D**ependable
- **Q**uality



R-100



R-100ST



R-100U

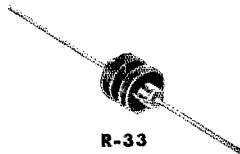

R-33



R-100S

PRECISION-WOUND RF CHOKES

R-100 employs pigtail leads; the R-100U has pigtail leads and a removable stand-off insulator; the R-100S has cotter-pin lug terminals and a non-removable stand-off insulator. All available in 2.5, 5 and 10 mh. sizes rated at 125 ma. The R-100ST has a 6-32 threaded stud at each end—available in 2.5 mh. The R-33 series chokes are 2-section r.f. chokes available in 10, 50, 100 and 750 uh sizes, and are rated at 33 ma.

National



NATIONAL COMPANY, Inc.
MALDEN, MASSACHUSETTS

Operating Article Series To Be Resumed Next Month

- Because of the urgency of bringing our readers a full report of FCC action in Docket 9295 (see starting on page 26) it has been necessary for us to omit installment No. 6 of the ARRL series on amateur operating. We shall resume this popular series next month.

HAMFEST CALENDAR

ONTARIO — Saturday, April 7th, at the Genosha Hotel, Oshawa — Annual Banquet of the North Shore Radio Club. XYLs and others are welcome. A program of professional entertainment has been arranged to accompany the turkey dinner. Tickets are available from club members and should be purchased one week before the banquet date.

HELVETIA 22 CONTEST

- 1) Purpose of this contest is to enable foreign amateurs to work as many Swiss cantons as possible to qualify for the Helvetia 22 award. Identifying call is "CQ H22."
- 2) *C.W. Section:* March 31st, 1300 to 2300 GCT and April 1st, 0500 to 1100 GCT.
Phone Section: April 21st, 1300 to 2300 GCT and April 22nd, 0500 to 1100 GCT.
- 3) Exchange signal reports followed by three digits, starting with 001, to indicate the number of the contact.
- 4) Score one point for each exchange. Multiplier is the sum of the number of cantons worked on each band.
- 5) Stations may be contacted only once on both 'phone or c.w. on the same band.
- 6) Logs to reach HB9HC, Milchbrukstr. 50, Zurich 6, Switzerland, by May 15th. Log form and station information patterned after ARRL DX Test forms. Be sure to include canton, which will be abbreviated during exchanges; e.g., Berne, BE.

MICROWAVE TEST EQUIPMENT WANTED

- We can now pay the highest possible prices for good clean microwave test gear. We can also use certain plumbing, thermistors and bolometer elements, as well as specialized cavities and VHF gear.

WESTON LABORATORIES

Weston 93

Massachusetts

Very little space is required to say:

"TELEPLEX TEACHES THE CODE"

But how it teaches it; The advantages of TELEPLEX; Fundamental principles that you must know, is a long story. Get the facts and compare. A Postcard will bring you "Some pertinent facts about Code."

TELEPLEX CO. • 804 E. Dawn Drive • MODESTO, CALIF.
(See it at Blan's, 64 Dey St., New York)

PIONEER CHASSIS PUNCHES



MODEL CKR 117 — Keyed 1 1/4"

FOR NON-ROTATING LOCKED MOUNTING OF AMPHENOL "S", MILLEN NOS. 33054-5-6 & 8, SOCKETS AND PLUGS, PERMITS USE OF SPRING WASHER MOUNTINGS. ELIMINATES SCREWS.



For mounting IF's, Terminal Strips, Sockets, Plugs, Meters, Controls, Xfmers, Switches, Panel Lites, Etc.

■ SQUARES		● ROUNDS		Simple Hand Wrench Screw Action		
5/8	\$2.95	1/2	\$1.95			1 1/4
1 1/16	\$3.25	3/8		1 1/8	\$2.60	
3/4	\$3.50	1 1/4		1 1/2		\$2.95
7/8	\$3.85	7/8		1 3/4	\$5.65	
1"	\$3.95	1	2 1/4			
● KEYED		1 1/16	\$2.30			
1 1/4	\$3.50	1 1/8				

"AT YOUR FAVORITE DISTRIBUTOR"

PIONEER BROACH COMPANY
LOS ANGELES 15, CALIF.

CODE WIRES Quickly!

E-Z CODE IT



Colored wire shortage? Identification problem? Here's the answer. E-Z Code it!! Thousands of Combinations. Waterproof. Tough. Permanent. All Colors. Very inexpensive. Remove numbered strip. Secure around end of wire—job's done. Try E-Z Code today!

WRITE TODAY for E-Z Code samples



ROCKET DISTRIBUTORS, INC.

209-14 41st Ave., Bayside, L. I., New York
BA 4-4000



RADIO and TELEVISION

Thorough Training in All Technical Phases

APPROVED FOR VETERANS

WEEKLY RATES DAYS—EVENINGS

FREE PLACEMENT SERVICE for GRADUATES

For Free Catalog write Dept. ST-51

RCA INSTITUTES, INC.

A Service of Radio Corporation of America
350 WEST 4th ST., NEW YORK 14, N. Y.



RADIO COURSES

- RADIO OPERATING
- RADIO SERVICING
- CODE
- FM TELEVISION

Preparation for Civilian, Maritime, Army and Navy license requirements.

Personal Counselling Services for Veterans
Write for Catalog T.Q.



TRADE & TECH. SCHOOL 229 W. 66 St., N. Y. 23
ENdicott 2-8117

Anyone Can Be a

Good Sender with a VIBROPLEX

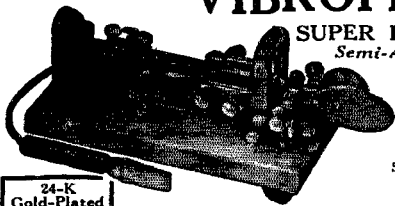

SUPER DELUXE
Semi-Automatic KEY

- Jewel Movement
- Touch Control
- Super-Speed Control

24-K Gold-Plated Base Top \$29.95

PRESENTATION Speed Range From Dead Slow to Lightning Fast

Thousands have become good senders with the Vibroplex. Many who thought they never could make the grade have found it easy with this Super Deluxe Vibroplex key. No matter what sending faults you may have Vibroplex will have you sending like the best in almost no time. Brings out natural ability you didn't know you had. So don't give up the idea of being a good sender — it's easy with a Vibroplex. Other models \$12.95 up. Left hand models, one dollar more. Order yours today! At dealers or direct. FREE catalog.

Headquarters for new portables, all models and styles of types. Also rebuilt Standard and portable typewriters with ALL CAPITAL letters and other styles of types. QUICK SERVICE. Order direct from us.

THE VIBROPLEX CO., INC.
833 Broadway New York 3, N. Y.



Founded in 1909

RADIO TELEPHONY RADIO TELEGRAPHY RADAR & LORAN

Courses ranging in length from 7 to 12 months. Dormitory room and board on campus for \$40.00 a month. The college owns KFAC, 5 KW broadcast station with studios located on campus. New students accepted monthly. If interested in radio training necessary to pass F.C.C. examinations for first-class telephone and second-class telegraph licenses, write for details.

PORT ARTHUR COLLEGE PORT ARTHUR TEXAS
Approved for G. I. training

HAM-ADS

(1) Advertising shall pertain to radio and shall be of nature of interest to radio amateurs or experimenters in their pursuit of the art.

(2) No display of any character will be accepted, nor can any special typographical arrangement, such as all or part capital letters be used which would tend to make one advertisement stand out from the others.

(3) The Ham-Ad rate is 30¢ per word, except as noted in paragraph (6) below.

(4) Remittance in full must accompany copy. No cash or contact discount or agency commission will be allowed.

(5) Closing date for Ham-Ads is the 25th of the second month preceding publication date.

(6) A special rate of 7¢ per word will apply to advertising which, in our judgment, is obviously non-commercial in nature and is placed and signed by a member of the American Radio Relay League. Thus, advertising of bona fide surplus equipment owned, used and for sale by an individual or apparatus offered for exchange or advertising inquiring for special equipment, if by a member of the American Radio Relay League takes the 7¢ rate. An attempt to deal in apparatus in quantity for profit, even if by an individual, is commercial and all advertising by him takes the 30¢ rate. Provisions of paragraphs (1), (2) and (5), apply to all advertising in this column regardless of which rate may apply.

(7) Because error is more easily avoided, it is requested signature and address be printed plainly.

(8) No advertiser may use more than 100 word a ny issue nor more than one ad in one issue.

Having made no investigation of the advertisers in the classified columns, the publishers of QST are unable to vouch for their integrity or for the grade or character of the products or services advertised.

Please note the 7¢ rate on ham-ads is available to ARRL members only!

QUARTZ—Direct importers from Brazil of best quality pure quartz suitable for making piezo-electric crystals. Diamond Drill Carbon Co., World Bldg., New York City.

QSLs, 100, \$1.75 up. Stamp for samples. Grifneth, W3FSW, 1042 Pine Heights Ave., Baltimore 29, Md.

SUBSCRIPTIONS, Radio publications a specialty. Earl Mead, Huntley, Montana, W7LMM.

QSLs, Very attractive. Best in printing and prices. Kromekote or any other stocks. Stamp for samples. W4LXXJ, Rood, Radford, Va.

WANTED: Marconi coherer magnetic detector. Multiple tuner; DeForest responder and other gear prior to 1920. Franklin Wingard, Rock Island, Ill.

QSLs TAprint, Sumrall, Mississippi.

QSLs, SWLs, Meade, W8KXL, 1507 Central Avenue, Kansas City, Kansas.

QSLs, modern. Sample booklet 12¢. Stamps okay. Westerners see samples at leading Ham stores. W6GFV, van Groos, 1436 N. Seacroft, Hollywood 27, California.

CONVENTIONAL ARRL National Convention in Seattle, July 27, 28, 29th, 1951. Plan your vacation in the Great Northwest during Seattle Centennial year. The time of your life! General Chairman: W7RT, 1921 Atlantic St., Seattle 44, Wash.

PHONE patch schematics, practical discussion. \$1.00. Nichols, W1MRK.

BEAMS and antenna elements. Send a card for full information. Riverside Tool Co., Box 87, Riverside, Illinois.

QSLs: Uncle Fred QSLs. Three colors and up. Rainbow map. QSLs. Special DX QSLs. Bargain QSLs. Samples rushed. 10¢. Uncle Fred, Box 86, Lynn, Penna.

QSLs-SWLs. High quality. Reasonable price. Samples. Bob Teachout, W1FSV, 40 Elm Street, Rutland, Vt.

MOTOROLA used communication equipment bought and sold. W5BCO, Ralph Hicks, 204 E. Fairview, Tulsa, Okla.

QSLs and SWLs cards. Enamel and mirror finish cards, and also Multi-Color flash cards. Samples. The Rainbow Press, 816 Maple Ave., New Philadelphia, Ohio.

FOR Sale: Collection ancient wireless and radio items dating back to 1902. Sell as whole or part. Thousand of old items must be cleared out fast Stamp, please, for list. W6LM, Wrightwood, Calif.

QSLs high quality, fair prices. Samples? W7GPP, R. D. Dawson, 1308 F. Street, The Dalles, Oregon.

WANTED: Teletype 1/60TH HP synchronous motor. W6ITH Moraga, Calif.

CRYSTALS: Our eighteenth year manufacturing precision crystal units for Marine, Aircraft, etc. Television markers. Regrinding service. Request catalogue. R. E. Nebel Laboratory, 1104 Lincoln Place, Brooklyn 13, N. Y.

QSLs, SWLs. They're better. Samples. C. Fritz, 1213 Briargate, Joliet, Ill.

CRYSTALS: Bassett precision Type 100A (FT-243) within 80, 40, 20 meter bands or MARS channels at \$1.50 each. Specify exact frequency and include postage. Rex Bassett, Inc., Bassett Building, Fort Lauderdale, Florida.

QSLs? SWLs? Modernistic? Cartoons? Photographic? DeLuxe? QSL samples, 10¢, Sakkers, W8DED, Holland, Michigan. Immediate QSL service

WANTED: Collins 310B-1, 310C-1, or 310C-2 exciter unit. State condition, age and price. W5BUF, Sil Thompson, 6460 Vicksburg Street, New Orleans, La.

LOOK! BC-224 converted to AC with speaker. In good condition. First good offer takes it. John Vick, W1OPH, 29 Calvin Road, West Hartford, Conn.

MOUNTED LM14 frequency meter, brand new, and in perfect condition. Converted separate power supply with calibration book. Best offer. W6VFP.

WANTED: RA-34 rectifiers; TCS sets, parts; PE-104; PE-103; BC-654 (SCR-284). Arrow Appliance, 525 Union, Lynn, Mass.

SELL Technical Radio Co. T-50-M 100-watt transmitter, 20-160 meters, extremely stable VFO, pair 207' s final, HD power supply, manual, spare tubes, \$87.50. W4KIZ, 2412 Brighton Drive, Louisville, Ky.

WANT: Good rcvr as S-40A or better. Have: motors, fans, office equipment, other items. Prefer local deal. Samkoisky, W2YSF, 527 Bedford Ave., Brooklyn, N. Y.

SELL: Meissner 150-B xmitter with exciter, \$250.00; Collins 310-B1 exciter, \$150.00; ARB/CRV46151 rcvr, 190 Kc to 9 Mc, \$20.00; BC453-A-Q-S'er, \$15.00; National NC-1-10 rcvr, \$25.00; G-E XFM-1 FM Transcator, \$35.00; Lyaco 75_mtr. mobile converter, \$15.00; PE-103-A, \$18.00; all new, or like new. Used BC-946 broadcast command rcvr, \$10.00. Want cash. No trades. W20VY, F. R. Vadney, 1855 8th Ave., Watervliet, N. Y.

SELL: RME-HF 10-20; \$47; D32A, \$40.00; Millen R-9er with coils for ten and twenty, connectors and instructions, \$15.00; S-72 parts, \$70; RK4D32, \$10.00; PR type ZJ 20-meter crystals, \$1.50; Millen 90281 power supply, \$45.00; 50 µf. 3200V volt vacuum condenser, \$5.00. Everything is in excellent condition. Robert Rosenquist, W8EHF, 2558 Ida, Omaha, Nebraska.

WANTED: an elec. driven Instructograph or similar code practice machine, reasonable, with tape and oscillator, prefer set-up enabling me to make my own tape. W. H. Burkhalter, 865 Laguna Ave., Los Angeles, Calif.

QSLs: Samples. Larry's QSL's, Opportunity, Wash.

WANT high power? Eight 833's for sale. Three in factory-sealed cartons. Will ship all tubes and two sockets express collect for \$75.00. W. L. Hamilton, 1817 Beechwood Ave., Nashville, Tenn.

WANTED to buy: a manual for the NC-120 receiver and a Biley VF-1 crystal holder. Rev. E. Roth, Mission San Juan, Capistrano, Calif.

SALE: Three BC-721 Handy Talkies, 80 meter band, with crystals, tubes, coils. Excellent condition. Best offer over \$100.00. Walter Barrett, Box 7, Bucknell University, Lewisburg, Penna.

DC to AC converters, 110 V—250, 300, 500 watts with filters. Janet and Ecco makes, 220V-DC to 150V-AC 3 Kw. Best offers over \$40.00 each. QST 1925 to date, with index supplement for early issues. Dr. R. H. Baker, W9VLLX, Wood, Wisconsin.

SELL: Triplet 169A modulation monitor; also QST's. George Kravitz, 7919 21st Avenue, Brooklyn 14, N. Y.

JOHNSON Viking 1, factory-tested after assembly, with tubes, microphone, key, low-pass filter, antenna relay and VFO 80 thru 10 meters. \$295.00. W4UCN, 522 Miles Circle, NAs, Memphis, Tenn.

WANTED: BC-221 tuning condenser. W2SNQ, 1 Kidgeway Ave. West Orange, N. J.

WOULD-Be ham wants used receiver, in good condition. What have you? Perry Weaner, Owens, Va.

BC-221 in metal cabinet guaranteed cond., first \$50.00 M.O. 40M Amphenol folded dipole, \$4.00, low transformers and crystals left. Selling out. Blum, 2601 Dibblee Ave., Columbus 4, Ohio.

WANTED: Used HRO-5 and pair of used 4-125As. State price and condition. Trade Meissner DeLuxe signal shifter. W6ANN, San Pedro, Calif.

SELL: Mobile 20-watt transmitter, control box, PE-103 dynamotor 3 crystals, mike, antenna, cable and Gon-set noise clipper, \$50.00. Instructions supplied. Eugene Gates, W6BKK, Phone EH-5348 or WE-7274 Hollywood area. 6216 La Mirada Ave., Hollywood 38, Calif.

FOR Sale: BC-221-J frequency meter with calibration book and crystal \$45.00. Abbott TR4, HQ-129-X, \$135.00. Clyde Keeler, 40 Seward Avenue, Port Jervis, N. Y.

SELL: Federal 167-BY Xmtr complete, 3200V supply and 2KVA Variac, \$275.00; BC-224A rcvr with AC supply, \$40.00; Prop pitch motor, \$5.00; BC-221, \$45.00; 2 new 1-82 Autosyn indicators, \$3.50 each; S-40A, \$50; S-55, used only 6 mos., \$60.00 or trade; Mod. xfrmer Thordarson 144450 ratio .62/1 at 4A.D.C. Pri impd, 3350/51.2 DB sell and Thordarson TTP86 3 Pri/3kVA 250V 60V, See 1460, 1320, 1210, 1100 per phase at .82A sell or trade for mobile gear. All F.o.b. Memphis: H. E. Mitchell, W4JW0, 770 Newell, Memphis, Tenn.

SCOTT SLMR 595KC-18 Mc \$100.00; HQ-120X, speaker, \$90.00; BC-348, speaker, AC supply, \$90.00; Leo Wachsteter, 37-21-80 St., Jackson Heights, Queens, L. I., N. Y. C. Tel. HA 4-2466 evenings.

HRO broadcast coils for HRO5TA wanted. Will swap antennas, tubes, etc., or cash if priced right. C. D. Craig, Box 375, Los Alamos, New Mexico.

SELL: Hallicrafters HT-6, 40-watt, tubes, coils for 10, 20, 40, 75, used by WALMU 1 1/2 years. Guaranteed, \$75.00. F.O.B. Blacksburg, Va. P.O. Box 99.

SEVENTY percent of our personnel are active, licensed hams. Just another reason why it pays to buy from Evans Radio, Concord, N. H.

WANTED: Panadaptor. Must be in excellent condition and priced right. Drop a postal card with proposition to W50WG, R. M. Reavis, 125 West Main St., Ardmore, Oklahoma.

NEW crystals for all commercial services at economical prices, also regrinding or replacement crystals for Motorola, Link, G-E and other commercial types. Over fifteen years of satisfaction and fast service! Eldson Electronic Co., Phone 3901, P.O. Box 31, 1802 No. Third St., Temple, Texas.

DISMANTLING Western Electric 5-C transmitter. Component parts available, also have BC-639A and 201A receiver, make offer. W7KVV.

BARGAINS, new and used transmitters, receivers, parts: Collins 32V1, \$395.00; Globe King, \$299.00; HT-9, \$199.00; Temco 75GA, \$225.00; Collins 75A1, \$298.00; new 150-watt phone, \$199.00; 32-57, \$76.00; NC-173, \$139.00; SX-43, \$129.00; RME-45, \$99.00; NC-46, RME-69, \$69.50; VHF-152A, \$69.00; SX-24 \$69.00; NC-100 \$59.00; Globe Trotter, \$57.50; HT-17, \$32.50; New Bud VFO 21, \$39.50; new Meissner signal calibrators, \$24.95; S-38, \$29.95; MB-611, \$29.00; 90800 exciter, \$29.50; Gon-Set 10-11 components, \$25.00; XE-10, \$19.95 and many others. Large stock of trade-ins. Free trial Terms are financed by Leo, W0GFC. Write for catalog and best deal to World Radio Labs, Inc., 740-44 West B'way, Council Bluffs, Iowa.

WANTED: Marconi tuners, Marconi magnetic detector, Electro Importing and Wireless Specialty apparatus; wireless books and catalogs before 1919. L. Rizoli, WIAAT, 100 Bay View, Salem, Mass.

BC-610E for sale with Newcomb commercial speech amplifier. Excellent condition. \$515.00. W5LVM, 2826 Model St., Dallas, Texas.
FOR Sale: Mark II 20-watt 80 and 40 meter phone CW and MCW transmitter-receiver in new condition, with 120-Volt AC power supply and microphone, headset, spare tubes, key and spare parts. Set complete and ready to operate. \$48.00. George Ashley, 315 McFadden Hall, Cornell University, Ithaca, N. Y.

HQ-129X for sale, less speaker. Excellent mechanical and electrical condition. Just realigned and overhauled to put it in first class shape. Best offer from \$110.00. F.o.b. W4RDH, 510 W. Gilbreath, Graham, N. C.

AC Instructograph, built-in oscillator, ten tapes. Practically new, \$25.00. Roy Foody (W2EPN), 63 Cooper St., Babylon, L. I., N. Y.

SWL aged 13 wishes to contact someone of approximately same age interested in ham radio, living in vicinity. Object: to study for ham ticket. Martin Gold, 1630 Undercliff Ave., Bronx, N. Y. Tel. Cypress 9-5591.

WANTED: Teletype 1/40 H.P. synchronous motor 1800 R.P.M. also plug-in coil for Port-A-Phone intercom set. W41J1, 828 N.W. 29th Ter., Miami, Fla.

MOBILE Generator whine? New Motorola \$5.00 generator filters, \$2.00 postpaid. Police surplus. W4HDC.

FOR Sale: BC-610E and modulator in good condition, tuning units, coils for 10, 20, 40, 80 meters, plus some commercial. \$650.00. Homer J. Owen, 128 South 8th St., Santa Paula, Calif.

FOR Sale: PP 813's, AM (805's) FM xmitter 80 to 10 meters; Meissner 9-1090 driver. Gray Bar-Metal cabinet. Fine job. Will not ship. R. A. Worley, W2W1, 723 Hamilton Ave., Trenton, N. J.

WANTED: Hallcrafters SX-25 high fidelity AM-tuner. Harry H. Gingrich, 4613 Derry St., Harrisburg, Penna.

MEASURE that R.F. 2-inch, round RF thermocouples 0 to 1 1/2 amp. range. \$1.50 each. R. L. Kalmback, W4IN, Lykesland, South Carolina.

BC-459-A with power supply, 75 watts input on 40 meters, \$25.00. Write W0MLK, 315 Dix Road, Jefferson City, Mo.

1919-1949 QST's. Complete volumes from 1924. Send for list. Volumes \$2.50 (sold complete only), odd issues 25 cents. W9LI, 102 Monroe, Elgin, Illinois.

WANTED: Radio control box BC-451-A modulator unit; BC-456-A or B, Antenna Relay Unit, BC-442-A or AM, and transmitter rack FT-226-A. State price. E. V. Fortmiller, W7MMC, 1782 Reservoir St., Salem Oregon.

NEW York City vicinity: Meissner Model BX signal shifter for sale. Cash and carry. Will demonstrate. In good condition. \$45.00. John Moran, W2VQD, Phone Virginia 5-7287.

AMERTRAN 2 Kw. 6200 volt power transformer, 2 Kw Variac 110 volts Federal 304 UHF signal generator, ARK-3 receiver, ARC-2 meter transmitter receiver, 80 meter ARC-5 receiver and transmitter. Send for list of parts. George Boross, W2ELY, 714 Bingle Street, Perth Amboy, N. J.

SELL: NC-57, in perfect condition. \$75.00. R. B. Steinkolk, W8GAJ, 6690 Kenwood Rd., Cincinnati 27, Ohio.

SELL: Collins 75A-1 in excellent condition. \$285 F.o.b. Miami. Ed. Zimmerman, W4FNQ, 621 S.W. 60th Ave., Miami 44, Fla. Locals call 87-8669 after 5 PM.

HAMMERLUND HQ-129X speaker, new RCA tubes, good condition, \$100.00. Express collect. W. Casby, W2ONK, R.D. #1, Box 119, Red Bank, N. J.

FOR Sale: WRL Globe Trotter xmitter, 6 months old, 80-40-20-10 coils. 2 xtals for 40. Factory-wired. Will ship C.o.d. Xtal mike included. \$60.00. C. Warner, Edgewood Court, Rockfall, Conn.

BARGAINS: New and reconditioned Collins, National, Hallcrafters, Hammarlund, RME, Millen, Gon-Set, others. Reconditioned S-38, \$29.00; S-40A, \$69.00; SX-43, \$119.00; NC-57, \$69.00; NC-173, \$139.00; NC-183, \$129.00; HQ-129X, \$139.00; RME-84, \$69.00; RME-45, \$89.00; DB22A, \$49.00; HF-10-20, \$49.00; VHF-152, \$49.00; SX-25, SX-42, SX-28A, ARK-5, NC-240D, HRO7, Collins 32V, Collins 75A, others. Terms. Shipped on approval. List free. Henry Radio, Butler, Mo.

ARRL staff openings. Applications for Contest Checking Post will be welcomed. Accuracy required and average proficiency with typewriter. Contest work a desirable but not required background. Amateurs 18-30 years preferred but all applications given careful consideration.

WANTED for W1AW post. An amateur with constructional and maintenance experience, also ability to set a good procedure example when on the air, is invited to apply. Mention ARRL organization—operating background or appointments, if any, if available and interested, also other radio experience, in writing for details and application form. In all cases indicate age, please. Handy, ARRL.

QST'S: 240 copies, 20 years, with index, good condition, Jan. 1930 through Dec. 1949. \$50.00 W8GVJ.

SELL 32V2. Perfect. Used three months. With xtal mike. \$495.00. W1KVG, Manchester, N. H. Phone 2-8409.

SURPLUS GOES TO WAR!

Your War Surplus is Needed for Defense

We are buying up all kinds of electronic equipment—Radio, Radar, Test Sets, Lab Equipment, Tubes and Parts; reconditioning and assembling them into complete sets for use in the nation's laboratories and factories.

AN/APR-4 and APR-1 Units, LAE, LAF & LAG Signal Generators, TS-174, TS-175 & TS-323 Frequency Meters, all kinds of "TS-", "IE-", "L-", "APR-", "ARR-", C-R, Boonton, Ferris, etc., equipment URGENTLY NEEDED. We will also buy ARC-1, ARC-3, ART-13, BC-348, BC-221, and any other good-quality equipment. Help us save time and correspondence—describe and price in your first letter.

ENGINEERING ASSOCIATES

434 Patterson Road

Dayton 9, Ohio

RADIO and TELEVISION

Over 30 years N.E. Radio Training Center. Train for all types FCC operators' licenses. Also Radio and Television servicing. FM-AM broadcasting transmitters at school. Send for Catalog Q.

MASS. RADIO SCHOOL

271 Huntington Avenue

Boston 13, Massachusetts

Lic. by Comm. Mass. Dept. Educ.

COMMERCIAL RADIO INSTITUTE

A RADIO TRAINING CENTER FOR 30 YEARS

Resident Courses Only • Broadcast, Service, Aeronautical, Television, Radar, Preparatory Mathematics, Frequency Modulation and Marine telegraphy. Classes now forming for summer term June 1st. Entrance examination May 21st.

Literature upon request. Veteran training

Dept. B, 38 West Biddle Street, Baltimore 1, Maryland



EVERY SEAL YOU USE HELPS CRIPPLED CHILDREN

RECEIVING SENDING CODE Speed without strain

CHAMPIONS ENDORSE CANDLER WAY

Get skill, accuracy, speed with the highly endorsed Candler System. Learn to send and receive by telegraph or radio code. Government service and commerce need thousands of better trained operators. Air commerce, mail, freight, etc., demand expert, reliable operators. Good pay. Get the Candler System, the maker of champions. It teaches you the "knack" of sound sense, alertness, speedy sending and receiving without strain. Adventure—good pay. Learn at home or wherever you are. Rush name today for free book.

FREE!

CANDLER SYSTEM CO.

Dept. 4-C, Box 928, Denver 1, Colorado, U.S.A. and at 121 Kingsway, London, W. C. 2, England

Designed for



Application

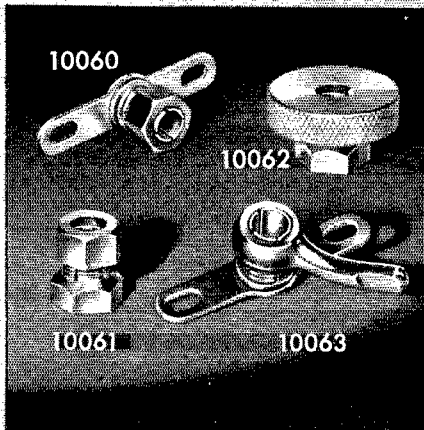

SHAFT LOCKS

In addition to the original No. 10060 and No. 10061 "DESIGNED FOR APPLICATION" shaft locks, we can also furnish such variations as the No. 10062 and No. 10063 for easy thumb operation as illustrated above. All types are available in bright nickel finish to meet Signal Corps requirements or black oxide to meet Navy specifications.

**JAMES MILLEN
MFG. CO., INC.**

MAIN OFFICE AND FACTORY
MALDEN
MASSACHUSETTS



Index of Advertisers

Allied Radio Corporation	91
American Phenolic Corporation	86
American Radio Relay League, Inc.	109
Amperex Electronic Corporation	87
Ashco Radio Co., Walter	101
Astastic Corp., The	117
Barker & Williamson, Inc.	113
Belden Manufacturing Co.	77
Bendix Radio Div.	115
Breedlove, Bernard H.	119
Candler System Company	125
Capitol Radio Eng. Institute	113, 121
Centralab.	85
Chicago Transformer Co.	88
Collips Radio Co.	2
Commercial Radio Institute	125
Dart Export Corporation	119
Dow-Key Co., The	117
Drake Co., The R. L.	110
Eitel-McCullough, Inc.	127
Electro-Voice, Inc.	79
Eldico of New York	80, 81
Engineering Associates	125
Gardiner & Co.	112
Gates Radio Company	111
General Electric Company	1
Greenlee Tool Co.	114
Hallcrafters Co., The	4, 7, 75
Harrison Radio Corporation	105
Harvey Radio Co., Inc.	93
Harvey-Wells Elec. Inc.	90
Henry Radio Stores	95
Hy-Life Antennae, Inc.	114c
Hytron Radio & Electronics Corp.	119
Instructograph Co.	115
Johnson Co., E. F.	82
Knights Co., The James	111
Leads Radio Co.	107
Lettine Radio Mfg. Co.	117
Lysco Manufacturing Co.	118
Lyman, Roger T.	120
McGraw-Hill Book Co.	102
Mallory & Co., P. R.	128
Martin Co., The Glenn L.	120
Mass. Radio & Teleg. School	125
Merit Transformer Corporation	108
Millen Mfg. Co., Inc., The James	126
Motorola, Inc.	116
Mosley Electronics	104
National Co., Inc.	73, 122, Cov. III
New York YMCA Tr. & Techn. Schools	123
Ohmite Manufacturing Co.	83
Overbrook Co., The	115
Petersen Radio Co.	5
Pioneer Broach Co.	123
Port Arthur College	123
Precision Apparatus Co.	84
Premax Products Co.	94
RCA Institutes, Inc.	123
Radio Corporation of America	Cov. IV
Radiocom, Inc.	89
Radio Shack Corporation, The	97
Rocket Distributors, Inc.	123
Shure Brothers	98
Signal Electric Mfg. Co.	120
Snyder Manufacturing Co.	100
Srepc, Inc.	108
Steinberg's, Inc.	106
Telex, Inc.	112
Teleplex Co.	122
Terminal Radio Corp.	99
Triplett Elec. Instrument Co.	92
Turner Co., The	121
United Transformer Company	Cov. II
Valparaiso Technical Institute	119
Yesto Company, The	118
Vibroplex Co., The	123
Ward Products Co.	96
Weston Laboratories	122
Wind Turbine Co.	116
Workshop Associates	119
World Radio Laboratories	103

For top performance . . . the 4-65A



In the past few years since the Eimac 4-65A became available, it has become one of the most widely used transmitting type tetrodes in its power class. The reason is simple . . . It is a better vacuum tube built not to meet a price but to surpass commonly accepted performance and quality standards.

The 4-65A is a ruggedly constructed tube incorporating the best principles of design found in high-power transmitting tubes. It is extremely versatile, operating over a wide range of plate voltages and well into the vhf.

If you're interested in CW . . . one 4-65A will handle 345 watts (class-C) with less than 2 watts grid drive permitting direct drive from a VFO with power to spare. For phone . . . one tube, when plate modulated, will handle 270 watts input with 2500 plate volts.

Why not use a tube made for transmitting service. Enjoy dependable performance and at the same time have power to spare . . . investigate the Eimac 4-65A . . . write for complete data today.

EITEL-McCULLOUGH, INC.
San Bruno, California

Export Agents: Frazar & Hansen, 301 Clay St., San Francisco, California

4-65A GENERAL CHARACTERISTICS

ELECTRICAL

Filament: Thoriated Tungsten	
Voltage	6.0 volts
Current	3.5 amps.
Grid-Screen	
Amplification Factor (Av.)	5
Direct Interelectrode	
Capacitances (Av.)	
Grid-Plate	0.08 uuf.
Input	8.0 uuf.
Output	2.1 uuf.

RADIO FREQUENCY POWER AMPLIFIER AND OSCILLATOR

Class-C Telephony or Telephony

MAXIMUM RATINGS

(Key-down conditions, per tube)

D-C Plate Voltage	- 3000 Max. Volts
D-C Screen Voltage	- 400 Max. Volts
D-C Grid Voltage	- 500 Max. Volts
D-C Plate Current	- 150 Max. Ma.
Plate Dissipation	- 65 Max. Watts
Screen Dissipation	- 10 Max. Watts
Grid Dissipation	- 5 Max. Watts

Eimac
TUBES

the 4-65A is another Eimac contribution to electronic progress

MALLORY HAM BULLETIN

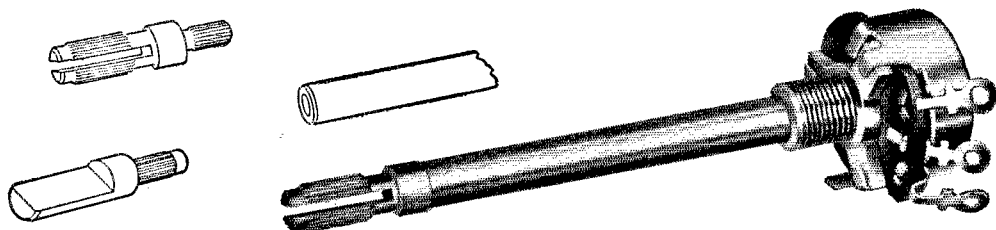

Designed And Constructed For Maximum Usefulness To The Amateur ... The Mallory Midgetrol*

There is no question but what the physical size of a volume control, as well as the length, diameter and contour of its shaft, determine to a great extent its usefulness to the amateur for building new radio equipment or repairing old.

Mallory engineers very definitely recognized the importance of these factors when they designed the Mallory Midgetrol series $\frac{15}{16}$ " diameter carbon controls, for these controls were designed specifically for maximum usefulness to the amateur (and for that matter, to the industrial or professional radio service user as well).

Practical imagination plus good old-fashioned engineering ingenuity went into the Midgetrol to give you a versatile control whose physical size ($\frac{15}{16}$ " in diameter) is small enough to fit the most miniature portable equipment, yet whose electrical characteristics make it entirely suitable for the largest communications set.

Far-sighted engineering has also given you a sensible, *permanently fixed, plain round brass shaft*, which may be altered quickly and effectively to accommodate standard "split-knurled" or "flatted" type knobs without sacrificing the highly desirable advantage of a stable, permanently fixed shaft. (Every round shaft Midgetrol is delivered complete with two unique steel "shaft-ends" which may be pressed permanently into the brass control shaft to accept common knob styles. No filing or unusual handling of the control shaft is required.)

In addition, the unique Midgetrol design has virtually licked the old and annoying problem of unsatisfactory AC switch installation, for an ingenious arrangement for locking the switch permanently and solidly into place has eliminated forever the annoyance of having to remove the control housing to attach the switch. Actually, a switch can be attached to a Midgetrol in much less time than it takes to tell about it.

When you go to see the Midgetrol at your Mallory Distributor's, don't expect a flashy, spectacular volume control, for the Midgetrol was not designed to be that kind of control. Instead, you're going to see a sensible control, designed to do the things a good volume control should do, and yet be as universal as possible without sacrificing a thing in good engineering fundamentals.

Frankly, we're extremely enthusiastic about the possibilities this round shaft Midgetrol has for amateur work, and we think you will be too, when you see it.

*Midgetrol—Trade Mark

P. R. MALLORY & CO., Inc.
INDIANAPOLIS 6 INDIANA

P. R. MALLORY & CO. Inc.
MALLORY

FORGET ANY STANDARD OF SELECTIVITY YOU HAVE EVER KNOWN... A STARTLING ANNOUNCEMENT WILL APPEAR ON THIS PAGE SOON

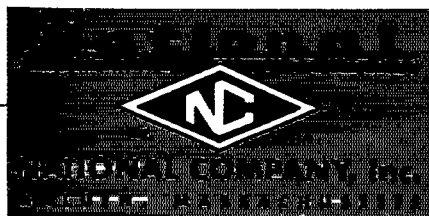
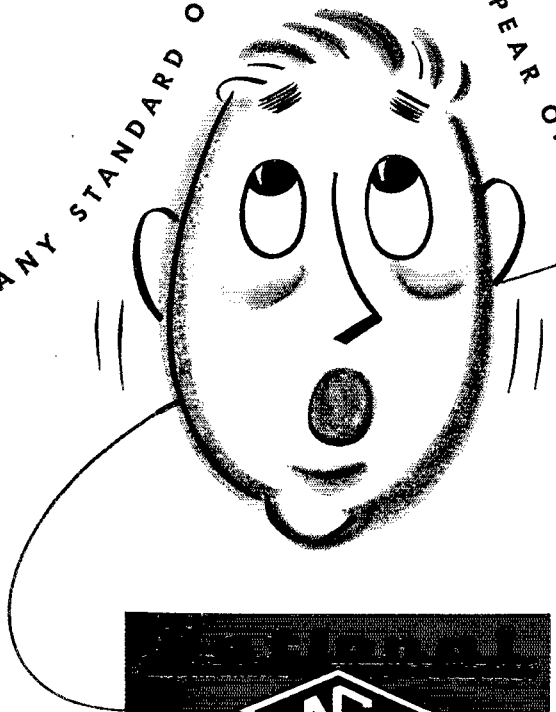

RCA TUBE LINE-UPS FOR 1951

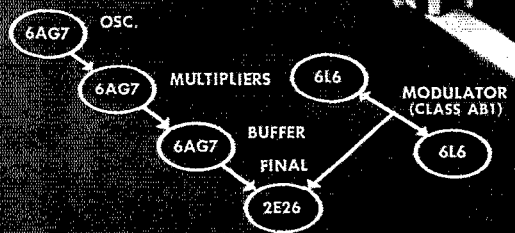
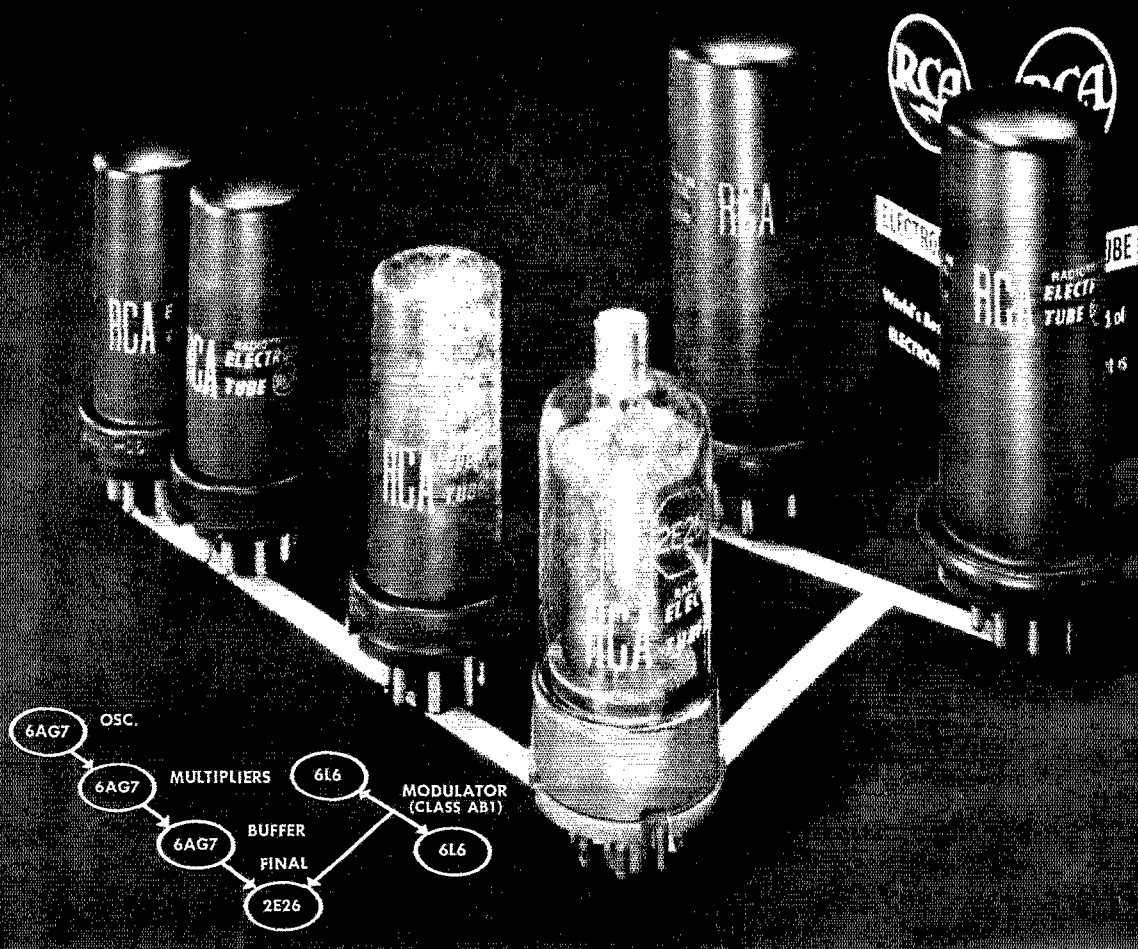

Low cost, high efficiency multi-band rig ...with RCA-2E26 beam power final

HERE'S AN ECONOMY PACKAGE that's *small* in its space and power requirements—but *big* in its accomplishments. With a husky RCA-2E26 beam power tube in the final—plus a pair of RCA-6L6's as modulators—this all-RCA line-up will handle a full 40 watts input on CW, and 27 watts input on phone.

The RCA-2E26 is easy as pie to drive... and delivers full output at low plate voltage. Because it operates at low plate voltages, a single inexpensive power supply may be used for the entire rig.

The RCA-2E26 incorporates superior internal shielding. What's more, the RCA-2E26 can be operated at full input right up to 125 Mc... or at slightly reduced input up to 150 Mc... so here's the basis for a quick-change multi-band transmitter in one, inexpensive, compact unit that can be used later for driving a higher power final.

To get all the tube power, performance, and life you pay for... buy genuine RCA tubes in the familiar red black-and-white cartons from your local RCA Tube Distributor.



RADIO CORPORATION of AMERICA
ELECTRON TUBES
HARRISON, N. J.