

December, 1950

40 Cents

45c in Canada

QST

devoted entirely to

amateur radio



Linear Standard Units..

THE ULTIMATE IN QUALITY...

UTC Linear Standard Audio Transformers represent the closest approach to the ideal component from the standpoint of uniform frequency response, low wave form distortion, high efficiency, thorough shielding and utmost dependability. UTC Linear Standard Units offer these features:

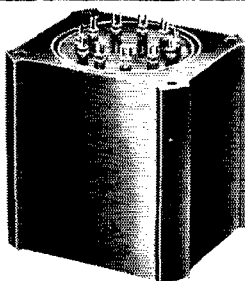

- True Hum Balancing Coil Structure . . . maximum neutralization of stray fields.
- Balanced Variable Impedance Line . . . permits highest fidelity on every tap of a universal unit . . . no line reflections or transverse coupling.
- Reversible Mounting . . . permits above chassis or sub-chassis wiring.
- Alloy Shields . . . maximum shielding from inductive pickup.
- Hiperm-Alloy . . . a stable, high permeability nickel-iron core material.
- Semi-Toroidal Multiple Coil Structure . . . minimum distributed capacity and leakage reactance.
- Precision Winding . . . accuracy of winding .1%, perfect balance of inductance and capacity; exact impedance reflection.
- High Fidelity . . . UTC Linear Standard Transformers are the only audio units with a guaranteed uniform response of ± 1 DB from 20-20,000 cycles.

TYPICAL LS LOW LEVEL TRANSFORMERS

Type No.	Application	Primary Impedance	Secondary Impedance	\pm db from	Max. Level	Relative hum-pickup reduction	Max. Unbalanced DC in prim'y	List Price
LS-10	Low impedance mike, pickup, or multiple line to grid	50, 125, 200, 250, 333, 500/600 ohms	80,000 ohms in two sections	20-20,000	+15 DB	-74 DB	5 MA	\$25.00
LS-10X	As Above	As above	50,000 ohms	20-20,000	+14 DB	-92 DB	5 MA	32.00
LS-12	Low impedance mike, pickup, or multiple line to push pull grids	50, 125, 200, 250, 333, 500/600 ohms	120,000 ohms overall, in two sections	20-20,000	+15 DB	-74 DB	5 MA	28.00
LS-12X	As above	As above	80,000 ohms overall, in two sections	20-20,000	+14 DB	-92 DB	5 MA	35.00
LS-26	Bridging line to single or push pull grids	5,000 ohms	80,000 ohms in two sections	15-20,000	+20 DB	-74 DB	0 MA	25.00
LS-19	Single plate to push pull grids like 2A3, 6L6, 300A. Split secondary	15,000 ohms	95,000 ohms; 1.25:1 each side	20-20,000	+17 DB	-50 DB	0 MA	24.00
LS-21	Single plate to push pull grids. Split primary and secondary	15,000 ohms	135,000 ohms; turn ratio 3:1 overall	20-20,000	+14 DB	-74 DB	0 MA	24.00
LS-22	Push pull plates to push pull grids. Split primary and secondary	30,000 ohms plate to plate	80,000 ohms; turn ratio 1.6:1 overall	20-20,000	+26 DB	-50 DB	.25 MA	31.00
LS-30	Mixing, low impedance mike, pickup, or multiple line to multiple line	50, 125, 200, 250, 333, 500/600 ohms	50, 125, 200, 250, 333, 500/600 ohms	20-20,000	+17 DB	-74 DB	5 MA	25.00
LS-30X	As above	As above	As above	20-20,000	+15 DB	-92 DB	3 MA	32.00
LS-27	Single plate to multiple line	15,000 ohms	50, 125, 200, 250, 333, 500/600 ohms	30-12,000 cycles	+20 DB	-74 DB	8 MA	24.00
LS-50	Single plate to multiple line	15,000 ohms	50, 125, 200, 250, 333, 500/600 ohms	20-20,000	+17 DB	-74 DB	0 MA	24.00
LS-51	Push pull low level plates to multiple line	30,000 ohms plate to plate	50, 125, 200, 250, 333, 500/600 ohms	20-20,000	+20 DB	-74 DB	1 MA	24.00
LS-141	Three sets of balanced windings for hybrid service, centertapped	500/200 ohms	500/600 ohms	30-12,000	+10 DB	-74 DB	0 MA	28.00

Write for our Catalog PS-409

SIMPLIFY YOUR POWER-SUPPLY CIRCUIT!

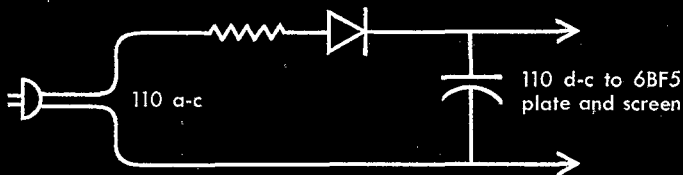

New G-E 6BF5 is designed to operate with 110 volts on plate and screen!

It's *simpler* to apply this fine new beam power tube . . . because there's good efficiency at low plate and screen voltages. High tube sensitivity makes possible a high output at 110 v. Therefore, no step-up transformer need be included in your power-supply circuit. The circuit is called on merely to rectify the voltage from your regular a-c line—a job which a selenium rectifier will do readily.

As the ratings at the right show, a single 6BF5 in Class A audio will deliver almost 2 w at 110 v. If you wish to apply a higher potential, the max rating of 250 v allows for voltages up to that figure. Thus you buy tube versatility as well as sensitivity.

Originally designed for—and commercially proved in—the audio-output stage of TV and broadcast receivers, G.E.'s new 6BF5 is an outstanding ham choice for audio work. Besides its easily-handled power-supply requirement, the tube has a set of electrical characteristics that call for close consideration when you design your new speech-amplifier.

These figures are summarized here. Your G-E tube distributor will be glad to give you more detailed information about the 6BF5—also, show you the tube and let you know the favorable price. See him today! Or write *Electronics Department, General Electric Company, Schenectady 5, New York.*



6BF5

7-pin miniature beam power audio tube

Typical Operation, Class A Amplifier

Plate voltage	110 v
Screen voltage	110 v
Grid No. 1, voltage	-7.5 v
Transconductance	7,500 micromhos
Max signal plate current	50 ma
Max signal screen current	8.5 ma
Load resistance	2,500 ohms
Power output	1.9 w

ELECTRONIC TUBES OF ALL TYPES FOR THE RADIO AMATEUR

GENERAL  ELECTRIC

180-JA8

Despite rumors **COLLINS IS NOT GOING OUT OF** **THE AMATEUR EQUIPMENT BUSINESS**

The grapevine is wrong. Here are the facts:

Production lines are rolling now for a large run of 75A-2 amateur receivers. These new receivers, engineered specifically for amateur use, will be in full distribution by February of next year.

Our factory is going ahead full steam for the production of the new Collins 1 KW transmitter. Deliveries will begin early next spring.

Meanwhile, production of the Collins 32V-2 continues steadily, and has been stepped up for a substantial increase in the number of units scheduled for delivery.

It is true that Collins has taken on a tremendous additional load for the Department of Defense. To accomplish this and to continue to serve you, it is still expanding its facilities in every reasonable way.

The first products of this company were for amateurs, and it still considers amateur equipment one of its most important products.

No — COLLINS IS NOT GOING OUT OF THE AMATEUR BUSINESS.

For the best in amateur radio, it's . . .

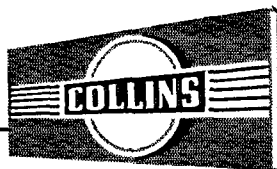

COLLINS RADIO COMPANY, Cedar Rapids, Iowa

11 West 42nd Street, NEW YORK 18

2700 West Olive Avenue, BURBANK

QST

DECEMBER 1950

VOLUME XXXIV • NUMBER 12

PUBLISHED, MONTHLY, AS ITS OFFICIAL ORGAN, BY THE AMERICAN RADIO RELAY LEAGUE, INC., AT WEST HARTFORD, CONN., U. S. A.; OFFICIAL ORGAN OF THE INTERNATIONAL AMATEUR RADIO UNION

STAFF

Editorial

A. L. BUDLONG, W1BUD
Editor

HAROLD M. McKEAN, W1CEG
Managing Editor

GEORGE GRAMMER, W1DF
Technical Editor

DONALD H. MIX, W1TS
BYRON GOODMAN, W1DX
Assistant Technical Editors

EDWARD P. TILTON, W1HDQ
V.H.F. Editor

RICHARD M. SMITH, W1FTX
C. VERNON CHAMBERS, W1JEO
Technical Assistants

ROD NEWKIRK, W9BRD
DX Editor

WALTER E. BRADLEY, W1FWH
Technical Information Service

Production

RALPH T. BEAUDIN, W1BAW
Production Manager

NANCY A. PRICE
Assistant

Advertising

F. CHEYNEY BECKLEY, W1GS
LORENTZ A. MORROW, W1VG
EDGAR D. COLLINS

Circulation

DAVID H. HOUGHTON
Circulation Manager

RALPH T. BEAUDIN, W1BAW
Assistant Circulation Manager

OFFICES

38 La Salle Road

West Hartford 7, Connecticut

Subscription rate in United States and Possessions, \$4.00 per year, postpaid; \$4.25 in the Dominion of Canada, \$5.00 in all other countries. Single copies, 40 cents. Foreign remittances should be by international postal or express money order or bank draft negotiable in the U. S. and for an equivalent amount in U. S. funds.

Entered as second-class matter May 29, 1919, at the post office at Hartford, Connecticut, under the Act of March 3, 1879. Acceptance for mailing at special rate of postage provided for in section 1102, Act of October 3, 1917, authorized September 9, 1922. Additional entry at Concord, N. H., authorized February 21, 1929, under the Act of February 28, 1925.

Copyright 1950 by the American Radio Relay League, Inc. Title registered at U. S. Patent Office. International copyright secured. All rights reserved. Quedan reservados todos los derechos. Printed in U.S.A.

INDEXED BY
INDUSTRIAL ARTS INDEX

—CONTENTS—

"It Seems to Us . . ."	9
Our Cover	12
Feed-Back	12
ARRL QSL Bureau	12
A Sharp I.F. Amplifier for 'Phone or C.W. <i>Byron Goodman, W1DX</i>	13
A Ham-Shack Frequency Standard <i>Wyn H. McGee, ZL3LR</i>	18
In QST 25 Years Ago This Month	19
Monument Honors Historic IBCG	20
Design for Communication <i>A. M. Pichitino, W3NJE, and F. J. Pichitino, W8KML</i>	21
Happenings of the Month	25
Universal S.W.R. Measurements with a Coaxial Bridge <i>George Grammer, W1DF</i>	27
TVI Tips — Harmonic Separators	30
Silent Keys	32
"Supermodulation" — An Evaluation and Explanation <i>Oswald G. Villard, jr., W6QYT</i>	33
Military Amateur Radio System	41
Two Unusual 144-Mc. Antennas — A Lightweight Flopover Array <i>Walter F. Bain, W2WFB</i>	42
The Houston Hayrake — A Compact 12-Element Array <i>W. E. Leverkus, W5KFY</i>	43
United States Naval Reserve	44
On the Air With Single Sideband	45
DX Century Club	46
I.A.R.U. News	48
Results, Fourteenth ARRL Field Day	49
Correspondence from Members	56
How's DX?	57
Announcing 10-Meter WAS Contest	60
WWW-WWVH Schedule	60
The World Above 50 Mc.	61
Hints and Kinks	66
Operating News	68
With the A.E.C.	70
Station Activities	74
QST Index for 1950	125

New AC-DC Version of
AN OLD FAVORITE...



hallicrafters
S-77

NOW AVAILABLE! \$99.95

Improved AC-DC version of the famous S-40B—the world's most popular ham receiver. What's the secret behind such popularity? Just good sound engineering—a stable straightforward circuit with plenty of what you want—at a price within reach of everyone.

One r-f, two i-f stages. Temperature compensated. Series type noise limiter. Microset iron core i-f coils. Separate electrical bandspread. Improved cabinet construction. Built-in PM speaker. 7 tubes plus rectifier.

EXPORT REPRESENTATIVES: Canadian Radio Manufacturers Corp., Toronto;
Philips Export Corp.; Ortiz Brothers International

hallicrafters
"The Radio Man's Radio"

WORLD'S LEADING MANUFACTURER OF PRECISION RADIO & TELEVISION • CHICAGO 24, ILLINOIS



Happy Christmas

BILL PETERSEN, WØJRY



PETERSEN RADIO COMPANY, Inc.

2800 W. BROADWAY, COUNCIL BLUFFS, IOWA

Section Communications Managers of the ARRL Communications Department

Reports Invited. All amateurs, especially League members, are invited to report station activities on the first of each month (or preceding month) direct to the SCM, the administrative ARRL official elected by members in each Section. Radio Club reports are also desired by SCMs for inclusion in QST. All ARRL Field Organization appointments are now available to League members. These include QRS, QES, QPS, QO and QBS. Also, where vacancies exist SCMs desire applications for SEC, EC, RM, and PAM. In addition to station and leadership appointments for Members, *all amateurs* in the United States and Canada are invited to join the ARRL Emergency Corps (ask for Form 7).

ATLANTIC DIVISION				
Eastern Pennsylvania Maryland-Delaware-D.C. Southern New Jersey Western New York Western Pennsylvania	W3BES W3BWT W2ASG W2PGT W3KWL	Jerry Mathis Eppa W. Darne Dr. Luther M. Mkitarian Harding A. Clark Ernest J. Hlinsky	617 Crescent Ave. 132 Tennessee Ave., N.E. 500 Warwick Road RFD 2 509 Beechwood Ave.	Glenide Washington 2, D.C. Haddonfield Manlius Farrell
CENTRAL DIVISION				
Illinois Indiana Wisconsin	W9EVJ W9RE W9RQM	Lloyd E. Hopkins W. E. Monigan Reno W. Goetsch	27 Lynch St. 1504 East Ewing 929 S. 7th Ave.	Elgin South Bend 14 Wausau
DAKOTA DIVISION				
North Dakota South Dakota Minnesota	W0JWY W0NGM W0RA	Rev. Lawrence C. Strandenaes J. S. Foasberg John B. Morgan	St. Andrew's Church 509 Idaho Ave., S.E. 1411 Summit Ave.	Westhope Huron St. Paul 5
DELTA DIVISION				
Arkansas Louisiana Mississippi Tennessee	W5DRW W5GHF W5DLA W4AFI	Dr. John L. Stockton Robert E. Barr J. C. Wallis D. G. Stewart	P. O. Box 302 Box 446 2406 Kelly St. McAlice Drive	Siloam Springs Springhill Gulfport Fountain City
GREAT LAKES DIVISION				
Kentucky* Michigan Ohio	W4NBY W8AQA W8HGW	Rev. Lynn C. White Robert B. Cooper Leslie Misch	104 Mound St. 132 Guild St., N.E. 21380 Mastick Rd.	Harlan Grand Rapids Cleveland 26
HUDSON DIVISION				
Eastern New York N. Y. C. & Long Island Northern New Jersey	W2CLL W2OBU W2NKD	George W. Sleeper George W. Cooke Thomas J. Kyan, jr.	76 Fuller Road 88-31 239th St. 1082 Anna St.	Albany 3 Baltimore 6, L. I. Elizabeth 4
MIDWEST DIVISION				
Iowa Kansas Missouri Nebraska	W0PP W0ICV W0ICD W0OED	William G. Davis Earl N. Johnston Ben H. Wendt Scott E. Davison	3rd St. 624 Roosevelt RFD 8 433 North Nye Ave.	Mitchellville Topeka North Kansas City Fremont
NEW ENGLAND DIVISION				
Connecticut Maine Eastern Massachusetts Western Massachusetts New Hampshire Rhode Island Vermont	W1VB W1VY W1ALP W1EOB W1JNC W1CIH W1NLO	Walter L. Glover Manley W. Haskell Frank L. Baker, jr. Victor W. Paounoff Norman A. Chapman Roy B. Fuller Burtis W. Dean	Glover Ave. 15 Fernlock St. 91 Atlantic St. 26 Denton Circle 99 Broadway 17 Ledge Road P. O. Box 81	Newtown Portland North Quincy 71 Springfield Concord East Greenwich Burlington
NORTHWESTERN DIVISION				
Alaska Idaho Montana Oregon Washington	KL7IG W7IMU W7KGJ W7MCO W7CZY	Charles M. Gray Alan K. Ross Edward G. Brown J. E. Roden Laurence Sebring	Box 1237 2105 Irene St. 421 Yellowstone Ave. 519 N.W. Ninth Route 2, Box 384	Douglas Boise Billings Pendleton Everett
PACIFIC DIVISION				
Hawaii Nevada Santa Clara Valley East Bay San Francisco Sacramento Valley San Joaquin Valley	KH6HJ W7BVZ W6LZL W6TL W6ATO W6ZF W6FYM	Dr. Robert Katsuki Carroll W. Short, jr. Roy I. Couzin Horace R. Greer R. F. Czeikowitz Ronald G. Martin E. Howard Hale	1817 Wilhelmina Rise 1608 Arizona St. 7 Englewood Ave. 41 Fairmount Ave. 243 Colon Ave. 2638 13th St. 741 E. Main St.	Honolulu 17 Boulder City Los Gatos Fairland 11 San Francisco 12 Sacramento 14 Turlock
ROANOKE DIVISION				
North Carolina South Carolina Virginia West Virginia	W4DCO W4AZT W4FF W8JM	Herman P. Jolitz Wade H. Holland H. Edgar Lindauer Donald B. Morris	P. O. Box 48 P. O. Box 116 Route 1, Box 431 303 Home St.	Clinton Greenville Aunandale Farmdale
ROCKY MOUNTAIN DIVISION				
Colorado Utah Wyoming	W0IOZ W7SP W7KfV	M. W. Mitchell Leonard F. Zimmerman Marion R. Neary	1959 Uinta St. House 4 Box 215	Denver 7 Saltair Laramie
SOUTHEASTERN DIVISION				
Alabama* Eastern Florida Western Florida Georgia West Indies (Cuba-P.R.-V.I.)	W4HFL W4FWZ W4ACB W4ZD KP4DJ	Percy Sexton John W. Hollister S. M. Douglas, jr. James P. Born, jr. William Werner	6 Johnson Circle 3809 Springfield Blvd. P. O. Box 3 25 First Ave., N.E. 563 Ramon Llovett	Northport Jacksonville Tallahassee Atlanta Urb. Truman, Rio Piedras, P. R. Gambou, C. Z.
Canal Zone	KZ5AW	Everett R. Kimmel	Box 264	
SOUTHWESTERN DIVISION				
Los Angeles Arizona San Diego	W6VIM W7MID W6YYM	Virge A. Gentry, jr. Jim Kennedy Mrs. Ellen White	2156 W. 108th St. 4511 N. 8th St. 3677 Wightman St.	Los Angeles 47 Phoenix San Diego
WEST GULF DIVISION				
Northern Texas Oklahoma Southern Texas New Mexico	W5BKH W5AHT/AST W5BDI W5SMA	William A. Green Frank E. Fisher Ammon O. Young Lawrence R. Walsh	1334 University Blvd. 104 East 11th St. 4803 Elf St. 2100A 35th Street	Abilene Pawhuska Houston 7 Los Alamos
MARITIME DIVISION				
Maritime (Nfld. & Labr. att.)	VE1DQ	A. M. Crowell	69 Dublin St.	Halifax, N. S.
ONTARIO DIVISION				
Ontario	VE3IA	G. Eric Farquhar	16 Emerald Crescent	Burlington, Ont.
QUEBEC DIVISION				
Quebec	VE2GL	Gordon A. Lynn	R.R. No. 1	Ste. Genevieve de Pierrefonds, P. Q.
VANALTA DIVISION				
Alberta British Columbia Yukon	VE6MJ VE7FB VE8AK	Sydney T. Jones Ernest Savage W. R. Williamson	P. O. Box 373 4553 West 12th Ave. P. O. Box 534	Edmonton, Alta. Vancouver Whitehorse, Y. T.
PRAIRIE DIVISION				
Manitoba Saskatchewan	VE4AM VE5DW	A. W. Morley J. H. Goodridge	25 Lennox Ave. c/o Canadian Pacific Air Lines	St. Vital Regina

* Officials appointed to act temporarily in the absence of a regular official.

hallicrafters

"The Radio Man's Radio"

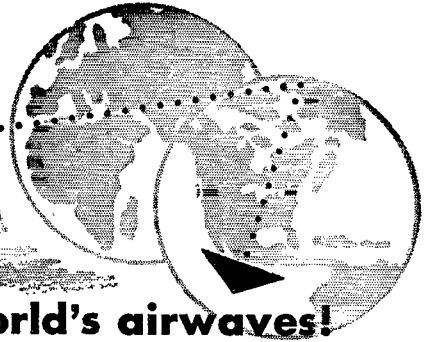

commands the world's airwaves!

In every price range, Hallicrafters offers precision instruments—to serve you better, and giving you more value for your investment than any other set

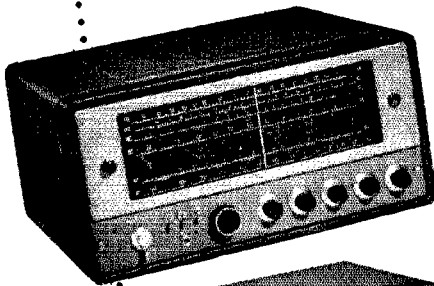

Model SX-62 World's finest receiver for the all-wave listener. Outperforms any broadcast receiver on any frequency—continuous coverage from 540 kc to 109 Mc in six bands. Crystal calibration oscillator built in. Six position selectivity with crystal filter. Two stages r-f, three stages i-f amplification. 10-watt push-pull high fidelity output. Phonograph jack. 14 tubes plus regulator and rectifier. **\$289.50**

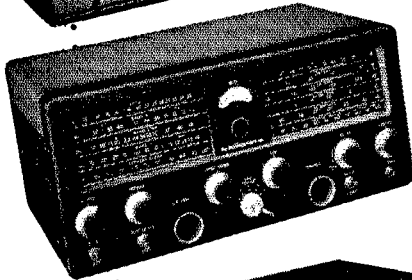

Model SX-71 Value-packed with features specifically asked for by the Hams. Extra sensitivity, selectivity, and stability; double super-heterodyne, plus built-in Narrow Band FM. One r-f, two conversion, and three i-f stages. Range 538 kc to 35 Mc, 46–55 Mc. Extra wide dials for Main and Bandsread Tuning. Sensitivity, Volume, BFO Pitch, Selectivity, and Crystal Phasing controls; AVC, BFO, Rec./Standby, ANL, Tone, and Phono-Rec. switches. Phonograph input jack. 500, 3.2-ohm output. **\$199.50**



Model S-77 New AC-DC version of the famous S-40B. Temperature compensated osc.; tuned r.f. stage, two i-f stages for better selectivity. Covers 540 kc to 43 Mc. in four bands. Sensitivity, volume, three-position Tone, BFO Pitch, controls; AVC, BFO, Rec./Standby, and Noise Limiter Switches. Built-in PM speaker. External power, remote control connections. 7 tubes plus rect. S-77. **\$99.95**

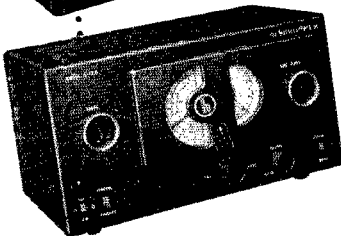

Model S-38B Pulls in broadcast stations in weak signal areas where ordinary sets fail. Also offers world-wide reception for the short-wave listener and the new amateur. Covers Broadcast Band and three short-wave bands 540 kc to 32 Mc. Separate Fine Tuning control. BFO, Rec./Standby, Speaker/Phones switches. Built-in PM speaker. Four tubes plus rectifier. For 115 V. AC or DC. **\$49.50**

WORLD'S LEADING MANUFACTURER OF PRECISION RADIO AND TELEVISION • CHICAGO 24, ILLINOIS

We want you to know that every effort is being made to keep our Distributors supplied. If the model you select is temporarily out of stock, please be patient—you'll find that a Precision HALLICRAFTERS is worth waiting for!

THE AMERICAN RADIO RELAY LEAGUE, INC.,

is a noncommercial association of radio amateurs, bonded for the promotion of interest in amateur radio communication and experimentation, for the relaying of messages by radio, for the advancement of the radio art and of the public welfare, for the representation of the radio amateur in legislative matters, and for the maintenance of fraternalism and a high standard of conduct.

It is an incorporated association without capital stock, chartered under the laws of Connecticut. Its affairs are governed by a Board of Directors, elected every two years by the general membership. The officers are elected or appointed by the Directors. The League is noncommercial and no one commercially engaged in the manufacture, sale or rental of radio apparatus is eligible to membership on its board.

"Of, by and for the amateur," it numbers within its ranks practically every worth-while amateur in the nation and has a history of glorious achievement as the standard-bearer in amateur affairs.

Inquiries regarding membership are solicited. A bona fide interest in amateur radio is the only essential qualification; ownership of a transmitting station and knowledge of the code are not prerequisites, although full voting membership is granted only to licensed amateurs.

All general correspondence should be addressed to the Secretary at the administrative headquarters at West Hartford, Connecticut.



Past Presidents

HIRAM PERCY MAXIM, W1AW, 1914-1936
EUGENE C. WOODRUFF, W8CMP, 1936-1940

Officers

President GEORGE W. BAILEY, W2KH
New York, N. Y.

Vice-President WAYLAND M. GROVES, W5NW
Odessa, Texas

Secretary A. L. BUDLONG, W1BUD
West Hartford, Connecticut

Communications Manager FRANCIS E. HANDY, W1BDI
West Hartford, Connecticut

Treasurer DAVID H. HOUGHTON
West Hartford, Connecticut

General Counsel PAUL M. SEGAL
816 Connecticut Ave., Washington 6, D. C.

Assistant Secretaries JOHN HUNTOON, W1LVQ
RICHARD L. BALDWIN, W1KIE HARRY PASTON, W1DJV
West Hartford, Connecticut

DIRECTORS

President
GEORGE W. BAILEY, W2KH
1 East 79th St., New York 21, N. Y.

Vice-President
WAYLAND M. GROVES, W5NW
P. O. Box 586, Odessa, Texas
(W5NW at Humble Pipe Line Camp, Odessa)

Canadian General Manager
ALEX REID, VE2BHE
240 Logan Ave., St. Lambert, P. Q.
Alternate: William W. Butchart, VE9LQ
10740 107 St., Edmonton, Alta.

Atlantic Division
WALTER BRADLEY MARTIN, W3QV
1033 Arbutha Rd., Abington, Pa.
Alternate: Henry W. Wickenhiser, Jr., W3KWA
1112 State Ave., Coronollis, Pa.

Central Division
JOHN G. DOYLE, W9GPI
4331 N. Wildwood Ave., Milwaukee 11, Wis.
Alternate: Wesley E. Marriner, W9AND
624 College Ave., Dixon, Ill.

Dakota Division
GOODWIN L. DOSLAND, W0TSN
Moorhead, Minn.
Alternate:

Delta Division
VICTOR CANFIELD, W5BSR
P. O. Box 365, Lake Charles, La.
Alternate: George S. Acton, W5BMM
Plain Dealing, La.

Great Lakes Division
JOHN H. BRABB, W8SPF
417 Ford Bldg., Detroit 26, Mich.
Alternate: Harold E. Stricker, W8WZ
247 W. 5th St., Marysville, Ohio

Hudson Division
JOSEPH M. JOINSTON, W2SOX
423 Monmouth Ave., Bradley Beach, N. J.
Alternate: Gay E. Mills, Jr., W2NJP
170 Broadway, New York 7, N. Y.

Midwest Division
LEONARD COLLETT, W0DEA
Civil Aeronautics Administration
Box 776, Joplin, Mo.
Alternate: Alvin G. Keyes, W0KTQ
1201 Merchants Nat'l Bank Bldg., Cedar Rapids, Ia.

New England Division
PERCY C. NOBLE, W1BVR
37 Broad St., Westfield, Mass.
Alternate: Clayton C. Gordon, W1HRC
70 Columbia Ave., Providence 5, R. I.

Northwestern Division
R. REX ROBERTS, W7CPY
837 Park Hill Drive, Billings, Mont.
Alternate: Allan D. Gunston, W7GP
1033 Salem Ave., Apt. 4, Dayton 6, Ohio

Pacific Division
KENNETH E. HUGHES, W6CIB
810 W. Orange Ave., So. San Francisco, Calif.
Alternate: C. Porter Evans, W6BF
134 Dracena Ave., Piedmont 11, Calif.

Ranoke Division
J. FRANK KEY, W4ZA
Box 707, Buena Vista, Va.
Alternate: Gus M. Browning, W4BPD
135 Broughton St., S. E., Orangeburg, S. C.

Rocky Mountain Division
FRANKLIN K. MATEJKA, W0DD
P. O. Box 212, Estes Park, Colo.
Alternate: William R. White, W0PDA
1263 Pearl St., Denver 3, Colo.

Southeastern Division
LAMAR HILL, W4BOL
104 Myrtle, Cochran, Ga.
Alternate: William P. Sides, W4AUP
Fleming Road, Montgomery, Ala.

Southwestern Division
JOHN R. GRIGGS, W6KW
10412 Don Pico Rd., RFD 2, Spring Valley, Calif.
Alternate: John E. Bickel, W6NY
2111 Edgewood Ave., Las Vegas, Nev.

West Gulf Division
DAVID H. CALK, W5BHO
7730 Joplin St., Houston 17, Texas
Alternate:

"It Seems to Us..."

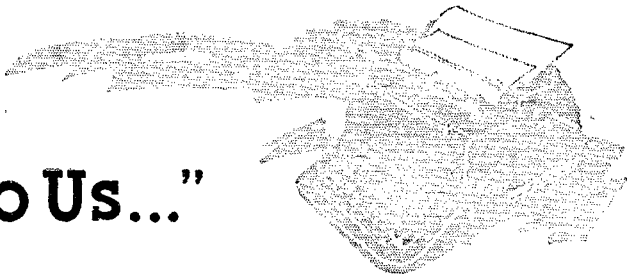

AMATEUR RADIO IN CIVIL DEFENSE

Emergency communication in the event of peacetime disaster has long been one of the traditionally self-appointed rôles of amateur radio in the United States. Now we are extending this to civil defense communications for the communities in which we live. This prospect poses a number of new problems.

Between the two types of emergency radio communication there are two significant — and all-important — differences. One involves the matter of "security"; the other, the nature of the service required of us.

In peacetime emergencies, there has never been any question of our operating except to the extent of our own ability to do so. Civil defense communications, however, presuppose a state of war involving this country. The question — the big question — is not whether we are able to furnish radio communications but whether we will be permitted to do so. The matter goes far beyond the purely amateur radio aspects of civil defense communications; it is the Big Question, and on its answer depends the outcome of the whole concept of the utilization of *any* radio facilities in time of war. The answer affects almost equally the broadcasting, police, fire, amateur radio and other services which might be expected to be pressed into service for civil defense activity.

The answer is one which has been sought diligently by everyone connected with civil defense planning responsibility for the past year and a half. No one has it yet, at least to the point that any official releases are being put out. We think, however, that it is possible to do some speculating on the subject based on ARRL's extensive association with the Hopley civil defense planning group, our participation in the months of work behind its report and behind the preparation of the recently-issued civil defense plan of the National Security Resources Board, our familiarity with the thinking in FCC and the military, and our knowledge of some of the inescapable facts of life as to what can and can't be done in the national interest in time of war. Furthermore, we think it is time that amateurs who are putting in hundreds of hours of hard work, who are sacrificing their personal and, in many cases, family interests, who are spending time and energy and dollars in order to fit themselves more capably for the possible utilization of their unique abilities in time of civil crisis . . . we think these amateurs are entitled to know whether or not, in another wartime emergency, their facilities have a reasonable chance of being used, and if so, on what bands.

Will we be used? As we see it at this stage, the answer is: Yes — if we show we can do the job.

Let us make it clear, first, that the question is not one primarily of finding frequencies on which to operate. Frequencies are a problem, obviously, when wartime conditions expand the military requirements a thousandfold overnight. But frequencies can always be found when the need is sufficiently great, and in all the talk we have ever heard about the conditions which would make our civil defense communications a live issue in any of our principal centers, it has been apparent that the need will be very great indeed. The question is primarily one of security. The civil defense planners may point out, as they have both in the Hopley and NSRB reports, that the nerve system of civil defense is communications; so it is. They may say, as they do, that provision must be made for emergency service as an alternate means of transmitting messages when regular facilities are destroyed, as indeed it must. They may go on to say, as they have, that such emergency services should include mobile

two-way radio equipment and amateur radio services and even go so far as to say, again as they do, that "amateur radio operators and networks will be used in civil defense communications." Nevertheless, it seems to us that the thing which has been left out and which we must face frankly is the unspoken additional proviso ". . . to the fullest extent deemed advisable in the interests of security." Can we afford to use any form of radio communications in civil defense work which would disclose to the enemy, the nature, location and extent of the damage inflicted? We think there is only one answer to that: We cannot afford radio communication in civil defense activity if it is of a nature as to make such disclosures.

Does that mean no radio in civil defense communications? Not at all — but it does mean that so far as any communications "in the clear" are concerned, they will have to stay off DX frequencies. It also means that if there should be some essential need for lower-frequency communications, there will have to be additional restrictions such as special security provisions, power limitations, etc., in connection with such operations.

Before going further into the matter of frequencies, let us now take up briefly the second aspect of civil defense communications which differentiates it from peacetime emergency communications. This is the nature of the service required.

The nature of the service required is going to be somewhat different from that we have been used to in emergency work because the circumstances will be different. In all civil defense planning talk we have heard so far there has been emphasis, from the start, on the *local* aspects of civil defense. The individual community or metropolitan area is the starting point and, it is fervently to be hoped, the ending point. Each community will be on its own to work out its own salvation and only if its facilities prove inadequate will help be sent from adjacent communities — if they are in a position to send it. If you are active in civil defense emergency communications planning (as we hope everyone soon will be if he is not already) start gearing your mind to that *local* concept — your own town or city and its particular and specialized problems. We've seen some talk lately of a "co-ordinated nation-wide" plan; by the very nature of the problem, there can be no such plan. Civil defense planning is primarily local planning, adapted to the requirements of the individual community.

Now about frequencies. If we are going to operate — as we think we are, on some basis — we need frequencies. So it is essential to know, as soon as we can, which of our bands we are going to be able to continue using — which bands we can start working into our civil defense communications activities with a reasonable assurance we will be able to continue working in them in the event of emergency.

Despite the hard work of a lot of people, despite the best efforts of your League staff and the head communications people of NSRB, and FCC and the military, all working together in the utmost harmony, we still don't have an answer to this one, either. Not in black-and-white over somebody's signature; not yet. The problem is being worked on by thoroughly capable individuals of all the agencies mentioned, all of whom are well aware of the desirability of getting an answer, and getting it soon. Maybe we will get it soon, but perhaps we won't, and in any event it may be the answer won't be as clean-cut as we would like. Nevertheless, it seems to us that some details of what is as yet admittedly a slightly fuzzy picture can be discerned.

Let us make it clear at the start we have nowhere encountered a feeling that an automatic shut-down of all amateur facilities will necessarily follow a future war emergency, as happened in World War I and World War II. On the contrary, there is evidence on every hand of a desire to see if amateur facilities, as a *part of organized civil defense measures*, can be continued. The same thing goes for frequencies: the attitude throughout is one of trying to find some way of making essential frequencies available to the extent security considerations and military requirements will permit, and to indicate them in advance if and when it is possible to do so. Pending such a development, however, it seems to us we can come up with some pretty likely answers by an examination of what civil defense requirements will be, whether security considerations indicate the use or non-use of the bands best suited to those requirements, and whether or not there is a reasonable chance of such bands, or necessary parts of them, being available as against known or probable military requirements.

Starting with the requirements, we have to assume, on the basis of the evidence so far, that most of our communications will be local in nature, as against long- or medium-distance in nature. Most of the emphasis, in addition, has so far been on mobile or portable facilities for such local needs. Local mobile, or portable, facilities — the answer is obvious: 2, 6 and 10 meters, primarily. For the remote possibility of medium-distance radio requirements: 75 or 160 meters.

Security? Security considerations instantly argue against *any* of the bands below the 10-meter band, generally speaking. It might be thought that the 10-meter band also properly belongs with the others ruled against by security considerations. But we think

not. Occasional long-distance characteristics it certainly does have, but we are on the wrong side of the sunspot cycle and the band will be getting progressively hopeless for DX communication; even now, it is only during certain hours of the day and certain months of the year it can sustain such communication. Considering the relatively great amount of low-power 10-meter mobile equipment available, we suspect "ten" will be regarded as probably okay on the "calculated risk" basis. As to the others, if all our requirements were strictly local, we could accept their unsuitableness on the basis of security. However, we may have some medium-distance or other specialized requirements that can't be satisfied on the v.h.f. bands and so it would be well to get some idea of the possibilities of restricted use of any of the lower-frequency bands. Twenty and 40: Wash them out; even with low power, the consistent DX carrying powers are much too great. Eighty and 160? We could considerably curtail their DX possibilities by the use of low power. For the occasional time they might be needed, they *could* also be set up under specialized security conditions. Considering the use of such medium-distance facilities is expected to be considerably less, we think either 80 or 160 might be held to one side as possibilities, though admittedly under carefully restricted conditions.

Availability? We'll start out by washing out 20 and 40 on this basis as quickly as we did on the basis of security; no informed and realistic consideration of military requirements of frequencies of this order could come up with any other possible answer. One-sixty? *Probably* okay, on the frequency segments now available. Eighty? This is a problem; nevertheless, it is our feeling that if the need is demonstrated to be sufficiently great for certain requirements that cannot be met elsewhere in civil defense radio work, there is a possibility of working out something to meet those essential minimum needs. Ten should be okay, as should be six; neither presents serious problems as to availability. Two? *Probably* — with the availability of thousands of two-meter installations a big argument in its favor (but we need more of 'em mobile or portable).

And now we begin to get the picture. Facilities for local communications, with primary reliance on 10, 6 and 2 as suitable, "safe," and probably available. Emphasis on mobile and portable equipment in these bands, with independent power in one form or another virtually a "must." Some possible reliance on 1.8 or 3.5 Mc., where plans formulated by civil defense authorities indicate medium-distance radio requirements; in our opinion, however, the problem of medium-distance requirements is of such a specialized nature that we do not believe it need be a concern of the majority of amateurs at this stage in civil defense planning. No consideration of either of these bands for any "in the clear" use locally.

Based on the best information we have at this writing, in late October of 1950, we think hams in civil defense can start to lay their plans in line with the preceding paragraphs. Admittedly, we have no written guarantees from anybody at this point (we'd print them instantly if we had). However, it must be apparent to any thinking reader that neither would we stick our neck out to the extent we have just done if we did not have at least some basis for our statement.

In conclusion, we would like to leave four thoughts.

First: we amateurs are not planning civil defense measures; we are, instead, offering a service to those who are. The responsibility for planning, quite properly, is being lodged with the responsible authorities of our cities and states. Our service is a facility; we are simply another form of communication. The most effective amateur cooperation in civil defense planning, as we see it, involves going to your local authorities and saying: "Here is an extensive, self-sustaining, self-servicing, self-trained and instantly available emergency radio service; tell us how you want to use it."

Second, don't get the idea that amateurs will be the whole show in civil defense radio communications. For one thing, primary use will always be made of wire facilities for communications needs; it is only when these fail or are inadequate that we turn to radio. Furthermore, when radio is required it will probably take all the radio available in a community — fire, police, state police, amateur, taxicabs, etc. All will have their part and that part will be determined by the local mayor's committee, or a similar group when higher levels are involved.

Third, the very best insurance of our being fitted into the permanent civil defense picture will result from our demonstrating, in advance, that we can do a job. Amateur Emergency Coördinators, who have not already done so, must move without delay to establish proper liaison with the local committees now being set up all over the country to develop local civil defense measures, so that when planning starts the availability of amateurs will be known to the responsible authorities. The amateur body as a whole must pitch in, now, to insure that the service we can supply will, when offered, be ready, extensive and effective. We cannot emphasize this point too strongly. Civil defense planners aren't going to be interested in a "paper" organization or a good idea in somebody's mind. They will want to know what we *have*; not what we could have if we had

more stations or more time or more organization. Our ability to fit ourselves into the local picture depends on our ability to demonstrate that we have organization and facilities in being. Every active amateur should sign up with his local Emergency Coördinator and participate in the work designed to fit him and his fellows into the local picture as the Coördinator determines it from the mayor's committee, or other designated body, and brings back those needs to the amateur group. The effectiveness of the story your Emergency Coördinator tells us will, in turn, determine the story the League officers can take to the top civil defense communications people at Washington — the people we must continue to sell, and can if we amateurs do the job of which we are capable. Of which, in fact, we alone are capable.

And fourth, remember that we now have two jobs on our hands — civil defense communications and peacetime emergency communications. The requirements are not the same, the frequencies required are not the same — and for peacetime emergency work there is no question of security or availability to argue against use of any of our frequency bands. Preparation for one, therefore, is not necessarily adequate preparation for the other.

From now on, we must prepare for both.

— A. L. B.

OUR COVER

Sitting in at the Headquarters Station, WIBUD speeds a greeting from all of us to all of you —

Merry Christmas!

Happy New Year!

FEED-BACK

The vertical supports (part No. 3 in Fig. 1) in the 12-element 2-meter array described on page 28 of October *QST* should be 86 inches long, not 46 inches as stated in the cut label. Thanks to W5OCP for calling this to our attention.

Strays

Edward Green, W6WZA, veteran star of radio, stage and screen, died September 19th in Los Angeles after a recurrent illness of two years. Amateur radio had been his hobby for more than a quarter century. Best known professionally for his radio rôle in "Duffy's Tavern," he first started in radio with Rudy Vallee in the '20s.

A four-page mimeograph, revised as of May 1950 and entitled "Bibliography of Articles Concerning Conversion of War Surplus Equipment for Civilian and School Use," may be obtained without charge by writing to the Office of Education, Federal Security Agency, Washington 25, D. C. The bibliography was originally compiled by Willis C. Brown, W3HBB, a specialist for aviation for the Agency.

New Electronics Terms Department:

From the Studio City (Calif.) *Graphic*, thanks to W6DDE: "An amateur can . . . reach 12,000 miles with only 30 watts of power, depending on *iconospheric* conditions." (Italics ours.)

A.R.R.L. QSL BUREAU

The function of the ARRL QSL Bureau system is to facilitate delivery to amateurs in the United States, its possessions, and Canada of those QSL cards which arrive from amateur stations in other parts of the world. Its operation is made possible by volunteer managers in each W, K and VE call area. All you have to do is send your QSL manager (see list below) a stamped self-addressed envelope which is about 4¼ by 9¼ inches in size, with your name and address in the usual place on the front of the envelope and your call printed in capital letters in the upper left-hand corner.

W and VE stations should not send cards for other W and VE stations through the QSL Bureau; they cannot be accepted. Likewise, cards for foreign stations should be sent only through the foreign bureaus. For a list of these overseas QSL bureaus, see page 48, this issue.

- W1, K1 — Frederick W. Reynolds, W1JNX, 112 Commonwealth Ave., Dedham, Mass.
W2, K2 — H. W. Yahnel, W2SN, Lake Ave., Helmetta, N. J.
W3, K3 — Jesse Bieberman, W3KT, Box 34, Philadelphia 5, Penna.
W4, K4 — Johnny Dortch, W4DDF, 1611 East Cahal Ave., Nashville, Tenn.
W5, K5 — L. W. May, jr., W5AJG, 9428 Hobart St., Dallas 18, Texas
W6, K6 — Horace R. Greer, W6TI, 414 Fairmount St., Oakland, Calif.
W7, K7 — Mary Ann Tatro, W7FWR, 513 N. Central, Olympia, Wash.
W8, K8 — William B. Davis, W8JNF, 4228 W. 217th St., Cleveland 16, Ohio
W9, K9 — John F. Schneider, W9CFT, 311 W. Ross Ave., Wausau, Wisc.
W0, K0 — Alva A. Smith, W6DMA, 238 East Main St., Caledonia, Minn.
VE1 — L. J. Fader, VE1FQ, 125 Henry St., Halifax, N. S.
VE2 — Austin A. W. Smith, VE2UW, 6164 Jeanne Mance, Montreal 8, Que.
VE3 — W. Bert Knowles, VE3QB, Lanark, Ont.
VE4 — Len Cuff, VE4LC, 286 Rutland St., St. James, Man.
VE5 — Fred Ward, VE5OP, 899 Connaught Ave., Moose Jaw, Sask.
VE6 — W. R. Savage, VE6EO, 329 15th St., North Lethbridge, Alta.
VE7 — H. R. Hough, VE7HR, 1785 Emerson St., Victoria, B. C.
VE8 — W. R. Williamson, VE8AK, Box 534, Whitehorse, Y. T.
KP4 — E. W. Mayer, KP4KD, Box 1061, San Juan, P. R.
KZ5 — C.Z.A.R.A., Box 407, Balboa, Canal Zone
KH6 — Andy H. Fuchikami, KH6BA, 2543 Namaun Dr., Honolulu, T. H.
KL7 — Box 73, Douglas, Alaska

A Sharp I.F. Amplifier for 'Phone or C.W.

A 50-Kc. "QRM-Dodger"

BY BYRON GOODMAN,* W1DX

QRM is a statistical sort of nuisance. There are times on any of our bands when the station you're interested in is so in the clear that you don't need any selectivity at all—a t.r.f. receiver will do an excellent job of dragging him in. When the statistics become unfavorable and QRM gets rough, the only solutions are (a) more selectivity, (b) telepathy, and (c) giving up. The less selectivity you have available in your receiver, the sooner you go from condition (a) to condition (b) and so on. The i.f. amplifier to be described has considerable selectivity for both 'phone and c.w., and using it means you can copy stations over a greater period of time without shifting to condition (b) or (c).

Many operators don't like selectivity. They say, "It makes the signals tune too sharp." This amplifier is no different—it, too, makes the signals tune sharp. Furthermore, on 'phone it doesn't give anything like high-fidelity reception. Its sole purpose is to increase your chances of copying the other station among heterodynes and stray sidebands. If we sound a little bitter, it's only because we have met too many hams who put *fidelity* before *copyability*, and we believe it should be the other way around. But we have also met plenty who appreciate the advantages of selectivity, and the rest of this is addressed to them.

Some time ago we described a selective amplifier at 50 kc. for c.w.,¹ but the fact that the thing was useless for 'phone was always there as a reminder that the job was incomplete. This new unit retains the same sharp selectivity for c.w. reception, but also has a bandwidth condition

suitable for 'phone reception of the more selective type.

Selective 'Phone Reception

Although many operators have improved their 'phone reception by judicious use of "Q5-ers" and crystal filters, there are disadvantages to both. Let's take a look at an ideal 'phone receiver characteristic and see where these other systems fall down. To copy an a.m. 'phone signal, you must receive at least the carrier and one sideband. There is no need to receive *both* sidebands since, in the immortal words of W1DBM, "They are both saying the same thing." It is also important that you receive the carrier, so that the signal can be demodulated properly at the detector. Further, the carrier amplitude at the detector should always be greater than the sidebands if overmodulation at the receiver is to be avoided. This is where the Q5-er falls down. Because it has a symmetrical selectivity characteristic, centering the passband on one sideband puts the carrier on one side and reduces its effective amplitude at the detector. In fact, for proper demodulation of a single sideband, the carrier amplitude should be quite a bit greater than the sideband amplitude. This can be done by using a crystal filter and setting the carrier in the peak of the crystal, but the sidebands are usually attenuated too much in this case. It works, however, as many operators will testify.

But all this leads us to the conclusion that the ideal receiver characteristic is one that looks like Fig. 1. To use such a passband, we would set the carrier in the narrow slot marked "A," and then one sideband would fall in the part marked "B." Obviously, "A" need only be wide enough to pass

* Assistant Technical Editor, QST.

¹ Goodman, "A Variable-Selectivity Sharp I.F. Amplifier," QST, May, 1950.

The selective 'phone and c.w. 50-kc. amplifier connects to the i.f. of a regular receiver, in the manner of the familiar Q5-er.

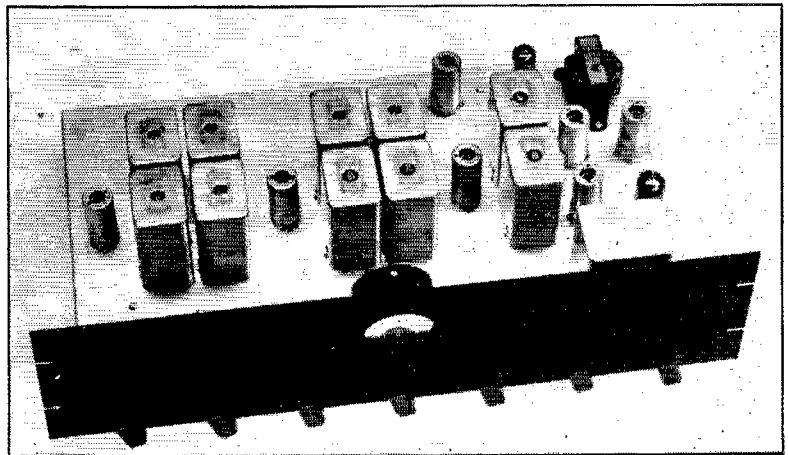

the carrier, so with perfect stability at the transmitter and receiver this could be only cycles wide! But it would be difficult to set the incoming carrier in such a narrow slot, just as it would be to receive c.w. with such a narrow passband, and something broader is more practical. Since the gain through this portion is greater than through portion "B," the carrier would be "exalted" and we would always have proper demodulation. The

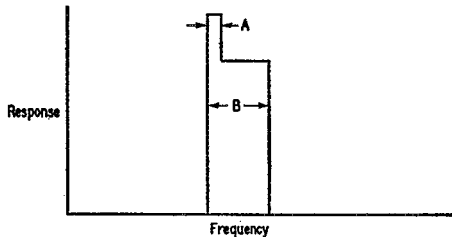

Fig. 1 — The ideal receiver characteristic for a.m. 'phone reception. The carrier fits in the narrow part "A" and one sideband is passed by "B." This is strictly dream stuff — they don't make i.f. amplifiers like this.

portion "B" would be wide enough to pass enough of the audio range to insure good copyability — if we made it 4000 or 5000 cycles we would approach "high fidelity" but we would open our receiver to more possible interference, so something less is indicated, perhaps around 2000 to 3000 cycles. To take advantage of the statistical nature of QRM, we should include provision for utilizing either of the sidebands of

an a.m. signal, selecting the one where the least interference occurs. This means using the "selectable-sideband" principle.³

How do you get such a characteristic? Frankly, we kicked a number of circuits around before we ended up with the final one, and while it certainly isn't perfect, it does approach the ideal. Fig. 2A shows how four tuned circuits, all tuned to the same frequency, are coupled to give a sharp characteristic suitable for c.w. By making the coupling capacitors C_1 , C_2 and C_3 small and using enough circuits, you approach the narrow, steep-sided characteristic desirable for selective c.w. reception.

The problem then revolves around switching this to something useful for 'phone and preferably approaching the characteristic of Fig. 1. The solution we came up with, after fumbling with a number of overcoupling tangents, was to "stagger-tune" some of the circuits. The simple way to do this is to retune some of the circuits by introducing series condensers, as shown in Fig. 2B. These can be switched readily without running into trouble, as will be shown later. With two of the circuits tuned to new frequencies (f_1 and f_2 in the sketch), and two remaining at the old frequency, f_0 , and by cascading several such stages we approach our ideal of Fig. 1, after a little "fudging" that will be described later.

The Circuit

The complete circuit of the amplifier is shown in Fig. 3. Receiver output at 455 kc. is fed into

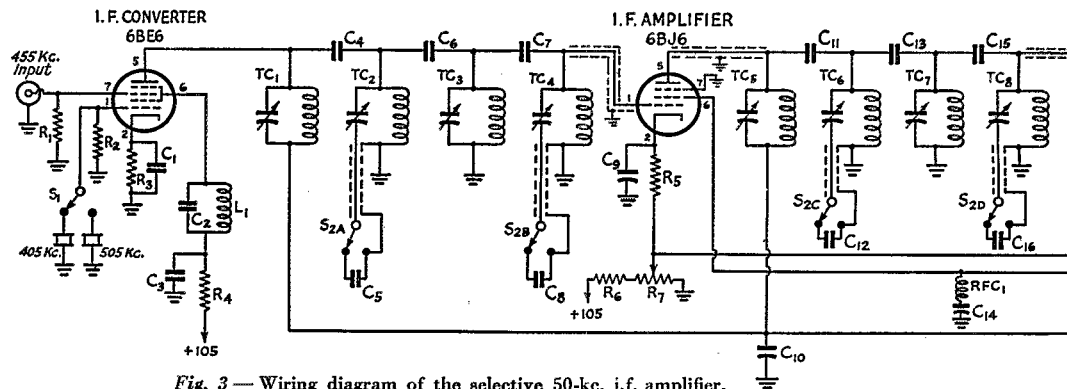

Fig. 3 — Wiring diagram of the selective 50-kc. i.f. amplifier.

- C₁, C₈, C₂₉, C₃₀ — 0.01- μ fd. ceramic disc.
- C₂ — 47- μ fd. mica.
- C₄, C₆, C₇, C₁₁, C₁₃, C₁₅, C₂₃ — 4.7- μ fd. mica.
- C₅, C₁₂ — 0.0078- μ fd. mica (0.0068 and 0.001 in parallel).
- C₃, C₁₆ — 0.0068- μ fd. mica.
- C₉, C₁₇, C₂₂, C₂₇ — 0.1- μ fd. 200-volt paper.
- C₁₀, C₁₄ — 1.0- μ fd. 400-volt paper.
- C₁₈ — 100- μ fd. midget variable.
- C₁₉, C₂₀, C₂₆, C₂₈, C₃₄, C₃₆ — 470- μ fd. mica.
- C₂₁, C₂₄, C₃₁ — 0.001- μ fd. mica.
- C₂₅ — 100- μ fd. mica.
- C₂₈ — 20- μ fd. 25-volt electrolytic.
- C₃₂ — 220- μ fd. mica.
- C₃₅, C₃₈, C₄₁ — 0.01- μ fd. 400-volt paper.
- C₃₇ — 0.002- μ fd. 400-volt paper.
- C₃₉, C₄₂ — 10- μ fd. 25-volt electrolytic.
- C₄₀ — 8- μ fd. 450-volt electrolytic.

- R₁, R₂₁, R₂₃ — 0.47 megohm.
- R₂, R₂₁ — 0.1 megohm.
- R₃ — 470 ohms.
- R₄, R₁₈ — 22,000 ohms.
- R₅, R₈, R₁₆ — 100 ohms.
- R₆ — 33,000 ohms, 2 watts.
- R₇ — 5000-ohm wire-wound potentiometer.
- R₉ — 2200 ohms, 1 watt.
- R₁₀ — 2200 ohms.
- R₁₁ — 33,000 ohms.
- R₁₂ — 56,000 ohms.
- R₁₄ — 330 ohms.
- R₁₅, R₂₂ — 1.0 megohm.
- R₁₇, R₁₈, R₂₃ — 4700 ohms.
- R₁₉ — 68,000 ohms.
- R₂₀, R₂₅ — 47,000 ohms.
- R₂₄ — 1000 ohms.
- R₂₅ — 0.25-megohm volume control.

the 6BE6 i.f. converter, where the crystal-controlled oscillator portion can be set either 50 kc. higher or lower, to use the familiar selectable-sideband principle. If the receiver i.f. were something other than 455 kc., the choice of crystals would be different, of course. Two 6BJ6 i.f. amplifier tubes are coupled by eight Millen 50-kc. high- Q tuned circuits, TC_1 - TC_8 , with provision through S_2 for switching the tuning of four of these circuits by cutting in series condensers C_5 , C_8 , C_{12} and C_{16} . The second 6BJ6 stage is coupled to a 6BE6 a.f. converter used for c.w. and s.s.b. suppressed-carrier reception, and also to another 6BJ6 i.f. amplifier. This i.f. amplifier feeds a diode rectifier for a.m. reception and also has a.v.c. voltage applied to its grid, to obtain some a.v.c. action and to give a logarithmic S-meter action. The switch, S_3 , selects output from one of the two detectors and also turns the b.f.o. on or off. The rest of the circuit includes a filter following S_3 to keep 50-kc. energy out of the audio amplifier, and a meter amplifier that kicks the S-meter around. The i.f. gain is controlled through R_7 , and the audio volume through R_{25} . The i.f. gain control is important, because the gain of the amplifier is much higher in the narrow-band (c.w.) condition than in the stagger-tuned ('phone) arrangement, and the gain setting must be changed when switch S_2 is thrown from one position to the other.

As mentioned in the earlier article,¹ over-all

² McLaughlin, "Exit Heterodyne QRM," *QST*, October, 1947.

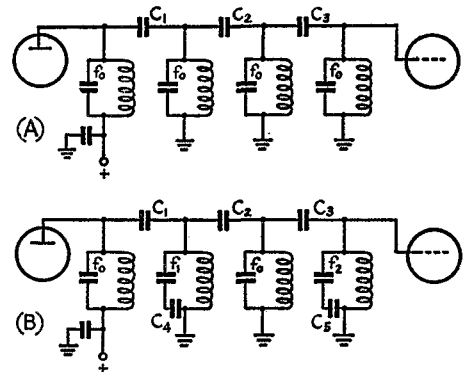
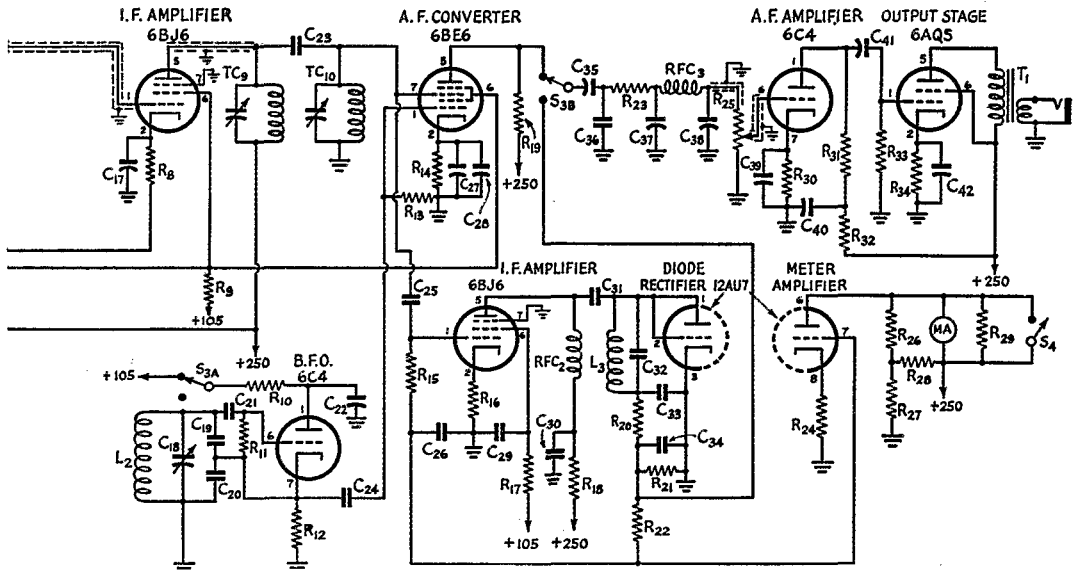

Fig. 2—A selective amplifier can be obtained by cascading a number of tuned circuits, as shown in A. The coupling condensers, C_1 , C_2 and C_3 , should be small, and each circuit is tuned to the same frequency. Adding condensers C_4 and C_5 will detune two of the circuits and give a broader "stagger-tuned" amplifier.

feed-back must be eliminated, and this means proper by-pass condensers in the common screen and plate leads. The choke, RFC_1 , is in there simply to series resonate with C_{14} at 50 kc. and bring the common screen circuit down to ground potential without using a by-pass condenser larger than $1 \mu\text{fd}$. Everything else in the circuit is conventional and familiar to anyone acquainted with i.f. amplifier practice. The switch, S_4 , for shorting out the S-meter, is an elaboration necessary only for someone who doesn't like to see the meter take a licking on occasion.



- R_{26} — 220 ohms.
- R_{27} — 47,000 ohms, 2 watts.
- R_{28} — 390 ohms.
- R_{29} — 47 ohms.
- R_{30} — 3900 ohms.
- R_{34} — 270 ohms.
- L_1 — 750 μh . (National R-33).
- L_2 — 40 mh. (Millen 34240).
- L_3 — 80 mh. (Millen 34280).
- MA — 0-1 milliammeter.

- RFC_1 — 67 t. No. 30 enam. close-wound on $\frac{1}{4}$ -inch diam. form (1-megohm resistor).
- RFC_2 — 80 mh. (Millen 34280), mounted at right angles to L_3 .
- RFC_3 — 125 mh. (Millen 34000-2 removed from can).
- S_1 , S_3 , S_4 — D.p.d.t. rotary switch (Mallory 3222J); one pole only used on S_1 and S_4 .
- S_2 — 4-pole rotary switch (Mallory 3242J).
- T_1 — Audio output transformer (Merit A-2902).
- TC_1 - TC_{10} — 50-kc. tuned circuit (Millen 63650).

Construction

This amplifier is built on a $10 \times 17 \times 2$ -inch aluminum chassis, with a $5\frac{1}{4}$ -inch-high relay-rack panel. Constructional details will, of course, vary with the builder and his particular station layout. The only point to watch in any modification is to be sure not to double the amplifier string back on itself, which might encourage feedback. The leads to audio volume control R_{25} , to S_2 , and to grids and plates of the first two 6BJ6 stages are run through shielded wire grounded at convenient points. The series condensers, C_5 , C_8 , C_{12} and C_{16} , are mounted on S_2 . The filter, C_{36} , R_{23} , RFC_3 , C_{37} and C_{38} , is mounted above the chassis in a small shield can, just to make more room under the chassis. One circuit refinement not shown in Fig. 3 is the separate "hot" heater lead from the 6BE6 i.f. converter and the 6C5 b.f.o. At the present time this is connected to the hot lead of the other heaters, but we plan some day to have a line-voltage regulator ahead of a separate heater transformer that will supply all oscillators in our receiving set-up. In s.s.b. work, and even on 10- and 20-meter c.w. work, we have found that the heater voltages drop enough when the transmitter is on to cool down the heaters and cause a slight frequency drift. Running these heaters on a regulated supply should reduce this effect, since the line voltage will always show some drop when the transmitter goes on.

Adjustment

The first step in aligning the amplifier, after the wiring has been checked and the fingers have been crossed, is to tune the circuits to 50 kc. approximately. For a signal source you can couple from your receiver at 455 kc. and feed it into the input of the amplifier. Tune in a steady signal (freqmeter or b.c. carrier) and align the tuned circuits TC_{10} back through TC_1 , with S_2 set to short out the condensers. When you have the circuits aligned, as indicated by the S-meter,

switch S_1 to the other crystal and see if the signal is still peaked. Unless you are very lucky, it won't be, and you now have to "split the difference" and realign the circuits until a signal peaked at one setting of S_1 will be peaked at the other. If you know the exact frequencies of your two crystals and have an accurate signal generator in the 50-kc. range, all you have to do is to align the circuits the first time on half the frequency difference between the two crystals. It may sound complicated, but it isn't. The experimental method will bring you right in the third or fourth time.

You can now check the b.f.o. tuning range by switching it on and watching the S-meter as you tune C_{18} through its range. The b.f.o. couples some energy into the S-meter circuit, and as you tune through you will find a peak. If it occurs with C_{18} about halfway, you are all set. If not, add or subtract fixed capacity across the circuit until it is right. Tuning the b.f.o. through its range should show an even rise and fall in the S-meter circuit—any sudden jump indicates some regeneration in the amplifier. Switch off the b.f.o., tune in a signal as indicated on the S-meter, and jump a 1- μ fd. condenser across the B+ and screen leads at various points throughout the amplifier. Any change in S-meter reading indicates regeneration in the amplifier, and it means you need more by-passing, or a modification of RFC_1 . In adjusting RFC_1 we wound it large and removed turns two at a time, with a constant signal through the amplifier. When the signal came down to a minimum and then started back up we rewound the choke to the turns that gave the minimum. This was done with R_7 set to give considerably more gain than we would ever use, and the amplifier is still regenerative at this high gain setting in the "sharp" condition. However, this gain is well beyond anything we would ever use, and at normal settings the amplifier is perfectly stable. You can also check the S-meter reading with the b.f.o. on (no signal

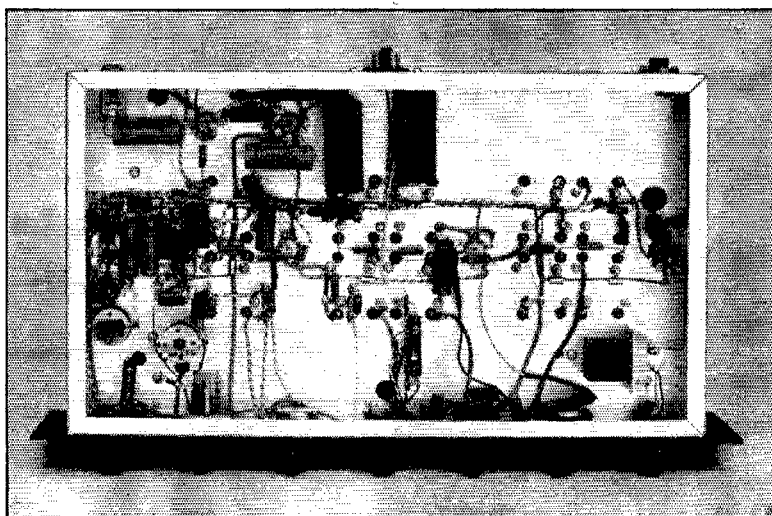

◆
Underneath the chassis of the 50-kc. amplifier.
◆

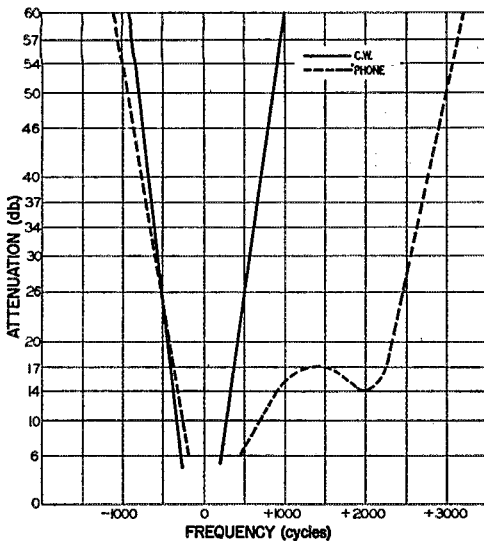

Fig. 4 — Measured selectivity of the i.f. amplifier, as used for c.w. and for 'phone reception.

coming through) to see if you can find any points along the +105-volt line where extra by-passing will cut down the b.f.o. leakage. A small mica trimmer, connected between Pins 1 and 7 of the 6BE6 and adjusted for minimum S-meter reading, will reduce the "space charge" coupling.

At about this point in the checking it is wise to try a little more capacity across C_{32} , since this fixed condenser tunes the coupling circuit between the 6BJ6 amplifier and the diode. With a steady signal coming through, hold a 10- or 20- μ fd. condenser across C_{32} . If the S-meter reading goes up, C_{32} is too small, and if the reading goes down the condenser is too large. The tuning isn't very critical, however, and you have plenty of signal to spare at this point.

If the S-meter doesn't zero with the b.f.o. off, try changing R_{23} slightly until it does. Final touching up can be done with the meter zero set.

Now switch S_2 to the other position and tune across an unmodulated signal, with the b.f.o. off and R_7 set for maximum gain. The meter reading will vary somewhat as the dashed line in Fig. 4, except that there will be a larger dip between the maximum hump and the other hump. This is where the "fudging" comes in. Experiment with the tuning of TC_9 and TC_{10} until the valley fits in a little, shooting for something like the characteristic shown in Fig. 4. You will find that you can change it considerably, so make your changes in small steps. Set it up by cut and try, using a b.c. station as your signal and adjusting for good intelligibility. It probably won't be necessary to touch C_5 , C_8 , C_{12} and C_{16} , unless you use some condensers that are incorrectly marked and thus far off the nominal value. Their value, of course, affects the position of the lower hump in the selectivity characteristic.

When you tune in a 'phone signal, you watch the S-meter and set the carrier at the maximum

meter reading, learning not to be fooled by the slight hump 2000 cycles off this point. If there is a heterodyne on the signal, you flip S_1 to the position giving the least interference. On c.w. you leave S_1 in either position, depending upon how you like to approach a c.w. signal. (That statement will only make sense to someone familiar with single-signal c.w. reception!)

In operation we generally use the i.f. gain controls in both receiver and 50-kc. i.f. where there is no chance for overload, with the audio adjusted for comfortable listening. On c.w. the S-meter is allowed to kick a little on a loud signal, and on 'phone it gets up to half scale on a good signal. This calls for some juggling of the gain controls as you tune across a band, but nothing unusual to normal c.w. operation. When throwing S_2 from one position to the other, it is advisable to reduce the audio volume to zero, or else the audio tube takes quite a licking because of the voltage difference at switch S_{2B} .

Incidentally, you may have to realign your receiver slightly to use this amplifier, or else get a pair of crystals that match your receiver. If, for example, the crystal in your present receiver is on 450 kc., and hence your i.f. is aligned there, the 405/505-kc. crystal combination won't be right for you. What you need is a 400- and a 500-kc. crystal. But since you won't need your crystal filter much any more, it is easier to switch it out of the circuit and realign your receiver i.f. amplifier. Tune in a signal on the 50-kc. amplifier and retune the receiver i.f. transformers for maximum signal, and that's all there is to it.

Performance

It is a little difficult to discuss the performance of this amplifier because we know some operators wouldn't like the operation. We use it following an HQ-129, to which we have added a 5-to-1 planetary drive on the bandspread shaft. This gives a tuning rate of around 10 or 12 kc. per knob rotation on 40 and 20, but this would be too slow for some people. C.w. signals go from a peak to inaudibility in a kilocycle or less, and you don't hear anything but clicks from signals 2 kc. away, unless they don't have clicks, in which case the signals don't even exist for you. On 'phone you have to tune more carefully than normal to peak a signal, and the only reward is better copyability. Some operators wouldn't like this, and they are certainly entitled to their opinions. The i.f. doesn't have as much unwanted low-frequency sideband rejection on 'phone as the W2KUJ type of phase-shift selectivity,³ but it has good heterodyne rejection for carriers 1 kc. or more away, and there isn't the heterodyne as you tune into an a.m. signal that there is in the phase-shift system.

Boiled down, if you want selectivity for both c.w. and 'phone, we think this is a good approach. If you don't want selectivity, you would be wasting your time to build the unit. You can listen to the loudest signal with *any* receiver.

³ Norgaard, "Practical Single-Sideband Reception," *QST*, July, 1948.

A Ham-Shack Frequency Standard

100-Kc. Oscillator and 10-Kc. Multivibrator Combination

BY WYN H. McGEE,* ZL3LR

THE instrument shown in the photographs will prove to be most useful around any shack and can be built from parts usually found in the junk box, with the possible exception of the 100-kc. crystal. Not only does it find its uses for band-edge spotting, etc., but it provides accurate 10-kc. subdivisions throughout the spectrum. The latter makes it a most desirable instrument for those wishing to calibrate their own receivers, grid-dip oscillators, or VFOs.

The Crystal Oscillator

A 6AC7 pentode is used here, connected in a Colpitts circuit, with condensers C_1 and C_2 dividing the tank voltage between the plate and grid circuits. Actually, the screen is used as the oscillator plate electrode, and the signal is picked off the plate. This method causes less frequency shift with varying loads on the oscillator. Capacitor C_4 in conjunction with resistor R_1 provides grid-leak bias to the tube.

* 24 Tainui St., Somerfield, Christchurch SW 1, New Zealand.

The 10-Kc. Multivibrator

The multivibrator is a type of relaxation oscillator that may be regarded as a frequency divider, performing functions opposite to the more familiar frequency multiplier. Operating alone, the multivibrator is of little use because of its highly unstable and ragged oscillations. Fortunately, however, it can be controlled by a stable crystal oscillator operating in harmonic relationship to the multivibrator. In the controlled condition the multivibrator emits a signal on its own fundamental frequency, this being a subharmonic of the crystal frequency and possessing the same order of accuracy as the 100-kc. controlling oscillator. The constants that determine the fundamental frequency of the multivibrator are the condensers, C_{10} , C_{11} (which usually are made equal) and the grid resistors, R_7 and R_8 . One of these is made variable, since it is possible to synchronize a given multivibrator on more than one submultiple of the controlling frequency. Thus the desired output frequency is obtained by variation of R_7 .

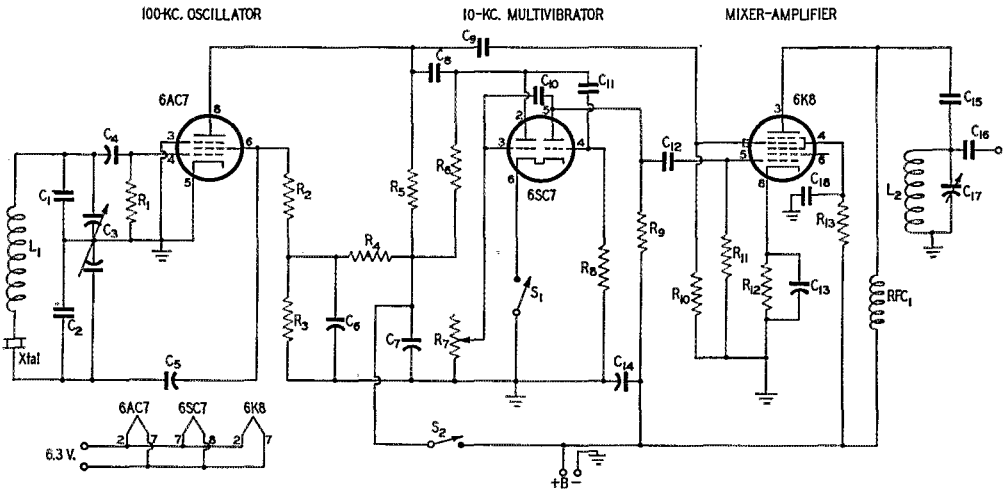
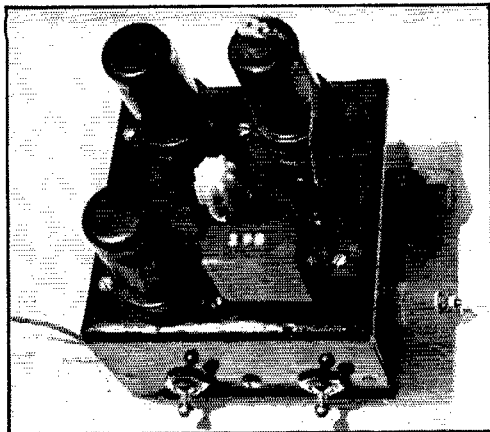

Fig. 1 — Circuit of the secondary frequency standard.

C_1 , C_2 — 50- μ fd. silvered mica.
 C_3 — 100- μ fd. per-section variable.
 C_4 , C_5 , C_{18} — 0.01- μ d. 400-volt paper.
 C_6 , C_7 , C_{13} , C_{14} — 0.1- μ d. 400-volt paper.
 C_8 , C_{12} — 10- μ fd. silvered mica.
 C_9 — 50- μ fd. silvered mica.
 C_{10} , C_{11} — 0.001- μ d. mica.
 C_{15} — 0.002- μ d. mica.
 C_{16} — 100- μ fd. mica.
 C_{17} — 50- μ fd. midget variable.
 R_1 , R_{10} — 1 megohm.
 R_2 , R_5 — 0.5 megohm.
 R_3 — 0.1 megohm.
 R_4 — 0.15 megohm.

R_6 , R_9 , R_{13} — 50,000 ohms.
 R_7 — 5000-ohm wire-wound variable.
 R_8 — 20,000 ohms.
 R_{11} — 0.25 megohm.
 R_{12} — 750 ohms.
 L_1 — 20-mh. r.f. choke.
 L_2 — 20 turns No. 32 on $\frac{1}{4}$ -inch polystyrene rod.
XTAL — 100 kc.
RFC₁ — 2.5-mh. r.f. choke.
 S_1 , S_2 — S.p.s.t. toggle.
All resistors are $\frac{1}{2}$ -watt rating unless otherwise stated.

NOTE: No connection to Pin 6 of 6K8.



A simple 100-kc. frequency standard giving 10-kc. points.

To ascertain whether the frequency is adjusted to the 10th harmonic it is necessary first to tune in two adjacent 100-kc. signals from the oscillator alone and note where they fall on the dial of the receiver. Next switch on the 10-kc. multivibrator by closing S_1 , and adjust R_7 till nine additional signals appear between the first two adjacent 100-kc. signals. Although a knob is shown on the shaft of R_7 , screwdriver adjustment is all that is necessary. Once the correct position is found for R_7 , no further adjustment is required.

The Mixer-Amplifier

The output from the 100-kc. oscillator and the 10-kc. multivibrator output are fed to separate control grids in the 6K8. Mixing is electronic and there is no variation in the 100-kc. output when switching the multivibrator on and off. The tank circuit, L_2C_{17} , is such that useful output is obtained from 14 to 30 megacycles. However, if it is desired to extend the operating limits all that is necessary is a change in L_2 . Plug-in

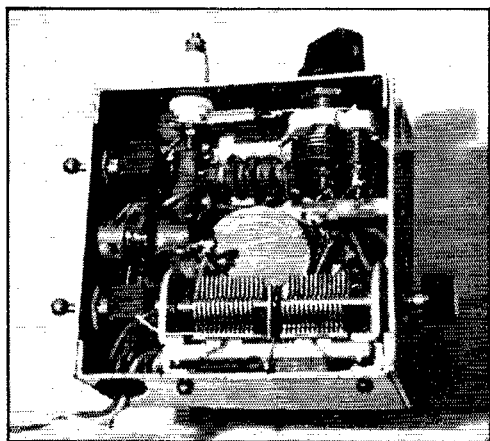

Bottom view of the secondary frequency standard.

coils or even a small single-bank wafer switch and several coils permanently mounted in the unit would possibly be an advantage.

Constructional Details

As can be seen from the photos there is no hard work involved. The unit is built on a chassis 4 inches square with a $2\frac{1}{4}$ -inch lip, and takes up little room on the desk. In most cases it could be mounted inside the receiver cabinet.

Because of the relatively small amount of power needed to operate the unit, it was not deemed necessary to include a special power supply. Voltage and current requirements are as follows: heater — 6.3 volts at 1.05 amp.; high voltage — 250 volts at 12 ma.



December 1925

... Two new picture transmitters for amateurs have been announced by Jenkins Laboratories.

... Practical methods of designing, constructing and testing power-supply filter chokes are presented by F. S. Dellenbaugh.

... Great interest is being shown in a German-developed frequency-doubling circuit using vacuum tubes.

... A beginner's battery-powered transmitter, built around a Type 201-A receiving tube, is described by Rufus P. Turner.

... The average age of amateurs is now 22.4 years, according to data collected by a Hq. survey.

... Body-capacity effects may be reduced appreciably by installing insulated shaft couplings on condensers and variometers.

... The first South Africa-United States contact has been realized. Amateurs participating in this achievement were J. S. Streeter, oA4Z, Capetown, and Jefferson Borden, uICMX, Fall River, Mass.

... Calibration of short-wave receivers or wavemeters may be simplified by using the harmonic system detailed by J. A. Baker, 1BIS.

... Plug-in coils and shunt tuning condensers are being investigated by the QST technical staff as a means of spreading the ham bands on our tuners.

... C. A. Briggs, 3CAB, offers specifications for an easy-to-read tuning dial.

... Station descriptions feature 2WC, Brooklyn, operated by Stanley P. McMinn, 5ZAI, Beeville, Texas, operated jointly by Henry W. Hall and James Hunt, and 9UQ, Ames, Iowa, the Iowa State College station.

Strays

January *Pageant*, on the newsstands in early December, carries an excellent picture-story featurette on amateur radio by Alfred Puhn, sparked by the Field Day activities of W2DAY, the Northern New Jersey Radio Assn. Something else sparked, too: Mr. Puhn has bought a receiver and an ARC-5 and is boning up!

Monument Honors Historic IBCG

*Commemorates Transmission of First Message
Across Atlantic on Short Waves*

OLD-TIME amateurs, notables of the radio industry, and civic officials turned out en masse on October 21st to dedicate an imposing monument marking the site of amateur station IBCG, star performer in the ARRL Transatlantic Tests of December 1921. Sponsored by the Radio Club of America, whose members built and operated the history-making station, the memorial is located on a special plot of land contributed by the town of Greenwich, Conn. The dedication address was delivered by Dr. Orestes H. Caldwell, former Federal Radio Commissioner, and the memorial was accepted for the town by First Selectman Wilbur M. Peck. During the ceremony bronze medallions were awarded to the six operators of the station, Major Edwin H. Armstrong, George E. Burghard, Ernest V. Amy, John F. Grinan, Minton Cronkhite and Walker P. Inman, and to Paul F. Godley, operator of ARRL's listening post in Scotland.

IBCG enjoyed an enviable reputation during its brief existence. It was one of the super ham stations of the era, especially designed and built for the attempt to put a short-wave signal across the Atlantic during the Transatlantic Tests. The de luxe layout was the Radio Club of America's answer to Mr. Godley's plea, "Please build a station that will get over. . . !" The transmitter

was a master-oscillator affair with three Type UV-204 "P" tubes in the final, running 990 watts input on the "short wave" of 236 meters. The antenna, strung between masts 105 and 75 feet high, was a T cage with a radial counterpoise. A Paragon RA-10 regenerative tuner with separate amplifier was used for receiving.

The overwhelming success of the Tests is a bright spot in the history of amateur radio. Twenty-eight stations were heard by "Paragon Paul" and his assistant, Inspector Pearson, who maintained a vigilant watch in a tent on the bleak coast at Ardrossan, Scotland. However, one signal stood out above the rest. . . "strong and steady" enough, in fact, to transmit the first message across an ocean on "worthless" short waves. Editor Warner, chronicling the Transatlantics in February, 1922, *QST*, described the feat of IBCG in the following words:

"IBCG seems an easy winner as the star station. In addition to being heard all over the map they got thru a coherent message on broadcast, at 3 A.M. GMT on Dec. 12th, which was acknowledged by Godley by cable to this office. The first transatlantic message ever sent read as follows:

"Nr 1 NY ck 12 to Paul Godley, Ardrossan, Scotland. Hearty congratulations. Burghard Inman Grinan Armstrong Amy Cronkhite"

The IBCG memorial, and principals in its dedication. L. to r.: Paul F. Godley, ex-2ZE; Major Edwin H. Armstrong, ex-GS; George E. Burghard, W2GEC; First Selectman Wilbur M. Peck; Dr. Orestes H. Caldwell; Ernest V. Amy, ex-2VK. IBCG operators John F. Grinan, Minton Cronkhite, and Walker P. Inman were unable to attend the ceremonies.



Design for Communication

A Speech Amplifier and Class B Driver Built for Cutting Through QRM

BY A. M. PICHITINO,* W3NJE, AND F. J. PICHITINO,** W8KML

IN RECENT years considerable research effort has been directed toward the improvement of intelligibility in speech communication systems. Sponsored by commercial organizations and the military, detailed investigations have been conducted on the effects of bandpass, clipping, filtering and low-high frequency balance on intelligibility. As a result of these investigations, techniques may be employed to improve appreciably the efficiency of radiotelephone communications.

Some five years ago, it was decided to design a speech amplifier-driver unit which would utilize the best techniques available. The results were striking in the degree of improved intelligibility, particularly in heavy interference. Based upon operational experience with the first unit, a second unit was designed to provide greater flexibility and was placed in operation two years ago with excellent results. The construction of the latter unit will be described in this paper, including some of the design considerations.

Upper-Frequency Cut-off

An investigation by the Harvard University Psycho-Acoustic Laboratory has shown that there is nothing to be gained in speech systems in extending the range beyond 3950 c.p.s., and that the intelligibility decreases as this upper frequency limit is reduced. A number of curves were plotted of speech intensity *versus* articulation percentage (intelligibility) for various upper frequency limits. These curves were obtained using *discrete words* and show a difference of less than 10 per cent articulation percentage when the upper frequency limit is set at 3000 c.p.s. rather than 3950 c.p.s. Moreover, the curves tend to group together when *connected speech* is used and there is no observable difference in intelligibility between a 3000 c.p.s. or 3950 c.p.s. limit in actual communication. Since there is no improvement in "communication" intelligibility with a higher upper limit than 3000 c.p.s., it appears advisable in the interests of decreased bandwidth, and hence reduced interference, to so limit the response.

* Franklin Institute, Laboratories for Research and Development, Philadelphia, Penna.

** Bendix Aviation Corporation Research Laboratories, Detroit, Mich.

◆
The speech-amplifier section is along the left edge of the chassis in this view; the filter is enclosed in the metal box at the left. The driver output transformer and 6L6 drivers are in left center. Power-supply components are grouped on the right-hand half of the chassis.

Quality and High-Low Balance

The quality of sound reproduction is obviously dependent upon the manner in which the frequencies in the original sound are reproduced. *Any* restriction of the frequencies present in the original sound will degrade the quality but, fortunately, appreciable frequency restriction may be utilized without objectionable degradation if the high and low frequencies are restricted in proper proportion. Experimental investigation has shown that if the product of the low and high cut-off frequencies is equal to a value between 500,000 and 600,000, proper frequency balance exists to provide good quality. Experience indicates that the value of 500,000 is more applicable to speech systems.

If the natural speech characteristic is not desired, the high-pitched "DX Screech" or low-pitched "Juke Box Growl" type of speech characteristic can be obtained by control of the low frequencies only. It is recommended that the upper-frequency cut-off be fixed at 3000 c.p.s. and the low-frequency cut-off placed at 170 c.p.s. for natural-sounding speech, above 170 c.p.s. for a high-pitched characteristic and below 170 c.p.s. for a low-pitched characteristic.

Clipping

It has been shown in the literature that peak clipping contributes greatly to the improvement of speech intelligibility. This is due not only to the improved consonant-vowel ratio wherein the intelligence-conveying consonants have been emphasized by the clipping of the vowel-produced peaks, but also to the increased average energy level permitted by elimination of the peaks. Although as much as 24 db. of peak clipping may be used without reduction in intelligibility, the quality under this condition leaves much to be desired.



Practical experience indicates that a good compromise between intelligibility, quality and amplifier gain requirements is 12 to 15 db. peak clipping.

Although the advantages of clipping are widely known, many amateurs have hesitated to employ clipping techniques. This has been brought about in large part by failure of some of the earlier experimenters to establish a correct amount of clipping and the resulting poor-sounding signals did not encourage wide adoption. A procedure for determination and adjustment of clipping level will be described later in the text.

Amplifier Design

The amplifier circuitry has been built upon a standard 3 × 13 × 17-inch chassis which includes power supply. The tube line-up is conventional, consisting of a 6J7 pentode input amplifier followed by one section of a 6SN7, a cathode-coupled 6SN7 clipper, a high-pass filter followed by half of a 6SN7, a 6SN7 phase inverter, and push-pull 6L6s with inverse feed-back as drivers. The schematic diagram is shown in Fig. 1.

It will be noted that no coupling transformers are used, with the exception of the driver output transformer. Transformers were omitted to re-

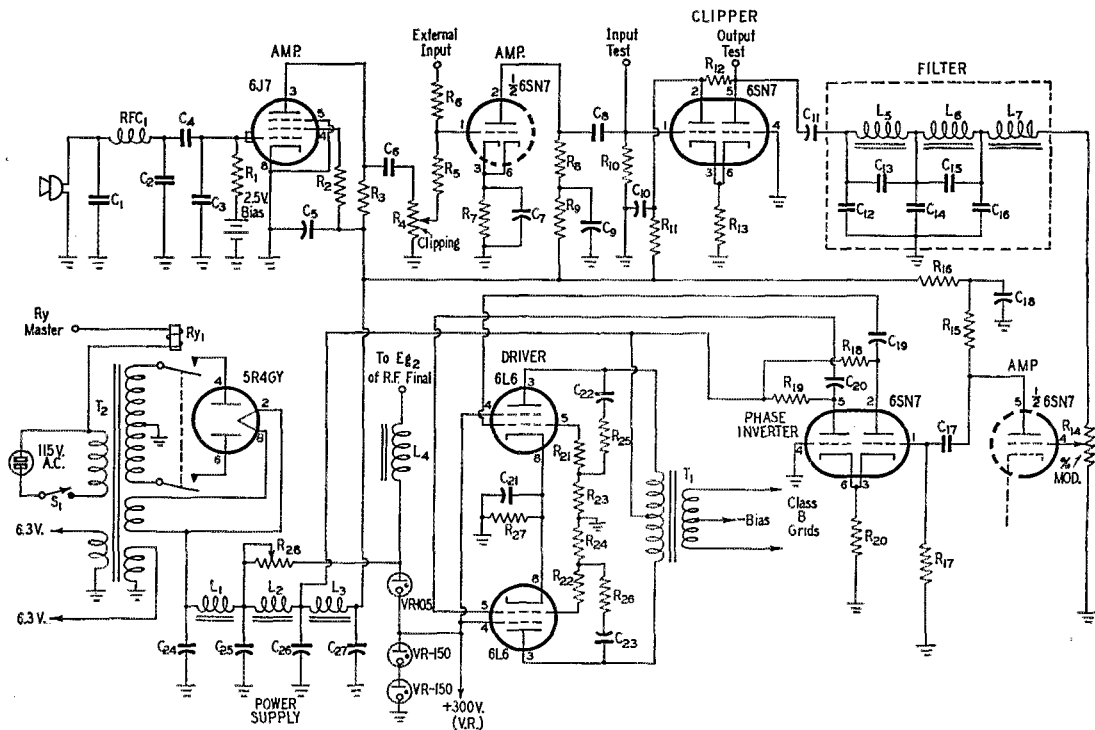

Fig. 1 — Circuit diagram of the clipper-filter speech amplifier.

- C₁, C₂, C₃ — 70- μ fd. mica.
- C₄, C₈, C₁₇ — 0.01- μ fd. mica.
- C₅, C₉, C₁₀, C₁₈, C₂₆, C₂₇ — 16- μ fd. electrolytic, 450 volts.
- C₆ — 0.001- μ fd. mica.
- C₇ — 25- μ fd. electrolytic, 50 volts.
- C₁₁ — 0.25- μ fd. paper, 600 volts.
- C₁₂ — 0.0021- μ fd. mica.
- C₁₃ — 0.00023- μ fd. mica.
- C₁₄ — 0.0018- μ fd. mica.
- C₁₅ — 0.001- μ fd. mica.
- C₁₆ — 0.00145- μ fd. mica.
- C₁₉, C₂₀, C₂₂, C₂₃ — 0.1- μ fd. paper, 600 volts.
- C₂₁ — 50- μ fd. electrolytic, 50 volts.
- C₂₄ — 0.5- μ fd. paper, 600 volts.
- C₂₅ — 10- μ fd. paper, 600 volts.
- R₁ — 1 megohm, $\frac{1}{2}$ watt.
- R₂ — 3 megohms, $\frac{1}{2}$ watt.
- R₃ — 0.4 megohm, 1-watt wire-wound.
- R₄ — 1-megohm potentiometer.
- R₅, R₆ — 0.22 megohm, $\frac{1}{2}$ watt.
- R₇ — 510 ohms, 1 watt.
- R₈, R₁₅ — 0.1 megohm, 1 watt.
- R₉ — 22,000 ohms, $\frac{1}{2}$ watt.
- R₁₀, R₁₇ — 0.1 megohm, $\frac{1}{2}$ watt.

- R₁₁ — 1000 ohms, 1 watt.
- R₁₂ — 33,000 ohms, 1 watt.
- R₁₃ — 4700 ohms, 1 watt.
- R₁₄ — 50,000-ohm potentiometer.
- R₁₆ — 10,000 ohms, 1 watt.
- R₁₈ — 12,000 ohms, 1 watt.
- R₁₉ — 47,000 ohms, 1 watt.
- R₂₀ — 1200 ohms, 1 watt.
- R₂₁, R₂₂ — 0.27 megohm, 1 watt.
- R₂₃, R₂₄ — 22,000 ohms, 1 watt.
- R₂₅, R₂₆ — 0.1 megohm, 1 watt.
- R₂₇ — 250 ohms, 10 watts.
- R₂₈ — 1000 ohms, 50-watt adjustable.
- R_{Y1} — D.p.s.t. relay, 115-volt coil, contacts insulated for 1000 volts.
- L₁, L₂ — 20 henrys, 200 ma.
- L₃ — 30 henrys, 100 ma.
- L₄ — 15 henrys, 110 ma.
- L₅ — 5.5 henrys.
- L₆ — 4.4 henrys.
- L₇ — 1.7 henrys.
- T₁ — Driver transformer, 6L6s to Class B grids.
- T₂ — 600 volts each side c.t. at 200 ma.; 5 volts at 3 amp.; 6.3 volts at 4 amp.; 6.3 volts at 3 amp. (Stancor P-6170).

duce the cost of the amplifier, because with 15 db. of clipping the waveforms become appreciably squared and expensive transformers are necessary to provide good reproduction. A wire-wound resistor is used for the plate load of the 6J7 to reduce the circuit noise which frequently becomes audible with high clipping levels. The clipper circuit is operated at lower than normal plate supply potential (through R_{11} and C_{10}) in order to start clipping at a lower level than with the usual 150-250 volt supply. This reduces the over-all gain requirement of the first two stages and helps to reduce hum and microphonic difficulties.

The low-pass filter was fabricated by individually reworking surplus ARC-5 chokes to obtain the desired values (by removing laminations). The chokes and associated capacitors are assembled in a $2 \times 4 \times 4$ -inch utility box and potted. Those who lack facilities to construct a filter will be interested in knowing that there is a reasonably-priced filter available commercially. While the filter characteristics are not ideal, they are still quite satisfactory and since the unit assembly includes a two-stage amplifier and clipper, it can be easily incorporated in existing amplifiers or will facilitate construction of a new amplifier.

A high-pass filter was originally incorporated ahead of the clipper and while it exhibited the desired frequency characteristic the a.c. pick-up was excessive. This was due to inadequate magnetic shielding of the chokes used in the filter and led to an investigation which showed that proper choice of RC coupling constants would provide the desired low-frequency amplifier characteristic. The over-all frequency response curve of the amplifier is shown in Fig. 2.

The 6L6 output stage is operated at a plate potential of 445 volts. Although this value is above the maximum rating of 360 volts, the stage is biased to keep within the rated plate dissipation and tube life has not been affected. The primary reason for the high potential of 445 volts is to utilize the amplifier power supply to supply screen potential (400 volts in the writers' cases) to a high-powered tetrode r.f. amplifier stage. A modulation reactor, L_4 , is placed in series with the screen supply lead to allow self-modulation of tubes such as the 813, 4-125A and 4-250A. It was deemed advisable to regulate the 6L6 screens and it then became simple to regulate the supply end of the modulation reactor by the use of one more VR tube. The regulator resistor, R_{23} , is of such a value that 4-250A tubes always are protected against excessive screen dissipation. This is because with the higher currents the voltage drops to an extent that

◆
The speech-amplifier resistors and small condensers are mounted on the terminal board along the left edge of the chassis. Components associated with the output stage and power supply are easily identified in this photograph. Note the test jacks just below and to the right of tube socket at the lower left.

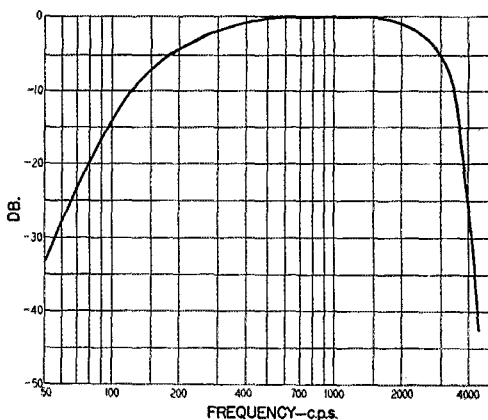

Fig. 2 — Frequency response curve of the amplifier of Fig. 1.

limits the screen power to a safe value even without plate voltage applied.

The bottom of the amplifier chassis is covered with a shield plate to minimize r.f. pick-up. The double-ended 6J7 is also used for this reason because it is easier to shield the isolated input grid — the input grid being subject to the greatest r.f. pick-up. The 6J7 cathode is grounded to minimize further r.f. pick-up difficulties.

Construction

The general construction layout is indicated in one of the photographs. It will be observed that the power supply components, particularly the power transformer, have been placed near the extreme end of the chassis to permit maximum separation from the low-level amplifier stages and hence reduce the a.c. field. Exact dimensions are not given because in the majority of cases components on hand will be used rather than those specified in the amplifier under discussion. Good amplifier wiring practices should be followed, with the filament wiring installed first as is usually done. The filaments should be floated without a grounded center tap. One side of the filaments should be grounded at a point, experimentally determined, which results in minimum hum in the amplifier output. In cases where the amplifier is subjected to very intense r.f. fields, it may be

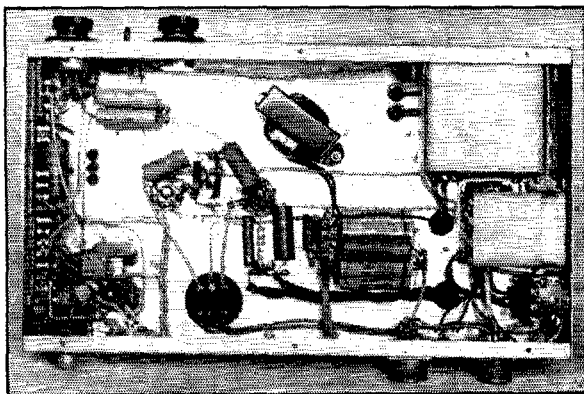

necessary to enclose the first three tubes within a small shield box. The tube grouping shown facilitates this.

Two small banana jacks which serve as test points are mounted on a small piece of $\frac{1}{4}$ " insulating material with the assembly mounted on stand-offs under the chassis. Two access holes are drilled in the rear wall of the chassis, aligned with the banana jacks so that an oscilloscope may be plugged into either jack for clipper calibration purposes. Table I shows the plate, screen and bias potentials of the amplifier.

Adjustment

The modulation percentage control, R_{14} , is set to give the desired modulation percentage, with care taken to verify that phase shifts produced by the filter do not cause a particularly large output at a specific frequency (within the passband) to overmodulate the transmitter. The clipping control must be adjusted for each microphone and person. During the adjustment process the speaker should be talking at the normal operating distance from the microphone, in a normal tone of voice and using representative terminology. The 'scope lead should be placed in the test jack which shows the output of the clipper stage. The clipping control, potentiometer R_4 , should be slowly advanced until the clipping effect is just noticeable. Clipping is indicated by a limiting or leveling action first noticeable on the peaks of the waveform.

The 'scope lead should now be placed in the test jack which shows the input to the clipper. The amplitude of the waveform peaks should be observed carefully, preferably by calibrating the 'scope in terms of voltage. With the speaker talking in the prescribed manner, the clipping control should be advanced to the point where the voltage amplitude of the waveform peaks is now as

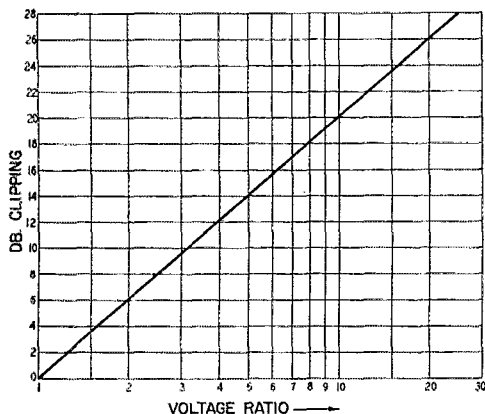

Fig. 3—Clipping in decibels as related to ratio of input voltage without clipping to input voltage with clipping.

many times greater than the original amplitude as the desired degree of clipping necessitates. For example, 15 db. of clipping represents a voltage ratio of 5.6, which requires that the clipping control be advanced to the point where the peak amplitude of the input to the clipper is 5.6 times the peak amplitude originally necessary at the input of the clipper to just start clipping. Fig. 3 is a plot of db. clipping versus voltage ratio. Using the above procedure the input clipping control can be directly calibrated in db. of clipping under actual operating conditions. Note that it is possible to calibrate the clipping control without having the transmitter on the air, since it is only necessary to calibrate relative to the clipping threshold — after which the modulation control may be adjusted to any desired modulation level.

TABLE I
Amplifier Element Potentials to Chassis

	6J7	$\frac{1}{2}$ -6SN7	6SN7 Clipper	$\frac{1}{2}$ -6SN7	6SN7 Phase Inverter	6L6 Output
Plate	215	110	{ 35 (Pin 2) 31 (Pin 5)	105	{ 350 (Pin 2) 290 (Pin 5)	445
Screen	50					300
Cathode	2.5* (bias cells)	3.5	1.9	3.5	14.2	23.5

Readings taken with Simpson Model 200 20,000 ohms voltmeter.
* Measured at battery; cathode 0.

Results and Acknowledgments

The operational results have been very satisfactory, with a striking improvement in communication under conditions of heavy interference. The restricted bandpass has contributed to reduced interference and leads to greater frequency utilization.

The writers wish to extend their appreciation for assistance by George Caffrey, W3JOO, who is responsible for the photography and who, in conjunction with Bill Rubin, W3MQU, fabricated the low-pass filter.

Strays

Heard in QSO on 7 Mc.:
WØBIG — W8HAM

An inexpensive method of checking transmitter harmonic radiation is available now that mail order houses are offering TV receiver front ends for less than \$10.00. The TV tuner is used in broadband-converter fashion, its output feeding the regular station communications receiver which is tuned over the i.f. range 21 to 25 Mc. The effect of adjusting harmonic traps or suppressors may be readily observed by watching the communications receiver S-meter. A length of shielded wire, with four to six inches exposed at the far end, makes a good probe. — W8LMV

Happenings of the Month

BURTON NEW DIRECTOR, CIVIL DEFENSE COMMUNICATIONS

Under the Executive Office of the President, the National Security Resources Board in Washington is rapidly setting up a complete staff to deal with civil defense problems. We are happy to announce that the man chosen for the new post of Director, Civil Defense Communications, is one with plenty of amateur background: Robert R. Burton, ex-W6GQW.

When we asked for some biographical dope from which to sketch in *QST* some highlights of his career, Bob's reply began by relating at length some youthful experiences of such common amateur interest that we hadn't the heart to cut out even a single word:

My first contact with radio was in 1920, at age 14, when I became acquainted with a group of budding young geniuses in my home town of Ogden, Utah, who were devoting a great deal of time toward building better electrolytic interrupters and providing special insulation for Model "T" spark coils in an effort to get bigger and better sparks. When these gadgets went into action the straight audio component of the explosion traveled almost as far as the r.f. disruption of the ether waves.



I soon graduated to vacuum tubes, and built one of the first radio receivers employing tubes in our community. As a result of the local fame I acquired thereby, I was invited to stage a demonstration at the high school where the teachers, the school board members, and his Honor the Mayor, were all agog when I set up my little black box in the auditorium. There was just one fly in the ointment — to obtain the necessary "A" battery, I ran a long wire

out of the auditorium window and down to the storage battery in a car which had been parked two stories below on the street. The idea of voltage drop never entered my head, and when my receiver failed to perk, I was embarrassed, chagrined, and just as much in the dark as anybody else as to why my receiver acted dead.

This dismal failure didn't even slightly deter our budding young genius group from building up to bigger and better flops. By exercising super salesmanship, we managed to talk the city fathers into setting aside a sizable sum for a radio station to be constructed in the belfry of the city hall. This station was to be publicly unveiled on the occasion of Utah's State Day, when the Governor of California would broadcast his greetings to the people of Utah. The Governor's greetings would be sent over the San Francisco broadcasting station, and the people of Utah would thrill to his words exactly at high noon, Utah time.

San Francisco happened to be 600 miles away but we were able to pick them up every night. Who would suspect that we couldn't do it in the daytime?

At the appointed day, on the appointed hour, the local dignitaries and thousands of our fellow citizens were gathered in front of the city hall. The Mayor gave a superb little introductory speech in which he pointed out to the Governor of California that gold was first discovered in California by a Mormon, and that the first mayor of San Francisco was a Mormon. When at high noon he came to

the part, "Ladies and gentlemen, I present the Governor of California!" there was a long, agonizing silence. Finally a thin voice quavered out of the loudspeaker: "Good people of Utah, I, the Governor of California, salute you!" This snappy salutation was immediately followed by a burst of marching music from a Sousa recording, and the crowd went wild with excitement.

Amateur radio had successfully met another crisis.

The general consensus was that while it was absolutely marvelous to hear a human voice transmitted without wires 600 miles across the desert, the Governor's oration was rather brief.

After three years of thus gaining radio experience the hard way, I one day became aware that a little neighbor girl, name of Annie, who had been an awful pain in the neck, had suddenly made a remarkable change for the better. In those days the following of the radio hobby was to me an expensive pastime, what with audion tubes costing \$6.50 and burning out at the flip of a rheostat. I found I didn't have enough ready cash to follow two hobbies simultaneously and — it's the old, old story — the hobby which wore skirts won out.

Six years later (after having spent three years in Germany as a missionary) I married this little hobby and with her now tucked safely under my arm I felt free to go back to my original love.

I got my first license in 1931 with call letters W6GQW. At that time, I was managing a silver fox ranch located in a small valley high in the mountains of Utah. Night after night I would climb up into the attic where I had my station, and leave my poor little bride downstairs to keep piling the coal on the fire. She always had the last word, however, because after she had stood her loneliness long enough, she would walk out on the front porch and pull the switch and I would have to climb down the ladder in the dark.

About that time I began to notice the ads appearing in certain popular magazines which would lead one to believe that a career in radio was a sure ticket to fame and fortune. The ads were labeled "Rich Rewards in Radio" and used to show a smart young radio officer in marine uniform with a blonde on one arm and a brunette on the other. As the depression lengthened, these full-page ads were cut down in size so that the radio op first lost the brunette, and then as the depression continued the space was cut again, and he lost the blonde too.

Was I deterred by this pathetic sequence? Not on your life! In 1933 I went after a commercial license and obtained my radiotelephone first class ticket. Subsequently I worked as an engineer in broadcasting stations in Utah, managed a broadcasting station for a while, and in 1939 came to Washington where I headed up radio work for the National Youth Administration.

When war came the NYA folded up and I transferred to the Office of Civilian Defense, where I was placed in charge of the War Emergency Radio Service in which the amateurs participated in civilian defense communications during the last war.

When it became apparent that this country would not be subject to air attack, I was drafted away from OCD by the Office of War Information. One year later, I transferred to the State Department where for the past six years I have been working for the Voice of America. My particular work has been acquiring the necessary frequencies on which the Voice operates. During the past six years, I have attended numerous international radio conferences. The Third Inter-American Radio Conference at Rio de Janeiro in 1945, the Atlantic City Conference in 1947, and others threw me in close contact with A. L. Budlong and other representatives of the ARRL.

In September, 1950, I transferred from State Department to the National Security Resources Board which had been given the responsibility for civil defense planning. My first love in radio was amateur radio, and it appears that now, again, I will have the opportunity to closely affiliate myself with the amateurs in my country.

EASY RENEWALS FOR SERVICEMEN

During the early part of War II, you may recall, amateurs in military service were granted the privilege of applying for renewal of their licenses by means of an informal letter, instead of the usual application form No. 610, so long as it contained an endorsement by the commanding officer certifying as to military service. With many amateurs again putting on uniform, the League felt that such a provision would again be desirable, and has found the Commission's staff in accord with the idea. The waiver is now in the works, and may be released before this issue of *QST* reaches you; if so, W1AW will have carried the news. Which is just another reason for keeping an ear on ARRL's Hq. station these days.

PHOTOCOPIES OF AMATEUR LICENSES

In recent weeks some amateurs have attempted to secure photocopies of their licenses for display in their mobile installations as station authorization — but have been refused by the firms approached on the basis that the making of such copies is "illegal." The confusion probably arises because of the comparatively new amateur license form combining both operator and station authorization. Photocopies have never been illegal, to our knowledge; on the other hand it is quite true that FCC does not recognize a photocopy of a license for *operator* purposes, since it is a personal authorization and should be carried by the individual at all times. Photocopies of *station* authorizations are specifically provided for in our regs for just such purposes as mobile installations. FCC's staff itself doesn't know where anyone got the idea it was "illegal" to photocopy the license form. If any amateur runs into this difficulty with a local company, we suggest he take along a *License Manual* to show the text of § 12.68.

CANAL ZONE DOINGS

Canal Zone amateurs have obtained special call letter license plates for their automobiles due to the efforts of several members of the Canal Zone Amateur Radio Association. The plates are blue with the call in white and will be available for display after December 15th.

KZ5AW tells us mobile operation will be permitted Canal Zone amateurs according to a provision of the recently revised regulations. Previously such operation was restricted by the military, although a special authorization permitted such operation during the recent Simulated Emergency Test.

WATCH YOUR EXPIRATION

Nearly one-half of present amateur licenses expire during 1951. Check the expiration date on yours *now* and arrange to apply for renewal sometime in the 120 days preceding expiration date. Remember that 3 contacts on c.w. are required as proof-of-use.

★ ★ ★

SINCE the war many countries of the world have set up currency restrictions which either prohibit the sending of money outside their boundaries or make it practically impossible. This has meant that hundreds of amateurs in other lands do not normally have the opportunity to renew their ARRL memberships and receive *QST* regularly. The situation is made more acute by the devaluation of many foreign currencies, for many of those who formerly were just barely able to get together the necessary American dollars now find it utterly impossible to do so. Yet to them *QST* is the lifeline of contact with American and world-wide amateur radio. As one of them said, "I'd gladly forego my bread ration if instead I could get *QST* regularly."

At the end of the war ARRL did in numerous instances grant membership and *QST* to prewar members overseas on a credit basis, but of course we couldn't carry membership-subscriptions on that basis indefinitely and, in practically all cases, we have been regretfully obliged to discontinue these arrangements. It occurs to us that perhaps American amateurs and club groups might wish this year to make a "care" package gift in the form of *QST* for Christmas, as many did last year. If it's something you'd like to do, we'll be glad to make necessary arrangements. The foreign membership dues are \$5. If you have a particular DX buddy in mind, give us his name — and complete address. If you have no special name, we can arrange to apply your remittance to a membership-subscription for a foreign amateur who cannot send his own money but wishes to renew. We'll let you know what amateur we select. And of course we'll send the recipient of your gift an appropriate note to tell him who his American patron is. Address ARRL, 38 La Salle Road, West Hartford 7, Connecticut.

★ ★ ★

Strays

WØBOL has found that it is quite possible for a ham beam to reflect a TV station signal to a neighbor's TV receiver antenna, thereby causing "ghosts" to appear on the TV screen. In Bob's case the cure was to reorientate the ham beam when not in use. There is no guarantee, though, that this expedient will work in metropolitan areas where there are TV receiving antennas and transmitting stations in all directions!

Universal S.W.R. Measurements with a Coaxial Bridge

A Method for Extending Range and Improving Accuracy

BY GEORGE GRAMMER,* WIDF

THE resistance-bridge s.w.r. indicator is generally thought to be useful only on lines of one characteristic impedance, unless the resistance in the standard arm is changed. However, it is readily possible to use a single fixed bridge on lines of any practical impedance, and of all types of construction. For example, any amateur who has a coax bridge and uses a coax-coupled antenna tuner is all set to measure the s.w.r. on a two-wire line just as readily as he measures the s.w.r. in the coax link.

The principle at the bottom of measurements of this sort is quite simple. An s.w.r. bridge, of whatever type, is essentially an instrument for comparing the applied and reflected components of voltage at the input terminals of the line. The ratio of these two voltages is uniquely determined by the standing-wave ratio. The function of the bridge circuit is to separate them so they can be measured independently (a thing that cannot be done with an ordinary voltmeter) but in order to do it the bridge must be set up for a specific value of impedance.

Suppose that, as in Fig. 1, a transformer, L_1L_2 , is inserted between a bridge and a terminated line. If L_1L_2 is an "ideal" transformer, a voltage across L_1 will appear across L_2 multiplied by the ratio of turns in L_2 to turns in L_1 . Conversely, a voltage applied to L_2 will be reduced in the same ratio to

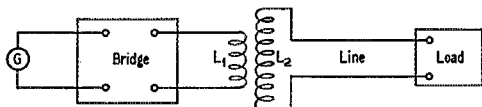

Fig. 1 — Theoretical circuit for making s.w.r. measurements on two-wire lines, using a coaxial bridge. This circuit is for illustrative purposes only, since a transformer, L_1L_2 , cannot be built with the necessary characteristics at radio frequencies.

appear across the terminals of L_1 . Any pair of voltages on either coil will be transformed by the other to new magnitudes, but the ratio of one voltage to the other will be intact. Consequently, if the bridge is operated in the normal procedure, the voltage reflected back from the load will appear at the bridge terminals in exactly the same ratio to the reference voltage as it would had the bridge been working directly into a line having the same s.w.r., but of the characteristic impedance for which the bridge was designed. With an ideal transformer, any fixed bridge could be

• With an antenna coupler or its equivalent, a fixed-resistance s.w.r. bridge of the coaxial type can be used for measuring either coaxial or parallel-conductor lines of any characteristic impedance. By minimizing the effects of unbalance on two-wire lines higher accuracy can be achieved than by direct bridge measurements.

used for making measurements on lines having any feasible characteristic impedance, merely by inserting the transformer.

However, an ideal transformer does not exist. At radio frequencies a simple transformer of the type shown in Fig. 1 would give highly inaccurate results because it would introduce voltage drops, principally reactive, not considered in the ideal transformer. An arrangement that does work is shown in Fig. 2. It uses coupled circuits so tuned that the reactive voltage drops are canceled out, leaving only the coil resistances to cause unwanted voltage drops. If good coils — i.e., coils having high Q — are used the resistance voltage drops are negligible over the range of measurements ordinarily useful, so for all practical purposes the resonant transformer introduces no error. In return for this, the circuit requires proper adjustment to the frequency at which the measurement is made, and must be set up for the characteristic impedance of the line to which it is connected. Both adjustments are simple to make.

Fig. 2 will be recognized as the ordinary antenna-coupler circuit, and the same component values that are used for the antenna coupler can be used for measuring s.w.r. The circuit is not the only one that can be used, but is well adapted to coupling to open-wire lines. It is convenient, but not absolutely necessary, to have the coupling between L_1 and L_2 variable. C_1 also is not strictly necessary, but does speed up the adjustment process. However, an ordinary coupler with a fixed link and no series condenser can be used, provided the link is large enough and is coupled tightly enough to L_2 .¹ If you have already been able to get a 1 to 1 s.w.r. in the coax link with the coupler connected to the line and antenna, you should have no trouble.

Suppose that the s.w.r. is to be measured in 300-ohm line. The procedure is the same whether the coax link and bridge are 50 or 75 ohms. Terminals AB should be as close as possible to the taps on the coil, and should in no event be con-

* Technical Editor, *QST*.

¹ Grammer, "Tailor Made Antenna Couplers," *QST*, May, 1950.

nected to the coil through even a very short section of transmission line, or anything resembling such a line. Connect a 300-ohm noninductive resistor to *AB*, with the regular line disconnected. Half-watt carbon resistors with 10 per cent tolerance are quite satisfactory for ordinary purposes; if a single 300-ohm unit cannot be obtained, two 150-ohm resistors in series may be used. Keep the connecting leads short.

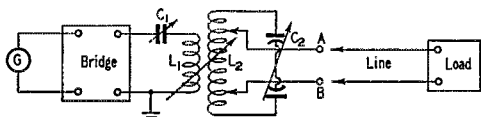

Fig. 2 — With this circuit (closely resembling the ordinary antenna coupler) s.w.r. measurements can be made with all the accuracy needed in practical work.

Now apply voltage from the r.f. source to the bridge, and adjust C_1 and C_2 for minimum reading. If the reading does not go to zero, try new tap positions, keeping them symmetrical with respect to the center of the coil, and adjust the condensers again. Varying the coupling between L_1 and L_2 also may help, but if the coupling is not adjustable and C_1 is not used, the taps alone should bring about a null. When a good null is secured, short-circuit *AB* and adjust the r.f. input for full-scale reading. On removing the short, with the 300-ohm resistor still connected, the reading should again drop to zero. The set-up is now ready for measuring s.w.r. on the 300-ohm transmission line.

Remove the resistor and connect the line to terminals *AB*. Connect it directly, not through relays, antenna ammeters and the like; they introduce impedance bumps that upset the measurement. Leave the tuning adjustments strictly alone — they are made solely for the purpose of getting a good null with the standardizing resistor in place and should not be touched during actual measurements. Once the actual line is connected, all you do is read the meter.

The frequency range over which consistent readings can be obtained with a given setting of the tuning controls will depend on how broad-tuning the circuit is initially. Using the antenna-coupler described some time ago in *QST*,¹ the writer has found the circuit to be nearly as broad for measurement purposes as it is for transferring power to the line. A single setting will suffice, for example, for all frequencies in the 14-Mc. band. This was tested by using various values of resistance at *AB* to simulate different standing-wave ratios, and the maximum variation in reflected voltage, with change in frequency, did not exceed plus or minus 2 per cent over the 14–14.4 Mc. range. The bridge was the one described in the 1950 *Handbook*, but with a 100-microampere meter and a 10,000-ohm series resistor substituted for the 1-ma. meter and its series resistor. The higher series resistance that can be used with a more sensitive meter raises the voltmeter impedance and thereby improves the performance of the bridge.

In checks over a frequency range with an actual line connected, it should be borne in mind that some change in s.w.r. with frequency is to be expected, depending on the selectivity of the antenna. The resistor test shows that the circuit does not make an apparent change in the s.w.r. over a reasonable frequency range. The measurements should be good over a frequency range, without readjustment, just as wide as that over which the bridge gives a good null with the standardizing resistor connected to *AB*. We have used 300-ohm line as an example in outlining the procedure, but it is to be understood that the resistor should match the characteristic impedance of whatever type of line is to be checked.

In general, it can be said that the over-all accuracy of s.w.r. reasurement with the method described here is very close to the accuracy of the bridge itself. The error tends to be a more-or-less constant percentage of the reflected voltage (the reading is slightly low because of losses in the tuned circuit), and since the actual deviation is small when the reflected voltage is small, the accuracy in terms of s.w.r. becomes greater the smaller the standing-wave ratio. For most practical purposes the error introduced by the tuned circuit can be considered negligible for standing-wave ratios below about 10 to 1. For very high standing-wave ratios the procedure can be modified to increase the accuracy, but the small need for measurements in this region does not justify a detailed description.

Eliminating the Parallel Component

The method of measurement described above has an important advantage over measurements made with a bridge connected directly to a two-wire line. With a directly-connected bridge the error, under some conditions, may be so large as to make the results useless. For example, we have seen cases where merely interchanging the line wires at the bridge terminals changed the indicated s.w.r. from 1 to 1 to as much as 4 or 5 to 1. We have also seen twin-lamps with the lamp toward the antenna glowing brightly while the one nearest the transmitter was dim; if the indication was to be believed, it could only mean that the antenna was furnishing power to the transmitter!

Errors of this sort are not necessarily the fault of the measuring equipment, but occur because the line currents are not perfectly balanced. The instrument merely indicates what it sees, which is the current (or voltage) at the point where it is connected. It has no way of knowing that what it is actually measuring is a composite current of which the true transmission-line current is only one element.

The causes of unbalance are various, but the over-all effect is the same: The total line current at any point is the sum of the true transmission-line current, which flows "push-pull" fashion, having the same amplitude but opposite phase in each wire at any point along the line, and a "parallel" current which has the same amplitude and the same phase in each wire at any point. Although a

bridge cannot differentiate between the two, a circuit of the general type shown in Fig. 2 can.

Fig. 3 shows why. If the center of the coil (the rest of the tuned circuit has been omitted for simplicity) is grounded, the transmission-line current flows in normal fashion as indicated by the solid arrows marked "TL." The in-phase parallel currents, shown by the broken arrows marked "P," flow in opposite directions through the two halves of L_2 and so induce equal and opposite voltages in L_1 if L_1 is equally coupled to each half. Hence the parallel currents balance out and have no effect in the circuit coupled to L_1 .

If the center of the coil is not grounded the parallel-type currents cannot flow through it at all as indicated at B. However, a high parallel voltage can build up all over the coil in the same phase, and through capacitive coupling between the two coils will cause a voltage to appear across L_1 . (This is also true if the center tap of L_2 is grounded, although to a lesser extent in most cases.) For complete freedom from all effects of the parallel component on the line the two coils should be separated by a Faraday screen, but in practice the arrangement shown at C works quite well. If the center of L_1 is grounded most of the capacitive coupling has to take place from the "hot" ends of L_2 , and grounding one side of L_1 confines most of the coupling to the hot end of the latter coil. The most desirable physical arrangement is shown at D, where both sides of

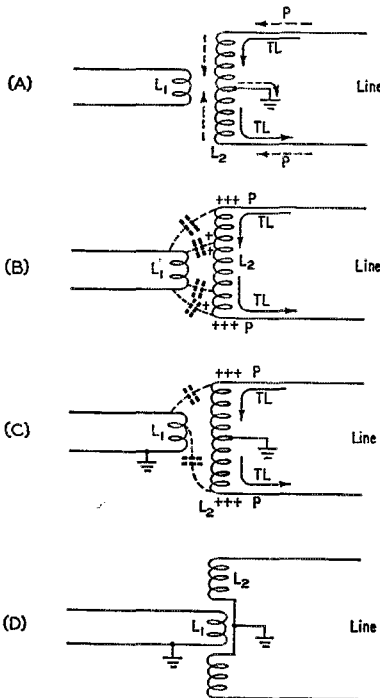

Fig. 3 — By using a balanced circuit and taking precautions to reduce capacitive coupling between the coils, the effects of parallel currents on a two-wire line can be made negligible in the measuring circuit.

L_1 are exposed to the grounded inner ends of the two halves of L_2 .

Practical circuits are shown in Fig. 4. Fig. 4A is suitable for two-wire lines of all available characteristic impedances.

The maximum flexibility in adjustment will be obtained if C_1 is used and the coupling between L_1 and L_2 can be varied, but neither is necessary if the coupler is designed as previously described.¹

The alternative circuit shown in Fig. 4B can be used with two-wire lines having impedances

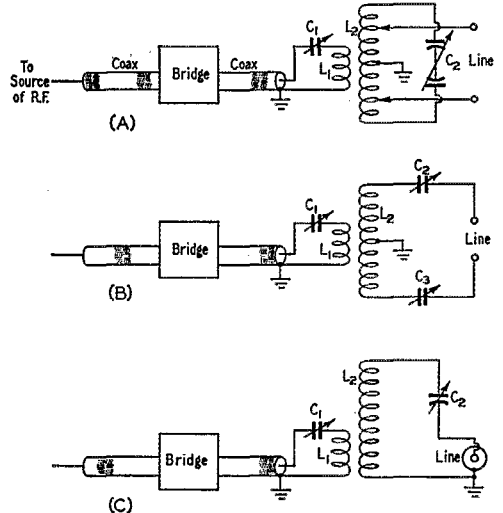

Fig. 4 — Recommended practical circuits. An antenna coupler with a fixed link can be used at A, and C_1 may be left out if the link is large enough to couple properly. Practical considerations in using the other two circuits are discussed in the text.

up to 300 ohms or so, but requires identical series condensers which should be tuned together. For adequate coupling between the primary and secondary circuits the L/C ratio in the latter circuit must be very high, and it is usually necessary to vary the coupling between L_1 and L_2 and use C_1 as well, before the circuit can be set up properly. The series-tuned arrangement is working under most favorable conditions with lines having characteristic impedances below 100 ohms.

The circuit at C can be used for making measurements on coax lines having characteristic impedances differing from that for which the bridge was designed. If a high L/C ratio is used in the secondary circuit, and if L_1 is large enough and can be coupled tightly enough to L_2 , it will not be necessary to use C_1 . However, provision should be made either for changing the L/C ratio or for varying the coupling between L_1 and L_2 .

The circuits of Fig. 4A and B have both been used by the author, and with either of them it was found that reversing the line wires at the terminals made no difference in the s.w.r. readings, even on lines which had considerable unbalance

(Continued on page 104)

TVI Tips

HARMONIC SEPARATORS

It has been pointed out many times in these pages that in reducing TVI it is essential to prevent v.h.f. harmonic currents from flowing on d.c. and low-frequency a.c. leads to the transmitter. The customary method of checking the presence and intensity of such currents is to use an indicating wavemeter, coupled in some fashion to the lead being investigated. This scheme has some disadvantages, the principal ones being that it is almost impossible to return to the same value of coupling, in changing back and forth between leads, and that the indication on the harmonic is sometimes masked by a spurious indication from the much more powerful fundamental frequency.

The remedy for the first condition is to use a device that can be inserted in the lead, ammeter style, instead of being inductively or capacitively coupled to it. The second condition can be cured by using more selectivity than can be obtained from the single tuned circuit that comprises the ordinary wavemeter. A gadget that meets the requirements quite well is shown in the accompanying photographs. As indicated in the circuit diagram, Fig. 1, it consists of a single-turn loop, of such small dimensions that it will have little effect on the electrical characteristics of the lead into which it is inserted, closely coupled to a circuit tuned to the harmonic frequency to be checked. This circuit, which is made fairly high- C to develop a relatively high circulating current, is in turn loosely coupled to a second circuit tuned to the harmonic. A crystal detector is connected to the latter circuit and the rectified d.c. output is used to operate a low-range milliammeter or microammeter. The additional selectivity provided by the intermediate tuned circuit is very

effective in reducing response to any but the desired frequency.

To make sure that the circuit will give indications only from the lead being checked, it should be shielded against external pick-up. Inasmuch as it will be used in leads carrying fairly high voltages, it should also be constructed so that it will be safe to use. The one shown in the photographs is built in a 3 by 4 by 5 box. The input leads go through feed-through insulators mounted on one cover plate. L_1 , which is a single turn $\frac{1}{2}$ inch in diameter, is covered with spaghetti tubing and is mounted directly on the feed-throughs. As further precaution against voltage breakdown from L_1 to the case, the tuned circuit $L_2C_1C_2$ is insulated from the case and is operated by an

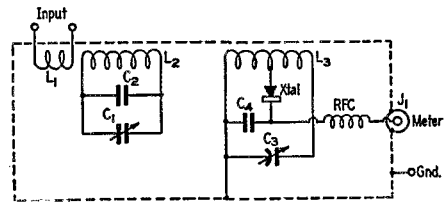
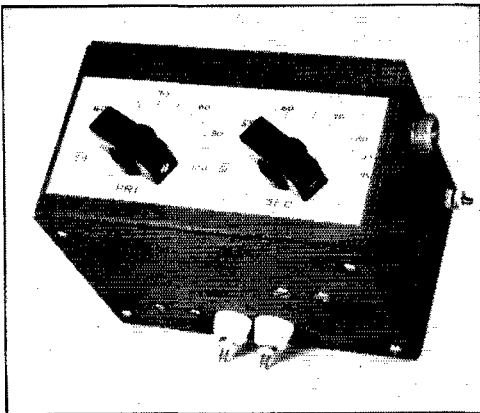

Fig. 1 — Harmonic checker for use in supply leads.

- C_1 — 75- μ fd. midget variable.
- C_2 — Approx. 30- μ fd. fixed mica (padding for band-spread).
- C_3 — 25- μ fd. midget variable.
- C_4 — 470- μ fd. mica.
- L_1 — 1 turn No. 14, $\frac{1}{2}$ -inch diameter.
- L_2 — 2 turns No. 14, $\frac{1}{2}$ -inch diameter, $\frac{1}{8}$ inch between turns.
- L_3 — 8 turns No. 14, $\frac{1}{2}$ -inch diameter, 1 inch long.
- J_1 — Chassis-type microphone cable connector.
- RFC — 7- μ h. r.f. choke (Ohmite Z-50).
- XTAL — 1N34 or equivalent.

insulated coupling and grounded extension shaft. The final circuit, L_3C_3 , is grounded to the case. The construction shown in the photographs is good for about 1000 volts; heavier feed-throughs would be required for higher voltages. The ground terminal should be connected to the d.c. return so that any breakdown will occur to ground through the case and not through the operator.

In building such a unit, use tight coupling between L_1 and L_2 , but allow a little separation between the coils to reduce the possibility of voltage breakdown. The coupling between L_2 and L_3 should be loose, but not so loose as to sacrifice sensitivity. To adjust it, put a small amount of r.f. current of some frequency within the 54-88 Mc. range through L_1 , take a trial position of the coupling between L_2 and L_3 , and then tap the crystal at various points along L_3 until the largest reading is obtained. (The input current can be supplied by a grid-dip oscillator loosely coupled to a loop connected to the input terminals.) Do this for various values of coupling, reducing the input signal strength from time to time, until maximum sensitivity is attained for weak signals. The coupling and position of the



Harmonic separator for checking supply leads. The feed-through insulators on the side panel connect in the lead being checked. The fitting on the side of the box at the upper right is for a shielded lead to the meter, while the screw terminal at the lower right is a safety ground. Calibrated dials are a convenience, since the circuits tune quite sharply.

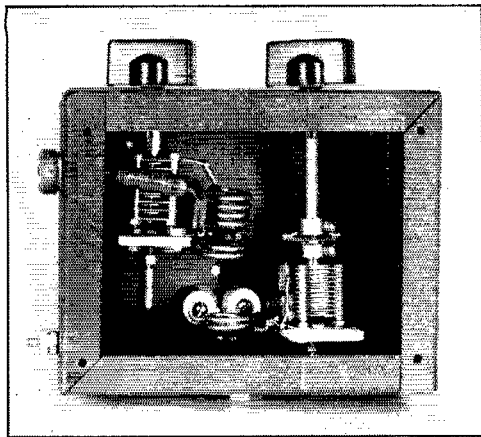

An inside view of the lead checker. The padding condenser on the primary circuit, lower right, consists of two small mica condensers in parallel to make up the necessary capacitance for good bandspreading in this circuit.

tap will depend on the sensitivity of the d.c. meter available. The unit shown was adjusted for use with a 0-100 d.c. microammeter and the distance between coils is $\frac{3}{8}$ inch. The two tuned circuits should be reasonably well separated, physically, to reduce capacitive coupling between them. Such coupling is not of much importance at the harmonic frequencies but may lead to undesired response from the fundamental.

This lead-checking version of the "harmonic separator" has proved to be convenient to use and, when properly set up initially, more sensitive than an ordinary crystal-detector wavemeter using the same d.c. indicator. This is probably because of the tight coupling to the lead being checked. The leads to the d.c. meter should be shielded, to prevent r.f. from getting in through the back door. Also, it is worth noting that while the instrument indicates the relative harmonic current at the point where it is inserted in the lead, the current may be different in the same lead a short distance farther along; there are usually standing waves along supply leads. In the event that the first try gives little or no indication, the harmonic should be measured at another point about a quarter wavelength away, just to make sure.

Harmonic Separator for the Antenna Circuit

Another application of the harmonic separator, and one that appeals to us as having excellent possibilities, is in the antenna circuit. In some of the more sticky TVI cases where traps and filters just don't seem to do anything, it is natural to suspect that the trouble may be caused principally by the fundamental radiation. But if a high-pass filter on the receiver also doesn't help, you find yourself up a blind alley because it isn't usually possible to dig further into a neighbor's receiver. Even if the receiver is your own, it is probably an unwieldy brute and not to be tackled

lightly. It would be a help if you *knew* whether the trouble was fundamental or harmonic.

A harmonic separator may help to bring out the right answer. The idea here is to take an approach just opposite to the normal one — keep the fundamental from being radiated but get the harmonic into the antenna. A circuit with which we have had some success in this respect is shown in Fig. 2. Like the separator described above, it uses two circuits tuned to the harmonic frequency. The secondary circuit is connected to the antenna feeders and the primary is in series with a lamp dummy antenna. Since there is practically no coupling to the feeders at the fundamental frequency, very little energy of that frequency is radiated and practically all of it will be dissipated in the dummy antenna. On the other hand, the harmonic will be trapped out in the primary circuit and coupled to the feeders. Since the primary circuit will have a relatively high parallel impedance compared with the impedance of the lamp dummy antenna, most of the harmonic energy should go into the antenna rather than into the lamp.

The circuit of Fig. 2 is arranged for coax input and parallel-line output. The necessary modifications for other combinations should be obvious. However, it is recommended that coax input be used whenever possible, and also that the unit be

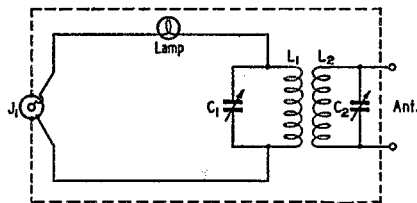

Fig. 2 — Harmonic separator for the antenna.

C_1, C_2 — 100- μ fd. midget variable.

L_1 — 1 turn, $\frac{1}{2}$ -inch diameter.

L_2 — 2 turns No. 14, $\frac{1}{2}$ -inch diameter, $\frac{1}{2}$ inch between turns.

J_1 — Coax connector.

shielded. The shielding is not needed to prevent harmonic radiation, but we found in at least one case that there was enough fundamental radiation from an unshielded unit, with unshielded leads between it and the transmitter, to obscure the harmonic radiation. Although this probably would not happen except in weak-signal regions, it is best to play safe and use some shielding. The same reason favors using coax between the transmitter and the unit itself.

The condenser settings, for a given harmonic, will depend on the constants of the input line in the case of C_1 , and on the antenna-feeder system in the case of C_2 . If the TV screen can be watched, it is simply a matter of finding the settings that give the most interference. If not, the circuits should be set to resonance at the harmonic frequency in question by means of a grid-dip meter, with both the input and output lines connected. If the primary circuit does not cause the meter to give a moderately sharp dip at resonance, it

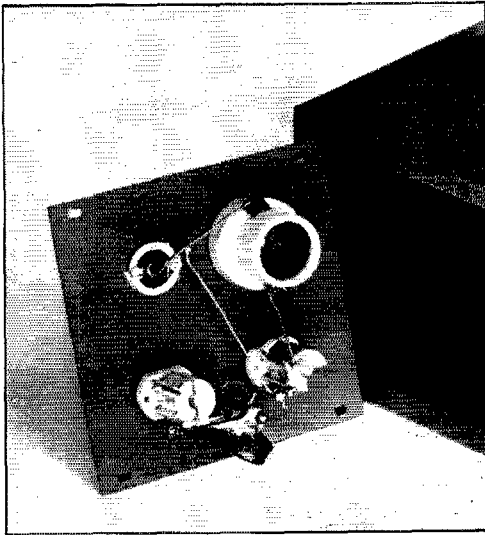

Harmonic separator for the antenna, constructed by WIFTX. This version is suitable for about 100 watts of r.f. and is built for coaxial input and 300-ohm line output, using a crystal socket for the latter. It fits in a 6 by 6 by 6 metal box. For higher power the same tuned circuits would be satisfactory, since the harmonic power is small in any event, but a larger enclosure would have to be used for housing a higher-power lamp.

might be well to try a different length of line between the transmitter and J_1 .

With the fundamental out of the picture (literally) it will be found that traps, low-pass filters and the like really do work. It will not take long to convince yourself of this if you start out with no filters or traps (or with existing traps detuned) and no antenna coupler, just taking the raw output from the transmitter. The TV picture will no doubt be a complete wreck under these conditions. If the harmonic-reducing devices are then introduced one by one, their effectiveness can easily be gauged, and you can readily determine whether the measures you have so far taken to reduce harmonics are sufficient. It should hardly be necessary to say, of course, that such checks will mean something *only* if the interference disappears completely when the antenna feeder is disconnected from the harmonic separator. In other words, the harmonic radiation from the transmitter itself must be negligible.

Assuming that the harmonic separator sees to it that practically all of your harmonic output is radiated, lack of interference with the separator in use should give you a clean bill of health so far as harmonics are concerned. If there is still TVI with the antenna normally connected to the transmitter, it is no doubt caused by the fundamental. At this point it is well to take a critical look at the TV receiver, but don't make the mistake of assuming that the receiver *has* to be at fault. It is not unusual for harmonics to be generated outside either the transmitter or receiver, by contact rectification of fundamental-frequency currents flowing in near-by conductors, particularly the metal work (including wiring)

around a house. We have been running into such cases from the very beginning of the TVI problem, and they are not easily solved. Interference of this type can frequently be identified by the fact that it tends to be intermittent, since the rectification takes place in an uncertain metal-to-metal contact whose resistance varies with random vibration or other causes.

One requisite of the harmonic separator is that it separate out nearly all of the harmonic power. It does not have to get the last microwatt; for example, if it transfers only half the available harmonic power to the antenna the interference will be only 3 db. below the maximum possible level, and so is practically as effective for testing purposes as if every last bit were delivered. Part of the question of maximum transfer is getting good coupling, at the harmonic frequency, to the transmitter. The load is not matched to the line at this frequency, so the loading will depend on the length of line between the transmitter and separator. It is therefore advisable to try a few different lengths of line between the two. Since the plate meter cannot be used to indicate loading at a harmonic, the only check on the effectiveness of the power transfer is in the intensity of interference caused by the harmonic.

The circuit shown in Fig. 2 has the defect that some proportion, dimensions unknown, of the harmonic power is dissipated in the dummy. However, it works reasonably well and is simple to make. More elaborate circuits that avoid losing any harmonic power in the dummy probably would be worthwhile, because an effective harmonic separator should be of inestimable aid in those cases where normal TVI-reduction procedure just doesn't produce results.

— G. G.

Silent Keys

IT IS with deep regret that we record the passing of these amateurs:

W1LQZ, Walter E. Trask, Danbury, Conn.
 W1MPV, Dr. Robert R. Kissick, Greenwood, R. I.
 W1REA, Alfred H. Boutin, Taunton, Mass.
 W2CFK, John G. Murcken, jr., Westwood, N. J.
 W2KJU, Carl G. Peterson, New York, N. Y.
 W2KRJ, Joseph A. Manz, Newark, N. J.
 W3DNZ, Charles J. Grundel, East Lansdowne, Penna.
 W3FCO, John L. White, Carnegie, Penna.
 W5PYT, William K. Harrison, Fort Worth, Texas.
 W6DCS, Robert J. Hare, San Gabriel, Calif.
 W6IBJ, Ward L. Anderson, Ukiah, Calif.
 W6WZA, Edward Green, Los Angeles, Calif.
 Ex-8CI, C. Tefft, Muskegon, Mich.
 W8DKI, Robert E. Miller, Detroit, Mich.
 W8MDQ, Elmer L. Miller, Dennison, Ohio
 Ex-W9LU, R. O. Jasperson, Umatilla, Fla.
 W9BHJ, H. Dean Blackman, Independence, Mo.
 W9CEN, George J. Barron, Davenport, Iowa
 G1BEDN, Lieut. T. D. Aldwell, RN, Belfast
 G15JN, J. Milliken, Belfast
 VK4RC, Robert Campbell, Brisbane

"Supermodulation"—An Evaluation and Explanation

A Discussion of Principles and Design Factors

BY OSWALD G. VILLARD, JR.,* W6QYT

DURING recent months considerable interest has been aroused by a method of amplitude modulation known as "supermodulation." First disclosed to amateurs in September, 1948, many articles have since appeared on the subject.^{1, 2, 3, 4, 5} In certain of these, claims have been advanced which leave with the reader an impression that not just a modulating method, but in reality an entirely new system of radio communication has been invented. For example, it is implied that in addition to its other advantages, "supermodulation" provides a greater ratio of sideband to carrier power than conventional systems, thus improving intelligibility. Further, the claim is made that the bandwidth required for communication is lowered with this system to the point where it is directly competitive with single-sideband operation in spectrum economy. Many amateurs who either have tried the system or listened to supermodulated stations report that in fact they *do* appear to be louder-sounding. The question is, does this result confirm the other claims? Is supermodulation in fact something really new and useful that radio engineers have overlooked for all these years?

This article offers an explanation for the experimental findings, substantiates some of the claims for supermodulation, and rejects others on the grounds that they are unproven. Operation of the circuit — as understood by the author — is discussed in detail, and a simplified version of the original circuit is presented. The opinions herein expressed are strictly those of the author. Anyone desirous of performing a decapitation is invited to write an article in reply!

Since the author's opinion is that supermodulation, while a useful method of amplitude modulation, is nevertheless *not* endowed with properties of greater intelligibility coincident with narrower bandwidth, nothing would make him happier than to be proven wrong, because such a

* Trustee, W6YX; Dept. of Electrical Engineering, Stanford University, Stanford, Calif.

¹ R. E. Taylor, "The 'Taylor' Super-Modulation' Principle" (Part I), *Radio News*, Sept., 1948, p. 42; Part II, *Radio News*, Oct., 1948, p. 44.

² R. P. Turner, "A Supermodulated Low-Power Phone Transmitter," *Radio News*, June, 1949, p. 51.

³ J. K. McCord, "Understanding Supermodulation," *Radio News*, Feb., 1950, p. 66.

⁴ R. P. Turner and J. W. Graves, "A Supermodulated Phone Transmitter," *Radio News*, May, 1950, p. 51.

⁵ M. E. Lowe, "The Sumdoget Transmitter," *Radio News*, July, 1950, p. 53.

⁶ R. E. Taylor, "Modulation System," U. S. Patent No. 2,282,347, May, 1942.

⁷ "Features of Grid and Plate Modulation in New System," *Electronics*, May, 1946, p. 192.

• "Supermodulation" has been a puzzle to everyone familiar with the physical principles of modulation, because many of the claims made for it are mutually conflicting. The explanation in this article is based on the Taylor patent claims and a study of the most probable operation of the published circuits. The author, who has developed original modulating systems himself and is well known to amateurs through his *QST* articles, is well qualified to discuss modulation systems authoritatively.

The first part of this article, at least, should be studied by everyone interested in telephony. Only when the basic facts of modulation are thoroughly grasped is it possible to assess the claims made for the various modulation schemes that periodically make their appearance.

result would represent a worth-while advance.

The conclusions, stated in greater detail, are:

1) Supermodulation is an interesting new method for obtaining high-efficiency amplitude modulation through grid-modulation techniques.

2) There does not appear to be any discernible way, with this system, by means of which the bandwidth can be reduced below that required for *any* amplitude-modulated 'phone signal.

3) There likewise does not appear to be any discernible means for increasing the amplitude of the sidebands with respect to the carrier so as to give greater intelligibility, without at the same time causing distortion and increasing the required bandwidth.

4) The experimentally-observed unusually-loud supermodulated signals are probably those in which the upward modulation peaks have been set to exceed the negative peaks. This gives a louder-sounding but distorted signal, in which the distortion is mostly even harmonics. Even-harmonic distortion reduces intelligibility very little, and since the corresponding sidebands lie closer on either side of the carrier than odd-harmonic sidebands, they may be somewhat less noticeable in practice.

5) There is a possibility that the circuit can be so adjusted as to give a controlled-carrier action, whereby *both* carrier and sidebands rise on modulation peaks. This might also account for the "louder sounding" signal, and if the adjustment were correct, no spurious sidebands would be generated. However, it appears that in the

circuits published thus far, any controlled-carrier action would be more or less incidental.

Basic Method

The basic idea of the supermodulated system is described in Taylor's U. S. Patent⁶ which was issued in 1942. A clear exposition will also be found in *Electronics*.⁷ Briefly, it is as follows. Conventional grid-modulated amplifiers operate with good efficiency at the peak of the modulation cycle, poor efficiency at the carrier level and with even worse efficiency as the modulation trough (or minimum) is approached. The most important part of the cycle is the carrier level, because modulation of appreciable depth is present such a small fraction of the time. One could tolerate almost any efficiency during modulation, if only the carrier efficiency were good. Taylor's idea is this: why not connect two grid-modulated amplifiers together in such a way that one amplifier can be adjusted to handle the carrier and negative modulation peaks with maximum efficiency, whereas the other can be adjusted to carry the positive modulation peaks? In this manner the carrier can be generated at an efficiency of roughly 66 per cent, instead of at 33 per cent as in conventional systems.

This is an excellent idea, and one which has been exploited before. The Doherty linear amplifier and the Terman-Woodyard high-efficiency grid-modulation system are examples. Both these methods, however, employ quarter-wave impedance-inverting lines for combining the carrier and the positive modulation peaks. This was done because the quarter-wave lines permit a sharing of the load at the crest of the modulation cycle: both the peak tube and the carrier tube contribute twice the carrier-level power output. The one drawback with quarter-wave lines is the fact that they are difficult to tune — almost prohibitively so, from a ham point of view.

Taylor has shown how the quarter-wave lines may be avoided, in a system whose efficiency nearly equals that of the previous ones. However, there is a penalty which must be accepted in exchange for simplified tuning: the peak tube must now carry the full crest power alone. The carrier tube in effect lies down on the job and passes the full load over to the peak tube at the crest of the modulation cycle. This is no disadvantage at low power levels, because most ordinary tubes have ample overload capacity, but for high-power broadcasting stations it might be a drawback. In order to modulate a 50-kilowatt transmitter, for example, the peak tube would have to be provided with a filament emission good for 200 kilowatts.

It is interesting that the Taylor system has a close analogue in the linear-amplifier field. S. T. Fisher has disclosed a "divided wave" linear amplifier, reported in both the *Proc. I.R.E.*⁸ and *QST*,⁹ which is really the same principle applied to a linear amplifier, and with a plurality of circuit branches instead of just two.

Carrier and Sidebands

Later on in this article, the author will present a more detailed exposition of his understanding of how the Taylor system works. At the moment, however, it is important to discuss some of the claims that have been made for it. One of these is a "carrier compression" effect which is supposed to increase the magnitude of the sidebands relative to the carrier for a given total modulated power output. It is stated that the reduction in carrier lessens heterodyne interference, and that the increased sidebands make the signal sound louder. Unfortunately, there just isn't any known way to upset the well-known ratio of carrier to sidebands in a 100 per cent modulated wave. It is either a 100 per cent modulated wave or it is something else. Certainly the percentage of modulation can be increased above 100 per cent, if desired, and without spurious sidebands, too, by converting a modulated amplifier into combined modulated amplifier and balanced modulator. This will very definitely give a louder-sounding signal. The way to do it has been described in detail by the author in both *Electronics*¹⁰ and *QST*.¹¹ Or again, it is possible to increase the carrier in accordance with the modulating signal, keeping the level at 100 per cent, and this is known as "controlled-carrier" modulation. It is further possible to make one sideband larger or smaller than the other by single-sideband techniques, and to alter the relative phases of carrier and sidebands, but these are the *only* possibilities for altering the situation without generating additional sidebands as in the case of phase or frequency modulation. If supermodulation is truly narrow-band, and differs in any respect from conventional a.m., then it must be some one of the above or a combination. Actually, it is very hard to see how the circuit could generate anything very different from straight a.m.

The reason for the confusion is probably the circumstance that when the Taylor circuit is modulated, the d.c. input to the peak tube increases while the input to the carrier tube *decreases*. There is a perfectly good explanation for this, as will be shown later. *However, it is erroneous to assume that the carrier level of the r.f. output is always the same thing as the d.c. input to the "carrier" tube.* Actually, the peak tube makes up for the power output the carrier tube fails to supply at the crest of the cycle, so that the resultant is a wave 100 per cent modulated as in any other a.m. system.

Channel Width

Another trap to be avoided is the temptation to "guesstimate" the spectrum of a modulated wave pattern seen on an oscilloscope. One cannot

⁸ S. T. Fisher, "A New Method of Amplifying with High Efficiency a Carrier Wave Modulated in Amplitude by a Voice Wave," *Proc. I.R.E.*, Vol. 34, No. 1, Jan., 1946, p. 3P.

⁹ S. T. Fisher, "A New Linear Amplifier Circuit," *QST*, Feb., 1946, p. 21.

¹⁰ O. G. Villard, jr., "Overmodulation Without Sideband Splatter," *Electronics*, Jan., 1947, p. 90.

¹¹ O. G. Villard, jr., "Overmodulation Splatter Suppression," *QST*, June, 1947, p. 13.

reliably tell what the carrier and sidebands are doing from such a pattern. The only safe way is to investigate them on an adequately sharp spectrum analyzer. The ordinary commercial panoramic analyzer is *not* sharp enough, incidentally, to give reliable indications under ordinary circumstances. Instead a selective receiver (with crystal filter in the sharpest position) should be used as a manually-operated spectrum analyzer, taking care that overloading does not occur. It turns out, for example, to be quite wrong to suppose that splatter is automatically avoided if the envelope of the modulated wave from a conventional transmitter is prevented from "pinching off" during modulation while the positive peaks are allowed to increase above the 100 per cent level. (Here sine-wave modulation is meant: an exception to this rule is asymmetrical speech waves.) Splatter — that is, spurious sidebands — is caused by transmitting a distorted modulated wave. The distortion may originate either in the audio circuits, or it may be generated in the r.f. circuits as when a conventional a.m. rig is overmodulated. Either way, spurious sidebands are generated.

In the case of an audio system incorporating clippers followed by low-pass filters, distortion occurs and spurious sidebands are generated, but they are confined to the channel by the action of the low-pass filter which in effect "cleans up" any distortion at the higher audio frequencies, and guarantees that any high-frequency audio wave modulating the carrier is *not* clipped and therefore not distorted. It does not matter if a 500-cycle wave is clipped and contains (say) three or four strong harmonics, because the highest of these produces sidebands only 2000 cycles on either side of the carrier. If an audio tone of 3000 cycles were clipped in the same way, however, the interference would be very troublesome. It is the function of the filter to remove harmonics of the higher audio frequencies and thus to undo the action of the clipper.

Unfortunately, there is no convenient way to obtain the benefits of a low-pass filter when the equivalent of clipping occurs in the r.f. circuits of a transmitter. The sidebands generated will be radiated at virtually full strength, even when they are 30 or 40 kc. away from the carrier. This is a point to be remembered with *all* grid-modulated or linear-amplifier transmitters.

Fig. 1A shows a conventional wave 100 per cent amplitude-modulated by a sine tone. In B we see the odd-looking waveform which results when the sidebands are increased above the point which gives 100 per cent modulation, *without any distortion of the sidebands such as occurs with overmodulation of a conventional rig*. We are accustomed to reduced-carrier single-sideband transmission; this is merely a reduced-carrier *double-sideband* signal. Any single-sideband transmitter can be made to generate a signal of this sort. Fig. 1C shows what happens when the amplitude of the tone is increased and the carrier is increased proportionately — this is "controlled carrier" transmission.

Fig. 1D shows a typical wave which might arise if the positive peaks were set to exceed the negative peaks in a supermodulated transmitter. Some of the referenced articles have implied that such an adjustment is permissible, but it most emphatically is not. It is nothing more than a somewhat stronger carrier modulated by a highly-distorted audio wave, as shown in the figure. With this signal we may expect strong spurious sidebands and adjacent-channel interference. No audio filter can possibly help this situation, because the distortion arises in the r.f. circuits of the transmitter.

Fig. 1 — Amplitude-modulation waveforms.

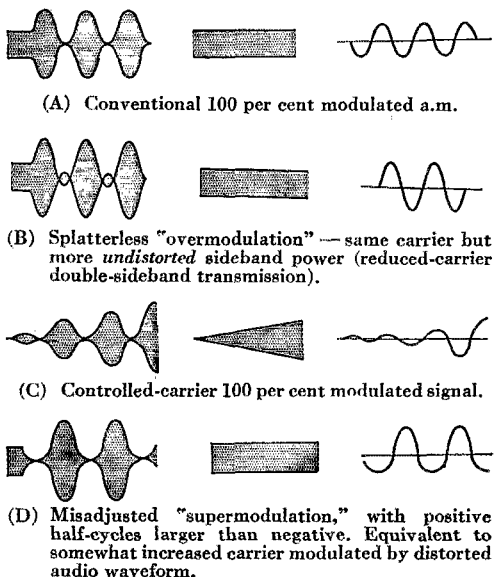

The adjustment of Fig. 1D is very tempting, nevertheless, for two reasons. First — the signal sounds loud, and the distortion is quite tolerable to the ear because it consists primarily of even harmonics which do not reduce intelligibility very much. (Pull out one tube of a push-pull Class AB₂ modulator, for example, and it is surprising how good reports can be obtained. Certainly nobody will have any difficulty in understanding speech under these conditions.)

Second, the splatter from this adjustment probably won't be as noticeable as that from an equivalent amount of straight overmodulation. Real overmodulation produces "buckshot" tens of kilocycles away from the carrier (if the signal is strong), because there is a phenomenally efficient clipping action when the Class C amplifier cuts off on the negative audio half-cycles. The sharp edges of this r.f. waveform contain very high harmonics; therefore sidebands quite far from the carrier will be found. (It is a paradox that the waveform of Fig. 1B also contains sharp edges; however, no splatter is caused because they are not the result of clipping action. This is another example of why a spectrum analyzer is more reliable than a 'scope.) In Fig. 1D there is

distortion, and consequently distortion-formed spurious sidebands, but there is no really drastic clipping. The spurious sidebands may be expected to be relatively closer to the carrier, because there are no really sharp discontinuities with the corresponding high-order harmonics and sidebands.

Still, there is no excuse for such an adjustment. Instead of interfering relatively a little bit with a lot of stations, as straight overmodulation does, this signal will tend to smother the men on either side.

As for the claim that supermodulation makes possible transmission in a bandwidth narrower than that required for a.m., it cannot be said that this has been substantiated by any theoretical information published thus far. Taylor's patent mentions that by performing certain adjustments, "one sideband was emphasized." However, no mention of this effect is to be found in the claims under the patent, which really represent what is patented. It seems likely that if this discovery had been considered important, it would either have been protected in the claims, or else not mentioned at all in the discussion lest someone else exploit the idea. The published articles imply that supermodulation is sharper, but the comparison is usually with a conventional rig which may or may not have been correctly tuned up. It is quite conceivable (on the basis of the above remarks, for example) that a badly-tuned supermodulated rig is sharper than a badly-tuned conventional rig, and this may have been what the authors had in mind.

One other point should be mentioned: with some versions of the supermodulated circuit, such as those shown in the patent, the possibility of incidental phase modulation — particularly of the output of the peak tube — cannot be ignored. The author has shown at least one situation in which phase and amplitude modulation may be combined to redistribute a sideband spectrum.^{12, 13} It seems very unlikely, however, that the supermodulation circuit as thus far published would be able to produce an equivalent result without severe incidental distortion.

Operating Principles

The following remarks are presented in an effort to clarify the method of operation of the supermodulation circuit as an amplitude-modulation system. It should be understood that this is only one interpretation — out of many possible ones — of how the system might be made to work in practice. For example, use of the basic principle with control-grid-modulated tetrodes will be discussed, both for the sake of simplicity and because this was the arrangement shown by Taylor. Actually, control-grid modulation of tetrodes is relatively nonlinear, the transfer characteristic having an almost parabolic curvature in the region where no grid current flows. It is therefore relatively undesirable. Screen modula-

tion, on the other hand, is remarkably linear and easy to adjust, and can be used equally well. This article, in short, is not intended to present the most practical or desirable circuit: its sole purpose is to illustrate the fundamental idea behind the Taylor system. It is a how-to-understand-and-design-it, rather than a how-to-build-it article, and is aimed at the experimenter who likes to know a bit more about *why* things behave the way they do, in order to be able to improve them.

It will help first to review ordinary grid modulation. The basic circuit of a grid-modulated tetrode amplifier is shown in Fig. 2. A tetrode is a desirable tube to use as an example for two reasons: first, the screen grid substantially eliminates the need for neutralizing circuits; and second, it makes the instantaneous plate current in the tube for all practical purposes independent of plate voltage (provided that the minimum instantaneous plate voltage is reasonably high, which we can guarantee by keeping the tank circuit well loaded). Both these circumstances greatly simplify explanation of the circuit, yet the difference in behavior between tetrode and triode amplifiers is relatively minor, and the following comments and conclusions can be extended without difficulty to triodes.

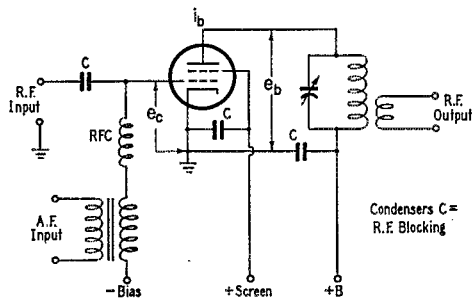

Fig. 2 — Basic circuit, ordinary grid-bias modulated amplifier.

We may now draw some diagrams showing the radio-frequency voltages in the various parts of the circuit as a function of time. See Fig. 3. We are interested in three things: (1) the instantaneous plate-to-ground voltage e_b ; (2) the instantaneous tube plate current i_b ; and (3) the instantaneous grid-to-ground voltage e_c . (See Fig. 2 for a definition of these quantities.) If we know how they vary over the modulating cycle, we know how the circuit is performing. For convenience, we can pick three points in the modulating cycle: the instantaneous minimum, or zero output level; the carrier level; and the instantaneous maximum or modulation peak level. Knowing the situation at these three levels, we can readily picture what happens in between.

In Fig. 3A, the zero output level is shown. The instantaneous grid voltage (solid line) is shown varying through one and one-half cycles of the radio frequency. This is the picture we would

¹² O. G. Villard, jr., "Composite Amplitude and Phase Modulation," *Electronics*, Nov., 1948, p. 86.

¹³ O. G. Villard, jr., "A Simple Single-Sideband Transmitter," *QST*, Nov., 1948, p. 15.

Fig. 3 — Radio-frequency waveforms at three points in the modulating cycle, ordinary grid-bias modulation.

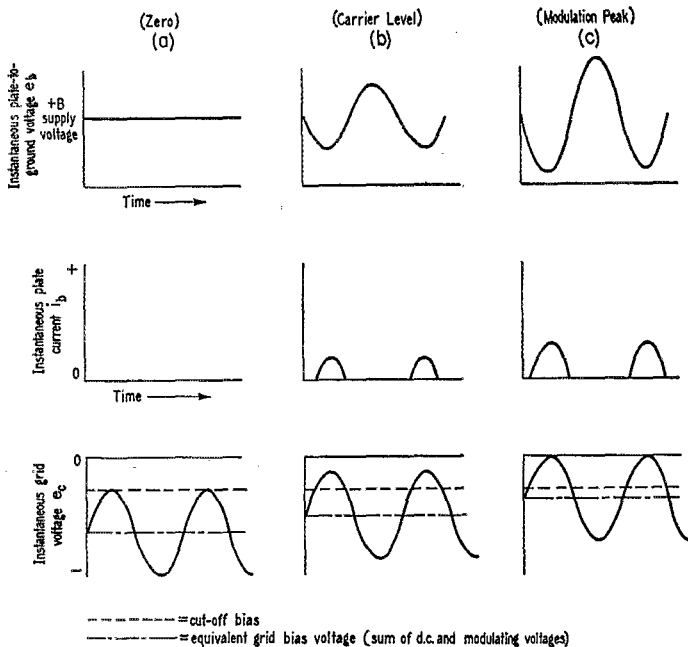

see if we connected an oscilloscope between grid and ground and then speeded up the sweep until the individual r.f. cycles became visible. At this high a sweep speed, of course, any modulating voltage superimposed on the grid bias would be essentially stationary, and effectively d.c., because it could not possibly vary appreciably during two cycles of r.f. The heavy dashed line passing through the center of the r.f. variation represents the value of this equivalent bias voltage, which could either be d.c. or d.c. plus the instantaneous value of some audio-frequency modulating voltage.

Note that the instantaneous grid voltage is more negative than the dotted line which represents cut-off bias for the particular value of screen voltage chosen. If the instantaneous grid voltage never becomes more positive than cut-off, no plate current can flow; no voltage can be developed across the tank circuit, and therefore there is no output. In B, however, the effective bias voltage has changed, and the superimposed r.f. drive pokes the instantaneous grid voltage above the cut-off line so that plate current flows for part of the cycle. Note that plate current flows for exactly as long as the instantaneous grid voltage is above the cut-off line, and the amplitude of the plate current pulse roughly corresponds to the amount by which the grid is driven above the cut-off line.

In C we have conditions at the peak of the cycle: the grid is driven to the point where it is about to go positive, whereupon grid current will flow, and the r.f. swing in the plate circuit has become just about as large as it can without causing the instantaneous plate voltage to touch the zero-voltage line.

Once again for simplicity, we will assume that the grid is not driven appreciably positive. No-grid-current operation is guaranteed to be non-linear, and the power output will be small, but it makes operation of the system easier to visualize. Once an over-all understanding has been gained, extension of the reasoning to include grid current is straightforward.

With the conditions of Fig. 3B and C, we can regard the tube as a source of current which passes through the tank circuit and produces a voltage drop across it. The only unusual point about this situation is the circumstance that the current is in the form of pulses, whereas the

voltage drop it produces is a sine wave. This comes about because a reasonably high- Q tank circuit can *only* support a sine wave across it. The current pulses can be thought of as being composed of a number of sine-wave components — a fundamental and various harmonics. Only one of these components — the fundamental — can produce a voltage drop across the tank, because it is the only component of current to which the tank circuit is tuned. The harmonic components pass on through as if the tank were essentially a short circuit.

The tank circuit, then, acts like an impedance in series with our current generator. We can adjust the *magnitude* of this impedance, by varying the loading on the tank. The tighter the load coupling, the lower the impedance; the looser the coupling, the higher the impedance. Now in Fig. 3C we assume that the tank-circuit impedance has been so chosen, by varying the load coupling, that the amount of current represented by the plate-current pulses will produce a voltage drop across the circuit equal to that shown. Note first, that the peak a.c. voltage drop subtracted from the d.c. supply voltage should swing down to approximately the screen voltage, which is commonly 15-25 per cent of the plate voltage. Note second, that the amount of plate current which flows is set by the conditions in the grid circuit and by the screen voltage. It is *not* affected by the plate voltage.

If we made the load coupling looser, then the a.c. voltage across the tank circuit would tend to rise, and this would force the minimum instantaneous plate voltage below the screen voltage. Under these conditions, plate current begins to be controlled by plate voltage, and we find that any further attempt to increase plate current by de-

creasing bias on the grid side is foiled because the plate voltage is swinging too low at the time we would like to draw this plate current, and thus an increased current cannot flow. This condition is called "saturation," and it should not occur at any point in the modulating cycle other than the very peak, or distortion of the modulated wave will result. This is why grid-modulated amplifiers must be loaded so heavily.

On the other hand, if we make the load coupling tighter, the a.c. voltage across the tank will decrease, and so will the power output and efficiency. Best results are obtained when loading is so adjusted that saturation is just reached at the modulation peak.

The supermodulation circuit is essentially two grid-modulated amplifiers connected to a common tank circuit. One possible arrangement is that of Fig. 4. Typical waveforms applicable to this circuit are shown in Fig. 5. Tube 1 is the carrier tube; Tube 2 the peak tube. The voltages and currents of Fig. 5 carry corresponding subscripts. Fig. 5B shows the carrier-level situation. It will be seen that the peak tube is biased beyond cut-off, and so contributes no output. The carrier tube is operated in a nearly saturated condition, delivering its maximum current output. The efficiency will be good in this adjustment because plate dissipation is low. To find average plate dissipation, mentally multiply the instantaneous plate voltage (e_b) by the instantaneous plate current (i_b) at each point of the cycle. The aver-

The zero-level situation in Fig. 5B requires little comment; the carrier tube is now biased beyond cut-off, and the peak tube far beyond cut-off. The modulation peak in Fig. 5C is accompanied by some interesting effects. First, note that the r.f. plate voltage on the carrier tube has doubled, and so has that on the peak tube, which is now just at saturation and supplying a large output. Operation of the peak tube forces a large voltage to appear on the plate of the carrier tube, which actually causes the plate to be driven negative at times when the plate current would otherwise be flowing. As a consequence, this tube delivers much less output than at carrier level; if any plate current flows at all it would be in the form of short, split pulses as shown. Thus the peak tube has to supply substantially the entire peak-level power output.

The point of tapping the peak tube down on the output tank circuit was to prevent this tube from saturating. Because of the center tap, when the carrier tube is saturated, as in Fig. 5B, the peak tube was well below saturation and thus able to deliver more output.

The purpose of the resistor in the audio lead to the carrier tube may now be understood. Because the carrier tube in 5C cannot deliver any useful output anyway, there is no point in letting its grid be driven far positive with a resulting waste of driving power. The series leak resistance causes this tube to bias itself off as soon as any grid current appears — thus, even though the audio source is attempting to drive the average grid voltage more positive, the negative bias across the grid resistance opposes this action. A small amount of clipping must occur, as indicated, in order to develop the necessary corrective bias.

The way in which the two tubes should combine in the tank circuit for proper operation is illustrated in idealized form in Fig. 6A. Here is shown the r.f. voltage across the tank as a function of instantaneous modulation level. From zero to the carrier-level (no-audio-signal) value, the carrier tube alone should produce a linearly-increasing output. From carrier level to peak, the contribution of the peak tube should rise from zero

to its maximum value. At the same time, the output of the carrier tube should steadily fall off because its plate is being driven instantaneously more negative. If this fall-off is linear, and the contribution of the peak tube is likewise linear, the sum of the two will give a linear increase in total output above the carrier level.

(Actually, there is no guarantee that the carrier tube's output will fall off exactly linearly, or for that matter that the peak tube will supply

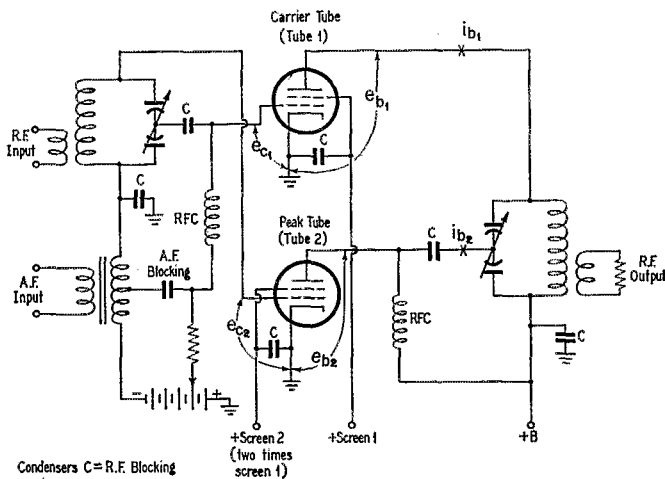

Fig. 4 — The basic circuit of the "supermodulation" system as interpreted by W6QYT.

age of the resulting instantaneous power curve equals the average plate dissipation. Plate dissipation is high in Fig. 3B, for example, because plate voltage is relatively high during the time plate current flows. In Fig. 3C or Fig. 5B it is much lower during this time interval, consequently the average of the product is smaller. The carrier efficiency of the Taylor circuit should be at least 66 per cent and will probably run appreciably higher.

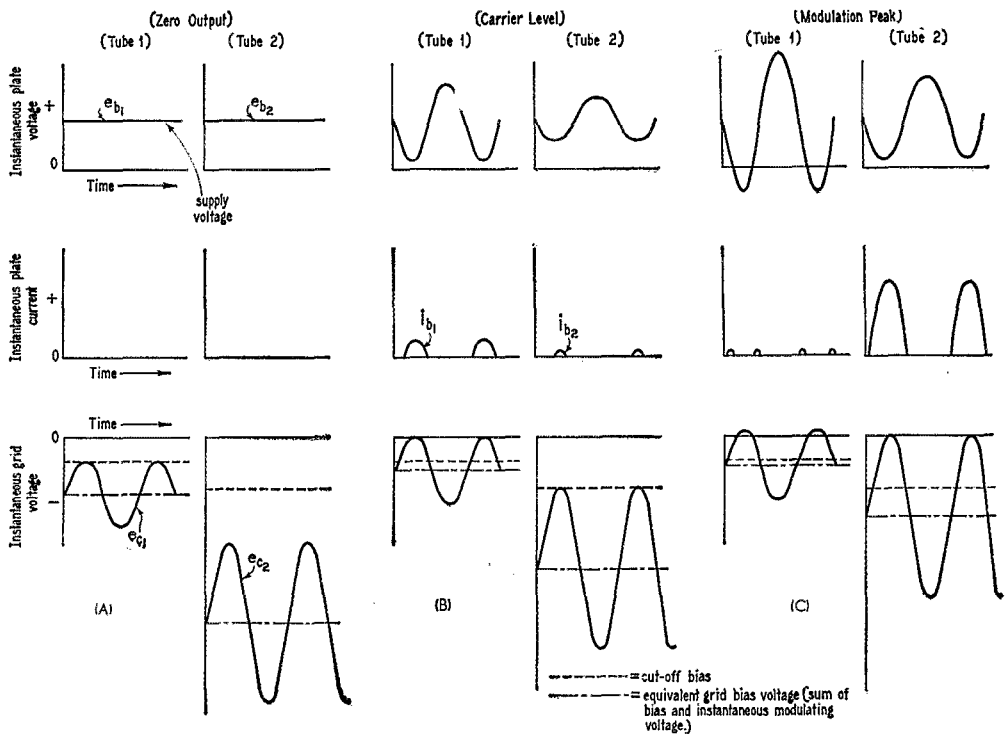

Fig. 5 — Typical radio-frequency waveforms at three points in the modulating cycle, supermodulation circuit.

its initial output linearly. However, in practice the two curves may match reasonably well.)

Remembering that the tubes are in reality current generators, the way in which their individual outputs vary can be represented as in Fig. 6B. Since the peak tube is delivering its r.f. output current to a tap at the center of the tank circuit, it must deliver *four* times the carrier tube's carrier-level current in order to effect full upward modulation, rather than twice this current as would be needed if the carrier tube handled the modulation peak alone. This follows first, because the carrier tube delivers no output at the modulation crest, and second, because the peak tube is connected to a load impedance (at the center tap) of only one-fourth the impedance presented to the carrier tube.

This requirement that the peak tube be able to deliver four times the current of the carrier tube must be taken into account in the design of a supermodulated amplifier. The following illustrates one possible method. Suppose we assume for the sake of discussion that neither peak tube nor

carrier tube shall draw grid current. This implies that the most positive value to which we can drive our control grids is zero volts. Assuming that carrier and peak tubes are identical, the only way to get four times the maximum plate current out of one is to raise its screen voltage. As a rule of thumb, we can say that for fixed grid voltage, plate current in an unsaturated tetrode will vary as the three-halves power of the screen voltage. Thus, if the peak tube is given a screen voltage approximately 2.5 times as large as that of the carrier tube, it will just be able to handle the peak.

In practice, it may be convenient to use a screen voltage twice as large, and then depend on

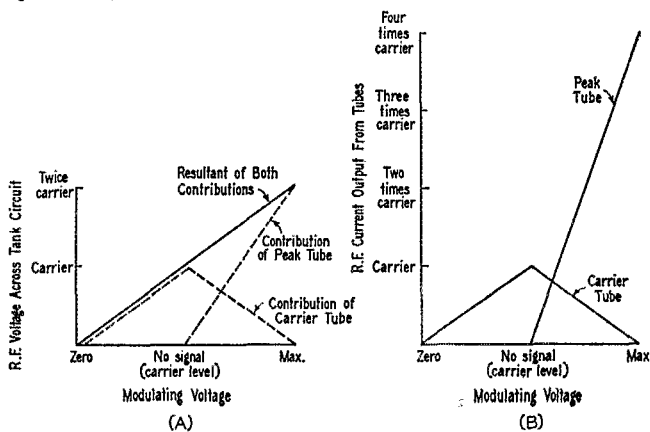

Fig. 6 — Radio-frequency output currents and voltages as a function of instantaneous modulation level.

driving the control grid of the peak tube slightly positive in order to get the full desired output. It is important, however, that some such provision be made for handling the modulation peak. Fig. 4 shows, for simplicity, a doubling of the peak-tube screen voltage.

If the peak tube is given a higher screen voltage, then higher bias, modulating, and r.f. driving voltages will be needed. This is illustrated in Fig. 5, and the practical means for providing the desired voltages are shown in Fig. 4. By means of taps on the grid tank, the modulation transformer, and the bias battery, the voltages applied to the carrier-tube grid are reduced in proportion to its lower screen voltage. Assuming identical tubes and no-grid-current operation, the peak tube's screen voltage should ideally be 2.5 times as large as the carrier tube's; similarly, its bias, r.f. driving, and modulating voltages should preferably be 2.5 times as large.

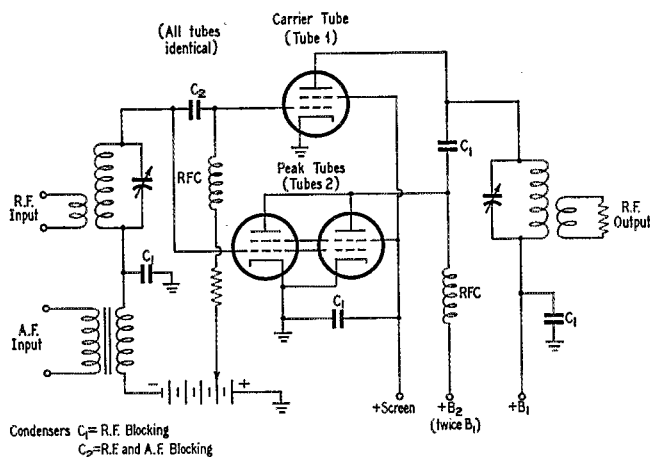

Fig. 7 — Simplified "supermodulation" circuit, requiring dual-voltage plate power supply.

Dissipation

It seems best with the supermodulation circuit to supply the screen of the carrier tube through a dropping resistor or voltage divider rather than directly from a low-impedance power supply. During the positive modulation half-cycles, the plate voltage of this tube is driven negative. This means that the screen grid will draw large amounts of current — sufficient, in fact, to damage it unless a resistor is provided to drop the voltage and limit the current. No such precaution is needed with the peak tube.

It helps at this point to know the peak-tube plate dissipation capacity required. A conservative design would permit 100 per cent modulation with a sine wave without overloading. It is readily calculated, assuming that the tubes have a linear modulation characteristic, that the peak-tube plate dissipation will be 0.51 times the unmodulated d.c. input to the carrier tube. This assumes a conservative 66 per cent maximum efficiency. Plate dissipation becomes 0.42 if the efficiency is 75 per cent, which is possible with

grid-modulated amplifiers if high plate voltages are used and somewhat more distortion is tolerated. The carrier-tube plate dissipation, with no modulation, is 0.33 and 0.25 times the d.c. input for these two cases respectively. Thus, we can say that in the normal range of operating efficiencies, the peak-tube plate dissipation under full sine-wave modulation will run between 1.55 and 1.66 times that of the carrier tube when no modulation is present. A moderately large peak tube is therefore required.

We can expect, under modulation, that the current input to the peak tube will rise to about 1.27 times the unmodulated carrier-tube plate current. The carrier-tube plate current, under modulation, should, according to the simple theory, drop to 0.364 times the carrier value, but in practice this latter figure may be expected to vary widely. The 1.27 figure, however, is likely to be reasonably accurate and checks, in fact, the example given in Taylor's patent fairly closely.

Carrier-tube plate dissipation should drop during modulation to approximately half the unmodulated value.

Other Possibilities

Other variations of the supermodulation circuit come to mind. If center-tapped grid and tank circuits are awkward, they can be eliminated by using a dual-voltage plate power supply as shown in Fig. 7. In this case, the peak tubes are shunt fed and supplied with twice the plate voltage applied to the carrier tube, thus preventing saturation until twice the carrier level. A combination bridge and full-wave plate power supply would be an

economical dual-voltage source or perhaps a buffer power supply of the correct voltage may already be available. Further simplification in Fig. 7 results from use of two paralleled peak tubes, identical to the carrier tube. Since there is no center tap, the current into the tank circuit need only be doubled at the modulation peak. Two tubes will supply this with the same screen, r.f. drive, and modulating voltages as applied to the carrier tube. Only the d.c. bias levels need be different.

Tuning adjustments with this circuit are particularly straightforward. This version is probably easiest to build (since no center-tapped r.f. or a.f. components are required) and may also be the most foolproof. The carrier tube may be operated at its maximum rated plate dissipation under no-signal conditions. Some extra peak-tube capacity is provided, but not enough to worry about in comparison with the convenience of having identical tubes. (The peak tube must have a larger plate dissipation than the carrier tube, in any event.)

(Continued on page 106)

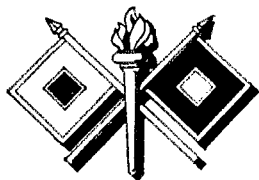

Military Amateur Radio System



THE nation's top military communicators turned out recently at Washington, D. C., to participate in the formal opening of a new Headquarters station (see page 27, November *QST*) for the Military Amateur Radio System. They paid high tribute to the radio amateurs of America for their rôles in national defense and their achievements in the field of public service.

The three Service secretaries — Frank Pace, jr., secretary of Army; Francis P. Matthews, secretary of Navy; and Thomas K. Finletter, secretary of Air Force — were treated to a dynamic demonstration of the flexibility of amateur radio while they were being briefed on how trained radio amateurs, by always being ready, have been the backbone of expanded military radio network operations in times of national emergency.

The ceremony began at high noon on the concourse of the Pentagon Building amid the popping of flash bulbs and the grinding of newsreel and television cameras. It was a full-scale production as the public was treated to its first glimpse of the "world's finest amateur radio station" at work.

Maj. General S. B. Akin, chief signal officer of the Army, and Maj. General Francis L. Ankenbrandt of the Air Force sketched the background and achievements of MARS for the forty-odd guests — guests who represented the radio industry, the American Radio Relay League, the Federal Communications Commission, the National Security Resources Board, and all the hams within shouting distance it was possible to contact.

General Akin said, "To me, this efficient installation and this ceremony today symbolize the skill and willingness of the ham which make him the valuable assistant that he is in time of disaster."

General Ankenbrandt traced the growth of MARS from its activation in November, 1948, to the present organization of more than 3000 members "working together to provide emergency communications for the military as well as civil communities." The amateur radiomen do this, General Ankenbrandt pointed out, by paralleling the same command channels as the Army and the Air Force. Thus, there really are two networks — working together — using slight variations in skills.

Standing by according to prearranged plan were radio contacts for the demonstrations. W3AX at the master console, assisted by A4ODI/W4ODI, A4EEP/W4EEP, and AF4-HBD/W4HBD, contacted A2USA in New York City (Governor's Island) on 5500 kc. In rapid succession, then, they QSY'd to 20,994 kc. for greetings from San Antonio; to 14,410 kc. to hear from the Commanding General, Northeast Command, at Fort Pepperell, St. Johns, Newfoundland; and then to 29,520 kc. where W3NL, W4BF, W3MNR, W3CDL and W3MYA reported in from their respective positions at the Lincoln Memorial, the White House, the Washington Monument, Washington National Airport, and

(Continued on page 106)



Left, M/Sgt. Paul E. Allyn operates the master control position in the Military Amateur Radio System headquarters station. Sgt. Albert E. McFarley is shown at the antenna coupler.

Right, WAC Operator Mary Laffler is shown in one of the four QSO booths available for visiting hams to operate.

Two Unusual 144-Mc. Antennas

Unorthodox Designs Produce Good Results in 2-Meter Work

• We get the idea, at times, that beam antenna technique is pretty well standardized, and it is true that most of us stick close to the beaten path when we put up a high-gain antenna, whether it is for 2 or 20. Here are two instances where fellows tried some different ideas, and came up with interesting departures from standard practice.

A Lightweight Flopover Array

BY WALTER F. BAIN,* W2WFB

LIVING in an area where considerable activity is to be found on 144 Mc. with both horizontal and vertical polarization, the writer has spent some time working with beams that could be operated in either position. Such an array should provide a fair amount of gain and a low radiation angle, whether vertical or horizontal, and it should be light in weight and low in wind resistance. If, in addition, it can be built easily and economically, these factors will weigh heavily in its favor.

The solution to this problem, currently in use at W2WFB, consists of four extended double Zepps, arranged as shown in the photograph and Fig. 1. All elements are driven. Viewing the array in its horizontal position, it is 0.7 wavelength high, 1.3 wavelengths wide and $\frac{1}{8}$ wavelength deep. The two sections are fed out of phase. The extra size over that of the more common half-wave H array brings its gain up to approximately 12 db., considerably more than would be obtained with the normal H design.

The elements and phasing sections are made of No. 8 aluminum wire, obtained quite inex-

pensively as clothesline. The radiators are 53 $\frac{1}{4}$ inches long and the phasing sections 57 inches. Each phasing line is mounted on three polystyrene insulators, one at each end and one in the middle. The line spacing is 1 $\frac{1}{4}$ inches. The system is fed with 300-ohm Twin-Lead, connected at the junction of two 16-inch pieces of the same material,

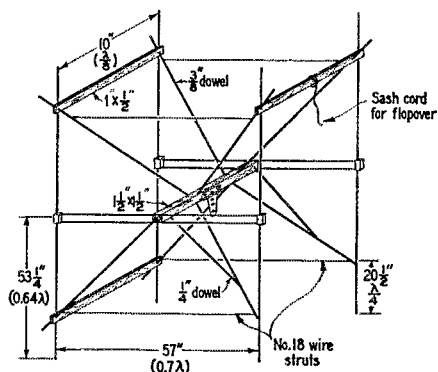

Fig. 1—Detail drawing of the lightweight flopover array described by W2WFB.

as shown in Fig. 2. A closed stub three inches long is connected at the junction. The forward section of 300-ohm line is transposed.

Support for the elements is provided by eight pieces of $\frac{3}{8}$ -inch dowel, each 44 inches long, set diagonally into an 18-inch-long center piece of 1 $\frac{1}{2}$ by 1 $\frac{1}{2}$. The proper spacing between the two H sections is maintained by four 1 x $\frac{1}{2}$ -inch pieces of wood strip, positioned so that they come at low-voltage points, a quarter wavelength in from the ends of the elements. These are drilled to fit tightly over the ends of the dowels. When the beam is to be operated as a flopover, one of the lower members is left out, to allow the beam to swing through 90 degrees. The two dowels in this position must then be braced with a pair of $\frac{1}{4}$ -inch dowels 36 inches long. The entire structure is made rigid by the use of struts of No. 18

◆
The 144-Mc. flopover array at W2WFB is light in weight and easy on the pocketbook.

QST for

* 607 University Ave., Syracuse 10, N. Y.

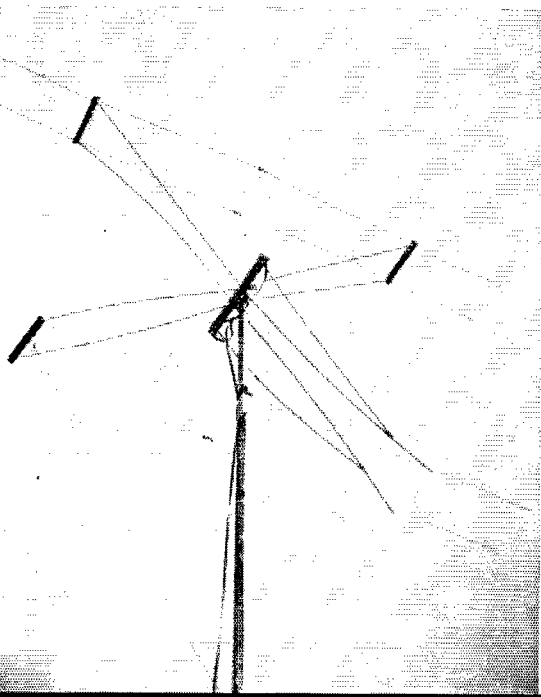

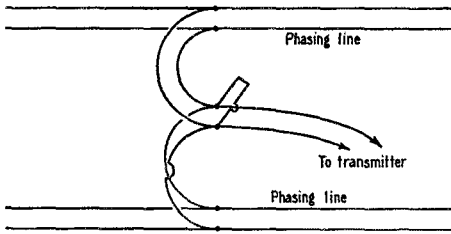

Fig. 2 — The W2WFB array is fed through two 16-inch lengths of 300-ohm line. The main transmission line, also Twin-Lead, is connected at the junction, in parallel with a 3-inch closed-end stub.

copper-clad steel wire, approximately 57 inches long. These are connected to the ends of the dowels and run perpendicular to the elements. They should be drawn up until the whole structure is rigid.

Floppover operation is made possible by mounting the center support on a large T hinge, the long side of which is fastened to a piece of oak three feet long. This piece, about three inches wide, is cut down for about the last eight inches of its length to fit tightly inside the pipe used for the main vertical support, or it may be strapped to the pipe externally. Details of the floppover arrangement are shown in Fig. 3.

Near the top of the vertical wood member is a small steel angle bracket, through which a $\frac{1}{4}$ -inch bolt is mounted to act as a stop when

the beam is pulled over from vertical to horizontal. A larger angle iron is mounted on the edge of the horizontal wooden member, and a screen door spring is run from this angle down to a suitable point on the vertical support. A piece of light sash cord attached to one of the horizontal spacers is used to pull the beam over, the tension of the spring returning it to vertical when pull on the rope is relaxed.

Though the matching section shown gives quite a low standing-wave ratio, it may be necessary to adjust the match over a limited range. This can be done by varying the length of the closed stub between about 2 and 4 inches.

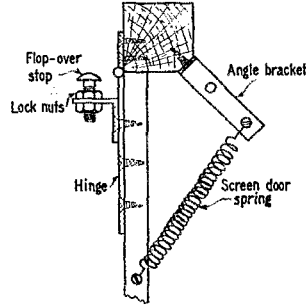

Fig. 3 — Details of the floppover arrangement.

The beam at W2WFB weighs only three pounds all told, and shows very little wind resistance because of the small wire and light structure used.

The Houston Hayrake — A Compact 12-Element Array

BY W. E. LEVERKUH, * W5KFY

HAVING had good results with a 6-element array consisting of two 3-element beams stacked side by side, we decided to try a 12-element job using the same general element arrangement. We wanted to use coaxial cable throughout, so the usual half-wave spacing between driven elements could not be employed. The spacing shown in Fig. 1 is the result of the propagation factor of the coaxial cable.

The method of feed can best be explained by numbering the driven-element sections and describing the method of connection. Sections 1 and 3 are connected by a 52-inch length (a full wavelength) of 52-ohm coaxial cable, connecting the upper portions to the inner conductor and the lower portions to the outer conductor. Sections 2 and 4 are connected in the same manner. Sections 2 and 3 are then connected together with a 26-inch length (a half wave) in the same way. The feed line, also 52-ohm cable, is connected to the midpoint of this middle section.

Reflectors spaced 18 inches in back of the driven elements and directors spaced 23 inches in front are added. Thus we have two 6-element arrays interwoven with one another and fed in phase. The feed line was cut so that it would be an even number of quarter wavelengths long, just in case, but the standing-wave ratio turned out to be satisfactorily low. The reflectors are

$39\frac{1}{2}$ inches long, the radiators $18\frac{5}{8}$ inches either side of center, and the directors $35\frac{1}{2}$ inches long.

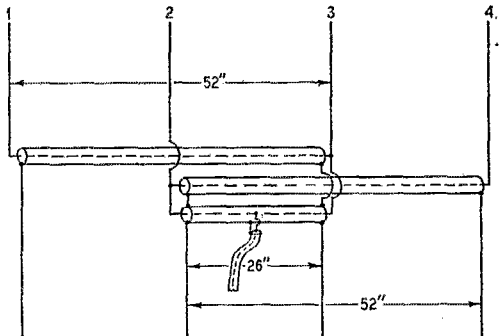

Fig. 1 — Driven element arrangement used by W5KFY. A director and a reflector are used with each of these, to make a 12-element array.

The array was operated in a vertical position originally, and performance checks were made against a ground-plane antenna for comparison purposes. Two stations across town gave us 25 db. and 15 db. respectively, as the indicated gain for the beam over the ground-plane. Obviously, these reports should not be taken at face value, but they do show that the array was giving considerable gain. The array has since been turned over to horizontal polarization.

*817 Leverkusen St., Houston 7, Texas.



United States Naval Reserve



Emergency Communications Planning: Naval Reserve activities that operate radio stations have instructions to acquaint local civil defense authorities, the Red Cross, and other interested agencies with the availability of USNR equipment and circuits, in order that definite plans for emergency communication service may be established. Particular emphasis is placed on liaison with amateur radio organizations and individual amateurs. USNR units are given the names and addresses of local ARRL emergency coordinators to facilitate arrangements for the interchange of services in the event of emergency.

Amateur radio clubs are working closely with Naval Reserve units in the development of local plans. The following clubs are cooperating with Naval Reserve Training Centers (NRTC), Organized Electronics Companies (OEC), Volunteer Electronics Companies (VEC), and Volunteer Electronics Platoons (VEP) as indicated:

Central Iowa Amateur Radio Club	(VEC, Marshalltown, Iowa, K0NAD)
Central Texas Amateur Radio Club	(OEC, Waco, K5NAU)
Denver (Colo.) Radio Club	(NRTC, K0NRC)
Eau Claire (Wisc.) Radio Club	(OEC, K9NAD)
Enid (Okla.) Amateur Radio Club	(OEC, K5NRY)
Frederick (Okla.) Amateur Radio Club	(VEC, K5NBS)
Fremont (Nebr.) Amateur Radio Club	(VEC, K0NRG)
Fort Wayne (Ind.) Radio Club	(NRTC, K9NAT)
Grand Prairie (Tex.) Amateur Radio Club	(VEC, K5NBG)
Hill Country Amateur Radio Club	(VEP, Kerrville, Tex., K5NBX)
Huron (S. Dak.) Amateur Radio Club	(VEC, K0NBP)
Hutchinson (Kans.) Amateur Radio Club	(NRTC, K0NRY)
Iowa-Illinois Amateur Radio Club	(NRTC, Burlington, Iowa, W0ZXG)



Lieut. A. L. Taylor, USNR, commanding officer, describes one of the Navy transmitters used by Volunteer Electronics Company 5-3. This Naval Reserve unit is located at the Technical Institute of the William and Mary-V.P.I. extension in Norfolk, Va. Amateur call is K4NBH.

Jackson (Mich.) Amateur Radio Assn.
Kaw Valley Radio Club

Lake County Amateur Radio Club

Neosho Valley Amateur Radio Club

Norman (Okla.) Amateur Radio Club
Odessa (Tex.) Amateur Radio Club
Radio Amateur Club of Port Arthur, Tex.
Red River Valley Amateur Radio Club

Santa Barbara Amateur Radio Club
South Plains Amateur Radio Club;

Springfield (Mo.) Amateur Radio Club
St. Cloud (Minn.) Amateur Radio Club
Tri-City Radio Amateur Club

Tri-State Amateur Radio Society

Wichita (Kans.) Police Amateur Radio Club

Wichita Falls (Tex.) Amateur Radio Club

(NRTC, K8NRJ)
(NRTC, Topeka, Kans., K0NRZ)

(OEC, Waukegan, Ill., K9NAC)

(VEC, Emporia, Kans., K0NAC)

(NRTC, K5NAY)
(OEC)

(NRTC, K5NRA)
(VEC, Paris, Tex., K5NBY)

(NRTC, K6NRA)
(NRTC, Lubbock, Tex., K5NAZ)

(NRTC, K0NRS)
(VEC, K0NAF)

(NRTC, Moline, Ill., K9NRD)

(NRTC, Evansville, Ind., W9UBN)

(NRTC, K0NRW)

(NRTC, K5NAO)

In addition to community planning, liaison is maintained between area-wide amateur radio emergency nets and Naval Reserve units. A notable example is affiliation between the South Texas Emergency Net (STEN) and the following USNR activities: OEC, Harlingen, K5NAN; NRTC, San Antonio, K5NR; NRTC, Houston, K5NRE; VEP, Eagle Pass, K5NRO. Other amateur nets with which USNR units are connected for emergency purposes include the Central Texas Emergency C.W. and 'Phone Nets, Kansas Emergency C.W. and 'Phone Nets, Minnesota State Emergency C.W. and 'Phone Nets, Missouri Emergency 'Phone Net, Oklahoma C.W. Net, Northeast Texas Caravan (mobile), and Northeast Texas Emergency C.W. and 'Phone Nets.

Code Practice

As a part of the program for training radiomen, Naval District Reserve Radio Control Stations conduct automatic transmissions of general information on regular schedules. The speeds employed make these transmissions useful to anyone studying for a ham ticket. Copying the following schedules will provide excellent code practice:

Sta.	Location	Speed	Frequency	Time & Days
NDA	Boston, Mass.	12 w.p.m.	5865 kc.	1930-2030 EST, Mon., Tues., Wed. 2000-2100 EST, Thurs.
NDB	Brooklyn, N. Y.	10-12 w.p.m.	2952, 4515 kc.	2000 EST, Mon. thru Thurs.
NDC	Norfolk, Va.	12 w.p.m.	3490, 7385 kc.	2000 EST, Mon. thru Thurs.
NDF	New Orleans, La.	10 w.p.m.	8000 kc.	2030 CST, Tues., Wed.
		16 w.p.m.	2854, 4105, 5155 kc.	2000-2030 CST, Tues., Wed., Thurs.
NDG	Naval Base, S. C.	8-12 w.p.m.	4170 kc.	2100-2130 EST, Mon., Tues., Thurs.
NDQ	Philadelphia, Pa.	10-12 w.p.m.	2820 kc.	1945 EST, Mon. thru Thurs.
NDS	Chicago, Ill.	12 w.p.m.	2856, 4015, 7995 kc.	2100 EST, Mon. thru Thurs.

(Continued on page 108)

On the Air with SINGLE SIDEBAND

"I just ain't interested!" is about the only excuse a fellow can legitimately give these days for not trying his hand at s.s.b. Right on the heels of the W1JEO/9 crystal-filter job in last month's *QST* came the "SSB Jr" of Don Norgaard, W2KUJ, described in the November-December *GE Ham News*. If you haven't seen this new design, we suggest you do so at once. Don has incorporated many clever angles in the construction of this 3-tube phase-shift exciter. Even if you already have a s.s.b. rig, the new phase-shift network circuit is worth your while. And, to top it off and further justify our opening sentence, we have the latest circuit for the W2UNJ phasing-type exciter, shown in Fig. 1 on this page. If at least one of these three units doesn't fill the bill for you, you just ain't interested!

G3FHL writes to say that still another G is on with s.s.b. This one is G2CR, and his phasing rig is patterned after that of W6DHG and ends up with a pair of PT15s running about 120 watts. G2NX says that he and several of the other s.s.b. Gs run a schedule every Tuesday night at 2100 GCT, around 3.69 Mc., and further adds that

Fig. 1 — The revised W2UNJ s.s.b. circuit. All parts are the same as in the circuit shown in the August, 1949, *QST* or the 1950 ARRL *Handbook*, except as noted below.

- C₈ — 400- μ fd. per-section b.c. condenser.
- C₂₁, C₂₂, C₂₃, C₂₄ — 0.001- μ fd. 500-volt mica.
- C₂₅, C₂₆ — 4- μ fd. 150-volt electrolytic.
- C₂₇ — 0.001- μ fd. 1000-volt mica.
- R₂₂, R₂₃, R₂₄, R₂₅ — 10,000 ohms, 1 watt.
- R₂₆, R₂₇ — 20,000-ohm potentiometer.
- R₂₈ — 7500 ohms, 10 watts.
- R₂₉, R₃₀ — 680 ohms, 2 watts.
- L₂ — 7-Mc. 75-watt coil, swinging link (Bud 21-612). L₁ and C₇ are in a plug-in can, for easy band changing.
- S₁ — D.p.d.t. toggle, preferably with "center-off" position.
- T₁, T₂ — 5-watt modulation transformer (Stancor A3812).

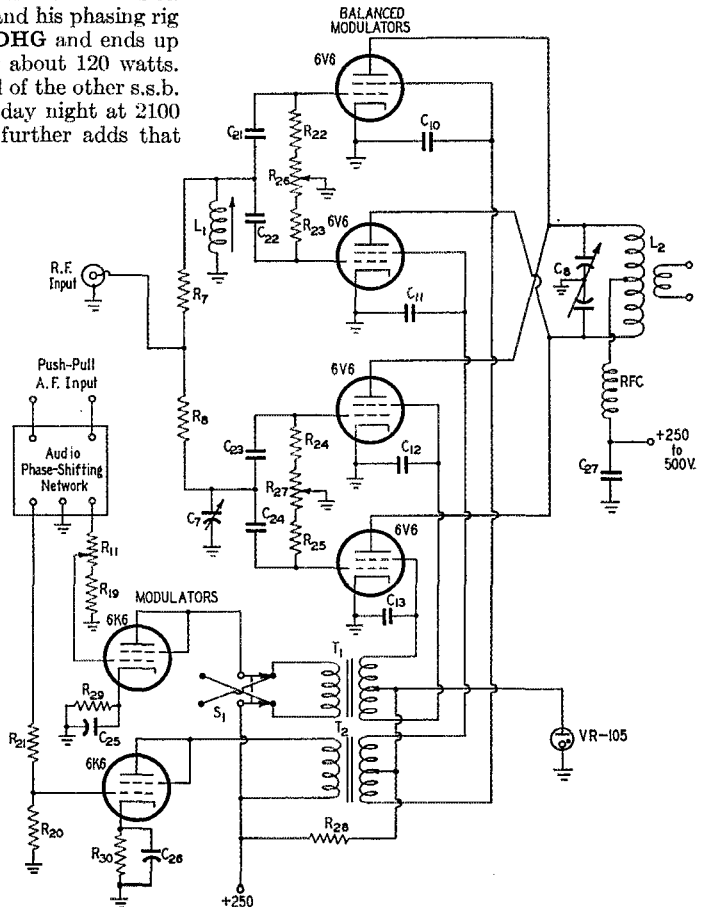

F8AJ is rumored to be on 14.3 Mc. with a phasing rig. W1SHN, W2ALJ, W2EB and W8DL D have been heard by several of the Gs.

W2NJR had interesting visits with W2KUJ, W2UNJ, W2SHN and W3ASW during his vacation. Needless to say, the first thing he did to the rig when he got home was to add voice-controlled break-in! He was also impressed by the use of Clapp oscillators with remote tuned circuits at W2UNJ and W3ASW. They mount the tuned circuit in a box near the operating position, and pipe it via twin coax line to the oscillator tube in the rig. And just to prove that one really doesn't need too complicated a receiver for s.s.b., Bob cites a QSL card he received from North Carolina, where the SWL was using a 6F8G regenerative receiver!

W3KPP passes along the dope that VEs 2SA, 3AAL, 3ADB and 3EI have all been active on s.s.b. recently, and adds that W9PHV has now worked over 75 different s.s.b. stations on 75 meters. And he concludes with "W6CH nightly confounds the Eastern Seaboard stations with his 3999-kc. signal as he works W6AO/6 on 3550-kc. c.w." Looks like they need some more s.s.b. stations out that-a-way.

(Continued on page 108)

DX Century Club

The following list contains the call letters and countries totals of all holders of the Postwar DX Century Club award as of October 15, 1950. The calls of new members as well as those receiving endorsement credit during the period September 15 through October 15, 1950, are included in this listing.

<p>236 W1FH</p> <p>231 W8HGW</p> <p>229 W6VFR</p> <p>226 G2PL</p> <p>225 W2BXA W3BES</p> <p>224 W6EBG</p> <p>223 W6ENV</p> <p>222 WØYXO</p> <p>220 W3GHD</p> <p>218 W3CPV W4BPD W6GRL W6MEK</p> <p>216 W9KOK G6ZO</p> <p>215 W3GAU W3KT G6RH</p> <p>214 W2QKS</p> <p>213 W3DPA FA9UN</p> <p>212 W8NBK</p> <p>211 W1TW W3EIV W4AIT</p> <p>210 W2AQW W6AMJ W6M3 W6SN W9NUN</p> <p>208 W6TT</p> <p>207 W2DS</p> <p>206 W3IYE</p> <p>205 PY1AJ ZL1HY</p> <p>203 W1ME PY1DH</p> <p>202 W2NSZ</p>	<p>W6NNV W9ANT W9RBI</p> <p>201 W2HMF W2IVO W6ZCY VE7HC LU6DJX</p> <p>200 W1BIH W1ENE W3JTC W4MR W6DZZ W6GAL W6SAI W7AMX ZL2CX</p> <p>198 W1CH W9PNQ</p> <p>197 W3JNN</p> <p>196 W2AGW W9DAE</p> <p>195 W1JYH W3OCU</p> <p>194 W2QHH</p> <p>193 W3EVP F8BS</p> <p>192 W2AGC W2OP W6SYG VE7ZM</p> <p>191 W2HZY W5FNA</p> <p>190 W2CWE W5ASG W4DI W6MJB W6OMC W6TS W6UOX VE3OD VE4RO CE3AG VK2DI</p> <p>187 KH6BA</p> <p>186 W4PN W6BPD ZS2X</p> <p>185 W1HX W2CY5 W5KC</p> <p>184 W2HMJ W7GJ FY2CI</p> <p>183 W1ADM W6PQT</p>	<p>182 W6QU W6SRU</p> <p>181 W2UFT W6ANN W6JCX W7GUV W8DX G2EC HB9J</p> <p>180 W2COK W3GWE W2YU W3DKT W3GRF W3OP W5JC W6B W6RBQ W6RM W6TI ON4QF VK2NS</p> <p>178 W3JV W4CYU PY1GJ VK3BZ</p> <p>177 W2GUM</p> <p>176 W2JVU</p> <p>175 W3QF W9IOD</p> <p>174 W8RDZ OK1FF</p> <p>173 W1CLX W3DRD G8PK</p> <p>172 W2ALO W3JKO W6CFE W9LNM W9TJ</p> <p>171 W2CSO W2EMW W2TKB G8IK HB9CX</p> <p>170 W2IMU W3KDP W4OM W5GEL W5KUC W6CJQ W6VE W8DMD W8SYC W8UAS W8WZ YØ8EP KH6LI KP4KD LA7Y ON4JW PT1AHL</p> <p>169 W1IA W2DKF W2FUD</p>	<p>168 KH6QH</p> <p>167 W1LOP G4CP</p> <p>166 W6TZD</p> <p>165 W5BGP W8UDP</p> <p>164 G3DO</p> <p>163 W6KUT OK1LM</p> <p>162 W2CNT W9AND</p> <p>161 W2PPW W2RDK W6EPZ W6GHU W6WKU W8BKP W6FJN W9FKC WØEYR HB9DO</p> <p>160 W1AB W2LJR W2JQC W4DKA W4LZF W5ENE W6CTL W6IBD W6FJN W8SDR CE3DZ G2FSR GW3ZV IKN ZL1BY</p> <p>159 W1DQH W4BRB</p> <p>158 W5EGK KP4CC</p> <p>157 W2SAI WØLLN</p> <p>156 W3LBG W6JYV W9AEH</p> <p>154 W8CVU W8KPL WØAIW HB9X</p> <p>153 W7LD W8JIN G2MI KH6VP</p> <p>152 W1IA W4VE W6EYR</p>	<p>W6JZP W7PGS W9TQL W9YNB VE3JJ K4AAA ZL3BJ</p> <p>151 W1FTX W3BXE W3NOH W6EYH W6MHB GM3AVA HK3CK KH6MI ON4TA OZ7EU VK3JE ZL2QM ZS6BW</p> <p>150 W1DX W1KVF W2LSX W2UL W3HRD W3JTK W3WU W4FVR W4ZD W6BVM W6CJS W6JK W6PZ W8DEN WØEYR W9CIA W9IU W9VND G2VD HB9EU H1R KH6CD OK1HI OK1VW ON4AZ PAØGN</p> <p>149 W2YW W5CEW</p> <p>148 W7FA HB9CE</p> <p>147 W3RCQ G5RV</p> <p>146 W2GVZ W8RGB W4CYT</p> <p>145 W6RW</p> <p>144 W4HA W5CGC KH6LG LØ7CD LU7CD SM5WI</p> <p>143 W2RGV W9FSR PY2OE ZL3GU</p> <p>142 W1NW W2DSB W3ALK W3LVD W6RZE W7BE</p>	<p>G4JZ I1AIV</p> <p>141 W1HA W1JLT W2OST W3LRF W4RBQ W5LGS W8WUU</p> <p>140 W1AH W1MUN W2ADP W2BI W2BRV W2GUR W2OMS W2QCP W2RWE W2ZA W3FUF W4DHZ W4IWO W5IGJ W6EAK W6LID W6WVQ W7DET W7ENW W7GBW W8DAW W8JL W8GLK WØGKS WØOUH G2AK Q G5YV H1O1 JAZKG OZ7CC PAØIF</p> <p>139 W1ZL WØTJ OK1CX</p> <p>138 W1RY W6FSJ</p> <p>137 W1DEP W5MIS W8BWC W8EYE</p> <p>136 W4HU WØNTA G3DCU ZS2AG</p> <p>135 W1BAV W1QF W2CTO W4JXM</p> <p>134 W1PKL W3LNE W6YC W4JFE W5CPI G3BI ZS5YF ZS6A</p> <p>133 W1LZE W2MEL W3ADZ W3KZQ W9CYU W9FJB G5SR LAGU</p>	<p>MISAB PY1HX</p> <p>132 W6CEM PY7WS W2QKL W2REF VK4EL</p> <p>131 W1KE W4AZK W6EAY W6MHH W6RLQ E3IF G6RC KH6PY SM5VW ZLAGA</p> <p>130 W1FJN W1ODU W2CZO W2GNQ W2GTL W2LTP W2TJF W3ARK W3LXZ W3LVJ W5LGG W6ATO W6DUB W6LER W6LVN W6OBD W8ZMC W9ABA W9UIG G5OO G6HI G6LX G8FW H1LT H1XK OK1CP OK1SV PAØJQ SM6HU VØ2DH ZS6CZ ZS6JU ZS6FN</p> <p>129 W1BLF W1OJM W1TX W2GTP W6ADP ZL1MR</p> <p>128 W1BFT G2AJ VK6SA</p> <p>127 W4FIJ W8MPW NY4CM</p> <p>126 W1BDS W2LPE W31XN W6DE W6RDR W9CTD ZC1CL</p> <p>125 W2BLS W2PJM W3EYF W8LFE W9CTT VESAAZ</p>	<p>11BEY OK1WX ZS5CU</p> <p>124 W1CJX W2QKJ W2REF W6BAM W6KYT W8EWS VE7VO G3AH G3YF G5VU G8VB PAØRC ZL3CC</p> <p>123 W4AAU W4ITR W7LXZ W9GRV W9UX IS1AHK PAØMZ VØ8AD ZS6GI</p> <p>122 W1ATE W1KWD W2FBA W2ICO W3FJS W6IFV W8AJW W9FKH W9NDA WØDU DL4TL H1ZZ</p> <p>121 W1WK W2AFU W2AW W2GFW W2OCF W3DGM W3GHS W4ML W5ACL W5CKY W7KWC W8BBA W8TJM WØAZT VE3AGC G5VO G8KU KG6AI OH2PK SM7MS VK5KO</p> <p>120 W1BGW W2PRN W2ROH W3EVT/1 W3MLW W4HTY W5KJY W5LYY W6BIL W6YZU W7AC W7GPP W7RT W8LAY W8NJC W9RQM CX1BZ G2HNO G2IO G3AWP G3CBN G3COJ G3TK G5FA G6SH G6XX</p>	<p>HB9FE HP1BR OK1AW ON4GC PAØCB ZL1MB</p> <p>119 W9MXX VE4XO CX1FY G8GB KL1TT SV1RX</p> <p>118 W6LDJ W6PH G6RB</p> <p>117 W2PQJ W6LS W6SR W8NAB VE7ZZ</p> <p>116 W2AGU W2ITD W3TIF W7BD</p> <p>115 W2NFR W6CEO W6NTR W9LNI PAØCP TF5EA</p> <p>114 W1JMT W8MFB W9ELA W9LON VK4RC VK5RX ZS6HO</p> <p>113 W1NLM W2TUD W2WC VE3ACS G8OJ VØ3HP ZS5BS</p> <p>112 W1BOD W2ABS W2MA W2MYT W3BEN W3MNO W7AYJ E4OJ W4QI G4FN G6XA G16TK H1UA P43LB W5GFM ZL3AB</p> <p>111 W1AWX W1HRI W1OXQ W2UAT W3CQU W3ZN W4EPA W4LIM W4LVV W5FFW W6KJ W8TTS</p>	<p>W9BRD W9DUR W9ERU W9NZZ W9SBE VE5JV G2BQC G4AR Z2JN ZS2AT</p> <p>110 W1MRP W6CJ W3CGS W3VZD W4AIS W4DCW W4ZD W5LHP W6AOD W6ETJ W6KYT W6VZ W8UYX W6WJX W6ZUI W7BTH W7PEY W8ARA W8FGX W9HLR W9MXP W9UXO W6CUV W6QVZ W9RIA W8SRX G3CCO G3DOG G3LF G5VU G8IH G8IL G8PL H1VS ON4JD PAØLR ZL4AW ZSIM 4X4BX</p> <p>109 W2ATJ W3FLL W6LMZ WØMCF/CI CO6AJ G3DHR G3AMM G8P G1ARY LØ8EN ON4FL PAØPN V57NK ZL2CU ZS1BK ZS6DW ZS6KK</p> <p>108 W1EZ W4QON W6LGD W6LN W6PUZ W6YMD VE3ADV W5GD VESAW EA9AI G2BOZ G5GK G6KS ØH2RY OK2DD SM5PA VK4FJ</p> <p>107 W1GKK W1KJ W1PDF</p>
---	--	--	---	--	--	---	--	--	--

WIZD W6CUL W6PWR W8ACE W8BNA W9BQE W8CKP VE1EP G3BKF G6BB G8IP G8OZ JASAA ON4PZ VOZGW Z5Z1W
106
W1CUX W1E0E W1KQY W1QL W2AZS W2DPS W2BJ W4CS W4DXI W4FPK W4NNS W4TM W6NGA W6DST VE2VW VE3AHV VO1B G2BXP G2CBA G2HFO G2ZF G3EZF G3OD G8TD
HAY OKICG SM6DN ZE1JJ
105
W1APA W1VW W2AUH W2KJZ W4COC W4DTM W5MET W6BUD W6DFY W6DOT W7ALS W8OCA W9ABB W9DUY W9MKF VE3KE VEAAS VE7KC DL7AA G3JW G6IC GM3CSM GM6MS HB9P MIZJ OH6NZ OK2OS V01B QN4MS PA9AL VK2ADE 4X4RE
104
W1AFB
W1DF W1LQO W2JJC W2MLC W2SLC W2TSL W2WJ W3BT W4T W5JUF W6DYP W6KRI W6LRU W6LV W6ZBY W6DEM W6EY W6GA W9TFU W9DSO W9S0 G8AZ G3FJ G6FB G8C4L OK1NS OK1OP OK1PN O4RA PA9L PY4IE VK2ACX ZL3HC Z51FD Z5U
103
W1BLO W1HAP W2P1N W2PR W2UPH
W3EV W3KMS W3LTV W4AAW W4KYX W5MMD W6APH W6BAX W6JHG W6JWL W6LMV W6WB W7DXZ W7HIA W8C0L W9VFY W9CFB W9RBA VE1B CM2SW CN8MG DL7AH D7FYT G3AKU G3ATU G3CMB/A G3DAH G8ON G8RC GM6MD GM8CH H1AFM I1NU I1UB KH6PM MD1D M85KW OK2SO SMA6WE ZBIAH
102
W2HY W2JA W3AFW W3AZG W4EY W4HYV W4NL W4KKX W4NHN W5BDI W5DQW W5NMA W6C7I W6JU W6NZ W6TGH W6UHA W6W0 W6WB W8LC W8LQ W8PNT W8VLK W9VW W9CDD W9DGH W9ERU W9FET VE1HG VE6FK E1G3 E1J F8TM G2YS G3BQR G3CFK G3EYV G3HK G4JB G5CI
G5CR G6VQ G6XS G8VW GM2FHH GM3RL GW3AHN HB9FI I1Z K2AU K25WZ OE1AD OK2EL OK3DG ON4Q OZ1C PA8RU PA8SU VK2YC ZL2B ZL3LR Z56LW
101
W1EFQ W1FTJ W1MLT W1NAV W1NMP W1ODY W2ATE W2KXK W2QKE W2ROM W2TNA W2UVE W3YS W3DYU W3ETT W3KA Z2AJB W4DIA
W4GHP W4KL W4JDR W4JY W4LHO W5HP W5KWY W6AMA W6ATZ W6CX W6KEK W6PBI W6PCC W6R0Z W6SC OZ7EU W6TU W7CNM W7ETK W7KSA W7LYL W8C1 W8CKX W8FJX W8HW W8HSW W8TAJ W8TUV W8ZU W9FNR W9GDI W9TWC W9VNI W9XKW VE1OK C1IAP DL1DA DL1FK DL1YQ PESAB G2AJB G2DM
G3VA G4G1 G4CJ G8RM G6QX G6XY G8NV GW4CX HB9BX IAD4K H1AFQ KH6LF KZ5IP OK1GT OK1SK OZ1W OZ7SN PK6HA VXSMP Z5CCT
100
W1BBS W1BUX W1COM W1EQ W1IOZ W1NS W1PEG W1PZ VE2GG W2HZN W2JJ W2CKK W2TK W3FU W3FQB W3JL W3KHU W3WJ W3MZE W3RBF
W4BGO W4DPE W4OT W4WR W4KCO W4KFC W4KIT W4OG W4OT W5BK W5CD W5FXN W5NW W5RS W6AY W6BUY W6CAE W6CGP W6DUC W6TH W6MI W6VBY W6VOE W6ZZ W7ONG W7RNG W8C4 W8CN W8LYP W8VU W9DGA W9HJ W9TL K3CCO W9MZP W9QL W9TMU W9UAZ W9BYF W9C6K W9DIB W9FFV VE1EA
VE1FN VE1PA VE1Q VE2BV VE5OZ VE7AAD VETCN CE4AD CE4CS CL1DC EASBE G2AO G2BJY G2FFO G3AAE G3AAG G3ACC G3BNE G3CDG G3IV G3WK G8JR G8BKG G8NU G8WUH HA4EA HB9K HC7KD I1AMU I1IT I1V I1PL K1JUM O4AK OE1CD OK1WF OZ4PA PA9BK PK4CS SM5IZ SM7IA Z56OW

RADIOTELEPHONE

195 W1FH
188 XE1AC
181 W6DI VQ4ERR
180 PY2CK
179 W8HGW LU6AJ
172 W2BXA
170 W1JCK W9RBI
166 W1NW0 GZPL
163 W3LTV
161 W1MCV
160 W2AFQ W5BGP
158 W4CYU
155 W8RU HB9DS
153 W4EYW
151 W7MBX ZL1HY
150 W8BF GZBF G6RH
148 W1ENE
144 G8IG
143 G3DO T1ZRC
142 W1BEO W1HKK W4GMA
141 W2APU W8KML GM3AVA HGR WZCX Z56W
140 W1LMB
W4AZD Z56Q
139 W4HA
136 G6AY
135 W4ESP I1SM
134 W1ADM
133 W3BES W6TT
132 W1WU W2EOH W6MBD
131 W2WZ W5ASG
130 W1FJN W1GOU W4MKB W6KQY W6VFR W6VWH W9ZZE VE7ZM
129 W3JNN
128 W4DCR HB9J
127 W9IOD
126 CX2CO
124 W6AM W8NXP
123 W8AUP
122 W1ATE W2RGT W4DM W6CHV W9TJ F9HE GZALN
121 W1FFO W5EFC W5KC W9PRZ CE1AH IRM
120 W1HX W1MMV W2AEB W2QKJ W2ZX
W4AQR W4IYM W4MO W5KQ W6MJQ W8BJ W9HP W9PUE CN8BA G8K P HC2OT H1ASM I1Y YV5AB
119 LU3DH W83Z Z56FU
118 W2VQM
117 PK4DA
116 W1CJ K F3WV
115 W3RIS W7EMP W8HRV W9UN W9EYR
114 W8AJW W8ZMC GM2U
T1ZEV
113 W2JY W2PBI W8BK GEP T1ZHP
112 W2QF W3GHS W4HRR W4MRA W5JA W6EVM G4JZ ZS1DO
111 W5CEW W9CZC W9ANF GZMI G5RV GC2RS OZ7TS YK1AC
110 W2NHZ W2SGX W2ZVS W3DHM W3DKT W3FCB W3MAC W9RNX W9VSK G3YM HUA I1VS
109 W6NG VES3DB DL4TL G8QX
108 W1BAV W2IUV W3MWP W4LW G6X ZSSCU Z56W
107 W4LZM W7PEY G4MS Z56W
106 W1FZ W9AV SMAKP T1ZO VK3JE
105 W21J W2ONV W4JCK W6AED W6UYX F8K SUIHF
104 W1BPH
W2AKX W2YTL W4AF W7HIA W8ACP W9PHZ EA2A G5OO G6TA HB9CX LX1S1 ZD4AH
103 W1PDF W2DPS W2ZS W2NQR W2QWS W3NA W5ALA W8SDR W9NCG W9UQD W8FQ VE1CR CE3AB I51AYN VP9G VQ9C YS2AG
102 W1HRI W1DRY W2MFS W4BA W4CW W4KY W4JU W5JWM W5NMA W6PWR W6SHW
W7HTB W81WI W8TLM W9XT W9SUG W9SGU VE7MS G2DF C3CC W89CX L1S1 KP4ES
101 W1KWD W2PRF W2RTX W2TAT W2UTH W2WME W2ZKG W5HFU W5JUF W9NCG W8FQ VE1CR W8NML W8ZOK W9BYX W9AV W9NWW VE3AU VE3BQ VE3BP G6WX G8VB I1AXD I1RB I1ZV KP4EZ
W2MA W2OR W3HU W3BLY W4AAW W4DYM W4ECE W4GLE W4LGG W5AL W5ERY W6TH W6OZE W6TZD W6UX W6YL W8AJH W8ALC W8FJ W9CKP W9LKG W9JF W9LQ W9NDA W9UJ W9TWH W9CSW W9GUV W9HX W9TJ CE3AE CT1NT CT1PK HB9DY I1AMU I1RC LU4MG L8CW OESYL VK2DI VP5AR VO5PB Z52IA Z54AD

Far East Amateur Operation Curtailed

Because of the Korean situation, operation by amateurs in the Japanese area on the 3.5- and 7-Mc. bands is no longer authorized. Operation is, however, still permitted on the 14-, 28-, 50- and 144-Mc. bands. Also for security reasons, 'phone patches are no longer permitted in Japan.

• An up-to-date listing of QSL bureaus of the world is published in the "IARU News" section of this QST, page 48. To expedite the handling of your DX cards, make a note of the changes and additions contained therein.

I.A.R.U. News



QSL BUREAUS OF THE WORLD

For best service on delivery of your QSLs to foreign amateurs, simply mail cards direct to the bureau of the proper country, as listed below (bold-face type indicates a recent change from previous listings). *Do not send foreign cards to A.R.R.L. headquarters except those for which no bureau is here listed.*

For service on incoming foreign cards, see list of domestic bureaus in *QST* under the heading, "A.R.R.L. QSL Bureau" (page 36, November, *QST*).

Alaska: J. W. McKinley, Box 1533, Juneau
Algeria: Via France
Argentina: R.C.A., Avenida Libertador General San Martin 1850, Buenos Aires
Australia: W.I.A., Box 2611W, G.P.O., Melbourne
Austria: Via ARRL
Austria: QSL Bureau (U. S. Occupation Forces), APO 777A, % Postmaster, New York, N. Y.
Azores: Via Portugal
Bahamas: C. N. Albury, Telecommunications Dept., Nassau
Barbados: VP6PX, Wood Goddard, Bromley, Welches, Christ Ch., Barbados, British West Indies
Belgian Congo: P.O. Box 271, Leopoldville
Belgium: U.B.A., Postbox 634, Brussels
Bermuda: VP9D, James A. Mann, The Cut, St. Georges
Bolivia: R.C.B., Casilla 15, Cochabamba
Brazil: L.A.B.R.E., Caixa Postal 2353, Rio de Janeiro
British Guiana: Desmond Yong, 22 Sussex St., Charlestown, Georgetown #16
British Honduras: D. Hunter, Box 178, Belize
Burma: B.A.R.S., P.O. Box 611, Rangoon
Canal Zone: Canal Zone Amateur Radio Association, Box 407, Balboa
Canton Island: Francis T. Blatt, KB6AG, % C.A.A., Canton Island, South Pacific
Ceylon: P.O. Box 907, Colombo
Chile: Radio Club de Chile, Box 761, Santiago
China: M. T. Young, P.O. Box 34, Taichung, Formosa
Colombia: L.C.R.A., P.O. Box 584, Bogotá
Cook Islands: Ray Holloway, P.O. Box 65, Rarotonga
Costa Rica: F. Gonzalez, Box 365, San Jose
Cuba: Radio Club de Cuba, QSL Bureau, Lealtad No. 660, Havana
Curacao: Via ARRL
Czechoslovakia: C.A.V., P.O. Box 69, Prague I.
Denmark: E.D.R., Box 79, Copenhagen, K.
Dominica: VP2DC, Roseau
East Africa: (VQ1, VQ3, VQ4, VQ5): P.O. Box 1313, Nairobi, Kenya Colony
Ecuador: Victoriano Salvador, P.O. Box 2536, Quito
Éire: I.R.T.S. QSL Bureau, 97 St. Stephens Green, Dublin
Ethiopia: Robert Newberg, ET3AE, Box 145, Addis Ababa
Fiji: S. H. Mayne, VR2AS, Victoria Parade, Suva
Finland: OH2NT, Kessarminkatu 25C12, Helsinki
France: R.E.F., 72 Rue Marceau, Montreuil sous Boise (Seine)
Germany: (DL2 calls only) QSL Bureau, % Posts & Telecommunications, Wahnheide, B.A.O.R. 19
Germany: (DL4 calls only) DL4 QSL Bureau, APO 757, % Postmaster, New York, N. Y.
Germany: (DL5 calls only) Via France
Germany: (other than above) D.A.R.C., Postbox 99, Munich 27
Gibraltar: E. D. Wills, ZB2I, 9 Naval Hospital Road
Great Britain (and British Empire): A. Milne, 29 Kechill Gardens, Hayes, Bromley, Kent

Greece: C. Tavaniotis, 17-A Bucharest St., Athens
Greenland: 1385th AAF Base Unit, APO 858, % Postmaster, New York, N. Y.
Grenada: VP2GE, St. Georges
Guam: G.R.A.L., Box 100, Guam, Marianas Islands
Guantanamo Bay: KG4AD, Box 35Q, Navy 115, % FPO, New York, N. Y.
Guatemala: Manuel Gomez de Leon, P.O. Box 12, Guatemala City
Haiti: Roger Lanois, % RCA, P.O. Box A-153, Port-au-Prince
Hawaii: A. H. Fuchikami, 2543 Namauu Dr., Honolulu
Hong Kong: Hong Kong Amateur Radio Transmitting Society, P.O. Box 541, Hong Kong
Hungary: H.S.R.L., Postbox 185, Budapest 4
Iceland: Islenskir Radio Amatorar, P.O. Box 1080, Reykjavik
India: Amateur Radio Club, India, P.O. Box 6666, Bombay 20
Indonesia: P.A.R.I., P.O. Box 222, Surabaya, Java
Israel: I.A.R.C, P.O. Box 4099, Tel-Aviv
Italy: A.R.I., Via San Paolo 10, Milano
Jamaica: Thomas Meyers, 122 Tower St., Kingston
Japan: F.E.A.R.L., APO 500, % Postmaster, San Francisco, Calif.
Luxembourg: LX1AB, 40 rue Trevides, Luxembourg
Macao: Via Hong Kong
Malta: R. F. Galea, 20, Collegiate Street, Birkirkara
Mauritius: V. de Robillard, Box 155, Port Louis
Mexico: L.M.R.E., Apartado Postal 907, Mexico, D.F.
Montserrat: VP2MY, Plymouth
Morocco: C. Grangier, Box 50, Casablanca
Morocco: *Tangier International Zone only:* EK1MD, Box 57, British Postoffice, Tangier
Mozambique: Liga dos Radio-Emissores, P.O. Box 812, Lourenco Marques
Netherlands: V.E.R.O.N., Postbox 400, Rotterdam
Netherlands East Indies: Hr. C. Loze, PKILZ, Burg. Kuhrweg, 47 Bandoeng, Java
Newfoundland: N.A.R.A., Box 660, St. Johns
New Zealand: N.Z.A.R.T., P.O. Box 489, Wellington C1
Nicaragua: L. B. Satres, Bolivar Ave., 106 Managua
Northern Rhodesia: N.R.A.R.S., P.O. Box 199, Livingstone
Norway: N.R.R.L., P.O. Box 898, Oslo
Pakistan: P.O. Box 416, Lahore
Palestine: See Israel
Panama, Republic of: L.P.R.A., P.O. Box 1616, Panama
Paraguay: R.C.P., Palma 310, Asuncion
Peru: R.C.P., Box 538, Lima
Philippine Islands: Elpidio G. DeCastro, Philippine Amateur Radio Assn., 931 R. Hidalgo St., Quisno, Manila
Poland: Polski Zwiasek Krotkofalowcow, P.O. Box 320, Warsaw
Portugal: R.E.P., Travessa Nova de S. Domingos, 34-1º Lisbon
Puerto Rico: E. W. Mayer, P.O. Box 1061, San Juan
Roumania: A.R.E.R., P.O. Box 95, Bucharest
Salvador: J. F. Mejia, 7ª Calle Poniente No. 76, San Salvador
South Africa: S.A.R.L.L., P.O. Box 3037, Capetown
Southern Rhodesia: R.S.S.R., Box 1068, Bulawayo
Spain: U.R.E., P.O. Box 220, Madrid
St. Vincent: VP2SA, Kingstown
Sweden: S.S.A., Stockholm 8
Switzerland: U.S.K.A., Postbox 1203, St. Gallen
Syria: P.O. Box 35, Damascus
Trieste: MF2AA, Major M.H.R. Carragher, HQ V.G. Police
Trinidad: Edgar H. Borde, 52 Mucurapo Rd., Port-of-Spain
Uruguay: R.C.U., Casilla 37, Montevideo
U.S.S.R.: Central Radio Club, Postbox N-88, Moscow
Venezuela: R.C.V., P.O. Box 2285, Caracas
Virgin Islands: Richard Spenceley, Box 403, St. Thomas
Yugoslavia: SAJ, Post Box 48, Belgrade

Results, Fourteenth ARRL Field Day

NEVER have so many amateurs taken part in any single periodic operating activity as turned out for the Fourteenth ARRL Field Day, held last June 24th-25th. From rocky shores on the Atlantic to islands in the Pacific, from tropical Canal Zone to chilly Alaska, they set up portable stations afield to test amateur radio's emergency preparedness in the field organization territory of the League. And a successful test it was! A total of 5935 individuals (a minimum figure, since all reports did not specify the exact number at each station) manned 609 portable stations and filled the air with signals from 1545 complete receiver-transmitter combinations. Once again the ARRL Field Day has proven to be the most popular of all exercises in the League's Calendar of Activities.

FD stations were operated under all sorts of conditions and in all kinds of weather. Mild weather prevailed in many areas, but as is her habit Mother Nature conspired to lend a touch of realism to the test in some quarters. Steaming humidity, the scorching heat of deserts, bitter cold, flood, rain, wind and snow were all encountered by Field Day participants. Whatever the conditions under which they operated, however, there was the determination to keep transmitting and receiving gear on the air and to make as many contacts as possible during the 24-hour period. This determination to do the best possible communicating job under any and all conditions is what has made amateur radio so highly respected for its public service value. The League extends heartiest congratulations to all who contributed in any way to this convincing display of our potential worth in times of emergency.

The Field Day is not without its competitive angles. The spirit of competition prompts many local groups and individuals to vie with each other in making the highest point scores. Local contests are often set up wherein the winners enjoy a dinner at the expense of the vanquished. Other contestants present documents to their competitors proclaiming the superiority of the higher-scoring group. Some groups get together for joint meetings following FD during which enjoyable bull sessions are held. Through all such post-FD ac-

tivities runs the spirit of friendly competition and good sportsmanship. For the purposes of QST reporting, there is also a system of score comparisons. Competition is considered to be among stations using like numbers of simultaneously-operated transmitting set-ups. The final scores are therefore tabulated according to the number of transmitters in operation at each station. In order that Class A entrants may compare their scores with those of leading FD stations in their particular geographical area, the top-scoring Class A station in each call area from which entries were received is listed below.

W1OC/1	12,438	VE1FO	3204
W2GSA/2	12,507	VE2ARC	3078
W3FRY/3	10,386	VE3JJ	7587
W4ZV/4	4968	VE6NQ	2601
W5PDO/5	4269	VE7AMF	1308
W6GAL/6	19,548	VO6H	384
W7RT/7	7155	KH6WO/KH6	882
W4FU/8	9603	KP4ID/KP4	870
W9IT/9	11,916	KZ5KZ/KZ5	1791
WØRA/Ø	7398		

All entries in Classes B, C and D were from one-transmitter stations, hence the call area leaders in those categories may be determined readily from reference to the accompanying complete score tabulations.

Sidelights

"We used weather balloons filled with hydrogen for supporting our 200-foot vertical on 75 'phone and to hold up the 20-meter rhombic. They worked out well until balloons broke due to too much strain on the necks where wires were attached. Next time we plan to use netting around the balloons to take the strain. The balloons lasted about 14 hours on the vertical and 5 hours on the rhombic. We got a lot of ideas from this FD and hope to roll up many more contacts next year." — *Capitol Suburban Radio Club, W3NEW/S*. . . . In addition to dipoles and beams, the Corpus Christi Radio Club used a long-wire antenna supported by a kite. . . . "An innovation, at least so far as we were concerned, was the installation of a TV receiver at the generator site for the use

◆

The Kalamazoo Amateur Radio Club operated five transmitters at Oshtemo, Michigan. A severe electrical storm raging while this photo of the 28- and 50-Mc. positions was taken failed to keep them off the air. *Left to right: W8VMI, W8EMD, W8VJP's junior op, W8VJP, W8FGK and an unidentified young FD aspirant.*

◆





of the generator attendant. Performance of the receiver on WBEN-TV, Channel 4, was fully satisfactory." — *KBT Radio Club, W2EWT/2*. . . . "Although our final score for the day is nothing to brag about, the important accomplishment, in my mind, was the fact that thirty odd KZ5s were persuaded to break up their home stations, lug gear around, participate in a Field Day, and like it!" — *KZ5AW, SCM, C. Z.* . . . "Our 420-Mc. contact was the first for any of us in our gang and caused quite a sensation. The distance covered was 110 miles as measured on an air map." — *Turlock Amateur Radio Club, W6BXN/6*. . . . "Frank Key, W3ZA, our Director, was guest of W4NC at Field Day. Just ask him if everyone was having fun. There is something about these Field Days which causes everyone to say, 'I'll be back again next year!'" — *Winston-Salem Amateur Radio Club, W4NC/4*. . . . "We had a few humorous events, one of which was our attempt to put up a long wire across the lake. Our boat sank and took the antenna and operator with it, but we rescued the operator because he was needed to operate one of the rigs!" — *Hull Amateur Radio Club, VE2IZ*. . . . "Equipment was operated off separate batteries from car with no charging equipment used during 24-hour period. Total ampere hours available was 410 at 24 volts. Batteries weighed 720 pounds!" — *W9FMH/9*. . . . "Lay at anchor during most of the contest in Sodus Bay, about forty miles east of Rochester, N. Y. Return trip started before noon on Sun-



Field Day was not without DX opportunities for some groups. Here's the 28-Mc. phone operating position of KZ5KZ/KZ5, entered in the three-transmitter class by members of the Canal Zone Emergency Net. C.Z.A.R.A. prexy KZ5RM does the talking. Contacts with this station were good DX for many low-powered FD stations.

day in fairly heavy sea. Trying to pound brass in the cabin of a forty-foot sailboat, a quartering sea and a 45-degree heel, is a real problem in acrobatics." — *W2VBH/2*. . . . "Five teen-age operators in the club worked a heavy schedule. Our rigs were powered by a 5-kw. generator with only a 700-watt load attached. Best FD yet!" — *Abington Township Amateur Radio Assn., W3NDZ/3*. . . . "K2AA/2 was located on the highest point of ground in South Jersey — 200 feet above sea level! We had a rotatable ten-element flip-flop beam on 2 meters which did a fine job as evidenced by our 128 contacts in 11 sections on that band. The annual thunder and lightning storms were right on schedule Saturday evening!" — *South Jersey Radio Assn.* . . . "I have often wondered how an individual ham would make out if called upon in a sudden emergency and this FD seemed a good time to find out. About a month before FD the rig was checked and then put in a corner until June 24th. In an attempt to simulate emergency conditions a little more closely, setting up the equipment in the field was delayed until the starting hour. It is interesting to note that the first contact was made at 1730, just 30 minutes later." — *W2GFG/2*. . . . "Weather was hottest of the season thus far and accompanied by high winds. Although 100% prepared for rain, that was about the only thing we didn't get! This Field Day did more to get our club members working together than anything we have done this year." — *Pioneer Radio Amateurs, W5ASQ/5*. . . . "On Sunday the communications director of the Red Cross (Windsor, Ont.) visited the site and was so impressed that he immediately appointed the president and club editor members of the local disaster committee and will provide space in the Red Cross building for installation of an emergency rig." — *Frontier Radio Club, VE3WD*. . . . "Nearly washed away Saturday night . . . torrential downpour . . . one receiver struck by lightning . . . typical Field Day weather!" — *Chesapeake Amateur Radio Club*. . . . "This FD effort represents the first for the newly-formed amalgamation of the Jersey Shore Amateur Radio Assn. and the Monmouth County Amateur Radio Assn. We chose the most skilled contest ops from the new group

As part of their FD operation, the Richmond Amateur Radio Club, W4ZV/4, transmitted a message from the Governor of Virginia to all Red Cross chapters in the state. State Treasurer Dillon, left, hands the message to G. S. Kennard, R. C. disaster communications chief. The message was then turned over to W4IWA, SEC, second from right, and ARRL Assistant Director W4FJ, who started it on its way. This ceremony took place on the State Capitol lawn.

QST for

Second only to the operating staff in importance on Field Day is the culinary department! At the site of W1OC/1, the Concord Brasspounders, chef W1EAW, foreground, busies himself tending to the gastronomic needs of W1s RVG, PZL, FTJ, RMY and PML. Operating nine transmitters, the W1OC/1 gang turned in the top WI score.



and the score shows it. We were pleased to work Rome, N. Y., and West Virginia on 144 Mc." — *Garden State Amateur Radio Assn., W2GSA/2*. . . . "WBNS-TV shot some film of our activities which was telecast June 27th." — *Columbus Amateur Radio Assn., W8EYE/8*. . . . "This Field Day we had a lot of fun as usual, but it was more like a real emergency than a field test. Weather rainy, damp and very humid. We were entirely under canvas using a 15-kw. gas-driven power unit. Red Cross gray ladies did a splendid job furnishing the personnel meals." — *Milwaukee Amateur Radio Emergency Corp, W9ESJ/9*. . . . "Extremely hot and as usual rain and lightning . . . two XYL ops, W3NHI and W3CUL, and five OM ops were present. . . . Just wait until next year!" — *Ridley Radio Club, W3CUL/3*. . . . "On 75 'phone we contacted station operating mobile on land, in the air, and on the sea. We also had one contact with an s.s.b. station." — *Nassau Radio Club, W2BVL/2*. . . . "Our area

food. The accent was on combined operations with all concerned. Hams involved totaled about 50, organized reserves about 40 and Red Cross about 15 persons. We expect to make bigger and better combined plans next Field Day. — *Wichita Amateur Radio Club, K0WAQ/0*. . . . "While we didn't come in first, we'll bet that we were on top in the 'grocery department.' We served complete meals, home style. The amount of food that the gang consumed is amazing! We prepared 22 pounds of canned ham, 30 pounds of potatoes, 20 pounds of beef, 14 pounds of sausage meat, 18 large loaves of bread, 12 large cans of corn, 12 cans of peaches, 12 cans of fruit salad, 30 quarts of milk and more than 600 cups of coffee! In addition we had plenty doughnuts, cakes, ice cream, cereal and other items." — *Northwest Amateur Radio Club, W9IT/9*. . . . "The biggest feature was our use of 144-Mc. teletype. We believe that in case of emergency such as the Compton earthquake 17 years ago this would prove to be most valuable. Therefore we concentrated on traffic handling at this operating position in order to demonstrate that amateur teletype can be operated successfully in the field from an emergency source of power." — *Mid-Cities Amateur Radio Club, W6GAL/6*.

CLUB AGGREGATE MOBILE SCORES

Associated Radio Amateurs of Long Beach	15,011
Metropolitan Radio Club of Los Angeles	4077
Bloomfield Radio Club	2875
West Palm Beach Radio Club	2563
Baltimore Amateur Radio Comm. Society	2253
Palomar Radio Club	1417
Fredericton Radio Amateurs Club	810
Austin Amateur Radio Club	781
Michiana Amateur Radio Club	633
Jacksonville Amateur Radio Society	567
Connecticut Wireless Assn.	387
Union County Amateur Radio Assn.	229
Vancouver Amateur Radio Club	148
Fort Smith Amateur Radio Club	57
Mitchell Radio Club	54
Door County Amateur Radio Club	40

was hit by a series of heavy cloudbursts just as the FD started and we lost our tent in the heavy wind. The rainfall was so heavy that we were completely flooded out. Both our generators went out in the first five minutes of the storm. We were able to restore power to the 'phone rigs at 6:00 P.M. and to the c.w. rigs at 8:00 P.M." — *Amateur Transmitters Association of Western Pennsylvania, W3UL/3*. . . . "We had the coöperation of organized reserves, Civil Air Patrol and the Red Cross for a combined Field Day Operation. CAP supplied generators. The reserve supplied a motor pool to run the generators, telephone lines and 'phones between radio units and to the local exchange. The Red Cross worked in shifts keeping all concerned full of coffee, doughnuts and other

CLASS A

Scores are tabulated according to the number of transmitters operated simultaneously at each field station. The figures and letters following each listing indicate the number of contacts, the power or power inputs used, the number of participants at each station, and the final score. The "power classification" used in computing the score is indicated by the letters A, B or C after the number of QSOs shown. A indicates power up to and including 30 watts (multiplier of 3); B indicates power over 30, up to and including 100 watts (multiplier of 2); C indicates over 100 watts (multiplier of 1). More than one letter indicates that at times power inputs fell within different classifications.

One Transmitter

W1EBH/1	South Lyme Beer, Chowder and Propagation Society	488-	AB- 7-	4140
W8HQ/8	Tusco Radio Club	385-	A- 9-	3780
W1TX/1	Conn. Wireless Assn.	358-	A-11-	3438
W1EOB/1	Hamden County Radio Club	349-	A- 3-	3366

W8II/8	(nonclub group)	334-	A- 7-	3231	WINDS/1	Norwalk Amateur Radio Assn.	103-	A-12-	1152
W4MSL/4	(nonclub group)	304-	A- 4-	2961	W2CGK/2	Amateur Radio Society of Queens	103-	A- 5-	1152
W9JKV/9	New Albany Amateur Radio Club	302-	A-12-	2943	W8FBC/8	(nonclub group)	103-	A- 5-	1152
W0TKX/0	Northwest Airlines Emergency Group	296-	A- 4-	2889	W0VML/0	QRM Club	166-	B-10-	1146
W3EWR/3	The Conestoga Glass Arm & Elbow Bending Society	299-	A- 5-	2691	W7NWA/7	Central Arizona Amateur Radio Group	123-	A- 8-	1197
W8YN/8	Calhoun Area Radio Club	268-	A- 5-	2637	W7ASG/7	Salem Amateur Radio Club	337-	C-17-	1056
W8AIC/8	Central Ohio Radio Club	264-	A-10-	2619	VE1DN/1	Dartmouth Amateur Radio Club	92-	A- 7-	1053
W0WJA/0	(nonclub group)	264-	A- 4-	2601	W0AUL/0	(nonclub group)	159-	B- 3-	1044
W4CYC/4	(nonclub group)	359-	B- 6-	2304	W8ND/8	Down River Radio Club	119-	AB- -	1041
W7SS/7	Butte Amateur Radio Club	232-	A- 7-	2223	W9NOQ/9	QRRR Club	115-	A- 5-	1035
W0GBZ/0	Jackson County Amateur Radio Club	221-	A-11-	2214	W8VVL/8	Queen City Emergency Net	172-	B-16-	1032
W2WER/2	Oswego County Radio Club	220-	A-15-	2205	W0JTF/0	(nonclub group)	86-	A- 4-	999
W0TIU/0	(nonclub group)	211-	A- 4-	2124	W0LSA/0	Bluff Amateur Radio Society	163-	AB- 3-	984
W4MGT/4	(nonclub group)	208-	A- 3-	2115	W0ZSJ/0	Mitchell Radio Amateurs Club	94-	A- 5-	981
W2UBU/2	(nonclub group)	201-	A- 5-	2034	W2RXW/2	Oneida Amateur Radio Club	79-	A- 3-	936
W9GZU/9	Navy Pier Amateur Radio Club	222-	A- 7-	1998	W2TIO/2	Newark Radio Club	103-	A- -	927
W0ZWY/0	Sioux Falls Amateur Radio Club	304-	B-11-	1824	W5RFY/5	Amateur Radio Club of Holdenville	127-	B- 3-	924
W9LYR/9	Milwaukee Radio Amateurs Club	201-	A- 5-	1809	W2HEQ/5	Field Engineers Radio Club	153-	B- 4-	918
W0RFT/0	Northeast Iowa Radio Amateur Assn.	164-	A-10-	1719	W0RGG/0	Tri-City Amateur Radio Club	102-	A- 4-	918
W4ZXN/4	Univ. of Louisville Amateur Radio Club	190-	A-11-	1710	KH6WO/KH6	Honolulu Amateur Radio Club	120-	B-12-	882
W8DXG/8	Muskingum Amateur Radio Assn.	285-	B- 6-	1710	W7MWS/7	Shy-Wy Radio Club	114-	B- 8-	834
W3EDU/3	York Amateur Radio Club	187-	A-18-	1683	W3PFT/3	Reading Radio Club	66-	A-12-	819
W0UCU/0	(nonclub group)	160-	A-16-	1593	W4ROS/4	(nonclub group)	103-	B- 3-	768
W8DFK/8	The Brass and Java League	174-	A- 5-	1566	W1MHL/1	Waltham Amateur Radio Assn.	80-	A- 9-	720
W7KKB/7	Copper City Gang	173-	A- 5-	1557	W9RKT/9	Mancorad Radio Club	53-	A- 5-	720
W0NBS/0	Jamesstown Amateur Radio Club	168-	A- 8-	1512	VE6CS/6	(nonclub group)	230-	C- 5-	690
W1QMF/1	Newington Amateur Radio League	139-	A-12-	1494	W0AGL/0	Gold Nugget Radio Club	96-	B- 5-	576
VE3RC/2	Ottawa Amateur Radio Club	161-	A- 7-	1449	W8RM/8	Perry Radio Club	62-	AB- 5-	561
W3ADE/3	Harrisburg Radio Amateurs Club	133-	A-15-	1422	W6MSL/5	(nonclub group)	62-	A- 3-	558
W3RQN/3	(nonclub group)	133-	A- 4-	1422	W8EEY/8	Midland Radio Club	61-	A- 8-	549
W1HGV/1	Nashua Mike and Key Club	211-	B- 7-	1356	W7MXH/7	Cascade Radio Club	90-	B- 4-	540
W6CMN/6	(nonclub group)	198-	B- 3-	1350	KH6ZG/KH6	Kauai Amateur Radio Club	65-	B- 6-	540
VE7AMF/7	Delta Radio Club	218-	B- 7-	1308	W8SIO/8	St. Joseph High School Amateur Radio Club	84-	B- -	504
W4TIS/4	Fort Benning-Columbus Amateur Radio Club	216-	B-15-	1296	VE2QN/2	(nonclub group)	25-	A- 7-	468
VE1JV/1	Pietou County Amateur Radio Club	119-	A-10-	1296	W7NNP/7	Walla Walla Radio Amateur Club	44-	A- 3-	396
W4WUR/4	Ashland Amateur Radio Club	113-	A- 6-	1242	VO6H/6	Goose Bay Amateur Radio Club	49-	B-10-	384
W9ITH/9	Sheboygan Amateur Radio Club	136-	A- 6-	1224	W7FMLJ/7	The Beer Guzzlers	42-	A- 5-	378
W4VT/4	Mid-South Amateur Radio Assn.	173-	B-17-	1188	W8PUF/8	Adrian Amateur Radio Club	125-	A- 4-	375
					W6KNZ/6	(nonclub group)	21-	A- 5-	324
					W0AAP/0	So. St. Louis Radio Club	154-	B- -	308
					W9IIE/9	Vermilion County Radio Club	50-	B- 4-	300
					W3KYR/3	Boys Club of St. Marys Amateur Radio Society	30-	A- 5-	270
					W7ACF/7	Valley Emergency Corps	27-	A- 3-	261
					W8PEL/8	Medina County Radio Club	76-	A- -	228
					W7IKV/7	Capitol City Radio Club	21-	A- -	216



Participating in the three-transmitter class, the Montreal Amateur Radio Club, VE2ARC, chalked up the second highest Field Day score in Canada. Shown here is the tent-protected 14-Mc. phone position in full swing Sunday afternoon.

Operating under the call W7NWP/7, W7LVB and W7NWP set up this completely battery-powered 10-watt station at Devil's Mountain near Mt. Vernon, Washington, and worked on 3.5 and 7 Mc. Shown here pounding out a call on 7 Mc. is W7LVB.

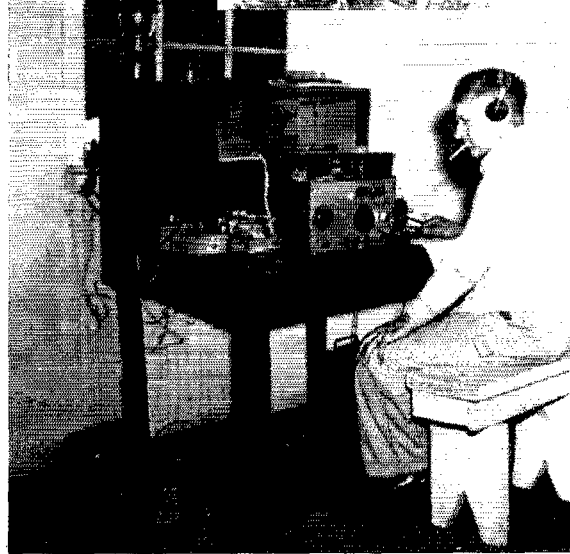

W5BPM/5	East Texas Amateur Radio Club	101-	B- 6-	202
W7ED/7	Gallatin Amateur Radio Club	27-	B- 4-	162
VE2ZL/2	(nonclub group)	34-	C- 6-	102
W8CLK/8	Crawford County Civil Air Patrol	16-	B- 4-	96
W1KOO/1	Burlington Amateur Radio Club	28-	C- 1-	28

Two Transmitters Operated Simultaneously

W0RA/0	St. Paul Radio Club	797-	A- 9-	7398
W9AIU/9	Egyptian Radio Club	649-	A-12-	6066
W8TQ/8	Dayton Amateur Radio Assn.	637-	A-16-	5976
W9RQM/9	Wisconsin Valley Radio Assn.	598-	A-24-	5679
W0DEP/0	(nonclub group)	567-	A- 5-	5328
W4ZV/4	Richmond Amateur Radio Club	527-	A-25-	4968
W1QQA/1	Bridgeport Radio Amateur Club	478-	A-13-	4527
W3PKV/3	Northeast Radio Club	465-	A-17-	4410
W0BMQ/0	St. Louis Spectrum Sparkers	459-	A- 7-	4131
K8FBC/8	A.M.C. Amateur Radio Club	422-	A-10-	3942
W2QYV/2	Niagara Radio Club	397-	A-12-	3816
W8FT/8	Findlay Radio Club	394-	A-20-	3771
W4FVM/4	Chattanooga Amateur Radio Club	401-	A-11-	3609
W8ZZ/8	Detroit Amateur Radio Assn.	372-	A-16-	3573
W5MUZ/5	Ouachita Valley Amateur Radio Club	370-	A-10-	3555
W9ERU/9	(nonclub group)	363-	AB- 5-	3291
W9PVA/9	(nonclub group)	326-	A- 8-	3159
W9MD/9	Illinois Ham Club	344-	A-15-	3096
W8DPU/8	Thumb Area Amateur Radio Assn.	146-	B- 8-	2826
W3KJJ/3	Schuykill Amateur Radio Club	283-	A- 4-	2772
W3NDZ/3	Abington Township Amateur Radio Assn.	281-	A- 7-	2754
W6YX/6	Stanford Univ. Radio Club	293-	AB- 4-	2694
W5KC/5	Baton Rouge Radio Amateurs Club	419-	B-30-	2676
W8CSF/8	Kanawha Valley Amateur Radio Assn.	442-	A- 8-	2652
W3QZF/3	Horseshoe Radio Club	268-	A-30-	2547
W8SWS/8	Piqua Radio Club	280-	A- 4-	2520
W5YJ/5	Oklahoma A & M Amateur Radio Club	253-	A-12-	2502
W0MHR/0	Northern Colorado Amateur Radio Club	278-	A-12-	2502
W3ISE/3	(nonclub group)	275-	A- 4-	2475
W6TO/6	Fresno Amateur Radio Club	247-	A-17-	2448
W3NMR/3	Lancaster Radio Transmitting Society	263-	A-21-	2367
W1AA/2	Lake Success Radio Club	227-	A-18-	2322
W2GGN/2	Queens Radio Amateurs Club	360-	AB-14-	2190
W8CMA/8	Allegan Area Radio Club	215-	A- 7-	2178
W9CNE/9	(nonclub group)	353-	B-15-	2118
W8WDQ/8	Southeast Amateur Radio Club	235-	A- 8-	2115
W9RNZ/9	Neenah-Menasha Amateur Radio Club	268-	AB- 8-	2055
VE2NI/2	Valois Radio Club	212-	A- 4-	2043

W6PZV/6	(nonclub group)	415-	AB- 7-	2028
W4IZ/4	Jacksonville Amateur Radio Society	193-	A-11-	1989
VE1CV/1	Annapolis Valley Amateur Radio Club	193-	A- 5-	1962
W9HHX/9	Milwaukee School of Engineering Amateur Radio Club	217-	A-12-	1953
W5PEW/5	El Paso Amateur Radio Club	284-	B-10-	1866
W4KH/4	Nashville Amateur Radio Club	216-	AB-25-	1788
W8KS/8	Westlake Amateur Radio Assn.	198-	A-13-	1782
W0EDY/0	Midway Amateur Radio Club	171-	A- 6-	1782
W1ORS/1	Stratford Amateur Radio Club	179-	A-11-	1746
VE3AEA/3	Peterborough Amateur Radio Club	191-	A- 9-	1719
W3CUL/3	Ridley Radio Club	264-	B- 7-	1584
W0SQN/0	Ottumwa Amateur Radio Club	155-	A- 6-	1530
W5HGT/5	Louisiana Tech Radio Club	152-	AB- 8-	1503
W4JD/4	Kingsport Amateur Radio Club	338-	BC-16-	1470
W5JNB/5	Big Spring Amateur Radio Club	226-	B-10-	1446
W4GSV/4	Alhany Amateur Radio Club	210-	B-20-	1410
W5RJX/5	Norman Amateur Radio Club	155-	A- 3-	1395
W8RTR/8	Canton Amateur Radio Club	206-	B-30-	1386
VE3ARX/3	Deep River Radio Club	127-	A- 5-	1368
W0AAB/0	Electron Club of Denver	134-	A- 6-	1341
W4NTL/4	Anniston Amateur Radio Club	192-	B-11-	1302
W1AQ/1	Associated Radio Amateurs So. New England	119-	A- 3-	1296
W1IA/1	South Shore Amateur Radio Club	119-	A-15-	1296
W3PIE/3	Fort Necessity Amateur Radio Assn.	143-	A-15-	1287
W2BXX/2	Brooklyn Polytechnic Radio Club	137-	A- 5-	1233
W9DPN/9	Point Radio Amateurs (nonclub group)	99-	A- 8-	1116
W1EBQ/1	(nonclub group)	119-	A- 3-	1071
W9GLY/9	Electron Club	117-	A- 7-	1053
W4RKI/4	Dar-Nek Radio Club	97-	A-11-	1008
W8CIA/8	Louisville Amateur Radio Club	142-	AB-16-	1008
W8YLA/8	Marquette County Radio Club	138-	AB- 7-	981

W5USN/5	(nonclub group)	150-	AC- 5-	975	W5EST/5	Bartlesville Radio Club	422-	AB-25-	3642
W2SV/2	Sunrise Radio Club	292-	A-16-	951	W8ICS/8	West Park Radiops	381-	A-24-	3582
W1KAE/1	Submarine Signal Amateur Radio Club	317-	AB-14-	874	W2OTC/2	(nonclub group)	595-	B- 9-	3570
VE3GZ/3	Stratford Amateur Radio Club	97-	A- 7-	873	W0POV/0	Suburban Radio Club	448-	-15-	3297
W5MBR/5	(nonclub group)	96-	A- 6-	864	W4BOL/4	(nonclub group)	534-	B- 6-	3294
W0ZLN/0	Univ. of Missouri Amateur Radio Club	144-	B- 5-	864	W1VB/1	Candlewood Amateur Radio Assn.	346-	AB-16-	3249
W4OLB/4	Smoky Mountain Amateur Radio Club	105-	B- 5-	792	W9HCF/9	Tri-Town Radio Amateur Club	334-	A-12-	3231
W6Z0J/6	Paso Robles Radio Club	87-	A- 4-	783	VE1FO/1	Halifax Amateur Radio Club	320-	A-15-	3204
K9FAJ/9	Twin City Radio Club	96-	AB-20-	782	W5FFF/5	Jackson Amateur Radio Club	321-	A-30-	3114
W1SBF/1	Meriden Amateur Radio Club	80-	AB- 9-	777	VE2ARC/2	Montreal Amateur Radio Club	326-	A- 4-	3078
W1MNG/1	Hampden County Radio Club (Group One)	58-	A-11-	722	W7NL/7	North Seattle Amateur Radio Club	316-	A-19-	3069
W1ACT/1	Fall River Amateur Radio Club	79-	A- 5-	711	W7OLF/7	Radio Club of Arizona	308-	A-10-	2997
VE6NA/6	Hat Ham Club	54-	A-11-	711	W2ZQ/2	Delaware Valley Radio Assn.	331-	A-15-	2979
W1QWJ/1	Hampden County Radio Club (Group Two)	85-	AB- 5-	690	W2MPL/2	Empire City Radio Club	468-	B-11-	2958
W4COB/4	Clearwater Amateur Radio Society	60-	A- 7-	675	W0CET/0	Kaw Valley Radio Club	492-	B-30-	2952
VE3AKO/3	(nonclub group)	58-	AB- 8-	666	W6BXN/6	Turlock Amateur Radio Club	295-	A-16-	2916
K9NRE/9	Evanston Naval Reserve	118-	ABC- 3-	633	K2AX/2	Morris Radio Club	398-	A-12-	2739
VE3AVU/3	North Shore Radio Club	43-	A-13-	621	W0TW/0	Denver Radio Club	271-	A-30-	2664
W2LZ/2	Walton Ham Group	102-	B- 6-	612	W6SF/6	Stockton Amateur Radio Club	268-	A-12-	2637
W8SIW/8	(nonclub group)	95-	B- 3-	570	W8LJ/8	Dayton Amateur Radio Assn. (Fun Group)	438-	B-32-	2628
W7NLI/7	(nonclub group)	59-	A- 4-	531	W9WWO/9	Western Ill. Radio Club	267-	A-10-	2628
KH6RS/KH6	Maui Amateur Radio Club	122-	AC-15-	507	W5HTK/5	Enid Amateur Radio Club	406-	B-15-	2586
KP4AJ/KP4	Borinquen Amateur Radio Club	109-	BC-21-	429	W0JAD/0	Clinton Amateur Radio Club	285-	AB-12-	2521
W2UQK/2	Clayton Radio Club	43-	A- 6-	387	W0BJT/0	Northwest St. Louis Amateur Radio Club	273-	A- 9-	2457
W8EXB/8	Crawford County Civil Air Patrol	47-	AB- 4-	354	W2SBV/2	Elinra Amateur Radio Assn.	273-	AB-12-	2448
W3IYR/3	(nonclub group)	67-	ABC- 3-	324	W5RIR/5	Radio Active Amateur Club	450-	ABC-12-	2421
W9AML/9	Central Ill. Radio Club	236-	BC- 9-	320	VE3ASD/3	Bay of Quinte Amateur Radio Club	377-	B-32-	2412
W9CXG/9	(nonclub group)	22-	A- 8-	198	W9ADF/9	Chicago Radio Traffic Assn.	238-	A-10-	2367
<i>Three Transmitters Operated Simultaneously</i>									
W2EWT/2	K.B.T. Radio Club	879-	A-19-	8190	W4CKB/8	Rebel Radio Club	357-	B-12-	2292
W0BYF/0	Cedar Valley Radio Club	701-	A-25-	6309	W1PZ/1	Pocahontas Radio Club	262-	A-12-	2268
W2KZ/2	Radio Assn. of Western N. Y.	639-	AB-16-	5829	K6NRA/6	Santa Barbara U. S. Naval Reserve & Santa Barbara Amateur Radio Club	255-	AC-20-	2130
W2QW/2	Raritan Valley Radio Club	600-	A-12-	5643	W9EH/9	Kishwaukee Radio Club	274-	AB-18-	2097
W1SKT/1	Narragansett Assn. of Amateur Radio Operators	603-	A-15-	5562	W8LII/8	Tri-City Amateur Radio Club	233-	AB- 7-	2010
W3QV/3	York Road Radio Club	571-	A-15-	5373	W1HOB/1	Parkway Radio Assn.	220-	A-13-	1980
W9APU/9	Rock River Radio Club	529-	A-12-	4986	W6FXD/6	San Diego Young Ladies Radio League	195-	A- 6-	1980
W3DIM/3	Capital Key & Mike Club	509-	A-10-	4806	W8YKV/8	Scioto Valley Amateur Radio Club	248-	AB-10-	1911
W8MRM/8	Motor City Radio Club	543-	AB- 9-	4551	W5IAS/5	Tulsa Amateur Radio Club	272-	AB-15-	1869
W4CN/4	Amateur Radio Transmitting Society of Louisville	472-	A-28-	4473	KZ5KZ/KZ5	Canal Zone Emergency Net	172-	A-30-	1791
K2AA/2	South Jersey Radio Assn.	459-	A-15-	4356	W4PED/4	Lynchburg Amateur Radio Club	382-	BC-13-	1752
W3AIR/3	Rock Creek Amateur Radio Assn.	456-	A-43-	4329	VE3YJ/3	London Amateur Radio Club	216-	AB- 7-	1713
W4PLB/4	Orlando Amateur Radio Club	595-	AB-17-	4227	VE1RC/1	Moncton Amateur Radio Club	154-	A-10-	1620
W3VV/3	McKean County Radio Club	448-	A-10-	4032	W4AP/4	Montgomery Amateur Radio Club	251-	AB- 7-	1566
W9CAF/9	Chicago Amateur Radio Club	418-	A-20-	3987	W6YAS/6	Frank Wiggins Amateur Radio Club	177-	AB- 7-	1539
W2WOX/2	Utica Amateur Radio Club	440-	A-12-	3960	W4NEP/4	Paducah Amateur Radio Club	163-	A-10-	1467
W8ODJ/8	Buckeye Shortwave Radio Assn.	412-	A-35-	3843	W5ESL/5	Temple Amateur Radio Club	182-	AB-10-	1350
W7LQB/7	Saguaro Radio Club	396-	A-10-	3798	W4NC/4	Winston-Salem Amateur Radio Club	224-	B-25-	1344
W0RVG/0	Heart of America Radio Club	520-	AB-21-	3744	W7JDB/7	Laramie Amateur Radio Club	115-	A- 4-	1269
W5LOV/5	Oklahoma County Emergency Net	523-	AB- 9-	3735	W7NYW/7	Baker Amateur Radio Club	140-	A- 9-	1260
W8QG/8	Springfield Amateur Radio Club	381-	A-35-	3654					



During an off-duty moment, members of the Mitchell Radio Amateurs Club, WØZSJ/Ø, test one of their mobile rigs. The smiling fellow doing the talking is WØHDO, SEC for Eastern South Dakota.

W9SD/9	Iroquois County Radio Club	152-	AB-11-	1233
VE3BXT/3	Scarboro Amateur Radio Club	137-	A-	1233
VE2IZ/2	Hull Amateur Radio Club	274-	ABC-10-	1224
W8VZ/8	(nonclub group)	171-	B-3-	1176
W2ARH/2	Binghamton Amateur Radio Club	122-	A-3-	1098
W2RCX/2	Batavia Amateur Radio Assn.	120-	A-10-	1080
KH6SZ/8	(nonclub group)	151-	AB-4-	1068
VE7ZV/7	Vancouver Amateur Radio Club	89-	A-5-	1026
W4FLW/4	(nonclub group)	143-	B-8-	1020
W1SAG/1	Hilltop Amateur Radio Club	97-	A-14-	873
W6HWF/6	Shasta County Radio Club	119-	AB-	870
KP4ID/KP4	Puerto Rico Amateur Club	120-	B-8-	870
W4PCC/4	Blue Ridge Amateur Radio Society	117-	AB-9-	837
W9DUD/9	Martinsville Amateur Radio Club	132-	B-6-	792
W5FGE/5	(nonclub group)	126-	B-4-	756
W9WX/9	(nonclub group)	159-	ABC-9-	739
WØSWD/Ø	Boone Mike & Key Club	57-	A-5-	738
WØILO/Ø	Red River Radio Amateur Club	79-	A-10-	711
W7LAB/7	Ogden Amateur Radio Operators Club	140-	BC-9-	692
W4PAR/4	Thomasville Amateur Radio Club	95-	AC-	655
VE1CU/1	Yarmouth Amateur Radio Club	71-	A-	639
KZ5ES/KZ5	(nonclub group)	85-	AB-5-	627
WØVRD/Ø	Muscataine Amateur Radio Club	202-	C-14-	606
W7NGW/7	Lower Columbia Amateur Radio Assn.	117-	AC-8-	558
WØFVT/Ø	Forx Radio Amateur Club	82-	B-5-	492
W7OQL/7	Southern Montana Amateur Radio Assn.	81-	B-7-	486
W7NPV/7	Hellgate Radio Club	48-	AB-9-	483
W3PR/3	Lebanon Valley Society Radio Amateurs	149-	A-5-	447
W9JZA/9	Lake County Amateur Radio Club	258-	ABC-20-	447
W8UPI/8	Portsmouth Radio Club	64-	AB-5-	429
WØEEE/Ø	Missouri School of Mines Radio Club	55-	B-8-	420

W2BMW/3 Tuboro Radio Club 159- B-14- 318

Four Transmitters Operated Simultaneously

W4FU/8	Ohio Valley Amateur Radio Assn.	1042-	A-16-	9603
W2AI/2	Central Jersey Radio Club	955-	A-19-	8838
W9EDK/9	Phomeblowers and Brass Pounders	732-	A-10-	6813
W2DAY/2	Northern New Jersey Radio Assn.	646-	A-36-	6039
VE3WD/3	Frontier Radio Club	617-	A-22-	5814
W6RTR/6	Crescenta Valley Radio Club	618-	A-12-	5787
W6YF/6	Citrus Belt Amateur Radio Club	597-	A-16-	5508
W6PD/6	Foothill Mobile Net	566-	A-11-	5299
W2BVL/2	Nassau Radio Club	543-	A-15-	5112
W2JV/2	Nutley Amateur Radio Society	510-	A-9-	4500
W9ESJ/9	Milwaukee Amateur Radio Emergency Corps	513-	AB-25-	4386
W5PDO/5	Los Alamos Radio Club	522-	AB-10-	4269
W9IKN/9	Elgin Amateur Radio Society	473-	A-14-	4257
W9UDU/9	Racine Megacycle Club	516-	AB-20-	4104
WØFZO/Ø	Sioux City Amateur Radio Club	500-	AB-35-	3717
W8IK/8	South Macomb Amateur Radio Club	583-	B-20-	3648
K5FBB/5	Keesler Amateur Radio Club	400-	A-10-	3600
W2GIZ/2	Union County Amateur Radio Assn.	415-	AB-25-	3567
W8ACW/8	Genesee County Radio Club	371-	A-15-	3564
W8AW/8	Edison Radio Amateurs Assn.	370-	A-18-	3555
W6CIS/6	North Peninsula Electronics Club	362-	A-15-	3483
W5MPZ/5	Sandia Base Radio Club	399-	AB-20-	3471
W2EFU/2	Schenectady Amateur Radio Assn.	363-	A-4-	3312
W7DK/7	Radio Club of Tacoma	331-	A-15-	3204
W2DPQ/2	Huntington Radio Club	475-	AB-20-	3135
WØFUM/Ø	Southwest Missouri Amateur Radio Club	490-	B-30-	3132
W8EYE/8	Columbus Amateur Radio Assn.	485-	B-25-	3108
W9BA/9	St. Clair Amateur Radio Club	482-	B-18-	3042
W3UL/3	Amateur Transmitters Assn. of Western Penn.	380-	AB-18-	3027
W2PW/2	Ithaca Mike & Key Club	392-	AB-20-	2712
K7FAG/7	The Old Pueblo Radio Club, The 25 Radio Club, The Davis-Monthan Radio Club	420-	B-35-	2670
W4QEE/4	Amateur Radio Club of Mobile	390-	AB-12-	2643
VE6NQ/6	Calgary Amateur Radio Assn.	273-	A-10-	2601
W8DC/8	Grand Rapids Amateur Radio Assn.	386-	AB-19-	2583
W2ZKS/2	Bayonne P.A.L. Amateur Radio Club	315-	AB-8-	2571
W4GNF/4	Greensboro Radio Club	257-	A-20-	2538
W9HF/9	Lake County Amateur Radio Club	282-	A-15-	2538
W18YE/1	Newport County Radio Club	382-	AB-10-	2535
VE1ND/1	Fredericton Radio Amateurs Club	341-	AB-10-	2529
W4MQN/4	Atlanta Radio Club	277-	AB-9-	2448
W7NZA/7	Amateur Radio Assn. of Bremerton	267-	A-22-	2403
W6OTX/6	Palo Alto Amateur Radio Assn.	245-	A-13-	2205
WØFP/Ø	Davenport Radio Amateur Club	226-	A-16-	2169

(Continued on page 108)



Correspondence From Members -

The Publishers of *QST* assume no responsibility for statements made herein by correspondents.

HISTORY REPEATS ITSELF

10110 Pierce Dr., Silver Spring, Md.

Editor, *QST*:

When I built my first short-wave receiver in 1930 or 1931, the first station I heard on it was W3BFZ, 75-meter 'phone, Ridley Park, Pa., just a few miles up the pike from where I lived in Chester, Pa.

Last night my oldest boy Mike (age 10) finished wiring his first receiver. I wound a coil for 80, clipped on an antenna and power supply, checked the action of the regeneration control, and handed him the cans. Thirty seconds later he had tuned in his first station, W3BFZ, 75-meter 'phone, etc.

If W3BFZ can keep talking for another 20 or 30 years we'll see how the third generation makes out.

The receiver, incidentally, is a copy of the 6SN7 detector-and-one-step shown in the 1950 *Handbook*, modified slightly to use available parts. It not only works surprisingly well, but did so from the very first. Congratulations to the *Handbook* writers.

— William P. Smith, W3GKP

ANOTHER BOOSTER

Grant Hill Rd., Tolland, Conn.

Editor, *QST*:

On October 17, 1950, 7:30 A.M. in the morning, Eastern Standard Time, I contacted amateur radio single-sideband station VK3CP. This contact was so successful that not one single word was missed from VK3CP during the one-hour contact. In addition, all other VK stations were Signal Strength 4 and under with readability no higher than R4. The single-sideband signal of VK3CP was received about a Strength 4 and Readability 5 with complete ease of reception during the one-hour period.

May I state that this demonstration of s.s.b. was sufficient to promote the future construction of a single-sideband transmitter for DX work at station W1ATE.

— C. R. Knowlton, W1ATE

RTTY

2703 Emmett Rd., Silver Spring, Md.

Editor, *QST*:

It must be very difficult for you fellows at Headquarters to decide which interests rate a special page or column. My question is — where does radioteletype fit into the picture? In other services it is daily replacing more manual circuits, and high-speed automatic signaling visually displayed to pilots is planned for replacement of voice communications in aircraft work. RTTY maintains accuracy, is speedy, and provides a written record; also, it can be relayed without a manual repeat.

Should not ARRL provide more promotion for radioteletype work and act as a clearing house for RTTY information? For a system of communications that is growing as fast as RTTY, we require "system standards" so that different groups of teletype-equipped stations can communicate with each other. Active RTTY networks of three or four stations each are operating locally — not realizing that one relay point would tie "local" nets together and establish a long-haul high-speed traffic and rag-chewing circuit.

In spite of the mechanical and electrical complications, some three or four hundred amateurs are now using radioteletype, mostly employing the two-meter band with two-tone audio modulation. November *QST* has reported the net of active two-meter RTTY stations handling traffic relays between New York and Washington, W2QGH-W2BFD-W2PAT-W2JAV-W3LMC-W4JCV and W3PYW are active in this work. W3JPP is a side feeder to the main

circuit. RTTY tape equipment or voice-recording equipment for relay will permit the traffic to move at 65 w.p.m. all along the circuit. Through the initiative of W2BFD, over three hundred RTTY equipments have been economically obtained for amateurs. W3NL and others have bought, repaired and put into service many junked equipments that can easily be combined with existing amateur radio installations.

I would like to see more interested amateurs taking over the machines as they become available for use. There are two important questions: (1) Is there today a genuine interest in radioteletype among a large group of amateurs, and (2) Bearing in mind both the v.h.f. experimenting and traffic groups as potential users, could not members reading this letter report RTTY activities to ARRL each month in order to provide some *QST* data.

In twenty years of hamming, including DX chasing, rag-chewing, frequency measurement and traffic handling, I have never enjoyed anything more than radioteletype hamming. I wish that more amateurs would share this pleasure.

— Frank C. White, W3PYW

[**EDITOR'S NOTE:** RTTY seems to have the widest immediate appeal to the experimenter who can complete the necessary circuitry with his own hand. The Communications Department would welcome the registration for Net Directory purposes and information of all traffic handlers as to interconnections for traffic origination and delivery via any RTTY nets established now and in the future. Readers interested in obtaining equipment see the "Story of Amateur Radio Teletype," page 16, October, 1948, *QST*.]

QUOTAS ON ACHIEVEMENT

216 Douglas Crescent, Sea Island, B. C.

Editor, *QST*:

Please, a suggestion regarding the operation of the annual DX contest. Either put a handicap on previous winners or better still allow a station to win only once.

I've tried a good many times to come out on top of the mad scramble but always lose out to the same combinations of high power, super locations and beams, to say nothing of ample time and funds. With all of these things the proficiency of operating takes a back seat and tends to discourage a good many potential DXers from entering into the spirit of the contest.

No, I'm not a sour-grape type; it's just that I'd like to see a few of the "lower strata" of the DX world, including myself, get a break.

After all, our friend "so and so" has by winning once, or more, proven he can do it. What more proof do we need? Now let's have some other joker prove what he can do with his lower power, poorer beam and location.

— Al Miller, VE7KC

RE EXAMS FOR THE BLIND

204 South Wilson Ave., Dunn, North Carolina

Editor, *QST*:

Out of genuine sincerity and the kindness of his heart, a brother ham expressed in October *QST* his wish that licensing regulations might be modified for blind applicants. As a blind man, may I be permitted to voice a dissenting appeal?

You hams are the finest people on earth; this, believe me, I have learned first hand. When you fellows go to bat for a person, or for a cause, you go all the way. And because this is so, I dare not remain silent.

Amateur radio is the only major hobby I know of which

(Continued on page 104)



How's DX?



CONDUCTED BY ROD NEWKIRK,* W9BRD

How:

Unless his usually rockbound pride breaks down occasionally to permit him a pseudonym, Jeeves never gets anything published that we know about. But we can't say he doesn't try. His most recently completed work, "Ode to a Clamp Tube," reads better backwards or sideways.

Nevertheless, we ran across a sheaf of foolscap in a bottom drawer not long ago from an unfinished Jeevesian work entitled "Unscrambling DX" or "Get Off My Lap, Hedy, the Asians are Breaking Through," which, in a few bold strokes, seems to sweep aside all the complicated confusion that clouds the subject of DX and gets down to the crux of the matter. The following quote will at least provide a tantalizing glimpse of the scintillating intellect of the man.

"If you can't seem to work DX like the other fellows, you have only two things to worry about — either you don't hear the stuff or it doesn't hear you.

"If you're hearing it okay, just two things to worry about — rig isn't putting out or skywire is no good.

"If rig is putting out almost a kilowatt, still just two things to worry about — feeders are punk or flat-top is fouled up.

"If the feeders check okay, then again merely two things to worry about — flat-top is running wrong way or isn't high enough. †

"So you finally end up by putting a 3-element rotary on top of a 90-foot mast, leaving just one thing to worry about — TVI."

Thus, you see, this DX business is really simplicity itself!

What:

The hardy souls who braved the magnetic storms in the twenty-meter range were amply rewarded with a shot at 3A2AB of Monaco. This choice tidbit was operated by DL4FS (ex-3A1B) and W8DAW found him leaking through on 14,006 kc. . . . ET9X (14,075) as snagged by W2JBL is a nice item; George adds EA9AP (13,980) and EK1FF (14,015) . . . W6AM was the No. 1 QSO for VR1F (14,055) and W3LMM would like to track down FL8AM who gave the QTH listed in "Where." Bill's latest feature FQ8AC, CR5AC, and VP8AK . . . VK1HV spends much time in the vicinity of 14,130 kc., finds W8DFQ . . . Demoting his 6L6 to the job of driver for his 813s, KZ5ES knocked off VP1AA (14,036), FA8s RJ (14,005), IH7 (14,038), HR1AT (14,037), HK4CF (14,000), IS1AEK (14,000), YO3GY (14,061), 7WL (14,060), YU3FL (14,055), KS4AC (14,000), UG6AB (14,058) and ZB2I (14,000). Earl is still after VR4AD (14,006), VU2IJ (14,030), HC2AB (14,000), VR1C (14,047), YS1O (14,026), ZM6AK (14,011), ZK1AB (14,041), KC6WC (14,032), PK1TM (14,080), ZK2AA (14,064) and FK8AB (14,004). He notices considerable VP8 activity on the band with VP8s AB, AI and AO spreading good cheer simultaneously . . . We haven't

* DX Editor, QST. Please mail reports of DX activity to W9BRD's home QTH: 1517 Fargo Ave., Chicago 26, Ill.

† Debatable point; if an underground antenna, may not be deep enough. — Ed.

checked on the brand of ouija board that W5ASG employs but the darned thing must be a wow. Bill had all the Russian countries worked save for UMR. One evening he heard the U boys ploughing through quite well and decided to break the monotony by calling CQ UMR. Need we continue further? UMR8KAA came right back, needing Arkansas as badly as W5ASG needed the Kirghizia Anyway, W5ASG's recent collection is glowing with the likes of PKs 1CI, 5AA, 6VK, VP8s AK, AJ, AP, UA0s KBB, VB, DU1GT, PJs 1UF, 2AA, ST2RD, 984s AR, AX, FF8JC, FY7YB, ZB2AN and Deception Islander C87ZJ . . . Away up in Nome, KL7SF encountered contacts with C3DH, C9AA (14,078), C1RL (14,011), HL1ZZ (14,030), VR2BW (14,016), VS6BN (14,006), VU2LU (14,080), KR6CF (14,083), PK1TM (14,018) and a PK5. Jim's traps haven't yet been sprung by FB8ZZ (14,031), HC2OT (14,027) and CN8EJ (14,011) . . . When roosting squinch owls aren't soaking up too much r.f. on W4CY's beam, JB is able to raise people like FM7WF, YU3FLB, ZS3K, F9GV/FC in Corsica, 3V8BB, PK4KS, TA3GVU, some VP8s and a CR5 . . . When W5FXN's DXCC diploma arrived his receiver blew up. But that deterred Jim not much: VQ8AF (14,102), VQ4KIF (14,025) and VP8AI (14,010) were hooked and he still has FO8s AD (14,023), AG (14,150), SV0UN (14,025), VP8AP (14,028) and VQ3BIF (14,078) under close surveillance . . . W9AHP's new semi-wide-spaced spinner simplified the raising of SP5ZPZ, ZS3S, EA6AF (14,035), VU2DJ (14,112), CS3AA (14,120), VQ2AB (14,050), LX1JW, CR6AW (14,040) and sundry others . . . The famous 40-watter, W2QHH, scared up SP1JF (14,069), 4X4DF (14,023), YO2BF (14,113), JA2DD (14,021), YS2LF (14,000), PK4DA (14,105) and VP5BE of the Caymans (VFO t7) . . . KV4AA notes that HR1s AT, DF and RL can frequently be found in a three-way on 14,001 kc. Dick also has a nice possibility in ZA2V (14,047) . . . URDC's *Universalia* specifies goodies ZD6JO, HLIUS (14,090), KB6AF (14,005) and VR3A (14,085) while TSARS' *Sparta* has the Hoosier gang scrambling for ZA2B (14,021) and VQ8AS (14,080) . . . W4BRB latched on to W4LVV/F8S, YA3B (14,042) and EA0AB (14,051). Among the 'phone adherents, W5ASG found VS1AY, PK3CS, ZC6DH, VP1NW, JA0IJ, FO8AD, KW6AP and KX6BA workable and W6AM hears that VR1F of the British Phoenix Isles is going to try A3 . . . YJ1AA (14,395) schedules KH6BA and VR3C (14,150) dittoes



KH6OA according to KV4AA Costa Rican conditions aren't had at all, judging from TI2HP's collection: EAa 6AF (14,340), 8BC (14,180), 8HS (14,180), EL5A (14,350), CS3AA of the Azores (14,345), DU1FH (14,160), VK1RB on Macquarie (14,150), VR2BT (14,285), ZK2AA (14,285) and one UP7NJ who checked okay with the beam but whose prefix seems strictly from hunger CN8EJ considers F08AB his best 20'-phone DX during his first month of operation.

Forty is experiencing a boom due to the nightly demise of 14-Mc. conditions. This band bears close scrutiny. For instance, W1ZL bumped into VK6DJ just before dark one evening. He also works ZS1JP at supertime and bagged the following on frequencies between 7000 and 7050: VP7NQ, TI2PZ, ZS5LB/CR6, ZE2JN, YU3FMA, LU9s CK, XQ and ZS2Q in addition to the more common species HK4DP (7020), KV4AU (7025) and CT1PM (7045) took W1SVL's 50-watt bait and W2QHH adds EA9AP (7006) At W9YDP we find ZS5LB/MM, VP9ZZ (7014), VK6AS (7050), YV6AO (7050) and a flock of VK/ZLs while W2OLU parried an LA4ZZ (7065) "78 north latitude" W1SVL and WISWD dug into the umpteenth layer and brought up one QZ5AK (7010) who said he was running ten watts on Tanau Cay, 150 miles south of Key West. Guess this is Cuban territory—odds bodkins, what next? Well, next we have another one, an MX1AF (7015 t7) donated by W6NGA. Manchuria or vicinity, hopes Bob Seattle's W7LFL worked W2QXB/MM (7000) off Greenland, VR2AS, KG6GU, YN3CP (7040) and FG8A (7015). The latter vows to QSL, by gosh The QRP Department this month is headed by W1MWK who raised F9YK, XE3K and 2 Gs while running 0.9 watt to a 50B5 final on 7100 kc. Antenna? Sure, an end-fed full wave VO4K and VK3AZW welcomed newcomer W2CXG to the DX game and W2EWZ finds the raising of ten different countries a normal evening's work in N. J. W4PRL's 35-watter cornered many besides KS4AC and HH2JC A new 807 and a 7280-kc. crystal from W2TXB may give us a crack at CR5AE ere long FM8AD (7005 t8) continues to decorate forty's low edge and EA8BC (7025 t4), C8KY and VQ8CE have been reported thereabouts.

Before we give ten back to the Indians, let's be magnanimous enough to give it one more chance. Anyway, W2ZVS refuses to throw in the towel. Dixie ran the gain up for ZE3JT, ZE2JE, ZB1H, ZS30, CN8s EG, EJ, MF2AA, MI3XX, OQ5NK, EK1RW, PJ5FN, FA3JY, JA2DJ, VPs 2GG, 6KM, CR6AV, KG4AK and a host of ZL/ZS fellows OQ5BR, VQ4ERR (28,300) and ZD1SW (28,432) answered TI2HP Those were all on voice, of course. But if you were optimistic enough to flip on the b.f.o. you might have heard such brave men as ZS3K (28,090), VQ2AB (28,045) and VQ9AA (28,015) trying to rally some c.w. activity against the solar onslaughts.

As for eighty, she blows hot and cold. The situation may be summed up adequately with excerpts from W4BRB's 3.5-Mc. notebook: Using a crystal donated by W2QHH, HRIAT (3516) brought joy to KV4AA, W4BOD, W1DHD, W4BRB and others. VP9ZZ (3515) and PY7WS (VFO, low end) were other actives. PY7WS made it WAC with a heap of ZL/VK QSOs; Batista also has skeds with ZM6AK (3515) but results are unknown as yet. TI2PZ and VP1AA both promise 80-meter activity in the weeks to come. Keep a lookout for FY7YB, crystal-controlled on 3516/3525.

One-stay promises to enjoy a busy winter season, PY7WS and G6ZO starting the ball rolling with a top-band QSO.

Where:

Bejebers and begorrah. WIDJV dug a new QSL bureau address out of the mail for your EI-bound QSLs: I.R.T.S. QSL Bureau, 97 St. Stephens Green, Dublin, Eire Although the prefix for Cyprus has switched from MD7 to ZC4 you needn't throw out the old QTH list. The last two letters remain the same in each case of change.

AP2N N. P. Henry, % Harbour Police, Karachi 7, Pakistan
 C1BC Chas. P. C. Wen, P. O. Box 409, Shanghai, China
 C1RL (QSL via W6BES)
 C9AA Box 508, Talienwan, China
 EA8AT P. O. Box 215, Tenerife, Canary Islands
 EA9AP (QSL via URE)

EK1FF (QSL via EK1AO)
 ET9X (QSL via ARRL)
 FF8MH M. Henry, Poste Restante, Dakar, F. W. A.
 FK8AD (QSL via REF)
 FL8AM % Father Henry, Djorn, French Somaliland
 MI3XX APO 843, % PM, New York, N. Y.
 MI3ZJ P. O. Box 247, Asmara, Eritrea
 MS4A (QSL via IIOJ)
 OE1KR (QSL via RSGB)
 PJ5RE (QSL via W8NKU or W4JDR)
 PK1AF (QSL via PARI)
 PK1SH (QSL via PARI)
 PK3MR M. R. LeCotey, Box 322, Soerabaja, Java
 SV0UN Mediterranean Hotel, Salonika, Greece
 SV9WM M/Sgt. G. M. Lawson, APO 206, % PM, New York, N. Y.
 VK1HV M. H. Jause, Wireless Opr., Australian National Antarctic Research Exp., Heard Island, Antarctica, via Melbourne, Australia
 VK1RA R. W. Allison, 98 Wardell Road, Dulwich Hill, NSW, Australia
 VP3FD Frank C. DeFreitas, 124 Parade St., Kingston, British Guiana
 VP3RG R. E. Greene, Atkinson Field, British Guiana
 VP3TF V. T. Foo, Atkinson Field, British Guiana
 VP3YG D. E. Yong, 22 Sussex Street, Charlestown, British Guiana
 VP5BI Leslie Dewdney, 67 Sandhurst Crescent, Half-Way-Tree, Jamaica, B. W. I.
 VP5BL Vin Hayes, % Hayes Radio Service, 127 1/2 Water Lane, Kingston, Jamaica, B. W. I.
 VP9ZZ Box 315, APO 856, % PM, New York, N. Y.
 VQ3KIF (QSL via SARL)
 VQ9AA (QSL via RSGB)
 VR1A Chas. Adams, % Radio Station, Betio Tarawa, Gilbert Islands
 VU2BF C. S. M. Thompson, Army Hq. Sig. Regt., New Delhi, India
 VU2CN Capt. Jagbir Singh Nanda, 2 Coy, South Comd. Sig. Regt., Colaba, Bombay, India
 VU2ZK Prof. S. P. Chakravarti, Govt. Engineering College, Jubbulpore, India
 YA2B (QSL via W2SN)
 YO3RZ (QSL via AAUSR)
 ZE2JE Box 460, Salisbury, Southern Rhodesia
 ZS5LB/MM (QSL via SARL)
 3A2AB (QSL via DL4 QSL Bureau)
 3V8BB V. Mazzanti, 23 Bis Rue de Marseille, Tunis, Tunisia
 4X4CW H. Osrin, Box 3080, Tel-Aviv, Israel

The majority of these were excerpted from the mail of W1s APA IKE SVL, W2s CJX JBL ZVS, W3LMM, W4s CYY JDR, W5FXN, W6NTR, W8s DAW DFQ, W9s CFT DOQ TRD YDP, KL7SF, VE1DB, the No. Calif. DX Club, and Messrs. J. MacPherson, M. K. Hare.

Tidbits:

Those robust signals labeled HZ1JD and HZ1JB on the low edge of twenty meters had some of the frat goggle-eyed but they're perfectly legit though undercover. A Wilcox rig



Bartolome Pina Cortes, EA6AF, is equally at home and equally popular on 'phone and c.w. (Photo courtesy XE1AC)

hooked to one of several available 800-foot diamonds did the trick most of the time while a revamped Signal Shifter at ten watts input plus dipole antenna was also employed. W2ARE, W1HA and W4KH answered the first CQs out of Jeddah. QSLs for contacts with these stations will soon be forthcoming, we are told. There may be another HZ active soon in addition to HZ1s KE and HZ. . . . If you're just about ready to apply for the HK certificate as outlined in the August issue, shame on us. HK1DZ, through W9GUV, notifies us that *any* ten HK cards will not do; they must all be from the HK1 call area. "If we should have decided to grant this certificate for the whole of Colombia, that is, from HK1 to HK8, we should have made it, we believe, very easy for our radio ham friends." . . . DL1CU writes to tell us that the DARC elections bring to duty the following officers: DL1FK, president; DL1KV, vice-president; DL7AA, test manager; DL1BA, QSL man-

THIS IS PJ5RP

There are a few cases of spontaneous combustion, but it usually takes a spark of some sort to start a fire. We'd like to introduce you to the spark that started a blaze of amateur activity in PJ-land—Harry Dudart.

ARRL began hearing from Dudart regularly a couple of years ago, when he ordered about 150 copies of the *Course in Radio Fundamentals*. Dudart was working for the Aruba Trading Company in N.W.I. and was somewhat dismayed that ham activity there was nil. Not only was it unrecognized by the government, but there were few inhabitants with the necessary knowledge. There were apparently a good many fellows interested in the idea, however, and Dudart took it upon himself to get things started. He began by organizing clubs in various towns, each club having at least one person who was qualified to give theory and code instruction.

Those of you who work DX know that this instruction bore fruit. One by one, PJ signals began to be heard. It wasn't easy, for radio parts were hard to come by and the government looked upon ham radio with no enthusiasm whatsoever.

That matter of government sanction proved to be the hardest nut to crack. Technical training is only a matter of time, and there are ways to get radio parts; but repeated correspondence and confabs with government officials bore no fruit. It later came to light that the official in charge of radio affairs had merely filed away in a deep drawer all the requests for amateur licensing. Affairs might have continued in that vein for some time had not something happened which blew the lid off the pot.

Late in September, 1950, the police paid Dudart a visit, confiscating his transmitter and subjecting him to exhaustive questioning. The other hams in town got wind of what was going on, and most of them took precautions to hide their equipment.

The PJ fellows immediately carried their story to every influential person they could contact, leaving no stone unturned, and a meeting was finally arranged with responsible government authorities. One of these government men turned out to be the newly-appointed official in charge of radio, who had a more sympathetic attitude toward ham radio. The result is that rules and examination procedures are being drawn up through the cooperation of both government and amateur representatives, and a notice has been published in the newspaper that those who want amateur licenses may apply through the Governor.

Dudart is quite philosophical about the whole affair. You see, he went through all this in Holland, where he operated under cover before licenses were issued. Arrested four times and jailed for a week, Dudart had his troubles as n0RP and PA0RP. But it's all worth while, says he, for without doubt there will soon be many PJ stations on the air legally. And it looks to us like the PJ fellows—and all of ham radio—owe Harry Dudart a vote of thanks.

— R. L. B.

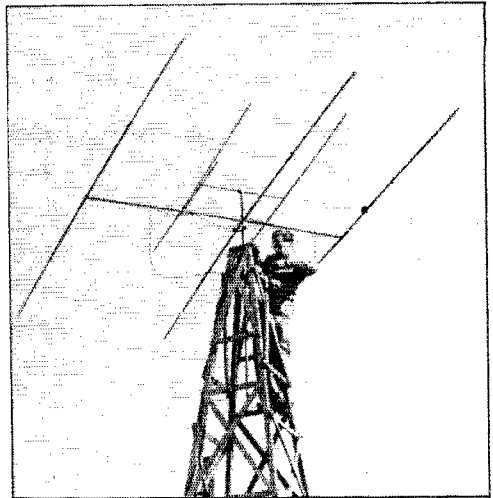

Formerly DX editor for Argentina's *Radio Onde*, Lucho Moreno Quintana of LU8BF tunes up his six-over-ten in Buenos Aires.

ager. The organization was made more centralized and there is representation for 13 DL districts. By the way, the limitation date for QSLs to qualify for the DARC's WAE (Worked All Europe) award has been moved from December 1, 1949, to June 1, 1946. If in need of full particulars, write the Secretary, DARC. . . . The latest report from CN8EG (W1PWK) has 500 QSOs in his log and 478 QSLs already issued for 72.5 hours of operation. Sounds like Steve has manufactured his own personal version of a combined Sweepstakes and DX Test—more power to him! . . . There has been a temporary ban on HB portable work in HE-land (Liechtenstein) points out W2QHH. Howy had been hoping to whip up some 80-meter activity in this vicinity during the present season. . . . Newly-active CN8EJ finds Moroccan conditions radiowise as good as CN8EG proclaims them. James tallied WACs on 10 'phone, 20 'phone and 20 c.w. in a month's operation. CN8s may run 50 watts on bands below 28 Mc., 100 watts on frequencies above. . . . All DK stations other than DK8 aren't necessarily phonies finds W3DJD. He has QSLs from French-zone DK9s KK and UU to prove it. . . . Through the close cooperation of the printer's imp we were able to include an interesting puzzle in the October number. Those who were able to find W9LM's 40-meter rotary and F9HE's compact layout may step to the head of the DX class.

Be wary of working stations in the ham bands bearing numeralless calls (like GKNW, ZPN, etc.) as such action may result in FCC cites. Occasionally special authorization is given for communication along this line as in the case of noteworthy aircraft flights, et al, as announced in *QST*. Under any other circumstances, ignore 'em. . . . "The ARALV (CM6/CO6) gives a neat certificate for a QSL from each of the Cuban districts (CM9/CO9 excluded because this does not apply to a geographical area)," informs W2QHH. . . . PA9OK is moving to the U. S. A., says W4CYY. W4PBD will sked him in New York City. Rumor has it that W4CYY sits up all night with a shotgun guarding his new AC4NC QSL! . . . Something went awry with the gear so HC8GI didn't make the air from the Galapagos after all. HC2JR mentions that HC8GI will make another bid in January. No W has yet claimed a WHC diploma, incidentally. Qualification depends upon contact with a station in five of the eight Ecuadorian call areas. No QSLs need be submitted; just full QSO data for log check is required. A special version is available upon contact with seven call areas; there are no HC3s on the air or licensed. Write the Guayaquil Radio Club, P. O. Box 784, Guayaquil, Ecuador, for more complete details.

Via W9NZZ we hear that ZS6OS is anxious to fulfill his QSL obligations for portable-ZS7 operation. Write Dan direct. . . . Ex-JA2BH is now on the air as W9QBI and old VO2G is signing KL7UA. . . . "The road to

(Continued on page 118)

Announcing 10-Meter WAS Contest

CONTEST PERIODS

Time	Start	End
	Dec. 8th and 15th	Dec. 10th and 17th
EST	6:00 P.M.	6:00 P.M.
CST	5:00 P.M.	5:00 P.M.
MST	4:00 P.M.	4:00 P.M.
PST	3:00 P.M.	3:00 P.M.

NEEED a card from Vermont or Rhode Island or Idaho to round out that 10-meter WAS? If so, here's an opportunity to acquire these valuable pasteboards and at the same time enjoy two week ends of operating fun.

If you were one of the gang who took part in the last Worked All States Contest, you will know what we mean. No one reached the total of 48 states worked but this time it may be a different story, so oil that bug and polish that mike and get set for a lot of pleasure.

If you are located anywhere in the League's field-organization territory (see page 6, any *QST*), you are cordially invited to take part in this operating activity. Contest reporting forms will be sent to all amateurs who request them but it is not necessary to use these forms if the sample form shown is followed. Total available operating time is 96 hours. C.w. to c.w., 'phone to c.w./c.w. to 'phone, or 'phone to 'phone may be used.

Now is the time for you to complete that WAS list. How many states can you work, OM?

10-METER WAS CONTEST REPORT

Station..... Location.....

Date and Time	Station	Report Sent	Report Received	Location	Number of Each New State as Worked
Dec. 8					
6:01 P.M.	W9MIR	57	58	Ill.	1
6:03	W5DEW	56	57	Texas	2
6:06	W5OQT	45	46	Okla.	3
6:10	W9ICW	58	59	Mo.	4
6:13	VE4AB	579	57	Man.	-
6:18	W9RBI	57	56	Wis.	5
6:21	W9YMF	58	599	Ill.	-
Dec. 9					
3:00 P.M.	W4NFY	57	57	Fla.	6
3:06	W8TT	59	59	Cal.	7
3:10	W9CFT	589	579	Wis.	-
3:13	W6AM	569	589	Cal.	-
3:17	KP4AB	59	59	P. R.	-

Number different stations worked 12

Number different states worked 7

(Claimed score: 12 points \times 7 states = 84)

I have observed all WAS Contest rules as well as all regulations established for amateur radio in my country. My report is correct and true to the best of my knowledge.

Signature.....

Address.....

Rules

- 1) *Eligibility*: The contest is open to all radio amateurs in the sections listed on page 6 of this issue of *QST*.
- 2) *Time*: All contacts must be made during the contest periods listed elsewhere in this announcement.
- 3) *QSOs*: Contacts must include report received and sent, location of station worked.
- 4) *Scoring*: One point is allowed for each contact and one multiplier point for each new state worked. The same station may be worked but once during the contest for credit. The final score equals the total contact points multiplied by the total number of different states worked.
- 5) *Reporting*: Contest work must be reported as shown in the sample form. Closing date of entries is January 15th, 1951.
- 6) *Awards*: A certificate will be given the highest scorer in each section.

WWV-WWVH SCHEDULES

FOR the benefit of amateurs and other interested groups, the National Bureau of Standards maintains a service of technical radio broadcasts over WWV, Beltsville, Md., and WWVH, Maui, Territory of Hawaii, on the following schedules:

The services from WWV include (1) standard radio frequencies of 2.5, 5, 10, 15, 20, 25, 30 and 35 Mc., (2) time announcements at 5-minute intervals by voice and International Morse code, (3) standard time intervals of 1 second, and 1, 4 and 5 minutes, (4) standard audio frequencies of 440 cycles (the standard musical pitch A above middle C) and 600 cycles, (5) radio propagation disturbance warnings by International Morse code consisting of the letters W, U or N, indicating warning, unstable conditions, or normal, respectively.

The audio frequencies are interrupted at precisely one minute before the hour and are resumed precisely on the hour and each five minutes thereafter. Code announcements are in GCT using the 24-hour system beginning with 0000 at midnight; voice announcements are in EST. The audio frequencies are transmitted alternately: The 600-cycle tone starts precisely on the hour and every 10 minutes thereafter, continuing for 4 minutes; the 440-cycle tone starts precisely five minutes after the hour and every 10 minutes thereafter, continuing for 4 minutes. Each carrier frequency is modulated by a seconds pulse which is heard as a faint tick; the pulse at the beginning of the last second of each minute is omitted.

Station WWVH, operated to provide coverage of the Pacific area, broadcasts on an experimental basis on 5, 10 and 15 Mc. The program of broadcasts on the three frequencies is essentially the same as that of WWV. Reception reports indicate that WWVH is received at many locations not served by WWV, thus extending the area served by standard frequencies and time signals. Time announcements in GCT are given from WWVH every five minutes by International Morse code only.

Operating Article Series To Be Resumed Next Month

- An extremely tight space situation in this issue, imposed by publication of the *QST* Annual Index and results of the 1950 Field Day, has made it necessary for us to omit installment No. 5 of the popular ARRL series on amateur operating. We shall resume next month with WIHQ's interesting and informative article, "V.H.F.: Why — How — When?"



The World Above 50 Mc.

CONDUCTED BY E. P. TILTON,* WIHDQ

AS IT HAS every year since 1946, October brought at least some sign of international DX on 50 Mc., but if we needed proof that the peak of the sunspot cycle has passed we found it in the way that most U. S. 50-Mc. men were left out of the DX picture. By the end of October, 1949, there had been several fine South American openings, giving nearly all sections of this country a shot at Ecuador and Argentina, and some less widespread openings to Peru, but as we go to press the record for October, 1950, looks considerably less impressive. There is DX on 6 below the Equator, and we have our first instances of 50-Mc. DX work from the West Indies to South America, but most of the Ws have been waiting in vain, to date.

Tropospheric conditions have continued good through the fall, however, and plenty of nice work was done by this medium on both 6 and 2 in October. Jumping to 420, we find a new record for two-way work between home stations, with one operator now proudly exhibiting five states, four call areas, and 182 miles worked two-way on that band.

West Indies Activity on 50 Mc.

It has long been felt that the islands of the West Indies would be excellent places from which to work 50-Mc. DX. Again and again reports have come in that stations were due to hit the band in Cuba, Puerto Rico, the Virgin Islands, or in the string of islands that make up the Lesser Antilles, but until this month all these prospects have been somehow led astray. Thus, it is with great joy that we welcome to the 6-meter ranks VP2GG, of St. Georges, Grenada. Smitty promised some months back that he was going to be on 50 Mc. as soon as possible. Getting on a new band is not easy in a spot like Grenada. Parts don't grow in the radio store around the corner; they come hard. But Smitty made it, and after several evenings of hearing South American signals on 6 he made his first contact, with PY3BW, at 7 p.m. EST, October 10th.

This was undoubtedly the first 50-Mc. DX worked from the Windward Islands, and for all we have any record to the contrary, in all the West Indies. He worked LU5CK, LU6DO and LU4DI immediately thereafter. Smitty uses the same rig as on lower bands, a pair of 6L6s operating as a push-push doubler, at 25 watts input, feeding a 2-element array. His frequency is 50.088 Mc. He started hearing LU, YV and PY on Sept. 20th, and has noticed that if 10-meter signals show up from South America unusually late in the evening and with a pronounced flutter, the 50-Mc. band is usually also open. You'll find a picture of VP2GG in "How's DX?" in November *QST*.

* V.H.F. Editor, *QST*.

◆
This stacked antenna system for 420, 144, 50 and 28 Mc. at W8EP, Terra Alta, West Virginia, has provided many v.h.f. contacts with that rare state.

December 1950

The pipeline from Venezuela to Argentina is carrying 50-Mc. signals again this fall. YV5AC, Caracas, found the band open to Argentina on Sept. 20th, 22nd, 29th and 30th, Oct. 3rd, 5th, 8th, 9th, and 15th. PY3s were in Sept. 29th, Oct. 5th, 8th and 9th. HC2OT and OA4AE were worked on Sept. 30th, and Uruguayan stations on the 8th and 9th. Most of the familiar calls from last year appear on Jerry's lists, and several new ones are showing up.

CE1AH, Chuquicamata, Chile, found 50 Mc. open to Brazil and Argentina several times in late September, and has been running tests with ZS1T, who finds some signs of life on 6 in that direction. Ida has another Chilean convert in CE1CQ.

Tropospheric Openings on 144 and 420 Mc.

On 144 Mc. the news of the month is concerned mainly with some fine tropospheric openings. Though the months of September and October are normally periods when pronounced aurora may be expected, the disturbances so far have been mild by comparison with those of July and August, and little aurora work has been reported for October, up to our deadline on the 27th.

The first few nights of the month found a stable inversion over most of the East and signals were running at phenomenal strength from Nova Scotia to Southern Virginia during the night of the 2nd, and the following morning. VE1QY was working the Virginia W4s with signals of almost local character through the early morning hours of the 3rd. He was back on again in mid-morning, to hook up with W4CVQ, Fayetteville, N. C., a distance of more than 900 miles. This is by about 200 miles the best hop that has been worked on 144 Mc. along the Eastern Seaboard, and is probably not much too less than the maximum that could have been worked under the conditions. A series of storms in the Gulf and West Indies provided a barrier at the southern end.

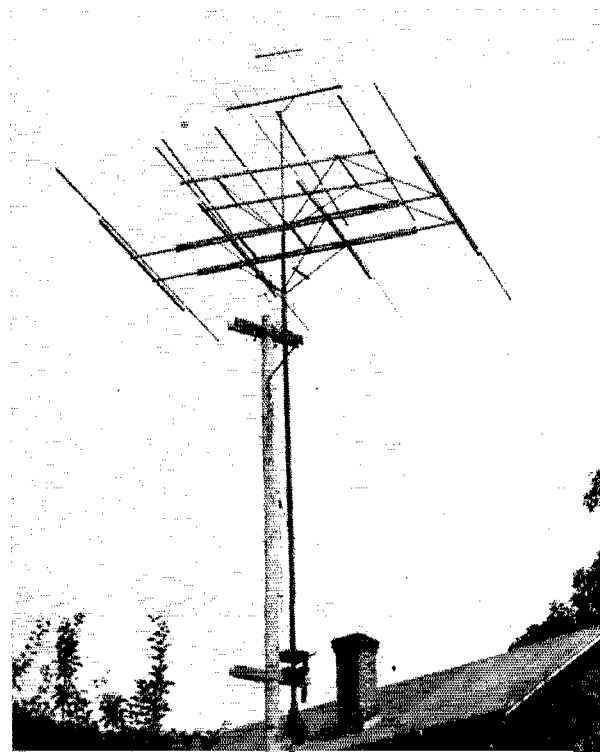

Still, the signals over the long haul were extremely strong, making one wonder when the sweep will be extended to South Carolina or Georgia, if not Florida!

Riding this same fine inversion, W2QED, Seabrook, N. J., got some of the gang around Norfolk and Hampton, Va., to change to 420 Mc., and at 12:45 A.M. on the 3rd two-way contact was established with W4ODG, Hampton, a distance of 185 miles. This is the best two-way DX yet reported between home stations on 420. W2QED also worked crossband with W4CLY, Cape Henry, who replied on 144 Mc., around midnight, and again at 8:54 A.M. W4NRK, Newport News, Va., was heard at 11 P.M. on the 3rd.

During the evening of the 3rd, W2BAV, Claryville, N. Y., had a short opening to the west. Around 9 P.M. W8BFQ began coming through with a strong signal, with news of business to the west. Soon the W9s began to come in at Claryville, and contacts were made with UCH, FPD, FVJ, VGD, JJU, NSF, UDD, ASM and ZHL before midnight. A feature of the evening for Bill was a contact with W4JDN, Erlanger, Ky., for state No. 20.

Oct. 6th-8th provided a tropospheric treat for the Middle West and South, with stations all the way from New Orleans to Chicago fattening their 144-Mc. states totals. W5MXJ, New Orleans, La., was the man of the hour for W9EQC, Aurora, Ill., and W9EHX, McLean, Ill., giving them a choice new state and DX of 820 and 740 miles, respectively. W5JTI, Jackson, Miss., worked W9s WOK, NFK and EQC. Between 9:10 P.M. on the 6th and 2:33 A.M. on the 7th, W4HHK, Collierville, Tenn., worked W4FBJ, Glasgow, Ky., W9SBZ and W9UCH, Ft. Wayne, Ind., W9LIR,

Champaign, Ill., W9EQC, W5MXJ and W5QER, New Orleans (off the back of the beam!), W9LF, Creve Coeur, Ill., W9SUV, Arcola, W9MAL, Peoria, and W9NFK, Franklin Park. Paul found the band hot to the south at 7:15 A.M. on the 8th, with W5MWW, New Boston, Texas, coming through. By 9:30 A.M. he had worked W5ML, Oil City, La., W5AQS, Palmer, Texas, W5FBT, Slaton, and W5s FEK and FSC of Houston. During this morning session W5ML made something of a local record, working five states in one hour flat. They included W4HHK and W5s MJC, AQS, EVQ, and RCI, for Tennessee, Arkansas, Texas, Louisiana, and Mississippi, respectively.

Another nice set-up moved across the eastern part of the country on Oct. 16th and 17th. Beginning at 8:30 P.M., W2BAV noted an f.m. station in Washington, D. C., coming through well on 106 Mc. At 8:30, W2OWF, Rochester, was worked. This was followed by 420-Mc. workouts with W2BQK and W2PT, about 100 miles to the south, but a check with W2QED was unsuccessful. At 10:30, W8DUL, Ypsilanti, Mich., came in, along with W8BFQ and W8WXV. The latter reported that W8EP, Terra Alta, W. Va., was coming through, and arranged a contact between him and W2BAV, for Bill's state No. 21. W4JDN, Erlanger, Ky., and W4RL, Herndon, Va., were also worked, but the southern W4s (so easily worked on coastal inversions) were conspicuous by their absence. The good paths were all west or southwest. This opening cleared the way for VE3AIB, Toronto, who picked up No. 12 in W4OXC, Louisville, Ky. He heard W4JDN, and W2PAU and W2NLY.

By the evening of the 17th the trailing edge of the big high had moved nearer the East Coast. By 8:18, W2BAV was coming in at W8EP, starting Smoke off on an unprecedented series with happy W1s, 2s and 3s, as follows: W1IZY, Middleboro, Mass., W1BCN, Hyannis, W2NLY, Oak Tree, N. J., W2QHZ, Brooklyn, N. Y., W1MNF, E. Orleans, Mass., W2AZL, Plainfield, N. J., W2GJC, Rahway, W1HDQ, Canton, Conn., W3OXQ, Almont, Penna., W1DJK, Osterville, Mass., W2FEJ, Little Neck, L. I., W1KTS, Waterbury, Conn., W2JRP, Caldwell, N. J., and W3OWW, Stewartstown, Penna.

While all this was going on, the stations around Washington, D. C., were pounding into W1, yet no sign was heard of the Cape Henry and Norfolk areas. Again and again through the summer and early fall it had been possible for those fortunate fellows who are situated close to the salt water to work the 500 miles from Cape Cod to Cape Henry, often with S9-plus signals, on nights when other stations, not more than 50 miles inland, have heard little or nothing. This was a rarity for the eastern 2-meter gang; a pure continental air-mass phenomenon, completely without the much more common coastal inversion. If you can lay hold of the series of weather maps for Oct. 16th to 18th, look them over carefully. There was never a better example of the trailing-edge phenomenon, uncomplicated by coastal inversion effects.

We hasten to remind those who may take the "Hoisington High" theory¹ too literally that it is not the barometric pressure gradient that causes the bending, but rather the air-mass discontinuity that accompanies it. The high-pressure areas on the weather maps are merely a means of spotting points where discontinuities are most likely to occur.

Here and There on 6 and 2

Wiesbaden, Germany — There is a growing weather consciousness among the DL 2-meter gang, according to DL4CK. Jack says that frequent checks are made with the local weather station, to determine when conditions are favorable. The telephone and the facilities of ham stations on lower bands are then used to line up stations in the right directions. The first 2-meter contact with the Munich area from Wiesbaden came about when DL4XS and DL4CK heard DL4DD in Freising testing. Without waiting for him to stand by, DL4CK put through a call on the landline, and the 180 miles of mountainous terrain was bridged for the first time; honors going to the DL4XS/DL3KE joint station atop the Hohe Wurzel. This was on Sept. 11th, and on the 12th the band broke wide open to England. A new European record of 520 miles was set by DL4XS and G2BMZ, and DL4XS worked at least 18 other Gs in the course of the evening session.

The first contact with Switzerland came during a field

¹ "Painless Prediction of 2-Meter Band Openings," Hoisington, October, 1949, QST, page 22.

2-Meter Standings

Call			Call				
States	Areas	Miles	States	Areas	Miles		
W1HDQ	16	6	650	W8ZEM/8	1	1	415
W1IZY	14	5	570	W6GGM	1	1	300
W1MNF	14	5	570	W6YYG	1	1	300
W1BCN	13	5	500				
W1CTW	12	4	500	W8WJC	20	7	775
				W8BFQ	20	7	775
W2BAV	21	7	1175	W8WXV	18	8	1200
W2NLY	18	6	750	W8UKS	18	7	720
W2PAU	15	6	740	W8EP	17	7	---
W3DFV	13	5	350	W8WRN	16	6	670
W2CET	12	5	405	W8RWV	14	7	500
W2DPB	12	5	500	W8WSE	14	6	620
W2QED	12	5	365	W8CYE	12	6	---
W2FEJ	12	5	---	W8CPA	12	---	650
W2QNZ	12	5	---	W8FQK	11	7	---
W3RUE	16	7	760	W9EQC	17	7	820
W8LNA	14	7	720	W9UCH	17	7	650
W3KWL	14	6	480	W9WOK	15	7	690
W3KBA	13	6	---	W9FVJ	15	6	660
W3OWW	13	6	600	W9NFK	12	7	600
W3GKP	13	6	610	W9PFE	11	5	800
W3KUX	12	5	575	W9GTA	11	5	440
W3PGV	12	5	---				
W3NKM	12	5	---	W9NFM	14	7	660
W3LMC	11	4	400	W9EMS	13	5	1080
				W9ZJB	12	7	1097
W4HHK	14	5	650	W9IHD	12	5	725
W4JDN	13	6	---	W9WGZ	11	5	760
W4LKZ	13	5	720	W9ELY	8	3	---
W4JFU	13	5	650	W9JHS	7	3	---
W4CLY	12	5	720				
W4FJ	12	5	700	VE3AIB	12	6	600
W4MKJ	11	5	650	VE1QY	11	4	900
W4OXC	10	5	500	VE3BQN	6	4	540
W4JFV	9	5	830	VE3DER	6	4	450
				VE3BOW	6	4	415
				VE3BPB	6	4	---
				VE3EAH	5	4	380
W5JTI	14	5	670				
W5ML	8	3	725				
W5ERD	8	3	570				
W5VY	7	3	1200				
W5AJG	7	2	450				
W5FBT	6	2	500				
W5FEK	6	2	500				
W5IRP	6	2	410				
W5JLY	4	2	650				
W5FSC	4	2	500				

day on Sept. 16th, when DL4AY, operating portable atop the Hohe Wurzel, worked HB9HK. Many of the DL gang were hearing HB9HK, from less favorable locations.

The Freising-to-Wiesbaden telephone warning circuit worked in reverse on Oct. 12th, when DL4CK received a call from DL4DD to the effect that conditions were good between the two areas. This netted DL4CK his first contact in that direction from his home location. Following the initial work at 6:45 P.M., half-hourly schedules were kept until 11:30.

Now that 2-meter activity is beginning to roll, the DL boys are looking around for chances to crack the 1200-mile record. There are no European stations far enough apart for this, so DL4s XS and CK are working on MD2AC in Tripoli. They expect to have him in business before the summer season.

As in many places in this country, it has been shown that mountainous terrain is no certain barrier to 144-Mc. signals. DL4DD received word that his signals were copied S9 in Marseilles, a distance of more than 400 miles over the Alps, one evening in early October.

Bedford, Nova Scotia — In the hope of flushing out some Ws by means of aurora propagation, VE1PQ is operating nearly every day between 3:30 and 5:30 P.M. EST on 50.15 Mc. He would like to have 50-Mc. men keep this in mind, and remember that aurora signals may come from slightly east of north, at times. Doug has just moved to a new location that should work out very nicely for v.h.f. purposes.

Westfield, N. J. — Hearing that W2AF (owner of one of the most potent 50-Mc. mobile rigs in the East) was going to be traveling through West Virginia on his vacation, W2IDZ thought that this was too good an opportunity to let pass. There are several 6-meter stations in that state, but they are all so situated that they have never worked out to the northeast except by sporadic-E skip. Last summer and in '49, quite a few of the W1s had caught that rare state on extremely short E-layer skip, but the W2s were just too close for that sort of thing.

W2AF arranged a series of 50-Mc. tests in West Virginia on Sept. 29th, 30th, Oct. 1st and 2nd, planning to be on the air for three periods, at 8, 8:30 and 9 P.M. On the 29th, Goy'n set up for business near Harpers Ferry, but W2MEU was the only station worked, and even this contact was made with very weak signals each way. Nothing came of the sked on the 30th. On Oct. 1st there he was, coming nicely at the sked time. This was it — almost. W2AF was operating in Front Royal, Va.! He promised to be at a high location near Martinsburg the following night, and was as good as his word. Though the waiting line had a few bad moments when Goy'n was late by a matter of some 7 minutes for the 8 P.M. schedule, he made up by working a bunch of W3s, W2s MEU, IQQ, AMJ, IDZ, CXE and PWP. The only W1 to catch him was W1CGY, who had missed out on the previous West Virginia chances.

Rochester, N. Y. — Has the trend to horizontal polarization discouraged you from using 2-meter mobile? W2QY felt that a horizontal mobile antenna for 144 Mc. was worth a try, so he made up a 2-meter version of the W1MUX "Halo" described in October 1947 QST, and in the A.R.R.L. Antenna Book. No attempt was made to tune it; rather, a folded dipole was made to standard dimensions of 0.143-inch aluminum wire, bent around into circular shape. The ends were held 1/8 inch apart with a split block of high-grade insulating material, and the system was fed with 300-ohm line. With this arrangement mounted 39 inches above the car top, Link is able to work fixed-station 522s out to distances of 25 miles or so nicely.

Los Angeles, Calif. — After many successful contacts with W6CTU, 150 miles to the north, in Porterville, W6NLZ is convinced that straight c.w. is the thing, and that much better distances could be covered regularly if more of the gang would get on regularly and use A1. Certainly his sigs don't just stop at Porterville. He is running automatic transmissions regularly on c.w., and would like to have stations at remote points listen for him and report any reception over unusual distances. He would also like to know the origin of the signal on 146.2 Mc. that is modulated with 1-second dashes of 45 cycles. The direction is about 345 degrees. W6CTU also hears it, at 335 degrees, indicating something in the Bay area.

Santa Cruz, Calif. — The tropospheric season begins in September and continues until around January, according to W6GGM. Like W6NLZ, he feels sure that many more contacts could be made if more operators would get on



Standings as of October 25th

W0ZJB	48	W5VY	47	W0HGE	47
W0BJV	48	W5JT	44	W0PK	47
W0CJS	48	W5ML	44	W0VZP	47
W5AJG	48	W5JLY	43	W0ALU	46
W9ZHL	48	W5ONS	43	W0NJT	46
W0ZHB	48	W5JME	43	W9QKM	46
W9QUV	48	W5VY	42	W0RQM	45
W6WNN	48	W5PAL	41	W0UIA	45
W6OB	48	W5NHD	41	W0UNS	42
		W5GNQ	41		
W1CLS	46	W5FSC	41	W0QIN	47
W1HDQ	46	W5HLD	40	W0DZM	47
W1CGY	45	W5HEZ	35	W0NFM	47
W1LLL	44			W0INI	47
W1KHL	43	W6UXN	47	W0TKX	47
W1HMS	43	W6LWS	41	W0KYF	44
W1LSN	41	W6OVK	40	W0JOL	44
W1EIO	40	W6TMI	40	W0JHS	43
				W0PKD	43
W2RLV	45	W7HEA	47	W0HVW	42
W2BYM	44	W7ERA	47	W0MVG	41
W2IDZ	43	W7BQX	45	W0IPI	41
W2AMJ	42	W7DYD	45		
W2MEU	42	W7JRG	42	VE3ANY	42
W2GGY	40	W7BOC	40	VE3AET	32
W2QVH	38	W7JPA	40	VE1QZ	32
W2FJH	37	W7FIV	40	VE1QY	31
		W7CAM	40	HC2OT	26
W3OJU	45	W7KFM	40	XE1GE	19
W3NKM	39	W7ACD	35		
W3JVI	38				
		W8QYD	45		
W4FBH	46	W8NQD	42		
W4EQM	44	W8YLS	41		
W4QN	42	W8GMS	41		
W4FWH	42	W8LBH	38		
W4CPZ	39	W8RFW	37		
W4OXC	39	W8UZ	37		
W4MS	39	W8WSE	36		
W4BEN	35				

Calls in bold-face are holders of special 50-Mc. WAS certificates listed in order of award numbers. Others are based on unverified reports.

with good beam antennas, sensitive receivers and higher power, even though the path down to Southern California is full of mountains, running up to 8000 feet. In some instances these mountains may be helpful, as a high-powered signal may scatter and cover quite a bit of territory after striking some of the higher peaks. For a while after the V.H.F. Party activity was low, but as word of the north-south DX contacts made during that affair got around there was a considerable pick-up, and recent evenings have netted numerous contacts with stations in the San Joaquin Valley. W6GGM works W6CTU, who, as reported above, works into Los Angeles, so liaison is established for future tests. The Fresno area has been represented by W6s JPU, SJS, UBK, PSQ, SRX, IMZ, JJE and EFS. The northern end of the San Joaquin Valley has W6s ERE, DUS, and FYM as regulars and CTU reports that the southern end has RJE, EHN and IMB on in Bakersfield. Around Monterey Bay are W6s KB, CCG, BUM and JCL. W6AJF, with high-powered controlled-carrier, n.f.m. (and TVI), has the outstanding signal from up north at W6GGM. From this list of calls it would appear that the reasons for lack of activity up and down California are just about the same as they are anywhere else: when there is no special incentive to bring a lot of fellows out, activity requires a little cultivating.

Jackson, Mo. — Working distances up to 800 miles or so is great stuff, but something more is needed to fill in when such openings are not in prospect. Providing regular work-outs is one of the ideas in back of the organization of a

Milwaukee to Jackson 2-meter net reported by W0PLJ. Beginning in early September, tests were scheduled for this circuit each Monday night at 7:30 p.m. The first attempt provided a complete circuit from W9AFT, Milwaukee, to W5JTI, Jackson, Miss., by way of W9EHX, McLean, Ill., W0KYF, University City, Mo., W0PLJ, Jackson, Mo., and W4HHK, Collierville, Tenn. The same circuit is also used to send information to W9NFK, from W5JTI and W4HHK.

The circuit was extended at each end on Oct. 16th, when a message originated by W0BJV, Watertown, S. Dak., at 7:10 p.m., traveled to W5JBW, Maplewood, La., in just under two hours. The reply giving this information was relayed back to W0BJV in one hour and 29 minutes. The routing was W0s BJV, AZE, SV, JHS, W9s FPE, AFT, LJV, ZHB, EHx, and the balance as before.

Such relaying can be used to stimulate interest and provide activity in almost any locality. It is in line with long-standing amateur traditions, it's good practice for possible emergency work, and what's more important, it's good fun. Have you tried it as a winter activity stimulus in your locality?

"Constant Modulation" on 50 Mc.

The modulation system described by W8YHR in *QST* for April and November looked like a good bet to W1KNI, Medford, Mass., so he decided to give it a try on his 50-Mc. 829B amplifier. The arrangement he uses is shown in Fig. 1. Selenium rectifiers are used in place of the tube rectifier used by W8YHR, and no negative voltage is applied to cut the carrier level when the modulation is off. With this arrangement a considerable carrier is transmitted at all times, but the level swings up by a matter of some 10 db. or so on audio peaks. Ken operates his 829B with as much as 1400 volts on the plates.

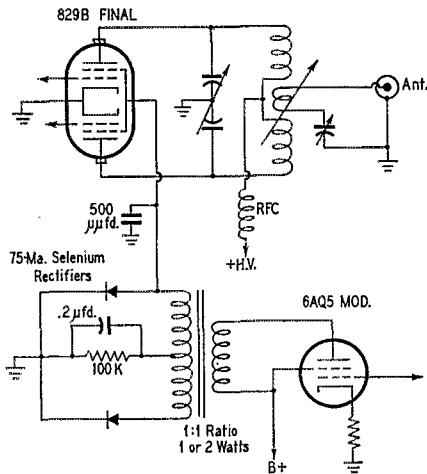

Fig. 1—The "constant modulation" system used on 50 Mc. by W1KNI. No negative voltage is supplied to the screen to cut the carrier off during periods of no modulation. The signal level swings upward by about 10 db. on modulation peaks, but the signal may be tuned in similarly to conventional a.m.

Because the carrier is not cut off, but only reduced, during periods of no modulation, the signal tunes in nearly like conventional a.m., though of course there is some S-meter swing. Listening to the signal at W1HDQ, some 100 miles distant, we find the signal as readable at low-signal levels as all but the very best plate-modulated outfits. Observers in the Boston area report that it sounds OK at close range as well. The system should be useful for mobile operation, and attractive to the c.w. man who wants to take a fling at v.h.f. voice work, but is kept from it by the cost and complexity of the gear required for plate modulation.

The World Above 420 Mc.

The 420-Mc. work with stations in Southern Virginia, reported earlier in these pages, is not all that W2QED, Seabrook, N. J., has accomplished recently. He has had more

than 30 contacts with W3OWW, Stewartstown, Penna., 75 miles away, and he works W3NAG, Havertown, Penna., and W2VWL, Glassboro, N. J., regularly. He has had cross-band contacts with W3BSV, Salisbury, Md., 80 miles. K2AH, East Orange, N. J., and W2BQK, Bergenfield, were worked two-way the night of the 21st, and K2AH again the following morning. W2TP was heard around 11 a.m. These are all in excess of 100 miles. Ken uses a 32-element flop-over array, working the W3s and 4s on horizontal and the northern W2s on vertical.

After a rather poor summer, G5BY finds things picking up on 420 Mc. this fall. He had crossband contacts with G6LK (who was on 145 Mc.) on Sept. 23th, 29th, Oct. 3rd, 4th, 11th, and 12th, without being able to hear G6LK on 420. They made three two-way contacts on the 16th, at 1855, 2055 and 2255 BST, all on straight c.w. This is a 161-mile hop, worked only once before two-way. G3CGE, 119 miles, was worked two-way also on the 16th.

On the 18th, G6LK was worked again, and during the contact G5BY was heard by a BRS (British equivalent of SWL) in London, about 180 miles. The listener advised several London stations of the reception, resulting in a 420-Mc. boom in the London area. Contacts with G6LK were made on the 19th and 20th, and G3CGE was worked on the 20th. The prize crossband contact was made on the 20th, with G2C1W, Rowford, Essex, 206 miles, Hilton's 420-Mc. sigs being reported S3 to 7.

The fall season has been producing strong signals between San Diego and Los Angeles on 420 Mc. W6RFW, San Diego, has worked W6GUE, W6IHK and W6NLZ. Attempts to correlate conditions on 144 and 420 have come to naught, according to W6CFL. W6NLZ says that the San Diego signals come through almost every evening, usually with extreme strength.

Not all the 420-Mc. work is concerned with trying to beat the DX record. Quite a bit of the interest in the band has resulted from the fact that it is the lowest frequency on which American hams can use A5 emission (television to patrons of the one-eyed monster). Working on 420 is just a means to an end for such fellows as W1BHD, Everett, Mass. Mel has a 5527 camera working, with an r.f. section ending up with an 832A straight amplifier. Reception is provided by a 6J6 converter similar to the one described in August *QST*, feeding into a standard TV receiver on Channel 6. His principal receiving customer to date has been W1KNA, who gets satisfactory reception of Mel's live pick-up. W1BHD would like to hear from others in his vicinity who are working on amateur TV.

New Record on 1200 Mc.

For the first time, we are able to list a two-way record on some band higher than 50 Mc. that is not held by a U. S. station. Over in England G8DD and G3QC had been working for some time on 2400 Mc., and had succeeded in working up to 46 miles two-way, but the lack of suitable locations made it difficult to try for something in excess of our 150-mile record. On 1200 Mc. the prospect looked better, the U. S. record being only 37 miles.

Using portable transceivers with British type CV-90 disc-seal tubes, feeding 18-inch parabolic-reflector antenna systems, G3QC operated from Merryton Low, a 1600-foot elevation near Leek, in Staffordshire, and G8DD was on Clee Hill, near Ludlow, in Shropshire, at an elevation of 1750 feet. Contact was made easily over the 60-mile line-of-sight path. This was on the morning of Oct. 1st. That afternoon G8DD moved to the Malvern Hills, a 1000-foot elevation in Worcestershire, 75 miles from G3QC. Again, communication was established, with signals S8 to 9, despite the fact that the path is not a completely clear one.

Thus we have two British hats in the u.h.f. records ring. Can anyone in this country do better than 75 miles on 1200 Mc.?

September V.H.F. Party — Final Results

As may be judged from the early highlights reported last month, the Fall V.H.F. Party, Sept. 23rd and 24th, found a wide variety of propagation conditions prevailing across the country. In the East both 50 and 144 Mc. were running at an all-time low, with only brief flurries of aurora on both days to provide any relief.

From the Alleghenies to west of the Mississippi a tropospheric opening Sunday night provided some good chances, reflected in higher-than-average scores by most participants in the Great Lakes, Central, and Midwest Divisions.

Only W2IQQ/2, of all stations in the East, managed to beat his June score. Operating from the same hilltop in North Caldwell, N. J., that he has used so successfully in the past, Wilson used 50, 144, 220 and 420 Mc. to run up the nation's highest score, 2646 points. Second high score for the entire country was posted by Margaret Roberts, W8BFQ, Everett, Ohio. Margaret used five bands (50, 144, 220, 420 and 2400 Mc.) to score 2088 points. She had the same multiplier as W2IQQ/2, and actually made five more contacts, but Wilson's extensive work in the pay-off bands, 220 and 420 Mc., gave him the edge.

A glance down through the scores will show that more contestants are making use of the higher bands to build up their scores. One would get the idea at times that there is little interest in the bands above 148 Mc., but we find 16 mentions each of the use of 220 and 420 Mc. The number of contacts made on these bands during the contest must have amounted to considerable activity, much of which might never have gotten there were it not for the contest incentive.

Once again we find at least two section awards going to the fair sex, and to the same two members, W8BFQ and W2FHJ. Margaret and Viola cleaned up the Ohio and N.Y.C.-L.I. Sections by wide margins over their nearest competitors.

The number of reports in the tabulation below is only a small fraction of the total number of stations participating. The poor conditions in some areas discouraged a number of operators who, had they taken the trouble to submit entries, might well have been section award winners. The Eastern Mass. Section leads in number of reports, 14. Western New York and Ontario show up well with 10 each. Illinois, Eastern New York, and Ohio follow with 8 each. Scores are listed by ARRL divisions and sections. The first column is the final score, followed by the number of contacts, the multiplier, and the bands used. A is 50 Mc., B 144, C 220, and D 420 Mc. or higher.

V.H.F. QSO Party, Sept. 23rd-24th

ATLANTIC DIVISION

E. Pennsylvania

W3FZQ 504-42-12-A-B
W3QMO 75-25-3-B
W3UKI 50-10-5-A-B

Md.-Del.-D. C.

W3PRB 228-38-6-A-B
W3LMC 192-48-4-B
W3WIT 36-18-2-B
W3HB 28-14-2-B
W3NH 24-12-2-B

W2FCG/2 69-23-3-B
W2ZRW 88-34-2-B
W2ZRC 64-32-2-B
W2ZUW 60-20-3-A-B
W2DV 22-11-2-B
W2VVG 22-11-2-B
W2OWF/2¹ 16-16-1-B
W2QXE/2¹ 11-11-1-B

W. Pennsylvania

W3KWH² 60-12-5-B
W3QZF² 36-9-4-B

CENTRAL DIVISION

So. New Jersey

W2BAY 54-9-6-A

W. New York

W2ZHB/2¹ 82-41-2-B
W2ZUX 72-20-3-B-D

Illinois

W9CGR 630-64-7-A-B-D
W9OBW 438-53-6-A-B-C-D
W9QKM 360-60-6-A-B
W9FVJ 328-41-8-B
W9IWE 285-33-5-B-D

W9DRN 230-34-5-B-D
W9KJU 99-17-3-B-C-D
W9CT 75-25-3-B

Indiana

W9HKQ 160-32-5-B
W9GTA 150-25-6-B
W9GLW 52-13-4-B
W9PEN 50-21-2-B-C

Wisconsin

W9PYM 192-32-6-A-B
W9PPE 60-15-4-B
W9TQ 5-18-3-B
W9HDZ 5-5-1-B

DAKOTA DIVISION

Minnesota

W9AAS 10-5-2-B

DELTA DIVISION

Louisiana

W6MKP 39-13-3-B

Tennessee

W4HHK 207-10-9-A-B-C

GREAT LAKES DIVISION

Kentucky

W40XC 300-30-10-A-B
W4JDN 60-15-4-B
W4RBK 14-7-2-A

Michigan

W8NNF 224-32-7-B
W8DIV 18-6-3-B

Ohio

W8BFQ 2088-88-18-A-B-C-D
W8LPD 369-41-9-A-B
W8LBH 102-14-3-A-C-D
W8BLN 60-20-3-B
W8WRN 52-13-4-A-B
W8FKC 39-13-3-B
W8UZ 36-18-2-A
W8QYD 12-6-2-A

HUDSON DIVISION

E. New York

W2PNQ 333-37-9-A-B
W2AUS 276-46-6-B
W2VRE 222-33-6-B-D
W2BVU 126-18-7-B
W2FV 124-31-4-B
W2NJF 120-30-4-B
W2EFU 112-28-4-B
W2YIK 56-14-4-A-B

N.Y.C.-L.I.

W2FHJ 884-68-13-A-B
W2AOD 322-34-7-B-D
W2DHB 300-40-5-B
W2ZSD 124-31-4-B
W2L GK 8-8-1-B

No. New Jersey

W2IQQ/2 2646-83-18-A-B-C-D
W2BQK 252-14-7-B-D
W2DZA 208-10-8-A-C
W2ZDR 130-26-5-B

MIDWEST DIVISION

Kansas

W0DVV 42-14-3-B

Missouri

W0MNNQ 130-18-5-B-C-D
W0IHD 68-17-4-B
W0NQC 45-15-3-B
W0VMU 4-4-1-B

NEW ENGLAND DIVISION

Connecticut

W1HDQ⁴ 1088-60-17-A-B-C
W1RWS⁴ 76-10-4-A
W1AW⁴ 64-16-4-A-B
W1DJV⁴ 57-19-3-A
W1KHM 39-13-3-B
W1QIB⁴ 27-9-3-A
W1PYO/¹ 26-13-2-B
W1IKE⁴ 22-11-2-A

E. Massachusetts

W1GJZ 936-78-12-A-B
W1QMN 410-82-5-B
W1BJN 316-79-4-B
W1MCR 236-59-4-B
W1MUD 210-70-3-B
W1NWL 171-19-9-A-B
W1BAQ 163-42-4-B
W1CTR 135-45-3-B
W1QOI 123-41-3-B
W1PYM 114-38-3-B
W1HIL 100-25-4-A-B
W1LYL 78-39-2-B
W1SQE 16-8-2-B
W1ALP 12-12-1-B
W1PLQ 10-10-1-B

W. Massachusetts

W1RFU/¹ 1008-47-16-A-B-C
W1JSM/¹ 414-69-6-B
W1CGY 372-31-12-A
W1OSA/¹ 224-32-7-B
W1NLE 108-19-4-B-C
W1PHU 10-5-2-B

New Hampshire

W1KEX/¹ 1316-83-14-A-B-C
W1LTO¹ 280-28-10-A-B
W1OSR/¹ 125-25-5-B
W1TBS 24-8-3-B

Vermont

W1CTW/¹ 1027-75-13-A-B-C

NORTHWESTERN DIVISION

Washington

W7GAH/⁷ 8-4-2-B

PACIFIC DIVISION

Santa Clara Valley

W6ZBS 70-14-5-B
W6GGM 60-15-4-B

East Bay

W6AJF 510-39-10-A-B-C-D
W6VDR/⁶ 15-3-1-D

San Francisco

W6BJR 90-15-6-A-B
W6SWP 60-15-4-B

(Continued on page 102)

¹ Multioperator station. Not eligible for award.

² Steel City Amateur Radio Club station, operated by W3RXT.

³ Horseshoe Radio Club station, operated by W3LJQ.

⁴ Headquarters staff member. Not eligible for award.

⁵ Pittsfield Radio Club station, operated by W1HAZ, W1HNE, W1DPY, W1SAN, W1IZN.



Hints and Kinks

For the Experimenter



SUBSTITUTE TANK CONDENSER FOR WIJEQ'S BANDPASS EXCITER

THE tank condenser used in the final amplifier of the "Two-Control VFO Rig with Bandpass Exciter"¹ described recently does not seem to be generally available at the present time. A completely interchangeable substitute for this important component (C_{54} in the original schematic diagram) can be home-built in a matter of minutes from a National type TMS-300 condenser by the following means:

Remove all of the stator plates from the condenser frame. This is a simple operation requiring only the releasing of the two tie bolts. Substitute four 1½-inch 6/32 machine screws for the original tie bolts, and make up two separate stator sections of six plates each. When mounting these stator sections position them so that the end plates are *outside* the two end rotor plates. Finally, remove the center four rotor plates. The resulting split-stator condenser is an exact substitute for the unavailable TMS-125-D.

— Phil Eckman, W3OEK

¹Chambers, "A Two-Control VFO Rig with Bandpass Exciter," *QST*, August, 1950, p. 24.

D.C. HEATER SUPPLY

THERE are times when a.c. heater operation results in undesirable hum effects, no matter how much care is taken to prevent it. Examples are the hum introduced in the first stage of a high-gain audio amplifier and the frequency modulation that often occurs in "hot cathode" oscillator circuits. The latter is particularly bothersome at frequencies of the order of 14 Mc. and higher in receiver h.f. oscillators and in VFOs.

A simple way out is to use a d.c. heater supply for the tube in which the hum or modulation arises. The circuit given in Fig. 1 will easily handle one 6.3-volt 0.3-amp. heater and has a ripple content of only about 3 per cent r.m.s. The rectifier is a rebuilt b.c. type selenium half-wave unit normally rated for 115-volt 100-ma. operation. These rectifiers consist of six plates, and when taken apart may be reassembled into

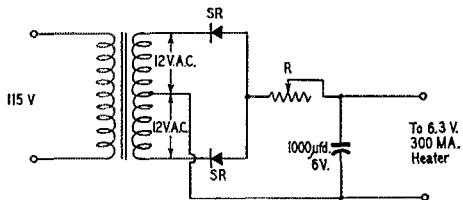

Fig. 1 — Circuit diagram of a d.c. heater supply for hum reduction in oscillators, speech amplifiers, etc.

a full-wave rectifier having three plates in parallel on each side. So connected, they can deliver 600 ma. without overload.

The selenium rectifier may be reassembled on the original support if additional soldering lugs similar to those on the unit are made from thin brass or other metal that will take solder.

The resistor, R , serves the dual purpose of adjustment of output voltage and of providing filtering in conjunction with the 1000- μ fd. condenser. With a center-tapped 24-volt filament transformer, as indicated in the drawing, a resistance in the neighborhood of 15 ohms will drop the voltage to 6.3 across a 300-ma. tube heater. An adjustable resistor should be used and the voltage set to the correct value by means of a d.c. voltmeter. Small 24-volt filament transformers have been on the market, but if not readily available it is not much of a job to rewind the secondary of the smallest size of 6.3-volt transformer. The output voltage is not critical, so long as at least 10 volts each side of the center-tap can be obtained, because any excess voltage drop can be taken up in the resistor.

While it is seldom necessary to handle two heaters (600 ma.), the rectifier is capable of it. To maintain the same filtering, the capacitance should be increased to 2000 μ fd. The resistance will be about halved because of the greater current drain.

These supplies should never be operated without the tube heater connected, because with no load the voltage will rise to a value that may break down the filter condenser. — George Grammer, W1DF

SIMPLE EXPERIMENTAL SHIELDING

IN the course of debugging some new equipment I felt the need for some shielding in certain spots. My living room shack is not equipped as a sheet-metal shop, so I borrowed some Reynolds Wrap aluminum foil from the supply used by the XYZ to wrap food for storage in the refrigerator. The foil was easily cut to the desired shape and size with scissors, and after determining just what shielding was needed, it was a simple matter to visit the shop of a friend the next day and cut and bend the desired shield for permanent installation in the rig. — John W. Weber, W9BDS

CONVERTING 28-VOLT D.C. RELAYS FOR 6-VOLT OPERATION

TO convert the small 28-volt relays used in most ARC-5 and 274-N receivers and transmitters for 6-volt d.c. operation remove all of the wire from the spool or spools and rewind them with No. 32 enameled wire.

By improvising a stand on which a spool of No. 32 wire can rotate with the pull, and by placing the spool to be rewound in the chuck of a drill press, the whole job can be done in less than five minutes. A long No. 6 screw in the base of the replay spool facilitates its replacement in the chuck. — *Arthur Worsnop, W2WBH*

ALL-BAND NEUTRALIZATION FOR BEAM TETRODES

THE purpose served by the circuit arrangement shown in Fig. 2 is to provide complete and noncritical neutralization of a single-ended beam-tube final amplifier on all bands (1.8 through 30 Mc. in my case).

A standard 5-prong plug-in coil is modified slightly so that the tank circuit itself includes two-thirds of the original winding (you usually have to remove turns) and the remaining third is used to obtain a little out-of-phase r.f. for the grid circuit. A small 3- to 30- μ fd. compression-type trimmer is mounted on the plug in coil, con-

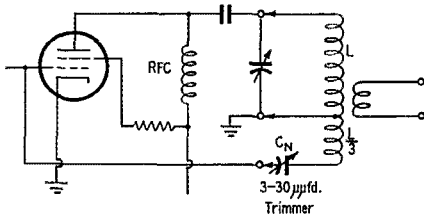

Fig. 2 — Simple plug-in neutralizing condenser arrangement for beam-tube amplifiers.

nected as shown, to provide the adjustment needed. Thus, just the right neutralizing adjustment for each band is automatically established when the coil is plugged in. Perfect stability is obtained on each band, a real bonus when one wants to preserve a soft keying characteristic developed in a preceding stage.

Triode stages, being less power-sensitive, probably do not need this treatment, as one setting of a single neutralizing condenser is usually adequate over the entire frequency range of the transmitter, but as anyone who has built a beam-tube amplifier will agree, it is mighty tricky to come out with maximum stability on all bands with only one neutralizing adjustment. The system shown here sidesteps the problem neatly, and has been used on a parallel-6L6 final stage with very gratifying results. — *Rod Newkirk, W9BRD*

VIBRATION CURE

AUTOMOBILE undercoat compound can be very useful in eliminating certain types of mechanical vibration in ham gear. For example, some low-cost chokes and transformers are often loosely assembled and will "talk back," sometimes causing serious audio feed-back in addition to being just plain annoying. Apply the undercoat in a layer $\frac{1}{8}$ to $\frac{1}{4}$ inch thick to silence these components. The same treatment can also be used to reduce the resonant audio vibration in VFO cabinets. — *G. P. McCasland, W4NCN*

TUNING CONDENSER FOR V.H.F.

FINE "split-stator" balanced tuning condensers for use in gear utilizing linear tank circuits can be made by the method illustrated in Fig. 3.

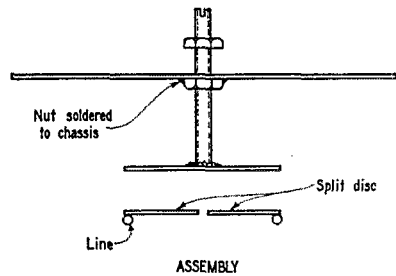

Fig. 3 — A homebuilt variable condenser for use in adjusting linear tank circuits in v.h.f. gear.

Two small copper discs, one of which is sliced in two, are used. Solder the halves of the split disc to the ends of the lines as shown. To the other disc, solder a small machine screw from which the head has been removed. The other end of this screw is slotted to facilitate screwdriver adjustment. The "rotor" plate thus formed is then mounted on the chassis or a small bracket by soldering a nut in fixed position.

— *Peter N. Saveskie, W5QXH*

CONSTRUCTION TIP

IF you've ever had trouble deciding just where to drill the panel to pass the shaft of a condenser that is already mounted on the chassis, here's a little trick that may solve your problem.

Take a small plumb bob and drill a $\frac{1}{4}$ -inch hole in its center. Press the bob gently on the shaft and then push it against the panel. The sharp end of the plumb bob will leave a mark on the panel, and it is then only necessary to center-punch and drill the hole. The result — a perfect fit. — *John J. Towey*

IMPROVED FLUTTER PREVENTION FOR BEAM ANTENNAS

THE insertion of wood strips inside antenna elements to prevent flutter as described in the Hints and Kinks section of April, 1949, *QST* has one disadvantage. While effective in preventing flutter, the strips rattle around inside the elements, causing considerable noise.

When my beam was taken down for cleaning recently, I tight-slipped some soft rubber grommets spaced a foot or two apart along the entire length of the $\frac{3}{16}$ -inch-square strips. The strips were then reinserted in the elements and the beam reassembled. Now, in addition to being flutterproof, the beam is also rattleproof. — *William Vandermay, W7DET*

**SWITCH
TO SAFETY!**





Operating News



F. E. HANDY, WIBDI, Communications Mgr.
JOHN E. CANN, WIRWS, Asst. Comm. Mgr., C.W.
GEORGE HART, WINJM, Natl. Emerg. Coördinator

J. A. MOSKEY, WIJMY, Deputy Comm. Mgr.
L. G. McCOY, WIICP, Asst. Comm. Mgr., 'Phone
LILLIAN M. SALTER, Administrative Aide

Code Certificate Awards. High interest in the Code Proficiency Certificate awards continues this season. Say what you will about high-speed tele-type and other high-speed tape circuits, there's still high personal appeal and value in the pinches in the manual ability to send and take down smoothly-flowing code groups . . . and operator ability is as always in demand! One's copying ability in the ARRL-arranged qualifying runs is the number of words at the rate of five characters and a space per each that can be received right off the air and *put down on paper* with 100 per cent accuracy for at least one full minute when plain language Continental Code is used.

The W1AW-WØTQD-W6OWP monthly runs for qualification go progressively through 15-, 20-, 25-, 30-, and 35-w.p.m. speeds. Our code certification is in *all* cases a recognition at speeds above initial license qualification and during W. W. II our certificates were frequently mentioned by operators wishing to show their ability along this line to various branches of the government. It is one thing to *ad lib* as you are casually listening and signals go in one ear and out the other and you get the general drift of the QSO. But it is quite another to *put down accurately* all that is sent. Some amateurs are just getting wise to this. However, one's curiosity about the speed he can take can easily be dispelled by listening to a qualifying run or one of the Monday-through-Friday practice sessions from W1AW. This is all by way of saying to any amateur who hasn't yet received the ARRL Code Proficiency award that we'll be happy to have you mark the qualifying run dates on your calendar and submit pencil or "mill" copy so you can get fullest advantage of this League service. Our aim is to continue to help all hams achieve the very top in technical and operating radio proficiency through being an amateur. If you haven't a certificate as yet get in on this program today!

TVI Trouble? The method of organizing a club interference committee and the functions of such a committee as a team — to monitor local public relations and arrange technical talks and demonstrations for the amateur group — were indicated on page 62 of January, 1950, *QST*. Copies of five mimeographs available from the ARRL CD for specific BCI or TVI situations were listed so that any amateurs describing their difficulties might, on request, receive appropriate advice and information. Reference to the *QST* index appearing with the December number for the last several years will disclose a wealth of information on the

subject. Add one to our January listing of CD TVI helps — the mimeographed bibliography of all this information. A radiogram or postal card will bring the Bibliography if the subject is becoming required reading for you.

Somebody Ought To Tell Him! The average amateur is an example of what a gentleman should be at all times. One very rarely finds amateurs guilty of bad manners on the air. The newcomer to the ham ranks is met with certain set procedures. By following these procedures he develops a natural tendency to be polite and cooperative at all times. However, there is one bad habit becoming more and more prevalent on the bands and it is felt that amateurs guilty of this should stop and consider. Scarcely an evening passes without one's hearing a QSO something like this: "Well, swell, Old Man, nice transmission but W5 so and so, a little lower in frequency, has a lousy signal and is splashing all over the place. Somebody ought to tell him about it." Or maybe this: "Boy! Do you get that buckshot and splash from that W8. He must think he owns the band."

How often have you heard the above type of remarks and how often have you been guilty of talking carelessly about a fellow amateur as you would not like to hear yourself talked about. W5 so and so, and the W8, probably *don't know* they *have* a maladjustment or are having trouble with their signals. How much *more* polite and more helpful it would be instead of criticizing to call the stations and let them know that they are having troubles. Every amateur *appreciates* help in keeping his signal clean and clear; he will not take offense if you call him and let him know in a nice way that he is having difficulties. Let's start a campaign of helping the other guy. You'll be helping yourself and operating conditions in the bands we all share when you do.

On Getting One's License. W8EDJ writes interestingly of his experiences. He decided to become a ham in September, 1949, getting his 15-w.p.m. ARRL certification in December and passing the examination and getting his license in March. The following comment emphasizes that a policy of Practice, Perseverance, Patience, and *More Practice* can be depended on to reach the goal. Other helps may assist but nothing will take the place of listening a lot, practicing sending, and keeping at it. From W8EDJ: "From all the money and time spent on code-learning suggestions and equipment, I salvaged a surplus key and built myself a good code-practice oscillator that could later be used as a keying monitor. I

have a disc recorder and made what was to be the first of a long line of practice records. I played records until I began to memorize them and then made new ones, gradually increasing my speed until in three or four months I was copying at 18 w.p.m. Kept practicing steadily from December to get over possible stage fright. Sailed through the exam with no difficulty in March."

Q Code Up-to-Date? Since January, 1949, certain ACy changes in the Q Code have been effective. So strong is habit, that in spite of publication in the *Handbook* and early '49 *QSTs*, some signals are still heard in the old pattern. Just for the record we repeat the exact meanings for some Qs that can be utilized widely in ham work. Up-to-date meanings follow:

QRX — When will you call me again?

I will call you again at . . . hours (on . . . kc.)

QRI — How is the tone of my transmission?

The tone of your transmission is . . . (1—good; 2—variable; 3—bad).

QSI — I have been unable to break in on your transmission.

QTX — Will you keep your station open for further communication with me until further notice (or . . . hours)?

I will keep my station open for further communication with you (until . . . hours).

The current 1950 *Handbook* (page 549) lists more Q signals, those most used in amateur work. In answer to QRI? most amateurs will continue to use RST as the simplest complete reporting system with T1-9 in RST definitions. Any use of QRI-3, saying in effect that one's signal is *bad*, can readily be followed by T1-9 to say *how bad!*

Suggestions on Good Operating. From time to time we are pleased to pick up from our correspondence the unsolicited letters, ideas, and criticisms received for or against particular amateur practices. Not every random or prejudiced thought sent the League to get it off someone's chest can be used. On the other hand, comments on operating, generally speaking, are soundly conceived, since they are inspired directly by actual operating conditions noticed in the various c.w. and 'phone bands.

W0PME comments on recent abuses of R which he has noted. "What is one supposed to think when an op gives forth with RR FB OM BUT PSE IMI QTH, PSE RPT AND QTH? . . . This poor practice seems prevalent on 7 Mc." If *all* was received, and only then, an operator is justified in responding with "R." If he needs a *fill*, he should ask for it. The R FB BUT PSE IMI . . . response either shows lack of knowledge of operating signals or a weak mind, according to W0PME.

W0WVZ (Buck) raises the question about failure of many amateurs to understand a personal sign or "sine" after someone sends them a message. He writes, "When you fellows receive a radiogram, if necessary to say Nr. 5 OK, add your personal identification. . . . Radio amateurs handle the landline check now, which is good. On landlines when one operator sends to another, the operator getting the message doesn't give his station call, but ordinarily OKs the tele-

gram with his *personal sign*. This may be one letter or two letters; it might be the two-letter initial of his name (or nickname). I have OKed my traffic in many years with the railroads, AP and WU with the letter Y." If the operator sending the traffic uses the personal sign, mainly useful in stations having more than one operator, this can be noted in the handling data put down by you with the station call on each message.

Coming Events. The popular 10-Meter WAS Contest will be repeated in two full week-end operating periods starting Dec. 8th and Dec. 15th. Can you work 10 meters? See the rules elsewhere in this issue; keep a simple list of all you work and send in the report for credit in *QST*. See how many of the states you can QSO and maybe win a certificate!

V.h.f. workers are adjusting their newest antennas and gear for the big annual test that is coming up in mid-January. It's called the *Fourth ARRL V.H.F. Sweepstakes*. Dates Jan. 13th-14th. Rules will appear in the January issue.

There will be the usual quarterly late-January CD Parties with both a c.w. (Jan. 20th-21st) and voice session (Jan. 27th-28th). These are open to all SCM appointees throughout the field organization. Rules are as contained in the January Bulletin to all who have qualified and received SCM appointment by late December when our envelopes are run. About appointment eligibility: Observers, ORS, OPS, OES, PAMs, RMs, ECs and other categories will be appointed by the section officials where openings for active organizers or station-appointees exist. Drop a line to your SCM for appointment along the lines of your interest. — F. E. H.

MEET THE SCMs

Robert B. Cooper, W8AQA, SCM of Michigan since February, 1949, received his first license in 1927, when the call W5AQA was issued to him, which was followed by W8YJU postwar, later modified to W8AQA.

The layout at W8AQA consists of a pair of VT-127As with 838 modulators on 3.85-Mc. 'phone running 600 watts, a pair of T55s on 14-Mc. 'phone running 600 watts, and a pair of T55s on 3.5-Mc. c.w.; all finals are driven with an ARC-5. A Millen exciter to a pair of T35Gs constitutes the rig for 14 and 28 Mc. A four-element beam on 28 Mc. does a fair amount of duty when the band is open, and a centered half wave is in regular use on 3.5 Mc. The receiving position is supplied with an HRO-7, a VHF-152A, and a Panadaptor.

The shack, located in a spare room, sports ORS, RCC, Old Timer's Club, and Code Proficiency Certificates.

SCM Cooper is a member of the Grand Rapids Amateur Radio Association and maintains regular attendance in the QMN (c.w.), Buzzards' Roost ('phone), and Michigan Emergency ('phone) Nets.

Bob's secondary hobby is photography. He is currently employed by the Consumers Power Company in the capacity of chief field tester in charge of the Western Division Electrical Laboratory.





The biggest AEC activity of the year has just been concluded — and it was really a corker! Almost 1400 messages have already been received at ARRL headquarters and more are still to follow. Advance reports from ECs indicate that in many cases participants did not originate messages to ARRL, which means that the number of participants in local drills alone will number well into the thousands. If you add to this the great many additional stations and operators who fell to in handling the many messages for ARRL and the Red Cross, we should have a figure that is an all-time high for the SET.

As a public demonstration, the 1950 SET glared out at millions of casual readers in local newspapers all over the country, as our ECs spread the word to every newspaper they could contact. Both advance notice and results, complete with pictures, were printed. As a test of our communications facilities, the SET pointed out sharply to each EC the shortcomings of his organization and his emergency plan, to be used as a basis for modifications and improvement in the future. On the one hand, we demonstrate to the public that we are ready; on the other, we find out for ourselves to what extent we are ready. In each case where this double-barreled feature of the SET was successfully carried out, the objective has been accomplished. Congratulations to all for a splendid turnout!

The complete write-up of the test will appear in *QST* early next year. We say "complete" advisedly, for the consolidated report will be only as complete as you ECs in the field make it by sending in your SET report forms. Last year 127 ECs reported. Out of over 1000 such appointees, we hope a greater percentage will report activity this year. Along with your report form, send along your EC annual report, any clippings, photos, comments, and relate any unusual incidents which occurred during the test. You have until the deadline for *QST* copy for the issue in which the write-up is to appear to get in your report and any other material, so if you have not yet reported it is probably still not too late — but there will be very little time left, if any, after you read this!

Having trouble getting cooperation from your city or town officials? The example set by Spokane (Wash.) city officials in cooperating with the local club may help, provided the proper approach is made. A year or so ago, the Spokane Radio Amateurs (Club) was looking around for a suitable location for a "ham shack." One of the members reported that there was a small but suitable building in one of Spokane's parks which was not being used, ideally located for a club installation. A committee of club members appeared before the Spokane City Park Board and formally requested use of the building, being careful to point out the services the club station and its members might render the city in time of need. A few days later the club received a letter from the President of the Park Board stating that their request had been granted and that they were free to move in at any time and make whatever alterations they wished.

With the help of generous donations from several business

houses, plus many hours' labor on the part of the membership, the club house was soon insulated, cedar lined and electrically heated. The members built a 125-watt transmitter and acquired a good receiver, also a code instruction machine, and was soon operating from the new location under the club call, W7NBR.

But this wasn't all. With civil defense in the offing, the club set out to develop a strong emergency corps organization. In recognition of their efforts and enthusiasm, the Spokane Commissioner of Public Safety made available, without cost, nineteen mobile a.m. transmitters and power supplies which had recently been replaced by newer equipment. Another twelve rigs were donated by the Washington Water Power Company. These 31 mobile rigs, plus a dozen or so already in service by some members, and augmented by many fixed stations, give Spokane and the civil defense program a really potent emergency communications network available at a moment's notice. Drills are held each Tuesday under direction of W7FQS, Spokane EC, with the club station, W7NBR, as net control. Activities are being coordinated with the CAP, Washington State Patrol, Spokane County Sheriff's Office, and the Spokane City Police.

Much progress can be achieved if the proper initiative is shown and backed up with enthusiasm and plenty of effort. The Spokane city officials are to be complimented on their foresight in encouraging their amateurs, but groups who would seek to achieve similar results should bear well in mind that *none of it would have been possible* without the enthusiastic support of all club members. Thanks to W7LTL for this helpful report.

NATIONAL CALLING AND EMERGENCY FREQUENCIES

C. W.	'PHONE
7100 kc. (day)	3875 kc.
3550 kc. (night)	14,225 kc.
14,050 kc.	29,640 kc.
28,100 kc.	

During periods of communications emergency these channels will be monitored by stations of the National Emergency Net for personal-inquiry traffic. At other times, these frequencies can be used as general calling frequencies to expedite general traffic movement between amateur stations. Emergency traffic has precedence. After contact has been made the frequency should be vacated immediately to accommodate other callers.

Members of the Boulder City, Nevada, ARRL Emergency Corps were called upon by their neighboring city of Needles, Calif., which is 110 miles away, to assist in furnishing radio communications for the Third Annual Colorado River Marathon. In the past considerable difficulty had been encountered during the outboard classic in locating disabled craft along the isolated 45-mile course between Topock, Arizona, and Parker Dam. Self-powered equipment was used at four locations along the course enabling the judges and race officials to check all craft past these points. At the close of the race much time was saved in checking missing craft past check points and dispatching pick-up boats by radio to the location last seen. Arrangements for the radio equipment used and operation of same were made by

Six mobile units and a fifty-watt portable control station, all owned by members of the Framingham (Mass.) Radio Club, turned out to supply communications on the occasion of a parade to celebrate the 250th incorporation anniversary of the Town of Framingham. Here are four of the mobiles, those of W1QXE, W1SQY, W1QQW and W1RVA. The portable transmitter and receiver of W1RHA are also shown. Identified operators are W1QXE, W1SQY, W1RKD (lower left), W1RVA, and W1QQW.

QST for



— —

The title of this column may undergo a slight change in the near future. Serious consideration is being given to changing the name of the ARRL Emergency Corps (AEC) to the Amateur Radio Emergency Corps (AREC), as a result of recommendations from the field. Like the idea?

TRAFFIC TOPICS

We are going to stick our necks *way* out and give a listing of nets which, according to our records, have not yet been registered this season. This will, undoubtedly, invite indignant letters and messages from far and near. We'll take the abuse if you'll supply us with the information on your net.

A few days after this appears in *QST*, a complete cross-indexed net directory will be compiled and made available upon request. This is the last call for nets to appear in this directory. The following list is of those nets registered last season who have not yet registered for the fall season. If your net is on this list, please send us the info on it posthaste so it can get into the new directory. We know that some of these nets are active, but have no new information on frequency, days, time, net managers, etc., which is needed for our files. If your net has not previously been in existence, it will not appear in the directory unless you register it.

- | | |
|---------------------------------------|---------------------------------------|
| Alabama Emergency Net (C.W.) | N.Y.C.-L.I. Traffic Net |
| Alaska C.W. Net | North Carolina Net |
| Alaska Emergency Net | Oregon Emergency Net (3600) |
| American Legion Net | Oregon Emergency Net (7200) |
| British Columbia Net | Pineapple Net |
| California Slow-Speed Net | Pioneer Net |
| Central Radio Amateur Club Net | Pony Express Net |
| Coastal Emergency Radio Net | Quebec Emergency Net |
| Cracker Emergency Net | Quebec Slow-Speed Net |
| Crossroads Net | QPO Net |
| Dog House Net | Rochester Emergency Net |
| Eleventh Regional Net | Sacramento Valley Section Traffic Net |
| Five O'clock Net | San Diego Emergency Net |
| Florida 'Phone Net (3950) | South Carolina Amateur Net |
| Gator Net (reported off until summer) | South Carolina 'Phone Net |
| Georgia/South Carolina Net | Southeast British Columbia AEC Net |
| Georgia Slow-Speed Net | Southern Border Net |
| Golden State Emergency Net | Southern New Jersey Net |
| Hamden Emergency 80-Meter C.W. Net | Suwanee Net |
| Indiana Slow Net | Transcontinental Independent Net |
| Jersey Net | Trunk Line C |
| Kansas City AEC Net | Trunk Line I |
| Kansas Net (QKS) | Trunk Line L |
| Kansas 75 'Phone Net | Twelfth Regional Net |
| Kansas Slow-Speed Net | Upper Peninsula Net (3625) |
| Kentucky Blue Grass Net | Utah State 'Phone Net |
| Long Beach Emergency Net | Valley Net |
| Minnesota 'Phone Net | Vermont Net |
| Morris County Emergency Net | Washington C.W. Net |
| Mountain Area Net | Western Mass. 10-Meter 'Phone Net |
| New England 'Phone Net | York Amateur Emergency Corps |
| New Mexico Emergency Net | |
| New Mexico 75-Meter 'Phone Net | |
| N.Y.C.-L.I. Emergency Net | |

— —

A word of praise is due all traffic-handlers who did such a wonderful job during the October Simulated Emergency Test. The various nets of the National Traffic System, Atlantic-Pacific Trunk Line, Rebel Net, Mission Trail Net, Swing-Shift Net, Transcontinental 'Phone Net and many others were right in there over a week end of the most intensified kind of traffic handling as messages flew thick and fast to and from American National Red Cross Headquarters in Washington and ARRL headquarters in West Hartford. These regular networks are still picking up traffic and relaying it in as this is being written, and well over a thousand have been received for ARRL headquarters alone.

Of particular note during the week end were the great numbers of old timers in traffic work who have not been heard much in traffic circles of recent years. Is a Simulated Emergency Test (or a real emergency) what it takes to get you fellows out? The old touch is still there, but we need

you in our regular set-up if we are to make our traffic systems continuing efficient organizations. How about it, OTs?

— —

From KL7ACX of Fort Richardson, Alaska, comes a request that only messages with complete military addresses should be accepted for transmission to members of the armed forces. The address should have as a minimum the full name, rank and organization of the addressee. While it is true that most armed forces installations have "locator" personnel, they are pretty tied up with normal requests, and it will make for speedier delivery of traffic if complete addresses are included in the first place. Since traffic for armed forces installations is bound to be on the increase, we think KL7ACX's point is well taken.

In routing all such armed forces traffic for points outside the United States (i.e., Guam, Japan, Okinawa, etc.), the location of the organization should not be given. For security reasons, an A.P.O. number should be used instead. If overseas traffic going west is routed via the National Traffic System, specifically the Sixth or Seventh Regional Nets (via Pacific Area Net), it will be relayed to its final destination without delay or reference being made to localities.

WIAW HOLIDAY SCHEDULE

The Headquarters station will not be operated on December 24th and 31st and during its early shift, 1500 to 2100 EST, December 25th and January 1st. WIAW will, however, operate its regular late shift, starting at 2100 EST on Christmas and New Year's Day. See page 55 of November *QST* for full WIAW schedule.

BRIEF

While working mobile from Yonkers, N. Y., Ralph Kilsheimer, W2QOM, contacted Vin Cadahy, OA4AS, whose wife and mother were residing only a half mile from Ralph's location. Continuing the contact, Ralph drove to the home of Vin's folks and had them speak to Lima over the mobile rig. That's really bringing ham radio to the public!

BRASS POUNDERS LEAGUE

Winners of BPL Certificates for September traffic:

Call	Orig.	Recd.	Ret.	Del.	Total
W6CF	33	2515	2479	27	5054
W9EBX	4	1836	1836	17	3693
W4PL	10	1249	1103	127	2489
W3CUL	61	1171	1022	114	2368
W7CZY	8	996	904	97	2005
KG6DI	751	620	0	470	1841
W6UW	1723	0	0	0	1723
W6JZ	20	660	632	50	1362
W6DTW	19	556	556	18	1149
W0ZJO	16	539	366	173	1094
W0AY	3	521	517	7	1048
W6DDE	25	488	287	201	1001
K2NYS	958	6	0	0	964
W1CRW	19	467	434	26	946
W6BPT	8	449	429	18	904
W7JJK	173	301	274	30	778
W6UTV	2	0	750	1	753
KG6FAA	154	299	240	59	752
W0PME	9	388	237	105	739
W6PIV	5	281	368	27	681
W0QXO	7	333	236	93	669
W3UF	30	275	245	60	610
W0HSO	0	299	296	3	598
W6GYH	34	257	114	143	548
W6WGO	0	0	524	0	524
W0SCA	5	260	162	97	524
W9ESJ	41	231	161	70	503

The following made the BPL for 100 or more *origination-plus-deliveries*:

W2COU 285	W6BGF 181	W2VNJ 123
W2PGT 258	W9BGN 148	W6LDR 105
JA2KW 210	W0EA 136	W2BO 104

A message total of 500 or more or 100 or more *origination-plus-deliveries* will put you in line for a place in the BPL. The Brass Pounders League is open to all operators who qualify for this monthly listing.

ELECTION NOTICE

(To all ARRL members residing in the Sections listed below.)

You are hereby notified that an election for Section Communications Manager is about to be held in your respective Sections. This notice supersedes previous notices.

Nominating petitions are solicited. The signatures of five or more ARRL full members of the Section concerned, in good standing, are required on each petition. No member shall sign more than one petition.

Each candidate for Section Communications Manager must have been a licensed amateur for at least two years and similarly a full member of the League for at least one continuous year immediately prior to his nomination.

Petitions must be in West Hartford, Conn., on or before noon on the closing dates specified. In cases where no valid nominating petitions were received in response to previous notices, the closing dates are set ahead to the dates given herewith. The complete name, address, and station call of the candidate should be included with the petition. It is advisable that eight or ten full member signatures be obtained, since on checking names against Headquarters files, with no time to return invalid petitions for additions, a petition may be found invalid by reason of expiring memberships, individual signers uncertain or ignorant of their membership status, etc.

The following nomination form is suggested: (Signers will please add city and street address to facilitate checking membership.)

Communications Manager, ARRL [place and date]
38 La Salle Road, West Hartford, Conn.

We, the undersigned full members of the
..... ARRL Section of the
Division, hereby nominate
as candidate for Section Communications Manager for this
Section for the next two-year term of office.

Elections will take place immediately after the closing dates specified for receipt of nominating petitions. The ballots mailed from Headquarters to full members will list in alphabetical sequence the names of all eligible candidates.

You are urged to take this initiative and file nominating petitions immediately. This is your opportunity to put the man of your choice in office.

— F. E. Handy, Communications Manager

Section	Closing Date	SCM	Present Term Ends
Alabama	Dec. 15, 1950	Leland W. Smith	Resigned
Yukon *	Dec. 15, 1950	W. R. Williamson	Mar. 17, 1949
Alaska	Dec. 15, 1950	Charles M. Gray	Sept. 15, 1950
Michigan	Dec. 15, 1950	Robert B. Cooper	Feb. 17, 1951
Kentucky	Jan. 2, 1951	Dr. Asa W. Adkins	Resigned
Oregon	Jan. 2, 1951	J. E. Roden	Mar. 1, 1951
Mississippi	Jan. 15, 1951	J. C. Wallis	Mar. 8, 1951
Western Penna.	Jan. 15, 1951	Ernest J. Hlinsky	Mar. 17, 1951
Md.-Del.-D. C.	Jan. 15, 1951	Eppa W. Darne	Mar. 21, 1951
Maine	Feb. 1, 1951	Manley W. Haskell	Apr. 15, 1951
Southern Texas	Feb. 15, 1951	Ammon O. Young	Apr. 29, 1951

* In Canadian Sections nominating petitions for Section Managers must be addressed to Canadian General Manager Alex Reid, 169 Logan Ave., St. Lambert, Quebec. To be valid such petitions must be filed with him on or before the closing dates named.

ELECTION RESULTS

Valid petitions nominating a single candidate as Section Manager were filed in a number of Sections, as provided in our Constitution and By-Laws, electing the following officials, the term of office starting on the date given.

New Hampshire	Norman A. Chapman, W1JNC	Aug. 15, 1950
West Indies	William Werner, KP4DJ	Aug. 15, 1950
Montana	Edward G. Brown, W7KQJ	Sept. 1, 1950
Northern Texas	William A. Green, W5BKH	Oct. 15, 1950
Maritime	Arthur M. Crowell, VE1DQ	Oct. 16, 1950
San Diego	Mrs. Ellen White, W6YYM	Oct. 16, 1950
Kansas	Earl N. Johnson, W6ICV	Oct. 29, 1950
Sacramento Valley	Ronald G. Martin, W6ZF	Nov. 1, 1950
Eastern New York	George W. Sleeper, W2CJL	Nov. 30, 1950
Saskatchewan	Harold R. Horn, VE5HR	Dec. 15, 1950
Oklahoma	Frank E. Fisher, W5AHT/AST	Dec. 15, 1950

In the Santa Clara Valley Section of the Pacific Division, Mr. Roy I. Couzin, W6LZL, and Mr. Edward J. Roussey, W6VCZ, were nomi-

nated. Mr. Couzin received 64 votes and Mr. Roussey received 55 votes. Mr. Couzin's term of office began Sept. 5, 1950.

In the Ohio Section of the Great Lakes Division, Mr. Leslie Misch, W8HGW, Mr. Bart J. Geib, W8WE, and Mr. John Erickson, W8DAE, were nominated. Mr. Misch received 224 votes, Mr. Geib received 177 votes, and Mr. Erickson received 134 votes. Mr. Misch's term of office began Oct. 1, 1950.

A.R.R.L. AFFILIATED CLUB HONOR ROLL

It is a pleasure to present additional Honor Roll affiliated clubs in the following listing, supplementing that which appeared in June QST. These are the societies whose entire membership consists of members of the League. The listings of clubs with 100 per cent ARRL membership are in accord with the Board policy of such special recognition, which is determined from information supplied us in the affiliated-club questionnaire or Annual Information Survey conducted as required by the Board. In early 1951 a form will be sent to every active affiliate for filings on which the next Honor Roll will be based.

Anniston Amateur Radio Club, Anniston, Alabama
Baton Rouge Radio Amateurs Club, Baton Rouge, La.
Birmingham Amateur Radio Club, Birmingham, Alabama
Dan'l Boone Radio Club, Columbia, Mo.
Enid Amateur Radio Club, Enid, Okla.
Grumman Amateur Radio Club, Bethpage, N. Y.
Helix Amateur Radio Club, La Mesa, Calif.
Inglewood Amateur Radio Club, Inc., Inglewood, Calif.
Kingsville Radio Club, Kingsville, Texas
M.A.K. Amateur Radio Association, Reading, Mass.
Northern California DX Club, Oakland, Calif.
O.B.P. Amateur Radio Club, Chapter Nr. 1, St. Louis, Mo.
Sunrise Radio Club, Laurelton, L. I., New York
Sussex County Amateur Radio Association, Sparta, N. J.
Union County Amateur Radio Association, Elizabeth, N. J.
Wichita Amateur Radio Club, Wichita, Kansas

SEPTEMBER F.M.T. RESULTS

The Second 1950 ARRL Frequency Measuring Test, open to both ARRL Official Observers and other amateurs, brought entries from 116 participants who made 236 measurements; 60 entries were submitted by observers and 56 by non-observers. Each participant has received an individual report comparing the accuracy of his measurements of the special WIAW FMT transmissions with those made during the test by a professional frequency-measuring laboratory.

Robert S. Palmer, W9CIH, top observer in the first 1950 test, was the leading entrant in the OO group. Heading the non-OO entrants was Everett C. Lindquist, W9CSU. The standings of other leaders in the test are given below. Since the official readings can only be accredited to 0.4 part per million, the decimal is shown only to permit establishment of listing order. In accordance with the announced rules, no entry consisting of a single measurement was considered eligible in the competition.

Observers	Leaders		
	Parts/ Million	Parts/ Million	
W9CIH	0.4	W9CSU	0.2
W2OUT	2.2	W8HB	0.3
W1MUN	2.8	W2FE	0.3
W7FU	5.9	W8PEN	1.3
W6OTR	6.8	W4FJ	4.0
W2AIQ	8.2	W6HUC	4.3
W6GTE	8.4	W8DTD	5.2
KH6BA	8.6	W5LHZ	6.5
W9CRD	10.0	W9VDB	6.9
W7KWC	12.1	W3MCG	3.4
W7GP	14.9	W1YK	8.5
W4CVO	15.0	W2PRI	10.0
W6DFO	20.4	W5IGM	12.4
W2TZ	21.7	W8BVY	16.9
W7CT	21.7	W4JUL	17.0

The following ratings are based on a single measurement: OOs — W4WO 0.3, W9TKX 1.7, W8WAV 3.0, W1BGW 3.3, W2YDG 3.6, W1MT 12.9, W4GQM 12.9, W3ASW 16.2; non-OOs — K25FL 1.1, W9MO 1.1, W4QN 3.9, W6BRA 5.9, W1HI 11.5.

Y.L.R.L. NOTES

Newly-elected officers of the Young Ladies Radio League for the 1950-1951 term are: W1FTJ, president; W8UDA, vice-president; W4HWR, secretary-treasurer; W1QON, publicity chairman. District chairmen for the same term are W1RTB, W2RUF, W3LSX, W4PPQ, W5PTW, W6ZYD, W7KEU, W8DQO, W9JTX, W0DBD, VE7YL, G2YL, ZS6GH.

An international organization of more than three hundred licensed woman operators, YLRL continues to invite licensed YLs the world over to become members. Any of the above-named officers will be pleased to give further information about the organization.

YLRL conducts QSO nets on the following schedule: Monday 7:00 p.m. EST, 14,360 kc.; Tuesday, 10:30 p.m. EST, 10-meter 'phone, NCS W9LRT on 29,080 kc., W7HHH on 29,000 kc.; Wednesday, 10:00 p.m., 7220 kc., NCS W3CUL; Thursday, 10:30 p.m., 3610 kc., NCS W1QJY; Friday, 6:00 a.m., 3900 kc., NCS W8ATB.

On December 9th and 10th and 16th and 17th the Young Ladies Radio League will sponsor a QSO party open to all licensed YL operators throughout the world. For the first time a trophy will be awarded for high c.w. score as well as 'phone operation. The 'phone contest will begin at 6:00 p.m. EST, December 9th, and will end at midnight EST, December 10th. The c.w. contest will begin at 6:00 p.m. EST, December 16th, and will end at midnight EST, December 17th. Any or all bands may be used, including cross-band operation. By using this method, YLs who work both 'phone and c.w. will have a chance to compete for either or both prizes. Call "CQ YLRL" and exchange the following information: contest contact number, station call, report, QTH, time, and whether you are a YLRL member or licensed YL non-YLRL member. **SCORING:** Count ten points for each YLRL member worked, five points for each licensed YL non-YLRL member worked. Total the number of points and multiply by the total number of states, possessions, and countries worked. No points will be given for working OMs during the contests. Contacts on different bands with the same operator may be counted toward the total score. QSLs or confirming verification will not be required; however, score sheets should be submitted to Dorothy Ann Willett, W8UDA, 3513 Fleming Road, Flint 5, Michigan. Score sheets will be found in the YLRL *Harmonics* or may be obtained by writing W8UDA.

160-METER TRANSATLANTIC TESTS

Working in cooperation with East Coast U.S.A. stations, English amateurs have arranged a series of Transatlantic tests on the 160-meter band during January, February and March of 1951. It is expected that peak conditions should prevail during January and February and the following times have been fixed for the main tests: January 14th and 28th, February 11th and 25th, and March 11th, between the hours of 1500 and 0800 GCT.

It has been suggested, chiefly by stations in VE1, that schedules should also be arranged for about midnight, GCT. Though not part of the main tests, there will be two special trial periods: January 20th and 21st, February 17th and 18th, between 2200 and 0200 GCT.

W and VE stations should call DX on the hour and each succeeding ten minutes, with the DX stations calling W and VE at five minutes past the hour and each succeeding ten minutes. Details will be published in *QST* next month.

F.C.C. SUSPENDS OPERATOR LICENSES

Violating FCC regulations doesn't pay! At a session held in Washington on September 27th, the Commission issued orders suspending the operator licenses of three amateurs for various violations of FCC Rules.

The amateur operator license of Harry L. DeBaun, W5RF, was suspended for six months as a result of three violations: (1) For communicating with unlicensed stations identified by the call signs W5BNK and W5GBY. (2) For operating his station in the 75-meter 'phone band without a Class A operator license. (3) For transmitting the call sign W5NUH which had not been assigned by proper authority to the station he was operating.

Thomas A. Jennings, W5HLJ, received an operator license suspension of 60 days for communicating with an unlicensed station identified by the call sign W5BNK. The operator license of Walter H. Bolton, W6TQV, was similarly suspended for 60 days as a penalty for communicating with an

unlicensed station identified by the call W6EAM.

In each of these three cases the Commission also ordered that during the period of operator license suspensions the licensees in question not permit their amateur stations to be operated by any person.

FCC continues to run down bootleg stations and licensed operators who flout the regulations. Don't risk the loss of your amateur operating privileges by contacting stations that you know are unlicensed. There should be no feeling of tolerance toward those persons who use frequencies unlawfully, particularly those who invade our amateur bands. Bootleg operation is a potential source of interference to the amateur service as well as to other authorized radio services. If you hear unlicensed stations, report them at once to the nearest FCC office.

CODE-PROFICIENCY PROGRAM

Twice each month special transmissions are made to enable you to qualify for the ARRL Code Proficiency Certificate. The next qualifying run from W1AW/W0TQD will be made on December 18th at 2130 EST. Identical texts will be sent simultaneously by automatic transmitters. Frequencies of transmission from W1AW will be 1887, 3555, 7215, 14,100, 28,060, 52,000 and 146,000 kc. W0TQD will transmit on 3534 kc. The next qualifying run from W6OWP only will be transmitted on December 2nd at 2100 PST on 3590 and 7248 kc.

Any person may apply; neither ARRL membership nor an amateur license is required. Send copies of all qualifying runs to ARRL for grading, stating the call of the station you copied. If you qualify at one of the five speeds transmitted, 15 through 85 w.p.m., you will receive a certificate. If your initial qualification is for a speed below 35 w.p.m., you may try later for endorsement stickers.

Code-practice transmissions are made from W1AW each evening, Monday through Friday, at 2130 EST. References to texts used on several of the transmissions are given below. These make it possible to check your copy.

Date	Subject of Practice Text from October <i>QST</i>
Dec. 2nd:	Qualifying Run, 2100 PST, from W6OWP only
Dec. 5th:	<i>T-Day in Sandwich</i> , p. 11
Dec. 8th:	<i>Shielded Construction</i> . . . , p. 14
Dec. 11th:	<i>Bandwidth of Two- and Three-Element Yagi Antennas</i> , p. 18
Dec. 13th:	<i>QSL Cards</i> , p. 21
Dec. 18th:	Qualifying Run, 2130 EST, W1AW, W0TQD
Dec. 19th:	<i>QSL Cards</i> , p. 24
Dec. 21st:	<i>Technical Topics</i> , p. 33
Dec. 27th:	<i>The World Above 60 Mc.</i> , p. 40
Dec. 29th:	<i>A V.H.F. Frequency Meter</i> , p. 46

A.R.R.L. ACTIVITIES CALENDAR

Dec. 2nd:	CP Qualifying Run — W6OWP
Dec. 8th-10th, 15th-17th:	10-Meter WAS Party
Dec. 18th:	CP Qualifying Run — W1AW, W0TQD
Jan. 5th:	CP Qualifying Run — W6OWP
Jan. 13th-14th:	V.H.F. Sweepstakes
Jan. 19th:	CP Qualifying Run — W1AW, W0TQD
Jan. 20th-21st:	CD QSO Party (c.w.)
Jan. 27th-28th:	CD QSO Party ('phone)
Feb. 3rd:	CP Qualifying Run — W6OWP
Feb. 7th:	Frequency Measuring Test
Feb. 9th-11th:	DX Competition (c.w.)
Feb. 14th:	CP Qualifying Run — W1AW, W0TQD
Feb. 16th-18th:	DX Competition ('phone)
Mar. 2nd:	CP Qualifying Run — W6OWP
Mar. 9th-11th:	DX Competition (c.w.)
Mar. 13th:	CP Qualifying Run — W1AW, W0TQD
Mar. 16th-18th:	DX Competition ('phone)
April 1st:	CP Qualifying Run — W6OWP
April 14th-15th:	CD QSO Party (c.w.)
April 19th:	CP Qualifying Run — W1AW, W0TQD
April 21st-22nd:	CD QSO Party ('phone)

• All operating amateurs are invited to report to the SCM on the first of each month, covering station activities for the preceding month. Radio Club news is also desired by SCMs for inclusion in these columns. The addresses of all SCMs will be found on page 6.

ATLANTIC DIVISION

EASTERN PENNSYLVANIA — SCM, Jerry Alathis, W3BES — The PACRC has decided to change the date of the hamfest to December 2nd because of conflicting date with other scheduled events. EU says the Wilkes-Barre gang is reorganizing its club. PMG reports the E. Pa. net is going again on 3610 kc. CUL attended the Hudson Division Convention where she met Bailey, Budlong, Brad Martin, and Harry Stein. CL, AXA is on 144 Mc. and will be looking for contacts with Philadelphia. PDJ is back home and is going to Temple University. NDZ/1 is on at college in Massachusetts. New officers of the Abington Twp. A.R.A. are PSB, pres.; OSE, vice-pres.; OQG, treas.; PDJ, secy. 0PNQ paid the Frankford Radio Club a visit and displayed some delightful DX QSLs including three AC4s, AC3, HV, etc. KFK, who was announced as EC for Philadelphia County, moved out of the County before he had a chance to take over his duty. The Northeast Radio Club now meets the first and third Tuesdays of each month at Carver Hall, Pratt and Summerdale Sts., Philadelphia, Pa. Listen for the NERC 10-meter net starting at 9:00 p.m. each evening. Visitors are always welcome. The member clubs of the PACRC have blank TVI forms to be filled out for TVI case histories which will be correlated by 2JAV. This form is an official-looking thing and the psychological effect of executing it in the presence of the complainant should be helpful. Also the data obtained will most certainly be a boon to the TVI sufferers. The clubs supply them free to members and will offer them to non-members for a nominal fee. Give the SJRA credit for this deal. Traffic: W3CUL 2368, NHH 141, PDJ 67, AXA 27, OML 14, PMG 3.

MARYLAND-DELAWARE-DISTRICT OF COLUMBIA — SCM, Eppa W. Darne, W3BWT — The Chesapeake Amateur Radio Club had Dr. Peter Castruccio as speaker for its Sept. 5th meeting. His subject was "Radio Control of Model Aircraft." At the Sept. 19th meeting L. W. Ballard, BVN, spoke on "The Expedition to St. Pierre and Miquelon Islands (FP8) with a 2-watter." The Washington Radio Club's Sept. 23rd meeting featured a talk on "Practical Notes on High Quality of Reproduction from Phonograph Records" by Richard Barnett of the Kellex Corp. The following officers were installed for the new 1950-1951 season: LPG, pres.; HHN, vice-pres.; OTC, corr. secy.; LSX, treas.; CDQ, rec. secy. Regular meetings are held the second and fourth Saturdays of each month in the Columbia Bowling Alley Building, 14th and Monroe Sts., N. W., 8:00 p.m. About thirty members of the Baltimore Amateur Radio Communications Society and the Chesapeake Amateur Radio Club have formed a new club known as the Maryland Mobile Radio Club. Meetings are held the first and third Fridays of each month at 9:00 p.m. BII is Net Control, and meetings are held at a different rendezvous each drill night. AKR visited some of his ham buddies in Albuquerque, N. M. JHW is moving his gear to an upstairs room of his home. PTZ received his 30-w.p.m. Code Proficiency sticker and his A-1 Operator's certificate. He has been handling traffic with TXN and clicking off some good DX between times. YQA is a new ham on 14- and 28-Mc. phone. PRZ is overhauling his main rig. PDZ vacationed in Illinois and has a new Collins 75-A. OPM is building a new beam. In the Wilmington, Delaware, Area, Emergency Coordinator GZII and the AEC group, in conjunction with Civil Defense, have formulated an emergency net. The call is "DEFLN." The net started Sept. 10th with 13 members and meets Thursdays at 9:00 p.m. and Sundays at 9:00 a.m. on 3650 kc. FWP has changed QTH to Kensington, Md. FQB has a new 28-Mc. vertical antenna that works well. MCG vacationed in Maine. FQZ vacationed in Wisconsin. QOM, Dr. Keats Pullen, a new Baltimore Area station, is on 7-Mc. c.w. QWE, also of the Baltimore Area, is on 7-Mc. c.w., and is a former WERS member. LVJ schedules KH6YL. EYX attended the Hudson Division Convention. EQK and AHK took a three-week trip to New Mexico and worked 28-Mc. mobile all the way. Traffic:

(Sept.) W3UF 610, GZH 106, PTZ 86, ECP 77, FWP 65, VE 49, ONB 38, DVW 14, JZY 11, BWT 10, IZL 8, NNX 6, FQB 5, AKR 4. (Aug.) W3UF 452.

SOUTHERN NEW JERSEY — SCM, Dr. Luther A. Alkitarian, W2ASG — ZVW is new RM for So. N. J. Net. FDI is a brand-new ham in Trenton, active on 3.5- and 7-Mc. c.w. ZYX is busy with TVI elimination. CFB has returned to the So. N. J. Net. ORS is being heard on 420 Mc. ZVW is active on SNJ, ZRN, EAN, and NJPN Nets. The following information is submitted for those interested in C.D. activities: ORS is Section EC. County ECs are OSV, Gloucester County; BBW/K2AZ, Atlantic, Cape May, and Gloucester Counties; BWP, Burlington County; SVV, Mercer County; IMA, Hunterdon County; and ZVW, Warren County. BAY is active on 56 Mc. BEI has a new tower. Say, gang, if you are interested in a bigger and better column, why not send in all the news? Traffic: W2ZVW 233, RFF 28, ORS 24, ASG 21, RG 18, ZI 18, ZYX 14, PPT 12, CFB 4.

WESTERN NEW YORK — SCM, Harding A. Clark, W2PQT — SEC: SJV. RM: RUF. The Syracuse Amateur Radio Club's exhibit at the New York State Fair was a big success with the public showing much interest in the two stations being operated, and the gang at K2NYS wishes to thank everyone who helped clear an unexpectedly large amount of traffic. EMW and YRF have been appointed ORS. The New York State Emergency Phone Net operates Sundays at 9:30 a.m. on 3920 kc. and invites anyone interested to call in. ECs are especially urged to make arrangements to have their area represented. The Rochester Mobile Club furnished communications for the annual Soap Box Derby, New York State Senior and Lightning sailing races. CR/mobile worked CN8EH. DFS/mobile worked W2DQP/AM in the South Atlantic. DYD is spending the winter in Florida and wants the gang to listen for him. Those interested in working in the Transcontinental Phone Net on 3.85 Mc. are requested to contact LMB. ICE has new QTH and is planning an antenna farm. The RDXA gang reports little activity on the air, but everyone is busy getting ready for a big season of DX. This gang has consistently won all DX contests for this section. Can't anybody break this monotony? QHH still is keeping his schedules with the Arctic and is shooting for DXCC on 7 Mc. this winter. YRF finally received a batch of cards from U.S.S.R. for contacts in 1948. Don't give up if you haven't received yours for more recent contacts. FMH is on a year's trip from Coast to Coast and wants the gang to look for him on 3.85-, 14-, and 28-Mc. phone. Traffic: K2NYS 964, W2COU 353, EMW 325, RUT 324, PGT 316, QHH 28, FCG 23, YRF 18, BKI 17.

WESTERN PENNSYLVANIA — SCM, Ernest J. Hlinsky, W3KWL — SEC: OMA. RMs: GEG and NUG. PAM: AER. The Upper Ohio Valley Emergency Net resumed activities Sept. 10th, with NUG as NCS for c.w. on 3590 kc. and MPO as NCS for phone on 3965 kc., with drills each Sunday at 9:30 a.m. The Polecat Net started Oct. 8th on 3665 kc. at 11:30 a.m. The Western Penna. Traffic Net, which resumed operations Oct. 2nd, has been moved from its regular net frequency of 3750 to 3585 kc. and drills nightly Mon. through Fri. at 7 p.m. under the direction of NUG and GEG. NRQ is the Steel City Amateur Radio Club's transmitter maintenance man. Thanks to RXT, NRQ, MTP, NKM, LOR, DNO, NWD, OMY, and RIK for a job well done. From the AT A News we received a notice of the club meeting. LMM is being credited with placing Pittsburgh among the leaders in emergency communications. From the publication of the Horseshoe Radio Club of Altoona we see that the 144-Mc. boys are going to town. QZF did a nice piece of DXing. Local stations on 144 Mc. are KJU, QKE, LQD, OQQ, and QZF. QPD worked his first 14-Mc. DX as KZ5. From up Erie way, the usual items of interest arrived. NGB enlisted in the Navy. OIK was heard on 28 Mc. The pole-raising at PSI brought out the best in amateur talent, with the help of LKJ, OIH, and KKT. OIE is rebuilding his beam. TFX continues his FB articles in the Erie paper and we learn that NLU is trying out a new 28-Mc. converter. VHP's 14- and 28-Mc. beam combination is the neatest around. The RAE is putting on a club membership drive. MMI has his mobile gear in operation. Others working on mobile gear are QPC and NAIP. NJH is using a p.p. 24G final on 7 Mc. KQU has two new directional antennas. LSS now has a revamped police transmitter for mobile use; he can be heard on 29,595 kc. LIW is rebuilding. LMM is doing FB as EC. TXZ and OIH are newly-appointed ECs. IYR's new 3.85-Mc. antenna is coming along fine. GEG is rounding up the Third Regional Net in FB shape. LNA worked his 14th state on 144 Mc. LMMI and LAT are ECs for Pittsburgh and Butler Counties.

Traffic: (Sept.) W3GEG 442, NRE 351, NCD 38, ODU 1. (Aug.) W3GEG 214.

CENTRAL DIVISION

ILLINOIS — SCM, Lloyd E. Hopkins, W9EVJ — SEC: QLZ, Section Nets: ILN, 3515 kc.; IEN, 3940 kc. EHS was kept busy in cathode ray tube research. MNR is planning on some c.w. net activity shortly. KJ is sweating out parasites in the new rig. NIU visited the police radio set-up in St. Louis. LNI got a TV receiver of his own to see what TVI is first hand. QN is doing some nice work on emergency set-up in Des Plaines. BGN is plagued with TVI and must restrict operating until changes are made. YIX has gone VFO and sends a nice traffic total. LIN is busy fighting rig trouble but hopes to join ILN again soon. HKA reports from Michigan, where he is spending his vacation, and worked more than 200 stations. NN and GDI report little activity during the month. ED reports erratic conditions on 7 Mc., where he does most of his operating. EBX reports TXN could use at least four West Coast stations. GYM entered the Navy. FED snagged Class A ticket. DL40M, one of our section gang, reports quite regularly on conditions over there. This has been another small month in the way of reports, but we do the best we can. Traffic: (Sept.) W9EBX 3693, BGN 386, ED 373, YIX 209, BUK 83, APK 50, UBF 48, KJ 46, ZQT 39, NN 18, LAX 16, LNI 7. (Aug.) W9KJ 124, FRP 2.

WISCONSIN — SCM, Reno W. Goetsch, W9RQM — SEC: YYY, RMs: LFK, CBE, CWZ, SZL, PAM: ESJ. C.w. net (WIN) 3625 kc., slow speed, 6:30 p.m.; regular, 7:00 p.m. Phone net (BEN) 3950 kc., 6:00 p.m. CBE has been appointed Central Area Net (CAN) manager. CIH has two new 50-ft. antenna supports. HQT is on 160 through 10 meters with a Lyco No. 600 TVI-proof rig. NCS on slow c.w. net are CWZ, HDZ, IQM, KKM, and BZU. HDZ worked Ohio and Minnesota on 144 Mc. OVO, new Duor County EC, now has 3.85-Mc. mobile. ADM is in the Navy. JQP has a new three-element beam. KXK has a new 14-Mc. vertical folded dipole and picked up 3 new certificates — Canal Zone, Hillbilly, and Argentina DX. The Point Radio Amateurs held its annual family picnic Sept. 13th. CIZ is on 28 Mc. with new beam. Wausau mobile units provided communication for direction of 4-mile-long parade. The Annual Ground Hog Party was held at Watertown, Sept. 10th, with QHR in charge. IZO has the trophy for the coming year. CWZ operates from both Auburndale and Stevens Point. HMX uses a BC-654 and PE-103 for mobile. IXA is new ORS. The M. & M. Club elected KPK, pres.; SECK, vice-pres.; and JXY, secy.-treas. The Club is conducting code and theory classes. AFT has 13 states and Canada in 7 call areas worked on 144 Mc. LQC and HMX joined AEC. IVE has been endorsed as EC for Outagamie County. HEL is on 28 Mc. with three-element beam and 60 watts. DSV is experimenting with 5 stacked reflectors behind his 3.85-Mc. doublet. Most of AOW's operating is on 3.85 Mc. UFX now has 4-250As in the final. PFK is active again. FLARC meets the first and third Tuesdays of each month at Madison. RBI is putting finishing touches on 55-ft. tower. SZL, the EC, ran a preview of the Emergency Test with good results. LEE and DXV are on 144 Mc. FPE worked 0BBN 18 days out of 18 tries on 144 Mc. Traffic: (Sept.) W9ESJ 503, LFK 73, ANM 70, CBE 66, STP 28, CIH 22, IQW 27, HQT 19, IXA 15, CWZ 11, HDZ 11, YCV 11, IQM 10, RQM 10, OVO 2, ERW 1. (Aug.) W9SUF 106.

DAKOTA DIVISION

NORTH DAKOTA — SCM, Rev. Lawrence C. Strandness, W0JWY — All who can operate 1,910, 3,670, and 3,860 Mc. are urged to join one or more of the nets so that we can have a larger and more efficient state-wide network. Code speed on 3,670 Mc. is held to 15 w.p.m. as an inducement to all. Our nets meet on MWF at 7:00 p.m. CST. Recent changes in QTH: AJH, of Minot, now is attending the A.C. in Fargo and is living with RRW; also at the A.C. is GSR of Harvey; BCH left Mandan to attend the U. of Arizona, and in Minneapolis working is PUJ. New call in Wilton is RHT. SSW reports he works GEH on 7,125 Mc. Ben left Willow City and now resides in Toledo, Ore., where he has purchased a six-acre ranch. IPC is attending school in Chicago. New call in Jamestown is BFO. HJK says that the Jamestown Club has built a de luxe tape code machine with the idea of offering a c.w. practice program on 28 Mc. Traffic: (Sept.) W0JWY 7. (Aug.) W0PUJ 8, GSR 6, OCI 6.

SOUTH DAKOTA — SCM, J. S. Foesberg, W0NGM — RRN has written up this month's report. New officers of the Black Hills A.R.C. are QHX, pres.; ADJ, vice-pres.; IWE, secy.; GFG, secy.; GLA, act. mgr. New Class A tickets: IWE, VQT, GLA, GFG, QHX, CZQ, QBK, and WET/4, all of Rapid City, and ZSH, of Aberdeen. SAT is attending School of Mines and working at KOTA, Rapid City. URD was elected president of Howlin' Wind R.C., Watertown. New call in Watertown is QLK. STY has moved from Huron to Watertown. AAI, Howlin' Wind Club station, now has a receiver. ZSJ, Mitchell Club, now is on with ART-13. New officers of Sioux Falls A.R.C. are RRN, pres.; Gregg Hibbard, secy.; RWE, keeper of the cash. IK and ZLB are at

Camp Carson, Colo., with the National Guard. CQ Club, Aberdeen, now is holding classes with AHU teaching theory and CTX code. IEL now has her own rig in the living room — 1625s in modulator and final. Traffic: W0PHR 66, RRN 5. **MINNESOTA** — SCM, John B. Morgan, W0RA — Acting SCM, Charles Bove, 0MXC. Asst. SCM, Jean E. Walter, 0KYE. SEC: BOL. The U. of M. station at the Armory, formerly known as W0DSF, has a new call, K0WAW. Art Monsees, DSF, whose call formerly was used, now is basking in the sunshine of California. All arrival traffic of the Flying Farmers of America Convention were handled by EA and KFF. EA now is in W6-Land preparing to board ship again for the winter. He will be looking for Minnesota contacts via 28-Mc. Maritime Mobile. RXL, of Duluth, worked five Twin Cities stations on 28 Mc. via temperature inversion. TGF has a nice signal on 50 Mc. down at Bricelyn, Minn. GPQ and OMC now are on 50 Mc. RXL has his beam up again after last winter's icing. BZG is a new ham in Duluth, using 274 units and a Breting receiver. QXI is building a new home with a new shack and antennas in mind. GKP has his old HRO receiver refined to operate like an HRO-50. KYE has a new SX-43. FMD has an ART-13 in his shack and another ART-13 in his bedroom for cold nights. Hi, MJJ has a new S-40B and AMM has a new SX-71 job. ZGO and HRY shifted to 14-Mc. phone rig after getting their Class A tickets. SGW now is mobile on 28 Mc. with a new rig. DOQ, ZRH, and GKP have put up a prize for the first two-way 144-Mc. contact established between the Iron Range and Duluth. SYW has a new rotatable two-element beam on 14 Mc. SYN has accepted a position with Philco which will keep him out of town much of the time. HZR has left for the services, which leaves YPN as the new president of the Minneapolis Radio Club. HEO is installing the oscillator section of an ART-13 as an ECO. MLT now is MLT-07, Minneapolis. We hear that the Slugger, BGY, now is going high power. He has acquired a transmitting tube the size of a water pitcher. OBM and ZXV still are on 14 Mc. looking for DX. We want everyone to join the Emergency Corps. See your EC or write your SEC. BOL. Traffic: W0EA 211, ITQ 186, MXC 30, UCV 13, TKX 6, RXL 4.

DELTA DIVISION

ARKANSAS — SCM, Dr. John L. Stockton, W5DRW — A FMF has daily schedule with his son, FME, at Camp Polk, La. OCY has new antenna for his 3.85-Mc. mobile rig. QIP is on 7 Mc. with 8 watts from a VFX-680. HFQ is working some 14.25-Mc. phone. PX is on 3.85-Mc. phone. PHP, ICE, and DUV are new members of the Arkansas phone net. NBW has been called to active duty with the Air Forces. OCX moved from Conway to Russellville. EA has been busy getting the slow-speed net started. BAB has a new mobile rig for 3.85 and 28 Mc. NBG and OCX are planning 50-Mc. operation. Anyone on 50 Mc., please contact NBG. GWT is attending school in Port Arthur, Tex. AUU is on 3.85 Mc. running 500 watts and using super-modulation. ASO is new EC and ORS. JIN is constructing new b.c. station for Conway, KCON. LOK is taking some special training at Ft. Sill, Okla., and can be worked from K5WAH. MED and LNI are on 3.5-Mc. c.w. IRG is new member of OZK Net. It has been suggested that we have an Arkansas OZK Party some week end. If enough of you are interested we can set a date and have a big get-together on the air. Anyone doing v.h.f. or u.h.f. work, please contact me about OES appointment. Traffic: W5FMF 43, DRW 29, MRD 19, EA 10, LUX 8.

MISSISSIPPI — SCM, J. C. Wallis, W5DLA — QMQ has new 28-Mc. C.S. beam with rotator, and is getting all set to warm up the band this winter. KYC was a recent visitor on the Gulf Coast. LPL's new QTH is Natchez. DEJ should not be loafing now that the Rebel Net and TLAP are in full swing. WZ is NCS of the Rebel Net on Tues. and Thurs. nights and also is a member of the TLAP. He is looking forward to a big traffic season. OGN has new Class A ticket. ZVO is taking a course in TV. GXO was a recent visitor to MGR. HKT helped MGR to rebuild the rotator mechanism of his 28-Mc. beam and to add Selsyn indicator. POE is mobile from new Studebaker. JNR is new 28-Mc. mobile. PVQ is building new home complete with ham shack. DOL has moved to Mobile, Ala. The Gulf Coast Club recently purchased a fine 16mm. sound projector, and invites all visiting hams to bring along a reel or two. Traffic: W5QMQ 80, WZ 46, KYC 22, ZVO 1.

TENNESSEE — SCM, D. G. Stewart, W4AFI — New appointees: AEE as EC; JD and LUH as OPS; FX as ORS. FDF visited Nashville and assisted AEE in getting the Emergency Corps for that area organized. The Kingsport Amateur Radio Club has agreed to expedite the call letter license plate project and all who have any information or contacts that might further same are requested to get in touch with that group. The Oak Ridge Radio Operators Club recently furnished communication for local Air Show, 23 and 4 Mc. being used with seven mobiles, one aircraft mobile, and two fixed stations. FDF, FQI, KAF, KMH, LGG, MJR, NDE, OJZ, and RRT participated. DLY now operates portable in Colorado. JD is mobiling on 28 Mc. with new rig. OOA is on 28 Mc. chasing DX. HHQ lost power trans-

former and now is QRP. RDK has new Class A ticket. RPT is building new rig with 24G final. PMR is a new OBS. OOA and RPT made a jaunt into Kentucky for some portable work with a 30-watter. RZA is a new ham in Knoxville. BD moved to Indiana. DCH is burning the midnight oil chasing DX. FCF moved to new shack. DQH is recovering from electrical burn. GD managed 93 countries in spite of TVI. A new call in Memphis is RBL. PL is pushing traffic total on up with limitations on operating hours by the YXL and doctor. Please note change in your SCM's address on page 6. Traffic: W4PL 2489, APC 119, BAQ 58, AEE 36, JD 36, OOA 35, NNJ 27, LUH 18, FX 13, NDC 12, HHQ 10, HQM 9, RPT 7, FLW 5, AFI 4, PMR 2.

GREAT LAKES DIVISION

KENTUCKY — Acting SCM, Rev. C. Lynn White, W4NBY — The Kentucky gang regrets the loss by moving of our SCM, Dr. A. W. Adkins, KWO, to Huntington, W. Va. However, Doc will be "on the air" from the new QTH soon. A new SCM will be selected according to the ARRL By-Laws. In the meantime the gang in Kentucky will please send monthly traffic and news reports to NBY, Harlan. KYN got under way Sept. 18 with a good bunch QNI. The NCS boys have been doing a fine job getting the net going and moving traffic. BAZ reports regular Emergency Corps drill at LVL, RRU, a new ham in Harlan, is active on 28 Mc. with a 32V-2 and 75-A and a swell mobile rig. CMP's mobile and portable rigs were busy most of the summer. The mobile hung up some nice DX. JPV is burning the midnight oil with a new 144-Mc. beam. The "Kentucky Korn Crackers Net" operates on 3945 kc. 8:00-9:00 A.M. each week day for traffic and ragchew. Plans are under way to get "The Bluegrass Net" going, which operates on 3890 kc. at 9 P.M. EST (phone). TFK is transferring his fine mobile rig from the old to the new — earl JTB is an operator at local b.c. station. ODK has a new 32V-2 still in the packing box. JP stays by his low-power rig and gets out. YPR is Kentucky's most consistent ham. Call him on 3.5-, 7-, or 14-Mc. c.w. any time. Gang, let's get those monthly reports in before the fifth of the month. Traffic: W4WTT 93, BAZ 44, YPR 35, CDA 29, NBY 23, MDB 15, ONT 15, FFQ 11, OGP 5, BXU 4.

MICHIGAN — SCM, Robert B. Cooper, W8AQA — Asst. SCM c.w., J. R. Beljan, 8SCW. Asst. SCM U.P., Arthur Kohn, 8TTY. SEC: GJH. RM/QMN: UKV. PAM/MEN: YNG. New appointments: ORS to 2RTZ/8; EC to EDO, Monroe County, and EJD, Schoolcraft County; OES to EXO. URM is busy with a code practice program. DLZ reports RRT now relocated in Grand Rapids and is very active in the emergency work. A short visit with SCW reveals completed plans for QMN this season. GJH attended the organizational meeting of the Red Cross Radio Amateur Club in the Detroit Area. COW has Class A license and reports that action has been taken by the Saginaw Area Radio Club to affiliate with the ARRL. TDO advises the Detroit Whip Club is making excellent progress, as evidenced by the large turnout at a mobile rally Oct. 2nd. The first emergency drill of the Calhoun Area Radio Club was held with a satisfactory attendance as reported by BET. NQ has his entire station completely enclosed in a cabinet that is mounted on rubber casters. TIC now is convalescing at home. QIT has a new 14-Mc. wide-spaced beam in service. SWF has a new exciter unit for his TVI and is making all the adjustments to prevent Channel 2 split. BLR now has a 5-acre antenna farm near Farmington. ILR sends a very informative sheet from the Edison Radio Amateur's Assn. showing the progress of the Club in the Field Day contacts for '48, '49, and '50. AYW has been made Director of Disaster Communications. DUK now is Class A and has a 20-w.p.m. sticker for his Code Proficiency certificate. YLA informs us a new operator in the Negaunee Area is FLR. OAF spent his vacation with EKY and gave his mobile rig a good workout in the Copper County. UKV now has an A-1 Operator's certificate. 9HKA/8 makes his last report from the Macinack Area. ZHB has completed the construction of his homemade superhet receiver. BVI is the proud possessor of a windmill tower for his antennas. FX is working on a coaxial-fed antenna for 3.5 and 7 Mc. WXO has k.o.ed his TVI and is experiencing a decided drop in telephone calls while working QMN. EXZ has a v.t.v.m. construction job completed. ELW has a VFO mobile job on 3.85 Mc. with a BC-457A. Traffic: W8RJC 252, ELW 243, YKC 183, SWG 155, EXZ 131, DAP 129, SCW 51, WXO 49, AQA 41, EJD 32, FX 19, WYL 19, BVI 17, IV 11, DED 9, TQP 9, ZHB 7, 9HKA/8 7, 8AYV 6, UKV 4, OAF 3, YLA 1.

OHIO — SCM, Leslie Misch, W8HGW — Asst. SCM, Robert L. Brewster, 8WDQ. SEC: UPB. PAM: PUN. RMs: DAE and PMJ. Thanks to those who elected me to the SCM post, and best of luck to Doc Stricker, our former SCM. DAE QSO'd 5 VKs during the VK/ZL Contest on 7 Mc. The Buckeye Net now operates Monday through Friday and help is needed from Toledo, Columbus, and Eastern Ohio. QAD is building new 10/20-meter beam. EIB is constructing new windmill tower. FJR, 15 years of age, is the youngest Clevelander on 28-Mc. phone. ATK has new 3.85-Mc. antenna. LBH was active on 50, 220, and 420 Mc. during the ARRL Sept. VHF Contest. The Cleve-

land Groundwave Contest was held Oct. 28th on 28 Mc. TRX now is in Norfolk awaiting a W4 call. EZE/8 is QRL for college and is active as engineer at WKCG, campus carrier current station. YFJ recently was married. HRN has new fifty-foot pole. DOG and EIV are conducting code classes. AUP will spend the winter in Florida. IVG was a guest at JRG's. PM is the tenth West Park Radiop to make DXCC. The Dog House Net Picnic was held at Serpent Mound on Oct. 1st. The first meeting of the Ohio Council Delegates will be held early in January. DPW is back on 28-Mc. phone with a Sonar he bought at the Cincy Hamfest. 6HTC, ex-8ZXX, was in Cincy recently and visited some of his old buddies. He says the W6s are working VK and ZL on 3.85 Mc. with mobile rigs. BPZ has his 829 on 3.85 Mc. with carrier-controlled modulation. DWT is well pleased with his newly-acquired HQ-120X. JNF is planning to go mobile. ELZA, Harbel, Liberia, and JNF were honored guests at the Akron Hamfest on Aug. 22nd. More than 200 attended. VEV now has a private plane. UPB still is looking for ECs in various Ohio localities. CQZ and BRG are now Class A, as is RPG. ICS has new 3.85-Mc. rig. DQE is building new VFO. EKX, CUL, and FOR have been called by the military. IOO is erecting windmill tower. DMJ still is struggling for that coveted DXCC. WVK is doing well with 25-watt mobile rig on 3.85 and 28 Mc. MQO has new antenna farm. BMP now is on 3.85 Mc. Judging from reports, the Simulated Emergency Test of October 15th promoted much activity throughout the State. Reflected CWA officials are BF, pres.; BXB, vice-pres.; FSP, secy. NYG is operating as SV0WX and is looking for Ohio contacts. MXL has acquired an XYL and a new home. FYW is a new amateur in Columbus. BAX, UZ, and WRN are doing well on u.h.f. PSF, Great Lakes Director, and UPB gave interesting talks at the Cincy Hamfest. Traffic: W8YCP 319, DAE 234, DSX 166, UPB 109, DXZ 103, AJW 57, GZ 42, WE 30, AL 17, TAQ 12, SFI 10, WAB 6, DXO 4, DZO 4, LBH 4, CBL 1.

HUDSON DIVISION

EASTERN NEW YORK — SCM, Fred Skinner, W2EQD — SEC: CLL. New ECs: VRE, Rye; LSD, Mount Vernon; EFU, Schenectady (Industrial); FZW, Schenectady (County); EQD, Pelham; GYV, Niskayuna; BRS, Rotterdam; and JZX, Scotia. QGH, Larchmont, is new OBS. Listen for him on 144 Mc. Stations who were active in the V.H.F. Contest include RMA, IEC, UKA, EFU, YIK, PNG, ACY, and OPQ. EQD is back at his home QTH and is active in MARS on phone and c.w. BER qualified for Class II OO appointment. HUM is directing activities on an emergency net for Columbia and Green Counties on 1887 kc. NJF is taking over for the Eastern New York Emergency Net on 3.85 Mc. The time has been changed to 9 A.M. Sundays. Traffic: W2CLL 469, TYC 339, EFU 218, PHO 133, BRS 121, DXY 120, LRW 100, EQD 8.

NEW YORK CITY AND LONG ISLAND — SCM, George V. Cooke, W20BU — Asst. SCM, Harry Dannels, 2TUK. SEC: BGO. RMs: PRE, BYF. PAM: GSC. Nassau County EC, FI, reports a long list of active stations reporting for weekly drills. Those recorded are GG, JXP, CB, YSL, SPI, ZKY, MFI, BTA, EBY, CDT, FI, TUK, RZ, DUS, ZUC, QHI, GQP, CEF, ANN, SNO, WVN, ZAI, LBJ, MIZ, ZJJ, YKM, UXY, LLR, KJY, and 4KKM/2. Aside from local drills, contact schedules were maintained with Suffolk, Queens, Westchester, and Orange Counties. Ten- and eighty-meter phone nets have been added to the Nassau County AEC with ZAI and QHI, respectively, as NCS. FI has been appointed to the Nassau County Communications Committee on Civilian Defense, taking over the post he held during the war. Fifty 144-Mc. mobile stations are promised for next spring to work in the C.D. set-up in Nassau. Queens County EC, PQG, has reorganized the AEC in Queens, with IAG as EC for 28-Mc. operations. DIC and UGZ are acting as Asst. ECs, the former handling the 1900 net and the latter the 2300 net on 29.52 Mc. During the threatened hurricane of Sept. 11th, the Red Cross alerted the Nassau AEC and the Queens group. All was in readiness for six hours with stations reporting every half hour until the danger was passed. All hams living in the N.Y.C. counties are requested to drop a postcard to BGO, our SEC, requesting application blanks for affiliation with the N.Y.C. Civilian Defense organization in radio. All clubs in the city proper are organizing training classes to produce as many operators as possible to help get the program rolling. The demands of N.Y.C. on amateur radio to function as a second line of communications has far surpassed the greatest number of stations and operators one could imagine would be needed. Therefore, all clubs in the area have agreed to assist in preparing for C.D. operation, and 144-Mc. nets are operating at present conducting weekly drills. In the very near future installations will be made at vital points to supply the C.D. needs, with a view toward unlimited expansion in the future. SJC, EC for Bronx and Manhattan, reports increased activity with the formation of 28- and 144-Mc. AEC nets. NZJ has been appointed EC, controlling all 144-Mc. operation in Queens County. Grid Leaks, the snappy paper of the UHF Club of Jamaica, states that JTV and DKH were hospitalized but are well on the road to recovery now. ZPG and ZEO have been called into the services. Many of the

(Continued on page 78)

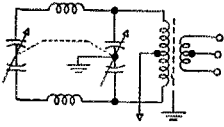

AS MANY of you know, the MB-40L (formerly MB-20) originally grew out of a *QST* article. Recently, the MB-40L multi-band tank was redesigned to improve both its electrical and mechanical performance. The original MB-40L worked well. It is our belief that the new tank will prove to be even better. The mechanical features which in the first model were improvised from standard parts have been much improved and the condenser assembly is now a rugged one piece unit similar in appearance to its big brother, the MB-150. The tuning range is the same, 3.45 mc. to 10 mc. and 12 mc. to 30 mc. The output circuit has been modified to include an electrostatic shield on the output link and a tap on the output coil. The need for the electrostatic shield is well known to most of our fellow hams — the others are finding out every time the coaxial cable is extended. We do not make any claim that the electrostatic shield will eliminate harmonics from the driver to the final, or from the final to the antenna, but we do know it will serve as another link in the battle for harmonic elimination.

Some peculiar troubles presented themselves during the design period. It was found that the capacity from the center of the low frequency inductance to the electrostatic shield had to be kept low to eliminate a peculiar tuning characteristic brought about by two grounds appearing on this tuned circuit — one, the rotor of the tuning condenser and the other through the capacity existing between the link shield and the center of the low frequency coil. Originally, the shield was a flat ribbon insulated from the low frequency inductance. The final result was air insulation, low coil to shield capacity and low shield to ground inductance. It should be pointed out here that the inductance of any lead or condenser grounding the frame of the tuning condenser should be low to prevent any impedance existing between the shield and ground.

The tap on the output link provides a choice of three output impedances. These impedances will vary with the particular tubes in use of course. Two, three or five turns are available to work into (or from) any line impedance between 50 and 300 ohms. Tests indicated that when used with a resistive load, the loading was quite uniform over the entire range of 3.5 to 30 mc.

During the testing of the first sample something was noticed that may be of some interest to users of this, as well as the MB-150 tank. The MB-40 was connected in the plate circuit of a single 807 tube, the 807 being driven by a 6L6. The 6L6 was highly biased and was generating a fair supply of harmonics. When excited on 3.5 mc. the 807 plate circuit could be tuned to many of the harmonics of 3.5 mc. and gave the impression, at first, that the dips in 807 plate current were due to false resonances in the MB-40L. Investigation proved that this condition was due to high harmonic content in the drive voltage. The MB-40L can, of course, be tuned to harmonics of the driving frequency. Although the MB-40L is tuned to two frequencies at the same time, they are not harmonically related, 40 meters does not occur at the same condenser setting 80 meters does etc. Occasionally, a 10-meter doubler will be used to drive a final amplifier, with a multi-band tank assembly in the final plate circuit. The multi-band tank can be tuned to 20-meters and a dip in plate current will be noted. This is not due to any defect in the multi-band tank assembly. The driving voltage from a doubler often contains enough 20-meter component to drive the final to fair output if the plate circuit is tuned to 20. This condition also exists of course with conventional plug-in coils.

ED HARRINGTON, W1JEL



local gang attended the annual Hudson Division Convention at Asbury Park. OUT is back as NCS on NYSS. PRE has resumed the RM job for 2RN, tying in with EAN and the local NLI Net on 3710 kc. at 1900, Mondays through Fridays. Outlets are badly needed all over the section. Contact BYF, RM for NLI Net, for particulars. DKO has accepted engineer job at WMSA in Massena, N. Y. AOD was heard by BAV at Claryville, N. Y. (approximately 90 miles) on 420 Mc. and has worked 10 states on 144 Mc. Section Net Certificates were earned by UGZ, DIC, JSV, YHX, and IAG. CJI is back in the Navy. UTB participates in the Mid-Island Club net on 3870 kc. on Sundays at 1000. BIV received his WAVE certificate. LGK wants to hear from all AEC members interested in 3.5-Mc. c.w. net operation. PF has resumed MARS schedules and ties in with NLI and is working on 4-wire radio patch. RTZ/8 reports into NLI regularly; he has new 129-X and 802 final. TUK, QBS, TNI, UYX, RZ, OBU, QAN and others operated BVL/2 at the Mineola Fair and cleared 306 messages. Traffic: W2VNJ 465, BO 403, OBU 362, DRD 215, SJC 123, ZDE 96, MQB 49, YIR 49, TJA 39, JBQ 35, DIC 21, LGK 17, TUK 16, OUT 14, BIV 12, YDG 12, ESO 8, IAG 5, PF 4, KVG 2.

NORTHERN NEW JERSEY—SCM, Thomas J. Ryan, jr., W2NKD—As a direct result of the Hudson Division Convention meetings the emergency organization in the section has progressed in leaps and bounds. The following EC appointments or endorsements have been made: OUS, Red Bank; QWF, West Orange; BU, Watchung; YLS, Everett; PAT, Shrewsbury; KQ, Closter; EC, Caldwell; BUX, Hudson County; ZK, Oceanport; NUL, Passaic County; IGX, Montclair; BRX, Asbury Park; VPL, Milltown; KBH, Fairlawn. ORS endorsements went to OXL and AWY. OPS endorsement went to LMB, who continues to knock off high traffic totals in 'phone nets. The Livingston Club, with its station located at the local Recreation Center, is using a Collins 75-A and 32-V. Also in use are two member-owned 28- and 144-Mc. mobile units, ten 144-Mc. walkie-talkies, and a 144-Mc. net is being formed. NAP represents the Club on the Livingston Defense Council. ZBY received Class A license. New members of NNJRA are BYT, CXW, GAS, and QPN. The club meets on the second and fourth Mondays at 60 Grand Ave., Englewood. The Tri-County Radio Assn. of Plainfield and the Raritan Valley Radio Club of New Brunswick held a joint meeting on Sept. 18th to discuss emergency work in Middlesex County. Speakers were the SMC, VQR, Middlesex County EC, BA1, and Plainfield EC. HNY, VQR and yours truly wish to express appreciation for the manner in which you have so wonderfully cooperated with your local EC, and also to commend the local ECs and County ECs for their great work in the planning of the section set-up. PKR is using a kw. on 14-Mc. 'phone, and is using 144-Mc. teletype. COT is doing a nice job on Civil Defense in Maplewood. He has SCR-522s ready to go at a moment's notice. BTS, 14 years of age, received Class A license. He is a member of the Long Branch Senior High School Radio Club. On Sept. 29th EWZ worked the following on 7 Mc.: GM3AFG, F3YE, G5LI, KP4UW, SM6AMF, GM6IZ, G3ABG, HB9GK, OK1XJ, VP7NQ, PA0LX, and CM6AH. Attention YLS: The Petticoat Net (PCN) has been formed and meets on 7200 kc. at 1400 EST on Mon., Wed., and Fri. NCS is 3HWD. Contact WCL for further details. PKR visited 6ISA at Capistrano and 6WKU at Los Angeles while on a three-week vacation. He also visited 9ABA in Chicago. ZYM has just completed rotary beam for 28 Mc. BFP is attending Iowa State University. KBH is the new EC of Fairlawn. NCY built antenna scope and checked rigs for the gang in Bergen County. CWK licked his TVI and is back on 3.5-Mc. c.w. One of the requisites of an appointment and its continuance is monthly reporting to the SCM. The writer would welcome recommendations for the appointment of a PAM for the section. All C.D. appointees in Morris County should now mail their monthly reports to the SCM of Northern New Jersey. Certificates for endorsement also should be forwarded in like manner. Traffic: W2CUI 214, UWK 160, CGG 159, AWY 76, NKD 70, NCY 65, ANG 51, CCS 43, WCL 41, OXL 32, LMB 19, CWK 8, YOB 4, NIY 3, CFB 2, EWZ 2

MIDWEST DIVISION

IOWA—SCM, William G. Davis, W0PP—SCA rates top billing this month; he made BPL both ways. That takes a lot of work. TLCN opened Sept. 25th. The Kansas gang took care of the ROWH program at the Midwest Division Convention. Dick Eidel, ex-2MHV, now is sporting 0RUP. He reports he has a new VFO, as per Feb. QST. RFT has gone back to sea with the Merchant Marine as radio officer. Your SCM met with the Waterloo gang recently and enjoyed the meeting very much. The boys are on their toes and have lots of plans for the good of ham radio. VHR is about to get on the air again. FWL is happy to have his daughter back home from the hospital. JRY has new Collins receiver. USE used his mobile on a trip to New York. EHF is building new 144-Mc. rig. QHG is building a new rig. QHK is attending the University of Nebraska. The Council Bluffs Club reports it now has eight members attending the University of Omaha and one at Creighton. BBX has new 10- and 20-meter beam. The Des Moines gang is up to the ears in work relative to the Midwest

Division Convention. The SCM received a query from the Delaware County Chapter of the Red Cross for information on the hams in that local. PP is trying to move the ham shack into the house between tricks. IFI was back in Iowa on business. BCB reports that he is on 160 meters; DIB reports likewise only with 15 watts. On Sept. 29th the Davenport Radio Amateur Club and all amateurs throughout the country lost a very fine friend in the passing away of George J. Barron. CEN, who was of great help in getting the Davenport Club started. For many years he had worked on 28 Mc. Traffic: W0SCA 524, QVA 74, NYX 20, RUP 13.

KANSAS—SCM, Earl N. Johnston, W0ICV—The Southern Kansas Radio Club of Winfield recently was organized with CJI, pres.; NJS, vice-pres.; HWN, secy.-treas. The Club meets the 1st and 3rd Wednesdays in City Commission Rooms. WARC, of Wichita, held a picnic Sept. 10th, the main feature being the hidden 10-meter transmitter hunt. The High Plains 160 Net on 1995 kc. meets at 1830 Mon., Wed., and Fri. Our most active OES, IPI, is attending radio school in Omaha. BNU, of Chanute, has new final, a pair of 810s on 3.5-, 7-, and 28-Mc. c.w. with 600 watts, and is awaiting new modulation transformer for 'phone. YZX, of Salina, put up a new antenna on 3.85 Mc. using a grid-dip oscillator for tripping. His FB signal is responsible for it. NEI, of Florence, is leaving for Ft. Monmouth to be with the Signal Corps. The 75 Net will miss Chuck but hopes to work him on 28 Mc. when he gets set up. OZA, of Pittsburg, also has gone into the services. New ECs are GCJ, of Marysville; TDW, of Eldorado; RC, of Wichita; and YCT, of KCK, which makes all Kansas counties with an EC now. KXL is active on Mo. Net, the Show Me Net on 7272 kc., TXN, and QKS Nets, which accounts for his FB traffic totals. CED, of Garden City, reports AQD at Plains, LNW, and AWR have enrolled in the AEC. OAQ reports the passing of ZAT, the victim of an auto accident. He was a veteran of three wars. He will be missed by the gang that knew him. Traffic: W0NIY 112, KXL 32, FDJ 31, ICV 19, LIX 2.

MISSOURI—SCM, Ben H. Wendt, W0ICD—Appointments and renewals: ARH, JAP, and GBJ as ORS; AZL as PAM. BJL, PLJ, and KYF are participating in a 2-meter net in which traffic is being relayed between Milwaukee, Wis., on the north and Jackson, Miss., on the south. The relays are being carried on with a goodly degree of success. OUD, the NCS for MON, has tendered her resignation after having faithfully conducted the Net for many years. OUD's successor will be announced as soon as a new NCS has been selected. DEA has rebuilt his modulator and is planning on revision in other gear, such as a 60-ft. broadcast-type antenna and a rotating three-element 14-Mc. beam. WAP is having trouble in getting the bugs out of his 3.5-Mc. c.w. rig but is having good success on TXN on 7-Mc. c.w. QXO, the early bird, is looking for more traffic on 7140 kc. between 6:00 and 8:00 A.M. CST. The Missouri section has lost an old stand-by in CGZ, as he has QSYD to Leavenworth. Kans. SOM proudly announces the arrival of a jr. operator, who probably will fill in the background from the mike arm. KIK is having difficulty in getting traffic off or on the hook because of TVI. PME turned in a fine traffic score just before leaving for the armed services. The HARC AEC group is planning a simulated emergency test in connection with the Red Cross in order to better coordinate methods in case an actual emergency arises. The keys of two hams in this area, ZAT and BHH, have recently been silenced. Traffic: W0PME 739, QXO 669, WAP 133, CGZ 10, OUD 6, QMF 4, SOM 3.

NEBRASKA—SCM, Scott E. Davison, W0EOD—We are sorry to report the resignation of RQK as SEC because of his heavy duties in microwave work. However, JED has accepted appointment as SEC. GFI has a new VFO to his 35Ts doing a nice job. CIR is building a new rig at his new home. YNA has VFO and a keying monitor for break-in as new equipment in his shack. RQK says thanks to all who helped him while he was SEC. BZS is a new call at North Platte. IXL is sporting a new rig. KJP is busy on new job and relocating his antenna. The 80-meter c.w. net elected FAM as new NCS with AY as his assistant and alternate. Shirley Tivis has received her B ticket with the call BXA. AQT has new mobile unit on the air and is building new 813 final for home rig. FMW reports 160-meter emergency net getting back into shape with a big gang enrolling. JJJ soon will have p.p. 807s for 'phone and c.w. operation, with clamp tube modulation. Enroll in the Emergency Corps now, gang. Get in touch with JED. LJO reports new officers of Hastings Club are YZL, pres.; NPZ, vice-pres.; LYZ, secy.-treas. BTM is a new call at Grand Island. AIN is sporting new SX-71. CBH is holding 14-Mc. 'phone schedule with Armed Forces Net. GMZ is on the mend after a siege of illness. FMW has new 40-watt mobile going on 160 meters. CMO is back on the air after moving. Traffic: (Sept.) W0AY 1048, HSO 598, GMZ 373, KJP 56, CBH 35, FMW 25, DMY 18, PAM 18, LJO 14, AIN 10, SAI 10, IXL 9, CMO 2. (Aug.) W0HSO 231, FMW 14, GFT 9.

NEW ENGLAND DIVISION

CONNECTICUT—SCM, Walter L. Glover, W1VB—The regular fall meeting of the Connecticut Net was held on Oct. 7th at the club rooms of GB in New Haven, (Continued on page 80)

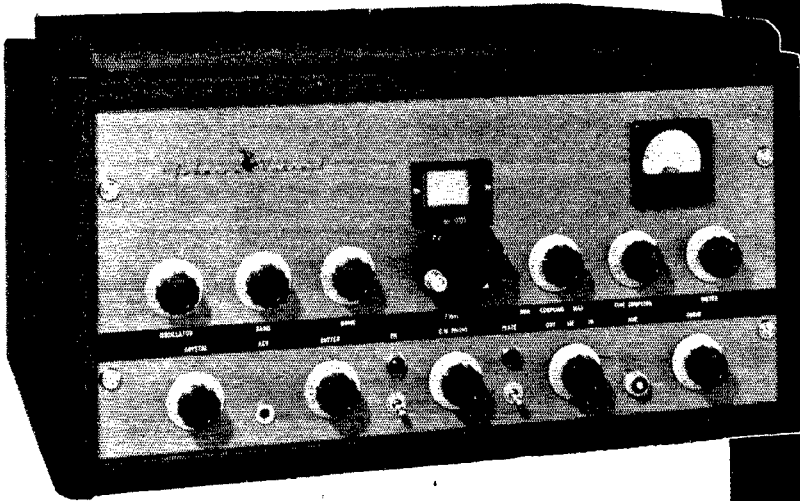

Features

- Output — 100 watts, with AM phone on all bands, 115 watts cw
- Band switching on all bands from front panel — no plug in coils
- Continuous tuning final tank—additional inductance switched in for 160 meter band
- Pi-section output stage for operating ease, efficiency
- Front panel control of ten crystals
- Unique Pierce oscillator
- VFO input receptacle
- Freedom from parasitics
- Two complete power supplies
- All stages metered
- Handsome desk cabinet 11-3/16" x 15" x 21"
- 807 modulators, frequency response limited from 300 to 3,000 cycles
- Most any antenna can be used without external couplers

Merry Christmas

... and MANY Happy New Years

with the

VIKING 1 Transmitter

(AVAILABLE IN KIT FORM ONLY)

What a wonderful way to start the New Year—on the air with a **VIKING 1**! Here's a rig that not only looks professional, but operates with that smooth convenience and dependable power that usually is found only in the most carefully designed and engineered commercial transmitters.

For example: Bandswitching is accomplished from the front panel and the pi-section output stage will efficiently load many antennas without external couplers. A full 100 watts output is provided on amateur bands 160, 80, 40, 20, 15 and 11-10 meters.

The **VIKING 1** is furnished unassembled but complete in every detail including wiring harness, drilled and punched chassis and panel and all parts except tubes, mike, crystals and key. Instructions are carefully detailed, profusely illustrated. Novice or old-timer alike can assemble and get brilliant performance from the **VIKING 1**. Tubes required—RF tubes: 6AU6, 6AQ5, 4D32—AF tubes: 6AU6, 6AU6, PP807's. Rectifiers: 6AL5, 5Z4, parallel 5R4's.

Why not own a "commercial in appearance," "commercial in performance" transmitter?

You'll be proud in '51—On the air with **VIKING 1**!

VIKING 1 Transmitter Kit (less tubes, crystals, mike & key),
Amateur Net Only

\$209.⁵⁰

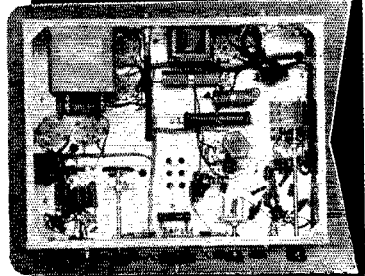

Wiring the **VIKING 1** is made easy by following the complete step-by-step instructions.

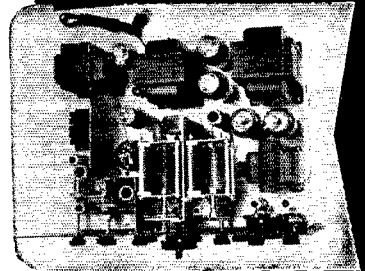

Careful design and layout permit short RF leads and ample shielding, resulting in highest degree of efficiency and stability.

See the **VIKING 1** at your **JOHNSON JOBBER** or write for illustrated folder — **TODAY!**



JOHNSON . . . a famous name in Radio!
E. F. JOHNSON CO., WASECA, MINNESOTA

when organizational matters for the coming season were ironed out. It was well attended and was honored by the presence of BVR, our Director. New officers of NHARA, recently elected, are SJO, pres.; SUA, vice-pres.; ATH, secy.; JQK, treas.; and KQY, DDP, and HMZ, directors. CARA held its annual dinner and election of officers on Oct. 13th. Officers elected were SZL, pres.; ADW, vice-pres.; KYF, secy.; and Huston, treas. The Yale Radio Club, YU, is organizing for the winter, but is temporarily off the air because of a new shack location. BVB has his new 28-Mc. mobile in operation. SGN has been called to active duty. ODW reports the local volunteer fire company is getting behind emergency communications set-up. RXL has left AW and now is working in Bristol. NJM has added a modulator to the rig, and hopes his voice won't get a "glass arm," too. TD keeps OBS schedules on 146 Mc. The gang misses DAV's peanut whistle, and hopes his XYL is recuperating satisfactorily. NLM is getting a 3.5-Mc. rig going. Traffic: WINJM 290, LV 100, BDI 83, BVB 73, RWS 51, GVK 33, KV 31, KYQ 27, ORP 18, HYF 15, OJR 12.

MAINE — SCM, Manley W. Haskell, W1VV — Revised Pine Tree Net data is as follows: Mon., NCS QUA, 1RN RQR; Tues., NCS NGV, 1RN NGV; Wed., NCS LKP, 1RN LKP; Thurs., NCS ROM, 1RN NGV; Fri., NCS NXX, 1RN NXX. RM is NGV; the Net meets on 3550 kc. at 1900, Mon. through Fri. Sea Gull Net, PAM PTL, 3961 kc. at 1715, Mon. through Fri. AEC Net, NCS QUA, 3588 kc. at 1845, Mon. through Fri. Maine Shuttle Net, NCS RQR, 3588 kc. at 1430, Mon. through Fri. New PAM is PTL. FBJ, former PAM, who formed the Sea Gull Net prior to 1937 and has acted as PAM since, now is colonel in charge of Maine Wing, CAP. SGN will start at 1715 instead of 1700 so that more members can attend. VV, as SCM, and IGW, as SEC, visited Knox County Radio Club, Rockland, Sept. 29th and spoke on AEC matters and CD liaison. LDC says that he enjoyed the hamfest at Kezar Lake and is ready for another. Many Maine amateurs attended the annual baked bean supper of the Communication Flight, Maine Wing, CAP, at Duck Pond Garage Hall Oct. 6th. The PAWA will hold a club supper at the same place early in November. QY and VV are Maine contacts for the New England Emergency Net on 3975 kc. Tuesdays at 1800 and also for TCPN. AQL now is OBS and EJS is new ORS. Traffic: WINGV 293, RQR 212, QUA 190, LKP 180, SWX 83, HYH 66, VV 40, LRG 35, SRQ 29, QY 27, RPT 25, SUK/SZM 16, JTH 13, NXX 12, AMR 9, PTL 7, PYY 3, SFZ1.

EASTERN MASSACHUSETTS — SCM, Frank L. Baker, jr., W1ALP — The New England Emergency Net will be on Mondays at 6 P.M. and during any emergencies on 3975 kc. SS is Net Control, PU is Alternate. Other members in this section are AHX, SLW, QLL, ZE, QGJ, and OQT. New ICs are IO, Danvers; PST, Brookline; HRA, Winchester; HYG, Dighton; OSX, Braintree. The Eastern Mass. Net is active on 3745 kc.; the slow-speed section at 6:15 and the regular at 7 and 10 P.M. Write to ALP or call in on the Net, Mon. through Fri. The recent V.H.F. Contest brought out the following new calls on 144 Mc.: QMN, FTB, AXO, GJZ, HXY, BJN, ODQ, IUU, QW, and BCW. HIL has a beam on 144 Mc. SYL, Melrose, is on 28 Mc. 6JR, ex-IHTP, of Quincy, is on 14 Mc. and working the East Coast. MMY is on 50 and 28 Mc. ATX is on 3.5 Mc. JY will have KIWAJ on 3.85-Mc. 'phone Wed. at 7 and 10 P.M. Thanks to EMG for the recent *Eastern Mass. Net Bulletin*. The Eastern Mass. A.R.A. meets the 1st and 3rd Wed. at the Cambridge Y.M.C.A. The South Shore Radio Club meets the 1st and 3rd Fri. nights at the Quincy Y.M.C.A. Recent visitors to ATP were DJ, OIR, MPP, and LIY. CTW and OEX operated 50, 144, and 220 Mc. from Hogback Mt., Vt., in the V.H.F. Contest. KEQ, BJB, DYY, and CLS are getting started on 420 Mc. The 50-Mc. Minute Men meet 9 A.M. Sundays with IN presiding. The New England Net meets on 50 Mc. Mondays at 8 P.M. with CLS presiding. EL has a Gon-Set converter mobile and is on 28 or 3.85 Mc. BHD is looking for more locals to get on 432 Mc. NUQ is on 144 Mc. ZW is on 14- and 28-Mc. 'phone. QEP has Class A. SS attended the convention at Asbury Park, N. J. LPM is new Natick EC. BL worked a W4 on 144 Mc. in Virginia. MCR is Boston EC and will appoint assistants for each one of our bands. OKK is assistant for 28 Mc. BL, EK, HLX, JOW, KVF, LMU, NSZ, OMU, PWV, PYM, and RM are on the Newton Emergency Net. RM has been appointed communications head for the City of Newton. LMU has RAO receiver. OMU has all-band rig on. KNI has been using "constant modulation" system. BB, SNK, and ALP helped in getting Governor's message to the Governor of Maine under "Operation Garcia," sponsored by PS. New officers of the Framingham Radio Club are RCJ, pres.; RXH, vice-pres.; MHC, secy.; MEG, treas. AHX has a 1 1/2-wave vertical and rhombic. BGH is on 3.85- and 14-Mc. c.w. QGL is back on the E.M. Net. The Brockton Club meets the 1st and 3rd Mon. at the Brooklyn Y.M.C.A. DMS has new single-wire antenna for all bands. QJB worked QRP portable from So. Jersey while on vacation. ZR belongs to new Petticoat Net. PCN. JFS is on 1.8 and 28 Mc. LN took JFS, SHU, and the XYL to the Concord Hamfest. BDU is on the E. Mass. Net. BGW is working lots of PKs, RQZ had a large group on 28 Mc.

during the hurricane. BB was on the National Emergency Net, NBS on the Eastern Mass. Net, and MCR with the net on 144 Mc. JQ and POF were on 3.85 Mc. AHX, who had an emergency generator and was the only means of communication out of West Falmouth, was on 3.85-Mc. 'phone. Others active were DFS, SS, and QP. Martha's Vineyard Amateur Radio Club held a ham-picnic with the following present: 2IKE, 1NZP, QLL, 3MCO, 1OJE, MBQ, SLV, SLW, MM, OQT, SGL, and Herb Brownell. HRY is Wellesley EC. NBS has gone to Brazil. ZS6XQ arrived in Boston and was greeted by BB, MPP, SS, GM, and QMD. AJ, BL, EK, RM, EYL, FUR, PWV, FOW, RWO, NSZ, HLX, OIW, LMU, and KVF took part in a "Mock Disaster" Oct. 7th. Traffic: (Sept.) WIKMG 199, SS 160, TY 125, LM 101, PU 95, DMS 79, KKK 56, ZR 33, QJB 24, PYM 23, JFS 17, DWO 14, BDU 8, LMU 8, NWL 6, AVY 3, WU 2, BAQ 1. (Aug.) W1QJG 60, BGW 4.

NEW HAMPSHIRE — SCM, Norman A. Chapman, W1JNC — SEC: KYG. RM: CRW. The N. H. Net (c.w.) frequency is 3685 kc., Mon. through Fri. at 7:00 P.M.; N. H. Emergency Net (c.w.), 3685 kc., Fri. at 6:30 P.M.; N. H. Emergency Net (phone) 3890 kc., Sun. at 1:00 P.M. OCY is active on 7 and 14 Mc. with new 100-watt rig and portable mobile 28-Mc. 'phone. CRW handled traffic from the Mac Millan Expedition, 20XE/MM. HDA is sticking to 28-Mc. 'phone with his rhombic aimed at W6-Land. NKI is back on 160-meter 'phone with a 100-watt rig. PZU has a new portable 80-meter rig. EWF added TA3 and UC2 to his DXCC list. TAC and TDJ are newly-licensed. TAE is pushing out a nice signal on 7 Mc. AIJ, RIS, and RMI passed the Class A exam at the N. H. Hamfest. QJY is pushing brass on 3.5 Mc. APK and JNC are members of the N. E. Emergency Net (3975 kc., Mon., 6:00 P.M.). 3EKK, of the Frankfort Radio Club, was a visitor at the Concord Brasspounders meeting. The 13th N. H. Hamfest held Sept. 17th was attended by 363. A very attractive ARRL booth was displayed where special effort was made to get AEC membership applications. The Concord Brasspounders again deserve praise for a good job. Traffic: (Sept.) W1CRW 946 JNC 36, QJX 22, PFU 17. (Aug.) W1QJX 18, PFU 16.

RHODE ISLAND — SCM, Roy B. Fuller, W1CJH — The Rhode Island Net (RIN) has resumed its winter schedule of Monday through Friday at 1900 on 3540 kc. Emergency nets reported active so far are Newport County Radio Club on Thursdays, Cranston Radio Assn. on 147.5 and 29.2 Mc.; NAARO on Monday on 29,080 kc. Amateur emergency nets were active during the September hurricane alert. Newport had two transmitters, one on 3.85 and another on 28 Mc. BVL, JFF, and OUR maintained a watch until 2 A.M., when all danger had subsided. NAARO's station was alerted with emergency power for any emergency. The Cranston Radio Assn. now is located in new quarters in the Red Cross Building in Auburn. SKC, the Club's newly-elected secretary, extends invitations to new members. We are saddened by the passing of Dr. Robert Kissock, MPV. The gang on 28 Mc. will miss an ardent ham. The Newport County Radio Club elected Winward Tripp to fill the vacancy caused by KUV's departure. Luck to the new president. MIJ is building a new rotary for 14 and 28 Mc. RVQ, 28-Mc. 'phone stalwart, is operating some 7-Mc. c.w. now.

VERMONT — SCM, Curtis W. Dean, W1NLO — The Vermont Hamfest and ARRL State Convention held Oct. 14th at the Burlington Country Club was attended by 225. BFT took first place in the Code Contest, with VE2CD second and FSV third. The afternoon program included ARRL's TVI film and PB talks by 2JIO, HDQ, HRC, and Harris Soule. TDG, Brattleboro, and TDR, Lyndonville, are new calls. FGO has 400-ft. center-fed antenna with 1100-ft. long feeders. RNZ has Class A ticket and is on Vermont 'phone net Sunday mornings. QNM has FB 28-Mc. mobile rig. FRT has the roof on the new house he has been building for the past two years. SPK is building 150-watt final. SET has Collins 32V-2. HLL is back on the air. MMV finally got his XYL's clothes line up. SVT has three-element 28-Mc. beam. KJG, OKH, QQN, NLO, AVP, and MMV took part in "Operation Garcia." ORO has gone TV. Traffic: W1KRV 34, AVP 23, RNA 17, NLO 10, SDG 9, FPS 7.

NORTHWESTERN DIVISION

ALASKA — SCM, Charles M. Gray, KL7IG — JE pulled the switch for the last time in KL7-Land and headed for Wake Island. We sure will miss Juneau's outlet for Stateside. OW and AB also are leaving for greener pastures. Congratulations to the Northwestern Alaska Radio Club of Nome. The Club now is a duly affiliated society. How about more in Alaska? W7VUV has received her call KL7VUV and also has gone Class A. That's two now for Juneau. RU will be OBS for Ketchikan and will be on 3892 kc. Mon., Wed., and Fri. with bulletins at 9:30 P.M. PST. GI has the DX bug and is knocking them over on 14 Mc. with a Viking I and a good location. FA has a new type of screen modulation and is putting it to work on 4-6.5A. FAO is going to town with 300 watts to the rig on 14 Mc. and is hooking some choice ones. If interested in EC appointment, contact PE, the SEC, at Fairbanks.

IDAHO — SCM, Alan K. Ross, W71WU — October was

(Continued on page 82)



ALSIMAG

TRADE MARK REG. U. S. PAT. OFF.

Custom Made Technical Ceramics

FOR ELECTRONIC
AND ELECTRICAL USES

SOLD ONLY TO MANUFACTURERS

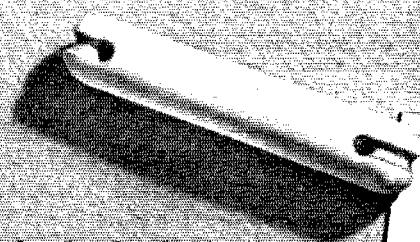
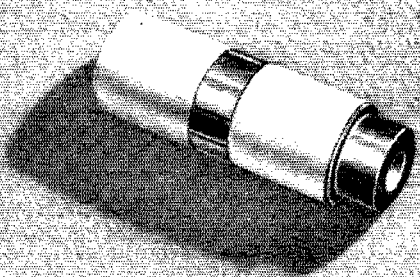
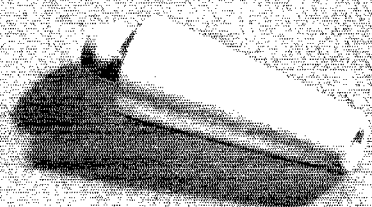

**AMERICAN LAVA
CORPORATION**
49TH YEAR OF CERAMIC LEADERSHIP
CHATTANOOGA 5, TENNESSEE

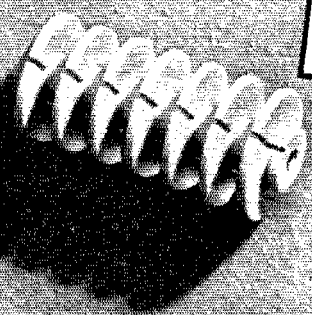

PACIFIC DIVISION

the big month in that many of us participated in the Simulated Emergency Tests. ECs are ELH, Moscow; FRM, Lewiston; ETU, Nampa; KJO, Boise; JALX, Twin Falls; and IBY, Jerome, Cassia, Minidoka, and Power Counties. Let's have your reports without fail as I sent detailed information to all ECs as well as all Net Controls of FARM and GEM Nets, in addition to some individual Net members, to try to make these tests a success. Let's hear from you fellows in the other parts of Idaho, such as Boundary, Bonner, Lemhi, and Madison Counties. I would like to try another Idaho QSO Party. The last two were not very successful. Whatsamatt, gang? If you are on the air you are eligible. Let's hear from all of you. Traffic: W7GHT 132, NH 64, BDL 45, IWU 33, BAA 21.

MONTANA — SCM, Edward G. Brown, W7KGJ — The Polson Hamfest was held Sept. 23rd and 24th with a good turnout. Festivities included a banquet and gabfest from 2 p.m. until 5:15 p.m. Sunday with 26 present. Among those attending were W7COH, PK, BNU, HMT, MBM, MBV, NCS, NOZ, HJV, IBH, JOI, OOG, and VE5EG. All reported a very enjoyable time. The SMARA of Billings plans another code class for the coming winter season. Last year SMARA gave code practice regularly to fifteen students and several have received their tickets. Some Billings YLs and XYLs plan to participate in the practice this season. A demonstration of amateur radio was given the Yellowstone Key Club by IWW in conjunction with his talk on Hobbies for Mental Health and Happiness. OPM has completed a new VFO. FIN is working on a beam project. KUH is rebuilding. KOR plans a new QTH at Billings. CT and AYG attended the Big Springs, Idaho, WILMU Hamfest. Montana c.w. and 'phone nets urgently need more stations for better state coverage. Please send your activities reports to your new SCM, KCGJ. Traffic: W7KGJ 97, BNU 13, KUH 5.

OREGON — SCM, J. E. Rodev, W7MQ — HLF made a trip to Salem and en route made some other visits discussing AEC plans and Civil Defense with various amateurs. GWE is new Net Manager for OEN, 3600 kc., and is reorganizing the Net, according to IIV, Oregon RM. NVA is new amateur at Sisters, Ore., and will be found on OSN. NNQ is new to Pendleton amateurs. DHX has just installed new 3.85- and 29-Mc. antennas. EBJ, Net Manager for OSN, wants stations all over the country to monitor 7170 kc. nightly at 1900 PST, and check in on new OSN channel. BWD is new EC for Corvallis Area, replacing NNU, resigned. HDN, our PAM, is asking for additional NCS for OEN 'phone channel. OVO is newly-licensed amateur in Medford. FFR is new OPS. OTB is newly licensed in Medford. AOL is new EC for Baker Area, replacing LQW who has resigned. OUV has moved to Portland from Wisconsin, where he held the call 9IWU. MYI reports that ORG is on 7 Mc. with low power, but is working all around the U. S. GEJ and AZP are barnstorming Eastern Oregon trying to kill a few deer and working 3.85-Mc. mobile between shots. New officers for Pendleton Amateur Radio Club are LQV, pres.; AIWE, vice-pres.; NNQ, secy.; and BKD, treas. JPM and PLS are back in the U. S. Navy. We regret to have to report the sudden death on Sept. 3rd of MNG. Lloyd H. Wilson. MNG received his license July 22, 1948, and was active on 7-Mc. c.w. until October, 1949, when he became active on 28-Mc. 'phone. An ardent ham, he enjoyed his contacts and the many friends made through his hobby. Traffic: W7HDN 127, EBJ 121, MQ 119, JRU 113, HLF 97, AJN 68, BSY 97, WMX 51, FY 44, GNJ 35, GWE 32, ODI 28, OJA 19, DHX 16, DZT 15, WL 13, OKH 7, KTG 2.

WASHINGTON — SCM, Laurence Sebring, W7CZY — SEC: KAA, RM: JJK. The Tri-City Emergency Corps meets on 3.85 and 28 Mc. for drills. The Puyallup gang had a booth at the Western Washington Fair which was very successful. NDO is back in the Navy. FRU is active on WSNet. NWP and LVB keep Sedro Woolley in touch with the outside world. JZR passed his Class A exam. GWN is moving to a better radio location, he hopes. ETO has new 28-Mc. beam. DGN moved his portable gear back to Seattle for the winter. EQN spends lots of his time on OO work. KTL has all the parts for his new beam and hopes to have it up soon. KWC has a fine mobile rig covering from 3.5 to 144 Mc. OQZ is mobile on 28 Mc. in the Kelso Area. DDQ is active in Bremerton, and reports EPW is back in the Navy. KCU reports receiving conditions are too bad for much activity in Colfax. The Walla Walla Valley Radio Amateur Club has started work on its new club house. Handling the picks, shovels, and assorted tools were NXI, LJK, KBA, GYH, FMI, KHF, FPP, OEU, NPN, KMP, NKO, HQC, LYO, NHS, OLO, OFF, and OBF. GYC takes care of the coffee pot. NPN received his WAC. ACF's XYL wants a TV set for Christmas. DRA delivered a lot of traffic from Korea. KAA is teaching electronics at Olympic Junior College in Bremerton. OHS, EC for the Tri-City-Richland Area, has the AEC organized and in operation with BX, MLZ, LEV, NLI, ELG, CUD, KHZ, JZX, MCA, FVI, KIX, KIN, JVF, QAN, OMB, NUV, HLG, MUM, DRF, BGH, NC, BIW, AAH, OCN, IIB, CNB, and 0FWC active. Please send in traffic scores and activities reports on the first of each month. Traffic: (Sept.) W7CZY 2005, JJK 778, FRU 152, APS 109, KCU 89, DRA 48, NWP 37, CWN 28, JZR 28, ETO 20, LVB 16, BX 15, DGN 8, EQN 7, KTL 6, KWC 2, (Aug.) W7JK 254, IOQ 217, MPH 94, GAT 42, ETO 26.

NEVADA — SCM, Carroll W. Short, jr., W7BVZ — SEC: JU. ECs: KTH, ILJ, JVV, MBQ, TJJ, KOA, and ZT. RM: PST. ORS: MZP. OPS: JUO. Southern Nevada Amateur Radio Club members and families attending its 4th annual picnic had an FB time. NWU is working lots of DX early mornings with 250 watts. NVY is on 7 Mc. evenings, 28 Mc. on Sundays, and will be on 3.5 Mc. soon. JU, LGS, and ex-6FD furnished communication for the Colorado River Marathon. JU is on 3660 and 7225 kc. JKD will be on from M.I.T. this winter. TKV finally made WAS on 7 Mc. IRX is on 3.85-Mc. mobile. Fred Sherman, OUQ, is a new ham in Reno. MWF is new Southern Nevada contact on NSN on 3660 kc., according to PST. There still are a number of official appointments open to League members. Write your SCM for information. AEC membership is open to all regardless of League affiliation. Write your local EC, or the SEC whose name appeared on page 71, Oct. QST. Traffic: W7JU 8.

SANTA CLARA VALLEY — SCM, Roy I. Couzin, W6LZL — ECs: TFZ, QLE, FTG, NX, and NOE. Greetings, gang, this is my first chance to thank you for the votes putting me in office to serve you as SCM. I will do my best to fulfill the position as well as BPT did. The County Fair is over and BPT, WGO, UW, and UTV made BPL. I attended a very impressive meeting of ECs and assistants of San Mateo County. TFZ really has the ball rolling. An SEC will be appointed soon. RNG's new rig is in the testing stage; a box of fuses is kept handy. VJK is making an effort to help out in emergency work. MNG is busy signing up new members for AEC and is rebuilding the rig. LZL is finishing up a year as president of SCCARA, taking over the reins of SCM, and is building c.w. rig, hoping TVI is a horrible thing of the past. HC is on MTN and RN6, holding down NW's spot while NW builds 7-Mc. rig. CIS is building portable rig for trips and emergency work and plans a trip to Nevada to visit part of his division and let them see a director for the first time. PDX visited VJH and came home with a limit of salmon. We hear ZYT makes a special effort to give reports to mobile rigs in this area. LXA has been under the weather this last month with a bad ticker, we all hope he is back on the air real soon. Well, gang, this winds up the first report. I would like to give you fellows with appointments a little nudge to get in your reports to me by the first of the month. It will help me a lot. Traffic: W6UW 1723, BPT 904, UTV 753, WGO 524, HC 13, CIS 11, MNG 2.

EAST BAY — SCM, Horace R. Greer, W6TI — Asst. SCM, Charles P. Henry, 6EJA. SEC: OBJ. ECs: AKB, EHS, NNS, IT, IDY, QDE, LAMZ, 9IVN /6 is a new ORS in the section, and we welcome him to the East Bay section. JZ makes BPL again. RRH is finishing a new 250-watt rig. On October 5th the Oakland Radio Club held a fun night for the XYLs and harmonics. YDI still is plugging along. EJA reports conditions very poor out Richmond way. IBJ, California Highway Patrol Radio Technician, at Ukiah, who originally was here at SFOBB and lived in Berkeley, passed away late in September. BIL got WACC Certificate No. 9. ASV, of Visalia, was a recent visitor to the section. ZX is under the weather once again and we all wish him a speedy recovery. DTW turns in an FB section report. ITH still is very QRL but finds some time to experiment with radio teletype and u.h.f. projects. BSY is back in the Navy and is signing JA2KIV in Japan. Mac sends his 73 to the gang. AFC has a new jr. operator and received his Class A license about the same time. PAK has been called to duty. WHA is experimenting with Clamp tube modulation applied to a Command transmitter on 3.85 Mc. AYN is active on MARS Net. WNJ completed a two-week tour of duty at Camp Cook. HDD is building a new 28-Mc. rig using an 829 in the final. NBARA reports that MLZ, HTE, ZJD, and CHI were directors of the emergency tests. KZF is the Mission Trail Net Civilian Defense Coordinator. The following members of MTN are on active service: TIX, RMG, QHW, UDF, MAJ, AAQ, KKH, and ZQL. EE, the City of Oakland Civilian Defense Coordinator, has appointed CX to get the Ham Dept. in working order. Bud already has held several meetings and those interested in this most important emergency work should get in touch with CX at once. FTIX sure is doing a bang-up job putting out the Pacific Area Net News. OBJ and his committee, along with the members of the Oakland Radio Club and the San Leandro Radio Club, were active in the October emergency tests. PB is QRL work. The 14-Mc. band has been poor and prospects do not look too good for a while. 7 Mc. looks good at this stage and 28 Mc. is picking up a little. Now is the time to be prepared. Traffic: W6JZ 1362, DTW 1149, YDI 36, RRH 13, EJA 8, W9IVN /6 8, 6TI 3.

SAN FRANCISCO — SCM, R. F. Czeikowitz, W6ATO — Phone JU 7-5561. SEC: NL. Phone PL 5-6457. San Francisco Area: EC: BYS. Congratulations to SWP, who at last has gone all out and made BPL. Pat says TVI persists, so he runs under 50 watts to the TCS. He also has a twelve-element beam and a 522 on 144 Mc. WQ1 is in the Navy. The Emergency Corps 144-Mc. glove compartment transceivers are coming off the production line, supervised in assembly by WCD. The SFRC picnic was a great success. We understand JZ is trying to start a 144-Mc. traffic net

(Continued on page 84)

LET'S LICK TVI

and brush the cobwebs off the rig

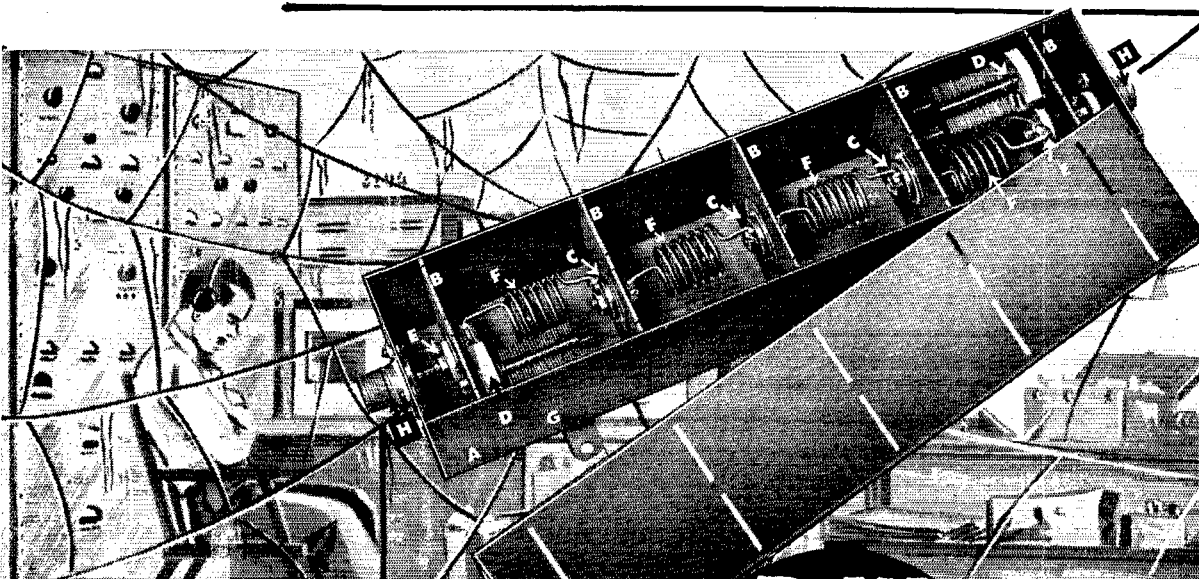

B&W

LOW PASS FILTER

- Provides extreme attenuation to all harmonics above 30 mc
- Eliminates individual filters for each band
- Handles 1 kilowatt with ease
- Insertion loss less than .25 db
- Low in cost . . . Easily installed

\$22.50

Amateur Net Price

Three years of intensive study of TVI problems first introduced the B&W Faraday Shielded Link. Now we proudly present a natural companion—the B&W Low Pass Filter. Properly installed in the antenna feed system, in accordance with our recommendations, the Low Pass Filter provides virtually complete harmonic suppression above 30 mc.

The B&W Low Pass Filter consists of two "m" derived end sections and three midsections of constant K type. Each section is contained in a completely sealed copper compartment to prevent inductive transfer of unwanted frequencies from section to section. RF bypass condensers in the K sections are of special low inductance design having resonant frequencies higher than 500 mc thus eliminating resonances within the TV bands, a fault common to conventional types of condensers.

Complete details on how you can banish TVI are available in *Filter Facts*—packed with each Low Pass Filter.

See your dealer today, or write for bulletin to Dept. Q-120.

- A** Precision fitted solid copper box—solder-sealed throughout
- B** Heavy copper ground plane shields
- C** Precision-Silvered, Low Inductance Mica Condensers
- D** "M" derived end sections peaked on Channel 2 (Coil not visible)
- E** Alsimag 196 Insulation
- F** Heavy, distortion-free, precision coils
- G** Convenient mounting brackets
- H** 52 & 75- Ω units fitted with standard coax connections
- I** Available in 52, 75, and 300 ohm models

BARKER & WILLIAMSON, Inc.

237 Fairfield Ave., Upper Darby, Pa.

P
D
Q!



Shown: Bliley
Type MC-9

**Production . . .
Delivery . . . Quality!**

Three qualifications are needed to assure performance on your orders. PRODUCTION facilities . . . keyed to your DELIVERY dates . . . plus rigid QUALITY control. These factors are basic with Bliley . . . top choice for 20 years.

**Bliley
CRYSTALS**

**BLILEY ELECTRIC COMPANY,
UNION STATION BLDG., ERIE, PENNA.**

for the Bay Area. All interested, contact him or SWP. We are all pleased that PGY is able to be up four hours a day after a long siege in bed. RBQ is on at all odd hours picking up a new country here and there. NL has TVI. JWF continues his regular schedules at CXO. WB and ATO now have television sets. Join the Emergency Corps. Phone BYB at BA 1-6157. The San Francisco Radio Club meets the fourth Friday at the American Legion Hall, 1641 Taraval St. The High Frequency and Amateur Mobile Society meets the second Friday at the Red Cross Bldg., 1625 Van Ness Ave. *Marin Area:* EC: KNZ, MRZ, KNZ, and FYJ are building mobile rigs for 160 meters. KNZ is especially working on antenna design for this frequency. The MRAC changed its regular meeting in order to attend the ionospheric talk by Oliver Ferrell at the HAMS meeting. All interested in emergency work, please contact KNZ. The Marin Radio Amateurs Club meets the second Friday in the Engineering Lecture Room, Marin College, Kentfield. *Eureka Area:* EC: SLX. CWR is building to go 28-Mc. mobile. SLX is trying new antenna for 28 Mc. NAO is building a new room, while IRJ is building a new rig. BJO was the lucky winner of the larger merchandise order donated by Electric Supply of Oakland, on the occasion of the visit of the SCM and SEC to the HARC meeting. The SCM and SEC wish to publicly express their appreciation for the splendid courtesy and hospitality of the Humboldt Club and its officers during their visit. BME now is working all bands, while AEY is working nights. GDV has been called into the service. Humboldt County hams who wish to join the Emergency Corps should see or write SLX. The Humboldt Amateur Radio Club meets the second and fourth Fridays in the YMCA rooms, rear of Municipal Auditorium, entrance on E St. *Sonoma Area:* Congratulations to the Sonoma County Radio Amateurs Club which recently became active again. The SCRA is seriously interested in emergency work and is working with both the Santa Rosa and the Sonoma County Disaster Committees. KIW is in charge of the emergency work. Many thanks from the SCM and the SEC for their very friendly and hospitable reception at a recent meeting of the SCRA. GGE is working 14-Mc. 'phone, while ULF is working 3.85 and 7 Mc. ELG apparently has switched from 3.5-Mc. c.w. to 3.85-Mc. 'phone. SAT is back on the air. DTV, KIW, and ELG were active in the Sonoma Township Disaster test, as were AJF and others. HQN, in Windsor, is busy handling traffic on RN6. The Sonoma County Radio Amateurs Club meets the first Wednesday in the Tap Room of the Grace Bros. Brewery on Second St., west of the Freeway in Santa Rosa. *Guam Area:* KG6FAA says his QSL obligations now are completed. W6OIS now is QRT at KG6FAA. Traffic: KG6DI 1841, KG6FAA 752, W6SWP 221, HQN 51, CHP 14, ATO 5.

SACRAMENTO VALLEY — SCM, Ronald G. Martin, W6ZF — Asst. SCMs: Northern Area, 6YNN; Central Area, 6CKV; Southern Area, 6SUP. SEC: KME. ECs: Met. Sacramento, AUO; Walnut Grove, AYZ; Dunsmuir, JDN; Paradise (Chico Area), HBM; Roseville, GHP. RM: PIV. OBS: AF, BTY, PAM: ZYV, OES: PIV, GHE. OOs: ZYV, YNM, BTY, GDO, YV. OPS: JDN. Nets: Sac, Emergency (city), AUO NCS. SVS. 29.4 Mc., ZYV NCS and GDE ANCS. Mother Lode, WSI NCS. *Northern Area:* Mt. Shasta Amateur Radio Club showed many Kodachromes at its Sept. 13th meeting. JDN installed BC-654A in his car. LEO is preparing 28-Mc. beam, putting Silver 701 in his car, and handling traffic on 7 Mc. YNM reports most of the gang went deer hunting and only ham radio was the portables used. The Shasta gang's net will be on 29.224 Mc. HPL and CFU are going 28-Mc. mobile. *Central Area:* GERC held regular club meeting at LYQ's in Corning. QEE is now mobile on 75. ZFJ has fair results with 160 mobile. CLG has 200 watts on 160. VQJ moved to East Coast. FOD is on 7 Mc. WYX moved to Sacramento. TSR works 160 'phone and 80 c.w. KYO and HBM work 144 Mc. regularly. GHE took unto himself an XYL. We need an RM in the Central Area. See CKV. *Southern Area:* KKL is new Roseville MTN outlet. CTH and UNT have 28-Mc. mobiles. EPG worked JA2 on 75. OOR and MYT are back on MTN. MBW moved back to Loomis. SUP handled some traffic for a change. GDO DXes Fresno and SFO on 144 Mc. HTS completed 28-Mc. WAS. HSB rebuilt his rotary gear. PIV is sojourning in Good Samaritan Hospital, Los Angeles, but has receiver to monitor RN6. CLV is sporting new baby YL. CQK is on 7 Mc. with one gallon. McClellan Amateur Radio Society met Oct. 3rd and planned winter activities. IYX just received his call and is on 7 Mc. QDT's Pontiac has new power plant aboard to run ART-13. ZF purchased an OWP electronic bug and reports it is climax of 33 years brass pounding. Traffic: W6PIV 681, MYT 152, JDN 111, ZF 76, YNM 13, GDO 17, LEO 10.

SAN JOAQUIN VALLEY — SCM, E. Howard Hale, W6FYM — ECs: AJE, CQI, GJO, HIP. OBS: EXH, OHT, GRO. OES: PSQ, UWY. ORS: GRO, HU. OPS: IEM, GRO. OO: GRO. SAR has 807 on 28 Mc. using "W6CKM screen modulation" and runs 150 watts input on peaks with FB reports. Newest CD appointment is UWY, of Manteca, as OES. AJE reports the Modesto 10-meter net is going strong, and the night of operation has been changed from Friday to Monday at the same hour. The Stockton-Turlock Clubs' picnic, held at Hagaman Park south of Turlock with Tur-

(Continued on page 88)

**Tune your rig for peak output
without creating interference**

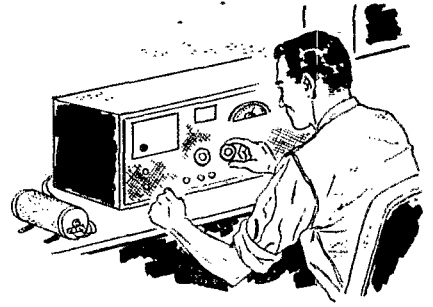

Use an **OHMITE** Dummy Antenna Resistor

- **RUGGED VITREOUS-ENAMELED CONSTRUCTION**
- **IMPROVED FREQUENCY CHARACTERISTICS**

Within their recommended operating frequency ranges, these superior dummy antenna resistors may, for all practical purposes, be considered "nonreactive" in performance.

Write for Bulletin 136

Here is the ideal dummy antenna resistor, designed to provide accurate measurement of R.F. power output (using R.F. ammeter) while keeping the signal off the air. Improved frequency characteristics result from a more effective proportionment of the d-c resistance, residual inductance, and distributed capacitance. In these units, residual inductance and distributed capacitance are kept to a minimum, making the natural resonant frequency as high as possible. Available in Type D-101, 100-watt unit, in 52, 73, 300, and 600-ohm values; and Type D-251, 250-watt unit, in 52, 73, 300, and 600 ohms.

OHMITE MANUFACTURING CO.
4863 Flournoy St. Chicago 44, Ill.



Be Right with

OHMITE

Reg. U. S. Pat. Off.

RHEOSTATS • RESISTORS • TAP SWITCHES

small

enough to fit in your coat pocket!

BIG

enough to do a man-sized job!

Stay on the air with...

PRECISION Series 40 Compact Wide-Range Circuit Tester

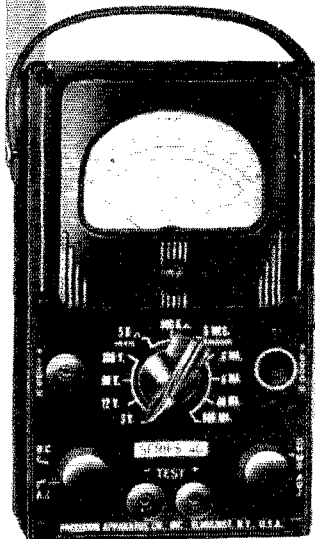

SELF-CONTAINED TO 6000 V. 600 MA 5 Megs. +70 DB

With full size 3" Meter

Complete with batteries and test leads.

Net Price \$26²⁵

LC-2 Custom leather carrying case.....

Net Price \$575

In custom molded carrying case, Series 40 is ideally dimensioned and engineered as a portable, compact test set to withstand the hard usage of amateur radio, servicing, production test, etc.

Series 40 offers features and components as incorporated in "Precision's" larger test sets, including: Rotary Selection = 1% shunts and multipliers = heavy duty insulated pin jacks = large numeralled, easy reading meter.

SPECIFICATIONS

- ★ 6 A.C.-D.C. & Output Voltage Ranges: all at 1000 ohms per volt. 0-3-12-40-300-1200-6000 volts.
- ★ 4 D.C. Current Ranges: 0-.6-6-60-600 MA.
- ★ 3 Resistance Ranges: self-contained batteries. 0-50000-500,000 ohms and 0-5 megohms.
- ★ 6 Decibel Ranges from -22 to +70 DB.
- ★ 1% Wirewound & Metallized Resistors.
- ★ Only 2 Pin Jacks serve all standard functions.
- ★ Recessed 6000 volt safety jack.
- ★ Anodized, etched aluminum panel: resistant to moisture and wear.

See this fine "Precision" Test Set at all leading radio parts and ham equipment distributors.

Write for latest Precision catalog describing quality Electronic Test Instruments for all phases of modern radio-electronics—A.M., F.M. and TV.

PRECISION APPARATUS COMPANY, Inc.

92-27 Horace Harding Blvd., Elmhurst 13, N. Y.

Export Division: 458 Broadway, N. Y. City, U.S.A.
Cables: MORHANEX

lock as host, was a huge success with about 30 families attending. VLS, of Fresno, worked NLZ in Los Angeles on 145 Mc. Sept. 23rd for the 1st L.A. to Central S. J. Valley 144-Mc. contact. Several of the gang in Turlock and Ripon were heard in or near L. A. but no contact was made. These included DVS, ERE, and BCL. DBH and SAH are new v.h.f. men. CQI reports the Tuolumne County EC program is almost a complete bust because 50 per cent of the licensed hams of the County are now in the armed forces. Two new calls in Stockton are 6QVP and 9UQN. Welcome to the section, fellows. Congrats to HIP and his KYL; a female harmonic radiated on Sept. 7th. No reports were received from Fresno or Kern Counties. The S.J.V. section c.w. net is not yet operating, as your SCM is having difficulty finding hams who are willing to participate in traffic-handling activities. Remember to send your activities and traffic reports to your SCM the 1st of each month.

ROANOKE DIVISION

NORTH CAROLINA—SCM, Herman P. Jolitz, W4DCQ—DSY, AH, DCQ, IFR, and NYN report a marked pickup of DX conditions. DLX and CVQ are active on 144 Mc. The North Carolina 'phone net is operating under the capable direction of BLV. You hams who operate on the net, remember that you can get your net certificate by being on 60 out of 80 meetings of the net. Net members in good standing are ANU, BLV, CJQ, CVQ, CYB, DGU, DLX, EHF, EJE, EXY, FBO, FLT, GKG, GOB, HGC, HSO, HUW, KYI, NAL, NBO, NYE, NZC, and TS. Remember, 3865 kc. at 7:30 EST, Monday through Friday. New OPS are IFR and NYN. If you think you qualify for appointment, drop a line to your PAM, RM or SCM. We need a qualified man as EC since Charlie Beard found it necessary to resign. We appreciate his fine work and will be looking for him back in the fold. We need ORS and OPS in the western part of the State. LDZ says that a vertical bounded on all sides by tin roofs interlaced with power company guy wires will not get out. How about that nice report from the ZC6. Jud? CTP finally found that courting and ham radio can go together, so NC has been on the air more often.

SOUTH CAROLINA—SCM, Wade H. Holland, W4AZT—BPD has been reelected as Alternate Director for the Roanoke Division. ILQ, Greenville County, and NLP, Williamsburg County, are actively working on a Civil Defense program with local authorities. We would like to hear from other ECs about such activities. Several EC appointments are open and applications are invited from anyone interested. The SCM is trying to compile a list of all mobile and emergency-powered stations in South Carolina and requests that everyone with such equipment advise by mail the type equipment and bands in use. FM, in Greenville, has self-powered unit for 3.5- and 7-Mc. c.w. and 3.85-Mc. 'phone. We welcome KWB, in Seneca, and OHN, in Spartanburg, to the 3.85-Mc. band and hope they will join the 'phone net. NLP has new antennas and a much-improved 'phone signal. We would like very much to receive information from the 28-Mc. gang and the c.w. nets for inclusion in activity reports. It is time for another South Carolina QSO Party, and suggestions as to the date and desired activity are in order. Last year's QSO Party turned out more South Carolina hams than any time since the war. Traffic: W4BPD 27, AZT 14, FM 14, BPD 8.

VIRGINIA—SCM, H. Edgar Lindauer, W4FF—The Virginia Net joined with the VFN gang on October 9th for a season's run of heavy traffic. The following stations made their debut on the first go round: SU, NRO, KVM, IA, AWH, BZE, NQV, BCI, IQR, KSW, FV, FF, FJ, PAS, KBB, DO (ex-4IRZ), KYD, KFC, MLE, and MGE. LAP sprained his back trying to raise a sky pole at his new QTH in time for opening net night. Haste makes waste; result, no LAP with a QNI. Tough break, Bill. Much interest is being shown in preparation for emergency organizations within many communities. State and local officials are inviting ECs to explain their set-up. A recent meeting with Fairfax County hams showed heavy interest. AAM, EC for Fairfax, held a special emergency test run in preparation for the Simulated Emergency Test. RWN, KYT, OAE, KRG, PNK, FF, and NQV were on deck using 28-, 14-, 7-, and 3.5-Mc. c.w. and 28-Mc. 'phone. The Richmond Hamfest at the Jefferson Hotel Oct. 22nd was attended by ARRL Prexy Bailey and Division Director Key. The PVRC met at 3WU's QTH. NNN, retiring prexy of PVRC, is leaving Virginia for Iowa and becomes just another SS contact from a coveted area. KYD needs Utah for WAS. KVM got his pilot's license. RCM/4 is acting prexy for William and Mary College Radio Club at PYN at Williamsburg and is trying to reactivate the rig there. NAD is building a portable rig and is active on VFN and transcontinental 'phone net. VFN average has been 28 stations per night QNI. FB! EMIJ is cranking up after completing his summer projects at home. PWX, who submitted measurements in the recent FMT, has his sights on an OO appointment. FV is active on 3RN, 4RN, and 5RN, c.w. LK and DO applied for ORS appointment. LRI has organized a strong effective emergency net for Arlington County on all bands. Traffic: W4FV 52, NBA 22, NAD 21, PWX 20, FF 16, LK 16, KFC 5.

(Continued on page 90)

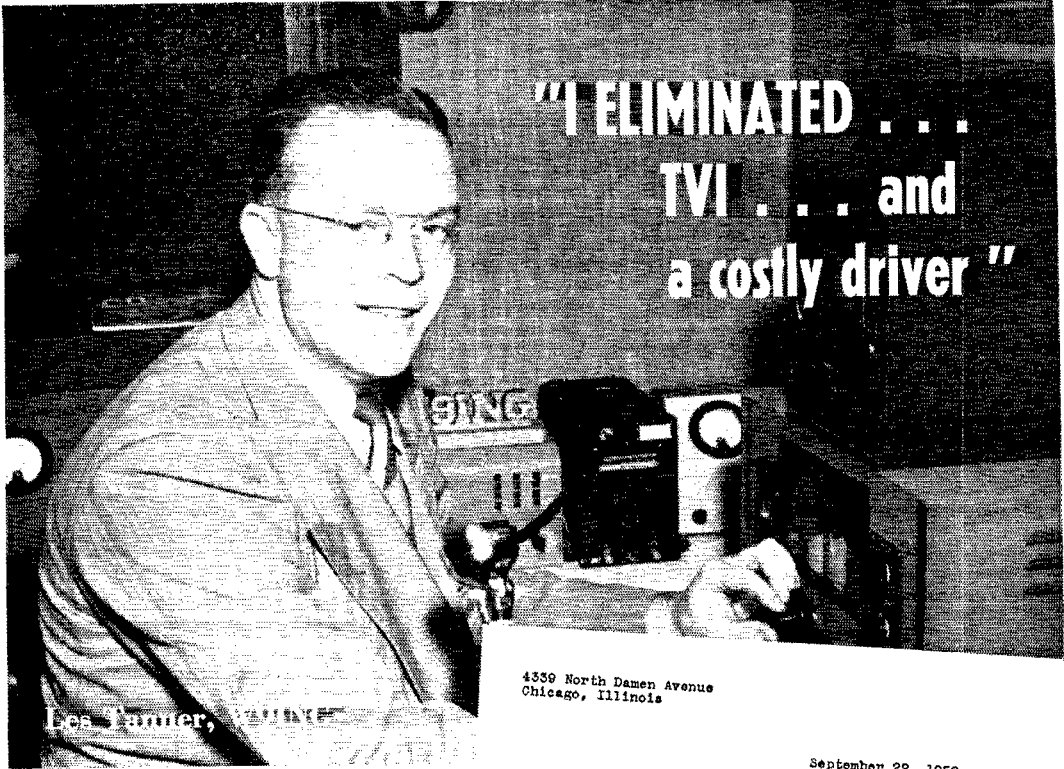

"I ELIMINATED . . .
TVI . . . and
a costly driver"

Les Tanner, W9ING

4339 North Damen Avenue
Chicago, Illinois

September 22, 1950

Eitel-McCullough, Inc.
San Bruno, California

Gentlemen:

For many years I have used triode tubes in the final class C stages of my transmitters.

With the event of television it became apparent that T.V.I. would quickly force me to curtail operating unless something could be done to eliminate this interference at the transmitter.

The answer proved to be a flea power exciter driving a single Eimac #4-250A tetrode in the class C final stage running at a conservative half KW input.

This tube line-up, plus a bit of common sense design, has made it possible for me to operate on the 10 and 20 meter phone bands without fear of disturbing many neighboring television viewers. The low drive requirements and high efficiency of the #4-250A tetrode have eliminated the necessity of using costly driver and doubler stages, thereby reducing the size of my transmitter by approximately fifty percent.

With best wishes for continued success, I remain

Very truly yours,

Les Tanner
Les Tanner
W9ING

LET/ehb

Benefit by the experience of Les Tanner and other outstanding amateurs . . . put Eimac tubes to work for you.

There are types for all power levels on all amateur bands. Eimac tetrodes coupled with common sense engineering techniques are the proved, economical way to reduce TVI.

Complete data on Eimac tube types, compiled in catalogue form especially for the amateur, is available free . . . write today.

Eimac
TUBES

EITEL-McCULLOUGH, INC.
San Bruno, California

Export Agents: Frazar & Hansen, 301 Clay St., San Francisco, California

HARRISON HAS ELDICO!

ANTENNASCOPE

Eliminate guesswork! Use the Eldico Antennascope to get maximum antenna efficiency! (See "Antennascope" Sept. CQ)

ACCURATELY MEASURE — • Radiation resistance of antenna • Resonant frequency of antenna • Impedance of transmission lines • SWR on feeders • Receiver input impedance.

Select the correct feedline impedance — Determine whether power is in antenna or being dissipated in feeders — Match antenna to receiver for improved reception — Reduce SWR — Minimize TVI Use with any type antenna or feeders. Use in conjunction with any Grid Dip Oscillator or RF Signal Generator.

Antennascope Kit. Complete, including 0-100 uA meter and instructions \$24.95
Antennascope—Wired and tested \$29.95

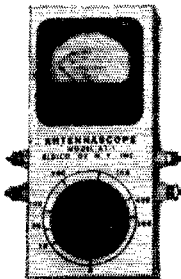

GRID DIP OSCILLATOR

One of the most valuable pieces of test equipment in the shack the GDO's value is greater than ever when used with the Eldico Antennascope. Improved model incorporates high-sensitivity regeneration circuit. Enables you to locate resonant circuits for pre-tuning or de-bugging without applying power to the rig or receiver; measures harmonics, may be used as a signal generator; and performs numerous other measuring functions. Grid Dipper special kit includes everything required, special case designed to facilitate one-hand operation, tube, internal power supply, meter and detailed instruction book covering assembly and applications. Operation 3 mc to 250 mc covered in six steps. Operation from 105-125 volts, 50-60 cycles a.c. \$24.80

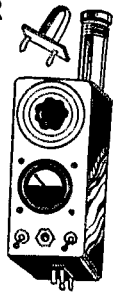

HARRISON HAS THE COMPLETE ELDICO LINE!!
— For fastest delivery on ANY Eldico item, rush your order to Harrison! Harrison has it!

TR-1 TRANSMITTER KIT

A conservative 300-Watt phone and c.w. rig 6V6-6V6-6L6-813, Class B 811 modulators. All bands, 80, 40, 20, 15, 11, and 10. Exciter broad band, single control PA tuning. Three power supplies delivering 1500 v.d.c. at 350 ma, 500 v.d.c. at 200 ma, and bias supply. Pre-punched chassis, tubes, transformers, capacitors, resistors, antenna changeover relay, meter, wire, hardware and coils included. Electro-Voice 915 high level crystal microphone part of the package. Plug in the crystal and line cord and you're on the air.

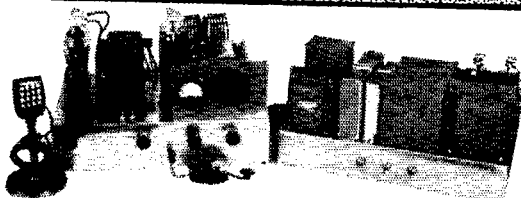

TR-1 Complete — Only \$199.50

MD-40 LOW POWER MODULATOR OR SPEECH AMPLIFIER

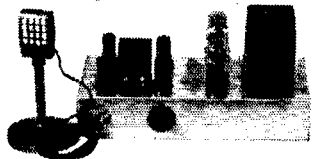

40 watts of audio, the MD-40 is a kit of the same superior parts that go into its bigger counterpart, the MD-100. In place of the 807, two 6L6s are used. On special order, at no additional cost, a 500-ohm plate-to-line output transformer will be supplied in place of the modulation transformer, making the MD-40 an ideal driver for a kw modulator. Complete, including the same standard communications Electro-Voice 915 high-level crystal microphone (less stand) **MD-40 Modulator Only — \$34.95**

MD-40 modulator or speech amplifier kit, as specified, but including heavy-duty power supply on same chassis. Supply includes oversize plate transformer, dual chokes and filters, and all other associated components.

MD-40P Modulator with Power Supply \$44.95

FREE! Send for your copy of the booklet "TVI Can Be Cured," plus latest price list of complete Eldico line, including information about the NEW, SENSATIONAL, 2-METER, SUPERHET RECEIVER. It's a beauty!!



TR-75 XMTR KIT

—
**Only
\$44.95**

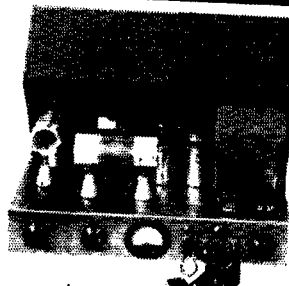

Loafing along at 75 watts this is the c.w. man's buy of the year. Simple enough for the beginner to assemble. Uses the time proven 6L6 oscillator-807 amplifier combination. Pi-network output. Husky power supply delivers 600 volts to the 807. Complete . . . not another bolt or wire to buy, including a smartly styled shielded cabinet to minimize television interference.

EXPORT DEPT.
CABLE ADDRESS
"HARRISORAD"



HARRISON

NEW YORK 7, N.Y.

225 GREENWICH STREET
(10 West Broadway, at Barclay St.)

Did you get your \$9.50 for \$1.50 yet?

For the most SENSATIONAL OFFER in radio history, send for "Free Money" Circular or see our October ads — QST, page 109 or CQ, page 45.
AN IDEAL CHRISTMAS GIFT! — HURRY! RUSH YOUR ORDER TODAY!

HARRISON HELPS SANTA WITH THESE FB GIFT SELECTIONS!

COLLINS 32V-2

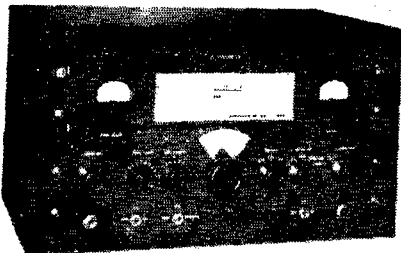

A compact, self-contained desk transmitter with built-in TVI reduction features. Covers 80, 40, 20, 15, 11, and 10 meters; conservatively rated at 150 watts. VFO control over entire range with famous Collins PTO - more reliable than most ham xtals! Features push-to-talk phone - break-in CW. Best medium powered rig available today - ask any Ham who's operated one!

New Collins 32V-2 **\$575.00**
Latest Improved Model

MILLEN GRID DIP OSCILLATOR



Ask any ham who owns one, and he'll tell you that the Millen Grid Dipper is the handiest piece of test gear on the workbench or in the shack. There is no substitute for Millen precision craftsmanship.

Millen 90651 - **\$55.00** (And worth it!!)

WORLD'S SMALLEST VOM!!

Here's the newest, improved model of the smallest volt-ohm-milliamperes meter in the world - even smaller dimensions than earlier instruments. Measures - AC Volts: 0-15, 0-150, and 0-750; DC Volts: 0-15, 0-150, and 0-750; DC MA: 0-150; Ohms: 0-100,000. Extra sensitive 240 microampere movement. Precision parts used throughout. Complete tester measures only 1 1/4" x 2 1/2" x 3 3/4".

Complete with Test Leads Item TE-2 **Only \$8.95**

LYSCO'S TVI-LESS VFO TRANSMITTER

Mod. 600-TV Areas • Mod. 500-Wide Open Spaces



FEATURES: Break-in keying, illuminated dial, PA Plate meter, 35 watt input on 160, 80, 40, 20, 15, 11 and 10 meters, provisions for modulator tie-in, Grid Meter Jack, complete with tubes and built-in power supply, VFO or Crystal "Rubbers" the Crystal also, Cabinet 17" x 9" x 11", Tubes OSC 6AG7, BUFF 6AG7, P. A. 807, Volt. Reg. VR-150 Rect. 5U4G, Mod. 500 Amateur Net. **\$109.95**
Mod. 600 Amateur Net. **\$119.95**

We fill all orders at lowest prices in effect at time of shipment.

HARRISON
NEW YORK 7, N.Y.
225 GREENWICH STREET
(10 West Broadway, at Barclay St.)

JOHNSON VIKING I

ONLY HARRISON HAS THE DE-TVI'ED VIKING!

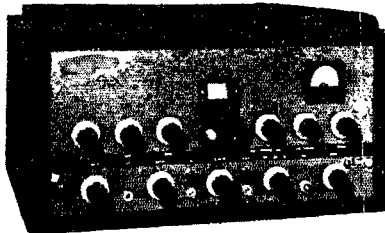

Here's America's newest fine quality transmitter, completely laboratory wired and tested, and incorporating TVI preventive measures. Conservatively operated 4D32 final amplifier delivers 100 Watts phone or 125 Watts CW OUTPUT! Push-pull 807 modulators! Completely band switching - 160-80-40-20-15-11-10 meters - optimum final tank Q on all bands - oscillator keying for break-in CW - low impedance coaxial output - provision for VFO - xtal selector for 10 frequencies - dual power supply - all circuits metered. Entirely self-contained in desk cabinet, 11" x 15" x 21" wide. Supplied complete with tubes and instruction book - ready to operate!

Johnson Viking I
Wired, tested, complete! **Only \$298.50**
Standard Viking I Kit, as supplied by the factory, Complete with instructions, less tubes **\$209.50**

MILLEN SWR BRIDGE

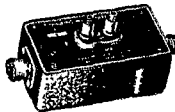

Having antenna trouble? Here's an instrument that will help solve your problems! The Millen Standing Wave Ratio Bridge indicates the SWR on 52 or 72 ohm coaxial transmission line. The unit is not frequency critical and can be used from 1 MC to 150 MC. Use in conjunction with any O-1 DC MA meter. Coax receptacles for input and output simplify attachment. A "must" if you use coax!

Millen 90671 - **\$15.00**

HARRISON HAM-A-LOG

The Special Christmas Edition of the Harrison Ham-A-Log is now being mailed!! Features new items, TVI aids, and lots of terrific bargains in Harrison Select Surplus and standard parts and equipment. For a real Merry Xmas, be sure to get your copy. If you're not on our mailing list, send a card today!

73, Bill Harrison, W2AVA

Super-Bandspread TRI-BAND Converter

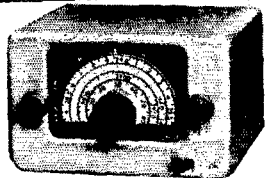

The Ultimate in Mobile Reception on 10-11, 20, and 75 Meters!

- Low noise, high gain RF stage for "big receiver" sensitivity!
- High stability oscillator for minimum frequency drift!
- Over eight linear inches of bandspread of 10-meter band! (Five complete revolutions of large tuning knob!) Proportionately wide spread of 11, 20, and 75 meter bands! Covers 15 Mc SWL band for good daytime BC reception in isolated areas.
- Edge illumination, plus color band, insures maximum dial readability. Calibration accuracy better than 1/10 of 1%!!
- Adjustable antenna trimmer for signal peaking.
- Four tubes: 6CB6-RF Amplifier, 6BM6-High Gain IF, 6AT6-Low Noise Triode Mixer, and 6C4-Clapp Type Oscillator.

Finest, most versatile, multi-band converter available for amateur mobile use. Also FB for use with any ham or BC receiver for "hot", dual conversion, 10, 20, or 75 meter reception! Same size cabinet as famous 10-11 and 3-30 Gonsets.

New Gonset Tri-Band Converter - **\$47.60**

Here are two reasons why the

LYSCO

TRANSMASTER

is today's fastest-selling amateur transmitter:

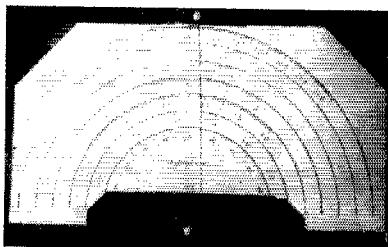

Accurate, open calibration, direct reading on all amateur bands through 29.7 Mc.

.....

Single-Control
band switch-
ing from 160
through 10
meters!



Mod. 600—TV Areas
Mod. 500—Wide Open Spaces

FEATURES: Break-in keying, illuminated dial, PA Plate meter, 35 watts input on 160, 80, 40, 20, 15, 11 and 10 meters, provisions for modulator tie-in, Grid Meter Jack, complete with tubes and built-in power supply, VFO or Crystal ("Rubbers" the Crystal also), Cabinet 17" x 9" x 11". Tubes OSC 6AG7, BUFG 6AG7, P. A. 807. Volt. Reg. VR-150 Rect. 5U4G.

Mod. 500 Amateur Net.....\$109.95
Mod. 600 Amateur Net.....\$119.95

LYSCO MODEL 75 4 SECTION TVI FILTER

as used in Model 600 Transmaster. Size 1 1/4" x 1 1/4" x 6"; white nickel finish. Reduces output of all harmonics above 30 Mc., at least 60 db. down. Will handle 200 watts, 52 ohm co-ax line. Terminated in SO-239 connectors.

\$10.95 Amateur net

BUY LYSCO PRODUCTS AT LEADING DEALERS—OR
WRITE FOR LITERATURE ON OTHER LYSCO PRODUCTS

LYSCO MFG. CO., Inc.

1401 CLINTON ST.

HOBOKEN, N. J.

(Continued from page 86)

WEST VIRGINIA — SCM, Donald B. Morris, W8JM — Director Key, 47A, attended the Assistant Directors' meeting at Parkersburg and spoke to the members of the Parkersburg Radio Club. HUG was appointed by Key as Assistant Director. Attending were Assistant Directors GBF, CSF, and JM, and members of the BARC and MARRA Radio Clubs; also RM DFC, and 1VQF and 1RNT from West Hartford. AUJ is Net Manager for WVN c.w. net. AUJ appointed DFC, EZR, BWK, and OXO as NCS. New ORS are AUJ, BWI, and OIC. BTV has moved to Michigan. EZR has recovered from a severe illness and is active again. DFC is reporting in to the WVN, 8RN, and 4RN Nets. New MARRA officers are JM, pres.; DHT, vice-pres.; BOK, secy.; Rhodes, treas.; FMU, act. mgr. JKN is active on 50 and 144 Mc. and is trying to work 420-Mc. stations from Buckhannon. PZT, VCA, AUJ, UHK, and BWD keep Weston active on all bands. Tips on stations for WACWV: EUE in Calhoun, EUZ in Nicholas, and DRU in Summers. After all these years JM finally has found Chloe. Calling CQ one night on 3.5 Mc., JM heard a weak signal coming back to him, signing W8EUE. After working EUE it was discovered that he was located at Chloe, Calhoun County, W. Va. Work W. Va. stations on 3770 and 3890 Kc. Traffic: W8AUJ 412, BWI 50, DFC 22, JM 6.

ROCKY MOUNTAIN DIVISION

COLORADO — SCM, M. W. Mitchell, W0IQZ — SECs: KHQ and SLN. RMs: ZJO and LZJ. SLN is new SEC for Denver area 10-meter activity. He has a very fine 10-meter mobile net set-up which is working with the city police, state police, and the new civilian defense organization. Greeley put on another FB hamfest Sept. 17th. Four states were represented. A club organization meeting was held at Colorado Springs on Sept. 30th. JMB was appointed president pro-tem until an election is held. KHQ gave a talk on emergency operation. LZJ and SGG were instrumental in getting notices to the gang via b.c. station announcements, newspapers, and sending out cards. SGG and his XYL gave us an FB southern-fried chicken dinner, while LZJ put KHQ and me up for the night. 3DF, George Sterling, FCC Commissioner, was a visitor at the Denver Radio Club. LZJ was off the air while rebuilding but now is back on and reports the Colorado slow-speed net is back in business at the same old stand, 3560 kc., and would like a few more in the net. DDM has 100 watts mobile on 3.85 Mc. AGU now is on 160-meter phone after some difficulty. AGU and IQZ had a game of golf with one stroke difference — guess who won? AGU of course. HJX has moved to Pueblo. PGX suffered considerable hail damage to his new car and the roof of his house. ZJO makes BPL again this month with a total of 1084. KHQ still is building and swapping to get his new rig going. His chassis look like an oil field from the number of holes drilled in them. Traffic: W0ZJO 1094, MOM 65, KHQ 8.

WYOMING — SCM Neary, KFV, has been called into the service (at Ft. Knox, Ky.) so that a vacancy in the SCM office exists, with Headquarters calling for nominating petitions (signed by five or more full members) for new SCM. LKQ, the EC at Caspar, has done a fine EC job there. HDS (SEC) has achieved section progress. ECs have been appointed in most of the county seats. They extend their planning and registration through each county for the present.

SOUTHEASTERN DIVISION

ALABAMA — Acting SCM, Percy Sexton, W4HFL — The Mobile gang had a better-than-ever set-up this year for the annual Deep Sea Fishing Rodeo. A 50-Mc. net was used with very good results between Dauphin Island and Mobile; 144 Mc. was used to form a duplex system. Taking part in the net were INU, GHZ, ITI, NGL, PSZ, PRS, GPK, MQI, QAT, OUW, OPH, MXE, GCZ, IAX, G0L, and UL. GBR has new c.w. rig. LEO now is with WROD, Daytona Beach, and has 60 watts on all bands. CYC is experimenting with pulse modulation. RNX operates 7 and 28 Mc. from Ft. Payne. CDV has a new rig on 3.85 Mc., p.p. 805w, 300 watts. GYD is rebuilding rig, TVI proof. HA is experimenting with wide-spaced 14-Mc. beam. PPK is a new net member from Trussville. AUP wants some activity on 160 meters for early mornings and late afternoons. MVM finally got his 48th state for W4S. MKV has been transferred to Decatur. Grady Clark, of Talladega, who is blind, received the call W4RYX. MVM is a new ORS in Mobile. KIX is doing FB handling traffic from Montgomery with AENP, AENB, RBL, and RN5. The Tuscaloosa gang pitched a surprise housewarming for BBE and his XYL, RLG, Oct. 7th. Attending were DAQ, EQG, ELX, MKV, HFL, RM, JLU, ITZ, IAK, MAB, KUX, HCV, and the XYLs. BFM answers AENP, AENB, and the Tennessee net regularly. Traffic: W4LSQ 198, LEN 57, KIX 50, BFM 13, MVM 12.

EASTERN FLORIDA — SCM, John W. Hollister, W4FWZ — It's getting close to the time for Tampa Fair traffic, gang, so we had better start getting our schedules in shape to help DUG and the Club gang again. ALP will be arranging schedules. He has 20 new AEC members signed

(Continued on page 87)

it's ALLIED for hallicrafters!

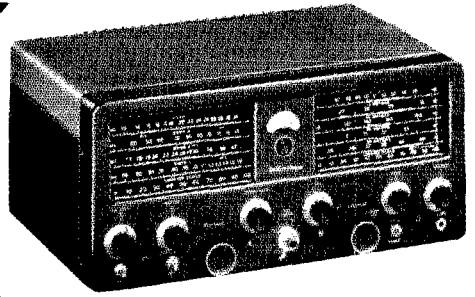

SX-71 Dual-IF Communications Model

A top-performing communications receiver at amazingly moderate cost! Covers five full bands: 538-1650 kc; 1600-4800 kc; 4.6-13.5 mc; 12.5-35 mc; 46-56 mc. Features double conversion superhet circuit, high image rejection, razor-sharp selectivity, extremely high sensitivity. Includes: full electrical bandspread; tuned RF stage, 3-step crystal filter; built-in NBFM adapter; automatic noise limiter; calibrated "S" meter; BFO pitch; tone control; extra-wide-vision dials; 3-watt communications-peaked audio; temperature compensation; universal antenna input. Skillful panel design puts every control at the operator's finger-tips—ready for instant action. In satin-black steel cabinet with chrome trim; 18½x7¾x12". Complete with 11 tubes, rectifier and regulator. For 105-125 volts, 50-60 cycles. Shpg. wt., 33 lbs.

97-506. SX-71, less speaker. Only **\$189.50**

\$28.43 down, \$14.23 monthly for 12 months

97-787. R-46 matching speaker, 19 lbs. **\$19.95**

All Prices Net F. O. B. Chicago

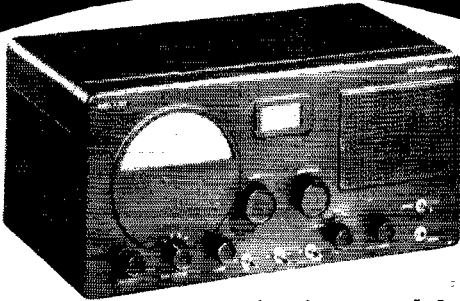

Latest S-40B Communications Model

New, advanced version of the famous S-40A. Covers 540 to 43 mc. Tuning dial calibrated for 5 Amateur bands. Features include: Electrical bandspread; ANL; AVC; variable-pitch BFO; flywheel tuning; code-phone switch; standby switch; tone control; separate sensitivity and volume controls. Complete with all tubes. Steel cabinet 18½x9x11". For 105-125 volts, 50-60 cycles A.C. Shpg. wt., 33 lbs.

97-546. S-40B Receiver. Only **\$89.95**

\$13.50 down, \$6.75 monthly for 12 months



Famous S-38B Super-Value All-Wave

The all-star, all-wave value. Covers 4 full bands, continuous from 540 kc to 32 mc. Electrical bandspread; Band Selector; Voice-Code switch; Speaker-headphones switch; Standby-receive switch, latest PM speaker. Furniture-steel cabinet, 12¾x7x7¼". Complete with all tubes. For 105-125 volts DC, or 40-60 cycles AC. Shpg. wt., 15 lbs.

97-508. Model S-38B Receiver. Only **\$49.50**

\$7.43 down, \$5.57 monthly for 8 months

**SEND TODAY
FOR YOUR**

Free 212-PAGE

ALLIED CATALOG

It's the only complete Buying Guide in Amateur Radio! 212 value-packed pages featuring all that's newest and best in receivers, transmitters, parts and station gear. Save money—save time—order from the 1951 ALLIED Catalog. Send for your **FREE** copy today.



ALLIED RADIO

Everything for the Ham

ALLIED RADIO CORP.

833 W. Jackson Blvd., Chicago 7, Ill., Dept. 15-M-O

- Send FREE 1951 ALLIED Catalog
- Enter order for Hallicrafters Model.
- Enclosed \$..... Full Payment
- Part Payment (Bal. C.O.D.)
- Send Time Payment details and order blank.

Name

Address

City..... Zone..... State.....

R. L. Drake Harmonic Reduction Filters

For
300 Ohm
Line

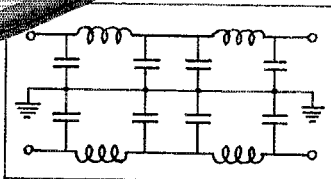
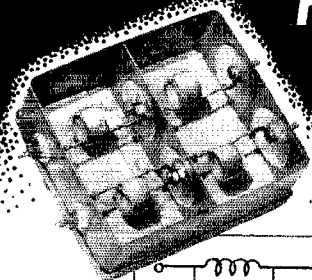

2

MODELS
TO CHOOSE FROM

TV-300-10HW - for 10-11 Meters
TV-300-20HW - for 20 Meters

Either Model,
Amateur Net **\$10.95**

The R. L. Drake 300 ohm Filters are the half-wave "Harmoniker" type and attenuate all harmonics outside the band for which they are designed. Attenuation of the second harmonic is approx. 30 db, and increases with each succeeding harmonic.

The balanced construction permits use in 300 ohm twin lead or in open wire lines 200 to 600 ohm. Rated to handle a modulated 1 KW transmitter in transmission lines with a low standing wave ratio.

See our November QST Ad for details on Low Pass Filters for Coax and 300 Ohm Transmission Lines — and High Pass Filters for the TV receiver.

THE R. L. DRAKE CO.
11 Longworth St., Dayton 2, Ohio

Drake Filters are precision engineered, completely assembled and adjusted. Specially constructed low inductance capacitors give maximum attenuation of high frequency harmonics. See them at your distributor today or write for complete information.

up, thanks to the SCR-299 installed at Red Cross Headquarters for the Tampa Club. The Dade Club also is seeking an SCR-299 from Uncle to put in enlarged club quarters at Red Club Building. Kind words: IE, back from a month in the mountains of North Carolina, sent a page full of orchids for OZC. RM for Gator Net, and the Net members on the traffic handled from Florida folks up there on vacation. Thanks, Charlie, I know the Net members appreciate it. OGI, RM for the Palmetto Net, got the Net off to a good start. Members are urged to report in again this season and new members are invited. 3675 kc. is the frequency at 7:00 P.M. Information on Civil Defense will be in QST and in special bulletins as available. Let me know if you are on your local committee. AFF at Boca Raton is. Who else? ECs should get a piece in the paper about the AEC and its relation to possible C.D. work. OCG writes that CQY is back on at Orlando on 14- and 28-Mc. 'phone. But CQR has gone to "Gawja." KJ was "Station of the Month" in the 3rd Army *Mars Bulletin*. All is not lost, LMG is on the Palmetto and MARS c.w. traffic nets. Other 'phone men are welcome. How come the faithful reporters didn't report this month? I have plenty of reporting cards if you need them. Some of you were sorely disappointed at not being able to get the FMT transmissions on all bands, but better luck next time. We sure have some good FMT contestants. Please send me something to print and send it before the fifth of each and every month. Traffic: W4OCG 190, OGI 63, KJ 44, LMT 35, FWZ 32.

GEORGIA — SCM, James P. Born, jr., W4ZD — New members added to the roll of the Georgia Cracker Net since the annual meeting of the net at Lithia Springs June 15, 1950, are as follows: CVY, DWE, EWN, K4FAL, GDW, GGD, INO, IPV, IVH, KXX, MEP, NAR, OKL, OSE, K4WAR, YRE, and HZG. OKL and his XYL, and OGS visited LDJ in Franklin, North Carolina. AAY is going MM in his cabin cruiser. HZG was in Emory Hospital for an operation. He now is at home recuperating. Good luck, Smitty, for a speedy recovery. MA now is on 28-Mc. 'phone. RPO has a new e.c.o. also a new mobile rig. OHH now is Class A; also Assistant EC for Upson County. ROL has moved to South Carolina. OGF has hooked a bad case of fringe-area TVL. MIP has his new 48-foot tower completed and is working on a three-element wide-spaced beam for 28 Mc. NXD now is Class A. LRB and RUZ are new hams at Robins Field. K4FAL, whose home call is MSX at Orlando, Fla., has a nice set-up at Robins Field. He has four separate operating positions using BC-610s on 3.5, 14, 7, and 28 Mc. 'phone and c.w. On 144 Mc. he is using BC-640 transmitter with BC-639 receiver. DXJ, JDR, and ZD have new DXCC certificates. RPO would like to hear from hams interested in joining a c.w. net. Traffic: (Sept.) W4KOR 58, ZD 10, MTS 9, OKL 6, AAY 5, LYG 4, MA 4. RPO 4. (Aug.) W4KOR 54.

WEST INDIES — SCM, William Werner, KP4DJ — BV, CH, CU, DU, DJ, HZ, JM, and KD, renewed AEC membership. CC, BL, DL, EY, HG, IT, and MO are new AEC members. BARC and PRARC participated in the S.E.T. IT received Class A license and has been appointed EC. NB, NC, NE, and NF are new hams at Ramey Field. MX is a new ham at Aguadilla. DR and MA are attending medical school in San Juan. JM has TBS-50, W2ZRN replaces Brother Mike at KP4AA. Colegio, San Jose. KD is working more DX on 7 than 14 Mc. Neighbors cut down the mango tree leaving space for 135-ft. Zepp. JO has new VHF-152 and 10-over-20 beam. KZ is building 10-20 phased array. MM has trouble with SX-28. KQ received Class A license. DL has Motorola mobile and mobilemount antenna. FS has 522 on 28 Mc. LH and W5RKC/KP4 have mobile rigs. DV, MS, and LC installed mobiles for S.E.T. W4EOA/KP4 installed 14-Mc. antenna on the next street 350 feet away to beat line noise. Traffic: KP4DJ 8, KD 4.

CANAL ZONE — SCM, Everett R. Kimmel, KZ5AW — With the passing of PA, our Route Manager, the section has lost a fine amateur and a crack traffic-handler. CG, with 350 watts and an electronic key, is picking up PA's regular schedules. AC, AW, FL, GD, MD, PC, RM, and WJ attended the housewarming at CG's new QTH, overlooking the airport and even the control tower. FL, our SEC, and PC, our PAM, on a jungle hill, operated PC's new mobile rig as a portable, giving the AEC gang a drill in locating a hidden transmitter and set off a stampede among the gang to acquire mobile rigs in anticipation of coming mobile authorization. LR is the envied operator of a 32V-2. RM is justly proud of his new home-built rig. In another local FMT, with MZ at the CAA station frequency gear as arbiter, the AEC gang came up with an average error of only 34.3 p/m for all participants. KZ will be operated again in the local hobby show. Traffic: KZ5WJ 38, PC 29, FL 21, LR 19, RM 6.

SOUTHWESTERN DIVISION

LOS ANGELES — SCM, Virge A. Gentry, jr., W6VIM — SEC: ESR. PAM: MVK. RMs: CE, GMN, DDE, FYW, JQB, and LDR. On behalf of the PAM, SEC, and the RMs, your SCM wishes you a very Merry Christmas. CE announces that 80 per cent of RN6 Net members made BPL for September. GYH had to terminate his schedules with KR6CA on 7 Mc. A recent order of General Mac-

(Continued on page 98)

RADIO SHACK Presents Gift Ideas for a Merry Xmas



V-M 3 Speed
PORTABLES

With built-in
speaker, amplifier,
tone control!



BARGAIN!

1/4" Drill,
Sander
Polisher!



\$12.95

Complete as shown, with 3/4" AC/DC drill, chuck, lambswool bonnet, 2 sanding discs, PLUS 40" detachable wood handle for using drill as floor waxer, etc. Gearing lubricated. Easily worth TWICE our special price. A deluxe gift at a give-away price!
Order: QST-3 Only **\$12.95**

LEFT: V-M 105, 3-speed amplified phono, dual-stylus crystal cartridge. Manual record change. Luggage-type carrying case. Plays all sizes, speeds, makes of records. Terrific gift! List \$37.50.
Order: QST-2 Only **\$26.46**

RIGHT: V-M 975, tri-o-matic portable amplified phono, automatically changes all speeds and sizes, INTERMIXES 10-12", automatic shut-off! List \$76.50.
Order: QST-1 Only **\$58.31**

GIVE A

GARRARD 3-SPEED CHANGER

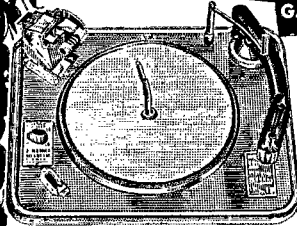

For high-fidelity installations. Plug-in head takes any cartridge. 1 1/2" x 1 3/4" space; and 5 3/4" over. 3 1/2" below motor board.
Order: QST-4 **\$36.80**

Wood base \$4.50. Motor board \$2.50. G.E. triple-play cartridge \$3.20. Astatic turnover crystal \$5.10

**MEISSNER
AM-FM
CHASSIS
ONLY**

\$57.21

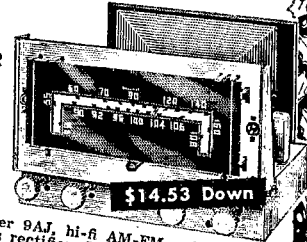

\$14.53 Down

New Meissner 9AJ, hi-fi AM-FM radio chassis. 8 tubes plus rectifier. Phono input and switch. D, 7 1/4" H. AC only. Full 4W output! List price \$89.41.
Order: QST-5 Only **\$57.21**
(With 12" PM coaxial speaker and 6V6 output transformer, SPECIAL at only \$70.55)

**Electric! Self Starting!
2400-Hour WORLD-WIDE Time!**

Only

\$12.50

*Plus \$2.50
U.S. Federal
excise tax

Ask for Model #300

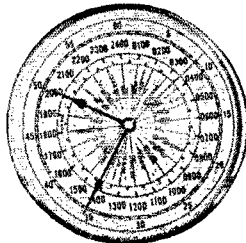

New electric, self-starting clock with 10" dial shows WORLD-WIDE TIME directly and clearly in every time zone! Shows minutes, seconds and 2400 hours! Rotating inner dial, hour, minute and giant sweep-second hands! Synchronous AC motor! Convex annealed glass crystal! Chrome-plated bezel! Dials lithographed in color; key cities and localities clearly shown!
LOWEST price ever!

**\$2.00 A.R.R.L. WORLD MAP FREE
WITH EVERY CLOCK PURCHASE!**
ORDER NOW FROM THIS AD! LIMITED SUPPLY!

SOLID CAST BRONZE ASHTRAY



Price includes up to six 1" letters! Individually boxed. Antique finish. 5 x 2 1/2 x 1 1/2". A magnificent, personal gift.
Order: QST-7 ... Only **\$3.50**

**WZIP
LOAD ON YOUR DIAL!**

**AUTO PLATE WITH HIS
CALL AND FREQUENCY!**

Silhouette auto plate with satin-silver call letters. Dial position or slogan (up to 15 letters) on background of red, green, dark blue or gray (specify). Order his today!
Order: QST-6 Only **\$5.00**

**The RADIO
SHACK Corp.**

CABLE ADDRESS - RADIOSHACK
167 WASHINGTON ST., BOSTON, MASS., U.S.A.

Merry Christmas from HARVEY

New—ELDICO—2 Meter XMITTER-RECEIVER



VHF superhet for amateur, civilian defense and CAP . . . mobile or fixed station operation. 144-150 mc. 10 tubes. Sensitive, stable, selective. Vernier tuning.

TRANSMITTER — Crystal controlled, 144-150 mc. 7 standard tubes. Coax connectors. Uses any power supply providing 300 v. at 200 ma. Screwdriver adjusted tuning controls.

Metal cabinets, in baked hammertone enamel, 5 1/2 x 9 1/2 x 5 1/2 in., with universal mounting flanges.

Receiver, in kit form, net \$59.95

Receiver, wired and tested, net 94.95

For external local oscillator, add \$5.00 to above.

Transmitter, in kit form, net \$49.95

Transmitter, wired and tested, net 74.95

*Prices are less power supply & speaker

ELDICO ANTENNASCOPE



Now you can be sure of maximum antenna performance with this Antennascope based on design of W. M. Scherer, W2AEF published in CQ, September. Used with a Grid-Dipper, you can measure radiation resistance, resonant frequency of antenna, line impedance, receiver input impedance, feedline s.w.r. Reduce TVI, increase xmitr efficiency, improve receiver performance, by knowing and measuring your rig. Eldico Antennascope is available in kit form or completely wired and tested.

Kit form \$24.95

Wired and tested \$29.95



NATIONAL NC-57

9-tube super with BFO and ANL, built-in speaker. A good receiver at a moderate price. **\$99.50**

NATIONAL SELECT-O-JECT

Boosts or rejects any audio signal (90 cps to 8,000 cps) 38 db! Supplied with full instructions for connecting to any receiver capable of supplying 6.3 v. at 0.6 amp. and 200-250 v. at 4 ma. \$24.95

HRO-50
\$359.00



Hallicrafters S-72 Portable Communications Receiver

For vacations or year-round use. BC and ham use, 4 bands—540 kc to 31 mc. Extra sensitivity for weak signal areas. AC, DC or batteries, whip or loop antenna. 8 tubes plus rectifier. Shpg. Wt. 16 lbs. **\$109.95**

HALLICRAFTERS S-38B

4 full wave bands. Continuous range from 540 kc to 32 mc. AC-DC super het circuit with many features usually found in more expensive receivers. Recommended for SWL and new amateurs. Complete with tubes. Only **\$49.50**

HALLICRAFTERS S-40B

A great receiver! 4 bands covering 540 kc to 43 mc. Exceptionally good signal-to-noise ratio and selectivity. Usual features plus automatic noise limiter, variable BFO, built-in PM speaker, 7 tubes plus rectifier. Only **\$99.95**

HALLICRAFTERS

SX-71
\$199.50



SUPERIOR POWERSTATS

Smooth, efficient, voltage control, 0-135 volts output from 115 volt AC line. Models also for 230 volt input. Write for free literature. Models for table and panel mounting.



Type 20, 3 amp. **\$12.50**
116, 7.5 amps, table mtg. **23.00**
116U, 7.5 amps, panel mtg. **18.00**
1126, 15 amps. **46.00**
1156, 45 amps. **118.00**

GRID DIP METER

MILLEN 90651
\$55.00



MILLEN No. 90671

Standing Wave Ratio Bridge
Net **\$15.00**

COLLINS 1 KW XMTTR

A well integrated, efficient rig in which maximum attention has been given to the amateur's TVI problem. Place your order now.

\$3,250.00



NEW COLLINS 75A-2

Double-conversion superhet with sensational stability, calibration accuracy and sensitivity... all the good features of the 75A-1, plus many new ones. Get your order in now for immediate delivery. Price, complete with tubes **\$420.00**; matching 10-inch speaker **\$20.00**.

COLLINS 32V-2 xmittr

\$575.00

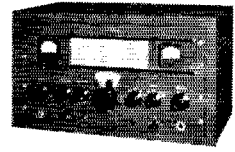

ELDICO

GRID DIP OSCILLATOR KIT

The most valuable piece of test equipment in the ham shack is the Grid Dipper. Build one with this kit and save countless hours in building, improving and debugging your rig. The GDO Kit builds an exact duplicate of the "Grid Dipper," now with regeneration. Includes everything from the special handy case permitting one-hand operation down to a complete application and instruction book. With tube and internal power supply, range 3 Mc to 250 Mc in 6 steps, size 5 1/2" x 2 3/8" x 3".
Complete Kit \$24.50



FREE TVI Book

Get your free copy of "TVI Can Be Cured". Just drop us a postcard with your call, name and address and we'll shoot it right to you.

All prices Net, F.O.B., N.Y.C. Include ample postage with your remittance, any excess will be refunded. Prices subject to change without notice.

Telephone: **2-1500** Luxembourg 2-1500

HARVEY RADIO COMPANY INC.

103 West 43rd St., New York 18, N. Y.

POPULAR PRICED — 2-MTR — EQUIPMENT FOR UNIVERSAL APPLICATION

DESIGNED FOR AMATEURS • Ideal for Civilian Defense and CAP

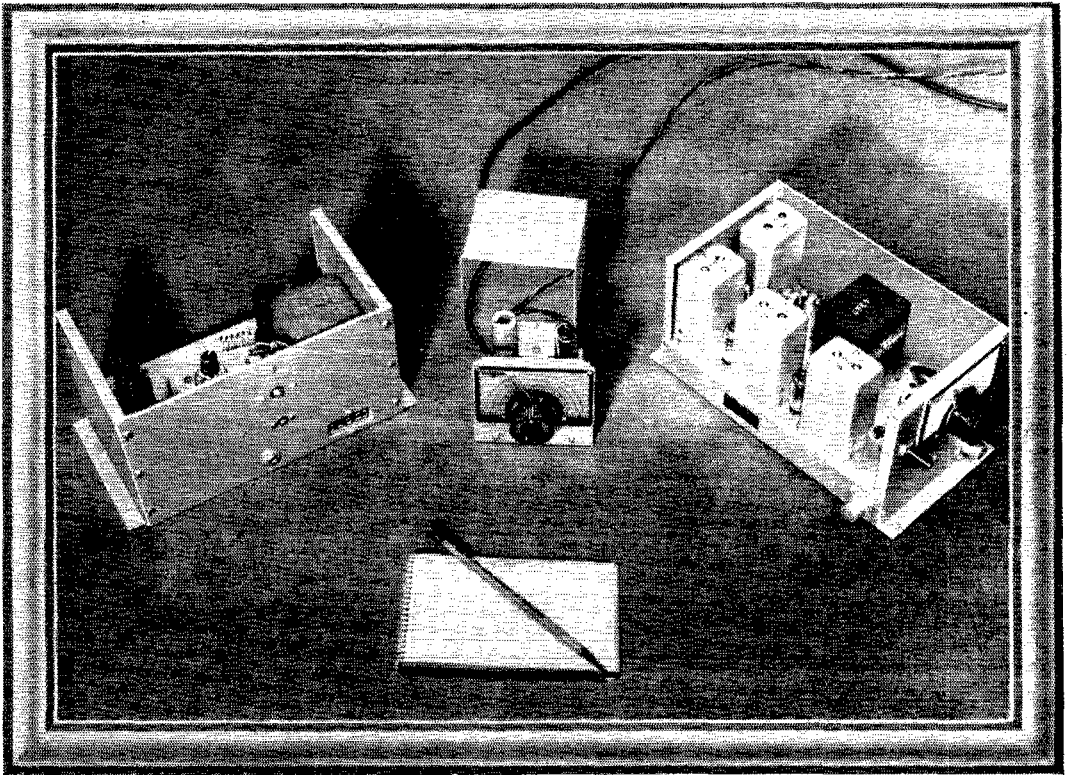

AT LAST

—a commercial vhf super-het! Designed for mobile or fixed station operation a complete* ten tube 2-meter AM superhet receiver tuning 144-150 mc with a sensitivity of better than 1 uv for 6 db signal-to-noise ratio. The Wallman r.f. circuit and 8-Mc. i.f. contribute to rock-steady stability and excellent performance. A.v.c. and a.n.l. included. The high-efficiency circuit has extremely economical power requirements. 6AK5 and 6J6 r.f. stages, 6AK5 mixer; 3 stages of 6BA6 i.f.; 6AL5 diode-detector noise limiter; 6AT6 audio amplifier; 6V6 audio output of 1 watt into 4 ohms; OA2 voltage regulator. For ease of tuning a precision vernier provides a velvet touch. The 6C4 local oscillator is designed as an integral assembly. At a slight additional cost it can be purchased in a small box for mounting in confined areas or where the feature of separate receiver tuning control is wanted.

Crystal control transmitter designed for operation in the 144-150 mc bands; 6AQ5 doublers; 5763 high-frequency pentode driving 2E26 final up to 22 Watts input.

6C4 speech amplifier for carbon microphone input driving 6V6 modulators. A modified pi network is provided for ease of coupling to any co-ax fed 2-meter antenna. Low power plate drain is only 300 v., 150 to 200 ma depending upon plate loading. Coax output and integral antenna switching included. All tuning controls are screw-driver adjusted to minimize detuning when used in mobile installations. Parts are conservatively rated to provide trouble-free performance. Layout and circuit design insures stable operation equal to standard low-frequency equipment.

Metal cabinets 5½" x 9½" x 5½" for both transmitter and receiver are finished in a handsome hammertone baked enamel. Flanges are provided for universal mounting in any convenient position. Jones plug and co-ax connectors on both transmitter and receiver units make installation rapid and positive. Standard components and tubes are used throughout should replacement of parts be necessary. Any power supply may be used capable of providing 300 volts at 200 ma. Separate or dual vibrator supplies are available as well as antennas, crystals, and all other accessories.

* Less power supply

PRICES

2-meter receiver in kit form.....	\$59.95
2-meter receiver wired and tested.....	94.95
For external local oscillator add \$5.00 to above prices	
2-meter transmitter in kit form.....	49.95
2-meter transmitter wired and tested.....	74.95

Signals of Distinction

ELDICO
OF NEW YORK
INCORPORATED

WRITE
W2UOL
FOR FREE—
TVI CAN BE
CURED.

44-31 DOUGLASTON PARKWAY • DOUGLASTON, L. I., NEW YORK • BAYside 9-8686

**Make Your
HOBBY
into a
GOOD PAY
JOB**

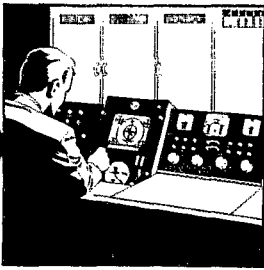

Add Technical Training to Your Practical Ham Experience



TELLS HOW —

**WE GUARANTEE
TO TRAIN AND COACH YOU
AT HOME UNTIL YOU GET
YOUR FCC COMMERCIAL
RADIO OPERATOR
LICENSE IF YOU'VE
HAD ANY HAM EXPERIENCE**

TELLS HOW —

**OUR AMAZINGLY EFFECTIVE
JOB-FINDING SERVICE
GETS BETTER JOBS IN RADIO
FOR OUR GRADUATES**



Gets Five Job-Offers From Broadcast Stations

"Your 'Chief Engineer's Bulletin' is a grand way of obtaining employment for your graduates who have obtained their 1st class license. Since my name has been on the list I have received calls or letters from five stations in the southern states, and am now employed as Transmitter Engineer at WMMT."—Elmer Powell, Box 274, Sparta, Tenn.

GETS CIVIL SERVICE JOB

"I have obtained a position at Wright-Patterson Air Force Base, Dayton, Ohio, as Junior Electronic Equipment Repairman. The Employment Application you prepared for me had a lot to do with my landing this desirable position."—Charles E. Loomis, 4516 Genessee Ave., Dayton 6, Ohio.

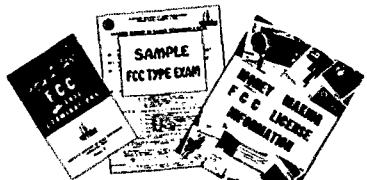

**GET
ALL 3
FREE!**

MAIL COUPON NOW!

CLEVELAND INSTITUTE OF RADIO ELECTRONICS
Desk QT-24, 4900 Euclid Bldg., Cleveland 13, Ohio

I want to know how I can get my FCC Commercial ticket in a minimum of time by training at home in spare time. Send me your amazing new free booklet, "Money Making FCC License Information", as well as a free sample FCC-type exam and Free Booklet, "How to Pass FCC Commercial License Examinations." (Does not cover exams for amateur license.)

Name..... Approved for
Address..... Veteran Training
City..... Zone..... State..... Under the G.I.
Bill of Rights

Veterans check for enrollment information under G.I. Bill

(Continued from page 98)

Arthur prohibits the use of 7 Mc. by Far East amateurs. However, they still can operate on 14 and 28 Mc. LDR received a 30-w.p.m. endorsement. MU is back on 28 Mc. RW is back on the air with a 32-V. GWB/6 had an experience that brings out the importance of retaining old message files. A member of his office died and there was no record of addresses of friends and relatives. GWB located the information among his old files. BHIG has equipment capable of operating all bands. FYW and OOU managed to win four prizes between them at the Convention. IYS has a new three-element beam on top of a 57-ft. tower. GAE used a pair of 24Cs in his new final. IYO is mobile on 28 Mc. AM reduced his noise level 6 to 8 db. by burying his power lines. YSK visited EXP and SYN on his way to the Convention. With regret we announce the passing of ABF and DCS. EFX and UFH are out of the hospital. YGB is back on the air. CSS and RL attended the Mt. Shasta Hamfest. EHA and EHB have a rig in their station wagon. Congratulations to OB for making WAS on 50 Mc. MVK/6, at Mt. Pinos, operated by ZUX and MVK, recently acted as liaison and effected the breaking of two West Coast v.h.f. records on the week end of the V.H.F. SS Contest. NLZ and EJL both worked VLS in Fresno for the first breakthrough of v.h.f. into Central California. Later YYG, in Manhattan Beach, worked GGM, at Santa Cruz, on 144 Mc. ESR has been in Arizona and VIM has been in Texas. CSS, HBY, and JM went on an expedition to Mojave. They report no TVI, no ignition noise, no power leaks; in fact, nobody. The success of the convention at Santa Barbara was due in no small part to the efforts of JTN and KFM. ESR announces the appointment of CWS as EC of the new Val-Area Net. This is a new AEC 28-Mc. mobile net covering the San Fernando Valley. GVE, IER, and NLZ have made several contacts on 430 Mc. with RVW in San Diego. Officers of the Ventura County Amateur Radio Club are IDU, pres.; QIW, secy.; KMJ, act. mgr. Sorry to learn that GTE's XYL has been in the hospital. At the convention at Santa Barbara TSW played host to AOA; GAL and MIH were QRT at the drawing, assisted by GHU. President Bailey spoke at ESR's AEC meeting. CE, DDE, and LDE had an unusual RM meeting; the SCMs of Los Angeles, East Bay, and San Joaquin Valley met; BPD was in on everything; MEN was as usual; CYI and FZO were exceptionally happy; CMN, EKM, and KW were campaigning; FOZ let the people of Santa Barbara know that the amateurs were in town; CND got lost at midnight. It was the best convention that your SCM has ever attended. IOX has resigned as RM. LEE expects to move to Arizona. VIM and ESR were dinner guests of the Radio 50 Club No. 2 of Whittier. TCE is a new amateur in Leavining. Confirmation of copy of DTY's official bulletin broadcasts indicate that he is getting results. Traffic: (Sept.) W6CE 5054, DDE 1001, GYH 548, LDR 404, ANT 187, GWB/6 83, CMN 65, JQB 60, BHG 49, FMG 38, FYW 30, HLZ 29, COZ 18, AM 5, YSK 5, DBY 4, BUK 2. (Aug.) W6DLR 61, HLZ 47, QAE 24, GWB/6 17, DBY 2.

ARIZONA — SCM, Jim Kennedy, W7MID — The Winslow Club has a 160-meter net going on 1990 kc., with roll call Wednesdays at 7 p.m. LYS was heard checking into the 3515-ke. net with an FB signal. OJQ has new three-element rotary for 28 Mc. KQV is building 'scope and rig. APE, in Winslow, has been reissued his old call after a lapse of ten years. LOS is building all-band rig. A new call for which we predict a big future as a DX hound is OWL, of St. Johns. Also active again in St. Johns are UKK and MNU. To those of the gang who failed to make it through the Class B exam we wish to extend our sympathy and wish you better luck next time. To those who made it safely, congrats, and isn't it nice to breathe the easy once more? The thanks of OIF and myself go to the fellows who participated in the Simulated Emergency Test on October 14th. This sort of demonstration is well worth while in many ways. LKT sports a new SX-71 receiver. OLB has acquired a 32V-1. MAE is putting his house and skywires back together after the windstorm.

SAN DIEGO — Acting SCM, Shelley Trotter, W6BAM — The section still is in need of a good man to take over the Section Emergency Coordinator job. Also ECs and PAMs are needed. Would appreciate hearing from anyone who is able to take over on any of these jobs. Only four reports were received this month from ORS, and as it is impossible to write up this column without news from you fellows, please send in more reports with news of your station activities. How about hearing from some of the other appointees besides ORS? Reports are welcome from anyone even though no appointment is held. BGF is doing a good job with traffic and makes BPL again this month on originations and deliveries. ELQ has the San Diego Section Net going in good shape on 3560 kc. at 8:30 p.m. PST and will welcome anyone checking in so that the Net will have better coverage in the section. 4YE, former SCM of the Alabama section, now is located at the Marine Corps Air Station at El Toro, and has applied for a W6 call. He is operating mobile on 3.85 and 28 Mc. and would like membership in the AEC. The gang at El Toro have formed a radio club with 9CPI as president. Traffic: W6BGF 321, BAM 234, ELQ 27, FMZ 4.

(Continued on page 98)

BOB HENRY, WØARA, OFFERS YOU:



LOW PRICES: I sell to you as cheap or cheaper than you can buy anywhere.

COMPLETE STOCKS: Collins, Hallicrafters, National, Hammarlund, RME, Millen, Harvey-Wells, Meissner, Gonset, Meck, Johnson, RCA, all other amateur receivers, transmitters, beams, TV, AM-FM, Polic-Alarm and Monitoradio, high fidelity amplifiers and speakers, test equipment, tubes, parts, etc. I can supply nearly any equipment shown in any catalog or advertisement and at lowest prices.

BEST TRADE-IN ALLOWANCE: Customers in all parts of the USA trade with me because I allow so much. Tell me what you have to trade and what you want. I also buy equipment.

TIME PAYMENTS: You can order anything on terms. I finance the terms myself to save you time and bother. Customers everywhere in the USA find my terms best. Write for details.

QUICK DELIVERY: Mail, phone, or wire your order. It will be shipped promptly. I can be reached nearly 24 hours a day, 7 days a week.

TEN-DAY TRIAL: Try any communications receiver ten days -- if you return it your only cost is shipping charges.

PERSONAL ATTENTION: The Butler store is run by Bob Henry, WØARA, and the Los Angeles store by Ted Henry, W6UOU. We make the deals ourselves. We finance the time payments ourselves. That way we have the lowest overhead and can do more for you. That's why YOU AND I CAN DO BUSINESS. Write, phone, or visit either store. Export orders solicited.

73,
Bob Henry
WØARA

Butler 1, Missouri

HENRY RADIO STORES

11240 Olympic Blvd.
LOS ANGELES 25
CALIF.

"WORLD'S LARGEST DISTRIBUTORS OF SHORT WAVE RECEIVERS"

BIG AMATEUR SEASON AHEAD!

YOU'LL WANT THESE —

Message Blanks. Official ARRL radio-gram forms, lithographed in green. Spaces for filling in preamble, address, text, signature and handling data are in proper order and fit your mill. Pad of 100 blanks—**35c**

Message Delivery Cards. Same style as Message Blanks. Convenient fill-in spaces. Printed in green.

On stamped government postcard—each **2c**
On unstamped card—each **1c**

Members' Stationery. For your DX letters and other correspondence. ARRL letterhead designed for members' use, lithographed on 8½ x 11 bond paper.

100 sheets—**\$1.00**

250 sheets—**\$1.50**

500 sheets—**\$2.50**

League Emblem. The well known ARRL diamond, black enameled with gold border and lettering. Official insignie of your league for thirty years. Two types: Pin (with safety clasp) or screw back.

Your choice—**50c**

Electrotype of League Emblem. Mounted on wood block ready for your printer to use on your QSL cards, personal stationery, etc. Each—**\$1.00**

QST Binders. Finished in reddish brown fabrikoid. Stiff covers. Each binder accommodates a year of QST and takes care of each month's copy as received. Opens flat at any page of any issue. (Available only in U. S. and possessions)

Each—**\$2.50**

We prepay postage on all these items

AMERICAN RADIO RELAY LEAGUE

West Hartford 7, Conn.

When ordering, please don't send stamps in payment

WEST GULF DIVISION

NORTHERN TEXAS—SCM, Joe G. Buch, W5CDU — IT has been busy with TV debugging and pacifying the neighborhood. GER has been active on 3.85-Mc. 'phone and busy with net participation. Newly-elected club officers for the Big Spring unit are: PXR, pres.; DZI, vice-pres.; PXD, secy. AW is working on new modulator and cussing high noise level on LO-Nites. AVT was on 14-Mc. 'phone long enough to work YN4CB and YV5AE. IGU is attending school in Okie Land. PSI and PXD are busy with YLs and such. BOH is on 14-Mc. c.w. and 28-Mc. 'phone with his TBS-50A. LUP is busy with Tesco mobile units. ZZP times 7 Mc. with one hand while putting up new houses with the other. NUH is QRL, keeping West Texas thirsts quenched — for a price. KIO is about ready to start operation with his 75-10 mobile unit. PXR is active on 7 Mc. when time permits. ARK is busy working c.w. and 'phone nets. GZU keeps busy with traffic and a bit of ragchewing. ASA and HBD are active with the c.w. net. This is my final report as your SCM, I am indebted to you who have made the job easier by contributing to this column and participating in the operations sponsored by the ARRL. I wish to thank the staff at Headquarters for their splendid cooperation and assistance. For our successor, BKH, we make this appeal so support by mailing your contributions for this column so they will reach Bill on the first of each month. Thanks arsin and very 73 to each member in the North Texas section. Traffic: W5GZU 215, BKH 99, ARK 71, AWT 19, PXR 3, AW 1.

OKLAHOMA—SCM, Frank E. Fisher, W5AHT/AST — SEC: AGM, RM; FOG, PAM: ATJ, Claude Gardner, our SEC, has to use two forms to report the organized AEC units now functioning. Let's get behind Claude and the AEC and make it 100 per cent for the State. FOG took over OWV's job as RM. Scott also is EC for Comanche County and now operates FOM which, together with his ranch, should keep him out of mischief. Let's get behind our RM and make this the number one section for efficient traffic-handling. FME now represents OLZ at Camp Polk, La. Lowell is the first station on at Polk and forms an important traffic link. The 45th Division is Oklahoma's own so it's up to us to provide them service and it should be good. HGC now is at Tinker AFB in a civilian capacity. We'll probably hear from George from the most unlikely places. EHC has doubled AEC membership in his county and has a very effective drill system coordinating operation on several frequencies. OPEN has a fine attendance on Sunday drill. PA still is rebuilding the shack with all the frills of civilization. KYG is back in Tulsa with another new sheepskin. Interest in mobile is picking up. FOG reports 20 mobiles at a recent drill where the boys called on all the ranchers in the vicinity and let them see what ham radio could do. Fine work, Scott! Guess everyone is busy, as few news reports have been received this month. Traffic: W5OYP 199. AHT 109, K5NRJ 95, W5FOM 69, MRK 23, HXG 17, MEZ 14, ADB 5, EHC 5.

SOUTHERN TEXAS—SCM, Ammon O. Young, W5BDI — NLY had a visit from 9HLS. MN still is handling plenty of traffic. New officers of the Houston Amateur Radio Club are as follows: LSE, pres.; NIT, vice-pres.; RKF, treas.; QGU, secy.; QZG, dir.; FJT, dir. Traffic: (Sept.) W5MN 357, (Aug.) W5MN 308.

NEW MEXICO—SCM, Lawrence R. Walsh, W5SMA — SEC: OMC, RM: NJR, PAM: BIW, PAM v.h.f.: FAG. The Los Alamos Radio Club held its monthly meeting at the home of SMA. QAU, of the Sandia Radio Club, was a guest and demonstrated the excellent mobile equipment which he has installed in his car. JXO and his XYL, WRS and his XYL and jr. operator, FPB, and SMA and his XYL enjoyed a cold and windy picnic in Aspen Basin Oct. 1st. The c.w. net elected NJR as Net Control. This carries with it the job of Route Manager for the coming year. MYQ now is set up in a new QTH. An entire room for the radio shack is somewhat offset by the proximity of the neighbor's television antenna. DRA took his Class A exam while in Houston. BIW is building a 10-20 8JK beam. The El Paso gang has a continuous watch on 3950 kc. for traffic for El Paso. PNX has been appointed Official Observer, Class IV. RMJ demonstrated portable operation to the gang at Highland High School in Albuquerque. 2CH/5 is a new member of the Sandia Radio Club. PLK has a TBS-50 installed in the station wagon for all-band mobile work. MYJ, of Santa Fe, is active on 28 Mc. QHB is active on 14-Mc. c.w. from Chiricahua. Traffic: W5PXX 90, RMJ 2.

CANADA MARITIME DIVISION

MARITIME—SCM, A. M. Crowell, VE1DQ — EQ, the EC, finds time for tri-weekly schedules with VE8 on 14-Mc. 'phone providing a most welcome link with their families for the boys in isolation with the D.O.T. HO, operated by ex-7YV, has the new rig going on 14-Mc. 'phone with 4-125 final. UC has been fairly active on 14-Mc. 'phone and is interested in QSOing the old home QTH in VE4-Land. NN got back from a nice vacation in the U.S.A. ON has returned to the air in home QTH after a vacation in (Continued on page 100)

Meissner

TRU SONIC

national
EST. 1914

American Beauty

CLAROSTAT



hallicrafters



Eimac
TUBES

THORDARSON

Jensen

AMPHENDL



Waceller

AEROVOX

RAYTHEON



Rauland



DU MONT
GARRARD



SPRAGUE



MALLORY

TRIPLET

Membrando
SILVER



B&W



OHMITE

IRC

Simpson

ASTATIC

ALTEC
LANSING CORPORATION



RMC



Taylor Tubes



GREENLEE



BUD

JACKSON

Bliley
CRYSTALS



SHURE

SANGAMO

ElectroVoice

HICKOK

TERMINAL

RADIO CORPORATION

Distributors of Radio & Electronic Equipment

85 CORTLANDT STREET
NEW YORK 7, N. Y. Phone: WOrth 4-3311

LOOK

POWER SUPPLY SCOOP!

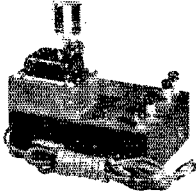

Utility power supply, 350 volts DC @ 50 Ma., 6.3 volts @ 2 Amp., black crackle chassis 6 1/4" x 5" x 2". Has choke and 2-section filter, AC switch and line cord, a wonderful buy, less No. 80 rectifier, only **\$2.25**

DUAL PLATE XFMR

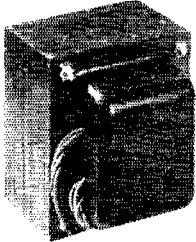

815-0-815 volts, 250 ma., PLUS 385-0-385 volts, 65 ma., 115 volt, 60 cycle primary, electro-static shield, upright mounting, fully shielded. A beautiful transformer with many applications.

\$6.95

5 1/4" x 4 3/4" x 5 1/4", 17 lbs.

10 HENRY CHOKE

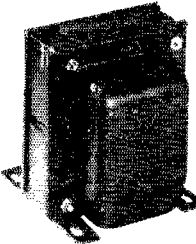

10 Henry, 250 Ma. choke, 100 ohms DC resistance, 3000 volt insulation, upright mounting, fully shielded. Check this price against ANY ad.

\$2.95

4 3/4" x 4" x 4", 9 lbs.

LIMITED STOCK

10 HENRY - 200 MA. CHOKE

150 ohms DC resistance, 1500 volt insulation, moisture proof mounting centers 3 1/8". Here is the best buy to date, **\$1.49** only.....

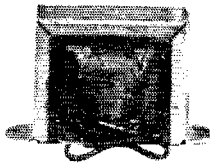

FILTER CONDENSER SPECIAL



6 MFD 600 WVDC G.E. Pyranol condenser, has mounting lugs, new, 4 3/4" high, 2 3/4" x 1 1/4", buy several at this **95¢** price.....

Steinberg's

633 WALNUT STREET • CINCINNATI 2, OHIO

VE3-Land, where he showed the boys how to really "get out" with the "lil 8 watter" on 14-Mc. 'phone. PQ has been giving 28 Mc. a whirr. ET has completed a nice all-band 'phone rig. LY has been watching 28 Mc. pretty closely but says conditions are not yet good. BC has been putting the TA-12 to work on 3.8-Mc. 'phone with nice results. IE is adding countries to his large list on 3.8-Mc. 'phone. HC is now on the "sick list." Recent visitors were VE2DD, ED, KN, and ex-8PA, of Resolution Island, and IE, of Grand Manan Island. W2PFL/MM had a long QSO with DQ on 28 Mc. while in port recently. KJ has returned to the R.C.A.F. AW is on 14-Mc. 'phone occasionally. Traffic: VE1FQ 40, MK 20, LO 9, AAK 7, DB 3.

ONTARIO DIVISION

ONTARIO — SCM, G. Eric Farquhar, VE3IA — Asst. SCM c.w.: W. Guillot, 3BUR. Asst. SCM 'phone: E. Kimble, 3FQ. SEC: KM. RMs: ATR, AWE, BMG, BUR, DU, GI, TM, WK, WY. PAMs: BSA, DF, FQ. Toronto and Hamilton Simulated Emergency Tests held in September were a definite success. Our C.G.M., Alex Reid, was a welcome visitor at the Hamilton Club meeting. He also gave the EC boys much information at a gathering of Emergency Corps members at a get-together in Oakville. Fall sessions of Ontario 'phone and AFARS Nets got under way in great style. C.w. nets, Beaver and Ontario, continue nightly with good traffic clearances. BBM, with a new QTH in London, says the house lease calls for no antennas. The London Club held a fine turkey banquet, the XYLS and OMs having a grand time. Recent appointments and endorsements are AMM, AZH, and BIB as EC; BLY, BUR, BVR, and DF as ORS; BUR as RM; DF and FQ as PAM; DF as OPS. Please contact your SCM if interested in any of the ARRL appointments. We really need Official Observer candidates. DU has returned from an excellent trip to the West Coast. APS rebuilt with the problem of TVI curbed. BUR is sporting Lyso 600 rig and going great guns as manager of TRN. JU and YR overhauled beams for the winter season. QT was responsible for running down and having cleared terrific noise level on 3.5 and 7 Mc. Thanks to you, Dick. Thanks for the FB support this month, gang. A nice bunch of reports was received, as traffic totals will show. Season's greetings and best wishes for the coming year. Traffic: (Sept.) VE3IA 288, BUR 250, ATR 159, WK 92, IL 85, RL 72, BVR 53, WY 50, KM 40, GI 29, BTQ 27, DBJ 27, BER 20, ASL 15, VD 14, AYW 11, DD 11, YJ 10, AZH 9, NI 9, DU 7, HK 7. (Aug.) VE3WY 73, IL 41, WK 25, DH 9. (June) VE3WY 212.

QUEBEC DIVISION

QUEBEC — SCM, Gordon A. Lynn, VE2GL — LO is new RM, replacing GM, who has given up hamming for the time being. AOB, an XYL, is a newcomer in Beaufort with 50 watts into long-wire antenna on 7 Mc. with SX-42 receiver. DU has new dipole for 3.8 Mc. fed with 300-ohms line, off center. EC maintains daily schedule with AKJ, and reports of having his 350-watter on 3.8-Mc. 'phone again after changing location of shack. DD is on 14 and 28 Mc. again with 75 watts. AGK visited St. Maurice Valley Region and gave a push to 144-Mc. operation. Twelve stations in the St. Maurice Valley Region now are active on that band. ACD is on 3.8-Mc. 'phone from Grand Mere. AHL has BC-458 which he uses as VFO and on which he has n.f.m. With the assistance of BG he erected 28-Mc. three-element beam and 135-ft. long all-band antenna. AKJ reports new antenna on 3.5 working FB. QN schedules the Saguenay and Gaspé Areas on 3.8 Mc. each Saturday and AFARS Wednesdays. PQN commenced activities Oct. 2nd on 3570 kc. BE now is using n.f.m., which eliminates his BCI problem. QN is organizing a Quebec City and District local net on the 160-meter band and has 20 members lined up. FG is operating under difficulties in new location with 33-ft. flat top and 33-ft. lead-in which he finds poor after having 135 ft. for so long. CA continues to schedule the boys in the Far North, his latest schedule being VESTC. Ecobisher. ACM has about 30 ft. of new 67-ft. tower erected. Let's have your reports, boys. Traffic: VE2QN 17, GL 7, EC 4, AKJ 2.

VANALTA DIVISION

ALBERTA — SCM, Sydney T. Jones, VE6MJ — YN proudly announces the arrival of another son. JP claims his 807s work better now that the grids have been cooked. EH and EA are going great guns with mobile rigs. DR is heard working single sideband. Sounds swell, Doc. The Lethbridge gang is publishing a fine paper each month. Let's support them; the subscription is only fifty cents per year. Send yours today to the secretary of the Southern Alberta Amateur Radio Club or via EO. JG has 28-Mc. beam all ready for operation if the band ever opens. MJ has installed motor on beam which he hopes he can keep from getting wet. LQ has a new car and is considering mobile, too. IY seems to think that RK39s are better tubes than 807s. CC has settled down for a good session of operating. RU hopes for nice contacts now his XYL is visiting in England. KS has taken over bandmaster duties with reserve

(Continued on page 102)

In Stock at Newark!

THE LATEST IN ELECTRONICS EQUIPMENT
FOR THE AMATEUR AND THE INDUSTRIAL USER

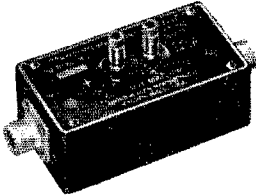

MILLEN 90671 STANDING WAVE RATIO BRIDGE

Indicates the standing wave ratio in a 51 or 75 ohm coaxial transmission line such as RG-8/U, RG-54/U, or RG-13/U. It is an RF bridge in which the resistance of the antenna transmission line and antenna, as seen by the transmitter, is compared to a 51 ohm resistor. An external 0 to 1 ma meter is used to indicate the amount of deviation from balance. Meter reading is changed to standing wave ratio by using calibration curve supplied. Useful range, 1 to 150 mc.
A1944. Wt. 1¼ lbs. \$15.00

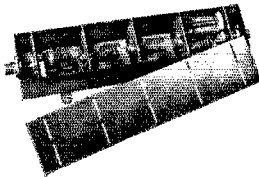

BARKER & WILLIAMSON LOW-PASS TVI FILTERS

Attenuate all frequencies above 50 mc by 75 db or more. Cover entire TV band, eliminating the need for individual filters for each transmitter frequency. Cut-off frequency approximately 30 mc; insertion loss less than .25 db. Handle 1 kilowatt easily. Consist of two "M" derived end sections and three mid-sections of constant "K" type. Av. wt. 2½ lbs.
A729. For single 52-ohm coax. \$17.00
A730. For single 75-ohm coax. \$17.00
A731. For 300-ohm line. \$17.00
ANY ABOVE \$22.50



STANCOR MODEL SA-403-A PLUG-IN CLIPPER-FILTER

Plug-in clipper-filter unit for preventing overmodulation or overdeviation in Amateur transmitters. Gives you more power and range with your present rig. No outboard wiring required—plugs into speech amplifier triode-driver tube socket. Filter frequency pass-band is 300-3000 cycles. Uses two 6J6 tubes (not supplied) to provide an overall gain of 40 db. Requires 180-250 volts DC at 5 ma and 6.3 volts at 0.9 amp. Input, 0.54 volts. 1½x1¾x4¼". Less tubes.
A2163. Wt. 12 oz. \$11.27

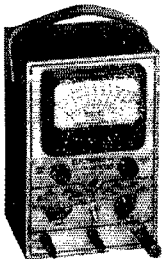

ELECTRONIC DESIGNS VTVM

Model 100. Ranges: DC volts, 0-3-10-30-100-300-1000 at 11 megohms constant input resistance, accurate within ±3%; AC volts, 0-10-30-100-300-1000 at 1000 ohms/volt, accurate within ±5%; ohms, 0-1000-10-1000-100,000; megohms, 0-1-1000; RF volts, 0-3-10-30. Employs bridge-type amplifier. Complete with DC probe, test leads for AC volts and ohms, and self-contained ohmmeter battery.
A1825. Wt. 14 lbs. \$52.50

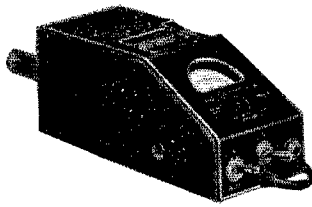

MILLEN GRID DIP METER

Model 90651. Versatile instrument for Amateur and lab. use. Calibrated oscillator for measuring resonance in a non-energized tuned circuit. May be used as a grid dip oscillator, an oscillating detector, a signal generator, and an indicating absorption wavemeter. Range: 1.7 to 300 mc in 7 bands. Has plug-in coils for each band. Transformer type power supply, plus provision for other external batteries.
A19413. Wt. 21 lbs. \$55.00

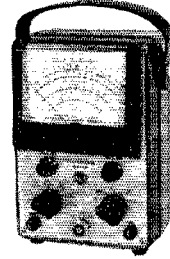

RCA SENIOR VOLTOHMYST

Model WV-97A. A new, improved version of the famous 195-A. Features full-wave, high-frequency rectifier circuit to measure peak-to-peak voltages up to 1400 volts. Measures and traces the complex waveform voltages found in video, sync, and deflection circuits. Wide response, 30 cps to 3 mc. Has zero-center scale for FM discriminator alignment. Resistance 0.1 ohm to 1000 megohms. With AC and DC probes.
A31. Wt. 10 lbs. \$62.50

SESSIONS SWITCH-TIMER MECHANISMS Make Your Present Radio a Clack-Radio

Turn radios, TV sets, electric appliances on or off at any pre-set time in a 12-hr. period. With these units, you can be awakened by music in the morning, or lulled to sleep at night—with the radio playing for as long as 90 minutes before the Sleep Switch turns it off. Size 2" x 3½" dia. Wt., 3 lbs.

25681. Model W-31. With Sleep Switch. \$5.75
25680. Model W-26. Without Sleep Switch. \$4.95

W-31.

Order Today from this Ad.

FOR PROMPT DELIVERY
WRITE DEPARTMENT B-120

Newark ELECTRIC COMPANY

323 WEST MADISON STREET
CHICAGO 6, ILLINOIS



TWO NAMES YOU CAN ALWAYS DEPEND UPON For Quality and Service!



Our Giant Store and Warehouse features a Complete Line of RCA Tubes, Test Equipment, Batteries, Radio and TV Replacement Parts, etc. Visit our Elaborate Sound Studio and New York's First "Radio Super-Market" — Serve Yourself and Save on Thousands of Standard and Surplus Items!

NEW RCA WO-56A 7" OSCILLOSCOPE

Unequaled in Performance, Unmatched in Versatility! This new extremely sensitive RCA 7" Scope features DUAL CONTROLS for Coarse and Fine adjustments, Identical Vert. and Horiz. Amplifiers... for response flat down to DC. Push-Pull throughout, High Amplifier Output and Gain, Phase Equality. Advanced Sweep Facilities include preset fixed position for TV vert. and horiz. waveforms, plus or minus sync for easy lock-in of upright or inverted pulse waveform, line-frequency sweep and sync, with phasing. Frequency Response of both amplifiers flat within —2 db from DC to 500 Kc; within —6 db at 1 Mc; usefull beyond 2 Mc. Square wave response—no tilt and overshoot. No. A19, Ship. Wt. 31 lbs.....Net **\$197.50**

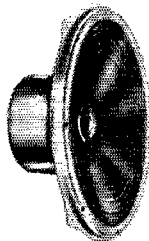
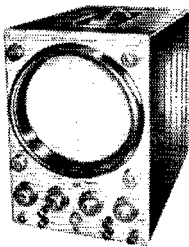

TERRIFIC! RCA 51552 15" Duo-Cone SPEAKER

The newest development of Dr. H. F. Olson. Has built-in crossover network. Delivers 25 watts of high fidelity audio over range of 40-12,000 cycles. Has two voice coils, each driving one of the duo-cones which vibrate as a single cone, at crossover frequencies (around 2,000 cps), avoiding "crossover" interference. 2 lb. Alnico V magnet. Amazing Performance! 18 lbs. No. A53, RCA 51552 Speaker Net **\$48.50**

Price Includes 2% Discount



RCA TV COMPONENTS

All RCA Television Components are "originals," with characteristics which are correct electrically and mechanically for the tubes and circuits. They are competitively priced!

RCA TUBES

RCA's unparalleled research facilities, engineering background, and experience contribute to the quality, dependability, and operating economy of EVERY RCA tube you buy.



FREE OUR NEW 1951 CATALOG

Your Name and Address to Dept. 12Q on a Postal Card Will Bring Your Copy!



212 FULTON STREET
NEW YORK 7, N. Y. Digby 9-1192

Most Complete Stock of Radio, TV, Electronic and Sound Equipment in the East!



squadron of RCAF. EH has been elected president of the NARC. Support your local Emergency Coordinator by applying for membership in the AEC now. Let your SCM know what you are doing; he wants to hear from you each month. Traffic: VE6OD 58, MJ 7.

BRITISH COLUMBIA — SCM, Ernest Savage, VE7FB — ID, the SEC; XA, the RM; and I, your SCM, would like to see some mail from you. Wonder if ADN knew K7FAK was off frequency. XA, our Route Manager, has lots of room for you who are interested in traffic. He is going to build a new rig this fall so he can be heard. AQQ is up to something big; parts going his way means a new rig. Doc is in the dog house with his landlord, who doesn't approve of amateur radio. AKO will be heard more often this year. ANC has a new receiver and new plans for the winter. MC seems to be fine with his Diathermy final, as it is called. Mr. & Mrs. A/KS/AKT did get a 616 on the air. PJ cleaned up his antenna and keying troubles, then decided to leave town. DB took the XYL's hints and moved into the basement. The Oliver Amateur Radio Club has lost its hard-working secretary, ZT, who has moved. PY is reported on the sick list. HE, the "Happy Engineer," is out gunning for wild life. Who beat who in the tennis tournament, the 13 Club versus Vancouver Club? Please write a line to your SCM; he would like it. Traffic: VE7XA 380, AOQ 17, FB 15, ZF 11.

PRAIRIE DIVISION

MANITOBA — SCM, A. W. Morley, VE4AM — PAM; MFA. AO was reflected president of BARG; MIV, vice-pres.; and KN, secretary-treasurer. The new club rooms are completed and located at the northeast corner of 13th St. and Lorne Ave. The Club meets the second Monday of each month and all visitors are welcome. WARC was honored when Mayor Coulter and Mrs. Coulter became honorary members of the Club as a result of the work done by amateurs during the flood. GJK and NA have new harmonics, both sons. 6HQ and GUB visited RO. DS, IF/GE, and GB visited the SCM. GB came in his new car. HP visited the VE3s in Dryden and Sioux Lookout. There was no report for this section in September QST and within a short while I received seven phone calls asking why not. This is your column, fellows, and I can't pick the stuff out of thin air. How about dropping me a line? I wish to thank all those who made the kind inquiries in regard to the XYL, JM. She is recovering fine and hopes to be back on very shortly. Traffic: VE4LF 10.

SASKATCHEWAN — SCM, J. H. Goodridge, VE5DW — HR, Route Manager, has formed a c.w. net in the section. Those who have reported in are BH, BV, DD, FF, and FG. They meet at 8 p.m. Monday through Friday on 3585 kc. Any c.w. operator interested in handling traffic is urged to report in for details. EE is using screen modulation. FY still is debugging his super-duper transmitter, which includes everything but a rotary beam. RC is back at U. of S. BE is now located in Saskatoon and working 3.8-Mc. phone. AJ is rebuilding and we hear he has purchased a Commander receiver. FR invites 3.8-Mc. phone with a converted TR-9. UO is trying to exterminate the hum in his rig. HL is back on 3.8-Mc. phone with 813 final and schedules YL in Saskatoon via YF. We understand AE now is 3DKG and CP now is 3ESH, both at Sioux Lookout, Ont. MA continues experiments with s.s.s.c. and schedules s.s.s.c. stations 7AFO and 7VP. OM, on the air since 1933, and president of the Moose Jaw Amateur Radio Club, has worked for many years building the club to its present high standard. The MJARC congratulates him on a promotion in the C.P.R. Traffic: VE5MA 58, JI 25, SE 24, YF 16, EE 12, HR 6, JW 6, PJ 5, PQ 5, FG 2, LL 2, DS 1.

50 Mc.

(Continued from page 85)

San Joaquin Valley	W6NLZ	150-18-5-B-D
W6VLS	72-18-4-B	K6BF 18-6-3-A-B

ROANOKE DIVISION

Virginia	VE3BQN
W4AO	VE3AIB
W4JAZ	VE3BOW
W4LVA	VE3ANT
	VE3EAH
	VE3DER
W. Virginia	VE3AZX
W3KWF/8	VE3QT/3
W8TDJ	VE3DHL
	VE3DGV

ONTARIO DIVISION

712-69-8-A-B-C-D
384-61-6-A-B
330-55-6-A-B
244-61-4-B
232-58-4-B
160-10-4-A-B
158-39-4-A-B
70-35-2-B
17-17-1-A
11-11-1-B

SOUTHWESTERN DIVISION

Los Angeles	W6MYK/61	750-75-5-A-B-D
-------------	----------	----------------

PRAIRIE DIVISION

Saskatchewan	VE5JK	15-3-1-D
--------------	-------	----------



Hunting a BARGAIN?

Save Money with a *Surprise* Trade-In Allowance on Your Used Test or Communication Equipment for one of the **NEW**

National RECEIVERS



EST. 1914

For saving cold cash on hot values nothing beats the bargain you get when you trade your used (factory-built) communication equipment for the National Receiver of your choice. To get your extra-liberal "Surprise" allowance, simply tell us what you have to trade. We'll respond, pronto, with our money saving offer. Wire, write, phone or use the handy coupon today!



Buy it at a sensational saving by trading in your used equipment. Tell us what you have to trade.
Shpg. wt. 34 lbs.....Only **NC-57 \$99⁰⁰**

For The Discriminating Radio Amateur

A super value when you take advantage of our "Surprise" offer on your used equipment. What have you to trade?

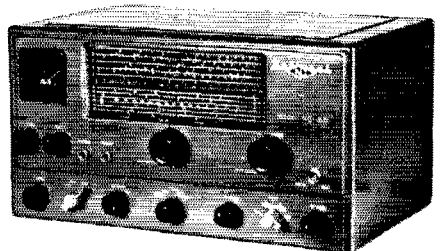

New NC-125
Shpg. wt. 36 lbs.
Less spkr.....Only **\$149⁵⁰**

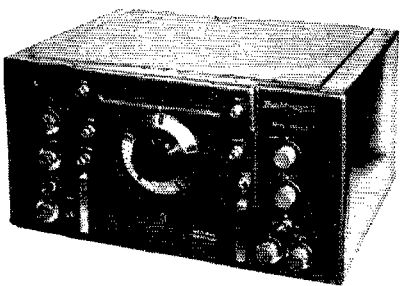

Buy this amazing HRO-50 by applying your trade-in allowance against the above price.
Shpg. wt. 80 lbs. Less spkr. Only **HRO-50 \$359⁰⁰**

FREE! New 164-page Catalog. The "Treasure Chest" of values. Send for your copy today.

All prices f. o. b. St. Louis
Phone Chestnut 1125

A WORD TO THE PROSPECTIVE NOVICE
From our complete stock of National Receivers you can choose the instrument ideally suited for your entry into the proposed Novice class of Licensee in Amateur Radio. Free copy of latest National catalog is yours for the asking. Depend on Walter Ashe for the latest and best buys in Radio, Electronics, Components and Supplies to meet your every requirement.

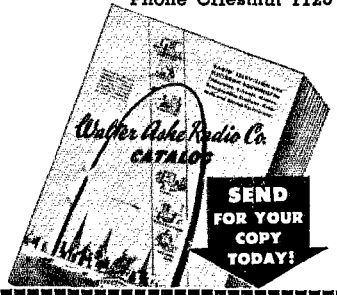

Walter Ashe
RADIO CO.
1125 PINE ST. • ST. LOUIS 1, MO.

Walter Ashe Radio Co.
1125 Pine St., St. Louis 1, Missouri Q-50-12

Rush Special "Surprise" Trade-in offer on my _____
(show make and model No. of used equipment)

for NATIONAL Receiver _____ (indicate model No.)

Mail my Free copy of new 164-page Walter Ashe Catalog.

Name _____
Address _____
City _____ Zone _____ State _____



The

Christmas Gift that Lasts All Year

QST

He won't turn up his coat collar to hide it.
He won't have to exchange it for one with longer sleeves.
He won't read it once and shove it out of sight.
It won't shrink.
And he'll like it whether he smokes or not.

QST is the one present that's always suitable, always welcome — a monthly reminder that you think enough of him to give him something he really wants.

Twelve issues of QST and a year's membership in A.R.R.L.

\$4.00 in U.S.A. and Possessions

\$4.25 in Canada

\$5.00 elsewhere

Of course the Christmas Card we mail him shows that the gift is from you

AMERICAN RADIO RELAY LEAGUE

34 LaSalle Rd.

West Hartford 7, Conn.

EASY TO LEARN CODE

It is easy and pleasant to learn or increase speed the modern way — with an **Instructograph Code Teacher**. Excellent for the beginner or advanced student. A quick, practical and dependable method. Available tapes from beginner's alphabet to typical messages on all subjects. Speed range 5 to 40 WPM. Always ready, no QRM, beats having someone send to you.

ENDORSED BY THOUSANDS!

The **Instructograph Code Teacher** literally takes the place of an operator-instructor and enables anyone to learn and master code without further assistance. Thousands of successful operators have "acquired the code" with the **Instructograph System**. Write today for full particulars and convenient rental plans



INSTRUCTOGRAPH COMPANY

4709 SHERIDAN ROAD, CHICAGO 40, ILLINOIS

104

S. W. R. Measurements

(Continued from page 89)

as shown by the readings on r.f. ammeters in the line. Bridge measurements made directly in the line will rarely stand this test. The method gives equally consistent readings when extra sections of line are cut in — another test that usually gives confusing answers with direct bridge measurements. A small variation is to be expected when the line length is changed in multiples of $\frac{1}{2}$ wavelength, unless the test resistor used in setting up the circuit initially has been very carefully matched to the actual characteristic impedance of the line. This can be done, but requires considerable cut-and-try, using a supply of resistors that in various combinations will add up to values both above and below the nominal line impedance. By using the resistors to terminate a number of different lengths of line the value that shows a 1-to-1 ratio throughout eventually can be found. The rather considerable trouble that this usually entails is not justified for the ordinary purpose of adjusting a match between the antenna and line. As between a perfect match and the kind obtained by using the nominal values, the difference in either line losses or broadness of tuning is of no practical consequence.

In using the technique described above for making s.w.r. measurements on the transmission line, it should be kept in mind that if the s.w.r. turns out to be greater than 1 to 1 the antenna-coupler adjustment that is used for measurement is *not* the one to use when feeding power into the antenna. For the latter purpose, the coupler *always* should be adjusted to give a 1 to 1 ratio in the coax link. This results in best power transfer to the antenna, lowest losses in the link circuit, broadest frequency coverage in the coupler circuit, and optimum operating conditions for a low-pass filter in the link circuit. The two adjustments will coincide only when the transmission line itself is perfectly matched by the antenna.

Correspondence

(Continued from page 66)

a sightless person may enjoy on an equal footing with his seeing colleagues. Won't you let us keep this feeling of equality? We are proud of it.

The license requirements are just stiff enough to offer a wholesome challenge to the man of average powers. The knowledge and skill demanded are the minimum necessary for complete enjoyment of the hobby, and for safe operation of electrical devices. And the FCC examiners are in every way kind and considerate, definitely hoping the blind applicant will pass.

In large measure, we blind hams operate our equipment independently. Some even build their own rigs, from scratch. Some construct and erect their antenna systems, even stacked arrays. We who already have our tickets are not geniuses; nor will those who seek theirs in the future be lacking in know-how or enthusiasm. We want and need no special favor; just mutual friendship and respect.

— Dr. D. W. Lynn, W4PMO

SWITCH TO SAFETY!



Our 28th Year



QUALITY - PRICE
DEPENDABILITY

**HOW TO SOLVE YOUR
VOLTAGE CONTROL
PROBLEMS**



TYPE 20



TYPE 1156



TYPE 116

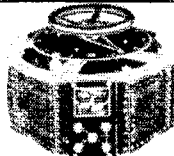

TYPE 1256



TYPE 116U

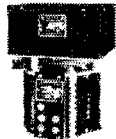

TYPE MZ1226

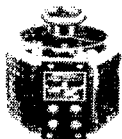

TYPE 1126



TYPE 2PF1126



TYPE IE51002



TYPE EM4102

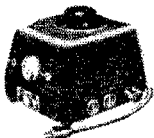

TYPE UC1M

Type	List Price
20	\$ 12.50
116	23.00
116U	18.00
1126	46.00
2PF1126	56.00
1156	118.00
1256	118.00
MZ1126	128.50
IE51002	175.00
EM4102	290.00
UC1M	46.00
Binding Posts	
DF30BC (Black)	.40
DF30RC (Red)	.40



**5-WAY
BINDING POST**

POWERSTAT

variable transformers

STABILINE

automatic voltage regulators

VOLTBOX

a-c power supplies

POWERSTAT VARIABLE TRANSFORMERS are autotransformers of toroidal core design with a movable brush tap which rotates to deliver a continuously adjustable output voltage from a-c power lines. They are available as manually operated or motor-driven models. **POWERSTATS** feature excellent regulation, conservative ratings, standard mounting, smooth control and high efficiency. They are offered in 115, 230 and 460 volts; single and three phase; 50/60 and 400/800 cycle types in capacities of 405 VA to 100 KVA.

STABILINE AUTOMATIC VOLTAGE REGULATORS maintain constant output voltage regardless of variations in line voltage and load current. Two types are available. Type IE is completely electronic with no moving parts. Waveform distortion never exceeds 3%. Numerous models are available for 115 and 230 volt operation in capacities from 1/4 to 5 KVA. Type EM consists of an electronic detector circuit controlling a motor-driven **POWERSTAT**. They feature zero waveform distortion, insensitivity to power factor and load, and have no effect on the system power factor. Numerous models are available in 115, 230, 460 volt, 50/60 cycle, single or three phase ratings in capacities from 2 to 100 KVA.

VOLTBOX A-C POWER SUPPLIES: Compact, portable sources of variable a-c voltage for use in laboratory, inspection and maintenance sections and in transmitter work rooms. Two types available: UC1M — 115v, 50/60 cycle, 1 phase, output 0-135 v, 7.5 amps, 1 KVA. UC2M — 230 v, 50/60 cycle, 1 phase, output 0-270v, 3.0 amps, 810 VA.

5-WAY BINDING POSTS 5 methods of connection. Complete insulation, 30 amp, current capacity, 1000 v. working voltage. Captive head for convenience. Red or black color. 5 connections: 1. Permanent clamping. 2. Spade Lug. 3. Plug-in for Banana Plug. 4. Looping and Clamping. 5. Clip-Lead.

If not rated 25% with order, balance C.O.D. All prices F.O.B. our warehouse New York. No order under \$2.00 We ship to any part of the globe.

LEEDS RADIO CO.

75 Vesey Street
COrtlandt 7-2612

Dept. QS 12
New York City 7

Froehliche Weihnachten!

FELICÉS PASCUAS! Buon Natale!

Een Vroolijk Kerstfeest!

Wesolich Swiat! Heureux Noel!

FELIZ NATAL!

Boldog Karacsont! Vesele Vanoco!

MERRY CHRISTMAS!

To Our Friends All Over The World

THE VESTO COMPANY

W80JI

MORE SIGNALS PER DOLLAR
From Money Invested in an Antenna

Self Supporting

STEEL TOWERS

For Rotary Beams, FM, TV

ATTRACTIVE—NO GUY WIRES!

- 4-Post Construction for Greater Strength!
- Galvanized Steel—Will Last A Lifetime!
- SAFE—Ladder to Top Platform
- COMPLETE—Ready to Assemble
- Easy to Erect or Move
- Withstands Heaviest Winds

(We will supply stress diagrams for your building inspector)

EASY MONTHLY PAYMENTS

Up to 12 Months to Pay!

All Vesto Towers are available on a special monthly payment plan which requires only 1/3 down. Write for free details.



Width at
Base Equal
to 1/5 Height

IMMEDIATE DELIVERY

on all 7 popular sizes. Note the low prices for these quality lifetime towers: 22' - \$84.75, 28' - \$104.75, 33' - \$123.75, 37' - \$144.75, 44' - \$164.75, 50' - \$192.75, 61' - \$259.75, 100' -

\$974.75. Towers are shipped to your home knocked down, FOB Kansas City, Mo., 4th class freight. Prices subject to change ... so order now! Send check or money order ... or write for free information.

WRITE TODAY
FOR COMPLETE
FREE INFORMATION
AND PHOTOGRAPHS

The VESTO Company

101 Main St., Parkville, Mo.

LEARN CODE!

SPEED UP Your
RECEIVING
with G-C

Automatic Sender

Type S

\$24.00 Postpaid in
U. S. A.



Housed in Aluminum Case. Black Instrument Finished. Small—Compact—Quiet induction type motor. 110 Volts—60 Cycle A.C.

Adjustable speed control, maintains constant speed at any setting. Complete with ten rolls of double perforated tape. A wide variety of other practice tapes available at 50c per roll.

GARDINER & COMPANY

STRATFORD

NEW JERSEY

"Supermodulation"

(Continued from page 40)

To cut down the number of tubes, it would be possible to make the peak tube an 815 and the carrier tube a 2E26, or the former an 829B and the latter an 807.

In the circuit of Fig. 7, the d.c. current to the peak tubes, under modulation, will rise to about 0.64 of the d.c. input to the carrier tube, or one-half the current required for the circuit of Fig. 4.

In general, if tubes having differing characteristics are used in the carrier and peak-tube sockets, it will be necessary to adjust the screen, bias, excitation and modulating voltages so as to ensure the ability to double (or quadruple) the current into the tank circuit at the crest of the modulating cycle. The positive half of the audio cycle must swing the peak tube substantially from cut-off to full output, while the negative half must swing the carrier tube from full output to zero.

The published supermodulation circuits show identical tubes with equal screen voltages but with differing modulating voltages. This is apparently because the extra output from the peak tube must then be obtained by driving its grid relatively far positive at the modulation peak. This is perfectly feasible, and gives more power output, but it requires more driving power, introduces a driver voltage regulation problem, and makes performance somewhat more difficult to predict. The circuits all show means for varying the r.f. excitation to carrier and peak tubes, and the procedure apparently is empirically to find the adjustment giving best linearity. It seems clear that these adjustments would have to be made with care.

The circuit should find acceptance in amateur service as an amplitude-modulation system owing to its relative simplicity of tuning and good efficiency. The many possible variations represent a challenge to experimental ingenuity, and it is clear that further exploration will pay rich dividends in improved technique.

M.A.R.S.

(Continued from page 41)

the U. S. Capitol, demonstrating the value of mobility in amateur radio in case of disaster. For the final contact, the station was linked with the light cruiser U.S.S. *Roanoke*, CL-145, from her position somewhere in the Atlantic. MARS frequency 5500 kc. was used for this QSO.

The station now operates on a 24-hour-a-day basis; there is a receptionist on hand at all times to greet the public and to arrange for any valid ham operator to "check out" the station equipment.

Principal credit for the construction of what has been called the "finest amateur radio station in existence" goes to Alton R. Hart, W3AX, electronics engineer for the Signal Corps, who put the station on paper, and Temco, Inc., of New York City, the manufacturers.

ANNOUNCING.



WRL'S BIG NEW 1951 CATALOG FREE

Send for the new 1951 complete WRL CATALOG containing everything new in radio and television. Our 1951 catalog is bigger than ever, jam-packed with bargains, completely indexed and arranged for quick easy reference. Send for your FREE copy today! No obligation!

Leo I. Meyerson
WØGFQ

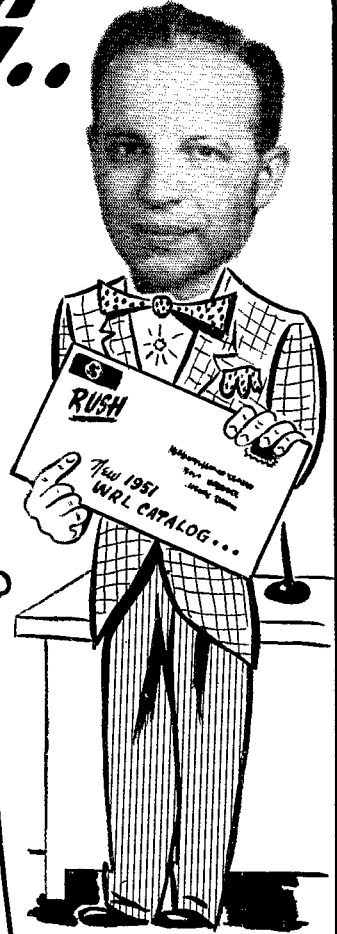

CU ON 20 - 10 & 75 METERS



GIANT RADIO REFERENCE MAP

Just right for your control room walls. Approximately 28" x 36". Contains time zones, amateur zones, monitoring stations. Mail coupon today and... **25c**

NEW WRL 400-A GLOBE KING TRANSMITTER

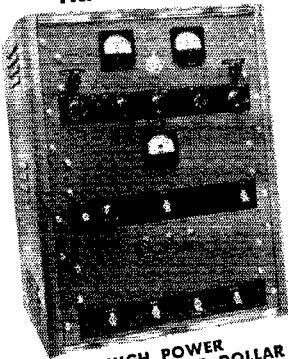

**HIGH POWER
MORE WATTS PER DOLLAR**
Our newest model with increased power—400 watts phone, 425 watts CW. Incorporates some of the latest TVI protective features. Efficient performance on all bands—10 to 160 on phone and CW. Provisions for ECO. Complete with tubes, meters, and one set of coils.

KIT FORM WIRED-TESTED
\$419.45 \$439.45
Low Down Payments

WRL 175 WATT GLOBE CHAMPION TRANSMITTER



MORE WATTS PER DOLLAR
R.F. Section a complete 175 watt XMTR. Provisions for ECO. Automatic fixed bias on Final and Buffer. Class B Speech Modulator. 175 watt input—10 thru 160 meter bands. Complete with tubes, meters, and 1 set of coils.

KIT FORM WIRED
\$279.00 \$299.00
LOW DOWN PAYMENT

Deal with us on the new COLLINS 75A2—\$420

WRITE - WIRE

PHONE 7795

World  **Radio**
LABORATORIES INCORPORATED
COUNCIL BLUFFS, IOWA

World Radio Laboratories, Inc.
744 West Broadway
Council Bluffs, Iowa

Q-12

Please send me:

- Radio Map Globe King Info
 New Catalog Globe Champion Info
 List of Guaranteed Used Equipment

Name _____

Address _____

City _____ State _____

RADAR, COMMUNICATIONS and SONAR TECHNICIANS WANTED

For Overseas Assignments

Technical Qualifications:

1. At least 3 years' practical experience in installation and maintenance.
2. Navy veterans ETM 1/c or higher.
3. Army veterans TECH/SGT or higher.

Personal Qualifications:

1. Age, over 22—must pass physical examination.
2. Ability to assume responsibility.
3. Must stand thorough character investigation.
4. Willing to go overseas for 1 year.

Base pay, bonus, living allowance, vacation add up to \$7,000.00 per year. Permanent connection with company possible.

Apply by Writing to:

C-3, P.O. Box 3552
Philadelphia 22, Pa.

Men qualified in RADAR, COMMUNICATIONS or SONAR give complete history. Interview will be arranged for successful applicants.

U.S.N.R.

(Continued from page 44)

NDW	San Francisco, Calif.	15	5340, 8150 w.p.m.	2000-2200 PST, Tues. and Thurs.
NPD	Seattle, Wash.	10	5295, 434 w.p.m.	2000-2100 PST, Mon. thru Thurs.
		14	5295, 434 w.p.m.	2100-2200 PST, Mon. thru Thurs.
		15	2792 w.p.m.	2000 PST, Mon. thru Thurs.
NQG	Imperial Beach, Calif.	15	2792 w.p.m.	2000 PST, Mon. thru Thurs.

Organized Electronics Companies

October QST listed the first group of Naval Reserve Electronics Companies to be placed in organized status. Units in the following cities have been designated Organized Electronics Companies since publication of the initial list:

Astoria, Ore. (K7NRV)	Medford, Ore.
Chillicothe, Ohio	North Bend, Ore. (K7NAP)
Helena, Mont.	Ramsey, New Jersey (K2NRW)

Here and There: Radioteletype installations are in operation in Naval Reserve training centers at Duluth, Minn. (K0NRN), Minneapolis (K0USN), Oshkosh, Wis. (K9-NRO), Dubuque, Iowa (K0NR), Milwaukee (K9NRR), St. Louis (K0NRH), Indianapolis (K9NR), Chicago (K9USN), Omaha (K0NRO), Denver (K0NRC), and Pueblo, Colo. (K0NAE). Upon completion of eight additional installations, nineteen Ninth Naval District training centers will be equipped for radioteletype (RATT). Selected training centers in other Naval districts also have RATT installations. . . . Six officers and twenty enlisted men of Volunteer Electronics Company 8-9, Frederick, Okla., displayed and operated K5NBS at the County Fair in mid-September.

S.S.B.

(Continued from page 46)

W2ALJ had his first s.s.b. contact with Europe when he worked CT1CL on 20. Other DX was ZLHJA with a 5-9+ report from the ZL. Although Mark hasn't room for an antenna on the band, he wonders why there isn't any s.s.b. activity on 160, since it is a logical band for the stuff from a stability standpoint. Perhaps some brave souls, with room for antennas, will try it in the near future.

PK4DA should be on 20 with his s.s.b. rig some time in December. He already has a phase-shift receiving adapter going.

— B. G.

Field Day

(Continued from page 56)

W9IUM/9	Door County Amateur Radio Club	248-	AB- 8-	2166
W1ICO/1	Framingham Radio Club	215-	A- 8-	2160
W0RUJ/0	South East Nebraska Radio Club	272-	B- 6-	2142
W8DDY/8	Tiffin Amateur Radio Club	233-	AB- 8-	2130
W8ZHO/8	Muskegon Area Amateur Radio Council	289-	AB-14-	2109
VE3DLJ/3	Queen City Amateur Radio Club	207-	A-26-	2088
W0BGG/0	Pioneer Radio Club	146-	A- 8-	2013
W2UTH/2	Rochester Amateur Radio Assn.	300-	AB-19-	2016
K5NRS/5	U. S. Naval Reserve Training Center	285-	ABC- 8-	2010
W0VVT/0	New Castle Amateur Radio Assn.	190-	A- 7-	1935
W3NE/2	Delaware-Lehigh Amateur Radio Club	214-	A-12-	1926
VE3BAC/3	Mohawk Amateur Radio Society	183-	A- 7-	1917

(Continued on page 110)

CALL LETTER PLATES

Type A-16 -
For Your Car

W8ENH

A large, sturdy cast aluminum plate with satin-finished letters and border against a black baked enamel background. Red, green, blue and gray -- 50¢ extra. Size - 2 1/4" x 8 1/2" with 1 1/2" letters.

Type A-19 -
For Panel Mounting

\$3.20 POSTPAID

a black baked enamel background. Red, green, blue and gray -- 50¢ extra. Size - 2 1/4" x 8 1/2" with 1 1/2" letters.

LAPEL BUTTONS

An attractive metal button with highly polished raised letters against a black background. Other colors 50¢ extra.

W9HKZ

ACTUAL SIZE **\$1.10 POSTPAID**

Type A-26L With Screw Backing
Type A-26P With Pin Backing

SREPCO Inc.
STANDARD RADIO & ELECTRONIC PRODUCTS
135 E. Second St. - DAYTON 2, OHIO - Tel. FUJON 2174

CASH WITH ORDER
Allow 3 weeks for delivery

WE GUARANTEE that RIDER BOOKS will show you how to get MORE out of your investment in ham gear---

Whether you're a fully experienced radio ham, a newly licensed amateur, or a SWL... knowing the answers to what—when—where—why—and how... will make it so much easier for you to ENJOY OPERATING!

Every well-equipped ham shack should have a 'scope. Every man who builds and operates a rig should know the instrument thoroughly. This practical book tells you everything you should know about an oscilloscope! **WHAT** it is... what it can **DO**... and **HOW** to use it properly!

ENCYCLOPEDIA ON CATHODE-RAY OSCILLOSCOPES AND THEIR USES

by John F. Rider and Seymour D. Uslan

The **FIRST** and **ONLY** book that so fully and clearly describes the 'scope... its construction... its capabilities... its applications in communications, engineering, research... with thousands of time-saving and labor-saving references, charts, waveforms, etc.

All oscilloscopes produced during the past ten years, a total of more than 70 different models, are accurately described—with specifications and wiring diagrams.

Planning to buy or build a 'scope? This book will help you select the type best suited to your needs! If you already own one, the book will show you how to increase your instrument's usefulness in a thousand and one ways.

992 Pages • 500,000 Words • 3,000 Illustrations
8½ x 11" Size • 22 Chapters • Completely Indexed
Easy to Read • Cloth Bound.....And only \$9.00



Beat the Tube Shortage! Stay On The Air!

This Sensational New RIDER Book Shows You **HOW** to Do It!

RECEIVING TUBE SUBSTITUTION GUIDE BOOK

by H. A. Middleton

For AM-FM-TV Receivers and Allied Equipment!

- 2500 Radio and TV Tube Substitutions Are Listed!
- TV Receiver Filament Wiring!
- Heater Substitution Wiring Instructions!
- Tube Types Classified by Functions!
- And A Wealth of Other Priceless Data!



EXTRA! In addition to tube information... this sensational book contains material on Cathode-Ray Tube Characteristics, Complete Tube Characteristics Chart, Ballast Tube Data, Pilot Light Information, Resistors—Capacitors—Transformer Color Codes, Transformer Substitution, Fixed Condenser Substitution, etc. . . .

208 Pages in Heavy Durable Paper Cover. 8½ x 11" Only.....\$2.40

TV and OTHER RECEIVING ANTENNAS

(Theory and Practice)
by Arnold B. Boyley



Tells you... **WHAT** each type can do... **HOW** to use it... and **WHICH** is best!

This is a text book on all types of receiving antennas. If you have any questions—you'll find the answers in this book! Radio amateur, manufacturer, engineer, student, service technician—all can use this text. **WE GUARANTEE IT!** Antenna data never before published anywhere will be found in it. And it's readable—because mathematics has been translated into charts and graphs.

606 Pages . . . 310 Illustrations.....And only \$6.00

New . . . Revised . . . Enlarged RADIO OPERATOR'S LICENSE Q and A MANUAL

by Milton Kaufman



All the **QUESTIONS** and **ANSWERS** for the FCC examinations. New Elements 2, 5 and 7 have been included—and Elements 3 and 6 have been revised as of the September, 1950, FCC Supplements. However, the outstanding feature of this book is a **THOROUGH FOLLOW-THROUGH** . . . a carefully prepared discussion of the answer to the technical question, so necessary for an absolute understanding of the answer. It also lists "extras" not ordinarily found in a volume of this type . . . including Useful Appendices which take in Small Vessel Direction Finders and Automatic Alarm.

766 Pages, Hundreds of Explanatory Diagrams..\$6.60

Planning to install your own TV receiver? Order this RIDER book, the **ONLY** text that gives you complete information on all the mechanical and electrical considerations.

TV INSTALLATION TECHNIQUES

by Samuel L. Marshall



KNOW the absolute facts about such things as ice loading, wind surface, and mounting requirements—whether for short chimney-attached mast or an 80 ft. tower, including foundation.

HAVE at your fingertips, accurate data on receiver adjustments in the home . . . municipal regulations governing the installation of TV antennas and masts in all of the major television areas in the U.S.

SURE to help you wherever and whenever any part of the installation requires "doping out"! A **TIMELY** and **IMPORTANT** book!

336 Pages • 270 Illustrations • 5½ x 8½ Size
Cloth BoundAnd only \$3.60

FM TRANSMISSION AND RECEPTION

by John F. Rider and Seymour D. Uslan



The entire system of frequency modulation is explained thoroughly . . . all types employed in amateur radio, television, broadcast, railroad, aviation, marine, police, point-to-point and mobile receivers. Basic theory, transmission, reception, circuit design and servicing are covered, with mathematics kept to a minimum. Almost all of the presently used FM commercial transmitters are described in detail.

416 Pages, Profusely Illustrated.....\$3.60



WE GUARANTEE your satisfaction! Make these books **PROVE** their value to you. Take advantage of our **10-DAY MONEY BACK GUARANTEE!**

JOHN F. RIDER, W2R1D

RUSH THIS COUPON TODAY

JOHN F. RIDER PUBLISHER, INC. 14
480 Canal Street, New York 13, N. Y.

Please send me the following books on your 10-day MONEY BACK GUARANTEE. If not satisfied—I will return the books, in good condition, for refund.

- | | |
|--|---------------|
| "Encyclopedia on Cathode-Ray Oscilloscopes and Their Uses" | \$9.00 |
| "TV and Other Receiving Antennas" | 6.00 |
| "TV Installation Techniques" | 3.60 |
| "Receiving Tube Substitution Guide Book" | 2.40 |
| "Radio Operator's License Q and A Manual" | 6.60 |
| "FM Transmission and Reception" | 3.60 |

Name _____
 Address _____

City _____ Zone _____ State _____

SAVE POSTAGE. If you enclose check or money-order WITH coupon, we will prepay postage charges. Money back if you return books within 10 days.

- Check Enclosed Money-Order Enclosed C.O.D.

ELECTRONICS TECHNICIANS WANTED

The RCA Service Company, Inc., a Radio Corporation of America subsidiary, needs qualified electronics technicians for U. S. and overseas assignments. Candidates must be of good character and qualified in the installation or maintenance of RADAR or COMMUNICATIONS equipment or TELEVISION receivers. No age limits, but must have at least three years of practical experience.

RCA Service Company offers comprehensive Company-paid hospitalization, accident and life insurance programs; paid vacations and holidays; periodic review for salary increases; and opportunity to obtain permanent position in our national and international service organization, engaged in the installation and maintenance of AM, FM and TV transmitters, electronic inspection devices, electron microscopes, theatre and home television, r-f heating equipment, mobile and microwave communications systems, and similar electronic equipment.

Base pay, overseas bonus, payments for actual living and other expenses, and benefits mentioned above add up to \$7,000 per year to start for overseas assignments, with periodic review of base salary thereafter. Openings also available at proportionately higher salaries for specially qualified technicians with supervisory ability.

Qualified technicians seeking an advantageous connection with a well-established company, having a broad-based, permanent peacetime and wartime service program, write to:

Mr. G. H. Metz, Personnel Manager

RCA Service Company, Inc., Camden 2, New Jersey



Founded in 1909

RADIO TELEPHONY RADIO TELEGRAPHY RADAR & LORAN

Courses ranging in length from 7 to 12 months. Dormitory room and board on campus for \$40.00 a month. The college owns KPAC, 5 KW broadcast station with studios located on campus. New students accepted monthly. If interested in radio training necessary to pass F.C.C. examinations for first-class telephone and second-class telegraph licenses, write for details.

PORT ARTHUR COLLEGE PORT ARTHUR
TEXAS
Approved for G. I. training

W7YN/7	Nevada Amateur Radio Assn.	229-	AB-15-	1884
W2KOJ/2	Watchung Valley Radio Club	192-	A-18-	1728
W3DIS/3	Darby Creek Electronics Club	160-	A- 8-	1665
W3PGO/3	Baltimore Signal Corps Amateur Radio Club	203-	AB-10-	1593
W3PSG/3	Baltimore Amateur Radio Comm. Society	175-	A-20-	1575
W7AIA/7	Vancouver Amateur Radio Club	141-	A- 4-	1494
W5ASQ/5	Pioneer Radio Amateurs	247-	B-16-	1482
W5ICS/5	Fort Smith Amateur Radio Club	200-	AB- 9-	1383
W9WPP/9	Saugamon Valley Radio Club	146-	AB-14-	1218
W9ART/9	Mike & Key Club of Green Bay	146-	AB- 8-	1146
W1EIO/1	Great Bay Radio Assn.	125-	A-14-	1125
W2PG/2	Ocean County Amateur Radio Assn.	183-	ABC-12-	1089
W10Q/1	Lowell Radio Operators Club	107-	AB- 7-	949
W3PIQ/3	South Hills Brass Pounders & Modulators	81-	A-18-	720
W1FPS/1	Tri-County Amateur Radio Club	59-	C- 8-	177
<i>Fire Transmitters Operated Simultaneously</i>				
W3FRY/3	Frankford Radio Club	1129-	A-30-	10,386
W6MSO/6	Inglewood Amateur Radio Club	874-	A-10-	8091
W7RT/7	West Seattle Amateur Radio Club	770-	A-25-	7155
W9CWP/9	York Radio Club	703-	A-20-	6363
W9AB/9	Michiana Amateur Radio Club	687-	A-30-	6318
W0NZ/0	Ak-Sar-Ben Radio Club	566-	A-35-	5490
W9DXU/9	Polecats Emergency Corps of The Ham-festers Radio Club	567-	A-18-	5346
W9SWQ/9	Four Lakes Amateur Radio Club	564-	A-12-	5301
W6FET/6	Valley Radio Society	561-	A-21-	5274
W8CCO/8	North-East Amateur Radio Club	577-	AB-16-	4782
W6FTW/6	Hi-Frequency Amateur Mobile Society	505-	A-16-	4770
W6CTH/6	San Francisco Radio Club	504-	A-1E-	4689
W2CPN/2	Lockport Amateur Radio Assn.	589-	AC-15-	4632
VE3CY/3	Kitchener-Waterloo Radio Amateur Club	504-	A-25-	4536
W3PGA/3	MARS Amateur Radio Society	485-	AB-12-	4110
W9CNP/9	Joliet Amateur Radio Society	456-	AB-	4017
W6JN/6	Sacramento Amateur Radio Club	490-	AB-21-	3996
W2GM/2	Albany Amateur Radio Assn.	405-	A-13-	3645
W8VY/8	Kalamazoo Amateur Radio Club	416-	AB-13-	3378
W8OAJ/8	Mercer County Radio Assn.	340-	A-10-	3285
W2ZV/2	Suffolk County Radio Club	546-	B- 5-	3276
W2KTF/2	Mid-Island Radio Club	325-	A-17-	3150
W5SC/5	San Antonio Radio Club	354-	AB-14-	2988
W6GG/6	Imperial Valley Amateur Radio Assn.	307-	A-10-	2988
W6ZUB/6	Tamapais Radio Club	307-	AB-10-	2721
W5MYJ/5	Santa Fe Radio Club	322-	AB- 6-	2640
K0WAQ/0	Wichita Amateur Radio Club	307-	AB-21-	2574
W2US/2	Suffolk Amateur Radio Club	275-	A-11-	2475
W7HZ/7	Valley Amateur Radio Club	237-	A-20-	2403
W1RO/1	Worcester County Radio Assn.	260-	A-13-	2340

(Continued on page 112)

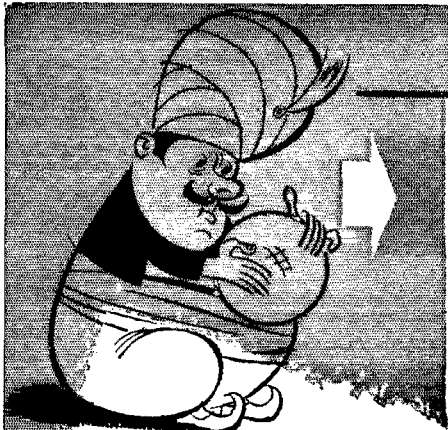

THERE'S A JK CRYSTAL IN YOUR FUTURE

It's a sure bet that once you've used a JK stabilized crystal, you'll be back for more.

Their dependability has earned them preference across the nation with electronics manufacturers everywhere.

What's more, there's a JK crystal to fit every need—available at modest cost in single units or in production quantities.

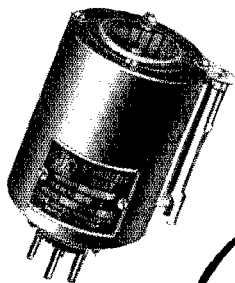

BROADCAST STABILIZED UNIT JK57MT

The new JK57MT has a frequency range from 400 kc to 1750 kc. Nominal temperature $60^{\circ} \pm 1^{\circ}$. Adjustable frequency $\pm .01\%$, so it can be put on exact frequency in your equipment. 6.3 volt 1 amp. heater. Completely insulated, will hold temperature to -20°C . Can be supplied with octal base (JK87MT) with or without thermometer, and set for various temperatures.

This new crystal features a unique and more positive method of varying the gap. Unlike conventional crystals, in which the entire electrode turns to change the frequency, the JK57MT variable electrode only moves up and down in guides like a piston. This completely eliminates any danger of damaging the crystal.

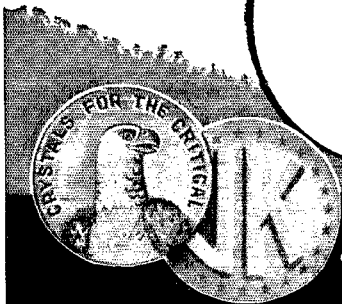

The James Knights Company
SANDWICH, ILLINOIS

**CODE SENDING
RECEIVING SPEED**

HAVE SKILL, ACCURACY

SEND and RECEIVE CODE the EASY — FASTER WAY! The CANDLER SYSTEM has developed expert Amateur and Commercial Operators, and Code Speed Champions. In a few weeks you can pass the code examination for license. You can send and receive with amazing skill and speed, without tension. Long hours of practice unnecessary to acquire proficiency. The WAY YOU LEARN is ALL IMPORTANT! By simple progressive lessons Candler teaches you at home to send and receive as easily as you talk or read — FAST, ACCURATELY. SEND Now For FREE BOOK — explains how fine amateurs and radiotelegraph experts learned code and developed skill and speed.

CANDLER SYSTEM CO.
Dept. 4-O, P. O. Box 928, Denver 1, Colo., U. S. A.
and at 121 Kingsway, London, W. C. 2, England

BROAD BAND TEN METER CONVERTERS...\$16

(postpaid)

These RF24 three tube units really perform. Peps up your set immeasurably, especially such models as the BC-348, BC-342, etc. Actually covers 20-30 Mc.—output 7.5 Mc.—measures $5 \times 7 \times 10\frac{1}{2}$. Spare tubes, coax fittings and instructions furnished. Needs no alteration to perform. Requires 200-250 V. 18 Ma + 6.3V at 2 amp. Used but guaranteed to work.

THE OVERBROOK COMPANY
OVERBROOK 81, MASS.

BUY OF A LIFETIME!

TRIED AND PROVEN THE WORLD OVER

LETTINE MODEL 240

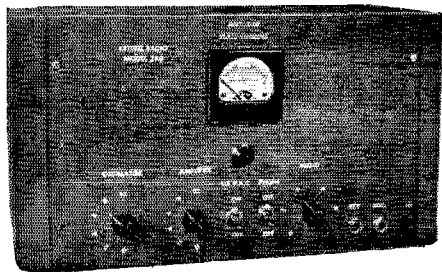

This beautiful transmitter originally sold for \$98. Buy it direct from our factory for only \$69.95, complete with instructions for TVI reduction. Even if you already have a transmitter of your own, this rig makes an excellent standby. You can't afford to miss this opportunity.

The 240 is a complete 40 watt Phone-CW rig, working all bands from 160 to 10 meters; complete with (8 x 14 x 8) cabinet, self contained power supply, meter, tubes, crystal and coils for 40 meters. Tube line-up: 6V6 osc., 807 final, 6SJ7 mike amp., 6N7 phase inverter, 2 6L6s mod., 5U4G rect. — weight 30 lbs. — 90 day guarantee. PRICE **\$69.95** \$20 deposit with order — the balance C.O.D.

Coils for 80, 20 and 10 meters \$2.42 per set. Coils for 160 meters \$3.00.

LETTINE RADIO MFG. CO.

62 Berkley St.

Valley Stream, N. Y.

HY-LITE'S NEW

SKY-LITE

ALL GROUNDED ARRAY FOR 10-11 METERS

4 ELEMENT 6 MTRS.
OR
3 ELEMENT 10-11
BOTH COMPLETE
WITH "T" MATCH

\$24⁹⁵
WRITE FOR
CATALOG
Q-12

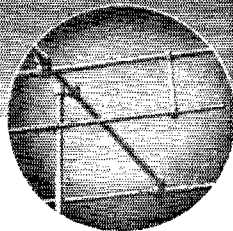

HY-LITE Antennae INC.

Makers of Fine Antennas for AMATEUR · FM · TELEVISION

242 EAST 137TH ST., NEW YORK 51, N. Y.

W3NEW/3	Capitol Suburban Radio Club	254-	A-22-	2286
W9DUK/9	Delaware Amateur Radio Assn.	233-	AB-26-	2259
VE1LC/1	Loyalist City Amateur Club	221-	A-12-	2223
W0SEE/0	Council Bluffs Radio Operators Club	275-	AB-11-	2031
W1BT/1	Manchester Radio Club	170-	A-15-	1827
W5OMC/5	Mesilla Valley Radio Club	130-	AB- 2-	1029
W5MS/5	Corpus Christi Radio Club	146-	B-15-	966
VE7GR/7	Club 13	96-	AB- 8-	819
W7PL/7	Pendleton Amateur Radio Club	109-	AB-10-	714

Six Transmitters Operated Simultaneously

W2VDJ/2	Lakeland Amateur Radio Assn.	920-	A-16-	8505
W2HXM/2	Sommerset Hills Radio Club	849-	A-22-	7641
W3GJY/3	Beaver Valley Amateur Radio Assn.	800-	A-10-	7425
W6VB/6	Mike & Key Club of Santa Monica	723-	A- -	6507
W2ZT/2	Ridgewood Radio Club	695-	A-18-	6480
W9SW/9	Chicago Suburban Radio Assn.	644-	A-18-	6030
W0HAM/0	Minneapolis Radio Club	611-	A-31-	5733
W6NWG/6	Palomar Radio Club	460-	A-20-	4335
W5KA/5	Austin Amateur Radio Club	500-	AB-45-	3732
W6YU/6	San Mateo County Amateur Radio Club	382-	A-20-	3663
W2AVZ/2	Hamilton Township Radio Assn.	347-	A-12-	3348
W7LRA/7	Utah Amateur Radio Club	457-	ABC-30-	2910
W20W/2	Binghamton Amateur Radio Assn.	353-	AB-10-	2868
W3SL/3	Delaware Amateur Radio Club	385-	AB-15-	2838
W7LT/7	Portland Amateur Radio Club	405-	B-15-	2580
W3APM/3	Chesapeake Amateur Radio Club	250-	A-22-	2475
W8DCN/8	Ann Arbor Radio Amateurs	275-	AB-20-	1986
W5PGI/5	Ardmore Amateur Radio Club	234-	B- 9-	1554

Seven Transmitters Operated Simultaneously

W20M/2	Tri-County Radio Assn.	1256-	A-30-	11,529
W6HO/6	Associated Radio Amateurs of Long Beach	928-	A-25-	9882
W9AP/9	North Suburban Radio Club	1055-	A-35-	9720
W6JM/6	Amateur Radio Club of Hollywood	1034-	AB-25-	7560
W6AEX/6	Society of Amateur Radio Operators	818-	A-30-	7362
W6CG/6	Royal Order of Sods Club	1100-	AB-15-	7260
W3KX/3	Electric City Radio Club	717-	A-20-	6696
W6UW/6	Santa Clara County Amateur Radio Assn.	582-	AB-27-	4581
W4PAY/4	Amateur Radio Club of Falls Church	391-	AB-23-	3573
VE3DJS/3	Niagara Peninsula Amateur Radio Club	448-	ABC-26-	3024
VE3BRR/3	Nortown Amateur Radio Club	221-	A-40-	1989
W9ANH/9	Wabash Valley Amateur Radio Assn.	148-	AB-11-	1326

Eight Transmitters Operated Simultaneously

W2GSA/2	Garden State Amateur Radio Assn.	1386-	AB-45-	12,507
W9IT/9	Northwest Amateur Radio Club	1299-	A-40-	11,916
W3USA/3	Potomac Valley Radio Club	981-	A-22-	9099

(Continued on page 114)

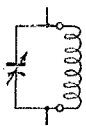

HOW MANY TURNS?

DON'T Guess and try and guess and try and guess and try and guess and try.



THE ARRL LIGHTNING CALCULATOR GIVES YOU THE ANSWER — FAST

Suppose, for example, you want to build the 80-meter plate tank for your 6V6 buffer and use a 200 $\mu\mu\text{fd}$. variable condenser you already own; you want the plate circuit to resonate at 3750 kc. with the condenser plates about three-fourths in. What about the tank coil?

Well, a 1½-inch long x 1-inch diameter coil form is easy to get, so grab your Calculator and find the largest size wire you can use on the form, and how many turns.

Here's all you have to do: Set 1¼ inches (allowing ⅛-inch at each end of the winding) on the Coil Length Scale opposite 1-inch on the Coil Diameter Scale and set the Frequency Scale so that 3750 kc. is opposite the large letter F. Without changing those settings, turn the pointer until its hair line is at 160 $\mu\mu\text{fd}$. (the condenser's probable capacitance value with plates about three fourths in) on the Capacity Scale.

And you have the answers! Simply read them under the pointer hair line. A glance at the Inductance Scale shows the coil value to be 11 micro-henrys. A look at the three Wire Scales tells you that No. 18 enameled wire can be used and that 23 turns to the inch make a close-wound coil. So, to make your tank coil, close-wind one and a quarter inches of a 1-inch diameter coil form with No. 18 enameled wire; 29 turns (1¼ x 23) will be required.

That's only one use for your Type A Calculator—the gadget that saves precious time. You'll have many others, all of them important.

There's a Type B Calculator, too. It makes Ohm's law problems easy!

ARRL LIGHTNING CALCULATOR Type A or Type B

\$1.00 postpaid anywhere



38 LA SALLE ROAD

THE AMERICAN RADIO RELAY LEAGUE, INC.

WEST HARTFORD 7, CONNECTICUT

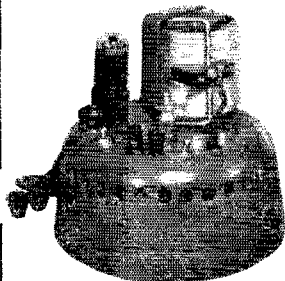

LEARN CODE

INCREASE SPEED

TELEPLEX makes it easy—fascinating. Since 1922 TELEPLEX has been leader in Teaching Code.

Compare and be convinced. You too will say: "TELEPLEX is the choice of those who know." Make your own terms.

Write today for Booklet Q 11 on how to get free trial

TELEPLEX CO.

804 East Dawn Drive

MODESTO, CALIF.

... if you are commercially or professionally interested in TV, read

TELEVISION ENGINEERING

for news of all that's NEW in the lab, plant and station involving design, manufacture, operation and maintenance of TV equipment for research, production, testing, receiving and transmitting.

Special Rate: 3 yrs. (36 issues) \$5

Bryan Davis Publishing Co., Inc.
(Publishers of SERVICE)

52 Vanderbilt Ave., New York 17, N. Y.

GOODBYE to ANTENNA MAST PROBLEMS

- ✓ Safe, easy to climb for antenna adjustments
- ✓ Easy to erect
- ✓ Weighs only 2 lbs. per foot
- ✓ Low in cost

Treat your antenna to a really modern mast! The Trylon is tops for any height of 10-20-30-40-50-60 feet. Costs no more than a pole. Easy to move to new location. Accommodates 10-meter rotary beams—doublets—rhombics and other wire antennas. Sturdy steel rod construction—hot dip galvanized, double-welded for safety.

Write for **FREE FOLDER**

WIND TURBINE COMPANY

240 E. Market Street
WEST CHESTER, PA.

TRYLON TOWERS & MASTS

DO YOU HAVE B-A's
148 PAGE 1951

FREE CATALOG?

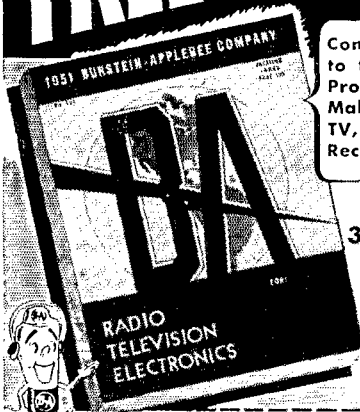

Complete Guide to the Latest Products of Top Makers in Radio, TV, Sound and Recording Fields

**INCLUDES
33 PAGES OF
DOLLAR-
SAVING
BARGAINS!**

FREE

BURSTEIN-APPLEBEE CO.
1012-14 McGee St.
Kansas City 6, Mo.

Send me your 1951 Catalog

Name.....

Address.....

City..... State.....

BURSTEIN-APPLEBEE CO.

VE3JJ/3	West Side Radio Club	798-	A-25-	7587
W6GER/6	Soledad Amateur Radio Club	770-	A-20-	7164
VE3BER/3	Clinton Amateur Radio Club	672-	A-21-	6048
W1OMI/1	El-Ray Amateur Radio Club	704-	AB-22-	5130
W1NEM/1	Hartford County Amateur Radio Assn.	460-	A-42-	4383

Nine Transmitters Operated Simultaneously

W1OC/1	Concord Brasspounders	1201-	A-24-	12,438
W6OT/6	Oakland Radio Club	1130-	AB-26-	9630
W6MGJ/6	Helix Amateur Radio Club	795-	A-18-	7155

Ten Transmitters Operated Simultaneously

VE3BNG/3	Hamilton Amateur Radio Club	797-	A-41-	7452
W6QOE/6	Southeast Radio Club	790-	ABC-27-	5809

Twelve Transmitters Operated Simultaneously

W6GAL/6	Mid-Cities Amateur Radio Club	1554-	A-35-	19,548
---------	-------------------------------	-------	-------	--------

CLASS B

Grouped in this special listing are the scores of single-transmitter Field Day stations manned by one or two operators. Where two persons participated, the call of the assisting operator is given following that of the amateur whose call was used. Figures following the call listings indicate number of contacts, power, and final score.

W1ORP/1 } 297-	A-4347	W5IER/5 } 210-	AB-1275
W1HFO } 284-	A-4171	W5REV } 67-	A-1242
W2JBQ/2 } 195-	A-2997	VE2JN/2 } 86-	A-1161
W2FBA } 163-	A-2565	W2LDS/2 } 127-	B-1143
W6GTM/6 } 254-	A-2511	W2HES } 141-	B-1014
W6HQM } 177-	A-2505	K5NBL/5 4 } 209-	A-1110
W9FAU } 212-	A-2133	W2RHQ/2 } 55-	A-1093
W8GW/8 1 } 216-	A-2169	W2EMW } 77-	A-918
W9QFH/9 } 133-	A-2133	KL7FA/KL7 } 64-	A-864
W9ZWN } 133-	A-2133	W9LNQ/9 } 65-	A-819
W3MCC/3 } 121-	A-1984	K9NRS/9 } 36-	AB-771
W3MFJ } 181-	A-1881	W9UXT } 57-	A-769
W5CA/5 } 136-	A-1836	W9PNE/9 } 40-	A-742
W5FYO } 108-	A-1795	W9TBU } 242-	C-726
W1ROM/1 2 } 162-	A-1683	W8IVC/8 } 49-	A-661
W9UKT/9 } 94-	A-1607	W3LSC/3 } 108-	B-648
W9IU } 176-	A-1584	W3HAC } 47-	AB-607
W6PJF/6 } 114-	A-1539	W6CXO/6 6 } 44-	A-594
W6INP } 143-	A-1512	W3PES } 35-	A-576
W6BAM/6 } 163-	A-1467	W3OOL/3 } 55-	AB-561
W6BFE } 136-	A-1467	W5HXX/5 } 55-	AB-561
W8SLF/8 } 108-	A-1795	W5RPP } 55-	AB-561
W8SJC } 162-	A-1683		
W8ZHP/8 } 94-	A-1607		
W10GU/1 } 176-	A-1584		
W1AMQ } 114-	A-1539		
W2CJZ/2 } 143-	A-1512		
W2LWE } 163-	A-1467		
W6WIR/6 } 136-	A-1836		
W6VIC } 108-	A-1795		
W6PWE/6 2 } 162-	A-1683		
W5FQ/5 2 } 94-	A-1607		
W1DJC/1 } 176-	A-1584		
W1NI } 114-	A-1539		

(Continued on page 116)

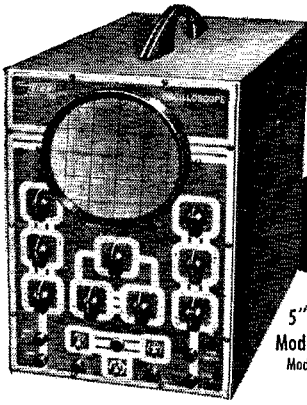

5" Push-Pull Oscilloscope
Model 425-K, Kit, \$39.95
Model 425, factory wired, \$69.95

Thousands of America's Hams
MUST BE ON THE BEAM!

NEW EICO instruments and **KITS**
give you **Laboratory Precision AT LOWEST COST!**

Vacuum Tube Voltmeter
Model 221-K, Kit, \$23.95
Model 221, factory wired, \$49.95

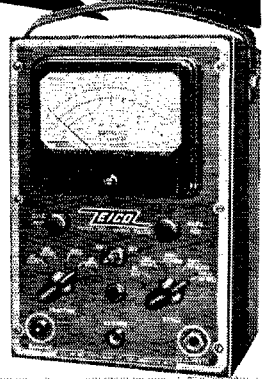

It's smart ham sense to cut your test equipment costs—without sacrificing quality. That's why more hams than ever before are building their own precision instruments with EICO KITS.

For top-notch laboratory-precision equipment, EICO gives you the newest efficient designs and circuitry and the finest quality brand-name electronic and mechanical components. Each EICO Kit is complete with pre-punched chassis, cabinet and etched panel. For rock-bottom cost, you do the simple assembly in one easy evening with the EICO simplified instructions.

EICO Kits and Instruments are acclaimed and used by the top-flight universities, schools and original equipment manufacturers from coast to coast. See the complete EICO line of superlatively engineered, handsome VTVM's, scopes, tube testers, signal and sweep generators, etc.—at your favorite jobber TODAY. Ask him about the EICO Make-Good Guarantee—the strongest guarantee in the industry! Write NOW for your free latest Catalog Q. Prices 5% higher on West Coast. Due to unsettled conditions, prices are subject to change without notice.

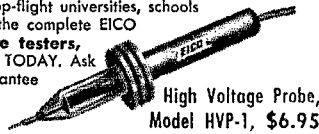

High Voltage Probe,
Model HVP-1, \$6.95

EICO ELECTRONIC INSTRUMENT CO., Inc.
276 NEWPORT STREET, BROOKLYN 12, N.Y.
© 1950, Electronic Instrument Co., Inc., Brooklyn, N.Y.

RADIO and TELEVISION

Over 30 years N.E. Radio Training Center. Train for all types FCC operators' licenses. Also Radio and Television servicing. FM-AM broadcasting transmitters at school. Send for Catalog Q.

MASS. RADIO SCHOOL

271 Huntington Avenue Boston 15, Massachusetts
Lic. by Comm. Mass. Dept. Educ.

SALESMEN WANTED

Radio and TV Parts and Equipment
INDUSTRIAL SALESMEN - COUNTER SALESMEN

A large New York Parts Distributor and Jobber offers an excellent opportunity for several EXPERIENCED salesmen to sell to Industrial Accounts by phone and in person, in the New York Metropolitan Area. We also need several over-the-counter salesmen who are used to large volume. Applicants must be thoroughly experienced in selling, and completely familiar with radio equipment. Our firm has an excellent reputation and is well known in the field. Please give FULL DETAILS in your letter. Replies will be held in strictest confidence. Our employees know of this ad.

Write to QST Box No. 170
38 LaSalle Road West Hartford 7, Conn.



RADIO and TELEVISION

Thorough Training in All
Technical Phases

APPROVED FOR VETERANS

WEEKLY RATES DAYS—EVENINGS
FREE PLACEMENT SERVICE FOR GRADUATES

For Free Catalog write Dept. ST-59

RCA INSTITUTES, INC.

A Service of Radio Corporation of America
350 WEST 4th ST., NEW YORK 14, N. Y.

SHOOTS TROUBLE FASTER! MAKES MORE MONEY FOR YOU ON JOB OR AT SERVICE BENCH!

In radio service work, time means money. Locate trouble faster, handle a much greater volume of work with the SIGNALLETTE. As a trouble shooting tool, the SIGNALLETTE has no equal. Merely plug in any 110V. AC-DC line, start at speaker end of circuit and trace back, stage by stage, listening in set's speaker. Generates RF, IF and AUDIO Frequencies 2500 cycles to 20 Megacycles. Also used for checks on Sensitivity, Gain, Peaking, Shielding, Tube testing. Wt. 13 oz. Fits pocket or tool kit. Satisfaction, or money back! See at your distributor or order direct.

Signalette

MULTI-FREQUENCY GENERATOR

\$995

at distributor or post-paid, direct. No C.O.D.'s, please. Ohioan's add 3% State Sales Tax.

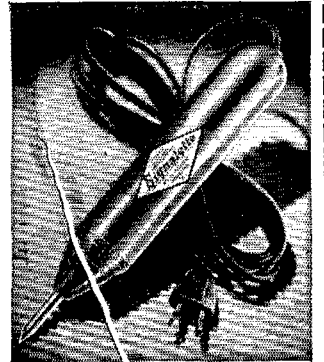

CLIPPARD INSTRUMENT LABORATORY, INC.

Dept. E, 1125 Bank Street, Cincinnati 14, Ohio
Qualified Jobbers write, wire for details

ATTENTION MOBILE HAMS

Complete mobile package — nothing else to buy. Outstanding mobile signals use motorola equipment — backed by years of communication equipment experience — World's largest producer of 2-way mobile equipment.

A mobile transmitter — P-7253 spring base rear with a double feature FM or AM at flip of the switch, the MOTOROLA FMT-30-DMS (27-30 MC.). **\$130.00**

P-7253 spring base rear — mount antenna **\$22.50**
New Gon-set Tri-Band Spread Converter... **\$47.60**

MOTOROLA P-69-13 or 18-ARS receiver with special noise limiter for use with any converter having 1440-3000 KC. **\$60.00**

3-30 famous Gon-set converter complete to connect to the P-69-13 or 18-ARS receiver. **\$39.95**
P-327-E Fire wall loud speaker.... **\$5.00**

The above comes complete with all necessary accessories and mounting hardware. Order direct or through the Motorola National Service Organization member in your area.

NOTE: This Receiver and Transmitter is equipment which has been returned from the field, modified and rebuilt for Amateur Service.

For further information write to:

MOTOROLA INC.

Amateur Sales Dept. QST—November

1327 W. Washington Blvd. Chicago 7, Illinois
Attention: Harry Harrison, W9LXL, Tel. Taylor 9-2200 Ext. 161

COMMERCIAL RADIO INSTITUTE

A RADIO TRAINING CENTER FOR 30 YEARS
Resident Courses Only • Broadcast, Service, Aeronautical, Television, Radar, Preparatory Mathematics, Frequency Modulation and Marine Telephony. Classes now forming for mid-year term Feb. 1st. Entrance examination Jan. 15th.

Literature upon request. Veteran training

Dept. B, 38 West Biddle Street, Baltimore 7, Maryland

HOW ABOUT YOUR SENDING ?

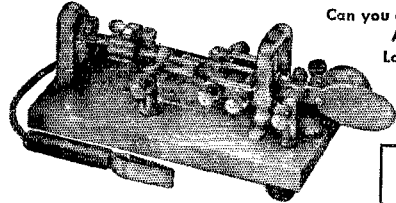

Can you do 40 W. P. M.?
Arm tire easily?
Lack confidence?

24-K
Gold-Plated
Base Top
\$29.95

PRESENTATION MODEL

**Get a Super Deluxe Vibroplex and
Be Sure of a Good Fit!**

Don't waste another day! Do as others are doing — get a Super Deluxe Vibroplex key NOW, the finest semi-automatic key made and the easiest to use! Even a beginner can operate it in a matter of minutes. Helps to develop a good flat... saves the arm... ends sending fatigue. Precision machined, with Patented Jewel movement for smoother, easier operation; Super-Speed Control Main Spring lets you send slower or faster than has ever before been possible; Touch Control permits instant adjustment of key to individual preference. So act now — being a good sender will guarantee you the best in sending enjoyment. Other models \$12.95 up. Left hand models, \$1.00 more. FREE catalog. At dealers, or DIRECT.



Headquarters for new portables — all models and styles of type. Also, rebuilt Standard and portable typewriters with ALL CAPITAL letters and other styles of type. QUICK service. ORDER NOW!

THE VIBROPLEX CO., INC.

833 Broadway New York 3, N. Y.

W6FCS/6	126- BC- 540	W7IWU/7	17- A- 229
W4GTS/4	39- A- 526	W7KHE/7	19- A- 171
W1NH/1 } W1MEP }	56- A- 504	W7GYH/7	17- A- 153
VE2SY/2 } VE2AFA }	7- A- 432	W0FDP/0	11- A- 148
VE6MJ/6	11- A- 351	W3KWF/8	15- A- 135
K2NRW/2 *	13- A- 342	VE2OE/2	10- A- 135
W7NWP/7 } W7LVB }	25- A- 337	W7OAW/7	22- B- 132
W1RNA/1 } W1CUN }	10- A- 324	W4JVV/4 } W4MQB }	60- B- 120
W2ESM/2	69- BC- 294	VE6QA/6 *	39- C- 117
W6JCC/5 *	48- B- 288	W1BDV/1	13- A- 114
KL7NK/KL7	32- B- 282	W3LSS/3	7- A- 94
W8USN/8 *	60- C- 255	W6PFE/6	7- A- 94
W7LNG/7	41- B- 246	W0RRN/0 *	9- A- 91
W2CUD/2	17- A- 243	W6GSR/0	10- A- 90
W2SXY/2	39- B- 234	W0FFN/0 } W0ESX }	6- A- 81
		W3AHQ/4	7- C- 21

* Cuyahoga Radio Assn. Operators W8QV, W8EBJ.

* Second operator's call not given.

* Meridian Amateur Radio Club. Operators W5DEJ, W5DNS.

* U. S. Naval Reserve. Operators W5PYU, W5PZC.

* San Francisco Naval Shipyard Amateur Radio Club. Operators W6DYV, W6JWF.

* Bellarmine College Prep Radio Club. Operators W6-GTF, W6GZV.

* El Toro Amateur Radio Club. Two operators.

* U. S. Naval Reserve. Operator W2YCM.

* Operators W8WHO, W8BPU.

* Eight operators: W9s EVJ, BUK, TEL, SYZ, IAY, RU, HAA, FFR.

* Two operators: W6IAM, W6FNJ.

CLASS C

Grouped in this tabulation are the scores of entrants in the mobile class. Figures following the call listings indicate number of contacts, power, number of participants at each mobile station and final score.

W6MBA/6	277- A-2-4077	W4HWA/4	17- A-2- 567
W6KNH/6	132- A-2-2119	W6ALD/6	26- A-1- 567
W6GJC/6	105- A-1-1417	W6RUC/6	17- A-1- 567
W2GFG/2	100- A-1-1350	W1SGA/1	24- A-2- 526
W6SCX/6	81- A-1-1309	W3BII/3	38- A-1- 513
W2BRJ/2	137- A-1-1293	W6HOA/6	35- A-1- 486
W6EPX/6	70- A-1-1201	W3NNX/3	35- A-1- 472
W2VBH/2	85- A-3-1147	VE1VJ/1	9- A-1- 459
W5DAH/5	60- A-2-1147	VE4NN/4	15- A-1- 459
W6UG/6	65- A-1-1134	W6CXZ/6	16- A-1- 432
W6EXB/6	55- A-2-1093	W8YK/6	32- A-1- 432
W6FEL/6	62- A-1-1053	W9FMH/9	48- B-2- 432
W2HF/2	51- A-1-1012	W6RCA/6	14- A-1- 405
W2VTP/2	67- A-1- 904	W6CK/6	13- A-1- 391
W2WUD/2	67- A-1- 904	VE4BJ/4	4- A-1- 391
W6ZVD/6	52- A-1- 904	W1BDI/1	17- B-1- 387
W6LSN/6	49- A-1- 877	VE2OF/2	13- A-2- 378
W2KLA/2	63- A-1- 850	W3QAL/3	26- A-1- 351
W4ROM/4	62- A-1- 837	VE1RF/1	1- A-1- 351
W2BYH/2	61- A-1- 823	W3OBY/3	24- A-1- 324
W1BB/1	32- A-1- 789	W6ZBB/6	8- A-1- 310
W5OVX/5	31- A-1- 756	W1MRQ/1	7- A-1- 297
W6ITC/6	41- A-1- 756	W5IJK/5	22- A-1- 297
W4LXY/4	30- A-2- 742	W4CPE/4	31- B-1- 279
W6INX/6	40- A-1- 742	W4AEP/4	5- A-1- 270
W6GZR/6	36- A-1- 715	W6NRM/6	19- A-1- 256
W6NSX/6	33- A-1- 648	W1MRQ/1	19- A-1- 256
W6PLX/6	33- A-1- 648	W3JE/3	18- A-1- 243
W1QLD/1	22- A-2- 634	W2CDQ/2	17- A-1- 229
W6LSO/6	20- A-1- 634	W4PLE/4	17- A-1- 229
W4MVJ/4	14- A-2- 607	W6HGU/6	2- A-1- 229
W4OBW/4	20- A-1- 607	W2OYD/2	16- A-1- 216
W2UJS/2	17- A-1- 580	W0IVK/9	13- A-1- 175
W6FE/6	27- A-1- 580	W3II/3	12- A-1- 162

(Continued on page 118)

NEW TURNER *Aristocrat*

MODEL 50D DYNAMIC

THE FINEST OF THE FINE

Designed and engineered for television, broadcast, and highest quality recording and public address work. Use the *Aristocrat* indoors or out—on stand, in hand, suspended, or concealed in stage settings. Flat response guaranteed within 2½ db from 50–15,000 c.p.s. Level: 56 db below 1 volt/dyne/sq. cm. Each unit is individually laboratory calibrated to insure specification standards. List \$150.00.

Write for Literature

In Canada: Canadian Marconi Company, Toronto, Ont. and branches.
Export: Ad. Auritema, Inc., 89 Broad Street, New York 4, New York

THE TURNER COMPANY

917 17th Street, N. E.

Cedar Rapids, Iowa

Microphones by **TURNER**



Crystals licensed under patents of Brush Development Co.

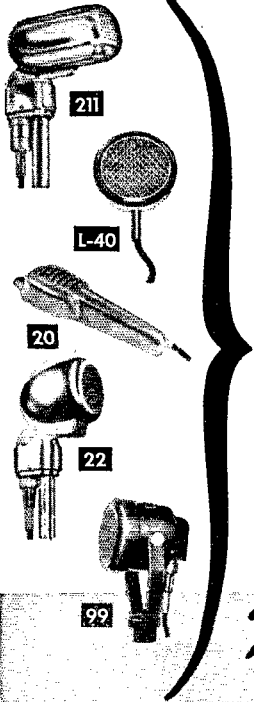

insuline *Metal Goods for every use!*

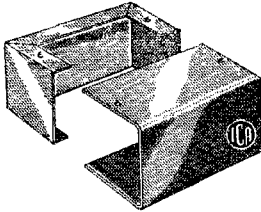

"FLEXI-MOUNT"
ALUMINUM CASES

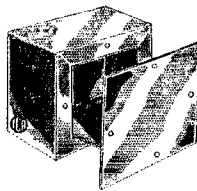

UTILITY CABINETS
with built-in chassis

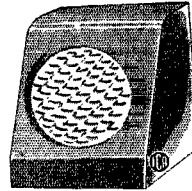

MIDGET
SPEAKER CASES

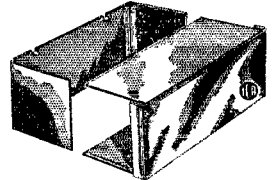

CHANNEL-LOCK
ALUMINUM BOXES



SLIP COVER
ALUMINUM BOXES

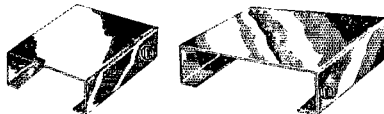

MINIATURE OPEN END ALUMINUM CHASSIS



ALUMINUM
UTILITY CABINETS

Just a few of the hundreds of different styles, sizes and types available. Write Dept. Q for complete catalog



insuline CORPORATION OF AMERICA

INSULINE BUILDING • 36-02 35th AVENUE • LONG ISLAND CITY, N. Y.
West Coast Branch and Warehouse: 1335 South Flower Street, Los Angeles, Calif.
Exclusive Canadian Sales Agents: CANADIAN MARCONI COMPANY, Montreal



NATIONAL

- **P**roven
- **D**eependable
- **Q**uality

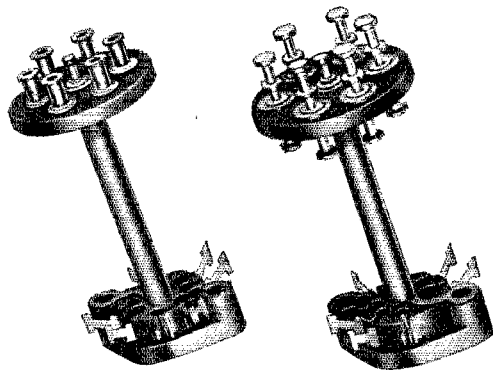

NEW TURRET SOCKET ASSEMBLIES

Designed for our 7-pin and 9-pin miniature tube sockets. Permit compact sub-assembly wiring at base of socket. Cadmium-plated brass center support has a standard length of two inches. Silver-plated brass terminal studs. Available either with holes through which leads can be drawn, or with solid studs. Center supports of varying lengths and other types of terminals can be supplied to manufacturers in quantity. Write for drawings.

National



NATIONAL COMPANY, Inc.
MALDEN, MASSACHUSETTS

W4BHJ/4	12- A-2- 162	W7KTL/7	7- A-1- 94
W6KEB/6	12- A-1- 162	W6SMW/9	6- A-1- 81
W5JMA/5	11- A-1- 148	W9YME/9	6- A-1- 81
W8OAF/8	11- A-1- 148	W4IUJ/4	1- A-1- 54
W9MYI/9	11- A-1- 148	W7NDB/7	4- A-1- 54
W5GPQ/5	9- A-1- 121	W9HDO/8	4- A-1- 54
W5PRO/5	9- A-1- 121	VE3BCH/3	4- A-1- 54
W9LVS/9	9- A-1- 121	W6JM/9	3- A-1- 40
W2PEY/2	8- A-1- 108	W8RER/5	3- A-1- 30
W3FDJ/3	7- A-1- 94	W1MGP/1	3- A-1- 27
W3NAP/3	7- A-1- 94	W4TH/4	2- A-1- 27
W4RMO/4	7- A-1- 94	K5NRN/5	2- A-1- 27
W5OMP/5	7- A-1- 94	W9ZLB/9	2- A-1- 27

HOME-STATION SCORES

W9DUA ¹⁰327	W7LOM.....44	W2VMX.....14
W4NRO.....230	W3JO.....43	W7AIG.....13
W8TZO.....163	W2WC.....42	W2NHH.....11
W2EWZ.....138	W9EBX.....40	VE2XR.....8
K2CC.....111	W2TYC.....39	W8WVL.....7
W2HY.....104	W3AER.....38	VE3CCG.....7
W5LAN.....97	W9CQM.....38	W8FRD.....6
W4RBG.....96	W9IQM.....38	W9ILR.....6
W2CGG.....93	W6LZY.....35	W3QNV.....4
W3CVE.....77	W6GTC.....32	W1NKK.....3
W6ROI.....64	W1LYL.....30	W4PSE.....3
W8YGR.....62	W2NIY.....27	W6SYW.....3
W8URM.....61	W7GVC.....27	W7HOM.....3
W2KEL.....50	W7DGN.....22	W1MGP.....2
VE3APF.....49	W1MRQ.....19	W3IHF.....2
W1AW.....48	W2SJB.....19	W3MAG.....2
W6IAM ¹¹44	W8TKW.....18	VE1VJ.....2
	W2KU.....14	

How's DX?

(Continued from page 59)

Andorra is impassable after September so Mick regrets that his safari must wait until 1951," reads a line from W1ZL. This would pertain to ON4QF's projected debut as PX1QF. . . . IS1AHK figures there's a mail bottleneck somewhere along the route to TA3FAS. He reads that TA3FAS has a 252-back-for-2000-sent percentage but Aldo has no Turkish confirmation to show for over a dozen cards sent TA3FAS. IS1AHK's statistics, furthermore, show only a return of 1200 for over 3500 QSLs shipped to Ws. This begins to look like a job for Scotland Yard. . . . Upon returning from a month's leave in England, ZC4XP takes up pen to bring us up to date on situation Cyprus. Currently active are ZC4s DC, HV, DJ, PE and, of course, XP. ZC4s JW and WE have QRTd for duty elsewhere. Sid records that the bulk of his vacation was spent in radio stores and ham shacks! . . . W6CAE and associates have called off their proposed Clipperton excursion for the time being. Larry meanwhile has collected his DXCC certificate. . . . AP2N tells W9FKC that AP2G expects to be signing MP4 ere very long. Mike still handles cards for AP2N and reports that the latter is constructing a new 20-meter beam. . . . "DX is fair here on the Bering Sea. The city mains run low (87 to 93 volts) and the gold dredges seem to throw 7Ss of line interference but any DX louder than S7 can be worked." So writes KL7SF, who finds South America tough to work up there. Friend KL7PL was formerly HZ2TG and W9MRS. These igloo boys have just about given up on rotaries; the climate plays havoc with such gear. . . . Italian Somaliland entries are getting as scarce as Jeeves' head-whiskers — ex-MS4FM pens word that MD4s GC and TH are also no more. Monty heard MS4CIB and ISZC working IIs but their operating procedure indicates they are primarily service stations. MS4A should again be active from Alula after a holiday in Italy.

We'll put up with Jeeves' relegating our illusions of skirt-sensitivities, ionospheric absorptions and pseudo-Brewster angles to the ash can, but we refuse to swallow assertions that the tough ones aren't more easily raised left-handed.

SWITCH TO SAFETY!



Do You Know This About Astatic Microphones?

THE CRYSTAL ELEMENTS of Astatic's famous D-104 and the long popular T-3 Microphones now have special METALSEAL protection against moisture and dryness.

THE NEWEST MODEL in the Astatic Microphone line is the Synabar, Model DR-10, a unidirectional cardioid crystal microphone of highest performance quality. An outstanding feature is the use of a special sintered metal to cancel out 15 db front to back, making the Synabar, for practical purposes, dead to sound from rear. Output level —54 db, frequency response 50 to 10,000 c.p.s. Has response selector switch, METALSEAL protection of crystal element.



Astatic Crystal Devices manufactured under Brush Development Co. patents



WRITE FOR COMPLETE DETAILS

Model DR-10-S

Electronics Training for Profitable Careers!

Civilian demands growing! CREI Home Study qualifies you for better paying jobs in essential industry or the Armed Forces

"Technicians may soon be as scarce as certain tubes," says an informed industry spokesman as growing military demands cut sharply into available skilled personnel. *Now is certainly the time to get into electronics!* In this essential industry you're assured—if qualified—of a lifetime career. And if you're headed for the Armed Services, your technical electronics ability will set you apart from the crowd—put you in line for supervisory work at extra pay in vital radar, navigation, or communications units.

CREI's practical home study training is recognized by industry and the military as outstanding. It starts with basic principles and goes step-by-step through advanced TV, communications, and industrial techniques. For detailed proof, send for booklet. It can lead to promotion, more money, and a lifetime career. Act now!

MAIL COUPON FOR FREE CATALOG

CAPITOL RADIO ENGINEERING INSTITUTE

Dept. 1612B, 16th & Park Rd., N.W., Wash. 10, D. C.

Send booklet "Your Future in the New World of Electronics" and course outline.

CHECK FIELD OF GREATEST INTEREST TV, FM & Advanced AM Servicing Aeronautical Radio Engineering Practical Television Engineering Radio-Electronics in Industry Broadcast Radio Engineering (AM, FM, TV) Practical Radio Engineering

Name.....

Street.....

City..... Zone..... State.....

If residence school in Wash., D. C. preferred, check here

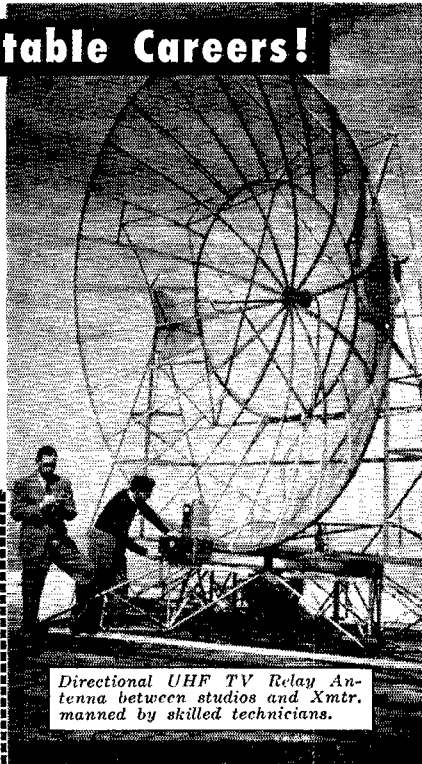

Directional UHF TV Relay Antenna between studios and Xmtr. manned by skilled technicians.

COLLINS 30FX 100-watt transmitter, modulator, and Millen Variann, \$90.00 or offer. Excellent National HFS, power supply, \$95.00. Want tuning fork audio oscillator; keying head; teletype equipment, tools; acoustics books. Longley, W2ANB, Slingerlands, N. Y.

FOR Sale: (N. Y. C. and Long Island). Moving. Name your price! Panadaptor, Telrad Frequency Standard, National 1-10 receiver, Hallicrafters S-36 (surplus), K.W. power transformer, 400-watt A.M. transmitter, Webster Wire Recorder with Hi-Fi amplifier, Triplett modulation meter, W2NLF, Worth 4-0770, Albert J. Eisenberg, 14 West 87th St., New York, N. Y.

FOR Sale: Two unconverted ART-13's, in excellent condition, \$110.00 each, F.o.b. Write or wire Elmer A. Searle W1IKV, Route 1, Helena, Mont.

BC610D, complete, perfect. Custom dual-diversity receiver, BC-342N. Make immediate offers. SX-25, SX-71, RAK6, Collins 310B1, BC221, BC453, BC454, BC459A, 7" Hallicrafters TV, Pilotuner (FM), hundreds of parts, books, magazines, etc. Write needs. No list. Baker, 4419A Olive St., St. Louis 8, Mo.

BC-221N, BC-342N, Army Manuals, like new, \$45.00 each. BC-348E, AC power schematic, excellent condition, \$40.00. Jay, 26-E Shepard, Cambridge, Mass. Call UN4-1832 evenings.

FOR Sale: Gonset 3-30, Stancor 203-A, Pa-103, Mobile Antenna, Microphone, cables. All little used. \$60.00. W9JQQ, 24 Forest, Park Forst, Chicago Heights, Ill.

WANTED: One Collins 70E8 VFO. Will pay cash for it. Also want QST for March 1948, Jonas R. Savage, RFD 2 Box 900, Vacaville, Calif.

QSL-SWL cards. Samples. Cushing, W1HJI, Box 32A, Manchester, N. H.

CF5702, Sub-miniature 6AK5, \$7.50 retail, only 98¢; circular slide rule, 2 1/4" radius, 12" equivalent, 98¢. 1N34 crystals, 75¢. 2J1G1 Selysny, you fix 'em. No returns, 2 for 49¢. Free "Tabogram", "TAB", 109 Liberty St., New York, N. Y.

I would like to contact other Citizens Radio stations (460 to 470 Mcs) 3A002 (exSWL) Joseph Zukauskas, 2227 Germantown Ave., Phila. 23, Penn.

BARGAINS: New and re-conditioned Collins, Hallicrafters, National, Hammarlund, RME, Millen, Meissner, Gonset, etc. Reconditioned S-38, \$29.00; S-40A, \$59.00; NC-57 \$59.00; NC-173, \$139.00, RME-84, \$59.00; RME-45, \$89.00; VHF-152A, \$69.00; HQ-129X, \$129.00; BC221, \$49.00; SX-42, \$199.00; SX-43, SX-25; SX-28, SX-28A, SX-62, S-39, NC-183, NC-240D, HRO7, NC-100; HF-10-20; DB22A, HF18, HT9, BC-610, 32V1, 75A, etc. Terms. Shipped on trial. List free. Henry Radio, Butler, Missouri.

FOR Sale: ART-13, unconverted, less power supplies and cables, \$85.00, W6PHL, 207, 19th St., Merced, Calif.

WANTED: 12" or larger TV receiver, cabinet optional. Have Super Pro BC-221, etc. for trade. W4PFA.

FOR Sale: New Panoramic radio adaptor, Navy Model RBV-2, \$150.00. Merlin Schumacker, Lomira, Wis.

SWAP: Argus C-3 camera and all accessories for Panadaptor. W7OMX, Rt. 3, Box 380, Bellevue, Washington.

URGENTLY needed: operating instructions and schematic for transmitter Telvar T60-2. Bob Hickman, W5PRS, 3204 Forest Park Boulevard, Ft. Worth 10, Texas.

SELL: All-band 150-watt xmitter bandswitch 6L6 and 807 stages, final 811 with B&W coils, 3 meters, complete with parts for final power supply, \$85.00 or make an offer. Old phone equipment but in working condition; modulator with 805a and VM4, speech amplifier, Thordareon, T-3 xtal mike, \$50.00. Make offer for B&W kilowatt coils, also end link 150 watt coils, 80 through 20. W. Dean, W4SJ, Box 1269, Nashville 2, Tenn.

SELL: SCR522 with RA62B (AC power supply) complete with control head and connectors. Both in excellent condition and unaltered. All for best offer over \$75.00. W4ILZ, W. M. Jackson, Box 106, Fayetteville, Tenn.

WANTED: Panadaptor. Must be in excellent condition and bargain. Send postcard with details to Tex Price, W4GXB, Drawer O, Greensboro, North Carolina.

CANADIANS: 40 designs, photos, cartoons and conventional QSL cards. Showing of type designs to aid in designing your own card. 10¢ (refunded with order) brings yours. W. John Chivers, Drawer 38, Grimsby, Ontario.

SELL: HQ-129X, matched speaker, excellent condition. Best offer from \$105.00. John Hagan, Box 353, Gambier, Ohio.

FOR Sale: Power supply built for 4D32 rig (750 volts), Stancor 30W mobile rig, Triplett 1696A broadcast type modulation monitor, 12" high fidelity speaker, speech amplifier, also tube assortment includes scarce tubes, George Kravitz, 7919, 20th Ave., Brooklyn 14, N. Y.

CRYSTALS: Precision, low drift, mounted units for all services. Breon Laboratories, 1520 Evergreen Rd., Williamsport, Penna.

FOR Sale: Mark II transmitter-receiver, 2-8 Mc, in excellent condition, with power supply for 110V AC operation, spare parts, boxes, microphone, headset, instruction manual, aerial variometer, 14 extra tubes, and inter-connecting cables. Complete and ready to go on 40 or 80 meters. What a bargain! \$78.00. Ashley, 315 McFadden Hall, Cornell University, Ithaca, N. Y.

ESTATE W3COR. Receivers HQ-120, \$60. RAK-7, \$50. Meissner EX (VFO), \$75.00. BC375 with 4 tuning units, \$25.00. Triplett 2432, \$40; 3413, \$45.00. Silver 904, C/R Bridge \$30. Cummins 1/2" drill \$13.50. Eimac VC/50, \$4.00, K&E "Minusa Special" instruments, \$7.50. Books, misc. other items. Stamp for list. Marjorie M. Geddes 4626 Western Ave., Washington 16, D. C.

PHONE patch schematics, practical discussion. \$1.00. Nichols, W1MRK.

ZIPPO lighter, ARRL insignia and call sign, inlaid enamel, \$5.00. Ideal birthday gift. McCarron, W2BNO, 384 E. 193rd St., New York, N. Y.

SELL: Complete station. Now on air. All best of equipment, PP, 4-250A. Similar to Banes CQ December 1948. Mounted in Par-Metal cabinets. Write for complete details. Will not sell piecemeal. George Bidwell, W9FIS, Abingdon, Illinois.

BC-221 Technical Manuals, for all models. New, original edition \$2.00. J. W. Craig, jr., 332 Henry Clay Blvd., Lexington 5, Ky.

WANTED: 32V 75A for cash. Box 574. White Plains, N. Y.

WILL Sell: SX-42, like new, with speaker, \$155.00. Millen #92101 pre-amplifier with coils, \$10.00. Sonar FM exciter unit complete, \$12.00. Valiant automatic key \$8.00. ART 12Vdc to 115VAC inverter \$12.00; 522 transmitter and receiver, converted \$15.00. Pro beam motor never used, \$8.00. J. R. Mowery, jr. W3BTY, P.O. Box 994, Lancaster, Penna.

PROP pitch motors are rapidly disappearing from surplus markets. Get yours now for only \$12.50 F.o.b. Roanoke, Va. Motors are brand new and unused. Complete conversion instructions included free. Aldhizer, W4JFV.

WANTED: Hammarlund
Super pro
Receivers SP-400X & SP-
400SX in good condition
BOX 175 QST

COMPLETE RADIO TRAINING!

Prepare now to accept a responsible position in Commercial Radio. New developments will demand technicians with thorough basic training, plus a knowledge of new techniques discovered during the war. Training open to high school graduates or those with high school equivalency. Courses 6 to 18 months' duration in RADIO AND ELECTRONICS. Approved Veteran training in Radio. Write for Particulars.

VALPARAISO TECHNICAL INSTITUTE
DEPT. TN Valparaiso, Ind.



He won't turn up his coat collar to hide it.

He won't have to exchange it for one with longer sleeves.

He won't read it once and shove it out of sight.

It won't shrink.

And he'll like it whether he smokes or not.

See Page 104

Designed for

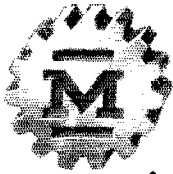

Application

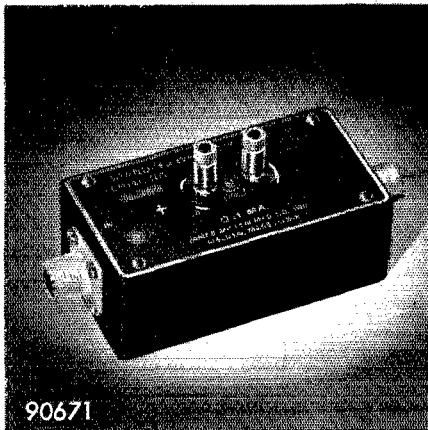

90671

**No. 90671
STANDING WAVE
RATIO BRIDGE**

The Millen S.W.R. bridge provides easy and inexpensive measurement of standing wave ratio on antennas using co-ax cable. The compact and sturdy rectangular shielding case (only 4 1/4" x 2 1/4" x 1 1/2") is fitted with co-ax terminals at both ends. Socket type binding posts provide connection to a 0-1 meter. (Use your own meter). Matching plug is furnished. As assembled the bridge is set up for 52 ohm line. A calibrated 75 ohm resistor is mounted inside the case for substitution in the circuit when 75 ohm line is used. A calibration curve showing standing wave ratio against meter reading is furnished.

**JAMES MILLEN
MFG. CO., INC.**

MAIN OFFICE AND FACTORY
**MALDEN
MASSACHUSETTS**



Index of Advertisers

Allied Radio Company.....	91
American Lava Corporation.....	81
American Radio Relay League, Inc.....	98, 104, 113, 121
Ashe Radio Co., Walter.....	103
Astatic Corp., The.....	119
Barker & Williamson, Inc.....	83
Billie Electric Company.....	84
Burstein-Applebee Company.....	114
Candler System Company.....	111
Capitol Radio Eng. Institute.....	119
Chicago Transformer Company.....	124
Cleveland Inst. of Radio Elec.....	96
Clippard Instrument Laboratories.....	115
Collins Radio Company.....	2
Commercial Radio Institute.....	116
Drake Co., The R. L.....	92
Eitel-McCullough, Inc.....	87
Eldico of New York.....	95
Electronic Instrument Co.....	115
Gardner & Company.....	106
General Electric Company.....	1
Hallicrafters Co., The.....	4, 7
Harrison Radio Corporation.....	88, 89
Harvey Radio Company.....	94
Henry Radio Stores.....	97
Hudson Radio & Television Corp.....	102
Hy-Lite Antennae, Inc.....	112
Instructograph Company.....	104
Insuline Corp. of America.....	117
Johnson Company, E. F.....	79
Knights Co., The James.....	111
Leeds Radio Company.....	105
Lettine Radio Mfg. Co.....	112
Lyseo Manufacturing Co.....	90
Mallory & Co., P. R.....	123
Mass. Radio & Teleg. School.....	115
Millen Mfg. Co., Inc., The James.....	122
Motorola, Inc.....	116
National Co., Inc.....	77, 118, Cov. III
Newark Electric Co.....	101
Ohmite Manufacturing Co.....	85
Overbrook Co., The.....	111
Palmlad, Ab Bo.....	121
Petersen Radio Company.....	5
Port Arthur College.....	110
Precision Apparatus Co.....	86
RCA Institutes, Inc.....	115
RCA Service Co., Inc.....	110
Radio Corporation of America.....	Cov. IV
Radio Shack Corporation, The.....	93
Rider Publishers, John F.....	109
Srepcu, Inc.....	108
Steinberg's, Inc.....	100
Telex Company.....	113
Television Engineering.....	113
Terminal Radio Corp.....	99
Turner Company, The.....	117
United Transformer Company.....	Cov. II
Valparaiso Technical Institute.....	121
Vesto Company, The.....	106
Vibroplex Company, The.....	116
Wind Turbine Company.....	114
World Radio Laboratories.....	107

MALLORY HAM BULLETIN

Switch Selection Doesn't Have To Be Difficult!



Modern amateur transmitters, receivers and test equipment would be something less than modern without the services of one or more rotary selector switches to make station operation more efficient and convenient.

Yet, many amateurs have hesitated to add band switching, meter switching and other desirable switching features to their rigs, simply because of the mistaken idea that such additions were expensive and difficult to make.

Actually, the design and installation of modern switching circuits into amateur equipment need not be difficult or expensive if normal care is used when selecting a switch for a particular job.

For your guidance, we have listed below a few recommendations which may prove helpful in choosing the switch most nearly filling your requirements.

TRANSMITTER BAND SWITCHING. The No. 160C series Mallory "Hamband" switches are designed especially for low power transmitter use. Styles are available for switching 1 to 5 transmitter stages to 4 predetermined bands. Low loss ceramic insulation is used throughout, and heavy duty terminal lugs to which the transmitter coils may be fastened, are featured.

TRANSMITTER METER SWITCHING. Two special meter switches are available. The No. 1400L switch for low power transmitters, enables a single meter to measure up to 12 separate circuits with complete isolation between circuits. The No. 151L is for use in transmitter service up to 1500 volts DC. A common meter may be used for measurement of 5 plate or screen circuits.

RECEIVER BAND SWITCHING. For receiver service up to 30 MC., the No. 1200 series switches are recommended. High-grade phenolic insulation is used, and various combinations up to 12 circuits, 6 bands and 6 sections are available. Above 30 MC., the ceramic insulated No. 170C and No. 180C series rotary switches are ideal. Combinations are available for switching a maximum of 6 circuits to 5 bands.

TEST EQUIPMENT SWITCHING. Almost all Mallory switches are suitable for this service; however, the No. 13124L, 24 point tap switch, and the No. 152L, 6 position, 2 circuit shorting switch are especially valuable for test equipment use. The No. 13124L is particularly satisfactory for volt-ohm-meter construction, while a swell 6 band utility test oscillator may be built around the No. 152L.

In addition, the amateur will find occasional use for lever action switches, single and multiple push-button switches, and jack switches—in all, more than 125 different types available from your Mallory Distributor.

Incidentally, your Mallory Distributor will be glad to discuss your switch problems with you, or, if we can be of help, simply send your requirements to us c/o P. R. Mallory & Co., Inc., P. O. Box 1558, Indianapolis 6, Indiana.

P. R. MALLORY & CO., Inc.
INDIANAPOLIS 6 INDIANA

P. R. MALLORY & CO., Inc.
MALLORY

CHICAGO

the transformer line
designed for Today's
Amateur Circuits . . .

FILAMENT TRANSFORMERS

Primary: 115/230 Volts, 50/60 Cycles

CHICAGO makes available a complete line of filament transformers, rated to provide voltages and currents for heating a wide range of receiving and transmitting tubes. All units are S-Type Mounting (see illustration at right); those with secondaries rated at less than 6 amps have solder-lug terminals, those over 6 amps have screw-type terminals. Units marked * are especially for high voltage rectifier supply, with secondary terminals insulated by ceramic bushings.

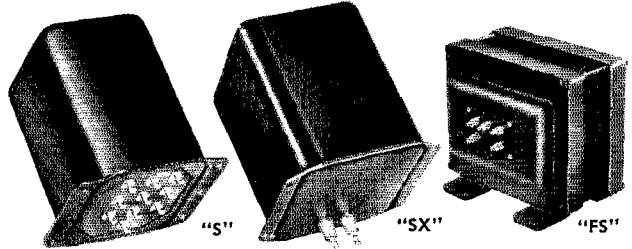

Catalog No.	Secondary Volts	Secondary Amps.	Insulation Volts RMS
F-25	2.5 CT	5.25	3500
F-210*	2.5 CT	10.	5000
F-210H*	2.5 CT	10.	9000
F-215H*	2.5 CT	15.	10000
F-54	5.0 CT	4.0	2500
F-55	5.0 CT	10.	2500
F-510H*	5.0 CT	10.	10000
F-516	5.0 CT	20.	2500
F-520HB*	5.0 CT	20.	10000
F-530	5.0 CT	30.	2500
F-65	6.3 CT	5.5	2500
F-610	6.3 CT	10.	2500
F-75	7.5 CT	5.0	2500
F-712	7.5 CT	12.	2500
F-725	7.5 CT	25.	2500
F-104	10 CT	4.0	2500
F-106	10 CT	6.5	2500
F-1010	10 CT	10.	2500
F-1110	11 CT	10.	2500

PLATE TRANSFORMERS

Primary: 115/230 Volts, 50/60 Cycles. Here they are—the top-performing plate transformers and matching filter reactors. They're conservatively designed, with ample insulation throughout. They operate with a temperature rise of 40° to 50°C at full load, 60 cycles, under CCS duty. Under ICAS conditions, the duty cycle is 15 minutes time on and 15 minutes time off, with same temperature rise applying as under CCS duty.

Catalog No.	Max. Pri. VA	Secondary A-C Load Volts	D-C Volts after filter	D-C Ma. CCS	ICAS	Mounting Type
P-45	185	675-0-675	400	250	325	S
		575-0-575	500			
P-67	250	900-0-900	750	250	325	S
		735-0-735	600			
P-107	310	1150-0-1150	1000	250	350	FS
		870-0-870	750			
P-1240	360	1425-0-1425*	1250	200	260	S
		600-0-600	400			
P-1512	550	1710-0-1710	1500	300	425	FS
		1430-0-1430	1250			
P-2520	915	2820-0-2820	2500	300	425	FS
		2260-0-2260	2000			
P-3025	1850	3450-0-3450	3000	500	700	FS
		2850-0-2850	2500			

*Both secondaries may be rectified simultaneously

SEND FOR FREE CATALOG!



You'll want the full details on CHICAGO'S New Equipment Line—the famous Sealed-in-Steel line that offers advanced engineering design to fit today's Amateur circuits. Write for your FREE catalog today—or get a copy from your parts distributor.

FILTER REACTORS

Catalog No.	Inductance in Henries	Max. D-C Ma.	D-C Resistance, Ohms	Insulation Volts RMS	Mounting Type
R-67	6	700	35	10,000	FS
R-105	10	500	40	9,000	FS
R-65	6	500	35	9,000	FS
R-103	10	300	40	7,500	SX
R-63	6	300	35	7,500	SX

CHICAGO Transformers are the Choice of Leading Amateurs

WRITE FOR
FREE
New Eqipt.
CATALOG
TODAY!

CHICAGO TRANSFORMER

DIVISION OF ESSEX WIRE CORPORATION

3501 ADDISON STREET • CHICAGO 18, ILLINOIS



Index to Volume XXXIV—1950

ANTENNAS — GENERAL

All-Band Mobile Antenna System, An (Perry)...	16, June
Antenna Feed-Through Panel (H & K).....	57, June
Antenna Polarization on 144 Mc. (Tilton)....	15, Jan.
Combined Cleat and Counterweight for Antennas (H & K).....	56, July
Compact Antenna for Low-Power Transmitters (H & K).....	104, Nov.
Preservative for Wooden Masts (H & K).....	53, Mar.
Shock Absorber for Flat-top Antennas (H & K).....	122, Oct.
Simple Nondirectional Antenna for Ten Meters, A (Becker).....	16, Feb.
Simple Vertical for Forty, A (Thornhill).....	58, May
Tunable 75-Meter Mobile Antenna, A (Buff)....	19, Aug.
Two-Band Antenna-Matching Networks (Marshall) Part III.....	36, Feb.

ANTENNAS — BEAMS

All-Driven Arrays (Andrew).....	14, July
All-Metal Construction in 2-Meter Arrays (Tilton).....	28, Oct.
Feedback.....	12, Dec.
Another Inductive Coupling System for Rotary Beams (Mumma).....	20, Sept.
Bandwidth of Two- and Three-Element Yagi Antennas (Shanklin).....	18, Oct.
Building a Rotatable End-Fire Array for 10 and 20 (Walter).....	38, Oct.
Direction-Indicator Hint (H & K).....	66, May
Driven-Element Length (Dukat).....	36, Oct.
Folded Elements in a Reversible Unidirectional Array (Kelley).....	22, Jan.
Improved Flutter Prevention for Beam Antennas (H & K).....	67, Dec.
Radiator Length and the Gamma Match.....	31, July
Simple Direction Indicator for Rotary Antennas (H & K).....	120, Oct.
Simplified Approach to Rotary-Beam Construction (Bonner).....	34, Nov.
Something New in Matching Devices (H & K)....	64, Apr.
T-Day in Sandwich (Faber).....	11, Oct.
Torque Protection for Rotary Beam Antennas (H & K).....	65, Apr.
Tower and Rotator Techniques (Hippe)	
Part I.....	34, May
Part II.....	40, June
Two Improvements in All-Metal Beam Construction (H & K).....	52, Mar.
Two Unusual 144-Mc. Antennas (Bain) (Leverkuhn).....	42, Dec.
Welding Aluminum with a Blowtorch (Washburn).....	22, Apr.

ANTENNAS — TRANSMISSION LINES

Coil Design for Link-Coupled Circuits (Pullen).....	34, July
Coupling Unbalanced to Balanced Lines (Isley).....	20, Apr.
Homebuilt Air-Dielectric Coaxial Lines (H & K).....	57, July
"Tailormade" Antenna Couplers (Grammer)....	19, May
Universal S.W.R. Measurements with a Coaxial Bridge (Grammer).....	27, Dec.

AUDIO-FREQUENCY EQUIPMENT AND DESIGN

Audio Phase-Shift Networks (Nibbe).....	42, Jan.
Cut-Off Frequencies and Audio Quality (Neil).....	25, Nov.
Design for Communication (Pichitino).....	21, Dec.
Frequency Response and Intelligibility.....	26, Nov.
More Effective Speech Amplification (Swafford).....	50, July
Premodulation Clipping and Filtering (Stuntz).....	22, Nov.
RC-Type Audio Signal Generator, An (Smith)....	32, Jan.

CIVIL DEFENSE

Amateur Radio in Civil Defense (editorial)....	9, Dec.
ARRL Comments on Disaster Service Proposals	33, Nov.

Burton New Director Civil Defense Communications.....	25, Dec.
Civil Defense Planning.....	25, Sept.
Civil Defense Planning — and the Radio Amateur.....	10, Oct.
Disaster Communications Service.....	54, Oct.
Disaster Communications Service Rules Proposals.....	10, Sept.
N.S.R.B. Plan, The (editorial).....	9, Nov.
Seattle A-Bomb Test, The (Hess).....	46, Nov.

COMMUNICATIONS DEPARTMENT

A-1 Operator Club.....	69, Mar.
ARRL-Affiliated Club Honor Roll.....	59, June
ARRL Countries List.....	40, Feb.
Countries-List Changes.....	55, Nov.
Countries List Policy.....	70, Mar.
DX Century Club.....	46, Dec.
DXCC Notes.....	58, Feb.; 71, Apr.; 63, July; 53, Aug.
FCC Suspends Operator Licenses.....	73, Dec.
Hams at Headquarters.....	78, Aug.
Meet the SCMs.....	66, Jan.; 72, Apr.; 49, Aug.; 61, Sept.; 74, Oct.; 69, Dec.
Net Directory.....	58, Nov.
Supplement.....	66, Jan.; 68, Mar.; 73, May
Seattle A-Bomb Test, The (Hess).....	46, Nov.
Simulated Emergency Test — 1949 (Hart).....	26, Mar.
SCM Elections.....	54, Feb.; 72, Apr.; 63, June; 53, Aug.; 72, Oct.; 72, Dec.
YLRL Notes.....	73, Dec.
28-Mc. Code Practice.....	57, Feb.; 71, Apr.

CONTESTS & OPERATING ACTIVITIES

Armed Forces Day Double-Header.....	31, Apr.
Results.....	29, Aug.
CD Party Results.....	64, Jan.; 67, Apr.; 67, July; 74, Oct.
Chicagoland Ham Mobilers Serve as Communications First-Liners.....	26, Jan.
Connecticut QSO Party.....	88, Oct.
DX Contest	
Announcing 16th ARRL DX Competition.....	17, Jan.; 35, Feb.
DX Contest Note.....	116, Mar.
Preview of C.W. Scores.....	60, May
Preview of 'Phone Scores.....	50, June
Final Results, C.W.....	53, Sept.
Final Results, 'Phone.....	58, Oct.
Fall VHF QSO Party.....	27, Sept.
Field Day, 1950 Rules.....	38, June
Claimed Scores.....	36, Sept.
Final Results.....	49, Dec.
First Virginia QSO Party.....	88, May
Frequency Measuring Test.....	68, Jan.; 60, Sept.
Results.....	69, May; 72, Dec.
June VHF QSO Party.....	45, June
Results — Ten-Meter WAS Contest (McCoy).....	32, Apr.
Simulated Emergency Test.....	57, Oct.
South Carolina QSO Party.....	74, Feb.
Sweepstakes	
1949 Claimed Scores.....	53, Feb.
Final Results — C.W.....	39, Apr.
Final Results — 'Phone.....	38, May
Corrections.....	67, July; 74, Oct.
1950 Announcement.....	64, Oct.; 16, Nov.
VE-W Contest.....	59, May
YL-OM Contest.....	64, Jan.
YL QSO Party.....	73, Dec.
3rd VHF Sweepstakes.....	52, Jan.; 52, Apr.
6th West Virginia QSO Party.....	88, Mar.
10-Meter WAS Contest.....	25, Jan.
1950 Announcement.....	51, Nov.; 60, Dec.
160-Meter Transatlantic Tests.....	73, Dec.

CONVENTIONS

Great Lakes Division.....	17, May
Hudson Division.....	24, Sept.

Midwest Division	49, Oct.
New Hampshire State	24, Sept.
Southwestern Division	24, Sept.
Vermont State	49, Oct.
West Gulf Division	44, Aug.

EDITORIALS

Amateur Radio in Civil Defense	9, Dec.
ARRL Comments on Amended FCC Proposals	9, Mar.
Bacon, Butter — and Books	9, Aug.
Director Elections	9, Aug.
Docket 9295	9, Feb.
DX Contest, The	9, Feb.
Getting the Most	9, June
"How to Become"	10, May
League Control	9, Apr.
Mobile on 29.6-29.7	9, July
Mobilization	9, Sept.
N.S.R.B. Plan, The	9, Nov.
Service Headquarters, The	9, Oct.
That 21-Mc. Band	9, Oct.
Thirty Six Years	9, May
Where's That 21-Mc. Band?	9, Jan.
1950-Style	9, Sept.

EMERGENCIES & EXPEDITIONS

Dakota Emergency	60, June; 65, July
Distress at Sea	56, Feb.
Fast Operating Pays Off	56, Feb.
Illinois-Missouri Ice Storm	67, Mar.
Iowa Ice Storm	65, July
Mercy Mission	67, Apr.
Mount Shasta Hamfest	57, Nov.
New Country Calls CQ, A (Reed)	25, July
Northwest Emergency	69, Apr.
Philippine Incident	71, Apr.
QRRR Winnipeg	32, Aug.
Quebec Fire	63, Sept.
Skagit Valley Emergency	54, Feb.
South Amboy "Report"	51, Aug.
SS <i>Marblehead</i> Fire	63, Sept.

FEATURES & FICTION

Amateur Television — A Progress Report (Tilton)	11, June
Answering the Beginner's Question — "C.W. or 'Phone?" (Hurd)	50, Jan.
"Calling CQ" (Hoffstetter)	28, May
Difficult Takes a Long Time, The (Williams)	48, Mar.
Future-hamie (Slobb)	46, May
"In the Spring a Young Ham's Fancy" (Nelson)	18, May
"Land of Morning Calm, The" (Maxwell)	48, Feb.
Loneliest Ham in the World, The (Goodman)	39, July
This is PJ5RP	59, Dec.
50 Years of Progress — A Report on Amateur Radio (Rapp)	48, Apr.

FOR THE BEGINNER

Answering the Beginner's Question — "C.W. or 'Phone" (Hurd)	50, Jan.
Beginner's Four-Tube Superhet Receiver, A (Mix)	11, Mar.
Feedback	39, June
Code-Practice Oscillator (H & K)	53, Mar.
Two-Stage Transmitter for the Beginner, A (Mix)	14, Apr.
2-Meter Station for the Novice, A (Tilton)	
Part I — The Receiver	27, Feb.
Correction	118, Apr.
Part II — The Transmitter R.F. Section	34, Mar.
Part III — Modulator, Power Supply	42, Apr.

HAPPENINGS OF THE MONTH

AFCAs Convention	33, May
Amended FCC Proposals	28, Jan.
Antenna Height Rules	25, Sept.
ARRL Comments on Amended Docket 9295 (Editorial)	9, Mar.
ARRL Comments on Disaster Service Proposals	33, Nov.
Board Agenda	33, May
Board Highlights	33, June
Board Meeting	32, May
Board Meeting Minutes	42, July

Board Minutes Correction	28, Jan.
"Braille Technical Press", The	38, Apr.
Burton New Director Civil Defense Communications	25, Dec.
Call New Director	41, July
Call Sign Allocations	31, Nov.
Call Sign License Plates	23, Aug.
Canal Zone Doings	26, Dec.
Civil Defense Planning	25, Sept.
Civil Defense Planning — and the Radio Amateur	10, Oct.
Director Elections	31, Nov.
Director Election Results	28, Jan.
Disaster Communications Service	54, Oct.
Disaster Communications Service Rules Proposed	10, Sept.
Docket 9295	39, Mar.; 32, May
Docket 9295 Oral Argument	10, July
EARC	25, Sept.
EARC Postponed	54, Oct.
Easy Renewals for Servicemen	26, Dec.
Election Notice	22, Aug.; 26, Sept.
Examination Schedule	30, Jan.; 42, July
Executive Committee Meetings	23, Aug.
Extraordinary Administrative Conference	38, Apr.
FCC Chief Engineer	32, May
FCC Disciplinary Actions	39, Mar.
FCC Reorganization	26, Sept.
Further Notice of Proposed Rulemaking	30, Jan.
Handy's 25th	38, Apr.
IARU Congress	33, May
National Guard Stations Ousted	26, Feb.
N.F.M. Extension	26, Sept.
Notice of Special Election (Roanoke)	29, Jan.
Notice of Special Election (West Gulf)	41, July
Notify FCC When Moving	33, May
Photocopies of Amateur Licenses	26, Dec.
Presidential Policy Board	38, Apr.
RID Association	33, May
RMA Withdraws Film	26, Feb.
Roanoke Special Election	39, Mar.; 32, May
Rules Changes	26, Feb.
Special Election Notice (Dakota Division)	23, Aug.
Staff Notes	26, Feb.
Sterling Reappointed to FCC	23, Aug.
Third Party Traffic Agreement Signed with Ecuador	23, Aug.
Unclaimed QSLs to be Destroyed	23, Aug.
Voice of America	27, Jan.
Washington Notes	31, Nov.
Watch Your Expiration	54, Oct.; 26, Dec.
Write Your Director	38, Apr.
W5NW Elected Vice-President	41, July
420-Mc. Sharing	39, Mar.

IARU NEWS

Austria	102, Sept.
Brazil's WAA Award	45, Mar.
Congress Highlights	49, Sept.
December Calendar	45, Mar.
Ethiopia	104, June
Far Eastern Operation	47, Dec.
France	49, Sept.
Indonesia	104, June
IARU Congress	45, Mar.
Japan	104, June
New Zealand DX Contest	45, Mar.
Panama	104, June
QSL Bureau Changes	45, Mar.; 102, Sept.
QSL Bureaus of the World	49, June; 48, Dec.
Roumania	104, Sept.
South America	45, Mar.
Sweden	104, Sept.
Tangier Zone	102, Sept.
VK-ZL DX Contest	49, Sept.

KEYING & CONTROL CIRCUITS

Automatic Transmitter Turner-Onner, An (Hiehle)	56, May
Break-In Amplifier Keying (Scruggs)	32, Oct.
Converting 28-Volt D.C. Relays for 6-Volt Operation (H & K)	66, Dec.
"Corkey" — A Tubeless Automatic Key (Montgomery)	44, Nov.

Debugging the Electronic Bug (Turrin).....	48, Jan.
Improved Keying for the GF-11 Transmitter (H & K).....	57, June
Key Clicks and Receiver Bandwidths (Goodman).....	34, Apr.
Master Control Box for the Ham Transmitter, A (Clemons).....	30, Oct.
Protection for Modulation Transformers (H & K)	57, June
Push-Button Power Control Circuits (Hansen).....	44, Sept.
Simple Voice-Operated Keyer for Automatic Break-In Operation, A (Flanagan).....	28, Sept.
Solution to the Keyed-VFO Problem, A (Smith)	11, Feb.

Tuning Condenser for VHF (Saveskie)	
All-Band Neutralization for Beam Tetrodes (Newkirk)	
Vibration Cure (McCasland)	
Construction Tip (Towey)	
Improved Flutter Prevention for Beam Antennas (Vandermay)	
D.C. Heater Supply (Grammer)	

MEASUREMENTS & TEST EQUIPMENT

Adapting the Coax S.W.R. Meter for Use with 300-Ohm Twin-Lead (H & K).....	45, Aug.
Calibrating a BC-221 Frequency Meter (Dudley)	40, Mar.
Feedback.....	10, May
Circuit Improvements in the Telrad 18-A (Trueblood).....	44, Oct.
Crystal Calibrator and R.F. Indicator (H & K).....	53, July
Gimmicks and Gadgets.....	31, Feb.
Ham-Shack Frequency Standard, A (McGee).....	18, Dec.
"How's My Modulation?" Indicator (H & K).....	67, Oct.
Impedance Bridge for Less than \$10, An (Dudley).....	19, June
Measuring Center Impedance of Antennas with the "Twin-Lamp" (H & K).....	67, May
Null Indicator for the BC-221 (H & K).....	66, May
RC-Type Audio Signal Generator, An (Smith).....	32, Jan.
Simplified LC Calculations (H & K).....	82, Mar.
Universal S.W.R. Measurements with a Coaxial Bridge (Grammer).....	27, Dec.
Using the BC-221 Frequency Meter at V.H.F. (H & K).....	46, Jan.
VHF Frequency Meter, A (Birnbaum).....	46, Oct.
Your BC-221 as an Audio Signal Generator (Voigt).....	18, Feb.

HINTS AND KINKS

January, page 46	
Adjustable Tuning Rate for VFOs (Fisher)	
Using the BC-221 Frequency Meter at VHF (Cross)	
February, page 33	
Combined Output Control and Screen-Protective Circuit (Roller)	
Another Neutralizing Kink for 813s (Jensen)	
Socket for Type 15E Tubes (McMullen)	
March, page 52	
Two Improvements in All-Metal Beam Construction (Tilton)	
Simplified LC Calculations (Rhodes)	
Code-Practice Oscillator (Lewis)	
Simple BCI Cure (Hall)	
Preservative for Wooden Masts (McCormick)	
Direct-Reading Dial for the HRO (Sen)	
April, page 64	
Something New in Matching Devices (Frank)	
Torque Protection for Rotary Beam Antennas (Cluett)	
"Clamper" Tube Troubles (Smith)	
May, page 66	
Null Indicator for the BC-221 (Wood)	
Improvement for Soldering Irons (Cohn)	
Direction-Indicator Unit (Orr)	
Soldering to Polystyrene Coil Forms (Dussault)	
Measuring Center Impedance of Antennas with the "Twin-Lamp" (Gross & Nofta)	
Inductive Coupling System (Horn)	
June, page 56	
Improved BFO Circuit for the SX-42 (Caron)	
A Handy Tool (Rash)	
Antenna Feed-Through Panel (Coffland)	
Protection for Modulation Transformers (Comstock)	
July, page 56	
Combined Cleat and Counterweight for Antennas (Lippincott)	
Nonskid Bug Mounting (Chambers)	
Crystal Calibrator and R.F. Indicator (Bradley)	
Bandspread for the VFX-680 (Kinsey)	
Tapping Small Coils (Chambers)	
Improved Keying for the GF-11 Transmitter (Thor-nally)	
Homebuilt Air-Dielectric Coaxial Lines (Sprowls)	
August, page 45	
Adapting the Coax SWR Meter for Use with 300-Ohm Twin-Lead (German)	
Audio-Filter Connection (Wagner)	
Homemade Insulators from Salvaged Medical Gear (Christ)	
October, page 67	
Simplified Bias Circuit for Class-C Amplifiers (Nibbe)	
"How's My Modulation?" Indicator (Hurd)	
Curing Heating-Pad QRM (Keay)	
Improved Circuit for Homemade S-meters (Grammer)	
Shielding for TVI Reduction (Chesire)	
Simple Direction Indicator for Rotary Antennas (John-son)	
Construction Tip (Baldwin)	
Shock Absorber for Flat-Top Antennas (Hunsicker)	
November, page 53	
Versatile Power Supply (Knochel)	
Broadcast Coils for the HRO-50 (Parrott)	
Compact Antenna for Low-Power Transmitters (Basal)	
Hum Reduction in the HQ-129-X (Buehrle)	
December, page 66	
Substitute Tank Condenser for W1JEQ's Bandpass Exciter (Eckman)	
Simple Experimental Shielding (Weber)	
Converting 28-Volt D.C. Relays for 6-Volt Operation (Worsnop)	

MISCELLANEOUS — GENERAL

Book Reviews	
Reference Data for Radio Engineers.....	38, Mar.
Feedback.....	10, May
Military Amateur Radio System.....	60, Jan.; 50, Feb.;
	62, Mar.; 57, May; 32, June; 24, July;
	53, Oct.; 27, Nov.; 41, Dec.
United States Naval Reserve.....	47, Jan.; 49, Feb.; 61, Mar.;
	48, May; 37, June; 27, July; 33, Sept.;
	49, Oct.; 37, Nov.; 44, Dec.
USA Calling!.....	32, Sept.; 64, Oct.
Voice of America Broadcasts.....	29, Jan.; 28, June
WIBCG Dedication.....	20, Dec.

MISCELLANEOUS — TECHNICAL

Code-Practice Oscillator (H & K).....	53, Mar.
Construction Tips (H & K).....	122, Oct.; 67, Dec.
Curing Heating Pad QRM (H & K).....	67, Oct.
Handy Tool, A (H & K).....	56, June
Homemade Insulators from Salvaged Medical Gear (H & K).....	45, Aug.
Improvement for Soldering Irons (H & K).....	66, May
It's a Pretty Pickle (Paddon).....	54, May
Nonskid Bug Mounting (H & K).....	56, July
Simple BCI Cure (H & K).....	53, Mar.
Simplified LC Calculations (H & K).....	52, Mar.
Soldering to Polystyrene Coil Forms (H & K).....	67, May
Welding Aluminum with a Blowtorch (Wash-burn).....	22, Apr.

MOBILE

All-Band Mobile Antenna System, An (Perry).....	16, June
Bandswitching Mobile Converter, A (Mix & Galin).....	18, Nov.
Compact 2-Meter Station for Mobile Use, A (Hayes).....	42, May
Four-Tube Bandswitching Circuit for Mobile Rigs (Linn).....	30, June
Mobile Converter for 144 Mc., A (Rand).....	35, Aug.
Tunable 75-Meter Mobile Antenna, A (Buff).....	19, Aug.
Vibration Cure (H & K).....	67, Dec.

MODULATION

Clamp-Tube Modulation.....	46, Mar.
"Constant Modulation" of the 813 (Lippert) ..	48, Nov.
"Constant-Modulation" Phone System, A (Lippert).....	11, Apr.
"How's My Modulation?" Indicator.....	67, Oct.

How to Visualize a 'Phone Signal.....	28, July	Two-Stage Transmitter for the Beginner, A (Mix).....	14, Apr.
Protection for Modulation Transformers (H & K).....	57, June		
"Supermodulation"—An Evaluation and Explanation (Villard).....	33, Dec.		

OPERATING PRACTICES

ARRL Operating Series	
Getting the Most (editorial).....	9, June
Basic Operating Procedure	
Part I—Radiotelegraphy (Goodman).....	20, July
Part II—Radiotelephony (Tilton).....	16, Aug.
Working DX (Goodman).....	40, Sept.
QSL Cards (Morrow).....	21, Oct.
General Operating (Huntoon).....	29, Nov.
Mobile on 29.6-29.7 (editorial).....	9, July
So Now You're Class A (Markusen).....	63, Jan.
So You Don't Get Out Very Well! (Ammerman).....	25, June

POWER SUPPLY

Incandescent Light Flicker (Shank).....	18, Mar.
Versatile Power Supply (H & K).....	53, Nov.

RADIOTELEPHONY

(See "Audio-Frequency Equipment and Design" and "Modulation")

RECEIVING

Accessory for C.W. Reception, An (Grammer).....	11, July
Audio-Filter Connection (H & K).....	45, Aug.
Broadcast Coils for the HRO-50 (H & K).....	53, Nov.
Direct-Reading Dial for the HRO (H & K).....	53, Mar.
Dual-Crystal "Q5-er", A (Titt).....	38, Sept.
Graphical Solution of Superhet Tuning Design (Prooijen).....	52, May
High-frequency Crystal Filter, A (Lange).....	58, Apr.
Hum Reduction in the HQ-129X (H & K).....	106, Nov.
Improved BFO Circuit for the SX-42 (H & K).....	56, June
Improved Circuit for Homemade 8-Meters (H & K).....	116, Oct.
Low-Cost Audio Filter, A (Montgomery).....	36, June
More Selectivity at Low Cost (Moster).....	26, Oct.
Noise Limiter for the HRO-M, A (Bloxam).....	34, June
Sharp I.F. Amplifier for 'Phone or c.w., A (Goodman).....	13, Dec.
Six-Meter Coils for the HRO (Windom).....	26, June
Two-Tube Crystal-Controlled Converter for 10 Meters, A (Paukner).....	30, Aug.
Variable-Selectivity Sharp I.F. Amplifier, A (Goodman).....	11, May

REGULATIONS

NFM Extension.....	26, Sept.
Photocopies of Amateur Licenses.....	26, Dec.
Rules changes (call signs).....	26, Feb.
Watch Your Expiration.....	54, Oct.; 26, Dec.
420-Mc. Sharing.....	39, Mar.

SINGLE SIDEBAND

Audio Phase-Shift Networks (Nibbe).....	42, Jan.
Crystal-Filter SSB Exciter, A (Edmunds).....	11, Nov.
On the Air with Single Sideband.....	38, Jan.; 44, Mar.; 60, Apr.; 40, June; 10, Aug.; 37, Sept.; 15, Nov.; 45, Dec.
Packaging the Basic 'Phone Exciter (Bradley).....	28, June
Simple Voice-Operated Keyer for Automatic Break-In Operation, A (Flanagan).....	28, Sept.
Tuning and Checking SSB Signals.....	34, Oct.

TRANSMITTERS

All-Band Crystal-Controlled Exciter, An (Langley).....	18, June
"Mountaineer"—A Hiker's Portable, The (Vreeland).....	17, Sept.
Feedback.....	10, Nov.
Shielded Construction for the Medium-Power Transmitter (Mix).....	14, Oct.
Two-Control VFO Rig with Bandpass Exciter, A (Chambers)	
Part I.....	24, Aug.
Part II.....	29, Sept.

TRANSMITTING

Adjustable Tuning Rate for VFOs (H & K).....	46, Jan.
All-Band Neutralization for Beam Tetrodes (H & K).....	67, Dec.
Another Neutralizing Kink for 813s (H & K).....	33, Feb.
Bandspread for the VFX-680 (H & K).....	57, July
"Clamper" Tube Troubles (H & K).....	65, Apr.
Coil Design for Link-Coupled Circuits (Pullen).....	34, July
Combined Output Control and Screen-Protective Circuit (H & K).....	33, Feb.
Converting 28-volt D.C. Relays for 6-volt Operation (H & K).....	66, Dec.
Crystal-Controlled Oscillators (Chambers).....	28, Mar.
Ground Wave at 1.8 Mc., The (Rockey).....	29, May
Improved Keying for the GF-11 Transmitter (H & K).....	57, July
Incandescent Light Flicker (Shank).....	18, Mar.
Inductive Coupling System (H & K).....	67, May
Key Clicks and Receiver Bandwidths (Goodman).....	34, Apr.
One-Tube VFO Amplifier, A (White & Sieck).....	20, Jan.
Plug-In Exciters from "Command" Transmitters (Wilcox & Hoffman).....	54, Jan.
Safety and Convenience in Transmitters (Bale).....	34, Sept.
Simple Experimental Shielding (H & K).....	66, Dec.
Simplified Bias Circuit for Class-C Amplifiers (H & K).....	67, Oct.
Sockets for Type 15E Tubes (H & K).....	33, Feb.
Solution to the Keyed-VFO Problem, A (Smith).....	11, Feb.
"Tailormade" Antenna Couplers (Grammer).....	19, May
Tapping Small Coils (H & K).....	57, July
Tip for Construction of W1JEQ's Bandpass Exciter (H & K).....	66, Dec.
Utilizing the 826 (Smith).....	25, May

TVI

Eliminating TVI with Low-Pass Filters (Grammer)	
Part I.....	19, Feb.
Part II.....	20, Mar.
Part III.....	23, Apr.
High-Attenuation Filter for Harmonic Suppression, A (Pichitino).....	11, Jan.
Low-Cost TVI Filter, A (Dene).....	16, May
Re: Half-Wave Filters.....	34, Feb.
Shielding for TVI Reduction (H & K).....	118, Oct.
Simple Experimental Shielding (H & K).....	66, Dec.
"Tailor Made" Antenna Couplers (Grammer).....	19, May
TVI Interference Problems (Kiser).....	44, Feb.
TVI Tips.....	54, Mar.; 46, Aug.; 30, Dec.
Feedback.....	10, Oct.
TVI-Proofing the ARC-5 VHF Transmitter (Johnson).....	50, Nov.

VHF & MICROWAVES

Adjusting Antenna Coupling in VHF Receivers (Cross).....	50, Mar.
All-Metal Construction in 2-Meter Arrays (Tilton).....	28, Oct.
Feedback.....	12, Dec.
Antenna Polarization on 144 Mc. (Tilton).....	15, Jan.
Better Results on 420 Mc. (Tilton).....	11, Aug.
Compact 2-Meter Station for Mobile Use, A (Hayes).....	42, May
Crystal-Controlled Converters for VHF Use (Tilton & Chambers).....	11, Sept.
External Noise at 28, 50 and 144 Mc.....	33, Oct.
Houston Hayrake, The—A Compact 12-Element Array (Leverkuhn).....	43, Dec.
Lightweight Flopover Array, A (Bain).....	42, Dec.
Mobile Converter for 144 Mc., A (Rand).....	35, Aug.
Six-Meter Coils for the HRO (Windom).....	26, June
Tuning Condenser for V.H.F. (H & K).....	67, Dec.
Using the BC-221 Frequency Meter at V.H.F. (H & K).....	46, Jan.
Utilizing the 826 (Smith).....	25, May
VHF Frequency Meter, A (Birnbaum).....	46, Oct.
2-Meter Station for the Novice, A (Tilton)	
Part I—The Receiver.....	27, Feb.
Correction.....	118, Apr.
Part II—The Transmitter R.F. Section.....	34, Mar.
Part III—Power Supply: Modulator.....	42, Apr.

who
but
NATIONAL
builds
like
this?

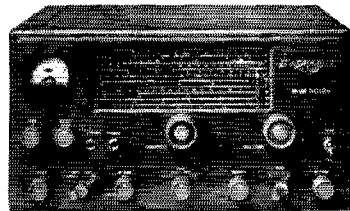
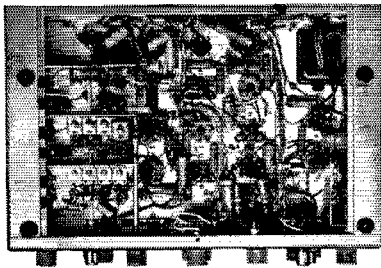
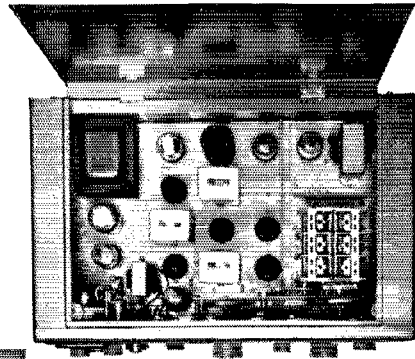

Lift the cover of the new NC-125. Look at the sturdy chassis, the quality of the National-made precision-wound coils, the solid construction of the tuning condenser, the dependability of the gear drive. Then remove the bottom plate and examine the cleanness of the cabled wiring. Especially in such a moderate-priced receiver, who but National builds like this?

Covers 550 kcs.—36 mcs. in 4 bands. Voice, CW, NFM (with adapter). Edge-lighted, direct-reading scale. Amateur, police, foreign, ship frequencies clearly marked. National Select-O-Ject built-in (rejects any selected audio frequency 45 db—boosts 38 db). Three microvolt sensitivity (for 10 db signal/noise ratio on 10-meter band). S-meter. AVC, ANL, ant. trimmer. Variable CW pitch control. Separate R.F. and audio gain controls. Volt. reg., stabilized oscillator. Jack for phono or NFM Adapter. Audio essentially flat to 10,000 c.p.s.



- NC-125 \$149.50*
- NC-125TS (matching spkr.) 11.00
- 686S vibrator supply for
6-volt operation 34.16

*Slightly higher west of the Rockies.

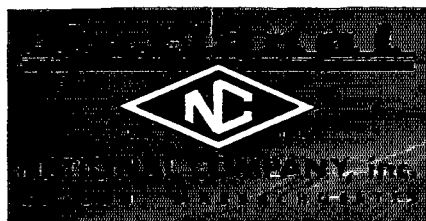
SEE INSIDE — THEN DECIDE ON

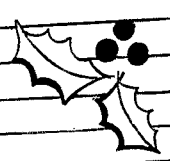

THE RCA TUBE DEPARTMENT YULE LOG

CALL	NAME	CALL	NAME	REMARKS
W10FS/9	Wally Pond	W2ZPD	Frank Neuner	
K2AH	George Rose	W2ZX1/9	George Flenner	
W2ADY	Bob Lord	W3CHV	LeRoy Wenger	
W2AAY	Horace Hanthorn	W3EJN	Charles Cramer	
W2BRP	Joe Evon	W3EOB	Fred Koeng	
W2CBL	George Jones	W3EWR	Dick Wenger	
W2CDP	Ken Bucklin	W3FEI	George Shenberger	
W2DGN	Russ Huntington	W3GJA	Art Jenkins	
W2FTW	Jim Owens	W3JRR	D. McKee	
W2FZV	Ed Smith	W3KBZ	Andy Rau	
W2GGV	Norm MacKenzie	W3KKX	Ted Schreiber	<i>Merry Christmas!</i> <i>Happy New Year!</i> <i>73 and good DX in 1951 - The gang</i>
W2GQK	John Sterner	W3KXA	A. D. Gordon	
W2HDW	E. Bartels	W3LIL	Andy Nekut	
W2HEA	A. G. Petrasek	W3MNX	Harry Pully	
W2IAR	Charles Poskonka	W3MZJ	Don Neigher	
W2IOP	Larry LeKashman	W3NFF	Hideo Takeuchi	
W2IYG	Clarence West	W3NOI	Bob Carvell	
W2JSX	Mattie Bell	W3NOK	Charles Nesslage	
W2KCN	Joe Pastor	W3OXG	Merrald Shrader	
W2LHP	Bob Cohen	W3PAX	Jim Weaver	
W2MDZ	J. P. Livingood	W3PGL	Gene Duckworth	
W2OWA	J. Row	W3PSK	Henry Kazanowski	
W2PUD	Dick Talpey	W3PTD	Dave Ballard	
W2QJV	Larry Freeman	W3QFQ	Norm Graham	
W2QLB	Syl Walczak	W3TLH	Merle Hoover	
W2RBO	Don Power	W3VAM	G. H. Urban	
W2RHB	R. L. Holtzheimer	W3VRR	Paul Klinko	
W2RVV	Tony Sariti	W3WSH	Bill Shaw	
W2RYI	Mack Seybold	KL7BV/W3	Frank Arams	
W2TQS	Herb McCord	W4AYT	Randy Frisbee	
W2UIJ	Dave Koch	W4MUR	Bill Jackson	
W2WCT	Hal Stamm	W8BPD	John Driver	
W2WDR	Jack Wasserman	W9EHF	M. Copan	
W2YM	George Hanchett	W9GZE	Steve Johnson	
W2YXL	Bob Klein	W9HYF	John Spooner	
W2ZGT	E. Coughlan	W9ZEE	Bob Stevens	
W2ZJU	P. Barna	W8PJ0	Bill Benner	



RADIO CORPORATION of AMERICA
ELECTRON TUBES **HARRISON, N. J.**