

October, 1950

40 Cents

45c in Canada

# QST



devoted entirely to

# amateur radio

# ULTRA COMPACT UNITS...OUNCER UNITS

## HIGH FIDELITY... SMALL SIZE... FROM STOCK

UTC Ultra compact audio units are small and light in weight, ideally suited to remote amplifier and similar compact equipment. High fidelity is obtainable in all individual units, the frequency response being  $\pm 2$  DB from 30 to 20,000 cycles.

True hum balancing coil structure combined with a high conductivity die cast outer case, effects good inductive shielding.

Type No.	Application	Primary Impedance	Secondary Impedance	List Price
A-10	Low impedance mike, pickup, or multiple line to grid	50, 125/150, 200/250, 333, 500/600 ohms	50 ohms	\$15.00
A-11	Low impedance mike, pickup, or line to 1 or 2 grids (multiple alloy shields for low hum pickup)	50, 200, 500	50,000 ohms	18.00
A-12	Low impedance mike, pickup, or multiple line to grids	50, 125/150, 200/250, 333, 500/600 ohms	80,000 ohms overall, in two sections	15.00
A-14	Dynamic microphone to one or two grids	30 ohms	50,000 ohms overall, in two sections	14.00
A-20	Mixing, mike, pickup, or multiple line to line	50, 125/150, 200/250, 333, 500/600 ohms	50, 125/150, 200/250, 333, 500/600 ohms	15.00
A-21	Mixing, low impedance mike, pickup, or line to line (multiple alloy shields for low hum pickup)	50, 200/250, 500/600	50, 200/250, 500/600	16.00
A-16	Single plate to single grid	15,000 ohms	60,000 ohms, 2:1 ratio	13.00
A-17	Single plate to single grid 8 MA unbalanced D.C.	As above	As above	15.00
A-18	Single plate to two grids, Split primary	15,000 ohms	80,000 ohms overall, 2.3:1 turn ratio	14.00
A-19	Single plate to two grids 8 MA unbalanced D.C.	15,000 ohms	80,000 ohms overall, 2.3:1 turn ratio	18.00
A-24	Single plate to multiple line	15,000 ohms	50, 125/150, 200/250, 333, 500/600 ohms	15.00
A-25	Single plate to multiple line 8 MA unbalanced D.C.	15,000 ohms	50, 125/150, 200/250, 333, 500/600 ohms	14.00
A-26	Push pull low level plates to multiple line	30,000 ohms plate to plate	50, 125/150, 200/250, 333, 500/600 ohms	15.00
A-27	Crystal microphone to multiple line	100,000 ohms	50, 125/150, 200/250, 333, 500/600 ohms	15.00
A-30	Audio choke, 250 henrys @ 5 MA 6000 ohms D.C., 65 henrys @ 10 MA 1500 ohms D.C.			10.00
A-32	Filter choke 60 henrys @ 15 MA 2000 ohms D.C., 15 henrys @ 30 MA 500 ohms D.C.			9.00

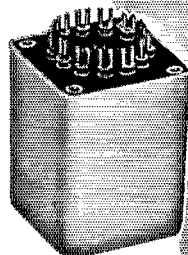

TYPE A CASE  
1 1/2" x 1 1/2" x 2" high

UTC OUNCER components represent the acme in compact quality transformers. These units, which weigh one ounce, are fully impregnated and sealed in a drawn aluminum housing 7/8" diameter... mounting opposite terminal board. High fidelity characteristics are provided, uniform from 40 to 15,000 cycles, except for O-14, O-15, and units carrying DC which are intended for voice frequencies from 150 to 4,000 cycles. Maximum level 0 DB.

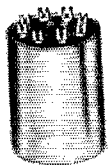

OUNCER CASE

7/8" Dia. x 1 1/4" high

Type No.	Application	Pri. Imp.	Sec. Imp.	List Price
O-1	Mike, pickup or line to 1 grid	50, 200/250, 500/600	50,000	\$13.25
O-2	Mike, pickup or line to 2 grids	50, 200/250, 500/600	50,000	13.25
O-3	Dynamic mike to 1 grid	7.5/30	50,000	12.00
O-4	Single plate to 1 grid	15,000	60,000	10.50
O-5	Plate to grid, D.C. in Pri.	15,000	60,000	10.50
O-6	Single plate to 2 grids	15,000	95,000	12.00
O-7	Plate to 2 grids, D.C. in Pri.	15,000	95,000	12.00
O-8	Single plate to line	15,000	50, 200/250, 500/600	13.25
O-9	Plate to line, D.C. in Pri.	15,000	50, 200/250, 500/600	13.25
O-10	Push pull plates to line	30,000 ohms plate to plate	50, 200/250, 500/600	13.25
O-11	Crystal mike to line	50,000	50, 200/250, 500/600	13.25
O-12	Mixing and matching	50, 200/250	50, 200/250, 500/600	12.00
O-13	Reactor, 300 Hys.—no D.C.; 50 Hys.—3 MA. D.C.		6000 ohms	9.50
O-14	50:1 mike or line to grid	200	1/2 megohm	13.25
O-15	10:1 single plate to grid	15,000	1 megohm	13.25

# MORE TUBE THAN BEFORE

Higher rated plate capacity and voltage . . . you get them in G. E.'s 6SN7-GTA. Here's new performance, new value!

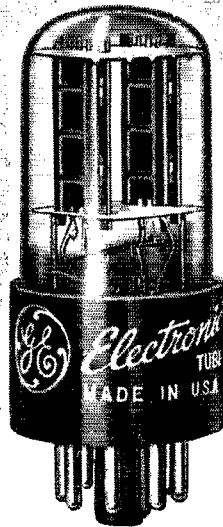

**6SN7-GTA  
TWIN-TRIODE  
AMPLIFIER**

GENERAL ELECTRIC tube design never stands still, never contents itself with existing standards. Still better performance is the aim! In Type 6SN7-GTA, new max ratings tell a feature story of G-E improvement in an amplifier, the 6SN7-GT, always popular with hams.

You get: twice as much rated dissipation, or 5 w per plate instead of the former 2.5 w . . . a two-thirds higher plate-voltage rating, or 500 v instead of 300 v . . . more than twice the earlier heater-cathode voltage figure (200 v against 90 v).

Filament voltage and current remain 6.3 v and 0.6 amp. No circuit change is involved in replacing a 6SN7-GT with the new type.

For audio, there's no better ham buy than the 6SN7-GTA. With its higher-rated performance, the tube is a standout choice as resistance-coupled amplifier, phase inverter, or for use in your low-power audio-output stage.

*Quality?* No finer anywhere. G-E-built

for television primarily, the 6SN7-GTA is proving itself daily, hourly, in TV home sets from coast to coast. *Value?* Plenty! The price, unchanged, remains a low receiving-tube price, purchasing a tube as versatile and useful as any you can find.

Your G-E tube distributor will be glad to tell you more. Or write *Electronics Department, General Electric Company, Schenectady 5, New York.*

● Read Ham News regularly. Ask your G-E tube distributor for your free copy of each bi-monthly issue. Or subscribe by the year, if this is more convenient for you; the cost is only \$1 annually to cover postage and handling charges. (This offer is confined to the continental U. S., Alaska, and Hawaii.) Your distributor will be glad to give you a blank direct to General Electric. Then you'll get every issue of Ham News by mail. New ideas, new circuits, new methods, all will reach you first . . . and fast!

ELECTRONIC TUBES OF ALL TYPES FOR THE RADIO AMATEUR

**GENERAL**  **ELECTRIC**

180-JAG

DID YOU EVER LOOK INSIDE AN

# OHMITE

## Type AB POTENTIOMETER?

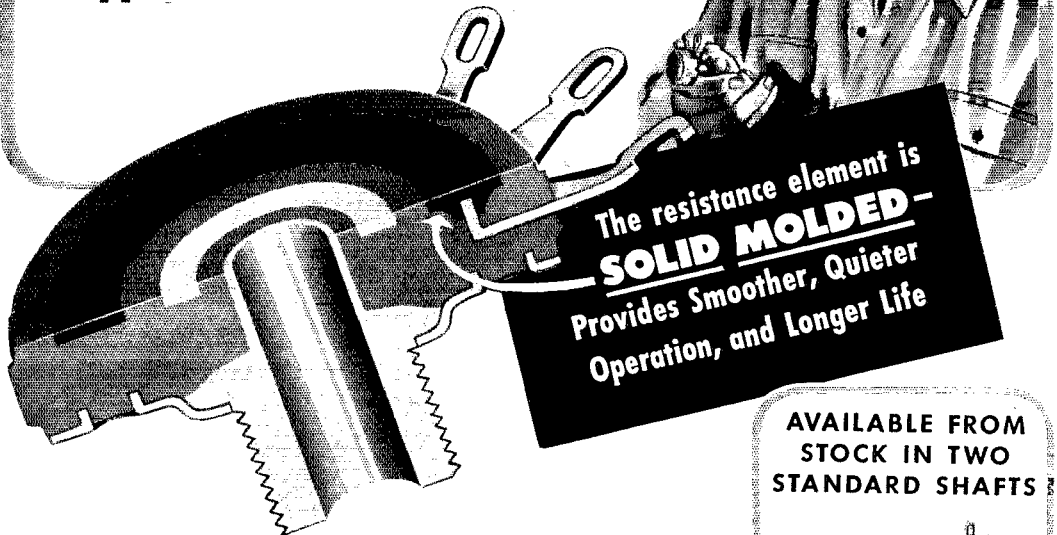

If you were to cut an OHMITE Type AB Potentiometer in half, you would see where these rugged little two-watt units get their reputation for reliability, long life, and smooth, quiet operation. The secret lies in their *unique design*.

The resistance element, for instance, is a thick, solid ring, molded under heat and pressure—not a sprayed film or paint type element. Because of this, the unit is unaffected by heat, cold, moisture, and length of service—and, the low noise level often becomes *less* with use! Furthermore, terminals are *imbedded* in the element, and all parts are corrosion resistant.

Use these fine components where reliability is important. Available in a wide variety of resistance values, and in three tapers—linear, clockwise logarithmic, and counter-clockwise logarithmic.

AVAILABLE AT ALL OHMITE DISTRIBUTORS

Write for **BULLETIN 131A**

OHMITE MANUFACTURING CO.  
4864 Flournoy St., Chicago 44, Illinois

Be Right with **OHMITE**

Reg. U. S. Pat. Off.

RHEOSTATS • RESISTORS • TAP SWITCHES

AVAILABLE FROM  
STOCK IN TWO  
STANDARD SHAFTS

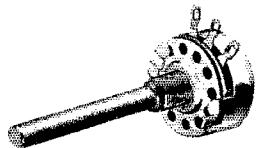

2" Dimension  
Round Shaft



Screwdriver Shaft  
with Locking Nut

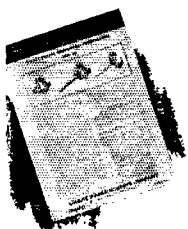

PUBLISHED, MONTHLY, AS ITS OFFICIAL ORGAN, BY THE AMERICAN RADIO RELAY LEAGUE, INC., AT WEST HARTFORD, CONN., U. S. A.; OFFICIAL ORGAN OF THE INTERNATIONAL AMATEUR RADIO UNION

### STAFF

#### Editorial

A. L. BUDLONG, W1BUD  
*Editor*

HAROLD M. McKEAN, W1CEG  
*Managing Editor*

GEORGE GRAMMER, W1DF  
*Technical Editor*

DONALD H. MIX, W1TS  
BYRON GOODMAN, W1DX  
*Assistant Technical Editors*

EDWARD P. TILTON, W1HDQ  
*V.H.F. Editor*

RICHARD M. SMITH, W1FTX  
C. VERNON CHAMBERS, W1JEQ  
*Technical Assistants*

ROD NEWKIRK, W9BRD  
*DX Editor*

WALTER E. BRADLEY, W1FWH  
*Technical Information Service*

#### Production

RALPH T. BEAUDIN, W1BAW  
*Production Manager*

NANCY A. PRICE  
*Assistant*

#### Advertising

F. CHEYNEY BEEKLEY, W1GS  
LORENTZ A. MORROW, W1VG  
EDGAR D. COLLINS

#### Circulation

DAVID H. HOUGHTON  
*Circulation Manager*

RALPH T. BEAUDIN, W1BAW  
*Assistant Circulation Manager*

### OFFICES

38 La Salle Road  
West Hartford 7, Connecticut

Subscription rate in United States and Possessions, \$4.00 per year, postpaid; \$4.25 in the Dominion of Canada, \$5.00 in all other countries. Single copies, 40 cents. Foreign remittances should be by international postal or express money order or bank draft negotiable in the U. S. and for an equivalent amount in U. S. funds.

Entered as second-class matter May 29, 1919, at the post office at Hartford, Connecticut, under the Act of March 3, 1879. Acceptance for mailing at special rate of postage provided for in section 1102, Act of October 3, 1917, authorized September 9, 1922. Additional entry at Concord, N. H., authorized February 21, 1929, under the Act of February 28, 1925.

Copyright 1950 by the American Radio Relay League, Inc. Title registered at U. S. Patent Office.

INDEXED BY  
INDUSTRIAL ARTS INDEX

## — CONTENTS —

"It Seems to Us . . ."	9
Civil Defense Planning — and the Radio Amateur . . .	10
Silent Keys . . . . .	10
Feed-Back . . . . .	10
T-Day in Sandwich . . . . . <i>Leon Faber, W9EH</i>	11
Shielded Construction for the Medium-Power Transmitter <i>Donald H. Mix, W1TS</i>	14
Bandwidth of Two- and Three-Element Yagi Antennas <i>J. P. Shanklin</i>	18
QSL Cards . . . . . <i>L. A. Morrow, W1VG</i>	21
More Selectivity at Low Cost <i>Gert M. F. Mosler, LU7CW</i>	26
All-Metal Construction in 2-Meter Arrays <i>Edward P. Tilton, W1HDQ</i>	28
A Master Control Box for the Ham Transmitter <i>Dale R. Clemons, W9BWD</i>	30
Break-In Amplifier Keying . . . <i>R. H. Scruggs, W2FRX</i>	32
Technical Topics —	
External Noise at 28, 50 and 144 Mc. . . . .	33
Tuning and Checking S.S.B. Signals . . . . .	34
Driven-Element Length . . . . .	36
Building a Rotatable End-Fire Array for 10 and 20 <i>Fred W. Walter, W8TWQ</i>	38
The World Above 50 Mc. . . . .	40
Surplus Corner —	
Circuit Improvements in the Telrad 18-A <i>Floyd A. Trueblood, W3LZC/7</i>	44
A V.H.F. Frequency Meter . . . <i>David Birnbaum, W3PGP</i>	46
United States Naval Reserve . . . . .	49
ARRL Conventions. . . . .	49
How's DX? . . . . .	50
Military Amateur Radio System. . . . .	53
Happenings of the Month . . . . .	54
October 14th-15th Simulated Emergency Test . . . . .	57
16th ARRL DX Contest . . . . .	58
U.S.A. Calling . . . . .	64
17th ARRL Sweepstakes . . . . .	64
Hamfest Calendar . . . . .	64
Correspondence from Members . . . . .	65
In QST 25 Years Ago This Month . . . . .	66
WWV-WVVH Schedule . . . . .	66
Hints and Kinks . . . . .	67
Operating News . . . . .	68
With the AEC . . . . .	70
Station Activities . . . . .	75
ARRL QSL Bureau . . . . .	108

# 2 New hallicrafters

for console performance with  
built-in convenience!

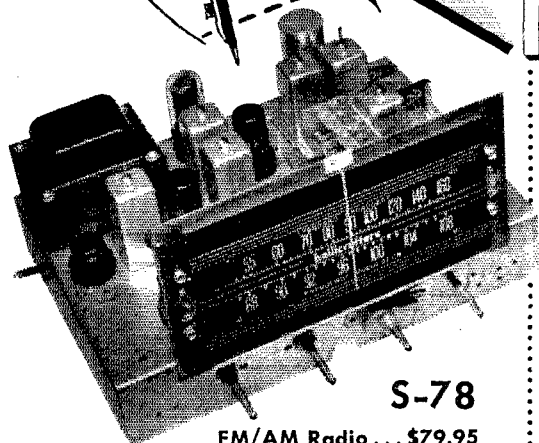

**S-78**

FM/AM Radio... \$79.95

New complete radio chassis with top performance characteristics. Broadcast 540-1700 kc and FM 88-108 Mc. Automatic freq. control for easier FM tuning. One broad-band FM r-f, two i-f stages. Freq. response 50 to 14,000 cps ( $\pm 3$  db). 8-watt push-pull output. Full range tone control. Wide edge-lighted dial; escutcheon, tuning knobs supplied. Size 12½" wide, 7¾" high, 11" deep. 10 tubes plus rect. 115V. AC only **\$79.95**



**ST-74**

FM/AM Tuner... \$54.50

New tuner for use with high fidelity amplifier. Broadcast Band 540-1700 kc and FM 88-108 Mc. One broad-band FM r-f, two i-f stages. Freq. response 60-12,000 cps ( $\pm 3$  db). Full-range tone control. Wide edge-lighted dial; escutcheon, tuning knobs supplied. Size 13¼" wide, 5½" high, 7⅞" deep. 6 tubes plus rect.—r-f, osc.-mixer, 2 i-f, FM Det., AM Det. For 115 V. AC only **\$54.50**

**hallicrafters**  
"The Radio Man's Radio"

WORLD'S LEADING MANUFACTURER OF PRECISION RADIO & TELEVISION • CHICAGO 24, ILLINOIS



# Standard of Excellence

PRs are on top! Wherever you go, the world around . . . wherever dependable radio frequency control is essential . . . PR Crystals stand out as the standard by which other crystals are judged. This is no accident. PR stands for superb QUALITY. Nothing is spared to make PRs truly the standard of excellence . . . and your dealer will tell you the same thing.

• 20 METERS, Type Z-3, \$3.75 • 40, 80 & 160 METERS, Type Z-2, \$2.75

PR

Crystals



Since 1934

USE **PR** AND KNOW WHERE YOU ARE

---

PETERSEN RADIO COMPANY, INC.  
2800 W. BROADWAY • COUNCIL BLUFFS, IOWA

## Section Communications Managers of the ARRL Communications Department

**Reports Invited.** All amateurs, especially League members, are invited to report station-activities on the first of each month (or preceding month) direct to the SCM, the administrative ARRL official elected by members in each Section. Radio Club reports are also desired by SCMs for inclusion in *OST*. All **ARRL Field Organization appointments** are now available to League members. These include ORS, OES, OPS, OO and OBS. Also, where vacancies exist SCMs desire applications for SEC, EC, RM, and PAM. In addition to station and leadership appointments for Members, *all amateurs* in the United States and Canada are invited to join the ARRL Emergency Corps (ask for Form 7).

ATLANTIC DIVISION				
Eastern Pennsylvania	W3BES	Jerry Mathis	617 Crescent Ave.	Glenside
Maryland-Delaware-D.C.	W3BWT	Eppa W. Darne	132 Tennessee Ave., N.E.	Washington 2, D.C.
Southern New Jersey	W2ASG	Dr. Luther M. Mkitarian	500 Warwick Road	Haddonfield
Western New York	W2PGT	Harding A. Clark	RFD 2	Maulius
Western Pennsylvania	W3KWL	Ernest J. Hlinsky	509 Beechwood Ave.	Farrell
CENTRAL DIVISION				
Illinois	W9EVJ	Lloyd E. Hopkins	27 Lynch St.	Elgin
Indiana	W9RE	W. E. Morgan	1504 East Ewing	South Bend 14
Wisconsin	W9RQM	Keno W. Goetsch	929 S. 7th Ave.	Wausau
DAKOTA DIVISION				
North Dakota	W0JWY	Rev. Lawrence C. Strandenaes	St. Andrew's Church	Westhope
South Dakota	W0NGM	J. S. Fosberg	509 Idaho Ave., S.E.	Huron
Minnesota	W0RA -	John B. Morgan	1411 Summit Ave.	St. Paul 5
DELTA DIVISION				
Arkansas	W5DRW	Dr. John L. Stockton	P. O. Box 302	Siloam Springs
Louisiana	W5GHH	Robert E. Barr	Box 446	Springhill
Mississippi	W5DLA	J. C. Wallis	2406 Kelly St.	Gulfport
Tennessee	W4AFI	D. G. Stewart	c/o W. Woodrow Minglewood Drive	Fountain City
GREAT LAKES DIVISION				
Kentucky	W4KWO	Dr. Asa W. Adkins	Box 240, Woodland Park	Hazard
Michigan	W8AQJ	Robert B. Cooper	132 Guild St., N.E.	Grand Rapids
Ohio	W8WZ	Dr. Harold E. Stricker	247 W. 5th St.	Marysville
HUDSON DIVISION				
Eastern New York	W2EOD	Fred Skinner	500 Wolfs Lane	Polham 65
N. Y. C. & Long Island	W20BU	George V. Cooke	88-31 239th St.	Bellerose 6, L. I.
Northern New Jersey	W2NKD	Thomas J. Ryan, jr.	1082 Anna St.	Elizabeth 4
MIDWEST DIVISION				
Iowa	W0PFP	William G. Davis	3rd St.	Mitchellville
Kansas	W0ICV	Earl N. Johnston	624 Roosevelt	Topeka
Missouri	W0ICD	Ben H. Wendt	RFD 8	North Kansas City
Nebraska	W0OED	Scott E. Davison	433 North Nye Ave.	Fremont
NEW ENGLAND DIVISION				
Connecticut	W1VB	Walter L. Glover	Glover Ave.	Newtown
Maine	W0VB	Stanley W. Haskell	15 Hemlock St.	Portland
Eastern Massachusetts	W1ALP	Frank L. Baker, jr.	91 Atlantic St.	North Quincy 71
Western Massachusetts	W1AZW	Prentiss M. Bailey	62 Dexter St.	Pittsfield
New Hampshire	W1INC	Norman A. Chapman	99 Broadway	Concord
Rhode Island	W1CJH	Koy B. Fuller	17 Ledge Road	East Greenwich
Vermont	W1NLO	Burtis W. Dean	P. O. Box 81	Burlington
NORTHWESTERN DIVISION				
Alaska	K17IG	Charles M. Gray	Box 1237	Douglas
Idaho	W71WU	Alan K. Ross	2105 Irene St.	Rouse
Montana*	W7KGI	Edward G. Brown	421 Yellowstone Ave.	Billings
Oregon	W7MQJ	J. E. Roden	519 N.W. Ninth	Pendleton
Washington	W7CZY	Laurence Sebring	Route 2, Box 384	Everett
PACIFIC DIVISION				
Hawaii	KH6HJ	Dr. Robert Katsuki	1817 Wilhelmina Rise	Honolulu 17
Nevada	W2BVZ	Carroll W. Short, jr.	1608 Arizona St.	Boulder City
Santa Clara Valley	W6BPT	Koy E. Pinkney	10th St.	Santa Clara
East Bay	W6TI	Horace R. Greer	414 Fairmont Ave.	Oakland 11
San Francisco	W6ATO	R. F. Czeikowitz	243 Colon Ave.	San Francisco 12
Sacramento Valley	W6ZF	Ronald G. Martin	2638 13th St.	Sacramento 14
San Joaquin Valley	W6FYM	E. Howard Hale	741 E. Main St.	Turlock
ROANOKE DIVISION				
North Carolina	W4DCQ	Herman P. Jolitz	617 College St.	Clinton
South Carolina	W4AZT	Wade H. Holland	P. O. Box 116	Greenville
Virginia	W4TFF	F. Edgar Linder	Route L, Box 431	Annandale
West Virginia	W8JM	Donald B. Morris	303 Home St.	Fairmont
ROCKY MOUNTAIN DIVISION				
Colorado	W0IQZ	M. W. Mitchell	1959 Uinta St.	Denver 7
Utah	W7SP	Leonard F. Zimmerman	House 4	Saltair
Wyoming	W7KfV	Marion K. Neary	Box 215	Laramie
SOUTHEASTERN DIVISION				
Alabama*	W4HFL	Percy Sexton	6 Johnson Circle	Northport
Eastern Florida	W4FWZ	John W. Hollister	3809 Springfield Blvd.	Jacksonville
Western Florida	W4ACB	S. M. Douglas, jr.	P. O. Box 3	Tallahassee
Georgia	W4ZD	James P. Born, jr.	25 First Ave., N.E.	Atlanta
West Indies (Cuba-P.R.-V.I.)	KP4DJ	William Werner	563 Ramon Llovet	Urb. Truman, Rio Piedras, P. R.
Canal Zone	KZ5AW	Everett R. Kimmel	Box 264	Gamboa, C. Z.
SOUTHWESTERN DIVISION				
Los Angeles	W6VIM	Virge A. Gentry, jr.	2156 W. 108th St.	Los Angeles 47
Arizona	W7MID	Jim Kennedy	4511 N. 8th St.	Phoenix
San Diego*	W6BAM	Shelley Trotter	15952 S. Ritchy St.	Santa Ana
WEST GULF DIVISION				
Northern Texas	W5BKH	William A. Green	1834 University Blvd.	Abilene
Oklahoma	W5AHT/AST	Frank E. Fisher	104 East 11th St.	Pawhuska
Southern Texas	W5BDF	Ammon O. Young	4803 Ell St.	Houston 7
New Mexico	W5SMA	Lawrence R. Walsh	2100A 35th Street	Los Alamos
MARITIME DIVISION				
Maritime (Nfld. & Labr. att.)	VE1DQ	A. M. Crowell	69 Dublin St.	Halifax, N. S.
ONTARIO DIVISION				
Ontario	VE3IA	G. Eric Farquhar	16 Emerald Crescent	Burlington, Ont.
QUEBEC DIVISION				
Quebec	VE2GL	Gordon A. Lynn	R. R. No. 1	Ste. Genevieve de Pierrfonds, P. Q.
VANALTA DIVISION				
Alberta	VE6MJ	Sydney T. Jones	P. O. Box 373	Edmonton, Alta.
British Columbia	VE7FB	Ernest Savage	4553 West 12th Ave.	Vancouver
Yukon	VE8AK	W. R. Williamson	P. O. Box 534	Whitehorse, Y. T.
PRAIRIE DIVISION				
Manitoba	VE4AM	A. W. Morley	26 Lennox Ave.	St. Vital
Saskatchewan	VE5DW	J. H. Goodridge	c/o Canadian Pacific Air Lines	Regina

\* Officials appointed to act temporarily in the absence of a regular official.



# hallicrafters

"The Radio Man's Radio"



## commands the world's airwaves!

In every price range, Hallicrafters offers precision instruments—to serve you better, and giving you more value for your investment than any other set.

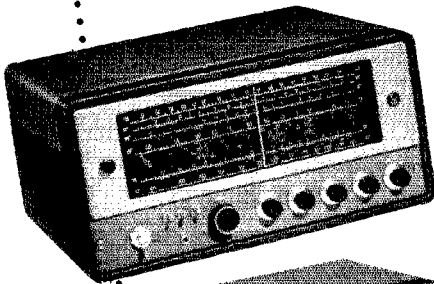

Model SX-62 World's finest receiver for the all-wave listener. Outperforms any broadcast receiver on any frequency—continuous coverage from 540 kc to 109 Mc in six bands. Crystal calibration oscillator built in. Six position selectivity with crystal filter. Two stages r-f, three stages i-f amplification. 10-watt push-pull high fidelity output. Phonograph jack. 14 tubes plus regulator and rectifier. . . . . \$269.50



Model SX-71 Value-packed with features specifically asked for by the Hams. Extra sensitivity, selectivity, and stability; double super-heterodyne, plus built-in Narrow Band FM. One r-f, two conversion, and three i-f stages. Range 538 kc to 35 Mc, 46-55 Mc. Extra wide dials for Main and Bandsread Tuning. Sensitivity, Volume, BFO Pitch, Selectivity, and Crystal Phasing controls.; AVC, BFO, Rec./Standby, ANL, Tone, and Phono-Rec. switches. Phonograph input jack. 500, 3.2-ohm output. . . . . \$189.50

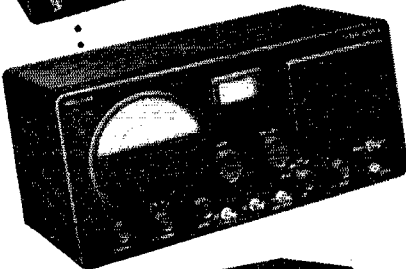

Model S-40B New version of an old favorite. Temperature compensated oscillator; tuned r-f stage, two i-f stages for better selectivity. Covers 540 kc to 43 Mc in four bands. Sensitivity, volume, three-position Tone, BFO Pitch, controls; AVC, BFO, Rec./Standby, and Noise Limiter Switches. Built-in PM speaker. External power, remote control connections. 7 tubes plus rect. S-40B . . . . . \$89.95

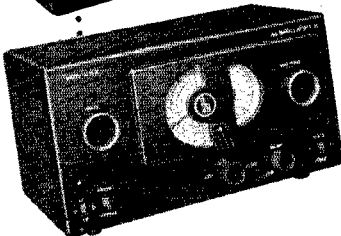

Model S-38B Pulls in broadcast stations in weak signal areas where ordinary sets fail. Also offers world-wide reception for the short-wave listener and the new amateur. Covers Broadcast Band and three short-wave bands 540 kc to 32 Mc. Separate Fine Tuning control. BFO, Rec./Standby, Speaker/Phones switches. Built-in PM speaker. Four tubes plus rectifier. For 115 V. AC or DC. . . . . \$49.50

WORLD'S LEADING MANUFACTURER OF PRECISION RADIO AND TELEVISION • CHICAGO 24, ILLINOIS

We want you to know that every effort is being made to keep our Distributors supplied. If the model you select is temporarily out of stock, please be patient—you'll find that a Precision HALICRAFTERS is worth waiting for!

# THE AMERICAN RADIO RELAY LEAGUE, INC.,

is a noncommercial association of radio amateurs, bonded for the promotion of interest in amateur radio communication and experimentation, for the relaying of messages by radio, for the advancement of the radio art and of the public welfare, for the representation of the radio amateur in legislative matters, and for the maintenance of fraternalism and a high standard of conduct.

It is an incorporated association without capital stock, chartered under the laws of Connecticut. Its affairs are governed by a Board of Directors, elected every two years by the general membership. The officers are elected or appointed by the Directors. The League is noncommercial and no one commercially engaged in the manufacture, sale or rental of radio apparatus is eligible to membership on its board.

"Of, by and for the amateur," it numbers within its ranks practically every worth-while amateur in the nation and has a history of glorious achievement as the standard-bearer in amateur affairs.

Inquiries regarding membership are solicited. A bona fide interest in amateur radio is the only essential qualification; ownership of a transmitting station and knowledge of the code are not prerequisite, although full voting membership is granted only to licensed amateurs.

All general correspondence should be addressed to the Secretary at the administrative headquarters at West Hartford, Connecticut.



## Past Presidents

HIRAM PERCY MAXIM, W1AW, 1914-1936  
EUGENE C. WOODRUFF, W8CMP, 1936-1940

• • • • •

## Officers

**President** . . . . . GEORGE W. BAILEY, W2KH  
New York, N. Y.

**Vice-President** . . . . . WAYLAND M. GROVES, W5NW  
Odessa, Texas

**Secretary** . . . . . A. L. BUDLONG, W1BUD  
West Hartford, Connecticut

**Communications Manager** . . . . . FRANCIS E. HANDY, W1BDI  
West Hartford, Connecticut

**Treasurer** . . . . . DAVID H. HOUGHTON  
West Hartford, Connecticut

• • • • •

**General Counsel** . . . . . PAUL M. SEGAL  
816 Connecticut Ave., Washington 6, D. C.

**Assistant Secretaries** . . . . . JOHN HUNTOON, W1LVQ  
RICHARD L. BALDWIN, W1KIE HARRY PASTON, W1DJV  
West Hartford, Connecticut

## DIRECTORS

### President

GEORGE W. BAILEY, W2KH  
1 East 79th St., New York 21, N. Y.

### Vice-President

WAYLAND M. GROVES, W5NW  
P. O. Box 586, Odessa, Texas  
(W5NW at Humble Pipe Line Camp, Odessa)

### Canadian General Manager

ALEX REID, VE2BE  
240 Logan Ave., St. Lambert, P. Q.  
**Alternate:** William W. Butchart, VE6LQ  
10740 107 St., Edmonton, Alta.

### Atlantic Division

WALTER BRADLEY MARTIN, W3QV  
1033 Arbutha Rd., Abington, Pa.  
**Alternate:** Henry W. Wickenhiser, Jr., W3KWA  
1112 State Ave., Coraopolis, Pa.

### Central Division

JOHN G. DOYLE, W9GPI  
4331 N. Wildwood Ave., Milwaukee 11, Wis.  
**Alternate:** Wesley E. Marriner, W9AND  
624 College Ave., Dixon, Ill.

### Dakota Division

GOODWIN L. DOSLAND, W0TSN  
Moorhead, Minn.  
**Alternate:**

### Delta Division

VICTOR CANFIELD, W5BSR  
P. O. Box 965, Lake Charles, La.  
**Alternate:** George S. Acton, W5BMM  
Plain Dealing, La.

### Great Lakes Division

JOHN H. BRABB, W8SPF  
417 Ford Bldg., Detroit 26, Mich.  
**Alternate:** Harold E. Stricker, W8WZ  
247 W. 5th St., Marysville, Ohio

### Hudson Division

JOSEPH M. JOHNSTON, W2SOX  
423 Monmouth Ave., Bradley Beach, N. J.  
**Alternate:** Gay E. Mihus, Jr., W2NJP  
170 Broadway, New York 7, N. Y.

### Midwest Division

LEONARD COLLETT, W0DEA  
Civil Aeronautics Administration  
Box 776, Joplin, Mo.  
**Alternate:** Alvin G. Keyes, W0KTK  
1201 Merchants Nat'l Bank Bldg., Cedar Rapids, Ia.

### New England Division

PERCY C. NOBLE, W1BVR  
37 Broad St., Westfield, Mass.  
**Alternate:** Clayton C. Gordon, W1HRC  
70 Columbia Ave., Providence 5, R. I.

### Northwestern Division

R. REX ROBERTS, W7CPY  
837 Park Hill Drive, Billings, Mont.  
**Alternate:** Allan D. Gunston, W7GP  
1033 Salem Ave., Apt. 4, Dayton 6, Ohio

### Pacific Division

KENNETH E. HUGHES, W6CIS  
810 W. Orange Ave., So. San Francisco, Calif.  
**Alternate:** C. Porter Evans, W6BF  
134 Dracena Ave., Piedmont 11, Calif.

### Roanoke Division

J. FRANK KEY, W4ZA  
Box 707, Buena Vista, Va.  
**Alternate:** Gus M. Browning, W4BPD  
135 Broughton St., S. E., Orangeburg, S. C.

### Rocky Mountain Division

FRANKLIN K. MATEJKA, W0DD  
P. O. Box 212, Estes Park, Colo.  
**Alternate:** William R. White, W0PDA  
1263 Pearl St., Denver 3, Colo.

### Southeastern Division

LAMAR HILL, W4BOL  
104 Myrtle, Cochran, Ga.  
**Alternate:** William P. Sides, W4AUP  
Fleming Road, Montgomery, Ala.

### Southwestern Division

JOHN R. GRIGGS, W6KW  
10412 Don Pico Rd., RFD 2, Spring Valley, Calif.  
**Alternate:** John E. Bickel, W6NY  
2111 Edgewood Ave., Las Vegas, Nev.

### West Gulf Division

DAVID H. CALK, W5BHO  
7730 Joplin St., Houston 17, Texas  
**Alternate:**

# "It Seems to Us..."

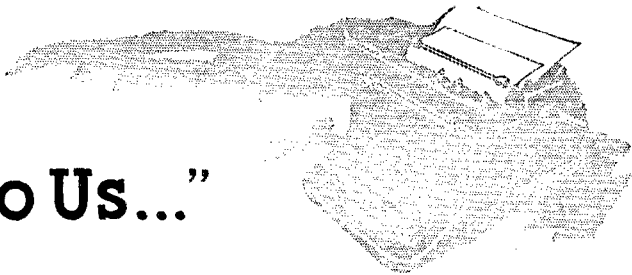

## THE SERVICE HEADQUARTERS

"Was called on to give a luncheon talk to the local Rotary Club . . . wonder if you have any information on tap to meet such situations?"

You bet — a typical half-hour talk, already prepared.

"I think we have enough hams in town now to organize a club. Do you have any dope on how to go about it?"

Yes, indeed — a 15-page mimeograph.

"Our group would like to set up a small exhibit on amateur radio at the centennial exposition at the county fairgrounds next month. We decided to write ARRL to find out if you have any suggestions along this line."

You're darned tootin' we do, OM — not only suggestions but the loan of certain items which will help make the exhibit a success.

It is part of our job at Hq. to have such things — and many others — available to fulfill membership needs. The staff at 38 La Salle Road is set up as a service organization. Every member of the League is familiar with the most important direct service — the supplying of *QST* each month. Most of you know, too, about other major service fields: about representation in international as well as domestic fields; about ARRL general operating activities, contests and awards with their detailed handling and checking; about field organization matters with their associated regular mimeograph newsletters; about the Technical Information Service; about field travel to conventions; about WIAW with its up-to-the-minute news bulletins and code practice schedules. Most of these are general in nature and application, and they occupy a major portion of the time of the staff.

But there are numerous individual and specific services, too, to fill membership requests similar to those we quoted at the top of this page. For the asking, we have pamphlets to educate the public on amateur radio, operating desk aids, sample broadcast scripts on amateur radio, suggestions for hamfest and convention planning, training aids films and quizzes for affiliated clubs, dope on how to set up code or theory training for beginners, safety rules, code charts, legal guidance for fellows

who have come across a knotty zoning ordinance problem in connection with the erection of a mast, straight dope on latest regulatory changes and interpretations of special cases of licensing, essential data on foreign regs in case you're going abroad. . . .

Well, shucks — let's put it this way: If you've got a problem, or a project, drop us a line; it's dollars to doughnuts we can be of help.

After all, that's what we're here for.

## THAT 21-MC. BAND

No need to worry now about putting up a 15-meter beam for *next* year's DX contest. The announcement of postponement of the Extraordinary Administrative Radio Conference, the instrument which was to bring the Atlantic City allocation table (including 21,000-21,450 kc. for amateurs) in effect, puts further into the future the anticipated date for the opening of this new amateur band.

Yet the news has its bright side. The conference would presumably also have set a date for our loss of 14,350-14,400 kc. More important, there conceivably could have been a move to take up the 3500-4000 kc. amateur allocation as a result of agitation to question the legality of the 1949 Washington, D. C., Inter-American agreement on that band.

While it is indeed unfortunate that the untold manhours of preparatory work by Government and industry (including amateur representatives this past year will not immediately be put to use, it must be admitted that the postponement of any international radio conference brings a sigh of relief. EARC is no exception.

## ARE YOU LICENSED?

- When joining the League or renewing your membership, it is important that you show whether you have an amateur license, either station or operator. Please state your call and/or the class of operator license held, that we may verify your classification.

# CIVIL DEFENSE PLANNING —AND THE RADIO AMATEUR

Responsibility for broad planning in civil defense in communications has been assigned to the National Security Resources Board. With the federal plans for standardization and guidance determined, states and municipalities will be depended on to carry out the responsibilities for self-help and develop their communications part of the plan. The broad scope of civil defense plans cannot be announced pending Presidential approval. Official release of plans is expected in the latter part of September, about the time this issue of *QST* appears. We can perhaps comment on the NSRB consideration which has thus far been given to the use of amateur service facilities.

The NSRB has followed the working out of typical problems in Seattle, Washington, and Chicago, Illinois, to assist in assessing manpower and equipment potentials for various jobs to be done. The Agency expresses a high degree of interest in the test results and stresses that the number of lives saved and the rehabilitation possible after any major disaster such as one of these simulated tests represents depend almost directly on rapid and successful communications. Amateur radio cooperation in these tests has been reported to and studied by the NSRB and the September release will include comment on the use of the amateur.

Civil defense communications will be counted on to warn people that an attack is imminent; to direct workers to their posts; to assure quick interchange of information and instructions. All forms of communications will be used, telephone, telegraph, and radio for important alternative systems. It is of the utmost importance to anticipate these communication needs and the purpose of civil defense communication planning, at regional, state and local levels in cooperation with authorities in the communications field. The needs include (1) establishment of c.d. control centers for dispatching workers, directing operations and information on air raids. (2) Warning networks (wire and radio). (3) Communications for highway control and transportation, evacuation and hospitalization. (4) Search and rescue purposes. Broadcasting, police, and fire systems automatically become part of civil defense communications, handling a heavy load of their type of communications of course during a disaster.

Communications organization at regional, state and local levels is contemplated in the plan. At local levels radio will be important, to be supplemented if necessary by messenger service and other emergency means. Mobile radio stations and any other possible means that can be developed are necessary. NSRB considers that under a carefully worked out plan amateurs are capable of making an important contribution to

civil defense. The program for integration of amateurs and their emergency networks and patterns to be suggested to the states are under study. Local surveys will be directed to include the number of mobile units and their frequency assignments, information that ARRL already has been completing from AEC groups. In the local plans, the availability of amateur portable transmitters and receivers for emergency use must be made known and designated. The NSRB plans for civil defense released in September of course cover much more than the communications aspect. On the latter, NSRB will be pursuing more detailed studies in each of the specialized communications branches involved in order to hand down to the states still more specific plans and recommendations. This will permit equipment acquisitions to go forward with more definite assurance that it will fit in properly when the bell is rung for the first local test.

Look for WIAW bulletins or check with Emergency Coördinators for information on any new regulations promulgated by FCC or plans for civil defense that concern our service. In the meantime don't forget the October SET this month, results of which are being reported fully to NSRB to be considered along with the Seattle and Chicago data now under study. It is expected that additional details on the unfolding plans concerning use of the amateur in civil defense communications can be given you in the next issue of *QST*.

## Silent Keys

It is with deep regret that we record the passing of these amateurs:

W2VIV, Robert W. Gardner, Fulton, N. Y.  
W5FPO, C. Alfred Thomas, Waveland, Miss.  
W6FDR, William B. Hollis, Oakland, Calif.  
W6FGH, Clyde R. Van Dyke, Redlands, Calif.  
W6MWO, Helen R. Cook, Beverly Hills, Calif.  
W6SXM, Kenneth S. Smith, North Hollywood, Calif.  
W7DA, Arthur H. Dahms, Seattle, Wash.  
G3AXT, Frank B. Jenkins, Bridgewater, Somerset  
G6SE, L. W. J. Robbins, Pinner, Middlesex  
KH6MB, Marce Ellingen, Lanikai, T. H.

## FEED-BACK

A coil and condenser in the high-pass coax filter of Fig. 2, page 47, August *QST*, unfortunately were shown in incorrect relationship. The circuit should look the same in either direction. The accompanying diagram is the correct one.

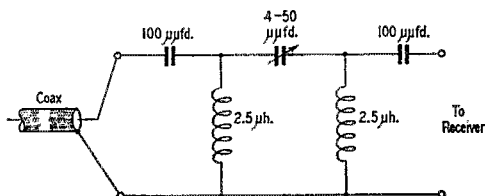

◆  
Up and up and up! The 36-element 10-meter array at W9EH towers 125 feet above ground (see this issue's cover). The entire pole rotates, though the structure weighs more than 2500 pounds.  
◆

## T-Day in Sandwich

### *Erecting a 36-Element 10-Meter Rotary*

BY LEON FABER,\* W9EH

**F**AR from the ordinary sleepy Sunday, July 16th came to Sandwich, Ill., on tiptoes of excitement. This was Tower Day — the day a giant 125-foot 36-element ten-meter beam was to go up. Not only was it to be one of the tallest installations in all Hamdom but the entire structure, weighing more than a ton, was to be rotatable. There was no doubt but that the towering edifice for the ultimate in 10-meter antennas would dwarf the entire community.

Sandwich is not unacquainted with the sometimes hectic goings-on in the electronic world, yet this day the town was humming with excitement. Flying hams, such as W9UAO, had come swooping down from the wild blue yonder; cars galore, converging to this spot from every point of the compass, carried enthusiastic hams coming in to see for themselves if such a thing could be done without the aid of atomic power!

Before long, more than 100 Midwestern hams, their numbers augmented by nearly three times as many curious townspeople, gathered at the site of the coming event. Had General Cornwallis led such an enthusiastic army, it is estimated that the Revolutionary War would have been wound up in two weeks — with a British victory! Excitement stimulates appetite, a fact carefully noted in our detailed plans for the erection of the tower. Hundreds of ham sandwiches and soft drinks were on tap to keep enthusiasm high and hands willing. Free advice on tower-erecting procedure was rife. Hams, and especially non-hams, had ideas aplenty as to how the great beam should be raised.

\* % The James Knights Co., Sandwich, Ill.

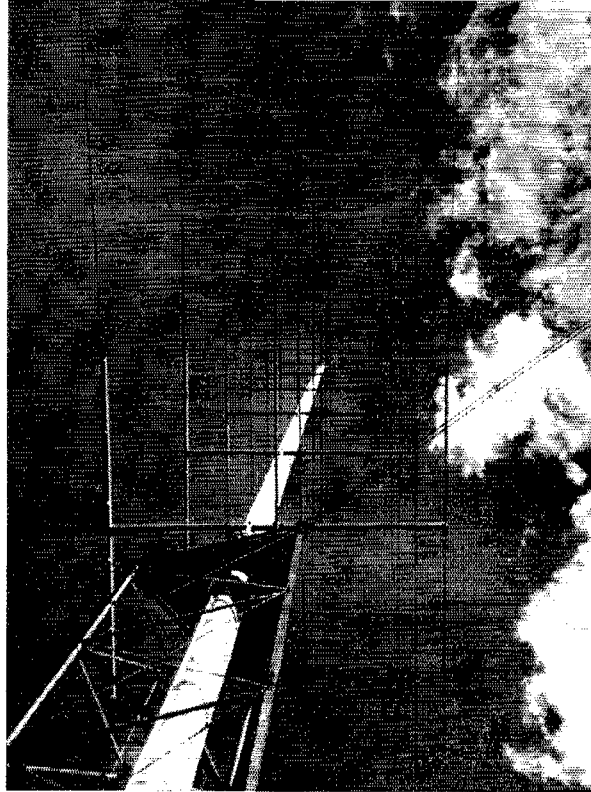

But for W9EH this day, despite its “hawk in the chicken yard” confusion, represented the culmination of months of research, planning, study, construction and weighing of calculated risks. If the giant could be raised, elements and all, here was a beam that we hoped would put our 150 watts on a par with the eager lads who feed their large finals till they burp.

The idea for this tower of towers was conceived one evening back in midwinter of 1948. While chewing the rag with a few of the boys on ten, it was casually mentioned that some day in the near future we intended to put up the biggest doggone beam they, or anyone else, ever heard of. Now this, so far as we were concerned, was approximately seventy-five per cent 10-meter hog-wash; the remaining twenty-five per cent just a nebulous idea that it would be nice to experiment with a huge antenna that was really up in the air.

The gang on ten disregarded the conversational aspects of the remark and from that moment on W9EH was going to put up a tremendous beam. We were stuck! As time went on, the project began to roll. Ideas, advice and counsel, recommendations, suggestions and opinions flowed through the medium of our receiver or were brought to the door by Uncle Sam's “men in gray.” Dissuasion vied with persuasion. It was all very confusing, but gradually as the months wore on the various ideas and recommendations began to crystallize into definite plans, and a clear picture of the future giant beam came into focus on our mental screen and in the pages of our notebook.

Space limitations do not allow mention of every

ham who made contributions to the planning of the big beam. Obviously, it was impossible to incorporate every suggestion received but all were of immense value in determining the final form of our antenna. Ed Tilton, W1HDQ, of QST, proved a friend indeed with his many helpful suggestions and well-rounded experience. Bill Petersen, WØJRY, who has a rather tremendous antenna of his own, was called upon frequently to suggest ways and means of avoiding the many pitfalls inherent in such a project. He proved to be eminently qualified. Tom Erdmann, W7DND, who knows his way around an antenna as well as the next guy, not only gave generously of his knowledge but is planning a trip out here to help with the experimental feed systems. John Holmbeck, W9KZO, put his trusty slide rule to work and hesitated not in burning the midnight oil. Leo Hodgeman, W9BSG, suggested many ideas to make the mechanical end of the construction a real success.

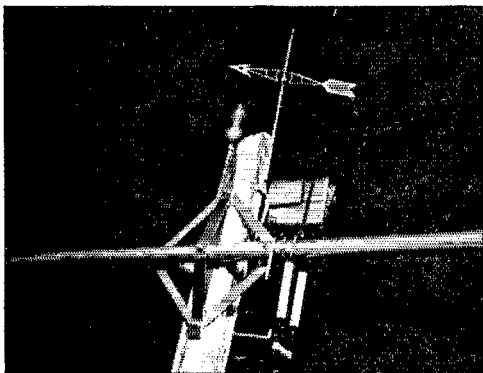

Top of the pole, with aircraft warning light and wind-direction indicator, showing the method of mounting the aluminum booms.

The original plan was to erect a 90-foot pole and stack two lazy-II antennas with directors and reflectors. This scheme was hastily scrapped, however, when we learned of a 125-foot pole in stock that could be had for the price of a 90-footer. We immediately ordered the pole and began planning a system somewhat more elaborate.

The mast, as it lay in the yard, was straight and slender — and huge. It had actually required three railway flatcars to transport this forest colossus from its West Coast home! The pole was of Washington fir and had been creosoted by the Graybar Company. This, while adding immeasurably to the life expectancy of the antenna, did nothing for its beauty. An application of aluminum paint glamorized the glorified clothespole sufficiently to mollify somewhat the XYL who was noting with some concern the growing melange of poles and towers sprouting up amongst the fruit trees, petunias and other flora of the back yard.

#### Planning and Construction

Up to this point, little thought had been devoted to the actual process of raising the pole to a

vertical position. It had been decided that design, construction and future servicing of the antenna would be considerably less complicated if pole and all rotated rather than a subassembly of some nature rotating free of the pole. This method, however, made raising the mast a tougher proposition. We quickly came to the conclusion that careful plans for the erection must be drawn up and that strict adherence to these plans would be of prime importance.

The first step was to build a supporting tower. This structure, erected on a seven-foot-square concrete base five feet thick, was built of 2-inch angle iron  $\frac{3}{16}$  inch thick. It is triangular in shape and 35 feet high, 6 feet wide on each side. The three perpendicular supporting legs consist of  $1\frac{1}{4}$ -inch galvanized pipe in addition to the angle iron. On top of the tower we built a platform of  $\frac{1}{4}$ -inch steel plate, 6 feet on a side and triangular in shape, with a hole slightly larger than the pole at the center. Four brass shoes, each with a surface area of 3 by 4 inches, were placed in proper position around the hole. These shoes, in conjunction with a steel sleeve fastened to the pole, serve as a bearing to permit the pole to rotate freely.

It was decided to fabricate the entire beam on the ground and raise it *in toto*. This procedure, while requiring extra care and skill in maneuvering the antenna into a vertical position, simplified assembly to a very considerable degree. Starting at the 35-foot level of the mast, steps were inserted to facilitate future climbing. An aircraft warning light was attached to the top end of the pole along with a wind-direction indicator, the latter device being intended as a convenience to the author who flies the company plane on business trips — especially when the fish are biting up north.

Attaching the six booms to the pole was next in order. These booms, made of  $2\frac{1}{2}$ -inch aluminum tubing, were mounted on an aluminum framework  $\frac{1}{4}$  inch thick cut out to reduce wind resistance and weight. Bolts of stainless steel run completely through the mast to secure the frame support.

Inasmuch as the wooden crossarms supporting the elements were in a vertical plane with respect to the pole on the ground it was necessary to begin raising the pole as these crossarms were attached, starting with the boom nearest the top of the mast. As each boom cleared the ground sufficiently the three crossarms and elements were attached and phasing section connected.

The antenna elements are surplus U. S. Army tank whips that came copper plated and painted. They are supported on 108 insulators. We used 108 insulators, 108 eyebolts, 108 cups, employing mass-production techniques. The beam consists of 12 directors, 12 reflectors and 12 radiators; vertical spacing is 16 feet 8 inches, horizontal spacing is 6 feet. From the photographs one can see that the elements were hung *underneath* the wood crossarms. Each insulator hangs in a small aluminum cup so it cannot change position even under stress and winds. Elements weighed 90

Part way up, the huge array was snubbed to a 50-foot gin pole, while preparations were made for the final phase of the lifting operation. The rotating pole is supported by the 35-foot steel tower at the right.

pounds, as did the crossarms. Miscellaneous bolts and aluminum braces weighed 50 pounds; the pole itself, 1800 pounds. Booms, steel steps, etc., bring the total weight to approximately 2500 pounds.

Hams who saw the beam wondered whether the slight element sagging, noticeable in the photos, would adversely affect operation. WØJRY, who has had two years of experience with a large beam employing the same type elements, swears by them. He says they gather very little ice due to their flexibility, and have very little wind resistance because of their size. Although he has seen them flopping as much as two feet in high winds, he got strong steady reports on other S-meters, and couldn't see that his final loading fluctuated. In large phased arrays such as this element spacing is not at all critical. All elements for the Sandwich operation were cut to length before raising. Radiators are 200 inches long, reflectors 206 inches, and directors 190 inches.

There is some controversy regarding the use of directors in a beam of this size. Ed Tilton, W1HDQ, felt that the gain of the beam without directors would be 17 db., and would only be 18 db. or so with the addition of directors. Bill Petersen, WØJRY, and Tom Erdmann, W7DND, felt that the directors would help almost as much on a large array as on a three-element beam. If we ever have the time, we may make comparative tests and settle the matter once and for all time. Theoretical power gain of the array is 63.

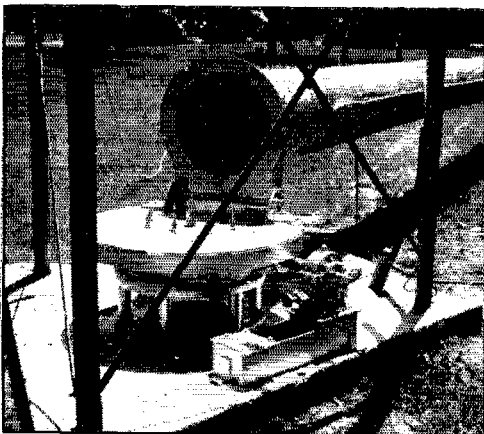

Rotator detail, showing hinge and collar by which the base of the mast was anchored during the raising stage. A milling table supports and rotates more than a ton of mast and ham antenna, yet a  $\frac{3}{4}$ -horsepower motor does the job easily. The motor, not shown in this photograph, is mounted on the base in the foreground. (Photos by James Knights, ex-W9HNX.)

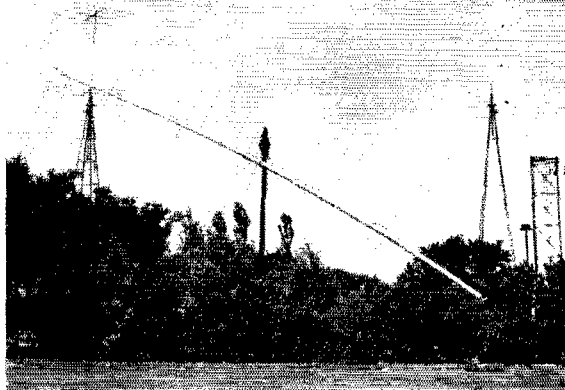

### Up It Goes!

The actual raising of the mast was somewhat anticlimactic — at least for those of us who had worked out all the details. The day dawned bright and clear and by nine in the morning preliminary preparations were well under way. Our yard rapidly took on the appearance of an old-time barbecue as people by the dozens arrived by car and by plane. Under shade trees, ladies rested comfortably in lawn chairs while their menfolk wandered about renewing old acquaintances, offering free advice and referring frequently to the huge tubs of ice resting under other shade trees. Mrs. W9BSG and Mrs. W9EH, with the aid of others of the ladies, did a marvelous job attending to the more solid food requirements of the assemblage. They prepared the many delightful items on the menu and served over one hundred guests, to everyone's complete satisfaction.

At approximately eleven o'clock the two winch trucks were jockeyed into position, block and tackles rigged, and we were set to go. We had previously set a 50-foot gin pole fifty feet out from the base of the supporting tower. From one of the winch trucks a cable was rigged over this and down to the antenna pole at a point approximately halfway up. Two guy ropes ran from the pole at the same point and out to each side, serving to prevent any appreciable sidewise motion as the pole was raised.

By the time the antenna pole had reached the top of the gin pole each element section was in place and the entire beam ready for final raising into its supporting tower. This step was accomplished by another winch truck which had moved into position behind the supporting tower. Also, the mast had been lashed to the gin pole, thus enabling the winch truck used in elevating it this far to move around with the second truck, adding to its power. The cables from the two trucks were run over the top of the tower and made fast to the pole at the proper points to attain the most lift. One side of the tower had been left open to permit the mast to swing into its vertical position. Also, the steel plate at the 35-foot level was made so that a section was removable for the same purpose.

(Continued on page 110)

# Shielded Construction for the Medium-Power Transmitter

*A Three-Tube 150-Watt Rig for Four Bands*

BY DONALD H. MIX,\* W1TS

By this time, any ham within 50 miles of a TV station is well aware of the fact that he can no longer live in peace with his neighbors if he continues to use the rig he built 10 years ago, or even 3 years ago — no matter what he may consider his rights in the matter. The job of modifying the existing transmitter or building something new may seem at first like a sizable undertaking. To be sure, some of the early efforts at TVI-proofing did get to be pretty complicated and unbeautiful to the eye. But as the details of the technique begin to get ironed out, we find that the constructional job really is not an insurmountable one, nor necessarily prohibitively expensive. It is true that we can't get away any more with parts screwed to a breadboard. But that sort of construction has been almost forgotten for some time. As we've had occasion to observe before, many of the measures that TV has forced upon us are those that ought to be taken anyway for the sake of transmitter performance.

A glance at the circuit diagram of Fig. 1 shows that the only points that might be considered as departures from the conventional of the past several years are the use of link instead of capacitive coupling between the oscillator and amplifier, and the insertion of simple harmonic suppressors or filters in the power leads. The oscillator is a modified Pierce. It drives either a single 807 as a straight amplifier, or two of them as push-push doublers. When a single tube is used, the heater of the other 807 is turned off

\* Assistant Technical Editor, *QST*.

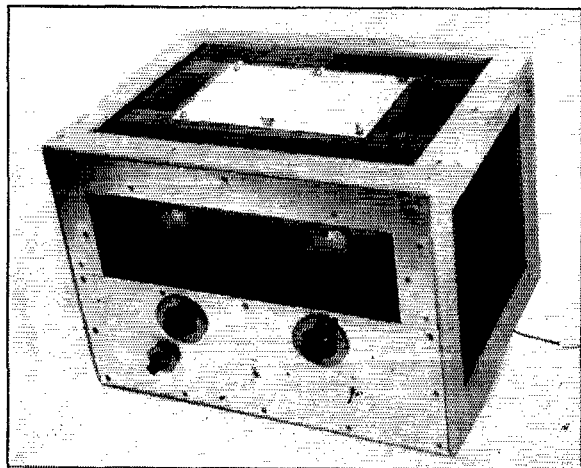

(S<sub>1</sub>) and the idle tube then serves as a neutralizing condenser for the other — an arrangement that has been used frequently in the past. When the two tubes are working as doublers, no neutralization is required, of course. By doubling frequency in the oscillator output circuit and doubling again in the final stage, 28-Mc. output is obtained with 7-Mc. crystals. VFO input can be used by means of capacitive coupling through a coax line and a plug (Millen 37412) that fits the crystal socket. The outer conductor of the coax line is grounded as close to the 6AG7 socket as practicable. When the plug is inserted, C<sub>1</sub> is grounded and serves as the screen by-pass for the 6AG7, while the grid is connected to the "hot" side of the VFO output.

Since the entire rig is designed to operate from a single power supply, VR tubes are used to stabilize the plate voltage for the oscillator. Adjustment of excitation and loading are not so critical if the screen supply is taken from a fixed-voltage source, rather than from series resistance. For this reason, the 807 screen voltage is also taken from the VR tap for c.w. operation. If the final is to be screen-and-plate-modulated, individual series screen resistors directly from the high-voltage terminal must be used. Each should have a rating of 50,000 ohms, 5 watts for operation at a plate voltage of 600. A small 45-volt biasing battery (90 volts for 'phone) mounted under the chassis serves to hold the amplifier input to a safe level when the oscillator is keyed.

The rig shown in the photos was built around the new 807-W tubes. Their smaller size permits a more compact arrangement with shorter leads, but in other respects, any superiority over the older type has not been conclusively established. V.h.f. parasitic suppression still is required, but the parasitic frequency is higher than that normally encountered with regular 807s and oscillation seems to be more readily discouraged. Longer experience is necessary before their possible advantages can be properly evaluated. In this instance, the insertion of small v.h.f. chokes in the plate leads and

The transmitter installed in its shielding enclosure. The illuminated meters can be read through the double-wall screening. The aluminum cover for the access opening is held tightly against the screening with wing nuts. Wood trim strips are used to cover the seams of the screening on all sides of the enclosure except the panel.



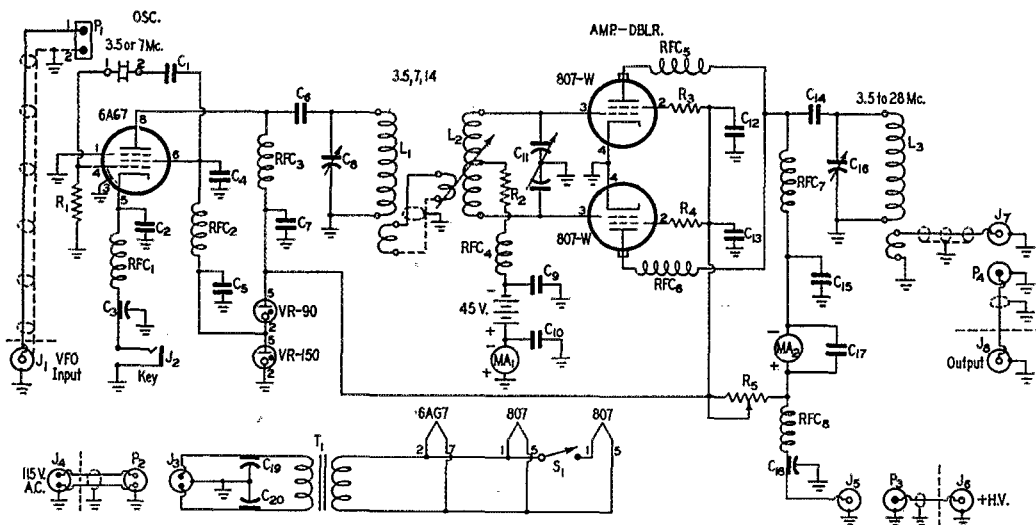

Fig. 1 — Circuit diagram of the shielded transmitter.

- $C_1, C_6$  — 0.002- $\mu$ fd. mica.  
 $C_2, C_5, C_7, C_9, C_{12}, C_{13}$  — 0.01- $\mu$ fd. ceramic disk.  
 $C_3$  — 0.01- $\mu$ fd. feed-through (Sprague 47P6).  
 $C_4$  — 25- $\mu$ fd. mica.  
 $C_8$  — 100- $\mu$ fd. variable (National ST-100).  
 $C_{10}, C_{17}$  — 0.001- $\mu$ fd. mica.  
 $C_{11}$  — 100- $\mu$ fd.-per-section variable (National STHD-100).  
 $C_{14}, C_{15}$  — 0.002- $\mu$ fd. 2000-volt silicone (Plasticon ASG13 Glassmike).  
 $C_{16}$  — 300- $\mu$ fd. variable (National TMS-300).  
 $C_{18}, C_{19}, C_{20}$  — 0.005- $\mu$ fd. feed-through (Sprague 46P8).  
 $R_1$  — 0.1 megohm,  $\frac{1}{2}$  watt.  
 $R_2$  — 1000 ohms, 1 watt.  
 $R_3, R_4$  — 100 ohms,  $\frac{1}{2}$  watt, noninductive.  
 $R_5$  — 15,000 ohms, 25 watts.  
 $L_1$  — 3.5 Mc. — 20  $\mu$ h. — 30 turns No. 22 d.s.c.,  $1\frac{1}{2}$  inches diam.,  $1\frac{1}{2}$  inches long, 4-turn link (National AR17-30-E with 26 turns removed).  
 — 7 Mc. — 10  $\mu$ h. — 18 turns No. 22 d.s.c.,  $1\frac{1}{2}$  inches diam.,  $1\frac{1}{2}$  inches long, 4-turn link (National AR17-40-E with 10 turns removed).  
 — 14 Mc. — 5  $\mu$ h. — 12 turns No. 22 d.s.c.,  $1\frac{1}{2}$  inches diam., 1 inch long, 3-turn link (National AR17-20-E).  
 $L_2$  — 3.5 Mc. — 40  $\mu$ h. — 38 turns No. 22 d.s.c. close-wound,  $1\frac{1}{2}$  inches diam., approx. 5-turn link over center (National AR17-30-S).  
 — 7 Mc. — 10  $\mu$ h. — 20 turns No. 22 d.s.c.,  $1\frac{1}{2}$  inches diam.,  $1\frac{1}{2}$  inches long, approx. 4-turn link over center (National AR17-40-S).  
 $L_3$  — 3.5 Mc. — 14  $\mu$ h. — 26 turns No. 18,  $1\frac{1}{8}$  inches diam.,  $2\frac{1}{2}$  inches long, 5-turn link (B & W JEL-40).  
 — 7 Mc. — 3  $\mu$ h. — 10 turns No. 18,  $1\frac{3}{8}$  inches diam., 2 inches long, 3-turn link (B & W JEL-20).  
 — 14 Mc. — 1.5  $\mu$ h. — 8 turns No. 14,  $1\frac{3}{8}$  inches diam., 2 inches long, 3-turn link (B & W JEL-10).  
 — 28 Mc. — 0.75  $\mu$ h. — 4 turns No. 14,  $1\frac{3}{8}$  inch diam., 1 inch long, 2-turn link (B & W JEL-6).  
 $J_1, J_7, J_8$  — Jones S-101-D connector.  
 $J_2$  — Open-circuit jack.  
 $J_3, J_4$  — Amphenol 80-PC2M connector.  
 $J_5, J_6$  — Amphenol 83-1R connector.  
 $MA_1$  — Milliammeter, 25-ma. scale.  
 $MA_2$  — Milliammeter, 300-ma. scale.  
 $P_1$  — Ribbon-line plug (Millen 37412).  
 $P_2$  — Amphenol 80-MCF1 connector.  
 $P_3$  — Amphenol 83-1SP connector.  
 $P_4$  — Jones P-101- $\frac{1}{4}$ -in. connector.  
 $RFC_1, RFC_3$  — 7- $\mu$ h. r.f. choke (Ohmite Z-50).  
 $RFC_2, RFC_4, RFC_6$  — 2.5-mh. choke (National R50).  
 $RFC_5, RFC_8$  — 8 turns No. 18,  $\frac{3}{4}$ -inch diam., close-wound (National R60—4  $\mu$ h. with turns removed).  
 $RFC_7$  — 1-mh. 300-ma. r.f. choke (National R300S).  
 $S_1$  — S.p.s.t. toggle.  
 $T_1$  — Filament transformer: 6.3 v., 2 a.

noninductive resistors at the screen terminals was all that was necessary to remove all tendency toward parasitic oscillation. As with other Sylvania 807s we have tried, optimum grid current seems to be 2 to 2.5 ma. maximum per tube, rather than the 3 to 4 ma. recommended for other brands.

Power-lead harmonic filtering consists of  $RFC_1$  and  $C_3$  in the keying lead,  $RFC_8$  and  $C_{18}$  in the high-voltage lead, and  $C_{19}$  and  $C_{20}$  in the a.c. line to the filament transformer. All power wiring is done with shielded wire. In the past, this has been found particularly beneficial in minimizing harmonic radiation from the power supply.

The transmitter may be keyed in the oscillator cathode circuit and meters are provided in the amplifier grid and plate circuits.

### Shielded Enclosure

The importance of shielding the transmitter has been pointed out in almost every writing dealing with TVI. Shielding is necessary to eliminate direct radiation of harmonics from the transmitter circuits and to make it possible for power-lead filters to do their job. In considering shielding enclosures, several factors, aside from those relating to shielding, must be taken into account. It was felt that screening made the most desirable (although perhaps not the most beautiful) type of enclosure, since it not only provides the necessary ventilation but also the visibility that most of us like to have just to make sure that something isn't burning up. Instead of trying to make a glove fit, it was

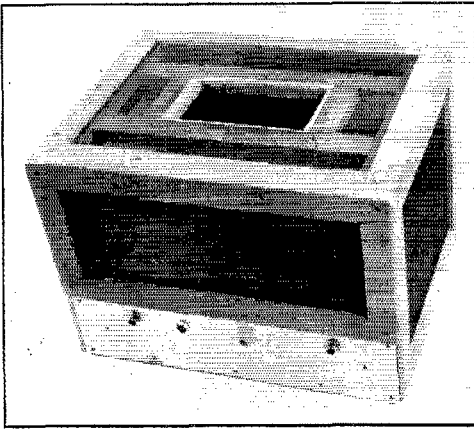

Rear view of the enclosure showing, from left to right, the shielded terminations for the r.f. output, a.c. line, key and VFO input. The trim strips have been added. The opening in the top provides access to the plug-in coils.

decided that the utility of the enclosure could be broadened by making the dimensions adequate to enclose the largest unit likely to be built. Thus, a rig can be made in quite conventional style on a standard chassis. Then the completed unit can be placed inside the enclosure and the control shafts extended, as necessary, to a control panel at the front of the enclosure. Shielded power leads can be used to connect the power terminals on the chassis to a shielded terminal strip at the rear of the enclosure, while standard panel bearings will keep the shielding complete at the front panel. The shielding of meters is no longer a problem, because they can be placed on a panel inside the enclosure where they can be read through the screening.

Double shielding, with the two shields insulated save at one point, is much more effective than single shielding, but it is considerably more difficult to build in practical form. Double-wall shielding with contacts between the shields has an effectiveness intermediate to the other two types and is much easier to apply.

The sketch of Fig. 2 will serve to illustrate the manner in which the enclosure is constructed. Each side (also top and bottom) consists basically of a square frame of 1 by 2 pine strip stock covered with bronze screening. Copper is better yet, although it is not always obtainable. Any sort of cabinetmaker's joint may be made at the corners of the frames if the builder has the necessary skill

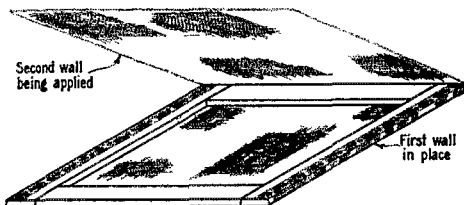

Fig. 2 — Two layers of screening are applied to each frame of the enclosure — one on each side of the frame.

and tools. Perhaps the easiest method for land-lubbers is simply to butt the four pieces and join them with iron angles from the dime store. To cover the edges of the frames as well as the openings, the first piece of screening is cut exactly to the *width* of the frame and about four inches longer than the length. Then one edge of the screen is tacked along the *front* face of the top strip. The screen is bent backward around the adjacent edge, stretched across the back of the frame, pulled around the opposite edge and tacked along the front face of the bottom strip. The second layer of screen is cut to a width equal to the *length* of the frame, and is applied to the *front* side of the frame in the same manner as that described above, except that it is wound around the frame in the opposite direction, i.e., from side to side, instead of from top to bottom. Fig. 3 suggests one method of stretching the screen tight. After tacking one end of the screen to the frame, the loose end is clamped between angle irons in a vise. When the bottom of the frame is pressed as indicated, the screen will be brought under tension while it is being tacked along the face of the upper edge of the frame.

The front and rear frames are constructed as shown in Fig. 4A. The intermediate strip is placed to come level with the top edge of the

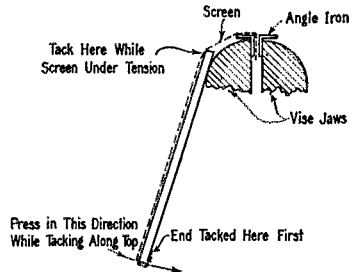

Fig. 3 — A suggested method for pulling the screen tight across the frame. See text.

aluminum control panel, or terminal board as the case may be. Both panel and terminal board should be brought tightly against the screening by generous use of wood screws. The construction of the top frame is shown in Fig. 4B. The additional framework makes provision for an access opening for changing coils and other minor adjustments. It is, of course, not necessary that the opening be placed at the center. It may be located wherever it is most convenient for reaching the desired parts of the transmitter. After this frame has been covered with screening, the screen across the opening can be slit and bent around the edges of the hole and tacked in place. Several long machine screws should be spaced around the edges of the opening so that the aluminum-sheet cover can be fastened down tightly against the screening with wing nuts. The cover should overlap the opening out to the edges of the wood framework around the hole.

The sides of the enclosure are fastened together tightly with several 1½-inch wood screws. The bottom can be removed for servicing underneath

The 807-Ws and their associated input and output tank circuits are constructed as a unit on a "U"-shaped bracket made from a single piece of aluminum sheet. This provides a low-inductance return from plate circuit to cathode independent of the chassis, as well as a measure of shielding between input and output circuits. The tank condensers are mounted directly on the bracket. The two coils are placed at right angles to minimize coupling. The resistors, chokes and by-pass condensers associated with the amplifier grid and screen circuits are grouped around the tube bases and connected with the shortest possible leads. Tubular-shaped  $C_{14}$  is supported (through a hole in the bracket) between the coil-socket terminal and the top of  $RFC_7$  which is mounted vertically between the two tubes. The parasitic chokes,  $RFC_5$  and  $RFC_6$ , are suspended between the tube caps and  $C_{14}$ . The oscillator components and the VR tubes are to the right. This view also shows the mounting of the meters and the shielded connections to the terminal board.

the chassis. Wood trim strips can be used to cover the seams of the screening if desired. Latticing wood is suitable if you don't care for something fancier.

The control shafts require holes in the two screening walls. The holes should be no larger than necessary. The ragged edges can be smoothed up by flowing solder around the rims of the holes after they have been cut.

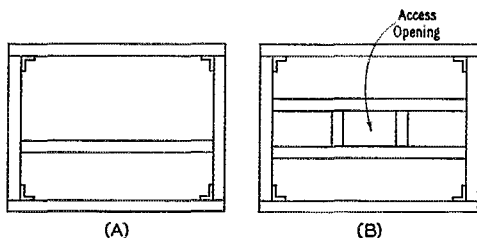
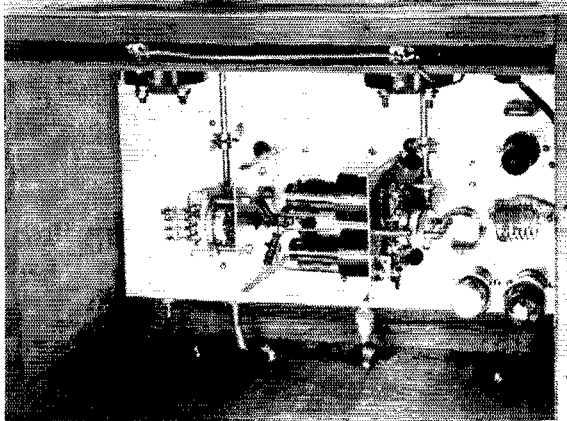

Fig. 4— In the front and back frames (A) a cross-piece is added as a support for the control panel and terminal board, respectively. The top frame (B) has additional members to accommodate an access opening.

All power and key wiring between the chassis and the terminal board at the rear should be shielded and the shield should be soldered to the screening as it passes through to the terminal board. Shielded fittings should be used as power terminals and it is advisable to use shielded wire between the terminal board and the power-supply unit.

The meters are mounted on a separate panel inside the enclosure. The panel is spaced away from the inner wall of screening by an inch or so. If there is any difficulty in reading the meters through the screening, 6.3-volt dial lamps operating from the filament transformer can be used to

The transmitter is built on a 17 × 10 × 3-inch chassis. The oscillator tank condenser is to the left, filament transformer and biasing battery to the right.  $R_5$  is at the center. On extension leads at the top are the key jack (mounted in a National microphone-jack shield), the meter lamps, the filament switch,  $S_1$ , and the meter leads with their by-pass condensers. All power wiring is done with shielded wire. Feed-through type by-pass condensers for harmonics are fastened directly to the a.c.-line and key terminals.



illuminate them. The lamps should be shaded toward the front to cut off the glare.

### Adjustment

With the VR tubes in place, but the other tubes out of their sockets,  $R_5$  should be adjusted until a meter connected externally in the high-voltage lead reads 40 ma. The remainder of the adjustment is quite conventional, remembering that it is possible to double frequency both in the output circuit and in the output stage. Thus, output can be obtained up to the 14-Mc. band with 80-meter crystals and up to the 28-Mc. band with 7-Mc. crystals.  $C_3L_1$  and  $C_{11}L_2$  should always be adjusted to the same frequency, of course.

When using a VFO, it is preferable to have the VFO output one band lower than the band to which the 6AG7 output circuit will be tuned. This avoids possible instability in the 6AG7 stage.

For maximum rated c.w. output, a 750-volt 300-ma. power supply is required (600 volts for 'phone). But a lower-voltage supply may be used for less than full output. If the supply voltage falls much below 400 volts, however, the VR tubes will not operate, unless lower-voltage VRs are used, thus reducing oscillator and screen voltages. As mentioned previously, the 807-Ws seem to work best with less than the usually-rated grid current of 3 to 4 ma. per tube. If the grid current is run much above 2 ma. per tube, the screen current becomes excessive. At lower plate voltages, even less grid current may become desirable. At maximum plate voltage, the loaded plate current should be limited to 100 ma. per

(Continued on page 110)

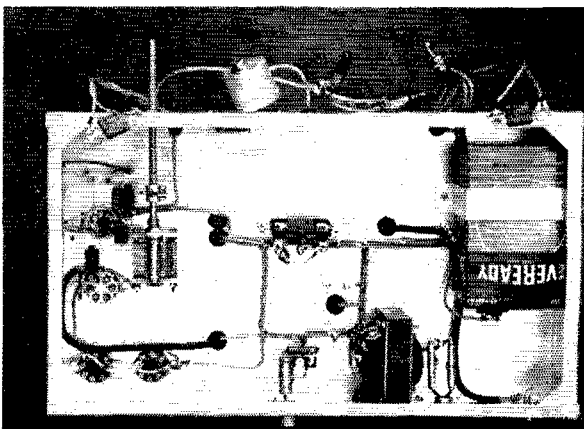

# Bandwidth of Two- and Three-Element Yagi Antennas

BY J. P. SHANKLIN,\* EX-W3CJH

**I**N spite of the wide use of the Yagi antenna, little information is available as to the width of the band over which the pattern and match will remain acceptable. To throw some light on this subject extensive tests were made on the two-element Yagi, and on a three-element Yagi having 0.3-wavelength spacing between the director and reflector.

The tests were made near 28 megacycles. The antenna was located in a large field and an automatic radiation-pattern plotter was used to investigate pattern bandwidth. Input impedance was measured on a specially-constructed impedance bridge. Impedance measurements were made through 60 feet of 52-ohm coaxial cable with due allowance for cable loss and electrical length.

In the tests both element lengths and spacing were varied. With each new dimensional combination, a series of radiation patterns and input-impedance measurements were made throughout the frequency range over which the voltage front-to-back ratio remained over 3 to 1. When making impedance measurements, the length of the fed element was adjusted so as to place resonance at approximately the frequency of least back radiation.

When the input impedance of the various antennas was plotted against frequency, it was found that the resistive component of the impedance remained approximately constant in all cases, while the reactive component plotted an approximately straight sloping line. This showed that the antenna input impedance performs very much like a simple series-resonant circuit, so the values of  $L$ ,  $C$ ,  $R$  and  $Q$  of this equivalent circuit were calculated. The results of these measurements and calculations on the two-element Yagi are given in Table I.

The information in Table I will hold exactly only for elements of approximately the same length-to-diameter ratio as those used in the tests. This ratio was 330. However, the data should be sufficiently accurate for the construction of practical antennas using ratios between about 200 and 400. This range will cover most 10- and 20-meter "plumber's delight" antennas.

The forward gain and beamwidth of the two-element antenna did not vary much with the three spacings tried. The beamwidth at band center was close to 64 degrees and varied little over the band. This corresponds to a gain of 5 db. The frequency range of low back radiation was rather narrow.

Having the input resistance and  $Q$  of the antenna, one would like to know how good a match can be obtained to the feed line and over what bandwidth. The standing-wave ratio on the feed line is caused by a resistance mismatch and/or the presence of reactance in the input impedance

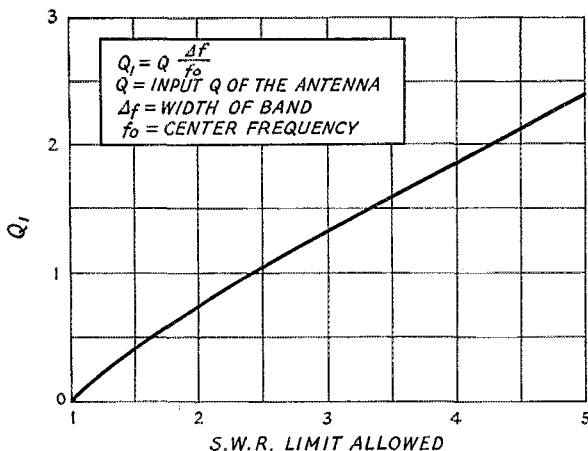

Fig. 1—This curve permits determining the frequency band that can be covered without exceeding a specified standing-wave ratio providing the  $Q$  of the antenna (as defined in the text) is known.

The feed cable was attached to the fed element by the use of the balun or balancing transformer shown in Fig. 2. The constants of this balun are such that the true feed impedance of the antenna could be measured through it over considerable bandwidths without resetting the shorting bar.

## The Two-Element Yagi

The two-element Yagi, due to its simplicity, was thoroughly investigated. The antenna in which the parasitic element acts as a director was found to have the most desirable characteristics.

\*% Research Division, Collins Radio Co., Cedar Rapids, Iowa.

TABLE I  
Feed Impedance and Front-to-Back Ratio of a Fed Dipole with One Director

Element Spacing	Fed Dipole Length	Director Length	Input Resistance at Band Center	Q	Front-to-Back Ratio at Band Center
0.050λ	0.509λ	0.484λ	13.2 Ω	53.2	20
0.075	0.504	0.476	24.4	29.4	8.3
0.100	0.504	0.469	28.1	20.0	4.3

• So far as we know, this is the first comprehensive treatment published anywhere on the plaguing question of the frequency range that can be covered by a parasitic beam. The author discusses it from the standpoints of front-to-back ratio and impedance variation, and gives curves useful for design purposes.

of the antenna. At resonance there is no reactance. The s.w.r. increases line losses and may make matching the transmitter and receiver to the line more difficult. If RG-8/U 52-ohm coaxial cable is used an s.w.r. of 3 to 1 will not cause serious line loss. With lower-loss open-wire lines a higher s.w.r. is allowable.

If the resonant-antenna impedance is lower than the line impedance, as will be true of most Yagis if fed with 52-ohm or 75-ohm lines, the s.w.r. at the band center will be  $Z_0/R$ , where  $Z_0$  is the surge impedance of the feed line and  $R$  is the resonant impedance of the antenna. It can be shown that to obtain the best band coverage, when the antenna impedance varies with frequency in the same way as the impedance of a series-resonant circuit, the resonant impedance should be somewhat below line impedance. If a maximum s.w.r. of 2 to 1 is to be allowed, the antenna impedance should be 80 per cent of line impedance. If an s.w.r. of 3 to 1 is allowed, the antenna impedance should be 60 per cent of line impedance.

Having satisfied the above condition, the approximate per cent bandwidth which the antenna will cover may be gotten from the curves of Fig. 1 with the help of the equation given in the figure.

The two-element Yagi spaced 0.075 wavelength will match with less than 3-to-1 s.w.r.

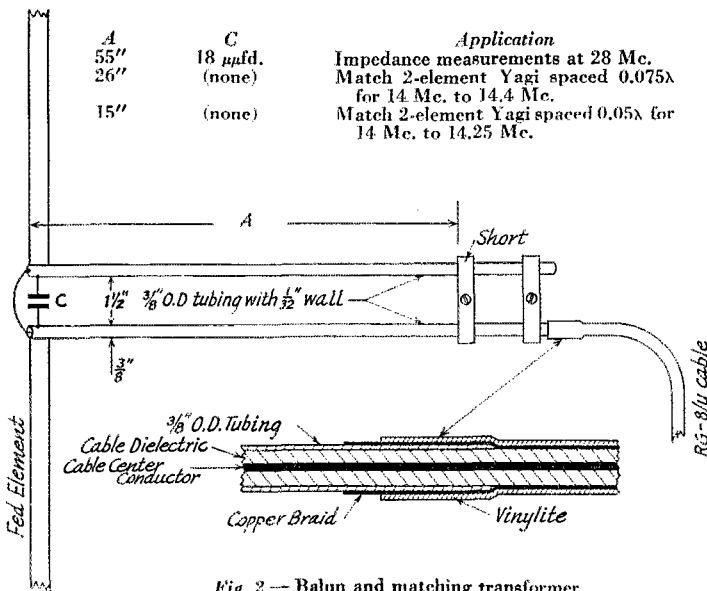

Fig. 2 — Balun and matching transformer.

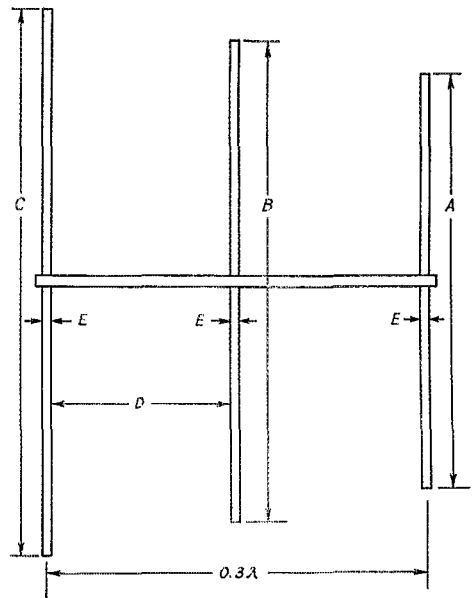

Fig. 3 — The three-element antenna on which tests were made. The length-to-diameter ratio of the elements ( $A/E$ ,  $B/E$ , and  $C/E$ ) was approximately 330.

over the band in which the front-to-back ratio remains more than 3 to 1 (about 10 db.) and is sufficiently broadband to cover the 14–14.4 Mc. band. However, it will not cover the band from 26.96 to 29.7 Mc. The resonant impedance of 24.4 ohms is slightly low for use with a 52-ohm feed line. This may be corrected by the type of balun shown in Fig. 2. The short balun with no loading capacity, used on 14 Mc., acts as a shunt inductance; the fed element is shortened approximately 14 inches to supply capacitance and so restore resonance.

With 0.05-wavelength spacing a better front-to-back ratio is obtained, particularly at band center, but the  $Q$  is so high that the antenna will not cover the whole 14–14.4 Mc. band. The approximate balun length for matching this antenna is also given in Fig. 2. In this case the fed element should be shortened about 2 feet.

It should be remembered that these arrays tune very sharply. The balun dimensions given in Fig. 2 are from theoretical calculations and will probably not be exact in all cases.

The two-element Yagi in which the parasitic element acts as a reflector proved to be broadband, but to have a rather poor

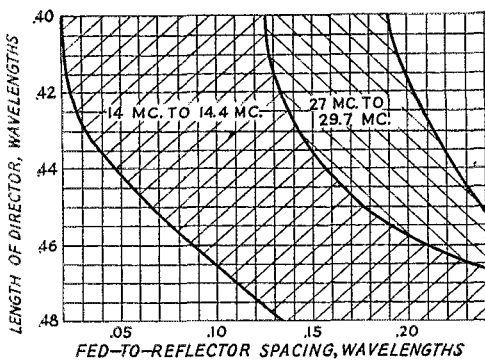

Fig. 4—Effect of director length and spacing between fed element and reflector on front-to-back ratio, three-element antenna. Shaded areas are for more than 1-to-1 voltage front-to-back ratio over the frequency ranges designated.

In the case of the 14-Mc. range the front-to-back ratio is greater than 4 to 1 anywhere to the right of the curve bounding the left-hand side of the shaded area. The bandwidth as defined by this limiting front-to-back ratio becomes greater in the upper right-hand portion of the figure (wide-band region), and less in the lower portion of the shaded area (narrow-band region).

The 27-29.7 Mc. range has the greatest bandwidth approximately midway between the two boundary curves.

front-to-back ratio. The highest front-to-back ratio found was 6.5 (16 db.) at band center and occurred with 0.2-wavelength spacing. The input resistance was 72 ohms and the  $Q$  was 4.7.

### The Three-Element Yagi

The three-element Yagi has five or six variables so far as pattern bandwidth is concerned. In order to reduce these to a reasonable number, it was decided to use an element length-to-diameter ratio of 330 and to fix the distance from the reflector to the director at 0.3 wavelength. The pattern will then be affected by the distance from the fed element to the reflector (distance  $D$  in Fig. 3) and the lengths of the director and reflector ( $A$  and  $C$  in Fig. 3). The length  $B$  of the fed element will affect only the input impedance if  $B$  is near a half wavelength.

With each set of dimensions tried, a series of radiation patterns and input-impedance measure-

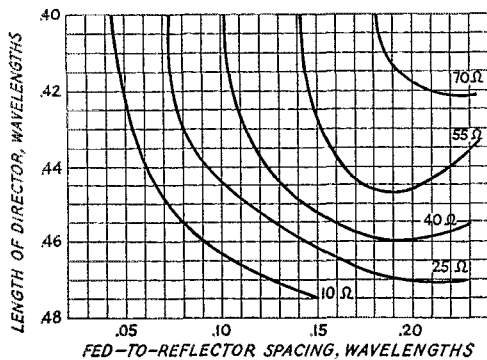

Fig. 5—Resonant resistance of fed dipole in a 3-element Yagi antenna, over-all length 0.3 wavelength.

ments were made over the frequency range for which the front-to-back ratio remained over 3 to 1.

The front-to-back ratio was found to be much more sensitive to frequency than the forward beamwidth. Fig. 4 was prepared to give some idea of the region over which good front-to-back ratios can be expected. The two shaded areas show the range of adjustment of director length and fed-element-to-reflector spacing within which a greater than 4-to-1 (12 db.) front-to-back ratio can be maintained in (1) the band 14-14.4 Mc., and (2) over the wider 27-29.7 Mc. range. The best reflector length did not vary greatly. It remained about 0.510 wavelength within the narrow-band region and became about 0.525 wavelength in the wide-band region.

As for forward beamwidth, in general the narrow-band region of Fig. 4 corresponds to sharper beams, and the broadband region to broader beams, though there is some advantage, in respect to forward beamwidth, in using the longest director that is consistent with the desired bandwidth. The total range of beamwidth variation was from 58 degrees to 72 degrees. This corresponds to a range of 5.9 db. to 4.1 db. in gain over a single halfwave dipole.<sup>1</sup>

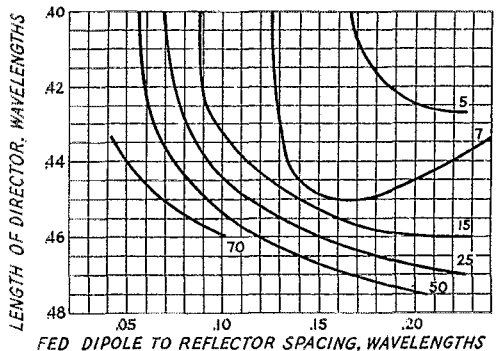

Fig. 6— $Q$  of input impedance of fed dipole in a 3-element Yagi antenna, over-all length 0.3 wavelength.

As for input impedance, Fig. 5 shows the resonant resistance of the fed element as it varies with director length and fed-to-director spacing. Fig. 6 shows how the  $Q$  of the input impedance varies under the same conditions. The approximate matching range of the input impedance may be calculated by applying the  $Q$  from Fig. 6 to Fig. 1 as was described before.

The proper length for the fed element was found to remain very near 0.49 wavelength at band center.

(Continued on page 112)

<sup>1</sup> It is well to keep in mind here that such gains do not necessarily represent the most that can be obtained with a three-element antenna of the same over-all length. Higher gains may be achieved by the use of longer directors and smaller reflector-to-fed-element spacings than those investigated. Such antennas have a very low input impedance, high  $Q$ , and the front-to-back ratio remains poor at all frequencies.

# QSL Cards

BY L. A. MORROW, W1VG

"ANY mail for me?" Daily, from coast to coast, the cry goes up. Is it from fair maidens pining for words of devotion from stalwart admirers? From grizzled tycoons with secret mergers pending? No. It's the plaintive, hopeful question of 50,000 active hams who are looking for the most important mail in the world — to them: QSL cards.

This scene, so familiar in U. S. homes, is repeated all over the world. To the PK4 near the Equator, to the VES above the Arctic Circle, yes, even to the KB6 on a dot in the vast Pacific, "mail" means QSLs.

It's a fact that ever since amateurs began to communicate with each other they have wanted written confirmations of the contacts. In the beginning a principal reason was probably that fading, interference from other spark stations

## Why a QSL?

Although reports on signals heard but not worked are often desired by the v.h.f. gang, the real function of a QSL is to confirm a QSO. The card must provide a place for the call letters of the station worked and it must state definitely that it confirms a two-way contact with that station. It should plainly show the other station's call, the signal report, the frequency band used, the date and time of the contact and whether it was on c.w. or 'phone. (If nothing appears regarding the use of c.w. or 'phone, and unless the report is of the Q — R — or RS — type in an authorized band, confirmation is for a c.w. contact.) The name and address of the station owner as well as the station call letters should be on the card.

Oh, sure, everyone knows that. But, unfortunately, everyone does not remember it. Many a pretty QSL has been rejected for WAS, DXCC or some other ARRL award because the designer was so art conscious that he let the signal-report line look like a confirmation of heard signals instead of signals worked.

Some foreign awards require that a certain minimum signal report be shown on the cards submitted and others necessitate designation of the frequency band used.

So let's look again for the ten things on our cards: *Our call, name, complete address; other station's call; fact that card confirms a QSO; mode of transmission, frequency band used, signal report, date, time.*

Where should the essential data appear? It's a matter of personal preference. The put-it-on-the-back gang says the card can be made neater and more attractive that way, while the show-everything boys contend that no one wants to take a card out of an album or off the wall to look at the back, and attractiveness need not be sacrificed when the signal report and all the rest of it are where they can be seen at a glance.



No art work, no frills, but everything necessary for the complete story of the QSO printed on the front. Black type on a Government postal. Remember when Alabama was in the Fifth District?

and static kept communication from being reliable, and it was encouraging to receive a letter or even a post card telling how loud and clear signals had been before QSS (as fading was then called) or QRM got in its dirty work.

But it's old stuff now, some of us think. Sending a card, for example, to confirm a rag chew between a W0 in Iowa and a W3 in Pennsylvania — why, that went out with two-tube bloopers. Well, maybe it's old stuff for the old timers (although it is kind of funny to see them knocking themselves out begging for QSLs from rare countries), but exchanging cards with each other is still a kick for most of us. Maybe we aren't the 35-w.p.m. traffic handlers, the red-hot contest operators, the DX hounds. But we are the ones who are on the air night after night. We're the majority in ham radio. Come to think of it, we practically are ham radio.

So let's keep this pleasant, and in many cases helpful, custom. And let's not look down our Class A noses at the newcomers when they say at 15 w.p.m., "Pse QSL OM I need ur card." We were all newcomers once.

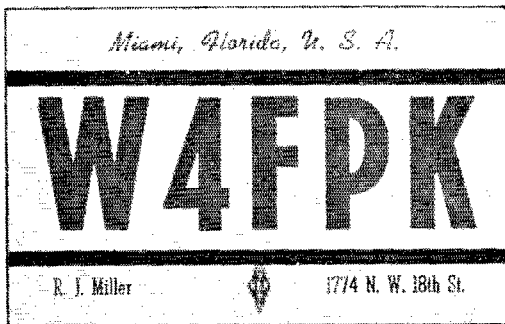

Clean-cut, neat and inexpensive, with blue type and two red stripes on a white background, W4FPK's card carries essential data on the address side.

But we must be sure to have the essential information — including our calls — on the back if it is not on the front; otherwise the card is just a picture post card, not a complete QSL.

The Postal Regulations' maximum dimensions of a card which takes 1¢ for domestic mailing are  $5\frac{5}{16}$  inches by  $3\frac{3}{16}$  inches. (Minimum: 4 inches by  $2\frac{3}{4}$  inches.) A Government postal is  $5\frac{1}{2}$  inches by  $3\frac{1}{4}$  inches but the standard size for QSLs is  $5\frac{1}{2}$  inches by  $3\frac{1}{2}$  inches, and most of us make our cards conform to those dimensions. Since use of a folded card raises a postage problem, it's a good idea to check with the post office before ordering that kind.

It is generally easier to take care of a card of standard size and even though a large QSL may be impressive when first received it is liable to become a nuisance and end its career folded, filed and forgotten.

### What Kind of Card?

No doubt we would all like to have QSLs that are individualistic, but the fact that there are some 125,000 licensed amateurs in the world makes it tough for any one of us to be original.

Still, advantage can be taken of a well-known characteristic of a state (wheat fields of the Dakotas, cowhands of Wyoming, Republicans of Maine) or country (coffee plantations of Brazil, bull fights of Spain), and the big-city ham can include on his card a photo or drawing of an easily identified feature of his city (Golden Gate Bridge, Big Ben, Eiffel Tower). Locating the city and country on a well-designed map is another idea that can be used in several different ways.

There was a time when QSLs were cluttered up with all sorts of information ranging from dates of past contest victories to a list of all the crystal frequencies employed. It is still customary to include important awards like DXCC and perhaps a brief description of the station — a v.h.f. station, especially — but the trend is definitely toward clean, neat cards with a minimum of copy. Essential information should not be left out.



The photograph of New York could hardly be mistaken for that of any other city. Printed from a half-tone plate, it shows through the blue call-letter overprint. The same overprint takes care of blue QSO data and blue border with white card showing through it for name and address. W2ZY gets in the ten essentials by writing both date and time on the date line, by designating c.w. or "phone after "band," and by crossing out the "1" when filling in the RS report.

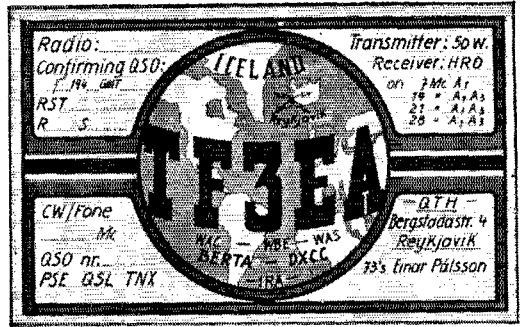

The gray-and-white map shows the QTH clearly. Lettering is black, call and two short horizontal stripes red outlined in black, rest of trim blue with black outline. Printed from a set of color plates.

We can pay a lot or a little for our cards. Printing colors from a combination line and half-tone plate made from an artist's hand lettering on a professional photographer's picture is the most costly. Photographer's, artist's and photoengraver's bills may total as much as \$50 and the cards printed in three or four colors may run as high as 5¢ each. On the other hand a QSL printer's stock card on which he overprints a call, name and address may be bought for as little as \$1.50 per hundred cards, postpaid.

Addresses of several QSL printers may be found in the Ham-Ad column of any issue of QST. For an elaborate card printed from a plate it is probably best to talk to a local photoengraver in order to get the project started.

But cards do not have to be printed. It is possible to mimeograph, use a rubber stamp, imprint from a homemade linoleum cut, draw and letter each card by hand, or use photography. Mimeographed cards are pretty sad and QSLs made from a rubber stamp are often not much better, although at least one firm does offer a stamp which is being used quite successfully.

A linoleum cut can be made by drawing the card design in reverse on a piece of linoleum, gouging out the background of the design, and mounting so that the cut can be used like a rubber stamp. It may as well be admitted, however, that the resulting card is not apt to take many prizes for looks.

Any of us who are fortunate enough to have artistic talent can turn out QSLs that are real gems, and each one can be different, too. But making cards by hand soon gets to be a grim business. The project generally ends by having the cards printed in black and white from a plate incorporating the best ideas from several QSLs. Then the only handwork remaining is coloring each card — and that can be omitted.

The ham who is an amateur photographer can let his imagination run wild, and emerge from the darkroom with almost anything. It might be a card showing just his call but it could be one with a view of his station, his antenna, his house and his family — including Ida, the maiden aunt with the china choppers.



The shutter bugs say it's neither hard nor expensive to make QSLs. Hamid Durmisevich, W6DQZ, outlines the job on his card something like this:

First, he took a good picture of his station. The negative measured  $2\frac{3}{8}$  inches by  $1\frac{1}{8}$  inches. Next, his brother laid out and lettered in India ink the card design, leaving a space for the station picture. (What, your brother is only two years old? Well. . . .) The layout was made on white stock measuring approximately 14 inches by 9 inches so that possible raggedness in lettering would be less noticeable when the reduction to QSL card size was made.

A  $5\frac{1}{2}$ -by- $3\frac{1}{2}$ -inch picture was then taken of the card and the place saved for the station picture was cut out of the negative. The last step was to fasten carefully with opaque tape the  $2\frac{3}{8}$ -by- $1\frac{1}{8}$ -inch picture negative into the cutout.

The  $5\frac{1}{2}$ -by- $3\frac{1}{2}$ -inch QSLs are contact-printed from this patched negative on regular sensitized post cards which have a semi-matte surface so they will take ink well.

This method is good when the station picture is a convenient size for the card. It has the desirable feature of permitting new station negatives to be patched into the old card layout negative when new pictures of the rig are taken. However, the patching-in must be done with extreme care or the station picture will not be square with the rest of the card.

When the station picture is too large to fit the QSL card a different procedure may be followed. Paste flat, with no wrinkles, a good print of the station picture on a proportionately large layout card, and, after adding the India ink lettering to the card, photograph this assembly. The new negative should be  $5\frac{1}{2}$  inches by  $3\frac{1}{2}$  inches so that contact prints on the sensitized post cards can be made from it.

In *QST* for October, 1939, several novel methods of obtaining negatives for contact print QSLs were described, and a procedure for making silhouette cards was outlined in the November, 1938, issue.

A QSL drawn by a good cartoonist can be effective when the picture tells a story and when the card is rather plain. Too many details usually result in humorless confusion.

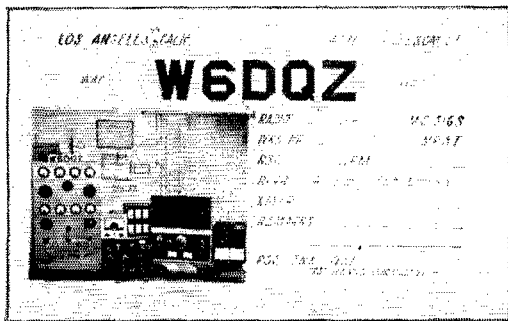

A photographic QSL. The text tells how W6DQZ made it.



Simultaneous sublimation of individual and aggregation. Each member's call is set up in type and printed in black on the familiar red, white and blue card.

Use of the same style card by members of a radio club helps make both the club and the members better known. Haven't we all heard something like the following? "W3BES? Oh, sure. Belongs to the Frankford Radio Club."

Sending special QSLs after contests is a good custom although not very common, unfortunately. We want to be sure that this type of card confirms a contact, however, or it will be nothing but a souvenir.

When designing a colored QSL it's wise to bear in mind that the card may appear in a picture of another ham's station, so we may as well choose colors that won't fade out when photographed. Red on white and black on white are good. Dark green, purple, blue and brown will come through. Pastel shades are apt to disappear.

### Flash! How To Get a QSL for Every Card Sent Out

That would be front page news, all right, but let's not fool ourselves. No one ever doped out a way to get an answer to every QSL and no one ever will. Most fellows will send a card for every card received, others will send a card to everybody but us (at least it seems that way), but a few just won't send cards at all.

Yes, a few just won't send cards at all — but only a few, and the fact that nearly every one of the 125,000 hams all over the world will buy, fill out and mail QSLs is one of the bright spots in amateur radio.

The QSL problem is a real one for many stations and the rarer the country, the greater the problem. It's so acute for some of the foreign amateurs that they almost hate to go on the air. And we may as well face it: The reason is largely because of us Ws.

All of the U. S. hams can never work a particular DX station. There are too many of us. But we keep on trying and each time he comes on a few of us succeed. Well, that's okay except that each one of us begs for a card with the result that the DX fellow is forced to spend about half his ham radio time doing clerical work — or get a reputation as a you-know-what because he won't QSL 100 per cent.



From the sixth through the sixteenth SS, this special contest card has been used each year by WIBEF. Sometimes it's red on white, sometimes blue on white, always with the same line-cut background. Appropriate annual changes are made in the type overprint.

The solution? Probably there isn't any. But there is one thing we can do: We can make it as painless for him as possible. Let's not ask him to send his card direct; it's expensive and even if we mail him International Reply Coupons he has to take more of his precious operating time to go through the stack he is getting ready for the QSL bureau, find the one for us, put it in an envelope and mail it.

Let's hold back on the sob letters until we are sure the card is not coming. The chances are that he's immune, anyway. He knows as well as we do that he is our first ZD7 and if he'd wring the tears out of all the letters he receives he'd have to operate maritime-mobile.

As for working him again just to tell him his card has not come — while the line-up curses fervidly — it's like Dorothy Dix's best advice to young girls: Don't do it.

The QSL bureau systems will function if we give them the opportunity. Most countries have bureaus and they all operate along the same lines. The ARRL QSL Bureau has been working successfully since 1933, and the twenty-two QSL managers in the United States, the U. S. Possessions and Canada are pretty sharp at running it. Imagine handling 7000 to 10,000 cards each month at no charge. Some fun! They may not be dukes, but hats off to them, anyway.

The bureau system saves both time and postage expense for foreign hams. Instead of mailing each card singly, the foreign operator sends his cards in bundles to the ARRL QSL managers, either direct or by way of his own bureau. Each of us keeps in the hands of the QSL manager for his call area a No. 10 stationer's size self-addressed and stamped envelope with our call plainly printed in ink in the upper left-hand corner. The QSL manager sorts the incoming cards and puts them in the proper envelopes, mailing the envelopes when they fill up. (We don't want to forget to send him another as soon as we receive one.) A list of ARRL QSL managers is published in *QST* every other month starting with the January issue each year.

How long should we wait, how long does it take for a W to get a DX card via the QSL Bureau system? The answer depends primarily upon

the foreigner's habits. Does he QSL every U. S. station worked, sending the cards in packages each month to the proper W QSL bureau? (If he does he's our boy!)

And what about us? Do we at all times keep an envelope in the hands of the QSL manager?

If he does and we do, then the shortest time between our QSO and his sending the card will be about a week, the time required for the package to reach our W QSL bureau will be about three weeks, and even if the QSL manager — who is generally up to here in cards — is able to open the package and put our card in our envelope immediately, the envelope may stay there another two weeks until it has enough cards in it to make it worth mailing. One week plus three weeks plus two weeks makes six weeks.

But suppose the other fellow sends QSLs only in answer to cards received, shipping through his own bureau three or four times a year. In about one week, if air mail is used, our card reaches him. In twelve more weeks his card in reply may go to his QSL bureau to wait twelve more weeks for an accumulation. Transit time to the U. S. will be about three weeks and if the foreign bureau sends the package to ARRL Headquarters another two weeks may elapse before the cards can be sorted in West Hartford, mailed and received by the QSL manager. In about two more weeks we receive the card. This adds up to thirty-two long weeks — eight months. Actually, the time consumed may be as much as a year.

Most cases will lie somewhere between these extremes. However, we can see that the time required to receive a foreign card via the ARRL QSL Bureau system may be anything from six weeks to a year, so there's no use getting ansy. We can mail another of our QSLs, of course, but when we are waiting for that last card to make DXCC, it's not the ability to write a tear jerker nor a scheme for sending a \$200 receiver to the fellow that we need: it's patience.

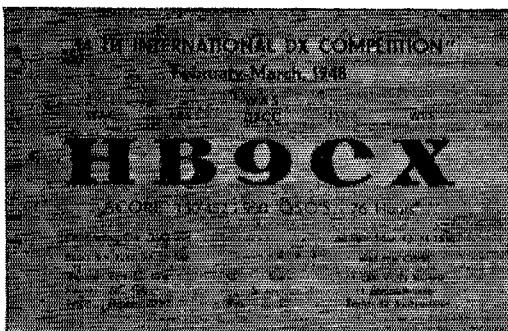

Neat, complete, hard-to-beat. Underlining the month, date, band, and using contest number instead of time of QSO left HB9CX with nothing to write on his 1918 DX Contest c.w. QSL except the other station's call and signal report. Score details, equipment, antenna, and awards are included in the black printing from type on a salmon-colored background. His 'phone QSL for the DX Contest of the same year was printed in black on a buff card. The only differences in copy were score details, dates, code numbers, bands, and "fone" instead of "c.w."

Occasionally a DX station sets up a special method of QSLing through another ham who handles the cards, but the two principal ways for us to send cards to foreign amateurs are direct and through his QSL bureau.

If he's in a rare country and if we know his address, having gotten it over the air or from a pal, the *Call Book* or "How's DX?" we'll probably be at the post office, panting, a few minutes after he signs off. But if we don't know his address and have no information on a special method, we ought to send the card to his own QSL bureau whether he said to or not. The only time we should send a card to ARRL Headquarters is when the station is under cover and when we're sure the QSL information has not been given in "How's DX?" in *QST* during the last few months.

If he's in a country having lots of active hams we are apt to send the card to his bureau, perhaps waiting until we have an accumulation of QSLs for that country.

And when should the card be sent to the QSL manager in our own call area? The answer to that one is easy: Never. Our QSL managers have all they can do to take care of incoming foreign QSLs, and that is the only kind they can handle.

A revised list of the foreign QSL bureaus with addresses is printed in "I.A.R.U. News" of the June and December issues of *QST* each year and brought up to date in other months as information is received at ARRL Headquarters.

Getting cards from Ws is not so serious a problem — at least for other Ws. If the only hams we ever worked in Utah or Vermont won't answer our QSLs, we can dig around and work others.

The greatest task seems to be the one faced by the beginner who wants to get 48 cards from 48 states. A WAS Certificate looks a long way off to a new ham running fifty watts to an 807. "Pse QSL OM I need ur card." Let's send it to him. Let's send it to him right away, without waiting for his. Surely we can spend a minute and a 1¢ stamp. Maybe the card will give him a lift just when he's beginning to believe that all hams are so-and-so's and that he'd be happier flying model planes.

There's one only way for Ws — and VEs — to send cards to each other, and that's direct. Neither the QSL manager nor ARRL Headquarters can handle the QSLs. Addresses can nearly always be found in the current edition of the *Radio Amateur Call Book*.

### What To Do with the Cards

And now let's consider that happy day of rest after the cards we wanted so badly have actually been received and sent to ARRL. The shiny certificates have been framed and hung with gentle hands where all visitors, including the Thursday Night Canasta, Conversation and Culture Club, can see them. The QSLs will soon be back from West Hartford and others are coming in, too, both via the QSL manager and direct.

What shall we do with the cards? Shall we display them on the wall or in an album, or shall we

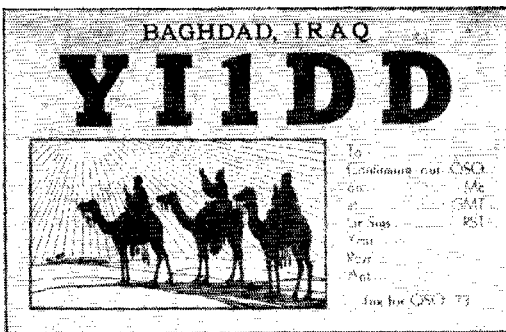

With an illustration like this the card just has to be from Iraq. A combination of type and a line cut made from the silhouette drawing, it's printed in green on white.

find a safe resting place and put them tenderly to bed?

Opinions vary. Some of the old timers are apt to smile a little at QSL wallpaper but probably most hams put up each card as soon as the post-man lets go of it, whether it's from the Indian Ocean or Indianapolis. The cards are usually thumb-tacked to the wall, although the schemes shown in the February, 1938, issue of *QST* for using wire, string or Scotch tape work well.

A plan followed by many DX men is to put some of the choice QSLs on the wall, perhaps grouping them around a world map or WAC Certificate, or to fix up a DXCC album with each page devoted to the best card from a given country.

We don't want to forget the fellow who always keeps a few QSLs in the most accessible place of all, his pocket. "Speaking of DX," he says, interrupting a traveling salesman story with a new twist, "I just happened to have these with me." It's easy to stop him, though — just tell him we worked the same guys on 160.

Sometimes a 48-page WAS book is made from a photograph album with room for three cards on each page to take care of a three-band WAS display. The cards can be fastened in with gummed corners or draftsman's Scotch tape, or put in transparent envelopes which are glued to the pages. Perhaps, instead of the album, the 48 cards are tacked on the wall around a map of the United States.

One group declares that it's foolish to display QSLs at all. They maintain that visiting hams would rather talk about their own cards and that non-hams don't know what it's all about, anyway. Their advice is to get a good file drawer, probably a used one from an office supply store, and file the DX cards first by continents, then by countries, then alphabetically by calls within each country. Tab cards to separate continents and countries are easily home-made. Ws and VEs are filed behind the DX cards, or in another drawer if we're lucky enough to need another, by call areas and then by states and provinces within the call areas. With this system, finding a card is both easy and fast and any QSL can be taken out

(Continued on page 112)

# More Selectivity at Low Cost

BY GERT M. F. MOSLER,\* LU7CW

THE constant increase in the number of amateur stations and their power leaves much to be desired in most of our homemade receivers, especially those which do not have a crystal filter stage. The inclusion of an i.f. filter is expensive outside the U.S.A., in view of the difficulties in getting hold of a good i.f. crystal, the special transformers, and the differential condenser. Though the circuit to be described is nothing new, I believe that many amateurs can benefit from it.

A 456-kc. tuned circuit of the type usually encountered in commercially-available i.f. transformers with a normal  $Q$  of 120 gives an attenuation of about 3.5 db. at 2 kc. off resonance, according to the *Radiotron Designer's Handbook*, while one 175-kc. tuned circuit with a normal  $Q$  of 80 gives an attenuation of 8.5 db. at 2 kc. off. This shows that the lower frequency is superior in selectivity, and by using the double-conversion system excellent results can be achieved at extremely low cost. As I was looking for maximum selectivity, especially for c.w. work, I decided to use the two windings of a 175-kc. transformer in series to get an even lower i.f. due to the increased inductance.

\* Ramon L. Falcon, No. 4923, Buenos Aires, Argentina.

• If you can't get a BC-453 cheap or, like LU7CW, live in a country where parts are expensive and hard to obtain, here's a simple Q5-er that can be built from b.c. replacement components.

## The Circuit

Fig. 1 shows the complete circuit. The second converter is hooked between the last i.f. transformer and the second detector of an existing receiver, and is composed of one converter tube (of any type you prefer) which transforms the original i.f. of 456 kc. (or what have you) to 80 to 100 kc. The new frequency is then amplified using any tube of the r.f. pentode type, and fed to a diode-triode detector-amplifier. The audio output is applied to the grid of the power stage in the receiver.

To make the low-frequency coils, get two 175-kc. i.f. transformers (preferably, although not necessarily, the iron-core type) and pull the coil assemblies out of the cans. Unsolder the coils from the trimmer condensers, pull out the iron cores, if any, and cut the tube that supports the

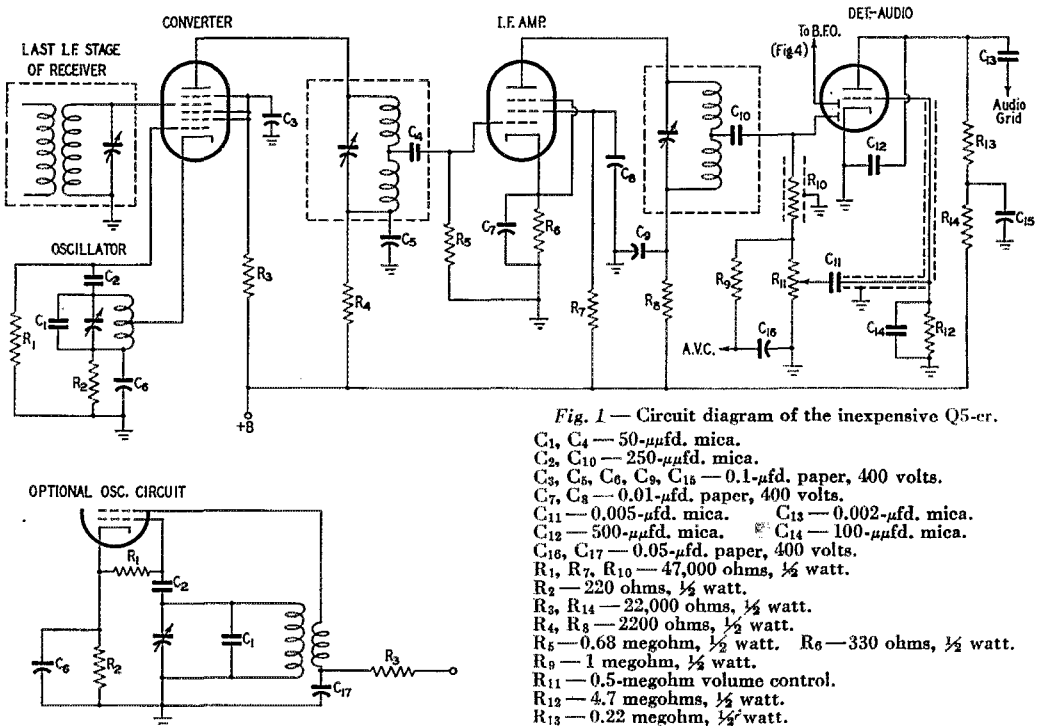

Fig. 1 — Circuit diagram of the inexpensive Q5-cr.

- C<sub>1</sub>, C<sub>4</sub> — 50- $\mu$ fd. mica.
- C<sub>2</sub>, C<sub>10</sub> — 250- $\mu$ fd. mica.
- C<sub>3</sub>, C<sub>5</sub>, C<sub>6</sub>, C<sub>9</sub>, C<sub>15</sub> — 0.1- $\mu$ fd. paper, 400 volts.
- C<sub>7</sub>, C<sub>8</sub> — 0.01- $\mu$ fd. paper, 400 volts.
- C<sub>11</sub> — 0.005- $\mu$ fd. mica.
- C<sub>13</sub> — 0.002- $\mu$ fd. mica.
- C<sub>12</sub> — 500- $\mu$ fd. mica.
- C<sub>14</sub> — 100- $\mu$ fd. mica.
- C<sub>16</sub>, C<sub>17</sub> — 0.05- $\mu$ fd. paper, 400 volts.
- R<sub>1</sub>, R<sub>7</sub>, R<sub>10</sub> — 47,000 ohms,  $\frac{1}{2}$  watt.
- R<sub>2</sub> — 220 ohms,  $\frac{1}{2}$  watt.
- R<sub>3</sub>, R<sub>14</sub> — 22,000 ohms,  $\frac{1}{2}$  watt.
- R<sub>4</sub>, R<sub>8</sub> — 2200 ohms,  $\frac{1}{2}$  watt.
- R<sub>5</sub> — 0.68 megohm,  $\frac{1}{2}$  watt.
- R<sub>6</sub> — 330 ohms,  $\frac{1}{2}$  watt.
- R<sub>9</sub> — 1 megohm,  $\frac{1}{2}$  watt.
- R<sub>11</sub> — 0.5-megohm volume control.
- R<sub>12</sub> — 4.7 megohms,  $\frac{1}{2}$  watt.
- R<sub>13</sub> — 0.22 megohm,  $\frac{1}{4}$  watt.

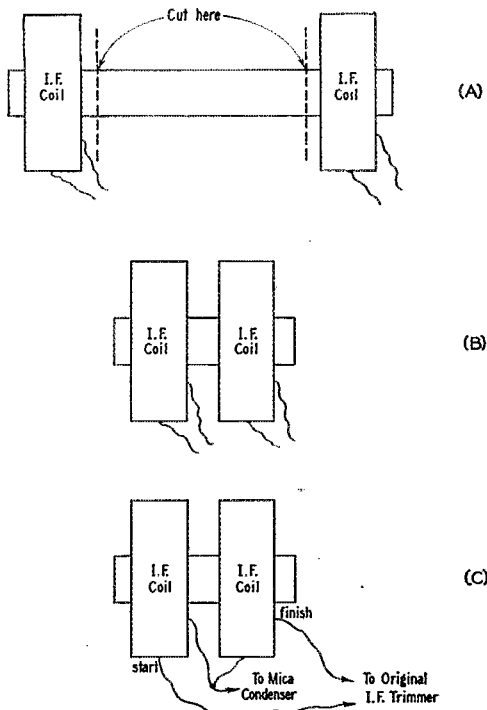

Fig. 2—Alterations in the 175-kc. coil assembly.

coils as shown in Fig. 2A. Place the coils very close together, introduce the iron cores and cement everything together with Duco cement, Fig. 2B. Then solder the finish of one coil to the start of the other, as in Fig. 2C. Solder the extreme ends to one trimmer, and connect the junction between the coils to a mica condenser as shown in Fig. 1. Replace the assemblies in the shield cans.

In receivers having a 456-kc. i.f., the converter oscillator coil can be the b.f.o. coil in the receiver. Connect a 50- $\mu$ fd. mica condenser across the b.f.o. coil to tune it 80 to 100 kc. below 456 kc. Other intermediate frequencies may require a different value of mica padding condenser. If the receiver has no b.f.o., get another i.f. transformer of the same frequency, unsolder one of the trimmers, and connect a 50- $\mu$ fd. fixed condenser in parallel with the other coil and trimmer, as in Fig. 3. The transformer can then be used in the optional oscillator circuit shown in the diagram of Fig. 1.

### Circuit Alignment

To align the circuit, short circuit the converter oscillator coil and apply a modulated 100-kc.

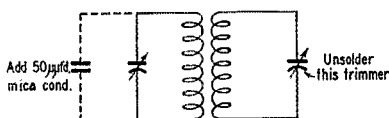

Fig. 3—Converting a 456-kc. i.f. transformer into an oscillator assembly.

signal from a test oscillator to the converter grid. The audio output from the 'speaker can be used for an indication, but more accurate results will be obtained by using the a.c. scale of a v.o.m. connected across the 'speaker voice coil. Adjust the trimmers on the low-frequency i.f. coils for maximum output (use minimum signal strength in order to avoid overloading), and then lower the test oscillator frequency a little at a time, each time adjusting the i.f. trimmers, until the lowest possible frequency is obtained. I was able to get down to 81 kc.

Next, take off the short circuit on the converter oscillator coil, set the test oscillator to 456 kc. (or the actual receiver i.f.), and connect the test oscillator output to the first 456-kc. i.f. stage. Adjust the converter oscillator trimmer for maximum output, and also repeak the trimmers of the i.f. transformer that feeds the converter tube. At this point the test oscillator and output meter should be disconnected and a strong signal tuned in on the receiver to check for overloading. If overloading occurs, substitute a variable resistor for  $R_2$  in the converter cathode circuit and determine the amount of resistance required to prevent overloading.

A low-frequency b.f.o. can be made by using a 2.5-mh. r.f. choke as the coil, tapping it between the first and second pies and shunting the whole coil by a 0.001- $\mu$ fd. mica condenser. Add small mica condensers (100  $\mu$ fd.) until a beat is heard and then wire in a small variable or trimmer condenser for pitch control. The b.f.o. coil and condensers should be enclosed in a shield can to prevent radiation of harmonics. Any convenient type of tube can be used in the b.f.o. Fig. 4 is the circuit.

### Performance

The selectivity with this circuit is such that 'phone signals are heard well only when tuned right in the center of the passband, and on c.w. there is a marked single-signal effect. Naturally,

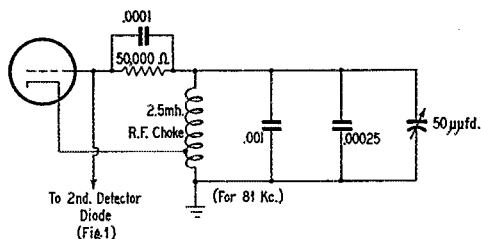

Fig. 4—B.f.o. circuit using a 2.5-mh. r.f. choke.

a strong signal may overload the circuit, but for 'phone this can be prevented by applying a.v.c. to the converter tube and possibly the low-frequency i.f. tube, along with the other tubes in the receiver that are normally controlled. On c.w. the overloading can be prevented by proper setting of the manual r.f. gain control. As compared with the receiver alone, the background noise is greatly reduced, which is to be expected with small i.f. bandwidth.

# All-Metal Construction in 2-Meter Arrays

*Lower Weight and Wind Resistance in Large Antenna Systems*

BY EDWARD P. TILTON,\* W1HDQ

FOR some years the all-metal approach to beam antenna design has been gaining favor for use on the frequencies from 50 to 14 Mc. Where a single driven element is used in conjunction with one or more parasitic elements in the same plane, all-metal construction usually results in the simplest and lightest type of array. The only supporting structure in the array itself is a boom of tubing or channel stock with the elements mounted on or through it at their centers, where the r.f. voltage is close to zero.

The pattern of such an array is usually at least as good as a wood-and-metal counterpart, where the elements are customarily mounted on stand-off insulators. But when phased elements are used, as in the familiar 16-element arrays so widely employed in 144-Mc. work, all-metal design poses some different problems. For these it has been more or less standard practice to use wooden frames, with the elements mounted on insulators, in order to keep the "hot" portions of the system free of metallic supports that might distort the pattern and reduce the effectiveness of the array.

The net result of adhering to wood-frame construction has been the erection of many large arrays that left much to be desired from a structural if not electrical standpoint, and the wind-

and higher, and the result will be considerably more rugged than would be possible with anything like the same weight in wood-frame designs.

To keep the parts of the supporting structure from distorting the antenna pattern unduly all elements are mounted in front of the supporting

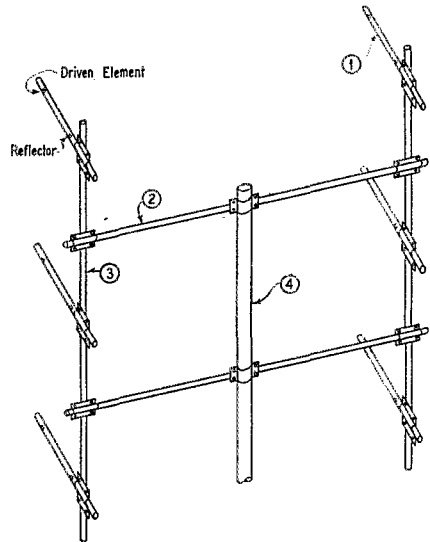
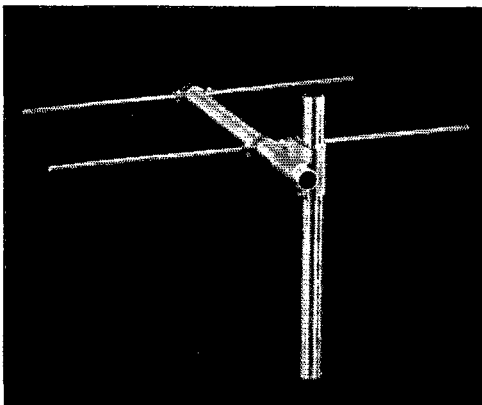

Fig. 1 — Supporting framework for a 12-element 144-Mc. array of all-metal design. Dimensions are as follows: element supports (1)  $\frac{3}{4}$  by 20 inches; horizontal members (2)  $\frac{3}{4}$  by 46 inches; vertical members (3)  $\frac{3}{4}$  by 46 inches; vertical support (4)  $1\frac{1}{2}$ -inch diameter, length as required; reflector-to-driven-element spacing 16 inches. Parts not shown in sketch: driven elements  $\frac{3}{4}$  by 38 inches; reflectors  $\frac{3}{4}$  by 40 inches; phasing lines No. 18 spaced 1 inch, 80 inches long, fanned out to  $3\frac{1}{2}$  inches at driven elements (transpose each half-wave section).



Model showing the method of assembling for all-metal construction of phased arrays.

storm mortality rate for 2-meter antennas has thus been rather high. The array described here was built to be both lighter in weight and lower in wind resistance than a wood-and-metal counterpart, and yet be at least as effective electrically. The basic construction involved can be applied to all sorts of phased arrays for 144 Mc.

\* V. H. F. Editor, QST.

frame. The photograph at the left shows an experimental model built to test the practicality of the ideas involved; it is not an actual antenna. The methods it illustrates are in use in a 12-element 144-Mc. array at W1HDQ. The supporting skeleton is shown in Fig. 1.

The joints between the horizontal and vertical members of the frame are made with small "U"-shaped clamps cut from sheet aluminum. Two of these clamps, shown in flat form at B in Fig. 2, are used at each joint. One of these and a larger one (A in Fig. 2) hold the  $\frac{3}{4}$ -inch diameter frame members to the  $1\frac{1}{2}$ -inch vertical supporting pipe. The screws and nuts used to hold these together should be 6-32 or larger. The elements are  $\frac{3}{4}$ -inch tubing, mounted in holes drilled through the element supports. Each element is held rig-

All-metal phased arrays for 50 and 144 Mc. The 12-element 144-Mc. array, in the middle of the structure, uses the method of construction described herewith.

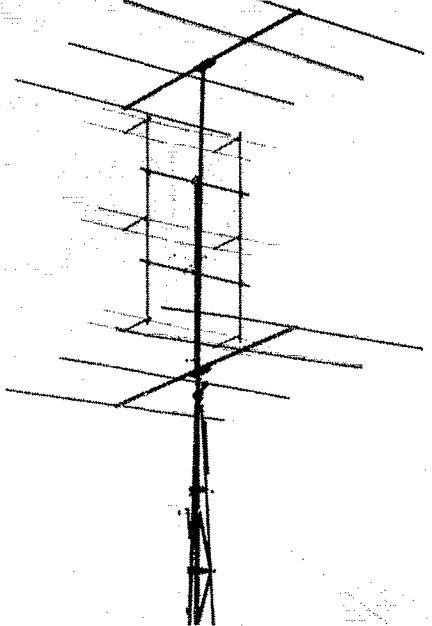

idly in place by a small clamp, shown at C, using 4-36 or 4-40 screws and nuts.

The dimensions shown for the clamps apply only when  $\frac{3}{4}$ -inch tubing is used for the frame,  $1\frac{1}{2}$ -inch for the main vertical support, and  $\frac{1}{4}$ -inch for the elements. When made as shown, the clamps hold the assembly together under tension as the bolts are drawn up tight, and the result is a very sturdy assembly. If tubing sizes other than those given above are to be used the clamp size can be determined readily by making experimental clamps of thin sheet metal or stiff cardboard. These can be folded and bent into the proper shape, checked for size, and then flattened out and used for templates.

There is nothing unusual about the array electrically. It is a standard 12-element arrangement using six driven elements in phase with reflectors spaced 0.2 wavelength in back. The elements are centered in the supporting members, and the horizontal spacing between the two halves of the array is adjusted by sliding the vertical supports sideways until there is about two inches between the ends of the reflector elements. This leaves the driven element ends about  $3\frac{1}{2}$  inches apart. This spacing is taken care of by fanning out the phasing sections as they near the driven elements. The lines are transposed between each set of driven elements, the system being fed at the center pair.

A new type of transmission line recently introduced by Gon-Set is used throughout, for phasing

sections and for the main transmission line. This is made of No. 18 Formvar wire, spaced one inch center to center with polystyrene spreaders every six inches.

The spacing of the last quarter wavelength of the line can be changed to make a matching section, thus avoiding the mechanical and electrical complications associated with the usual type of separate Q type of matching device. Experimentation with the feed system showed that a matching section of approximately 400 ohms was required. This was made by cutting down the spacing of the last 20 inches of the line to one-half inch.

The line is made originally by heating the wire and pressing it into the polystyrene spreaders, the latter melting at moderate temperatures. It can be taken apart by holding a soldering iron tip against the wire until the plastic softens slightly, when the wire can be lifted out. It is reassembled at the closer spacing by the same method.

The popular 300-ohm Twin-Lead may also be used for the transmission line with good results. The phasing sections should be open-wire line in either case. The feed impedance of the array was found to be in the neighborhood of 350 ohms, so either the Gon-Set line or Twin-Lead can be connected directly to the feed point without a serious standing-wave ratio. The matching device is advisable only if a long run of line is needed. With lengths up to 50 feet or so it is unlikely that its use would make any noticeable difference.

This new 12-element 2-meter array is now mounted between the two sections of a stacked 4-over-4 for 50 Mc., in the manner of the "V.H.F. Sandwich" described last year in *QST*.<sup>1</sup> The open-wire line is held in place at various support points with screw-eye type stand-offs normally used for mounting RG-59/U coax. These make a nice fit around the  $\frac{1}{4}$ -inch spreaders in the line.

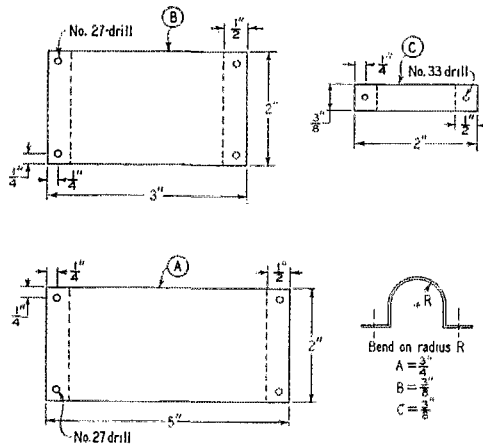

Fig. 2—Detail drawings of the clamps used to assemble the all-metal 2-meter array. A, B and C are before bending into "U" shape. The right-angle bends should be made first, along the dotted lines as shown, then the plates may be bent around a piece of pipe of the proper diameter. Sheet stock should be  $\frac{1}{16}$ -inch or heavier aluminum.

<sup>1</sup>"The V.H.F. Sandwich," June, 1949, *QST*, p. 36.

# A Master Control Box for the Ham Transmitter

*Safety and Convenience on the Operating Table*

BY DALE R. CLEMONS,\* W9BWD

THE importance of a suitable control system for the ham station equipment cannot be overemphasized. Too many hams put up with haywire arrangements that are inconvenient and inflexible and often a danger to both operator and costly equipment when they might just as easily have a smoothly-functioning system.

While every operator will wish to reserve personal choice as to details, one common theme should be observed. First, the controls and equipment of a similar nature should be grouped together as a unit at the most convenient spot. Second, the control unit should be made as flexible as possible to take care of future alteration and expansion. This means plenty of terminals which may be strapped together in combinations to suit a wide range of requirements.

The control box shown in the photograph is described here as an illustrative example rather than a model to be rigidly copied. Nevertheless, it should serve adequately in the majority of installations. Referring to Fig. 1, the a.c. line enters at the lower left through the main switch,  $S_2$ . This switch turns on all filaments in the transmitter. A separate switch,  $S_1$ , turns on the receiver power. For stand-by periods of appreciable length, I have included  $L_1$  in series with the transmitter filament-transformer primaries. This reduces the filament voltage by about 15 per cent, but keeps the filaments warm for immediate operation. Tube life is increased and the power bill is reduced.  $S_3$  shorts out  $L_1$  when full voltage is needed. Two lamps, differing in color, serve to indicate the stand-by condition.  $L_1$  consists of

80 turns of No. 18 wire wound on a closed core having a cross section of about  $1\frac{1}{2}$  inches. Any reclaimed 20-watt transformer or choke core may be used. The winding may be tapped if desired. The completed job should be impregnated or dipped in paraffin to prevent hum.

$S_5$  is the change-over switch which performs all of the functions necessary in switching from receiving to transmitting. In the transmitting position, the bottom pole closes the +B line to the monitor, while the top three poles apply the a.c. line to various control relays. These include a relay that shorts the receiver input and opens the receiver screen supply, one that switches the antenna-tank link coil to the transmitter link line and another that applies plate power to the exciter. When  $S_7$  is closed, a relay controlling the plate power for the final amplifier also will be operated by  $S_6$ . (For 'phone work another control relay, switch and pair of terminals would be desirable.) Similarly, when  $S_4$  is in the upper position, the keying relay will be closed. Under these conditions, a key plugged in at  $J_1$  will operate the keying relay, the receiver-protecting relay and the antenna relay for break-in operation. If a separate antenna is used for receiving, and it is not desired to operate the antenna change-over relay with the key, the control terminals for this relay may be strapped in parallel with the terminals going to the exciter plate-supply relay instead.

When  $S_4$  is in the downward position, the keying relay may be operated independently of the other relays by plugging the key in at  $J_2$ . The contacts of the keying relay come back through the control-panel terminals to  $P_1$ . This plug may be inserted in either of the two keying-filter input jacks,  $J_3$  or  $J_4$ . The output terminals of this filter go to the circuit to be keyed. The lag-filter

\* 179 Lawton Rd., Riverside, Ill.

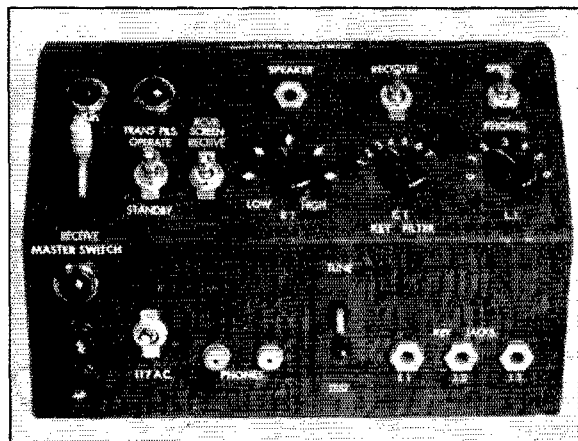

A homemade transmitter control box, showing one type of construction.





# Break-In Amplifier Keying

## Chirpless Keying for Contests and Traffic

BY R. H. SCRUGGS,\* W2FRX

THE article<sup>1</sup> in March, 1948, *QST* on "having your cake and eating it, too" described two ways to obtain break-in performance with amplifier keying, and it was a big step in the right direction. However, some of the components it called for that I didn't have in the junk box weren't exactly in the 50-cent class. Probably a few other chaps who need to clean up their clicks and chirps also don't have such items as 375-0-375 transformers, rectifier tubes, Millisec relays and 6AS7s lying around, so my less-expensive approach to the problem may be of interest.

Basically the system provides for vacuum-tube keying of an amplifier stage, together with a circuit that turns the oscillator on when the key is closed and holds it on for from  $\frac{1}{5}$  to  $1\frac{3}{4}$  seconds after the key is opened. The holding time is adjustable.

The circuit, shown in Fig. 1, was used with a

\* 40-15 81st St., Jackson Heights, L. I., N. Y.

<sup>1</sup> Goodman, "Improved Break-In Keying."

Halicrafters HT-18, but it can be applied to practically any low-power exciter. The HT-18 uses a 6BA6 oscillator, and the keyed amplifier stage is a 6L6. The keying circuit of Fig. 1 has been simplified and made less expensive by using a transformerless supply, a 6Y6G keyer tube instead of the more expensive 6AS7, and a moderate-priced relay that has been very satisfactory.

The operation of the circuit is similar to the original, of course, but a few points of difference may be worth mentioning. The cathode of the 6Y6G keyer tube is not returned directly to ground but to a point slightly negative, as determined by the location of the tap on  $R_4$ . This is about -20 volts in my case, and this voltage counteracts the cathode bias introduced by the drop across the keyer tube. The tap is set to the point that gives the same cathode current with the keyer tube in the circuit (and the key down) as is obtained through the circuit without the keyer tube.

(Continued on page 114)

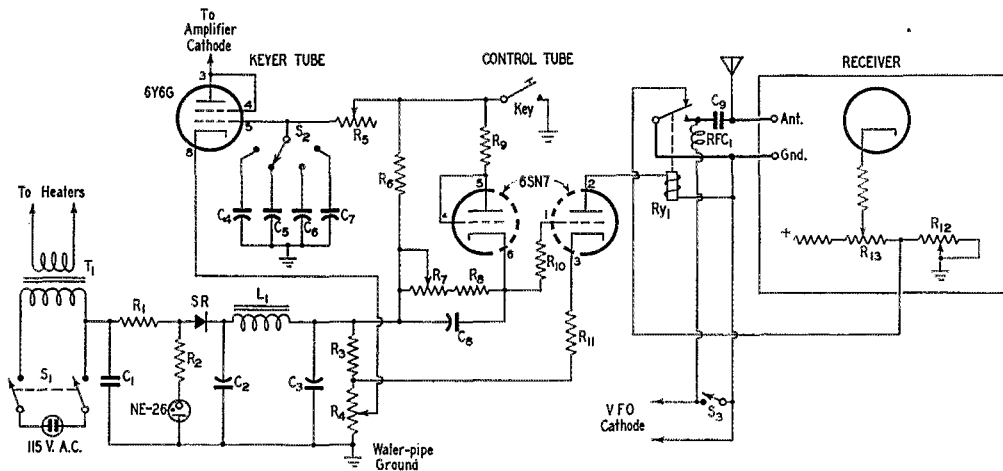

Fig. 1 — The break-in keying system at W2FRX.

- C<sub>1</sub> — 0.01- $\mu$ fd. 600-volt mica.
- C<sub>2</sub> — 24- $\mu$ fd. 150-volt electrolytic.
- C<sub>3</sub> — 16- $\mu$ fd. 150-volt electrolytic.
- C<sub>4</sub> — 0.001- $\mu$ fd. paper.
- C<sub>5</sub> — 0.003- $\mu$ fd. paper.
- C<sub>6</sub> — 0.005- $\mu$ fd. paper.
- C<sub>7</sub> — 0.1- $\mu$ fd. paper.
- C<sub>8</sub> — 0.25- $\mu$ fd. paper.
- C<sub>9</sub> — 0.001- $\mu$ fd. mica.
- R<sub>1</sub> — 27 ohms, 1 watt.
- R<sub>2</sub> — 0.2 megohm, 2 watts.
- R<sub>3</sub> — 1800 ohms, 2 watts.
- R<sub>4</sub> — 10,000 ohms, 5 watts (set to give -20 volts).
- R<sub>5</sub> — 1-megohm potentiometer.
- R<sub>6</sub> — 0.2 megohm, 1 watt.

- R<sub>7</sub> — 5-megohm potentiometer.
- R<sub>8</sub>, R<sub>10</sub> — 1 megohm,  $\frac{1}{2}$  watt.
- R<sub>9</sub> — 470 ohms,  $\frac{1}{2}$  watt.
- R<sub>11</sub> — 20,000 ohms, 5 watts.
- R<sub>12</sub> — 10,000-ohm wire-wound potentiometer.
- R<sub>13</sub> — Receiver r.f. gain control.
- L<sub>1</sub> — 50-ma. filter choke.
- RFC<sub>1</sub> — 2.5-mh. r.f. choke.
- Ry<sub>1</sub> — 10,000-ohm relay (Potter & Brumfield 90-LM5-10000).
- S<sub>1</sub> — D.p.s.t. toggle.
- S<sub>2</sub> — Single-pole 4-position rotary switch.
- S<sub>3</sub> — S.p.s.t. momentary, toggle, or microswitch.
- SR — 75-ma. selenium rectifier.
- T<sub>1</sub> — 6.3-volt transformer.

# • Technical Topics —

## External Noise at 28, 50 and 144 Mc.

SEPTEMBER, 1950 *QST* described a family of S crystal-controlled converters for use on 10, 6 and 2 meters. They were designed to have low noise figures, and they go about as far in this direction as is possible at present with conventional tubes and tank circuits. The 10-meter job was checked at well below 3 db.; 6-meter one is nearly as good, and the 2-meter figure runs around 5 to 6 db. This is far better than commercially-available receivers for these frequencies will do, when measured on the same set-up,<sup>1</sup> and well below most homebuilt jobs currently being used. With this gear we have the satisfaction of knowing that if a signal can be heard in our location with any sort of conventional receiving device, these converters will bring it in.

The location is an exceptionally good one, too — high on a hill well out in the country, remote from any form of man-made noise, so the low-noise characteristics of the converters show up to the best possible advantage. Previous experience has shown that this situation gives us a considerable advantage on 28 Mc. over the fellows in the heavily-populated cities, where the man-made noise level is generally higher, even when relatively ineffective receiving equipment is used at WHDQ.

We anticipated a further improvement when the low-noise front ends were put to work, particularly on 10 and 6. On 2 we had been using low-noise technique for some time previously, so only the stability angle of the crystal-controlled job could be expected to contribute to our receiving effectiveness on that band. On 28 Mc. the weak-signal readability was better with the new converter, but the variable nature of the reception on that band made it hard to say just how much improvement was being realized. On 50 Mc., however, we expected an immediate and obvious change for the better. The converter in use had been checked at about 6 db.; the 3-db. noise figure in the new job should help the readability on weak signals, it seemed.

A barely-audible c.w. harmonic was used first for comparison between the two converters. Using the same receiver as an i.f., the signal was picked up with first one converter and the other, checking the signal for S-meter rise over the noise level, and for readability by ear. Alas — there was no difference whatever! The same turned out to be true in listening tests on various phone signals we could hear on 50 Mc. The crystal-controlled job gave beautifully stable reception, but once the signal was tuned in properly on the tunable job the readability was exactly the same. When the signal went into the noise

on one converter it was in the noise on the other. There was nothing to choose from between the two.

This started us checking noise on the antenna. For days and nights on end we checked the noise level picked up by our 10- and 6-meter beams in various directions. The converter gain control was set up so that the S-meter read S1, with a 300-ohm carbon resistor connected across the antenna input of the converter, and the input circuit peaked carefully. Then the antenna was plugged in and readings taken. On 50 Mc. there was never less than 2 S-units increase in noise; on 28 Mc. never less than 3. Average was  $2\frac{1}{2}$  S-units of noise on 50 Mc. and  $4\frac{1}{2}$  on 28 Mc.; this with a 3-element array on 10 and a 4-element on 6. The noise was not the result of regeneration, by the way; with no resistor load the noise reading was slightly *less* than with it. And with a nonresonant antenna (for example, the 10-meter beam connected to the 6-meter converter) there was only a very slight indication of antenna noise.

The noise readings have been taken at all hours, in all directions, and during all types of propagation conditions. The noise is *always* there, and it is considerable, though it may increase when the bands in question are open for DX propagation of any kind, and occasionally when they are not. Solar noise, for instance, was observed one night just at sundown, when lining the 50-Mc. array up on the setting sun resulted in 9 S-units of noise. This racket disappeared and the reading dropped back to normal very shortly after sundown. A similar though less marked effect has been observed in the east on a few mornings.

Checks have also been run using a General Radio Audio Output Meter to record the change in noise, with and without the antenna. This is done with the a.v.c. off, of course. The lowest value of 50-Mc. noise recorded in this way is 7 db.

All this indicates to us that much of the talk about low-noise front ends making it possible to hear signals on 50 and 28 Mc. that you never knew were there previously is an overenthusiastic view of the potentialities of the low-noise r.f. section. True, there are plenty of receivers now being sold that can be improved markedly by the addition of a low-noise front end, but this may be at least partly because the receiver in question is lacking in *gain*, especially in the lower-priced jobs. That lack can be made up in the i.f. system, or even in the audio. Low-noise front ends will help in weak-signal work only if the noise coming in via the antenna is lower than the receiver's noise figure. If the external noise is

<sup>1</sup> Using the noise generator described in *QST* for August, 1949.

already higher than the receiver noise figure, all a low-noise front end will get anyone is higher S-meter readings. There will be no improvement whatever in *readability*, no matter how good the front end may be.

When we go to 144 Mc., however, the picture changes markedly. Here the same test shows only one-half S-unit of antenna noise, and an output-meter reading of about 2 db. Now we can go to work on the front end — on a frequency where front end design in commercially-available equipment is generally poor. Let's say you have a 522 front end, whose noise figure may be as bad as 20 db., if it has had no special attention in the conversion process and is equipped with the original 9000-series tubes. If you change to a low-noise converter ahead of a communications receiver you can get down to perhaps a 5-db. noise figure. Then, if you have only 3 db. of noise from the antenna, you will be able to read signals that are as much as 12 db. weaker than

before. Put it another way: the fellow who was just barely readable with 100 watts input can now drop to 5 or 6 watts and continue with the same readability when you switch receivers!

As we go higher in frequency the improvement to be obtained from low-noise front ends becomes more marked but it is also much more difficult to achieve, so even here again the problem is first to get adequate *gain*. The real criterion, on any frequency, is whether the weakest signal is unreadable because it is buried in the noise, or whether, if you could turn the gain control up another notch, you might be able to copy him. If loss in the noise is the limiting factor, *and that noise is coming in on the antenna*, then no super r.f. stages will help you one bit. If the noise stays up at the same level when the antenna is replaced by a load resistor, then you need to go to work on the front end of your receiver, no matter what band you're listening on. — *E.P.T.*

## Tuning and Checking S.S.B. Signals

ONE of the hazards of amateur operation these days is the threat of TVI. The word "threat" is used deliberately, because it is sad but true, as many hams can attest, that the *threat is always* there. Even after you get your rig cleaned up to the point where you don't bother the viewing of any of the local stations, some joker is liable to call you on the 'phone during a QSO to tell you that you're breaking up his 130-mile reception of some snowy signal he never saw before. You try to explain a few of the facts of life, such as "service area," "temperature inversion," "-80 db. harmonics" and the like, and he tells you how much he paid for his television set. You finally hang up in varying degrees of disgust, muttering, "If only those guys weren't so dumb!" or "Why don't they ever learn a little about how things work?"

Naturally, you would expect in a technical hobby like ours, where everyone is supposed to have at least a nodding acquaintance with how things work, that no ham would lay himself wide open to the same under-the-breath mutterings, but many do. To paraphrase the first paragraph, one of the hazards of single-sideband operation is that of being told by some joker that "Your signal is all over the band" or "You're busting

up everything." You try to explain that the receiver's a.v.c. is probably the culprit,<sup>1</sup> and the usual reply is to the effect that "If s.s.b. is going to do that to our [price given] receivers, it shouldn't be allowed on the air." The s.s.b. operator sigs off muttering, quite justifiably, "If only those guys weren't so dumb!" or "Why don't they ever learn a little bit about how things work?"

So what? So this. If you have been guilty in the past of a display of ignorance or you would like to avoid it in the future, we will tell you how to check a s.s.b. signal and give an accurate report. It is true, of course, that some s.s.b. signals do take up more room than necessary, just as some a.m. and n.f.m. signals do. However, a good s.s.b. signal takes up little more than *half* the spectrum space of the best a.m. signal, so whenever you tell a s.s.b. station he is "broad" you're saying he is badly out of adjustment. In most cases he isn't broad, and it is your receiver, not his transmitter, that is at fault, but here's how you can be sure. On your receiver:

1. Turn the r.f. gain very low.
2. Turn the audio volume up high.
3. Turn off the a.v.c. (O-F-F, *OFF!*).
4. Turn up the r.f. gain until you can hear the signals comfortably, and no farther.
5. Look around the band and see if the s.s.b. signal really does occupy a lot of dial space (compared to the other a.m. signals on the band).

Of course you won't be able to understand what the s.s.b. station is saying, because we left out something,

<sup>1</sup> For an explanation, see " . . . The Other Foot," *QST*, April, 1949.

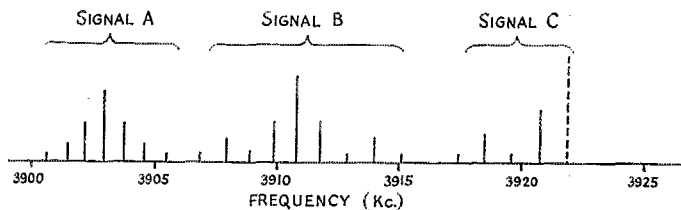

Fig. 1 — An instantaneous frequency-vs.-amplitude representation of a portion of an amateur band. Signals A and B are a.m. signals, and C is a single-sideband suppressed-carrier signal. Signal C is using the lower sideband, and the suppressed carrier is represented by the dashed line.

but you can check on his "spurious" signals under these conditions. The more selectivity you have in your receiver the better the check, and a real good test should be made with the crystal filter in. The whole point of the procedure outlined above is to insure against receiver overload. If you follow the instructions, your receiver won't overload, and you should be able to give the s.s.b. a fair check. You will find that you can receive a.m. and n.f.m. signals with the receiver set up this way, so obviously it is the proper receiver condition when you are trying to copy a.m. or n.f.m. that is only a few kc. away from a s.s.b. signal. Remember this, and the next time (or the first time) s.s.b. seems to break up your a.m. reception, try your receiver set up this way before you call the s.s.b. station a lot of fancy names. As a matter of fact, your receiver should be set this way when checking the bandwidth of a.m. or n.f.m. signals, *not* with the a.v.c. on as some misguided individuals do. To check with the a.v.c. on requires a receiver that is as sharp or sharper than the "super-selective c.w." variety.

### Tuning In a S.S.B. Signal

If you have come along this far, you're probably pretty sincere about doing an honest job in the receiving field, so let's take a look at how to receive a s.s.b. signal properly. It is a lot easier to do if you have a mental picture of what's going on, so let's assume that an instantaneous picture of a 25-kc. section of the 75-meter sub-band looks like Fig. 1. Signal representations of this kind were discussed a few months ago,<sup>2</sup> in case you aren't familiar with them. Your receiver can be considered a sort of "peephole" that you slide back and forth across the band. If you were going to build a working model of this receiver-operation picture, you would cut out a long strip of cardboard, as shown in Fig. 2A, and notch it as shown. The width and shape of the notch varies somewhat with the type of receiver—the more selectivity you have, the narrower this notch would be. Your working model would consist of this cardboard strip laid on Fig. 1. Turning the tuning knob of the receiver corresponds to sliding this strip back and forth across the band. When the tuning scale on your receiver indicates "3903 kc." it corresponds to the notch being centered on 3903 kc. on Fig. 1, and all you could see (and hear) would be "Signal A" and a bit of "Signal B" that also shows through. With the notch centered on 3911 kc. you would see (and hear) only "Signal B," and with the receiver (cardboard scale) centered anywhere from 3918 to 3921 kc. you could see all of Signal C.

After you have moved the notched cardboard mentally across the band a few times, you're ready for the next step. Forgetting the band for a minute, visualize the notched cardboard with a small piece of celluloid mounted on it. This celluloid has a single vertical line scribed on it, repre-

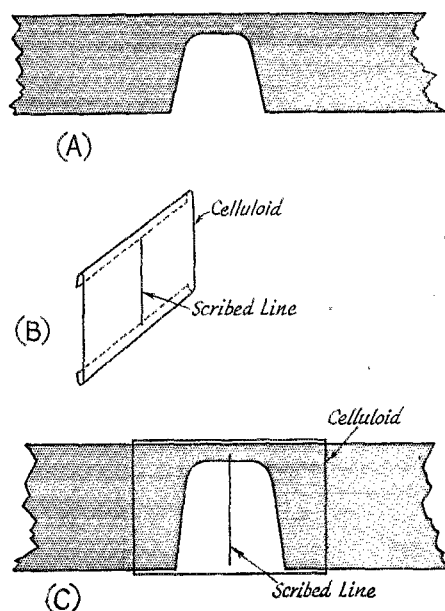

Fig. 2 — Parts required for model receiver to be used with Fig. 1. The strip at A could be a piece of cardboard, notched as shown to represent the "pass-band." A celluloid slider with a line scribed on it, to represent the b.f.o. frequency, would represent the b.f.o., as shown at B. With b.f.o. on, the celluloid slider would be clipped on the cardboard strip, as shown in C. Thus A represents a receiver with b.f.o. off, and C with b.f.o. on.

sending the beat-oscillator frequency. A working model would look like Fig. 2B. Assembled on your receiver model, it would look like Fig. 2C. Your b.f.o. adjustment on your receiver is the same as moving this celluloid clip with respect to the notch on the cardboard, but your tuning knob moves the cardboard strip *and* the celluloid together. This simply means that the relationship between b.f.o. frequency (line on celluloid) and the receiver passband (notch in cardboard) is constant with receiver tuning.

Your receiver with b.f.o. off looks like Fig. 2A — it looks like Fig. 2C when the b.f.o. is on.

Now you're ready to tune in that s.s.b. station, represented by Signal C in Fig. 1. With b.f.o. off, tune your receiver until Signal C is centered in the passband. As mentioned before, any setting between 3918 and 3921 would allow him to come through, and he would be centered at 3919.5 kc. You can do this with the a.v.c. on, telling when you have him centered by the point where he kicks the S-meter the highest, or you can do it with the a.v.c. off and the receiver set up as described earlier, with the r.f. gain backed down, in which case you tune aurally for maximum sound on peaks. In any event, center him and then turn the r.f. gain down, a.v.c. off, the audio gain up, and then turn on the b.f.o. Vary the b.f.o. frequency slowly back and forth until the speech becomes recognizable and you can copy the voice. This corresponds to sliding the celluloid scale back and forth until you have the

<sup>2</sup> "How To Visualize a 'Phone Signal," *QST*, July, 1950.

scribed line exactly or very close to superimposed on the dashed line in Signal C. (The dashed line represents the suppressed carrier.) Sit back and relax — you have just accomplished something that amateurs with 25 years of experience have found difficult or impossible!

It should now be obvious that if the b.f.o. were originally set on the proper side of the passband, you could have done the tuning with the main dial alone, and this is generally a little easier to do, particularly with receivers with slow tuning rates. On some receivers, however, the b.f.o. tuning rate is slower than the main-dial rate, and that is why we described it this way.

Since some s.s.b. stations use the upper sideband and some the lower, it is also apparent that setting the b.f.o. with respect to the passband for one s.s.b. signal is not necessarily correct for another, but it will be right for all s.s.b. signals using that same (upper or lower) sideband.

Now that you know *how* to tune in the s.s.b. signals, you may still not understand *why* you have to do it this way, instead of just using the same technique as in a.m. If so, go back to the earlier article<sup>2</sup> and read up on *suppressed-carrier* signals. If you want to know why these fellows are using s.s.b., work one of them and ask him.

— B. G.

## Driven-Element Length

[The discussion below, a letter from W1BOD, not only will be of practical value to those who may have run into difficulty in the adjustment of parasitic beams, but throws new light on the subject generally. — Ed.]

THE comments in July *QST* concerning beam-element lengths and their effect on s.w.r.<sup>1</sup> bring up a point concerning element lengths in two-element parasitic beams which has not been discussed in any amateur literature, as far as I know.

I have been a booster of two-element beams for some time, because I am not convinced that the improved performance of three-element beams

<sup>1</sup> Technical Topics, "Radiator Length and the Gamma Match," *QST*, July, 1950.

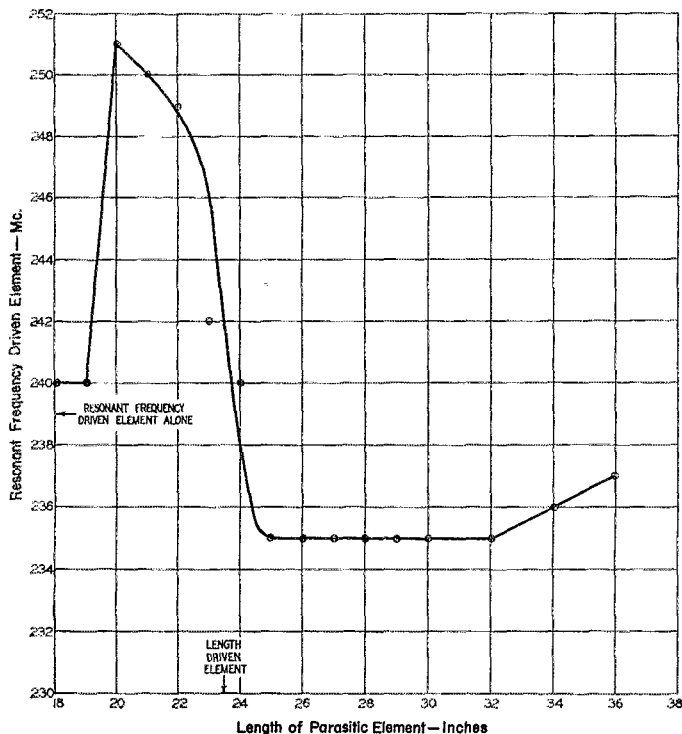

offsets their size and mechanical complexity. The first two-element beam I built was for 10 c.w. I used a 0.1D combination with 300-ohm feed and a "T"-match. For element lengths, I used those given in the *A.R.R.L. Antenna Handbook* for three-element beams. After interminable trips between the cellar and the roof, it became apparent that the s.w.r. could not be brought to low values with any adjustments of the "T"-match. The s.w.r. indicator was a "twin-lamp" device. Just as described in your note, it appeared that the load on the transmission line must have a reactive component that could only be tuned out at the antenna tuner, and adjustment of the element length was in order. Lengthening the driven element brought the s.w.r. down to the point where the one lamp filament was almost burning out, with the other filament showing no color at all.

The lengths finally used were appreciably longer than those for three-element beams. The radiator length was 17.33', and the director length was 16' 5". This would give a megacycle/foot factor of 486 for the radiator for the frequency to which it was tuned (28,050 Mc.).

Last month I completed a 20-meter two-element beam (also 0.1D, 300-ohm "T"-match), and while I should have profited by my 10-meter experience, I once more used *Handbook* dimensions for the initial set-up. Again, the same difficulties were encountered.



Fig. 1 — Resonant frequency of driven element as a function of parasitic-element length when the element spacing is 0.1 wavelength. The data may be scaled to lower frequencies if the length/diameter ratio (360) is maintained approximately.

Fig. 2—Same as Fig. 1, but with 0.2 wavelength element spacing.

Measuring the resonance of the radiator with a dip meter showed it to be around 15 Mc. Again lengthening the radiator brought the s.w.r. down beautifully. Actually, the radiator length came out at 35.5', or a megacycle/foot factor of 497. The director was 7 per cent shorter.

In analyzing the two situations, it seemed reasonable that the addition of a director would introduce reactance into the radiator and modify its resonant frequency. If the parasitic element were a reflector, it would add reactance of the opposite sign and hence reduce or even nullify the effect of the director. If such were the case, the element lengths in two-element beams must be fundamentally different from those in three-element beams.

Experiments with a grid-dip meter and some lengths of wire making up simple beams at about 240 megacycles demonstrated this length variation between two- and three-element beams beautifully. Attached are two graphs (Figs. 1 and 2) showing the variation in resonant frequency of the driven element as the length of the parasitic element was varied. One is for 0.1-wavelength spacing, and the other is for 0.2-wavelength spacing. The material used was 0.065" diameter brass wire which gives a length/diameter ratio of 360. This is about the value used for beam elements at lower frequencies. The dip meter was lightly coupled to the driven element at the center. All elements were straight lengths of wire with no loops for coupling.

As you can see, when the parasitic element is shorter than the radiator (i.e., a director), the resonant frequency of the driven element is raised by an appreciable amount. Similarly, when the parasitic element is longer, the resonant frequency of the driven element is lowered. For director operation, the megacycle/foot factor comes out about 485 for 0.1-wavelength spacing. For reflector operation at 0.2 wavelength, the factor is 451.

As was suspected in the first place, it is interesting to note that the effect of a director at 0.1-wavelength spacing is just about the same as that of a reflector at 0.2-wavelength spacing, but with opposite sign. Accordingly, a 24½" reflector was placed at 0.2 wavelength and a 22.5" director at 0.1 wavelength. The resonant frequency of the driven element when this three-element array was measured came out, for all practical purposes, the same as that of the element alone or 240 megacycles. This would give a megacycle/foot factor of 470, which is pretty

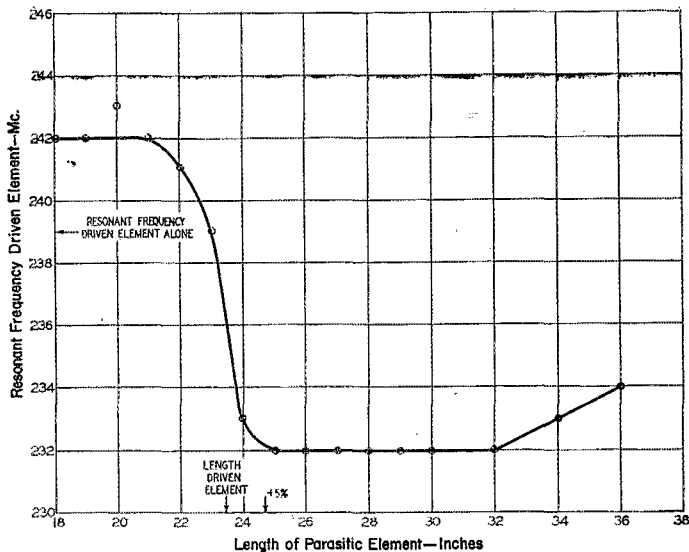

close to what is ordinarily used for three-element beams.

It is also interesting that these curves show that the effect of a reflector seems to be greatest at 0.2-wavelength spacing, while that of a director is most pronounced at 0.1 spacing, which may account for the commonly accepted fact that 0.2R/0.1D combination gives optimum gain.

Of course, depending on the director tuning, the megacycle/foot factor can be anywhere from 470 to 500 or so for 0.1D directors. For 0.2R reflectors it is 470 to 455. In any case, the important thing is that three-element lengths do not apply to two-element beams. As for the length of the reflectors and directors themselves, I assume that the four per cent shorter than the radiator for the director, and five to six per cent longer for the reflector, still applies and seems to fit the right spots in the curves.

It is unfortunate that these data could not be combined with front/back ratio and gain, but that gets a bit too complicated for the time I have available. — F. M. Dukak, W1BOD

## Strays

A new miniature magnetron developed by the Signal Corps is only four inches long, lead-pencil size in diameter, and operates at less than 100 volts anode potential. — *Ohmite News*

An enterprising amateur in VP5 recently sent some lottery tickets to a Canadian amateur via the ARRL QSL Bureau system. The tickets were in a sealed envelope addressed to the Canadian in care of QSL Manager VE3QB, and the latter merely readdressed the envelope without opening it. The post office authorities, however, spotted the lottery tickets, with the result that VE3QB lost his mailing privileges for about nine days until the matter was cleared up. Amateurs are reminded that the sending of lottery tickets through the mail is prohibited by postal regulations in both Canada and the United States.

# Building a Rotatable End-Fire Array for 10 and 20

*A Simple and Inexpensive Two-Band Beam Antenna*

BY FRED W. WALTER,\* W8TWQ

**D**URING the past few years the popularity of three- and four-element parasitic arrays has grown by leaps and bounds. In many ways this has been enhanced by such constructional advantages as the availability of light-weight metals for the elements and the crying need for a more-efficient antenna system to combat crowded band conditions. For the amount of money expended, these antennas, when properly erected and adjusted, give unparalleled performance on the band for which they have been designed.

However, antennas of this type have three serious drawbacks. The parasitic array may be used on one band only.<sup>1</sup> If operation is desired on ten and twenty meters, it is necessary to stack two such antennas, one above the other, on the same mast, each with its own transmission line, or common-line change-over relay, or a separate tower for each antenna must be provided. The latter may be prompted by the inability of the mast to support two antennas because of the weights encountered and the increased wind resistance. Thus two-band operation often necessitates two complete antennas, practically doubling the cost.

The second and probably most important drawback is that although the properly-adjusted three-element beam may give 7-db. gain over that of a half-wave antenna, it is difficult to adjust for such performance. Close-spaced beams are very sharp in tuning because of the low radiation resistance. Furthermore, most parasitic arrays are not mounted on masts that permit the operator to make adjustments of reflector and director length, as well as dipole length, for best front-to-back ratio or forward gain. This is further complicated if both ten- and twenty-meter parasitic arrays are mounted on the same mast. At best, many parasitic arrays are adjusted on the ground, or a short distance off ground. Thus over-all gain may drop from 7 to 5 or 4 db. when the beam is hoisted in place.

\*4763 Grace Road, North Olmsted, Ohio.

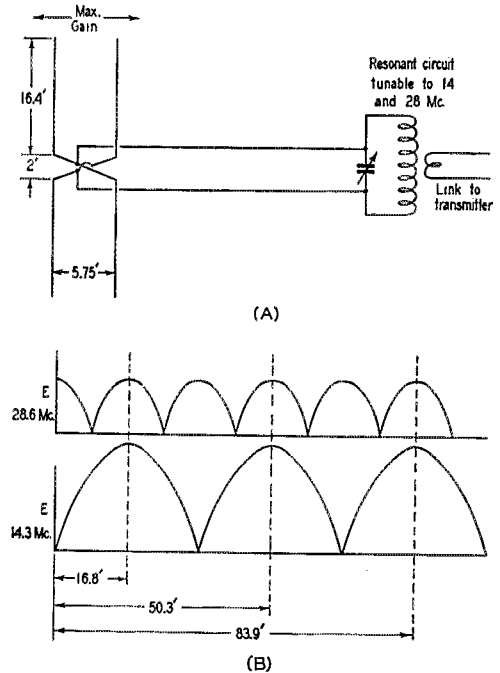

Fig. 1 — (A) — Sketch of the two-band end-fire array with dimensions. (B) — Voltage-wave patterns for 10 and 20 for various feeder lengths.

Thirdly, although there are many advantages to having maximum directivity in one direction only, it becomes a drawback in DX contests, since many minutes are wasted in rotating the beam through 360 degrees to scan every direction. Many contacts are missed entirely because both received and transmitted signals are seriously attenuated in directions other than that in which the antenna is pointed.

Would it not be much more satisfactory to make use of an 8JK antenna system that practically assures the operator of 4- to 5-db. gain on two bands, requires no adjustment, may be arranged for ten- and twenty-meter operation, utilizes one transmission line and one antenna tuner, is

<sup>1</sup>This does not apply to special systems, such as Pichitino, *QST*, Oct., 1948, and McCullough, *QST*, Dec., 1946.

The bamboo poles are reinforced near the center with strips of packing-case wood.

**QST for**



The wire elements of this end-fire array are supported on a light framework of bamboo poles.

physically narrower and weighs less than a close-spaced twenty-meter parasitic three-element array, and, best of all, does not require critical adjustment?

### Construction

Such an antenna answering the above description has recently been constructed at a total expense of less than \$10.00, including two quarts of paint and welding of the steel mounting plate and two-inch pipe flange. The antenna is not heavy; it weighs in the neighborhood of 50 pounds complete. Its construction is novel, and it makes use of aluminum clothesline wire for the antenna elements and Brazilian bamboo for the supports. It is extremely strong and has withstood heavy winds with no ill effects. The lumber used was scrap 1 × 3-inch pine salvaged from packing boxes. Since the scraps were not long enough, two pieces were bolted together to form each of the four supports, as shown in the photographs. Were this antenna to be constructed with purchased lumber, 1 × 3-inch boards approximately 8 feet long would suffice. The bamboo poles were originally 18 feet long. After attaching these poles individually to the boards with 1½-inch "U" bolts, they were cut off at about 11 feet. This trimming was done after the antenna was strung in place, and the proper amount of "bow" achieved. The triangular superstructure, also constructed of 1 × 3-inch lumber, is about 30 inches high and supports the center spreader and feeders. The center spreader support also is made of Brazilian bamboo trimmed to a length of 6 feet. The junction of the aluminum wire and the copper-wire feeders is securely clamped to insure the best possible joint. Following the joining of the feeders to the terminals of the aluminum wire, the joint was securely taped to resist moisture. This is necessary because of the electrolytic action which may occur in time at the junction of dissimilar metals.

### Dimensions

Since the antenna was designed for operation on ten and twenty meters, the dimensions followed are more or less a compromise to insure the best possible two-band operation. As an example, antenna handbooks indicate that maximum gain for two parallel half-wave elements combined in an end-fire array having currents 180 degrees out of phase occurs when the spacing between elements is  $\frac{1}{2}$  wavelength. A compromise in the case of the antenna described makes the spacing 5.75 feet which corresponds to a spacing of  $\frac{1}{4}$  wavelength on ten meters, and  $\frac{1}{2}$  wavelength on twenty meters. The antenna dimensions have

A simple "A"-shaped structure at the center holds the middle spreader.

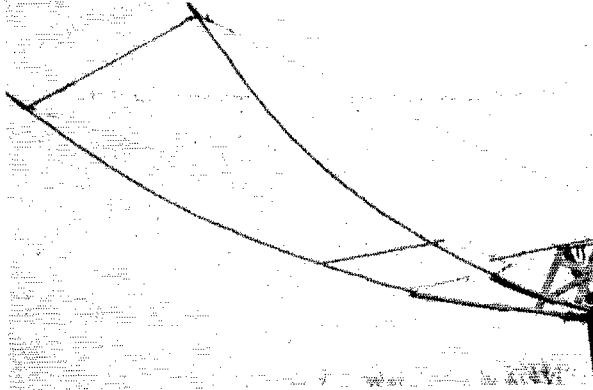

been computed on the basis of a frequency of 28.6 Mc. and, correspondingly, 14.3 Mc. Also, the longitudinal spacing between the elements is not critical on twenty meters, but should be about 2 feet on ten meters so this has been taken into consideration. Fig. 1A shows a sketch of the antenna system with dimensions.

Although the antenna length is not critical for any particular frequency for the 8JK array, it is absolutely essential that each element making up the beam be exactly the same length. In the case of the antenna described, each element is 16.4 feet in length. The array described results in a four-element beam on ten meters, and a two-element beam on twenty meters. Once this antenna has been constructed, no pruning is necessary; it is merely hoisted in place to the top of the mast after it is constructed and there it remains. It is a bidirectional beam, necessitating a rotation of only 180 degrees for complete coverage.

The antenna described makes use of an open-wire line with 3-inch spacing. Its over-all length to the antenna tuner was made suitable for voltage feeding on both ten and twenty meters. The variable capacitor used in the tuner is of sufficient capacitance to allow tuning to resonance on both bands. Therefore, it is necessary only to tune the tuner to resonance; provided the tuned line is of proper length, no change from series to parallel tuning is required. The sketch of Fig. 1B indicates that a feeder length of 50.3 feet has been chosen, but equal results may also be obtained with feeder lengths of 16.8 feet, 83.9 feet, 117.46 feet, etc. Of course, the feeder lengths indicated are those calculated. They may be pruned to optimum with the aid of a grid-dip oscillator.

An 8JK antenna need not be elaborate nor expensive. It is extremely flexible, and without doubt provides the least-expensive sure-fire array for two-band operation.





# The World Above 50 Mc.



CONDUCTED BY E. P. TILTON,\* WHDQ

**T**HE v.h.f. news for August can be summed up in one word: *aurora!* Though we think of spring and fall as the major aurora periods, August brought two of the most remarkable aurora openings in v.h.f. history. A display of "northern lights" on the 7th, reported over much of Northeastern U. S. as one of the most brilliant in recent years, was accompanied by a splendid opening of both 50 and 144 Mc. Again, beginning on the evening of the 18th and continuing intermittently through the early hours of the 20th, the v.h.f. bands saw unprecedented aurora activity.

With nearly 15 years' experience to draw on, the 6-meter gang know what to expect of ionosphere storm periods, but even old hands at the game were in for a treat in these sessions. On 144 Mc. the news of July's aurora DX had spread rapidly. No longer did the appearance of aurora on lower frequencies catch the 2-meter fraternity napping. From North Dakota to North Carolina and from Mississippi to Maine the reports came rolling in. States and call area totals rocketed upward as paths of as much as 900 miles were spanned on 144 Mc. DX up to 1200 miles was worked on 50 Mc.

It would be impossible to discuss all the work in detail, but as the results are of more than ordinary interest DX reports received to date are given in condensed form at the end of this department. If you find this listing helpful, please let us know. Or better yet, send in a record of the unusual stuff you hear and work, for future use.

An intriguing angle in aurora work is that "location" probably has less to do with success in working aurora DX than in other forms of extended-range v.h.f. work. Given a good antenna system (the bigger the better), a stable and sensitive receiver, a nodding acquaintance with the code, and a willingness to dig for the weak ones, almost anyone can make out well in aurora openings. Being on top of the highest hill in the county never hurt any v.h.f. man, of course, but if you are down in a hole and have shied away from v.h.f. work on that account, take heart — aurora DX may be for you.

Though the aurora activity took first place in nearly everyone's attention, there were other interesting doings on the v.h.f. bands. The sporadic-E season, as if to compensate for its late start, continued well into August, with skip openings coming frequently up to about the middle of the month and occasionally thereafter. Tropospheric openings of major importance, con-

\* V.H.F. Editor, QST.

## TROPOSPHERIC RECORDS SHATTERED!

### W2BAV Works Missouri, Iowa and Kansas on 144 Mc.

This was the one Bill had been waiting for. Last winter he had picked Red Hill, Claryville, N. Y., as the site for his biggest swing at the v.h.f. records. Since early spring he'd been hard at it, getting operating quarters built, power lines run, and gear installed.

Red Hill is a 3000-foot elevation, with a clear shot west for many miles. The rig at W2BAV is a kilowatt job, with a 48-element rotary and a hot receiver to give it real authority.

All this began to pay off on the night of Sept. 7th. Beginning at 10:20 EDST, and continuing on to 4 A.M., W2BAV worked 21 W8s, 29 W9s, and W0ONQ, Independence, Mo., W0MNO, N. Kansas City, Mo., W0ZJB, Gashland, Mo., W0EMS, Adair, Iowa, and W0DSR, Greenleaf, Kans., on 144 Mc. The W0s are all well over 1000 miles, with W0DSR apparently just a few miles short of the 1200-mile record.

More details next month.

spicuous by their absence heretofore in 1950, were showing up here and there. Some indication of the possibilities in this field were indicated when Nova Scotia and Southern Virginia were hooked up on August 25th with S9-plus signals each way on 144 Mc. Carolinas, Georgia and Florida next?

Numerous "firsts" were written into the v.h.f. record in August. Among these were the first W1-W9 and W1-VE3 2-meter contacts, handed to your conductor by W9UCH and VE3AIB. W2NLY, Oak Tree, N. J., accounted for the first work from his state to Illinois, Kentucky and Michigan, with W9FVJ, W4MKJ and W8RWW at the other ends. W2EH slipped in ahead of Jim to make the first New Jersey-Indiana contact with W9UCH. Aurora contacts between W5JTI, Jackson, Miss., and W8WRN, Columbus, Ohio, and W4AO, Falls Church, Va., and W0IID, Overland, Mo., are believed to have been firsts for 144-Mc. work between these states. W2PAU's contact with W8EP is probably the first between New Jersey and West Virginia. The best two-way

DX yet reported is about 750 miles, but several heard reports indicate that aurora DX on 144 Mc. may eventually reach 1000 miles or more.

The opening of the 7th was a relatively short evening affair, beginning around 7:15 EST, perhaps an hour after the first indications appeared on 28 Mc. It was about over by 8:45, when the visible display flickered out. On the 18th the opening was similar though shorter, 2-meter DX being reported only from about 8 to 9 p.m. EST. The aurora condition remained in evidence on lower frequencies, however, and the 2-meter band was open again the following morning, probably before anyone was on hand to take advantage of it. DX contacts were reported as early as 7 a.m. CST, when W9FVJ and W0IHD got under way. Eastern operators found contacts possible at this time, and reports indicate that 2 meters was open until about 11 EST, reopening again in the early afternoon, and remaining active until 3 or 4 a.m. on the 20th. This is by far the longest opening, and the most extensive geographically, yet observed on 144 Mc. The work by W5JTI, Jackson, Miss., is believed to be the southernmost observation of 2-meter aurora propagation. There are some as yet unconfirmed reports of Florida activity. If anyone has more

information along this line we'd like to have it. Was W4AOK in Florida actually in there, as some have reported?

With all this aurora activity on 144 Mc. the question arises about the possibility of similar DX on 220 and 420. It took high-gain antenna systems, low-noise receivers, and fairly high-power c.w. transmitters to open our eyes to the 2-meter possibilities. How long is it going to be before 500 miles or more is spanned on 220 or 420 by similar techniques?

### Here and There on 6 and 2

*Minneapolis, Minn.* — Once the middle of August is past a 50-Mc. man usually feels that his chances of picking up new states are low. Thus W0TEKX was mightily pleased when the aurora of Aug. 18th netted him W0AEH, Ogden, Iowa, for No. 45. He hastened to write out a card informing us of the fact. Then, before mail time the following morning, he caught W8YLS, Palmer, Mich., for No. 46. When things died down around noon he penciled the late information across a corner of the postcard and went out to mail it, well satisfied with two new ones in as many days. Then he came home and found 6 open again, this time to North Dakota, where W0MEK was on hand to provide No. 47. Like many Midwesterners, Bob now needs only Nevada.

*Wakefield, Mass.* — During the aurora session of Aug. 7th, W1EKT heard a W2 calling CQ on c.w. At the conclusion of the transmission the last portion, consisting of the call and K, were heard repeated with about a 2-second delay, and much weaker. The question is, where was that signal going all that time? At 186,000 miles per second it could cover quite a bit of territory in something over 2 seconds!

*Yarmouth, N. S.* — Until midsummer the path down the Atlantic Seaboard from Nova Scotia has not been open for 2-meter communication as often as in the past few years, according to VE1QY. This is confirmed by W1BCN, Hyannis, Mass., and by your conductor, who agrees that W4 contacts have been few and far between. July 30th was a startling reversal of this, however. On this evening VE1QY worked W4CLY, Cape Henry, Va., the best 2-meter DX yet worked along the Atlantic Coast. This path was open again on Aug. 25th and 26th, with W4s CLY, KDN, JHC, JFU, and OIK all making the hop to Yarmouth, a distance of some 700 miles. With Jerry's signals reaching S9-plus at W4CLY, one can't help but wonder how much farther he could have been heard down the Coast. These contacts came about with the installation of a flop-over array at VE1QY.

The path from Yarmouth to Cape Henry is almost entirely over water, but close enough to the coast to catch the favorable effects that build up there almost nightly during the summer months. When Jerry was in contact with the W4s, they were being heard in W1 and W2, but these areas were not being heard in Nova Scotia, nor was VE1QY being heard here. By the 27th, VE1QY was S9-plus throughout W1 and W2, but the W4s were no longer audible, either here or in VE1. From the 25th through into the morning of the 28th, VE1QY was hearing W signals, the nearest point in the States being some 200 miles away.

*Cape Henry, Va.* — The aurora effect was in evidence at least this far down the Atlantic Seaboard. W4CLY heard plenty of DX (see tabulation) but he couldn't raise a soul. The reason? He holds forth on 147 Mc. Moral — tune the band, not just the first 500 kc!

The necessity for spreading out becomes obvious during aurora openings, when a large slice of the 2-meter population in the entire country starts coming through in any one location. There is no question but that much choice DX was missed because the weaker and more distant stations were buried in low-end QRM. W9UCH, for example, called the writer for more than half an hour before the uproar thinned down to the point where anything but the loud W3s and 8s could be heard at the bottom of the band. Making use of that portion of the band above 144.5 Mc. would help a lot. Going above 145 would be better yet!

*Everett, Ohio* — It took the aurora session of the 7th to get W8BFQ on c.w., but one look at the tabulation of reports will show how quickly Margaret got the hang of it. She is now just one state behind Jerry, W8WJC, making the states-worked competition in W8 (and the nation) something of a family affair.

### 2-Meter Standings

Call	States Areas Miles			Call	States Areas Miles		
W1HDQ	15	6	650	W5JTI	14	5	660
W1PIV	13	5	550	W5ERD	8	3	570
W1BCN	12	4	500	W5ML	8	3	560
W1CTW	12	4	500	W5VY	7	3	1200
W1REZ	11	4	-	W5IRP	6	2	400
W1JSM	10	4	-	W5JLY	2	1	1000*
W1GJO	10	3	-	W6ZEM/6	1	1	415
W2NLY	17	6	750	W6DLR	1	1	190
W2PAU	15	6	740	W8WJC	19	7	700
W2NLY	14	6	570	W8WXY	18	8	1200
W2NGA	13	5	-	W8UKS	18	7	720
W2DFV	13	5	350	W8BFQ	18	7	600
W2CET	12	5	405	W8WRN	16	6	670
W2DPB	12	5	500	W8WSE	14	6	620
W2WLS	12	4	-	W8RWW	14	7	500
W2QNZ	11	5	-	W8CYE	12	6	-
W2NFI	11	5	500	W8CPA	12	-	650
W2FHJ	11	4	-	W8FQK	11	7	-
W2PJA	10	4	-	W9UCH	17	7	650
W3RUE	16	7	760	W9FVJ	15	6	660
W3KBA	13	6	-	W9JMS	13	6	600
W3OWW	13	6	600	W9PK	10	5	-
W3GKP	13	6	610	W9GLY	10	5	525
W3KWL	13	6	480	W9ULA	9	6	540
W3KUX	12	5	575	W9NFK	8	4	410
W3PGV	12	5	-	W9OBW	8	4	-
W3NKM	12	5	-	W0NFM	14	7	660
W3LMC	11	4	400	W0EMS	13	5	830
W4HHK	14	5	650	W0IHD	12	5	725
W4JFU	13	5	650	W0WGZ	10	4	760
W4IKZ	13	5	500	VE3AIB	10	6	600
W4CLY	12	5	720	VE1QY	10	4	720
W4FJ	12	5	450	VE3BPB	6	4	-
W4FBJ	11	5	-	VE3BQN	5	4	540
W4JDN	11	5	-	VE3EAH	4	4	380
W4MKJ	10	5	475				
W4JFV	9	5	830				

\* Crossband

To try to tie the whole thing up, W4HHK, Collierville, Tenn., put through a telephone call to W5JTI at 2 A.M., routing Tim out of bed to look for W8BFQ, but he worked W8WRN instead. This contact was one of the last reported, taking place at 3:57 A.M. EST on the 20th.

**Compton, Calif.** — Here's a July item that just missed the last issue. On the 30th W6OB worked W7TJY for his first Nevada contact and his 48th state on 50 Mc. Jack is thus the second W6 to report working all states on 50 Mc., but he and W6WNN are having some QSL trouble so neither has yet gathered the necessary written confirmations for the 50-Mc. WAS award.

**Niue Island** — It's a little late in the solar cycle, but nonetheless good news: ZK2AA promises to be on 50.4 Mc. by the middle of September. Judging by last spring's activity between KH6 and VK, ZL and South America, he still may do some good work.

**Tilburg, Netherlands** — A student at Heiden University writes that he would like to correspond with an American amateur who is particularly interested in the technical aspects of v.h.f. communication. His name and address: A. Velge, 5 Nazarethstraat, Tilburg, Netherlands.

**Shiloh, Ohio** — What direction was your beam aimed during the aurora sessions? W8WXV aimed west for W4-HHK, and the same is reported to have been the case at W8WJC/BFQ. W8WRN says his was northwest. The position of the aurora is subject to wide variations, so the optimum may be far from north in some cases. It's better not to take it for granted, in any event.

**Baltimore, Md.** — A teletype link to New York on 144 Mc. is in prospect. W3LMC is set for it, with W2JAV, Hammonton, N. J., getting ready.

A later report from W2BFD tells us that the system had its first workout Aug. 24th. With W2QGH, W2JAV, W3LMC, W3PYW, and W4JCV handling the relays, messages were exchanged between New York and Washington in snappy order.

**Davenport, Iowa** — A number of 2-meter transmitters running automatically each evening (or around the clock, if possible) would help to maintain interest in 144-Mc. work, according to W0ETJ, who says that many recruits to the band give up after a short time because they frequently are unable to hear anything. The automatic transmitters would serve two purposes: they would provide a constant check on propagation conditions, and give isolated stations a signal with which to work in getting their receivers working at peak performance. W9ACC and W0ETJ are in contact nearly every night at 11 CST. They would be glad to hear from others who would be interested in 2-meter schedules at this or other times.

**Willard, Wis.** — The daily 144-Mc. sked with W0HXY and others is still being kept regularly by W9FPE, though the path is 140 miles or more. W0TI, Millbank, S. Dak., and W0AZE, Bellingham, Minn., nearly 300 miles to the west, have also been worked successfully, though not on regular schedule. W9JBF, Wausau, also works W0JHS, W0HXY and W0SV regularly. W9FPE and W0JHS are trying for the first Wisconsin-Minnesota contact on 420 Mc.

**East Longmeadow, Mass.** — Noting that nearly every v.h.f. contest brings about a 50-Mc. contact with W3OJU, Washington, D. C., W1CGY decided to see how they could make out on a regular schedule. Since early in August these two, separated by 325 miles, have made a try nightly on 6 at 10:30 EDST. Though it is far from a consistent communication schedule, they have heard each other a high percentage of the time. About half the contacts have been good enough for information exchanges on c.w., and a few times voice has been used. Often the signals have meteor burst characteristics, disappearing completely in spots and popping back at 85 or so at intervals. Both stations run around 100 watts. W1CGY uses a stacked 4-over-4 array, W3OJU a single 4-element. Locations are good, but not extraordinary.

**Ada, Okla.** — "Working on 2 has given me the biggest kick I've had since my first QSO 11 years ago. It's just like fishing — you never know what you will get, but some of the catches are bound to be big ones if you keep at it long enough." So writes W5LOW. Some of his big ones, caught on Aug. 8th and 9th, were W6s LFW, Gashland, MNQ, N. Kansas City, ONQ, Independence, Mo., and DVV, Merriam, Kan., all 320 miles or more distant.

**Portland, Ore.** — In order to further interest in 144-Mc. work W7MHK is on 144.9 Mc. nightly looking for contacts between 7 and 10 p.m. He uses horizontal polarization. On Aug. 6th, when the gang in Yakima, Wash., had their



### Standings as of August 25th

W0ZJB	48	W6VY	47	W0HGE	47
W0BJV	48	W5JTI	44	W0WPK	47
W6CJS	48	W6ML	44	W0VZP	47
W5AJG	48	W5JLY	43	W0ALU	46
W9ZHL	48	W5ONS	43	W0NJT	46
W0ZHB	48	W5JME	43	W0JMS	45
W0QUV	48	W6VY	42	W0QKM	45
W6WNN	48	W6FAL	41	W0RQM	45
W6OB	48	W6NHD	41	W0UTA	45
		W5GNQ	41	W0UNS	42
W1CLS	46	W5FSC	41		
W1HDQ	46	W5HLD	40		
W1CGY	44	W5HEZ	35	W0QIN	47
W1LLL	44			W0DZM	47
W1KHL	43	W6UXN	47	W0NFM	47
W1HMS	43	W6IWS	41	W0INI	47
W1LSN	41	W6OVV	40	W0TKX	47
W1EIO	40	W6TMI	40	W0KYF	44
				W0JOL	44
W2RLV	45			W0JHS	43
W2BYM	44	W7HEA	47	W0PKD	43
W2AMJ	41	W7ERA	47	W0HVW	42
W2MEU	41	W7BQX	45	W0IFI	41
W2IDZ	40	W7DYD	45		
W2GYV	40	W7JRG	42		
W2QVH	38	W7BOC	40	VE3ANY	42
W2FHJ	37	W7JFA	40	VE1QZ	32
		W7FV	40	VE1QY	31
W3OJU	45	W7CAM	40	VE3AET	29
W3NKM	39	W7KFM	40	HC2OT	26
W3JVI	38	W7ACD	35	XE1GE	19
W4FBH	46				
W4EQM	44	W8QYD	45		
W4QN	42	W8YLS	41		
W4FWH	42	W8NQD	41		
W4CPZ	39	W8CMS	40		
W4MS	38	W8LBH	37		
W4OXC	37	W8RFW	37		
W4BEN	35	W8UZ	37		
		W8WSE	36		

Calls in bold face are holders of special 50-Mc. WAS certificates, all listed in order of award numbers. Others are based on unverified reports.

2-meter field day, Mark was able to work W7EGV/7 near Olympia, Wash., a distance of some 105 miles, over rugged country. W7EVO, W7JJX and W7FS were on in Port Orchard and Tacoma, but they were not heard in Portland. W7MHK will be glad to arrange schedules with interested parties in any direction.

### The World Above 420 Mc.

The Frustrated Fellow Sufferers of Four-Twenty Society of Los Angeles meets irregularly, but frequently, at the home of one of the members. Purpose: to gather together all the 420 gear that has been started but left hanging in midair when the builders ran into trouble. The owners thereof then compare notes and help each other get their troubles ironed out. By pooling test equipment and ideas charter members of the FFS420S, W6s ELA, ELS, BWY, MIVK, EYN, and Radio Technician Bill Butler have put several new 420-Mc. stations on the air around Los Angeles. They have found it wise to appoint one of the 420 gang to operate a beacon station during meetings so that they can be sure of a signal for receiver tests. W6HZ has been acting in this capacity so far. The 2-meter band is used for promotion and arrangements. Organizer: W6MVK.

In the Memphis area W4HHK, Collierville, is working W4BYN, Memphis, Tenn., easily on 420, despite low power and antennas at moderate heights. W4BYN uses an 832 tripler driven by his 2-meter rig. The receiver is a 6J6 (one half as mixer, the other as oscillator) with a coaxial tank

input circuit. This works into a 25-Mc. i.f. strip. He uses a 16-element horizontal array. W4HHK also has an 832 tripler, feeding 16 driven elements backed up by a screen reflector. The receiver has a 1N21 crystal mixer in a coaxial circuit, with a 955 oscillator and 6AK5 i.f. amplifier, feeding an HFS on 45 Mc. The HFS works into an NC-183 for reception of W4BYN's crystal control, or the superregenerative second detector of the HFS can be used for modulated oscillator reception, if any. Other Memphis area 420-Mc. prospects are W4s DLX, FGG, VT, and CV.

Interest in 420-Mc. work continues to increase along the Atlantic Seaboard. At a recent 220-420 night at the Stratford (Conn.) Radio Club, W1JW and W1YO demonstrated several ways of getting on these bands with readily-available gear. W1PBB provided communication with the group at the meeting, with his rigs on 144, 220 and 420 Mc. Barney joined the group personally later in the evening. His information that the nightly schedule with the W2s (kept regularly for several months at 9:30 P.M.) has resulted in many 420-Mc. contacts at 40 to 80 miles should help to get more fellows started on 420 along the Connecticut shore.

What is undoubtedly an amateur TV DX record was set recently when W6UOV and W6VSY (see June QST, page 11) packed their 420-Mc. equipment off to Mt. Diablo. Borrowing a.c. power from KSBR-FM, the boys sent TV pictures to W6MYL in Camino, some 90 miles distant. Because of the low power the signal was weak, but Jim could see everything that was going on. W6AJF, Sonoma, 30 miles away, received the picture with excellent quality. Another trip is planned for the near future with higher power.

In the Los Angeles area the late summer and early fall provide almost continuous inversions and excellent propagation in the direction of San Diego. The way the 2-meter signals pound in over this path makes W6CFL feel that 420, and even the higher bands would be a cinch. He is on 420 nightly, but finds little regular activity. One newcomer, W6MCT at El Segundo, was welcomed recently.

Since his last report, G5BY has made several interesting contacts on 435 Mc. These include G3CGE, Southampton, 119 miles, worked crossband, with G5BY on 145 Mc.; G3CFR, Bournemouth, 100 miles, also crossband; and G2XC, Portsmouth, 132 miles, worked two-way on 435 Mc.

## V. H. F. AURORA DX, AUGUST 1950 50 Mc.

WØTKX Minneapolis, Minn.  
7th — Worked W9QKM. Heard W3NKM, W2BCR, WØMVG  
18th — Worked W8YLS, W9RQM, WØAEH  
19th — Worked WØMEK. Heard W8s YLS LBH, W9PK, W6s AEH CJS  
W1CGY East Longmeadow, Mass.  
7th — Worked W3OJU. Heard W8JKN, W3TIF, W2s RDZ CFY, W4AVT, W9VZP, VY6R  
19th — Worked W1EIO, W3OJU, W9RQM, WØCJS. Heard W3s GGR KFM NKM, W4s RBK HVV AVT, W8TDJ, W9FJB  
W1CLS Waltham, Mass.  
7th — Worked W9NJT, W2CFY. Heard W4s HVV AVT, W3NKM  
W1KHL Middletown, Conn.  
7th — Worked VE3AET, W2CFY. Heard VY6R, W9VZP, W4s AVT HVV, W3NKM  
W3FZQ Glenside, Penna.  
19th — Worked W1EIO, WØFYC. Heard VY6R  
W1EKT Wakefield, Mass.  
7th — Heard VY6R, VE3AET

## 144 Mc.

W1ZY Middleboro, Mass.  
7th — Worked VE3AIB, W3s LNA RUE KWL BYF, W4AO. Heard W8s RWW WXV  
19th — Worked W8s WXV BFQ BAX SFG, W3s QKI LZD, W2s ORI SFK. Heard W8YEG, VE3AQG  
W1HDQ Canton, Conn.  
7th — Worked W3s KWL LNA, VE3AIB, W8s FQK BFQ, W9UCH. Heard W8s RWW WRN WXV 2BEV/8, W4AO, W3LWN, W9EEX  
18th — Heard W8BFQ, W9EEX  
19th — Worked W8WXY, W2RPO  
W1HDF Elmwood, Conn.  
19th — Heard W2s SFK NLY PAU OPQ, W8s BFQ WRN BAK

W2NLY Oak Tree, N. J.  
19th — Worked W8s WXV BFQ RWW WRN, W3QKI, W4MKJ, VE3AIB, W9s UCH FVJ  
W2SFK Glens Falls, N. Y.  
7th — Worked W8WXY, W3LNA, VE3AIB. Heard W3s KWL CTN, W8s BFQ FQK, W4AO  
19th — Worked W3KWL, W1ZY, W8SFG. Heard W2s AZW EH PAU, W3s LZD AIR LNA RUE, W4s AO OLK, W8s WRN WXV  
W3KWL Farrell, Penna.  
7th — Worked W1s IZY HDQ, VE3AIB, W8FQK, W9s WOK EHX. Heard W2s JAV SFK BEV/8, W3AIR, W4AO, W8s WXV WRN GJF WJC FQK BAX QUR RWW, W9s EHX WOK ZHB FVJ, VE3AIB  
19th — Heard W2s NLY AZL PAU OPQ FBA SFK OPQ, W4s OXC OLK HHK, W9s ENX FVJ ALO LF GGH EQC UCH GDM, W9s ZJB BJL  
W4HHK Collierville, Tenn.  
19th — Worked W8s WXV WRN BFQ, W9LIR. Heard W4OXC, W8LPD, W9s WVE UCH LIR, W9s IHD ZJB  
W8WRN Columbus, Ohio  
7th — Heard W1s HDQ IZY, W2JAV, W3s RUE LNA KWL, W4AO, W9s UCH WOK EHX FVJ, W9s IHD ESL  
19th — Worked W2s PAU NLY, W3AIR, W4s HHK OXC, W5JTI, W9WOK. Heard W2s FBA OPQ ANU BEV/8, W3s LZD QKI KWL RUE MON, W4s OXC MKJ, W9s QKM GGM EQC HKI CGR GGH LPF SUV, W9s BJL IHD, VE3AIB  
W8FQK Greenwich, Ohio  
7th — Worked W1HDQ, W2SFK, W3KWL, W4AO, W8TBS, W9s EHX WOK, WØIHD. Heard W1ZY, W3s AIR LNA RUE, W8s RWW WRN DVL GJF, W9s LIR UCH, WØKYF  
W8BFQ Everett, Ohio  
7th — Worked W1HDQ. Heard W1ZY, W3LNA, W4AO, W8s RWW ZUR, W9UCH  
19th — Worked W1ZY, W2s NLY AZL PAU, W3LZD. W4s HHK OXC, W9s LF GGH WOK. Heard 59 stations in W1, 2, 3, 4, 8, 9, Ø and VE3.  
W4AO Falls Church, Va.  
7th — Worked W1ZY, W2FBA, VE3s AIB EAH, W8s FQK, GJU, W9s EHX UCH ZHL SUV ZHB. Heard W1HDQ, W2SFK, W3RUE, W8s WXV BFQ  
W9UCH Ft. Wayne, Ind.  
7th — Worked W1HDQ, W4AO. Heard W1ZY, W3s KWL LNA RUE AIR, W8s FQK GJF WXV ZUR WRN, W9s WOK EHX LIR FPE NFK FKI, WØIHD, VE3s BQN AIB BGB  
18th — Worked W3QKI. Heard VE3AIB, W8s WXV BFQ DUL, W9s FVJ HXS SVR LIR EHX CGR  
19th — Worked W2s EH NLY, W3s LNA LWN AIR, W4s HHK AO OXC IKZ, WØGGH, W9s BJL ZJB. Heard W3s QKI RUE MON KWL, W4MKJ, W8s RWW DUL WRN ZUR DQR ZCH CUC LPD SFG FQK, W9s RGH MBI ALU QKM LIR VZM HSK FVJ LPF HKI, W9s IHD BJL, VE3AIB  
W9FVJ Toledo, Ohio  
19th — Worked W2s RPO NLY, WØIHD. Heard W1s IZY HDQ, W2ESJ, W3s LNA QKI, W4s AO MLK, W9s DDX EMS  
W9NFK Franklin Park, and W9WOK Bensenville, Ill.  
7th — Heard W1s IZY HDQ, W2BEV/8, W3s KWL AIR RUE, W4AO, W8s RWW ZUR WXV FQK WRN GJF TBS, W9s LIR SUV FVJ EHX UCH MBI UIA ZHL ZHB ALU, W9s IHD KYF, VE3s AIB EAH  
WØIHD Overland, Mo.  
7th — Worked W8s FQK WXV ZUR, W9FKI. Heard W3s AIR RUE, W4AO, W8s TBS GJF BAX, W9UCH  
19th-20th — Worked W3s LNA QKI, W4s OXC AO, W8s WXV LPD RWW, W9s HKI FPE FVJ WOK. Heard W4HHK, W8s EP WRN BFQ, W9s ECP ASM WVE EQC DRN AGT AFT, WØHQ1  
W4CLY Cape Henry, Va.  
7th — Heard W8BFQ, W3RUE  
19th — Heard W3KWL, W8s LPD YEG, W9s UCH ASM  
W4IKZ Lynnhaven, Va.  
19th — Worked W9UCH  
W2BEV/8 Lockwood, Ohio  
7th — Worked W9EEX, W1HDQ. Heard W1ZY, W3s KWL LNA RUE, W4AO, W8s WXV FQK WRN RWW GJF TBS, VE3AIB

# • Surplus Corner —

## Circuit Improvements in the Telrad 18-A

BY FLOYD A. TRUEBLOOD,\* W3LZC/7

MANY amateurs have purchased Telrad 18-A secondary frequency standards on the surplus market, and in many instances the new owners have experienced difficulty in obtaining satisfactory performance until certain improvements in the original circuit are made. The most common faults with the unit are failure of the crystal to "start" readily, instability in the multivibrator circuit, and insufficient flexibility in the crystal circuit which prevents its adjustment to exactly 100 kc. All of these defects can be remedied without great difficulty, and performance of the modified unit has proven far more satisfactory than the original.

The circuit of the original unit utilizes a crystal which can be made to oscillate at either 100 kc. or 1000 kc., depending upon the position of  $S_1$  in Fig. 1. The output of the oscillator is fed to

\* 1522 N. E. Weidler St., Portland, Ore.

one grid of a 6L7 amplifier-mixer. In addition, a 10-ke. multivibrator using a 6N7 in a "locked-in" oscillator is used to provide beats every 10 kc. through the frequency range covered by the unit. Provision is made for adjustment of the crystal frequency to exactly 100 kc. so that it may be zero-beat with a primary frequency standard such as WWV. The circuit of the author's unit was as shown in Fig. 1. Not all components have been given symbol designations in this diagram because the exact values were either not known or unnecessary for the modifications to be described.

The faults described above are corrected by an improvement in the crystal circuit, and by substituting a blocking oscillator of the driven type for the multivibrator. The new circuit is inherently more stable than the original, and accomplishes the desired results far more satis-

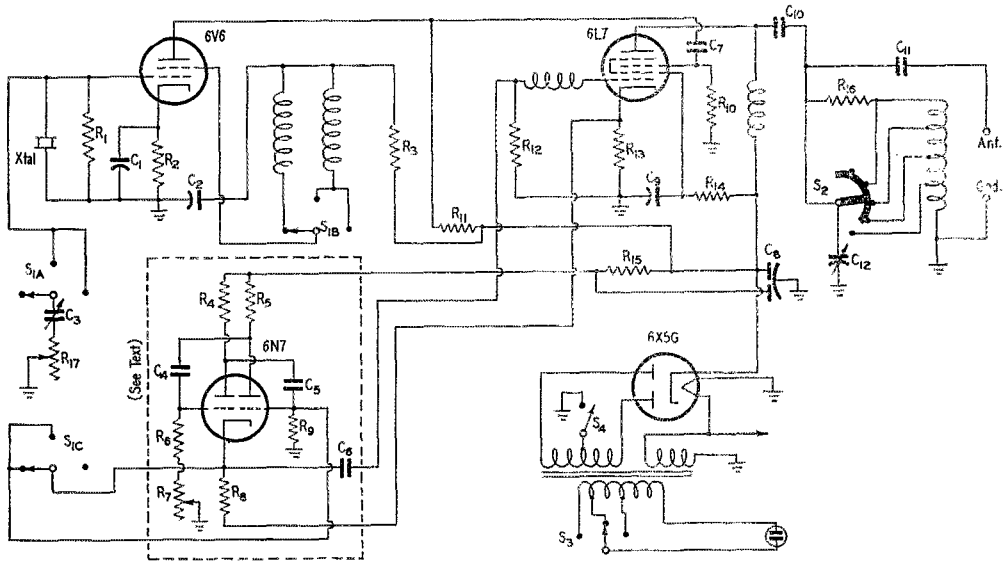

Fig. 1 — Circuit diagram of the Telrad 18-A frequency standard.

- $C_1, C_2, C_9$  — 0.1- $\mu$ fd. paper.
- $C_3$  — 3–30- $\mu$ fd. mica trimmer.
- $C_4, C_5, C_6, C_{10}$  — 0.002- $\mu$ fd. mica.
- $C_7$  — 0.001- $\mu$ fd. mica.
- $C_8$  — 8 $\times$ 8- $\mu$ fd. electrolytic.
- $C_{11}$  — 10- $\mu$ fd. mica.
- $C_{12}$  — 70- $\mu$ fd. tuning.
- $R_1$  — 5 megohms,  $\frac{1}{2}$  watt.
- $R_2$  — 500 ohms,  $\frac{1}{2}$  watt.
- $R_3$  — 25,000 ohms, 1 watt.
- $R_4, R_5$  — 2500 ohms, 1 watt.
- $R_6$  — 20,000 ohms, 1 watt.
- $R_7$  — 15,000-ohm potentiometer.
- $R_8$  — 100 ohms,  $\frac{1}{2}$  watt.

- $R_9$  — 30,000 ohms, 1 watt.
- $R_{10}$  — 50,000 ohms,  $\frac{1}{2}$  watt.
- $R_{11}$  — 85,000 ohms, 1 watt.
- $R_{12}$  — 0.1 megohm,  $\frac{1}{2}$  watt.
- $R_{13}$  — 200 ohms,  $\frac{1}{2}$  watt.
- $R_{14}$  — 15,000 ohms, 1 watt.
- $R_{15}$  — 3200 ohms, 1 watt.
- $R_{16}$  — 10,000 ohms,  $\frac{1}{2}$  watt.
- $R_{17}$  — 0.5-megohm linear potentiometer.
- Xtal — Biley SMC100.
- $S_1$  — Special switch.
- $S_2$  — Single-pole 5-position shorting-type rotary.
- $S_3$  — Single-pole 3-position line-voltage selector.
- $S_4$  — S.p.s.t. toggle switch.

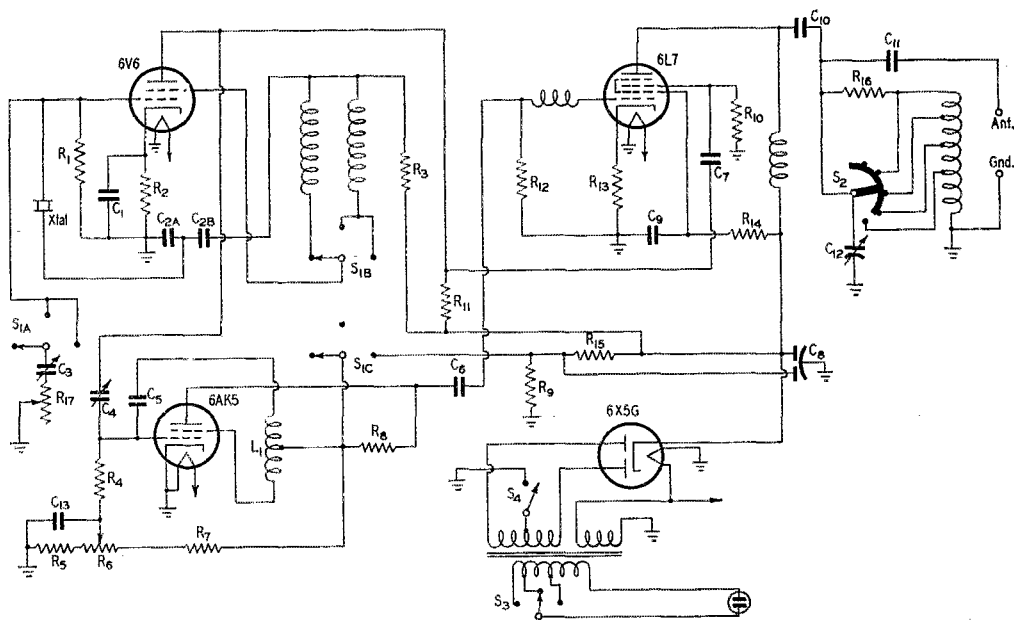

Fig. 2 — Circuit diagram of the modified frequency standard.

C<sub>1</sub>, C<sub>8</sub>, C<sub>7</sub>, C<sub>8</sub>, C<sub>9</sub>, C<sub>10</sub>, C<sub>11</sub>, C<sub>12</sub> — Same values as in Fig. 1.

C<sub>2A</sub> — 0.002- $\mu$ fd. mica.

C<sub>2B</sub> — 0.01- $\mu$ fd. mica.

C<sub>4</sub> — 3-30- $\mu$ fd. mica trimmer.

C<sub>5</sub> — 50- $\mu$ fd. ceramic or silver mica.

C<sub>6</sub> — 0.02- $\mu$ fd. paper.

C<sub>13</sub> — 0.05- $\mu$ fd. paper.

R<sub>1</sub>, R<sub>2</sub>, R<sub>3</sub>, R<sub>10</sub>, R<sub>11</sub>, R<sub>12</sub>, R<sub>13</sub>, R<sub>14</sub>, R<sub>15</sub>, R<sub>16</sub>, R<sub>17</sub> — Same as in Fig. 1.

R<sub>4</sub> — 0.75 megohm,  $\frac{1}{2}$  watt.

R<sub>5</sub> — 1200 ohms,  $\frac{1}{2}$  watt.

R<sub>6</sub> — 10,000-ohm linear potentiometer.

R<sub>7</sub> — 75,000 ohms,  $\frac{1}{2}$  watt.

R<sub>8</sub> — 0.1 megohm,  $\frac{1}{2}$  watt.

R<sub>9</sub> — 25,000 ohms, 1 watt.

L<sub>1</sub> — 10-mh. c.t. (Millen 34210-1).

Xtal — Bliley SMC100.

S<sub>1</sub> — 3-pole 3-position nonshorting single-deck rotary (compact type).

S<sub>2</sub>, S<sub>3</sub> — Same as in Fig. 1.

S<sub>4</sub> — S.p.s.t. toggle switch.

factorily. The revised circuit is shown in Fig. 2. As in Fig. 1, not all parts have been given designations for the reason mentioned previously. Very few new parts are needed, as will be apparent from comparison of the parts lists of the two diagrams. R<sub>9</sub> was inserted to drop the plate voltage of the 6AK5 blocking oscillator stage to 100 volts. A somewhat larger or smaller resistor may be needed in some cases to adjust this voltage to the correct value.

### Modifying the Unit

Remove the top and bottom plates from the instrument. Remove the knobs and the switch retainer ring from the front. After the two screws in each side of the case and the one in the center of the front of the case have been removed, the chassis may then be slid out. Unsolder all leads to the interval selector switch and remove it. Since this switch as originally constructed will not accomplish all the operations desired in the redesigned unit, it must be replaced with a suitable one. Install a replacement switch of the type indicated in Fig. 2 but do not connect the leads to the switch as yet. Remove all components of the circuit enclosed in dashed lines in Fig. 1. Take out the octal socket and cover the hole in the chassis with a piece of aluminum or steel in which a seven-prong miniature socket

has been mounted. After replacing R<sub>7</sub> of Fig. 1 with a 10,000-ohm potentiometer, rewire the 10-kc. generator portion of the circuit as shown in Fig. 2. Make connection to the interval selector switch as shown in Fig. 2. Remove the crystal unit from its mounting bracket. Cut the head off a 6-32 bolt, and screw one end of the bolt into a half-inch steatite pillar and, after placing a lock washer and solder lug on the bolt, screw the other end into the crystal unit. Replace the unit on the mounting bracket, making sure that the arrow on the case is in a vertical position. Make the associated circuit change mentioned previously and shown in Fig. 2. Carefully clean the pins of the 6AK5 and place it in its socket.

### Adjustment

Before any adjustments are made, S<sub>3</sub> should be set for the correct line voltage. At this point, the control knobs may be attached but the unit should not be replaced in the case until final adjustment of C<sub>4</sub> has been completed and the instrument is operating satisfactorily. Connect the unit for operation and adjust for 100-kc. output. Tune in WWV (or other standard signal which is an even multiple of 100 kc.) on a receiver. The amplitude of the signal supplied to the receiver by the instrument may be varied

(Continued on page 114)

# A V.H.F. Frequency Meter

BY DAVID BIRNBAUM,\* W3PGP

UNTIL fairly recently, a signal generator which would cover the range from 100 kc. to 30 Mc. has been all that the average amateur or serviceman needed. With the recent trend toward the higher frequencies, however, a generator capable of covering the v.h.f. range of 30 to 300 Mc. is almost a necessity.

The instrument to be described is patterned after a piece of Army equipment, the TS-323/UR, which is more or less a higher-frequency version of the well-known BC-221. Although it is not possible for the average home constructor to duplicate the extreme mechanical and electrical stability of the BC-221, entirely satisfactory results can be obtained by taking advantage of various pieces of surplus gear that are available and using a reasonable amount of care in construction.

## Description

The tube line-up consists of a 9002 oscillator, 6AK5 harmonic generator, 6AK5 mixer, 9001 audio amplifier or modulator, and a 6C4 crystal

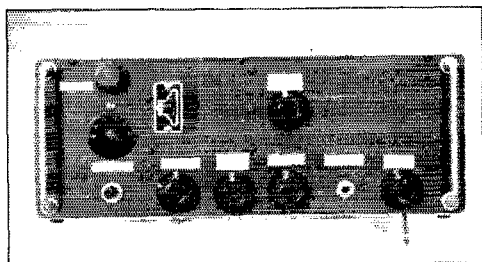

The v.h.f. frequency meter described by W3PGP is built in a BC-375 tuning unit case and uses many of the original components.

oscillator. The oscillator covers a fundamental range of 20 to 40 Mc., and the harmonic amplifier extends the useful range to well above 300 Mc. The mixer enables an outside signal to beat with the oscillator, or the crystal to beat with the oscillator for calibration purposes, depending on whether the calibration switch is off or on. The 9001 is used as either an audio amplifier feeding a pair of 'phones or as a modulator for the oscillator, depending on whether the modulation switch is off or on. With the audio output transformer used, a modulation tone of about 2000 cycles is obtained.

The crystal oscillator is coupled to the mixer when it is desired to adjust the freqmeter to the originally calibrated frequency. A 1-Mc. crystal here would have been ideal, but the writer had a surplus 5-Mc. crystal in his possession so it was used. It furnishes an adequate number of check points throughout the entire range. These are pro-

duced in the following manner: the crystal is oscillating on 5 Mc., and producing harmonics at 10, 15, 20, and every 5-Mc. step thereafter up to a point where the harmonics become too weak to be of use. By zero beating the crystal with WWV, and then zero beating the freqmeter oscillator with a crystal harmonic, momentary accuracy can be obtained. With moderate care in the mechanical construction of the oscillator, this accuracy may be extended over longer periods of time.

Since the oscillator fundamental frequency is from 20 to 40 Mc., and the crystal is emitting harmonics at every 5 Mc., check points are available at every 5 Mc. from 20 to 40 by zero beating the fundamental of the oscillator with the 4th, 5th, 6th, 7th, and 8th harmonics of the crystal. Crystal check points are also available at every half megacycle from 20 to 40. The point at 20.5 Mc., for example, results from beating the 41st harmonic of the crystal, or 205 Mc., with the 10th harmonic of the oscillator at 20.5 Mc. Actually, numerous other check points may be heard, but by using only those mentioned above, checks will occur at every half megacycle from 20 to 40 Mc., at every 1 Mc. from 40 to 80 Mc., at every 2 Mc. from 80 to 160 Mc., and at every 4 Mc. from 160 to 300 Mc.

The procedure used in employing these check points is to turn the calibration switch on, set the main dial at a check point nearest the frequency desired, and adjust the corrector trimmer to zero beat in the 'phones.

## Construction

The BC-375 series of tuning units, parts of which are used in this frequency meter, are put together to stay, as anyone who has disassembled one will readily agree. Double-bearing four-point mounted tuning condensers, a smooth-working dial reading directly to one part in 2500, and a rigid aluminum case contribute to the stability of these units in the original transmitter. Use is made of the "U"-shaped chassis, the dial assembly, and one of the tuning condensers. This condenser is the one which mounts on four ceramic pillars, has 31 plates, and a capacitance of about 20 to 150  $\mu\text{fd}$ . A new front panel and top plate are made from  $\frac{1}{8}$ -inch aluminum, the old panel serving to mark out the holes for the dial. The original perforated bottom plate is retained, the top one being discarded for lack of rigidity. A length of  $\frac{1}{2}$ -inch-square brass rod is bolted along the top of the front panel on the inside, and is drilled and tapped, allowing the top plate to be screwed down firmly on all sides.

The chassis is divided into two parts by the aluminum shield that comes with the unit. All parts except the power supply and audio stage

\* Box 121, Laurel, Md.



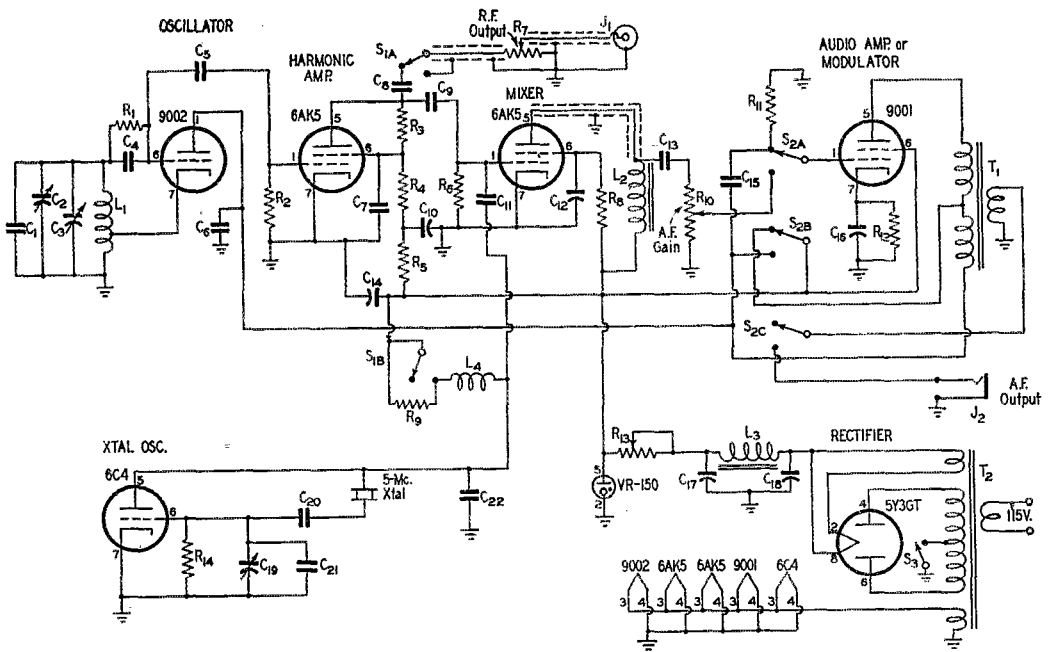

Fig. 1 — Circuit diagram of a v.h.f. frequency meter.

- $C_1$  — 3- $\mu$ fd. negative-500 Ceramicon.  
 $C_2$  — 2-plate midget variable, 5  $\mu$ fd.  
 $C_3$  — Main tuning condenser, 20 to 150  $\mu$ fd. (from BC-375).  
 $C_4$  — 100- $\mu$ fd. ceramic.  
 $C_5, C_9$  — 25- $\mu$ fd. ceramic.  
 $C_8$  — 0.01- $\mu$ fd. mica.  
 $C_7, C_8, C_{16}$  — 470- $\mu$ fd. ceramic.  
 $C_{10}, C_{14}$  — 2- $\mu$ fd. 300-volt paper.  
 $C_{11}$  — 10- $\mu$ fd. ceramic.  
 $C_{12}$  — 0.1- $\mu$ fd. 400-volt paper.  
 $C_{13}$  — 0.001- $\mu$ fd. mica.  
 $C_{16}$  — 25- $\mu$ fd. 50-volt electrolytic.  
 $C_{17}, C_{18}$  — 20- $\mu$ fd. 450-volt electrolytic.  
 $C_{19}$  — 7-45- $\mu$ fd. ceramic variable.  
 $C_{20}$  — 0.002- $\mu$ fd. mica.  
 $C_{21}, C_{22}$  — 30- $\mu$ fd. ceramic (or as needed to zero beat with WWV).  
 $R_1$  — 47,000 ohms,  $\frac{1}{2}$  watt.  
 $R_2, R_{14}$  — 0.1 megohm,  $\frac{1}{2}$  watt.

- $R_3, R_4$  — 47 ohms,  $\frac{1}{2}$  watt.  
 $R_5, R_{12}$  — 1000 ohms,  $\frac{1}{2}$  watt.  
 $R_6$  — 0.47 megohm,  $\frac{1}{2}$  watt.  
 $R_7$  — 500-ohm variable, carbon.  
 $R_8, R_9$  — 2.2 megohms,  $\frac{1}{2}$  watt.  
 $R_{10}$  — 1-megohm potentiometer.  
 $R_{11}$  — 0.27 megohm,  $\frac{1}{2}$  watt.  
 $R_{13}$  — 2500 ohms, 10 watts, sliding tap.  
 $L_1$  — 4  $\frac{1}{2}$  turns, No. 16,  $\frac{1}{4}$ -inch diam., 1 inch long.  
 $L_2$  — Audio choke, 500 henrys (from BC-357).  
 $L_3$  — 10 henrys, 50 ma.  
 $L_4$  — 1-mh. r.f. choke.  
 $J_1$  — Coaxial connector.  
 $J_2$  — Open-circuit jack.  
 $S_{1A}, B$  — D.p.d.t. wafer switch.  
 $S_{2A}, B, C$  — T.p.d.t. wafer switch.  
 $S_3$  — S.p.s.t. wafer switch.  
 $T_1$  — SCR-522 modulation transformer or equivalent.  
 $T_2$  — Replacement power transformer: 600 v. center-tapped, 50 ma.; 5 v., 2 amp.; 6.3 v., 3 amp.

are placed in the left-hand compartment. The aluminum channels supporting the tuning condenser are also used to support a small aluminum chassis on which are mounted the various components, as seen in the top-view photograph. A similar type of mounting used in the power-supply compartment on the right is also shown, the remaining two channels being used here.

To preserve as much as possible the original solidity of construction the No. 10 wire used in the tuning unit was re-used to connect the tuning condenser and coil, the oscillator grid and condenser, and the corrector trimmer and condenser. A little cut-and-try may be necessary on the oscillator coil to enable the 20-40 Mc. range to be covered with a slight overlap at each end. The connections from the cathode tap to the cathode and from the tuning condenser to the grid are made by means of miniature feed-through

insulators which require only  $\frac{1}{8}$ -inch holes through the chassis. The grid leak and condenser are mounted underneath the chassis.

The only adjustment that is not available from the front panel is the crystal trimmer, which requires only occasional change. This ceramic trimmer is mounted on the chassis, and can be reached through a hole in the top cover plate. The other controls are placed as shown in the photographs, to give fairly short, direct leads. All switches are of the rotary wafer type, to avoid the jarring that accompanies operation of a toggle switch. The output control is insulated from the panel with fiber washers.

To reduce drift attributable to heating, openings are made in the top plate, and a piece of  $\frac{1}{4}$ -inch asbestos Sheetrock is bolted to the partition separating the power supply from the rest of the unit. Heating effects are further reduced by

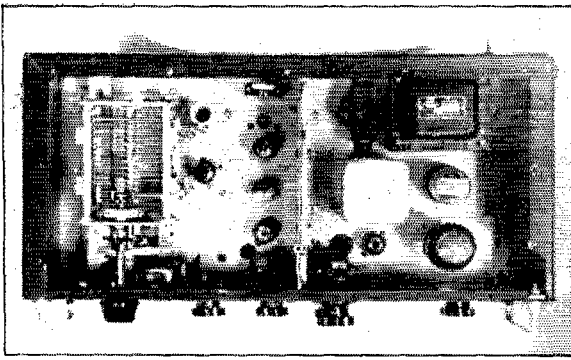

The v.h.f. frequency meter described by W3PGP is built in a BC-375 tuning unit case and uses the tuning condenser and vernier drive from this unit. The r.f. portion is in the left compartment, with the power-supply components in the right section.



changes necessary, as may the output tube. The crystal oscillator, a 6C4 in a Pierce circuit, may need extra capacitance to reach zero beat with WWV. In the author's case added capacitance was needed from both plate and grid to ground. This might not be necessary with another crystal, or with a different type of crystal circuit. The resistor  $R_9$  is used to permit a small amount of current to flow to the crystal tube when the crystal switch is off, but not enough to produce oscillation. This helps to keep the tube at an even temperature.

### Calibration

The calibration is the most arduous task in the construction of this instrument, and it is up to the individual as to how much time will be spent on this end. A calibration at every 100 kc. from 20 to 40 Mc. will produce enough points for the average need, and if intermediate frequencies are desired, a calibration at every 50 or 25 kc. can be made.

A receiver that will tune from 20 to 40 Mc. and a 100-kc. standard that has been zero-beat with WWV are required. With the corrector trimmer at half capacitance, set up the receiver on successive 100-kc. points from 20 to 40 Mc., and zero beat the freqmeter to each of these points. A reading of each freqmeter dial setting may then be taken and marked down in the calibration book. A partial calibration might appear as below.

Dial	Frequency in Megacycles			
63	20.0	40.0	80.0	160.0
107	20.1	40.2	80.4	160.8
140.5	20.2	40.4	80.8	161.6
173.5	20.3	40.6	81.2	162.4
203	20.4	40.8	81.6	163.2

The frequencies 20.0, 40.0, 80.0, and 160.0 should be marked in red to indicate crystal check points.

This calibration would enable reading directly to 100 kc. at 40 Mc., or an accuracy of 0.25 per cent, assuming negligible error in correcting the crystal to WWV, and the freqmeter check points to the crystal. Since about 2400 degrees are used to cover the fundamental range, each degree represents about 8 kilo-

(Continued on page 116)



Bottom view of the v.h.f. frequency meter.

use of a 3- $\mu$ fd. minus-500 Ceramicon. Since the tuning condenser used has just about the proper capacity ratio for the proper coverage, any variation in compensation should be done by varying the coefficient of the Ceramicon rather than changing its value. The maximum that can be used and still cover the full 20-40 Mc. range is 3 to 4  $\mu$ fd.

The corrector trimmer, a 2-plate midget, is mounted on a piece of  $\frac{1}{8}$ -inch aluminum which, in turn, is bolted to the front plate of the main tuning condenser, resulting in a rigid assembly. It is tuned from the front panel by a shaft coupling and a length of  $\frac{1}{4}$ -inch brass rod, a panel bearing being used for support.

The one mechanical difficulty encountered, an annoying backlash, resulted from the tuning condenser being slightly out of line with the dial. This condition was corrected and backlash reduced to one degree by mounting the tuning condenser with aluminum right-angle brackets at the two rear corners only, depending on the dial shaft coupling for front support. With this arrangement the condenser turns quite freely, the aluminum giving enough to correct any slight misalignment.

### Circuits

The circuits used are conventional. A 9002 Hartley oscillator drives a harmonic amplifier which may be either a 6AJ5 or 6AK5. The mixer stage may be either a 6AK5 or 9001 with no

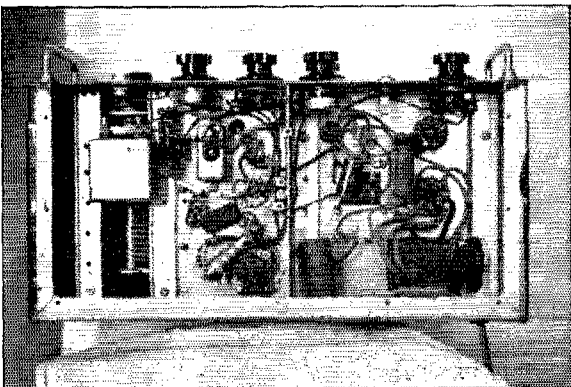



# United States Naval Reserve



**F**IFTY specially-qualified Naval Reserve volunteer electronics companies are being placed in organized status by the Navy. First to be designated as Organized Electronics Companies are units at the following points (amateur calls are indicated where assigned):

Alton, Ill. (K9NAK)	Kingsville, Texas (K5NRP)
Appleton, Wis. (K9NRN)	Malden, Mass. (K1NRA)
Bloomington, Ind. (K9NRU)	New Braunfels, Texas (K5NAL)
Bremerton, Wash. (K7NRP)	Odessa, Texas
Champaign, Ill. (K9NAP)	Pine Bluff, Ark. (K5NRM)
Dalton, Ga.	Shawnee, Okla. (K5NRZ)
Eau Claire, Wis. (K9NAD)	Tyler, Texas (K5NAS)
Enid, Okla. (K5NRY)	Waco, Texas (K5NAU)
Eureka Springs, Ark. (K5NBT)	Washington, N. C.
Payetteville, Ark.	Waukegan, Ill. (K9NAC)
Harlingen, Texas (K5NAN)	Winfield, Kans. (K9NRX)
Janesville, Wis.	

Each organized company will have a personnel allowance of five officers and 50 enlisted personnel, including a minimum of 20 seamen. Each group will be commanded by a lieutenant commander or officer of lower rank, and will have at least one officer or petty officer second class or above qualified as instructor for each of the following four ratings: electronics technician, radioman, radarman, and sonarman.

Twenty-four paid drills and two weeks' training duty with pay will be authorized each unit annually. District commandants are recommending to the Chief of Naval Personnel those companies which meet the minimum personnel requirements for authorized organized status. No organized electronics units will be allowed in locations where organized surface, submarine, or air units are established.

Lieut. Cmdr. F. O. McDonald, USN, has reported to the Bureau of Naval Personnel for duty in connection with the Naval Reserve Electronics Program. "Mac" comes to Washington from Pearl Harbor, where he was KH6TU. Earlier calls were W7KFO, KA1MD, and W6OXX. He now operates W4RPI from his home in Falls Church, Va. Working closely with Cmdr. McDonald on Naval Reserve matters is Mr. R. W. Parker who, after many years in Naval communications, finally succumbed to the "ham bug" and signs W3QAF at Greenbelt, Md.

The following description of radiomen is quoted, without comment, from a recent *Reserve Electronics Bulletin* of the Ninth Naval District:

### What Are Radiomen?

Among the stranger people on this earth are radiomen. A radioman is a person either going on or coming off watch. Contrary to popular belief, radiomen are not crazy. A radioman has two brains: one perfectly normal brain, which is

destroyed during the process of learning radio, and another which is in a constant state of turmoil, and is used proficiently in his work. This latter brain is filled with dots and dashes and procedure signs.

Radiomen are like ground hogs. They seldom, if ever, see the sun, coming up topside only on Saturday at the request of the Commanding Officer. Then, if the sun is shining and a radioman sees his shadow, he goes below and everyone knows there will be six more days of sunshine.

Sitting at his typewriter, a radioman receives an endless story of the world flowing through his ears, unable to get out because both ears are stopped up by headphones. The stuff flows out through his fingers and is given out as press news, weather messages, and so forth.

When conversing with a radioman, don't try to point your story by asking if he remembers "The Message to Garcia," because he will jump up and scream, "What's the number of it?", "Who sent it?", "If it's lost, it didn't happen on my watch."

Radiomen live on black coffee and cigarettes. All through the long midwatches they sit and dit and dah, so tired and weary of it all and wondering why they ever chose radio as a profession. When they go off duty, they hurry home to the little "ham" radio sets and just dit and dah to their heart's content. Girls who fall for radiomen will find they are courted with considerable sparking, and after they are married, will receive much broadcasting, both loud and long. Radiomen are found on all ships and in all stations and are quite harmless if left alone, fed occasionally, and given annual leave so they can rig up new "ham" outfits at home.

## ARRL Conventions VERMONT STATE

Burlington, Vermont, Oct. 14th

The annual Vermont Hamfest and State ARRL Convention will be held on Saturday, October 14th, at the Burlington (Vt.) Country Club (plenty of parking space), under the sponsorship of the Burlington Amateur Radio Club.

Among the attractions on the day-long program are FCC exams at 10:30 A.M. and 1:00 P.M.; ARRL's TVI film; QST's V.H.F. Editor Ed Tilton, W1HDQ; a code-copying contest; a traffic and emergency meeting; and a banquet followed by entertainment and dancing. The Burlington Country Club has an 18-hole golf course, with a green fee of \$1.00. There will also be activities for the YLs and XYLs.

Advance registrations for \$4.00 may be obtained from Burt Dean, WINLO, P.O. Box 81, Burlington, Vt. Registration at the door will be \$4.50.

### MIDWEST DIVISION

Des Moines, Iowa, October 21st-22nd

The 1950 ARRL Midwest Division Convention will be held October 21st and 22nd at the Hotel Savery in Des Moines, under the sponsorship of the Des Moines Radio Amateur Association. This is the first convention to be held in Des Moines since 1939, and the DMRAA is planning a bang-up affair. Plans call for technical discussions on v.h.f., TVI, and mobile installations, plus a talk by League Secretary Budlong. There will also be XYL activities, a dance, and an initiation into the Royal Order of the Wouff Hong. Pre-registration will be \$7.00, which includes two meals. Registration at the convention will be \$7.50. Further information may be obtained by writing to Garry Hunter, W9HUY, 2412 Garfield, Des Moines.



# How's DX?

CONDUCTED BY ROD NEWKIRK,\* W9BRD

## How:

Now that the dire necessity for eliminating the huge backlog has arisen, it is hoped that the recent announcement concerning the destruction of unclaimed QSLs held by ARRL QSL bureaus will shake the lethargy from a good many DX workers — that is, enough to cause them to come through with envelopes as per instructions.

The QSL card, in addition to being a unique part-and-parcel tradition of the amateur radio domain, represents in each instance — even if a duplicate among duplicates — considerable time and effort on the part of several people. Hence it will be no cheerful task to cart them to the incinerators.

The situation brings to mind a fairly good question that has been troubling others besides ourselves: What the deuce do rapid-fire DX stations like XF1A, KV4AA, and ON4QF do with all the W/VE cards they must inevitably receive? Even granted they lived in 47-room villas they certainly must be out of wall space by now. Probably they file them systematically for reference purposes. What files they must be!

Some of the very active DX boys less permanently located are up against it, however. A few pounds of postals can hardly be tolerated in a cramped duffelbag or footlocker and everybody doesn't have a "home QTH" to which they may be sent. Yet rather than consign them to the drab fate outlined in the opening paragraphs old W/VE QSLs could well reach their Valhalla in a more utilitarian blaze of glory.

\* DX Editor, QST. Please mail reports of DX activity to W9BRD's home QTH: 1517 Fargo Ave., Chicago 26, Ill.



For instance, when the Post Exchange is entirely out of the Bicycle brand, a fair-sized W/VE card file may produce a dandy Poker deck. One merely has to trim them to standard size after selecting suits of black, red, blue, and green hue; omit the first call area and use, say, VE2 through VE5 for Jack through Ace respectively.

We visualize getting quite a bang from drawing to a pair of W2s and coming out with a Full House. In time, no doubt, certain hand combinations would acquire ham-jargon nicknames. Four W6s might be termed a Powerhouse, for one. Two pairs of W6s and W7s can be a European's Delight. The DXCC Straight or QRM Flush could well take their places in a future edition of Hoyle's.

The possibilities for Canasta need not be gone into here but fellows who work 'phone shall bear watching in this case for the possibility of their slipping an SWL card or two into the meld. [Step down, Boss. Let's make it a snappy game of Five Hundred with guess-who's card as Joker. — Jeeves]

## What:

Ed Tilton's favorite substitute for the Heavyside Layer, the Aurora Borealis, has been intermittently gumming things up on DX frequencies. Those unable to get decent results with the old kw. have found some solace in noting the same difficulties beset the superpowered point-to-point commercial services. Small consolation, indeed. W5FXN did well under such circumstances with VK1YM (14,043) of Heard Island, VR2BW (14,022), UP2KBC (14,082 t7), ZB2I (14,075), ZD2LO (14,102), ZM6AK (14,050), MI3IM (14,015), PK5JT (14,100), PK6LN (14,125), HH2LD (14,006), HZ1JD (14,055), EL2GQD (14,055), KC6WC (14,109), YS2O (14,050), and EZ4Y . . . . . At W2QHH there was EZ4Y (14,004) of the Saar as well as KX6AA (14,113), FP8AF, and LX4FS (14,006). That EZ4Y was worked as 9S4AX (14,007 t8) by W8DAW (see Tidbits) and Russ also bagged CS3AA (14,126) . . . . . W4CTS is head-scratching over YD5BT (14,020) who is obviously reviving, he says, the late-lamented DX Swing . . . . . Oldtimer-just-returned VK3ZP is back on looking for old friends around 14,040 kc. and some of the gaud comment re a YA2B holding forth on 14,035 kc. . . . . VE1DB was put on the trail of EA9AB (14,015) of Spanish Guinea and W5QMJ found his rock-bound frequency of 14,148 good for contacts with CT3AV, EL5B, VP5AK, and VP7NR . . . . . W9NN hit it rich on LA9JB, 4X4CR, VR5GC, and ET3AB while W9ABA clicked with UA9FR (14,050) on Sakhalin, CR5AD, VQ4KRL, VQ4BB, EA6AF, and ZK1AZ/MM anchored off Niue, all haunting the low edge of the band . . . . . A couple of weeks of vacation for W9ALI netted Larry a long string of DX including JAs 2DD, 2RO, 8AB, TF3SF, CN8EF, YU3FMA, HPILO, KR6s DB, EI, an LX4 and a KX6 . . . . . KZ5ES's 6L6 at 20 watts tied onto a 200-foot wire captured YV5s AE, DM, PJs 1UF (14,070), 5FN (14,019), ZBIAR (14,039), KX6BA (14,060-135), EK1AR (14,120), FM7WF (14,076), and FA9IO. VU2CJ (14,048), CPIAQ (14,064), LX1AS (14,058), YO3GY, and UB5BG are still on Austin's stalk list . . . . . W5LAK is now sharing the key of W5YH at Port Arthur College . . . . . W2AGW found FK8AI available (14,091) and W9GMZ was among the fortunates to spear LX4FS . . . . . PK5AA (14,100) and ZS3K (14,115) are valued items at W6NTR, and W9TKV spent some of his vacation time conversing with folk like ZC6AB, W2OXE/MM, SP5ZPZ, TA3AA,

One of the monthly meetings of the Okinawa Radio Amateur League brought this turnout recently: front row — KR6s AD, CI, DR, ED, BU, DL, DQ, CE, CL, DU, EE; standing — KR6s CO, EC, EH, DZ, CH, FI, BA, CF. (Photo courtesy KR6CL.)



VRIC, HRIRL, VP1NW (14,060 t8), ZE1JI, and FY7YB . . . . . WIBOD scraped up EA9s AQ (14,020), BB (14,050), FY7YB (14,026), KR6CA (14,020), VR2BU (14,070), VK1PG (14,035), VK9MR (14,090 t8), DU1WP (14,060 t7), JA2s DH (14,040), and DI (14,105). Frank speaks of a particularly lively period one morning when VK9s MR and RM elected to handle pile-ups within 5 kc. of each other . . . . . ZB1EU (14,023), JA2DD (14,090), IS1AHK (14,005), VP6s PV and WF are featured on W5ONL's list and W4MR collaborated with MS4FM, M3AB, Y12UW and a CR5 during the slow season . . . . . SU1UU (14,014) intrigues W6EAY and Eric adds SP1CM (14,001), TA3AA (14,000), ZM6AK (14,055), PK6LN (14,070), VR2AA (14,055), and VQ3BNU (14,110). W6EAY had quite a nerve-racking time of it one evening when two countries he needed wound up zero-beat with each other. He collected HR1GM from the melee but ZK1BC got away . . . . . W6ALQ specifies working HL1CB, HC2KB, TI2s PZ, QV, KR6CW, and KB6AF with the new vertical quarter-wave; and in the *Bulletin* of the So. Calif. DX Club are recommended: ZD8A (14,020), HZ1AB (14,060), FB8RXD (14,075), ZD6JL (14,170), GD3FAC (14,015), OY3IGO (14,030), PK6CS (14,130 t7), KB6AM (14,022), and FL8AC (14,120). A VU7AH is also reported active during the mornings on 14,075 kc.

In the microphone department, Alfonso Velasco piloted XE1AC into the receivers of CR7BB (14,305), CR9AB (14,122), DU1DR (14,180), HA5BD (14,325), KC6WC (14,208), KB6AO (14,259), EA8AY (14,293), EA9AI (14,314), OE5CA (14,325), PK1DX (14,189), PK4KS (14,162), SV9WN (14,351), VK9JC (14,306), ZE2JK (14,312), VSs 1AY (14,308), 2CJ (14,365), 6AZ (14,339), ZS7C (14,306), 3V8AT (14,307), and 4X4BJ (14,376) . . . . . W9HP has fresh "phone confirmations from PK6SC, YO7WL, VS7GR, GD3UB, HZ1AB, VPSAK, VK1ADS, and AP2N but still awaits varies from UA3AM, VQ2HC, VQ8AX, CR5UP, ZP5BL, and CR6AI . . . . . The aforementioned *Bulletin* puts the finger on 3V8BB (14,390), ZD2LO (14,310), VK9FM (14,360), FN8AD (14,310) and PK6CS (14,130).

*Eighty, forty, and ten* should be putting forth a respectable DX performance by now but heretofore, and especially on ten, the situation may be summed up in one descriptive word — Bah. CE3AG (3505) and FP8AC made it 73 80-meter countries at W2QHH to provide the only bright light in the 3.5-Mc. picture . . . . . F5s 8AB and 8AD have been perking up forty meters a bit on the low edge as have VR2BZ and ZK1AZ/MM, according to W9AND and W2WWP . . . . . KZ5ES ran across SM5AHK and KG4AQ (7010) . . . . . Calls from DL1CJ and KZ5BE alerted WIBGJ to the fact that forty can change character from a local rag-chew band to a DX range in a matter of minutes and one XG7NO has been throwing some weird A2 at the boys who frequent the 7200-kc. vicinity . . . . . Africans should be breaking through on ten with fair consistency about this time and W2ZVS has accumulated ZD4AB, OQ5CJ, VQ4s ERR, SC and VL as well as VP6s HM, HR, JK, ZL2QT, and CE6AM via the voice route.

### Where:

The liberalization of the amateur status in Curacao has been dangling fire for some time now. We ceased some time ago the publication of PJ direct-route QTHs as it transpired that they were and still are "under cover." Their QSO instructions to avoid radio terminology upon mail to them is only too often unheeded. W8NKKU has arranged with PJ5RE to handle the relay of cards to any and all PJ stations so you may ship yours, until further notice, to Carl W. Krueger, 5639 Glasgow Rd., Sylvania, Ohio . . . . . W2DKF and W8DAW apprise us that 9S4AX (as listed below) is the Saarland QSL manager and will QSP all 9S4-bound confirmations. Those desiring cards to be answered direct should enclose IRCs therewith.

GN8EG Navy 214, Box B, % FPO, New York, N. Y.  
 ex-CR5UP (QSL to CT1BW)

EA9AT (QSL via URE)  
 EA9AB Box 111, Santa Isabel, Spanish Guinea  
 FM7WS St. Joseph, Martinique, F. W. I.  
 FSSAD (QSL via REF)  
 FY7YB Ravin, Post Office, Cayenne, French Guiana  
 ex-HLIBJ Capt. R. U. Mawby, W3FFM, 1560 E. Berks St., Philadelphia 25, Pa.  
 KB6AF (QSL via KH6BA)  
 KG4AT Navy 115, % FPO, New York, N. Y.  
 LX4FS (QSL via LX1JW)  
 LX4XV (QSL via LX1JW)  
 OA8A Don Stark, Box 2492, Lima, Peru  
 OE1UN (QSL via RSGB)  
 PK5AA Devos, % Radio Station, Balikpapan, Borneo. R. of I.  
 TA1AT (QSL via ARRL)  
 TI2QV Edgar Bolanos, 8 St., 16-18 Ave., San Jose, Costa Rica  
 VK1PG (QSL to VK2PG)  
 VP4TAB 60 Second St., Barataria, Trinidad, B. W. I.  
 YV5EH Gustavo Hernandez, Cristo a Cordova 93, Caracas, Venezuela  
 ZC4TC (ex-ST2TC) T. Christodoulides, Polis-Paphos, Cyprus  
 ZS3K % Survey Dept., Windhoek, S. W. Africa  
 ZS3X Box 85, Windhoek, S. W. Africa  
 4X4DR Paul Vidor, 3 Gezer St., Tel-Aviv, Israel  
 9S4AL Rudi Bluel, Heinestrasse 24, Saarbrücken 3, Saarland  
 9S4AR Kurt Schneider, Scheffelstrasse 39, Saarbrücken 3, Saarland  
 9S4AX Alfred Woerner, Saarstrasse 9, Saarbrücken 3, Saarland  
 9S4AZ Fritz Meyer-Buchardt, Halbergstrasse 35, Saarbrücken 3, Saarland

You've got to hand it to W1s APU BOD, W2s AGW CJX DKF ZVS, W3LPF, W4NUI, W5s FXN QMJ RS, W6s ALQ NTR, W8s DAW YNY, W9s ABA and CFT KA NDA RQM, and VE1DB for dishing up these dillies.

### Tidbits:

Every Svalbard lead that W3JTC runs down seems to come to naught. Larry learned that LAs 4MA and 9JB were mainlanders although LA3MA formerly operated from the island. In a letter from VQ4ERR, W3JTC reads that the GPO of Seychelles has issued but one license and that to VQ4KRL as VQ9KRL. The VQ4 was accompanying a brother who hunts pirate treasure and his VQ9 activity was produced with a tiny three-watter. He hopes to make the trip again one day . . . . . The much-sought-after Yemen line on the Countries List was briefly represented by MD9AA as operated by Ken Ellis (HZ1KE, etc.). W3JTC and W4s FU and NNN were among the few fortunate enough to snap up this one . . . . . Over 1600 DL licenses have been issued according to DL1KV and this includes occupational and nationals; the prefix DL6 is the latest assigned to nationals. Some DK8s operate incognito in the Russian zone but all other DKs are phoneys. Otried vouchers for the efficiency of the DARC QSL Bureau and also mentions September activity of the DARC Annual Convention

A recent qualifier for the 'phone DXCC award, A. Bonnechaux of Versailles, is seated at the controls of his compact yet effective station, F9HE.



station, DLØKT ..... TA1AT is back on with about twenty watts and WIBUX was the only U. S. station contacted among 45 countries worked. He hopes to enter future DX tests with a minimum of 150 watts, however ..... ZS6HL paid W3JTC and friends a personal visit and expects to see them via radio from the VK/ZL vicinity before long ..... EA8CO/EA8AW inquires through J Hart of 617 Grove St., Irvington, N. J., as to whether any W might be interested in exchanging a receiver such as the HQ-129X for a Spanish stamp collection of equivalent value ..... We are sorry to learn that CN8EL's better half, W6HHD, has been hospitalized and wish her a speedy recovery. Teresa claims to be a c.w. hound but can also hold her own on 10- and 11-meter 'phone ..... CX1CX returns to the air again after three years inactivity and pushes 800 watts into a pair of 4-125As. Doc wonders if anyone is still seeking his QSL and is willing to go back through the log to 1926 as long as an IRC accompanies each request ..... On October 7th through 8th the HB9s will be active from all cantons for the purpose of giving DX stations a good shot at the H-22 Swiss award. Full details are lacking but there are 22 cantons in Switzerland. Has anyone got 'em all worked? W2QHH volunteers this info and we note that he now has WPR-150 and that's a heck of a lot of KP4s ..... VS2CP is rather disappointed in the response to his QSLs and also regrets that he is unable to comply with requests for air-mailing his cards. VS2CP has always QSL'd 100 per cent via bureaus and hopes to increase his power from 20 to 150 watts quite soon ..... W4HWC ran across a PX1A card confirming a contact with K4ESH which took place in '46. Moral: *Never* give up. Ken also reports 3V8 and PK6 cards moving through W4DDF's bureau ..... W1DJV learns that VR6AC of Pitcairn has been unable to obtain parts for the repair and maintenance of the rig there. We hope the problem has been solved ere you read this ..... W7HLU received "Radio-Onda" Argentine DX Certificate No. 36 from LU8BF. The award is slightly larger than 9 by 12 inches and is printed in Spanish ..... W2SGX has it that CR7IL returned to Mozambique from a stay in Europe and finds himself some 1000 cards behind in the QSL department. He has been working hard to bring this backlog up to date ..... A well-known DXer of many years back has returned to the air as 9S4AX. This would be Alfred Woerner who has held the calls TS4SAX, EZ4SAX, D4QET, EZ4Y, EZ4EL, and EZ4BI. W2DKF understands that the Saarland gang battled for two years to get their licenses and there are quite a few 9S4s on the air at this writing. The Saar is *not* a separate country on the Countries List ..... The passing of his mother has caused a change in the QTH of W4MR and we hope to see Al as active as before in the near future. Al feels that a vote of thanks should be passed along to TA3AA by the DX gang; Jules was responsible for three new ones in the W4MR log — TA, SV6, and AR8 ..... W1PWK has been visiting all sorts of places in the Mediterranean area — TA, ZB1, SVØ, et al — and yet found time to put CN8EQ

on the air. One postcard has a picture on it showing a medicine-man type waving a couple of four-foot snakes — wow! Jeeves says we'll do our North African traveling via the *National Geographic* ..... We ordinarily have no space available to present SWL doings but it is worthy of note that John DeMeyer of Lansing, Mich., has confirmed 198 countries in amateur 'phone reception. This shows that our 'phone DX men still have quite a few to go after. John has an interesting point concerning the c.w. YA3AB reportedly active some time ago. With Russian-to-English alphabetical translation YA3AB becomes UA3AW. Whether the Russian alphabet is ever transmitted with English c.w. equivalents is, of course, the question ..... OY3IGO has finished his double-conversion superhet but still has trouble picking Ws out of the pile-ups that occur as soon as he touches the key. W1EFQ was told that OY2RD is now QRT ..... KS4AN leaves Swan Island in favor of the returning KS4AI (W5KWY) and KS4AC will continue to be quite active on c.w. Perhaps Ralph will be able to finish off his DXCC in his next session as KS4AI ..... CR1ØAA and MS4FM have been reported to have closed down and W4MKB passes word through W1DJV to the effect that ZS9F's rig was struck by lightning, causing him the loss of one eye and damage to the other. Jimmy, who worked 28-Mc. 'phone and 7-Mc. c.w., is now undergoing treatment in England and has the best wishes of all the DX fraternity for an early recovery and return to the air ..... W3DGM heard that G5GK was the first Englishman to make the Chilean WACE award and the second European after DL7AA ..... W5ONL is counting his lucky stars after making a move to a QTH just within the DXCC rules limit. That Rule 7 can surely be a heartbreaker but it's obviously necessary to draw the line someplace ..... The Fourth All-European DX Contest will be sponsored by the SSA this year during the Swedish society's 25th-Year Jubilee period. The 'phone



HK6JH is very active on 20 and 40 meters, preferring c.w. Running a maximum of 50 watts, Mario guarantees a fast QSL for all contacts.

section of the test is dated December 1st-2nd-3rd while the c.w. portion is scheduled for November 24th-25th-26th. Starting and ending times are 1901 and 1900 on each set of dates respectively (Eastern Standard Time). The contest call will be CQ AW on the part of European stations and CQ EU for others. There will be certificate awards issued to the three highest scorers in each country and each W/VE call area. The exchanges will consist of RST (c.w.) and RS ('phone) with three self-assigned digits appended. For a complete copy of rules and technicalities write: SSA Contest Committee, Box 609, Gothenburg, Sweden. It is unfortunate that the c.w. period falls on one of our Sweepstakes week ends ..... W9AND has assisted VR1C and KX6AA in obtaining a supply of blank QSLs and W1CEG notes that 4X4CW is now signing 4X4FA ..... The FEARL boys are attempting to secure n.f.m. privileges comparable to those available to Ws. At present JAs cannot use the emis-

(Continued on page 116)

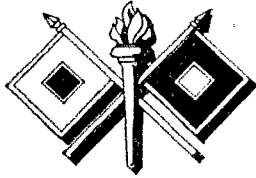

# Military Amateur Radio System



**A** NEW MANUAL of MARS-Army operating instructions has been prepared at the direction of the Chief Signal Officer and distributed to all Army members of the Military Amateur Radio System. The booklet appears in the familiar orange-and-black cover and bears the crossed-flag insignia of the Signal Corps. It is designed as a one-volume ready reference for all questions that might arise in the operation of an Army amateur net.

The newly-released manual contains a standing operating procedure (SOP), radiotelegraph procedure, radiotelephone procedure, and certain of the operating signals (both military and international) that are commonly employed in MARS operations.

Since most amateurs already are familiar with the formalities of establishing contact—the answer, the various signs of separation or pause, etc.—most of the manual deals with specifics such as circuit operation and message preparation.

MARS members really wear two hats. When they put on their MARS hat, they are military radio operators and are required to operate according to procedures prescribed by the joint Army-Navy-Air Force publications (JANAP). But when they take off their MARS hats, they wear the FCC-licensed amateur hat, and operate within the ham bands. There is no carry-over of military procedure into purely amateur radio operations.

Because one of the purposes of MARS is to coordinate the methods and procedures of military radiomen with the amateur fraternity, it is

necessary that MARS members become proficient in JANAP procedure, which is designed to provide maximum security for military radio operations as well as complete interchangeability of personnel and equipment.

In certain types of operation, normal amateur procedure has an advantage over JANAP. Here, the MARS member, as an amateur, must be equally well-trained.

A significant change in MARS c.w. net operation is the elimination of signal strength and readability reports. A station assumes it has a readability of "good" unless otherwise notified. RST reports are exchanged only when communication is unsatisfactory.

Detailed instructions are furnished for changing the headings on traffic that is received on a MARS circuit and is to be relayed via some traffic outlet in the ham bands, or conversely, how to process properly a message received by amateur radio for transmission over a MARS circuit.

Crossband operation between MARS frequencies and amateur frequencies is specifically forbidden.

Also included in the manual are:

- 1) Suggestions to net control stations for building *esprit de corps* and assisting in the integration of military and amateur operations.
- 2) Definitions and step-by-step procedures for emergency operations.
- 3) Concise and definite language whereby radiotelegraph and radiotelephone communications may be conducted accurately, rapidly, and with security obtainable.

Army brass is brass pounder! Former Chief of Ordnance, Maj. General Julian S. Hatcher, USA, Ret., A4RNO/W4RNO, is an active Martian, operating from his Falls Church, Va., home. General Hatcher, one of the world's foremost small arms experts, is technical editor of *The American Rifleman* and a member of the National Board for the Promotion of Rifle Practice and the U. S. Olympic Games Committee.

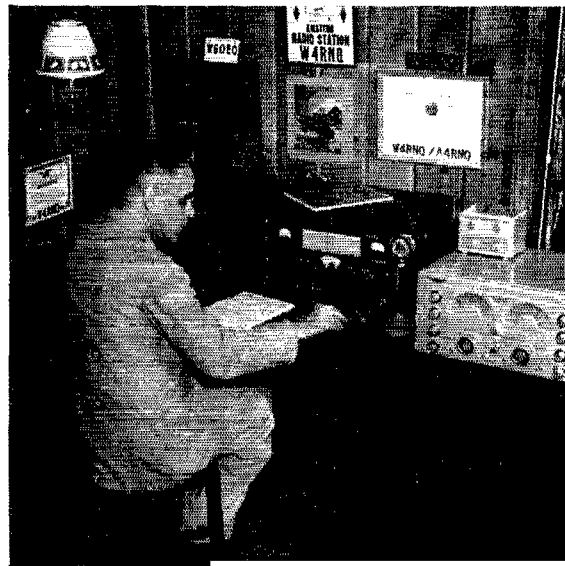

# Happenings of the Month

## E.A.R.C. POSTPONED

Responsive to a U. S. proposal, member-nations of the International Telecommunications Union have agreed to a postponement, for at least six months, of the Extraordinary Administrative Radio Conference which had been scheduled for The Hague beginning September 25th. The conference is subject to later call when the Administrative Council is of the opinion that world conditions are again such that the meeting can successfully be held.

This means a further delay in our expectation of receiving the green light on a new 21-Mc. band — as well as delay in the date when we lose the top 50 kc. of 14 Mc. But the announcement in general is good news for amateur radio, which has never been able to look forward to international conferences with any enthusiasm. More good news is that the U. S. intends to propose, soon, postponement of the 1952 Buenos Aires conference for five years, or until 1957.

## WATCH YOUR EXPIRATION

Postwar amateur station licensing began February 8, 1946. In the succeeding twelve months about 40,000 amateur station licenses were issued on the new five-year term basis, mostly renewals from Pearl Harbor extensions. Thus about that number of amateur licenses will come up again for renewal in the twelve months period beginning next February. Since that figure represents half the present amateur total, it's a 50-50 chance that yours is one of them. Watch the date on your license and make sure a renewal application goes in to FCC at Washington about three months before expiration date (the regs say any time after 120 days prior to expiration). If your current ticket was issued in February '46, it's almost time to write your district FCC office for renewal forms.

At the moment, proof-of-use requirements for renewal are still contacts by c.w. with three amateur stations in the U. S., within the last six months of the license term. Be sure to include your present ticket with your application for renewal. Watch *QST*, too, for what happens in Docket 9295, since FCC is currently proposing different renewal requirements — in terms of operating time instead of number of contacts: "a minimum total of either 2 hours operating time during the last 3 months or 5 hours operating time during the last 12 months of the (operator) license term," plus a statement that you can send and receive code at the rate required for the license being renewed.

If you should forget to renew on time, FCC will permit you, by a proviso effective with licenses expiring after January 1, 1951, to apply

for "renewal" as long as one year after expiration. In such event your old ticket is no good after expiration date; the idea is simply to save you and FCC the trouble of another examination. In effect, it provides that you may have a new amateur license without examination if you held one within the past year and can demonstrate "proof-of-use" (prior to its expiration) as required for renewal. Such licenses will not be backdated.

Of course, if since 1946 you've moved or advanced to Class A and thereby had occasion to modify your license, it has been extended for a five-year period from the modification date. In this connection, however, note that if the new rules in Docket 9295 go through as proposed, modifications will no longer extend a license and it will have a finite term of five years from date of original issuance.

## DISASTER COMMUNICATIONS SERVICE

Last month on page 10 we outlined the highlights of FCC's proposal to establish a disaster communications service in 1750-1800 kc. Regular readers of *QST* will recall that the League, in its 1944 *Presentation for the Amateur Service*, asked that this band be made available to amateurs primarily for emergency,<sup>1</sup> and that in 1945 FCC issued tentative findings indicating its intention to make 50 kc. available somewhere in that portion of the spectrum for a disaster service primarily composed of amateurs,<sup>2</sup> whereupon the League filed a supplementary brief again asking that the channels be 1750-1800 kc.<sup>3</sup> This, in general, became the Commission's view and eventually that of the U. S. in preparation for Atlantic City, a hurdle which was successfully passed. In 1949 the League addressed the Commission requesting early implementation of this disaster band so that amateur organization for emergency communication could proceed on those frequencies, a letter which was at least instrumental in the proposals the Commission now is making. Text of the proposed regulations is printed herewith. A supplementary notice indicates that for uniformity in processing applications a standard form will be required instead of a notarized letter; for lack of space the form is not reproduced here.

This proposal is *not*, in itself, a plan for amateur civilian-defense communication in wartime, that being another matter in which the League is working closely with FCC, the National Security Resources Board, and other Washington agencies, toward a plan to permit such communication on some of our own frequencies.

<sup>1</sup> *QST*, November, 1944, p. 19.

<sup>2</sup> *QST*, July, 1945, p. 15.

<sup>3</sup> *QST*, August, 1945, p. 24.



**PART 20**  
**RULES GOVERNING DISASTER COMMUNICATIONS SERVICE**

**20.1 Basis and Purpose.** —

(a) The basis for these rules is the Communications Act of 1934, as amended, and applicable treaties and agreements to which the United States is a party. These rules are issued pursuant to authority contained in Title III of the Communications Act of 1934, as amended, which vests authority in the Federal Communications Commission to regulate radio transmissions and to issue licenses to stations.

(b) The purpose of these rules is to make provision for the authorization of radio stations to operate in a Disaster Communications Service. These stations will provide communications in connection with disasters and other incidents involving loss of communications facilities normally available or demanding the temporary establishment of communications facilities beyond those normally available. As used herein, the term "disaster and other incidents" means an occurrence of such a nature as to involve the health or safety of a community or larger area and shall include, but not be limited to, floods, earthquakes, hurricanes, explosions, and consequences of armed attack.

**20.2 Scope of Service.** —

(a) Stations operating in this service are authorized to transmit and receive only disaster communications as set forth in Section 20.5 of these rules for:

- (1) Liaison purposes between individual or network stations handling disaster communications on their own regularly assigned service frequencies; or
- (2) Direct operation of Disaster Communications Service networks having no other frequencies available or none satisfactory for the distances to be covered.

(b) Payment in any form for handling any communications in this service is prohibited, provided, however, that the utilization of persons on a salary basis in connection with the service is permitted.

**20.3 Disaster station defined.** — Any government or non-government radio station able to function as a fixed, land, or mobile station and authorized, if government by its controlling federal government agency or if non-government by the Federal Communications Commission, to operate in the Disaster Communications Service.

**20.4 Activation and Points of Communication.** —

(a) All stations in the Disaster Communications Service are authorized to communicate with one another only when competent local authority:

- (1) Determines that a pending or actual disaster warrants their activation, or
- (2) Schedules training operations, practice drills, or tests to keep the networks and associated stations alert and the frequencies in use.

(b) Competent local authority is defined as meaning that authority within a community or larger area which is so designated in the coordinated disaster communications plan for the area concerned. In the absence of a specific authority named in the plan, the individual in charge of the net control station, or his representative, for the local Disaster Communications Service net established in accordance with the disaster plan shall be considered as competent local authority for activating the net. Nothing in this sub-section shall be deemed to preclude any station from using the Scene of Disaster Frequency at any time the safety of life and property are in danger as a result of a disaster as that term is defined in Section 20.1 (b).

**20.5 Disaster Communications defined.** — Disaster communications shall comprise only the following:

- (a) Communications when there is no impending or actual disaster.
  - (i) Necessary drills and tests to insure the es-

tablishment and maintenance of efficient networks of disaster stations. These drills and tests may include the pre-arranged exchange of communications by stations of established networks with stations outside any established network provided that the purpose of such exchange is to provide training and practice in the establishment and maintenance of liaison and coordination between such network and non-network stations.

(b) Communications when there is an impending or actual disaster, the order of priority to be descending in the order named:

- (i) Communications directly concerning:
  - (a) the activation of a disaster network, or
  - (b) the establishment and maintenance of liaison and coordination between:
    - (1) the stations of one network and the stations of any other network,
    - (2) any network station and any non-network station of any agency possessed of its own system of radio-communication which is actually engaged in averting or overcoming the effects of the disaster, or
    - (3) any non-network station of one agency possessed of its own system of radiocommunication which is actually engaged in averting or overcoming the effects of the disaster and any non-network station of any other agency possessed of its own system of radiocommunication which is actually engaged in averting or overcoming the effects of the disaster.
- (ii) Communications directly concerning the conduct of service by an activated disaster network.
- (iii) Communications directly concerning safety of life, preservation of property, or maintenance of law and order by authorized government agencies.
- (iv) Communications directly concerning the accumulation and dissemination of public information regarding safety of life, preservation of property, or maintenance of law and order by authorized government agencies.
- (v) Communications directly concerning the transaction of business.
- (vi) Communications directly concerning personal matters not included in any of the foregoing categories.

**20.6 Eligibility.** —

- (a) Authorizations to operate in the Disaster Communications Service will be issued to any person eligible under the Communications Act of 1934, as amended, provided the station or proposed station will operate as an element of a disaster communications network set up under a locally coordinated disaster plan.
- (b) If the station to be operated in the service is a United States Government station, the authority to so operate will be granted by the appropriate United States Government agency concerned.

**20.7 Organization of networks.** — Local disaster communications networks shall be organized by whatever local group or groups of people may be interested in providing such a service. In any particular area there may be several networks and each network may be independent of the others. Wherever there are several networks in the same area, however, they will all share the available frequencies in an efficient and orderly manner, under a single coordinated disaster communication plan. Any particular network shall be organized and set up along such lines and include the making of such written records that an inspection of the network will show that there is in fact a local disaster network of definitely identified stations with appropriate leadership and rules for self-government and operating procedure that will tend to assure an orderly and reasonably efficient service.

The various networks in different areas shall establish proper liaison arrangements so that in case of need they can all work together under a coordinated inter-area plan.

20.8 *Specific Frequencies, Emission, Power.* —

(a) Within the band 1750-1800 kc, disaster stations shall be limited to their choice of the following specific frequencies with the specific type of emission indicated: (Selection and use of frequencies shall be in accordance with a coordinated local area and adjacent area disaster communication plan)

- (1) *CIV Channels* (15-1.0 kc. channels)
1. 1750-1751 kc, 1.0A1 (1750.5 kc center)
  2. 1751-1752 kc, 1.0A1 (1751.5 kc center)
  3. 1752-1753 kc, 1.0A1 (1752.5 kc center)
  4. 1753-1754 kc, 1.0A1 (1753.5 kc center)
  5. 1754-1755 kc, 1.0A1 (1754.5 kc center)
  6. 1755-1756 kc, 1.0A1 (1755.5 kc center)
  7. 1756-1757 kc, 1.0A1 (1756.5 kc center)
  8. 1757-1758 kc, 1.0A1 (1757.5 kc center)
  9. 1758-1759 kc, 1.0A1 (1758.5 kc center)
  10. 1759-1760 kc, 1.0A1 (1759.5 kc center)
  11. 1760-1761 kc, 1.0A1 (1760.5 kc center)
  12. 1761-1762 kc, 1.0A1 (1761.5 kc center)
  13. 1762-1763 kc, 1.0A1 (1762.5 kc center)
  14. 1763-1764 kc, 1.0A1 (1763.5 kc center)
  15. 1764-1765 kc, 1.0A1 (1764.5 kc center)

(2) *Scene of Disaster Channel* (1-7 kc channel)  
S.O.D.-1765-1772 kc, 2.5A1 or 7A3 (1768.5 kc center)

- (3) *Phone Channels* (4-7 kc channels)
1. 1772-1779 kc, 7A3 (1775.5 kc center)
  2. 1779-1786 kc, 7A3 (1782.5 kc center)
  3. 1786-1793 kc, 7A3 (1789.5 kc center)
  4. 1793-1800 kc, 7A3 (1796.5 kc center)

(b) For purpose of demonstrating compliance with paragraph (a) of this section, the following limits apply:

(1) Any emission appearing on any frequency, removed from the carrier frequency by at least 50 percent, but not more than 100 percent, of the maximum authorized bandwidth shall be attenuated not less than 25 db below the unmodulated carrier.

(2) Any spurious or harmonic emission appearing on any frequency removed from the carrier frequency by at least 100 percent of the maximum authorized bandwidth shall be attenuated below the unmodulated carrier by not less than the amount indicated in the following table:

Maximum authorized plate power input to the final radio frequency stage	Attenuation (db)
3 watts or less	40
Over 3 watts and including 150 watts	60
Over 150 watts and including 600 watts	70
Over 600 watts	80

(c) When an authorized emission results in harmful interference, the Commission may, in its discretion, require appropriate technical changes in equipment to alleviate the interference.

- (d) The carrier frequency of each authorized transmitter in these services shall be maintained within 0.005 percent of the assigned frequency.
- (e) The transmitting equipment in a radio station in the disaster communications service shall be adjusted in such a manner as to produce the minimum radiation necessary to carry out the communication desired when such station is sending radio communications or signals of disaster and radio communications relating thereto.

20.9 *Operator Requirements.* — Any amateur radio operator license issued by the Federal Communications Commission authorizing operation of an amateur station in the amateur segments of the 1800-2000 kc. band qualifies the holder of such license to operate an authorized Disaster Station in the 1750-1800 kc. band, in accordance with these rules. Any commercial radio operator license qualifies its holder to operate authorized Disaster Stations under these rules to the extent that the same method of operation is permitted in any other service in which the commercial license can normally be used. All transmitter adjustments or tests during or coincident with the installation, servicing or maintenance of a disaster station which may affect its proper operation shall be made by or under the immediate supervision and responsibility of a person holding the above-type amateur operator license or the holder of either a first or second class commercial radio operator license which authorizes adjustments and repair to the type of equipment being used in the Disaster Communications Service, in accordance with the type of emission being employed.

20.10 *Station Applications, Licenses, and Authorizations.* —

- (a) An application for authorization to operate, in the Disaster Communications Service, a radio station already licensed in a different service shall be submitted as a notarized letter directly to the Secretary, Federal Communications Commission, Washington 25, D. C. Such letter shall describe in detail the applicant's eligibility under Section 20.7 of these rules, and shall be supported by an attached certified copy of the locally coordinated disaster communication plan, or if already submitted shall include a reference to it in the application letter.
- (b) An application (by an applicant not presently licensed in another radio service) for license to operate a radio station in the Disaster Communications Service only, shall be submitted as indicated in paragraph (a) of this Section for an authorization, and shall be accompanied by an application for a radio station construction permit (FCC Forms Nos. 401 and 401a).

20.11 *Term of Station Authorizations and Licenses.* —

- (a) Authorizations to operate in the Disaster Communications Service for stations already licensed in other services will be issued, upon satisfactory application, for a term concurrent with the present station licenses.
- (b) Licenses for new stations, to operate in this service only, will be issued upon application on FCC Form 403, after completion of construction or installation in accordance with the terms and conditions set forth in the construction permit. Such licenses normally will be issued for an original term of from one to four years, as the Commission may determine in each case, to permit the orderly scheduling of renewals, and for a renewal term of four years.

20.12 *Station Identification.* —

- (a) Call signs. Radio stations licensed in a service other than the Disaster Communications Service shall identify their transmissions in the Disaster Communications Service by using the regular station call signs assigned to them for the service in which they normally operate. Radio stations licensed only in the Disaster Communications Service shall use a special call sign assigned to them for that service.
- (b) Use of call signs. Each station shall transmit the call sign of the station being called followed by its own call sign at the beginning of each series

**CONSTITUTION & BY-LAWS  
AND OFFICERS' REPORTS  
AVAILABLE TO MEMBERS**

In April of each year the officers of the League make comprehensive written reports to the directors. The Board has made these reports available to interested members. The cost price is 75 cents per copy, postpaid. A copy of the Constitution & By-Laws will be sent to any member free upon request. Address the Secretary at West Hartford.

## OCTOBER 14TH-15TH SIMULATED EMERGENCY TEST

Are you ready for the Annual ARRL Simulated Emergency Test? If you're registered in the ARRL Emergency Corps, you probably already have been alerted to take part in this annual test of amateur radio's emergency communications preparedness. If you're not a member of the Corps, get in touch with your local Emergency Coordinator and ask to be registered in the AEC in order that you may receive full details on this and future tests. Perhaps you're out of touch with emergency organization in your section and don't know who your Coordinator is; if that's the case, rush a postal or radiogram to your Section Communications Manager asking for the name and address of your EC. Don't pass up the opportunity to assist in this test of amateur radio facilities because you may not happen to be an ARRL member. There is a place for every amateur in the AEC.

As in previous tests, this year's SET will be based on announcements by Coordinators of local communications problems simulating those likely to be encountered in actual emergencies. Individual amateurs participating will have no inkling of their exact part in the test until the day of the exercise, October 14th or 15th, depending on local plans.

Other phases of the test will be known beforehand. In accordance with the arrangement of the past three years, stations taking part in the test will originate messages both to ARRL Headquarters and to the National American Red Cross. Each participating station will originate a message for relay to ARRL, and each Emergency Coordinator will endeavor to obtain a message from the Red Cross Chapter in his community, addressed to National Red Cross. With the possibility of thousands of Red Cross Chapters originating messages and the origination of countless messages from individual amateur participants in the test, there will be a heavy traffic load. Messages in general will be forwarded via normal amateur traffic routes. Where the regular traffic channels become overloaded, amateurs should devise alternate ways of relaying messages to their destinations expeditiously. In the event you do not find it possible to participate fully in local exercises, you may be able to assist by getting on the air whenever you can during the test and standing by to handle some of the traffic.

Each Red Cross message, depending on its place of origin, will be addressed to one of three points in the United States, Washington, D. C., Evanston, Illinois, and San Francisco, California. There will be amateur stations on the air at these three points: W3PZA, W9DUA and W6CXO (assisted by W6BHY and W6OT). Located at main terminals of the Red Cross coast-to-coast teletype network, they will be considered delivery points. Extensive monitoring schedules will be kept by these stations on the following National Emergency Frequencies: 3550, 7100 and 14,050 kc. c.w., 3875 and 14,225 kc. 'phone. As in actual emergencies, these stations often may be reached by direct calls on the frequencies concerned.

Stations of the National Emergency Net and WIAW will be monitoring the National Emergency Frequencies for relay of both Red Cross and ARRL traffic. ARRL traffic may also be routed via any Connecticut station. It is suggested that amateurs seeking contact with Connecticut stations make calls on or near 3640 kc., the frequency of the Connecticut c.w. net, or 3880 kc., where Connecticut 'Phone Net stations will be active.

Be ready during the week end of October 14th-15th. Assist amateur radio to demonstrate that it is one strong facility prepared to be of service in the public interest wherever and whenever disaster should strike!

of communications with the called station, at least once each fifteen minutes of such operation, and when signing off communication with the called station. One-way transmissions intended for several Disaster Communications Stations shall be identified in the same manner except that a general call or group name may be used in place of the call signs of the several stations intended to receive the transmission. Test transmissions of a station tuning up or making adjustments with a signal on the air must be identified by announcement of its sign at the beginning and end of the test period and each two minutes of that period.

### 20.13 *Equipment requirements.*—

- (a) Frequencies, types of emission, band-width limitations, frequency tolerance and power are specified in Section 20.8 of these rules.
- (b) Transmitting equipment shall include specific means for practicable limitations of emissions to the frequency channel being employed.
- (c) When the radio frequency carrier of a station in the Disaster Communications Service is amplitude modulated, such modulation shall not exceed 100% on negative peaks.

### 20.14 *Radio Station Log.*—The licensee of each radio station authorized to operate in the Disaster Communications Service shall keep a log of all operations in the 1750-1800 kc. band which shall include the following:

- (a) Name and address of the disaster station licensee or authorization holder, station call sign used in the disaster service, disaster station authorization date and number, and d.c. plate power input to the r.f. tube or tubes supplying power to the antenna system. This information need be entered only once in the log unless there is a change in any of the above items. Each change shall be entered with the date the change is made.
- (b) Date and time of beginning and end of each period during which the disaster station is manned.
- (c) Signature of each licensed operator who manipulates the key of a manually operated radiotelegraph transmitter or the signature of each licensed operator who operates a transmitter using any other type of emission, and the name (or signature) of any person not holding a radio operator license who transmits by voice. The signature of the operator shall be entered with the date and time at both the beginning and end of each period during which he is manning the controls of the disaster station and at least once on each page additional to the first page covering the period for which he is the responsible operator. The signature of any additional operator who operates the station during the regular watch of another operator shall be entered in the proper space for that additional operator's transmissions.
- (d) Upon completion of each period of operation for drill, training, or liaison purposes and each period of operation in connection with an imminent or actual disaster, there shall be entered in the log a summary of such operation describing its nature and giving pertinent details.
- (e) There shall be no erasures, obliteration or destruction of any part of the disaster station log. Corrections shall be made by striking out erroneous portions and initialling and dating the correction.

### 20.15 *Availability of station license or authorization and operator licenses.*—

- (a) The station license or authorization for a radio station in the Disaster Communications Service, or photo copy thereof, shall be permanently attached to the transmitter if the transmitter is readily accessible, or permanently posted at the transmitter control position.
- (b) The original radio operator license or license verification card of the operator controlling the emissions of a station in the Disaster Communications Service shall be carried on his person, or kept immediately available at the place where he is operating the disaster station.

# 16th ARRL DX Contest

## Part II: Final Results — 'Phone Section

**P**ART I of the 1950 ARRL International DX Competition results, published in September *QST*, reported the scores and highlights of the c.w. contest. The story is rounded out this month by recounting the final scores in the 'phone section of the fray, the outcome of the club competition, and by a collection of photographs showing c.w. and 'phone leaders and the shacks from which they chalked up award-winning scores.

'Phone contest reports were submitted by 535 participants; 387 of these were from W, VE and VO stations and 148 from foreign points. Certificate awards are being presented to 64 U. S. and Canadian entrants and to 51 contestants outside the W/VE/VO area.

### Highlights

In order to give appropriate credit on a geographical basis to contest leaders, and to give future 'phone DX contestants some idea of the kind of competition they may anticipate in 1951, the following tabulation showing the top score in each U. S. and Canadian licensing area is presented:

W1ATE	243,004	W0PRZ	97,812
W2RGV	108,864	VE1ET	33,660
W3BES	204,919	VE2NI	41,652
W4DCQ	246,720	VE3AUJ	71,712
W5ERD	36,295	VE4RO	60,288
W6RM	135,486	VE5JG	5985
W7ESK	135,270	VE6FK	7812
W8REU	193,599	VE7EL	74,307
W9EWC	135,876	VO2N	8775

Honors for the top contact total in the U. S. and Canada were shared by W1ATE and W4DCQ, who each tallied 514 QSOs. Twenty-eight other 'phone DXers topped the 250 mark: W3BES 481, W8REU 441, W4DQH 417, W8HUD 404, W4LXE 402, W6RM 386, W8KML 372,

W4KWY 367, W3LOE 355, W3DHM 351, W9EWC 338, W7ESK 334, W6TT 333, W2RGV 324, W8HRV 322, W2BXA 320, W4OM 315, W1JCX 299, W2VQM 295, W3GHS 291, W0JRY 289, W0PRZ 288, W6PWR 282, W2PBG 278, VE7EL 267, W6YI 264, W9UUN 264, W1CJH 256.

Highest multipliers: W4DCQ 160, W1ATE 158, W8HUD 155, W3LOE 152, W8REU 147, W4DQH 144, W3BES 143, W8KML 140, W4KWY 139, W3DHM 136, W7ESK 135,

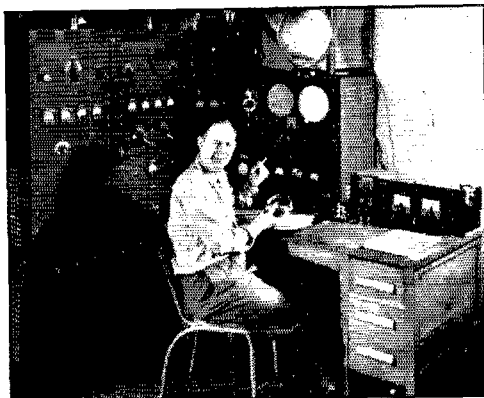

Bob Cheek, W3LOE, wears a happy smile at the operating position where he chalked up 434,073 points and had 563 QSOs in the c.w. fray, setting a new U. S.-Canada contact record. Practically all the gear at W3LOE, including the receiver, is home constructed.

W4LXE 134, W9EWC 134, W8HRV 128, W4OM 127, W1JCX 121, W3GHS 117, W6RM 117, W9UUN 116, W0PRZ 114, W2RGV 112, W2VQM 110, VE7ZM 110, W2PBG 107, W6PWR 107, W6TT 107, W4LIM 106.

Outside the U. S.-Canada area, the top scorers in each continental area were as follows: *Asia* — XZ2SY 1680; *Africa* — ZS6DW 88,800; *Europe* — G2PU 149,760; *North America* — XF1A 253,260; *Oceania* — KH6IJ 105,609; *South America* — CE2CC 100,080.

An old timer in 'phone contests, Herman P. Jolitz, W4DCQ, put Clinton, North Carolina, on the DX contest map. Herman's score was second to none in the W/VE/VO area. His station is like something out of a ham's dream! The shack is located at the base of a 66-foot steel tower which supports a three-element 14-Mc. rotary beam and a four-element 28-Mc. array. The 75-meter antenna, a half-wave dipole, is 85 feet in the air. Transmitting gear is housed in four racks and consists of separate rigs for 75, 20 and 10; all circuits are individually metered. There's no shortage of mikes at W4DCQ. Count them!

**QST for**



Leaders in number of contacts with W/VE/VO: XF1A 1225, G2PU 1040, 11BDV 1018, F8SK 976, SM5UM 892, 11RD 805, ZS6DW 800, VP6SD 779, KH6IJ 749, CE2CC 702, PA0AD 681, EA4CM 610, G2LK 608, YS2AG 568, LX1JW 558, IS1AYN 525.

High multipliers: XF1A 70, VP6SD 64, XE2W 63, LX1JW 59, CE2CC 48, G2PU 48, TG9AD 48, YS2AG 48, EA4CM 47, KH6IJ 47, PY2CK 46, HC2OL 43, CE2AX 42, SM5UM 40, VK3AWN 40.

### Disqualifications

The following entrants are deemed ineligible for 'phone score listings or awards in the 16th ARRL DX Competition. In each case disqualification is for off-frequency operation as confirmed by one or more FCC citations or advisory notices or two accredited ARRL Official Observer measurements: W1BFB, W2ESM, W3NA, W4FUM, W4KFC, W5GZK, W6BJU, W6ITA, W6NIG, W7JUO, W7MLF, W8NXF, W8PQQ, W9RBI, W0NWW, CM9AA.

### Club Scores

A gavel with engraved silver band is offered in each ARRL DX contest to the radio club whose members submit the highest aggregate score. Competition for this award was widespread this year; 45 groups submitted entries, compared with only 20 in the previous contest. Winner of the 1950 gavel is the Southern California DX Club, which brought club DX honors back to western U. S. once more; the last W6 group to receive a gavel was the South Bay Amateurs Association of Los Angeles, winner of the 1940 club competition. The gavel in this contest was won in a close race with the Frankford Radio Club of Philadelphia, recipient of the last three such awards offered. Hearty congrats, Southern California!

A tabulation of the other clubs that entered the competition accompanies this report. Special certificates are being awarded to the leading 'phone and c.w. operators in each club that submitted the minimum number of entries required by the rules for individual awards.

### Sidelights

Outstanding emergency service was rendered by W3PDZ and KZ5NM in the contest. The following was extracted from W3PDZ's log: "Heard KZ5NM calling Roanoke, Virginia, with urgent traffic. After some time, noticed he had no luck, so I called and asked if I could be of assistance with a telephone call. He said W4OKP's brother-in-law had just been killed in an aircraft accident in Panama. I telephoned W4OKP and passed along the sad news. Later I received details of the accident from KZ5NM, recorded them, and played the recording to W4OKP's XYL over the telephone." . . . XF1A worked W6AM on five 'phone bands, 3.5, 14, 27, 28 and 144 Mc! . . . "First contact with W on 3.5-Mc. 'phone gave me a thrill. Worked W4DCQ on that band." -- ZL1MQ. . . In addition to directive arrays on 14 and 27 Mc., WIATE had a two-element



Herman Greve, W9EWC, made the top 'phone score in W9 and won the Wisconsin section award hands down. There may be neater operating positions, but they're certainly not numerous! Note how Herman has arranged his gear so that all controls are handy.

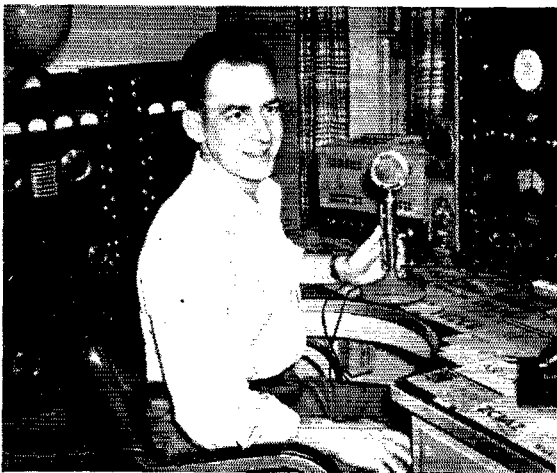

Above: Michigan 'phone winner and highest W8 scorer Don Cummings, W8REU, gets out, judging from the fine collection of DX QSLs displayed on his operating desk! Below: J. M. Cordova, EK1AO, brought joy to the hearts of many c.w. contestants. He had 1149 contacts, gave a substantial boost to many U. S. and Canadian multihitlers.



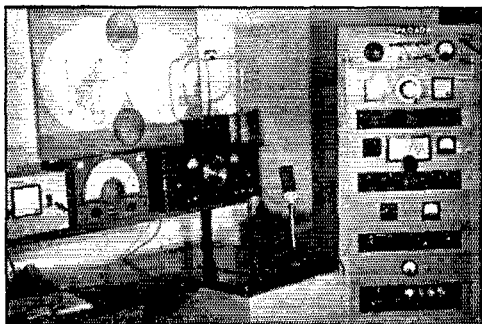

PA0AD, Hilversum, Netherlands, winner of the PA0 phone award. Op P. J. Huis used two-section 8JK fixed beams on 10, 20 and 80 meters, ran only 50 watts input.

beam on 75. . . . "All in all, boys were very courteous and sporting about coming on working me and then slipping off the frequency." — KP4DU. . . . All contestants weren't high-power specialists. VE2NI ran 70 watts to p.p. 807s. Belgian winner ON4CC used a mere 40 watts input; Vee-beams on 10 and 20 helped. . . . Probably the most elaborate beam used in the phone contest was W0JRY's 24-element job.

— . . . —

The dates of the 17th ARRL International DX Competition will be announced in November QST. It's never too early to start preparations for the next contest, so get that station and gear ready for the 1951 battle!

### 'PHONE SCORES

#### Sixteenth International DX Competition

Operator of the station first-listed in each section and country is winner for that area, unless otherwise indicated. . . . The multiplier used in determining score is given with the score listing — in the case of U. S.—Canada this is the total of the countries worked on each frequency band used; in the case of non-W/VE/VO entries it is the total of the U. S.—Canada districts worked on each band. . . .

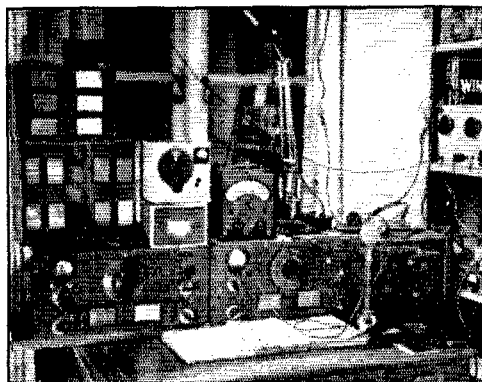

GC4LI, one of two stations active on c.w. from the Channel Islands during the contest, was eagerly sought after by DXers on this side of the Atlantic. A long-wire antenna, 137 feet overall and 25 feet high, was used on 7, 14 and 28 Mc. and the power input at no time exceeded 40 watts.

The number of contacts established is next listed. . . . The letters A, B, and C approximate the input to the final stage at each station; A indicates power up to and including 100 watts; B indicates over 100 watts, up to and including 500 watts; C indicates over 500 watts. . . . The total operating time to the nearest hour is given for each station and is the last figure following the score. . . . Example of listings: W3BES 204,919-143-481-C-72, or final score 204,919; multiplier 143; 481 contacts; power over 500 watts; total operating time 72 hours. . . . Stations manned by more than one operator are grouped in order of score following single-operator station listings in each section or country tabulation; calls of participants at multioperator stations are listed in parentheses.

#### ATLANTIC DIVISION

##### E. Pennsylvania

W3BES.....	204,919-143-481-C-72
W3DHM.....	143,208-136-351-C-68
W3GHS.....	101,907-117-211-B-54
W3DOE.....	63,813-89-239-B-43
W3IGW.....	35,442-86-149-B-40
W3EOA.....	34,788-78-152-C-52
W3IMV.....	27,374-69-132-B-42
W3DIS.....	27,258-93-154-B-29
W3KTI.....	21,750-58-125-C--
W3IXN.....	18,228-49-124-B--

W3JTK.....	3510-30-39-C-17
W3EQK.....	2952-24-41-B--
W3DRD.....	2754-27-34-B-12
W3KDP.....	2040-17-40-B-6
W3PDX.....	960-16-20-B-7
W3WV.....	390-10-13-A-6
W3BVO.....	312-8-13-B-14
W3FQB.....	162-6-9-A-4
W3AEL.....	90-5-6-B-1

##### So. New Jersey

W2RGV.....	103,964-112-324-B-71
W2QKJ.....	24,408-54-151-B-28



A new country was added to many U. S. and Canadian DXCC totals when IISN/M1 appeared on c.w. from San Marino in the contest. The President of the Republic, Prof. Giacomini, took an interest in the operations and is here shown with IISN, right, and Francesco Checchi, left, a close friend of the latter. In the background is the Government Palace.

W3CPV.....	13,038-53-84-B-15
W3FUF.....	12,555-45-93-B-23
W3FN.....	8888-32-103-A-16
W3MAC.....	8323-24-124-A-29
W3BET.....	7140-34-70-C
W3MQC.....	4623-23-67-B-17
W3CTJ.....	3384-24-47-C--
W3GHD.....	3276-28-39-B-5
W3KEW.....	2574-26-33-B-16
W3HNW.....	2046-22-31-B-4
W3QLW.....	1575-21-25-B-10
W3KKN.....	1518-11-46-A-4
W3BTP.....	1092-14-26-B-8
W3KIW.....	828-12-23-A-5
W3OCU.....	783-9-29-C-9
W3TW.....	216-6-9-B-4
W3EWW.....	189-7-9-C-3
W3MOU (W3JOD).....	3944-29-46-C-20
W3OXQ (W3JPD).....	2432-19-43-A--

##### W. New York

W2VOM.....	95,470-110-295-C-52
W2MA.....	30,016-67-150-C-60
W2QWS.....	24,805-55-151-B-36
W2TVR.....	17,688-44-134-B-28
W2PJM.....	14,094-54-87-B-25
W2UTH.....	11,448-36-106-B-28
W2PVG.....	9102-41-74-C-42
W2ZJ.....	4590-30-51-C-20
W2UBR.....	3780-30-42-B-10
W2RWN.....	3213-21-51-B-13
W2FE.....	2596-22-40-B-
W2FA.....	2262-26-29-B-3
W2QCP.....	2040-24-29-B-5
W2QXB.....	810-15-18-B-21
W2IQK.....	650-13-17-B-
W2TXB.....	561-11-17-C-4

##### Md.-Del.-D.C.

W3PDZ.....	37,611-63-199-C-31
W3AM.....	35,091-63-187-C-30
W3IYE.....	14,544-48-101-C-25
W3NNX.....	3508-27-68-B-26
W3FQZ.....	4704-32-49-B-10
W3EIS.....	4116-28-49-C-20

##### W. Pennsylvania

W3LOE.....	160,968-152-355-C-60
------------	----------------------

Efficient antennas helped W9LM to make the highest W9 c.w. score. Hal Leighton is proud of his collection of rotaries, particularly the 40-meter job, left, which has remained in the air despite several bad storms. To the right are the 10- and 20-meter beams. The 80-meter skywire, not shown, is a ground-plane.



W3KQU.....55,940-86-214-B-41  
W3AER.....2520-24-35-B-12

**CENTRAL DIVISION**

*Illinois*

W9BU.....45,045-91-165-C-54  
W9BDV.....33,781-93-139-C-75  
W9FAB.....34,800-75-156-B-6  
W9NII.....32,494-77-141-B-52  
W9IT.....19,712-56-118-B-23  
W9DBM.....7884-35-73-B-29  
W9TBA.....5730-25-64-B-27  
W9MWO.....5610-34-55-B-22  
W9DWO.....5548-38-49-B-7  
W9WYT.....4993-34-49-B-6  
W9JUV.....4056-26-52-B-11  
W9BWM.....1032-14-26-A-13  
W9DRM.....864-12-24-B-5  
W9CA.....672-14-16-A-4  
W9INP.....168-7-8-A-8  
W9EVT (W9a DBM EXY GWR GXE)  
65,250-90-243-B-96

*Indiana*

W9UUN.....91,872-116-264-B-55  
W9UEM.....5902-26-76-B-17  
W9WCE.....4620-20-77-B-17  
W9CWO.....4218-37-38-C-8  
W9IFK.....1845-15-41-A-6  
W9FWS.....714-14-17-B-10

*Wisconsin*

W9EWC.....135,876-134-338-C-75  
W9DUB.....42,696-72-200-B-42  
W9BVC.....23,755-71-133-C-38  
W9BXC.....23,710-58-163-B-35  
W9FDX.....15,870-46-115-B-28  
W9CPE.....10,490-41-126-B-16  
W9RNX.....10,428-44-79-A-40  
W9KXK.....9120-32-95-A-40  
W9YMG.....6612-29-76-C-18  
W9HMG.....4950-33-50-B-17  
W9LNM.....1197-19-21-B-10

**DAKOTA DIVISION**

*North Dakota*

W0VSK.....16,968-56-101-B-45  
W0IFC.....12,282-46-89-B-6  
W0NBS.....4500-30-51-B-26

*South Dakota*

W0PRZ.....97,812-114-288-C-75  
W0NGM.....1026-18-19-B-20

*Minnesota*

W0VIP.....3402-27-42-B-11  
W0TKX.....1071-17-21-C-10  
W0BRA.....192-8-8-B-6  
W0RXL.....168-7-8-C-3

**DELTA DIVISION**

*Arkansas*

W5HFQ.....16,170-49-110-C-36

*Louisiana*

W5KC.....18,540-60-103-B-28  
W5CEW.....3822-26-49-C-1  
W5CGC.....1280-20-22-C-18

*Tennessee*

W4DQH.....179,280-144-417-C-76  
W4NNJ.....1200-24-26-B-10

**GREAT LAKES DIVISION**

*Kentucky*

W4OYG.....15,876-54-98-C-30  
W4CDO.....6498-38-57-B-20

*Michigan*

W8REU.....193,599-147-441-B-79  
W8HUD.....186,930-155-404-C-1  
W8KML.....154,840-140-372-C-55  
W8NML.....14,100-60-78-C-23  
W8CLR.....13,560-40-113-A-23  
W8BVG.....7252-37-66-C-1  
W8NGO.....7035-35-67-B-38  
W8SOE.....6480-30-72-C-20  
W8DX.....6360-40-53-B-30  
W8DLS.....4140-23-60-B-48  
W8AZA.....3600-25-48-A-13  
W8SY.....2808-26-36-C-4  
W8DAW.....1728-16-36-B-5  
W8SS.....210-7-10-B-14  
W8IQS.....147-7-7-B-6  
W8TPV (W8YPU).....42,552-72-197-B-66

*Ohio*

W8HRV.....123,648-128-322-C-66  
W8NSS.....40,176-72-185-B-34  
W8ZOK.....39,000-65-202-B-42  
W8AJW.....33,948-69-165-A-36  
W8VOZ.....28,710-55-174-C-1  
W8QAD.....20,193-53-127-B-30  
W8BNJ.....15,132-52-97-B-36  
W8BFH.....11,880-40-99-A-27  
W8LAX.....11,808-41-96-B-1  
W8KC.....11,732-41-96-B-38  
W8MDM.....6530-22-63-B-6  
W8PMM.....3534-31-38-B-19  
80G.....2870-29-33-B-7  
W8MCC.....1008-16-21-B-1  
W8MQG.....990-11-30-B-6  
W8JFC.....810-15-18-B-4  
W8FQT.....363-11-11-C-4  
W8HGW.....351-13-15-B-6  
W8CGG.....297-9-11-A-6  
W8IKA.....210-7-10-B-1  
W8BSR.....126-6-7-B-21

**HUDSON DIVISION**

*E. New York*

W2RYT.....44,968-77-195-C-63  
W2GMU.....14,921-43-117-C-17  
W2PFU.....5346-22-81-B-46  
W2AOF.....264-8-11-A-6  
W2KDS.....48-4-4-B-1

*N.Y.C.-L.I.*

W2PBG.....39,238-107-278-C-66  
W2GSN.....4161-19-73-B-13  
W2EGG.....3519-23-51-C-12  
W2BT.....2904-22-44-B-1  
W2BIT.....2112-22-32-C-10  
W2WZ.....330-10-11-C-3  
W2ZSD.....3-1-1-A-1

*No. New Jersey*

W2BXA.....93,296-98-320-C-40  
W2JFO.....21,216-52-136-B-45  
W2ZYS.....9928-34-98-B-16  
W2JOJ.....9720-30-108-A-16  
W2JJI.....9030-43-70-B-22  
W2JUV.....8004-46-58-B-13  
W2JMC.....5115-31-55-B-22

**CLUB SCORES**

Club	Score
Southern California DX Club	2,885,687
Frankford Radio Club	2,488,162
Potomac Valley Radio Club	2,107,941
Northern California DX Club	1,495,276
Deutscher Amateur Radio Club	743,012
The DX Club	637,104
Northwest Amateur Radio Club	497,284
North Suburban Radio Club	459,912
Rochester DX Assn.	455,233
Conn. Wireless Assn.	455,052
Greater Cincinnati Amateur Radio Assn.	433,910
Maul Amateur Radio Club	376,834
Winnipeg Amateur Radio Club	343,810
Hidgewood Radio Club	337,940
Hampden County Radio Club	334,104
Rebel Radio Club	268,247
Narragansett Assn. Amateur Radio Operators	244,827
Dayton Amateur Radio Assn.	233,376
San Antonio Radio Club	232,827
South Lyme Beer, Chowder and Propagation Society	202,173
Dade Radio Club	178,466
South Macomb Amateur Radio Assn.	169,042
El-Ray Radio Club	137,487
Jacksonville Amateur Radio Society	135,570
Montreal Amateur Radio Club	107,234
West Park Radiops.	100,839
Schenectady Amateur Radio Assn.	100,083
Garden City Radio Club	94,353
Denver Radio Club	87,305
York Road Radio Club	79,592
Michigan Amateur Radio Club	63,095
Elmira Radio Amateur Assn.	59,866
Columbus Amateur Radio Assn.	51,832
Northeast Radio Club of Philadelphia	48,474
Four Lakes Amateur Radio Club	45,530
Yarmouth Amateur Radio Club	37,056
Buckeye Shortwave Radio Assn.	30,981
Caddo Amateur Radio Club	21,938
Monmouth County Amateur Radio Assn.	17,496
Springfield Amateur Radio Club	12,524
Lancaster Radio Transmitting Society	11,685
Austin Amateur Radio Club	10,821
Canton Radio Club	10,323
Case Institute of Tech. Radio Club	6623
Morris Radio Club	4743

C.W. Winner	'Phone Winner
W6ITY	W6TZD
W3BES	W3BES
W4KFC	W4LIM
W6MVO	W6TT
D1LDX	D1IRK
W3DOE	W3GHS
W9LM	W9BDV
W9FJB	
W2FA	W2VQM
W1BII	
W8BHW	
KE6MG	
	VE4RO
W2ATE	W2JFQ
W1JYH	W1CJK
W4BRB	W4POF
W8ZJM	W8NNS
W1DF	
W4LVV	
W8DAW	W8NML
W4IZ	
W8PMM	W8AJW
	W2RYT
W2GSN	
W6AZT	
W8ALB	
	W2PJM
W8EYE	
	W9BVX
W8QYI	
W5CGC	W8BFH
W2ZEP	
W8OG	
W8FXN	
W8AL	
W8YPT	
	W2YTI



Winner of the phone award for Ecuador and second highest South American scorer was O. B. Crosskreuz, HC2OL. The contest receiver was a 75-A, the transmitter p.p. 4-125As modulated by a 80s; wide-spaced rotaries were shown on 10 and 20 meters and a folded dipole on 75. Shown at the mike is HC2OL's XYL, a nonparticipant in the contest operations.

### PACIFIC DIVISION

<i>Nevada</i>		W6FSJ.....19,140-53-110-C-28
W7JLV.....3390-30-38-C-		W6BJZ.....1433-16-31-B-8
		W6JHH.....40-4-4-B-8
<i>Santa Clara Valley</i>		<i>Arizona</i>
W6MDY.....2520-24-35-B-36		W7MOW.....5019-33-51-B-31
W6HKG.....12-2-2-B-10		W7PZ.....2673-27-33-B-28
<i>East Bay</i>		<i>San Diego</i>
W6RM.....135,494-117-336-C-		W6ITY.....65,835-95-231-C-
W6TT.....103,048-107-333-C-75		W6CHV.....29,808-72-138-B-58
W6PWR.....30,522-107-332-C-75		W6MI.....1197-19-21-A-10
W6BY.....75,540-95-264-C-61		<b>WEST GULF DIVISION</b>
W6LDD.....1204-16-25-C-10		<i>Northern Texas</i>
W6KEK.....300-10-10-C-		W6SRD.....35,295-85-143-B-52
<i>San Francisco</i>		W6SMJ.....1416-32-46-A-27
W6WB.....29,056-64-152-C-		<i>Oklahoma</i>
W6ATO.....1512-18-28-C-8		W6SLJ.....11,178-46-81-B-25
W6GPB.....75-5-5-A-2		<i>Southern Texas</i>
<i>Sacramento Valley</i>		W6SOE.....19,198-53-111-B-50
W6GVM.....13,680-48-95-C-		W6JWM.....89-42-71-C-
W6GDO.....1008-16-21-B-9		W6BBI.....5994-37-54-C-33

### ROANOKE DIVISION

<i>North Carolina</i>		<i>Canada</i>
W4DCQ.....246,720-160-514-C-88		<i>Maritime</i>
W4ASQ.....10,731-49-74-B-19		VE1ET.....33,660-69-165-B-31
W41FR.....900-15-20-B-6		VE1KN.....2376-24-33-B-
W4KYI.....48-4-4-B-4		VE1FO.....1275-17-25-B-6
		VE1CU.....1056-16-22-B-8
<i>Virginia</i>		<i>Ontario</i>
W4KWY.....153,039-139-367-C-		VE3AUJ.....71,712-95-219-C-60
W4OM.....119,761-127-315-C-		VE3ADJ.....40,650-75-182-B-50
W41LM.....72,292-106-228-B-64		VE3AXE.....16,830-55-102-B-34
W4AEH.....2,400-20-40-B-		VE3HB.....16,744-52-108-B-32
W41UO.....1,930-20-33-B-		VE3AMW.....3186-27-40-B-
W41UO.....117-23-B-7		VE3BUV.....3159-27-39-B-30
W4KMS.....363-11-11-B-6		VE3BQ.....2550-25-34-B-12
W4LUE.....90-5-6-C-1		VE3AJQ.....1930-22-30-A-11
W4KFT.....75-5-5-B-2		VE3BYV.....1740-20-29-B-14
W4JUY.....3-1-1-B-1		VE3KO.....966-14-23-B-11
W4NNV.....3-1-1-B-1		VE3JU (VE3BHS).....37,814-73-174-C-70
<i>West Virginia</i>		<i>Quebec</i>
W8AVW.....936-13-24-B-5		VE2NI.....41,652-78-179-A-61
W8WSL.....855-15-19-B-		VE2GW.....11,960-40-100-B-34
W8JM.....3-1-1-B-1		VE2BK.....6732-34-66-B-13

### ROCKY MOUNTAIN DIVISION

<i>Colorado</i>		<i>Alberta</i>
W0SBE.....15,504-28-136-C-50		VE6FK.....7812-42-62-B-25
W0WPO.....966-14-23-A-10		VE6AP.....1827-21-31-B-13
W0CDP.....351-9-13-B-6		VE6AO.....189-7-9-B-3
		VE6CN.....75-5-5-B-2
<i>Wyoming</i>		<i>British Columbia</i>
W7KOP.....5760-30-64-C-45		VE7EL.....74,307-92-267-B-66

### SOUTHEASTERN DIVISION

<i>Alabama</i>		<i>Manitoba</i>
W4FMO.....90-5-6-A-5		VE4RO.....60,288-95-210-B-51
<i>E. Florida</i>		VE4FX.....32,148-76-141-B-52
W4LNE.....29,632-64-155-B-55		VE4RP.....30,030-77-130-B-56
W41ZM.....22,515-57-133-B-15		VE4KF.....24,990-70-119-B-39
W4BMR.....8352-48-58-B-		VE4LC.....21,172-67-106-A-43
W4POF.....4725-25-63-B-12		VE4TK.....10,650-50-71-A-32
W4QED.....627-11-19-B-		VE4HU.....168-7-8--
W4EEO.....432-12-18-B-16		<i>Saskatchewan</i>
W4CKE.....192-8-8-A-4		VE5JG.....5935-35-57-B-30
<i>W. Florida</i>		VE5JV.....2283-26-30-B-
W4AGB.....7644-39-66-B-23		VE5MS.....256-8-11-A-18
<i>Georgia</i>		VE5CX.....85-5-6-A-7
W4LXE.....161,335-134-402-C-74		VE5OM.....27-3-3-B-2
W4FGL.....14,094-54-87-B-23		<i>Newfoundland</i>
W4INO.....13,918-49-94-B-31		VO2N.....3775-45-66-B-19

### SOUTHWESTERN DIVISION

<i>Los Angeles</i>	
W6TZD.....49,941-93-179-C-	
W6AM.....29,323-71-138-C-30	

W2EOH.....4512-32-47-C-21	W1HSB.....1254-19-22-B--
W2LTP.....147-7-7-C--	W1PWK.....690-10-23-A-5
W2VAM.....126-6-7-B-3	W1BLX.....600-10-20-B-7
W2GKE.....27-3-3-B-4	W1LFD.....488-8-21-B-4

### MIDWEST DIVISION

<i>Iowa</i>		<i>W. Massachusetts</i>	
W0JRY.....55,965-65-289-C-42	W1CJL.....39,216-76-172-C-32	W1RFB.....21,660-60-121-C-23	W1ZD.....11,280-47-80-C-13
W0HDX.....770-11-24-B-8	W1RJR.....5797-31-63-A-12	W1LHT.....340-12-33-A-	W1RHU.....162-6-9-B-3
W0FDL.....720-12-20-B-4	W1RHY.....12-2-2-B-2	W1QDE (W1SCF W2QKK W9JCD Wm. Grace).....78,570-97-270-C-75	
W0DIB.....108-6-6-B-4			
<i>Kansas</i>		<i>New Hampshire</i>	
W0VBO.....13,113-47-93-B-29	W1BFT.....36,516-68-179-B-	W1RZD.....20,148-46-146-B-31	W1KKT.....8424-36-78-A-39
W0AAO.....900-15-20-B-6	W1CWC.....1578-21-25-C-3	W1OCV.....27-3-3-A-	
<i>Missouri</i>		<i>Rhode Island</i>	
W0GUV.....38,505-85-151-C-67	W1CJH.....69,888-91-256-B-70	W1LFE.....5211-27-65-B-10	W1KUF.....90-5-6-B-1
W0DCB.....24,012-69-116-A-50	W1QNM.....4182-34-43-B-21		
W0BAF.....20,655-51-135-B-40			
W0ANF.....18,535-55-113-C-48			
W0MCX.....7719-31-83-C-29			
W0AJU.....3999-31-43-C-22			
W0GAV.....1045-19-19-A-3			
W0BOS.....72-4-6-B-2			
<i>Nebraska</i>			
W0BBS.....19,602-66-99-C-52			

### NEW ENGLAND DIVISION

<i>Connecticut</i>		<i>Vermont</i>	
W1ATE.....243,004-158-514-C-84	W1QNM.....4182-34-43-B-21		
W1QFQ.....11,500-46-84-B-26			
W1MRP.....5352-32-87-B-			
W1DEP.....4914-26-63-B-25			
W1AJO.....3975-25-53-B-16			
W1ICP.....2178-22-33-C-7			
W1FTX.....1620-18-30-A-			
W1NLM.....1365-13-35-A-11			
W1BUD.....360-10-12-A-			
W1BDI.....6-1-2-B-1			
<i>Maine</i>		<i>Oregon</i>	
W1PGZ.....43,650-75-195-C-	W1KSA.....12,420-46-90-C-32	W1NFC.....1254-19-22-B-	
W1BLF.....25,500-68-125-C-29			
W1RPC.....6336-32-68-A-14			
W1NXX.....84-4-7-B-2			
<i>E. Massachusetts</i>		<i>Washington</i>	
W1LXC.....107,569-121-299-C-64	W1TESK.....135,270-135-334-C-	W1KTL.....1368-19-24-B-33	W1MHW.....708-12-20-B-20
W1ALA.....13,904-44-106-B-20	W1FLD.....528-11-16-C-	W1BCH.....384-8-16-B-7	

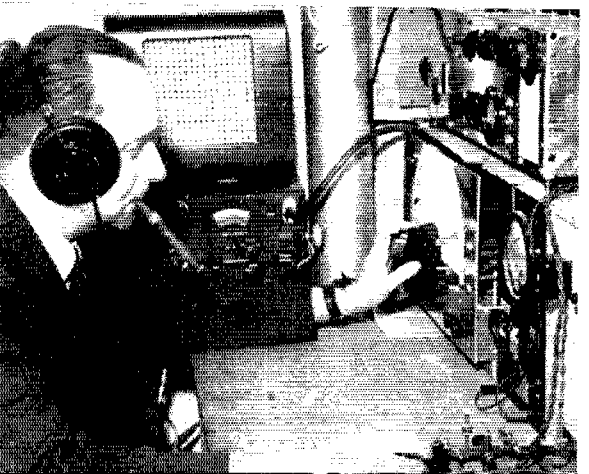

Cigar-smoking O. H. Eridsen, OZ3FL, Denmark c.w. winner, goes in for homemade gear. His transmitter, constructed from parts of a BC-375E, ran 100 watts to a 211 and his receiver is a ten-tube double-conversion superhet.

**QST for**



**AFRICA**

*Algeria*  
 FA3JY.....18,775-31-201-A -

*Kenya*  
 VQARF.....10,400-13-268-A-28

*Union of South Africa*  
 Z56DW.....38,800-37-800-A -  
 Z56B.....21,373-29-246-A-24

**ASIA**

*Burma*  
 XZ2SY.....1630-14-40-B-8  
 XZ2KN.....1107-9-41-B-8

*Malaya*  
 VS1DZ.....1575-7-75-A -  
 VS2BS.....114-2-19-B -

**EUROPE**

*Austria*  
 OESYL.....9009-21-143-A-15

*Belgium*  
 ON4CC.....42,528-32-443-A-30

*Czechoslovakia*  
 OK2SD.....33,858-38-308-A-46  
 OK1HJ.....26,940-30-300-A-35  
 OK1MB.....19,872-23-293-A-20  
 OK1RW.....13,356-21-215-A-28  
 OK1VW.....10,054-22-153-A-18  
 OK1BM.....2470-10-34-A-9  
 OK2DD.....994-14-26-A-8

*Denmark*  
 OZTSM.....42,822-39-369-A -  
 OZTG.....38,570-29-448-A-68  
 OZ3EA.....24,920-29-300-A-35  
 OZTEU.....6647-17-131-A -  
 OZTRN.....5610-17-111-A-41  
 OZ7X.....3539-17-111-A -  
 OZ7H.....1644-12-137-A -  
 OZ5HV.....1485-11-45-A -  
 OZ1W.....780-12-33-A -

*England*

G2PU.....149,760-48-1010-B-52  
 G2LK.....69,400-28-608-B-40  
 G2DYV.....17,472-26-224-A-24  
 G3ANH.....17,296-16-362-B-21  
 G2FRL.....8130-15-181-A -  
 G6CB.....6929-13-181-B-21  
 G3QV.....434-7-21-B -

*Finland*

OH6NR.....2356-17-56-A-8

*France*

F8SK.....111,264-38-976-A-72  
 F9BD.....31,730-38-281-A-21  
 F9JN.....24,967-27-307-A -  
 F9RM.....15,002-21-254-A -  
 F3OX.....15,741-33-166-A -  
 F8XP.....7523-17-128-A -  
 F9NG.....5078-18-94-A -  
 F8NH.....4444-11-136-B-10  
 F9DN.....3597-11-110-A -  
 F3DP.....2915-11-270-A -  
 F8VG.....675-9-25-A -  
 F3OO.....525-7-25-A -  
 F9IL.....308-7-15-A -

F9AJ.....261-8-11-A -  
 F3TJ.....18-2-3-A -

*Germany*

DL4LN.....50,112-36-464-B-28  
 DL1FK.....26,146-34-260-B-27  
 DL4CN.....6363-21-101-B-34  
 DL1TS.....3474-23-80-A-13  
 DL4OE.....2278-17-51-A -  
 DL3AR.....833-7-40-B-4  
 DL3DC.....189-7-9-A-5

*Iceland*

TF3MB.....2912-14-70-A -  
 TF3SF.....1800-10-62-A -

*Italy*

I1BDV.....93,744-31-1018-B -  
 I1RB.....91,770-38-805-A-49  
 I1BKH.....2844-12-81-A-24

*Luxembourg*

LX1JW.....98,058-59-558-B -

*Netherlands*

PA0AD.....65,376-32-681-A -  
 PA0RU.....34,692-28-413-A -  
 PA0ZJ.....8136-12-230-A -  
 PA0UV.....3744-12-105-A-14  
 PA0TQ.....2694-9-99-A -  
 PA0X.....1278-8-51-A -  
 PA0JA.....126-6-7-A-2  
 PA0VB.....36-3-4-A-3

*Norway*

LATY.....9450-27-119-A-15  
 LA9T.....2800-14-67-A-7  
 LA8J.....356-3-4-A -

*Poland*

SP5PZ.....959-7-47-A-8  
 SP5AB.....228-6-13-A-2

*Portugal*

CTINT.....5457-17-107-A-16  
 CTIFM.....1218-14-29-A-5

*Sardinia*

IS1AYN.....48,112-31-525-A -  
 IS1FIC.....16-2-3-A-1

*Spain*

FA4CM.....84,741-47-610-B-46  
 EA2CA.....41,752-34-411-A-53  
 EA4CK.....30,328-34-303-B -

*Sweden*

SM5UM.....107,040-40-892-B-60  
 SM5AI.....26,975-25-349-B-23  
 SM4YF.....14,330-30-162-A-18  
 SM5AMI.....1152-9-43-A-30  
 SM3EP.....1122-11-34-A -  
 SM5ABK (Ingenar Mitaitzky)  
 36-2-6-A -

*Switzerland*

HB9CX.....12,000-32-125-B-8

*Wales*

GW2UH.....43,710-31-479-B-29

**NORTH AMERICA**

*Alaska*  
 K17ZM.....11,844-28-141-B-28  
 K17GW.....5757-19-101-A-16

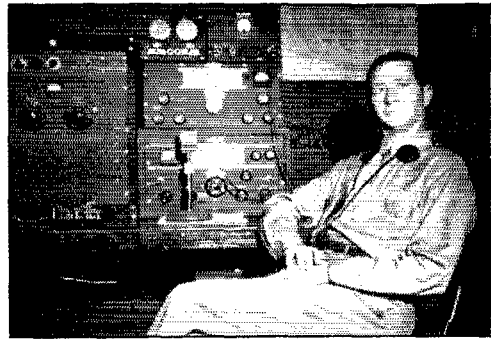

East Bay section 'phone winner and top-scoring W6, C. B. Smith, W6RM. His antenna farm contains two vee-beams, a rhombic, "5 over 5" for 10 meters and two parasitic arrays!

*Barbados*  
 VP6SD.....148,480-64-779-B-38

*Bermuda*  
 VP9KK.....7408-16-156-B-11

*Cuba*  
 CO6OK.....1833-13-47-A-4

*Guatemala*  
 TG9AD.....52,584-48-368-A-25

*Mexico*  
 XE2W.....253,260-70-1225-C -  
 XE2W.....119,511-63-637-A-27

*Nicaragua*  
 YN4CB.....6900-15-155-B -

*Panama*  
 HP1LA.....21,624-24-301-A-48  
 HP1LB.....10,668-21-178-B-12  
 HP1GL.....6355-15-153-B -

*Puerto Rico*  
 KP4DU.....21,624-24-301-A-48

*Salvador*  
 YS2AG.....81,216-48-568-A-27  
 YS1O.....3495-15-81-A -

*Suan Island*  
 KS4AC.....4000-20-68-A-2

*Windward Islands*  
 VP2GG.....20,640-32-221-A-26

**OCEANIA**

*Australia*  
 VK3AWN.....41,320-40-347-A-38  
 VK2JZ.....60-4-5-A -

*Hawaiian Islands*  
 KH6JL.....105,609-47-749-C-38  
 KH6OL.....805-7-39-A -  
 KH6OJ.....174-6-10-A -

*Java*  
 PK3LC.....16,962-33-175-A -

*New Zealand*  
 ZL1MQ.....26,419-29-304-A-33

*Sumatra*  
 PK4DA.....34,986-34-343-A -

*Tonga Islands*  
 VR5PL.....378-7-18-B -

**SOUTH AMERICA**

*Argentina*  
 LUSAD.....32,798-31-356-B-29

*Bolivia*  
 CP5FB.....6660-15-149-B-14

*Brazil*  
 PY2CK.....51,244-46-372-C-23  
 PY4R1.....23,932-31-238-B-63  
 PY6CO.....12,474-18-231-C -

*Chile*  
 CE2CC.....100,030-48-702-B-44  
 CE2AX.....47,082-42-377-A -  
 CE3HL (Amadeo Pascual)  
 6308-23-99-A-14

*Colombia*  
 HK1DZ.....14,442-29-167-B -

*Ecuador*  
 HC2OL.....104,954-43-426-B-16  
 HC2KB.....21,504-28-256-A -

*Guiana, British*  
 VP3MCB.....50,472-36-469-B-38  
 VP3HAG.....16,093-19-285-A -

*Peru*  
 OA4CO.....6192-24-86-B-9  
 OA4AO.....4536-16-84-A-7  
 OA4DW.....768-12-22-B-2  
 OA1E (Charles Stainforth,  
 Anne Cochrane)  
 77,174-47-552-A-35

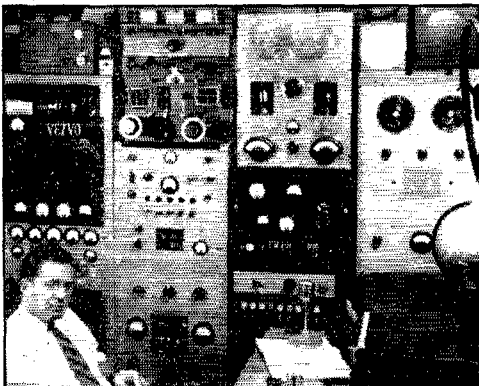

This imposing array of ham equipment was where the far-reaching contest signal of VE7VO, operated by Ted Fowler of Vancouver, B. C., originated. Ted turned in the top Canadian c.w. score.

The operators of the stations listed below, although not wishing to enter for competition, did send in logs for checking purposes. Their assistance is acknowledged with thanks.

C.W.: W1's I'XB, P'XF, NKB, YA, W2's CDP, CJX, FBS, KDS, LXI, NOY, NZC, ODZ, OLU, VNJ, ZDZ, W3's ADZ, DLI, KNQ, NRE, QGO, RWJ, W4's IJE, MMD, PHJ, W5RX, W6's DLR, JKH/2, NTR, RLQ, WEG, ZBY, ZDF, W7's KQD, LYL, W8's BLS, BRA, LYT, VDF, WXO, YCT, ZZU, W9's MQK, UAZ, YCZ, W0's AFU, BNU, CTR, DST, GUV, VEISS, VE2VT, VE3's BMB, XY, YV, VE6RU, DLV's AA, AP, E15G, F8's NV, VK, F9TK, G2FXI, G3CEG, G2AWT, KH6's ABG, WW, K17ZF, LA58, OK1DE, PK2ZZ, SM4UJ, VK2PY, VK7LJ, ZL2AI, ZL3GR, ZSGHO.

'PHONE: W1's CPS, EIO, HDQ, MCW, RFW, W2's AKX, CGP, RUK, UOZ, W3CDL, W4PPD, W5's BGP, KTL, PM, QIX, SU, W6USL/5, W7FFF, W9's HKZ, QNK, VHX, YPD, W0MKF, VE1's GH, HD, OM, VE2's HM, ID, IZ, VE3's BQP, RL, CE2's AG, BQ, CP1AS, DL7AA, G5OJ, G5MF, HK4DF, I1ZV, K17RZ, KP4AJ, LU3BAC, T65DM, VK3BW, VS1's AX, BO.



# U.S.A. CALLING!

## SIGNAL CORPS

Qualified civilians are needed to fill positions as military instructors, technical writers, and electronic engineers at the Signal Corps Center, Fort Monmouth, N. J. A brief description of the openings, grades to be filled, and required qualifications follows:

**MILITARY INSTRUCTORS** — Grades GS-5, GS-7, GS-9. Instructs classes of military personnel in one of the following subjects: microwave radio relay, radar, radio electronics, fixed station radio, central office techniques, teletype installation and maintenance, repeater and carrier, dial central office maintenance, etc. *Minimum qualification requirements:* (a) applicants must have at least four years' general experience which has given them a good working technical knowledge of the trade or field for which application is made; (b) in lieu of this general experience the applicant must have had resident training in a trade or vocational school above high school or in an armed forces service school, or in a college or university leading to a bachelor's degree in a pertinent field. (b) may be credited toward (a) on a year-for-year basis.

**TECHNICAL WRITERS** — Grades GS-5, GS-7, GS-9, GS-11. Depending on grade, writes, edits and prepares technical publications, handbooks, pamphlets, instruction books, etc. Edits and revises scientific manuscripts on radio, radar, electronics, communications, and photography. Writes instruction manuals on theory, operation, and maintenance of Signal Corps equipment; determines media and methods of presentation of material. Prepares charts, graphs, schematic diagrams, etc. *Minimum qualifications:* (a) at least three years' experience in the technical or scientific writing field, or (b) successful completion of a full four-year course in an accredited college or university with a major in an appropriate field, or (c) a time-equivalent combination of (a) and (b).

**ELECTRONIC ENGINEERS** — Grades GS-5, GS-7, GS-9, GS-11, GS-12. Depending on grade, participates in the design, development, modification, construction and testing of radar, radio, and wire communications equipment, electron tubes, electronic control and measurement instruments, sonar equipment and similar devices; plans and computes processes; prepares sketches; conducts performance tests; interprets and evaluates test findings; prepares technical reports. *Minimum qualification requirements:* (a) successful completion of a full four-year course in an accredited college or university with a major in electrical or electronic engineering, or (b) four years of progressive technical engineering experience which has provided a thorough knowledge of the physical and mathematical sciences required for completion of a full four-year engineering curriculum, or (c) any time-equivalent combination of (a) and (b).

Annual salaries for the various grades are: GS-5 \$3100; GS-7 \$3825; GS-9 \$4600; GS-11 \$5400; GS-12 \$6400. Amateurs desiring further particulars on any of these openings should write to the Chief, Civilian Personnel Branch, Fort Monmouth, N. J., for a detailed information sheet. Interested applicants should submit a completed Standard Form 57, "Application for Federal Employment" (available at any first- or second-class post office), prior to calling in person for an interview.

## 17th ARRL Sweepstakes — Nov. 18th-19th and 25th-26th

How many ARRL sections and how many stations in those sections can you work in two week ends? If you are located anywhere in the League's field-organization territory (see page 6), you are cordially invited to take part in this popular annual operating activity. Any amateur bands, 'phone or c.w., may be used. The total operating time allowed each contestant is 40 hours. The Sweepstakes comprises seventy-two c.w. and seventy-two 'phone contests! 'Phone entries are compared only with other 'phone entries — c.w. scores only with other c.w. scores — in your particular section, in the competition for awards. The week-end periods starting Saturday afternoon (1500 PST or 1800 EST) on the 18th and 25th of November mark the open season for SS contacts. "CQ SS" or "Calling any Sweepstakes station" will be the calls indicating your wish to pile up a score!

A complete announcement of the contest, including the rules governing participation, will appear in November *QST*. The rules will be the same as those of the 1949 SS. Amateurs in remote ARRL sections who do not receive the November issue before the Sweepstakes may refer to November, 1949, *QST* for contest details.

Contest reporting forms will be sent to all amateurs who request them by mail or radiogram. It is not necessary to make advance entry or to use these forms, if the report form prescribed in November 1949 or, in the next issue of *QST*, is followed.

*CU in the '50 SS!*

## HAMFEST CALENDAR

**MISSOURI** — Sunday, October 8th, at Poplar Bluff — MOARKY hamfest sponsored by the Bluff Amateur Radio Society. An excellent program has been arranged, including banquet, speakers, mobile contest. Amateurs, SWLs, and friends are invited. For further information write Bluff Amateur Radio Society, P.O. Box 484, Poplar Bluff, Mo.

## IS YOURS ON FILE WITH YOUR QSL MGR?

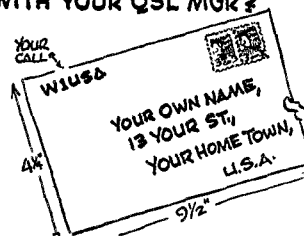

See page 108 of this *QST* for the name and address of your QSL Manager



# Correspondence From Members -

The Publishers of *QST* assume no responsibility for statements made herein by correspondents.

## CQ F.D.

East Elm St.  
Goessel, Kans.

Editor, *QST*:

About a year or so ago I noticed in *QST* that the M.D.'s were forming a ham club and in the August issue we hear from a clergyman. How about it — are there any funeral directors or morticians besides myself who have ham radio as a hobby? Would like to hear from and chew the rag with some of you fellows.

— Henry G. Bergen, W6GLV

## HOW ABOUT THAT?

1600 Lebanon Rd.  
Nashville, Tenn.

Editor, *QST*:

Interesting note: On page 80 of the *Radio Amateur's Handbook*, 26th edition, 1949, is an explanation of the polarity of a vertical radio beam. Living in Nashville, Tenn., I have noticed that reception from Pittsburgh, Pa., is very good on 20 meters. On a compass declination map of the United States I have noted the radio beam from Pittsburgh would travel at approximately right angles to reach here. That would place the "magnetic lines of force" of a vertical beam in parallel to the magnetic field of the earth.

Then again this could be due to the proper skip distance.

— George B. Powell

## CALL LETTER LICENSE PLATES

730 Willow Ave.  
Hayward, Calif.

Editor, *QST*:

As an amateur and a police officer I would appreciate the opportunity to express my thoughts regarding issuance of vehicle license numbers corresponding to amateur call letters. There may be some aspects of the situation which are not at first evident, and they should be carefully considered by any amateur group or club before action is taken in an effort to secure legislative action toward furthering this policy.

Of prime importance in any system of registration of vehicles is just that — a comprehensive system. That is to say, an arrangement whereby all license numbers fall into patterns. As an example, California employs a combination of one or two numbers followed by a letter and three or four numbers. For this reason if a car is involved in a crime and a witness observes only part of the license number, it is quite often possible to ascertain the correct number and trace the car through a cross check of the possible number and the vehicle description. Now assume a system of registration which permits exceptions to the rule and consider the additional problems involved. I do not wish to convey the impression that amateurs as a whole make a habit of violating the law, but almost invariably when a major crime is committed, the perpetrators employ a stolen car. It could quite easily be one owned by a radio amateur. The governments of many states have for many years labored to achieve the best systems of registration with the above thought as a prime factor. With a selected group privileged to receive special licenses this work will have been in vain. Needless to say some states are exceptions, and these no doubt would be the ones most willing to bestow special favors. Further investigation would disclose that these same states are the most lax in their driver's license requirements, and have the highest accident toll per capita.

In a democracy all people are presumed to possess the

same rights and privileges. For this reason isn't it logical to assume that other organizations will request and have every right to expect special licenses? Fraternal organizations, the Masons, the Elks, the Moose, the armed forces personnel, ad infinitum.

Doctors place their emblem above the license number, college fraternity members place their emblem on the windshield; radio amateurs can purchase decal transfers for their windshields. Let's all work toward keeping that license number on your car something worth while — an identification that will continue to fight crime and allow the law-enforcement agencies to recover your car speedily if it should ever be stolen.

— Arthur E. Allen, jr., W6YDA

[Editor's Note: ARRL Headquarters has furnished guidance and advice to many groups but has left the promotion of the necessary legislation up to the initiative of the local groups, since it is a matter for the individual states to resolve. We presume that the states which have already enacted such legislation are aware of "disadvantages" such as W6YDA mentions but have weighed them against the advantages — e.g., having radio amateurs readily identifiable in the event of some disaster requiring their services. Lack of highway safety and "special favors" do not necessarily go hand in hand. It has been possible in Connecticut, for example, to obtain a special combination of license plate symbols by payment of a small additional fee. (WIBDI has the license plate "ARRL.") However, Connecticut licensing requirements are very strict, and Connecticut has consistently won the National Highway Safety Award. As for windshield decals — many states, Connecticut included, have motor vehicle regulations which prohibit the placing of such vision obstructions as decals on windshields.]

## FOR THE CLUBS

16901 Bollinger Drive  
Pacific Palisades, Calif.

Editor, *QST*:

I'd like to offer the following for the consideration of affiliated clubs.

There are a lot of members who would like to be able to attend your club meetings more often, but can't leave the XYL for too many evenings a week. How about dispensing with that long dry business meeting, transfer it to an executive committee, and keep your meetings more interesting. Invite all of the XYLs in for a social evening, then slowly expose them to the germs of radio. Your XYL would like to come to the meeting but she does not like to be the only woman there. It would give her a stimulating outside interest, and she would not feel like a radio widow.

— Keith Elford, W6AYB

## HIGH-PASS FILTERS

244 17 St.  
Brooklyn, N. Y.

Editor, *QST*:

I think it is long past time for ARRL to approach the television manufacturers in regard to making receiver high-pass filters standard equipment on every receiver. We have gotten very excited over various threats to Hamdom but, in my opinion, TVI is the greatest of all the threats. How much effect it has had may best be judged by listening any night on any band and noting the few signals emanating from those centers of television — N.Y.C., Chicago, etc.

Every television receiver built to date and all those to be built without the filters is going to be a noose to hang some unsuspecting amateur. We all know the TV receivers

have no selectivity, yet it becomes our burden to try to overcome the interference. Many TV sets use i.f.'s of around 21 Mc.; what happens when (and if) we get the 15-meter band? After we have spent many hours and many dollars trying to clean up our transmitters to a point far beyond anything ever intended in the requirements and knowledge "of the art," the neighbor's receiver needs a filter.

In all fairness, every TV viewer is entitled to interference-free reception. But the receivers are so poorly designed that they accept any and all interference.

— A. D. Billington, W2SUJ

[EDITOR'S NOTE: It is very true that a high-pass filter installed at the TV receiver will help to prevent the interference caused by overloading of the front end of the TV receiver. However, no receiver filter will do anything about amateur harmonics that fall in TV channels. Those harmonics are the amateur's responsibility and must be eliminated by him if interference-free TV reception is to be expected.]

## READY-REFERENCE INDEX

36 Darenth Road  
Stamford Hill  
London, N 16, England

Editor, *QST*:

Readers of *QST* may find this little filing system worth adopting to help them find articles in past copies easily. I cut out the "Contents" page of each *QST* received and

paste it in a book. This listing of contents makes it much easier to find an article than would be the case if I had to pull all my *QST*'s from the bookcase and go through each one separately to find what is needed.

Visiting hams who want dope on past articles also appreciate being handed a small book containing this list of contents, rather than being told to "Have a look through the *QST*'s in the bookcase." The average note book will hold the contents lists of some three or four years' issues.

— Les Parnell, G8PP

## FROM ONE WHO KNOWS

Marble Hill, Mo.

Editor, *QST*:

I think there should be something done to help the blind get amateur licenses if they are interested. What should be done, and I think it could be, is to put a motion up to the FCC on lowering the requirements for totally blind people or the ones that are almost totally blind. It would open up a new world for the blind. There wouldn't be enough applicants to bother the FCC.

You see, I was blind for 22 years, until three years ago, and so I know from experience what an amateur license could mean to those who are blind. Although I now have perfect eyesight, I can remember when it was different.

What do the fellows think about this idea?

— L. H. Estes, W8BOE



October 1925

... RCA announces a new receiver power tube, the Type 210, which shows great promise as a low-power transmitting bottle.

... The importance of shielding and by-passing in stabilizing high-gain r.f. amplifier stages in receivers is stressed by Dr. L. M. Hull.

... A timely and enlightening article, "Wave Propagation at High Frequencies," is authored by Drs. A. Hoyt Taylor and E. O. Hulbert, researchers at the Naval Research Laboratory.

... The Army and the League have worked out a plan for cooperation between amateurs and the Signal Corps.

... George Sturley, 7BJ, records T.O.M.'s latest rantings and ravings anent rotten operating, yowling bloopers, and buckling rainspout masts.

... Assistant Technical Editor John M. Clayton discusses high-frequency resistance standards, taking into account the factors of skin effect, inductance, capacitance, and temperature coefficient of the resistance wire.

... The Third ARRL National Convention, held in Chicago, is now a pleasant memory to the 450 amateurs who attended.

... Convenient coil-design charts for helping to get a short-wave receiver on the desired wave are presented by R. R. Batcher of A. H. Grebe & Co.

... Dime-store art gum is recommended as an excellent shock-absorber material for noisy motor generator installations.

... The U.S.S. *Seattle* is reported en route home from its Pacific cruise. ARRL Traffic Manager F. H. Schnell, who is operating NRRL aboard the ship, will report on the special short-wave tests in an early issue of *QST*.

... Another DX path has been opened: NUQG, the U.S.S. *Pillsbury*, at Chefoo, China, has worked ch1EG, Vileun, Chile.

... Three typical amateur stations of the times are described this month. They are A. W. Everest's 1ARE, Pittsfield, Mass., Arthur A. Collins' 9CXX, Cedar Rapids, Iowa, and Abner R. Wilson's 7NT, Butte, Mont.

## WWV-WWVH SCHEDULES

FOR the benefit of amateurs and other interested groups, the National Bureau of Standards maintains a service of technical radio broadcasts over WWV, Eeltsville, Md., and WWVH, Maui, Territory of Hawaii, on the following schedules:

The services from WWV include (1) standard radio frequencies of 2.5, 5, 10, 15, 20, 25, 30 and 35 Mc., (2) time announcements at 5-minute intervals by voice and International Morse code, (3) standard time intervals of 1 second, and 1, 4 and 5 minutes, (4) standard audio frequencies of 440 cycles (the standard musical pitch A above middle C) and 600 cycles, (5) radio propagation disturbance warnings by International Morse code consisting of the letters W, U or N, indicating warning, unstable conditions, or normal, respectively.

The audio frequencies are interrupted at precisely one minute before the hour and are resumed precisely on the hour and each five minutes thereafter. Code announcements are in GCT using the 24-hour system beginning with 0000 at midnight; voice announcements are in EST. The audio frequencies are transmitted alternately: The 600-cycle tone starts precisely on the hour and every 10 minutes thereafter, continuing for 4 minutes; the 440-cycle tone starts precisely five minutes after the hour and every 10 minutes thereafter, continuing for 4 minutes. Each carrier frequency is modulated by a seconds pulse which is heard as a faint tick; the pulse at the beginning of the last second of each minute is omitted.

Station WWVH, operated to provide coverage of the Pacific area, broadcasts on an experimental basis on 5, 10 and 15 Mc. The program of broadcasts on the three frequencies is essentially the same as that of WWV. Reception reports indicate that WWVH is received at many locations not served by WWV, thus extending the area served by standard frequencies and time signals. Time announcements in GCT are given from WWVH every five minutes by International Morse code only.

**SWITCH  
TO SAFETY!**





# Hints and Kinks

## For the Experimenter



### SIMPLIFIED BIAS CIRCUIT FOR CLASS-C AMPLIFIERS

THE circuit shown in Fig. 1 is a simple means of obtaining operating bias for tubes such as the 304-TL which require relatively large bias voltage at more grid current than it is convenient to furnish through the usual small bias pack.

A tetrode, such as the 6L6 or 807, connected as a high- $\mu$  triode (both grids tied together) is used as a cathode follower. Bias voltage for the Class C stage is then obtained from the voltage drop through the cathode follower. In key-up conditions (when no grid current is being drawn by the Class C stage) the bias furnished by the small power pack keeps the final amplifier cut off, and the bias on the cathode follower is then adjusted to cut-off by means of potentiometer  $R_1$ . When the key is closed, the Class C stage draws grid current through the cathode follower, which must be rated to handle the power consumed in the grid circuit (grid current  $\times$  bias voltage). In my own application, the 304-TL runs at a kilowatt input, with 90 ma. grid current and  $-230$  volts bias. Two 6L6s in parallel handle this situation nicely.

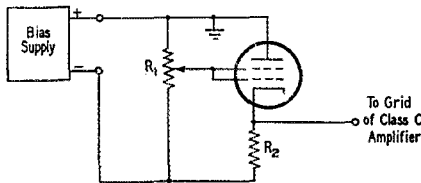

Fig. 1 — A simplified biasing arrangement for tubes such as the 304-TL. A cathode follower, biased to cut-off under key-up conditions, takes the place of a heavy-duty bias supply.  $R_1$  should be a 0.5-megohm potentiometer, and  $R_2$  about 0.25 megohm.

The supply voltage must be greater than the bias required by an amount sufficient to bias the cathode follower to near cut-off under key-up conditions. When the key is closed the output voltage will change by the amount of change in the cathode-follower bias necessary to pass the load current, but the drain on the supply is very small, being about 1 ma. in the set-up described above. Thus, the need for an expensive well-regulated bias source is eliminated.

— George H. Nibbe, W6BES

### "HOW'S MY MODULATION?" INDICATOR

SELDOM are "On-the-air" reports critical enough, particularly as to quality of modulation, and since it is virtually impossible to tell anything by listening to yourself with a monitor, the following scheme has been adopted at W2PFU for adjusting

the 'phone level for minimum distortion, correct clipping rig, general speech quality, hum, etc.

A three- or four-foot length of wire and a 1N34 germanium diode are coupled into the microphone input of a wire recorder placed on a table a few feet from the transmitter, as shown in Fig. 2.

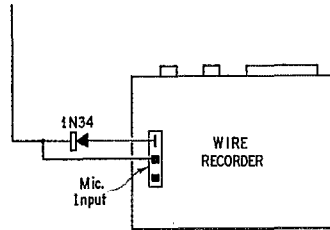

Fig. 2 — Connections used by W2PFU to permit recording of his own signal.

The wire recorder is turned to "record" position, the transmitter is turned on, and, while the adjustments are being made, the operator describes the adjustments, dial settings, and other pertinent data. At the conclusion of the series of adjustments the transmitter is turned off and the material recorded on the wire is played back. This gives the operator a personal and first-hand description of just what his modulation does sound like. Obviously, during the test the input level to the wire recorder must be adjusted to the proper recording level.

Tests can be made with the transmitter loaded into a dummy antenna or while the operator is in QSO with another amateur. Broadcasting your tests to the world is not recommended.

— Dallas T. Hurd, W2PFU

### CURING HEATING-PAD QRM

FOR some time I had a bad case of QRM from a heating pad used in the house next door. After considerable investigation, it was found that the disconcerting racket could be eliminated only by by-passing each of the thermostats in the heating pad with small condensers.

To do this it is necessary to open the pad and solder 0.005- $\mu$ fd. condensers right at the thermostat terminals. The new ceramic disc-type condensers are ideal for the job because of their small physical size. They are wafer-thin, so their use does not introduce annoying lumps in the pad.

Care must be taken to see that proper insulation is made of each joint so that the user will not be hurt by exposed wires. By careful placement of the condensers, the thermostats themselves can be used as mechanical guards for the rather frail condensers.

(Continued on page 116)



# Operating News



F. E. HANDY, WIBDI, Communications Mgr.  
JOHN E. CANN, WIRWS, Asst. Comm. Mgr., C.W.  
GEORGE HART, WINJM, Natl. Emerg. Coördinator

J. A. MOSKEY, WIJMY, Deputy Comm. Mgr.  
L. G. McCOY, WIICP, Asst. Comm. Mgr., 'Phone  
LILLIAN M. SALTER, Administrative Aide

**NSRB Plans and the Amateur.** ARRL representatives have been in regular attendance at FCC, MARS, and NSRB meetings to represent the amateur, and everywhere find the amateur highly regarded and assured consideration in civil and other defense plans. The National Security Resources Board has now completed its broader planning recommendations for the nation, based on the principle of self-help between communities, and recognizing the principle that self-preservation after major disasters — such as those simulated at Seattle and Chicago (as typical defense problems) — *depends on rapid and efficient communications.* As recounted more completely elsewhere in this issue (see "Civil Defense Planning"), the NSRB report contains a complete section on communications and expected requirements at national, regional, state, and local levels in the civilian defense plans, including comment on the use of the amateur. Full data on amateur service operating organization and the existing provisions within our Emergency Corps have been presented by the League in its contacts with the various Washington agencies concerned.

**Recommendations.** (1) ARRL urges every SEC and EC to miss no opportunity to get into the appropriate public safety and civilian defense committees, councils, groups, etc., as these are established at state and community levels. (2) ECs will register station data and enroll *all* active amateurs in the ARRL Emergency Corps, full or supporting division — as proper in view of individual time to be active in any radio tests. The actual community planning for use and deployment of amateur units for any contingency will be in accord with the plans of appropriate local authorities as determined by amateur service emergency coördinators. (3) Old AEC cards now will receive annual endorsement or renewal to identify holders participating in current civilian defense tests and/or the ARRL Simulated Emergency Test. Get your registration up-to-date, if necessary. (4) ECs will issue the new Official Mobile Unit and Emergency Radio Unit identifying cards to AEC registrants wherever status justifies. *Every* mobile and every emergency-powered registrant is to be reported through channels to ARRL, so that our national mobilization strength in the October test can be reported accurately to the interested Washington agencies. Get this recognition-identification card as soon as you can qualify!

**ARRL SECs.** Annually, we run the complete list of Section Emergency Coördinators in *QST*. It is particularly fitting that we present the address of each such section official at this time. Amateurs wishing to register for emergency work and not knowing their EC should contact their SEC for registration form and information. In Michigan, Connecticut, and a number of other states, ARRL SECs already have been invited to sit in on their state civilian defense communication committees to represent the amateur service in civilian defense plans at that level. Additional representation will be needed at municipal as well as state levels now that more information is being disclosed on the NSRB pattern for all civilian defense efforts, including communications. ECs and SECs will continue to perfect amateur service plans to help in every state and community. ECs have the word on development of communications, and the amateur who wants to be in on important chances to use amateur radio should be registered in the AEC. Of course, if your community does *not* now have an active EC ready to provide amateur know-how and give leadership to a local group enlisting in the common effort, it is high time that the local club or you as an individual recommended one. Give your SEC the name of a qualified and likely prospect for this EC leadership post in accordance with the qualifications prescribed in the League structure.

**Contest Entries.** In connection with the Sweepstakes scheduled for November, or other contest-radio activities, it is only necessary to send in the logs in the proper form shown with the contest announcement or use mimeographed forms obtainable on request from ARRL. All contest entries become the property of ARRL. No logs or entries in contests can be returned. The volume of interest in contests and our staff limitations make these rules necessary. Never send FCC logs or legal-important material unless requested to do so for some special verification purpose upon request. Unless forwarded at our special request, we cannot be responsible for any such submissions.

**On Requesting Appointments.** All amateurs who are *not* currently a participating part of operating organization through activity or appointment-holding are invited to contact SCMs (address on page 6) and qualify for a post along the lines of natural interest. A booklet more completely describing the appointment requisites will be sent to members on request by radiogram or

postal card. Note the fields for participation in the following list:

- EC \* Emergency Coördinator. Organizes amateurs of a community or other area for emergency radio service; liaison with officials and agencies served; also with other local communication facilities.
- ORS Official Relay Station. Traffic service, operates nets and trunk lines.
- OPS Official 'Phone Station. Voice operating, example in setting operating standards, activities on voice.
- OES Official Experimental Station. Experimental operating, collects reports v.h.f.-u.h.f.-s.h.f. propagation data, may engage in facsimile, TT, TV, etc., experiments.
- OBS \* Official Bulletin Station. Transmits ARRL and FCC bulletin information to amateurs.
- OO Official Observer. Sends cooperative notices to amateurs to assist in frequency observance, insures high-quality signals, and prevents FCC trouble.

\* Available where SCM determines vacancies exist. Ask your SCM.

**Courtesy and Operating Efficiency in the "SS."** A commendation for one SS operator (last year) includes comment on some slack operating practices that ought to be watched in the SS just coming up! It is *highly* desirable that the order of preamble or exchange used in the SS should be closely adhered to by each operator. As in all two-way communications the OK, QSL, or "receipt" should not only be *given* when the information is correctly received but sending operators should be sure the contact got this and is moving along. Only thus can a participating operator put down the information and you be certain that he has completed the contact requirement for his two points. Cross-checking of logs last year indicated that more points than customarily rated deduction on account of such *incomplete* QSOs . . . that is, contacts *not* receipted for or lacking fills.

"For the few that decry the SS and other contests let me say the following on principle. Every year I see miracles performed in the way of stammering newcomer locals transformed into respectable operators almost overnight. It seems to instill them with an alertness that would take months or years to accomplish in ordinary operation. . . .

"Must take my ear muffs off (no hat here) to W2IOP for acknowledging by number . . . 146 R VA . . . on each receipt. This was the way the thing was meant to be done. Some this year improperly skipped the "station of origin," thinking to get the jump on the more conscientious brethren perhaps. . . . — W9BRD

Every second adds up when one goes after 30-an-hour but this business of getting lax in acknowledgments, some not even bothering but just opening up with a CQ 3 kc, higher or lower . . . and letting the other fellow worry about subtracting the point should be curtailed. Cutting the contact short by leaving people up in the air with no acknowledgment is "no go."

Meet the oldest and youngest members of the Walla Walla Valley Radio Amateur Club. Frank Burdick, W7JWB, left, is 83 years old. He works 7 Mc. exclusively with a 100-watt rig. Frank received his amateur ticket when he was 72! He has two sons, W7NKU and W7NXV, both in their fifties. Youngster Marc Nathan, W7NUK, 13, is active on 40 and 10 meters with low power. W7FPP, who sent us the photo, says Marc is "hotter than a firecracker about amateur radio."

**Fall Activities.** October brings the CD Parties with 'phone and c.w. sections, a bulletin-announced get-together by radio of all SCM appointees taking place in the last two week ends of the month. This is the "day off" that comes every so often for field organization workers in the ARRL family. The latch string is out on appointments (see above) for those members with active stations who carry out the operating and organization responsibilities to each other and to hams generally. *More* than contest interest is of course required in this group of League appointees where of-by-and-for-the-amateur is more than a slogan!

October also should mark the "biggest yet" in the way of Simulated Emergency Tests. The part for *your* community should be a surprise deployment of Emergency Corps facilities on either the 14th or 15th of October. The magnitude of what is tried depends on voluntary amateur interest in public service work and on the local amateur service plans sponsored by your emergency coördinator. The exercise will be tied in, where possible, we hope, with the over-all communication plans of responsible authorities in your community — city, Red Cross, civilian defense plans, etc. — but it is a *locally*-announced disaster test that starts off the on-the-air operating. Belonging to the Corps is a prime way to get in this test and to be pulling your weight in amateur radio. *Every amateur* should register on our Emergency Corps blanks not only his mobile, but the home and portable gear that could become a last-ditch facility for establishing outside radio communications in a disaster. The Corps, sponsored by ARRL, does not require membership in any organization, but only an amateur license, an active station, and your registration. Don't pass up the opportunity to get the pleasure and acquire skills that come from operating your equipment in any or all these tests. All amateurs *and prospective amateurs* are also cordially invited to take a crack at the monthly qualifying runs for Code Proficiency Certificates. WIAW-WØTQD-W6OWP schedules for this popular program and other activities are noted in the Activities Calendar appearing elsewhere in this issue.

See you on the air in the October CD Parties and other fall activities.

— F.E.H.

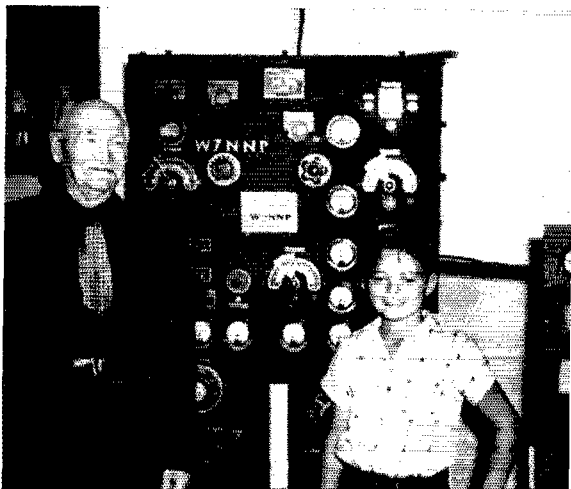



The October Simulated Emergency Test is just over the horizon, and this year we are looking for bigger-than-ever participation by AEC groups. Since last year, AEC progress has been made in leaps and bounds, especially along mobile lines. The starting of plans for civilian defense in recent months has lent additional impetus to the AEC movement. How about *doubling* last year's participation?

Note that this year (see last month's column) we expect to put a figure on the total of national participation. Each group's objective will be to contribute as many points as possible toward that national total, and each individual should strive to contribute as many points to his group's total as his presence, ability and equipment will permit.

By the time you read this, ECs will be busily preparing for the big event, lining up new registrants from among local amateurs not previously registered, contacting their local civic relief agencies for cooperation, preparing news releases, making arrangements for the disposition of mobiles and fixed stations and planning the incident or incidents under which the organization will act. A bulletin from headquarters will have been received making recommendations, and explaining the scoring system. Traffic nets will be mustering their strength for the big expected flow of traffic from the field to headquarters and from Red Cross chapters to their national headquarters.

But the measure of performance of an AEC organization is not in the score (which is noncompetitive anyway) so much as in the spirit and efficiency with which the simulated emergency is executed. Civilian defense will probably be the keynote this year, and in this all amateurs should take an interest.

*Let us make the October Simulated Emergency Test for 1950 serve as our notice to the nation, in one strong, united voice, that Amateur Radio is prepared to serve in the event of any disaster. It is our golden opportunity to show our strength, our numbers and our value — and that way lies recognition and utilization.*

Last month we announced the availability of "Official Mobile Unit" and "Emergency Radio Unit" cards to be issued to AEC members by ECs in recognition of extra effort in equipping themselves with and operating emergency portable and mobile gear. We thought you might like to see what they look like, so this month we are illustrating the "Official Mobile Unit" (Form 30) card.

**AMERICAN RADIO RELAY LEAGUE**  
**EMERGENCY CORPS**  
**FOR PUBLIC SERVICE**

This certifies that \_\_\_\_\_  
licensee of \_\_\_\_\_, owns and operates a mobile amateur radio station designated as \_\_\_\_\_

**OFFICIAL MOBILE UNIT**

of the ARRL Emergency Corps for one year from date below or endorsement on reverse side. This unit will be held in readiness at all times to render emergency radio communication in the public interest.

Dated \_\_\_\_\_

*F. E. Handy*  
Comm. Mgr. A.R.R.L.

A.R.R.L. Emergency Coordinator

This card does not take the place of anything; it's something new. It is issued, by the EC (SECs and SCMs can also issue if there is no EC in your community), to members of the ARRL Emergency Corps under his jurisdiction who have shown that they have mobile units in operating condition, ready and willing to take an assignment in the event of emergency. If your AEC group does not have a mobile contingent, now is the time to get one started. In addition to the "Official Mobile Unit" card, mobiles will be issued

an "Emergency Radio Unit" card — but we'll talk about that next month.

AEC members were instrumental in providing communications for the Intercollegiate Rowing Regatta on the Ohio River at Marietta, Ohio, on June 17th. W8VZ, Marietta EC, took the lead in working out details. One station was placed in the steward's car of the observation train, one on the judge's barge, one at the finish line and one at the boathouse. In addition, three rigs were on the observation train for the news reporters. 185 messages were handled, mostly between officials. W8s PGL, DDE and VZ were stationed at the finish line tent, which was the press location also. W8MIT was on the referee's boat and W8BNH on the judge's barge. The rig on the steward's car of the observation train was handled by W8AWL. Other amateurs assisting at various places were W8s ACO, BVQ, CNF and HUG. Several of these hams came over from Parkersburg, W. Va., to help out the Marietta boys. They have received many letters of commendation from the Intercollegiate Rowing Association officials, the press and others for whom they handled traffic so efficiently and willingly.

— W8UPB, SEC Ohio

The Philadelphia Area Council and member radio clubs, on request of the Coast Guard Auxiliary, provided complete amateur radio communication for the Outboard Speed Boat races on the Delaware River, June 4th. W3BES was coordinator for arrangements. W2LY/2, W3QV/3, W3PKV/3, W3EM/3, W3KFK/3, W3BES/2, W3UKI, W3DUU, W3BXE/2, W3PUP/2 and W2ZQ/2 were the stations handling the event.

On May 4th, at Troy, N. Y., a demonstration of amateur emergency equipment and procedure was given by a group of AEC members, to acquaint Red Cross leaders, Fire Department officers and a representative group of Boy Scouts and Scout officials with the capabilities of the personnel and gear available, in the event of a disaster. Four fixed and three mobile units were used on 2- and 75-meter 'phone, although provision had been made also to use c.w. if needed. Emergency units were installed both in public buildings and private homes for the purpose of the demonstration. The emergency was theoretically caused by a severe electrical storm accompanied by high winds, resulting in failure of commercial electrical and telephone service and extensive fires. Red Cross and Fire Department officials appealed for communications assistance, which was furnished.

Among those present were the Red Cross Disaster Chairman, representatives of the press, the Fire Department, a local broadcast station, and the SEC, W2CLL. Amateurs participating in the demonstration were W2s AWF, CLL, DIF, ILL, IWI, OVY, SUL, WIK, YXE, ZYJ.

— W2ILL, EC Troy, N. Y.

The annual Cotton Carnival held in Memphis, Tenn., during the week of May 7th to 13th, featured three parades which were controlled by amateur radio members of the Memphis Emergency Corps. Mobiles and portables operating on ten meters were used. The mobile units, equally spaced in the line of parade, were equipped with red and green lights mounted on top of each car to signal units of the parade behind what action to take. Each car was marked on each side and on the top with a large numeral for identification by observers who contacted the fixed stations by telephone to advise if any gaps were developing or crowding up was occurring. The fixed station would then advise the mobile units so that the proper light signal might be given. As a result of this system, excellent formation and good control over the parade movements were maintained. Six mobile units and two portable stations were used in the longest parade.

Parade operation is a real test for automobiles and their batteries. The slow driving requires a good clean cooling system to prevent overheating and the batteries receive little charge while moving at parade speed. Some cars used two batteries to insure continuous operation. Newspaper, radio and television publicity was given to this amateur operation and mobile operation in Memphis was stimulated as a result. W4LI and W4BAQ were in charge. Mobile units were supplied by W4BAW, W4HSU, W4LRO, W4NBN, W4PXX and W4FWX. The portable stations were operated by W4HHK and W4IBG.

— W4BAQ, EC Memphis, Tenn.



## Section Emergency Coördinators of the ARRL Emergency Corps

The Section Emergency Coördinator is appointed by the SCM to take charge of the promotion of the ARRL Emergency Corps organization throughout the Section. He acts as the SCM's executive in the furthering of provisions for emergency amateur radio communications in every community likely to suffer in case of a communications emergency. One of the duties of the SEC is to recommend the appointment of Emergency Coördinators for the various communities in his Section. Does *your* town have an EC? If not, recommend the name of a likely prospect to the SEC. The SEC invites your questions concerning the status of the AEC in your Section.

ATLANTIC DIVISION				
Eastern Pennsylvania	W3ISE	W. T. Shreve	1507 Niessen Rd.	Orland
Maryland-Delaware-D.C.	W3EIS	Donald McClenon		Beltsville, Md.
Southern New Jersey	W2ORS	Charles B. Roop	201 Pavilion Ave.	Riverside
Western New York	W2SIV	Ed Graf	31 King St.	Tonawanda
Western Pennsylvania	W3OMA	Walter P. Remele	20 N. Howard Ave.	Bellevue
CENTRAL DIVISION				
Illinois	W9QLZ	Geo. E. Keith, jr.	RFD 2, Box 22A	Utica
Indiana				
Wisconsin	W9YVV	Clarence Wahner	3351 N. 14th St.	Milwaukee
DAKOTA DIVISION				
North Dakota	W0SSW/NRQ	John S. Glass	601 17th	Bismarck
South Dakota	W0HDO	Coy Delapp	c/o Montgomery Ward Store	Mitchell
	W0GLA	Frank Mayer	511 St. Joe St.	Rapid City
Minnesota	W0BOI	Robert A. Pehim	1130 Delaware Ave.	St. Paul 7
DELTA DIVISION				
Arkansas	W5EA	Leo V. Brians	6th William	Carlisle
Louisiana	W5KTE	James M. Coleman	6900 Louisville St.	New Orleans
Mississippi	W5MUG	Floyd C. Teetson	122 West Fourth St.	Hattiesburg
Tennessee	W4FDF	John A. Oliver	135 Marshall Circle	Oak Ridge
GREAT LAKES DIVISION				
Kentucky	W4BEW	E. G. Leachman	1314 Maryland Court	Ashland
Michigan	W8GHH	Francis E. Garry	620 Chayer Street	Flint 3
Ohio	W8UPB	Dana Cartright, sr.	Box 82	Lockland
HUDSON DIVISION				
Eastern New York	W2CLL	George W. Sleeper	76 Fuller Rd., Rt. 96	Albany 3
N.Y.C. & Long Island	W2BGO	Vincent F. Kenney	140-45 Ash Ave.	Flushing, L. I.
Northern New Jersey	W2VQR	Lloyd H. Manamon	410 1/2 Fifth Avenue	Asbury Park
MIDWEST DIVISION				
Iowa	W0FP	T. J. Innis	R. R. 1, Lincoln Road	Bettendorf
Kansas	W0PAH	W. G. Schrenk	1528 Pierre St.	Manhattan
Missouri	W0VRF	O. H. Huggins	3605 E. 72nd St.	Kansas City
Nebraska	W0RQK	William T. Gemmer	1708 West Sixth Street	North Platte
NEW ENGLAND DIVISION				
Connecticut	W1LKF	Peter K. de Bruyn	163 South Marshall St.	Hartford 5
Maine	W1IGW	Donald R. Dean	36 James St.	Auburn
Eastern Massachusetts	W1BL	Raymond E. Boardman	53 Thurston Road	Newton Upper Falls 64
Western Massachusetts	W1UD	Isaac Cresser	76 Carlland St.	Springfield
New Hampshire	W1KYG	Timothy Apostolos	93 Benjamin Rd.	Manchester
Rhode Island	W1MIJ	Carl M. Getter	185 Early St.	Providence
Vermont	W1JEN	Harold Drown	15 1/4 Peru St.	Burlington
NORTHWESTERN DIVISION				
Alaska	KL7PE	John H. Huber	16th & Maryanne St.	Fairbanks
Idaho	W7IWU	Alan K. Ross	2105 Irene St.	Boise
Montana	W7CT	Leslie E. Crouter	608 Yellowstone Ave.	Billings
Oregon	W7HLF	Dwight J. Albright	Box 508	Medford
Washington	W7KAA	H. D. Weeden	Route 4, Box 174	Port Orchard
PACIFIC DIVISION				
Hawaii	KH6AS	John Keawe	714 Ocean View Drive	Honolulu
Nevada	W7JU	Ray T. Warner	539 Birch St.	Boulder City
Santa Clara Valley				
East Bay	W60BJ	Omar Day	1441 81st Ave.	Oakland
San Francisco	W6NL	Samuel C. Van Liew	215 Knowles Ave.	Daly City
Sacramento Valley	W6KME	E. J. Schoenbackler	1622 Que Street	Sacramento 14
San Joaquin Valley				
ROANOKE DIVISION				
North Carolina	W4KJS	C. F. Beard	2824 Bon Aire	Winston-Salem
South Carolina	W4ANK	T. Hunter Wood	Route 6, Box 690	Naval Base
Virginia	W4IWA	George A. Cottrell, jr.	707 Maple Ave.	Richmond 26
West Virginia	W8FMU	Ray Wardle	501 Pythian St.	Morgantown
ROCKY MOUNTAIN DIVISION				
Colorado	W0KHO	O. E. Cunningham	Massachusetts St.	Eads
Utah	W7UTM	Floyd Hinshaw	165 East 4th North St.	Bountiful
Wyoming	W7HDS	Mrs. Lizette Wolf	3222 Dillon Ave.	Cheyenne
SOUTHEASTERN DIVISION				
Alabama	W4MBA	Robert M. Avery	117 Coffee Street	Talladega
Eastern Florida	W4IQV	Albert G. Snow, jr.	314 W. St. John Street	Lake City
Western Florida	W4ACB	S. Monte Douglas, jr.	P.O. Box 3	Tallahassee
Georgia	W4MMB	Fred M. Stafford	1132 West Peachtree St., N.W.	Atlanta
West Indies (Cuba-P.R.-V.I.)	KP4ES	Pedro J. Piza	Box 2001	Ponce, P.R.
Canal Zone	KZ5FL	Frank H. Lerchen	Box 124	Balboa
SOUTHWESTERN DIVISION				
Los Angeles	W6ESR	S. A. Greenlee	1701 Sepulveda Blvd.	Manhattan Beach
Arizona	W7OIF	Cameron Allen	1020 E. Maryland	Phoenix
San Diego				
WEST GULF DIVISION				
Northern Texas	W58KH	William A. Green	1834 University Boulevard	Abilene
Oklahoma	W5AGM	Claude E. Gardner	2520 Cashion Pl.	Oklahoma City
Southern Texas	W5GJS	George N. Sharp	3541 Federal St.	Pasadena
New Mexico	W5BYX	William Edens	Box 426	Truth or Consequences
MARITIME DIVISION				
Maritime (Nfld. & Labr. att.)	VE1FQ	L. J. Fader	125 Henry St.	Halifax, N. S.
ONTARIO DIVISION				
Ontario	VE3KM	T. W. Clemence	King St.	East Bartonville, Ont.
QUEBEC DIVISION				
Quebec	VE2A	Gordon S. Waugh	3184 King Edward Ave.	Montreal, P. Q.
VANALTA DIVISION				
Alberta	VE6MJ	Sydney T. Jones	P.O. Box 373	Edmonton, Alta.
British Columbia	VE7ID	R. O. Norman	8090 Main Street	Vancouver, B. C.
Yukon				
PRAIRIE DIVISION				
Manitoba				
Saskatchewan	VE5SE	S. Ewert		Herbert, Sask.

## BRASS POUNDERS LEAGUE

Winners of BPL Certificates for July traffic:

Call	Orig.	Recd.	Rel.	Del.	Total
W6CE	19	1149	1151	20	2339
W7CZY	34	996	913	68	2011
W4PL	22	791	733	58	1604
KG6DI	718	512	239	0	1469
W6YYN	3	672	654	12	1341
W3CUL	161	526	452	165	1304
W9EBX	8	437	426	11	882
W6JZ	46	392	333	92	863
W6GER/6	768	6	2	2	778
W8BTY	10	301	237	56	604
W9BGN	19	245	157	87	508

The following made the BPL for 100 or more *origination-plus-deliveries*:

KG6FAA	261	KL7SC	137	K5NRJ	107
W6GYH	174	W7KCU	123	W6AYL	104
KR6DB	161	W9QXO	120		

A message total of 500 or more or 100 or more *origination-plus-deliveries* will put you in line for a place in the BPL. The Brass Pounders League is open to all operators who qualify for this monthly listing.

## TRAFFIC TOPICS

We have been informed by W6JZ of the passing of Bill Hollis, W6FDR. Since Bill was an outstanding traffic man with many years of experience, and a crack operator, we think it appropriate that we traffickers should here record our sorrow at losing such an esteemed member of our group.

Bill was active in the AARS prewar, when he was W5FDR, and postwar he became a regular occupant of the BPL, having appeared in that honored column nineteen times. His highest traffic total was 3323, racked up in December, '49. He was a mainstay of the West Coast's Pioneer Net, and later its manager. Operators like Bill Hollis don't grow on trees, and we are going to miss him.

Have you registered your net? This is just a reminder, supplementing our squib last month, that your net should be registered for our card file and forthcoming net directory *whether or not* you registered last season. Unless we have definite indication of continued activity of a net, that net will be dropped from our register — and even if we know that a net is still active, it will help a great deal to have up-to-date information on operation available. See last month's "Traffic Topics" for a list of things we need to know about each net, and drop us a line on it, or use one of our net registration cards.

Most units of the National Traffic System are going into high gear by the first of October, in much the same manner in which we conducted successful operating last season. Summer operation was only partially successful, as was ex-

pected, but we learned many lessons which will be used to good advantage next summer. Net managers are gearing to go for the winter season. There are still a few weak spots.

The outstanding need is for more complete support by section nets, both 'phone and c.w., in putting traffic into and taking it out of the regional nets. We have previously recommended that section nets meet at 1900 and 2200 local time, for best connections with the regional nets of NTS. We renew this recommendation for the new season, and hope that more section traffic nets will find it possible to follow this pattern.

At the regional level, some reorganization will be necessary. The Second, Fourth, Fifth, Ninth, Twelfth and Thirteenth Regional Nets, mostly dormant for the summer, will have to start from scratch, in some cases necessitating the appointment of new managers. Other regional nets have been operative all summer, some of them on a restricted schedule, for whom winter operation will be merely a matter of expanding the operating schedule as more personnel becomes available.

At area level, the Central Area Net will have to be reactivated, having been inactive throughout most of the summer. The Mountain Area Net was discontinued last spring and we hope to be able to include this net and the Twelfth Regional Net in the Pacific Area, unless activity in the Mountain Area becomes sufficient to form this area set-up again. EAN and PAN have been active all summer at full steam.

The greatest need for assistance will be in the Central Area (Central Time Zone), where one Regional Net (the Tenth) has been carrying the bulk of the load during the summer. Amateurs in this area who are interested in participating are invited and urged to do so by writing to headquarters and offering their services. There will probably be openings for NCS, liaison stations and even net managers, if you are interested.

In the Eastern Area (EST Zone) the big need will be for good traffic men with strong signals who are willing to spend some late hours once every week or so clearing traffic to and from the western areas. The latest schedule, of course, will be with the Pacific Area Net, at 2330 EST. If we get ten good traffickers who are willing to make this schedule once every two weeks, our problem in this respect will be minimized.

We are presently working on the design of certificates for all members of the National Traffic System, from Section up through Area Net. These are expected to be available shortly, so get into NTS and earn your certificate now, so that yours will be among the first issued.

## ELECTION NOTICE

(To all ARRL members residing in the Sections listed below.)

You are hereby notified that an election for Section Communications Manager is about to be held in your respective Sections. This notice supersedes previous notices.

Nominating petitions are solicited. The signatures of five or more ARRL full members of the Section concerned, in good standing, are required on each petition. No member shall sign more than one petition.

Each candidate for Section Communications Manager must have been a licensed amateur for at least two years and similarly a full member of the League for at least one continuous year immediately prior to his nomination.

Petitions must be in West Hartford, Conn., on or before noon on the closing dates specified. In cases where no valid nominating petitions were received in response to previous notices, the closing dates are set ahead to the dates given herewith. The complete name, address, and station call of the candidate should be included with the petition. It is advisable that eight or ten full member signatures be obtained, since on checking names against Headquarters files, with no time to return invalid petitions for additions, a



This little group of League officials was in attendance at the North Platte Hamfest held at the Coty Park, North Platte, Nebraska. *Left to right*, W0OED, Scott Davison, the capable SCM of Nebraska, W0KJP, Guy R. Bailey, organizer and net control of the Nebraska 'Phone Net, and W0DD, Frank Matejka, well-known Director of the Rocky Mountain Division.

QST for

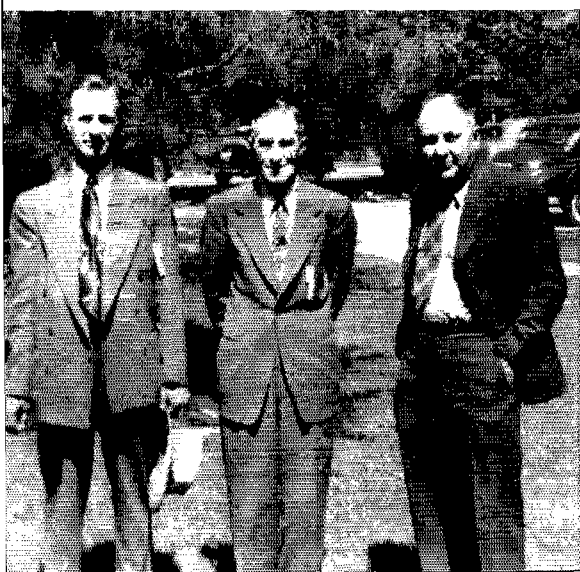

petition may be found invalid by reason of expiring memberships, individual signers uncertain or ignorant of their membership status, etc.

The following nomination form is suggested: (Signers will please add city and street address to facilitate checking membership.)

Communications Manager, ARRL [place and date]  
 38 La Salle Road, West Hartford, Conn.  
 We, the undersigned full members of the .....  
 Division, hereby nominate ..... ARRL Section of the .....  
 as candidate for Section Communications Manager for this  
 Section for the next two-year term of office.

Elections will take place immediately after the closing dates specified for receipt of nominating petitions. The ballots mailed from Headquarters to full members will list in alphabetical sequence the names of all eligible candidates. You are urged to take this initiative and file nominating petitions immediately. This is your opportunity to put the man of your choice in office.

— F. E. Handy, Communications Manager

Section	Closing Date	SCM	Present Term Ends
Yukon *	Oct. 16, 1950	W. R. Williamson	Mar. 17, 1949
Maritime *	Oct. 16, 1950	Arthur M. Crowell	Apr. 15, 1950
Alaska	Oct. 16, 1950	Charles M. Gray	Sept. 15, 1950
Alabama	Oct. 16, 1950	Leland W. Smith	Resigned
San Diego	Oct. 16, 1950	Dale S. Bose	Resigned
Hawaii	Nov. 15, 1950	Dr. Robert Y. Katsuki	Jan. 14, 1951
Michigan	Dec. 15, 1950	Robert B. Cooper	Feb. 17, 1951
Minnesota	Dec. 15, 1950	John B. Morgan	Feb. 17, 1951

\* In Canadian Sections nominating petitions for Section Managers must be addressed to Canadian General Manager Alex Reid, 169 Logan Ave., St. Lambert, Quebec. To be valid such petitions must be filed with him on or before the closing dates named.

### ELECTION RESULTS

Valid petitions nominating a single candidate as Section Manager were filed in a number of Sections, as provided in our Constitution and By-Laws, electing the following officials, the term of office starting on the date given.

North Carolina	Herman P. Jolitz, W4DCQ	Aug. 15, 1950
Colorado	M. W. Mitchell, W0IQZ	Sept. 15, 1950
Canal Zone	Everett R. Kimmel, KZ5AW	Sept. 15, 1950
Illinois	Lloyd E. Hopkins, W9EVJ	Sept. 30, 1950
Rhode Island	Roy B. Fuller, W1CJH	Oct. 1, 1950

### CODE-PROFICIENCY AWARDS

Have you received an ARRL Code Proficiency Certificate yet? Twice each month special transmissions are made to enable you to qualify for the award. The next qualifying run from W1AW/W0TQD will be made on October 16th at 2130 EST. Identical texts will be sent simultaneously by automatic transmitters. Frequencies of transmission from W1AW will be 1887, 3555, 7215, 14,100, 28,060, 52,000 and 146,000 kc. W0TQD will transmit on 3534 kc. The next qualifying run from W6OWP only will be transmitted on October 8th at 2100 PST on 3590 and 7248 kc.

Any person may apply; neither ARRL membership nor an amateur license is required. Send copies of all qualifying runs to ARRL for grading, stating the call of the station you copied. If you qualify at one of the five speeds transmitted, 15 through 35 w.p.m., you will receive a certificate. If your initial qualification is for a speed below 35 w.p.m., you may try later for endorsement stickers.

Code-practice transmissions are made from W1AW each evening, Monday through Friday, at 2130 EST. References to texts used on several of the transmissions are given below. These make it possible to check your copy. To get sending practice hook up your own key and buzzer and attempt to send in step with W1AW.

Date	Subject of Practice Text from August QST
Oct. 4th:	Better Results on 480 Mc., p. 11
Oct. 6th:	Basic Operating Procedure, p. 16
Oct. 8th:	Qualifying Run, 2100 PST, from W6OWP only
Oct. 10th:	A Tunable 75-Meter Mobile Antenna, p. 19
Oct. 12th:	A Two-Control VFO Rig . . . , p. 24

Oct. 16th:	Qualifying Run, 2130 EST, W1AW, W0TQD
Oct. 18th:	A Two-Tube Crystal-Controlled Converter . . . p. 30
Oct. 20th:	QRRR Winnipeg, p. 32
Oct. 24th:	A Mobile Converter for 144 Mc., p. 35
Oct. 26th:	The World Above 50 Mc., p. 39

### DX CENTURY CLUB AWARDS

#### HONOR ROLL

W1FH.....235	G2PL.....225	W6ENV....222
W8HGW.....223	W2BXA....224	W0YXO....220
W6VFR.....225	W6EBG....224	W3GHD....219
	W3BES....223	

#### RADIOTELEPHONE

W1FH.....194	VQ4ERR...181	W9RBI....170
XE1AC.....186	L08AJ....176	W2BXA....169
W6DI.....181	W8HGW....174	W1JCX....168
	PY2CK....171	

From July 15 to August 15, 1950, DXCC certificates and endorsements based on postwar contacts with 100-or-more countries have been issued to the amateurs listed below.

#### NEW MEMBERS

VK3JE.....151	4X4RE....105	W6RCC....101
W4AAU....123	G6PB.....104	W6PBI....101
W3DGM....121	PY4IE....104	W4JDR....101
G8OJ.....113	ZB1AH....103	W1AFA....101
W1QXQ....111	W2PIN....103	W0BMQ....100
ZL4AW....110	G3CMB/A...103	G13BK...100
ZS1BK....109	G5CR.....102	W8JM....100
W6LMZ....109	F8TM....102	W1PPZ....100
ZL2CU....109	W2JA....102	W9TMU....100
W4LQN....108	KZ5AU....102	VE1PA....100
G6BB....107	ZL3LR....102	H7KED....100
OK1CG....106	W6NZ....102	G3ODG....100
W1EOB....106	DL1YQ....101	CE4AD....100
	CPIAP....101	

#### RADIOTELEPHONE

W7EMP.....115	W0SQO....102	W9UJ....100
F9HE.....108	W4RJU....102	W8YI....100
VK3JE....106	W9BVX....101	W4DYM....100
W2YYL....104	W8CYL....101	W0TJ....100
	VP5AR....100	

#### ENDORSEMENTS

W1TW.....210	W6KUF....162	W1QF....135
W3DPA....210	CE3DZ....160	W3KZQ....133
PA0UN....210	W6CTL....160	PY7WS....132
W6MX....210	KP4CC....158	W6RLQ....131
W6NNV....202	W9YNB....152	W2LTP....130
W2NSZ....202	W4VE....152	SM6HU....130
W9RBI....202	W9TQL....152	I1XK....130
VE7HC....201	W6MHB....151	W1ODU....130
W6DZZ....200	OK1HI....150	W1CJH....124
W4MR....199	W2LSX....150	W2REF....124
W2AGW....196	W8DEN....150	W2GTL....123
W3JNN....192	W8HFE....150	W3FYS....122
W6TS....189	W6EYE....150	SM7MS....121
KH6BA....187	W9VND....150	W2GFV....121
W6BPD....186	W1FTX....150	W3MLW....120
W2EMJ....184	KH6CD....150	W5LXY....120
G2EC....181	W5EGK....148	G3AWP....120
W3OP....180	W4CYY....146	W6BIL....120
W3DKT....180	W2UEL....144	W9LYR....114
W6TI....180	W5LGS....141	W1BOD....112
ON4QF....180	W1HA....141	G3COJ....112
W2WZ....174	W4RBQ....141	G3LP....110
W1CLX....173	W3LPE....141	W4DCW....110
W2EMW....171	W8DAW....140	W5CGS....110
W3KDP....170	W6WWQ....140	W6ZUI....110
W4OM....170	W3FUF....140	W6ETJ....110
W2CSO....166	W0TJ....139	4X4BX....110
W9AND....162	WIDEP....137	W2CGJ....110

#### RADIOTELEPHONE

W2AFQ....160	I1SM....135	W0HP....120
W4EWY....153	W2EOH....132	W1CJH....116
W8LTU....150	ZS6Q....130	G02RS....111
G2ZB....150	CE1AH....121	W0PUE....110

## A.R.R.L. ACTIVITIES CALENDAR

Oct. 8th: CP Qualifying Run — W6OWP  
 Oct. 14th: Simulated Emergency Test  
 Oct. 17th: CP Qualifying Run — W1AW, W6TQD  
 Oct. 21st-22nd: CD QSO Party (c.w.)  
 Oct. 23th-29th: CD QSO Party (phone)  
 Nov. 4th: CP Qualifying Run — W6OWP  
 Nov. 16th: CP Qualifying Run — W1AW, W6TQD  
 Nov. 18th-19th, 25th-26th: Sweepstakes Contest  
 Dec. 2nd: CP Qualifying Run — W6OWP  
 Dec. 18th: CP Qualifying Run — W1AW, W6TQD  
 Dec. 8th-10th, 15th-17th: 10-Meter WAS Party  
 Jan. 5th: CP Qualifying Run — W6OWP  
 Jan. 19th: CP Qualifying Run — W1AW, W6TQD  
 Jan. 13th-14th: V.H.F. Sweepstakes  
 Jan. 20th-21st: CD QSO Party (c.w.)  
 Jan. 27th-28th: CD QSO Party (phone)

### MEET THE SCMs

David G. Stewart, recently elected to serve a two-year term as SCM of Tennessee, was issued his first license in July, 1931, at which time he received his present call, W4AFL.

Dave's amateur interests are varied; he has taken part in ARRL Field Day activities and did notable amateur radio emergency work during the Mississippi Valley Flood of early 1937, for which service he was awarded a Public Service certificate and also received a letter of commendation from the Commandant of the Eighth Naval District. In addition, he holds RCC, WAC, and A-1 Operators Club



certificates, belongs to the Fountain City Radio Club, and is an active member of the Tennessee c.w. and 'phone nets.

While the operating position of W4AFL is located in the living room, the transmitter, Meissner Signal Shifter-807-p.p. 100THs modulated by TZ-40s Class B, is in the basement. Receiving equipment consists of an HRO-7 and an SX-17; antennas are a three-element 28-Mc. beam and an 80-meter center-fed half-wave. Bands covered are 28, 14, 7, and 3.5 Mc., 'phone and c.w.

Other than amateur radio Dave's favorite pastimes are fishing, swimming, and football. He is employed by the Southern Bell Telephone & Telegraph Company as a supervisor.

### BRIEFS

On May 27th, W3NXX, Phil Christ, was handling some traffic from KZ5NM when TI2TG broke in with an urgent

request for help. Five people had been taken ill with Rat Fever and they were in need of immediate treatment with aureomycin, the new wonder drug. W3NXX had a doctor friend in the shack at the time of the contact and he immediately called the University hospital and obtained the drug for shipment. The aureomycin was sent air mail, special delivery, one hour after the initial contact and was received in Costa Rica on May 29th, two days later.

- . . . -

Ouch! In the Sweepstakes corrections published on page 67 of July QST, we stated that the winner of the San Francisco c.w. award was W6ATA. The "correction" was in error. The rightful winner was W6ATO. Our apologies, OAI.

### JULY CD QSO PARTIES

Listed below are the highest claimed scores for the July C.W. and 'Phone CD QSO Parties. The figures following each call indicate the claimed score, number of contacts and number of ARRL sections worked. Complete results with listings by League divisions and sections will appear in the October CD Bulletin.

C.W.			
W4KFC	120,950-403-59	W1MRQ	47,885-150-61
W1JYH	108,300-376-57	W0PHR	47,840-208-46
W1EOB	106,720-361-58	W2LPJ	47,500-186-50
W3HRD	85,800-325-52	W9GDI	47,000-200-47
W3VES	84,975-302-55	W7EAU	45,387-123-41
W9QLW	75,625-269-55	W2ZRR	44,220-194-44
W6CUF	70,355-147-52	W4DLX	43,870-209-41
W2CWK	67,500-264-50	W2YDG	42,785-192-43
W3FQB	66,750-260-50	W4MNT	42,780-186-46
W9NH	63,600-234-53	W1CRW	42,240-192-14
W6CIS	62,950-136-50	W3CUL	42,075-181-45
W9UBP	61,480-228-53	W8TAA	42,065-172-47
W1AQE	60,960-254-48	W9JTX	41,595-171-47
W6ISQ	60,864-137-48	W2QBS	41,400-201-40
W8DAE	60,515-240-49	W7MLL	41,022-106-43
W2GFG	57,120-231-48	W5OYP	40,750-163-50
W8TZO	56,880-230-48	W2CEY	40,725-181-45
W2ZYW	53,100-229-45	W6LDR	40,500-100-45
W3NTD	51,975-226-45	W0AY	40,180-157-49

Others with scores over 25,000: VE3QE 39,780, W8YCP 39,560, W1QIS 37,800, W2WZQ 37,000, VE3BL 36,450, W8EXI 35,465, W1ODW 34,850, W2NIY 34,200, W0TKX 33,540, VE7XA 33,345, W2OBU 33,250, W8AJW 29,610, W5DRW 29,355, W9TT 28,595, W9DGA 27,880, W2EC 27,710, W2EWZ 27,125, W4PED 26,600, W3QLI 25,460, W0IA 25,145.

### 'PHONE

W4DCQ	26,705-109-49	W3CUL	4400-38-20
W4KFC	13,650-71-35	W5PPS	4255-33-23
W6CHV	13,056-45-32	W7KEV	4140-23-20
W4FY	9380-62-23	W1MRQ	4070-30-22
W8NOH	8400-51-30	W5DEI	4070-30-22
W2ZVW	8265-50-29	W0TKX	3610-31-19
W4DLX	7695-52-27	W0DEA	3600-29-20
W8AJW	6110-42-26	W1AW	3465-26-21
W1CJH	5800-40-29	W3POW	3200-25-20
W3PMG	5280-38-24	W3KEW	2979-28-18
W4CYC	4875-35-25	W2QBS	2210-28-13

### NATIONAL CALLING AND EMERGENCY FREQUENCIES

C.W.	'PHONE
7100 kc. (day)	3875 kc.
3550 kc. (night)	14,225 kc.
14,050 kc.	29,640 kc.
28,100 kc.	

During periods of communications emergency these channels will be monitored by stations of the National Emergency Net for personal-inquiry traffic. At other times, these frequencies can be used as general calling frequencies to expedite general traffic movement between amateur stations. Emergency traffic has precedence. After contact has been made the frequency should be vacated immediately to accommodate other callers.

• All operating amateurs are invited to report to the SCM on the first of each month, covering station activities for the preceding month. Radio Club news is also desired by SCMs for inclusion in these columns. The addresses of all SCMs will be found on page 6.

**ATLANTIC DIVISION**

**EASTERN PENNSYLVANIA** — SCM, Jerry Mathis, W3BES — CUL still carries the traffic load for the section. Most of the activity of late centers around public service and emergency communications. KFK is the new EC for Philadelphia County. A communications plan for the County has been arranged and an appropriation requested for eight key stations. The Eastern Pennsylvania disaster net frequency is 3610 kc. for c.w. and 3910 kc. for 'phone. We are attempting to have as near to continuous monitoring on those spots as possible. Drills are being worked out and mock disaster problems planned. The Havertown Net already has done something along this line using 144 Mc. The Council of Radio Clubs will run a quasi hamfest in October. The Council has continued to provide communication for the Schuylkill Shell Races. QLI enjoyed his first CD Party. LTV royally entertained the Frankford Radio Club at an outdoor party at his home. A couple of softball games were played and CPY thought the Club was good enough to challenge some of the other clubs to a game or two. Traffic: W3CUL 1304, PDJ 12, BXE 3, QLI 2.

**MARYLAND-DELAWARE-DISTRICT OF COLUMBIA** — SCM, Eppa W. Darné, W3BWT — The Capitol Suburban Radio Club, at its July 6th meeting, featured NL as speaker on odd topics, teletypes, etc. Past Field Day items were discussed, as well as the splendid articles and pictures of Field Day activities, presented by the local newspapers. On July 21st, the Club had a picnic at Greenbelt Lake, with the Club furnishing drinks, games, and prizes, all thoroughly enjoyed by the members and their families. The Baltimore Amateur Radio Communications Society held its Field Day test at the QTH of Mr. and Mrs. Hannal, AFR, who furnished the location, facilities, and refreshments, which were enjoyed by all participating for the 24-hour period. On July 23rd, the Club's mobile group traveled to Caledonia State Park in Pennsylvania. AFR, GBB, QBG, JCL, JE, and IFW made up the group and enjoyed participating and the swell picnic baskets which were brought along. Members of the Chesapeake Amateur Radio Club, at its July 18th meeting, enjoyed a talk and demonstration by Jim Gordon of Bendix Radio, his subject being "A Simplified Method of Frequency Measurement." The Washington Radio Club's July meeting, held July 22nd, was a "gabfest." The Rock Creek Amateur Radio Association's meeting of July 28th was a visit to television station WOIC. IZL has a Lyseo 600 rig, operating on 1.7 through 28 Mc. with VFO and 40 watts final input, including built-in T.V. filter. Modulator is external. Mike worked 30 states in three weeks and has mobile rigs on 3.85, 14, 28, and 50 Mc. CVE is newly-appointed ORS and is mostly on 7 Mc. with 100 watts into an 815 final. GRF is chasing DX on 14 Mc. JVI is on 50 Mc. and urges all on this band to report into the net each Friday at 9:00 P.M. CDQ spent July and August in Europe visiting hams and friends. AFR is on with a prewar suppressor-modulated 55-watt rig, and has just bought another BC-610. QFB is newly-appointed Official Observer, Class IV. EYX now is Official Observer Class I, helped 4RAO get on the air, and is now one of the supervisors of PZA, the Red Cross National Headquarters disaster station. LSX lost antenna in high wind, but is back on 14 Mc. QCB has new VFO and received his Rag Chewers Club certificate. OEU is on 14-Mc. 'phone with BC-610. JE worked BH while the latter was vacationing in New Hampshire. AFR and JES are new additions to the Baltimore mobile group. LVJ has been off because of vacation and out-of-town business. CVE schedules 6BAM and 9GGG on 7 Mc. and did well in the last CD Contest. WN and AKX have excellent teletype gear in operation. LPL is the proud grandfather of twins. ACM and PZK are on 144 Mc. AKB and BWT, along with Mr. and Mrs. DK, spent their vacation period at Ocean City, N. J. Traffic: W3PTZ 31, LZM 21, NNX 16, CVE 12, LSX 4.

**SOUTHERN NEW JERSEY** — SCM, Dr. Luther M.

Mkitarian, W2ASG — Through the effort of YAO a bill will be introduced to the State of New Jersey Legislature this fall for issuance of automobile licenses with amateur call letters. Hon. N. C. Smith, Assemblyman from Ocean City, is drafting it. In the near future copy of the prepared bill be submitted to radio clubs within the State for consideration. PAU was general chairman of the SJRA picnic. CXX has returned home from USNS *Mission San Luis Rey*. ZVV worked 50 stations in the last CD Party. VMX has brand-new WAS and Lieutenant's Commission certificates. PFT wants more members from the southern counties for the New Jersey State emergency 'phone net. (0900 Sundays, 3900 kc.) Traffic: W2ZVV 79, PFT 10, ASG 8, ZI 8, ZYX 2.

**WESTERN PENNSYLVANIA** — SCM, Ernest J. Hlinsky, W3KWL — Unofficial reports show 563 registered at the South Hills Brass Pounders & Modulators of Pittsburgh Hamfest held recently at South Park. It took over two hours to distribute the large number of prizes. Congratulations to LFO, MML, KHHT, KVL, and all who made such a swell affair possible. The Radio Association of Erie also held a hamfest. LOD will be all ready to carry on as ORS this fall. AER says 14 Mc. is dead in the morning. It looks like there will be plenty of competition from MIZ and GJY in this coming SS. NRE is anxious for that traffic again. MOT says he will try CD. PY is back to work after a serious illness. GJY is getting swell-headed since he got that Collins rig. Just kidding, John. LSS is now AEC. We expect a visit from ODU one of these days. IYR is assisting Civil Air Patrol with communications network. LNW sends in this report: PUT is back on the air with 150 watts on 3.85-Mc. 'phone. LNW took a party of 23 boys to Seven Mountains and used amateur radio to communicate with the boys' parents. PAB is leaving for Notre Dame. The Port Necessity Radio Assn. showed up at the hamfest in full color. Those jackets with the club call, PLE, looked great. The club now is affiliated with ARRL. UUZ has an 813 on 7 Mc. WVE is building a new 28-Mc. beam. Those boys from the Steel City Radio Club sure are a swell bunch and according to DNO, RXT, it looks like that old 144-Mc. club transmitter is really getting a workout. Have you ever heard of an Irish man's picnic? Listen to KWH, with such guys as NKM, DNO, RXT, NRQ, RIK, MTP, OKU, NRG, KYC, and NJZ all trying to talk with a mouth full of beer. Up Erie way you just pick up a Sunday newspaper and some of the best articles written about amateur radio by TPX appear. It's with great regret that we do not have enough space allotted to us to print some of these swell articles. Also great credit goes to Mr. Peter L. Yokes who does a marvelous job in his articles written about the ham and understood by the public who reads his articles. Gentlemen, my hat is off to two swell journalists. Traffic: W3AER 15, FYR 9, LSS 3.

**CENTRAL DIVISION**

**ILLINOIS** — SCM, Lloyd E. Hopkins, W9EVJ — Your SCM has been advised of his election for another term and will continue to serve you as in the past. MEZ, of Joliet, had pleasure working DL4OM, formerly of his home town. PHE put up a new 28-Mc. beam, became the proud owner of two ZL cards the same week, and lost fiber and a pair of 866s in 30K. GBT replaced the wooden skyhook with 61-foot windmill tower and is pondering sixteen-element u.h.f. job. EBX reports TXN stations doing a good job on traffic during the summer months. JNC reports the North Suburban Radio Club continues to grow with the addition of several new members. Lefty keeps in touch with W2OXX/MM Monday evenings. UBP has the rig perking on 14 Mc. but work interferes at present. BGN has a half-kw, operating on 7 Mc. FKI reports hearing six stations on 144 Mc. during the recent atmospheric disturbances. GDI only found time for the CD Party. LNI reported into our c.w. net recently after many years' absence. KJ and YIX find the LLN Net to their liking and report regularly. NN had five good contacts with W2OXX/MM and handled traffic for folks in Chicago. BUK had his basement flooded during a recent downpour and had to keep his feet on a box during net operation. IMX reports the Danville gang was well represented at the Weldon Springs picnic. PFD is having a nice time on 144 Mc. UJ finds the canning season cuts into 28-Mc. activity. YXP is working on 3.85-Mc. mobile installation. TME sports a new SX-71. GMU and HSZ are new members of the Vermilion County Radio Club. IMX is acquiring some 144-Mc. gear. KMC writes to inform us of the birth of a son and the purchase of a new SX-71. IEU, having graduated from Purdue, accepted a position with Collins Radio and now is 0IEU. YTZ says he is in the midst of a summer slump. IVN visited BRD. JNK received his ticket in February and since then has enjoyed contacts with first, fifth, sixth, and

seventh district stations with less than 10 watts output on 7 Mc. The EMD Radio Club of La Grange has WFH as president and JNK as secretary. JJO has the rig all set for operation on 11N and is waiting for the receiver to be aligned. Traffic: (July) W9EBX 892, BGN 508, YIX 105, IVN 102, KJ 88, YTZ 46, BUK 38, UBP 32, NN 16, FKI 14, FFR 12, ZQT 8, JNC 4, LNI 1. (June) W9UBP 27, YIX 18, KJ 7.

INDIANA — SCM, W. E. Monigan, W9RE — BJK has returned from Colorado Springs and reports a fine visit. DKV says outside interests are keeping him busy, but he hopes for more spare time soon. HZB is building a portable. PIQ changed QTH and is back on the air now. EBF has a new car and will try mobile now. FEI was in Minnesota fishing. No fish were seen by the SCM, though. BFB has moved to Kentucky. CUN has the love bug. NSF uses his TV to tell when 50 Mc. is open. TT says he is getting old. Aren't we all? JMK has moved to Arkansas. NEC has moved to California. FJI reports that ZLZMU listens each day at 12:30 to 13:00 NZ Time for low-power W stations; he tunes from 29.5 Mc. up. FJI visited in California. New officers of the South Bend XYL Club are Mrs. Stanley Johnson, pres.; Mrs. Paul Metzner, vice-pres.; Mrs. Keith Schwartz, secy.; Mrs. Matthew Pierachala, treas. Traffic: W9QLW 91, TT 59, RCB 50, DGA 30, BJK 17, DOK 16, RE 17.

WISCONSIN — SCM, Reno W. Goetsch, W9RQM — YCV is working on mobile rig with provisions for 3.85-Mc. phone operation as well as other bands. RLB took along his 30-watt emergency rig for operation during his vacation in North Carolina. ERW took 30 w.p.m. in Code Proficiency Test. FCF received Class A ticket. HDZ is working on a mobile rig. HID, ANB, NVJ, GYH, AFS, ODL, SECK, KKK, and Mr. S. Carr, former instructors at Scott and Truax Fields, held a picnic at the home of EWC. KKK, ERW, and RQM were active in the CD Party. Milwaukee's 144-Mc. Emergency Net is adapting its drills to an Emergency Warning System. GQG, RUF, IQW, SZL, and UFX had EC appointments endorsed. YYY, the SFC, urges all Emergency Coordinators to complete plans now for participation in the National Emergency Test. HQT and HHS are new OOs. NYS has a 150-watt bandswitching rig for 4, 3.5, 7, and 14 Mc., phone and c.w., while 25 watts and a center-loaded whip takes care of the mobile work on 4 Mc. RSR is a regular on the MARS nets. The second BEN picnic was held at Selfridge Park, Ripon, Aug. 27th. FPE is working 8TL South Dakota, into his series of schedules on 144 Mc. JBF has been operating portable from Rib Mt. (highest point in Wisconsin) with an SCR-522 on 144 Mc. with excellent signals from Milwaukee and other points in the State. With the fall operating season at hand, make arrangements now to take part in some phase of operating activities in the section. The WIN (c.w.) Net, the BEN (phone) Net, and the Emergency Corps all welcome your participation. Additional appointments as ORS, OPS, OO, OBS, OES, and EC also are needed. Eleven members of the Milwaukee School of Engineering Amateur Radio Club, using the club call HAX, contacted 225 hams in the United States, Canada, and Alaska on Field Day. Traffic: W9ESJ 293, ANM 36, IQW 21, UIT 8, FXA 2, HDZ 2, RQM 2.

## DAKOTA DIVISION

NORTH DAKOTA — SCM, Rev. Lawrence C. Strandnaes, W0JWY — My thanks and appreciation to all the hams I met personally on my jaunt through the section the latter part of July in the interest of section organization. The members of every club I visited showed a real spirit of friendship and cooperation and I am sure section activity will, in the near future, reach new heights in the matter of net operation and emergency preparedness. It is my regret that I could not meet every ham in the State. HDD reports that all details have been taken care of to reorganize the Minot Club and the expected membership should reach twenty. PJT says that his brother, KZL, now is 5PAA in Oklahoma City. Look for him on 7.110 Mc. EOZ finally moved into his beautiful new house, where he will have his rig set up in a specially-built radio room. All hams in the section are invited and encouraged to send me reports and news of activities. How about it?

SOUTH DAKOTA — SCM, J. S. Fosberg, W0NGM — Best wishes to the newly-organized CQ Club of Aberdeen. The Club has 22 members and the officers are PRZ, ZUS, IK, ZLB, SAT, IEL, and CTX. A station license has been applied for with PRZ as trustee. New South Dakota Class A tickets: IEL, ZUS, and IYZ of Aberdeen; BLZ, Sioux Falls; MZW, Philip; and STI, Presho. New call: BOB, Aberdeen. BLZ has new HRO-50. PHR is OES and garnered more than 47,000 points in his first CD Contest. South Dakota station activities now are written by RRN, who is new Assistant SCM. His address is 1900 South Menlo, Sioux Falls. Please get all the news to him by the first of each month. No news was received from Huron, Rapid City, Watertown, or Mitchell this month.

MINNESOTA — SCM, John B. Morgan, W0RA — Acting SCM, Chas. Bove, 0MXC. SEC: BOL, AWK is all prepared for the winter with a new beam on 28 Mc. QYZ and QEQ are now mobile. YBM has moved from Snobs Knob to a new QTH in Robbinsdale. RTE is on 28 Mc. with an 814 using n.l.m. NJZ has a new HRO-5 and a new

beam on 14 Mc. QIN is quite versatile; he operates mobile on 28, 50, and 144 Mc. We need more stations to sign up for OO and OES appointments. Join the Emergency Corps now. Everyone who operates mobile is requested to ask his SEC or EC for an application for membership as "Official Mobile Unit." This is a new recognition for portables and mobiles. The Twin City Mobile Club is having tough competition on its Hidden Transmitter Hunts by the YTs and XYLs. Esther, CAI, is chief of the feminine gang who have entered the transmitter hunts. We haven't heard BOL on 3.85 Mc. this summer but Bob says he bought a new home in West St. Paul which has been taking up all his spare time. He is installing a new fifty-foot pole for that 3.85-Mc. vertical. In the meantime, Bob has been operating mobile on 28 Mc. The new QTH of BOL is 1130 Delaware, St. Paul (7). Minn. Traffic: W0ITQ 32, BGY 28, MXC 20, UCV 18, LDI 8, QYZ 2.

## DELTA DIVISION

ARKANSAS — SCM, Dr. John I. Stockton, W5DRW — A RFQ is on 3.5 and 7 Mc. with 100 watts and has a new SX-71. LUX is new RM and is working 3.85-Mc. mobile. MRD has a 3.85-Mc. QSL from JA2-Land. Nice going. Omer, QI is working 14.25-Mc. DX. FMF worked 14- and 7-Mc. DX during the summer. We hate to report the moving of EGX to New Orleans from our section. Good luck, Burt, BAB has a new 14-Mc. beam working FB. ICS has a new low-powered rig on 3.85 Mc. EA worked 28-Mc. mobile on his vacation to Ohio. MVO is on 7 Mc. with 80 watts, and is the proud father of a jr. operator. I appreciated the nomination as SCM and will do the best job that I can with everybody's cooperation. Thank you. The traffic season is just around the corner and let's all try to make this the biggest and best traffic season for our section. The Ozark Net meets on 3695 kc. at 7 p.m. CST week days. The Arkansas emergency phone net meets on Mondays at 6 a.m. CST on 3885 kc. 73 and see you on the band.

LOUISIANA — SCM, Robert E. Barr, W5GHP — Louisiana lost another old-timer when PPO joined the Silent Keys August 7th as the result of a heart attack. Al was a prominent New Orleans lumberman and the founder of the Short Wave Amateur Club and recently had maintained residence in Wavelead, Miss. on the nearby Gulf Coast. CEW has returned to 3.85 Mc. with a new high-power rig. MOT is practicing law in Louisiana. MO is back on 3.85 Mc. after a year or so on 14 Mc. exclusively. The Monroe Ham Club is setting up an emergency plan for complete self-powered units on all bands. KTE has been reappointed as SEC. LVG and KRX are late additions to the Pelican Net. The Pelican Net will meet on Thursday nights at 7:30 on 3870 kc. for the remainder of the summer. The Delta 75 phone net is just finishing four years of operation without a skipped meeting. EKY, GMO, and DOK are conspicuous by their inactivity. Wonder why? KCH is steadily recuperating after a long illness. IGQ and the XYL are the proud parents of twins. IZS is running 600 watts to p.p. 813s. HEJ and HEK are pushing emergency organization in the Ouachita Valley Area. BV and family spent a vacation in the Ozarks. GHF vacationed along the Mississippi Gulf Coast. HQE represents the Lake Ponchartrain Area on the Pelican Net. BMM and CEW argue relative merits of antennas. If there is any 160-meter activity in the State, the SCM would like your reports.

MISSISSIPPI — SCM, J. C. Wallis, W5DLA — Recent appointments in our section are IHP as PAM, RGM as EC, PUI as EC, PFF as EC, and KUT as EC. Those receiving endorsements are IPL as ORS, DEJ as ORS, ZVO as ORS, CUU as EC, ANP as EC, and MAR as EC. DNS and DEJ still are active on 144 Mc. They also were active in Field Day activity. OGN is home from school and is on the air. CUU visited New York City recently. WZ rebuilt the rig and is on 3.85 Mc. JJA has a new beam on 14 Mc. PPB is Army Reserve station. QMQ reports he had a lot of fun in the CD Contest. FQ/5 and FBB/5 were calls heard participating in Field Day activity. MGK has applied for OBS appointment. ZVO has a rig on 14-Mc. phone just as he said he would. Traffic is light for this month. Here's hoping we will have plenty to report next time. Traffic: W5ZVO 14.

TENNESSEE — SCM, D. G. Stewart, W4AFI — Officers of the newly-formed club in Murfreesboro are NDC, pres.; QAN, vice-pres.; MTQ, secy.-treas.; ROT, act. mgr. The Club sponsored an exhibit at the Lions Club exposition under the call of NDU and accepted traffic. BV is back in the States and operating 14-Mc. c.w. and 4-Mc. phone. AEE is temporarily closed because of loss of power transformer. RDK built new grid-dip meter. NNH made DXCC on 14-Mc. c.w. and is rebuilding. FDF visited Memphis and other points west. ILY is operating 28-Mc. mobile. FWX vacationed in VE and MEN in E. Tennessee. MRD is back on the air. LRE left us for Army service. PL again reports a staggering traffic total. He picked up most of it to and from the Far East and has received letters of appreciation from various parts of the country. LER is a proud papa. FVM is operating EC-610 on 7 Mc. LNN works in CAA net. DJJ is handling BBT schedules while he moves to a new home. FLW reports considerable activity on 50 Mc. and furnished snapshots of Field Day set-up. LQE and HHQ are planning 28-Mc. net for Knoxville and vicinity. AM is

(Continued on page 80)

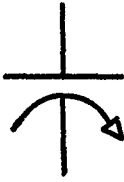

SOMETIMES a new product is the result of intensive design by engineers trying to perfect a particular model for a particular purpose. Sometimes, as occasionally happens here at National, a new product is merely the result of one of our large family of hams adapting one of our products to his own uses. This work is done on his own time with no general applications in mind. Sometimes a group of products results from both of these procedures.

We certainly spent much time and effort to design the dual general-coverage tuning capacitor used in the HFS receiver. It was redesigned several times to produce the features included in the final product. These features include such things as ball-bearings to reduce back-lash and play, wide low inductance stator strap connectors, tube socket mounted as a part of the unit, rigid construction, silver plating, etc. This effort produced what we believe is just about the finest VHF tuning capacitor obtainable.

About a year and a half ago, W1PMS decided to take a crack at the 220 mc. band. For receiving purposes he worked out a very fine VHF converter which is described in *QST* for October 1948. This work was done just for fun but resulted in adapting the HFS tuning capacitors into 220 mc. tuning tanks that proved to be excellent. This tank was never produced commercially but did give us the idea that a very good VHF capacitor for hams could be made by double spacing the original HFS capacitor for limited frequency coverage. This was built in both single and dual sections and has proved to be very satisfactory. It has, however, become a "ghost" capacitor. It has appeared in apparatus described in the Handbook and recent *QST* articles but no one seems to know how to get one as the items did not get into our last catalog.

We will list the available capacitors below so that you will know what they are. You can get them through your dealer even though they are not included in our catalog.

VHF-1S	Gen. Coverage	Single section	22.0 mmf. cap.
VHF-1D	Bandsread	Single section	6.75 mmf. cap.
VHF-2S	Gen. Coverage	Dual section	22.0 mmf. cap.
VHF-2D	Bandsread	Dual section	6.75 mmf. cap.

The dual units are ideal for mixer-oscillator circuits where isolation requires the use of single sections which can be ganged with dual sections if desired.

CAL HADLOCK, W1CTW



# Announcing the Collins

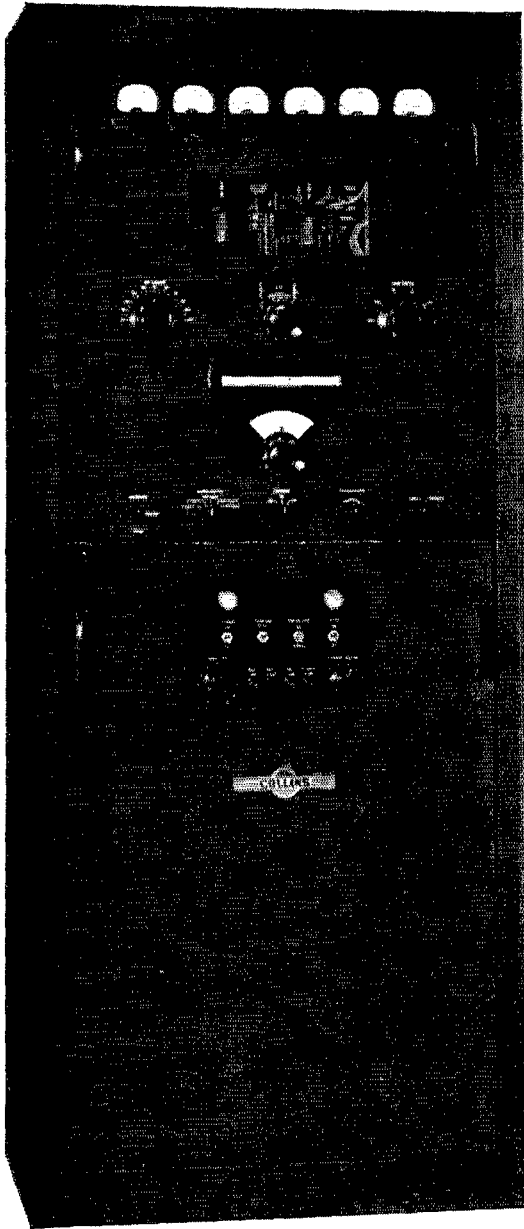

The new Collins KW-1 will satisfy the most exacting demand for built-in convenience of operation. This kilowatt husky, completely contained in an attractive wrinkle-finish cabinet, is as easy to operate as a Collins 32V.

The KW-1 is a product of the most modern design techniques, resulting in a well integrated, efficient rig in which maximum attention has been given to the amateur's TVI problem. Here are some of its features:

**Power Input:** 1000 watts on CW, phone, and narrow band FM. Provision for NBFM is provided as standard equipment in the transmitter.

**Frequency Range:** This transmitter was designed specifically for the best possible performance on the 160, 80, 40, 20, 15, 11-10 meter amateur bands.

**Tuning Controls:** Complete bandswitching of the exciter, driver, and power amplifier is accomplished by a single control on the front of the transmitter. This reduces to 4 the number of tuning control functions required: bandswitch selection, frequency setting, PA tuning, and PA loading. Over any narrow frequency

The tuning dial escutcheon matches that of the 75A-2 and 51J-1 receivers



# KW-1 amateur transmitter

## One kilowatt input phone, CW, and NBFM

range, only frequency setting adjustment is necessary. Frequency control is by means of a newly developed, extremely stable, hermetically sealed master oscillator.

**Desk Operation:** The entire exciter-power amplifier section is removable and may be placed on the operating desk if desired. However, the operating controls can all be reached from a sitting position if the transmitter is installed adjoining the desk.

**TVI Reduction** is accomplished through the utilization of multiple tuned circuits at the output frequency on every band. A minimum of three circuits at the output frequency greatly attenuate not only the second and third harmonics, but sub-harmonics as well. In addition, particular attention has been paid to filtering all the control and power leads entering the exciter-power amplifier compartment, which itself is a totally enclosed and shielded structure. A Collins 35C-1 low pass filter is incorporated as standard equipment.

**Output Network:** A conventional pi followed by an L section for increased harmonic attenuation.

**Audio System:** The speech amplifier has a peak clipper plus a low and high level filter. It permits high-percentage modulation without splatter, adding notably to intelligibility.

**Tube Line-up:** Exciter — one 6BA6, five 6AQ5's, one 807W, one 12AU7, one 6AL5. Power amplifier — two 4-250A's. Speech amplifier — one 12AX7, one 6AL5, two 12AU7's, two 6B4G's, two 810's. Rectifiers — two 872's, one 5R4GY, three 5V4's.

**Meters:** Modulator current, PA plate current, high voltage, line voltage, multi-purpose meter, antenna ammeter.

**Circuit Protection:** Line fuses plus overload relay in Class C amplifier current lead.

**Output Impedance:** 50 ohms with 2.5-1 standing wave ratio.

**Power Input:** 115/230 volts 60 cycle single phase grounded neutral.

**Size:** 28" wide, 18" deep, 66½" high.

Deliveries to Collins distributors will begin in March. Price to be announced.

If you intend to buy a KW-1, we urge that you make arrangements at once with your Collins distributor.

For the best in amateur equipment, it's . . .

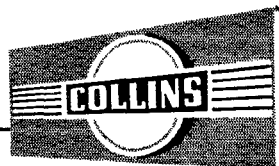

**COLLINS RADIO COMPANY, Cedar Rapids, Iowa**

11 West 42nd Street, NEW YORK 18

2700 West Olive Avenue, BURBANK

# DX LOGGING SIMPLIFIED with this 2400-HOUR CLOCK

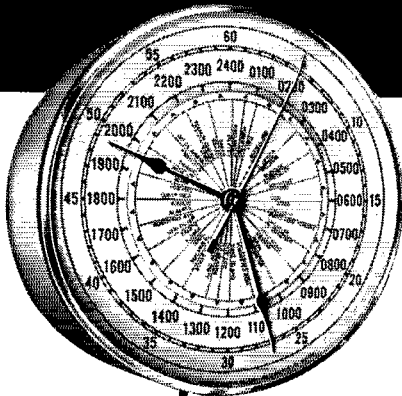

## MODEL TD-2400

The clock that has been proven and accepted by hams all over the world.

**MOTOR:** Synchronous clock motor (self-starting), AC operated.\*

**CASE:** 10" diameter - gray wrinkle finish, chrome-plated bezel.

**HANDS:** Black, with red sweep second-hand.

**DIALS:** 10" diameter - shows minutes, seconds and 2400-hour.

6" diameter - rotating inner dial, frictionally attached to hour hand, in red and blue; shows time directly in all time zones.

**CRYSTAL:** Convex annealed glass.

**MOUNTING:** Can be wall or panel mounted.

\*standard 110-volt, 60 cycle; other voltages and frequencies on special orders.

2400-hour time in every time-zone all over the world, right before you. Simply set hour hand and inner dial for your time-zone, read time in any zone easily, quickly, accurately.

Sold only through authorized dealers

# Timing Devices Co.

**EAST McKEESPORT, PENNA.**

TIMING DEVICES CO., Manufacturers of clocks and electrical controls, now located in new modern plant, East McKeesport, Penna.

(Continued from page 76)

back on 28 Mc. with new Viking after a long absence. FLS raised the beam higher and topped it with TV antenna. AFI visited GEH and AEE. HG is off for repairs; another power transformer gone. The Tennessee phone and c.w. nets are now in full swing on 3980 and 3737 kc., respectively. The Corn-Cob Net recently sponsored an outing at Cumberland State Park. Traffic: W4PL 1604, AFI 4, BAQ 2, FLW 1.

## GREAT LAKES DIVISION

**KENTUCKY** - SCM, Dr. Asa W. Adkins, W4KWO - I believe the most outstanding activity for the month of June was the Mammoth Cave Ham Reunion. We had SCMs present from Ohio, Tennessee, and Kentucky. Great Lakes Division Director, Mr. John Brabb, 8SPF, was also present. He says he never knew hillbillies could be so social, and applied for reservations for the third Sunday in June 1951! We had visitors from Michigan, Ohio, Illinois, Indiana, and Tennessee. The latch string is always out to any ham. Mark the date on your calendar: Third Sunday in June, 1951. The bull session on the porch at the Hotel on Saturday and Sunday nights is one of the outstanding features and last until the wee hours of the morning. Everything is discussed at the sessions, and everyone has his say. These meetings break up with a general handshaking, better understanding and a closer-knit circle of hams. OXX, Charles E. Bailey, Jr., Midshipman USN, is now at the Naval Academy, Room 3333, Baneroff Hall, Annapolis, Md.; he's using the call 3ADO. 4RKT/4 conducted Field Day operations five miles southwest of Owensboro; eleven operators, of which three are AEC members, participated. OYI set up a portable station at Camp Hogg, a Boy Scout camp near Lewisport, Ky.; no telephones were available there and he kept schedules with NLX in Owensboro. Traffic: W4NLX 107, IDY 55, OYI 55, MWX 30, CDA 2.

**MICHIGAN** - SCM, Robert B. Cooper, W8AQA - Asst. SCM c.w.: J. R. Boljan, 8SCW, Asst. SCM U.P.; Arthur Kohn, 8TTY, SEC; GJH, RMs/QMN; UKV and TRN, PAM; YNG. New appointments are DED as OPS and ELW as ORS. Endorsements were made as follows: To DED, as OBS, ZCH as OES, YMO, TZD, and CRH as ORS. You are admonished to inspect your official appointment, and if it needs endorsement please forward your certificate to this office as soon as possible. Anyone who feels his station activity warrants appointment as ORS, OPS, OO, or OES is requested to drop a line to your SCM or one of the assistants for the necessary information. In the light of the present world-wide conditions, your emergency standing certainly should be given some very serious thought. UTH did a very good job in bringing the BR Roster up to date. A line to George will bring you a copy. 2LMB/8 held open house at his Sigbee QTH and a goodly number were present to enjoy the unsurpassed hospitality and the very fine summer radio location. The Muskegon Council held its annual picnic and enjoyed a fine turnout. MGQ was seen at the Muskegon picnic with a brand-new DynaFlow. TBP reports a new 7-lb. YL jr. operator. YMO is getting used to his new HRO-50 but must move his scene of operations to Mont Rose for the winter. ZCI is improving the appearance of his rig during his summer vacation. 2RTZ/8 reports the rig improvements for IKV are progressing very nicely. RJC has been plagued with transmitter troubles but hopes the "bugs" have been completely eliminated so that in the ensuing season he can be of real value in traffic-handling. DAP is doing a fine job in holding up the QMN for the summer. QGZ and OAF did some nice traffic-handling for the Cutter *Macinaw* in the Chicago-Macinaw Sail Boat Races. FLA reports the "Indians" in Allegan have vacated the reservation as a result of some concerted effort on the part of the Allegan Radio Club, and the local TV stations did carry some nice publicity as the result of the work. FX and TZD were heard in the CD Party and TZD reports 25,200 points. QIT is having some distortion in the speech amplifier of his rig and is using the rebuilding opportunity to do some TVI elimination. LKV reports EZO is a new operator in the Jackson Area. Those who remember George Mensel, of Lewiston, will be happy to know that FTK is now the XYL's call. Traffic: W8RJC 225, ELW 162, TRN 123, DAP 103, 2LMB/8 56, WVL 36, TBP 23, AQA 19, QGZ 12, YKC 12, OAF 6, YMO 2, ZCI 1.

**OHIO** - SCM, Dr. Harold E. Stricker, W8WZ - Asst. SCMs, Charles Lohner, 8RN, and C. D. Hall, 8PUN, SEC; UPB, RMs; DAE and PMJ. PAM; PUN. Your SCM attended the hamfest put on by the Cleveland Council of Clubs and also the one put on by the Piqua Club, which included hams from the Miami Valley. The boys had the weather in their favor for a change and many were present at both places. The latest ARRL information was given in short order. A new appointment is CPA as OES. *Ham Flashes* has taken the place of the *Voice Coil*. Our Director spoke at the last meeting of the Alliance Radio Club. From the *Carascope*: The Red Cross station in Columbus is completely installed and in operation. Plans for the hamfest are complete, and by the time you read this, this year's hamfest will be history and as usual everybody will have had a good time. UHF had some good openings in July, according to WRN, and the boys took full advantage of the situation.

(Continued on page 82)

# COLLINS' NEW KILOWATT PACKAGE

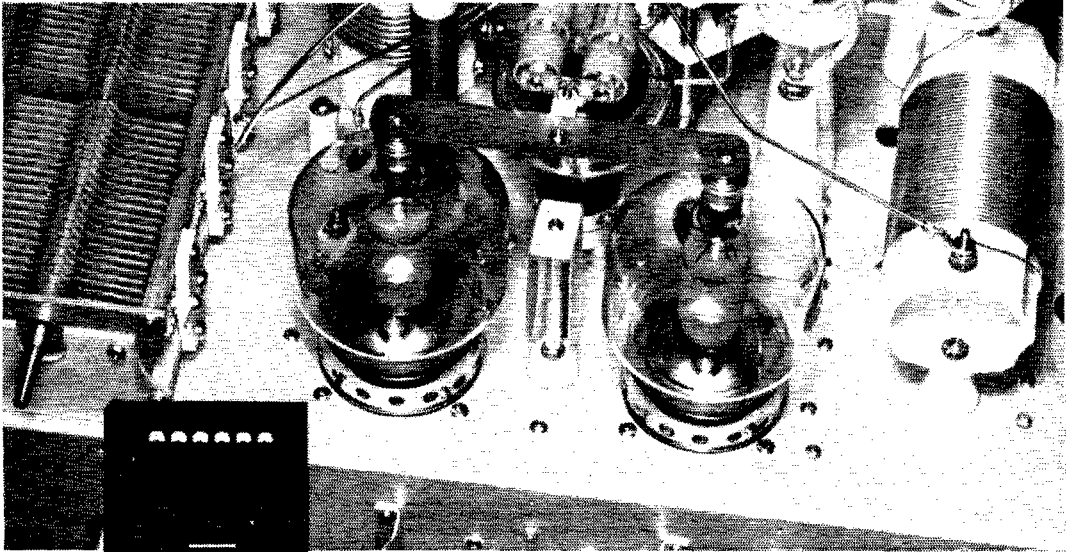

Built for convenience, the new Collins TVI-free, kilowatt-husky, KW-1 amateur transmitter incorporates the latest in modern design techniques . . . including Eimac 4-250A tetrodes. It has been designed specifically for the best possible performance through the 160 to 10 meter bands. Complete bandswitching is accomplished by a single control. Tuning controls have been reduced to four. This new Collins 1 kw. "package" transmitter provides the ultimate in operating simplicity, maximum power with reasonable economy .

Take advantage of modern circuit techniques and operating stability made possible through the use of Eimac tetrodes . . . You can have power to spare and, above all, be able to spend more time operating and less time tuning your rig.

Complete data on these outstanding tubes are available from Eimac . . . the world's leading power tetrode manufacturer.

*Eimac*  
TUBES

EITEL-McCULLOUGH, INC.  
San Bruno, California

Export Agents: Frazar & Hansen, 301 Clay St., San Francisco, California

266

# BIG AMATEUR SEASON AHEAD!

## YOU'LL WANT THESE—

**Message Blanks.** Official ARRL radio-gram forms, lithographed in green. Spaces for filling in preamble, address, text, signature and handling data are in proper order and fit your mill. Pad of 100 blanks—**35c**

**Message Delivery Cards.** Same style as Message Blanks. Convenient fill-in spaces. Printed in green.

On stamped government postcard—each **2c**  
On unstamped card—each **1c**

**Members' Stationery.** For your DX letters and other correspondence. ARRL letterhead designed for members' use, lithographed on 8½ x 11 bond paper.

100 sheets—**\$1.00**

250 sheets—**\$1.50**

500 sheets—**\$2.50**

**League Emblem.** The well known ARRL diamond, black enameled with gold border and lettering. Official insignia of your League for thirty years. Two types: Pin (with safety clasp) or screw back.

Your choice—**50c**

**Electrotype of League Emblem.** Mounted on wood block ready for your printer to use on your QSL cards, personal stationery, etc. Each—**\$1.00**

**QST Binders.** Finished in reddish brown fabrikoid. Stiff covers. Each binder accommodates a year of QST and takes care of each month's copy as received. Opens flat at any page of any issue. (*Available only in U. S. and possessions*) Each—**\$2.50**

*We prepay postage on all these items*

## AMERICAN RADIO RELAY LEAGUE

West Hartford 7, Conn.

*When ordering, please don't send stamps in payment*

From the Q-5 of the Springfield Club: The Club's picnic was held August 13th in George Rogers State Park with many in attendance. Using walkie-talkies, several of the boys walked around the course and relayed the results of the golf matches at the Springfield Country Club. New hams are FNM and GSA. From the *Mike and Key*: A special meeting was held on August 15th with INJM as the principal speaker. He discussed "Our Stake in Amateur Radio," with particular emphasis on emergency communications. As you know, he is our National Emergency Coordinator. From JFC we hear that YCC strayed from ham radio to parachute-jumping. His chute fouled partially at 2800 feet and then tore when it did open, but he was fortunate to land on a soft spot. JFC has been trying to talk him back into ham radio. BFB is operating mobile from Florida. AQ worked portable in Maine during August. IVC has a small rig in his bakery for EC work. PR still is working on TVI. BQV is operating from KZ5IP. PLC has new Collins transmitter and NC-183. DAE states that the BN still is in operation and is handling traffic in spite of QRN. DGC has moved from Xenia to Springfield. CBI has new HRO-50. ZQU is building a new Parapadpter with circular base line. TZO made WAS on 3.5 Mc. DXO has beam trouble; also CNY and WZ. Looking through the files we find the following: Some few faithful report every month. Some miss once in a while. Some are negligent throughout the summer months. Some need jacking up by a letter. Some have their appointments cancelled because they don't answer the letter. In general, though, I will say that I have had excellent cooperation from a bunch of swell guys. Traffic: W8EZE/8 115, DAE 105, RN 66, DSX 57, AJW 23, SCG 22, AL 19, GZ 17, EQN 15, WAB 12, YCP 10, WAV 8, AQ 6, CBI 5, DZO 3, DXO 2.

## HUDSON DIVISION

**EASTERN NEW YORK — SCM, Fred Skinner, W2EQD**  
— SEC: CLL. Things were dull this month from the number of reports received. GYV is getting set for 3.5-Mc. operation. EQD is operating portable near Brainard for the summer — 3.85-Mc. phone and 3.5-Mc. c.w. ZEQ was appointed EC for Yorktown Heights. BSH's appointment as ORS was endorsed. PCQ's appointment as EC was endorsed. Several appointments are overdue for endorsement. Look at your certificates and send me any signed originally or endorsed over a year ago. Traffic: W2PHO 176, TYC 56, FZW 25, AQF 19, BRS 12.

**NEW YORK CITY AND LONG ISLAND — SCM, George V. Cooke, W2OBU — Asst. SCM, Harry Dannals, 2TUK. SEC: BGO. RMs: BYF, PRE, PAM: GSC.** With a view to a more effective AEC it has been agreed by ECs to concentrate on greater organization of mobile and walkie-talkie gear for 144-Mc. operation. However, the present 3.85- and 28-Mc. emergency nets will not be abandoned, but all additional 144-Mc. stations that can be activated will assume important duties. The Northern Queens 10-meter net has increased its membership by 12 in the past month, bringing the total to 52, of which 55 per cent have emergency power. PQG is EC and is assisted by a staff of ten active stations to act for him at any time. The 10-meter net frequency has been changed to 29.600 Mc. with the 2-meter group remaining on 147.6 Mc. Internet affiliations are maintained by LGK, ZDE, and FNL. In a 10-meter net partially covering Brooklyn, Queens, and Nassau, LAG, as EC for Southern Queens, conducted eight drills in two nets during July, an exceptionally good showing for the summer time, and also has added six new AEC members. 25.520 Mc. is the mobile and fixed operating frequency of this net. 80-meter c.w. drills are held on 3.6 Mc. with LGK as low-frequency net control. FI, EC for Nassau, maintains his net interest with five drills for the month with 21 stations reporting, and added ZAI and LKU as new members on the internet frequency of 146.25 Mc. Contacts were maintained with PCQ, SQW, WZF, LGK, QGH, NJF, and ZTS for coverage of six counties from Suffolk to Orange. Several new mobile rigs are being built for the October annual test, and the promise of an exceptionally busy winter season is looked forward to with interest. An engineering committee of four has been appointed to guide all AEC members in future construction to advantage and comprises EXI, as chairman, BVB, TUK, and BFD, the latter being the guiding light in the radioteletypewriter emergency net on 144 Mc. With the resignation of WLB, who has left for M.I.T. with VOS, SJC takes over as EC for Manhattan and the Bronx. All in this area are asked to contact SJC for affiliation with the AEC. In Suffolk, KDB, the EC there, is setting up a comprehensive organization for coverage with nets operating on 3.85 and 144 Mc. and an 80-meter c.w. group which can be heard on 3.6 Mc. Their list of stations using emergency power includes PLA, PDU, AJF, MZB, EKI, and KDB. Mobiles are PLA, PDU, NXZ, SAH, AJF, ABS, BTC, UGH, CJZ, MZB, and WA, and NXZ and LGZ operating maritime mobile. SAH is covering Red Cross liaison and EKI is building up the 80- and 40-meter c.w. nets. New ECs in Suffolk are AJF, EKI, MZB, and PDU. TJA and NPU received OPS appointments. KYN has been appointed OBS. KVG, NPU, and AOD have been appointed OES. DYP, ex-ILAV, ex-ELSA, now is located in Bayside, working 7 Mc. ENP is a new licensee in Bronx

(Continued on page 84)

# MALLORY HAM BULLETIN

## For Meter Switching In Beam Tube Circuits

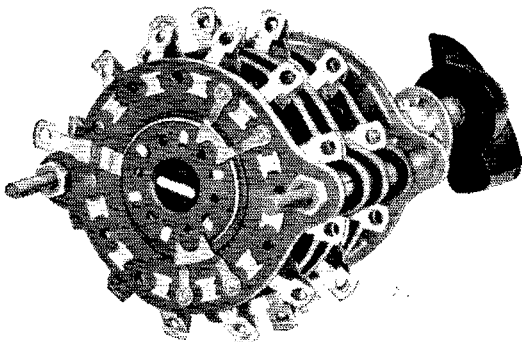

Most amateurs agree that measurement of grid, screen and plate currents in transmitter amplifier stages employing power sensitive 6L6, 807, 832A and similar beam tubes is highly desirable to assure most efficient and reliable operation with a minimum of harm to these tubes.

Yet, in practice, few amateurs observe this rule, mainly because of the apparent difficulty in designing a suitable meter switching circuit which will permit economical single meter measurement of the three circuits.

Probably you have encountered a similar problem in your own rig, and wondered how it could be solved. If you have, we'd like to recommend the Mollory 1400L "Circuit Opening" switch as the ideal solution.

The 1400L is a 12 position, 4 section rotary switch. The outer 2 sections consist of 1 circuit 12 position wafers of the non-shorting type. The inner 2 sections consist of wafers with 12 positions, but of a special construction to permit automatic shorting of all like positions between wafers with the exception of the position in use at any one time.

The unique construction of the 1400L switch makes it ideal for transmitter and test equipment meter switching when complete electrical isolation of the meter from all circuits but the one in use is desired.

The 1400L is so versatile that with its use a single meter may be inserted into or removed from, up to 12 electrically isolated circuits. Voltages and currents may be measured inter-mixed. Multiplier shunt or series resistors may be inserted automatically into each circuit to expand the basic movement of the meter. And circuit polarity can be observed automatically so that either grid or plate currents may be measured.

The 1400L gives the amateur precisely what is needed in meter switching circuits.

Even so, in spite of its unusual, special construction, its price is still well within the limits of the average pocket-book.

If you have a beam power tube in your Xmitter (and who hasn't in this day and age), it will pay you to see the 1400L at your Mollory Distributors', and lay plans to add its usefulness to your rig.

Incidentally, when you go to see the 1400L, don't forget those other fine Mollory parts including: controls, rheostats, Potentiometers, pads, tubular capacitors, transmitting capacitors, dry electrolytics, dry disc rectifiers, vibrators and vibrator power supplies.

P. R. MALLORY & CO., Inc.  
INDIANAPOLIS 6 INDIANA

P. R. MALLORY & CO. Inc.  
**MALLORY**

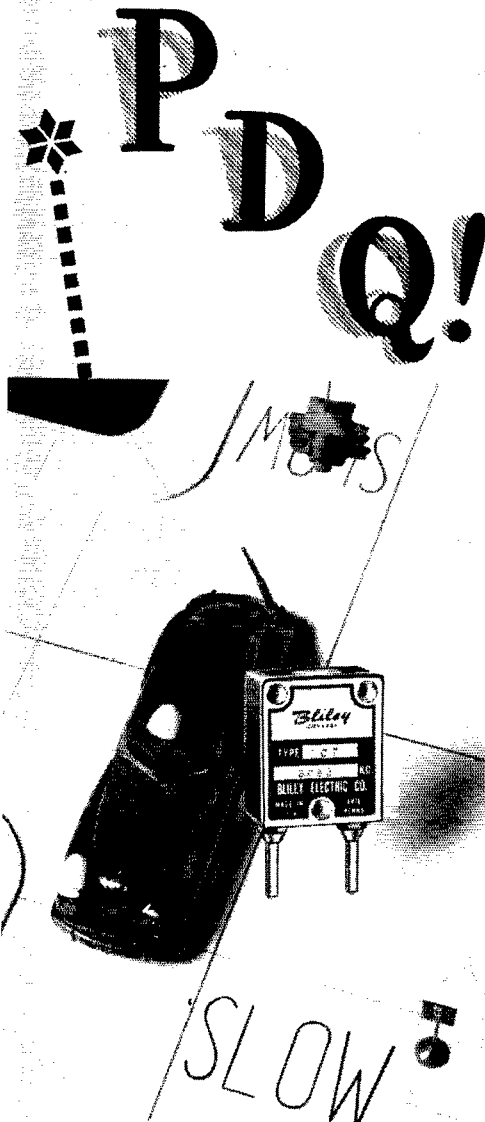

Shown:  
Bliley type MC-7



**POLICE**

**SERVICES DEMAND QUALITY!**

Yes, all mobile services demand dependable crystal performance. Bliley engineering skill plus craftsmanship throughout production is quality. Your frequency control will be better with Bliley, the top choice for 20 years.

**Bliley**  
CRYSTALS

BILEY ELECTRIC COMPANY, UNION  
STATION BLDG., ERIE, PENNSYLVANIA

and is joining the Empire City Club. URX and CTX are active with s.s.b. on 3.85 Mc. and remark on the absence of s.s.b. activity. Approximately ten stations are working 420 Mc. in the section and AOD reports working 1PBB, Stratford, Conn., with S9 both ways. CED and DNT also are active on 420 Mc. AQX has been appointed Asst. EC for Massapequa Park. PF spent some time on active duty at Fort Monmouth, operating K2USA and A2MON, and cleared some TVI problems. ZED became the newest member of KARC. PL, EBZ, DRM, and GUB handled traffic while at Camp Edwards. Mass. Traffic: (July) W2ZDE 132, MQB 70, OBU 67, SJC 42, VVP 35, CEV 34, LPI 14, RQJ 13, TUK 8, YIR 8, BQP 5, PF 3, QBS 2. (June) W2CEV 62, OUT 58, IAG 14.

**NORTHERN NEW JERSEY** — SCM, Thomas J. Ryan, jr., W2NKD — It is a pleasure to report that organizational plans for N.N.J. are progressing better than was anticipated. Your new SEC is VQR, 410½ Fifth Ave., Asbury Park. He is in complete charge of all emergency work in the section. Please address all emergency correspondence to him, including EC certificates requiring endorsements. During July VQR and yours truly discussed the emergency situation in N.N.J. as it exists now and our plans for the future. All ECs will hear from VQR about plans for this season. The following appointments were cancelled: QEM, BLS, CQB, HII, MLW, LBI, TZY, MJC, BWI, LX, HHW, QLF, GVZ, KTR, OCC, PQC, APL, LFR, ZCL, GMN, NWA, ABX, CFB, and HZY as ORS, MKN, OSQ, MIG, DFV, GJC, QHS, LZZ, BTZ, LAG, KPO, OCC, QUF, DME, WK, OOC, LAIB, DRA, GIZ, IIN, and TUA as OPS. QEM, OSQ, JN, PAT, CQB, BU, LOP, OFM, DFV, FDL, ZL, EUI, DRA, and BTZ as EC. GJC and DRA as PAM. HYV, GFW, BF, PXR, JT, KG, and MRG as OO. JDC, BRC, OOC, DRA, VCZ, IIN, and SN as OBS. If your call is among those listed above and you are active on the air and would like to assume the duties of one or more available League appointments to suit your capabilities, send a card to the SCM (address on page 6) and your request will be fulfilled. You will appreciate that N.N.J. wants to be proud of an "active" group of amateurs on the air. Your activity as an appointee not only furthers the cause of ham radio, but you can participate in such activities as the CD Parties and LO-Nite and receive the very latest news of amateur radio via League bulletins. As an EC you are an asset to your community. If you hold an appointment now, check the date of your last endorsement. Send it along and bring it up to date. UWK, RM of the N.N.J. Slow Speed Net, authorized net certificates for CCS, DCL, DOZ, DZA, NCY, NIY, ZBY, DIB, NUL, VYB, and WCL. WCL, a YL from Rockaway, is the newest ORS in the section. EC appointments or endorsements went to UOU, Teaneck; ZBY, Hackensack; NCY, Dumont; JUC, Englewood; DCL, Palisades Park; CCS, Westwood; COT, Maplewood; and BUX, Union City. New OO certificates went to NIY and GVZ. DZA, recently appointed OES, reports that 220-Mc. activity is on the up-swing, mainly through the efforts of KQ, NUI, KBH, FMI, IQQ, HRN, UWK, PJA, GWR, and RPW. There is a get-together every Sunday at 1000 and weekdays from 2000 to 2200. ALZ, a ship's radio operator, is on the air from ZBY's shack. NNJRA had a float in the Teaneck July 4th parade. NIY got his WAVE certificate. EBK and his son, DXU, are now on 7 Mc. YOY is working toward an NJC certificate. BLL pounds brass on 14 Mc. EKU is a regular on the emergency 'phone net on 3.85 Mc. OUS worked two mobile marine stations off Miami and one in the Pacific. GSARA is working with CQB putting emergency gear in C.A.P. truck. ZEP, son of ABL, is very active in traffic work. EWZ is over the 9000 QSO mark. JKH is 3.85-Mc. 'phone net member. Traffic: (July) W2CGG 153, CUI 105, ZEP 48, OUS 10, WCL 10, OXL 8, CJX 4, NIY 2, (June) W2CUI 132, JKH 10, EWZ 3.

**MIDWEST DIVISION**

**IOWA** — SCM, William G. Davis, W6PP — Judging by I reports the whole section must have been on vacation with the SCM as only three reports were received, from SCA, NYX, and the Council Bluffs Club. NYX reports that TED has enlisted in the Air Corps. SCA reports daily schedules with 8RN and Mon., Wed., and Fri. schedule with PAN and a daily schedule with K4USA. He also reports that TEN goes on full schedule Sept. 15th. The Manila picnic was held with the usual success. New officers of the Council Bluffs Radio Operators Club are SEE, pres.; QUF, vice-pres.; JRY, secy.; UTF, treas. Co-editors of Sparks, the club paper, are NOC and UJL. Reporter is VFX. UTF now is in the U. S. Air Corps. UUV is holding code classes for beginners. YZF is back on the air. PP has returned from a vacation which took him to the West Coast via the Painted Desert and Grand Canyon and return via Zion and Bryce Canyon, Salt Lake City, and Estes Park. At Estes Park a fine visit was had with IPI, formerly of Twin Lakes. This will be the shortest report since I've been SCM because of lack of reports. Let's hope for better reporting this month.

**KANSAS** — SCM, Earl N. Johnston, W6ICV — The High Plains Net meets on 1995 kc. Mon., Wed., and Fri. at 1930; and the Kansas 75-meter 'phone net on 8920 kc.

(Continued on page 89)

Be Sure of Your Installations... Next Year

Use *Aptitude-Tested*  
**MIKE CABLE** Now

Now, you can be sure of your installations with Belden Microphone Cables. They are *Aptitude-Tested* and rated to give you safe and complete knowledge of their characteristics. Furthermore, Belden Mike Cables are built for maximum service. Put them to work for you now—and be sure . . . specify Belden.

Belden Manufacturing Company  
4621 W. Van Buren Street  
Chicago 44, Illinois

No. 8424  
Use for interconnecting power cable for all electronic uses. Also used as a microphone cable.

No. 8423  
Nominal Capacitance 54 mmf per ft. Use for carbon microphones.

No. 8412  
Nominal Capacitance 68 mmf per ft. Use for carbon microphones.

No. 8422  
Nominal Capacitance 32 mmf per ft. Use for carbon microphones.

No. 8410  
Nominal Capacitance 33 mmf per ft. Use for crystal, ribbon, and carbon microphones.

No. 8411  
Nominal Capacitance 37 mmf per ft. Use for lapel microphone.

No. 8401  
Nominal Capacitance 25 mmf per ft. For crystal, ribbon, carbon microphones.

**Belden**  
*Radio WIRE*

The  
*Aptitude-Tested* **LINE**

# CRYSTAL CALIBRATOR

MEASUREMENTS CORPORATION

## Model 111

250 Kc.

To

1000 Mc.

Harmonic Range:

.25 Mc. Oscillator:  
.25-450 Mc.

1 Mc. Oscillator:  
1-600 Mc.

10 Mc. Oscillator:  
10-1000 Mc.

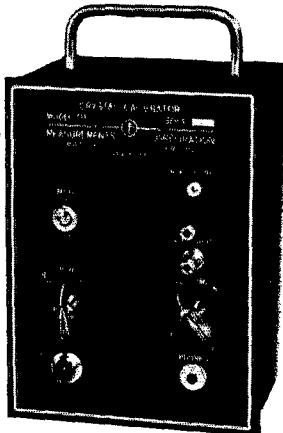

Calibrate Your Own —  
RECEIVERS

TRANSMITTERS  
GRID-DIP METERS  
SIGNAL GENERATORS

And Other Equipment to a  
Frequency Accuracy of  $\pm 0.001\%$

### MODEL 111

A DUAL PURPOSE CALIBRATOR  
with

- CRYSTAL-CONTROLLED OSCILLATOR
- BUILT-IN DETECTOR
- 2 MICROWATT SENSITIVITY

#### SPECIFICATIONS:

117 volts, 50/60 cycles; 18 watts,  
6" wide, 8" high, 5" deep; 4 lbs.

**MEASUREMENTS CORPORATION**  
BOONTON  NEW JERSEY

Sun. at 0800, Tues. and Fri. at 1230 and Thurs. at 1845. The QKS and QKS s.s. c.w. net started Sept. 18th with the same schedule as last year. QKS meets at 1845 Mon., Wed., and Fri. on 3610 kc., and the QKS s.s. Tues. and Thurs. at 1845, also on 3610 kc. The 'phone nets met all summer with good attendance while the traffic handlers went to other nets to carry on. The Kansas-Nebraska Radio Club is the name adopted for the amateurs who met at Haddam, Kans. The initial meeting held June 18th at Belleville City Park was attended by HKB, NAS, VRL, EHO, ADS, and APG. Officers are APG, pres.; NAS, vice-pres.; HKB, secy.; V. L. Wransky, treas.; and Fritz Meyers, act. mgr. OOT of Kansas City, is laid up in a hospital in Durant, Okla., with a broken leg. OOU, again of Emporia, left for service Sept. 4th. IZJ also is joining up. IFI, in his OES report, shows plenty of activity on the ultra-highs, making over 141 contacts between June 20th and July 16th. He's hear from the rest of you u.h.f. men, UPU, AAZ, WGM, QJF, ECF, HBS, QV, and MUY, of Salina, and ABV and IOV, of the Kaw Valley Radio Club, set up portable fixed station at Red Cross Headquarters, two portable stations at First Aid tents at Lake Shawnee, and four mobile stations (ECF, AAZ, QV, and MUY) for the All Sports Festival July 4th and handled a bit of traffic to coordinate activities of the Red Cross. Traffic: W8NLY 32, KXL 7, IGV 3.

MISSOURI — SCM, Ben H. Wendt, W8ICD — Now is the time to look over that emergency gear. The coming winter may bring with it the havoc of ice storms and flood waters. Emergency gear that is not ready to go will be of no value in an emergency. While on a trip through the South, PLJ dropped in on EJT, who speaks the same 144-Mc. language as his visitor. Matt has finished a 3-over-3 beam on 144 Mc. and now is planning a new rig. PTG will be back on 144 Mc. patiently waiting for those scarce openings. QMF has the 3.85-Mc. mobile working to his satisfaction while on 14 Mc. he has improved receiving with a DB-20. QXO is all out for traffic on 7140 to 7150 kc. every morning between 8:00 and 8:00 a.m. Mac will be glad to handle any long-haul traffic. Traffic also can be cleared through OUD, usually found around 7030 kc. BPD is a new call in Springfield. PME blew up the 3.85-Mc. rig and will be QRT for some time. The Missouri emergency net will move to 3580 kc. this fall. This change in net frequency is caused by heavy QRM from VE 'phone. The HARC came up with something new in the way of a club meeting in that the meeting was held at an amusement park. After the details of the meeting had been dispensed with the main object seemed to be to find out how dippy and dizzy a ham could get by trying the various rides at reduced rates to the club. Appointments and renewals: QMF and PLJ as OES; OMG as PAM; PTG, OMG, and QMF as OPS; PTG as EC; OUD, WAP, DU, and KPJ as ORS. Traffic: W8QXO 466, PME 83, WAP 36, CGZ 13, QMF 6, SOM 5, ICD 4, TLY 4.

NEBRASKA — SCM, Scott E. Davison, W8OED — July was a busy month for those who were fortunate to have mobile rigs on the air. INT is a new call in Omaha, having moved there from South Dakota. ZJF has 200 watts on 28 Mc. BQR has erected a narrow-spaced 28-Mc. beam using gamma match. APH now is on 7 Mc. AGE is building up a 150-watt all-band transmitter with 4D32 in final. He also has a new SX-71. EUT visited EKP and EXP recently. NZ, DMQ, and KJP attended the Maunilla Picnic. GFI turned in an FB record in the recent CD Contest. YDZ is in the Navy, stationed in California. BFC and YSK are new hams in Norfolk. AY, with 400 watts, turned in a fine performance in the CD Contest. CMO attended the Wyoming Hamfest while on his vacation. He now is preparing to go 3.85-Mc. mobile. BXJ now is mobile. RYG's new QTH is Lincoln. TIP reports the High Plains Net still active. GFI is operating 3.5 and 7 Mc. with 60-watt VFO. WBE reports a fine vacation. PLF is going 14-Mc. mobile. JDJ and EDI held schedule while EDI was on vacation. HQQ operated mobile while in Estes Park on vacation. The QRM, Pioneer, and Sioux City Radio Clubs held a three-way duel on Field Day, the two lows to entertain in the club. Result: Sioux City ate for free in a big picnic held Aug. 27th at Wildwood Park at Fremont. KJP hasn't missed a hamfest so far this summer. FAM and EDD visited hams in Omaha recently. AYO is sporting new Globe King. Traffic: (July) W8AY 176, FMW 14, KCK 3, EUT 2, JED 1. (June) W8KJP 46, DMY 18. (May) W8KJP 128.

#### NEW ENGLAND DIVISION

MAINE — SCM, Manley W. Haskell, W1VW — PTN, M 3550 kc., 1900, Mon.-Wed.-Fri., RM NGV on PTN at 1900; RN, at 1945; and EAN, on 3705 kc., at 2030. SEC is IGW and PAM is FBJ. The Sea Gull Net will resume activities the first week after Daylight Saving goes out. QUA drills the AEC net on 3588 kc. twice weekly. IGW reports that there are about fifty mobile units in Maine, with most of them on 3.85 Mc., a couple on 28 Mc., and the rest on 144 Mc. The SEC has conferred with Col. Spaulding Bisbee, State Director of Civilian Defense and Public Safety. Present plans indicate that the AEC will act independently and be able to supply communications for the Civil Defense set-up. There are at the present time 141 full and supporting members of the AEC in Maine. NGV was

(Continued on page 88)





**ALSiMAG<sup>®</sup>**

CUSTOM MADE TECHNICAL CERAMICS  
for electrical and electronic uses

(SOLD ONLY TO MANUFACTURERS)

49TH YEAR OF CERAMIC LEADERSHIP

**AMERICAN LAVA CORPORATION**

CHATTANOOGA 5, TENNESSEE

Versatile \*

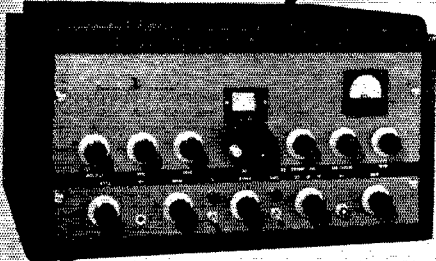

\* the **JOHNSON VIKING 1**  
TRANSMITTER KIT

Conservatively rated at 100 watts AM phone output, 115 watts CW. Incorporates features such as band-switching, crystal control or optional VFO input, pi-network output tuning and complete coverage of all amateur bands from 160 to 10 meters.

Recognizing the fact that many of the varied activities for which the Viking is suitable take place outside the amateur bands, we list herewith its complete frequency range.

Band	Low Freq. Limit	High Freq. Limit
160	1.8 mc.	2.4 mc.
80	2.9	4.4
40	5.2	8.0
20	9.8	15.0
15	15.0	21.8
10	21.0	30.0

VFO drive requirements are very slight. Only six volts of 7.5 mc. RF is required for full output at 30 mcs., less for the 14 and 7 mc. bands. Two volts of 1.75 mc. VFO output is ample excitation for 1.75 and 3.5 mc. output.

Delivering full output on phone with 115 volts 50/60 cycle line voltage, the transmitter's power consumption is 350 watts. With line voltage between 105 and 120 volts, performance is satisfactory.

In addition to being a completely self contained, compact, and efficient 100 watt transmitter, the Viking 1 can be used as a driver for a kilowatt amplifier. Full output of the modulator is available at a nominal 500 ohms impedance.

Now being displayed by most leading jobbers, the Viking 1 Transmitter Kit (less tubes, crystals, mike and key).

Amateur Net . . . . . \$209.50



**JOHNSON**

a famous name in Radio

E. F. JOHNSON CO. WASECA, MINN.

**CONNECTICUT QSO PARTY**  
October 28-29, 1950

All Connecticut amateurs are cordially invited to take part in the Third Annual Connecticut QSO Party to be sponsored by the Connecticut Wireless Assn.

Rules: 1) The Party will begin at 5:00 P.M. EST October 28th and end at 11:00 P.M. EST October 29th. 2) Any and all amateur bands may be used, and either phone, c.w., or both. C.w.-to-phone and cross-band contacts are permitted, but no extra credit is allowed for such QSOs. 3) The general call will be "CQ CN" on c.w. and "CQ Connecticut" on phone. 4) The same station may be worked but once regardless of band. 5) Exchange names of towns or cities. 6) Score 1 point per contact; multiply contact points by number of towns or cities worked for final score. 7) Reports must show times of QSO, call of stations worked, town or city area of station worked. All reports must be postmarked no later than November 15th and should be sent to J. H. Thompson, WBIII, 633 East Main St., Torrington, Conn. 8) Prizes will be awarded to the participants submitting first, second and third highest scores. All decisions of the C.W.A. Contest Committee will be final.

Here is an opportunity to see how many Connecticut stations you can work in a 30-hour period. Get on the air October 28th and 29th and meet the gang around your section!

visited by BBN and 2EJP. A new ham is TBE down that way. RQR yelps that the "hamfest at Portland was par-excellence and then some." SFZ has a new final that needs debugging — then look out, for he is running 300 watts to the final. He is OO on 3.5, 7, and 14 Mc. SUX, SZM has finished that new VFO, so now he can hop from here to there and make more contacts. The Portland Hamfest held July 29th was attended by 344 amateurs and their ladies. Among those present were Ed Handy, Doc Hayes, and Irv Vermilya. The PAWA says, "Thanks for the turnout — more next year." Traffic: WINGVY 281, LKP 135, QUA 95, RQR 59, SFZ 48, VV 43, PTL 30, SUK/SZM 29, OTM 9, COV 6, PYY 5, KDE 1, SWX 1.

**EASTERN MASSACHUSETTS** — SCM, Frank L. Baker, jr., W1ALP — Eastern Massachusetts Net frequency is 3745 kc. NBS has taken over as Route Manager. We want to give QMJ a hand for the nice job he did. He will be very busy at Northeastern for a few years. New appointments: LAO as EC for Saugus, AVY as EC for New Bedford, AVY as ORS, RTW as OBS. The following have had their appointments endorsed for another year: LAO and LQQ as OPS; BB as OO; BB, ICO, KYX, DFS, and MVO as EC; QMJ, NBS, BDU, and JCK as ORS; LMU, LQQ, and LAO as OBS; LMU as OES. SPQ is ex-2ZPM and now is living in Westwood. He has applied for OO appointment. RYB is on 7 Mc. We are sorry to have to report the death of Myron Tong, ex-HUN of Quincy. Our sympathy to ICO on the death of his mother. AXA is moving back to Swampscott. MME is building a new QTH on a hill in Hull. This section was well represented at the Portland Hamfest. Ex-ONZ was in Boston recently; he is in the Air Corps. QJI, of Quincy, is on 14-Mc. phone. NOV is on 14-Mc. c.w. QGG, in Stoneham, is on 3.85-Mc. phone. JJJ operated KIWAF on 3.85-Mc. phone during National Guard maneuvers at Camp Edwards and handled some traffic. ENW is on 144-Mc. portable. AEZ/MM is on 144-Mc. in W2-Land. SCS, who is IIM's XYL, is on 160 meters. PSP/MM, in Marblehead, is on 144 Mc. CTR worked 2BV on 144 Mc. JOL had the rig on 144 Mc. while up in Maine. SNN and RLA were on National Guard duty. LDD, RLA, SNN, and PYM had a quadruplex QSO on 144 Mc. SNO, of Medford, has a new jr. operator, and with a rig in Q87 worked 2BV in New Jersey on 144 Mc. The T-9 Radio Club held a meeting at MNK's QTH. GGV won the Club's 80-meter contest. JNV has a new baby YL. The South Shore Club held its first summer meeting. BGH is busy with outboard motors. AWO has a new home in Wenham. JNK got married. JNE is in Japan. LQQ has a new shack in his basement. LAO is building a VFO for 3.5 Mc. for portable work. OBN renewed his ORS appointment. BAQ has taken the EC job for Arlington. The Newton Emergency Net has four mobile rigs and five fixed; Red Cross, City Hall, Fire Department, and Waban Hill, and also the hospital. The monthly drill was held with the following hams: BL, EK, H LX, RM, LMU, JOW, and PWV. More help is needed, so how about it, you other hams in Newton? RM has ARC-5 on 144 Mc. OMU is rebuilding a high-power rig. KVF has a broad-band converter on 28 Mc. BL has TR-4 in his car. PWV is rewinding modulation transformer. LMU is working on ARC-5 and converter for 144 Mc. LAO has schedule with MGN/1, Kingston, N. H., and JTJ/1. ASN is visiting VE1LN, IPC, BLR, and IF worked mobile on the way to the Portland Hamfest on

(Continued on page 90)

# "I use SYLVANIA 1N56's in my monitoring equipment"

says J. P. Born, Jr., W4ZD

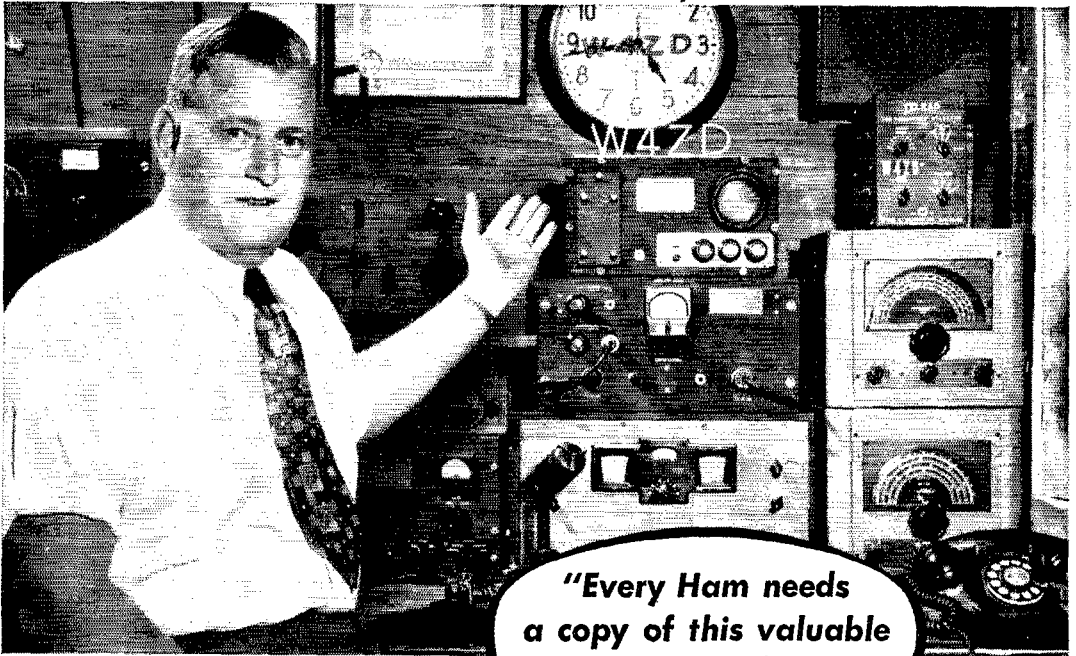

"Every Ham needs a copy of this valuable book... only \$1.00."

"I use Sylvania 1N56's in my field strength meter and transmitter failure alarm, and 1N34's in my modulation meter. These small crystal diodes save me valuable space on my operating desk and give me accurate and dependable service. They also come in handy around W4ZD . . . in my low-voltage bias supply, premodulation speech clipper, carrier-operated inverse feedback circuit and transmitter adjusting gimmicks."

Mr. Born, who is also the Atlanta Police Radio Department's operator technician, uses several of the many circuit suggestions found in Sylvania's new and valuable book "40 Uses for Germanium Diodes." Other suggestions include receiver, wave shaping, and video applications . . . suggestions for distortion meters, tricky telephone circuits . . . and many others.

Mail the coupon for your copy of this booklet NOW. You'll find it well worth its low price of \$1.00.

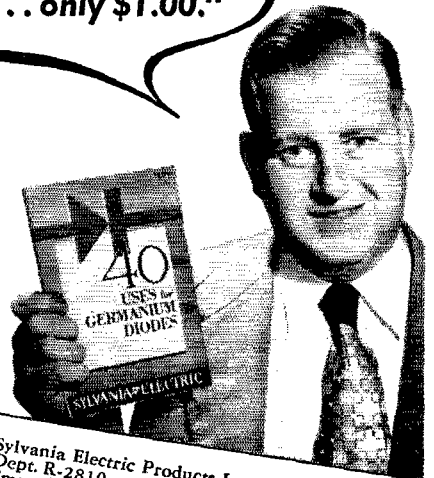

# SYLVANIA ELECTRIC

RADIO TUBES; TELEVISION PICTURE TUBES; ELECTRONIC PRODUCTS; ELECTRONIC TEST EQUIPMENT; FLUORESCENT LAMPS, FIXTURES, SIGN TUBING, WIRING DEVICES; LIGHT BULBS; PHOTOLAMPS; TELEVISION SETS

Sylvania Electric Products Inc.  
Dept. R-2810  
Emporium, Pa.  
Enclosed please find \$1.00 for copy of new circuit book "40 Uses for Germanium Diodes."

Name \_\_\_\_\_  
Street \_\_\_\_\_  
City \_\_\_\_\_  
State \_\_\_\_\_ Zone \_\_\_\_\_



**FIELD DAY...  
EVERY DAY!**

**Precision Series 85**

**AC-DC Circuit Tester**

(20,000 Ohms per Volt)

**will help YOU to  
STAY on the AIR**

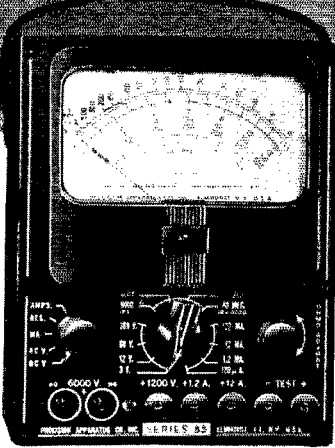

**Self-Contained to**

**6000 volts, 60 Megohms, 12 Amperes, +70DB**

A compact, laboratory type, high sensitivity test set indispensable for test and maintenance of modern amateur communications equipment.

20,000 Ohms per Volt D.C. — 1000 Ohms per Volt A.C.

**VOLTAGE RANGES:** 0-3-12-60-300-1200-6000 A.C. & D.C.

**CURRENT RANGES:** 0-120 microamps; 0-1.2-12-120-MA;

0-1.2-12 Amps D.C.

**RESISTANCE RANGES:** 0-6000-600K-6 Meg-60 Megohms.

**DECIBEL RANGES:** From -26 to +70DB.

Complete with batteries and test leads..... **\$3875**

**PLUS superior physical features:**

- ★ 4 1/2", 50 microamps, Easy Reading Meter.
- ★ Heavy duty bakelite case 5 1/2 x 7 1/2 x 3".
- ★ Deep etched, anodized aluminum panel.
- ★ Recessed 6000 volt safety jacks.
- ★ Only two pin jacks for all standard ranges.

**LC-1 LEATHER CARRYING CASE**—Custom designed, top-grain cowhide case with tool and test lead compartment. \$875  
See Series 85 and other famous "Precision" instruments, on display at leading radio parts and ham equipment distributors. Write for latest catalog.

**Precision Apparatus Co., Inc.**

92-27 Horace Harding Blvd., Elmhurst 13, N. Y.

Export: 458 B'way, N. Y. City, U.S.A. Cables: MORHANEX  
In Canada: Atlas Radio Corp. Ltd., Toronto, Ontario

3.5 Mc. with LAO. BDM is on 28 Mc. at Groton, Mass. QJL is at Army Camp on Cape Cod. SMO is working 7 Mc. from the car and is getting out good, working W6s. QAIJ won a v.h.f. HY-Q transmitter at Portland. MRQ set up a station at the Hobby Show. BGW has Gon-Set three-band converters for mobile rig. WU has rig in the car working good. Traffic: (July) WJQMJ 406, TY 143, SS 76, DMS 63, PU 38, LM 17, HWE 8, NWL 5, CTR 2, WU 2. (June) WJQMJ 116, QJB 42, MRQ 33, BGW 3.

**WESTERN MASSACHUSETTS** — SCM, Prentiss M. Bailey, WIAZW — SEC: UD, RM: BVR. Net frequency, 3725 kc., Mon. through Fri. at 7 p.m. HFO and EOB renewed ORS appointments. QJN is on 3.85-Mc. 'phone with TBS-50D. LHW is rebuilding with higher power. HW and AGM recently renewed old acquaintances on 28-Mc. 'phone after a lapse of 25 years. BVR attended the Portland Hamfest. MUN is back in the swing after vacation. TAL and CLU are new hams in Worcester. KC spent vacation in Maine. EPQ finally has 100 cards for DXCC. BDV enjoyed a complete 10-week vacation — free from work and lots of time for radio. SIT sends in traffic. BH has new jr. operator. AGM enjoyed his vacation with 28-Mc. mobile. NLE had fun on 144 Mc. from his summer camp in Wales. JYH and EOB really battled in the last CD Party but JYH edged Vic by a mere 2000 points. BHU and RZG made good scores with their low-power rigs. The HCRC held its annual picnic at Look Park in Northampton. IZN built up 3.85-Mc. 'phone during vacation. SYX, SDO, and SDS applied for membership in the AEC. Plans for a WMN slow-speed net are well under way and should be rolling by the time you read this. Remember that there also is a West. Massachusetts 'phone net each Sunday morning on 3865 kc. at 9 a.m., and a West. Massachusetts 'phone net on 29,050 kc. each Thursday at 2100. Let's have more activity on all of our nets. There is plenty of room for all of us whether we operate c.w. or 'phone. Let's get those mobile rigs and emergency rigs in order for the October Simulated Emergency Test so that we can show what we can do in case the real thing comes along. AZW visited BDV/1 at his summer home in York Beach. JLM is operating mobile on the SS *California Swoord*, which runs from Portland, Me., to Houston and return. He uses 28-Mc. 'phone and 7-Mc. c.w. Traffic: WIRHU 35, BVR 21, BDV 6, SIT 3, MOK 2.

**NEW HAMPSHIRE** — Acting SCM, Clifton R. Wilkinson, WICRW — RM: CRW, MXP is spending week ends at his place near Alton Bay on Lake Winnepesaukee, and expects to operate in NHN again this fall. PFU has a new antenna for 3.5 Mc., up 60 feet. QJX reports to operate 75- and 160-meter 'phone soon. GMM expects he is so busy he is unable to QNT NHN but expects he will operate this coming winter. SAL expects to have higher power using an 8005 and hopes to have it ready for the winter season. He is using new antenna tuning network and doing a swell job. POK spent a week in Maine with BNC. He is rebuilding the rig. JGI lost his oscillator power supply but will be back in the groove very soon. PVF made WAS in June and made WAC a year ago, but lacking one QSL he has a total of 54 countries. At present he is at UNH and is operating a BC-474 with invisible antenna using #28 wire, but it works. SIC, of Whitefield, is back in the Navy and had to close his radio shop. ORN is back at George Washington University in Virginia. CRW is working mobile all bands, 'phone and c.w., and is watching for the gang. Traffic: (July) WICRW 198, QJX 16, PFU 8, PVF/1 4. (June) WJQJX 32, RFP 3.

**VERMONT** — SCM, Burtis W. Dean, WINLO — The location of the Annual Vermont Hamfest and State ARRL Convention in Burlington has been shifted from the Hotel Vermont to the Burlington Country Club, where there is plenty of free parking space and an 18-hole golf course. The BARC has a bang-up program lined up for you fellows this year. BJP is working DX on 144 Mc. He contacted VE2PV in Trois-Rivieres, Quebec, a distance of 120 miles. RWX has sixteen-element beam on 144 Mc. CUN is building a twenty-element beam for 144 Mc. PZX is back on the air from Windsor. FPS is OBS. MEP has portable gear for 420 Mc. TAN is Frank Barnes of Rutland. TBG is Romeo Gamache of Burlington. RFR is mobile on 29 Mc. while new house is being built. BJP, JEN, KR, V, LTW, ELJ, IT, NLO, RNZ, and RPK, with their XYLs and jr. operators had an FB outing at MMN's and OAK's Sunday, July 16th. CU Overt 14th at the Burlington Country Club. Traffic: WIAVP 28, RNA 4.

**NORTHWESTERN DIVISION**

**ALASKA** — SCM, Charles M. Gray, KL7IG — It looks like SC qualifies for the BPL this month. He is with the Alaska Packers at Kodiak and is there for the summer. W4OAV/KL7 is on the air in Anchorage running a BC-458A with 25 watts to a folded dipole and using an HQ-129X receiver. He is from Florida and is working for C.A.A. CZ entered the last CD Party and worked up a score of 10,700. ABU is now in Kalamazoo, Michigan. PE is now the SEC for our section and doing a good job. 3892 kc. is being used as a ground observers' net. Please keep it clear. Traffic: KL7SC 137.

**IDAHO** — SCM, Alan K. Ross, W7IWU — Shelley: ACD and BKJ report on the Big Springs Hamfest and state that 29 licensed amateurs from four states were present.

(Continued on page 92)

# CHICAGO

the transformer line  
designed for Today's  
Amateur Circuits . . .

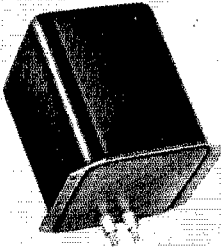
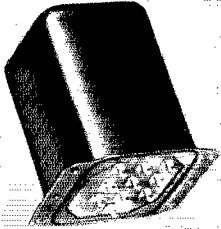

## PLATE TRANSFORMERS--Primary 115/230 Volts, 50/60 Cycles

Here they are—top-performing, plate transformers and matching filter reactors. They're conservatively designed, with ample insulation throughout. They operate with a temperature rise of 40° to 50°C at full load, 60 cycles, under CCS duty. Under ICAS conditions, duty cycle is 15 min. on and 15 off, 40°-50° temperature rise.

Catalog No.	Max. Pri. VA	Secondary A-C Load Volts	D-C Volts after filter	D-C Ma. CCS	ICAS
P-45	185	675-0-675	400	250	325
		575-0-575	500		
P-67	250	900-0-900	750	250	325
		735-0-735	600		
P-107	310	1150-0-1150	1000	250	350
		870-0-870	750		
P-1240	360	1425-0-1425*	1250	150	200
		600-0-600	400		
P-1512	550	1710-0-1710	1500	300	425
		1430-0-1430	1250		
P-2520	915	2820-0-2820	2500	300	425
		2260-0-2260	2000		
P-3025	1850	3450-0-3450	3000	500	700
		2850-0-2850	2500		

\*Both secondaries may be rectified simultaneously

## FILTER REACTORS

Catalog No.	Inductance in Henries	Max. D-C Ma.	D-C Resistance, Ohms	Insulation Volts RMS
R-67	6	700	35	10,000
R-105	10	500	40	9,000
R-65	6	500	35	9,000
R-103	10	300	40	7,500
R-63	6	300	35	7,500

## Filament Transformers

CHICAGO offers a complete line of filament transformers, rated to provide voltages and currents for heating a wide range of receiving and transmitting tubes. Filament units geared to today's Amateur circuits are fully described in our New Equipment Catalog. Write for your FREE copy today.

## Splatter Chokes



Designed specifically for use in high level "clipper" filters. They eliminate splatter caused by heavy modulation, limit band width to 3,000 cycles, effectively increase "get through" phone signal ability, prevent negative peak clipping. Windings tapped to cover inductance range from .02 to 1.5 hys at relatively constant Q. Adequately insulated to withstand high peak voltages.

Catalog No.	D-C Ma.	Insulation Volts	Inductance in Henries
SR-300	300	7,500	.02 to 1.5 Hy
SR-500	500	10,000	.02 to 1.5 Hy

WRITE FOR APPLICATION DATA SHEET

## Low Pass Filter No. LPF-1

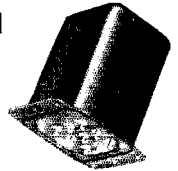

Designed to provide optimum attenuation of audio frequencies above 3,000 cycles. Economically and effectively confines a speech signal within narrow frequency limits. The filter operates out of a source impedance of 15,000 ohms (as presented by plate of single 6C5, 6J5, or triode-connected 6J7) into a 100,000 ohm grid. Step-up ratio of 1: 2.63 is obtained when primary is connected to 100,000 ohm secondary. A plate blocking condenser is required to prevent D-C from saturating the coils in the filter proper. Filter operates satisfactorily at signal levels of +10 volts RMS across the 100,000 ohm secondary, or of +0.7 volts RMS at 500 ohms.

WRITE FOR APPLICATION DATA SHEET

WRITE FOR  
FREE  
New Equip.  
CATALOG  
TODAY!

# CHICAGO TRANSFORMER

DIVISION OF ESSEX WIRE CORPORATION

3501 ADDISON STREET • CHICAGO 18, ILLINOIS



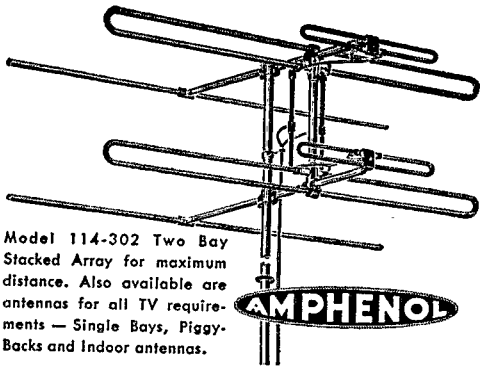

Model 114-302 Two Bay Stacked Array for maximum distance. Also available are antennas for all TV requirements — Single Bays, Piggy-Backs and Indoor antennas.

## TV and FM ANTENNAS

All Amphenol antennas are engineered and perfected in our Development Laboratories. They will provide unsurpassed reception of FM and TV signals and assure long, trouble-free service.

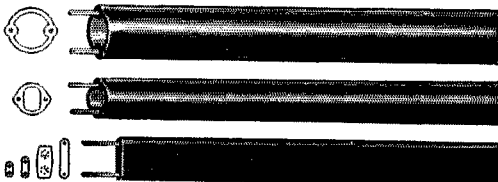

## TWIN-LEAD TRANSMISSION LINES

Amphenol Twin-Lead is the ideal means of transmitting signals with minimum losses. Durable polyethylene dielectric resists weather, acids, alkalies, and oils. Remains flexible at  $-70^{\circ}\text{C}$ . For standard FM and TV receiver installations use Receiving Twin-Lead — No. 14-271 for deluxe installations.

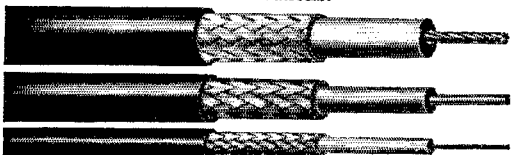

## COAXIAL CABLES

Amphenol Coaxial "RG" cables are produced to standards that surpass Army-Navy specifications. Charts showing characteristics and dimensions are available upon request.

## RADIO SOCKETS and CONNECTORS AN CONNECTORS RF CONNECTORS

Catalogs of Amphenol products will be mailed upon request. Be sure your name is on the mailing list to receive our monthly magazine, The Amphenol Engineering News.

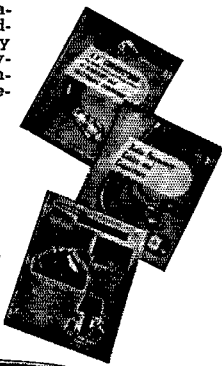

**AMPHENOL**

**AMERICAN PHENOLIC CORPORATION**

1830 SO. 54TH AVENUE  
CHICAGO 50, ILLINOIS

Lots of fun was had by all, with some entertainment by BAA and talking doll, "Dopey," and music by NBD and his XYL. Another hamfest is planned for next year. ACD reports 164 contacts in 36 states on 50 Mc. Power is 500 watts. While on a trip through Glacier Park, he met EL5A, who is now a W1 in Reading, Mass. St. Anthony: LQU is moving back to Idaho from Cornish, Utah. Boise: SHN, ALY, KJO, and IWU have been vacationing and traveling with mobile rigs. IWU visited North Idaho, meeting GHT, FRM, ELH, HKK, BVK, FIS, and KIL, with fine stopovers at GHT and KIL. The Navy has called NIQ, JHX, and APK.

OREGON — SCM, J. E. Roden, W7MIQ — Baker: HAZ is a new OPS. The Baker Club put on a big picnic and Field Day recently and it was a real success. Bend: SY is a new OPS and was chairman for the recent successful OEN picnic at Suttle Lake. Eugene: LVN is a new OPS here, and also operates very successful mobile on 3.85 Mc. Klamath Falls: MYI promises more activity on the amateur bands since he may have to quit work because of back trouble. ORG is a new licensed amateur here, and is radio instructor in high school. Medford: OJA is doing a fine job as jump station between OSN and OEN Nets. HLF is keeping Official Bulletins before OEN members by a regular schedule. Portland: AXJ and AJN are new OPS here. DHX has a new skyhook up on 65-foot poles. ORX is a newly-licensed amateur and is active on 29-Mc. mobile. LXR has returned here to reside after a year in Pendleton. HDN, our PAM, is doing a real job in getting the gang interested in OPS appointments. Scappoose: MVJ reports that his interests shortly will be confined exclusively to the v.h.f. bands. Suttle Lake: JKU reports that this is a new QTH for him. He also is new OPS, and helped SY in putting on the big annual OEN picnic at this resort. AXJ reports that Civilian Defense plans and the amateurs' part in them now are in the formative stage. Salem: KGU is new EC for the Salem Area. Traffic: W7HDN 109, HLF 85, HV 73, AJN 62, MQ 53, DHX 38, BSY 37, JRU 35, JKU 32, ODI 30, FY 24, NFU 24, AXJ 18, ESJ 18, OHX 16, GUR 14, AZK 11, ADX 10.

WASHINGTON — SCM, Laurence Sebring, W7CZY — SEC: KAA, RM: JJK. Section Net: 1800 PDST, 3695 kc. The WSN picnic was a success with DXF, RT, APS, ZU, MCV, JJK, MPH, LEC, OEB, HQO, KTO, FWR, FWD, EKW, FRU, LVB, NWP, CWN, KCU, EQN, and CZY present. LJM had to take down his antenna to make way for a new city project. ACP painted his house. FIX finished the California Routing Guide, which was a real undertaking. Radio conditions are bad in Colfax, say KCU and EQN. MPH works at the experimental station at Puyallup. CWN took a portable rig on his vacation. FWD keeps Olympia on the air. PWR has stacks of QSL cards, so send in your self-addressed stamped envelopes for yours. You might have one from AC4 or FPD. DRA is busy keeping Nalley's pickle factory running. JZR has a schedule with KCU. ZU still is working on his yacht. KAA and the Bremerton gang had a booth at the Kitsap County Fair. NWP works out well with low power. MBY keeps Bellingham active on WARTS. ETO has been doing some trout fishing. LVB puts out a better signal with his 9-watt battery-operated rig than he does from home. ZY and NTX have 28-Mc. mobile rigs operating. KWC has a new exciter going. KTL received his WAC phone certificate. ZL2CU stopped in to visit with DDQ. JBH is farming instead of hamming. RT has a fine mobile unit. The Bremerton Emergency Net meets every Wednesday at 9 P.M. on 28,900 kc. OHS is new EC for the Richland Area. Send your envelopes to FWR for QSL cards and send in your activity report to the SCM on the first of each month. Traffic: W7CZY 2011, IOQ 354, KCU 190, FIX 148, MPH 123, CWN 110, FWD 54, DRA 35, JZR 34, ZU 25, ACF 21, KAA 15, NWP 15, MBY 10, ETO 9, LVB 8, APS 1.

## PACIFIC DIVISION

HAWAII — SCM, Dr. Robert Katsuki, KH6HJ — PY says Aloha to the gang. He will appear as a W4 from Charleston, S. C. MN, our PAM, is rebuilding and therefore is off the air. He ought to have plenty of punch when he reappears. ADY applied for and received his ORS appointment. He has an ARC-5 on 3.5 and 7 Mc. and has a 300-watt job on 28-Mc. phone. FD found KH6WO/KH6 pushing close to 100 watts using an all-band transmitter, "V" antenna, and two gasoline-driven generators. The mobile gang held its monthly meeting at the Haiku Communication Station in Kaneohe (KH6AAA). RU has been rebuilding to a 200-watt semi-portable all-band rig. AO got a pink ticket from Cupid and lost his bachelorhood. QK now is KB6AO. ABS works 14 and 28 Mc. from his QTH in Waimanalo. Traffic: KH6AN 4, HJ 4.

NEVADA — SCM, Carroll W. Short, jr., W7BVZ — CX operated portable at Lake Tahoe as 6CW while on vacation. He, JLV, and KLK are working W5, W6, W7, and W8 districts on 50 Mc. BVZ received an FB certificate for a perfect copy of the Defense Day message. KEV was called to active duty in the Navy. KJQ has low power on 50 Mc. and a three-element beam. TFF and his XYL, KVF, have moved to Las Vegas from Boulder City. OOG moved to Montana. M. A. Cook, OQK, is a new ham in

(Continued on page 94)

# BOB HENRY, WØARA, OFFERS YOU:



**LOW PRICES:** I sell to you as cheap or cheaper than you can buy anywhere.

**COMPLETE STOCKS:** Collins, Hallicrafters, National, Hammarlund, RME, Millen, Harvey-Wells, Meissner, Gonset, Meck, Johnson, RCA, all other amateur receivers, transmitters, beams, TV, AM-FM, Polic-Alarm and Monitoradio, high fidelity amplifiers and speakers, test equipment, tubes, parts, etc. I can supply nearly any equipment shown in any catalog or advertisement and at lowest prices.

**BEST TRADE-IN ALLOWANCE:** Customers in all parts of the USA trade with me because I allow so much. Tell me what you have to trade and what you want. I also buy equipment.

**TIME PAYMENTS:** You can order anything on terms. I finance the terms myself to save you time and bother. Customers everywhere in the USA find my terms best. Write for details.

**QUICK DELIVERY:** Mail, phone, or wire your order. It will be shipped promptly. I can be reached nearly 24 hours a day, 7 days a week.

**TEN-DAY TRIAL:** Try any communications receiver ten days -- if you return it your only cost is shipping charges.

**PERSONAL ATTENTION:** The Butler store is run by Bob Henry, WØARA, and the Los Angeles store by Ted Henry, W6UJU. We make the deals ourselves. We finance the time payments ourselves. That way we have the lowest overhead and can do more for you. That's why YOU AND I CAN DO BUSINESS. Write, phone, or visit either store. Export orders solicited.

73,

*Bob Henry*  
WØARA

Butler 1, Missouri

## HENRY RADIO STORES

11240 Olympic Blvd.  
LOS ANGELES 25  
CALIF.

'WORLD'S LARGEST DISTRIBUTORS OF SHORT WAVE RECEIVERS'

*Johnson Announces*

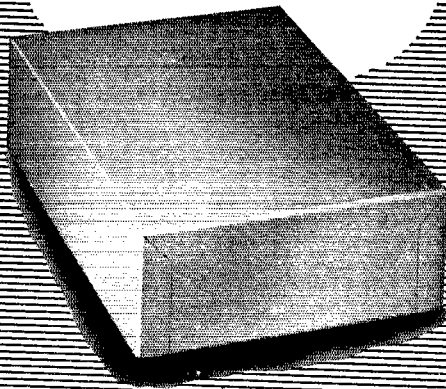

## A GREAT ADVANCE IN CHASSIS DESIGN

### NO OVERLAPS PERMIT LOCATING HOLES ANYWHERE

The new JOHNSON chassis mark a real advance in design by eliminating bulky butt overlaps at chassis corners. Because the chassis are single thickness at all usable areas, you can locate holes all the way to the corners. You can mount volume controls, toggle switches, etc., without trouble — and mount them flush inside of the cabinet because of the single thickness feature.

There has been no sacrifice of strength! Ruggedness, rigidity, and durability are assured by welded tie bars on the inside of the "turned under" bottom edge. These tie bars do not interfere with hole location or with the mounting of any components. Bottom plates may be fastened to the reinforced edges at bottom.

These new JOHNSON chassis in various sizes are now available from stock in limited quantities.



**E. F. JOHNSON CO.**  
WASECA, MINNESOTA

Boulder City. Any ARRL members interested in appointment as ORS, QFS, OBS, or OO, please write your SCM.

SANTA CLARA VALLEY — SCM, Roy E. Pinkham, W6BPT — NW still is keeping schedules on traffic nets and is trying to get the rig rebuilt. HC will be QRL moving into new QTH. Harry will be back on the traffic nets when he gets settled. BPT returned from a vacation trip to Nevada. He visited 7TJY, 7NOH, 7PST, and 7NSB while in Carson City. KFF has been called into the Navy. His new address is AT3, VF 874, c/o F.P.O., San Francisco. SCCARA now has emergency gas-driven generator to power the rig at UW. CFK is ready to work on the hamfest of SCCARA for the next year. Good going, Dick. HAN is working on two-meter net for emergency in case of need. ZRJ returned from a cruise with the Naval Reserve. Traffic: W6AYL 479, BPT 219, NW 175, HC 34, RFF 2.

EAST BAY — SCM, Horace R. Greer, W6TI — Asst. SCM, Charles P. Henry, 6EJA. SEC: OBJ. ECs: AKB, EHS, NNS, IT, IDY, QDE, and LMZ. It is with great sorrow that I report the passing of Bill Hollis, FDR, on August 6th. Bill was a great guy and although pretty ill with a heart ailment for the past two years he always found time to get on the air and try to keep things rolling. Bill, a real old-timer, was RM and ORS and handled considerable traffic. With small war clouds that could grow, OBJ is most interested that all ECs check over their lists and bring all records up to date. K6AW has a new jr. operator. ZZF has a brand-new Class A license. HDD is QRL MARS Net. WHA enjoyed his portable rig during his vacation. CZU expects to be signing a J call soon. The Vallejo Club furnished the circuits for the Soap Box Derby in the area. Those assisting were: CHI, ZZF, ZJD, PAK, BPC, MLZ, and WGM. Everything worked without a hitch and made a favorable impression. ZUI is having beam problems. JZ keeps the traffic rolling, making BPL in May, June, and July. YDI has a mobile rig working FB on 3.5 and 3.85 Mc. OJW reports that he took a three-week vacation and his 28-Mc. mobile made it most enjoyable. Newly-elected officers of the Mission Trail Net are: BPT, pres.; 7NOH, vice-pres.; UH, treas.; JSB, secy.; ANR, EC; 7TJY, tlc. mgr.; Frank Halstead, OO. TP really caught some fish this year while on his vacation. The East Bay section was sorry to hear of the passing in August of BUY's Dad. DX has been so poor at times on the 14-Mc. band some have wondered if any foreigners use this band any more. GIZ and MEK hope to move into new homes soon. We understand that the 7-Mc. band is plenty hot these days, and this winter should find the band something like prewar days. They are calling ELW the silent man these days. The Northern and Southern California DX Clubs are making plans for their joint conference meeting to be held next January in Fresno. OT is busy with MTN and RN6. EY at last turns in a traffic report. Traffic: W6JZ 863, DTW 355, OT 68, YDI 52, ZUI 21, TT 6.

SAN FRANCISCO — SCM, R. F. Czeikowitz, W6ATO — Phone JU 7-5561. SEC: NL. Phone PL 5-4457. The High Frequency and Mobile Society (S.F.) meets the second Friday at the Red Cross Building, 1625 Van Ness Ave. The Humboldt Radio Amateurs Club (Eureka) meets the second and fourth Fridays in YMCA rooms, rear of Municipal Auditorium, entrance E St. The Marin Radio Amateurs Club (Kentfield) meets the second Friday in the Engineering Lecture Room, Marin College. The San Francisco Radio Club (S.F.) meets the fourth Friday at American Legion Hall, 1641 Taraval St. *Marin Area:* EC: KNZ. FYS has a low-frequency i.f. strip for single signal c.w. reception. KNZ is working on a 160-meter mobile receiver. HUX is working with KNZ on the emergency gear for the club. XYQ is working on s.s.b. filters. MRZ is working on a controlled-carrier rig. LUM, BCM, JTP, and K6BU are on 28 Mc.; in addition LUM is on 3.85 Mc. and JTP is on 160 meters. *San Francisco Area:* EC: BYS. CXO has been rewired and works much more efficiently. CDE and BWL are busy with TV installation work. CXO and other stations helped K6GDI keep a clear channel for HLIUS in Korea, who was still on as of July 23rd with much emergency traffic. A very ambitious program has been set up by the combined SCMs and SECs of the San Francisco and East Bay sections, meeting with the staffs of CXO, OT, and BHY, in regard to the Simulated Emergency Test to be held October 14-15. All three stations will have definite responsibilities, schedules, and frequencies to guard during the test, and will be connected by a three-way 144-Mc. net. *Eureka Area:* EC: SLX, GXX, a very active member of the HARC, has enlisted in the U. S. Navy. FCL, AEY, FYX, and YUH are all working on 144 Mc. now. FCR is moving his mobile gear into a new car. ZZK is operating portable on 7 Mc. While NAO has been gone on his vacation, DQA has been improving his time building new antenna towers. BJO, BWV, and YUH all handled traffic for the Redwood Empire Air Tour Show, and helped in the landing and taking off of the aircraft. LE works in the Weather Bureau. WYP, BSM, EQQ, ZSE, and BBN are all building gear of one kind or another. CWR is a chief radioman in the USNR unit at Eureka. Lt. Varner, the CO of the unit, has approved the following: After 27 years, the old Naval militia armory upstairs on the northeast corner of 2nd and C St. is being completely reorged by a group of technicians from Mare Island with radio, radar, and signalling. New flooring and electrical circuits are being installed. Workshops, class-

(Continued on page 96)





*Your* **NEW 1951**  
**ALLIED CATALOG**  
*is Ready Now!*  
**212 VALUE-PACKED PAGES**

**YOU'LL FIND ALL THE NEW GEAR  
 IN YOUR NEW 1951 ALLIED CATALOG**

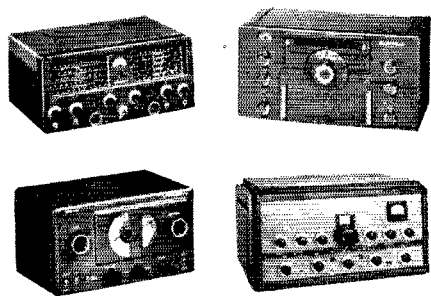

**Have Every Buying Advantage**

- World's Largest Amateur Stocks
- A Real Break on Time Payments
- A Square Deal on Trade-Ins
- Fastest Service on All Orders
- Ham-to-Ham Personal Help

**ALLIED  
 RADIO**

*Everything for the Ham*

**Send for the Leading  
 Amateur Buying Guide**

It's ready for you—the *only* Amateur Buying Guide that gives you *complete* selections of station equipment at consistently lowest prices. The new 1951 ALLIED Catalog brings you all the newest and best in receivers, transmitters, parts and station gear, ready for immediate shipment from the world's largest stocks.

Expert service by our seasoned ham staff—dollar-saving trade-in allowances, an amazingly liberal Time Payment plan—15 day trial on receivers—full 90-day guarantee—all these add up to the most reliable, money-saving service in Amateur Radio. Send for your 1951 ALLIED Catalog today—and get all these buying advantages.

**IT PAYS TO BE "EQUIPPED BY ALLIED"**

Keep Your ALLIED  
 Buying Guide Handy

**FREE**



ALLIED RADIO CORP.  
 833 W. Jackson Blvd., Dept. 15-K-O  
 Chicago 7, Illinois

Send FREE New 1951 ALLIED Catalog

Name.....

Address.....

City.....Zone.....State.....

Here is the  
**PERFECT MOBILE RIG**  
**H-W BANDMASTER XMTRS**  
 have **EVERYTHING** required  
 from **2 to 80 Meters**

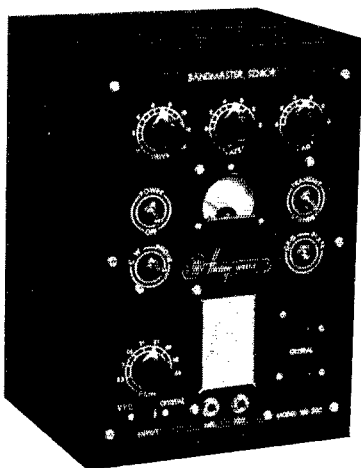

Over 3000 BANDMASTERS now in use around the world—it's the most popular and versatile small transmitter of the age.

**YOUR BANDMASTER REMAINS MODERN BECAUSE—**

It is PROTECTED by a continuous Technical Bulletin Service mailed regularly to all registered owners:

**AN INSURANCE POLICY**

Which provides methods of adding new features to your present BANDMASTER as they are developed. In this way no BANDMASTER becomes obsolete or outmoded.

**3 BANDMASTER MODELS**

JUNIOR \$87.50	SENIOR \$111.50	DELUXE \$137.50
-------------------	--------------------	--------------------

Simple inexpensive accessory kit converts Junior to Senior. Built-in antenna changeover and push-to-talk relay now available at small extra cost.

**BANDMASTER POWER SUPPLIES**

APS-50 for 110 A.C. \$39.50	DPS-50 for 6 or 12 V. 6V—\$87.50 12V—\$54.50	VPS-50 6 V. Vibrator \$29.75
-----------------------------------	---	------------------------------------

SEE THEM AT YOUR SUPPLY HOUSE  
 Send Now for Latest CATALOG  
**Harvey-WELLS ELECTRONICS, INC.**

SOUTHBRIDGE, MASSACHUSETTS

rooms, and movie rooms will be built in. The armory then will become the home of the local Naval Reserve forces. *Guam Area:* KG6DI continues his amazing traffic work with a total of 1,469 for July. Clark advises that Korean traffic should be routed through W7CZY and 6DTW to him as he has a schedule nightly with HLIUS at Pusan. He says he received Rogers on QSP to HLIUS by return mail. Regrets to Clark on his having gotten across 2650 volts from index finger to elbow, and we are all glad the results were not more serious. Traffic: KG6DI 1469, KG6FAA 363, KR6DB 161, W6SWP 48, CXO 39, GXH 35, CHP 14, ATO 4

**SACRAMENTO VALLEY**—SCM, Ronald G. Martin, W6ZF—Asst. SCMs: Northern Area 6YNM; Central Area, 6CKV; Southern Area, 6SUP. SEC: KME, ECs: Met. Sacramento, AUO; Walnut Grove, AYZ; Dunsmuir, JDN; Paradise (Chico Area), HBM; Roseville, GHP, RM; PIV, OBS: AF, BTY, PAM; ZYV, OES: PIV, GHE, OOs: ZYV, YNM, BTY, GDO, YV, OPS: JDN, Sac. Emergency Net (city), AUO, NCS, SVS Traffic Net, 29.4 Mc., ZYV NCS, GDE, ANCS, Mother Lode Net, W6I NCS, Northern Area: QIT, ex-6LKW, is working on ART-13 for all bands. ILY is trying super modulated 4E27s. YNM installed mobile in new Plymouth. IEO installed Silver 701 for 28-Mc. mobile. JDN works 75 mobile. IOI is experimenting with super-modulation. IOM, newcomer at Dunsmuir, made first contact on 7 Mc. *Central Area:* GERC is sponsoring a hamfest, Sunday, Oct. 15th, Hamilton City Park, half way between Chico and Orland. GKV worked DVS in Turlock on 144 Mc. CLG, PJV, and ZPJ are on 160. GCM says 160 is good. GVA and HNL are new SVS Net members. *Southern Area:* Placer Radio Club under call 6PXB/7 trekked to Mt. Rose near Reno to give gang contacts on 2, 10, and 75. AVK is Chairman on SARC TVI Committee. QEO, Chairman Calif. State Fair Amateur Radio Committee, reports 1950 theme is emergency communications. MIW built cascade converter. VBI moved into section from L.A. OXG is on 160. ERR has 40 watts on 75 into long wire, with consistent DX reports. CTI has 25-watt portable on 75. KMB has new portable at his mountain cabin. JN is experimenting with RTTY. WLL, ZWZ, AUO, HGW, QDT, GDO, GDE, GHN, QYQ, MIW, and Cal Smail were part of Fair Committee and thanks are due them for a successful exhibit. GQS now is on 75. DUK is converting 522 for 144 Mc. ZF is rebuilding to p.p. 813s. Traffic: W6PIV 37, ZF 34, JDN 32, KRX 6, ASI 5

**SAN JOAQUIN VALLEY**—SCM, E. Howard Hale, W6FYM—ECs: CQI, AJE, GJO, HIP, OBS: EXH, OHT, GRO, OES: PSQ, ORS; GRO, HE, OPS: IEM, GRO, OO: GRO, NSK has moved from Hanford to Newport Beach, near L.A. We are sorry to see him leave the section as we were counting on him to be a strong link in the new SJV Section c.w. net on 3.5-Mc. c.w. AJE reports that the emergency net in the Modesto Area is going full blast during the summer months, meeting every Friday at 1930 PDST on 28.8 Mc. The Stockton Club has a worthwhile summer project handling camp-to-home contacts for Camp Menzies Girl Scout Camp in the High Sierras. CPT and UWY were at the camp site and WBZ handled the home end by phone patch. GIW and your SCM walked off with the bulk of the prizes at the last Stockton Club meeting. GS and LRQ report for Bakersfield that their club now is affiliated and meets the 1st and 3rd Fridays. GRO sends the lone report from the Fresno Area. Keith still is an active worker on the American Legion Net, 3975 kc. The Turlock Club has been accepted for affiliation by ARRL. They will have a booth at the Stanislaus District Fair, handling traffic on 3.85- and 146.7-Mc. phone. EXH has started a code practice class nightly at 2000 PDST on 146.12 Mc. GQZ and PJF keep daily schedules on 7-Mc. c.w. and both check into the YL net regularly. PGP is a new AEC member in Visalia and is mobile on 28.5 Mc. We need ECs for Kern, Tulare, Kings, Fresno, Madera, and Merced Counties. Traffic: W6GRO 52, EXH 12, NSK 4.

**ROANOKE DIVISION**

**VIRGINIA**—SCM, H. E. Lindauer, W4FF—The Simulated Emergency Test schedule for October 14th and 15th should attract considerable interest from the emergency gang; viz.: SEC, ECs, AEC members, and plenty of others interested in joining up in time to take part. Write your SCM or SEC. The current international picture makes it imperative that emergency preparations should be taken very seriously. The State of Virginia, because of its proximity to the national capital and its potential link toward the south and west, has much strategic importance. Let's crank up the gear, and be ready to participate. AAM, new EC for Fairfax County, has organized a 30-station emergency phone net and has applied for a frequency of 3950 kc. The net operates daily between 1900 and 2000 E.D.S.T. with PHL as NCS. Joiners are welcome. PHL also keeps 29,640-ke. mobile busy 24 hours (stand-by and operation). CA, in Roanoke, registered for the Emergency Corps. PVA reports mobile on 29,120 kc. with plenty of bugs to be sprayed. MLH schedules ESN on 7120 kc. VE renewed his ORS appointment again and may be found on 3.5, 7, 14, and 28 Mc. Doo reports 150 countries confirmed; these beams really work. CVO is erecting one on a 40-foot

(Continued on page 98)

# RADIO SHACK PRESENTS PART OF THE TERRIFIC Hallicrafters 1951 ALL-STAR LINEUP!

## ST-74 FM-AM TUNER, \$54.50

AM 540-1700 kc, FM 88-108 mc. 60-12,000 cps. 6 tubes plus rect. Tone control. Attaches to amplifier. 115 V. AC. 13 1/4 x 5 1/2 x 7 3/4". With hardware.

Cat. No. 36-067 .....\$54.50

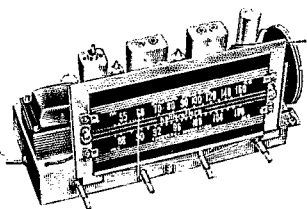

## ST-78 FM-AM CHASSIS, \$79.95

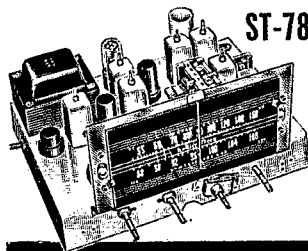

Complete radio chassis, 8-watt push-pull output. 50-14,000 cps. 10 tubes plus rect. Tone control. 115 V. AC. 12 1/2 x 7 1/2 x 11". With hardware.

Cat. No. 36-068 .....\$79.95

## FIRST ANNOUNCEMENT! AMAZING NEW SR-75 XMTR-RCVR FOR \$79.95

Combines the S-38B receiver with a slick little 10-watt transmitter covering the 80, 40, 20, 11 and 10 meter bands! Receives 540 kc to 32 mc. Xtal osc; osc keying through relay. Only 12 3/4 x 7 x 7 3/4", 16 lbs.

Cat. No. 35-017 .....\$79.95

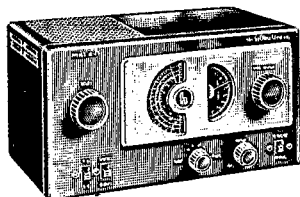

## NEW R-46 10" PM SPEAKER, \$19.95

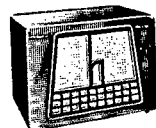

New speaker designed for Hallicrafters receivers, also "tops" for P.A. work. Satin-black metal cabinet, 15 x 11 x 10 3/4". Built-in 5/600 ohms transformer.

Cat. No. 36-060 .....\$19.95

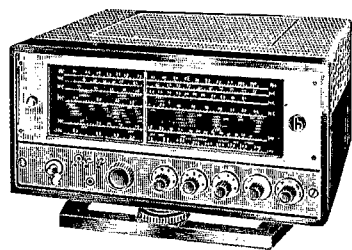

## BRILLIANT SW-FM-AM RECEIVER SX-62 IS WORLD'S FINEST SET FOR HAMS, SWL'S, AND HI-FIERS

Only SX-62 features CONTINUOUS coverage from 540 kc to 109 mc in six bands — broadcast through all the amateur, short wave, police and FM radio bands. Features: built-in crystal calibrator; six-position selectivity with crystal filter; two r-f and three i-f stages; separate bass and treble controls; 10-watt push-pull high fidelity output; phono jack; 14 tubes plus rectifier; AC operation. Attach any good PM speaker. Cat. No. 36-061 .....\$269.50

## FREE! RADIO SHACK'S

## GIANT 1951 CATALOG!

Just issued! 172 pages BIG, one of the few all-new mail order catalogs to be released this year! A gold mine of product information and listings for hams, labs, industry. 3 index pages! Lowest prices! Write TODAY for your free copy! NOTE: if you received our 1950 catalog, DON'T write — the 1951 issue will be sent to you automatically.

NAME \_\_\_\_\_

STREET \_\_\_\_\_

CITY \_\_\_\_\_ STATE \_\_\_\_\_

*The* **RADIO SHACK** Corp.

167 WASHINGTON ST., BOSTON, MASS.

**ORDER BY MAIL TODAY FROM THE RADIO SHACK!**

# New 10 Meter MOBILE TRANSMITTING ANTENNA

## NEEDS BUT 1 HOLE FOR INSTALLATION

### WARD SPP-143 AUTOMOBILE TRANSMITTING ANTENNA



Ward's exclusive 8-Ball Universal Mount requires only one 15/16" hole and fits any surface curving from 35° below horizontal to horizontal.

Ward SPP-143 transmitting aerial can be installed on the cowl, fender or flat rear deck. Whenever the transmitter is removed, the same hole can be easily plugged or used to mount a Ward 8-Ball standard broadcast antenna. The short 55½" rod reduces damage from overhead obstructions. Construction of the rod assembly permits simple removal in case of non-repairable damage. The special hook-up, illustrated below, developed by Ward research, enables the SPP-143 antenna to match and in some factors exceed the rear mounted ¼ wave 10 meter antenna.

Ward's SPP-143 antenna is sold at leading parts jobbers.

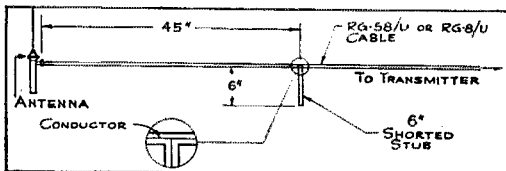

**THE WARD PRODUCTS CORP.**  
Division of The Gabriel Co.

1523 EAST 45th STREET • CLEVELAND 3, OHIO

telephone pole planted for the purpose. PVA, in Chincoteague, has back copies of QST available free to a young squirt in the beginner stage. FB, LIM is a new OPS. Net activities again will crash through on the usual frequency and time beginning early in October. New stations are invited, especially in the extreme southwest. An Alternate NCS for each regular NCS is solicited. Any volunteers? Traffic reports still suffer from summer vacations and are very few in number. Traffic: W4MLH 12, CVO 7.

**WEST VIRGINIA** — SCM, Donald B. Morris, W8JAI — Beckley radio amateurs held a successful picnic at Beckwith 4H Camp. YBQ started to the site, but drove over 250 miles and never found the site because his mobile gear failed and he got lost in the mountainous country. DRU has 20-w.p.m. code sticker and new 7-Mc. antenna. FUU, a new amateur in Hinton, is active on 7 Mc. with 200 watts to a pair of 24Gs. WSL and JM have just received the first postwar DXCC certificates issued to West Virginia amateurs. BTX comes up again with an excellent summer traffic total. Summer traffic schedules also paid off for AUJ at Weston. PQQ has 14-Mc. 'phone schedule with KR6CO and c.w. schedule with KR6CA and also received excellent write-up with pictures in Charleston newspaper. NTV toured New England and visited WIAW. KWI, YBQ, and VAB attended hamfest in Pittsburgh. FMU operated portable while attending U. of Illinois. HSC is one of the dependables on the Potomac Valley Flood Net. MARA plans to enter complete station with operators in the Monongahala Valley Hobby Show. To work West Virginia stations look around 3770 and 3890 kc. Traffic: W8BTV 604, AUJ 182, PQQ 16.

### ROCKY MOUNTAIN DIVISION

**COLORADO** — SCM, M. W. Mitchell, W0IQZ — SRC: KHQ, RMs: ZJO and LZV. ZJO has been busy building a cabin on Grand Mesa. KHQ is on 14 Mc. and is getting quite a kick out of it. He reports that the Colorado emergency net is now held on Sunday mornings at 0830 instead of 0730. OWP moved to a new QTH and is putting up new masts and rebuilding the rig. He still is in Brush, however, just a new part of town. OPF is building new 300-watt rig using an 813 in final. SFS is sweating out a Class A. PSB has his Class A and is going on 'phone. PQQ is going to Colorado University but manages to do a little hamming. LZV is planning bigger and better operations this fall. Yours truly finished the Clapp oscillator-exciter unit and it now is working swell after about three months sweating out the bugs. There were approximately two bugs for each dollar of the American National Debt! Traffic totals are rather low this month because of vacations and QRN on 3.5 and 7 Mc. I wish to take this opportunity to thank all those who were responsible for my reflection for another two-year term. I will do my best in the future, as I have in the past, and will endeavor to justify your faith in me. SGQ traded cars, is moving into a new house, and building a new rig and beam, which accounts for his inactivity the past few months. OWP was in the hospital for some time, but now is back on the job. Traffic: W0ZJO 58, KHQ 2.

**UTAH** — SCM, Leonard F. Zimmerman, W7SP — NZZ, Weber College amateur station, is testing a new beam with the help of NAU and NAY. LQU has moved to St. Anthony, Idaho. GBI has completed his new mobile station and is looking for contacts. MFQ took a trip through the Midwest this summer and reports many FB personal contacts with the hams in that region. 6VXR was a guest of JVA for several days. UIB reports little activity this month other than getting the rig oiled up for fall. He says there is too much QRN for that 3.5-Mc. WAS now. The good old FARM NET, with operations one day per week, was the only traffic net in this section to survive the summer QRN. Traffic: W7MFQ 21, SP 14.

**WYOMING** — SCM, Marion R. Neary, W7KVF — The Wyoming Hamfest at Camp Carey, near Glenrock, was quite well represented from all parts of the State. Numerous mobile rigs were in evidence. GSQ operated portable at the site with a dry-battery-powered emergency rig. HDS recruited more members for the Emergency Corps. PGS gave an interesting lecture and demonstration on beam antennas by use of microwave equipment. 0DD, Rocky Mountain Division Director, found his way into the Hamfest by use of mobile 3.85-Mc. 'phone. GS is working nice DX on 7 Mc. with his powerful 40 watts. GOH is experimenting with mobile antennas for 3.85 Mc. JDB is on a summer cruise with the Navy. EVH and OWZ stopped by to chat with the SCM. Activity is mounting throughout the State to obtain call letters on auto license plates. Traffic: W7HDS 4.

### SOUTHEASTERN DIVISION

**ALABAMA** — SCM, Leland W. Smith, W4YE — The Services are taking many of our active Alabama hams, including JYB, MJG, and K4FAG. HFL is rebuilding for high power. OEN has new 300-watt rig using 813 final. Same for EBO, who will have 813 Class B linear. EJZ is rebuilding for 28 and 14 Mc. K4KBQ is active on several nets in Birmingham, OKF operated portable from National

(Continued on page 100)

# HARVEY for the new, the tried, the true

## JUST ANNOUNCED!!

### COLLINS 1 KW XMTR

To be available about March 1951. Price will be in range \$3000-3500. Get your order in now to be one of the first to get this outstanding new rig.

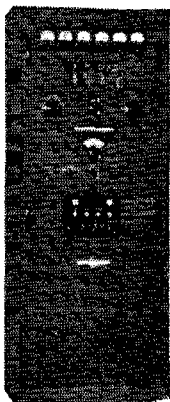

### SUPERIOR POWERSTATS

Smooth, efficient, voltage control, 0-135 volts output from 115 volt AC line. Models also for 230 volt input. Write for free literature. Models for table and panel mounting.



Type 20, 3 amp ..... \$12.50  
116, 7.5 amps, table mtg. 23.00  
116U, 7.5 amps, panel mtg. 18.00  
1126, 15 amps ..... 46.00  
1156, 45 amps ..... 118.00

### NEW COLLINS 75A-2

Double-conversion superhet with sensational stability, calibration accuracy and sensitivity. . . . all the good features of the 75A-1, plus many new ones. Price, complete with tubes \$420.; matching 10-inch speaker \$20.00.

### ANTENNAS

Complete line of Premax and Master Mount antennas and mounts carried in stock at all times. All Hy-Lite 6, 10, 20 meter beams as well as TV Yagis always in stock.

### GON-SET CONVERTERS

3-30 Gon-Set Converter; 10-11 Gon-Set Converter; 20 meter Gon-Set Converter; 75 meter Gon-Set Converter. Shpg. Wt. ea. 4 1/2 lbs. each, \$39.95

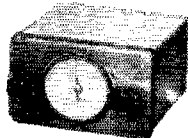

Gon-Set Noise Clipper, Wt. 1/2 lb. \$8.25

NEW Gon-Set Tri-Band Converter \$42.50

**NOTE:** In view of the rapidly changing price situation in both complete units and components we wish to emphasize that all prices are subject to change without notice, and are Net, F.O.B., N.Y.C.

## ANTENNASCOPE



Now you can be sure of maximum antenna performance with this Antennascope based on design of W. M. Scherer, W2AEF published in CQ, September. Used with a Grid-Dipper, you can measure radiation resistance, resonant frequency of antenna, line impedance, receiver input impedance, feedline s.w.r. Reduce TVI, increase xmtr efficiency, improve receiver performance, by knowing and measuring your rig. Eldico Antennascope is available in kit form or completely wired and tested.

Kit form ..... \$24.95; Wired and tested ..... \$29.95

### THE NEW SUBRACO MT 15X



The finest in mobile rigs available today. 30 watts power, class B 100% modulation, with push-to-talk and built-in coaxial type antenna relay. Xmtr complete with tubes, coaxial antenna connector, mounting brackets, etc. Shipping weight 15 lbs. .... \$87.50

MT15X for 20 meters \$87.50



### SUBRACO DS400

Dynamotor supply. 6V. DC input, 400 V. at 175 ma. output. Complete with built-in control relays, filter, etc. Shpg. Wt. 10 lbs. .... \$79.95



### MILLEN 90651

MILLEN GRID DIP METER  
Ready to go. \$55.00

## ELDICO PRODUCTS

### NEW IMPROVED GRID DIP OSCILLATOR KIT



The most valuable piece of test equipment in the ham shack is the Grid Dipper. Build one with this kit and save countless hours in building, improving and debugging your rig. The GDO Kit builds an exact duplicate of the "Grid Dipper," now with regeneration. Includes everything from the special handy case permitting one-hand operation down to a complete application and instruction book. With tube and internal power supply, range 3 Mc to 250 Mc in 6 steps, size 3 1/2" x 2 3/8" x 3".

Complete Kit \$24.50

Eldico TVT-62 low-pass filter, kit. \$7.99

Wired and tested ..... \$10.99

Eldico TVR-300 for Twinex or TVR-62 for co-ax, high-pass filter, kit ..... \$1.98

Wired and tested, either type \$3.98

Brute Force line filter, kit..... \$5.98

Wired and tested ..... \$8.98

Copper mesh shielding, 36" wide, min. order 6 sq. ft., per sq. ft. .... \$85 plus \$.50 per order for packing.

TR-1 transmitter kit..... \$199.50

TR-75 transmitter kit..... \$44.95

MD-40, 40-watt modulator kit... \$34.95

MD-40-P, same with power sup. \$44.95

MD-100, 100-watt mod. kit ..... \$49.95

Wired and tested..... \$59.95

### ELDICO HIGH VOLTAGE POWER SUPPLY KITS

Kit No.	Output	Price
HV-1500	1500 v. 350 ma.	\$39.50
HV-2000	2000 v. 500 ma.	79.50
HV-2000SP	2000 v. 700 ma.	95.95
HV-2500	2500 v. 500 ma.	99.95

### ELECTRONIC BUG AUTOMATIC DOTS AND DASHES

EE-2



EE-1, kit form..... \$21.95  
Wired and tested ..... \$27.95

EE-2, with integral monitor,  
Kit form ..... \$29.95  
Wired and tested \$39.95

Telephone: **7** LUXemburg 2-1500

**HARVEY**  
RADIO COMPANY, INC.

103 West 43rd St., New York 18, N. Y.

Write for  
FREE  
TVI BOOK





# Hunting a BARGAIN?

Save Money with a *Surprise* Trade-In Allowance on Your Used Test or Communication Equipment for one of the **NEW**

## **National** RECEIVERS



For saving cold cash on hot values nothing beats the bargain you get when you trade your used (factory-built) communication equipment for the National Receiver of your choice. To get your extra-liberal "Surprise" allowance, simply tell us what you have to trade. We'll respond, pronto, with our money saving offer. Wire, write, phone or use the handy coupon today!

### For The Discriminating Radio Amateur

A super value when you take advantage of our "Surprise" offer on your used equipment. What have you to trade?

**New NC-125**  
Shpg. wt. 36 lbs.  
Less spkr.....Only

**\$149<sup>50</sup>**



Buy it at a sensational saving by trading in your used equipment. Tell us what you have to trade.  
Shpg. wt. 34 lbs.....Only

**NC-57**  
**\$99<sup>50</sup>**

**FREE!** New 164-page Catalog. The "Treasure Chest" of values. Send for your copy today.

All prices f. o. b. St. Louis  
Phone CHEstnut 1125

**A WORD TO THE PROSPECTIVE NOVICE**  
From our complete stock of National Receivers you can choose the instrument ideally suited for your entry into the proposed Novice class of Licensee in Amateur Radio. Free copy of latest National catalog is yours for the asking. Depend on Walter Ashe for the latest and best buys in Radio, Electronics, Components and Supplies to meet your every requirement.

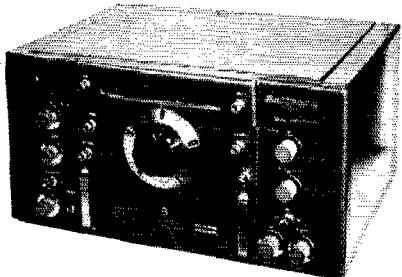
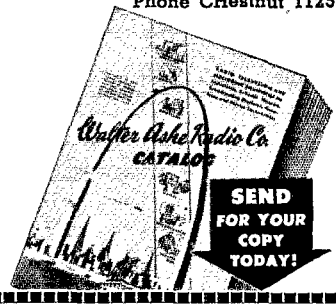

Buy this amazing HRO-50 by applying your trade-in allowance against the above price.  
Shpg. wt. 80 lbs. Less spkr. .... Only

**HRO-50**  
**\$359<sup>00</sup>**

**Walter Ashe**  
**RADIO CO.**  
1125 PINE ST. • ST. LOUIS 1, MO.

Walter Ashe Radio Co.  
1125 Pine St., St. Louis 1, Missouri Q-50-10

Rush Special "Surprise" Trade-in offer on my \_\_\_\_\_  
(show make and model No. of used equipment)

for NATIONAL Receiver \_\_\_\_\_ (indicate model No.)

Mail my Free copy of new 164-page Walter Ashe Catalog.

Name \_\_\_\_\_  
Address \_\_\_\_\_  
City \_\_\_\_\_ Zone \_\_\_\_\_ State \_\_\_\_\_

# LOOK

## POWER SUPPLY SCOOP!

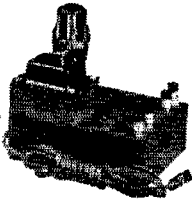

Utility power supply, 350 volts dc @ 50 Ma., 6.3 volts @ 2 Amp., black crackle chassis  $6\frac{1}{2}$ " x 5" x 2". Has choke and 2-section filter, AC switch and line cord, a wonderful buy, less No. 80 rectifier, only..... **\$2.25**

## BEACON RECEIVER

For any remote control application, BC-341-F, 2-tube, 140-160 Mc. receiver. Ultra-sensitive plate-current relay in set can be used to control external circuits, open doors, etc. Handsome aluminum cabinet, circuit printed inside. Uses 12C8, 12SQ7, or 6B8, 6SQ7 (tubes not included). **\$2.25**



## PLATE TRANSFORMER

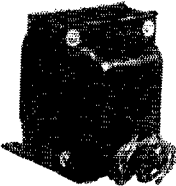

510-0-510 volt, 200 Ma. transformer, fully shielded, upright mounting, electrostatic shielding,  $4\frac{1}{2}$ " high, 4" wide, 4" deep, 9 lbs. at less than half regular price **\$3.95**

## 10 HENRY

### 200 MA. CHOKE

150 ohms dc resistance, 1500 volt insulation, moisture proof, mounting centers  $3\frac{1}{8}$ ". Here is the best buy to date, only..... **\$1.49**

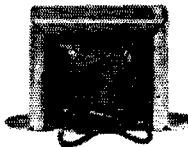

## FILTER CONDENSER SPECIAL

6 MFD 600 WVDC G.E. Pyranol condenser, has mounting lugs, new,  $4\frac{3}{4}$ " high,  $2\frac{3}{4}$ " x  $1\frac{1}{4}$ ", buy several at this price..... **95¢**

# Steinberg's

633 WALNUT STREET • CINCINNATI 2, OHIO

hospital. BL and FL are out and mending, but OY still is in the clutches of the medicos and is scheduled to be returned to the U. S. A. OY has been very active in the AEC and CZARA and the gang will miss him. GM is in the States on official business. GF is our newest licensee. Requests or cards for a 1950 Field Day QSL should be forwarded to AW. Thanks to the efforts of CZARA president RM and SEC FL, the Canal Zone section will have call license plates for 1951. Traffic: KZ5FL 20, LR 17, RM 6, BT 4.

## SOUTHWESTERN DIVISION

LOS ANGELES — SCM, Virge A. Gentry, jr., W6VIM — L SEC: ESR. PAM: MVK. RMs: CE, CMN, DDE, FYW, IOX, and LDR. Hi, gang! We've heard a lot of favorable comment about the July Inglewood Hamfest and Picnic. Credit is due all those responsible, especially the Inglewood Amateur Radio Club. Another major change has been made in the AEC. SEC WOU resigned July 31st because of an increase in his working hours. Mel wishes to thank the entire AEC for helping him get started in the job. AEC veteran ESR's business situation is such that he was able to accept reappointment to the SEC post. AEC veteran RTT replaced DLQ as EC for the Centinella Valley Area. DLQ requested resignation because of an increase in his working hours. DLR's July DXing went something like this: (G14RY, VR2AS, VS1DB, TG9AD, F08AC, ZS2FE, and DL1FF. CMN has been on 3.85-Mc. 'phone. YSK reports affiliation with the 1.9-Mc. Gyppo Net. LDR reports that the Southern California Net needs a traffic outlet in the Long Beach Area. GYH received appointment as ORS. We are glad to hear that AEE has licked his TVI and is back on the air with a kw, and a radioteletypewriter. IZY worked CX1GG for 15 minutes with 50 watts. BHG reports that DL4DI is back Stateside and hopes to be on the air in Long Beach soon. AAE completed a tour of duty at the U. S. Naval Amphibious Base at San Diego. ISQ now has a pair of 4-125As, ambition, but no time. MJU handled the Mount Baldy Area AEC while the regular EC, COZ, operated portable from the San Bernardino Mountains. FYW received a "Certificate of Merit" in connection with his participation in the Armed Forces Day Amateur Radio Competition in May. MYI resigned from the Templeton High School staff and moved to the Redwood City Area. IWD is looking for 144-Mc. contacts. MSG is experimenting with a radioteletypewriter. LKF worked an EL AM has shifted most of his operating from his Long Beach station to his rhombic-laden ranch station in the Palos Verdes Hills, TL, PSX, and APQ have returned from Monterey, Calif., where they have been "on location" for five weeks with Warner Bros. TL operated 28-Mc. with an MBF. PSX was on 3.85-Mc. 'phone with a 654 while APQ kibitzed from the side lines. Regular schedules were maintained with EP and KP. TDW received OBS appointment. CFL is ready to work San Diego on 420 Mc. Our greatest difficulty might be in getting San Diego to go on 420 Mc. We wonder if one of you OOs would help CFL get his 2400-Mc. transmitter into the band. HII MCT has been heard on 420 Mc. TDW operated 3.85-Mc. 'phone while mobile railroad was in motion! A TBS-50 was used in the caboose. One of the 28-Mc. contacts was with a maritime mobile station off the coast of Cuba. We wish to thank all of you for helping your SCM to get the station appointments up to date. Let's all keep 'em there. We are again approaching a time when every amateur should be emergency-minded enough to register in the AEC. Even if you don't own equipment, you can at least offer your services by registering in the AEC as a supporting member. Traffic: (July) WGCE 2339, GYH 418, LDR 163, ANT 96, HLZ 59, BHG 57, CMN 42, GWB 34, JQB 29, AM 10, COZ/67, YSK 4, FYW 3, QAE 3, AAE 1, GYI 1 (June) W6EVH 4.

ARIZONA — SCM, Jim Kennedy, W7MID — The Arizona gang was saddened to learn of the death of NPP's XYL, Christine, a polio victim. KRW and LQB did nice jobs of getting the news through to Ecuador and Massachusetts. MOW reports a new country for his list. VR2BP. JYZ's home now supports a new four-element 14-Mc. beam. LVR has been helping to clear the channel for IAW's code practice runs. A new Class A license in Phoenix is QNO. A new call in Ajo is OQS, who puts out a potent mobile signal with 50 watts input. LBN has a nifty home-built scope. If you're a League member, why not apply for an official appointment of some sort? This will make you eligible for the CD Parties and you'll get a lot of information from Headquarters, letting you know what cooks around the country. If you're not a League member, we'd still like you to register yourself and your gear with us for membership in the Amateur Emergency Corps. A state-wide emergency plan is now being set up, and ham radio will have a major role in the plan. Cameron Allen, OIF, 1020 E. Maryland, Phoenix, is State Emergency Coordinator, so why not drop him a card requesting an application form for the AEC? Traffic: W7MOW 10, LVR 6, JYZ 3, MID 2.

SAN DIEGO — SCM, Dale S. Bose, W6BWO — The summer months have taken their customary toll of activities, but the Soledad Amateur Radio Club of San Diego handled the amateur exhibit at the San Diego Fair at Del Mar. The Club station, GER/6, was operated by members

(Continued on page 104)



# HAMS? No!



## THESE MEN ARE NOT AMATEURS

A PHYSICIST with Dupont  
 A New Jersey radio SERVICEMAN  
 A radio school INSTRUCTOR in Wash-  
 ington  
 A Navy RADIO OPERATOR  
 An ELECTRICIAN at Bethlehem Steel  
 A telephone LINESMAN in California  
 An ENGINEER in a Minnesota broadcast  
 station

**BUT**—they work in electronics, and, like thou-  
 sands of others employed in radio and its allied  
 industries, they bought Handbooks. You would  
 naturally expect men like these to have the  
 latest edition.

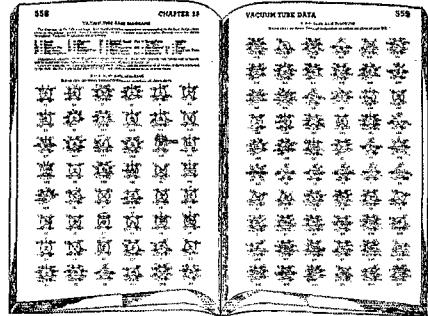

## NOW LOOK AT THESE MEN

A SALESMAN for a Tennessee hosiery mill  
 A PSYCHOLOGY PROFESSOR at the Uni-  
 versity of Texas  
 A Massachusetts PHYSICIAN  
 A publishing company PRESSMAN in Illinois  
 A TRAPPER and prospector in British  
 Columbia  
 A CONDUCTOR on the A. T. & S. F. railroad  
 The chief CHEMIST of a Pennsylvania  
 corporation

**They're NOT in electronics  
 And they're NOT amateurs  
 Yet, each one bought a Handbook**

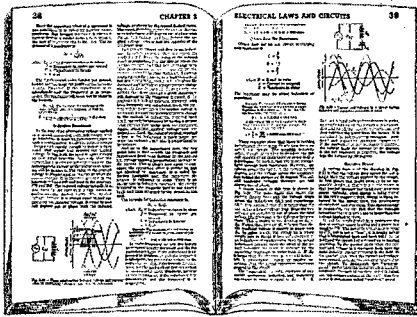

## THE HANDBOOK IS USEFUL TO EVERYBODY!

It has 25 chapters on electrical and radio theory, vacuum tube principles, modulation, keying, antennas, transmission lines, power supplies, VHF, UHF, workshop techniques, miscellaneous data and station operating.

It tells you how to build many types of equipment for receiving, transmitting, testing, measuring.

With its 1076 illustrations, 89 charts and tables, 414 tube base diagrams, 77 basic formulas, 118 page catalog, the **1950 RADIO AMATEUR'S HANDBOOK** has something important in it for YOU.

**\$2.00**

*\$2.25 in U. S. Possessions and Canada, \$2.50 elsewhere*



38 LA SALLE ROAD

**THE AMERICAN RADIO RELAY LEAGUE, INC.**

WEST HARTFORD 7, CONNECTICUT



# Your Own Secret Weapon: ELECTRONICS TRAINING!

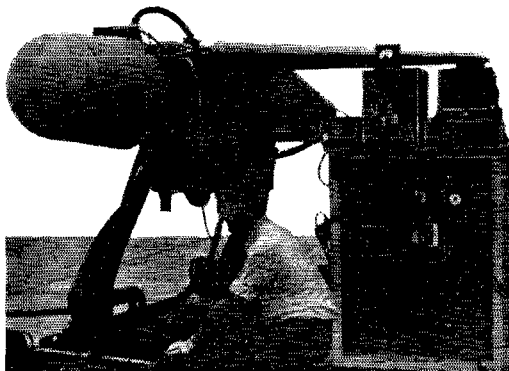

Radar-guided glider bomb.  
Official U. S. Navy Photo

**Whether in the Armed Services or Industry  
CREI TRAINING PAYS OFF — with  
More Money, Interesting Jobs, Secure Careers**

Electronics in war directs gunfire, drops bombs, finds enemy planes, "homes" friendly planes, detonates explosives, and finds targets. Any man with electronics training gets an important berth in the Services. Just as essential to industry, the man with advanced electronics know-how is assured of an interesting, well-paid career.

CREI offers practical technical training through home study. It grounds you thoroughly in fundamentals required for work in guided missiles, TV, and the whole field of communications and electronics. With CREI training you qualify for work in an industry desperately in need of qualified men. Or, if you enter the armed services, your electronics knowledge puts you in line for promotion.

Make your own opportunity. Start preparing now — while there is still time. The cost is within reach of all, the terms easy. Write immediately!

## MAIL COUPON FOR FREE CATALOG

**CAPITOL RADIO ENGINEERING INSTITUTE**  
Dept. 1610B, 16th & Park Rd., N.W., Wash. 10, D. C.

Send booklet "Your Future in the New World of Electronics" and course outline.

CHECK  PRACTICAL TELEVISION ENGINEERING  
FIELD  TV, FM & ADVANCED AM SERVICING  
OF  PRACTICAL RADIO ENGINEERING  
GREATEST  AERONAUTICAL RADIO ENGINEERING  
INTEREST  BROADCAST RADIO ENGINEERING (AM, FM, TV)  
 RADIO-ELECTRONICS IN INDUSTRY

Name.....  
Street.....  
City..... Zone..... State.....  
If residence school in Wash., D. C. preferred, check here

of the Club and did a swell job with quite a bit of traffic as well as winning several ribbons and certificates. The Fuller-ton and Orange County Clubs are planning to participate in the Orange County Fair at Santa Ana. This will be the last report from me as SCM, as I am forced to resign the office because of lack of time to devote to it. I have purchased a farm in Northern California so will soon be leaving the San Diego section. Thanks to everyone for his cooperation. Traffic: W6YYN 1341, GER/6 778, BAM 10.

## WEST GULF DIVISION

**N**ORTHERN TEXAS — SCM, Joe G. Buch, W5CDU — JNK reports for the Caravan Club. With a charter membership of 14 in May, 1948, the present membership numbers 42 and includes the following: BNQ, CC, CN, CPW, CKK, CVB, DAS, DM, DXR, ECE, EDW, ESC, EVX, FXV, HBE, HGU, IFY, ISM, IUA, JKY, JQY, JNK, KUS, KVS, KWC, KZN, LCJ, LSP, LVM, MC, MIY, MQH, NAX, NEK, NRE, OGG, PDX, PWF, PZA, QMF, and RG. Operating frequencies are 3990 and 29,150 kc. Members report in by mobile or fixed stations at 1400 on Sundays. We believe the Caravan Club sets the pace for the best organized mobile unit in the country. On Field Day, the Club's 522 rig was set up and contact was made with 4HHK on 144 Mc. This represents a distance of 425 miles. MA has a good 28-Mc. signal — in nearby TV receivers. EN and OFV are AECs in Greenville. LGY is Florida bound; Helen's car license number is 8873. RWM is a brand-new call in Benjamin. QMJ, his son, also operates from Benjamin. Glad to hear BBH back on the active list. OLW is running 20 watts on 14 Mc. PPS rolled up 4255 points in the CD Party. JJC is struggling on 3.85 Mc. with a clothesline antenna. How about asking your friends to become ARRL members? We need them in this helpful and democratic organization of amateurs. You wouldn't know it is summer, judging by the activity of Northern Texas section EC nets. Traffic: W5ARK 85, BKH 84, PPS 8.

**OKLAHOMA** — SCM, Frank E. Fisher, W5AHT/AST — SEC: AGM. RM: OWV. PAM: ATJ. The Oklahoma Phone Emergency Net now has a monthly bulletin called *Open Letter*, with EAK as reporter. Net attendance on Sunday morning drill has averaged perhaps two-thirds total membership — very good for summer. OLZ is having its troubles since the Korean situation affects much of its membership. OWV has resigned as RM because his new job moves him about. Keith now is pounding brass on railway land lines. KDH is about to take the same step. K5WAH is closed down because PML has been transferred to duty at points unknown. GVV has taken over MARS duties but will stay with OLZ. Dutch, at FOM, celebrated his twentieth wedding anniversary. Full members of Oklahoma AEC now rate a pass through state police lines, thanks to the efforts of AGM. Claude has been fitting about the country on business, leaving EHC to look after AEC affairs. The Pioneer ARC had a ham picnic at Lake Ponca, attended by some thirty-odd. JP completed new home and shack. BIW spent three weeks chasing parasites on one exciter. Looks like ECA is quitting the ham game — for a time! EGR has a jr. operator and is going mobile on 28 Mc. Is this a coincidence? Ardmore welcomes a new ham, RVX. There is much activity on 144 Mc, but no details are reported. Traffic: K5NRJ 325, W5AHT 19, FOM 19, EHC 18, OYP 17, OQD 9, ADB 1.

**SOUTHERN TEXAS** — SCM, Ammon O. Young, W5BDI — MN is handling plenty of traffic. ACL is on all the popular bands and has even been on phone. NNY, NMG, and IYR, who has new HRO-50, are DXing on 14 Mc. LX is on 28 Mc, just waiting for the band to open for DX. ADZ has been dividing his time between DX and fishing. LXY is moving to new QTH where he may be able to put up a rhombic. EZE is on 160 meters. AYU is on 3.85, 7, 14, and 28 Mc, when not looking for KPRC-TV. FEK is very active on 144 Mc., and has added several states this season. The Port Arthur College Radio Club has its familiar call, W5YH, back from FCC. The PAC Net meets Mondays, 7 to 8 CST, on 14,049 kc, and 8 to 9 P.M. CST on 7025 kc. Traffic: W5MN 444.

**NEW MEXICO** — SCM, Lawrence R. Walsh, W5SMA — SEC: BYX. RM: ZU. PAM: BIW. PAM v.l.f.: FAG. Your SCM incorrectly reported the officers of the Sandia Radio Club. Here is the correct listing: MSG, pres.; JXC, vice-pres.; QPK, treas.; FPB, secy. At the July 24th meeting of the Sandia Radio Club MSG spoke on "The Various Uses of the BC-221 Frequency Meter." FPB is to be congratulated on the FB job he did in compiling a "personnel roster" of the members of the Sandia Radio Club. A new member of the Albuquerque AEC is RMJ, who is on 7 Mc. Anyone who has not signed a petition for call sign license plates, please send a penny postcard to Francis Gornley, W5KWR, 670 Canyon Road, Santa Fe, N. Mex., stating that you wish your name added to the petition. A new call in Albuquerque is FVO, formerly 7JQU of Smithfield, Utah. PLK has a new HRO-50. On July 13th, Truth or Consequences, N. M. (home of our SEC), enjoyed an emergency condition after a 5-inch cloudburst washed out roads and telephone lines. BYX, JXH, BIW, and KBP handled traffic for the bus lines and the telephone company. NXP

(Continued on page 106)



**Our 28th Year**  
**QUALITY - PRICE**  
**DEPENDABILITY**

**PLATE TRANSFORMERS**

For Small Transmitters. DC Voltage Ratings are Approx. Values Obtained at Output of a 2 section Choke input Filter. Using Mercury Vapor Rectifier Tubes Pri. is for 115 V. 60 cy.

Type No.	Sec. Rms. Volts	DC Volts	Sec. MA.	H. Dimensions	W. Dimensions	D. Dimensions	Price Each
P 57	660-660†	500	250	4 5/8	3 1/2	5	\$7.35
P 58	550-550	400	125	4 5/8	3 1/2	5	\$9.01
	1080-1080	1000*	150	4 5/8	3 1/2	5 1/8	\$8.82
P 59	500-500	750	225	4 5/8	3 1/2	4	\$21.90
	900-900	600	300	5 3/4	6 1/8	4	\$27.49
P 67	1450-1450	1200	300	5 3/4	6 1/8	4 1/4	\$27.49
	1175-1175	1000	300	5 3/4	6 1/8	4 1/4	\$27.49
P 68	2100-2100	1750	300	5 3/4	6 1/8	4 1/4	\$27.49
	1800-1800	1500	300	5 3/4	6 1/8	4 1/4	\$27.49

\* For dual operation with simultaneous use of both sec. ratings.  
 † Has 40-volt bias tap.

**LYSCO**

**EXCITER - TRANSMITTER**  
 Model 600 Model 500  
 De-TV-Ed Conventional VFO or XTAL



35 watts input on 10, 11, 20, 40, 80 & 160 meters. Output 50 ohm coax. Break-in keying—P.A. meter—Band switch and all controls on front of panel. Large illuminated vernier dial. Series/Tuned "Colpitt's" Oscillator—Voltage regulated power supply—Modulator terminals at rear of chassis. Tubes—6AG7 Oscillator, 6AG7 Buffer, 807 P.A., 5U4G Rectifier, VR-150 Voltage regulator. Furnished in handsome metal cabinet 15"x19"x8" complete with tubes, ready to go.  
 Model 600 .....\$119.95  
 Model 500 .....\$109.95  
 Descriptive bulletin on request.  
 Model 50 Antenna Coupler designed to feed long wire from transmitter .....\$ 11.95

**INTERPHONE AMPLIFIER**

BC 8611 has input for carbon or magnetic mike, 1-6V6 & 1-6SJ7 tube, volume control. Operates on 24V. input. Complete with dynamotor & mounted in a sturdy metal cabinet. Shipping Weight 14 lbs. Any way you look at it it's worth having at our price of .....\$2.95

**GRID DIP METER**  
**LYSCO "DIPMASTER"**

3 Mc to 150 Mc frequency range; calibrated dial. Ideal for Signal generator, 3.4 to 300 Mc range phone monitor, F.S. meter, or absorption wavemeter. Complete power supply and tubes. Really a good buy at .....\$32.83



**ALUMINUM CHASSIS**

7x6x2...18 gauge.....	\$0.82	10x14x3...16 gauge.....	\$2.26
9x7x2...18 gauge.....	\$0.92	15x7x3...16 gauge.....	\$1.76
7x7x2...18 gauge.....	\$1.03	17x10x3...16 gauge.....	\$2.20
5x10x3...18 gauge.....	\$1.12	17x13x3...16 gauge.....	\$2.82
7x11x2...18 gauge.....	\$1.06	17x13x5...14 gauge.....	\$3.67
12x10x3...18 gauge.....	\$1.62		

We carry a complete stock of steel & Aluminum Chassis & Panels.

**METERS**



100 amp.—6 volt D.C., 3 inch scale, 4 1/2" square, Grey finish, supplied with 100 amp. shunt. Brand New. Each as illustrated .....\$1.45

**SPECIALS**

**REMOTE CONTROL BOXES**  
 For SCR 522's, Consists of 5 push button switches, 5 Western Electric Pilot Assemblies, with Electric Pilot Bulbs and Dimmer, and lever Switch all finished in Black Crackle. Order yours Today for only .....\$ .95

2 1/2 watt Argon bulbs 10 for \$1.75  
 1/4 watt Bayonet base Neons 10 for \$1.90  
 FT-243 XTAL holders 12 for \$0.50  
 2x2 RECTIFIERS .....\$0.39  
 8BP1 C.R. Tube .....\$1.45  
 BC484 CONTROL BOX .....\$0.95  
 T-30 THROAT MIKE 10 for \$1.00

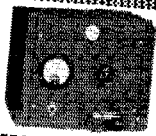

**RAPID ELECTRIC SELENIUM RECTIFIER MODEL 507 SPECIFICATION**

AC Input—110/120V. AC 60 cycle single phase.  
 DC Output—5 Amperes 0-7 Volts Duty—Continuous

**FEATURES:**

Accurately calibrated voltmeter—Output current and voltage tapered control affecting smooth variation from zero to maximum—Full wave rectification with capacitor filtering—Extra smooth (low ripple) DC power.

**SUGGESTED APPLICATIONS:**

Battery charging—(from 2 volt to 6 volt cells) at any current up to 5 Amps.—Battery eliminator—substitute for dry or wet cells—Operate and control speed of model locomotive—DC power for hobby plating kits—Portable DC supply for Analytical Chemist to do "on the Spot" analyzing—Ideal for Physic and Chemistry teachers and School Laboratories. **\$19.95**

**FILAMENT TRANSFORMERS**

Type 940 2.5VCT @ 10 Amps.	7500V Ins.	\$3.08
Type 040 5. VCT @ 3 Amps.	2500V Ins.	\$2.26
Type 941 5 VCT @ 6 Amps.	2500V Ins.	\$2.66
Type 943 5 VCT @ 3 Amps.	2500V Ins.	\$5.88
Type 946 6.3VCT @ 20 Amps.	2500V Ins.	\$2.20
Type 947 6.3VCT @ 3 Amps.	2500V Ins.	\$2.94
Type 948 6.3VCT @ 6 Amps.	2500V Ins.	\$2.20
Type 960 7.5VCT @ 10 Amps.	2500V Ins.	\$2.94
Type 143 7.5VCT @ 4 Amps.	2500V Ins.	\$4.11
Type 146 10 VCT @ 8 Amps.	2500V Ins.	\$2.64
Type 961 Dual 6.3VCT @ 10 Amps.	3000V Ins.	\$4.53
Type 041 5VCT @ 3 Amps.	2500V Ins.	\$5.44
6.3VCT @ 3.6 Amps.		\$3.69

**RAYTHEON VOLTAGE STABILIZERS**

Positive Stabilization ± 1/2%  
 Input 95-130 volts, 60 cycles single phase; output 115 volts stabilized to ± 1/2%. \*Output 6.0 or 7.5 volts stabilized ± 1/2%.

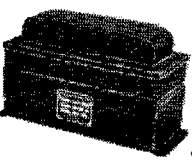

Catalog No.	Output Cap. Watts	Net wt. lbs.	Price
VR-6110	15	4	\$15.00
VR-6101	30	5	\$17.00
VR-6111	30	5	\$17.00
VR-6112	60	8	\$24.00
VR-6113	120	14	\$31.00
VR-6114	250	25	\$48.00
VR-6115	500	45	\$75.00
VR-6116	1000	92	\$125.00

**VARIABLE CONDENSER**

6 Gang; 1 section of .00025 Mfd., 4 sections .000035 Mfd., 1 section of .00005 Mfd.; with 5 air trimmers of 15 to 25 Mmfd capacity. Silver Plated. Each only .....\$95c



**SUPERIOR POWERSTATS**

Smooth, efficient voltage control. 0 to 135V. output from 115V. AC line.  
 Type 20 (illustrated) 3 amps.....\$12.50  
 116 for table mtg 7.5 amps..... 23.00  
 116U for panel mtg 7.5 amps..... 18.00  
 1126 15 amps..... 28.00  
 1156 45 amps..... 46.00  
 Also available for 230 volt input. Write for descriptive literature.

**CHOKES**

SMOOTHING TYPE	Hy	SWINGING TYPE	Hy	Price Each
C-80	10	C-87	4-16	150
C-81	10	C-88	4-16	200
C-82	10	C-89	4-16	250
C-83	8	C-90	3-14	300

All above 3000 Volts Insulation

If not rated 25% with order, balance C. O. D. All prices F. O. B. our warehouse New York. No order under \$2.00 We ship to any part of the globe.

**LEEDS RADIO CO.**

75 Vesey Street Dept. QS 1  
 Cortlandt 7-3440 New York City 7

# RADAR, COMMUNICATIONS and SONAR TECHNICIANS WANTED

For Overseas Assignments

## Technical Qualifications:

1. At least 3 years' practical experience in installation and maintenance.
2. Navy veterans ETM 1/c or higher.
3. Army veterans TECH/SGT or higher.

## Personal Qualifications:

1. Age, over 22—must pass physical examination.
2. Ability to assume responsibility.
3. Must stand thorough character investigation.
4. Willing to go overseas for 1 year.

Base pay, bonus, living allowance, vacation add up to \$7,000.00 per year. Permanent connection with company possible.

Apply by Writing to:

C-3, P.O. Box 3552  
Philadelphia 22, Pa.

Men qualified in RADAR, COMMUNICATIONS or SONAR give complete history. Interview will be arranged for successful applicants.

has a new three-element 14-Mc. beam to use with his 32V-1. BIW is teaching the theory part of the Messilla Valley Club training program. The class meets Tuesday and Friday evenings.

## CANADA MARITIME DIVISION

**MARITIME** — SCM, A. M. Crowell, VE1DQ — SEC: FQ. At this writing the SCM is on his way to Detroit to attend a convention so this is FQ trying to fill the gap. CR did an FB job of lining up contacts for FP8AC at St. Pierre. HC and TI ran schedules with the Carlins, in their amphibious jeep on its journey across the Atlantic. HC and BC have been running tests on 50 Mc. QZ has the 50-Mc. tape running on 50.10 Mc. BV is aboard the ice-breaker, *N. B. McLean*. The HARC and the Yarmouth gang recently held picnics. BF attended the North Bay Hamfest. EA recently visited VO-Land. KW has been transferred to the RCAF Signals School at Clinton as an instructor. UC has been transferred to Camp Borden. Newcomers to the VE1 district include 4DO and 2SS. LG is sporting a new Commander receiver. 3YR was a recent visitor to Halifax. BB operated from the Shediac Lobster Festival. VO has returned to Cross Island. 3ZW was a recent visitor and operated portable from Big Island. JS has been posted to St. Paul's Island for a year. FQ contacted the MacMillan Expedition ship, the *Bowdoin*, W2OXE/MM. Among those heard on 3.8-Mc. mobile are GH, SH, EY, JK, BB, GF, JG, NZ, AA, CI, ME, and IK. Traffic: VE1FQ 35, BK 10, DB 7.

## ONTARIO DIVISION

**ONTARIO** — SCM, G. Eric Farquhar, VE3IA — Greetings and thanks to those who nominated and elected me as their representative for the next two-year term. Because of the summer recess, reports on VE3 activity are somewhat scarce. Successful hamfests were held by the Gateway Radio Club of North Bay, the Ottawa Amateur Radio Club, and the Ontario Phone Club. BUR spent vacation in WI-Land and visited Headquarters, reporting an FB time. BCZ has settled down in temporary quarters, having been forced out of his regular quarters by fire. BLY handled important illness traffic. IA contacted the schooner *Bowdoin* and QSP traffic. GI turns in a good month's total despite having been busy rebuilding. EAA and DEI now are located in Peterboro. Our SEC, KM, reminds all to be ready for the Simulated Emergency Tests being run in Ontario on Sept. 9th and 10th. Let's have your reports, gang, so we can make your activities known. Traffic: (July) VE3IA 157, ATR 49, GI 42, KM 39, YJ 34, BUR 27, WY 21, BLY 18, AYW 11, OJ 6. (June) VE3YJ 56, AZH 17.

## QUEBEC DIVISION

**QUEBEC** — SCM, Gordon A. Lynn, VE2GL — CA reports continued schedules and traffic-handling by Phullis with 8SM, Resolution Island. OM is being transferred to Hong Kong, where he hopes to get on the air. GM has sold out and will be absent from the air for a while. XR is taking over the managership of PQN and QEN. AKJ has new 3.5-Mc. off-center-fed antennas and is now ORS. The St. Johns Amateur Radio Club held a successful picnic at Plage Labelle on Aug. 5th with hams from St. Johns, Iberville, Beloeil, Bedford, St. Lambert, and Montreal attending. JN has 3.8-Mc. mobile in the car and RC is contemplating the same, having the center-loaded whip in place and the rig being installed. AIO has super-modulation on 3.8, 14, 28, and 50 Mc. XF continues handling traffic with north country in a big way, usually after midnight. HH is experimenting with super-modulation and 3.8 Mc. LP is now at Roberval but finds operating time limited. NM is being transferred to Frobisher and will be working portable VE8 until he gets his new call. GD is on 3.8-Mc. phone from new QTH in St. Lambert. AEH has converted his 19-set to screen grid modulation. By the time this appears PQN will be starting activity for fall and winter. Drop in on 8570 kc. with traffic or to take traffic. Traffic: VE2ZF 192, CA 29, QN 28, AKJ 1.

## VANALTA DIVISION

**BRITISH COLUMBIA** — SCM, Ernest Savage, VE7FB — ZF has been host to CN, ACW, W7BQS, W7EBK, FB, AKD, and others who have stopped there on their way through Penticton. Those that didn't make Kelowna Hamfest sure missed a night and a swell Sunday. US is now in Vancouver. AGK is looking for northern members to form a c.w. net on 3.5 Mc. Look for him on 3537 kc. at 2130. ABF is operating from Fort Edward. Also up there is AKG. That potent grunt you hear on seventy-five is OD and not five watts now. The Nanaimo ARC reports officers are DH, pres.; HB, vice-pres.; SH (YL), secy. The Club is moving to a new club room, thanks to the City of Nanaimo. YI, at Maiden Creek near Clinton, is doing fine. If you are out that way stop and visit. AKD has done a fine job mounting PE-103 in the mobile and sure gets out. Those two nickel poles on the stern end of a car is MQ. SF visited

(Continued on page 108)

### CODE SENDING SPEED RECEIVING SPEED



#### HAVE SKILL, ACCURACY

SEND and RECEIVE CODE this EASY — FASTER WAY! THE CANDLER SYSTEM has developed expert Amateur and Commercial Operators, and Code Speed Champions. In a few weeks you can pass the code examination for license. You can send and receive with amazing skill and speed, without tension. Long hours of practice unnecessary to acquire proficiency. THE WAY YOU LEARN is ALL IMPORTANT! By simple progressive lessons Candler teaches you at home to send and receive as easily as you talk or read — FAST, ACCURATELY. SEND Now For FREE BOOK — explains how fine amateurs and radio-telegraph experts learned code and developed skill and speed.

#### CANDLER SYSTEM CO.

Dept. 4-L, P. O. Box 928, Denver 1, Colo., U. S. A.  
and at 121 Kingsway, London, W. C. 2, England

**immediate  
delivery...**

# hallicrafters

**HERE'S** your chance to get the sensational Hallicrafters receivers you've been trying so hard to find. **THEY'RE ALL HERE... in stock at Newark... FOR IMMEDIATE DELIVERY!** Order Now... While They Last!

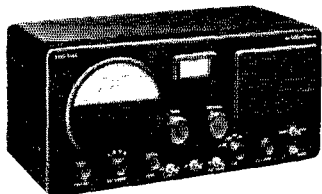

## WORLD FAMOUS S-40B RECEIVER

**\$89.95**

No. A2060. Shpg. wt., 33 lbs. A great receiver known by hams everywhere for excellent performance. Has Automatic Noise Limiter, Variable BFO, enclosed PM speaker. Exceptionally good signal-to-noise ratio and selectivity. Four bands cover 540 kc to 43 mc. A terrific buy at this price!

## SX-71 5-BAND RECEIVER

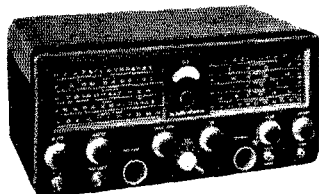

**\$189.50**

No. A2095. Shpg. wt., 33 lbs. Expressly designed for hams and SWL's. 538 kc to 35 mc, 46-56 mc coverage. Has all the latest refinements in receiver engineering... double-

conversion circuit, high-image rejection... at moderate price!  
No. A2073. Matching spkr. for above. Wt., 19 lbs..... \$16.95

## SX-62 ALL WAVE RECEIVER

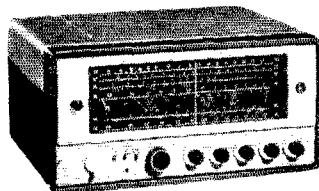

**\$269.50**

No. A2066. Shpg. wt., 77 lbs. World-wide reception. High-fidelity. Ultra-selective and super-sensitive. For the ultimate in every performance quality.

No. A2075. Bass Reflex Spkr. for above. 30 lbs..... \$34.50

**NEWARK STOCKS THE COMPLETE HALLICRAFTERS LINE. WRITE US ABOUT EQUIPMENT NOT LISTED ON THIS PAGE... OR VISIT OUR MODERN SALESROOM FOR A DEMONSTRATION OF THE LATEST HALLICRAFTERS EQUIPMENT**

**ORDER  
FROM  
DEPT. B100**

**NEWARK  
ELECTRIC COMPANY**

**ONE YEAR  
TO PAY**

for merchandise  
\$75.00 or over. Write  
for Time Payment  
Order Blank

**323 W. MADISON STREET • CHICAGO 6, ILLINOIS**

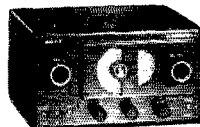

**Low-Priced  
S-38B  
Receiver**

**\$49.50**

No. A2068. Shpg. wt., 14 lbs. By far the biggest dollar value in a four band receiver. Quality workmanship and features usually found in receivers sold at twice the price. AC-DC superhet circuit, covers 540 kc to 32 mc.



**The New  
S-78 FM-AM  
Chassis**

**\$79.95**

A2059. Shpg. wt., 23 lbs. Precision built FM-AM chassis for those "custom-tailored" jobs that demand the ultimate in performance. Features include Automatic Frequency Control and phono input.

## ST-74 FM-AM Tuner Chassis

A2058. Shpg. wt., 13 lbs. Hallicrafters famous engineering is at its best in this new low-cost high-fidelity FM-AM tuner. Affords superb reception over the entire 88-108 mc FM band and the 540-1650 kc AM band.

Efficient circuit gives high performance with low power consumption. **\$54.50**



**S-72 Portable  
4-Band Receiver**

**\$99.95**

No. A2079. Shpg. wt., 16 lbs. Operates on AC, DC, or batteries. Features RF gain control for CW, Automatic Noise Limiter, phone jack on front panel. Typical Hallicrafters quality throughout. Covers 540 kc to 31 mc. The ideal portable for the ham, the SWL, and the entire family to enjoy. Less batteries.

No. 19286. Battery pack for above. 7 lbs. \$4.03

**SEND FOR OUR LATEST  
BARGAIN FLYER**

Full of the best buys in Amateur equipment. Real savings... large selection... prompt mail order service. Send for your free copy now.



**ORDER TODAY DIRECT  
FROM THIS AD.**

# Telex Headsets Keep QSO's Q5

**CAA**  
APPROVED



## THE TELEX TWINSET

The Twinset is easy on the ears! No pressure whatsoever, background noise blocked out. It clips sharply at 3000 cps adding another Q5'er to your receiving setup. Mighty relaxin' for hours of traffic, DX, or just plain rag chewing.

The Twinset weighs only 1.6 ounces, completely eliminates fatigue and discomfort.

Write for free folder on the Twinset today . . . or see your Parts Jobber.

**TELEX** Dept. Y-21-10  
**TELEX PARK**  
**ST. PAUL, MINN.**

In Canada, ATLAS RADIO CORP., TORONTO

Standard of the World for Quality Headsets

### LEARN CODE!

SPEED UP Your  
RECEIVING  
with G-C  
**Automatic Sender**

Type S  
\$24.00 Postpaid in  
U. S. A.



Housed in Aluminum Case. Black Instrument Finished. Small—Compact—Quiet induction type motor. 110 Volts—60 Cycle A.C.

Adjustable speed control, maintains constant speed at any Setting. Complete with ten rolls of double perforated tape. A wide variety of other practice tapes available at 50c per roll.

**GARDINER & COMPANY**  
STRATFORD NEW JERSEY

Vancouver with his yacht, *Bendora*. TE, who has sold nearly every amateur in British Columbia some radio gear, has moved east to work. UT has taken over as EC for Southeastern British Columbia, which is bordered by 49 to 52' north, Alberta, to 120 1/2 west. If you live in there your EC would be pleased to hear you check in at 1730 on 3755 kc. on Tuesdays. Traffic: VE7TF 162, UT 67, ZF 23, AOQ 22, FB 21, XA 16.

## PRAIRIE DIVISION

**MANITOBA** — SCM, A. W. Morley, VE4AM — PAM: M. FA. Winnipeg EC: RP, Shilo EC: DN. It happened again. Winnipeg was hit by a hail storm and near hurricane. It has happened twice and it can happen again. See your EC and join up. JN, at Waskada, is sporting a new car. WF, at The Pas, is on 14-Mc. 'phone. GQ is up to 23 states on 50 Mc. with Pennsylvania and Maryland being the new ones. 3DU visited AM on his way west. LF, QI, and QV are trying out new twin-folded dipoles. AC is the call of WARC. LE, NN, and QD spent their vacation at Clear Lake. AM/JM spent theirs in VE3-Land visiting 3DFF and 3AHD. The Manitoba 'phone net is operating on 3760 kc. again and anyone is welcome to report in. If you can't make it regularly, do it when you can. The net proved its worth during the flood. RP, NT, SR, and AM are known to have lost beams or antennas over the week end. Traffic: (July) VE4GQ 2. (May) VE4RO 1237, SR 1012, NI 284, AM 221, IW 182, LC 106, TJ 80, SC 44, ML 42.

**SASKATCHEWAN** — SCM, J. H. Goodridge, VE5DW — The Section Hamfest was held in Saskatoon July 1st and 2nd, sponsored by the Saskatoon Amateur Radio Club under the able leadership of GR, the hamfest manager. The Saskatoon gang is to be commended on putting on a successful hamfest with record-breaking attendance. MA won the "Fur Lined Buttonholes," also the award for the best all-round mobile rig, JI and his XYL, IJ, found the hidden transmitter. PM, the section's newest ham, won the grand prize, an HQ-129 receiver. DA is a new call in Regina. JI has a new mobile rig and visited VE4-Land, calling on FA, HR, NR, CI, and RD. UQ now has a mobile rig in his truck. IC has moved to Tisdale. Traffic: VE5JI 13, MA 9, VF 7, BZ 6, RB 5, DW 4.

## A.R.R.L. QSL BUREAU

(*Bold-face type indicates recent change of address*)

- W1, K1 — Frederick W. Reynolds, W1JNX, 112 Commonwealth Ave., Dedham, Mass.
- W2, K2 — Henry W. Yahnel, W2SN, Lake Ave., Helmetta, N. J.
- W3, K3 — Jesse Bieberman, W3KT, Box 34, Philadelphia 5, Penna.
- W4, K4 — Johnny Dortch, W4DDF, 1611 East Cahal Ave., Nashville, Tenn.
- W5, K5 — L. W. May, jr., W5AJG, 9428 Hobart St., Dallas 18, Texas
- W6, K6 — Horace R. Greer, W6TI, 114 Fairmount St., Oakland, Calif.
- W7, K7 — Mary Ann Tatro, W7FWR, 513 N. Central, Olympia, Wash.
- W8, K8 — William B. Davis, W8JNF, 4228 W. 217th St., Cleveland 16, Ohio.
- W9, K9 — John F. Schneider, W9CFT, 311 W. Ross Ave., Wausau, Wisc.
- W0, K0 — Alva A. Smith, W0DMA, 238 East Main St., Caledonia, Minn.
- VE1 — L. J. Fader, VE1FQ, 125 Henry St., Halifax, N. S.
- VE2 — Austin A. W. Smith, VE2UW, 6164 Jeanne Mance, Montreal 8, Que.
- VE3 — W. Bert Knowles, VE3QB, Lanark, Ont.
- VE4 — Len Cuff, VE4LC, 286 Rutland St., St. James, Man.
- VE5 — Fred Ward, VE5OP, 899 Connaught Ave., Moose Jaw, Sask.
- VE6 — W. R. Savage, VE6EO, 329 15th St., North Lethbridge, Alta.
- VE7 — H. R. Hough, VE7HR, 1785 Emerson St., Victoria, B. C.
- VE8 — W. R. Williamson, VE8AK, Box 534, Whitehorse, Y. T.
- KP4 — E. W. Mayer, KP4KD, P. O. Box 1061, San Juan, P. R.
- KZ5 — C.Z.A.R.A., Box 407, Balboa, Canal Zone.
- KH6 — Andy H. Fuchikami, KH6BA, 2543 Namaau Dr., Honolulu, T. H.
- KL7 — Box 73, Douglas, Alaska

# WOULD YOU SEND \$1.50 TO GET \$9.50 ?

WELL, HERE'S EVEN MORE FOR YOUR MONEY!!

For only \$1.50, you get —



Your own personal copy of the world famous Radio's Master Buyers Guide, priced by the publishers at — **\$5.50**

**AND** Four Credit Slips, each worth \$1.00 on orders of \$5 or more. **4.00**

**PLUS** All you can save with this book and Harrison's low prices! **\$\$\$\$**

**Total Value — Over \$9.50**

YOU'VE undoubtedly seen previous editions of this indispensable book at the right hand of important Engineers and busy Purchasing Agents. Now, here is your opportunity to put it to work for you — to save you real money and time in your purchases of Radio-Electronic equipment and parts.

AND, who brings you this sensational offer?

## Only HARRISON!

Your HAM HEADQUARTERS since 1925! As Authorized Factory Distributor for all leading manufacturers, we give you fast and dependable mail order service — immediate deliveries from our huge stock! And our prices are guaranteed to be the lowest obtainable anywhere!

Plenty of active hams on our staff to make sure that all of your orders and inquiries are handled intelligently!

**HURRY! Don't Miss Out!**

**QUANTITY LIMITED!**

**Rush Letter or Coupon Now!**

**Bil Harrison, W2AVA**

**HARRISON RADIO CORPORATION**  
225 Greenwich St., New York 7, New York

**OK, Bil** — Here's my \$1.50. Mail me, postpaid, the new Radio's Master, discount code, and those four \$1 credit slips, with 10 day return for refund privilege. Also send me future Ham-A-Logs, without charge.

Name \_\_\_\_\_ Call \_\_\_\_\_  
(If licensed amateur)

Address \_\_\_\_\_

**YOUR MONEY BACK** if you don't agree that this is the biggest bargain you've ever seen!

● Not a condensed, incomplete, mail order type catalog but a comprehensive encyclopedia of all radio parts and equipment. Produced with the full cooperation of hundreds of top manufacturers such as National, Amphenol, Bud, Webster, RCA, Hallcrafters, Johnson, Astatic, Thordarson, Eimac, B & W, Millen, etc. etc. The very latest, complete information!!

● The detailed specifications of all makes, and list price discount code, means you can pick the best items for your purpose and order them from HARRISON at lowest cost.

● An attractive, durably bound, hard cover book, with handy index, which takes the place of the usual pile, or incomplete file, of manufacturers' catalogs.

● Whether you build, buy, or are just planning, it will pay you to get this book now!

Have a problem? Need information? Just drop me a line. You'll get a prompt, personal reply by return mail.  
73, Bil Harrison, W2AVA

**HARRISON**  
NEW YORK 7, N.Y.  
225 GREENWICH STREET  
(10 West Broadway, at Barclay St.)  
BARclay 7-7777

# ELECTRONICS TECHNICIANS

FOR

Radar, Communications, Television Receivers

Needed By

**RCA SERVICE COMPANY, INC.**

A Radio Corporation of America Subsidiary  
for U.S. and Overseas

## REQUIREMENTS:

- Good Character
- Training in Installation or Maintenance of Radar, Communications or Television
- Give Full Details of Practical Experience

Qualified Candidates Will Be Interviewed Promptly

## COMPENSATION:

Up to \$7,000.00 a year to start  
For Overseas Assignment  
With Periodic Review of Base Salary Thereafter  
Made up of—

- Base Salary
- Overseas Bonus
- Actual Living and other Expenses
- Accident, Hospitalization, and Life Insurance
- Vacation and Holiday Pay

Qualified technicians seeking connection with leading company having permanent program for installation and service of military equipment, AM, FM, TV transmitters and receivers, and electronic devices, such as electron microscopes, mobile and microwave communications, theatre TV, write full history to:

**RCA SERVICE COMPANY, INC.**

CAMDEN 2, NEW JERSEY



go **APPROVED!**  
**mobile!**  
**ACCEPTED!**

*Master Mobile*  
ANTENNAS MOUNTS

Sold at all Leading Distributors or Write  
MASTER MOBILE MOUNTS, INC.  
5200 Wilshire Blvd., Los Angeles 36, California

## T-Day in Sandwich

(Continued from page 13)

### Feeding the Colossus

The entire feed and control system to the tower is underground. All control wires are carried in a 2½-inch conduit. R.f. is fed to the tower via a semirigid 50-ohm ½-inch copper coax line, nitrogen filled, and selected because loss at 30 Mc. is about 0.5 db. per 100 feet. At the base of the array flexible coax is again used, and run to a matching transformer. The open-wire line, seen in the stiff-neck photo, is the phasing section, consisting of No. 12 wire spaced 4 inches. This is connected to each radiator and transposed every half wave.

### Milling-Machine Rotator

The rotator carries the entire weight of the complete array, approximately 2500 pounds. For this reason it is a husky affair—a milling-machine table 24 inches in diameter. If you shop around a bit, you can pick up one of these from an old scrapped machine for a song. It's set up on pillars, has a gear reduction mechanism of 1800 to 1. The detailed photo shows the bottom of the pole fastened to the rotator with a hinge so the butt of the pole couldn't get away during the raising. There's a sleeve and flange around the base of the pole to which the hinge is fastened. The rotating mechanism was released during installations so it could swing back and forth slightly to prevent breaking the gears.

Now, lest this story of our new antenna be misconstrued, we hasten to state that it was not our intention of using the printed page as a media for our bragging. That we will confine to ten meters. Rather, consider this as a clarion warning to all hams: Brothers, when you make a statement on the ham bands—be prepared to back it up!

## Shielded Transmitter

(Continued from page 17)

tube. At lower plate voltages, it may not be possible to load the amplifier to rated maximum plate current. In this case, the loading should be adjusted for maximum obtainable output. If antenna-current meters aren't available, don't load the amplifier beyond the point where there is still an easily-distinguishable dip in plate current at resonance.

With a dummy load inside the enclosure, a sensitive absorption frequency meter showed no indication of r.f. outside the enclosure or along the power leads at any frequency—including the fundamental. This indicates that there should be no cause for complaint about direct radiation from the transmitter circuits.

**SWITCH  
TO SAFETY!**





# ELDICO'S ANTENNASCOPE

TAKES THE *GUESS WORK* OUT OF ANTENNA PERFORMANCE!

At last you can be positive of having maximum antenna performance and efficiency with the new Eldico Antennascope based on the design appearing in September CQ. The Antennascope is an impedance measuring meter used in conjunction with any grid dip oscillator. With the Eldico Antennascope you can measure —

- Radiation resistance of your antenna
- Resonant frequency of your antenna
- Impedance of your transmission line
- Input impedance of your receiver
- Standing-wave ratio on your feedline
- Indicator is Simpson 0-100  $\mu$ a

You can determine, for certain, whether you should be using 52-ohm or 72-ohm coax; whether your folded dipole is taking the load or its all on resonant feeder; whether the power is going into the antenna where it belongs! You can get vastly improved receiver performance by properly matching a receiving antenna to the input . . . and the Antennascope will give you this information. You can cut down your standing-wave ratio by proper antenna adjustment, adjustments made simple because the Antennascope will give you the necessary information accurately and rapidly. You can materially reduce TVI and BCI by guaranteeing yourself cold feeders — with the Antennascope the r.f. can be poured into the skywire where it belongs.

Whether your antenna is the old reliable Zepp or a stacked 20-meter giant, the Antennascope will be an investment well made. It is the kind of instrument that will become as important around your shack as the neon glow lamp and the volt-ohmmeter.

Antennascope kit, including everything required, meter case, full detailed instructions. . . . . **\$24.95**

Antennascope, complete ready to operate **\$29.95**

*If your local distributor can't supply you, order directly from Eldico. Order promptly because the supply of kits and finished units is limited. Orders will be filled in order of receipt*

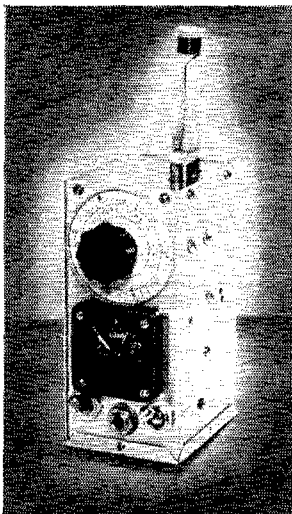
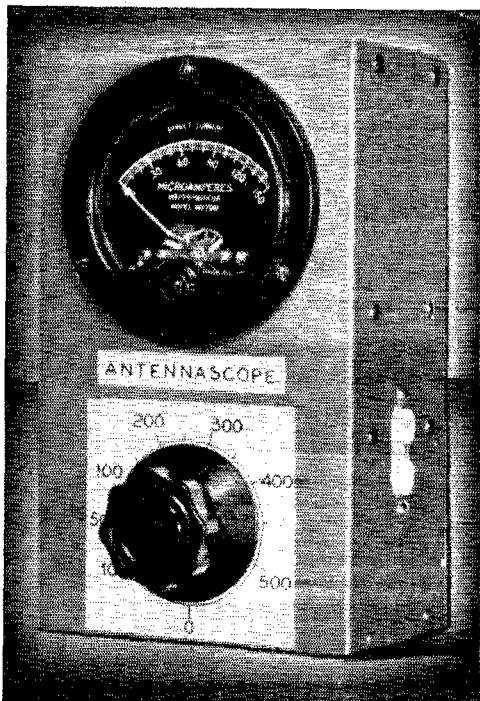

## ELDICO'S GRID DIPPER

One of the most valuable pieces of test equipment in the shack the GDO's value is greater than ever when used with the Eldico Antennascope. Improved model incorporates high-sensitivity regeneration circuit. Enables you to locate resonant circuits for pre-tuning or de-bugging without applying power to the rig or receiver; measures harmonics, may be used as a signal generator; and performs numerous other measuring functions. Grid Dipper kit includes everything required, special case designed to facilitate one-hand operation, tube, internal power supply, meter and detailed instruction book covering assembly and applications. Range 3 mc to 250 mc covered in six steps. Operation from 105-125 volts, 50-60 cycles a.c. . . . . **\$24.50**

Modification kit, including instructions to convert original Grid-Dip oscillator to improved version with regeneration as described above. . . . . **\$3.00**

F. O. B. our plant. Send postage.

*Signals of Distinction*

**ELDICO OF NEW YORK**  
INCORPORATED  
44-31 DOUGLSTON PARKWAY  
DOUGLSTON, L. I., NEW YORK

**FREE — FREE**  
**WRITE TODAY**  
**TO W2UOL FOR**  
**YOUR COPY**



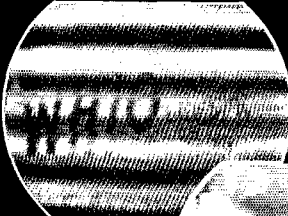

**Seein's  
Believin',  
HERE'S PROOF**

Actual Photos  
taken with no  
filter (above)  
and with a Drake  
Filter in lead-in  
(at right)



**THE R. L. DRAKE  
High Pass Television Filter**

for installation in the lead-in at the TV set is proving a boon to the preservation of amateur radio. Overloading of the front end of the TV set by your fundamental—as shown in the top picture—is the most common complaint. If you have TVI it will pay you to try the R. L. Drake High Pass Filter on your neighbor's sets before making costly changes in your rig.

Two models available  
**TV-300-50HP for 300-Ohm Twin Lead and  
TV-72-50HP for small 72-Ohm Coax.**

Also a complete line of Low Pass and Half Wave Filters for harmonic reduction in the transmission line of your xmitr.

**\$5.95  
LIST**  
Discounts to  
dealers, servicemen  
and amateurs

See them at your  
distributor or  
write us for details.

**The R. L. DRAKE Co.**  
11 Longworth St., Dayton 2, O.

**COMPLETE RADIO TRAINING!**

Prepare now to accept a responsible position in Commercial Radio. New developments will demand technicians with thorough basic training, plus a knowledge of new techniques discovered during the war. Training open to high school graduates, or those with high school equivalency. Courses 6 to 18 months' duration in RADIO AND ELECTRONICS. Approved Veteran training in Radio. Write for Particulars.

**VALPARAISO TECHNICAL INSTITUTE**  
DEPT. TN Valparaiso, Ind.

**CALL LETTER PLATES**

Type A-18 -  
For Your Car



A large, sturdy cast aluminum plate with satin-finished letters and border against

Type A-19 -  
For Panel  
Mounting

**\$2.95 POSTPAID**

a black baked enamel background. Red, green, blue and gray -- 50¢ extra. Size - 2 1/4" x 8 1/2" with 1 1/2" letters.

**LAPEL BUTTONS**

An attractive metal button with highly polished raised letters against a black background. Other colors 50¢ extra.



**\$1.10 POSTPAID**

Type A-26L With Screw Backing  
Type A-26P With Pin Backing

**SREPCO** Inc.

STANDARD RADIO & ELECTRONIC PRODUCTS  
135 E. Second St. DAYTON 2, OHIO - Tel. FULTON 2174

CASH WITH ORDER  
Allow 3 weeks for delivery

**Yagi Antennas**

(Continued from page 80)

We come to the conclusion, then, that the lengths of the reflector and fed element remain nearly constant for operation at a given center frequency, but that pattern bandwidth, input-impedance level, and match bandwidth may be greatly changed by adjustment of the director length and fed-to-reflector spacings. Beamwidth and gain are also affected, but not as greatly, by the same adjustments. Short directors and the larger fed-to-reflector spacings are good for broadband operation and give more practical levels of input impedance at some sacrifice of gain.

Although most of the tests were made on the Yagi 0.3 wavelength long, a few tests were made with 0.2 and 0.4 wavelength between the director and reflector. It was found possible to get high front-to-back ratios with the 0.2-wavelength-long antenna, but the Q of the input impedance was higher so not as much bandwidth could be covered. Conversely, with the 0.4-wavelength-long antenna, good bandwidth could be obtained but the front-to-back ratios were somewhat lower.

The tests reported in this article were made with the antennas 0.4 wavelength above ground. To check the ground effect, two of the antennas were raised to 0.75 wavelength above ground and the impedance and pattern tests rerun. Measurable changes could be detected, but were not sufficiently great to invalidate the data taken at 0.4 wavelength from the ground.

**QSL Cards**

(Continued from page 25)

of the file and examined on both sides without blowing the dust off of it or tearing its corners.

Well, that's about it. Getting the dope together for this article has been interesting, but why all the fuss about QSLs? What if my dear pal down the street did get a card from Tristan de Cunha? I had a good, solid QSO with ZD9AA myself. (At least, I'm almost sure he came back the second time.) I don't care if I never get his . . . say, is that the doorbell? Oh, just the postman. Well, as I was saying, I don't care if — oh, the POSTMAN!

Any mail for me?

**IS YOURS ON FILE  
WITH YOUR QSL MGR?**

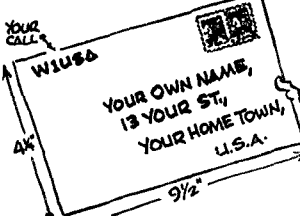

# We Have the Most Satisfied Customers

Ask the fellows who deal with me. They'll tell you that WRL will allow you more for your present equipment—that WRL's large volume of sales mean faster turnover and greater savings. Our customers know that we finance our own paper, eliminating all red tape. We will accept a low down payment and you can name your own terms. WRL buys more equipment—WRL sells more equipment. We offer the most personalized service anywhere.

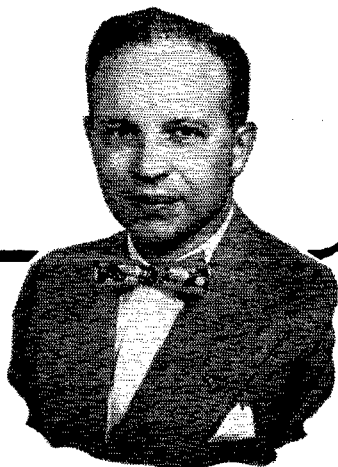

Leo I. Meyerson  
WØGFQ

## NOW YOU CAN AFFORD TO OWN A BEAM 10 METER BEAM

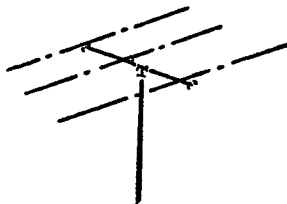

Plumber's delight 3 element beam quickly assembled; furnished with Gamma match. Extremely light; all aluminum construction; grounded antenna; very low priced. Furnished less mast and lead. Full instructions furnished.

Narrow spaced . . . . \$14.75  
Wide spaced . . . . . \$15.95

## NEW WRL "400" GLOBE KING TRANSMITTER

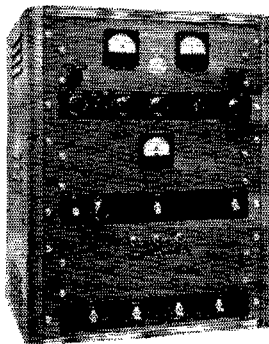

**MORE WATTS PER DOLLAR**  
Efficient performance on all bands—10 to 160 on phone and CW. 350 watts phone—400 watts CW. Provisions for ECO. Complete with tubes, meters, and one set of coils.

**KIT FORM WIRED-TESTED**  
**\$379.45 \$399.45**  
LOW DOWN PAYMENT

CU ON 20 - 10 & 75 METERS



### GIANT RADIO REFERENCE MAPS

Just right for your control room walls. Approximately 28" X 36". Contains time zones, amateur zones, monitoring stations. Mail coupon today and . . . . .

**25c**



**FREE**

Deal with the "World's Most Personalized Radio Supply House". Send for your new complete WRL Catalog containing everything new in radio.

## WRL 175 WATT GLOBE CHAMPION TRANSMITTER

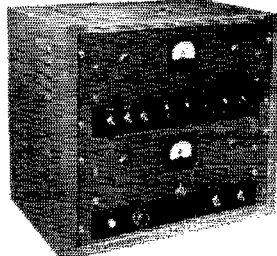

**MORE WATTS PER DOLLAR**  
R.F. Section a complete 175 watt XMTR. Provisions for ECO. Automatic fixed bias on Final and Buffer. Class B Speech Modulator. 175 watt input—10 thru 160 meter bands. Complete with tubes, meters, and 1 set of coils.

**KIT FORM WIRED**  
**\$279.00 \$299.00**  
LOW DOWN PAYMENT

Deal with us on the new COLLINS 75A2—\$420

WRITE - WIRE

PHONE 7795

**World Radio**  
LABORATORIES INCORPORATED  
COUNCIL BLUFFS, IOWA



World Radio Laboratories, Inc.  
744 West Broadway  
Council Bluffs, Iowa

Q-10

Please send me:

- Radio Map  10 Meter Beam Info  
 New Catalog  Globe King Info  
 List of Guaranteed Used Equipment

Name \_\_\_\_\_

Address \_\_\_\_\_

City \_\_\_\_\_ State \_\_\_\_\_

## ATTENTION MOBILE HAMS

Complete mobile package — nothing else to buy. Outstanding mobile signals use Motorola equipment — backed by years of communication equipment experience — World's largest producer of 2-way mobile equipment.

A mobile transmitter with a double feature FM or AM at flip of the switch, the MOTOROLA FMT-30-DMS (27-30 MC.). **\$130.00**

P-7253 spring base rear — mount antenna **\$22.50**

New Gon-set Tri-Band Spread Gon-verter... **\$42.50**

MOTOROLA P-69-13 or 18-ARS receiver with special noise limiter for use with any converter having 1440-3000 KC. **\$60.00**

3-30 famous Gon-set converter complete to connect to the P-69-13 or 18-ARS receiver. **\$39.95**

P-327-E Fire wall loud speaker.... **\$5.00**

The above comes complete with all necessary accessories and mounting hardware. Order direct or through the Motorola National Service Organization member in your area.

NOTE: This Receiver and Transmitter is equipment which has been returned from the field, modified and rebuilt for Amateur Service.

For further information write to:

**MOTOROLA INC.**

Amateur Sales Dept. QST — October

1327 W. Washington Blvd. Chicago 7, Illinois

Attention: Harry Harrison, W9LLX, Tel. Taylor 9-2200 Ext. 161

## Amplifier Keying

(Continued from page 52)

The switch,  $S_2$ , and the potentiometer,  $R_5$ , permit adjustment of the keying characteristic, as in any vacuum-tube keyer. A softer "break" characteristic can be obtained by increasing the value of  $R_6$ , but 0.2 megohm was found to be satisfactory at W2FRX. The "hold-in" time of the circuit is increased by cutting in more resistance at  $R_7$ . A momentary switch,  $S_3$ , is used to set the oscillator frequency without turning on the amplifier stage. The relay  $Ry_1$  serves the triple purpose of shorting the receiver input, changing the receiver gain, and closing the oscillator circuit. The control,  $R_{12}$ , added to the receiver, sets the key-down gain of the receiver independently of the normal gain control and is useful when monitoring one's sending.

The small neon bulb will glow if the line plug is plugged in correctly, otherwise you have no bias — but no blown fuse, either! The power supply delivers about 140 volts negative.

The Potter & Brumfield relay used at  $Ry_1$  shows 19 volts across it with the key down. Although it doesn't close as fast as the Millisec relay recommended in the original article, it is fast enough for me, and only the slightest "chipping" of the first dot results. "Dots" not bad!

## Surplus Corner

(Continued from page 45)

by changing the setting of  $S_2$  and varying  $C_{12}$  or by employing variable capacitive coupling to the receiver. Adjust  $C_3$  and  $R_{17}$  until zero beat with the standard signal is obtained. Adjust  $R_6$  to approximately midpoint. Set the interval selector switch to 10 kc. and increase the capacity of  $C_4$  to the point where the blocking oscillator locks in with the crystal oscillator but not beyond this point. This condition exists when the pips between 100-ke. intervals on the receiver become distinct and clear. Adjust  $R_6$  until nine pips between 100-ke. intervals can be heard. In some cases it may be necessary to change the value of  $R_5$  or  $R_7$  or both to bring the frequency of the blocking oscillator into the desired range. If any change is necessary, different values of  $R_6$  should be tried first. Readjust  $C_4$  and  $R_6$  slightly as necessary to make the signals sound cleanest.

In the foregoing procedure, only one precaution need be taken. That is, the adjustment of the crystal oscillator to zero beat with a standard signal, as indicated above, should be made before  $R_6$  is adjusted for the correct interval and cleanest signal. If the procedure is reversed, the blocking oscillator may tend to kick out of synchronism as the frequency of the crystal changes during adjustment. This does not constitute a disadvantage in the instrument but is merely a matter of procedure. If no difficulties have become apparent during adjustment, the frequency standard is ready for use and the case may be replaced.

NOW... Quickly and Easily  
cut SQUARE and OBLONG  
openings in radio chassis



WITH THE GREENLEE No. 731  
SQUARE RADIO CHASSIS PUNCH

Now, in 1½ minutes or less you can do hole-cutting jobs that might take an hour or so with old "drilling and filing" methods. Simply insert GREENLEE Punch and turn with an ordinary wrench; a "clean" square or oblong opening is quickly cut. An indispensable, timesaving tool that pays for itself in a hurry.



In sizes ¾", ¾" and 1"

TOOLS FOR CRAFTSMEN  
**GREENLEE**

Write today for facts and prices on this handy Punch. Greenlee Tool Co., 1870 Columbia Ave., Rockford, Illinois.



## don't crystal gaze

SELECT JK CRYSTALS  
AND BE SURE . . .

There's no guess work involved when you use JK stabilized crystals. Every JK crystal is manufactured with such care—and pride—that you can take it for granted there is none more dependable anywhere.

▶ Next time you need crystals, specify JK crystals—and be sure!

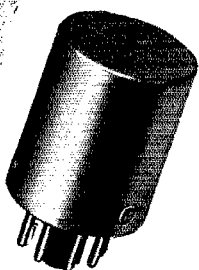

## JK STABILIZED HEAT JK02

JK stabilized heat—JK02 will accommodate two stabilized H17 crystals (HC6 type). Has standard octal base, 6.3-volt heater at less than 1 amp. Temperature stability  $\pm 1^{\circ}\text{C}$ . Oven is normally set at  $+60^{\circ}\text{C}$ . Can be supplied set at other temperatures on special order.



*The James Knights Company*  
SANDWICH, ILLINOIS

## SHOOTS TROUBLE FASTER! MAKES MORE MONEY FOR YOU ON JOB OR AT SERVICE BENCH!

In radio service work, time means money. Locate trouble faster, handle a much greater volume of work with the **SIGNALLETTE**. As a trouble shooting tool, **SIGNALLETTE** has no equal. Merely plug in any 110V. AC-DC line, start at speaker end of circuit and trace back, stage by stage, listening in set's speaker. Generates RF, IF and AUDIO Frequencies 2500 cycles to 20 Megacycles. Also used for checks on Sensitivity, Gain, Peaking, Shielding, Tube testing. Wt. 13 oz. Fits pocket or tool kit. Satisfaction, or money back! See at your distributor or order direct.

# Signallette

MULTI-FREQUENCY GENERATOR

**\$995**

at distributor or post-paid, direct. No C.O.D.'s, please. Ohioan's add 3% State Sales Tax.



**CLIPPARD INSTRUMENT LABORATORY, INC.**

Dept. E, 1125 Bank Street, Cincinnati 14, Ohio  
Qualified Jobbers write, wire for details

## BUY OF A LIFETIME!

TRIED AND PROVEN THE WORLD OVER

LETTINE MODEL 240

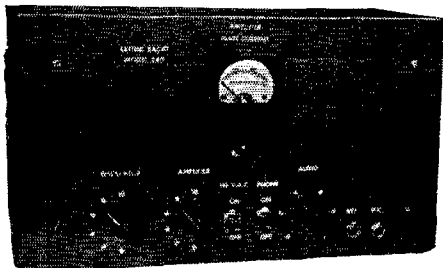

This beautiful transmitter originally sold for \$98. Buy it direct from our factory for only \$69.95, complete with instructions for TVI reduction. Even if you already have a transmitter of your own, this rig makes an excellent standby. You can't afford to miss this opportunity.

The 240 is a complete 40 watt Phone-CW rig, working all bands from 160 to 10 meters; complete with (8 x 14 x 8) cabinet, self contained power supply, meter, tubes, crystal and coils for 40 meters. Tube line-up: 6V6 osc., 307 final, 6SJ7 mike amp., 6N7 phase inverter, 2 6L6s mod., 5U4G rect. — weight 30 lbs. — 90 day guarantee. PRICE **\$69.95** \$20 deposit with order — the balance C.O.D. Coils for 80, 20 and 10 meters \$2.42 per set. Coils for 160 meters \$3.00.

LETTINE RADIO MFG. CO.

62 Berkley St.

Valley Stream, N. Y.

HY-LITE'S NEW

# SKY-LITE

ALL GROUNDED ARRAY FOR 10-11 METERS



4 ELEMENT 6 MTRS.  
OR  
3 ELEMENT 10-11  
BOTH COMPLETE  
WITH "T" MATCH

**\$ 24<sup>95</sup>**  
WRITE FOR  
CATALOG  
Q-10

## HY-LITE Antennae INC.

Makers of Fine Antennas for AMATEUR · FM · TELEVISION

242 EAST 137TH ST., NEW YORK 51, N. Y.

## V. H. F. Frequency Meter

(Continued from page 48)

cycles. Because of the slight backlash in the dial, accuracy is improved by approach the desired setting from the same direction at all times.

Although not sufficiently accurate for commercial purposes such as precise frequency measurements, this piece of gear has proved to be extremely useful in the alignment of television, f.m. and amateur v.h.f. receivers. All parts are readily available, many in surplus. The output transformer is a 522 modulation transformer, and the audio coupling choke came from a BC-357 beacon receiver. Standard parts could, of course, be used, but in the author's case the use of various surplus components helped noticeably in cutting down the size of the junk box which had begun to get out of hand.

## How's DX?

(Continued from page 62)

sion on frequencies below 50 Mc. . . . . Radio OTC of Leopoldville in the Belgian Congo broadcasts 20-minute programs devoted to amateur radio on 9787 kc. They may be heard from the 50-kw. International Good Will Station on Wednesdays at 1410 EST (English), 1310 (Dutch), and 1510 (French). The Dutch-language broadcast is omitted on the 2nd and 4th Wednesdays of each month. ONARA is instrumental in producing these features . . . . . In the So. Calif. DX Club *Bulletin* we see that VS1BX is hoping to fire up his little 20-watt portable station on Cocos Island immediately if not sooner . . . . . CS prefixes are being assigned to stationed U. S. personnel by the Portuguese government, according to W3LFP and W8DAW. CS3s and CS6s are reported active.

Jeeves certainly has his nerve wisecracking on the subject of card playing. We have confirmed what W1DX and W1CH discovered; he can't even make a decent dummy at Bridge.

## Hints & Kinks

(Continued from page 67)

Each manufacturer seems to have his own pet circuit for heat control in these pads, and as many as four thermostats will be found in some makes. By-passing each one has done the job to complete satisfaction here, and it is hoped that others plagued with this annoyance will have similar success.

— O. S. Keay, W6SJK

## IMPROVED CIRCUIT FOR HOMEMADE S-METERS

S-METER circuits that work on the plate or screen current of one or more variable- $\mu$  tubes have the disadvantage that the meter readings are not linear in terms of decibels. This is because of the shape of the plate- or screen-current curve as the grid bias is varied. At small grid biases the slope is large and the meter is "sensitive," but at some fairly critical value of grid voltage, depending on the tube type, the slope becomes low and further increases in grid bias make very little change in plate current. The needle "hits a stone wall" at the signal level that represents about S9 in the average receiver.

(Continued on page 118)

# Astatic

presents the **NEW SYNABAR**  
unidirectional cardioid crystal  
microphone

*Astatic's* NEW SYNABAR MICROPHONE offers a new measure of clear-toned performance quality . . . and its perfection does not diminish through long service life, thanks to a new ruggedness of construction. Perhaps the outstanding engineering achievement incorporated in this newly perfected unit is the use of a special sintered metal to cancel out 15 db front to back, making the Synabar, for practical purposes, dead to sound from the rear. Excellent frequency range, from 50 to 10,000 c.p.s., is further enhanced by a Response Selector switch, which provides choice of ideal pick-up characteristics for either crisp voice or general voice and music. The Synabar's crystal element has a special METALSEAL protection against moisture or dryness. A high impedance microphone, it has an output level of -54 db. It has a satin chrome finish, is furnished with detachable concentric cable connector and 20 feet of single conductor shielded cable, and is available in models with or without off-on switch.



DR-10  
List Price \$37.25  
DR-10-S\*  
List Price \$39.95  
\*With off-on switch



Astatic Crystal Devices manufactured under Brush Development Co. patents

## Make Your Hobby Into a Good-Paying Job

**ADD TECHNICAL TRAINING**  
to your  
**PRACTICAL HAM EXPERIENCE**

Then use our  
**Amazingly Effective**  
**JOB-FINDING SERVICE**



**Get this Amazing Booklet FREE**

**TELLS HOW**

**TELLS HOW**

**WE GUARANTEE**  
TO TRAIN AND COACH YOU  
AT HOME UNTIL YOU GET  
**YOUR FCC LICENSE**

Our Amazingly effective Job-Finding Service helps CIRE Students get better jobs. Here are just two of many examples:

**GETS JOB WITH CAA**

"I have had a half dozen or so offers since I mailed some fifty of the two hundred employment applications your school forwarded me. I accepted a position with the Civil Aeronautics Administration as maintenance technician. Thank you very much for the fine help your organization has given me." — Dale E. Young, 122 Robbins St., Owosso, Mich.

**GETS JOB IN BROADCASTING**

"I have accepted a position with KWAD. I secured this position through the help of your Job-Finding Service and I had at least six other offers. I am sincerely under obligation to you." — Fred W. Kincaid, Box 241, Wadena, Minn.

**CLEVELAND INSTITUTE OF RADIO ELECTRONICS**  
Desk QT-22, 4900 Euclid Bldg., Cleveland 13, Ohio

I want to know how I can get my FCC ticket in a minimum of time by training at home in spare time. Send me your amazing new free booklet, "Money Making FCC License Information," as well as a free sample FCC type exam and Free Booklet, "How to Pass FCC License Examinations." (Does not cover exams for amateur license)

Name.....  
Address.....  
City..... Zone..... State.....  
Approved for Veteran Training under the G.I. Bill of Rights  
Veterans check for enrollment information under G.I. Bill



**MORE SIGNALS PER DOLLAR**  
From Money Invested in an Antenna

Self Supporting  
**STEEL TOWERS**  
For Rotary Beams, FM, TV

**ATTRACTIVE—NO GUY WIRES!**

- 4-Post Construction for Greater Strength!
- Galvanized Steel—Will Last A Lifetime!
- SAFE—Ladder to Top Platform
- COMPLETE—Ready to Assemble
- Easy to Erect or Move
- Withstands Heaviest Winds

(We will supply stress diagrams for your building inspector)

**EASY MONTHLY PAYMENTS**

Up to 12 Months to Pay!

All Vesto Towers are available on a special monthly payment plan which requires only 1/3 down. Write for free details.

Width at  
Base Equal  
to 1/5 Height

**IMMEDIATE DELIVERY**

on all 7 popular sizes. Note the low prices for these quality lifetime towers: 22'—\$84.75, 28'—\$104.75, 33'—\$123.75, 39'—\$144.75, 44'—\$164.75, 50'—\$192.75, 61'—\$259.75, 100'—

\$974.75. Towers are shipped to your home knocked down, FOB Kansas City, Mo., 4th class freight. Prices subject to change... so order now! Send check or money order... or write for free information.

WRITE TODAY FOR COMPLETE FREE INFORMATION AND PHOTOGRAPHS

**The VESTO Company**

101 Main St., Parkville, Mo.

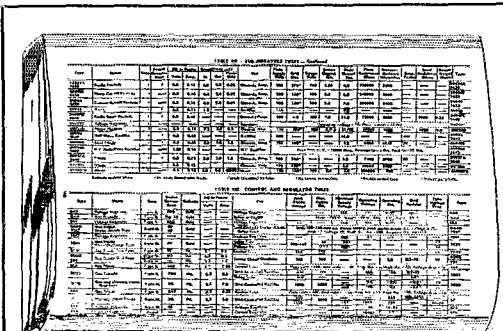

One of the vacuum tube pages in the Handbook

Forty additional pages of tube characteristics plus seven pages of tube base diagrams cover receiving, transmitting, control and cathode ray tubes as well as miniatures, sub-miniatures, rectifiers, klystrons and cavity magnetrons. A 2½ page index makes it easy for you to find information on any of the 1320 tubes.

Data on vacuum tubes—more than 50 pages in the 605 page

**RADIO AMATEUR'S HANDBOOK**  
**\$2.00**

\$1.25 in U. S. Possessions and Canada, \$2.50 elsewhere  
**THE AMERICAN RADIO RELAY LEAGUE, INC.**  
West Hartford 7, Conn.

The bias voltage developed by the a.v.c. circuit is approximately a logarithmic function of the input signal voltage, and if it is applied to a tube whose plate current is directly proportional to the grid voltage a meter in the plate circuit will read according to a linear decibel scale. This system is used in at least one manufactured receiver but for clockwise indications requires a d.c. meter with a reversed movement.

The circuit of Fig. 3 gives substantially the same results with the conventional meter movement. It uses the familiar bridge arrangement with a triode meter tube. The tube operates as a degenerative d.c. amplifier with the a.v.c. voltage

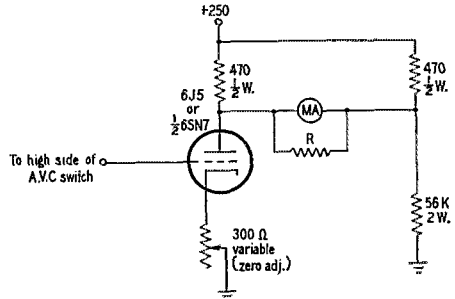

Fig. 3 — Circuit for an improved homemade S-meter.

applied to its grid. The reference current flows through the 56,000-ohm resistor and is slightly under 5 ma. with a 250-volt plate supply. A meter range of 0-1 or 0-2 ma. is satisfactory.

To adjust the system, pull the meter tube out of its socket or otherwise break the plate-cathode circuit so no plate current flows, and adjust the value of the resistor *R* across the meter until the scale reading is maximum. The value of resistance required will depend on the internal resistance of the meter, and must be determined by trial and error (the current is approximately 2.5 ma.). Then replace the meter tube, allow it to warm up, turn the a.v.c. switch to "off" so the grid is shorted to ground, and adjust the 3000-ohm variable resistor for zero meter current. When the a.v.c. is "on," the meter will follow the signal variations up to the point where the voltage is high enough to cut off the meter tube's plate current. This will occur in the neighborhood of 15 volts with a 6J5 or 6SN7GT, and represents a rather high-amplitude signal.

The bridge circuit, while not exactly linear, is quite satisfactory from a practical standpoint. It will handle a signal range of well over 80 db. The meter cannot be "pinned," because the maximum reading occurs when the tube plate current is driven to zero, at which point further increases in a.v.c. bias cause no change. — George Grammer, *W1DF*

**SHIELDING FOR TVI REDUCTION**

FOR those who do not have the price of an enclosed rack or cabinet in which to shield their transmitters, here's an inexpensive substitute that has proved effective.

(Continued from page 120)



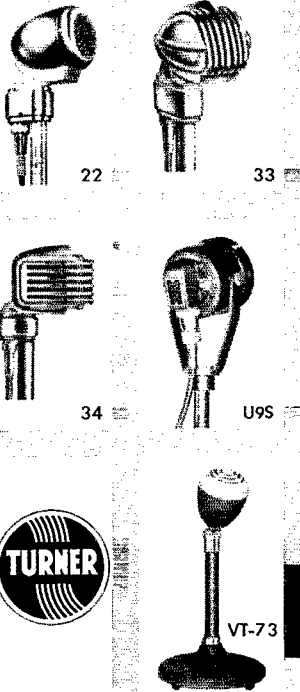

Compare the style  
 Compare the ruggedness  
 Compare the performance  
 Compare the price

Turner Microphones  
 invite comparison

Model 33X.....\$24.50 List  
 Model 33D.....\$27.00 List

Write for complete literature

In Canada: Canadian Marconi Company,  
 Montreal, P.Q., and branches.

Export: Ad. Auriema, Inc., 89 Broad Street,  
 New York 4, N. Y.

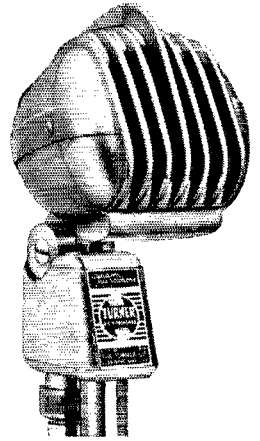

## THE TURNER COMPANY

917 17th Street, N. E.

Cedar Rapids, Iowa

*Microphones by* **TURNER**

Crystals licensed under patents of the Brush Development Company.

### RADIO COURSES

- RADIO OPERATING
- RADIO SERVICING
- CODE
- FM TELEVISION

Preparation for Civilian, Maritime, Army and Navy  
 license requirements.

Personal Counselling Services for Veterans  
 Write for Catalog T.Q.



**TRADE & TECH. SCHOOL** 229 W. 66 St., N. Y. 23  
 ENdicott 2-8117

### GOLD PLATED CRYSTALS

**2 FOR \$100** POSTPAID  
 IN THE U.S.A.

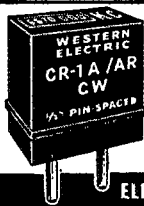

All fundamental freqs. in Kilocycles			
5910	6510	6690	7390
6350	6610	7270	7480
6370	6670	7350	7580
6470	6940	7380	9720

GUARANTEED

**ELECTRONICRAFT, Inc.** 5 Waverly Place  
 Tuckahoe 7 N. Y.



Founded in 1909

### RADIO TELEPHONY RADIO TELEGRAPHY RADAR & LORAN

Courses ranging in length from 7 to 12 months. Dormitory  
 room and board on campus for \$40.00 a month. The college  
 owns KPAC, 5 KW broadcast station with studios located on  
 campus. New students accepted monthly. If interested in  
 radio training necessary to pass F.C.C. examinations for  
 first-class telephone and second-class telegraph licenses,  
 write for details.

**PORT ARTHUR COLLEGE** PORT ARTHUR  
 TEXAS  
 Approved for G. I. training

### TWICE AS EASY AS HAND SENDING!

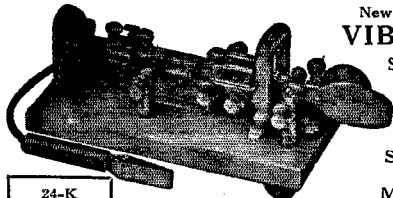

### New Super DeLuxe VIBROPLEX

Semi-Automatic  
**KEY**  
 JEWEL  
 Movement  
 SUPER-SPEED  
 Control  
 MAIN SPRING

24-K  
 Gold-Plated  
 Base Top  
**\$29.95**

### "PRESENTATION"

There's no arm-tiring effort, no nerve strain when  
 you do your sending with this New, Super DeLuxe  
 Vibroplex key! Requires no special  
 skill to operate. Smooth, positive action. Adjusts in-  
 stantly to personal touch and style of sending. Now  
 you can send slower or faster than has ever before  
 been possible. Twice as easy as hand sending...  
 100% better! No wonder good operators prefer this  
 easy-working key. Other models in Standard and  
 DeLuxe finish, \$12.95 up. Left hand models one dollar  
 more. KKEE catalog. ORDER YOURS TO-DAY!  
 At dealers, or direct.



Headquarters for new portables — all models and styles  
 of type. Also, rebuilt Standard and portable typewriters  
 with ALL CAPITAL letters and other styles of type. Im-  
 mediate delivery. ORDER NOW!

**THE VIBROPLEX CO., Inc.**  
 833 Broadway New York 3, N. Y.

## THE HUNTER BAND-IT 20B

A Fine Band Switching Multiplier Unit

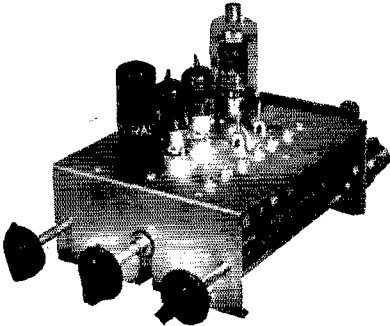

- Controls: Band Switch, Buffer Tuning, Final Tuning.
- Tubes: 6AG7, 2-12AU7, 2E26 (not furnished).
- Size: 5½" wide, 9¾" long, 2¾" high.
- Output: 20 watts.
- Bands: 160, 80, 40, 20, 15 and 10.
- Input Volts: 8 to 12 v. r.m.s.
- Oscillator: Crystal or M.O. on 160 meters.
- Power Requirements: 6.3 v. @2.5 a., 270 to 300 v. @110 ma., 525 v. @60 to 90 ma.
- Price: Only \$47.95 f.o.b. Iowa City

Send for your descriptive folder today. A fine unit to design the 1 kw. final around

**THE HUNTER MFG. CO., INC.**  
IOWA CITY, IOWA

## BROAD BAND TEN METER CONVERTERS... \$16

(postpaid)

These RF24 three tube units really perform. Peps up your set immeasurably, especially such models as the BC-348, BC-342, etc. Actually covers 20-30 Mc.—output 7.5 Mc.—measures 5 x 7 x 10½. Spare tubes, coax fittings and instructions furnished. Needs no alteration to perform. Requires 200-250 V. 18 Ma + 6.3V at 2 amp. Used but guaranteed to work.

**THE OVERBROOK COMPANY**  
OVERBROOK 81, MASS.

Wallpaper about two feet out along each wall in one corner of the shack with aluminum foil (available at low cost in grocery stores). This is best done by applying rubber cement to both the wall and the back of the aluminum foil. Place the transmitter in this corner, standing it parallel to one wall, and at right angles to the other. Close the remaining open sides with a thin plywood door to which aluminum foil has been similarly cemented. Ground the foil, and the result is a shielded transmitter enclosure for less than a dollar. — William E. Cheshire, W8UPC

## SIMPLE DIRECTION INDICATOR FOR ROTARY ANTENNAS

THE homebuilt gadget illustrated in Fig. 4 is an inexpensive solution to the direction-indicator problem. While it admittedly lacks some of the refinements possible with synchro motors, its low cost and simplicity offset its minor deficiencies.

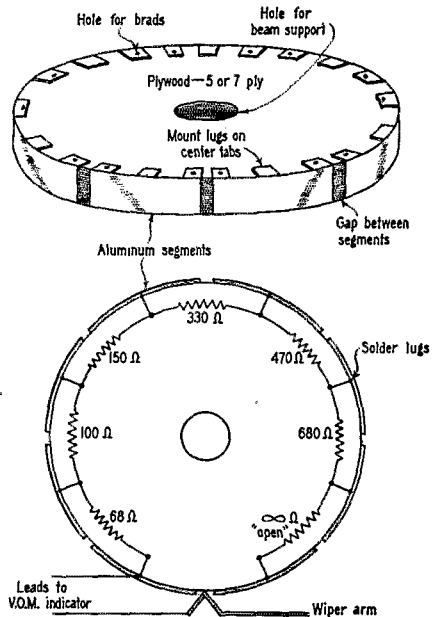

Fig. 4 — A simple direction-indicator mechanism that uses a homebuilt step-resistor and the station v.o.m.

A six-inch diameter piece of half-inch plywood, a little scrap aluminum, some half-watt resistors, plus two wires and the station volt-ohmmeter are all the parts required. The circular piece of wood, after first being coated with waterproof shellac, is fitted with eight aluminum segments used as contacts in a variable-step resistor as shown in the drawing. The aluminum segments are spaced around the circumference of the wheel, and are fastened to it with small brads. The resistors are mounted on the center tabs of the aluminum segments by means of solder lugs placed beneath the brads when the segments are tacked in position.

(Continued on page 122)



## A. C. SHANEY'S NEW TAPE RECORDER MANUAL

ELEMENTS of SINGLE and DUAL TRACK TAPE RECORDING and 1001 APPLICATIONS

... IS "FINE BUSINESS"!

Hams, Experimenters, Technicians interested in tape recording will find a GOLD MINE of valuable information in this complete, comprehensive reference guide. 112 pages, crammed with circuit diagrams, construction hints, over 100 illustrations, latest theories in Tape Recording design. Order your copy today!

Only \$1.00 postpaid

**AMPLIFIER CORP. of AMERICA**  
398-11 Broadway, New York 13, N. Y.

*Continues...*  
**Breaking All  
 Performance  
 Records**

10 METER BEAM ANTENNA

"The 10-Meter Beam arrived in fine shape. It has been up in the air for about four weeks and it works out fine — doing all and more than you said it would do. Two weeks ago we had a very bad wind storm that blew for eight hours with winds of more than 80 m.p.h. and gusts of more than 105 m.p.h. Trees and houses came down, but my Workshop Beam stayed up during it all without the slightest bit of damage." — A. C. EMMETT, JR. KL7SS, Yakutat, Alaska

"I have had one of your 10-Meter Beams since the fall of last year. It has gone through four hurricanes without mishap since original installation." — E. A. BAKER W4MGW, Fort Lauderdale, Fla.

**The WORKSHOP ASSOCIATES, INC.**

*Specialists in High-Frequency Antennas*

135 CRESCENT ROAD, NEEDHAM HEIGHTS 94, MASSACHUSETTS



**Workshop Amateur Antennas**

- |   |          |
|---|----------|
| 2-Meter Beam Antenna #146AB                 | \$21.50  |
| 6-Meter Beam Antenna #52AB                  | \$9.00   |
| 10-Meter Dipole Antenna #29AD               | \$8.00   |
| 10-Meter 3-Element Beam Conversion Kit #29B | \$31.50  |
| 20-Meter 3-Element Beam Antenna #14         | \$120.00 |
| 6-Meter 6-Element Array #52AB-2             | \$27.75  |
| 6-Element "Dual-Ten" Beam Antenna #29X      | \$100.00 |
| 10- and 20-Meter Stacked Array #2914        | \$181.00 |

Available at better dealers

**BUILD YOUR OWN  
 GEIGER COUNTER!**

It's EASY to build your own Searchmaster Geiger Counter with this COMPLETE kit. Contains everything you need! Headset, tubes, batteries, metal case. Fully guaranteed! Sensitive to both beta and gamma radiation! Illus. Instructions. FREE radioactive specimen.



Write for  
 FREE  
 literature

**SCIENCE KITS LTD.**

5514-R Hollywood Blvd. • Hollywood 28, Calif.

**RADIO and TELEVISION**

Over 30 years N.E. Radio Training Center. Train for all types FCC operators' licenses. Also Radio and Television servicing. FM-AM broadcasting transmitters at school. Send for Catalog Q.

**MASS. RADIO SCHOOL**

271 Huntington Avenue Boston 15, Massachusetts  
 Lic. by Comm. Mass. Dept. Educ.

**EASY TO LEARN CODE**

It is easy and pleasant to learn or increase speed the modern way — with an **Instructograph Code Teacher**. Excellent for the beginner or advanced student. A quick, practical and dependable method. Available tapes from beginner's alphabet to typical messages on all subjects. Speed range 5 to 40 WPM. Always ready, no QRM, beats having someone send to you.



**ENDORSED BY THOUSANDS!**

The **Instructograph Code Teacher** literally takes the place of an operator-instructor and enables anyone to learn and master code without further assistance. Thousands of successful operators have "acquired the code" with the **Instructograph System**. Write today for full particulars and convenient rental plans.

**INSTRUCTOGRAPH COMPANY**

4709 SHERIDAN ROAD, CHICAGO 40, ILLINOIS

**COMMERCIAL RADIO INSTITUTE**

A RADIO TRAINING CENTER FOR 30 YEARS

**Resident Courses Only** • Broadcast, Service, Aeronautical, Television, Radar, Preparatory Mathematics, Frequency Modulation and Marine telegraphy. Classes now forming for fall term Oct. 1st. Entrance examination Sept. 25th.

Literature upon request. Veteran training

Dept. B, 38 West Biddle Street, Baltimore 1, Maryland



**RADIO and TELEVISION**

Thorough Training in All Technical Phases

APPROVED FOR VETERANS

WEEKLY RATES. DAYS—EVENINGS

FREE PLACEMENT SERVICE for GRADUATES

For Free Catalog write Dept. ST-50

**RCA INSTITUTES, INC.**

A Service of Radio Corporation of America  
 350 WEST 4th ST., NEW YORK 14, N. Y.

BE ONE OF THE FIRST TO GET  
 ON THE AIR WITH THE

**NEW  
 75A-2**

**EASY TERMS**

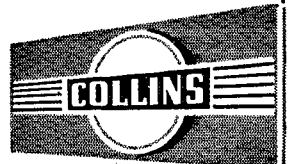

WRITE TODAY TO

**ACK RADIO SUPPLY CO.**

2205 Third Avenue, No., Birmingham, Alabama



# NATIONAL

- **Proven**
- **Dependable**
- **Quality**

MB-40L

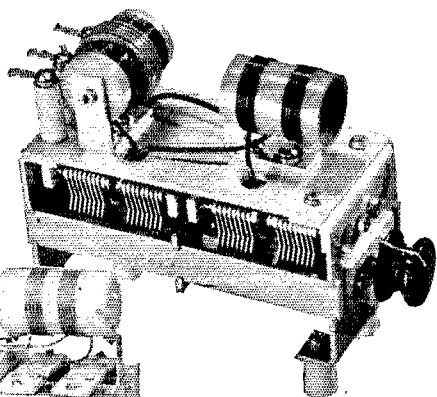

MB-150

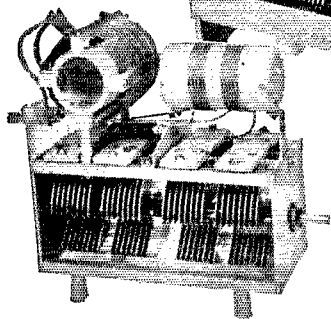

## MULTI-BAND TANK ASSEMBLIES

The unique MB-150 high-power and MB-40L low-power multi-band tank assemblies will tune all bands from 80 to 10 meters with a single 180° rotation of the capacitor without changing coils.

The MB-150 is intended for use in plate tank circuits having an input up to 150 watts. It is ideal for a pair of 807's, 809's or a single 829 B. Net \$18.75

The MB-40L may be used in the grid circuits of tubes employing the MB-150L in the plate circuit. Will handle 40 watts if link is kept loaded. Net \$9.90

The wiper arm is mounted in position on the structure that supports the beam.

The advantages of this system are numerous. It is inexpensive, and it utilizes the station volt-ohmmeter, which isn't ordinarily used for other purposes when the station is on the air. No external power supplies are required, because the indicator is actuated by the batteries of the volt-ohmmeter. Once the beam is pointed in the desired direction, the meter can be removed from the circuit, thus preventing unnecessary battery drain.

With eight aluminum segments, as shown, only eight directions are indicated, and the accuracy is plus or minus 22½ degrees. With a bit more work, a larger number of segments and resistors could be used to permit these figures to be improved. You can suit your own requirements. By using the resistance values shown, an approximately linear deflection of the basically nonlinear ohmmeter scale is obtained, but here again, you can suit your own requirements, using whatever resistance values you have on hand, making suitable corrections in the "calibration" on the face of the indicator. Full use of the entire scale of the meter is made possible by using "zero" and "infinite" resistors at the extreme ends of the circumference of the wheel.

— Cecil K. Johnson, W0TLY

### CONSTRUCTION TIP

IN many cases of surplus conversion or modification of other gear it becomes necessary to mount a knob or extension shaft in a location where the use of a setscrew is not feasible. Most cements or glues will not serve satisfactorily because they contract upon hardening, which results in a loose, wobbly shaft or knob. The solution lies in the use of "Smooth-On No. 1," available in any hardware store, which expands during hardening.

— R. L. Baldwin, W1LKE

### SHOCK ABSORBER FOR FLAT-TOP ANTENNAS

IF you've ever used a flat-top antenna supported between two trees, you've probably had the sad experience of seeing one or more of the insulators shattered when the trees whip around in random directions during high winds. After losing several antennas in this way, I solved my difficulties by placing an automotive valve spring "in series" with the end insulator and the wire that holds the antenna to the tree. The spring takes up the initial shock when the wind tosses things about, and thus far has prevented any further breakage.

— Grover Hunsicker, W0BDE

National



NATIONAL COMPANY, Inc.  
MALDEN, MASSACHUSETTS

## SWITCH TO SAFETY!



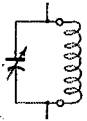

**HOW MANY TURNS?**  
**DON'T** Guess and try and guess and  
 try and guess and try and guess and try.



**THE ARRL LIGHTNING CALCULATOR  
 GIVES YOU THE ANSWER—FAST**

Suppose, for example, you want to build the 80-meter plate tank for your 6V6 buffer and use a 200  $\mu\text{fd}$ . variable condenser you already own; you want the plate circuit to resonate at 3750 kc. with the condenser plates about three-fourths in. What about the tank coil?

Well, a 1½-inch long x 1-inch diameter coil form is easy to get, so grab your Calculator and find the largest size wire you can use on the form, and how many turns.

Here's all you have to do: Set 1¼ inches (allowing ½-inch at each end of the winding) on the Coil Length Scale opposite 1-inch on the Coil Diameter Scale and set the Frequency Scale so that 3750 kc. is opposite the large letter F. Without changing those settings, turn the pointer until its hair line is at 160  $\mu\text{fd}$ . (the condenser's probable capacitance value with plates about three fourths in) on the Capacity Scale.

And you have the answers! Simply read them under the pointer hair line. A glance at the Inductance Scale shows the coil value to be 11 micro-henrys. A look at the three Wire Scales tells you that No. 18 enameled wire can be used and that 23 turns to the inch make a close-wound coil. So, to make your tank coil, close-wind one and a quarter inches of a 1-inch diameter coil form with No. 18 enameled wire; 29 turns (1¼ x 23) will be required.

That's only one use for your Type A Calculator—the gadget that saves precious time. You'll have many others, all of them important.

There's a Type B Calculator, too. It makes Ohm's Law problems easy!

**ARRL LIGHTNING CALCULATOR, Type A or Type B**

**\$1.00** *postpaid anywhere*



38 LA SALLE ROAD

**THE AMERICAN RADIO RELAY LEAGUE, INC.**

WEST HARTFORD 7, CONNECTICUT



**Thousands of America's Hams  
 MUST BE ON THE BEAM!**

**NEW EICO** instruments and **KITS**  
 give you **Laboratory Precision AT LOWEST COST!**

5" Push-Pull Oscilloscope  
 Model 425-K, Kit, \$39.95  
 Model 425, factory wired, \$69.95

Vacuum Tube Voltmeter  
 Model 221-K, Kit, \$23.95  
 Model 221, factory wired, \$49.95

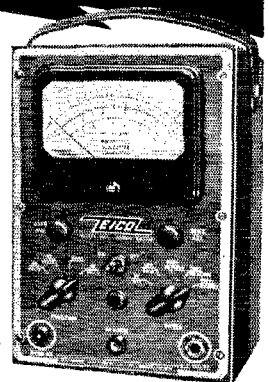

It's smart ham sense to cut your test equipment costs—without sacrificing quality. That's why more hams than ever before are building their own precision instruments with EICO KITS.

For top-notch laboratory-precision equipment, EICO gives you the newest efficient designs and circuitry and the finest quality brand-name electronic and mechanical components. Each EICO Kit is complete with pre-punched chassis, cabinet and etched panel. For rock-bottom cost, you do the simple assembly in one easy evening with the EICO simplified instructions.

EICO Kits and Instruments are acclaimed and used by the top-flight universities, schools and original equipment manufacturers from coast to coast. See the complete EICO line of superlatively engineered, handsome VTVM's, scopes, tube testers, signal and sweep generators, etc.—at your favorite jobber TODAY. Ask him about the EICO Make-Good Guarantee—the strongest guarantee in the Industry! Write NOW for your free latest Catalog Q.

*Prices 5% higher on West Coast*



High Voltage Probe,  
 Model HVP-1, \$6.95



**ELECTRONIC INSTRUMENT CO., Inc.**  
 276 NEWPORT STREET, BROOKLYN 12, N. Y.

© 1950, Electronic Instrument Co., Inc., Brooklyn, N. Y.

# HAM-ADS

(1) Advertising shall pertain to radio and shall be of nature of interest to radio amateurs or experimenters in their pursuit of the art.

(2) No display of any character will be accepted, nor can any special typographical arrangement, such as all or part capital letters be used which would tend to make one advertisement stand out from the others.

(3) The Ham-Ad rate is 30¢ per word, except as noted in paragraph (6) below.

(4) Remittance in full must accompany copy. No cash or contact discount or agency commission will be allowed.

(5) Closing date for Ham-Ads is the 25th of the second month preceding publication date.

(6) A special rate of 7¢ per word will apply to advertising which, in our judgment, is obviously non-commercial in nature and is placed and signed by a member of the American Radio Relay League. Thus, advertising of bona fide surplus equipment owned, used and for sale by an individual or apparatus offered for exchange or advertising inquiring for special equipment, if by a member of the American Radio Relay League takes the 7¢ rate. An attempt to deal in apparatus in quantity for profit, even if by an individual, is commercial and all advertising by him takes the 30¢ rate. Provisions of paragraphs (1), (2) and (5), apply to all advertising in this column regardless of which rate may apply.

(7) Because error is more easily avoided, it is requested signature and address be printed plainly.

(8) No advertiser may use more than 100 words in any one issue nor more than one ad in one issue.

*Having made no investigation of the advertisers in the classified columns, the publishers of QST are unable to vouch for their integrity or for the grade or character of the products or services advertised.*

Please note the 7¢ rate on Ham ads is available to ARRL members only.

**QUARTZ**—Direct importers from Brazil of best quality pure quartz suitable for making piezo-electric crystals. Diamond Drill Carbon Co., 719 World Bldg., New York City.

**QSLs**, 100, \$1.25 up. Stamp for samples. Griffith, W3FSW, 1042 Pine Heights Ave., Baltimore 29, Md.

**QSL's**, SWL's. Finest stock. Fairest prices. Faster service. Dossett, W9BHW QSL Factory, 855 Burlington, Frankfort, Ind.

**QSLSI** Kromkote cards at a fair price. Dauphinee, W1KMP, Box 219, Cambridge 39, Mass.

**SUBSCRIPTIONS**. Radio publications a specialty. Earl Mead, Huntley, Montana, W7LGM.

**QSL's** high quality, fair prices. Samples? W7GPP, R. D. Dawson, 1308 F. Street, The Dalles, Oregon.

**10-METER Beams**, \$19.50. Send Card for free information, Riverside Tool Co., Box 87, Riverside, Illinois.

**CRYSTALS**: Bassett Type 100A precision low-drift units made to your exact specified frequency within the 80 or 40 or 20 amateur bands, at \$1.50 each, plus postage. Rex Bassett, Inc., Bassett Building, Ft. Lauderdale, Fla.

**QSL's**. Very attractive. Best in printing and prices. Kromkote or any other stocks. Stamp for samples. W4LXJ, Roop, Radford, Va.

**FOR Sale**: Closing out on first class equipment, like new. Collins 75A1, 1 Kw variable transformer with meter, MM2 micromatch power supplies, modulator, Beams, 40 ft steel tower, rotator, selayns, Orval Hanson, W8TOW, Watertown, South Dakota.

**MOTOROLA** dispatchers, new, \$350.00. Used: \$250.00. W5BCO, Hichs, 204 E. Fairview, Tulsa, Okla.

**ARE you or a friend going to try for an amateur radio operator's license?** Check yourself with a complete coverage multiple-choice test similar to those used by the F.C.C. Class B & C test, \$1.75. Class A test, \$2.00. Amateur Radio Supply, 1013 Seventh Ave., Worthington, Minnesota.

**1000 VA transformer** 1100-2200-4400 each side CT. Guaranteed. Dawson, 5740 Woodrow, Detroit 10, Mich. \$15.00.

**PHONE** patch schematic, practical discussion. \$1.00. Nichols, W1MRK.

**FULLY** amplitude modulate any tetrede or pentode to maximum ratings with three watts audio. No transformers, excellent quality. Duo-controlled carrier modulation. Details, \$1.00. R. Best, W4JGA, Greensboro, N. C.

**QSLs**. The W5RV Press. Cards and stationery for the discriminating amateur and SWL. 043 Eagle Avenue, Jackson, Mississippi.

**866A Kit**: 2 tubes, sockets and 2.5VCT/10 amp, 10 Kc transformer, \$5.95. 1N34 crystal, 6¢. Free "Tabogram", amazing bargains. "TAB", 109 Liberty Street, New York, N. Y.

**QSLs**: Have you seen them yet? Samples today. Your best bet: Larry's QSL's, Opportunity, Washington, P.O. Box 59.

**SELL**: F.V. and F.M. booster 2 to 6 and 7-13 channels. New. Very cheap. C. Horn, 325 East 163rd St., New York City 56, N. Y.

**NEW crystals** for all commercial services at economical prices, also regrinding Motorola, Link, G.E. and other commercial crystals. Over fourteen years of satisfaction and fast service! Eldson Electronic Co., Phone 3901, 1802 No. Third St., Temple, Texas.

**QSLs? SWLs?** Modernistic? Cartoons? Photographic? Deluxe? QSL samples, 3¢. Sakkers, W8DED, Holland, Michigan. Immediate QSL service!

**QSLs-SWL cards**. Samples. Cushing, W1HJI, Box 32A, Manchester, N. H.

**FOR Sale**: BC-610E, 80 through 10, speech amplifier, antenna tuner, 15 amp variac, extra meters. Shielded for TVI \$600 F.o.b. W8ZQC, Olmsted Falls, Ohio.

**SELL**: SX-28 Hallcrafters' ham receiver, .55-42 Mc. with 8" pin wood cased separate speaker. In good condition, and works fine. Need cash. Best offer over \$100 F.o.b. Also have 3" oscillograph with built-in FM wobulator for audio tests, and VTM, both as new. W. H. Pendleton, 154 Mass. Ave., Arlington 74, Mass.

**FOR Sale**: Collins 32V-2, \$575 and 75A-1, \$375. Perfect, like new. Earl Carsner, Johnson Air Force Base, Japan. Telephone 5489.

**SELL**: Collins 75A1, two months old, \$295.00. BC-610D converted, \$575.00. W4ELL, 495 Lightfoot Road, Louisville, Ky.

**SPECIALIZED QSL's**, SWL's! Samples! Ace Print Shop, Jeppesen, W9QFZ, 2705 South 7th, Council Bluffs 1, Iowa.

**QSL-SWLs**. High quality. Reasonable price. Samples. Bob Teachout, W1FSV, 40 Elm Street, Rutland, Vt.

**WANT**: 32V-2 or 1; 75A-1; S-72. Trade: Federal BC-325B; 344-D; 654-A; 779-B; 221-E; ART-13; TCS-11; LM-7; EE-8-B. Write to Normandy Farm, 18425 4th SW, Seattle, Washington.

**BARGAINS**: New and used transmitters, receivers, parts: BC-610, \$450.00; Globe King, \$299.00; HT-9, \$225.00; Temco 75CA, \$250.00; Sonar SR-75, \$129.00; ART-13, \$119.00; Collins 75A1, \$295.00; new 150-watt phone, \$199.00; HT-6, \$85.00; Meck T-60, \$85.00; Globe Trotter, \$37.50; new Bud VFC, \$39.50; New Meisner signal enhancers, \$29.95; IRO complete, \$129.00; SX-43, \$19.00; NC-173, HQ-129X, \$139.00; RME-45, \$99.00; SX-42, \$189.00; SX-25, \$89.00; RME-69, \$69.50; VHF152A, \$69.00; S-38, \$29.95 and many others. Large stock of trade-ins. Free trial. Terms financed by Leo, WOGFO. Write for catalog and best deal to World Radio Laboratories, 740-44 West Broadway, Council Bluffs, Iowa.

**WANTED**: APR-4 receiver and tuning units. State condition and price. W2DB, 274 Boulevard, Scarsdale, N. Y.

**WANT** communications receivers. Pay cash or will make big allowances on new receivers. Have bargains in large stock of new and reconditioned Collins, National, Hammarlund, RME, Milten, Meisner, or other equipment. Shipped on trial. Terms financed by us. Write for free list. Henry Radio, Butler, Mo.

**SACRIFICE**: "Brand new" National "57", "S" meter, both #75. General Electric Unimeter, 24-hour clock, best offer. Frank Woolley, (Meter Division) Westinghouse, Newark, N. J.

**SELL QST's** 1917 to 1920. Miniature copy QST, G.R. Experimenter, Vol. 1, Vol. 2. Electrical Experimenters 1917 to 1921. Mesco catalog #9, issued 1916. Collins Wireless Bulletin, Jan.-Dec. 1909. "Ban Off" slip. Adams-Morgan 1915 catalog. Wm. Ducky 1914 catalog. Meisner Electrodynamics 1916. Clapp Eastham 1915 catalog. IRE Year Book, 1914; DeForest catalog, 1919. Many more. L. Rizoli, WIAAT, 100 Bay View Ave., Salem, Mass.

**FOR Sale**: 32V1, \$395.00. Postpaid. Frank Finch, 812 West 4th, Port Angeles, Wash.

**SELL**: Kennedy 110 Universal Receiver, 525 amplifier, \$50.00; Wireless Specialty Apparatus Co. IP 501A receiver and IP 503 loading unit, \$50.00. All units in very good condition. V. J. Weber, R.D. 1, Millford, Pike Co., Penna.

**OUTSTANDING bargain**: Meisner 150-B transmitter, all re-mounted in 42" Par-Metal cabinet. Complete with V.F.O. and 3 extra 813's. Looks like commercial. Cannot ship, come take or best offer. Write your mind. A. H. Emery, W2CVT, Dutchess Tpk., Poughkeepsie, N. Y.

**HALLCRAFTERS Model SX-42** receiver and matching speaker. Lists \$318.00. For sale \$175.00 F.o.b. California. W6DSV, G. W. Carlson, 151 16th Ave., San Mateo, California.

**WANTED**: Marconi Coherer Magnetic detector. Multiple tuner; DeForest responder and other gear prior to 1920. Franklin Wingard, Rock Island, Ill.

**PROP** pitch motors unused, brand new, complete instructions for conversion. Packed for shipment. \$12.50 F.o.b. Roanoke, Va. Limited quantity. Wire or write W4JFV, Aldinger, 512 Albermarle Ave., Roanoke, Va.

**WANTED**: Plate xformer; to deliver approx. 3000 VDC at 500-700 Ma. from 120/220 V ac. Please state mfg., RME No. (if possible) and the approximate size and weight. R. L. Snyder, W2AZD, 824 E. 21st St., Brooklyn 10, N. Y.

**SELLING** station, Liberty ship transmitter, slightly used, 750 Ma., 2500 volt supply. Pair 813's. Pi network, eight meters, eleven tubes, three complete power supplies, individual circuit switches, master control switch. Reports, "sounds like WJAW". Beautifully finished, ready to operate at \$300.00. Also, Collins 75A1 receiver, year old, little used, like new: \$265.00. Dr. C. Scheiffel, % Mayo Clinic, Clin. Sec. Rochester, Minnesota.

**SELECTIVE** buying includes National receivers for top quality and long lasting performance at Evans Radio in Concord, N. H. P.O. Box 312, 10 Hills Avenue.

**60% discount** on used but positively guaranteed xtals, imported meters and old issues of QST and CQ. Write for details. Maj. G. M. Blencoe, W2ESM/A2ESM Quarters 114-21, West Point, N. Y.

**SELL** Collins 75A1, \$325.00. L. Giannini, 561 Brussels St., San Francisco, Calif.

**WANTED**: AN/APR-4 receivers and tuning units, UHF signal generator; laboratory quality test equipment, dial telephones, stepping switches; Motorola program clocks and tuners; surplus, APR-5A, TS-174/U, TS-175/U, P1A-R-5, ABR-7, ART-13, etc. Cash or trade. Description and mention price in first letter. C. Littell, jr., Farhills, Box 26, Dayton 9, Ohio.

**WILL** sell unused copy of "Radiotron Designer's Handbook"; Henney's "Radio Engineering Handbook"; "Practical Radio Communication" by Nilson-Horning. Best offer? Roberts, W1KUK, 71 Elm, West Haven, Conn.

**WEBSTER Model No. 79** wire-recorder foundation unit, hardly used. Original carton, instructions, extra spool of wire. Best offer. Hayden, W4IWS, Owens, Va.

**10 and 20-meter beams**, \$19.25 up. Aluminum tubing, etc. Willard Radcliff, Fostoria, Ohio.

**SELL**: NC-240-D. On dealer's shelf two years. Used six hours, like brand new. \$157.00, expressed. Ross Thorp, 313 Delta, Filmt, Mich.

C. FRITZ for better QSL's. 1213 Briargate, Joliet, Illinois.

SALE or trade: Hammarlund Super Pro BC-779 in good condition, \$100.00. Want: commercial 10-meter mobile equipment. L. Girouard, WOODQ, 12434 Pothill Boulevard, San Fernando, Calif.

WANTED: Wilcox F3/CW3 2. Mc coils; RAS coil rack CNA-10037. Bliss, W4ES, 2585 S. Bayshore, Miami 33, Fla.

SELL: Chicago vicinity: 75A1 practically new, \$300.00. Instructograph, 12 tapes, phones and practice set, \$23.00. Also sell SX-25, 540R receivers. Gene Sedberry, 7321 W. 127th Street, Palos Heights, Illinois. Phone 571W.

NC-57, S-meter, preamplifier, unmarked, \$70.00. R. G. Clark, 505 Wilton Road, Towson 4, Baltimore, Md.

SELL: Two excellent condition BC-222's and battery eliminator for them. Best offer over \$20.00. W. Ohlsen, W0QAM, 816 Hodge Avenue, Ames, Iowa.

BOAT, two-man inflatable, and equipment. Sell, swap for Command xmitters, etc. W2CCZ.

QSLs: Uncle Fred's QSLs. Three colors and up. Rainbow map QSLs. Special DX QSLs. Bargain QSLs. Samples, 10¢. Uncle Fred, Box 86, Lynn, Penna.

TRADE Meissner 150-B transmitter converted to 10.20 and for crystal mike, in excellent condition looks good as new, for good television receiver of equal value. W4KSV, Fairwell, Box 892, Lynchburg, Va.

WANTED: Two 1000 Kc. crystals for LM or BC-221 freq. meter. Neman, W3QOB, 5002 54th Place, Hyattsville, Md.

500 Watt VFO fone, \$150.00. R. A. Bost, W0YIH, 820 Maud, Poplar Bluff, Mo.

HQ-129X tcvr, spkr, in excellent condx. \$125.00. Hunter Cycle-master, like new, \$125.00; 250 watt xmitter, 1r T40, mod. by 807's, in gray cabinet, beautifully constructed. Surpasses most commercial equipment. Write for details. Daniels, W9DSV, Box 261, Webster, Wisc.

SELL: Have several copies each, new, original Army Technical Manuals on BC-221, all models, \$2.00; BC-312-342; BC-314-344; TG10 keyers; I-72 signal generators; I-56-F test set; PE-99-B; Radio transmitter 149-A; Precision model REV-10-MCPC voltmeter; Wilcox receiver CW3 and F3; Repair and calibration of electrical measuring instruments; trouble-shooting and repair of radio equipment; any one \$1.25. BC-453A and SCR522A schematic wiring diagram, 25¢ each. TU10B tuning unit, original carton, make offer. Frank Dunan, W3NB, 1717 Lang Place, NE, Washington 2, D. C.

SELL used RCA ACT, 20 watt cw/phone transmitter, complete tubes, crystals, \$35.00. Cost \$129.50. Curtis, KPRO, Longview, Texas.

SACRIFICE: \$60.00, cost \$200.00. 30-watt fone/c.w. transmitter 80-40-20-10 meters, Hammarlund made, complete with JT30 mike, all in perfect condition. W1NKW, Harold Ryall, 76 Fox Hill Road, Nahant, Mass.

WOULD like to get in touch with anyone with Call Books earlier than 1919. W4AD, Box 793, Rome, Ga.

WANT: HRO-7, M. G. Morgan, WIHDA, Thayer School of Engineering, Hanover, N. H.

NATIONAL HRO #7, complete coils, power box, speaker, etc. 7 months old. In excellent condition. Sacrifice \$255.00. C. D. Soresi, Andrews Chapel, Vienna, Va. (phone Falls Church 6122).

SELLING out: SX-25 recently aligned and checked, \$70.00; BC-221M, National 1-10 factory coils, speaker and power supply; transformers, chokes, filters, xtals and numerous other Ham gear all in perfect shape. Sell separately or all for \$200.00. Dealers inquiries invited. List free. Blum, 2661 Dibblee Ave., Columbus 4, Ohio.

FOR Sale: BC-342-N. Modified as per QST for September, 1946. Provision for external S-Meter. Excellent condition. Best offer above \$65.00. C. Vernon Chambers, W1JEQ, 111 Englewood Ave., West Hartford 10, Conn.

WANTED: A few TR-4s. State condition, price, etc. WIBB.

QSLs! Taprint, Sumrall, Mississippi.

SALE: Federal 167BY fone and cw, 500 watts input, a giveaway at \$275.00 or best offer. Have to sell. Reason: marriage. W1P5V, Black, 447 Commercial St., Provincetown, Mass.

TRADE complete 6 1/2 volume set Howard Sam's Photofact Radio and Television Service manuals, in perfect condition. Cost over \$120.00. For Harvey-Wells TB5-50(A) or kit/watt power supply components. Martin Yuriga, W9CWB, 333 Roosevelt St., Gary, Indiana.

WANTED: 1250 Mc receiver. Sell 3 new RCA 8012's, \$2.00, 2 early type BC-221 double coil assemblies \$2.00. Bob Dresser, W1JW, Long Hill, Conn.

## AMATEURS

WITH

## TEST EQUIPMENT

The present emergency requires putting back into service both military and laboratory quality commercial test equipment. Interested in any TS, I, BC or other good pieces. Critically need TS-34's, TS-100's, TS-174's and any I-208's, plus gear made by Boonton, General Radio, Stoddard, etc. Please communicate giving full nomenclature and serial numbers. Describe condition with your lowest cash price.

WESTON LABORATORIES

WESTON 93, MASS.

## GOODBYE to ANTENNA MAST PROBLEMS



- ✓ Safe, easy to climb for antenna adjustments
- ✓ Easy to erect
- ✓ Weights only 2 lbs. per foot
- ✓ Low in cost

Treat your antenna to a really modern mast! The Trylon is tops for any height of 10-20-30-40-50-60 feet. Costs no more than a pole. Easy to move to new location. Accommodates 10-meter rotary beams—doublets—rhombics and other wire antennas. Sturdy steel rod construction—hot dip galvanized, double-welded for safety.

Write for FREE FOLDER

## WIND TURBINE COMPANY

240 E. Market Street  
WEST CHESTER, PA.

# TRYLON



# TOWERS & MASTS

## LET'S GO LYSCO

NO HAM STATION SHOULD BE WITHOUT A  
**Lysco Grid Dip Meter**  
NOT A KIT

- 955 OSC.
- 3.4 to 170 Mgs. as Dip Meter
- 3.4 to 340 Mgs. as Signal Generator
- 5 Plug-in Coils

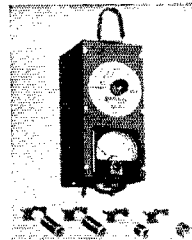

- Phone Monitor
- CW Monitor
- Harmonic Indicator
- Absorption Wavemeter
- Measures Tuned Circuits, Antennas, etc.

Complete ready to operate Model DMR. . . . . \$33.50 net

### OTHER LYSCO PRODUCTS

- MOBILE CONVERTERS:** Model 130—26 to 30 M.C., Model 132—14 to 14.4 M.C., Model 133—3.5 to 4 M.C. Complete with Tubes. . . . . \$32.50 Net
- MOBILE TRANSMITTERS:** Model 129—26 to 30 M.C., Model 175—3.5 to 4 M.C. . . . . \$23.95 Net less Tubes
- MOBILE VFO:** Model 381—3.5 to 7, 7 to 7.5 MCS, Model 381-R—3.5 to 7, 7 to 7.5 MCS. Remote Tuned Circuit on 381. Amateur Net. . . . . \$21.95, 381-R. . . . . \$27.95. Complete

Buy LySCO Products at Leading Distributors

LYSCO MFG. CO., INC.

1401 CLINTON ST.

HOBOKEN, N. J.

Designed for

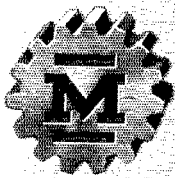

Application

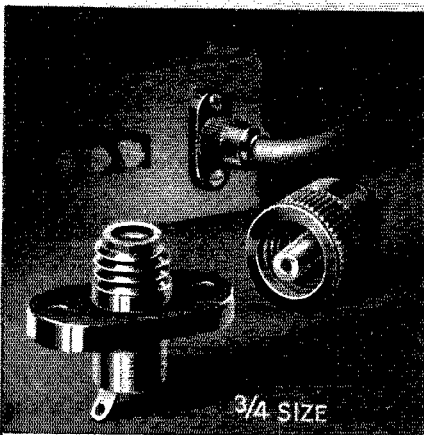

**THE NO. 37001  
SAFETY TERMINAL**

An old favorite in the line of exclusive Millen "Designed for Application" products. Combination high voltage terminal and thru-bushing. Tapered contact pin fits firmly into conical socket providing large area, low resistance connection. Pin is swivel mounted in cap to prevent twisting of lead wire. Easy to use. 1/4" o.d. insulation high voltage cable fits into opening in cap. Bare conductor passes thru pin for easy soldering to pre-tinned tip of contact plug.

Standard 37001 available in either black or red bakelite. No. 37501 is low loss mica filled yellow bakelite for R.F. applications.

**JAMES MILLEN  
MFG. CO., INC.**

MAIN OFFICE AND FACTORY  
**MALDEN  
MASSACHUSETTS**



**Index of Advertisers**

Ack Radio Supply Company	121
Allied Radio Company	95
American Lava Corporation	87
American Phenolic Corporation	92
American Radio Relay League, Inc.	82, 103, 118, 123
Amplifier Corp. of America	120
Ashe Radio Co., Walter	101
Astatic Corp., The	117
Barker & Williamson, Inc.	127
Belden Manufacturing Company	85
Bliley Electric Company	84
Candler System Company	106
Capitol Radio Eng. Institute	104
Chicago Transformer Company	91
Cleve. Institute of Radio Electronics	117
Clippard Instrument Laboratories	115
Collins Radio Company	78, 79
Commercial Radio Institute	121
Drake Co., The R. L.	112
Eitel-McCullough, Inc.	81
Eldico of New York	111
Electro-Voice, Inc.	128
Electronic Instrument Company	123
Electroncraft, Inc.	119
Gardiner & Company	108
General Electric Company	1
Greenlee Tool Company	114
Halicrafters Co., The	4, 7
Harrison Radio Corporation	109
Harvey Radio Company	99
Harvey-Wells Electronics, Inc.	96
Henry Radio Stores	93
Hudson Radio & Television Corp.	100
Hunter Manufacturing Company	120
Hy-Lite Antennae, Inc.	116
Instructograph Company	121
Johnson Co., E. F.	88, 94
Knights Co., The James	115
Leeds Radio Company	105
Lettine Radio Manufacturing Co.	116
Lyco Manufacturing Company	125
Mallory & Co., P. R.	83
Mass. Radio & Teleg. School	121
Master Mobile Mounts, Inc.	110
Measurements Corporation	86
Millen Mfg. Co., Inc., The James	126
Motorola, Inc.	114
National Co., Inc.	76, 122, Cov. III
Newark Electric Co.	107
New York YMCA Trade & Tech School	119
Ohmite Manufacturing Company	2
Overbrook Company, The	120
Petersen Radio Company	5
Port Arthur College	119
Precision Apparatus Company	90
RCA Institutes, Inc.	121
RCA Service Co., Inc.	110
Radio Corporation of America	Cov. IV
Radio Shack Corporation, The	97
Science Kits	121
Srepro, Inc.	112
Steinberg's Inc.	102
Sylvania Electric Products	89
Telex, Inc.	108
Timing Devices Company	80
Turner Company, The	119
United Transformer Company	Cov. II
Valparaiso Technical Inst.	112
Vesto Company, The	118
Vibroplex Company, The	119
Ward Products Corporation	98
Weston Laboratories	125
Wind Turbine Company	125
Workshop Associates	121
World Rad o Laboratories, Inc.	113



# LET'S LICK TVI

and brush the cobwebs off the rig

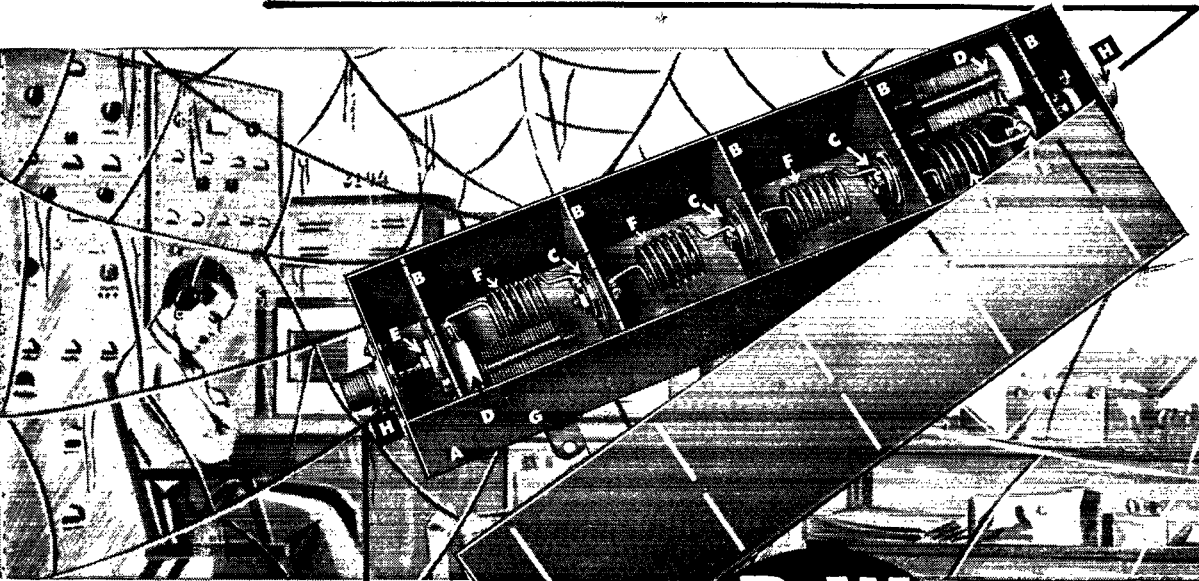

## B&W

### LOW PASS FILTER

- Provides extreme attenuation to all harmonics above 30 mc
  - Eliminates individual filters for each band
  - Handles 1 kilowatt with ease
  - Insertion loss less than .25 db
  - Low in cost . . . Easily installed
- \$22.50**  
Amateur Net Price

Three years of intensive study of TVI problems first introduced the B&W Faraday Shielded Link. Now we proudly present a natural companion—the B&W Low Pass Filter. Properly installed in the antenna feed system, in accordance with our recommendations, the Low Pass Filter provides virtually complete harmonic suppression above 30 mc.

The B&W Low Pass Filter consists of two "m" derived end sections and three midsections of constant K type. Each section is contained in a completely sealed copper compartment to prevent inductive transfer of unwanted frequencies from section to section. RF bypass condensers in the K sections are of special low inductance design having resonant frequencies higher than 500 mc thus eliminating resonances within the TV bands, a fault common to conventional types of condensers.

Complete details on how you can banish TVI are available in *Filter Facts*—packed with each Low Pass Filter.

See your dealer today, or write for bulletin to Dept. Q-100.

- A** Precision fitted solid copper box—solder-sealed throughout
- B** Heavy copper ground plate shields
- C** Precision-Silvered, Low Inductance Mica Condensers
- D** "M" derived end sections peaked on Channel 2 (Coil not visible)
- E** Alsimag 196 Insulation
- F** Heavy, distortion-free, precision coils
- G** Convenient mounting brackets
- H** 52 & 75  $\Omega$  units fitted with standard coax connections
- I** Available in 52, 75, and 300 ohm models

# BARKER & WILLIAMSON, Inc.

237 Fairfield Ave., Upper Darby, Pa.

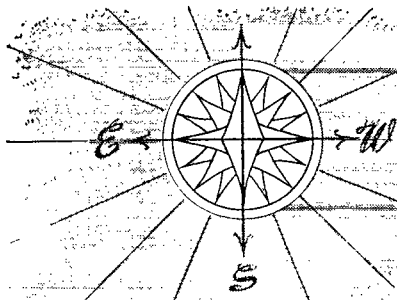

**The MERCURY**  
Rugged, handsome Crystal or Dynamic. Extra quality features at minimum cost. List prices from \$24.50 to \$34.50.

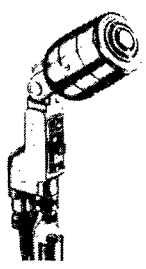

**The "630" DYNAMIC**  
Very popular super-dynamic. Ideal frequency response. High output. Acoustalloy diaphragm. Lists at \$39.50.



**The CARDAX**  
World's favorite premium crystal mike—the first high level crystal cardioid with dual frequency response. List, \$39.50

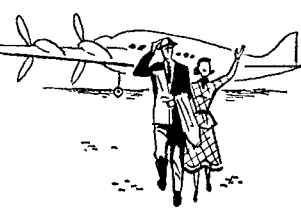

*wherever you go*

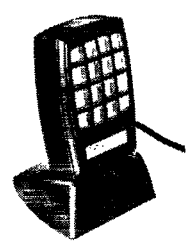
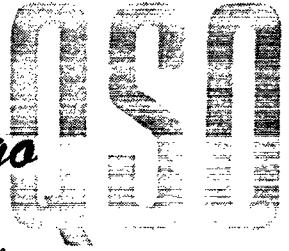

**The CENTURY**  
Low-cost all-purpose crystal and dynamic models. Rugged, dependable. Satin chromium finish. Lists at \$11.00 and up



Across the U. S. A....out to far-away places...your chance of a clear QSO is *better* with an E-V mike.

E-V engineered response puts your exact speaking voice on your carrier...assures quick, individual voice recognition. There's a model made for you in the complete E-V line...with all the *extra* quality, *extra* features, *extra* value you want.

*Ask your E-V Distributor, or write for Catalog No. 110.*

Microphones • High Fidelity Speakers  
Phono Pickups • Self-Tuning TV Boosters

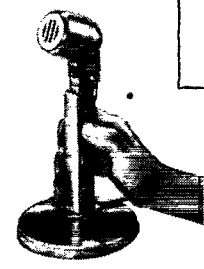

**TOUCH-TO-TALK**  
First to fit any mike with 3/4" x 27 stand coupler. Finger-tip relay operation or microphone "On-Off." With or without mike.



**Electro-Voice**

404 CARROLL STREET, BUCHANAN, MICH.  
Export: 13 East 40th St., N.Y. 16, U.S.A., Cables: Arlab

Pat. Pend., Crystal Microphones Licensed Under Brush Patents



**IT'S NEW!**

**IT'S A NATIONAL!**

**NC  
125\***

**IT'S PACKED WITH BIG SET FEATURES!**

**IT'S MODERATELY PRICED!**

- Covers 550 kcs to 36 mc in 4 bands. Voice or CW.
- Edge-lighted direct-reading scale with amateur, police, foreign, ship frequencies clearly marked.
- Sensational National Select-O-Ject built-in. Rejects any selected audio signal (100-12,000 c.p.s.) 45 db — boosts 38 db. Minimizes noise, unwanted signals.
- 3-microvolt sensitivity (for 10 db signal/noise ratio on 10-meter band).
- Lively S-meter on panel — reads S9 to 50 mv. signal.
- Up-to-the-minute features include: AVC, automatic noise limiter, antenna trimmer, variable CW pitch control, separate R. F. and audio gain controls, jack for phono or NFM-73B adapter, volt. reg., stabilized oscillator, audio amplifier essentially flat to 10,000 c.p.s. when used with phono.

*\*Coming soon — see your jobber*

NC - 125 . . . \$149.50 \*  
 NC - 125TS (matching spkr.) . . . \$11.00  
 686S vibrator supply for 6-volt  
 operation . . . \$34.16

\*Slightly higher west of the Rockies



# BEAM POWER



**PICK YOUR POWER FROM THIS CHART**

Final Amplifier			R.F. Driver		Modulator Tube	
Watts Input	Beam Power	Tube Type	Beam Power	Tube Type	Push-Pull Stage	Service Class
CW & FM*	17	5763	5763	6AQ5	AB <sub>1</sub>	
	34	5763	5763	6F6	AB <sub>2</sub>	
	40	2E26	5763	6F6	AB <sub>2</sub>	
	80	2E26	5763	6F6	AB <sub>2</sub>	
	75	807	5763	2E26	AB <sub>2</sub>	
	150	807	807	807	AB <sub>2</sub>	
	500	813	807	811-A	AB <sub>2</sub>	
	1000	813	807	810	B	

\*Maximum ICAS Ratings for RF Amplifier—Class C Telegraphy  
 †Maximum ICAS Ratings for RF Amplifier—Class C Telegraphy

The Fountainhead of Modern Tube Development is RCA

## In modern rigs power gain counts ...and RCA Beam Power tubes have it

THIS QUARTET of beam power tubes offers the modern approach to compact, efficient transmitter design. They require less drive and deliver more output at lower plate voltage, than any other similar tube types within a comparable price range. In addition ... the absence of high-level intermediate stages in a beam power transmitter is a long step toward the elimination of TVI.

What's more ... these RCA beam power tubes are excellent for quick-change, multi-band transmitters because they seldom require stabilization in well-designed circuits.

Newest of the family is the RCA-5763 miniature ... capable of 17 watts input (ICAS-class C telegraphy) to 175 Mc. Its high power gain and *extra* emission make it a highly efficient frequency multiplier.

To get all the performance and life you pay for ... buy genuine RCA tubes in the familiar red, black, and white cartons from your local RCA tube supplier.

Are you getting the new RCA HAM TIPS? Copies are available from your local RCA tube supplier.



**RADIO CORPORATION of AMERICA**  
 ELECTRON TUBES  
 HARRISON, N. J.