

June, 1949

40 Cents

QST

devoted entirely to

amateur radio

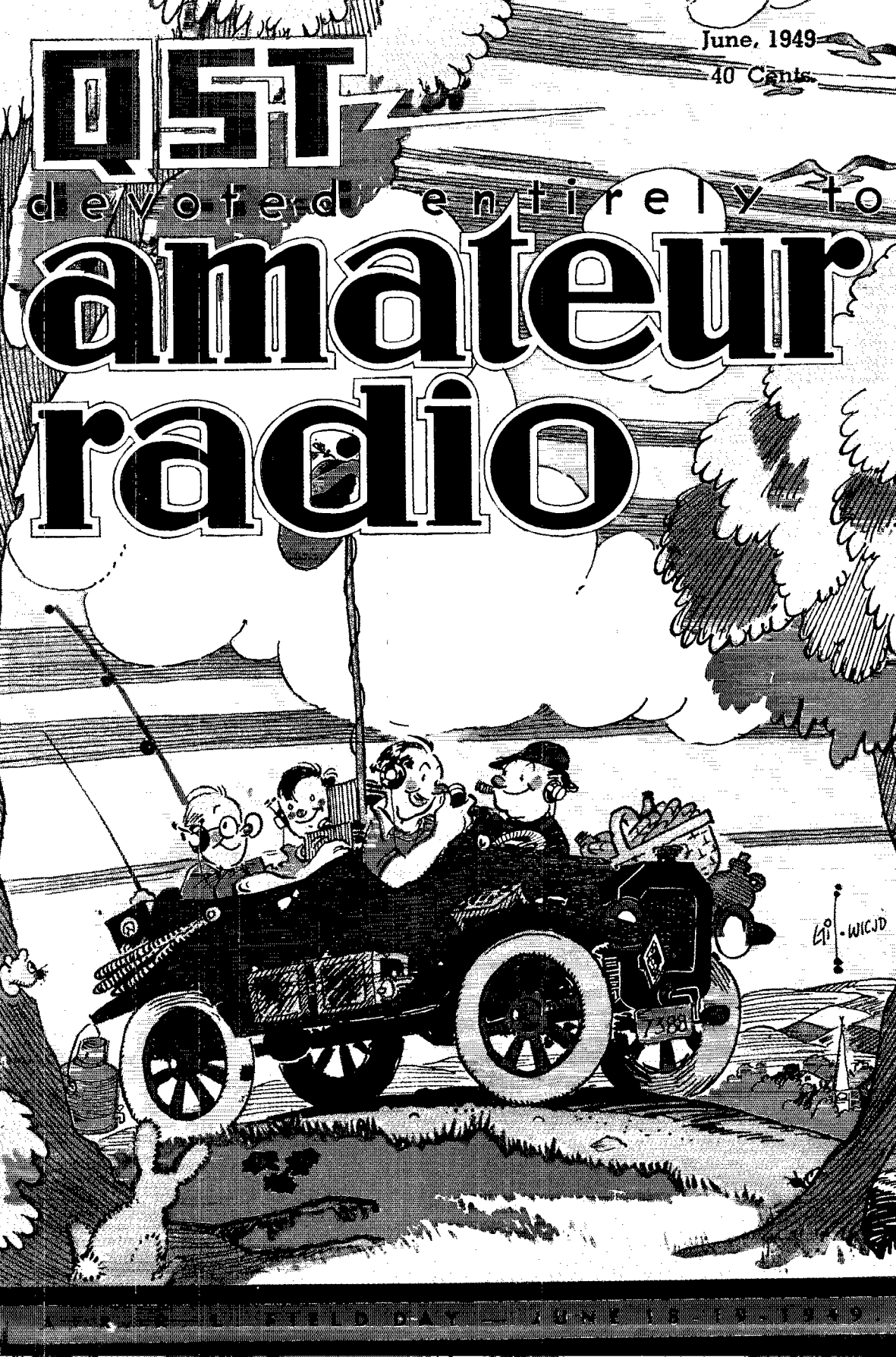

64 WICJD

COMPONENTS FOR EVERY APPLICATION



LINEAR STANDARD
High Fidelity Ideal

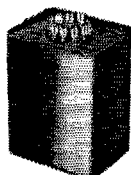

HIPERM ALLOY
High Fidelity . . . Compact



ULTRA COMPACT
Portable . . . High Fidelity



OUNCER
Wide Range . . . 1 ounce

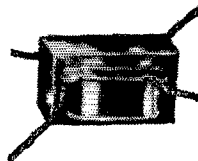

SUB OUNCER
Weight 1/2 ounce

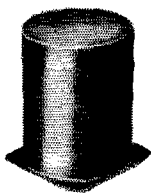

COMMERCIAL GRADE
Industrial Dependability

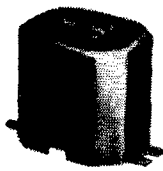

SPECIAL SERIES
Quality for the "Ham"

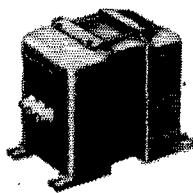

POWER COMPONENTS
Rugged . . . Dependable



VARITRAN
Voltage Adjustors



MODULATION UNITS
One watt to 100KW

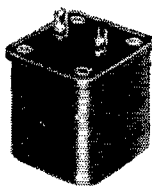

VARIABLE INDUCTOR
Adjust like a Trimmer



TOROID HIGH Q COILS
Accuracy . . . Stability



TOROID FILTERS
Any type to 300KC

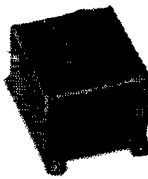

MU-CORE FILTERS
Any type 1/2 - 10,000 cyc.

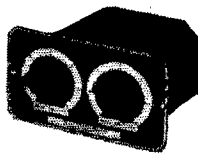

EQUALIZERS
Broadcast & Sound



PULSE TRANSFORMERS
For all Services

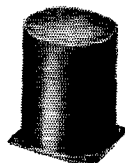

SATURABLE REACTORS
Power or Phase Control

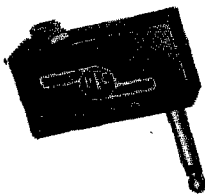

PLUG IN ADAPTER
Impedance Matching



FOSTERITE
Grade 3 JAN Components



CABLE TYPE
For mike cable line

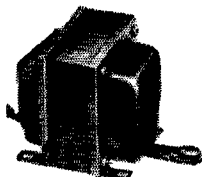

VERTICAL SHELLS
Husky . . . Inexpensive



REPLACEMENT
Universal Mounting



STEP-DOWN
Up to 2500W . . . Stock

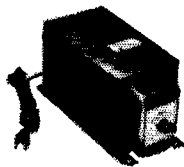

LINE ADJUSTORS
Match any line voltage

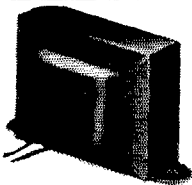

CHANNEL FRAME
Simple Low cost

United Transformer Co.



What new audio-amplifier tube kayos
hiss, hum, and microphonics?

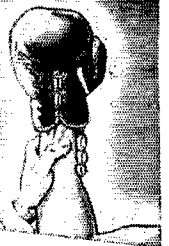

THE KEN-RAD 12AY7 MINIATURE— A REAL CHAMPION, WITH STANDOUT QUALITIES OF DESIGN!



12AY7
MEDIUM-MU
TWIN
TRIODE



Filament voltage 6.3 v, 12.6 v
Filament current .3 amp, .15 amp
Plate voltage 250 v
Plate current 3 ma
Amplification factor 40
Grid bias -4 v
Transconductance 1,750 micromhos

WHEN building a high-gain, low-level amplifier, your guard must be up against hiss, hum, and microphonics — the “unholy three” in audio circuits. You’re safer from these bugaboos if (1) your circuit is properly designed, (2) you have the right audio-amplifier tube.

Selection of the latter narrows down quickly to the Ken-Rad 12AY7 — the pace-setting new miniature specially developed by Ken-Rad and General Electric designers to reduce the noise by-products in audio amplification.

In originating Type 12AY7 with its low-noise and low-microphonics character, a miniature-tube design was chosen not alone because miniatures are modern, but because small electrodes mean low mass . . . and low mass aids in reducing microphonic output.

The result is a compact twin triode with a place to itself in the ham’s list of tubes for early application . . . a *new* miniature to give your rig *new* clean signal characteristics.* Ask your Ken-Rad distributor or dealer to show you the 12AY7. Study how this finely engineered tube is built. Here are quality of design and quality of manufacture, the two combining for topnotch audio-amplifier performance!

*Illustrating the kind of amplifier which can be built with the 12AY7, a recent article in the trade press describes a wide-frequency-response amplifier using 3 of these tubes with a harmonic-distortion figure of only 1/2 of 1 per cent, and the average noise 87 db down (from a +24 dbm level).

FOR KEN-RAD QUALITY
LOOK BEYOND THE DATA SHEET!

182-HA27

KEN-RAD *Radio Tubes*

PRODUCT OF GENERAL ELECTRIC COMPANY

Schenectady 5, New York

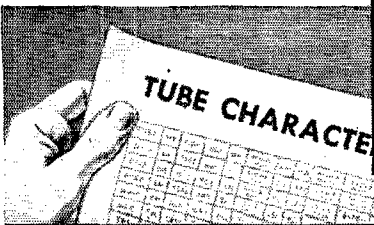

YOUR PREFERRED SOURCE FOR AMATEUR TUBES IS YOUR NEARBY KEN-RAD DISTRIBUTOR OR DEALER

How does the 75A-1 do on SSSC?

RAYMOND F. HOFFMAN, W5NRP,
HAS FOUND OUT "FROM THE
OUTSIDE LOOKING IN."

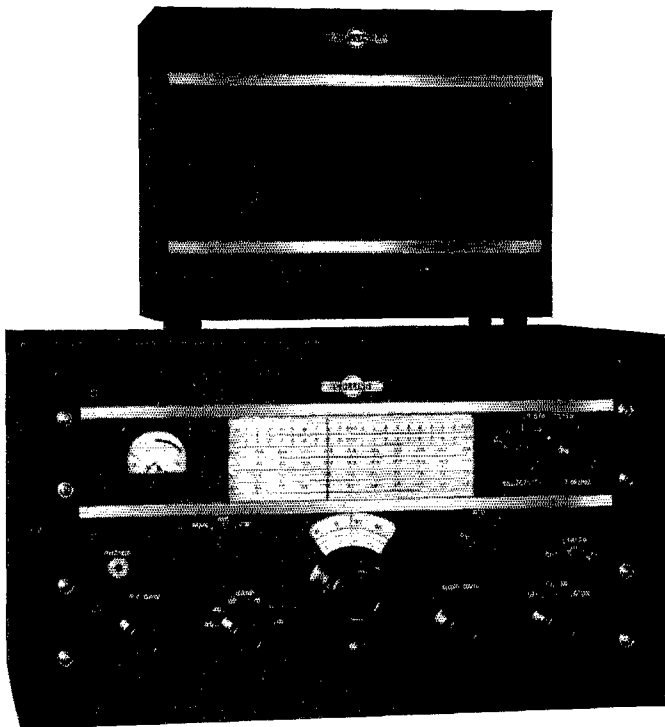

HE WRITES: "I have been meaning to write this letter for about the last six months but have never quite gotten to it. During this time I have had my transmitter on SSSC and quite recently have put it on the twenty-eight megacycle band. As you may well imagine, I talk to myself on many of my contacts because of very bad receiver stability on ten—much more so than on twenty, and that was bad enough.

"I have kept a fairly accurate log of the receivers used on the other end and although I cannot say that Collins 75A-1's are in the majority, they certainly have

had the least amount of trouble by a very large margin. I have never yet had a Collins user who was not able to copy the SSSC signals and do a good job of it.

"Quite recently on ten I had a contact with a man using the 75A-1. We talked for about twenty minutes on SSSC and at the end of the contact he noted the fact that he **HAD NOT TOUCHED THE RECEIVER.**

"You know that your receiver is good; perhaps you might like to quote a satisfied user in a new sense of the word. I find a great deal of pleasure in 'using the other man's 75A-1'."

NOTE: If radio is also your business, look to Collins for very high performance in broadcast station equipment, and airborne and ground station radio communication gear.

FOR SUCCESS IN AMATEUR RADIO, ITS . . .

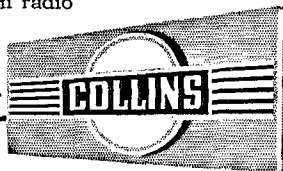

COLLINS RADIO COMPANY, Cedar Rapids, Iowa

11 West 42nd Street, New York 18, N. Y.

458 South Spring Street, Los Angeles 13, Calif.



JUNE 1949

VOLUME XXXIII • NUMBER 6

PUBLISHED, MONTHLY, AS ITS OFFICIAL ORGAN, BY THE AMERICAN RADIO RELAY LEAGUE, INC., AT WEST HARTFORD, CONN., U. S. A.; OFFICIAL ORGAN OF THE INTERNATIONAL AMATEUR RADIO UNION

STAFF

Editorial

A. L. BUDLONG, WIBUD
(Acting Secretary, ARRL)
Editor

HAROLD M. McKEAN, WICEG
Assistant Editor

GEORGE GRAMMER, WIDF
(Technical Director, ARRL)
Technical Editor

DONALD H. MIX, WITS
BYRON GOODMAN, WIDX
Assistant Technical Editors

EDWARD P. TILTON, WIHQ
V.H.F. Editor

RICHARD M. SMITH, WIFTX
C. VERNON CHAMBERS, WI1EQ
Technical Assistants

ROD NEWKIRK, W9BRD
DX Editor

WALTER E. BRADLEY, WIFWH
Technical Information Service

Production

RALPH T. BEAUDIN, WIBAW
Superintendent

NANCY A. PRICE
Assistant

Advertising

F. CHEYNEY BEEKLEY, WIGS
LORENTZ A. MORROW, W1VG
EDGAR D. COLLINS

Circulation

DAVID H. HOUGHTON
Circulation Manager

RALPH T. BEAUDIN, WIBAW
Assistant Circulation Manager

OFFICES

38 La Salle Road
West Hartford 7, Connecticut

Subscription rate in United States and Possessions, \$4.00 per year, postpaid; \$4.50 in the Dominion of Canada, \$5.00 in all other countries. Single copies, 40 cents. Foreign remittances should be by international postal or express money order or bank draft negotiable in the U. S. and for an equivalent amount in U. S. funds.

Entered as second-class matter May 29, 1913, at the post office at Hartford, Connecticut, under the Act of March 3, 1879. Acceptance for mailing at special rate of postage provided for in section 1103, Act of October 3, 1917, authorized September 9, 1922. Additional entry at Concord, N. H., authorized February 21, 1929, under the Act of February 28, 1925.

Copyright 1949 by the American Radio Relay League, Inc. Title registered at U. S. Patent Office.

INDEXED BY
INDUSTRIAL ARTS INDEX

- CONTENTS -

"It Seems to Us . . ." 9
VFOs for 'Phone or C.W. . . . Ben W. Roberts, W9IEU 11
Coming Conventions 14
What! No Antenna? 15
Happenings of the Month 18
Teletype Reception with Make-Break Keying
Dana A. Griffin, W2AOE 24
Multiple-Circuit Tuners from Grid to Feeder
C. Vernon Chambers, WIJEQ 25
A Filter Design for the Single-Sideband Transmitter
Fred M. Berry, W0MNN 29
The V.H.F. Sandwich . . . Edward P. Tilton, WIHQ 36
The World Above 50 Mc. 38
Clinton B. DeSoto, 1912-1949 41
New Books 41
Inverted Rhombics and Biconical Beams 42
TVI Tips 44
Silent Keys 45
15th ARRL DX Contest 46
In QST 25 Years Ago This Month 46
How's DX? 47
I.A.R.U. News 50
Modernizing the Prewar HRO Loren G. Windom, W8GZ 51
An Experimental All-Band Nondirectional Transmitting
Antenna G. L. Countryman, W1RBK, W3HH 54
A Two-Bit Tower with Million-Dollar Performance
W. C. Rippy, jr., W4HYR 56
Hamfest Calendar 57
Technical Topics —
Still More on the "Super-Selective C.W. Receiver" . . . 58
1949 ARRL Field Day Rules . . . F. E. Handy, W1BDI 59
Correspondence from Members 62
Hints and Kinks 63
Operating News 64
Station Activities 72
Book Review 106

New hallicrafters 15-in. Custom Installation TV

150 sq. in.
picture

MODEL T-69
\$259⁵⁰
complete with
15-in. tube

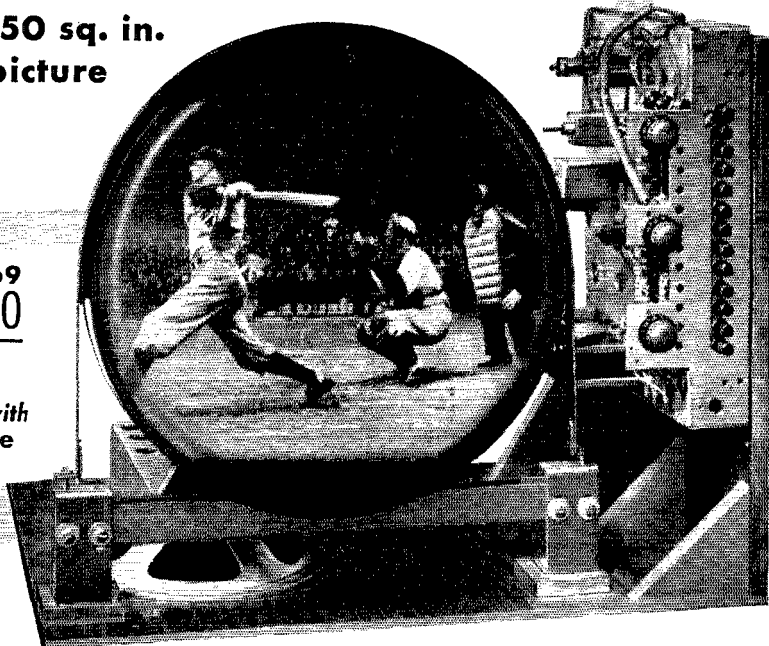

Send for folder of original
custom-installation designs
by Hallicrafters.

A *new* chassis, specially designed
for big picture-tube operation.
Completely aligned and tested.
Regular RMA 90-day guarantee
applies to all parts. See your
local parts distributor for details.

There is vital need in the **Armed Services** for young
men with professional skill, particularly physicians
and dentists. For information write to the office of
the Secretary of Defense, Washington, D.C.

the hallicrafters co.

4401 WEST FIFTH AVENUE • CHICAGO 24, ILLINOIS

Sole Hallicrafters Representative in Canada: Rogers Majestic Limited, Toronto, Montreal.

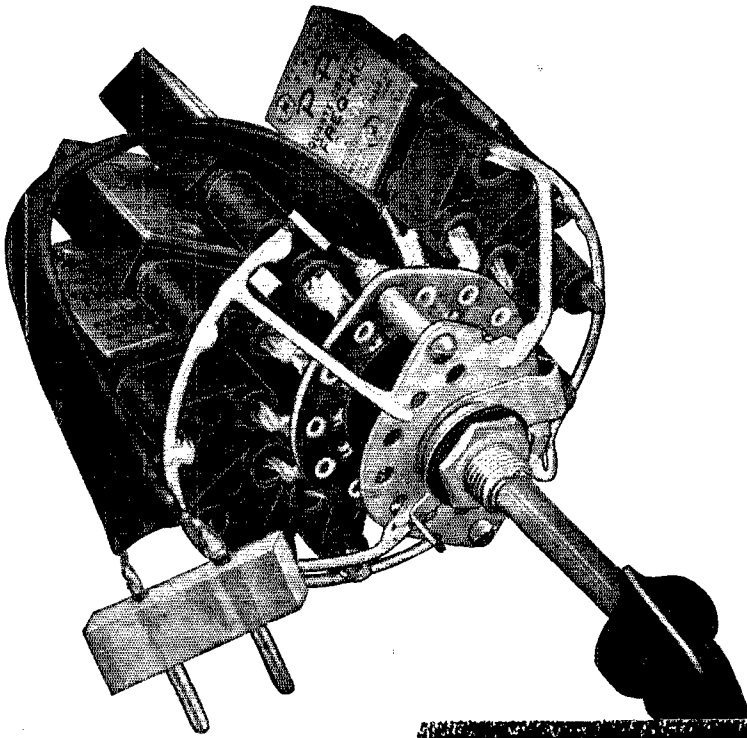

NOW YOU CAN GO PLACES!

QSY is as easy as pie! Yes, the Crystal Shifter illustrated above gives you INSTANT SELECTION of as many as eleven crystal controlled frequencies within a 100 kc. or so range on phone . . . without removing excitation, turning off plate current, or retuning of transmitter stages . . . without danger of getting out of the band . . . with positive knowledge of where you are ALL THE TIME! You can build this PR Crystal Shifter in a half hour or less with a soldering iron and a pair of pliers. You can follow the construction easily from the above photo. Components needed are: Centralab 11 position rotary switch assembly No. 1402;

eleven (or less) Cinch No. 9827 single crystal sockets; a length of No. 12 tinned copper wire; a Mosely 75-5 adaptor plug; a piece of 300-ohm Twin-lead; and a group of PR Precision Crystals. Use PRs you now have and add more frequencies as you want to. Mount the completed assembly on the front panel, plug into your crystal socket and you're ready to flit from frequency to frequency at will! It occupies less than 3½ inches of panel space. Many 10 meter phone men are already using the Crystal Shifter. Make it! Try it! — Petersen Radio Company, Inc., 2800 W. Broadway, Council Bluffs, Ia.



SINCE 1934

PR Precision CRYSTALS

10 METERS
PR Type Z-5.

Harmonic oscillator. Ideal for "straight through" mobile operation. High activity. Heavy drive without damage in our special circuit \$5.00

20 METERS
PR Type Z-3.

Harmonic oscillator. Low drift. High activity. Can be keyed in most circuits. High power output. Just as stable as fundamental oscillators \$3.75

40, 80 & 160 METERS
PR Type Z-2.

Rugged, low drift fundamental oscillators. High activity and power output with maximum crystal currents. Accurate calibration. . \$2.75

Section Communications Managers of the ARRL Communications Department

Reports Invited. All amateurs, especially League members, are invited to report station activities on the first of each month (for preceding month) direct to the SCM, the administrative ARRL official elected by members in each Section. Radio Club reports are also desired by SCMs for inclusion in QST. All ARRL Field Organization appointments are now available to League members. These include ORS, OES, OPS, OO and OBS. Also, where vacancies exist SCMs desire applications for SEC, EC, RM, and PAM. In addition to station and leadership appointments for Members, *all amateurs* are invited to join the ARRL Emergency Corps (ask for Form 7).

ATLANTIC DIVISION			
Eastern Pennsylvania Maryland-Delaware-D.C. Southern New Jersey Western New York Western Pennsylvania	W4BES W4BWT W2OXX W2PGT W3KWL	Jerry Mathis Eppa W. Darne G. W. (Bill) Funnell Harding A. Clark Ernest J. Hinsky	633 Crescent Ave. 132 Tennessee Ave., N.E. 22 Wyoming Ave. 753 Westmoreland Ave. 509 Beechwood Ave.
CENTRAL DIVISION			
Illinois Indiana Wisconsin	W9EVI W9FSG W9RQM	Lloyd E. Hopkins Charles H. Conway Reno W. Gotsch	27 Lynch St. 3335 College Ave. 929 S. 7th Ave.
DAKOTA DIVISION			
North Dakota South Dakota Minnesota	W0GZD W0NGM W0RA	Paul M. Bossoletti J. S. Foasberg John B. Morgan,	204 Polk St. 509 Idaho Ave., S.E. 1411 Summit Ave.
DELTA DIVISION			
Arkansas Louisiana Mississippi Tennessee	W5JIC W5VT W3DLA W4QTA	Marshall Riggs W. J. Wilkinson, jr. J. C. Wallis Ward Bulrman	Room 313, Jefferson Hotel 2406 Kelly St. 1000 Overlook Ave.
GREAT LAKES DIVISION			
Kentucky Michigan Ohio	W4CDA W8AQA W8WZ	W. C. Alcock Robert B. Cooper Dr. Harold E. Stricker	155 St. Mildred's Court 132 Guild St., N.W. 247 W. 5th St.
HUDSON DIVISION			
Eastern New York N. Y. C. & Long Island Northern New Jersey	W2EOD W2KDC W2ANW	Fred Skinner Charles Ham, jr. Thomas J. Lyon	500 Wolfs Lane 200 Harvard St. 190 Mortimer
MIDWEST DIVISION			
Iowa Kansas Missouri Nebraska	W8PP W8ICV W8ICD W8RQK	William G. Davi Earl N. Johnston Ben H. Wendt William T. Gemmer	3rd St. 624 Roosevelt RFD 10 1708 West 6th St.
NEW ENGLAND DIVISION			
Connecticut Maine Eastern Massachusetts Western Massachusetts New Hampshire Rhode Island Vermont	W1VB W1VY W1ALP W1AZW W1AOQ W1CJH W1NLO	Walter L. Glover Manley W. Haskell Frank L. Baker, jr. Prentiss M. Bailey Gilman K. Crowell Roy B. Fuller Burtis W. Dean	Glover Ave. 15 Hemlock St. 91 Atlantic St. 62 Dexter St. 15 Academy St. 17 Lodge Road P. O. Box 81
NORTHWESTERN DIVISION			
Alaska Idaho Montana Oregon Washington	KL7IC W1TJU W7EGN W7MQ W7ACF	Charles M. Gray Alan K. Ross Fred B. Tintinger J. E. Roden Clifford Cavanaugh	Box 1237 2105 Irene St. 328 Central 519 N.W. Ninth Route 1
PACIFIC DIVISION			
Hawaii Nevada Santa Clara Valley East Bay San Francisco Sacramento Valley Philippines San Joaquin Valley	KH6HJ W7CX W6BPT W7ALP W6NL W0ZF KA1AL W6FKL	Dr. Robert Katsuki N. Arthur Sowle Roy E. Pinkham Horace R. Greer Samuel C. Van Lew Ronald G. Martin M/Sgt. Stanley J. Gier Ted R. Souza	1817 Wilhelmina Rise Box 2025 1065 Fremont St. 914 Araratmount Ave. 215 Knowles Ave. 2638 13th St. 14th Communications Sqdn. Command, APO 74, c/o Postmaster 3515 Home Ave. Fresno 4
ROANOKE DIVISION			
North Carolina South Carolina Virginia West Virginia	W4CYB W4BOE/ANG W4KFC W8JM	W. J. Worthan Ted Ferguson Victor C. Clark Donald B. Morris	c/o Duke Power Co. 3422 Rosewood Drive Box 73 303 Home St.
ROCKY MOUNTAIN DIVISION			
Colorado Utah-Wyoming	W0IQZ W7NPU	M. W. Mitchell Alvin M. Phillips	1959 Uinta St. RFD 2
SOUTHEASTERN DIVISION			
Alabama Eastern Florida Western Florida Georgia West Indies (Cuba-P.R.-V.L.) Causal Zone	W4CJW W4FWZ W4DAO W4DXI K4K4K K25AW	Dr. Arthur W. Woods John W. Hollister Luther M. Holt Clay Griffin Everett Mayer Everett R. Kimmel	411 Woodward Bldg. 3809 Springfield Blvd. 223 W. Romana St. 1557 Athens Ave., S.W. P. O. Box 1061 Box 264
SOUTHWESTERN DIVISION			
Los Angeles Arizona San Diego	W6IOX W7MLL W6BWO	Vincent J. Haggerty Gladlen C. Elliott Dale S. Rose	1017 Indio Muerto St. 39 North Melwood 1285 E. California St.
WEST GULF DIVISION			
Northern Texas Oklahoma Southern Texas New Mexico	W5CDU W5AHT/AST W5BDI W5SMA	Joe C. Buch Frank E. Fisher Ammon O. Young Lawrence R. Walsh	5234 Vickery Boulevard 104 East 11th St. 4803 Eli St. P. O. Box 1663
MARITIME DIVISION			
Maritime (Nfld. & Labr. att.)	VE1DQ	A. M. Crowell	69 Dublin St.
ONTARIO DIVISION			
Ontario	VE3CP	Thomas Hunter, jr.	1920 Ellrose Ave.
QUEBEC DIVISION			
Quebec	VE2GL	Gordon A. Lynn	c/o Radio Division Montreal Airport
VANALTA DIVISION			
Alberta British Columbia Yukon	VE6MJ VE7HP VE8AK	Sydney T. Jones J. T. Hepburn W. R. Williamson	P. O. Box 373 1149 Cortell Rd. Radio Range Sta., D.O.T.
PRAIRIE DIVISION			
Manitoba Saskatchewan	VE4AM VE5DW	A. W. Morley J. H. Goodridge	26 Lennox Ave. c/o Canadian Pacific Air Lines
			Glenside Gardens Washington 2, D. C. Auburn Syracuse 10 Farrell Elgin Indianapolis 5 Wausau Grand Forks Huron St. Paul 5 Danville Shreveport Gaffport Chattanooga Danville Grand Rapids Marysville Pelham 65 Westbury Rutherford Mitchellville Topeka North Kansas City North Platte Newtown Portland North Quincy 71 Pittsfield Concord East Greenwich Burlington Douglas Boise Whitefish Pendleton Auburn Honolulu 17 Reno Santa Clara Oakland 11 Daly City Sacramento 14 San Francisco, Calif. Fresno 4 Charlotte 1 Columbia 25 Annandale Fairmont Denver 7 Ogden, Utah Birmingham Jacksonville Pensacola Atlanta San Juan 5, P. R. Gamboua, C. Z. Santa Barbara Tucson Santa Ana Dallas Pawhuska Houston 7 Los Alamos Halifax, N. S. Windsor, Ont. Montreal, P. Q. Edmonton, Alta. North Vancouver Teslin, Y. T. St. Vital Prince Albert

To Amateurs who want Excellent Ham Performance at Moderate Prices!

Here is advance information on a new Hallicrafters Ham receiver, the SX-71. It will have top performance features in a price to please you—considerably under \$200.

Band width will be less than 14 kc, 1000 times down from resonance. The double superheterodyne design will give image rejection at 28 Mc of better than 300 to 1. And the sensitivity will be in the order of 1 microvolt.

Five bands will give continuous coverage from 538 kc to 56 Mc; also, there will be calibrated band-spread scales for 80, 40, 20, 10, and 6 meters. NBFM reception will be available, via *built-in* limiter and balanced detector stages.

Here is a receiver expressly designed for you, for superior Ham operation. It is coming soon.

Watch for it.

P.S. A New Portable receiver will be announced next month!

the hallicrafters co.

4401 W. Fifth Ave., Chicago 24, Ill.

MANUFACTURERS OF PRECISION RADIO & TELEVISION EQUIPMENT

THE AMERICAN RADIO RELAY LEAGUE, INC.,

is a noncommercial association of radio amateurs, bonded for the promotion of interest in amateur radio communication and experimentation, for the relaying of messages by radio, for the advancement of the radio art and of the public welfare, for the representation of the radio amateur in legislative matters, and for the maintenance of fraternalism and a high standard of conduct.

It is an incorporated association without capital stock, chartered under the laws of Connecticut. Its affairs are governed by a Board of Directors, elected every two years by the general membership. The officers are elected or appointed by the Directors. The League is noncommercial and no one commercially engaged in the manufacture, sale or rental of radio apparatus is eligible to membership on its board.

"Of, by and for the amateur," it numbers within its ranks practically every worth-while amateur in the nation and has a history of glorious achievement as the standard-bearer in amateur affairs.

Inquiries regarding membership are solicited. A bona fide interest in amateur radio is the only essential qualification; ownership of a transmitting station and knowledge of the code are not prerequisite, although full voting membership is granted only to licensed amateurs.

All general correspondence should be addressed to the Secretary at the administrative headquarters at West Hartford, Connecticut.



Past Presidents

HIRAM PERCY MAXIM, W1AW, 1914-1936
EUGENE C. WOODRUFF, W8CMP, 1936-1940

Officers

President GEORGE W. BAILEY, W2KH
New York, N. Y.

Vice-President J. LINCOLN MCCARGAR, W6EY
Oakland, California

Acting Secretary A. L. BUDLONG, W1BUD
West Hartford, Connecticut

Communications Manager FRANCIS E. HANDY, W1BDI
West Hartford, Connecticut

Treasurer DAVID H. HOUGHTON
West Hartford, Connecticut

General Counsel PAUL M. SEGAL
816 Connecticut Ave., Washington 6, D. C.

Assistant Secretaries JOHN HUNTOON, W1LVQ
LEROY T. WAGGONER, W1PEK, RICHARD L. BALDWIN, W1IKE
West Hartford, Connecticut

DIRECTORS

President
GEORGE W. BAILEY, W2KH
1 East 79th St., New York 21, N. Y.

Vice-President
J. LINCOLN MCCARGAR, W6EY
66 Hamilton Place, Oakland 12, Calif.

Canadian General Manager
ALEX REID, VE2BE
240 Logan Ave., St. Lambert, P. Q.
Alternate: Leonard W. Mitchell, VE3AZ
6 Orchard Green, Toronto 17, Ont.

Atlantic Division
WALTER BRADLEY MARTIN, W3QV
1033 Arbuta Rd., Abington, Pa.
Alternate: Henry W. Wickenhiser, Jr., W3KWA
112 State Ave., Coraopolis, Pa.

Central Division
JOHN G. DOYLE, W9GPI
4331 N. Wildwood Ave., Milwaukee 11, Wis.
Alternate: Wesley E. Marriner, W9AND
624 College Ave., Dixon, Ill.

Dakota Division
GOODWIN L. DOSLAND, W0TSN
Moorhead, Minnesota
Alternate: Robert A. Kimber, W0BLK
Canyon Lake Rd., Rapid City, S. D.

Delta Division
VICTOR CANFIELD, W5BSR
P. O. Box 985, Lake Charles, La.
Alternate: James W. Watkins, W4FLS
220 N. Howell St., Chattanooga, Tenn.

Great Lakes Division
HAROLD C. BIRD, W8DPE
114 Hickory Dr., Crescent Lake, Pontiac, Mich.
Alternate: John H. Brabb, W8SPF
1321 Berkshire Rd., Grosse Pointe Park 30, Mich.

Hudson Division
JOSEPH M. JOHNSTON, W2SOX
423 Monmouth Ave., Bradley Beach, N. J.
Alternate: Gay E. Millus, Jr., W2NJP
170 Broadway, New York 7, N. Y.

Midwest Division
LEONARD COLLETT, W0DEA
Civil Aeronautics Administration
Box 775, Joplin, Mo.
Alternate: Alvin G. Keyes, W0KQT
1201 Merchants Nat'l Bank Bldg., Cedar Rapids, Ia.

New England Division
PERCY C. NOBLE, W1BVR
37 Broad St., Westfield, Mass.
Alternate: Clayton C. Gordon, W1HRC
70 Columbia Ave., Providence 5, R. I.

Northwestern Division
R. REX ROBERTS, W7CPY
110 W. Brennan St., Glendive, Mont.
Alternate: Allan D. Gunston, W7GPF
7209 Wright Ave., Seattle 6, Wash.

Pacific Division
WILLIAM A. LADLEY, W6RBQ
200 Naylor St., San Francisco 12, Calif.
Alternate: Kenneth E. Hughes, W6CTS
810 W. Orange Ave., So. San Francisco, Calif.

Roanoke Division
EVERETT I. BATTEY, W4IA
2008 N. Cleveland St., Arlington, Va.
Alternate: J. Frank Key, W4ZA
Box 707, Buena Vista, Va.

Rocky Mountain Division
FRANKLIN K. MATEJKA, W0DD1
P. O. Box 212, Estes Park, Colo.
Alternate: William R. White, W0PDA
1263 Pearl St., Denver 3, Colo.

Southeastern Division
WILLIAM C. SHELTON, W4A8R
327 Revilo Blvd., Daytona Beach, Fla.
Alternate: William P. Sides, W4AUP
Fleming Road, Montgomery, Ala.

Southwestern Division
JOHN R. GRIGGS, W6KW
3212 Grape St., San Diego 2, Calif.
Alternate: John E. Bickel, W6NY
1834 Whittier Blvd., Whittier, Calif.

West Gulf Division
WAYLAND M. GROVES, W5NW
P. O. Box 586, Odessa, Texas
(W5NW at Humble Pipe Line Camp, Odessa)
Alternate: David H. Calk, W5BIO
7730 Joplin St., Houston 17, Texas

"It Seems to Us..."

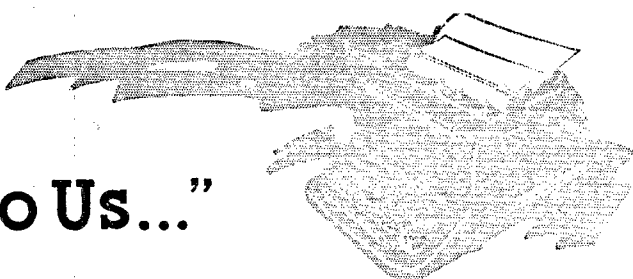

F.C.C.'S AMATEUR RULES PROPOSALS

Beginning on page 20 of this issue of *QST* we print what appear destined to be among the most controversial proposals for changes in the amateur rules in recent years. That, at least, is the conclusion that must be drawn as we write this, approximately a week after the Commission's release of the proposals. Already at ARRL Headquarters, we have been in receipt of telephone calls, telegrams, radiograms and letters supporting or denouncing, or simply asking for information. Almost all, however, wind up wanting to know whether the League had anything to do with the formulation of the proposals and, if not, what our stand is going to be and what we are going to do about them. That is what we propose to go into here.

Let us make one thing perfectly clear at the outset. These are FCC proposals for changes in the amateur rules, worked out in recent months *entirely within the Commission* by members of the FCC's staff without consultation with the ARRL or anyone else. They were formulated by the Radio Operator and Amateur Division of the Commission under the direction of George K. Rollins, W3GA, its chief, after coordination with all other divisions of the Commission, and now announced as the *Commission's* ideas on the subject. In drawing up these proposed rules the Commission clearly states it has made use of a great variety of suggestions and recommendations received by it (including ARRL's recommendations of last May). As it then goes on to say in paragraph 3 of its Notice accompanying the proposals:

The resulting judgment of the Commission is that the Amateur Radio Service would very much benefit from, and needs, a new overall plan or blueprint to provide scope and direction for immediate and long range development of the service.

These proposals are the result.

Second, there seems at this writing to be a disposition on the part of many amateurs to think these are mere suggestions on the subject from the Commission. Not so; this is a

notice of intention to make actual changes in our rules. FCC gives all interested parties formal notice that they have until July 20, 1949, to comment on them. After that date, and depending on the nature of the comment received, it may simply put the rules into effect, with or without revision, or it may deem the comment of such nature as to warrant the holding of a hearing or oral argument at Washington before final action is taken.

As to the position ARRL will take about the FCC proposals, it is not possible at the moment for the writer of this editorial to say. Traditionally, that will be a prerogative of the League's Board of Directors, the elected representatives of the membership; it is the directors who will decide what the League's comments will be on these proposed rules. Happily, the Commission has issued its proposals in time to permit full discussion of every detail at the annual meeting of the League's Board to be held at Hartford beginning May 27th, shortly after the appearance of this issue, and has given ample time for filing of comment thereafter. For our part, immediately after announcement of the proposals, ARRL Hq. circulated the complete text of the proposals and the Commission's accompanying Notice to every League director, alternate and assistant director, to all the 575-plus radio clubs affiliated with ARRL, to every one of the Communications Department's appointees (all field officials, ORS, OPS, OES, OO, etc.) to a total of nearly 3500, and advertised availability of copies of the proposals to any amateur on request. Thus there is a month available for full examination and discussion by the membership prior to the meeting of the Board. It is reasonable to assume that by the time the directors meet they will have had ample opportunity to sound out the opinions of the membership, to weigh the merits of the proposals, and to come to the meeting prepared to give their best thought on the League's position with respect to them. Until the Board makes its decisions, however, we do not know what the answer will be as to the League's position. That will be for the directors, not the Head-

quarters, to decide. The directors will consult with members of the Headquarters staff, and the League's general counsel, upon technical and legal aspects, but the final decision will be the Board's, and its alone.

The position of the League up to this time has already been spread on the record, and reported in *QST*. It is represented by the recommendations of the League's Board made as the result of its meeting in May, 1948. These were reported, and the philosophy behind them expounded, on page 29 of the June, 1948, issue, pages 9 and 30 of the July, 1948, issue, and page 9 of the August, 1948, *QST*. The basic recommendations have been recently summarized in the March, 1949, issue, page 36, at which time we also summarized the counterproposals of two other groups referred to in the Commission's notice. To save you time in looking up that issue, the pertinent ARRL Board's recommendations of last year were:

- 1) Expansion of the 75-meter Class A 'phone band to 3800-4000 kc.
- 2) No change on 40, 20 or 10 meters.
- 3) A 16-w.p.m. code test for future Class A license examinations.
- 4) One year "apprenticeship" for new amateurs before permitting them use of 'phone below 29.7 Mc.
- 5) An exclusive c.w. assignment 50-50.1 Mc.; A0 or "duplex" above 51 Mc.; and n.f.m. permitted above 50.1 Mc.

Comparison of these recommendations with the current FCC proposals will serve as a fair basis for estimating what the 1948 Board's thinking would be on the Commission's ideas. However, conditions change even in one short year; the 1949 Board may have somewhat different views on these problems.

At this point we think it pertinent to note, as will the directors at the Board meeting, that the Commission's announcement is more than a simple set of proposals for changes in the rules affecting 'phone bands and 'phone licensing. During the first week of discussion on the air, the 'phone aspects appeared to overshadow other features of the Commission's proposals, and opinion for or against the proposed rules seemed to be based largely on the 'phone features. The Commission's proposals go far beyond these matters, however; read the prefacing "Notice of Proposed Rule Making" carefully, and then read the proposed rules down to the end. As can be seen, the matter of extension of the 75-meter 'phone band (although with a bandwidth of emission limitation of 3 kc.) and eventual reexamination of all Class A licensees with a 20-w.p.m. code test represent only a small part of the proposals. We have such new things as an initial declaration of purpose for

the amateur service; the introduction of what may be termed apparatus specifications in our regulations (which the League has always opposed in principle); new renewal requirements; two new classes of license, with reduced code speed, in addition to the ones we now have; new examination elements; and even a regulation proposal with respect to round-table operations. There is far more involved in these rules than matters of 'phone policy; evaluation of their merits will require the most careful study by the Board.

In conclusion, we want to mention one aspect of the current development, perhaps the most important of them all, whose significance should not be overlooked. That is that these proposals, in the aggregate, represent the first time in our recollection that the Commission or any of its predecessor bodies has *on its own motion* injected itself into the major aspects of our regulations touching on basic amateur internal policy and intra-service philosophy. In all the long history of amateur radio in this country, the regulatory agency has heretofore always looked to the amateur himself, through the ARRL's Board of Directors, for thought on these matters. Differences of amateur opinion about them there have always been and always will be; nevertheless, in all this time the amateur body has ended up with a single set of recommendations at Washington from one group — ARRL — speaking for amateur radio as a whole. In consequence, its recommendations have almost without exception been accepted by the Commission in writing its rules, resulting in our enjoyment of a privilege unique among the radio services, that of virtually writing our own internal regulations. As against this, we have during the past year witnessed the action of minority groups, dissatisfied with the Board's recommendations, undertaking to form "national" societies in order to appeal direct to Washington in an endeavor to promote acceptance of their particular points of view.

To our way of thinking, it is no coincidence, therefore, that for the first time FCC is doing the job itself. We believe the present action of the Commission stems directly from this demonstrated inability of amateur radio to settle its differences within its own ranks, thus forcing FCC to do our thinking for us. If these current FCC proposals find general acceptance among amateurs, then perhaps this is a sound idea. But if the Commission's proposals do not meet with general acceptance by the amateur body, then we must all realize there will be a continuation of the Commission's policy unless amateurs recognize that in the long run their best interests will be served by speaking with one voice before our government authorities.

— A. L. B.

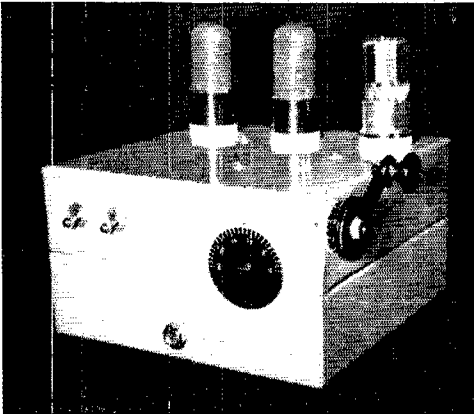

The all-band VFO. The two switches to the left are the control switches. The key jack is below and the trimmer-adjusting hole behind the tuning crank.

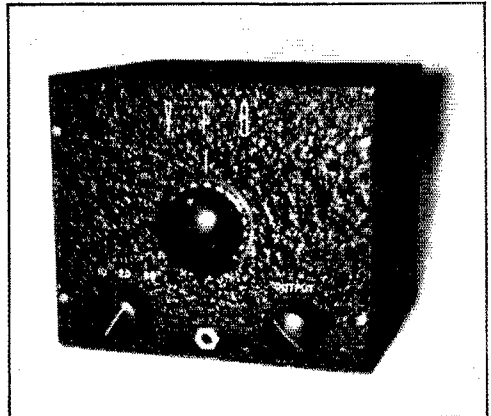

The 'phone-band VFO is built in a standard steel cabinet accommodating a $7 \times 7 \times 2$ -inch chassis. The tuning control is a National type A vernier dial.

VFOs for 'Phone or C.W.

Build Your Frequency Control To Suit Your Requirements

BY BEN W. ROBERTS,* W9IEU

THERE is no doubt that the series-tuned Colpitts (Clapp) oscillator circuit is rapidly becoming the standard basis on which ham VFOs are built. However, there will always remain room for individualism in constructional design and variation in details of the circuit to suit some particular operating interest. The accompanying photographs and diagrams show that while two VFO units may be built around a common basic circuit, the finished products may bear little resemblance, in either physical appearance or operating features.

The unit that will be described first might be called an "all-band" model. That is, the tuning system is designed to spread the single range of 1700 to 2000 kc. over most of the dial scale. Those portions of the range whose harmonics cover the narrower higher-frequency bands, of course, occupy smaller portions of the dial range, but the tuning rate is slowed down to a satisfactory pace by the use of a high-ratio worm-gear tuning drive.

The circuit is shown in Fig. 1. A 6J5 triode oscillator drives two untuned buffer stages using 6F6s. C_1 is the tuning condenser, while C_3 is a fixed mica padder. C_2 is a small trimmer for centering the band on the dial. RFC_1 and C_3 comprise an r.f. filter in the keying lead.

The amplifier input is coupled to the cathode of the oscillator, the plate being grounded for r.f. through C_7 . Resistors are used in the grid circuits

of the amplifiers and r.f. chokes in the plate circuits. RFC_2 is altered by removing one of the pies to make it dissimilar to RFC_3 , and C_{12} is reduced to $10 \mu\text{fd.}$ to prevent low-frequency parasitics. Both amplifier stages are provided with cathode-resistor protective bias.

S_1 connects the three VFO cathodes to the key for adjustment of the VFO without energizing the entire transmitter. S_2 also connects the VFO cathodes to the key, and in addition can be used to turn on an external piece of equipment through terminal A. The VFO may be turned on and off by an external switch through the use of terminal B.

The unit is designed to operate from a small supply delivering 250 to 300 volts with a VR-regulated tap at 150 volts for the oscillator plate.

Building the All-Band Model

Being an old-fashioned breadboard man at heart, I spent many hours trying to decide how to construct a breadboard VFO without exposing a lot of parts that should be shielded from the rest of the rig. The double-chassis idea shown in the photographs was finally chosen as a simple solution. With this type of construction, the heat from the tubes is excluded from the frequency-determining components. Very little heat is generated inside the chassis.

The two $7 \times 7 \times 2$ -inch chassis are fastened together, bottom to bottom, by tapping holes in the lip of the upper chassis for machine screws

*Lostant, Illinois.

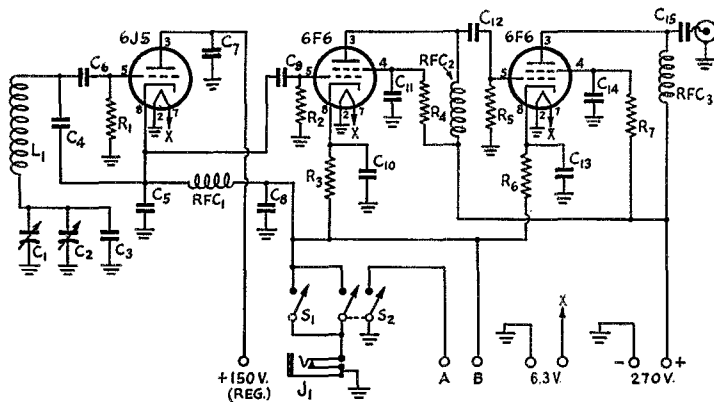

Fig. 1 — Circuit diagram of the all-band VFO.

- C₁ — 100- μ fd. midget (Bud MC-1855).
- C₂ — 12- μ fd. midget trimmer (CRL).
- C₃ — 100- μ fd. silver mica.
- C₄, C₅ — 0.001- μ fd. silver mica.
- C₆, C₉, C₁₅ — 100- μ fd. mica.
- C₇, C₈, C₁₀, C₁₁, C₁₃, C₁₄ — 0.0033- μ fd. mica.
- C₁₂ — 10- μ fd. mica.
- R₁, R₅ — 0.1 megohm, $\frac{1}{2}$ watt.
- R₂ — 47,000 ohms, $\frac{1}{2}$ watt.

- R₃, R₆ — 390 ohms, 1 watt.
- R₄, R₇ — 10,000 ohms, 1 watt.
- L₁ — 92 turns, 1-inch diam., 3 inches long (B & W Miniductor type 3016 with 4 turns removed).
- J₁ — Closed-circuit jack.
- RFC₁, RFC₃ — 2.5-mh. r.f. choke.
- RFC₂ — Same as RFC₁, with one pie removed.
- S₁ — S.p.s.t. toggle switch.
- S₂ — D.p.s.t. toggle switch.

that are passed up, through large holes in the bottom chassis, on the end of a screw-holding screwdriver. Alternatively, sections of threaded rod with nuts at both ends could be used to clamp the two chassis together.

The only parts fastened to the bottom chassis are the key jack and part of the dial mechanism. This mechanism, taken from a BC-375 tuning

unit, provides 2500 dial divisions for a condenser rotation of 180 degrees. One of the three mounting pillars is fastened to the top chassis, while the other two are anchored to the bottom chassis after the two chassis are joined together. It was necessary to cut the chassis lip away in spots to clear the framework. The tuning shaft is fitted with a homemade crank fashioned from a scrap of aluminum and a hardware-store knob. This makes it easy to tune from one end of the band to the other in a matter of seconds. The tuning condenser is mounted on $\frac{3}{4}$ -inch cone insulators. The trimmer, C₂, connected directly across the terminals of the tuning condenser, is adjusted with a screwdriver through a hole in the side of the chassis just to the rear of the tuning control.

To eliminate a slight mechanical instability that developed during initial tests, a strip of $\frac{1}{4}$ -inch polystyrene, just wide enough to fit snugly, was slipped inside the coil vertically and cemented to the coil spacing strips. The coil was then mounted on stand-off insulators alongside the tuning condenser by means of machine screws through holes drilled edgewise through the polystyrene strips.

The three tubes are lined up at the rear of the chassis with the oscillator tube to the right. A power-supply receptacle, a coaxial output connector and terminals A and B are at the rear in the back edge of the upper chassis.

After the mounting holes were located and drilled, the chassis were given the same hard smooth finish found on automobiles by having them sprayed with two coats of auto-body under-

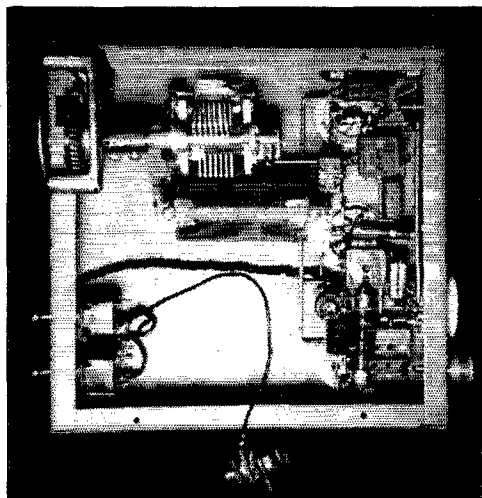

Bottom view of the all-band VFO, showing the mounting of the tuning condenser and its dial mechanism. The oscillator coil is below the tuning condenser. All three r.f. chokes are mounted at right angles to each other.

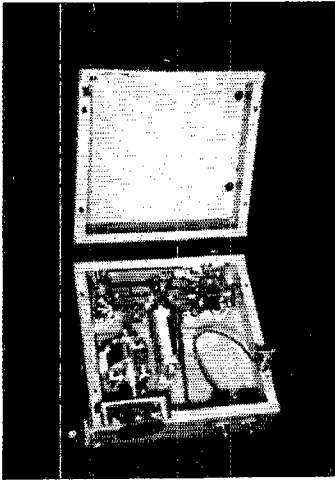

The bottom-cover chassis is provided with clearance holes to pass a screwdriver when fastening the two chassis together.

coating and four coats of dove grey Du Pont No. 202-39112 lacquer and rubbing them down with auto-body compound.

The 6J5 should draw a plate current of about 7 ma., while the total for the two amplifier stages should be in the vicinity of 50 ma. The output is sufficient to drive a 6L6 doubler to a grid current of 3 ma. through a 30,000-ohm grid leak when coupled by the 100- μ fd. condenser, C_{15} , and a foot of coaxial cable.

The 'Phone-Band Model VFO

The circuit of the second model is shown in Fig. 2. The oscillator circuit basically is the same as that shown in Fig. 1, but a more complicated tuning arrangement is incorporated to band-spread the frequencies whose harmonics fall

within the 75-, 20- and 10-meter 'phone bands. The tuning range is changed by a switching system that selects one of two tuning condensers that differ in capacitance, and an appropriate padder. C_3 and C_4 are sections of the dual tuning condenser. The 15- μ fd. section, C_4 , in parallel with C_5 , gives a tuning range of 1900 to 2000 kc. to cover 3800 to 4000 kc. in the output stage. In the 10-meter position, the extra padder C_1 is switched in, which changes the oscillator range to cover about 1756 to 1855 kc. whose harmonics will embrace the range of 28,100 to 29,700 kc.

When the switch is in the 20-meter position, the smaller section of the tuning condenser, C_3 , is in use together with padder C_2 . This spreads out the harmonics that fall in the 14-Mc. 'phone band over most of the dial.

Following the oscillator is a 6AC7 untuned buffer amplifier which drives a 6V6 doubler. Provision is also made for using the 6V6 stage as a pentode crystal oscillator, the opening of S_2 disabling the preceding stages. While $C_{17}L_2$ normally covers 80 meters, plug-in coils may be used with higher-frequency crystals. The key is in the cathode circuit of all three tubes.

Construction of the 'Phone-Band Model

While there is no reason why this model couldn't be built along the same lines as the all-band version, I chose to vary the design to fit a standard cabinet enclosure. All of the parts can be mounted on a 7 \times 7 \times 2-inch chassis without crowding. The dual tuning condenser is mounted at the center behind the main tuning dial, with L_1 and L_2 on either side at right angles to each other. The tubes are lined up along the rear and power-supply and output connections along the back edge.

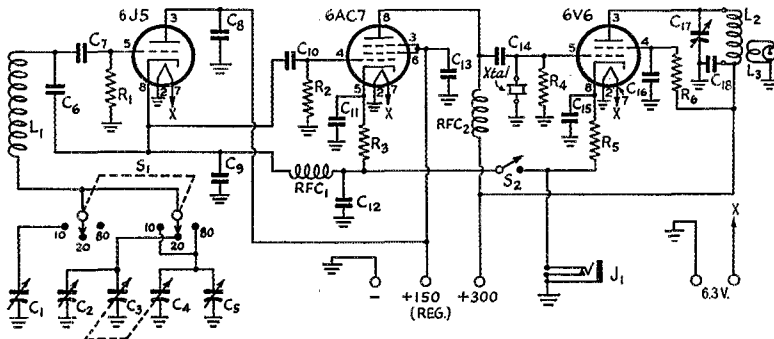

Fig. 2 — Circuit diagram of the 'phone-band VFO.

- C_1, C_2, C_5 — 100- μ fd. midget air trimmer (Hammarlund APC-100).
- C_3, C_4 — Sections of dual 15- μ fd. midget variable, 3 plates removed from C_3 section (Hammarlund HFD-15X).
- C_6, C_9 — 0.001- μ fd. silver mica.
- C_7, C_{10}, C_{14} — 100- μ fd. mica.
- $C_8, C_{11}, C_{12}, C_{13}, C_{15}, C_{16}, C_{18}$ — 0.0068- μ fd. mica.
- C_{17} — 100- μ fd. midget variable.
- R_1, R_2, R_4 — 0.1 megohm, 1 watt.

- R_3, R_5 — 390 ohms, 1 watt.
- R_6 — 10,000 ohms, 2 watts.
- L_1 — 90 μ h. (Bud OEL-160).
- L_2 — 32 turns No. 18, 1 $\frac{1}{2}$ -inch diam., close-wound.
- L_3 — 2 turns No. 18 on same form as L_2 .
- J_1 — Closed-circuit jack.
- RFC $_1, RFC_2$ — 2.5-mh. r.f. choke.
- S_1 — Two-section 3-position wafer switch (Mallory 1315-L).
- S_2 — S.p.s.t. toggle switch.

Underneath, the doubler tuning condenser, C_{17} , is near the doubler-coil socket, with the bandspread switch balancing it in the opposite corner. The three air trimmers are in line just far enough off the center line of the chassis to permit their shafts to be adjusted from the top through holes in the chassis. Holes also are drilled for the connecting leads between the tuning condenser, the switch and the trimmers.

To provide ventilation three socket holes were punched along the back of the box near the top.

Adjustment

If the crystal-oscillator feature is included, the 6V6 stage should be checked first, with an 80-meter crystal in the socket and S_2 open. With this part of the circuit operating properly, the other two stages can be turned on.

To set the oscillator tuning ranges, first turn S_1 to the 80-meter position. Set the tuning condenser to maximum capacitance and adjust C_5 until the oscillator harmonic is heard at 3800 kc. The tuning condenser should then cover the range up to 4000 kc. With the switch in the 20-meter position, C_2 should be similarly adjusted for 14,200 kc. The last adjustment, for 28 Mc., is made with S_1 in the 10-meter position, setting C_1 so that the harmonic falls at 28,100 kc. with the tuning condenser set at maximum capacitance.

As mentioned previously, the output of the 6V6 doubler stage is always in the 75-meter band, suitable external doubler stages being necessary to reach the higher-frequency bands.

With a 300-volt supply having a VR-regulated tap for 150 volts, the oscillator tube should draw



Inside view of the 'phone-band VFO. The 6J5 and the air-wound oscillator coil are to the right.

about 7 ma. and the other two stages a total of about 45 ma. with the 6V6 loaded. The output obtainable from the 6V6 should be about 5 watts.

Checks on both models show excellent stability. With either model it has been possible to key the oscillator without hearing an audible beat while listening to the 10-meter harmonic set at zero beat. The frequency drift was found to be less than a half kilocycle over a period of hours when checked against the harmonic of a local broadcasting station. Most of this drift occurred during the first few minutes of operation.

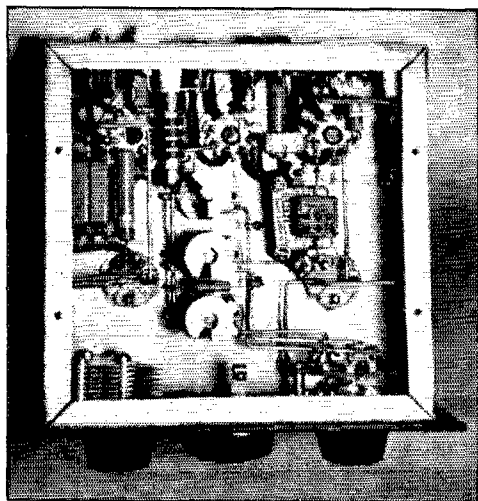

Bottom of the chassis in the 'phone-band model VFO. The three air trimmers are at the center. The condenser in the lower left-hand corner is the doubler tank condenser. The bandspread switch is to the right.

COMING CONVENTIONS

- August 5th-7th — Vanalta Division, Vancouver
- August 26th-28th — West Gulf Division, Dallas
- September 3rd-5th — Maritime Division, Halifax
- September 17th — New Hampshire State, Manchester
- October 8th-9th — Midwest Division, Omaha

IS YOURS ON FILE
WITH YOUR QSL MGR?

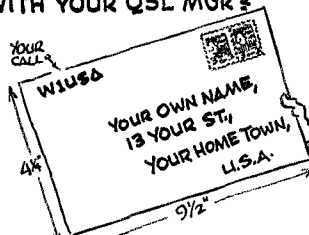

What! No Antenna?

Getting Results with Indoor Radiating Systems

AFTER working several stations in a row that were all using indoor antennas, we were hit with the idea that perhaps a lot of operators have denied themselves the use of the low-frequency bands because they feel that they don't have the room necessary for the antenna. A few letters in the right directions brought back the dope on these indoor antennas, and it is presented here in the hope that it will demonstrate that you don't need a Rocky Point, j.g., to enjoy low-frequency operation.

This just represents a sample of a very few of the indoor antennas that are in use. We will be pleased to hear from operators with other different types of inside antennas that have worked well.

W2ALO, RUTHERFORD, N. J.

THE antenna used by Jules Obester, W2ALO, is an excellent example of how to keep from being licked at anything. Located on the top floor of a 4-story 28-family brick apartment house, the only spot for the 14-Mc. antenna was in the 12 by 16 operating shack. What with fire escapes, BX cable, and steam and water pipes all around, this was bound to put the antenna something less than the "several wavelengths from surrounding objects" recommended by the books. But the antenna that was evolved is shown in Fig. 1, and it works well. It is, of course, a half-wavelength dipole folded to fit into the room and fed with RG-8/U coaxial cable. The cable was made an electrical half wavelength long, so that it acts as a half-wavelength transformer and the antenna impedance value appears at the end of

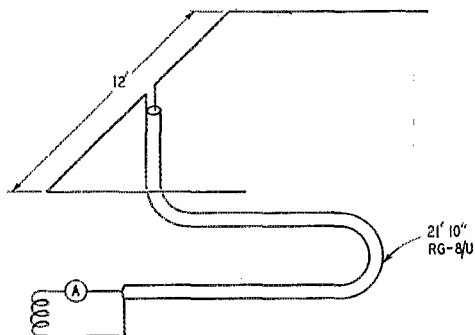

Fig. 1 — The 14-Mc. dipole at W2ALO consists of 30 feet of No. 14 wire mounted in the picture molding in a 12 x 16-foot room and fed with a half wavelength of RG-8/U. The wire length was determined experimentally (see text) and is less than the usual value for a half wavelength.

the line. By trimming the original 33-foot length of the dipole down to the value that showed maximum line current (for constant transmitter input), the loading effects of surrounding objects and the folding of the wire were compensated for, and the final length worked out to be something just under 30 feet. When the right length was found, it was noticed that no retuning of the final-amplifier tank was required, from no load to full load, indicating that little or no reactance is introduced.

On the theory that the maximum-current portion of the antenna does the most radiating, the center of the antenna is mounted on the north wall of the room, in an effort to get into Asia a little better. However, the antenna is not too directional, and 164 countries have been worked postwar on 14 Mc., with never more than 350 watts input. The Pacific islands seem to be the most difficult to work, but this might be accounted for by the need for the signal to travel through 150 feet of apartment house before getting out into the open! However, the more distant stations — VKs and ZLs — can be worked easily, in the same direction.

Snow on the roof seems to have some effect in confining the signal, but the performance of the antenna has amazed any and all who have seen it. The wire is about 40 feet above ground.

W2HZY, BLOOMFIELD, N. J.

THERE is nothing very unusual about the indoor antenna used by George Wright at W2HZY — it is a folded dipole made of No. 14 wire spaced 2 inches and fed with Amphenol tubular 1-kw. 300-ohm line — but it gets out nicely. Located in the attic of a two-story house, it is about 33 feet above ground, and power lines and telephone wires run fairly close to the house on two sides. The antenna is used in the normal fashion on 14 Mc. and as a Marconi (by tying the feeders together) on 7 and 3.5 Mc. The location is an ordinary one, on a small hill in the residential section, and the transmitter input runs approximately 750 watts.

Results? A two-year schedule with ZL3AB with hardly a miss, several S8 and S9 reports in Asia and the Philippines, and a total of 192 countries worked! While W2HZY hastens to admit that he received some help on about 10 or 15 of these countries and might not have them if he were a "lone wolf," we submit that he had to be putting a good signal there to work them under present conditions!

W2PLR, BAYSIDE, L. I., N. Y.

LET'S be practical about the whole thing — a fellow needs power or a 27-hour day to run up a string of countries these days, because he's competing against a lot of fellows with power and some mighty good antennas. So it isn't surprising to find that the lower-powered indoor-antenna fellows don't have the big strings of countries, but neither do the low-powered stations with outdoor antennas. For example, Ben Tyson, of W2PLR, runs 50 watts on 7, 14 and 28 Mc., but has managed to grab himself WAC on 14 and 28 Mc., and a total of 87 countries. He knocked off 64 sections in the 1947 SS Contest, just in case you think our only yardstick of effectiveness is one's countries total.

The antenna at W2PLR is shown in Fig. 2. It is a square loop, 15 feet on a side, supported in the attic of a two-story house. The house has "hip-roof" construction, and four sloping roof rafters furnish good points for fastening the antenna insulators. The transmitter is located in the attic and remotely controlled, so the feedline from the antenna to transmitter is just a 4-foot length of 300-ohm Twin-Lead. The same antenna is used for receiving, through an antenna relay and some more Twin-Lead.

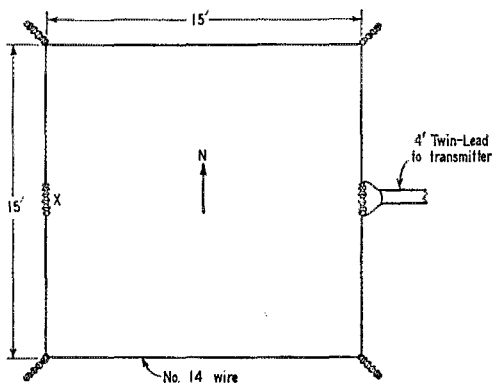

Fig. 2 — The loop at W2PLR is closed at point X for 14- and 28-Mc. operation, and opened when working on 7 Mc. The loop is mounted in the horizontal plane, in the attic.

As W2PLR puts it, "The antenna is a loop on 14 and 28 Mc., with point X shorted, but this is opened for 7-Mc. operation and the antenna becomes a badly bent-up dipole." The antenna seems to get out fairly well in all directions, with a slight edge in the east-west directions.

W5ONJ, TUCKERMAN, ARK.

THE operations of James Brock, W5ONJ, are confined to 40 meters, but he isn't complaining about the results with his attic antenna. The wire, bent as shown in Fig. 3, is located in the attic of a two-story house near the business sec-

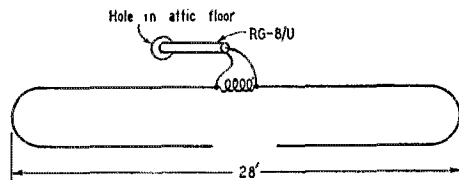

Fig. 3 — The over-all length of the 7-Mc. antenna at W5ONJ is 62 feet, crowded into a 29-foot attic. The coaxial-cable feed runs through a hole in the attic floor to the shack below.

tion of town. Running 200 watts, W5ONJ is just about all he needs for WAS, which should indicate that his work isn't confined to local rag-chews. A three-turn coil at the center of the antenna helps to make up for the shortened length of antenna and also seems to provide a better match for the RG-8/U line. The line couples at the transmitter through a 3-turn link.

W0EVW ST. LOUIS, MO.

RUNNING only 40 watts, Tom Million of W0EVW has little fault to find with the results he gets with a 14-Mc. folded dipole of 300-ohm Twin-Lead tucked away in the attic. The shack is located in a flat only seven blocks from the downtown section, and is surrounded by apartments, a factory, a school and a church steeple, but he gets out on 3.5, 14 and 28 Mc. The feeders are tied together for 3.5-Mc. work, and the power is fed in the normal manner for 14 and 28 Mc. Although this isn't what the book says for folded dipoles working on twice their design frequency, it doesn't seem to bother either W0EVW or the stations he works. The antenna is about 40 feet above ground. One continent is lacking for WAC, and a few states for WAS.

W2BRC, ELIZABETH, N. J.

WHEN John Nicholas built his antenna for W2BRC, he had a problem that was solved in a novel manner. While fortunate enough to have an attic long enough for a 68-foot flat top under the peak of the four-family frame house, his shack is located on the first floor and the attic corresponds to a third floor. How to feed the antenna for multiband operation? It's simple — just run an open-wire feedline up the outside of the house to the eaves, through the eaves to the inside of the attic, and along the roof rafters to the center of the flat top! He thus has multiband operation with a low-loss tuned feedline — if he were to use Twin-Lead or other solid-dielectric line and run it inside the house, as might seem to be a good idea at first glance, the losses would run much higher.

The antenna flat top is 28 feet above ground, and the 807 final amplifier is usually run at 50 watts input on 80 and 40 meters. This is plenty for W2BRC to work into the traffic nets on 3.5 and 7 Mc., run up good scores in the CD contests, and acquire a 7-Mc. WAC and 36 countries.

VE3PB, TORONTO, ONT.

The first efforts of Stanley Dane, VE3PB, to work out with 40 watts and an indoor antenna from his third-story shack were not very successful. While short lengths of wire could be coupled to some extent with a "universal coupler," the thing seemed to be good for only local contacts on 40 and 80. Many tests and careful pruning on 40 meters evolved the antenna shown in Fig. 4A, which works well on the band and has given him some good West Coast contacts. The antenna is hung along two walls and down the back of a door. Anyone duplicating the antenna should secure the wire firmly on the walls, because changes in angles or even a half-turn difference on the coil will make a difference in loading. The antenna was checked by how far away from the far end a neon bulb would light, keeping the transmitter input constant for the various tests.

On 80 meters VE3PB ran into trouble. The 40-meter antenna worked against ground was unsatisfactory. An antenna similar to that in Fig. 4A but with a larger coil and longer wire lengths loaded fine. But one could light the neon bulb on the transmitter, metal ash trays, bed springs, and the frame of an aquarium. Mittens had to be worn while tuning the receiver. Reports four miles away were RST 229. It wasn't much good.

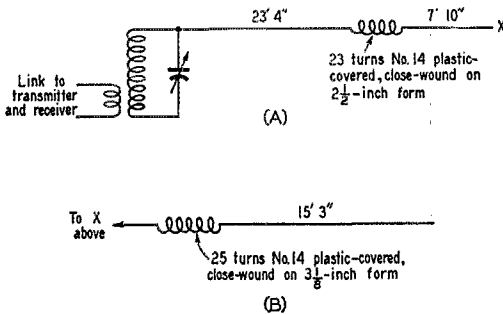

Fig. 4 — The 40- and 80-meter indoor antennas used at VE3PB. The antenna at A is used on 40, and it runs around the wall on two sides of the room and down the back of a door. On 80, the addition shown in B is clipped to the end of the 40-meter antenna. The antenna tuner is a coil-and-condenser combination that will resonate to the band in use.

But everything was cooled down and the rig worked out on 80 by adding the arrangement shown in Fig. 4B to the end of the 40-meter antenna, with this extra wire lying on the floor near the third wall. It, too, must be carefully pruned and fixed in a definite position. VE3PB concludes that the low-powered indoor-antenna operator must be careful in pruning his antenna so as not to shoot the whole system above ground, but with an indoor antenna and sensible operating he can have all of the fun and contacts he desires.

WIDX, WETHERSFIELD, CONN.

INTRIGUED by an antenna invented by W5TG and wanting a 7-Mc. skywire for the ARRL QSO Party, the antenna shown in Fig. 5 was tried at WIDX. W5TG pointed out that, since a 3-wire doublet shows 600 ohms at the feed point, half of one should show 300 ohms. Since the attic was not quite long enough to house a horizontal quarter wave at 7 Mc., the last few feet had to be dropped down, as shown in Fig. 5. The 3-

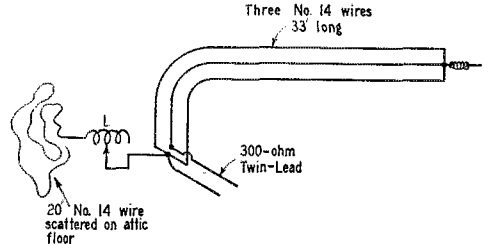

Fig. 5 — A horizontal 7-Mc. quarter-wave antenna used at WIDX. Half of a 3-wire dipole is used and fed with 300-ohm Twin-Lead. To ground one side of the transmission line and the end of the antenna, a capacity (a 20-foot length of wire scattered on floor) and an inductance, *L*, are made series resonant at the operating frequency.

wire doublet (wires spaced about 1 foot) was fed with 300-ohm Twin-Lead at the base. A good ground was not available for the quarter-wave antenna, so a counterpoise was tried, consisting of several random lengths of wire hung out a vent in the attic. This didn't work too well, as indicated by a "twin-lamp" s.w.r. indicator on the feedline, so the system illustrated in Fig. 5 was hit upon. It is a version of the old "top-loaded" antenna idea, and its purpose is to provide a low-potential (ground) point at a point removed from ground, as in an attic. About 20 feet of No. 14 wire was scattered haphazardly around on the floor, to furnish the loading capacity, and an adjustable inductor was used at *L*. (This was one of the continuously-adjustable coils salvaged from a BC-375. It has two rolling contactors on it and is ideal for this particular purpose.) The inductance at *L* was then changed a turn at a time. Nothing much happened at first, and the s.w.r. was still high, but suddenly the s.w.r. dropped and, within one turn on *L*, a setting was found in which the one lamp of the twin-lamp was completely out while the other burned brilliantly over the entire 7-Mc. band. No comparisons with other antennas are available, but the thing worked well on 7 Mc. On 14 Mc. the s.w.r. in the line runs high, but contacts have been made around the country and overseas. It is essentially a one-band antenna, of course, and is included in this symposium only to draw attention to the "grounding" method employed.

(Continued on page 108)

Happenings of the Month

INTER-AMERICAN CONFERENCE

Delegates of 25 countries of the American region convened in Washington on April 25th to open the joint sessions of the Fourth Inter-American and Region 2 Radio Conferences. The FIAR portion of this series of meetings, expected to last about six weeks, will consider revision of the Santiago (1940) agreement, including regional allocations up to 4000 kc.; the Region 2 portion, which consists of the FIAR countries plus several European nations which have colonies in this hemisphere, will implement the regional allocation of frequencies under the Atlantic City table.

With unusual speed — in fact, right during the formalities of opening the conference — the delegates promptly set up committees to handle the agenda items; meeting the very next day, several of these committees were broken down into subcommittees to begin actual work on the documents. Of immediate importance to amateurs is Subcommittee 4A, the allocations group of the FIAR committee, which is currently examining the table of frequencies from 10 up to 4000 kc. The position of the United States, as has been previously reported, is to provide amateurs sharing rights in 1800–2000 kc., and the exclusive band 3500–4000 kc. We shall have more to report next month, or perhaps before then via W1AW. Meanwhile, Acting Secretary Budlong and Assistant Secretary Huntoon are nearly permanently in Washington, participating in the committee meetings. Amateurs from other countries serving as delegates or advisers are: CP5EL, PY1DR, VE3AC, VE3NW, VE4CC, HK3GT, HK3CM, TI2AW, CM2GM, CO2DA, YV5AA and YV5CB.

REPRESENTATIVES COMMEND AMATEURS

The House of Representatives has passed a Resolution commending amateur radio operators for their contributions to the public welfare. Introduction of the Resolution was by Rep. Frederick R. Coudert, jr. (N. Y.), and the idea originated with New York City amateurs. Chairman Coy of FCC expressed that body's endorsement of the resolution while it was in committee. The text (H. Res. 106):

RESOLUTION

Whereas amateur radio operators serve the Nation in war and peace; and

Whereas amateur radio is a hobby involving the sending and receiving of messages by code or voice without pecuniary gain; and

Whereas the right to practice that hobby is granted only to those who have passed an examination given by the Federal Communications Commission; and

Whereas such amateurs have aided in keeping the lines of communication open during floods, storms, and other disasters, and so helped in the rescue of life and property; and

Whereas amateur or ham radio has provided a reservoir of self-trained operators for national defense; and

Whereas amateur radio has through research and experimentation enriched the radio art, the products of which are enjoyed by all citizens; and

Whereas several thousand of such licensed amateurs live in the United States of America and its possessions: Therefore be it

Resolved, That the House of Representatives of the United States, on behalf of a grateful citizenry, expresses its gratitude to radio operators of amateur standing for their service both past and present.

27-MC. BAND TO BE SHIFTED

The long-awaited change in our 27-Mc. band to accord with the Atlantic City table is being made effective July 1st. Our present assignment is 27,160 to 27,430 kc., but as of July 1st it will be shifted to 26,960–27,230 kc. The pertinent portion of Section 12.111 of the amateur rules will then read:

(5) 26,960 to 27,230 Mc., using unmodulated carrier, radiotelegraphy, radiotelephony, radio printer, or facsimile, with any type of emission except damped waves and pulse, subject to such interference as may result from the emissions of industrial, scientific and medical devices within 160 kc. of the frequency 27,120 Mc.

Simply to bring it in line with the foregoing change, Section 12.134 will be amended as follows:

12.134. *Modulation of carrier wave.* — Except for brief tests or adjustments and except for operation in the band 26,960 to 27,230 Mc., an amateur radiotelephone station shall not emit a carrier wave on frequencies below 144 Mc. unless modulated for the purpose of communication.

RADIO OPS-TECHNICIANS WANTED

The United States Government has openings for radio operator-technicians who are interested in careers in radio communications and general electronics involving extensive overseas duty. There are also openings for highly-qualified instructors and executives, which involve a higher proportion of duty in the United States. Applicants are being accepted whose radio training ranges from none to many years of experience plus engineering degrees, although only young and very promising candidates are accepted if they have no previous training or experience in radio. Base salaries range from \$2724 for trainees to \$6235 per year for communications executives.

Before employees are assigned to duty they are

given training designed to bring their telegraph code speed to 25 w.p.m. using speed key and mill, and to enable them to maintain and overhaul communications receivers and transmitters up to 500 watts output. Base salaries upon completion of training and assignment to overseas posts ordinarily range from \$3351 to \$3727, and up to \$4479 for unusually well-qualified men and junior supervisors. Overseas assignments are widely scattered. Length of overseas tours of duty (usually 24 months), leave, promotion, employee benefits, transportation and baggage allowances, annual salary increases, etc., are in accordance with standard Government regulations. Because special allowances fluctuate widely, only base salaries are mentioned here.

Because the nature of the work places maximum responsibility upon the individual radio operator-technician, and because a maximum flexibility of adjustment to new and unusual situations is required, successful amateurs with highly-developed skills both as operators and technicians, and with pronounced characteristics of loyalty, dependability, judgment, discretion, and ingenuity, are most in demand. Adaptability to this work as a career depends to a considerable extent upon flexibility—both ability to cope with different situations, and willingness to accept a wide variety of posts. Most executive and training positions will be filled at salaries of \$4479 or \$5232, with a few initial salaries of \$6235 possible. All such positions require extensive experience. Engineering degrees are desirable.

Interested applicants are requested to write a brief application letter to Box 73, % Administrative Headquarters, the American Radio Relay League, West Hartford 7, Conn. Considerable duplication of effort will be avoided by the applicant if he follows the form given below in his letter *answering all questions as briefly as possible and in the same order:*

1) Type of position desired (i.e., radio operator-technician, instructor, executive, etc.)

2) Experience and Training:

a) Number of months radio training and type (college, service school, technical or trade school).

b) Number of years radio experience and type (military, merchant marine, commercial, Government).

c) Amount of this experience in telegraphy and amount in construction or maintenance.

d) Present radiotelegraph speed.

e) Present or past radio licenses, including amateur.

3) Parts of the world (or climates) in which duty is *not* desired.

4) Age and marital status, including number and ages of children.

If your initial application appears promising, you will be sent full application forms upon which detailed information can be entered.

F.C.C. AMATEUR RULES PROPOSALS

On April 21st FCC released a notice of proposed rule-making to amend amateur regulations in rather substantial respects. We publish in the following pages both the text of the notice and the proposed changes in regulations. As they are involved, let us summarize here the highlights, first pointing out that the FCC proposals in most respects go far beyond the comparatively simple recommendations made to the Commission by ARRL as a result of the 1948 Board meeting (see the editorial in this issue for a summary).

FCC proposes a complete revision of license classes: an Amateur Extra Class (new) eventually to replace Class A, to be required for operation on the 75- and 20-meter 'phone bands and to include a 20-w.p.m. code test and an advanced technical exam; an Advanced Class (temporary name for Class A until it is abolished) which will not be issued or renewed after December, 1950; a General Class and a Conditional Class, which are essentially new names for Classes B and C, the requirements and privileges to remain substantially as at present; a Technician Class, with code test at 5 w.p.m. and privileges only above 220 Mc.; and a Novice Class, with a 5-w.p.m. test and simplified examination, but with 75 watts maximum; crystal-controlled c.w. only in 3700-3750, 14,100-14,150, 28,000-28,500 kc.; and c.w. or 'phone in 145-147 Mc. New requirements for renewal of all classes of license are proposed.

Elaborating a moment on the Class A matter, which seems to have been the principal subject of on-the-air discussions so far, we would point out that in effect the Commission proposes to reexamine every amateur, including a code test at 20 w.p.m., before permitting him to continue use of the 75- and 20-meter 'phone bands. This would be accomplished by not issuing or renewing the Advanced Class (Class A) license after December of 1950. Present Class A licenses expiring after that date would not be renewed except as General Class (Class B privileges); to be able to continue operation in the "restricted" 'phone bands, such licensees would have to take the new examination with higher code-speed test.

Frequencywise, FCC proposes that any type modulation except pulse (e.g., frequency or phase or amplitude or single-sideband) would be permitted in all amateur 'phone bands, but with limits on bandwidth of emission. In 3850-4000 and 14,200-14,300 kc., the limit for emitted bandwidth would be 6 kc.; FCC proposes to open 3800-3850 to 'phone, but with a 3-kc. limit. In the 10-meter band, 28.5-29.65 Mc. would have a 10-kc. bandwidth restriction, and the remainder of the 'phone band would have a 6-kc. bandwidth limit. On 6 meters, the bandwidth permitted would be 20 kc., and there would be an exclusive c.w. portion 50.0-50.1 Mc.

Before the
FEDERAL COMMUNICATIONS COMMISSION
Washington, D. C.

In the Matter of
Amendment of Part 12
of the Commission's
Rules Governing
Amateur Radio Service }
DOCKET No. 9295

NOTICE OF PROPOSED RULE MAKING

1. Notice is hereby given of proposed rule making in the above-entitled matter.

2. Heretofore the Commission has received from the American Radio Relay League, Inc., of Hartford, Connecticut, the National Amateur Radio Council, Inc., of Indianapolis, Indiana, and the Society of American Radio Amateurs of Washington, D.C., all national organizations of radio amateurs, various proposals in writing for certain changes in the Commission's Rules Governing Amateur Radio Service. The first proposals were submitted by the American Radio Relay League, followed by the others in the order named. Through channels outside of the Commission, publicity was given to the text or substance of one or more of these proposals. As a result, the Commission has received a number of comments from individual amateurs and groups of amateurs, dealing in one way or another with the subject matter covered by the proposals of the above organizations.

3. The receipt of the aforementioned items was not itself the occasion for the Commission to commence consideration of the fundamental and controversial issues involved in the proposals that have been received. However, the receipt of these items did serve to point up the timeliness of a study of these matters and to provide the Commission with a number of very valuable suggestions and an indication of the variety of views held by various members and segments of the amateur body.

4. The Commission has considered all of the proposals received. Also, it has reflected upon the general situation in which the Amateur Radio Service finds itself today and the general course of events leading up to that situation. The resulting judgement of the Commission is that the Amateur Radio Service would very much benefit from, and needs, a new overall plan or blueprint to provide scope and direction for the immediate and long range development of the service.

5. In entering upon this course, the Commission has used freely of the many splendid suggestions received. The sincerity and thoughtfulness behind these suggestions, as well as behind those not actually used, are evident and recognized. Great appreciation, therefore, is expressed for all of these suggestions, as well as for the spirit of cooperation demonstrated by those interested.

6. It will be noted upon examination that the proposals herein made, while numerous, are interrelated and constitute an overall plan. The purpose of this plan is as follows:

- (a) To provide for the continued and directed enhancement of the Amateur Service in its value to the public as a voluntary, non-commercial, communications service, particularly with respect to providing emergency communications;
- (b) To provide for the continued extension of the amateur's proven ability to contribute to the advancement of the radio art;
- (c) The continued improvement in the Amateur Service through a program which provides for encouragement for advancing skills in both the communication and technical phases of the art;
- (d) To provide a reservoir of trained operators, technicians and electronics experts for:

- (1) The growing radio industry in peacetime; and
- (2) The vastly increased demands of both the radio industry and the military services in times of national emergency.

7. The foregoing purposes are herein, or will later be, encompassed in proposed rules along the following general lines:

- (a) Recognition of the communications system aspect of the service by specific encouragement of the establishment and use of traffic nets and of handling on a voluntary impartial basis, non-commercial third party messages, emphasizing at all times the importance of emergency operations. Examinations and license requirements would be geared to this phase of amateur activity.
- (b) Establishment of an integrated and continuously reviewed and revitalized plan for improving operations and techniques and providing more efficient frequency utilization through the adoption of progressively higher performance standards, such as:
 - (1) Immediate designation of certain portions of the amateur bands for narrow bandwidth techniques; and
 - (2) Immediate establishment of realistic limits on bandwidth of emissions in all heavily-occupied bands.
- (c) Creation of initial interest on the part of the novice, particularly youth, through the establishment of a short term, non-renewable beginner's license of comparatively easy attainment. Also the encouragement of continued interest on the part of all amateurs through the progressive raising of standards at the highest level of license. As a companion measure, and particularly to promote developments on the higher frequencies, licensing at the first level above the beginner would permit alternate routes. One route would be for the communicator who would substantially resemble today's Class B* and C* amateur. The other would be for the experimenter or technician who today has no precise counterpart and who would be permitted to operate only on the higher frequency bands. Class A*, B*, and C* licenses would be continued as at present, except that commencing with January 1, 1951, Class A* licenses would no longer be issued and would be renewed only as Class B*. The special privileges associated with Class A* licenses would be absorbed in a new special top grade of license of diploma form which would be called the Amateur Extra Class* license. Eligible applicants could qualify for the Extra Class license as soon as it was established, but there would be no compulsion, based on the desire for Class A* special privileges, to qualify for it until it was no longer possible to obtain or to renew a Class A* license. Qualifications for the Extra Class license would include a minimum number of hours operating experience as a Class A*, B*, or C* amateur, a higher speed telegraphic code test and other advanced requirements of knowledge in both technical and communications fields as well as all the knowledge usually required for a Class A* license.

This license would have practical value in that it would constitute evidence of exceptional proficiency for such consideration as this factor might warrant, and, in addition, would constitute a very real target for those among the amateurs in whom pride of superior ability and accomplishment would constitute a spur to special endeavor.

* See paragraph (d), below.

- (d) In paragraph (c), above, reference is made to Class A, B, and C operator licenses (which exist today), and also to three new classes of operator licenses (which do not exist today). The latter are proposed to provide for the beginner or novice, the experimenter or technician, and for the amateur who has extraordinary qualifications. As hereafter shown, it is proposed to call these new classes of operator licenses, respectively, the Amateur Novice Class, Amateur Technician Class, and Amateur Extra Class (the last one for extra qualifications and extra privileges). These are descriptive titles. In order to be consistent and logical, it is proposed to change the nondescriptive titles of existing classes of operator licenses (A, B, and C) to titles of descriptive character. Thus, A is proposed to be changed to Amateur Advanced Class, B to Amateur General Class, and C to Amateur Conditional Class (the last one conditioned on geographical location with respect to quarterly examination points).

8. From the standpoint of the problem whether to provide a different sharing arrangement of frequencies between those used for telephony and for other types of emission, the present Commission proposals provide for an additional 50 kc (3800-3850 kc) for telephony in the 3500-4000 kc band with a permitted total bandwidth of emissions of 3 kc. The band 50.0-50.1 Mc would be designated exclusively for radiotelegraphy with A1 emission. The proposed beginner's class of license would permit telephony only in the band 145-147 Mc. Permanent provision is made for the use of NBFM and other narrow band techniques throughout all the bands available for telephony. Limitations on the bandwidth of emissions for telephony, ranging from 3 kc to 20 kc, are proposed for all bands except the new 27 Mc band and the bands above 54 Mc for which no bandwidth limitations are immediately proposed. The bands so limited are 3800-3850 kc, 3 kc; 3850-4000 kc, 6 kc; 14200-14300 kc, 6 kc; 28.5-29.65 Mc, 10 kc; 29.65-29.7 Mc, 6 kc; and 50.1-54.0 Mc, 20 kc. Wide band frequency modulation would be no longer permitted in the sub-bands 29.0-29.7 Mc and 52.5-54.0 Mc. Additional provision for A0 emission is not proposed.

9. As part of the plan described in paragraphs 7 and 8 above, it is proposed to revise the renewal service requirements for existing classes of amateur operator licenses (Classes A, B, and C proposed to be called Advanced, General, and Conditional respectively) in order that such requirements will be consistent with those which are being proposed for the new classes of licenses herein described (Amateur Extra Class and Technician Class). It has been thought for some time that the present renewal service requirements (three separate radiotelegraph contacts with other amateur stations in the United States during the last six months preceding the date of filing application for renewal) have little or no practical value as proof of qualification for renewal without examination. Accordingly, the attached Notice of Proposed Rule Making sets forth renewal service requirements for the existing and proposed (excluding Novice Class license which is not renewable) classes of amateur operator licenses. The one year grace period set forth in the recently published Notice of Proposed Rule Making (Docket 9240) has been incorporated in this proposal.

10. The proposed amendments, authority for which is contained in Sections 4(i), 303(b), (c), (e), (f), (g), (l), and (r) of the Communications Act of 1934, as amended, are set forth in an appendix attached to this notice.

11. Any interested party who is of the opinion that the proposed amendments should not be adopted, or should not be adopted in the form set forth may file with the Commission, on or before July 20, 1949, a written statement or brief setting forth his comments. At the same time, persons favoring the amendments as proposed may file statements in support thereof. The Commission will consider any such comments that are received before taking any final action regarding the proposed amendments, and if any comments are received which appear to warrant the holding of a hearing or oral argument before final action is taken, notice of the time and place of such hearing or oral argument will be given.

12. In accordance with Section 1.764 of the Commission's Rules and Regulations, an original and at least fourteen copies of all statements, briefs or comments shall be furnished the Commission.

FEDERAL COMMUNICATIONS COMMISSION

Adopted: April 20, 1949

Released: April 21, 1949

T. J. Slowie,
Secretary

— * * * —

Proposals for Changes in Amateur Rules

PART 12 RULES GOVERNING AMATEUR RADIO SERVICE, is amended as follows:

Directions for altering text: Insert the following text of new Section 12.0, *Basis and Purpose*. — These rules and regulations are designed to provide an amateur radio service having a fundamental purpose as expressed by the following principles:

(a) The continued and directed enhancement of the amateur service in its value to the public as a voluntary noncommercial communication service, particularly with respect to providing emergency communications.

(b) The continued extension of the amateur's proven ability to contribute to the advancement of the radio art.

(c) The continued improvement in the amateur service through a program which provides for encouragement for advancing skills in both the communication and technical phases of the art.

(d) The providing of a reservoir of trained operators technicians and electronics experts for:

- 1) The growing radio industry in peacetime; and
- 2) The vastly increased demands of both the radio industry and the military services in times of national emergency.

Substitute the following text for the present text of subparagraph 2 of paragraph (a) of Section 12.111, Frequencies and Types of Emission for Use of Amateur Stations:

(2) 3500 to 4000 kc. Use of this band is restricted to amateur radio stations as follows:

(i) 3500-4000 kc, radiotelegraphy using type A-1 emission only, to those stations located within the continental limits of the United States, the Territories of Alaska and Hawaii, Puerto Rico, the Virgin Islands and all United States possessions lying west of the Territory of Hawaii to 170 degrees west longitude.

(ii) 3800 to 3850 kc, radiotelephony using any type of modulation, except pulse, provided that the total bandwidth of emissions does not exceed 3 kilocycles, to those stations located within the continental limits of the United States, the Territories of Alaska and Hawaii, Puerto Rico, the Virgin Islands and all United States possessions lying west of the Territory of Hawaii to 170 degrees west longitude subject to the further restriction that radiotelephone types of emission may be used only by an amateur station which is licensed to an amateur operator holding an amateur extra-class or advanced-class (Class A) operator license and then only when operated and controlled by an amateur operator holding an amateur extra-class or advanced-class (Class A) operator license.

(iii) 3850 to 4000 kc, radiotelephony using any type of modulation, except pulse, provided that the total bandwidth of emissions does not exceed 6 kilocycles, to those stations

located within the continental limits of the United States, the Territories of Alaska and Hawaii, Puerto Rico, the Virgin Islands and all United States possessions lying west of the Territory of Hawaii to 170 degrees west longitude, subject to the further restriction that radiotelephone types of emission may be used only by an amateur station which is licensed to an amateur operator holding an amateur extra-class or advanced-class (Class A) operator license and then only when operated and controlled by an amateur operator holding an amateur extra-class or advanced-class (Class A) operator license.

Substitute the following text of subparagraph (4) of paragraph (a) of Section 12.111, Frequencies and Types of Emission for Use of Amateur Stations:

(4) 14,000 to 14,400 kc, radiotelegraphy using Type A-1 emission only; 14,200 to 14,300 kc, radiotelephony using any type of modulation except pulse, provided that the total bandwidth of emission does not exceed 6 kilocycles, subject to the restriction that radiotelephone types of emission may be used only by an amateur station which is licensed to an amateur operator holding an extra-class or advanced-class (Class A) operator license and then only when operated and controlled by an amateur operator holding an amateur extra-class or advanced-class (Class A) operator license.

Substitute the following text for the present text of subparagraph (6) and (7) of paragraph (a) of Section 12.111, Frequencies and Types of Emission for Use of Amateur Stations:

(6) 28.0 to 29.7 Mc, radiotelegraphy using Type A-1 emission only; 29.0 to 29.7 Mc, radiotelegraphy using carrier-shift techniques provided that the maximum shift does not exceed 1 kilocycle; 28.5 to 29.65 Mc, radiotelephony using any type of modulation, except pulse, provided that the total bandwidth of emissions does not exceed 10 kilocycles; 29.65 to 29.7 Mc, radiotelephony, using any type of modulation, except pulse, provided that the total bandwidth of emissions does not exceed 6 kilocycles.

(7) 50.0 to 54.0 Mc; 50.0 to 50.1 Mc, radiotelegraphy using Type A-1 emission only; 50.1 to 54.0 Mc, radiotelephony using any type of modulation except pulse, provided the total bandwidth of emissions does not exceed 20 kilocycles, or radiotelegraphy using any type of tone modulation or facsimile using amplitude modulation.

Substitute the following text for the present text of Section 12.21, Eligibility for License:

12.21 Eligibility for License: — Persons are eligible to apply for the various classes of amateur operator licenses as follows:

Amateur extra-class. — Any citizen of the United States whose application shows that while operating under a valid amateur operator license, advanced-class, general-class, or conditional-class (or Class A, B or C) issued by the Federal Communications Commission, the applicant has accumulated a minimum of 28 hours of operating experience during the last 12 months immediately preceding the date of his application.

Advanced Class (Class A). — Any citizen of the United States who at any time prior to the receipt of his application by the Commission has held, for a period of a year or more, an amateur radio operator license, general-class or conditional-class (or Class B or C) issued by the Federal Communications Commission. New advanced-class amateur operator licenses will not be issued after December 31, 1950. Commencing with January 1, 1951, valid advanced-class (or Class A) licenses will be renewed only as general-class, although holders of expiring advanced-class (or Class A) licenses may, if eligible, apply for amateur extra-class licenses.

General Class. — Any citizen of the United States.

Conditional Class. — Any citizen of the United States whose actual residence, address, and proposed amateur station are more than 125 miles airline distance from the nearest location at which examinations are held at intervals of not more than 3 months for amateur operator licenses; or who is shown by physician's certificate to be unable to appear for examination because of protracted disability; or

who is shown by certificate of the commanding officer to be in the armed forces of the United States at an Army, Air Force, Navy or Coast Guard station, and, for that reason, unable to appear for examination at the time and place designated by the Commission.

Technician Class. — Any citizen of the United States.

Novice Class. — Same eligibility requirements as conditional class except that the following classes of persons are not eligible for the novice class license: (a) Former holders of novice-class license, and (b) present or former holders of any class of commercial operator licenses issued on the basis of a technical examination.

Substitute the following text for the present text of Section 12.23, Classification of Operating Privileges:

12.23 Classes and Privileges of Amateur Operator Licenses. — Amateur extra-class. — All authorized amateur privileges and also any special privileges that the Commission might grant from time to time.

Advanced class (Class A). — All authorized amateur privileges except those reserved for holders of the amateur extra-class license.

General class or conditional class (Class B or C). — All authorized amateur privileges except those reserved for holders of the amateur extra-class or advanced-class (Class A) licenses.

Technician class. — All authorized amateur privileges in the amateur frequency bands above 220 Mc.

Novice class. — Those amateur privileges as designated and limited as follows:

(a) The d.c. plate-power input to the vacuum tube or tubes supplying the power to the antenna shall not exceed 75 watts.

(b) Only the following frequency bands and types of emission may be used, and the emissions of the transmitter must be crystal-controlled except in the 145–147 Mc band:

(1) 3700 to 3750 kc, radiotelegraphy using only Type A-1 emission, in accordance with the geographical restrictions set forth in Section 12.111 (a) (2) (i).

(2) 14,100 to 14,150 kc, radiotelegraphy using only Type A-1 emission.

(3) 28.0 to 28.5 Mc, radiotelegraphy using only Type A-1 emission.

(4) 145 to 147 Mc, radiotelegraphy or radiotelephony using any type of emission except pulse emission and Type B emissions.

Substitute the following text for the present text of Section 12.27, Renewal of Amateur Operator License:

12.27 Renewal of Amateur Operator License. — Application for renewal without examination of an amateur operator license, except the novice class, shall be filed not more than 120 days prior to the date of expiration, and the following renewal requirement shall be fulfilled as appropriate for the class of license:

Amateur extra-class. — The application shall include a statement subject to proof upon request, that the applicant has accumulated a minimum of 50 hours of lawful operation during the entire term of and under the license being renewed, or a minimum of 10 hours of such operation during the last six months immediately preceding the date of application, and that he can send by handkey and receive by ear, in plain language, messages in the International Morse code at a speed of not less than 20 words per minute in the manner described in Section 12.42, Element 1 (E) of the rules.

Advanced class (Class A). — After December 31, 1950, may not be renewed, as advanced class (Class A) but may be renewed as general class on application which includes a statement, subject to proof upon request, that the applicant has accumulated a minimum of 50 hours of lawful operation during the entire term of and under the license being renewed, or a minimum of 10 hours of such operation during the last six months immediately preceding the date of application, and that he can send by handkey and receive by ear, in plain language, messages in the International Morse code at a speed of not less than 13 words per minute in the manner described in Section 12.42, Element 1 of these rules.

General Class (Class B). — The application shall include a statement, subject to proof upon request, that the applicant has accumulated a minimum of 50 hours of lawful operation during the entire term of and under the license being renewed, or a minimum of 10 hours of such operation during the last 6 months immediately preceding the date of application, and that he can send by handkey and receive by ear, in plain language, messages in the International Morse code at a speed of not less than 13 words per minute in the manner described in Section 12.42, Element 1 of these rules.

Conditional class (Class C). — The application shall include a statement, subject to proof upon request, that the applicant has accumulated a minimum of 50 hours of lawful operation during the entire term of and under the license being renewed, or a minimum of 10 hours of such operation during the last 6 months immediately preceding the date of application and that he can send by handkey and receive by ear, in plain language, messages in the International Morse code at a speed of not less than 13 words per minute in the manner described in Section 12.42, Element 1 of these rules.

Technician class. — The application shall include a statement, subject to proof upon request, that the applicant has accumulated a minimum of 50 hours of lawful operation during the entire term of and under the license being renewed, or a minimum of 10 hours of lawful operation during the last 6 months immediately preceding the date of application, and that he can send by handkey and receive by ear in plain language, messages in the International Morse code at a speed of not less than 5 words per minute in the manner described in Section 12.42, Element 1 (NT).

Novice class. — This class of operator license may not be renewed.

Substitute the following text for the present text of Section 12.29, License Term:

12.29 License Term. — Amateur operator licenses are normally valid for a period of 5 years from the date of issuance of a new or renewed license, except the novice class which is normally valid for a period of one year from the date of issuance. Modified and duplicate licenses shall bear the same date of expiration as the licenses for which they are modifications or duplicates.

Substitute the following text for the present text of Section 12.42, Elements of Examination:

12.42 Elements of Examination. — The examinations for the various classes of amateur operating privileges comprise combinations of various of the following elements:

Element 1. Code test. — Ability to send by handkey and receive by ear, in plain language, messages in the International Morse code at a speed of not less than 13 words per minute, free of omissions or other error, for a continuous period of at least 1 minute, during a test period of 5 minutes, counting 5 characters to the word, each numeral or punctuation mark counting as 2 characters. (Advanced class, general class and conditional class (Classes A, B and C).)

Element 1(E). Code test. — Ability to send by handkey and receive by ear in plain language, messages in the International Morse code at a speed of not less than 20 words per minute free of omissions or other error for a continuous period of at least 1 minute during a test period of 5 minutes, counting 5 characters to the word, each numeral or punctuation mark counting as 2 characters (Amateur extra-class).

Element 1(NT). Code test. — Ability to send by handkey and receive by ear messages in plain language in the International Morse code at a speed of not less than 5 words per minute (each character formed at a speed of 7.3 words per minute, but with increased spacing between characters and words so as to result in an overall speed of 5 words per minute.) (Novice and technician classes.)

Element 2. Amateur radio operation and apparatus, including telephone and telegraph. (Amateur extra class, advanced class, general class, conditional class (Classes A, B, and C), and technician class.)

Element 3. Provisions of treaties, statutes and regulations affecting amateurs. (Amateur extra class, advanced class, general class, conditional class (Classes A, B, and C), and technician class.)

Element 3(N). Rules and Regulations essential to beginners' operation including sufficient elementary radio theory for the understanding of these rules (Novice class).

Element 4. Advanced amateur telephony. (Amateur extra class and advanced class (Class A).)

Element 4(E). Advanced amateur radio theory including techniques for operating within bands designated for narrow bandwidths of emission. (Amateur extra class).

Substitute the following text for the present text of Section 12.43, Elements Required for Various Privileges:

12.43 Elements Required for Amateur Operator License Examinations:

Amateur extra class. — Examination consists of Elements 1(E), 2, 3, 4, and 4(E).

Advanced class (Class A). — Examination consists of Elements 1, 2, 3, and 4.

General class and conditional class (Classes B and C). — Examination consists of Elements 1, 2, and 3.

Technician class. — Examination consists of Elements 1(NT), 2, and 3.

Novice class. — Examination consists of Elements 1(NT), and 3(N).

Substitute the following text for the present text of the first paragraph of Section 12.44, Manner of conducting examinations:

12.44 Manner of Conducting Examinations. — The examinations for all amateur classes of operator licenses except the conditional and novice classes will be conducted by an authorized Commission employee or representative at locations and times specified by the Commission.

Substitute the following text for the present text of the first paragraph of Section 12.46, Examination Credit:

12.46 Examination Credit. — An applicant holding a valid amateur operator license, other than the conditional class (Class C) or novice class, applying for a higher class of amateur operator license will be required to pass only those elements of the examination that were not included in the examination for the presently-held amateur license.

An applicant for amateur advanced class (Class A) operator license will be given credit for examination Element 4 if within two years prior to the receipt of his application by the Commission he held Class A privileges.

An applicant for any class of operator license, except the novice class and the extra class, will be given credit for examination Element 1 or 1(NT) if within five years prior to the receipt of his application by the Commission he held a radiotelegraph first or second class operator license. An applicant for the amateur extra class operator license will be given credit for examination Element 1(E) if within five years prior to the receipt of his application by the Commission he held a radiotelegraph first class operator license.

No examination credit, except as above provided, shall be allowed on the basis of holding or having held FCC amateur or commercial operator license.

A holder of an amateur conditional (Class C) or novice operator license will not thereby be accorded an abridged examination for any other class of amateur operator license.

Substitute the following text for the present text of Section 12.65, License Period:

12.65 License Period. — The license for an amateur station is normally valid for a period of five years from the date of issuance of a new or renewed license, except that an amateur station license issued to the holder of a novice class amateur operator license is normally valid for a period of one year from the date of issuance. Modified or duplicate licenses shall bear the same issue date and expiration date as the licenses for which they are modifications or duplicates.

Insert the following text of new Section 12.107, Roundtable Operations:

12.107 Roundtable Operations. — Whenever more than two amateur stations are in communication with each other, one of them shall act as control station in the interest of orderly communications procedure.

Teletype Reception with Make-Break Keying

BY DANA A. GRIFFIN,* W2AOE

AMATEURS who are now using teletype machines for communications work may be interested in a system that was developed and tested by the writer in 1946. As at that time there seemed to be no amateur interest in this form of communication the work was dropped. This sys-

tem uses off-on keying and gets around the necessity for using two-tone modulation or frequency-shift keying. It has a very substantial capability of discrimination against noise.

A loop circuit was set up between locations in downtown and midtown New York over a 5-mile path. The 11-meter and 2-meter bands were used. Both teletype machines were located downtown, as shown in Fig. 1. Transmission north was accomplished with a surplus 144-Mc. crystal-controlled transceiver with one-watt output. The signal was received on a similar unit and retransmitted south by a 10-watt 11-meter transmitter. The signal was picked up on an SX-28 and fed into the receiving teletype machine. This location is extremely noisy — the S-meter readings average around S7 on building noises of all types. Haywire antennas were employed so the signal never boosted the S-meter reading much beyond S9. Despite this severe handicap, the system worked very well. Amateur teletype fans should obtain excellent results as they will rarely, if ever, encounter such poor receiving conditions.

The receiver circuit is shown in Fig. 2. A reverse-diode r.f. noise limiter is used in conjunction with a blocking-oscillator "tone-noise generator." The audio amplifier of the receiver can be followed by an audio

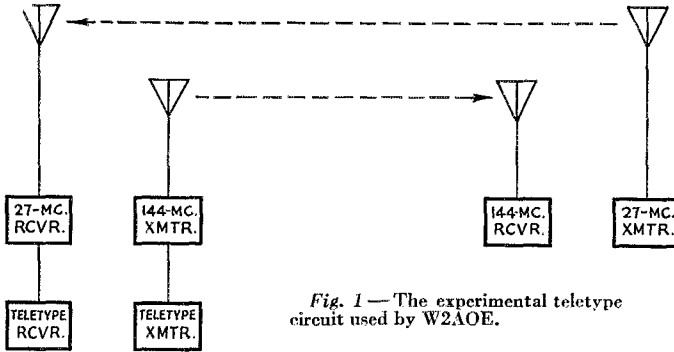

Fig. 1 — The experimental teletype circuit used by W2AOE.

filter, if desired, or the output can be fed directly into the rectifier. The rectified audio output of an SX-28 is sufficient to operate the teletype relay directly. The low-current teletype relay generally used in radioteletype work will reduce the audio output requirements.

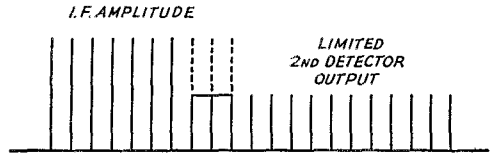

Fig. 3 — Pulses from the blocking oscillator (together with incoming noise pulses) are limited as shown at the right to provide constant audio output. An incoming carrier at least equal to the limiting level suppresses the noise and provides the keying "space."

The blocking oscillator shown in the diagram operates at the receiver's intermediate frequency. The repetition rate can be adjusted to any convenient frequency. Between 400 and 600 cycles is a good choice. The output level of this oscillator is not important because the noise limiter

* Communication Measurements Laboratory, Inc., 120 Greenwich St., New York 6, N. Y.

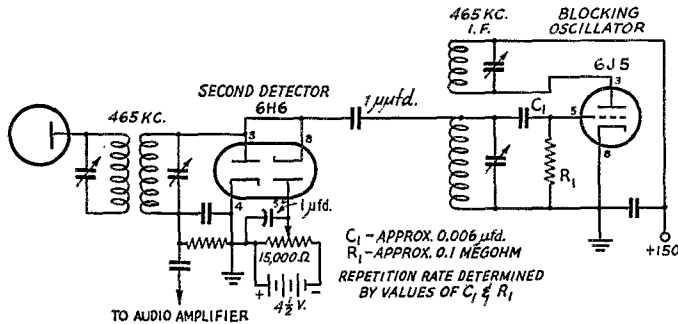

Fig. 2 — Circuit diagram of the second-detector circuit used with a standard communications receiver. The blocking oscillator provides noise pulses for the "mark" signal.

The rectified audio output of an SX-28 is sufficient to operate the teletype relay directly. The low-current teletype relay generally used in radioteletype work will reduce the audio output requirements. The blocking oscillator shown in the diagram operates at the receiver's intermediate frequency. The repetition rate can be adjusted to any convenient frequency. Between 400 and 600 cycles is a good choice. The output level of this oscillator is not important because the noise limiter

(Continued on page 108)

Multiple-Circuit Tuners from Grid to Feeder

A Six-Band R.F. Amplifier and Antenna Coupler

BY C. VERNON CHAMBERS,* W1JEQ

IN the attempt to obtain rapid band changing, many of us have either constructed or purchased an exciter unit that will hop from band to band at the flip of a single control. Frequently, though, means for rapid and simple band changing end right there — at the output circuit of the exciter — because the power amplifier and the antenna coupler use plug-in coils. In other words, our fancy exciter hasn't minimized the band-changing ordeal so very much after all.

The use of an all-band tuner in the plate circuit of an amplifier as demonstrated by W1CJL¹ was one new step toward speeding up and simplifying the job of changing bands at the output end of the transmitter. After studying King's data we began to wonder if the multiple-band tuner idea couldn't be expanded to include the amplifier grid circuit and the antenna coupler. The only commercial model of such a tuner — the MB-150 — was a 150-watt unit and no doubt could be modified for use as an antenna coupler. But it seemed unnecessarily large for the grid circuit of a 150-watt amplifier, so we felt it advisable to try constructing a lower-power unit using the same principles.

Although we had some misgivings at the start, it turned out that the design of the grid tuner was a simple matter; we just duplicated the C and L values of the MB-150 with components of smaller physical size. Construction was an

even lighter task and getting it to work gave no trouble at all.² In fact, the three operations — design, construction and testing — involved far less time and labor than is usually expended on a 6-band tuned circuit using either bandswitching or plug-in coils.

In addition to the multiple-circuit tuners that permit rapid band changing without plug-in coils or r.f. switches, the amplifier described here uses economical and easy-to-drive 807 tubes and is complete with heater supply, protective-bias system, TVI filters and provision for matching a wide range of antenna impedances. Effective shielding and a finished appearance are provided by an inexpensive steel utility can. Changing bands becomes a simple task when this unit is used along with a single-control exciter capable of delivering approximately 3 watts output.

The Amplifier Circuit

The circuit diagram of the amplifier is given in Fig. 1. The push-pull arrangement is conventional except for the grid and plate tuners. Operating bias for the 807s is developed across R_1 and R_2 is the series-dropping resistor for the screen grids. A Type 6Y6G tube, connected between R_1 and R_2 , serves as a screen-voltage limiter when excitation is removed from the amplifier. RFC_1 and RFC_2 in the grid circuit, and C_{10} , C_{11} , C_7L_4 and C_8L_5 in the plate circuit combine to prevent parasitic oscillation. However, the primary function of the condensers and coils is the suppression of v.h.f. harmonics falling in the television channels between 54 and 88 Mc. Filters installed in the heater and high-voltage leads attenuate the flow of harmonic currents in the external wiring.

* Technical Assistant, QST.

¹ King, "No Turrets — Just Tunel" QST, March, 1948.

² Those who don't care to go to the trouble of building their own will be interested to know that a similar tuner will soon be available commercially.

◆

This 150-watt amplifier-antenna coupler, covering 3.5 to 30 Mc. without bandswitches or plug-in coils, includes means to reduce TVI and is complete except for plate supply. Grid and plate meters are to the left and right of the grid-circuit tuning control. The tuning controls for the antenna coupler and the amplifier tuner are at the left and right sides of the panel just above the meters.

◆



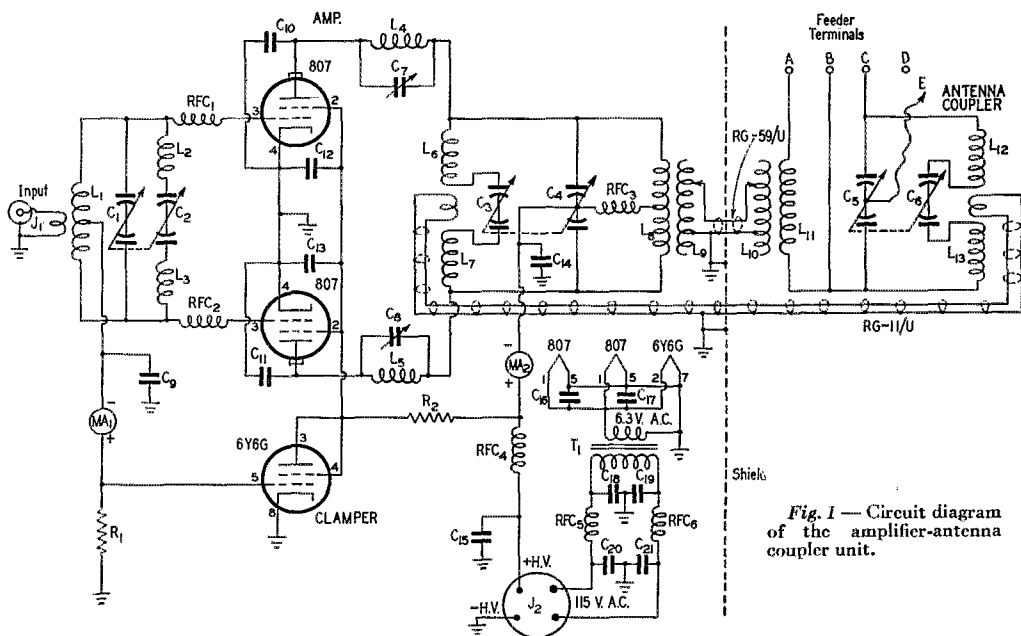

Fig. 1 — Circuit diagram of the amplifier-antenna coupler unit.

- C_1, C_2 — 125- μ fd. variable (National SSH 125).
 C_3, C_4, C_5, C_6 — 110- μ fd. per-section variable (part of National MB-150 tuner).
 C_7, C_8 — 50- μ fd. variable (National PSE).
 C_9 — 0.0047- μ fd. mica.
 C_{10}, C_{11} — 10- μ fd. tubular; see text.
 C_{12}, C_{13} — 0.005- μ fd. ceramic (Centralab DA 048).
 C_{14} — 0.001- μ fd. mica, 1200 volts working.
 C_{15} — 470- μ fd. mica, 1200 volts working.
 $C_{16}, C_{17}, C_{18}, C_{19}, C_{20}, C_{21}$ — 470- μ fd. mica.
 R_1 — 12,000 ohms, 1 watt.
 R_2 — 25,000 ohms, 20 watts.
 L_1 — 30 turns No. 22 enam., center-tapped, 1 $\frac{1}{4}$ inches long, 1-inch diam.
 L_2, L_3 — 7 turns No. 22 enam., $\frac{5}{16}$ inch long, 1-inch diam., with a $\frac{3}{8}$ -inch space between sections.

- L_4, L_5 — 4 turns No. 16 tinned, 1 inch long, $\frac{5}{16}$ -inch diam.
 L_6, L_7, L_{12}, L_{13} — 5 turns No. 12, $\frac{5}{8}$ inch long, 1 $\frac{1}{4}$ -inch diam., with a $\frac{3}{8}$ -inch space between sections.
 L_8, L_{11} — 18 turns No. 12, 2 inches long, 1 $\frac{1}{4}$ -inch diam.; L_8 is center-tapped.
 L_9, L_{10} — 12 turns No. 12, 2 $\frac{1}{2}$ inches long, 2 $\frac{1}{2}$ -inch diam. (NOTE: L_8 to L_{13} , inc. — part of MB-150 tuner.)
 J_1 — Coaxial-cable connector.
 J_2 — 4-prong male plug.
 MA_1 — 0-25 d.c. milliammeter.
 MA_2 — 0-300 d.c. milliammeter.
 RFC_1, RFC_2 — 1- μ h. r.f. choke (National R33).
 RFC_3 — 2.5-mh. r.f. choke (part of MB-150 tuner).
 RFC_4, RFC_5, RFC_6 — 7- μ h. r.f. choke (Ohmite Z50).
 T_1 — 6.3-volt 3-amp. filament transformer (Stancor P5014).

Excitation for the amplifier is fed through a low-impedance link to the low-frequency coil, L_1 , of the grid tuner. Output from the plate circuit is transferred to the antenna coupler through two coaxial cables. One of the lines, a section of RG-59/U, is tapped on output-coupling coil L_9 and carries output at 3.5 and 7 Mc. A length of RG-11/U, link-coupled to L_6 and L_7 , completes the coupling circuit at 14, 21, 27 and 28 Mc.

Antenna-Coupler Circuit

The circuit diagram of the antenna coupler is also given in Fig. 1. The MB-150 assembly has been rewired so that the low-frequency section of the circuit, $C_5L_{10}L_{11}$, can be used for either series or parallel tuning at 3.5 and 7 Mc. C_5, C_6, L_{12} and L_{13} form a parallel-tuned coupler at 14 Mc. and above.

Selection of series or parallel tuning is accomplished by making proper use of terminals A, B, C, D and E . The flexible clip lead, E , connected to the rotor side of C_5 , permits either shorting out one section of the capacitor or using the two sections in series or parallel. A connection chart shows the jumper and feeder connections required for low-, medium- and high- C operation of the series and parallel circuits.

Construction

The front view shows a Middletown No. UC 11128 utility can, with the bottom plate removed, fastened to the chassis by means of aluminum strips and a front panel. The cabinet measures 8 by 11 by 12 inches and the chassis 3 by 10 by 12 inches. The panel is 12 $\frac{1}{4}$ inches wide by 10 $\frac{1}{2}$ inches high and the aluminum strips measure 1 by 10 inches.

Ventilation for the amplifier is provided for by the 1-inch hangover at the rear of the assembly and by holes cut in the top cover of the cabinet. A slot in the top cover, covered with a small aluminum plate as seen in the front view, permits adjustment of the harmonic traps with the cover in place.

The inside view shows the plate and antenna-coupler tuners and the "clammer" tube mounted on the main chassis. The 807s, submounted on an aluminum channel, are to the right of the plate tuner and the tubular by-pass condensers, C_{10} and C_{11} , are between the 807s. The harmonic traps, C_7L_4 and C_8L_6 , are supported by a $1\frac{1}{2} \times 3\frac{1}{4}$ -inch piece of polystyrene which is in turn mounted on the frame of the plate tuning assembly.

Antenna-Coupler Connection Chart

Tuning	"C"	Feeder Terminals	Jump Terminals	Connect Clip Lead "E" to
Series	Low	A & C	—	D
Series	Medium	A & C	—	B or C
Series	High	A & D	B & C	D
Parallel	Low	A & B	A & C	D
Parallel	Medium	A & B	A & C	B or C
Parallel	High	A & B	A & C	A

The cabinet is divided into compartments by a partition made from the bottom cover of the can. Holes drilled in the partition pass the coaxial cables which run between the plate and the antenna-coupler circuits. Notice that the high-frequency coaxial link is made from heavy-duty cable; the RG-59/U breaks down under this application. The rear right-hand corner of the cabinet has been cut free and then hinged, thus providing access to the antenna-coupler terminals. Normally, the door is held closed by the top cover.

A bottom view shows the 807 tube sockets and the tubular condensers mounted on a $2\frac{1}{2}$ -inch wide channel which is bolted to the front and rear walls of the chassis. Rolled-over edges give the channel adequate strength. The heater and screen by-pass condensers and the grid r.f. chokes are connected directly at the socket terminals. The heater transformer and the screen resistor are at the front left-hand corner of the chassis and the plate by-pass condenser and the TVI-filter components are to the rear. Jacks for the r.f. and power-input cables are mounted on the rear wall of the chassis and the grid tuner is located to the right of the subchassis.

To obtain symmetry the control for the grid tuner is set at the center of the panel as shown by the front view. This necessitates a pulley arrangement between the panel-bearing assembly and

the control shaft of the tuner. Inexpensive pulleys were made by cutting "V"-shaped slots around small tuning knobs. The cutting was done with a 3-cornered file after the knobs, equipped with $\frac{1}{4}$ -inch shafts, were mounted in a drill chuck. Two holes, large enough to clear dial cable and at right angles to the "V" slot, are drilled in each knob to prevent the cable from slipping.

Construction of the grid tuner is a simple matter. The two split-stator condensers, C_1 and C_2 , are mounted on a strip of bakelite by means of "L"-shaped metal brackets. An insulated coupler is used between the shafts of the condensers. The grid coils, wound on 1-inch diameter forms, are mounted on the condenser frames. Spacers $\frac{1}{4}$ inch long are placed between the bottom of the coil forms and the condensers to provide a reasonable space between the windings and the metal frames. A lug strip mounted on the front stator terminal of C_1 as shown in the bottom view of the amplifier is used as the tie point for the center-tap of L_1 and the c.t. by-pass condenser, C_9 .

Modification of the MB-150 used as an antenna coupler is a few minutes' work. First, the r.f. choke is removed from the unit. Second, one end of the low-frequency coil, L_{11} of Fig. 1, is disconnected from the tuning condenser. The four feeder terminals and the clip lead are now mounted and the unit rewired to resemble the circuit of Fig. 1. The photograph of the amplifier shows only three feeder terminals mounted along the bottom edge of the terminal block at the rear of the tuner, but it is recommended that a fourth one be included.

The output leads of the MB-150s are equipped with clips. We removed the clips and soldered one of the flexible leads (at both plate tuner and antenna coupler) to the third turn of the coupling winding. The second flexible lead, in both cases, is terminated with a flat-jaw Mueller clip and the original MB-150 clips are used as permanent taps on windings L_9 and L_{10} .

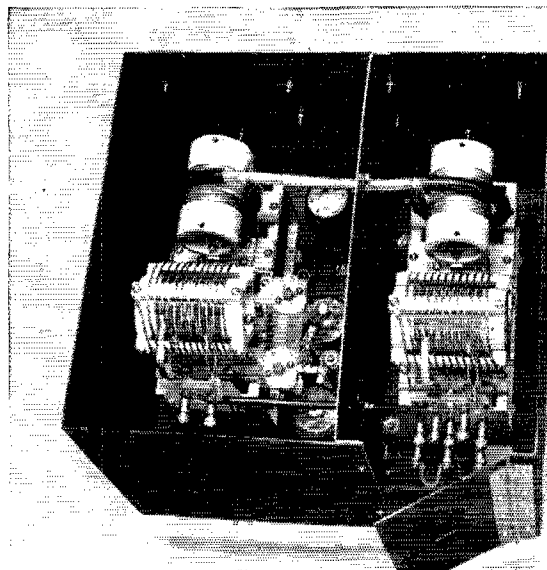

Interior view of the amplifier-antenna coupler.

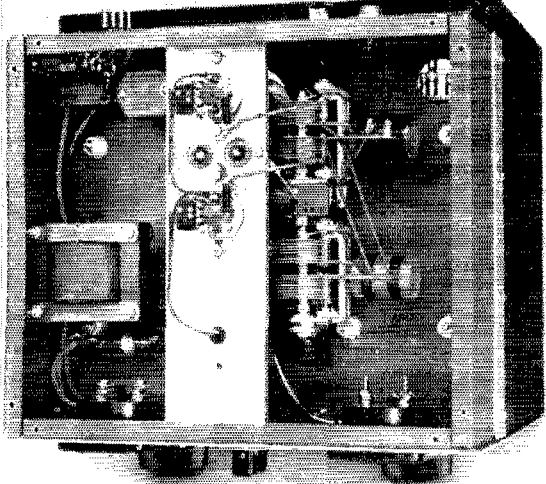

The tubular-type plate by-pass condensers, C_{10} and C_{11} , are homemade affairs. The outer tubes are $4\frac{3}{4}$ -inch lengths of 9/16-inch i.d. copper pipe. The internal members, $\frac{1}{4}$ inch in diameter by 5 inches long, may be cut from either aluminum or copper rod. These rods should be drilled and tapped at one end and rounded off at the opposite end. The large tubes are soldered to a flat copper mounting plate after the latter has been drilled to accommodate the o.d. of the tubes. Millen 47001 coil forms serve as the spacers between the inner and outer sections of the condensers. The outsides of the coil forms should be coated with cement before the forms are forced into the copper tubes.

Power Supply

The power supply should deliver 750 volts for c.w. operation or 600 volts if the amplifier is plate-modulated. In either case the current drain will be approximately 220 ma. — 200 ma. for the plate circuit and 15 to 20 ma. for the screen grids.

Preliminary Tests

Testing of the grid tuner is done with heater voltage and r.f. excitation applied to the amplifier. Output from the exciter should be adjusted to cause an amplifier grid current of approximately 10 ma. at all amateur frequencies from 3.5 through 29.7 Mc. When operating the multiple-circuit tuner, it must be remembered that the effective resonant frequency does not increase in the usual sequence as the ganged condensers are rotated through the tuning range. Starting with maximum capacitance, the low-frequency edges of the 6 bands tune in the following order; 14, 3.5, 21, 7, 27 and 28 Mc.

The plate circuit of the amplifier is tested in the usual manner. With both excitation and high voltage applied, the plate current should be approximately 20 ma. when the plate tuner is resonated without load. A full-load current of 200 ma. may be obtained with a 100-watt lamp connected across several turns of L_9 . The screen-

The chassis shields the grid tuner from the other r.f. coils as shown in this bottom view. The TVI filters for the external leads are mounted on a small terminal board at the rear of the chassis. A flat aluminum plate, not shown in the photograph, serves as a shield and bottom plate for the unit.

grid input should be approximately 16 ma. at 300 volts when the amplifier is loaded. Output from the exciter may now be readjusted so the 807 grid current will be 8 ma. The normal bias developed across R_1 is 90 volts.

With the 6Y6G in place, excitation cut-off and plate voltage applied, the plate current should not exceed 35 ma. Screen voltage will be approximately 30 volts under these conditions.

The antenna coupler may be tested with either an antenna or a dummy load connected to the feeder terminals. Lamp-bulb combinations that will simulate antenna loads of various impedances are listed elsewhere.³ Coupling between the amplifier and the antenna coupler at 3.5 and 7 Mc. is adjusted by positioning the taps on the coupling coils, L_9 and L_{10} . Once these taps have been located to give proper coupling, it is only necessary to change the positions of the flexible clip leads when going from 3.5 to 7 Mc. Just where the taps should be placed, as well as the selection of either series or parallel tuning, will depend on the load impedance that is worked into. Low-impedance loads usually require fairly large coupling coils and series tuning while high impedances are ordinarily coupled to with smaller links and parallel tuning.

At frequencies above 7 Mc., the low-frequency coupling link is shorted out at the plate-circuit end.

The modified MB-150 must be used as a parallel-tuned coupler at 14 Mc. and above. Coupling between amplifier and antenna tuner is fixed by the coaxial-type link⁴ which provides adequate coupling on all four bands. Because parallel tuning is a *must* at 14 Mc. and above, it is essential that the antenna system be designed for parallel tuning at these frequencies. Multiband antennas that will meet this requirement are described in *The Radio Amateur's Handbook* and in the *A.R.R.L. Antenna Book*.

Harmonic Traps

Adjustment of harmonic traps has received previous treatment, and this operation should be carried out with the transmitter coupled to an antenna. When testing the original model with full input at 28 Mc., it was possible to tune out every indication of r.f. at the second and third

(Continued on page 108)

^{3,4} Grammer, "Pointers on Harmonic Reduction," *QST*, April, 1949.

A Filter Design for the Single-Sideband Transmitter

BY FRED M. BERRY,* W0MNN

SINGLE-sideband transmission has been in use on the amateur bands for well over a year, and its theoretical advantages over a.m. and n.f.m., both in reducing QRM and its ability to "get through," have been proved in practice. Although there is room for improvement in receiver stability and selectivity, this has not proved such a handicap as it first seemed.

The greatest obstacle to greater single-sideband activity is the need for a simple and inexpensive means of converting existing a.m. transmitters to single-sideband operation. While it has been used commercially for many years, single sideband is new to most amateurs. Like any new technique, it appears complicated at first glance. However, many excellent articles¹ have appeared in *QST* and other publications, for anyone who is still unfamiliar with the basic principles.

Briefly reviewing: One basic method of producing single sideband, termed the "phasing" method, eliminates carrier and undesired sideband by employing two balanced modulators with 90-degree carrier and audio networks.² This system enables the sideband to be produced directly at the desired output frequency. While this has certain advantages, there is little assurance that the necessary high degree of phase and amplitude balance will be maintained over long periods of time. There is also difficulty in determining with simple test equipment whether the

undesired sideband has been sufficiently suppressed.

In the filter method of generating single sideband, a double sideband is first generated in a balanced modulator (where the carrier is eliminated), and the filter removes the undesired sideband by "brute force." While this method does not have the "finesse" claimed for the "phasing" method, it is positive, and requires no critical adjustments. Since the filter is a passive network, sideband suppression is not affected by other circuit variations, tube gains, etc.

Filters using only inductors and capacitors are practical only at frequencies in the order of 10 to 50 kc., and the sideband must be obtained at some low frequency and heterodyned to the desired output frequency. This is not a serious handicap, and enables the output frequency to be varied without disturbing the sideband-generating portion of the circuit. Contrary to the statement made by some, the selection of either upper or lower sideband is simple, requiring only a frequency change of one of the oscillators.

The block diagram of a practical single-sideband transmitter is shown in Fig. 1. The selection of upper or lower sideband is accomplished by switching the frequency of the second oscillator. In the notation of Fig. 1, "USB" and "LSB" indicate the position of sideband at the points noted with respect to the input speech frequencies. This is not to be confused with the particular sideband of the second oscillator that is selected by the second i.f. Careful study of Fig. 1 will make this clear.

Although not directly indicated in Fig. 1, the

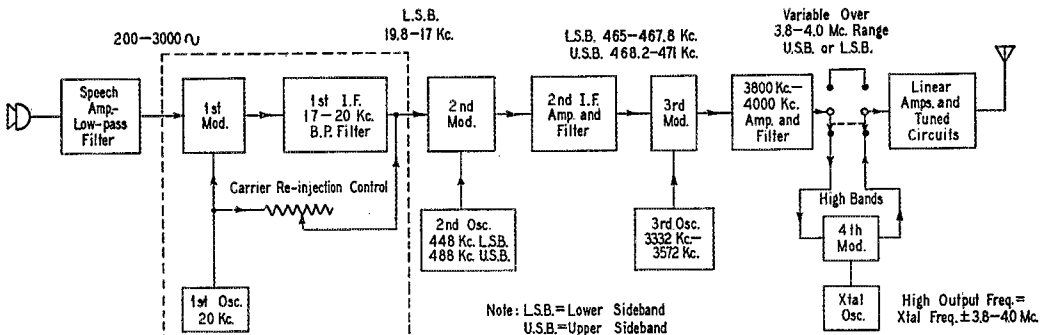
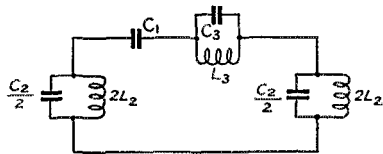

Fig. 1 — Block diagram of a typical single-sideband suppressed-carrier transmitter or exciter. The equipment inside the dashed area is described in this article.

requirements of the various filters might be briefly reviewed. The first i.f. filter must select a band of frequencies from about 19.8 to 17 kc. and have high attenuation to frequencies of 20.2 to 23 kc. (the other sideband). The second i.f. selectivity must be such that it will greatly attenuate the frequencies of the unwanted sideband generated in the second modulation process. This unwanted sideband will be removed by twice the frequency of the first i.f. (34 to 40 kc. for 17-20 kc. first i.f.). The second-oscillator frequency must also be prevented from being transmitted. A balanced modulator for the second modulator will remove most of this undesired signal but is not to be relied upon for complete elimination; therefore, the second i.f. should also have considerable attenuation at ± 20 kc. Coupled tuned circuits of conventional i.f. transformer design are satisfactory at the frequencies chosen.

The third i.f. requirements are similar to those of the second i.f. except that, with the frequencies chosen, the selectivity requirements are more lenient. It would be quite practical to employ a mixer (modulator) not of the balanced type, for the third modulator. Further notes on the complete exciter or transmitter are beyond the scope of the present article, as the first i.f. filter is considered to be more difficult to the average constructor and is deserving of full consideration.^{3, 4}



$$C_{1K} = \frac{f_2 - f_1}{4\pi f_1 f_2 R}; L_{2K} = \frac{(f_2 - f_1)R}{4\pi f_1 f_2} \quad h = \sqrt{\left(-\frac{f_1^2}{f_2 \omega^2}\right)\left(-\frac{f_2^2}{f_2 \omega^2}\right)}$$

$$C_1 = a C_{2K}; C_2 = m_1 C_{2K}$$

$$C_3 = \frac{1 - m_1^2}{4h} \cdot C_{2K}$$

$$L_2 = L_{2K}$$

$$L_3 = \frac{h}{a} \cdot L_{2K}$$

$$a = \frac{(1 - m_1^2) f_2 \omega^2}{4 f_1 f_2}$$

$$m_1 = \frac{f_1 f_2}{f_2 \omega^2} + h$$

Fig. 2 — The basic *m*-derived pi section used in the filter.

The primary purpose of this article is to describe in detail the construction of a highly-selective first i.f. filter that can be built at a reasonable cost and with a minimum of special test equipment.

³ The general technique is shown by Nichols, "A Single-Sideband Transmitter for Amateur Operation," *QST*, Jan., 1948.

⁴ In the original manuscript, Mr. Berry showed the 2nd oscillator (Fig. 1) on either 448 or 485 kc. It was changed as shown because this maintains the output (suppressed) carrier on the same frequency when transmitting either upper or lower sideband, and it is a little easier.

Filter Design

In considering the design of this filter, quality of components and desirable characteristics were of first consideration; low cost and ease of construction were achieved by selection of the type of filter sections and impedance transformations. Sharp cut-off is restricted to the high-frequency edge of the passband, concentrating the attenuation where most needed, and resulting in a mini-

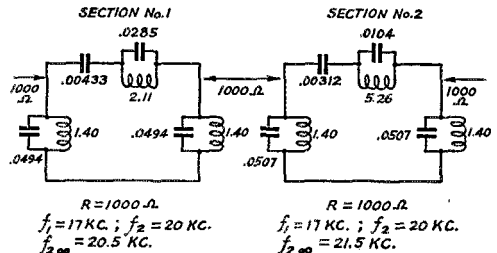

Fig. 3 — Component values of the individual pi sections of the filter. Values are in μ fd. and mh.

imum number of inductors. This filter is designed for selection of the lower sideband, but since the position of the sideband may be altered at the output of the transmitter in a succeeding modulator stage, this is no handicap.

A figure of approximately 40 db. reduction of the undesired sideband was selected as a practical value. It is believed that values much lower may tend to limit operation on the adjacent channel (when sufficiently selective receivers are in use). Values much over 40 db. would probably not be worth while even if a greater ratio were obtained at the output of the filter, because intermodulation in succeeding stages of the transmitter is likely to introduce spurious beat products of low intensity. (Note: In any single-sideband transmitter, improper amplifier bias and overloading in the linear amplifiers is to be avoided as the effect is similar to an overmodulated a.m. transmitter, with its resultant splatter.⁵)

A bandwidth of 2800 to 3000 cycles has proved satisfactory for commercial communication and is thought to be a practical one for amateur use.

A frequency band of 17 to 20 kc. was chosen in preference to one of lower frequency to reduce the selectivity requirements of the second i.f. filter, as previously noted. This rather high frequency (for a single-sideband filter) also has the feature of lower component values, lowering cost and making hand winding of the inductors feasible.

The filter consists of two *m*-derived pi sections of the type shown in Fig. 2. This type of section has one frequency of infinite rejection on the high-frequency side of the passband. By using two sections, one with the rejection frequency at

⁵ Reque, "Linear R.F. Amplifiers," *QST*, May, 1949.

20.5 kc. and the other at 21.5 kc., the resultant attenuation on the high-frequency side is quite high. When the two sections are combined, the inductors and capacitors at the junction may be combined, to reduce to five the total number of inductors in the complete filter.

The input and output impedance characteristics are the same as that of the mid-shunt constant- k type of filter of the same cut-off frequency. This sort of termination impedance is economical and works well either directly from a ring modulator or resistance terminations.

The design impedance R of 1000 ohms was selected to give desirable component values and desirable input and output impedances obtained by transformer action in the end inductors.

The resultant values calculated from the design formulas of Fig. 2 for each section are given in Fig. 3, and in Fig. 4 for the two sections combined.

To those who may wish to calculate similar filters, note that if sections are to be joined, the design impedance and the cut-off frequencies must be the same for both sections, although the frequencies of infinite attenuation may be different.

The filter of Fig. 4 might now be constructed, and if proper components are available, the insertion loss between 1000-ohm resistive impedances would be approximately that of Fig. 5. A low dissipation factor (high Q) is necessary in most of the components to obtain the required characteristics. Resistive losses internal to the filter not only will cause a greater loss at all frequencies but will "round off" the edges and prevent the rapid rise of attenuation needed just outside the passband.

Except in the case of C_1 and C_7 (Fig. 4), mica or other low-loss types of capacitors are necessary for proper filter action. C_1 , C_4 and C_7 are large values for mica capacitors and would be expensive. Ordinarily they would have to be made from a large number of paralleled units. C_1 and C_7 appear directly in parallel with the terminating resistances and it has been found that good-quality paper capacitors are satisfactory here.

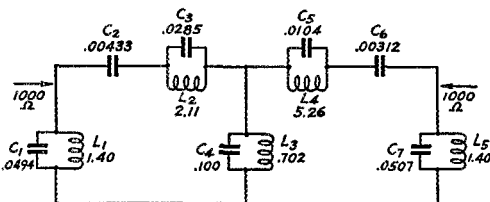

Fig. 4—Component values of the filter after combination of the parallel components. Values are in μfd . and mh.

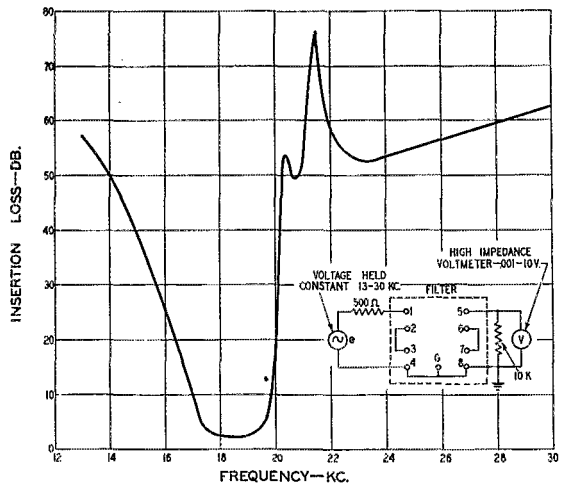

Fig. 5—Attenuation characteristic of the filter shown in Fig. 4. The test set-up diagram refers to Fig. 6.

C_4 is located internally and must be of low-loss type for best results. It is possible, however, to use impedance transformation at L_3C_4 and permit a smaller mica capacitor to be used for C_4 at the expense of a larger value for L_3 . The method of impedance transformation employed also permits a relaxation of the capacitor tolerance. Any reasonable value may be used for C_4 provided the inductor is adjusted to the correct antiresonant frequency. The correct impedance may then be regained by tapping L_3 . With inductors of high coupling between turns, the proper point of tapping is such that the inductance between common and tap is approximately that of the value of L_3 before transformation. The modification with the more desirable values is shown in Fig. 6.

Component Tolerances

In the filter of Fig. 4, the tolerance of some of the elements is quite critical, particularly that of the series arms. It has been found in the design of filters of this type that the tolerance of LC ratios is not particularly critical provided the correct resonant and antiresonant frequencies are maintained. Practically, this leads to the selection of capacitors to a tolerance of ± 5 per cent or better, and resonating each LC circuit to the correct frequency by turn adjustment of the inductor. The maximum possible error of 10 per cent in the impedance match between junctions of the filter arms is not serious. Greater tolerances will cause a "ripple" in the passband and other deviations from the desired characteristics. In following this procedure, note that the series arms of the filter have both a resonant and an antiresonant frequency, with the inductor as a common element for both. Obviously, the inductor could not be adjusted

independently for both frequencies. To permit this desired independent adjustment, a tapped-inductor arrangement is used.

Considering the series arm $C_2-L_2-C_3$, C_3 is selected with a tolerance such that it will always be larger than the calculated nominal value. L_2 may then be adjusted with this new value of C_3 to the correct antiresonant frequency and will have fewer turns than the original calculated value of L_2 . Leaving C_3 connected across the exact number of turns necessary for antiresonance, turns may be added to L_2 until the entire combination of L_2 , C_3 in series with C_2 and the added winding of L_2 will series-resonate at the correct frequency. The exact value of C_3 will set the impedance of the entire arm, and ± 5 per cent is permissible.

The series arm $C_5-C_6-L_4$ is considered and modified in the same manner.

This now leaves only four capacitors, C_1 , C_2 , C_5 and C_7 , to be selected to plus or minus 5 per cent. Each capacitor may of course be made up of two or more units in parallel if necessary to obtain the correct value.

The filter may be further modified by the addition of separate windings to L_1 and L_5 to permit operation directly from a ring modulator and into the grids of a balanced tube modulator. This adds little additional cost, and accurate balance can be easily obtained by using bifilar windings.

In the design given, an impedance of 500 ohms was selected for the input winding of L_1 , since a copper-oxide ring modulator operates quite satisfactorily into this impedance. The impedance of the output winding of L_5 is a compromise between desired voltage step-up and keeping the number of turns to a value that permits hand winding. The completed filter design after all modifications is shown in Fig. 6. In the event other input or output impedances are desired, the number of turns and method of connection of these added windings may be altered to

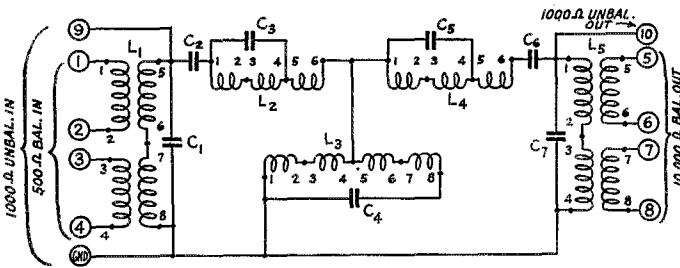

Fig. 6 — Revised filter of Fig. 4, with provision for balanced or unbalanced input and output.

- C_1 — 0.049 μ fd. $\pm 5\%$, paper.
- C_2 — 0.0043 μ fd. $\pm 5\%$, mica.
- C_3 — 0.03 μ fd. + tol., mica.
- C_4 — 0.03 μ fd. $\pm 20\%$, mica.
- C_5 — 0.011 μ fd. + tol., mica.
- C_6 — 0.0031 μ fd. $\pm 5\%$, mica.
- C_7 — 0.051 μ fd. $\pm 5\%$, paper.
- L_1 (1-4) — 0.7 mh., 33 turns No. 26, bifilar.
- L_1 (5-8) — 1.4 mh., approx. 47 turns No. 26, bifilar.
- L_2 (1-4) — 2.0 mh., approx. 80 turns No. 26, bifilar.
- L_2 (5-6) — 0 to 20 turns No. 26, single.
- L_3 (1-4) — 0.7 mh., approx. 47 turns No. 26, bifilar.
- L_3 (1-8) — 2.3 mh., approx. 86 turns No. 26, bifilar.
- L_4 (1-4) — 5.0 mh., approx. 125 turns No. 26, bifilar.
- L_4 (5-6) — 0 to 20 turns No. 26, single.
- L_5 (5-8) — 14.0 mh., 160 turns No. 28, bifilar.
- L_5 (1-4) — 1.4 mh., approx. 47 turns No. 26, bifilar.

All wire Formvar or d.s.c. — see text.
 L_1 and L_5 wound on Western Electric P476930 core ring.

L_2 , L_3 and L_4 on Western Electric P284395 core ring.

$$\text{Approx. turns P476930} = 1000 / \sqrt{\frac{164}{L}}$$

$$\text{Approx. turns P284395} = 1000 / \sqrt{\frac{79}{L}}$$

Inductor	Resonant Frequencies	
	Capacity	Freq., kc.
L_1 (5-8)	C_1	19.1
L_2 (1-4)	C_3	20.5
L_2 (1-6) with C_3 connected	C_2	19.1
L_3 (1-4)	0.1 μ fd. $\pm 5\%$	19.0
L_3 (1-8)	C_4	19.0
L_4 (1-4)	C_5	21.5
L_4 (1-6) with C_5 connected	C_6	18.9
L_5 (1-4)	C_7	18.9

meet the requirements. Since the impedance varies directly with the inductance of the windings (with 1.4 mh. the inductance for 1000 ohms impedance), the required inductance in millihenrys for any new impedances may be found by dividing the new impedance in ohms by 1000 and multiplying the result by 1.4. The number of turns required can be found from the formulas for the inductors given in Fig. 6.

Filter Alignment

As has previously been mentioned, the LC combinations must be resonant at the desired frequency. In an m -type filter with closely-spaced rejection frequencies, it is very important to hold to very close frequency tolerances; while a constant error is not serious the spacing of one frequency to the next is critical.

Heretofore, it has been considered necessary to use expensive laboratory equipment, which is out of the reach of many. Signal generators for the range of 15 to 30 kc. are not common, and those available are usually not of sufficient accuracy. However, with the aid of a BC-221 frequency meter the main obstacle has been removed. The fundamental frequency range of the low band of the BC-221 is 125-250 kc., and it has sufficient output voltage to give a reasonable indication on most oscilloscopes. The BC-221 is used only as a calibration means for the test signal generator. The test generator may easily be made from the junk box, and the usual calibration problem

solved by the BC-221. In fact, good procedure is to use only a rough calibration and use the BC-221 continuously for frequency set. The method of connection of the frequency-check system is shown in Fig. 7. The oscilloscope vertical and horizontal inputs are used to give the familiar Lissajous figures as a means of comparing frequencies. Since most of the frequencies needed from the test generator are one-tenth that of the BC-221 it is convenient to use the chart calibration points for 125-250 kc. By moving the decimal point one place to the left and obtaining a 10:1 Lissajous pattern on the oscilloscope the frequency may be read directly. Other multiples must, of course, be used for some frequencies.

An LC-type signal generator is recommended for best stability, and particularly if one has to be constructed.

A method of resonating that gives accurate results is shown in Fig. 7. This method measures all LC combinations as a series-resonant circuit. With the LC combination connected as shown, a sharp dip in amplitude occurs when the frequency is at the exact series-resonant point, since the impedance is then a minimum. Although not critical, R of Fig. 7 should be the smallest value that will still give a readable indication. When an entire series arm is resonated the dip will not be as great but will be very sharp.

Coil Construction

In selecting inductors for the filter, the Q is of primary importance. Q values of at least 150 are necessary for all inductors except possibly L_1 and L_5 . L_1 and L_5 , as in the case of C_1 and C_7 , are in parallel with the terminations, and losses here have much less effect. While many types of inductors might be used, the toroidal type has many advantages and core rings of molybdenum Permally are now available to the amateur.

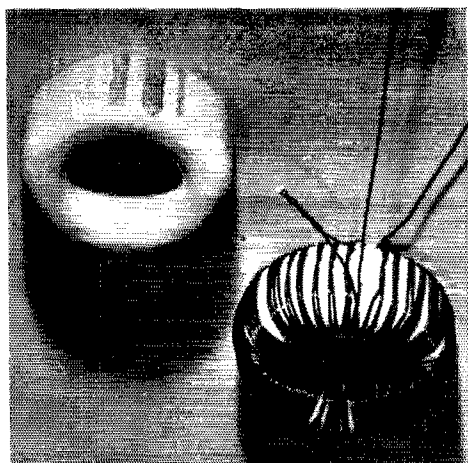

A finished toroid coil of the type used in the sideband filter. An unwound core is shown at the left.

Toroidal coils of this material are small in size and have a very low external field, and the inductance remains quite constant with power level and temperature. The coupling between turns is high, so that leakage reactance may be neglected in the design of the built-in transformers and tapped coils. The one disadvantage of using toroidal coils is the difficulty of winding, since the wire must be threaded through the core. However, in this filter special attention was given to keeping the inductances low, and winding is not too difficult. Two different grades of core material were used in the inductors for the filter of Fig. 6 (attenuation characteristics shown in Fig. 5).

Inductors L_2 , L_3 and L_4 use cores having an effective permeability of 60, producing Q s of 200 to 250 at 20 kc. L_1 and L_5 cores were of 125 permeability, reducing the required number of turns and still permitting Q s of over 100. The construction data in Fig. 6 give the approximate number of turns of the inductors when using Western Electric core rings P476930 for L_1 and L_5 , and P284395 for L_2 , L_3 and L_4 . P476930 and P284395 have nominal inductances of 164 and 79 millihenrys respectively per 1000 turns. The approximate number of turns for a specified inductance, as given by the manufacturer, is found by the formulas given in Fig. 6.

Since a tolerance is allowed on the capacitors, and the permeability of the cores varies slightly, the exact number of turns will vary and must be determined by measurement. For this reason sufficient length of wire should be allowed for the windings so that the additional number of turns necessary may be found by test. The extra length of leads will not

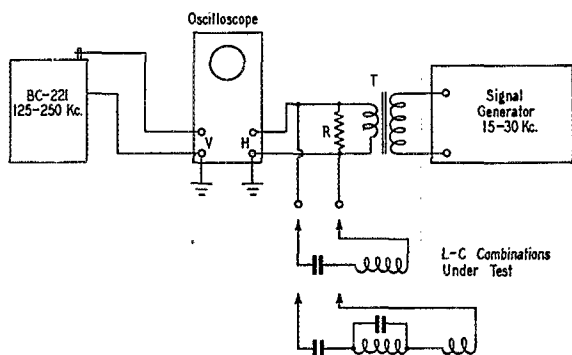

Fig. 7—The method used for checking coil-and-condenser combinations. An accurate frequency check is obtained by using a BC-221 to check the 10th harmonic of the test signal generator. The LC combination under test is adjusted for minimum horizontal amplitude at the desired frequency.

R—1 to 10 ohms, ½ watt. See text.

T—Step-down transformer. A 500-to-6-ohm audio transformer is suitable with generator outputs of 500 ohms or less.

affect the test, and these leads may later be cut to proper length after the correct number of turns has been determined.

Wire size is not critical and deviation from that given in Fig. 6 may be made if winding area does not limit. "Formvar" insulation, or the equivalent, is recommended and is easy to wind, but single silk or nylon is satisfactory. Plain enamel not of the Formvar type is to be avoided, because of the possibility of shorted turns.

In order to reduce the number of times the wire must be threaded through the core ring, all windings are bifilar except the adjustment windings 5-6 of L_2 and L_4 . In the bifilar type of winding, two wires are held together and wound as one. After winding, the start of one wire (3) may be connected to the finish of the other (2), thus connecting the two in the series-aiding manner. As in telephone practice, the numbering of

wire in the core ring, and then winding in opposite directions through the core ring respectively with each end of the bifilar wire. The wire should be evenly distributed around the core ring, but this is not particularly critical.

The following procedure for proper identification and labeling of bifilar windings may be used: Select one of the ends of the completed winding and arbitrarily label them 1 and 3. Now by use of an ohmmeter, locate the wire at the opposite end of the winding which checks continuity to "1." This of course will be "2" and may be spliced to "3." With the exception of the input and output winding of L_1 and L_5 , the free wires, 1 and 4, may be left long and any additional turns necessary may be obtained by winding on singly, with care that the wire continues through the core in the same direction.

The bifilar windings 5-6 and 7-8 follow the same procedure. However, when two windings are to be series-connected such as 1-2, 3-4 and 5-6, 7-8, care must be taken in selection of the end of winding to label 5, 7. The proper labeling is such that the wire ends 5, 7 pass through the core center in the same direction as the wire ends 1, 3.

The input windings of L_1 (1-4) and output windings of L_5 (5-8) are not critical in inductance and may be wound first to the specified number of turns. If desired, a layer of tape may be applied over these windings before application of the second windings.

L_3 (1-4) is wound and resonated with a 0.1- μ f. test capacitor to 19.0 kc. Adjust to the nearest turn that produces resonance closest to the exact frequency. C_1 and C_7 may be paralleled and used temporarily for the test capacitor. The second winding of L_3 (5-8) is now applied and series-connected with the inner winding, 1-4. Turns are adjusted to secure resonance with C_4 at 19 kc. No connection is made to the tap during adjustment. Note that wide tolerances on C_4 are allowed and the exact number of turns of L_3 will depend on this tolerance.

L_1 (5-8) and L_5 (1-4) are wound and resonated with their associated capacitors, C_1 and C_7 .

L_2 (1-4) is now wound and resonated with C_3 . As previously mentioned, the value of C_3 may vary over a wide range (plus tolerance), and will determine the number of turns of windings 1-4. Note that the total number of turns for L_2 , including adjustment winding 5-6 depends only on the exact value of C_2 . Thus if C_3 is large, winding 1-4 will have fewer turns, and 5-6 will have more. After resonating C_3 connect it in parallel with windings 1-4 and the combination in series with

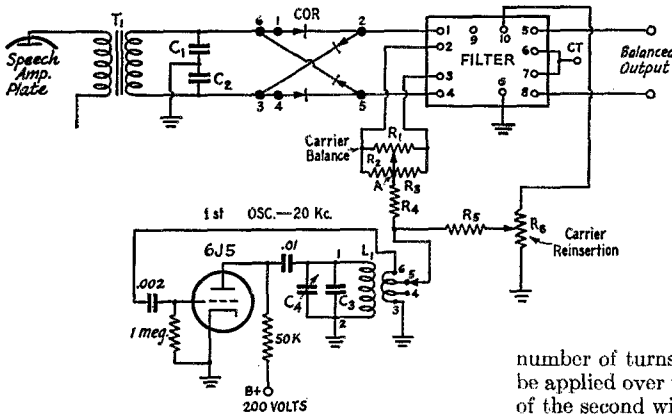

Fig. 8 — A suggested circuit for the 20-kc. oscillator and balanced modulator to be used with the filter.

C_1, C_2 — 0.05- μ f. $\pm 20\%$, matched to within 1% by trial.

C_3 — 0.01- μ f. silver mica.

C_4 — 200- μ f. variable or adjustable.

R_1 — 5000-ohm potentiometer.

R_2, R_3 — 150 ohms, $\frac{1}{2}$ watt.

R_4 — See text.

R_5 — 3000 to 5000 ohms.

R_6 — 1000-ohm potentiometer.

L_1 — 284 turns or 142 bifilar, No. 26 Formvar or s.s.c., for coil 1-2. Coil 3-6 is 40 turns of same tapped every 10 turns. Both coils are wound on the same W.E. P284395 core ring.

COR — Copper-oxide modulator (Varistor). See text.

T_1 — Output transformer, plate to 500 ohms.

windings connected for series aiding is such that the direction of current at one instant is from 1 to 2; 3 to 4; 5 to 6; etc. Thus if 2 and 3 and 4 and 5 are connected together and external connections are made to 1 and 6, the windings are series-aiding.

In winding, the length of wire to be pulled through for each turn may be halved by starting at the center of the bifilar (doubled) length of

C_2 . Check the resonant frequency of the entire series arm, less winding $5-6$. It should be higher than the frequency as given in Fig. 6. Now, wind turns on for the trimming winding $5-6$, and, with it connected, recheck the resonant frequency. Adjust turns of $5-6$ until correct frequency is obtained. In the event that the resonant frequency was lower than the correct value before the addition of $5-6$ it is an indication that C_2 was too low; and the entire adjust-and-check procedure must be repeated with a larger value for C_2 .

L_4 is now wound and resonated with C_5 and C_6 following the same procedure as for L_2 , C_3 , C_2 .

The filter may now be wired temporarily for test before mounting. The method of connection for test is shown in Fig. 5. While a sensitive voltmeter or decibel meter of high impedance is necessary for accurate measurement, an oscilloscope may be used instead for an approximation. If the filter is flat through the passband and attenuates rapidly on the high side it is likely that no errors have been made. If the oscilloscope gain is adjusted for full deflection at the center of the passband, the deflection at points above about 20.4 kc. should be barely visible if at all.

The mounting of the components will be left to the builder, but it is to be noted that the inductors may be mounted very close together and near metal surfaces without harmful effect, with the possible exception that L_1 and L_5 should be given some separation from one another. A metal screw may be used through the center of an inductor without harm provided it does not constitute a shorted turn, as it would if metal washers were used on both sides and the washers connected together.

A suggested schematic using the filter is shown in Fig. 8. The speech amplifier should feature low- and high-frequency cut-off as with any 'phone transmitter. Some high-frequency attenuation may be obtained by the action of the secondary of T_1 with C_1 , C_2 . It is well first to run a frequency-response check on the speech amplifier including T_1 , C_1 , C_2 with the modulator disconnected and a 500-ohm resistor substituted.

The 20-kc. oscillator shown uses a toroidal inductor. Other types of oscillators will perform satisfactorily if the output impedance is held low. The number of turns of inductor L_1 and value of C_3 may be adjusted for proper frequency using the BC-221 and the proper feed-back adjusted by the secondary winding $3-4-5-6$. The taps on this winding are desirable to adjust the voltage at the junction of R_2 , R_3 from 2 to 5 volts. Selection of 100 to 500 ohms for R_4 also permits some adjustment. R_5 should be as high as possible for least loading on the oscillator and filter, still permitting enough 20-kc. output for any desired amount of carrier reinjection.

One point not obvious is that R_2 and R_3 with R_1 in parallel are actually in series with the input to the filter. The values chosen normally

give a good impedance match between the modulator and filter. If 1N34s or vacuum tubes are used instead of copper oxide for the modulator, a resistor may have to be placed across filter terminals 1 and 4, and R_2 and R_3 lowered in value. Proper match may be noted when audio is fed into the speech amplifier and varied from 200 to 3000 cycles. If the speech amplifier has previously checked flat, the output from the filter at terminals 5 and 8 as measured with a voltmeter or noted by the oscilloscope should vary as the response through the filter alone with frequencies of 19.8 to 17.0 kc. A ripple in output amplitude indicates incorrect modulator match.

Copper-oxide "Varistors" available in surplus, which have proven satisfactory with the values given, are Western Electric D162258, D163139 and D98914. The terminal numbering given for "COR" of Fig. 8 is for these types.

Modulator balance for maximum carrier reduction is normally quite simple. A sensitive voltmeter or oscilloscope is connected to output terminals 5 and 6. With no input to the speech amplifier and R_5 turned for minimum carrier, adjust the carrier balance control R_1 for minimum output.

Balance should be obtained near the center of the adjustment range. If not, a trimming resistor may be paralleled with R_2 or R_3 . Some capacity unbalance in the Varistor or input winding of the filter may prevent sufficient carrier balance and small values of capacity may be added from filter terminal 1 or 4 to ground. Capacity may also be tried across C_1 or C_2 .

Note that any hum in the speech amplifier will appear as an output carrier, but of course will be 60 or 120 cycles from the true carrier. Hum may be identified by temporarily shorting the primary of T_1 .

Audio is now connected to the input of the speech amplifier and the level adjusted to a maximum of 0.25 volt at the output of T_1 .

If the output of the speech amplifier is a pure tone the output of the filter should be a single frequency of 20 kc. minus the audio frequency. Using a sweep rate that is a submultiple of the audio input frequency, a check may be made for the presence of a modulation envelope. Such a trace represents more than one frequency in the output and may be caused by distortion in the speech amplifier or overloading of the modulator. A slight modulation pattern is permissible as this represents only a slight distortion of speech and not spurious signals out of the passband.

The modulator is now ready to be connected to the succeeding stages of the exciter.

**SWITCH
TO SAFETY!**



The V.H.F. Sandwich

Stacked Arrays for 50 and 144 Mc.

BY EDWARD P. TILTON,* WIHDQ

Not so long ago anyone with a 3- or 4-element beam on a v.h.f. band really had something. His signal stood out like a beacon over the best efforts of the stations equipped with various forms of dipoles. But times have changed, and so have fashions in v.h.f. antennas. The possessor of a 4-element array now just about breaks even with his fellows, for nearly everyone has found that the erection of a rotary array for 6 or 2 meters presents no insurmountable problems.

The arrangement of a few parasitic elements in the proper physical relationship to the driven dipole does work wonders, but the simple parasitic array fails in one respect: it does not materially lower the *minimum* angle of radiation.¹ Since grazing the horizon is nearly always our objective in v.h.f. work, we can add miles to our coverage if we can pull our radiation angle down a few degrees. This can best be accomplished with stacked systems, wherein arrays are mounted one above the other and fed in phase.

The stacked array shown in the accompanying photograph was installed at WIHDQ to see just what improvement could be effected with such an arrangement. At points where we were already

consistently readable the change was not spectacular, but the stacking really paid off on the more difficult paths. The 50-Mc. signal of W1CGX, Brattleboro, Vt., for instance, had been barely audible on c.w., and never readable on voice, with the former 4-element array. With the 4-over-4 providing just about its theoretical 4-db improvement, Ray became readable 90 per cent of the time on 'phone, and a nightly schedule instituted the first evening the 8-element array was up on the tower has never failed, in more than a month of operation.

The 2-meter job, erected primarily to see what could be done with horizontal polarization in the vertical East, is not a big array, as 144-Mc. antenna systems go, but we just couldn't see that nine feet of pipe between the two 6-meter bays going to waste. Thus far it has been useful principally for DX attempts when the band is open, but a contact with Western New York and heard reports from as far away as southern Virginia, during a recent aurora opening, are marked up to its credit.

Mechanical Details

The structure incorporates all-metal design. Booms for the 50-Mc. section are 1½-inch 24ST tubing. Elements are ¾-inch tubing of the same alloy, forced through holes in the booms. Element spacing is 0.2 wavelength for the directors and 0.15 for the reflector. These somewhat smaller dimensions than were used in the 4-element system described by the writer previously in *QST* and the *Handbooks* were decided upon in order to reduce the size, weight and wind resistance of the stacked system. The booms are mounted on the vertical member (a 1½-inch o.d. pipe) by means of blocks of wood, the only nonmetallic parts employed. These were made from pieces of two-by-four one foot long. A hole the size of the mast is made in the block near one side, at the middle of the block lengthwise. The block is then sawed lengthwise in a vertical plane, through the middle of this hole. Bolting the two portions together provides a tight fit around the vertical pipe. The



A "four-over-four" array for 144 Mc., mounted between the bays of a similar array for 50 Mc. Stacking of two bays a half wave apart lowers the radiation angle appreciably below that obtainable with elements in a single plane, and nets a gain of about 4 db. over that of a single array.

QST for

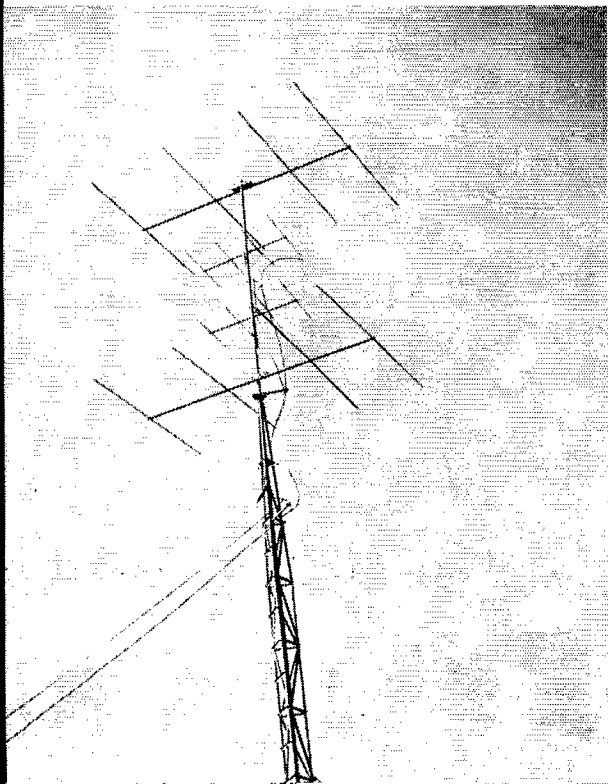

* V.H.F. Editor, *QST*.

¹ "Parasitic Array Patterns," Gillson, March, 1949, *QST*.

boom is bolted to the block at three points. This method of mounting provides a rigid assembly. The booms should be bonded to the main support to provide lightning protection.

The 2-meter array employs somewhat similar design but uses smaller components, because of its lower weight. Booms are of one-inch tubing, and elements of $\frac{1}{8}$ -inch, mounted through the booms, as with the 6-meter assembly. The booms are mounted through the vertical member, which is $1\frac{1}{2}$ -inch tubing. As the vertical support for the 6-meter array takes quite a bit of strain, it was thought inadvisable to make holes through it, so the 2-meter array was fastened to the main pipe with a pair of "U" bolts. This has the advantage of making the smaller array a completely separate assembly, which can be detached from the main stem at will. Element spacing is 0.2 wavelength throughout.

The Feed Systems

The same principle is used in the feed arrangement of both arrays, but it is worked out in a slightly different manner. The bays are a half wave apart, with the feeder connected at the midpoint between the two, the phasing line operating as a double "Q" section in each case. Folded-dipole radiators are used in the 6-meter array, while a "T" match was used in the 2-meter one. There is, of course, no reason why the same system could not have been used in both.

The main transmission line for each array is 300-ohm Twin-Lead, the heavy-duty tubular type being used on the 6-meter portion. In each case the method of feed was checked out for minimum standing-wave ratio with one bay alone; then the phasing section for the two bays was proportioned so that it would serve as a "Q" section as well. Dimensions are given in the accompanying table. The feedlines are brought at right angles from the phasing sections to stand-off insulators on the main vertical support. They drop vertically to a combination tie point and bearing, just below the lower boom of the 6-meter array. From this anchor, which rotates with the beams, they drop loosely to a fixed tie point, with enough slack left to permit slightly more than 360 degrees of rotation.

The fed sections of the 50-Mc. folded dipoles are made of $\frac{3}{16}$ -inch copper tubing, mounted on $\frac{1}{8}$ -inch cone stand-offs. The outer ends are supported on metal pillars of the same length. Two stand-offs are used for each side of the dipole; otherwise the rather soft tubing tends to sag and disturb the spacing between it and the larger element. The copper tubing is flattened in a vise at the points where it is to be mounted. The 4-to-1 conductor ratio, and the spacing of one inch, center to center, between the two conductors gives the necessary impedance step-up to match 300-ohm line, in a 4-element array of the spacings mentioned earlier.

A similar arrangement might have been used in the 2-meter array, but the "T" match was substituted for variety, and because a suitable conductor ratio was not so practical with the smaller-sized elements used. Adjusting clips for the "T" section were made from grid clips slipped over the respective elements and soldered together in such a position as to give a spacing of about $1\frac{1}{4}$ inches, center to center. A one-inch ceramic stand-off was used on each section, to hold the "T" section in alignment with the main element. The phasing section is the same as in the larger array: No. 12 wire spaced one inch. The point of connection between the "T" section and the dipole turned out to be approximately 5 inches from the center, but this should be adjusted for minimum standing-wave ratio.

Dimensions of the 6- and 2-Meter Stacked Arrays, in Inches

	Radiator	Reflector	1st Director	2nd Director
50 Mc.	110	116	105	103
144 Mc.	38	40	36	35 $\frac{1}{4}$
	Phasing Line	Reflector Spacing	Director Spacing	
50 Mc.	114	34	46	
144 Mc.	39 $\frac{1}{2}$	15 $\frac{1}{4}$	15 $\frac{1}{4}$	

It will be noted that the dimensions given in the table are strictly conventional. Actually the elements in one of the 6-meter bays were made adjustable, just to check on the figures we'd obtained in several previous beam workouts. Adjustments were made carefully for maximum forward gain, but the lengths came out so close to formula dimensions that we once more came to the conclusion that tuning of elements for forward gain is a waste of effort, when spacings of this order are used and the antenna is mounted in an average clear position.

~~to~~ Strays

To the Compilers of the Antenna Book

To beam, or not to beam,

That is the question.

Whether it be better to try a newborn quad,

With shorted stubs a-dangling on the sod,
Or flat-topped jobs, with T-match all complete,

With all dimensions changed from wavelengths
into feet.

Aye. There's the rub.

Whether to discard the good delight of
plumbers,

That's served us well these happy postwar sum-
mers,

For something that we wot not of.

Whose crucifix of oregon may yet transfix

Our puny hopes of working rare DX,

And wake; to find in our more saner spells,

We've lost an awful lot of useful decibels.

— ZS5HX in "Radio-ZS"



The World Above 50 Mc.

CONDUCTED BY E. P. TILTON,* WHDQ

AURORA DX openings, like oysters, are best in months with an "r," and April, 1949, was one of the best. The aurora session of the 7th was probably the best of this species yet to be experienced by 50-Mc. men, and it produced a flurry of 144-Mc. contacts as well. Again on the 12th, coincident with an eclipse of the moon, both bands were open. Both occasions found quite a few operators on 144 Mc. blissfully unaware that anything unusual was going on, so that those who were on the alert were not able to make too many contacts. Work by means of aurora reflection probably does not present much chance of breaking the existing 144-Mc. record, but it does offer an unparalleled opportunity for working into sections of the country on both 6 and 2 meters that are otherwise out of reach. More important, aurora DX is possible from almost any location, leaving the fellows having exceptionally good radio locations without their customary advantage.

By the time that this material appears in print the spring aurora period will be largely past, but openings can happen any time. So let's be on the lookout for them, and be ready to get in there, with c.w., when opportunities break. Some new states and call areas may be worked if we play our cards right. It is probable that 144-Mc. openings occur more often than we have previously supposed, and our slowness in recognizing the presence of this form of DX on 2 may be charged to our fairly recent, and still only partial, conversion to c.w. technique on this band.

Moving our lowest v.h.f. band from 56 to 50 Mc. made possible a few aurora contacts on voice, the character of the signals approaching that heard on 28 Mc., but experience on 144 Mc. to date has indicated that c.w. is the sole medium by which DX contacts are possible on the higher band. Signals take on a quality best described as "an intermittent roar superimposed on a steady one," and the sound is changed hardly at all when the h.f.o. is turned on or off.

Neither of the dates mentioned above provided any appreciable amount of visible aurora in most locations, yet the 50-Mc. opening of the 7th lasted for at least four hours, and signals were of good intensity. The 144-Mc. signals were in only when the phase-distortion effects were most pronounced on 50 Mc., but even 2 was open for an hour or more.

* V.H.F. Editor, QST

Double Hop on 6—Es Reported on 144 Mc.!

The 50-Mc. band was open for more than 12 hours on May 4th, part of the time for transcontinental work between W7CAM and numerous W1s. All call areas but W6 were heard along the East Coast, in the earliest opening of its kind in 50-Mc. history.

What may be the first authentic instance of sporadic-E skip on 144 Mc. is reported by W4HHK, Collierville, Tenn., who heard W7FGG, Tucson, Ariz., at 12:50 p.m. EST. Confirmation was obtained by telephone immediately after the reception, when an attempt at two-way contact on 144 Mc. failed.

The spring 50-Mc. sporadic-E season officially got under way on April 27th, raising again the specter that has haunted this department through all its ten-year history — that of a series of major band openings, each occurring on the 27th of this month, from April to August, necessitating a major rewrite of our introductory paragraphs.

The coincidence of aurora effect over the northern half of the country and an opening to South America showed up again on the 7th. While aurora contacts were being made on 50 Mc. all the way from Maine to Washington, W5OTU, Brownsville, Texas, W5UW, Missouri City, Texas, and W4IUJ, West Palm Beach, Fla., were working HC20T, at Guayaquil, Ecuador.

Around the World on 6 and 2

Watertown, S. D. — The aurora opening of April 7th provided the missing link in the 50-Mc. WAS chain for Stan Burghardt, W0BJV. Nebraska has been a stumbling block for a number of the 6-meter gang in Minnesota and South Dakota who have been on the verge of WAS for nearly a year. Activity in Nebraska was slight, and the distances were long for extended ground wave and short for sporadic-E skip. W0DNW, North Platte, was the hero of the occasion for W0BJV. Stan had 47 cards waiting, and the Nebraska QSL came through promptly, so W0BJV becomes the second man to have an authentic 50-Mc. WAS. His special certificate, prominently labeled "Award Number Two," is on the way as we write. W9QUV, Moline, Ill., is having QSL trouble, but he is expected to be in line for Number Three.

Canton, Conn. — April 7th was a big date for your conductor, too. Hearing W1, 2, 3, 4, 8 and VE3 roaring (and we do mean roaring) in on 6

we called W8WSE, who was known to have a big 2-meter beam. Would he listen on 2? You bet — so over to 144-Mc. c.w. at W1HDQ. No result with Mike, but a "CQ DX" raised W2RPO, North Tonawanda, N. Y., for our first 2-meter aurora QSO. Other aurora signals could be heard, but Ralph was the only one on c.w. Next day, however, came a heard report from W4IKZ, Lynnhaven, Va., whom we missed because of failure to tune the high end. Shame!

W2RPO reported hearing and calling W9JMS and W8WSE, without result. W8WSE never did hear W1HDQ, but he worked W9FVJ, Toledo, Ill., and heard W9JMS. W4IKZ heard no other aurora signals than W1HDQ, though he listened on both horizontal and vertical for the duration of the opening. All the above contacts were made with horizontal polarization. It is believed that some work was done with vertical also, but we do not have details. This aurora business on 144 Mc. is still very much news, and we know very little about it. If you hear or work anything by this medium on 144 Mc. be sure to let us have the full story.

Winthrop, Mass. — Activity low on 6? Not at W1DJ! Arthur, whose hamming covers a span of nearly 50 years, 17 of them on v.h.f., took time out recently to pull some activity figures from his 1948 logs. During the year 2138 50-Mc. contacts were made, of which 523 were in connection with net activities, leaving 1615 individual QSOs. This is what comes of having two licensed operators in the family. Martha, W1OIR, is also an avid 50-Mc. enthusiast.

Bremerton, Wash. — If you've missed the call of W3CIR/1, now no longer appearing in his comfortable spot near the top of the states-worked-on-50-Mc. list, look for it to reappear as W3CIR/7. Ed is working on 6 from Bremerton, and though his states-worked listing would be 2 at this writing we have no doubt that things will be different after May.

Monterrey, Mexico — After having frequent trouble with 6-meter operators who could not handle the code, XE2C got a modulator going, and will be making plenty of contacts with Ws this spring and summer. His location is 175 miles west of the southern tip of Texas, so he should be in a better position to work much of this country than the XE1s down in Mexico City. He had numerous contacts with South American stations, and one opening to W5, in late March and early April.

Sheridan, Wyo. — Probably not many outside Wyoming have worked this state on 144 Mc., but the total will be swelled if W7JRG has his way. After working W7GBI, W0DNW and W0BJV for three new states on 50 Mc. by the aurora route, Ken is looking forward to doing the same on 144 Mc. He has a 24-element array (originally vertical, but being changed over to horizontal), and 80 watts to a 3E29 on 144.288 Mc.

Huntington, L. I. — Two-meter men who want to put on fairly high power are overlooking a good bet in the 826 tubes, now available at ridiculously low prices on the surplus market, says W2GPO. Puss is running 600 watts to a pair of 826s, in the amplifier shown in the accompanying photograph. The layout is unconventional, but effective. The tube sockets are mounted on edge, by means of hook bolts made from ordinary machine screws, and are maintained in alignment by stiff rods connecting the filament terminals. The grid circuit is a tuned loop of wire, and the plate tank

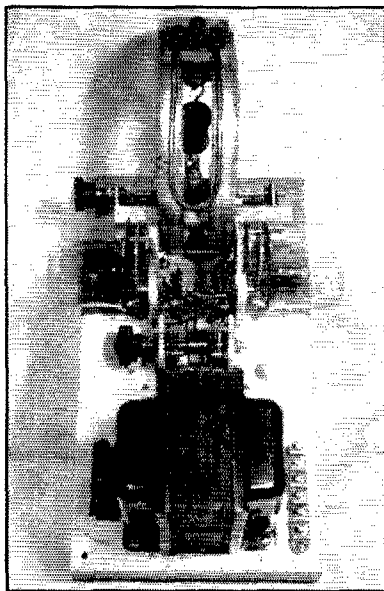

With this amplifier of unusual design, W2GPO is able to run 600 watts input on 144 Mc. Final tubes are 826s, mounted in a horizontal position. An electric fan is turned on the tubes and tank circuit for forced-air cooling. See text for further details.

is $\frac{3}{4}$ -inch silver-plated copper, bent into a semi-circular shape. This is also condenser-tuned, so that the position of the shorting bar is not changed in the course of ordinary adjustments. Neutralizing condensers are pieces of aluminum mounted in the two top socket holes on each side.

Initial experiments with this amplifier showed that far beyond the normal tube ratings could be run, but the tank circuit ran very hot. Larger tubing, plus a blast of air from a small electric fan, took care of this. Plate current is 400 ma., at 1600 volts. The driver is an ARC-5, with 400 volts on the 832-A. This provides 40 ma. grid current, at 140 volts bias, in the 826s. Grid resistor is 3500 ohms.

Clacton, Essex, England — The 50-Mc. openings between England and South Africa which began in late March continued well into April, crossband contacts being made between G6DHI

on 28 Mc. and ZS1P on 50 Mc. on April 5th and 11th. The path was also open for brief intervals on the 6th. Excerpts from G6DH's report follow: "As on many past occasions the days of high southerly m.u.f. found conditions disturbed over paths involving transmission through the northern auroral zones, and m.u.f. for these paths was apparently far below normal. It is difficult to say whether this is actually a case of low m.u.f., or whether it is due to absorption (and/or reflection at shorter distances) by regions lower than f_2 On two occasions when ZS1P was receivable on 50 Mc. at G6DH it was found that no other signals could be heard above 37 Mc., yet several signals up to 45 Mc. are known to be receivable under suitable conditions. It appeared that reception was limited to a comparatively narrow band from the m.u.f. down. . . . ZS1P says that this effect is often noticeable in TV reception from England. Generally either the video on 45 Mc. or the sound on 41.5 Mc. is receivable with good strength, but seldom are both simultaneously good." G6DH also points out that southerly m.u.f. reaches 50 Mc. more often than was formerly supposed; that 50-Mc. contacts might have been possible with South Africa on many occasions in the past when observers have given up simply because the highest signals they heard were about 38 Mc.

Guayaquil, Ecuador — The 50-Mc. band was open for HC2OT to W5 on March 26th, 30th, April 3rd, 7th, 15th and 17th, and W4IUIJ was worked on the 7th for Steve's first Florida contact. Mexico was worked on March 26th, 29th, 31st, April 2nd, 7th, 15th, 17th and 20th; Venezuela on March 27th and 29th; Argentina on March 30th, April 4th, 5th, and 17th; and Chile on March 29th and 31st. KZ5NB and TI2AFC have both been heard, but are not yet added to the countries-worked column, which stands at 10. Steve is still looking for a W3 for 50-Mc. WACA.

Shawnee, Okla. — Here's one which didn't quite make last month's news: W5GNQ had a solid QSO with LU6DO on March 30th, at 8:20 p.m. CST. Avery is still running only 15 watts input on 6.

Sharon, Pa. — The Mercer County Radio Association will conduct an expedition to a 4760-foot elevation in the Allegheny Mountains, 15 miles from Elkin, W. Va., for the June V.H.F. Party on the 4th and 5th. The Mountaineer Radio Association of Fairmount, W. Va., is joint sponsor of this project, and will furnish their 10-kw. emergency generator for power. The call will be W3CJB/8. Power is to be 100 watts on 144.15, 145 and 146.8 Mc., as well as several frequencies in the 6-meter band.

Pukinmäki, Finland — A few Finnish amateurs are now in business on 144 Mc., according to OH2PK, who is working with 2NY, 2NV, 2OK and 2OL. On 50 Mc., with temporary per-



Standings as of April 25th

W9ZHB	48	W5AJG	43	W9ZHL	46
W6ZJB	48	W5ML	42	W9DWU	46
W9QUV	48	W5VY	40	W9PK	43
W6BJV	48	W5HLD	40	W9JMS	43
		W5JLY	40	W9ALU	42
W1CLS	44	W5FRU	38	W9QKM	41
W1LLL	40	W5FSC	37	W9RQM	38
W1HDQ	39	W5DXB	35	W9UTA	37
W1CGY	39	W5ZZF	34	W9AB	26
W1LSN	37	W5GNQ	32		
W1HMS	36	W5JBW	32	W6USI	47
W1JLK	35	W5IOP	30	W6QIN	47
W1NF	35	W5LTU	24	W6DZM	47
W1KHL	34	W5LWG	19	W6NFM	46
W1DJ	30			W6CJS	45
W1ATP	30	W6UXN	47	W6KYF	44
W1AF	29	W6OVK	40	W6INI	43
W1EIO	25	W6ANN	38	W6KPK	42
W1HIL	21	W6BPT	35	W6TQK	42
		W6AMD	35	W6SV	42
W2BYM	39	W6LWS	37	W6HXY	41
W2IDZ	39	W6FPV	31	W6YUQ	39
W2AMJ	38	W6BWG	18	W6JHS	38
W2RLY	38			W6PKD	36
W2QVH	37	W7BQX	45	W6GSW	29
W2RGV	26	W7ERA	43		
		W7DYD	41	VE3ANY	33
W30JU	39	W7HEA	40	VE1QY	28
W3OR	35	W7FDJ	36	VE1QZ	28
W3RUE	34	W7FFD	35	XE1KE	23
W3MKL	33	W7KAD	35	VE4CQ	20
W3MQU	27	W7JPA	35	VE3AET	16
		W7QAP	32	HC2OT	16
W4EQM	43	W7JRG	31	XB2C	14
W4QN	40	W7ACD	28	VE2GT	14
W4G1Y	40	W7JPN	19	XE1QE	10
W4E1D	40	W7OWX	15		
W4DRZ	38				
W4FBH	34	W8QYD	44		
W4GMP	34	W8NQD	31		
W4WMI	33	W8RFW	25		
W4FNR	33	W8LBH	25		
W4KKU	31	W8TDJ	22		
W4LNG	31				
W4HVV	29				
W4MS	26				
W4FJ	26				

mits, are OH3NB and 2PK, working daily over a 90-mile path.

Jacksonville, N. Y. — Central New York, never very active v.h.f. territory heretofore, has a growing 2-meter population as a result of the efforts of W2ZUZ, who is on from the 2100-foot elevation of WVFC-FM, near Ithaca. His frequency is 147 Mc., and he is on nightly from 7:30 to 8:30, and as much later as there is anything to be worked in the way of DX. Since this is a location toward which few beams would ordinarily be aimed, Walt asks that the boys in Pennsylvania and other

(Continued on page 110)

Clinton B. DeSoto

1912-1949

It becomes our sad duty to record the passing, on April 27th, of Clinton B. DeSoto, W2IU, technical editor of the *Proceedings of the I.R.E.* and former editor of *QST*. Mr. DeSoto, who was 37 years of age, died of a heart attack.

Clint DeSoto combined with rare skill his two main interests — radio and journalism. Licensed in 1926 as W9KL in his home state of Wisconsin, while studying journalism, he came to the attention of ARRL Hq. because of the research work he was doing on a history of amateur radio. He became an assistant secretary of ARRL (and WICBD) in 1930, a position he held for 12 years. Clint handled the League's publicity work, the "IARU News" and "Correspondence" departments of *QST* as well as numerous feature stories and, in addition to routine office duties, visited many amateur clubs and conventions as a representative of Hq. In 1936 the League published his completed history of amateur radio, *Two Hundred Meters and Down*. Just before the war, as an independent project, he authored *Calling CQ*, a popular book on the



exploits of amateur operators.

In 1942 Clint became, in quick succession, assistant editor, executive editor and, finally, editor of *QST*. His innumerable *QST* articles during almost 16 years of association with League Hq. witness that he was both a good technician and an unusually competent journalist. His comprehensive interest in amateur radio is well illustrated in the subject matter of his *QST* writings, such as improved ham receivers and transmitters, recording principles, radio control of models, military wartime developments, and his wartime training series for beginners, "Who Killed the Sig-

nal?" That Clint had a keen sense of the dramatic and human-interest aspects of amateur radio is attested by his capable handling of "Hamdom" pages as well as feature stories concerning amateur work in communications emergencies.

In late 1945 DeSoto resigned from the employ of the League and accepted an editorship of the journal of the professional society, a post to which he brought a wealth of amateur-acquired skill and which he ably filled to the time of his sudden passing.

NEW BOOKS

Radio Fundamentals, by Arthur L. Albert. Published by McGraw-Hill Book Co., Inc., 330 West 42nd St., New York City, 1948. 583 pages + 11 index pages. 6 × 9 inches. Price \$4.50.

Servicing the Modern Car Radio, by A. L. Hurlbut. Published by Murray Hill Books, Inc., 232 Madison Ave., New York 16, N. Y., 1948. Second edition. 688 pages + 4 index pages. 9 × 12 inches. Price \$7.50.

Post War Communications Receiver Manual, compiled and published by Howard W. Sams & Co., Inc., Indianapolis 7, Ind. 1948. Second edition. 11 × 8 inches. Price \$3.00.

Radar Primer, by J. L. Hornung. Published by McGraw-Hill Book Co., Inc., 330 West 42nd St., New York City, 1948. 210 pages + 3 bibliography pages + 5 index pages. 8 × 5½ inches. Price \$3.50.

Radio Operating Questions and Answers, by the late A. R. Nilson, and J. L. Hornung. Published by McGraw-Hill Book Co., 330 West 42nd St., New York City, 1948. Ninth edition. 360 pages + 48 appendix pages + 24 index pages + 82 addenda pages. 7½ × 5 inches. Price \$3.60.

Velocity-Modulated Thermionic Tubes, by A. H. W. Beck. Published by MacMillan Company, New York City, 1948. 165 pages + 11 appendix pages + 2 index pages. 8 × 5½ inches. Price \$3.75.

Principles of Radar, by Denis Taylor and C. H. Westcott. Published by MacMillan Company, New York City, 1948. 127 pages + 10 appendix pages + 3 index pages. 8 × 5½ inches. Price \$3.50.

Radio Component Handbook, by A. C. Matthews and Staff. Published by Technical Advertising Associates, Cheltenham, Penna., 1948. 211 pages. 6 × 9 inches. \$2.50.

Radio Industry Red Book, compiled and published by Howard W. Sams & Co., Inc., Indianapolis 7, Indiana, 1948. 446 pages.

Inverted Rhombics and Biconical Beams

Some Ideas for High-Frequency Antenna Systems

WE have received several sets of notes from Mr. Dean O. Morgan, * W2NNT, in which he describes some interesting antennas he has developed for TV work. In the hope that they may offer possibilities for further development of amateur-band antennas, he is passing along his findings to anyone interested in antennas, which means just about everyone.

The Inverted Rhombic

The first of these systems W2NNT calls the "inverted rhombic." In amateur circles the basic unit of this system will be recognized as the "bi-square" that has been used by itself or with a reflector by some of the 28-Mc. gang. The basic unit is shown in Fig. 1A, and it is seen to have a square configuration with half-wavelength sides. Fed at the bottom (or top) with either a tuned line or a flat line and matching system,

*% Morgan Television Co.,
725 Seward St.,
Rochester, N. Y.

it gives a horizontally-polarized signal at right angles to the plane of the antenna. Mr. Morgan's first contribution is some design formulas and a method for feeding the thing with 300-ohm line, as shown in Fig. 1B. He gives for the lengths,

$$l_1 = \frac{468}{f \text{ (Mc.)}}$$

$$l_2 = \frac{472}{f \text{ (Mc.)}}$$

The 300-ohm line is attached at points $0.1l_2$ below the center of the l_2 sides. Thus an antenna for 29 Mc. would have upper sides of $l_1 = 468/29 = 16.15$ feet = 16 feet 2 inches and $l_2 = 472/29 = 16.25$ feet = 16 feet 3 inches. The feedline would be attached 20 inches below the center of l_2 ($0.1 \times 16.25 = 1.625$ feet = 20 inches). W2NNT's measurements indicate the gain of such an antenna to be 3.8 db. with an interior angle of 90 degrees (as shown), and with an interior angle of 60 degrees the gain was 3.6. Since the smaller angle represents a saving in the total height required, this would seem to be worth investigating for amateur work. Such an antenna backed up

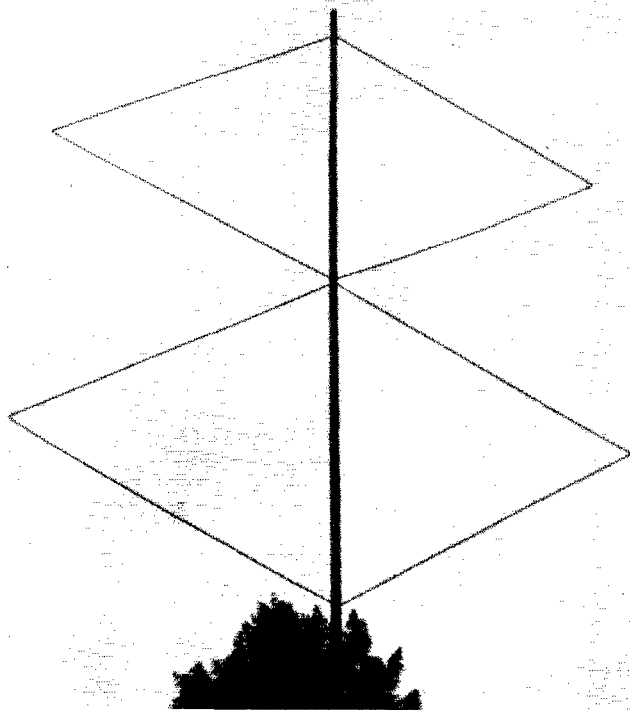

A double inverted-rhombic antenna for high-frequency work is easily supported by a single wooden mast. The TV antenna shown here uses an interior angle of 60 degrees — slightly more gain is obtained by increasing the angle to 90 degrees.

Fig. 1 — The 90-degree inverted rhombic at A is better known to amateurs as the "hisquare" antenna. It can be fed without special matching sections by tapping the feeders on to the elements, as shown in B (see text for dimensions). How several sections can be stacked and fed at the bottom is shown at C.

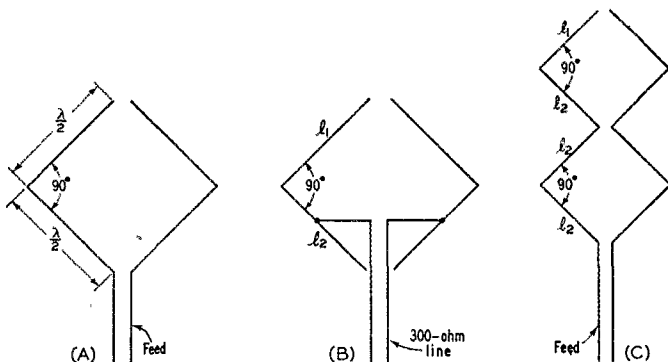

by a reflector from 0.1 to 0.2 wavelength away (tuned to the proper frequency either by adjusting the lengths or with a parallel-tuned circuit at the base of the reflector) might have some real merit. The point of connection of the 300-ohm line would change, of course, but the proper point of attachment shouldn't be too hard to find.

For TV work, the "inverted rhombic" is stacked,¹ as shown in Fig. 1C and the photograph. This arrangement results in a large structure for 28 Mc., but it shouldn't be out of proportion at 50 and 144 Mc. More than two can be stacked, to lower the vertical angle of radiation, but when four or more are used it is advisable to feed the system at the center, for better current distribution.

are joined at the point of crossing, and how the driven element is fed with 300-ohm or other line, by simply tapping on at the correct point.

The elements can be made with telescoping ends for adjustment of the lengths, in the usual manner. For 0.2-wavelength director spacing and 0.15-wavelength reflector spacing, W2NNT gives the element lengths (l in Fig. 2A) as

$$\text{Director} = 450/f \text{ (Mc.)}$$

$$\text{Antenna} = 452/f \text{ (Mc.)}$$

$$\text{Reflector} = 466/f \text{ (Mc.)}$$

For a design frequency of 28.6 Mc., this works out to be 15 feet 9 inches for the director, 15 feet 10 inches for the antenna, and 16 feet 4 inches for

Fig. 2 — The "biconical" beam uses a double element for each element in the usual 3-element beam. Crossed elements as shown at A are used, and the 60-degree angle has been found to give maximum gain. The driven element can be fed with 300-ohm line by tapping it on the elements a little distance each side of center. See text for dimensions.

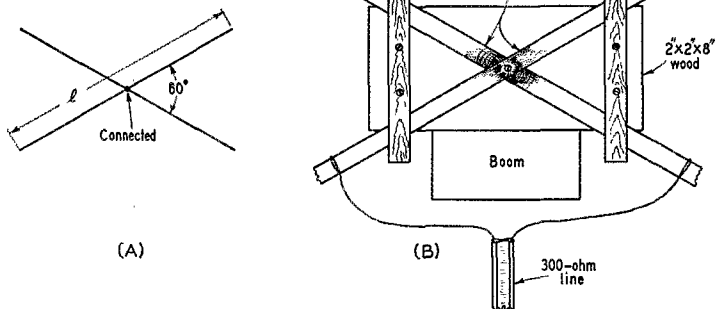

The Biconical Beam

The other antenna tried by W2NNT looks as if it might have considerable application among amateurs on 28 and 21 Mc. It follows the general scheme of the normal 3-element beam, except that the elements are "X"-shaped, as shown in Fig. 2A. The angle of 60 degrees between elements has been found to give maximum gain. The detail in Fig. 2B shows how the elements

the reflector. Using 300-ohm transmission line, the line taps on 10 inches either side of the crossover point.

In his experimental work, W2NNT has found this 28-Mc. beam to show approximately 3 db. gain over a similar beam with ordinary elements, or about 10 to 11 db. over a dipole. The bandwidth over which the s.w.r. did not exceed 2 to 1 was 3 Mc. There are, of course, many different mechanical arrangements that can be used to obtain this element configuration.

¹ And called the "Mor-Gain" antenna.

— B. G.

TVI Tips

PROBABLY most amateurs who have been troubled with TVI do not realize that it makes a great deal of difference just where in the TV channel the offending harmonic falls. This point stood out in the engineering studies made of picture interference some years ago, but it is not too easy to put definite numbers on it because

you've reached the limit of what can be done to prevent harmonic radiation.

There is no question at all but that a harmonic falling near the picture carrier will do the most damage. The greater the separation between harmonic and picture carrier the better, providing that the harmonic does not run into the sound channel in the process of moving away from the picture carrier. Fig. 1 shows the results of some measurements we made recently on the one TV signal available on a "service" basis in West Hartford. At the time the measurements were made the signal was not strong enough to give more than about half contrast with the receiver gain full on; we have been told that field-strength measurements made in the Hartford area show the signal to range from about 50 to 200 microvolts per meter — well below the 500-microvolt figure that FCC considers to be the minimum required for good reception in noise-free locations (which ours is not!).

The data from which Fig. 1 was plotted were obtained by loosely coupling a v.h.f. signal generator to the antenna connections of the receiver and then adjusting the generator output until interference was just detectable in the picture. This was done throughout the television channel. The signal-generator readings were then reduced to a relative basis, using as a reference the smallest signal strength that caused detectable interference. As shown by the curves, the interference was worst when the interfering frequency was on or near the picture carrier. Taking the relative amplitude here as "1," it can be seen that when the interference was 1 megacycle away from the picture carrier (either 0.25 Mc. or 2.25 Mc. from the low edge of the TV channel) a signal 10 times as strong was required to produce just-visible interference. At the upper edge of the picture signal — about 4 Mc. from the picture carrier or 5.25 Mc. from the low edge of the channel — almost 2000 times as much voltage was required to cause just-discernible interference as on the picture carrier itself.

Now such a tremendous ratio probably will not hold for all TV receivers. The relative response at the high end of the picture signal will depend on the receiver's i.f. and video bandwidths

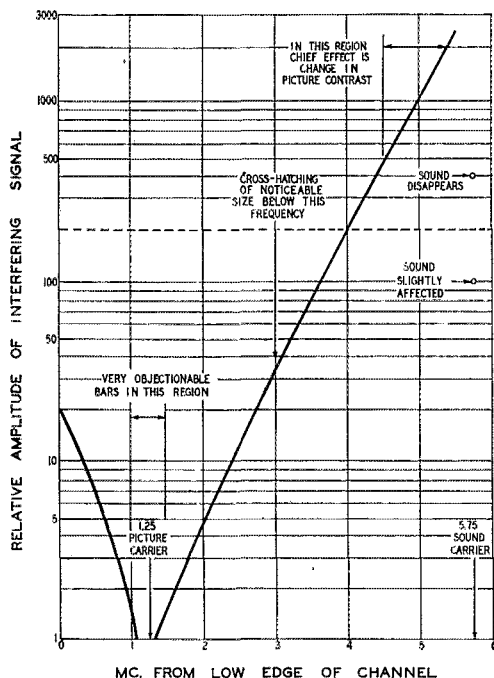

Fig. 1 — Relative voltage required to produce equal interference in various parts of TV channel.

interference is a subjective thing — one person will not be greatly bothered by interference that another would consider bad enough to spoil enjoyment of a program. Also, it varies with the program material, scene lighting, and many other factors. But it is quite possible to make some general observations, and a little attention to the choice of an operating frequency may be enough to get you over the hump when you think

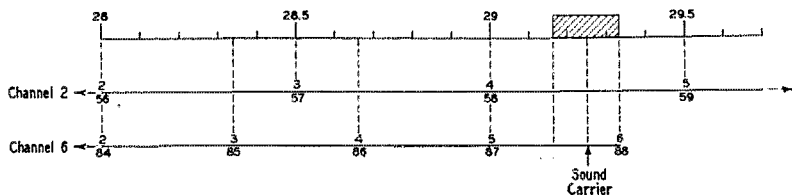

Fig. 2 — Harmonic relationship of 28-Mc. band to Channels 2 and 6.

and the state of circuit alignment. However, the picture quality with this particular receiver does not suffer by comparison with other receivers we have used. Although the ratios should not be taken too literally, they are probably dependable in indicating the order of magnitude.

No means were available for determining the relative strength of the TV signal and the interference. However, it was approximated by indirect methods. It is well known that in f.m. reception if two signals are on the same frequency a difference of 6 db. in strength will enable the stronger one to suppress the weaker. The graph shows the interfering signal strengths that were necessary to meet two conditions — (1) the value where the interference was just suppressed by the TV sound carrier, (2) the value where the interference just suppressed the TV sound carrier. The presumption was, then, that the sound-carrier strength was just midway between these two values. On the further assumption that the sound and picture carriers had the same strength (this was supported by other measurements) the TV signal was assumed to have a relative strength of 200 on the scale used on the graph. Consequently the signal that just caused interference at the frequency of the picture carrier was 46 db. below the picture carrier. This checks rather well with the 40-db. figure that has been generally accepted as the necessary ratio of TV signal to interference, for good TV reception.

But note this: When the interfering signal was 4 Mc. from the low edge of the channel it had to be as strong as the picture carrier to cause detectable interference, and at the upper edge of the picture signal it had to be ten times as strong! Furthermore, the "annoyance factor" of the interference varies as well, being much less in the upper reaches of the channel. This has been shown in a rough way on the graph. At the upper edge the cross-hatching is so fine that the picture must be inspected rather closely to see it; at normal viewing distance it shows up mostly as a sort of graying over of the picture. The bigger the bars — and the closer the interfering frequency to the picture carrier the bigger they get — the more objectionable the interference, even when the bars are just visible.

In terms of frequencies in the ten-meter band, Fig. 2 shows how this information can be applied. The second and third harmonics from 28 Mc. fall in Channels 2 (54-60 Mc.) and 6 (82-88 Mc.). In neither case is it possible for a harmonic to fall right on the picture carrier; in both channels the lowest harmonic frequency is 2 Mc. above the low edge of the TV channel. (The small numbers above the frequencies correspond to the Mc. from the low edge as shown in Fig. 1.) In areas where Channel 2 is in use harmonic interference should be considerably reduced by working above 29 Mc. — as far toward the upper edge of

the band as is possible without getting into trouble with the sound carrier. The sound carrier is at 59.75 Mc., so no harmonic reaches it, but the harmonic should be kept 250 to 500 kc. away from it to be on the safe side. In Channel 6 areas there are two optimum regions — between about 28.7 and 29 or 29.1 Mc., and above 29.5 Mc. In the latter case the harmonic is entirely outside the TV channel and is least likely to cause interference. The shaded region should be avoided in these areas because the harmonic will fall near enough to the sound channel to be in danger of doing damage. In the data shown in Fig. 1, the interfering signal showed up in the sound channel when the frequency was about 250 kc. below the sound carrier — this with a signal ten times as strong as the sound signal.

So choosing the proper operating frequency can be of considerable help in reducing harmonic TVI. It is conceivable that in mild cases it may be all that is required. But mostly it will be a last resort, not a cure-all. It is distinctly not a substitute for harmonic-reduction measures at the transmitter nor for protecting the receiver against overload from a strong fundamental signal.

— G. G.

Silent Keys

It is with deep regret that we record the passing of these amateurs:

W1EAV, Charles R. Washburn, Marion, Mass.

W1QZY, David W. Taylor, Medford, Mass.

W2IU, ex-W1CBD-W9KLL, Clinton B. DeSoto, former editor *QST*, New York City

W3FL, Edwin E. Widmer, Philadelphia, Penna.

W5AHK, Millard M. Walker, Wharton, Texas

W5HKU, Lyndon E. Dawson, Ruston, La.

W6HVS, Leon S. Kruger, San Diego, Calif.

W6PHX, Harry L. Elliott, North Sacramento, Calif.

W8TGU, Harold C. Ramsey, Zanesville, Ohio

W8YFT, Henry L. Luoma, Ahmeek, Mich.

W8ZKR, Henry H. Hargreaves, Manistique, Mich.

EALAH, Luis de Reque

G3BBM, Lawrence G. Hayns

G4MH, J. F. Fish, Blackpool, Lancs.

G6HP, Thomas B. Wimbush, Burnley, Lancs.

GM3BZP, Ian A. Bates, Perth

15th ARRL DX Contest

High 'Phone Scores

Based on reports received during the first few weeks following that annual battle of the mikes, the 'phone section of the Annual ARRL DX Competition, we are pleased to present a preview of the high scores and performance records of those who took part.

Among the W/VE mikesters engaged in the battle, top talker was W1ATE, who worked 89 different countries, made 468 contacts and a multiplier of 160 for a claimed score of 223,040 points. Trailing closely behind, W3BES logged 500 contacts with 77 countries for a multiplier of 147 to score 219,765. The only other score above the two hundred thousand mark received at this writing is that of W8HRV, 214,830, resulting from 434 contacts and 167 multiplier (76 different countries worked).

Claimed scores over 50,000 were made by W7ESK 196,506, W8REU 174,450, W4DQH 137,093, W3DHM 130,634, W6ITA 123,343, W9EWC 120,384, W8HRV 113,400, W1AFZ 110,550, W2BXA 106,835, VE7EL 106,736, W6RM 105,621, W4KWY 102,960, W4OM 97,342, W5BGP 88,200, W4FUM 85,347, W2VQM 83,868, VE7ZM 83,694, W5KZN 81,534, W3GHS 79,860, W2PQJ 76,230, W1BFB 74,844, W4LXE 68,478, W8NXF 65,754, W0PRZ 65,728, W6AM 64,768, W9UUN 64,602, WSVAN 58,968, W0ANF 52,962, W8NSS 52,416, W1ONK 52,374, W5LWV 52,154, W4KCQ 51,336, VE7VO 50,997.

Entries from points outside the U. S. and Canada are still coming in each day. In that category, the highest score thus far received is that of HC1KP, 189,465 points, 743 contacts, 85 multiplier. TG9AN claims an even 1000 contacts, multiplier of 48 and 143,328 points. PY2CK's log records 1002 QSOs, a claimed score of 141,218 and multiplier of 49. Next in line with scores over 50,000: VP6SD 109,296, KH6IJ 93,280, G8QW 62,279, HK3CU 54,230, CT1QF 54,150, ZC6XY 51,207, DL4VN 51,183.

It is believed that most of the top 'phone entries have already been received and that the above figures give a fairly accurate picture of the results that may be expected in the final analysis. However, we must emphasize that these relative standings are based on claimed scores. Complete and final results will be published in a later issue after the huge task of checking all entries has been accomplished.

SWITCH TO SAFETY!



SUPERHETERODYNES "that work" are very much in the limelight in June, 1924, *QST*. In presenting his enlightening symposium on this timely topic, Technical Editor Kruse has consulted with numerous receiver-circuit authorities of the day. Shown as a worthy example of advanced design is a neutrodyne-superheterodyne constructed by J. L. A. McLaughlin.

There's nothing mysterious about the circuitry of the new master-oscillator power-amplifier transmitters, E. A. Laport, ex-1CBO, ably explains. In similar vein, Philip Laskowitz, 9DHI, describes an effective break-in system which should have wide application among our relay stations. A tempting vacation-time project is suggested by Gordon Hammond's (3CEL) 80-foot mast — total cost five dollars!

Ballots have been counted in the first election to be held under the League's new constitution, resulting in the following Board membership: A. H. Keith Russell, Canadian 9AL, George L. Bidwell, C. M. Jansky, jr., 9XI, B. F. Painter, 5MB, H. F. Dobbs, 4ZA, L. B. Laizure, 9RR, A. H. Babcock, 6ZD, Clyde E. Darr, 8ZZ, G. H. Pinney, 1CKP, Karl W. Weingarten, 7BG, W. T. Gravely, 3BZ, Paul M. Segal, 9EEA, and F. M. Corlett, 5ZC.

After an anxious month, amateur radio has successfully reestablished contact with the MacMillan Expedition in the Far North. Fifteen-year-old Everett Sutton, 7DJ, was the amateur to pierce the Arctic silence and handle traffic from Operator Don Mix, telling that all was well with the *Bowdoin's* party. An equally creditable performance has been turned in by Canadian amateurs who assisted news services during a trans-Atlantic cable breakdown.

The past spring was a great season for ARRL conventions, Halifax, Seattle and Philadelphia serving as hosts for rousing get-togethers. The Philadelphia meeting, ably reported in this issue by W. Bradley Martin, was marked by the awarding to Traffic Manager Schnell of the *QST* brown derby for being the first North American amateur to work two-way across the Atlantic. Editor Warner has already collected on his latest Transatlantic wager with W. W. Burnham of London, his winnings this round being a handsome mantel timepiece.

Gleanings: 4KU, Atlanta, and 6CGW, Long Beach, merit the approbation of the station descriptions section. . . . ARRL is coöperating with the French government in running reception tests of the Eiffel Tower station, FL. . . . A promising piece of "New Apparatus" is an adjustable resistor known as the "Bradleyohm."

How's DX?

CONDUCTED BY ROD NEWKIRK,* W9BRD

How:

We note a gratifying decrease in the number of manufactured DX QSOs turned out by the previously frowned-upon "buddy system." Apparently it has been widely realized that DXCC rank should be reserved for McCoy DX men who stand on their own two feet, and should not be used as a measure of how many "friends" and how much callous nerve an individual might possess.

No, a mediocre location and/or the use of microcosmic power does not entitle anyone to DX served on a silver platter. Hundreds of guys in this same boat stand by and take their fair shots at the rare ones, come what may. In their case it may be a long, winding road to the top but when they do get their hands on that fancy diploma it's *all* theirs.

Jeeves, if you've finished making out our SWL cards for the DXCC Round-up, order some more for the next one. Then read us the mail. . . .

What:

Could be that most of the boys are up on 160 after their postwar 1.7-Mc. WAC but things on *eighty* have slowed down to a walk. W4LVV comes through with a tasty morsel in VP5AT, Caicos (3510). . . . PY7WS (3515) made it 51 on the band for W2QHH while W8PCS needed but eight watts to a VFO unit to snare VO2CD and ZL1HM (3545). . . . W9PNE clings to a 77-6J5 battery blooper receiver for 80 and had little trouble completing his 3.5-Mc. WAC with same plus 200 watts to an 8005. . . . New ones for W0CFB were VP1AA, VP2LX, OZ1W and EI4Q.

The variety of stuff making its appearance on *forty* has grown limited but the band still bears watching. ZL1CH/VR4 (7050) and VR2AR (7070) are a pair of nifties holding forth during the wee hours, for instance. . . . Europeans aren't so plentiful but W3JAK ran down UA3KBT, UB5AZ, OH1NW and OH3NU. . . . Now up over 130 on 40, W2RDK added ZD4AB (7035) and YS1RA (7020) during dawn hours. . . . 50 watts netted ZB1Q (7020), SU1CR (7000), HK5CR, EA5BE, EA4LQ, VP3ACS (7010) and YV5AL (7010) for W2YZG. . . . W2OWX has 15 watts less than that but raised LA7Y, OK1SX, PZ1WX (7010), VP4TR, VP6SJ, VP9CC and CT1HT. . . . Among W5ONL's list we spot KM6AK (7035) and

W7MGO now awaits cards from ZS5GF (7031), I1LX, KV4AA (7019), CE7CD (7025) and VS2BX (7028). . . . W0CFB has QRT for the summer months after adding W2WMV/C1, JA3AA and CE4AD. . . . W2BJ is an old 7-Mc. enthusiast and bagged people like CP1AQ, FASIII, CT1AZ, EA1AB and EA5BE with his 33-up-33-out skywire.

If Tilton hadn't once had a buffer-doubler on *twenty* we'd say he was just too lazy to wind coils with so many turns; Anyway, KH6PM likes the band what with EL3A (14,075), FASIH (14,120), ISIAFM (14,125), FUBAA (14,020), TA3GVU (14,120), VQ8AY (14,085), ZD4AB (14,060) and two people signing EP8EA (14,150) and FP8AF (14,090). Those are still on Fred's stalk list but he did capture CX6AD (14,065), CP1AQ (14,060), FO8AD (14,050), HP1PL (14,075 t8), NY4DD (14,030), OQ5QF (14,100) and VP8AK (14,125). . . . G6RH sneaked past the Ws to the tune of W8QOH/HS (14,085), EA8CO (14,185f), EA6AZ in the Balearics (14,065), FESAB (14,030), FI8ZZ (14,015), FD8RG (14,045), FK8AB (14,020), FO8AC (14,030), VK9PJ (14,110), KC6EA (14,085), VQ4CUR (14,010 t8), VR2AP (14,150), VR2BJ (14,070), UP2AA (14,100), ZK2AA (14,135) and W6MCF/Formosa (14,040). . . . ZC4AC (14,070), YT7DD (14,080), 4X4CJ (14,090), W3CHH/Iwo (14,060), ZC1CL (14,070) and YK1AF (14,080) were snapped up by W1KUF while W1KMY hooked VK9NR (14,-



* DX Editor, QST. Please mail reports of DX activity to W9BRD's home QTH: 1517 Fargo Ave., Chicago 26, Ill.

020), GC3EML (14,060), LB3XA, HA5B (14,025), JA2KG (VFO) and ZE1JI (14,000) W3NOH's fanciest: SP5BA (14,080), MD7RCS (14,065), HZ1HZ (14,000), EA8MC (14,095 t7), CT2BN (VFO t8), KX6BE (14,009 t8) and YS1RA (14,045). Al is curious about one YA1AA who passes out the QTH "1 Kabul Ave., Herat, Afghanistan." An influx of TV sets has annoyed W8KPL but didn't slow him down appreciably: W0HWI/KS6 (14,040), HB1EO/HE (14,060-14,110), VQ4LM (14,040), VS7RA (14,030), AP5B (14,030), MI3AB (14,070), CR7AO (14,060), CT3AV (14,155), DU1AP (14,070), EK1DI (14,025), EK1DO (14,070), EK1GW (14,020), YS1ZG (14,050), ZD9AA (14,010), HA5BP (14,150), UI8KAA (14,060), UG6KAA (14,015), UF6AB (14,080), GD3UB (14,070) and GAGNT, a flyboy over the Sahara From W8KOS's list we swipe MT2A (14,090) and W3QLW donates GC2CNC (14,025), GC5OU (14,060), OE1AD (14,047) and OK1CK The indoor wire at W9MDG managed FA8BG (14,000), OE5YL (14,000) and EA5BE, while 40 watts raised UA3DQ, UA1AI, UC2AD (14,040) and OX3MF (14,036) for W7WEN VE3AWE ran into two ship stations, MN2AC and OH1OR, as well as CT3AA and IS1AHK (14,005) VE1HG's 40-watt 807 has tallied over 100 postwar countries, Harry's latest being VS9AL, ZC6PM, JA2AZ, ZD1BD, CR6AW, VQ2DH, MD4BPC and MD1D From W4LVV's whopping assortment we select SV5UN (14,040), I1YA/Trieste (14,050), FF8GP (14,050 QRH), CR7IZ (14,070) and an AX2B (14,000) who specifies Socotra as his QTH VK1VU (14,060) claims W4MR as his first W4 contact and W8SYC has high quality in YK1VL (14,050), YK1AB (14,035), VU2LJ (14,115), VS2CH (14,090),



The bands have certainly been brightened by the activity of the ZC6UN crew in Haifa. A group of the operators are, *l. to r.*, SM5LR, W2NUP, PA9BB and W2BSP.

LX1SO (14,089) and two finger-crossers, ZD3TA and TA2AR KZ5IP bucked the W/VE competition successfully for ZD4AM (14,025), ZK1AL (14,065), VS7NX (14,010), OQ5RA (14,030), TF3AB (14,010), OE1FF (14,008), YR5W (14,012) and VS1CX.

The strictly-'phone reports are few but we surmise the A3 adherents are all busy making out QSLs with meat like ZD3A, VR3A, C1DH/C3, C7TY, ZS8A, HL1BJ, IS1AYN, LX1JW, YS2AG, KR6s AS AX BG and BO, JA5 2AZ 2BF 3AB 4AD 7AA, MI3SC and YS2AG being collected by W2DMJ's 810s W3QLW hollered happily at HC2JR (14,305), KG6EQ (14,265), VP2GG (14,375), VP5AR (14,170), VP6CDI (14,145) and ZL1MR W2MPA adds FQ8SN, ZD2S, YK1AB, ZC1AZ, EA8CO, MI3SI, TA3GVU, C1PL, DU1VVS, FA3JX, OQ5LL, IS1AHK, HA1KK, W7LZJ/C6, UB5KAG, 4X4CZ, W2EJV/PK3, VP3HAG, LX1BU, ZC6XY and EL7A to the list of juice you might uncover sans BFO QRM.

Blowing alternately hot and cold in true style, *ten* dished out CN8ER (28,016), IS1AFM (28,010), UR2KAE (28,005), YS1H, GC4LI (28,040), OA4AS and VP5AS to W2YHY's 807 while six consecutive 'phone contacts formulated a fast WAC for W8VAN, namely VQ4RF, DL4PQ, CX1ME, VK2KZ, JA2AZ and a VE6 LU8BF regularly runs into CP5FB, LU1ZA, LU2ZB, KH6s RE and RR, and VP4TAN via the voice route and G6RH pinned down AC4RF (28,050), VP2AJ (28,020), VQ8AD (28,050 t7 QRH) on c.w. plus VQ5PBD (28,390) on A3 Traffic-hound W8NOH sampled *ten* and liked EA4FA (28,015), UB5BK (28,030), OA1F (28,250f) and KG6DI W3NOH did well with SV0WA and AP5Z while W0LNT pitches in with KV4AA, EA5BE, OH8NF, LA6O, UB5AZ, FA8CR, CX4CZ and OE8AN.

W8SWG finds things booming on *eleven*, picking off KG6DG, PY2AC, YR5A, TG9JK, SP8XA and EL3A on c.w. and LX1JW, EA4LA, OA1E, VP6CDI, HC1KP, PY2CK and TG9AN using voice TA3GVU (27,220) completed W2QHH's 11-meter WAC so this part of the spectrum is worth a listen now and then.

Where:

It might be well to reiterate that the addresses given herein are by no means vouched for by this department (nor results therefrom guaranteed!). Obviously, were we to check and verify each one, by the time they appeared in print their value would be nil. So take your chances and good luck, OMs. . . .

AG2AB

Cpl. E. Metrick, Hq. & Hq. Co., 351 Inf., F.T.T., APO 209, % PM, N.Y.C., N. Y.

ex-D4AEQ

W6FRS, 1230 Brannick Avenue, Los Angeles 23, Calif.

EA8CO

Box 346, Las Palmas, Canary Islands



Rurik Lonnroth, OH2QQ, has enjoyed contacts with hundreds of Ws from his meticulous layout in Helsinki. D.c. mains (250 volts) limit the input to 50 watts and two antennae are employed, a long wire and an end-fire east-west beam. Receiving is done with an NC-100XA.

EA8MC Manuel Causimor, Sol Y Ortega, 23, Laguna, Tenerife, Canary Islands
 EK1DP BPO No. 57, Tangier Zone, North Africa
 EL8A (via W2QKE)
 FO8AD (same as RV2)
 HL1BA (via W2MQD)
 IIRMO Via San Rocco, 10, Cremona, Italy
 KC6WA Navy 3054, FPO, San Francisco, Calif.
 LU1ZB QSL to R. Marquez 255, San Isidro (P.B.A.), Argentina
 LU2ZA Alberto Torres, Isla Laurie Observatorio Meteorologico, Argentina
 LZ1AB Box 242, Sofia, Bulgaria
 LZ6AA Franz Pohnis, Box 271, Sofia, Bulgaria
 MD2AC S/Sgt. M. E. Gallaher, 1950 AACCS Sqdn., APO 231, % PM, N.Y.C., N. Y.
 MD7RCS (via RSGB)
 MI3SI Radio Marina, Asmara, Eritrea
 MT2D K. L. Williams, % BOAC, Tripoli, Tripolitania, North Africa
 (via ARRL)
 PK3JT (via W5KC)
 SP5BA Box 25, Malakal, Southern Sudan
 ST2RA John Birch, Juba, Sudan
 ST2WB (via W2CYC)
 SU2AA % Dept. of Civil Aviation, Port Moresby, Papua Territory
 VK3PJ
 VO2CQ Bristol Airfield, Argentina, Nfld., Navy 103, FPO, N.Y.C., N. Y.
 VO4AD H. H. Keeping, Box 13, Port aux Basques, Newfoundland
 ex-VP4TY D. E. Yong, 22 Sussex St., Charlestown, Georgetown 16, British Guiana
 VP7NK Box 703, Nassau, Bahamas
 VR2BG D. Rummings, % RNZAF, Suva, Fiji Islands
 VR2BK J. L. Byrne, % Sgts. Mess. RNZAF Stn., Lauthala Bay, Fiji Islands
 VR2BL % Nadi Airport, Fiji Islands
 VR5JA P.O. Box 47, Nukualofa, Tonga Islands
 VR5PL (now same as above)
 VS2CH (via RSGB)

W1EEC/KW6 (to home QTH)
 W2YXG/KH6 W. H. Barnes, Navy 28, FPO, San Francisco, Calif.
 W3CHH/Iwo APO 264, Unit One, % PM, San Francisco, Calif.
 W6DGS/KW6 (to home QTH)
 W6GIB/KW6 (to home QTH)
 W7LZJ/C6 (to home QTH)
 W0MCF/C3 Box 10, Navy 3930, FPO, San Francisco, Calif.
 YM4AW QSL to 85 Park Ave., Amityville, L.I. N.Y.
 YS1RA % American Embassy, San Salvador Salvador, C.A.
 YS1VJ Jorge Vasquez, Telefonos, San Salvador Salvador, C.A.
 ZC6PM (via ARRL)
 ZD2S R. Sherwood, % WAAC, Lagos, Nigeria
 ZD3A Box 16, Bathurst, Gambia, B.W.A.
 ZE2JL E. H. Blackwell, P.O. Box 121, Umtali, Southern Rhodesia
 ZL1GE/P QSL to O. Harrison, 75 Stenhouse, Edinburgh 11, Scotland

This variety thanks to W1s IOZ KUF QIQ QMJ RWS, W2s BJ CJX DMJ EQS LXI MPA SN, W3NOH, W4s MR VE, W5s LY JPC, W6PH, W8s KPL SWG WWU, W9CFT, W0s BNU TKX, KH6PM, LU8BF, OK1WY.

Tidbits:

Local QRM around Fiji is growing fierce, reports VR2BC. There are now seven active stations within a half-mile radius of Nadi Airport and more newcomers are expected directly. Graham has a yen for magnetic recording and would welcome a few rag-chews on this subject. NY4DD informs us that the six present Guantanamo Bay licensees are NY4s AW BA JB LB RD and his truly. ET3AD reports sparse Ethiopian activity but holds forth on 80, 40 and 20, 'phone and c.w., to furnish more than his share of contacts with this rare point. W3JTC's *PVRC DX News* speaks of VQ2DH's planned visit to ZD6 during April. Anybody grab this one? The following sidelights of KH6VP's sojourn to VR4 trickle through: Bill (ex-W7BE, W3IWM) worked 889 fortunates in 85 hours of operation on three bands. A rhombic headed toward KH6 was used and power ranged from 40 to 400 watts. Intending to give W7s a decent break, he found conditions stacked against him with all U.S. areas except the northwest coming through. Atmospherics made things really rough. W4CYC was the first station raised and S9 reports became the rule thereafter. KH6VP has done his DXing from many parts of the U.S. and maintains that the W7 gang has the toughest row to hoe. [Guess he never had to use a skywire atop a Cicero two-flat, eh, boss? — *Jeeves*] Maybe not, *Jeeves*, but that VR4 clambake was a job well done. A DXer of the old school, G6QX, proposes a toast to this modern generation of DX stalwarts who can hang on for hours on end to grab a new one.

(Continued on page 118)

I.A.R.U. News

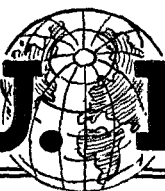

QSL BUREAUS OF THE WORLD

For best service on delivery of your QSLs to foreign amateurs, simply mail cards direct to the bureau of the proper country, as listed below (boldface type indicates a recent change from previous listings). Do not send foreign cards to A.R.R.L. headquarters except those for which no bureau is here listed.

For service on incoming foreign cards, see list of domestic QSL bureaus in previous issues of QST under the heading, "A.R.R.L. QSL Bureau" (page 30, April QST).

Alaska: J. W. McKinley, Box 1533, Juneau
Algeria: Via France
Argentina: R.C.A., Av. Alvear 2750, Buenos Aires
Australia: W.I.A., Box 2611W, G.P.O., Melbourne
Austria: Via ARRL
Azores: Via Portugal
Barbados: VP6PX, Wood Goddard, Bromley, Welches, Christ Ch., Barbados, British West Indies
Belgian Congo: P.O. Box 271, Leopoldville
Belgium: U.B.A., Postbox 634, Brussels
Bermuda: VP9D, James A. Mann, The Cut, St. Georges
Bolivia: R.C.B., Casilla 15, Cochabamba
Brazil: L.A.B.R.E., Caixa Postal 2353, Rio de Janeiro
British Guiana: Desmond Yong, 22 Sussex St., Charles-town, Georgetown #16
British Honduras: D. Hunter, Box 178, Belize
Burma: B.A.R.S., P.O. Box 611, Rangoon
Canal Zone: Canal Zone Amateur Association, Box 407, Balboa
Canton Island: Francis T. Blatt, KB6AG, % C.A.A., Canton Island, South Pacific
Ceylon: P.O. Box 907, Colombo
Chile: Radio Club de Chile, Box 761, Santiago
China: K. L. Koo, P.O. Box 409, Shanghai
Colombia: L.C.R.A., P.O. Box 584, Bogotá
Cook Islands: Ray Holloway, P.O. Box 65, Rarotonga
Costa Rica: F. Gonzalez, Box 365, San Jose
Cuba: James D. Bourne, Lealtad 660, Habana
Czechoslovakia: C.A.V., P.O. Box 69, Prague I.
Denmark: E.D.R., Box 79, Copenhagen, K.
Dominica: VP2DC, Roseau
Ecuador: Victoriano Salvador, P.O. Box 2536, Quito
Éire: R. Mooney, "Eyrefield," Killiney Co., Dublin
Ethiopia: ET3AF, P.O. Box 858, Addis Ababa
Fiji: S. H. Mayne, VR2AS, Victoria Parade, Suva
Finland: P.O. Box 306, Helsinki
France: Service QSL, R.E.F., 6 rue du Pont de Lodi, Paris 6
Germany: (DL2 calls only) E. G. Styles, PW/DP Branch, 120 Hq. CCG (BB), Brunswick BAOR (II)
Germany: (DL4 calls only) M/Sgt. A. R. Varney, OPM, EUCOM, APO 757, % Postmaster, New York, N. Y.
Germany: (DL5 calls only) Via France
Germany: (other than above) D.A.R.C., Post box 99, Munich 27
Great Britain (and British Empire): A. Milne, 29 Kechill Gardens, Hayes, Bromley, Kent
Greece: C. Tavaniotis, 17-A Bucharest St., Athens
Greenland: 1385th AAF Base Unit, APO 858, % Postmaster, New York, N. Y.
Grenada: VP2GE, St. Georges

Guam: G.R.A.I., APO 234, % Postmaster, San Francisco, Calif.
Guatemala: Manuel Gomez de Leon, P.O. Box 12, Guatemala City
Haiti: Roger Lanois, % RCA, P.O. Box A-153, Port-au-Prince
Hawaii: A. H. Fuchikami, 2543 Namaun Dr., Honolulu
Hong Kong: Hong Kong Amateur Radio Transmitting Society, P.O. Box 541, Hong Kong
Hungary: H.S.R.L., Postbox 185, Budapest 4
Iceland: Islenzkir Radio Amatorar, P.O. Box 1080, Reykjavik
India: J. Nicholson, Nadiar Estate, % Munnar P.O., Travancore
Israel: See Palestine
Italy: A.R.I., Via San Paolo 10, Milano
Jamaica: Thomas Meyers, 122 Tower St., Kingston
Japan: F.E.A.R.L., APO 500, % Postmaster, San Francisco, Calif.
Luxembourg: G. Berger, 20 Louvigny St.
Macao: Via Hong Kong
Malta: Via Great Britain
Mauritius: V. de Robillard, Box 155, Port Louis
Mexico: L.M.R.E., Apartado Postal 907, Mexico, D.F.
Montserrat: VP2MY, Plymouth
Morocco: C. Grandier, Box 50, Casablanca
Morocco: Tangier International Zone only: EK1MD, Box 57, British Postoffice, Tangier
Mozambique: Liga dos Radio-Emissores, P.O. Box 812, Lourenco Marques.
Netherlands: V.E.R.O.N., Postbox 400, Rotterdam
Netherlands East Indies: Hr. C. Loze, PK1LZ, Burg. Kuhrweg, 47 Bandoeng, Java
Newfoundland: N.A.R.A., Box 680, St. Johns
New Zealand: N.Z.A.R.T., P.O. Box 489, Wellington C1
Nicaragua: L. B. Satres, Bolivar Ave., 106 Managua
Northern Rhodesia: N.R.A.R.S., P.O. Box 199, Livingstone
Norway: N.R.R.L., P.O. Box 898, Oslo
Pakistan: Via India
Palestine: P.O. Box 4099, Tel-Aviv
Panama: Republic of: L.P.R.A., P.O. Box 1616, Panama
Paraguay: R.C.P., Palma 310, Asuncion
Peru: R.C.P., Box 538, Lima
Philippine Islands: Elpidio G. DeCastro, Philippine Amateur Radio Assn., 931 R. Hidalgo St., Quiapo, Manila
Puerto Rico: E. W. Mayer, P.O. Box 1061, San Juan
Portugal: R.E.F., Travessa Nova de S. Domingos, 34-1° Lisbon
Roumania: Vasilescu, Box 326, Bucharest
Salvador: J. F. Mejia, 7* Calle Poniente No. 76, San Salvador
South Africa: S.A.R.L., P.O. Box 3037, Capetown
Southern Rhodesia: S. E. B. Anderson, ZEZJN, 3388 Queens Park, Bulawayo
Spain: U.R.E., P.O. Box 220, Madrid
St. Vincent: VP2SA, Kingstown
Sweden: S.S.A., Stockholm 8
Switzerland: U.S.K.A., Postbox 1203, St. Gallen
Syria: P.O. Box 35, Damascus
Trieste: A.R.A.T., P.O. Box 301
Trinidad: Edgar H. Borde, 52 Mucurapo Rd., Port-of-Spain
Uruguay: R.C.U., Casilla 37, Montevideo
U.S.S.R.: Central Radio Club, Postbox N-88, Moscow
Venezuela: R.C.V., Apartado 1247, Caracas
Virgin Islands: Richard Spenceley, KV4AA, Box 403, St. Thomas
Yugoslavia: Post Box 180, Ljubljana

(Continued on page 114)

Modernizing the Prewar HRO

BY LOREN G. WINDOM,* W8GZ

SOME months ago the writer had occasion to compare his prewar HRO receiver (No. Y-219) with several of the new HRO-7 receivers. My conclusion was that the old HRO was still a top-notch receiver but that several improvements were indicated — conversion of the high-frequency oscillator and the addition of a noise limiter. After extended use at W8GZ

with certain minor modifications dictated by simplicity.

Conversion of the H.F. Oscillator

Conversion of the high-frequency oscillator consists of substituting a 6C4 and associated 0A2 regulator tube in place of the 6C6 or equivalent oscillator and the adding of a temperature-compensating condenser across the oscillator bandspread trimmer condenser. Circuit details are given in Fig. 1.

Remove the present h.f. oscillator tube and socket from the chassis. With a hack-saw blade or similar tool enlarge the present tube-socket hole into a rectangular hole approximately $1\frac{1}{4}$ by 2 inches. Cut a piece of sheet aluminum into a rectangle approximately $2\frac{3}{8}$ inches by $2\frac{3}{8}$ inches. On this piece of aluminum mount the sockets for the 6C4 and 0A2 tubes. Space these sockets approximately $1\frac{1}{4}$ inches between centers. This socket assembly is now centered over the rectangular hole in the chassis and fastened in place by means of small bolts or rivets in each corner of the aluminum sheet. The 6C4 tube must be toward the front. Connect the 6C4 and 0A2 as shown in Fig. 1.

Temperature Compensation

Temperature compensation is obtained by connecting a 10- μ fd. ceramic, with a coefficient of $-0.00077 \mu\text{fd.}/\mu\text{fd.}/^\circ\text{C}$, across the oscillator bandspread trimmer condenser. This temperature compensation is used on the 28-, 14- and 7-Mc. coils. It cannot be used on the 3.5-Mc. coils without modifying the coil-assembly components, which is hardly worth while.

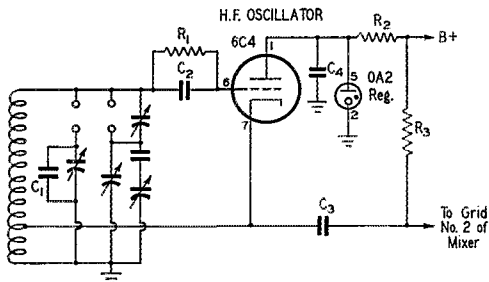

Fig. 1 — Revisions in the high-frequency oscillator circuit.

- C₁ — 10- μ fd. ceramic, $-0.00077 \mu\text{fd.}/\mu\text{fd.}/^\circ\text{C}$ (see text).
- C₂ — 100- μ fd. ceramic.
- C₃ — 0.01- μ fd. mica, 600 volts.
- C₄ — 0.1- μ fd. 400-volt paper.
- R₁ — 22,000 ohms, $\frac{1}{2}$ watt.
- R₂ — 5000 ohms, 10 watts.
- R₃ — 0.1 megohm, $\frac{1}{2}$ watt.

the writer believes that the following suggested conversion represents a worth-while improvement in any HRO. What the writer has done is to apply to the HRO the improved circuit of the HRO-7.

* Pickerington Road, Reynoldsburg, Ohio.

A top view of the "modernized" HRO. The old oscillator tube and socket have been replaced by an aluminum plate that mounts a 6C4 oscillator tube and 0A2 regulator tube. A 6H6 second detector has been substituted, and a 6H6 noise limiter and 6SJ7 audio amplifier have been added.

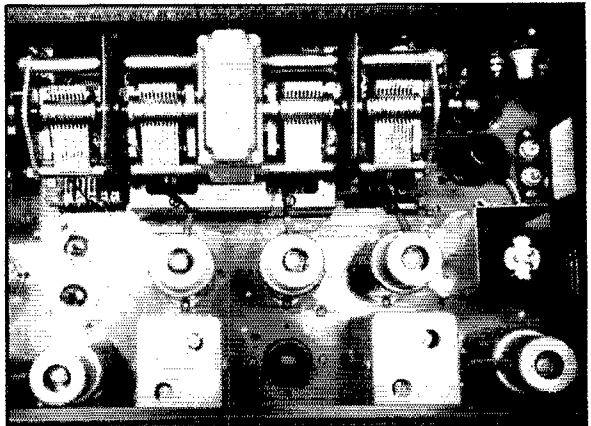

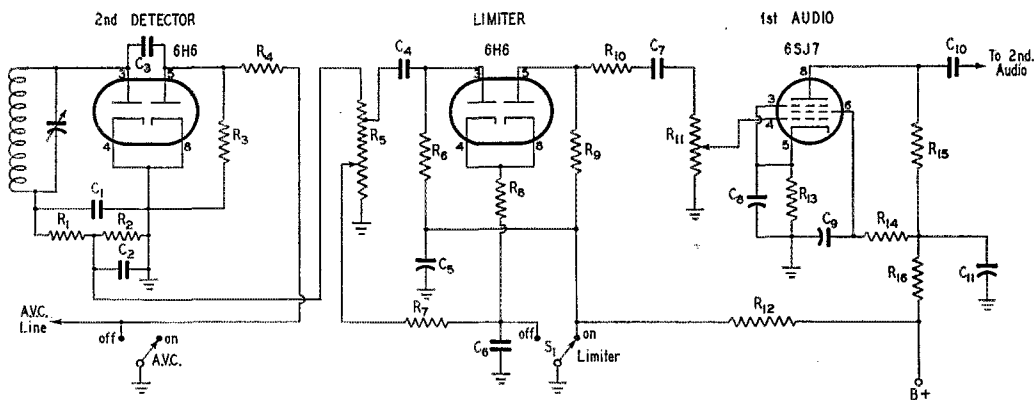

Fig. 2 — The revised second detector and first audio, and the new limiter, are from the circuit of the HRO-7.

- C₁ — 270- μ fd. mica or ceramic.
- C₂, C₃ — 100- μ fd. mica or ceramic.
- C₄, C₅, C₆, C₈, C₁₀, C₁₁ — 0.1- μ fd. 100-volt paper.
- C₇ — 0.01- μ fd. 600-volt paper.
- C₈ — 25- μ fd. 50-volt electrolytic.
- R₁, R₁₆ — 47,000 ohms.
- R₂, R₉ — 0.47 megohm.
- R₃, R₄ — 1.5 megohms.

- R₅ — 0.5-megohm potentiometer tapped at 22,000 ohms (IRC Type D17-133X) or as in Fig. 3.
- R₆, R₇, R₈, R₁₀ — 0.22 megohm.
- R₁₁ — 0.5-megohm volume control.
- R₁₂, R₁₄ — 0.82 megohm.
- R₁₃ — 2200 ohms.
- R₁₅ — 0.1 megohm.
- All resistors half-watt.
- S₁ — Switch mounted on R₅ (IRC No. 43).

Remove the h.f. oscillator brush board (the bar with four contact fingers in the right-hand coil slot) and add a fifth contact arm to this brush board, by using a piece of spring brass or any other similar material. The brush board is already drilled and slotted for the fifth contact. All that is necessary is to fashion the arm out of suitable metal and fasten it on the board with a small bolt or rivet. If you desire, a new 5-contact brush board can be purchased very cheaply directly from the National Company, Malden, Mass.

Connect the temperature-compensating condenser from this new contact arm to ground. Be sure to leave the condenser leads long enough so that the compensating condenser can be pressed against the 6C4 oscillator tube. Use a small ceramic stand-off insulator to support this condenser and give it mechanical rigidity.

Next remove the 28-Mc. h.f. oscillator coil can from the plug-in rack and remove the coil assembly from its shield can. Solder a connection from Contact 1 (it is plainly marked and was previously unused) to the stator connection of the bandspread trimmer condenser. Make it short and stiff for mechanical rigidity. Replace into the shield can and back onto the rack. Repeat the operation for the 14- and 7-Mc. coils. Leave the 3.5-Mc. coils untouched.

Warm up the receiver and realign the bandspread trimmer on the h.f. oscillator coils for 28, 14 and 7 Mc. This is Adjustment 7 in the HRO instruction manual. A slight decrease in capacity is necessary, because you have added 10 μ fd. across this trimmer. Remember that the h.f.

oscillator should always be on the high-frequency side of the signal, so if your oscillator tunes at two points the counterclockwise one is the correct point. See page 8, HRO instruction manual. Check your bandspread. On the 28-Mc. coil, 28.0 Mc. should come at 50 on the dial and 29.7 Mc. should come at 450 on the dial. Similarly, the band limits for the 14- and 7-Mc. coils should come at 50 and 450. If the bandspread is out, realign as outlined on pages 8 and 9 of the manual.

Exact temperature compensation is secured by pressing the compensating condenser closer to or farther away from the 6C4 oscillator tube. In the writer's receiver the correct point is approximately $\frac{1}{8}$ inch from the center of the side of the 6C4 tube. At W8GZ this adjustment gives a maximum drift at 29.7 Mc. of plus or minus one (1) dial division, starting with a cold receiver.

If the oscillator "sqeags," or operates at several frequencies simultaneously, reduce the grid leak to around 18,000 ohms or else use a grid condenser of lower capacity. Do not change the oscillator coil!

A final point on temperature compensation. Remember that a cold coil plugged into a hot receiver will have some drift in spite of your compensation. You can correct this by keeping the extra coils on top of the receiver or any other place where their temperature will be substantially the same as that of the receiver. If you desire, you can introduce additional temperature compensation directly into the plug-in coils by removing the coils from their shield cans and soldering a small negative-coefficient condenser from Terminal 1 to Terminal 4 on the 28-, 14-

and 7-Mc. coils. The exact size of this condenser will depend upon your own particular HRO. After adding the condenser you must still be able to "zero" the oscillator with the bandspread trimmer condenser. The writer's experience has been that condensers of from 3 to 5 $\mu\text{fd.}$, with a coefficient of $-0.00077/\mu\text{fd.}/\mu\text{fd.}/^{\circ}\text{C.}$ are about the maximum usable capacities. A little trial and error will give you the best possible combination. However, unless you do a lot of coil shifting this coil compensation is hardly necessary.

Noise Limiter

At W8GZ one of the rhombic antennas parallels a state highway for nearly 1000 feet. The ignition interference is terrific! After much cut and try, the writer settled upon the circuit shown in Fig. 2 as giving the best results with a minimum of change in the HRO.

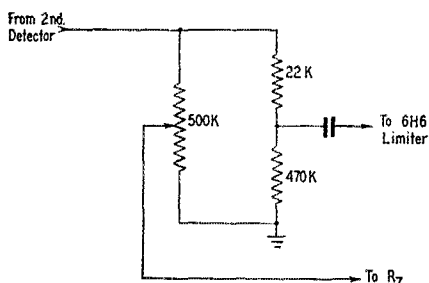

Fig. 3 — A substitute circuit for R_5 of Fig. 2.

The first step is to take your HRO "as is" (either with or without the h.f. oscillator conversion). Connect a signal generator or some source of definitely fixed and unvarying signal to the antenna terminals and feed a 28- or 14-Mc. signal into the receiver. The exact frequency is unimportant. Tune in this signal very carefully and make a note of the S-meter reading. You are now ready to begin work.

The added antenna-shorting relay is mounted under the antenna terminals (near the b.f.o. tuning condenser).

Remove the 6B7 second detector and its socket from the chassis and replace with a 6H6 socket and tube. Connect it as shown in Fig. 2. Mount the 6H6 noise limiter and 6SJ7 first audio into the chassis directly behind the S-meter, the 6H6 noise limiter to the front. The noise-limiter control is mounted to the lower right of the head-phone jack. Connect as in Fig. 2. Both 6H6 tubes use 4.3-ohm 2-watt resistors in series with the heaters to reduce the voltage at the sockets to 5.0 volts.

The noise-limiter control may be either a 0.5-megohm potentiometer with a tap at 20,000 to 25,000 ohms (Fig. 2) as is used at W8GZ, or it may consist of a 0.5-megohm potentiometer shunting a 22,000-ohm and a 0.47-megohm resistor (Fig. 3) as in the HRO-7.

After completing the wiring realign the 6H6 second detector for maximum output. (Adjustment 13 and 14, HRO instruction manual.)

Reconnect the signal generator or signal source and again tune the signal in carefully as before. The S-meter reading will now be somewhat lower than it was before adding the noise limiter. Using a long screwdriver or similar tool *very carefully* increase the capacity of the crystal-filter output coupling condenser by turning clockwise (Adjustment 9, HRO instruction manual) until the S-meter reads the same as before installing the limiter. Do *not* go beyond this point or you will lose selectivity.

Your conversion is now complete. The S-meter should operate exactly as it did before conversion. You have a receiver with an extremely stable oscillator and an excellent noise limiter — and last but not least the over-all gain of your receiver is slightly higher than it was before you started work. While you are at it hadn't you better check your tubes and then touch up the alignment of the entire receiver in accordance with the instruction manual?

(Continued on page 116)

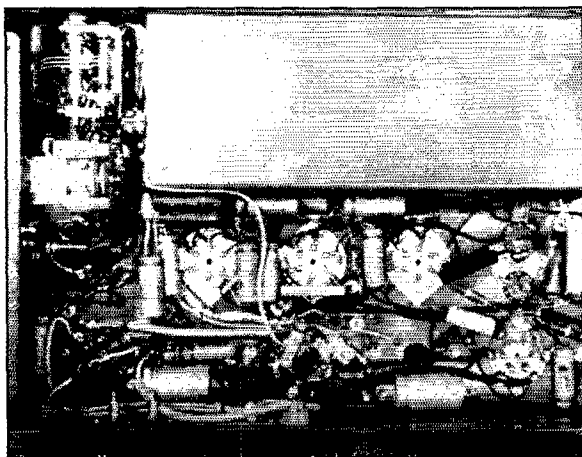

An Experimental All-Band Nondirectional Transmitting Antenna

Some Possibilities Offered by the Tilted Folded Dipole

BY G. L. COUNTRYMAN,* WIRBK, W3HH

Few improvements in antennas for the lower frequency bands have been forthcoming for several years. The arrangement to be discussed is not entirely original with the author but was based on some Navy antenna studies. Initial tests indicate that it may provide an acceptable solution to amateur multiband operation.

Briefly, it is an aperiodic system that will give uniform output over a frequency of approximately a 5-to-1 ratio with nondirectional characteristics and without critical adjustment. In fact, the only adjustment is to couple the final tank to a 600-ohm line.

The practical experiments conducted by the author are incomplete, but it is hoped that the publication of the data contained herein will encourage experimenting by other amateurs.

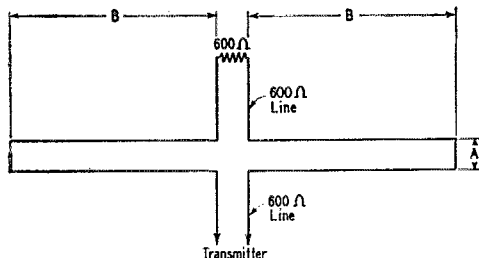

Fig. 1 — General diagram of the terminated folded dipole. Dimensions for *A* and *B* are suggested in the text.

There are many questions unanswered: measured variation in standing-wave ratio over a given frequency range, loss in power attributable to the resistance termination, experimentally-obtained radiation patterns, etc.

Essentially, the system — shown in Fig. 1 — is a nonresonant folded dipole. It is fed with a 600-ohm line. This antenna, if horizontal, will be quite directional at right angles to its axis, with pronounced minima off the ends. As the antenna is tilted with respect to ground, this pattern gradually changes until at an angle of 30 degrees it becomes nondirectional for all practical purposes. Translated into terms of amateur construction this means that only one mast is required, together with a short pole six feet or so in height

* Comdr., USN; Electronics Officer, Boston Naval Shipyard, Boston, Mass.

• Those hams who are experimentally inclined will no doubt be interested in the possibilities that this antenna system suggests. Practical tests by the author have shown that the single antenna may be operated over a frequency range as great as 5 to 1 with a relatively small change in the standing-wave ratio on the line and that the pattern is essentially nondirectional.

supporting the low end. There seems to be no marked advantage in an increase in over-all height of the antenna. On the contrary, reports from a distance indicate that signals are definitely better with one end of the antenna only six feet from the ground, perhaps because of a resulting lower angle of radiation.

Because complications are introduced by the resistance termination, it is difficult to make an adequate analysis or evaluation of a terminated folded dipole by conventional methods. It becomes necessary to measure performance experimentally.

One of the Navy laboratories has investigated the performance of this type of antenna and has reported unfavorably upon it. However, the laboratory study was based upon a vertical monopole erected over a metallic ground plane, using conventional measuring instruments, and the characteristics obtained were applied mathematically to arrive at theoretical characteristics for the resistance-terminated folded dipole. Operational tests were not made by this laboratory and their theoretical findings are not borne out by the limited practical tests conducted by the author.

It is of interest to note that the standing-wave ratios estimated by the laboratory for various frequencies from 4 to 22 Mc. ranged from a minimum of 1.4 to a maximum of 2.6, with an average close to 1.7. These ratios compare favorably with average s.w.r.s found in amateur installations. It should be remembered that these standing-wave ratios were not measured but were arrived at by calculation.

Dimensions

Fig. 1 gives a general idea of the system with the important dimensions indicated except for

the angle of tilt. Fig. 2 indicates the required tilt with a suggested pole arrangement and dimensions pertaining thereto. Two particular sizes should be of interest to amateurs, one of which will have maximum efficiency from 3.5 Mc. to

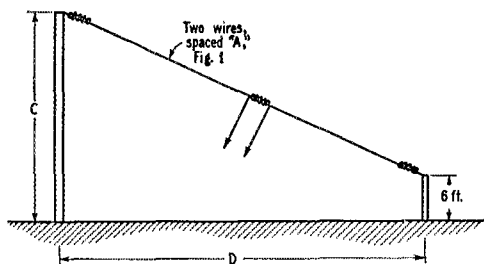

Fig. 2 — Tilting the terminated folded dipole tends to make the pattern nondirectional. For dimensions C and D, see text.

17.5 Mc. and the other being optimum from 7 Mc. to 35 Mc. Dimensions may be developed using the formulas set forth to cover higher-frequency bands, but at 28 Mc. and higher frequencies directional arrays are easy to construct and preferable because of the increased gain. The following dimensions are applicable to the frequency ranges selected above:

Dimension	3.5 to 17.5 Mc.	7 to 35 Mc.
A	2 ft. 10 in.	1 ft. 6 in.
B	46 ft. 10 in.	23 ft. 5 in.
C	56 ft. 0 in.	32 ft. 0 in.
D	80 ft. 0 in.	44 ft. 0 in.

For an impedance of 600 ohms, the center-to-center spacing of the feeder wires, divided by the diameter of the feeder wires, must equal 70. This means that No. 12 wire spaced six inches will be acceptable. Six-inch spreaders are readily available and the wire will not stretch unduly. No. 10 wire should be spaced 7 inches and No. 16 wire should be spaced 3½ inches.

Terminating Resistor

The terminating resistor should be non-inductive and have a minimum rating equal to 35 per cent of the input power to the final stage. It may be a carbon or graphite rod, adequately protected from the elements, or merely a long 600-ohm transmission line constructed of resistance wire. If the latter is used, the line may be carried vertically down from the center of one leg of the antenna to a short pole and then, if required, extended to one of the masts and doubled back and forth between the masts. If a carbon resistor is used, there is apparently no difference whether the rod is connected directly into the antenna as shown in Fig. 3, or at the end of a transmission line, as shown in Fig. 1. However, it is easier to adjust the resistance and

protect it from the elements when it is installed at a fixed location on the ground than when it is suspended across an insulator in the antenna wire.

Formulas

The following formulas will be of assistance in developing antennas for different frequency coverages:

$$\text{Antenna-wire spacing (A)} = \frac{3000}{f \text{ (kc.)}} \times 3.28$$

for lowest frequency

$$\text{Antenna length, each half (B)} = \frac{50,000}{f \text{ (kc.)}} \times 3.28$$

for lowest frequency

To convert decimal parts of one foot into inches, multiply by 12.

$$\text{One meter} = 3.28 \text{ feet.}$$

$$\text{Frequency (kc.)} = \frac{300,000}{\lambda \text{ (meters)}}$$

The length of the antenna and the wire spacing may well be the object of further experiments but initial tests indicate that the first two formulas shown above are reasonably accurate and that the system is operable over a 5-to-1 frequency range as previously mentioned.

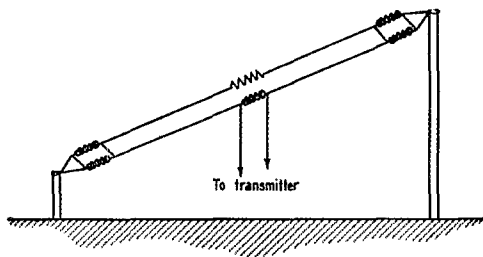

Fig. 3 — The terminating resistor may be placed directly in the antenna, or at the end of a transmission line as indicated in Fig. 1.

Initial tests with these antennas indicate no change in signal strength on 40 meters at a distance of 2000 miles when compared with a conventional half-wave antenna, center fed with tuned feeders and carefully adjusted for optimum output at one selected frequency. Good reports were received on both 20 and 80 meters but comparative reports are not available because of the lack of antennas specifically designed for those bands. Transmitter loading was normal.

NATIONAL EMERGENCY FREQUENCIES

C.W.	'PHONE
7100 kc. (day)	3875 kc.
3550 kc. (night)	

During periods of communications emergency these channels will be monitored by stations of the National Emergency Net for the handling of third-party personal-inquiry traffic.

A Two-Bit Tower with Million-Dollar Performance

BY W. C. RIPPY, JR.,* W4HYR

ANTENNA trouble, mate? Then lend an ear to a plan for a sky hook that's simple and cheap to build, yet strong enough to withstand sleet, windstorms and other inclemencies of the weather. The idea was borrowed from steel towers used in constructing the Allatoona Dam in North Georgia. Those 100-foot towers were unusually strong, capable of supporting 40-ton buckets of concrete between them.

width and breadth as you build toward the top but in this case width and breadth are uniform and cross boards are all the same size, thereby saving you a lot of time measuring and sawing.

Construction

To construct the mast, lay out two sides first. Get twelve 15-foot 2×2 s, three for each corner. Splice each three of them with 8-foot 1×2 s, and you have four 45-foot pieces. Nail the fourteen 3-foot 1×2 s zigzag fashion between each pair of the 45-foot lengths: The distance between each pair of long pieces is now one foot. Then nail 1-foot braces across the sides at the bottom, middle and top, three on each side.

The two sides are now ready to be put together — with more of the 3-foot 1×2 s and short braces. When finished, you will have fourteen zigzag 1×2 s and three braces from top to bottom on each side.

The ladder comes next, and then the paint. Future builders of such towers can profit by the writer's experience in two respects. First, put the ladder on the outside rather than on the inside of the structure! While having it on the inside may add to the beauty of the finished product, the pressure of climbing feet slowly presses the steps away from the corner pieces and in time weakens the nails to the danger point. Use conveniently-spaced short 1×2 s for the ladder.

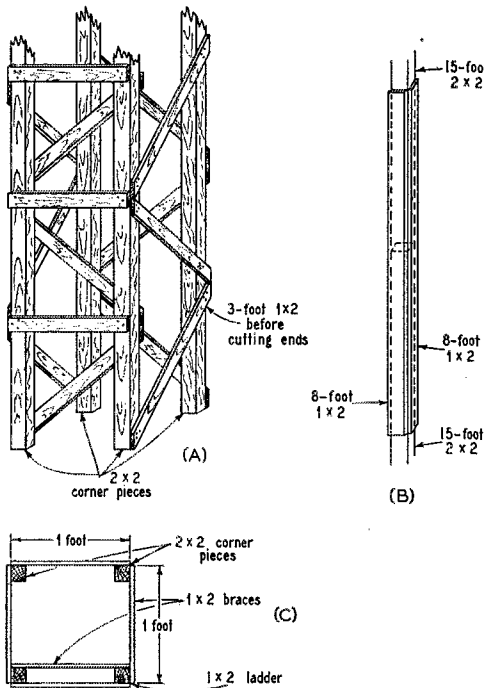
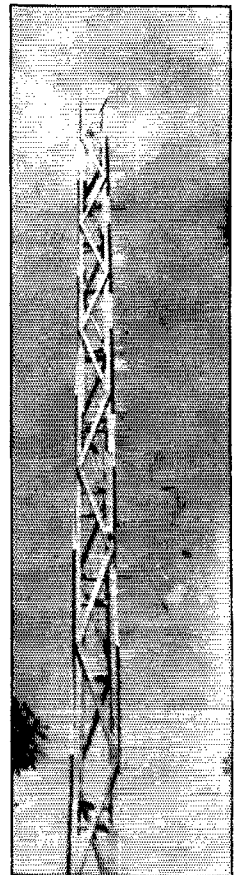

Fig. 1 -- Details of the tower construction. The general assembly is shown at A, with a cross-sectional view at C. The method of joining the 2×2 corner posts is shown in B.

The antenna mast is a small replica of the construction tower. It looks like a 40-foot-high vine trellis, one foot square in cross section, with fourteen 3-foot 1×2 s nailed zigzag fashion from bottom to top on four sides. The whole structure weighs only 180 pounds.

The unusual feature of this tower is the simplicity of construction. Some towers decrease in



The "two-bit tower" belies its name, both in appearance and performance.

Use conveniently-spaced short 1×2 s for the ladder.

* 3542 Kingsboro Road, N.E., Atlanta, Ga.

The finished tower was painted with white creosote. White was fine, probably the best color for outside work of this type. However, the creosote flaked and peeled in about six months, making it necessary to repaint the tower with more durable outside white house paint. So use house paint the first time.

Putting Up the Tower

The tower uses two sets of guy wires, four from the top to support the structure and four from the middle to prevent sympathetic vibration.

First, level the site for the base. Iron stakes driven into the bedrock and bolted to the tower will help steady it. Lay bricks level within the iron stakes for the wooden mast to rest on, to discourage termites.

Now for erecting the tower. In spite of the light weight, its shape calls for the strength of six men to stand it on end. A gin pole and block-and-tackle simplify the job of getting the tower up the last 60 degrees. When it is up, tighten the guy wires and the job is finished. Hang your antenna on it, and all is set.

The long pieces for your corner posts, white pine, should run about \$7. The rest of the lumber, crosspieces, bracers and splicers, will be about \$10. Paint, one gallon of good-grade outside white, costs \$5.40. New stranded stainless-steel wire (enough for this job) runs about \$5.60. Also, you will have to invest in some strain insulators for your guy wires and the iron spikes. Although this totals \$30, you should be able to build this tower for half the price if you dig around the secondhand lumber piles.

The tower is strong, stable and sturdy in all types of weather, including heavy wind. The tower shown in the photograph completed its second winter with flying colors — no sign of weakness in spite of much sleet and many windstorms. Such a tower should last as long as a house built of similar materials.

And when you want to paint again, don't hesitate to climb to the top. True, it seems risky to climb a 1 x 1 x 40-foot structure, but don't be afraid — it is stable. No "rocking" was detected when the job was done at W4HYR. Stable, weatherworthy and cheap, this tower is well worth your time and money to build.

Strays

It is only natural that Salesman-SCM W6RA should haunt the Hamm Building in Saint Paul in quest of business!

— . . . —

Another record fell by the wayside recently when ten-year-old Jane Bieberman, W3OVV (our December cover), and nine-year-old Kent Lattig, W9FZE (our March cover), worked each other. Frank, VE2TA, who is eleven years old, has also QSOed Jane. The pre-Teen-Agers are now out to make it an international three-way.

HAMFEST CALENDAR

ALASKA — July 25-26th, at Paxson Lake, between Anchorage and Fairbanks. Auspices Arctic Radio Club. Competitions, rag-chew sessions, banquet, XYL program. Particulars from H. B. Frickey, KL7EC, % Radio Supply Co., Fairbanks, Alaska.

ALBERTA — July 30th-31st, at Edmonton. Sponsored by Northern Alberta Radio Club. Varied program includes entertainment, contests, etc., for OMs and XYLs. Bring bathing suits, golf clubs and portable gear. Get further dope from Secy., Northern Alberta Radio Club, Box 129, Edmonton, Alta.

CALIFORNIA — June 26th, at Chico. Staged by Golden Empire Radio Club of Northern California. Registration, \$1.50, includes contests, Dutch lunch, entertainment, program. Tickets or information from Secy. Winston E. Roberts, W6GUV, P. O. Box 19, Chico, Calif.

CALIFORNIA — June 12th, at Coyote Point, San Mateo. (Turn east at Peninsula Ave. overpass, look for the 10-foot balloon.) Two-meter hidden-transmitter hunt, brass pounder's contest, auction, children's games with prizes, special YL and XYL events. Bring your lunch — coffee free! Tickets \$1.00.

DAKOTAS — June 12th, at Island Park, Mayville. N. D. Hamboree-picnic, good fellowship, free ice cream and drinks. Bring the family or YL and a picnic lunch. In event of inclement weather affair will be held in the Municipal Auditorium.

GEORGIA — June 5th, at Grant Park, Atlanta. Auspices Atlanta Radio Club. Barbecue, noted speakers, contests, all-around good time scheduled. Reservations, \$2.50, to Gus Barron, WAEFS, 425 Peachtree St., N. E., Atlanta, Ga., by June 1st.

ILLINOIS — June 5th, at Camp Ki-Shau-Wau, near Starved Rock State Park (follow signs south from junction Routes 71 and 178). Sponsored by Starved Rock Radio Club. Entertainment, speakers and exhibits are billed. Lunch available on grounds. Come, rain or shine — shelter available. Advance registration \$1.00, at the gate \$1.50.

ILLINOIS — June 26th, at Weldon Springs State Park Pavilion, near Clinton. Sponsored jointly by Cenosis Amateur Radio Club, Danville Amateur Radio Club, Bloomington Amateur Radio Club, Springfield Amateur Radio Club, Weldon Springs Amateur Radio Club, and the Decatur Signal Depot Amateur Radio Club. Starts at 11 A.M., rain or shine. Bring the family, would-be-ham friends and a picnic lunch — admission and refreshments free! Picnic motto: "Free for All — All for Free."

IOWA — July 17th, at Fairmont Park, Council Bluffs. Auspices Council Bluffs Radio Operators Club. Two-meter treasure hunt, featuring big prize, starts at 2 P.M. Registration, \$1.50, includes all the food and whistle-wetter you can hold. Tickets available in advance from Secy. O. W. Miller, W0SEE, 2926 Ave. C, Council Bluffs, Iowa.

MONTANA — July 16th and 17th, at East Glacier in Glacier National Park. Fourteenth Annual Glacier-Waterton International Peace Park Hamfest. Cabins with or without housekeeping facilities available as well as coffee shop, meals, store, gasoline and oils. Plan your vacation around this get-together. Write Ray A. Fretz, W7DSS, Secy., 401 First National Bank Bldg., Great Falls, Mont., for further information.

NEBRASKA — June 5th, at Cody Park, North Platte. Arranged by North Platte Amateur Radio Club. Bring picnic lunch — refreshments free! Additional information available from C. A. Colvin, W0VHR, 5319 No. 52nd St., RFD 7, Omaha, Nebr.

SASKATCHEWAN — July 1st, at Regina. Plans for a gala time now being formulated — be sure to attend. Contact SCM J. H. Goodridge, VE5DW, % Canadian Pacific Air Lines, Prince Albert, Sask., for reservations or particulars.

• Technical Topics —

Still More on the "Super-Selective C.W. Receiver"

THE April issue of *QST*, with its "Technical Topic" on the W9AEH receiver, was out only a few days when several letters came in with tips on the transformers and on the receiver. Here is a summary of the information.

George Goldstone, W8MGQ, wrote to tell us that the CFI unit from an ART-13 transmitter has some coils that might be used in sharp low-frequency transformers. The little unit marked "Z-2201" (there are two in a CFI) contains a 50- and a 200-kc. tuned circuit. Both inductors are slug-tuned in powdered-iron pots, and they are mounted side by side in a bakelite housing inside a shield can. By removing the 200-kc. coil and substituting the 50-kc. coil from another unit, it should be possible to make a fair transformer. On the *Q*-meter, the 50-kc. coil shows a *Q* of 80 at 85 kc., just twice that of the coils in the 85-kc. transformers used in the BC-453. Some stores have the Z-2201 units for 25 cents — a CFI unit for about \$1.50 has two Z-2201 units. We haven't tried these as transformers in a low-frequency i.f. strip, but we can vouch for the *Q* figure.

From Canada, A. E. Pugh, VE5AP, writes to say that the Bendix MN-26 radio-compass receiver, available in surplus, contains a total of 22 powdered-iron pots and cores, with various coils mounted in the pots. Many of them tune to around 110 kc., so they are in the range and might be useful. The receiver has a wealth of condensers and resistors, a 5-gang tuning condenser and a 24-volt dynamotor. We don't know how useful the coils would be in i.f. transformer applications, and the receivers go for about \$25 in the current market, so we may never know, unless the QRM gets real bad.

But apparently you have to hear the W9AEH receiver before you really wake up to this selectivity business. Harold Leighton, W9LM, writes to tell what he did after listening to the receiver on several occasions. He was so impressed that he wanted something like it. He had a McLaughlin Selectable-Sideband Adapter¹ on the tail end of his HQ-129, but it wasn't good enough on c.w., so he added a little additional selectivity. He took six Hammarlund SS-50 transformers (special low-frequency transformers available for the McLaughlin system) and increased the separation between pots by $\frac{3}{8}$ inches, to loosen the coupling. He then built an i.f.

amplifier using two of these transformers between each stage, and patterned the detector circuit after the McLaughlin design. For a 50-kc. b.f.o. he used the coil from a BC-453 surplus unit, padded with micas and tuned by a 100- μ fd. variable.

To give him the various degrees of selectivity he wants, a 4-position switch is used. The first gives straight audio output from the HQ-129, with the crystal filter in Position 4. In the second position, the headphone output is taken from the selectable-sideband adapter. Position No. 3 gives the receiver selectivity plus the selectable-sideband adapter selectivity plus the six loosely-coupled SS-50s selectivity, and No. 4 uses all this plus an audio filter! A beat note of about 375 kc. is generally used, and in Positions 3 and 4, no signal has ever been heard on the other side of zero beat, and practically all signals are gone by the time the beat reaches 800 cycles on the high side. Plates have been removed from the band-spread condenser in the 129, and only 150 kc. is covered on 14 and 28 Mc., and on 3.5 and 7 Mc. only 30 kc.! The main bandset condenser is reset to cover the band. On 40 and 80 meters, all of the selectivity can be used practically all of the time. The most trouble with drift comes from the HQ-129 b.f.o., which is used only in Position 1 and so is of little importance. Fine tuning is available on the 50-kc. b.f.o., however, and a handy gimmick is the pair of pencil marks on the panel that permits flipping the b.f.o. from one spot to another that gives exactly the same beat note on the other side of the signal.

Selectivity? It looks like we're just beginning to scratch the surface. With selectivity comes the requirement for more stability, and with both comes more enjoyable operating. Who said everything had been done in amateur radio?

— B.G.

Sweepstakes Scores Next Month

• The unusually tight space situation this issue, imposed by the need for bringing to the attention of members the full text of the new proposed FCC rule-making (pages 20 through 23), has made it necessary for us to hold over until July *QST* publication of the official results of the 15th ARRL Sweepstakes.

¹ McLaughlin, "Selectable Single-Sideband Reception Simplified," *QST*, April, 1948.

1949 ARRL Field Day Rules

Annual Test for Emergency-Powered Stations, June 18th-19th

BY F. E. HANDY,* WIBDI

This year's Field Day provides for (1) *club-and-group portable station participation* like that of last year, *except* no battery multiplier, (2) *unit or individual portable-station participation*, just as last year, including the 1.5 multiplier when everything is on batteries, and (3) *mobile-rig participation*, a new department of listings distinct from either of the above for any amateur stations that qualify for such separate listing. Mobile entries, invited this year, must be under *one call* throughout the FD, that of the amateur having legal control of the particular mobile installation. Each mobile-entry call signal must be different from that of *any other* FD station participating. Only *one* mobile can be entered under the one call. ARRL will classify mobile entries for listing by 1, 2, etc. transmitter classes, depending on the number of transmitters used at the same time. Most, of course, will be "1 transmitter." "Mobile" reports must show individual control (call signal), list operators handling key or mike, give antenna type and length, power supply, and *may* credit or identify this entry with one club, if a member, and if desired to contribute to some club's "aggregate mobile" score. Mobiles can claim 1.5 multiplier credit, where all equipment runs from batteries. (4) *Home-station participation*. This is the customary listing of work reported by fixed amateur stations with those afield.

Signal reports and ARRL section or specific location must be exchanged in proof of QSO. All station operation must be in compliance with government regulations to be accepted for FD credit. The rules include the usual liberal multiplier credits for contacts made independently of commercial mains. The credits for correct radio relaying of *FD messages only* are 1 for receiving, 1 for sending onward by radio and 25 for a single radio-origination. Instead of sending the special Field Day messages out of the section, they should be given to stations in the *same* state or section where your SCM or SEC will get them by radio, or later mail delivery. Avoid errors in form or "check" that will deduct points from your score. Mobiles can cross a time-zone line but *not* receive credit for more than 24 hours operation if they do so. Antennas so long as to take *external support* (impractical for vehicle in normal motion) cannot be used for any contacts

* Communications Manager, ARRL.

¹ Not Daylight Time.

ALL LICENSED AMATEURS, RADIO CLUBS & GROUPS:

Test mobile as well as portable stations in the 1949 ARRL Field Day — June 18th-19th.

Starts 4 P.M. Local Standard¹ Time, Sat.

Ends 4 P.M. Local Standard¹ Time, Sun.

without classifying the station as class (1) or (2) instead of (3) above. Rigs designed to give several hours of service from car batteries, "transportable rigs with handles," suitcase portables, gas-powered message-center type stations suited for community clearing-house purposes, precut antennas, car rigs that have *installed* equipment to work on 3.5-, 3.9- and 7-Mc., also on "two" and "ten" for local contact service (as in the Vanport disaster where dike patrolling was necessary) should *all* be part and parcel of Field Day planning!

Locations, Band-Mode Transmitter Groupings, Scoring Plan, Definitions and Examples

Locations: For participation in classes (1) or (2) all control locations for equipment operating under one call and responsibility-to-FCC (or Canadian government) *must be not more than 500 feet from a given spot* for points to count toward one score. *Only* portables in the field, away from fixed-station power and conveniences, are eligible for such listing. For class (3) or mobile participation a single identifying call used through the entire FD and differing from any other station taking part must be used, but there are *no restrictions* as to location. Reports must show point(s) of operation. Class (4) home stations must be at government-recorded addresses.

Bands: One transmitter may be changed from band to band at will for a 1-transmitter entry. The number of units in simultaneous operation *at any one time* determines our classification of the entry. It is regarded as improper, unethical, and grounds for disqualification to use more than one transmitter at one time in the same band. (Such as one on 3510 and 3800 kc., or 14.1 and 14.35 Mc., for example.) This is not construed to bar two transmitters, one on 75 fone and one on 80 c.w., or one on 7-Mc. and one on 3.5-Mc. c.w. at the same time, for a 2-transmitter-class entry.

Each 'phone and c.w. band or band-made sector is regarded as a separate band. A.m. and n.f.m. are considered the same mode for FD purposes. (Eleven meters will be regarded as one band using voice, another when using c.w., as distinct from similar 10-meter considerations.)

The following 13 bands (and additional u.h.f.-s.h.f. bands if you choose) constitute *separate bands* on which simultaneous operation may be arranged if desired: *A1*: 3500-4000, 7000-7300, 14,000-14,400, 27,160-27,430, 28,000-29,700 kc.; 50-54 and 144-148 Mc. *A3*: 3850-4000 kc.; 142-143, 285-297 Mc.; 27,160-27,430 kc.; 50-54 and 144-148 Mc. (In Canada VE 'phone bands apply.)

Points: Each amateur station worked by an FD station counts 1 point toward the score. *The same station contacted again counts only if the FD transmitter credit reported is on a different amateur frequency band.* . . . see (3). (*Home stations*: 1 point per FD portable worked.)

Message Credits: The text of Field Day messages to SEC or SCM (see address in *QST*, p. 6) will include (a) the number of operators, (b) location or QTH, and (c) the number of AEC members at the FD station. Each such message originated by radio counts 25 points before multiplier (there will be a deduction of ten points for omission of handling data and ten for defects in form or procedure), if the text is submitted with a worked list by bands showing on-off times for each transmitter. *Relays*: 2 added points before multiplier (1 for receiving, 1 for sending on) may be claimed by FD handling station. Delivery to addressee is required on all FD messages in transit at end of the test as prerequisite to credit, of course. (*Home stations*: 1 point for each message received and mailed to Hq., 2 points for relays, 1 when received, 1 when forwarded by radio.)

Multipliers: Multipliers are not applicable to home stations. The scores of all FD stations in the Northwestern, Pacific, Rocky Mt., Southwestern, and West Gulf Divisions will be multiplied by 1.5. *FD credits*: Powers up to and including 30 watts input to the final take a multiplier of 3 for the points earned. Power limits between 30 and 100 watts, inclusive, similarly take a multiplier of 2 for the points earned when so operating.

Independence-of-Mains Multiplier: Multiply points by 3 when obtained operating with all radio equipment independent of commercial power source.

Battery-Credit Multiplier for Mobile, or Unit-Individual Entries: (Not applicable to club-and-group or home-station entries). Score of class (2) and (3) entrants is subject to additional multiplier of 1.5 for points made while using battery power source on *all equipment*. Charging batteries from *commercial mains* while said batteries are connected to transmitter or receiver voids the "independence-from-mains" multiplier.

Regarding battery power, the battery capacity or size should in all cases be adequate to make station operative for at least one hour of continuous operation to justify use of a 1.5 multiplier, applicable only for entries in class 2 or 3. Like other multipliers, this will apply *only* to those QSOs and message points earned at times when station is completely operated from a battery primary source.

Club Aggregate-Mobile Scores. In addition to each unit mobile entry by the controlling licensee, a club claim may be submitted in the form of separate letter-tabulation of all *mobile* scores of bona fide resident members. All club mobile credits will be separate from and not combined in any way with club-and-group scores derived from work at club or group location. It will be required that the club identity be noted on mobile logs of the individual reporters as well as that the club secretary submit a claimed aggregate-mobile score for any club mobile credit. Credits to the degree supported by the logs of the individuals will be allowed. Only club members residing in a club territory, belonging to and attending meetings of a club, may contribute to an aggregate-mobile club listing.

Definitions

Mobile stations (Class 3) are defined as complete installations including power source and antenna, mounted in or on vehicles and capable of being used while in normal motion. (A boat, car, trailer, etc. station installation may qualify . . . but the antenna used must be proper for actual mobile use, *not* a long wire or beam that could not be utilized without earthbound support apart from the vehicle itself. If they utilize antenna supports *not normal or suitable* for use during vehicular motion of the vehicle in which installed, boat, car, etc., installations must be classified as portable *instead of mobile*, and either under class (1) or (2) instead of (3). Likewise, a car installation that has to plug in on a commercial source is "earthbound" and must be classified as portable. Such may be capable of small movement but is not mobile in fact. (Contacts may be made in motion or from any location(s) without prejudice to entry, however.)

Portable stations are those established at sites away from customary fixed-station locations for FD purposes. All units, including antenna, must be transported, erected and reassembled for the Field Day except where transported as one ready-to-work unit. Portable equipment or units will be placed *under one call* and the control of *one licensee*, for *one-score group* or entry.

Unit or individual participation (Class 2) is that portable-station work accomplished away from home site and submitted by either one or two licensed operators.

Club and group participation (Class 1) is that portable-station work away from home site sub-

mitted by three or more licensed operators.

Home stations (Class 4) are those fixed amateur stations not operating portable or mobile but reporting contacts they make with portable or mobile stations active in the FD.

Scoring

Example 1 (may be either of the Mobile, or Unit-Individual Classes):

Assume a 25-watt rig wholly on batteries, not originating or relaying any messages, and not having more than two operators.

40 points (40 stations)

×3 (power below 30 watts)

120

×3 (all power must be independent of commercial mains)

360

×1.5 (Class 2 or 3 and everything on batteries)

540 claimed score

Example 2

Same as Example 1 but one required message origination is duly sent and received for, and reported. We have:

25 + 40 = 65 pts.

×9 (3 × 3)

585

×1.5 (batteries and Class 2)

877.5 claimed score

Example 3

Assume a club, the Emergency Radio Club of Floodcrest, Wis. (or alternatively a group of 3 oprs.), runs a portable with 85 watts input to final, using batteries or gas generator. One message started in good form (25 points); 1 received and relayed onward (2 points), both reported to ARRL.

230 points (230 QSO) + 25 + 2 257

(power between 30 and 100 watts) ×2

514

(all independent of mains) ×3

1542 claimed score

No battery multiplier for either clubs or groups.

Reports

Mail individual and group reports on or before July 11th, eliminating duplicate contacts. Show contact time, band used, *attach traffic for claims*. Messages must show *handling data*, watts power and sources of power. Entrants must use the ARRL forms or follow the form to be given in June, '49, *QST*. Mimeographed FD forms are available on request.

"Dear Editor: I have followed with great interest your articles and correspondence on underground antennas.

"I tried several directive beams buried in four feet of moist earth. After several reports from various hams I found I had no more power than with the old skywire. I dug deeper — even tried rhombics — but reports were still the same ('Nice sig, OM, but some guy in California has 10 kw. right on you.')

!!! I consulted the old faithful ARRL *Handbook* and decided to try a multiple-wavelength vertical on ten meters.

"I did not have to look far for a suitable antenna site. We have a 200-foot well right in our basement. I hooked a variometer to the final tank and from same connected a No. 6 stranded wire to a pipe running into the well.

"I was delighted to raise a C2 in Hankow, China, on my first CQ. Chinese stations were heard that pinned the S-meter on the receiver.

"I soon discovered that all I could work were Chinese amateurs. Now wouldn't this bear out the *Handbook* theory that 'the more wavelengths an antenna has, the more it tends to radiate straight off the end'?" — W7LLE

W0HQW was walking along the street of a Northern Minnesota mining town, wearing his new radium-dial wrist watch, when he noticed several chaps following him, wearing earphones and carrying little black boxes — which turned out to be Geiger counters! — W0KYE

A notable QRP WAC performance has been turned in by W2GX. Using 3 watts input on 11-meter 'phone, Russ successfully completed the all-continent feat in *one day*! Some of W2GX's contacts were crossband to ten meters.

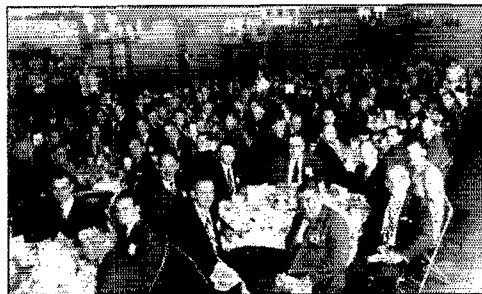

Tales of the "good old days" were swapped freely when approximately 200 venerables of ham radio turned out for the Fifth Old Timers' Night of the Delaware Valley Radio Association, on April 9th. Among those in attendance were Irving Vermilya, W1ZE, Lloyd Espenshied, C. D. Tuska, first editor of *QST*, A. L. Budlong, present editor, and Major C. F. Welch, USMCR, ex-W6BBK. Ed Raser, W2ZI, was general chairman and Les Allen, W2QOK, acted as toastmaster.



Correspondence From Members-

The Publishers of *QST* assume no responsibility for statements made herein by correspondents.

160 METERS

1109 S. Country Club Dr., Schenectady, N. Y.

Editor, *QST*:

I have just received the "flash" that 160 meters was opened as of April 7th.

The return of this nearly-lost ham band is double evidence that the League has again successfully defended amateur radio rights. I am fully confident that the League will handle successfully any similar situations which may arise in the future.

— George H. Floyd, jr., W2RYT

W. Palm Beach, Fla.

Editor, *QST*:

Although I am not primarily a 'phone man nor do I nurture such aspirations, I cannot but feel malevolently gleeful about the return of 160. Not only does it reaffirm the Government's confidence in the amateur but, for my money, it will put the lid on the coffin of the "anti-ARRL" clique of leftists. This, I think, is peachy!

— Gene Sykes, W4BRB

MEMBERSHIP DUES

University of Pennsylvania, Philadelphia 4, Pa.

Editor, *QST*:

Congratulations on the April editorial. Many of us do not appreciate the extra services rendered by the ARRL and what these services mean to amateur radio. I, for one, feel that the services are worth the full price of the \$4.00 a year and look upon *QST* as a bonus.

— Henry R. Pemberton, W3PN

1033 North 20th St., Lafayette, Ind.

Editor, *QST*:

The little story on membership dues certainly made me see the light. . . . My renewal will be forthcoming (as soon as I pay my spring taxes).

— John W. Milks, W9ZES

St. Raphael's Church, DuBois, Ind.

Editor, *QST*:

As a radio magazine *QST* alone is worth every cent of four dollars for twelve issues if one reads it carefully and not cursorily.

— Rev. Joseph Terstege, W9LQE

4818 Greenspring Ave., Baltimore, Md.

Editor, *QST*:

I've been reading various letters in *QST* from members who are kicking or resigning because of increased dues. Frankly, they don't deserve to belong. I think that membership in ARRL is the most reasonable value on today's superinflated market and why anyone should not think the same is beyond me. A subscription to *QST* alone (aside from membership privileges) is worth double its present cost from what I know of magazines. Where else could one find such a broad collection of technical data, etc.?

— Marx S. Kaufman, W3IUC

105 E. Mistletoe, San Antonio 1, Texas

Editor, *QST*:

I am inclined somewhat to be sympathetic with those who think the price too high. Take the April issue, for instance. It contains 112 pages but there are only 28 pages of technical information. That is just 25 per cent of the magazine. Advertising occupies 40 per cent. From this

viewpoint \$4.00 is a little high for about 300 pages of so-called technical information.

— Vernon S. Wier, M.D.

536 Merchants Road, Rochester 9, N. Y.

Editor, *QST*:

It is only with much hesitation that I enclose my four dollars for another year of *QST*. I have not overlooked your first notice, because I was considering the reasons for the increase in dues as given in *QST*.

True, your costs of operation have increased, and it is only fair that your income should increase also. The dues in the ARRL have increased in the past two years over one-half.

I would like to know how your advertising rates have increased in the same period of time. I do know that your classified advertisements in *QST* have not increased at all.

— Robert W. Kester

[EDITOR'S NOTE: Wrong, OM. Classified-ad rates have doubled since the war; only the special member rate, less than production cost and thereby operated as a membership service, remains the same. Display-advertising rates were increased proportionately to the rise in circulation back in 1945, two years before the first rise in dues.]

Box 55, Dix, Nebraska

Editor, *QST*:

Congratulations to you for printing the very good article on the 522. I, for one, would like to see many, many more such articles in future issues of *QST*.

As to the price of *QST* as mentioned in the April issue, I find that there are several articles appearing each year that are worth more to me than the subscription price.

— Raymond H. Johnson, W0WUV

1184 College Ave., Elmira, N. Y.

Editor, *QST*:

The DX cards which I receive thru the QSL Bureau are well worth the four bucks to me.

Just do the best you can for the "average ham" and let the chips fall where they may.

— Joseph W. Meyer, W2VVW

60th and Broadway, Galveston, Texas

Editor, *QST*:

I refer to the wails about the uppage in membership dues to the League.

Being in the broadcasting business, with many years of experience in same, I would like to point out to these disgruntled lads that we broadcasters would be ecstatically happy to be able to be a member of any organization which would give us legal, technical, and research services, and, give us an exceedingly valuable periodical, all for the sum of, let us say, ONE THOUSAND DOLLARS A YEAR! If we broadcasters could obtain such representation as the ARRL and its committees give to the amateur fraternity as a whole, we would be indeed awed at the prospect!

In small words, what I'm trying to say is this: For the services involved with the privilege of voting upon every important issue that arises . . . with the power of electing our own representatives for our particular area, plus an excellent magazine which in itself constitutes a rather concise study course in radio, we are indeed fortunate to get by with as little a fee as \$4.00 annually!

— L. D. Clough, W6GQV

(Continued on page 118)



Hints and Kinks

For the Experimenter



SPEEDING UP "PROP-PITCH" BEAM ROTATORS

THOSE who complain that they can grow long white beards while waiting for their beams to turn around toward a choice piece of DX can heave a sigh of relief. No, you don't do it with external step-up gears, V belts, or by speeding up the motor until it burns out! Here's how it is done. Remove:

- 1) the bevel gear;
- 2) its thrust bearing plate;
- 3) the upper case of the speed reduction unit housing;
- 4) the large ring gear with the spline on it.

This last item is the first thing you will see upon removing Item 3, and is illustrated in Fig. 1, where it is resting to the right of the assembly, in front of the upper gear case.



Fig. 1—The "works" inside a propeller-pitch beam rotator. The ring gear mentioned in the text is shown at the right, in front of the upper gear housing. The gear carrier, which is to be drilled and tapped, is still fastened to the top of the assembly. After modification, rotation speeds up to 5 r.p.m. may be obtained with these motors.

Grind the teeth off the hardened, splined ring gear. (Not off the splined portion, but off the *inside* of the ring!) Next drill and tap four holes in the gear carrier over which the ring gear was placed. Line the holes up with the holes that already exist in the face of the ring gear, and bolt the two together. Reassemble the whole thing and refill it with oil. You can now turn your beam at 4 or 5 r.p.m. if you want to. To reduce this to a more-comfortable 2 r.p.m. it is only necessary to reduce the voltage applied to the motor. Don't

worry about the slight reduction in power caused by "short-circuiting" one of the several planetary gear sets. It will still have enough steam to "rotate the house should the beam get stuck."
— David G. Vanderhoek, W2VLL

A SAFETY REMINDER

THE popularity of that excellent power-supply circuit that uses, in addition to the usual rectifier-and-filter set-up, a reverse-connected half-wave rectifier to supply a negative bias voltage, prompts this word of warning:

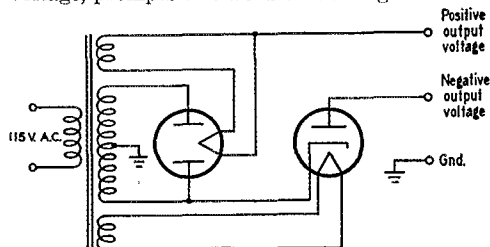

Fig. 2—Most of us have used this convenient arrangement at one time or another to obtain both plate voltage and bias voltage from a common transformer. If you use such a supply, do you recognize the dangers that you encounter with it if you put the on-off switch in the center-tap of the secondary?

The circuit, shown in Fig. 2, is a bridge rectifier with an output voltage equal to approximately half the transformer secondary voltage. This voltage appears from the positive output terminal to ground, and also from the negative output terminal to ground.

Obviously, a d.c. potential equal to approximately the total effective transformer secondary voltage appears between the two output terminals when the supply is operating. If we follow the common practice of turning the power supply off merely by lifting the center-tap of the high-voltage secondary off ground, the d.c. potential *continues* to appear between the positive and negative output terminals of the supply even after we have, supposedly, turned the thing off! Thus, if we go probing around inside the rig where such a supply is used, we are exposing ourselves to the full secondary voltage of the transformer.

The moral of the story: Don't place your on-off switch in the center-tap of a supply that is used for both plate and bias voltages. It is a lot safer to put the switch in the primary, and all it costs is a separate filament transformer, not your life.

— Ben Roberts, W9IEU

(Continued on page 120)



Operating News



F. E. HANDY, WIBDI, Communications Mgr.
J. A. MOSKEY, WIJMY, Asst. Comm. Mgr.
ALBERT HAYES, WIIIN, Natl. Emerg. Coördinator

◆ GEORGE HART, WINIM, Communications Asst.
JOHN E. CANN, WIRWS, Communications Asst.
LILLIAN M. SALTER, Communications Asst.

Overmodulation Difficulty! The following actual exchange was reported to ARRL recently by an official observer.

W1 ---: "Turn up the modulation, Bob. Maybe we can carry on in spite of 50-mile skip. You are kinda weak here. . . ." W9 --- /1: "Sorry, but I have this thing up to about 300 per cent as it is, and I guess that isn't helping very much."

FCC's Section 12.133 requires that in the case of A-3 emission, one's transmitter shall *not* be modulated to the extent that interfering spurious radiation occurs, and in no case shall the emitted carrier wave be amplitude-modulated in excess of 100 per cent. Spurious modulation products and transient effects (also mentioned in the FCC section) are generated under adjustments that cause overmodulation. It seems to happen at increasing frequency that operators so frankly ignoring the regulations and requirements of good amateur operating are getting FCC notices, many of which have also been sent for unnecessary testing and failure to identify by giving the call at proper intervals.

A Plea to DX Stations. W2SFA wants *QST* to emphasize the following two things to all DX operators for their work in the DX Contest or at other times:

- 1) Use short CQs.
- 2) Specify the tuning range (within 100 kc. on 10 meters).

Mr. Tenny's letter suggests that this would eliminate a large amount of QRM from so many Ws calling DX all over the band, thus giving weak DX stations a chance to get out instead of being covered up by the Ws, and this should improve dispositions all around as well as improve the efficiency with which stations in this region would be worked. While his suggestions were intended only to be applicable to 10-meter 'phone, the basic ideas are sound wherever applied. *W-VE Note.* There's little sense in running a calling marathon on our end, either, trying to make yours the longest call, when the DX amateur, to save his time, is working 'em as fast as he can. The short call with listening pauses, and resumption of call if appropriate, with due regard to choice of a little different frequency than the pile-up, may bring the desired result.

ARRL Field Day — June 18th-19th. To set up and try out one's emergency transmitter fulfills the meaning behind our ARRL FD. Every amateur can *prove his ability* to maintain communications when the chips are down by completing as much as *one* emergency-powered QSO. This is the time of year in which the FD has been arranged to give even more point to just such testing.

For FD rules see the full announcement elsewhere in this issue of *QST*. Recognizing the need for car-installed equipment, both h.f. and v.h.f., this year's rules have added a new classification for *mobile rig entries*. We hope many hundreds of amateurs will report a brief or full-fledged test of mobile or portable work in the Field Day using their own completely-transportable facilities.

If you haven't such a mobile rig as described yet, you may incline to interest in planning a suitcase portable. Equipment suitable for vacation work or emergency also can be kept ready for quick action and operation from emergency power whenever called for. Many amateurs also habitually use such small transmitters as regular station adjuncts, for keeping schedules or reporting into nets. This is one way to have enjoyable local QSOs in a hurry when not inclined to fire up one's higher-powered and more-elaborate equipment. Report your *unit or individual portable station* work in this FD for comparison with similar set-ups away from home sites. Scores for all such entries are confined to the work accomplished by one or two licensed amateur operators, additional operators requiring other classifications.

As usual there will be *club and group portable station entries*, these to be compared with those of other clubs and groups operating with the same number of simultaneously-operated portable transmitters. In the urban locations having such club-arranged or coördinator-inspired group availabilities, join your operations to some of these. If you do this, you will be assured of a top experience shared with a lot of other amateurs. The FD club plans provide for a workout of both the capabilities of the equipment and develop operating know-how for a great many types of installations and operations involved. Best of luck and fun in the FD!

— F.E.H.

CODE-PROFICIENCY AWARDS

Have you received an ARRL Code Proficiency Certificate yet? Twice each month special transmissions are made to enable you to qualify for the award. The next qualifying run from WIAW/WØTQD will be made on June 15th at 2200 EST. Identical texts will be sent simultaneously by automatic transmitters. Frequencies of transmission from WIAW will be 3555, 7215, 14,100, 28,060, 52,000 and 146,000 kc., from WØTQD 3534 kc. The next qualifying run from W6OWP only will be transmitted on June 3rd at 2100 PST on 3590 and 7248 kc. For additional dates, see the ARRL Activities Calendar elsewhere in these pages. These W6OWP-only runs will have different text from the runs sent by WIAW and WØTQD, but copy will be handled in exactly the same way as the transmission from WIAW and WØTQD.

Send copies of all qualifying runs to ARRL for grading, stating the call of the station you copied. If you qualify at one of the five speeds trans-

mitted, 15 through 35 w.p.m., you will receive a certificate. If your initial qualification is for a speed below 35 w.p.m., you may try later for endorsement stickers.

Code-practice transmissions are made from WIAW each evening, Monday through Friday, at 10:00 p.m. EST. References to texts used on several of the transmissions are given below. These make it possible to check your copy.

Date	Subject of Practice Text from April QST
June 1st:	<i>Getting Back on "160,"</i> p. 11
June 3rd:	Qualifying Run, 2100 PST, from W6OWP only
June 3rd:	<i>Pointers on Harmonic Reduction,</i> p. 14
June 7th:	<i>Better Results with the 822,</i> p. 23
June 9th:	<i>Grounded Folded Dipoles,</i> p. 28
June 13th:	<i>Surplus Corner,</i> p. 31
June 15th:	Qualifying Run, 2200 EST, from WIAW and WØTQD
June 17th:	<i>Deep Freeze,</i> p. 35
June 21st:	<i>A New Approach to Antenna Design,</i> p. 42
June 23rd:	<i>Technical Topics,</i> p. 44
June 27th:	<i>The 1949 Governors-to-President Relay,</i> p. 49
June 29th:	<i>The World Above 60 Mc.,</i> p. 51

DX CENTURY CLUB AWARDS

DXCC Certificates based on postwar contacts with 100 or more countries have been issued to the amateurs listed below. The countries-worked totals indicated have been certified by examination of written evidence under the award rules as published in March, 1947, QST.

HONOR ROLL

W1FH.....	216	W2BXA.....	196
W6VFR.....	207	W4BPD.....	194
W8HGW.....	201	W3GAU.....	191
W3BES.....	200	W2AQW.....	190
G2PL.....	200	W1CH.....	190

RADIOTELEPHONE

W1FH.....	175	W1JCX.....	143
W6DI.....	150	W2AFQ.....	143
W4CYU.....	150	XE1AC.....	142
W8HGW.....	147	VQ4ERR.....	142
G2PL.....	145	W2BXA.....	139

From March 15 to April 15, 1949, DXCC certificates and endorsements based on postwar contacts with 100-or-more countries have been issued to the amateurs listed below.

NEW MEMBERS

W5MIS.....	137	W3ARK.....	103
G3BI.....	113	W2QKJ.....	103
W3FLH.....	109	W8VLL.....	102
VE6GD.....	108	W8BBA.....	102
VE8AW.....	108	G3BQR.....	102
W4JFE.....	108	W2CNT.....	102
WINW.....	106	G2HNO.....	102
G2HFO.....	106	VQ2DH.....	101
W6DUB.....	104	W8TJM.....	101
VK4EL.....	104	W8LCN.....	100
W6CFB.....	103	VE1EA.....	100

RADIOTELEPHONE

W2AKX.....	104	W4AZD.....	100
W1EKU.....	102	ZL2GX.....	100
W3LTU.....	102		

ENDORSEMENTS

W8HGW.....	201	W8NBK.....	171
G2PL.....	200	PY1AJ.....	170
W3GAU.....	191	W6MJB.....	170
W2AQW.....	190	W2DS.....	170
W1CH.....	190	W9KOK.....	170
W3KT.....	180	W2CWE.....	162
W6QJU.....	174	PY1DH.....	160
W8RDZ.....	174	W6AM.....	160
W2IOP.....	174	W3EPV.....	154
W2HZY.....	172	W2QHH.....	154
W4AIT.....	172	W2PWP.....	153

W4DKA.....	151	W8UDR.....	130
W7GUI.....	150	G2FSR.....	125
ON4JW.....	150	W5KUC.....	123
VE7HC.....	150	W1HA.....	123
W3DKT.....	142	W2FBA.....	122
W2UFT.....	142	W2GUR.....	122
I1KN.....	142	W1FTX.....	122
W4KXN.....	141	W2GNQ.....	121
KP4KD.....	140	W3LVJ.....	121
W3OP.....	140	W6CIS.....	121
W6KUT.....	140	W2TXB.....	121
Q27CC.....	140	W6BVM.....	121
W3LBG.....	139	W3FUF.....	120
VK5JS.....	137	W3KZQ.....	120
W9TJ.....	134	SM5LL.....	120
W1ZL.....	133	W2RWE.....	120
W8UOX.....	133	G3TK.....	120
W7GUV.....	131	W1AH.....	120
W5GEL.....	131	W4VE.....	117
ZS6CZ.....	130	HB9EU.....	116
G2AKQ.....	130	W8KPL.....	115
W6IBD.....	130	W1HR1.....	111
G5OO.....	130	G8FW.....	110
W1FJN.....	130		

RADIOTELEPHONE

W4CYU.....	150	W1MCW.....	128
VQ4ERR.....	142	W1GOU.....	122
W2ZW.....	131	W2ZX.....	111
W8BF.....	131	W6MBD.....	110
W1FJN.....	130		

A.R.R.L. ACTIVITIES CALENDAR

June 3rd: CP Qualifying Run — W6OWP
 June 4th-5th: V.H.F. Contest
 June 15th: CP Qualifying Run — W1AW, WØTQD
 June 18th-19th: ARRL Field Day
 July 2nd: CP Qualifying Run — W6OWP
 July 19th: CP Qualifying Run — W1AW, WØTQD
 July 23rd-24th: CD QSO Party
 Aug. 1st: CP Qualifying Run — W6OWP
 Aug. 18th: CP Qualifying Run — W1AW, WØTQD
 Sept. 6th: CP Qualifying Run — W6OWP
 Sept. 16th: Frequency-Measuring Test
 Sept. 19th: CP Qualifying Run — W1AW, WØTQD
 Sept. 24th-25th: V.H.F. Contest
 Oct. 7th: CP Qualifying Run — W6OWP
 Oct. 14th: CP Qualifying Run — W1AW, WØTQD
 Oct. 15th-16th: Simulated-Emergency Test

TRAFFIC TOPICS

The denizens of the BPL, change from month to month, but close perusal will show that certain stations are consistently among that select group, while others, like Vesuvius, flare into violent action only occasionally, such occasions interspersed with long periods of silence. It has long been our feeling that, while great credit is due anyone who makes BPL, certainly a great deal more credit is due those who make it consistently, month after month; yet our traffic-handlers get credit only on their monthly performances.

Pursuing this theme a bit, we decided to engage in a bit of research in the BPL. If we were

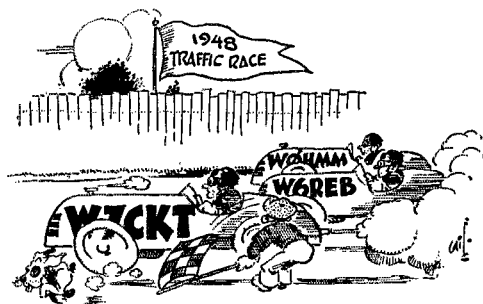

officially to crown a "Traffic Champ" each year, who would he be? Who would be the leading traffic man in each call area, in each ARRL division or section? We decided to find the answer at least to the first question, and then, having become deeply engrossed in the subject, to select the outstanding traffic man for 1948 from each call area; and having done this, we discovered that other significant trends made themselves known.

Two traffickers made BPL *ten* times in 1948: W7CKT and WØHMM. Of these two, W7CKT

rolled up the higher BPL traffic total, 14,408 points! Even without adding his traffic totals for the two months he did *not* make BPL, this is an average of well over 1000 per month. This amazing total was amassed partly during the summer months; for example, in August, while most of us were basking in the summer sunshine, CKT racked up the incredible traffic total of 3008 points, the highest postwar total and the only one over 3000. WØHMM, the runner-up in number of BPLs, also made it ten times for a BPL traffic total of 8921. W6REB, Mr. Traffic himself on the West Coast, made BPL nine times for a total of 10,054 points. We believe that such consistent over-all performance deserves some special recognition! W7CKT was the "champ" in 1948. W6REB and WØHMM shared the runner-up spot. Who is gunning for the 1949 "championship"?

In 1948, the boys on the West Coast really showed us how to handle traffic. The tabulation which follows shows how W6-land led the way by a wide margin, and gives the leader in each call area with the number of times he made BPL shown in parentheses. It is not hard to see that some of the call areas would have fared far worse had it not been for the performance of one outstanding traffic man!

Call Area	No. BPL Listings	Outstanding Station
W6	41	W6REB (9)
W7	25	W7CKT (10)
W2	21	W2RUF (3)
W5	18	W5LSN (4)
WØ	18	WØHMM (10)
W1	17	W1QMI/INF (4)
W8	13	W8TRN (4)
W9	12	W9SYZ (5)
W3	11	W3ECP (6)
W4	8	W4PL (4)
VE	4	VE3ATR (3)

The faces of some of the CD personnel here at Headquarters took on a fiery crimson color when it was realized that some of the examples of word count in messages given on page 521 of the 1949 *Radio Amateur's Handbook* are erroneous. We spotted this shortly after the new *Handbook* came out, and now that W8LOT has pinned us down we must blushing admit: some of the examples in the *Handbook* are *wrong*, especially in the examples for counting figures. The information in our booklet *Operating an Amateur Radio Station* is correct, and steps have been taken to see that there is no recurrence of the *Handbook* faux pas.

An annual get-together of all the traffic men of a section to discuss the section's traffic problems is one of the best ways of ironing out difficulties and making plans for future activities, to say nothing of the good-fellowship to be derived from meeting personally the fellows you handle traffic with on the section net. Several sections we know of sponsor such a meeting every year, some-

times twice a year. They can take the form of a simple discussion get-together with coffee and sinkers served by the host, or of a more elaborate affair complete with banquet, speakers and assessment to pay for the former. Many sections whose traffic fortunes are at a low ebb would do well to adopt this means of forming *esprit de corps*. A case in point: the New York City-Long Island Section is sponsoring a dinner to be held at the Franklin Hotel, Jamaica, N. Y., on June 11th at 1930. RM W2OBU invites all traffic-handlers to attend. Tickets are \$3.00.

Some sections are too extensive in area to make personal meetings practicable. In that case, a good alternative is a section net news bulletin. True, it costs money to put out a bulletin, and it costs someone some time. Assuming that the SCM or RM has sufficient enthusiasm to get such a project rolling, the bulletin can be financed by donations thereafter. It is worth a try. The "Washington State Net News," edited by W7FIX, is one of the best we have seen. It is complete with general news notes by the SCM, monthly traffic totals, pertinent traffic topics that net operation indicates need comment, net information, net attendance rosters, miscellaneous notes from here and there about the section, letters, light-veined commentary, and many other little bits of info of interest to the section traffic handlers, all rolled into eleven legal-sized pages. It shows what can be done when the interest is high, but even when the interest is low a well-designed bulletin will go far toward stirring up interest; and once it is stirred up, continuance and expansion is almost assured.

COUNTRIES-LIST CHANGES

Since the adoption of the ARRL Postwar Countries List, the official standard used in connection with the annual DX Competition and the DX Century Club, several changes have been reported in this department. See page 40 of March, 1949, *QST* for the latest revised list. We are pleased to announce the addition of one more country to the list: Israel, 4X4. DXCC credit will be given those who submit evidence of having worked Israel (including both 4X4 and ZC6) since May 14, 1948, the date on which the independent State was set up. Make this change on your list and watch the Operating News department for further changes and additions.

A neat, quiet-looking station, this W0QXO, is it not? A glance at page 38 of April, '49, *QST* will remind you, however, that this was the scene of one of the greatest demonstrations of amateur radio's ability to handle record traffic in time of emergency that has been seen in years. Paul holds ORS and RM appointments, and we'll bet he did not look this calm and collected during the "Deep Freeze."

BRASS POUNDERS LEAGUE

Winners of BPL Certificates for March traffic:

Call	Orig.	Del.	Rel.	Extra Del. Credit	Total
W7CZY	56	156	2541	75	2828
W6REB	38	42	2042	36	2158
W9EBX	6	12	2092	12	2122
W6CE	18	47	1782	44	1891
W4PL	6	40	31	1766	1843
W7CKT	0	7	1224	7	1238
W7KCU	935	127	0	83	1145
W6LSN	13	22	972	19	1026
W6HMM	14	18	910	9	951
W2RUF	30	57	728	36	851
W7EAU	621	39	92	24	776
W4MVJ	690	20	22	12	744
W5GZU	5	9	722	6	742
KG6DI	152	405	125	52	734
W6DDE	37	237	208	234	716
W7IOQ	101	0	606	0	707
W7FRU	10	10	675	4	699
W6HFF	12	105	478	103	698
W2TYU	41	89	462	79	671
W8NOH	38	134	372	120	664
W4CFL	27	43	544	31	645
W9QLL	31	113	387	109	640
W1CRW	21	82	506	22	631
W7ZU	69	161	249	148	627
W8GBF	38	69	480	16	603
W2RTZ/4	23	69	436	58	586
W2WZQ	28	36	506	10	580
W4ZC	331	109	28	109	577
W7LFA	18	24	517	6	565
W6TQD	5	548	8	4	565
W9NH	30	61	408	51	550
W6CFZ	32	216	80	212	540
W1QMJ	15	23	478	19	535
W2CLL	54	87	360	31	532
W8UUS	225	210	85	0	520
W5DRW	11	3	478	20	512
W4MXU	26	35	426	20	507
W4MNT	6	31	454	12	503

The following made the BPL for deliveries:

W6FAM 210	W2VNJ 161	W5LUX 118
W4ETN 192	W1RWS 160	W2VOS 117
W9TT 187	W1JE 132	W1ZR 116
W6IC 187	W7JEG 128	W6OUU 115
W7JZR 185	W6NTY 128	W3ECP 114
W7FIX 181	W1IIN 124	W6NL 104
W9QXO 170	W2PGT 123	W8UKV 104
W6SYZ 168	W2TYC 119	W8TRN 101

A message total of 500 or more or 100 "deliveries plus extra delivery credits" will put you in line for a place in the BPL. The Brass Pounders League listing is open to all operators who qualify for this monthly "honor roll."

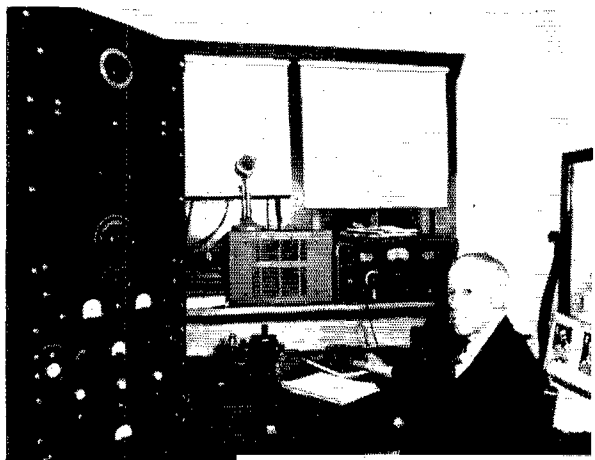

WITH THE A.E.C.

At 5:45 A.M., Sunday, March 27, 1949, the La Crescenta, Calif., EC, W6BTA, was called by Deputy Sheriff J. Reith and informed that a party of 18 Boy Scouts and three men was lost in the Big Tujunga and Little Tujunga Canyon area and that communications aid was requested.

The Local Mountain Rescue Plan was immediately put into action, net control for 10, 75 and 2 meters falling to W6YKB and W6UBY. A 10-meter mobile unit, W6FKW, was dispatched to the Montrose sheriff's substation to act as liaison for them with the rescue units. W6HMC, mobile, W6VRK, mobile, W6BTA, 2-meter pack unit, and W6SVU, mobile, were dispatched to the base of operations. From there W6BTA went into the search area on foot with the pack transceiver to relay the needs of the rescue units. In spite of the extremely-rugged mountainous terrain, constant contact with W6VRK at the base of operations was maintained on schedule every 15 minutes. All requests from the search parties were relayed by W6HMC to W6UBY who then fed traffic into the local organized net for delivery to its destination. The search came to a successful end about 2:30 P.M. when all nets were closed.

The following other amateurs were of material assistance to the success of this venture: W6YGT, W6ODW, W6LCY, W6KQS, W6FMJ, W6ZWS and WØLKP.

At 4:05 A.M., Monday, March 28, 1949, the EC, W6BTA, was called by Deputy Sheriff Sgt. Jack Garvin and informed that a sixteen-year-old boy and three dogs on a hike in Big Tujunga Canyon and a climb to Condor Peak had been lost since late Sunday, and that communications assistance was needed again.

The Local Mountain Rescue Plan was once more put into action. Net control for 10 and 75 was W6UBY, W6VRK on 2- and 10-meter mobile, W6SVU on 10-meter mobile, and W6BTA with the two-meter pack set, went with the sheriff's detail to search the area to set up a base of operations with W6HMC handling outgoing traffic on 75 'phone. The search came to an end before a base set up was in operation. The boy and dogs were found on the road on the way out, cold, wet and hungry. The net and the sheriff's office were advised of developments and the AEC net was cleared and closed at 7 A.M.

At 4:30 A.M. on the morning of March 30th the local highway patrol officer called SEC W5HGC on the 'phone and advised that a tornado had just struck Blackwell, Oklahoma. He requested that W5HGC notify headquarters and stand by for information from him as he was going into the area. W5HGC then contacted W5PA at Tulsa by long-distance 'phone and was able to get a line into Blackwell to W5HFW. He was unaware of the storm, although his home was only a few blocks outside of the area. W5HFW then furnished information to all agencies unable to get through by commercial lines which were intact from the north. No communications emergency existed; however, W5MFW and W5HXC at Blackwell handled considerable traffic during the remainder of the day.

It was about 6:15 A.M. this same morning that W5JKQ at Canton, Oklahoma, called the Oklahoma 'Phone Net (on c.w.) and advised that Canton had also been hard hit and that a town to the North of them, Longdale, was gone completely. This was the first word from these areas. Through W5JKQ and W5WQ information was passed to all relief agencies.

SEC Cartwright, W8UPB, is trying to determine how many AEC groups have their control stations located in Red Cross premises, with a possible view toward some type of on-the-air liaison between them in time of emergency. If your group is set up in the Red Cross headquarters, please drop Carty a line.

W2WHB and W2UZX, in collaboration with the New York City headquarters of the Red Cross, are calling "CQ RC TFC" at 4:00 P.M. daily on 3550 kc., to provide a traffic route for those AEC groups in the Northeastern Area of Red Cross who may wish to operate a message service for their RC groups.

SOUTH DAKOTA ICE EMERGENCY

On Wednesday, March 30th, it started raining in the morning and toward evening it had turned to a very wet and heavy snow that was starting to build up on the wires. At 10:30 P.M. the power failed in the entire city of Mitchell, a community of 16,000 population. At that time, local hams, WØGCP, WØDBE, and WØHDO, were notified by the local broadcast station,



This is not a famous vocal trio demonstrating their wares but Delta Division Director Canfield, W5BSR (right), sharing a pleasant moment with Memphis EC Walt Mewborn, W4BAQ (left), and National EC WIIIN at a special meeting of the Mid-South Amateur Radio Association at Memphis on April 1st, during which emergency communications was the main topic of discussion.

QST for



KMHK, that their tower lights had failed and that they were off the air and were unable to notify the CAA of this failure as there were no wire services out of the city.

We—WØGCP, WØDBE and WØHDO,—surveyed our own stations and found that the antennas were down and that we were without power. It was decided that WØGCP's antenna would be the easiest to repair, so we hauled WØHDO's battery-operated gear to that location and set up a BC-654 on 80 c.w.

Several calls were made but we didn't raise anyone due to the heavy QRN. About 1:00 A.M. Thursday, we were able to contact WØSRR in Grundy Center, Iowa, who was on 75 'phone and informed him of our situation here. He took the message for CAA and we had no further need for an outlet so closed down for the night.

About 8:00 A.M. Thursday, WØHDO had calls from the Northwestern Bell Telephone, Western Union and Milwaukee Railroad, all wanting to get information to their respective headquarters as to the extent of their wire damage. It wasn't until then that we realized the seriousness of the situation. We were completely isolated, no power in a large portion of the city, no water pressure in the city mains because of power failure at the pumping stations. Thousands of poles were down, and there were thousands of wire breaks in the Bell and WU lines. Again we surveyed our stations and found that WØDBE was the only one with power and an antenna that could be used if we could clean off some of the snow and sleet that had formed on the feeders.

We tuned up on the South Dakota c.w. net frequency and made contact with KØNRU, the Naval Reserve Station in Sioux Falls, and asked them to stand by to handle traffic. About 10:00 A.M. power was restored to WØGCP and it was decided to make it the headquarters station as Bill, the operator, is the EC and also the RM; he also has a higher-power station and ready access to a telephone. From that time on WØGCP was in constant contact with KØNRU, WØSRX in Yankton and, later, WØILL in Huron.

Thursday afternoon WØZZX erected a temporary antenna and contacted WØDOP in Sioux Falls, who was in contact with the Iowa 'Phone Net and was able to handle several Milwaukee train orders and Western Union messages.

From 10:30 P.M. Wednesday, until 4:00 P.M. Saturday, when the last message left the hook, amateur radio was our only contact with the outside.

Amateurs outside the immediate storm area who were of material assistance included: WØBIZ, WØCRY, WØDJM, WØEFI, WØGWH, WØIBP, WØKSS, WØMPQ, WØOVD, WØPHR, WØRRN, WØZIQ and WØZRA.

—WØHDO, Section Emergency
Coördinator

STOCKTON, MISSOURI, "RADIO-LIFT"

It was a cold, ice-dominated night when a frantic "CQ Springfield" went out from WØWRQ, Stockton, Mo., on 3640 kc. Stockton had never dreamed that there would be a time when the only communications outlet would be amateur radio. A terrific ice storm a week earlier had flattened its only long-distance lines and had left only four local telephones, out of five hundred, in contact with the central telephone office.

WØWRQ had replaced his full-wave 7-Mc. antenna and, with emergency power connections restored, had tried in vain to establish contact with Springfield, the regular relay distribution point for commercial communications to Stockton. It was soon evident that for short-haul emergency traffic 7 Mc. was very poor compared with 3.5 Mc. With bell wire the only thing at hand, coils for 3.5 Mc. were hurriedly wound and served very well. WØBRN, Butler, and WØHVW, Pleasant Hill, were worked and agreed to monitor the Stockton frequency, 3640 kc., until contact could be made with Springfield.

Calls on 3640 kc. didn't seem to be getting much result but gobs of Springfield stations could be heard on 3960 'phone. Only one crystal in the 'phone band was available, 3910 kc. WØGZR, Joplin, was heard on 3910 kc. and asked if he would use his VFO to QSY to 3960 kc. and ask the Springfield gang to look for WØWRQ on 3640 kc. with traffic for Springfield. In two minutes time WØWRQ was QSO WØCXF and WØEBE, emergency coördinator for Springfield.

For several days during the emergency WØEBE and WØHUI were compelled to lock their businesses to meet schedules at 0900, 1100, 1200, 1500, 1615, 1700 and 1800. Later, KØNRS, at the Naval Reserve Training Center, relieved them of some of the schedules that conflicted with business, and did a swell job. Southwest Missouri Amateur Radio Club "Field Day" operations really paid off in this emergency and many of the 40 active members took assignments on the "Radio-Lift." Stations participating by handling traffic or keeping schedules were WØEBE, WØHUI, WØQUZ, WØCGZ, WØCGJ, WØBHC, WØUEH, WØERU, WØADL and KØNRS, all in Springfield, Mo.; WØDEA, WØGZR, Joplin, Mo.; WØDEQ, Bolivar, Mo.; WØCKK, WØNNH, Marionville, Mo.; WØBRN, WØZXX, Butler, Mo.; WØCXF, Fort Scott, Kans.; WØAHA, Independence, Kans.; WØJXJ, Kansas City, Mo.; WØBKJ, Fort Wayne, Ind.; and W4BAQ, Memphis, Tenn.

Through April 15th 277 messages had been handled on the Stockton "Radio-Lift," with 138 sent, 139 received and 136 delivered. The emergency operation is still being carried on because cable and other equipment for Stockton's new telephone system will not be delivered before midsummer. — H. C. King, WØWRQ

PRIZE-ARTICLE CONTEST

- The accompanying article wins a prize in the CD Article Contest.

You are invited to submit entries in this contest. The author of each article used is awarded a \$10 prize, consisting of \$5 in U. S. Savings Stamps and \$5 in ARRL supplies or publications (except *QST*). Contributions may be on any subject of interest to amateur radio operators. Articles are selected on originality and value to the fraternity.

OPERATION MOSQUITO *The Small Group Breaks Into Field Day Operation*

By the FD Gang at W8DFK/8

Field Day is one of the *big* ARRL activities of the year. For several years, we attended the FD set-ups of several of the radio clubs with which we were associated, but we were always disappointed, since most of our time was spent in watching other guys doing the operating. After the war, a group of five of us (W8s MMZ, TLQ, UNA, ZEP and ZTA) began to bend our efforts toward FD operation.

As a result, Field Day 1947 found us set up in a goat barn. The operation was just a feeler — an attempt to familiarize ourselves with FD operation technique and to determine what equipment is necessary for successful operation. We used our home-station equipment, operated from commercial power mains. The gear worked very well, but it was apparent that lighter, more flexible equipment was required. Our own portable "shack" and power supply were a must. A major source of trouble that year was antenna erection. Jim, W8TLQ, our chief sky-wire hanger, climbed umpteen trees umpty-two times. He also rode a chimney that broke off under him and crashed to the ground. Thus by the time the starting gun sounded, his efficiency as an operator was below par.

We had a lot of fun that year, enough to make us want to do a real job the next year, and when our score appeared in *QST*, we didn't think we had done too badly for a bunch of novices.

Our second FD operation was a real safari. We had located a lightly-wooded knoll way back on a friend's farm, so we really needed our tents and generator. We loaded the gear on the Friday before FD operations began and set off for camp. This gave us time to get the camp established and get a good night's rest, so that we were ready to go to work on the radio end early in the morning. After a nice hot meal (cooked on a gasoline stove), we sprayed the tent with a gallon of DDT, hit the sack, and dreamed about high scores.

Now the big day was at hand. After a hearty breakfast of bacon and eggs, we got to work. There were three principal jobs to be done; arranging the operating positions, getting the

generator set up and running, and putting up the antennas. Since there were only four of us this year, we split up into teams of two. The first team took care of the first two jobs, and the second put up the antennas. The operating positions were set up on card tables placed along one side of the 8 × 12-foot wall-type tent. The generator was set up about one hundred feet from the operations tent, and power was run up through RG-8/U cable. The shielding effect of the outer conductor is very helpful, especially when grounded, and the cable at present available on the surplus market has the additional virtue of being inexpensive.

Jim hit upon a rather novel method for erecting the antennas. He is an avid archer, so he tied a piece of light twine to an arrow, and then shot the arrow over a convenient branch. The light twine was then tied to somewhat heavier cord (parcel-post cord) which was in turn tied to the antenna insulator. The antenna was pulled up to the desired height, and then the cord was tied to some convenient low branch or bush. For wire, we used No. 18 enameled copper, which the past two years have proved most satisfactory. All antennas were end fed. In two hours, two men put up four half-wave antennas, two for eighty, one for forty, and one for twenty.

By 3:00 P.M. we were ready to go. The generator (a 1.5-kw. 110-volt 60-cycle gasoline-engine-driven job) was perking away. The rigs were a converted BC-457 for eighty, a BC-459 for forty, and a BC-459 plus doubler for twenty. The receivers were BC-348s and a BC-224. All this equipment is ideal for FD operation, being simple and similar. All very fine — but then came the trouble. Thunder and lightning and rain, rain, rain. We were happy that the tent didn't leak! When the starting time came, the QRN was terrific, but signals could be heard on forty, so we opened up on that band. Eighty began to calm down by about 10 P.M., and it got pretty hot during the night. Unfortunately, the doubler for twenty had had a mishap, so we were stuck with two-band operation. We really went to town on those two, though. There was no generator hash, thanks to a filter, and the antennas worked well. Just as an example, we worked a KH6 on forty, and the rig was running at less than thirty watts input. By morning the rain had stopped, and the sun was starting to dry things off, thanks to our hilltop location. Gil's cover cartoon had been strangely prophetic!

Operation for the rest of the day was routine, including the fact that eighty went dead. When closedown time came, it didn't take us too long to break camp and get started toward home.

After considering the matter, we decided it was about time we had our own call (we used W8TLQ/8 in 1947, and W8ZEP/8 in 1948). So we formed ourselves into the Brass and Java League, and have been assigned W8DFK.

ELECTION NOTICE

Our second year's operation had taught us a few things, and we'll list them here, hoping that they may give you some helpful hints:

- 1) Keep equipment simple, and small in quantity.
- 2) Be prepared for bad weather.
- 3) Plan to have hot food for most of the meals.
- 4) Have a comfortable sleeping place arranged.
- 5) Have the antenna locations planned beforehand.
- 6) Test all the c.w. rigs for clicks beforehand, and if any exist, get rid of 'em. Remember you're going to be a couple of hundred feet at most from your buddy's receiver.
- 7) Try to have at least two operators for each rig, so that each can get some rest.

Well, we'll see you from W8DFK/8 . . . if you get in on this FD operation . . . and you're missing a lot of fun if you don't.

W1AW OPERATING SCHEDULE

(All times given are Eastern Standard Time)

Operating-Visiting Hours:

Monday through Friday: 1130-0600 (next day).
 Saturday: 1900-0230 (Sunday).
 Sunday: 1600-2200

A mimeographed local map showing how to get from main state highways (or from Hq. office) to W1AW will be sent to amateurs advising their intention to visit the station.

General Operation: Refer to page 65, March *QST*, for a chart showing W1AW general operation. This schedule is still in effect and is not reproduced here for space considerations. Mimeographed complete master schedules of all W1AW operation in EST, CST, MST or PST are available upon request.

Official Bulletin Schedule: Bulletins containing the latest information on matters of general interest to amateurs are transmitted on regular schedules:

Frequencies:

C.W. — 3555, 7215, 14,100, 28,060, 52,000, 146,000 kc.
 'Phone — 3950, 14,280, 29,000, 52,000, 146,000 kc.

Times:

Sunday through Friday, 2000 by c.w., 2100 by 'phone.
 Monday through Saturday, 2330 by 'phone, 2400 by c.w.

Code-Proficiency Program: Practice transmissions at 15, 20, 25, 30 and 35 w.p.m. are made on Tuesdays and Thursdays on the above-listed frequencies starting at 2200, and on Monday, Wednesday and Friday at 9, 12, 18, 25 and 35 w.p.m. Approximately ten minutes of practice is given at each speed. Next certificate qualifying run is scheduled for Wednesday, June 15th.

W1AW will be closed from 2200 May 29th until 1130 May 31st. Similar provisions will be made for July 4th. The station participates in all official ARRL operating activities, omitting some week-end general operating periods for this purpose (see Activities Calendar).

(To all ARRL Members residing in the Sections listed below:)

You are hereby notified that an election for Section Communications Manager is about to be held in your respective Sections. This notice supersedes previous notices.

Nominating petitions are solicited. The signatures of five or more ARRL full members of the Section concerned, in good standing, are required on each petition. No member shall sign more than one petition.

Each candidate for Section Communications Manager must have been a licensed amateur for at least two years and similarly a full member of the League for at least one continuous year immediately prior to his nomination.

Petitions must be in West Hartford, Conn., on or before noon on the closing dates specified. In cases where no valid nominating petitions were received in response to previous notices, the closing dates are set ahead to the dates given herewith. The complete name, address, and station call of the candidate should be included with the petition. It is advisable that eight or ten full-member signatures be obtained, since on checking names against Headquarters files, with no time to return invalid petitions for additions, a petition may be found invalid by reason of expiring memberships, individual signers uncertain or ignorant of their membership status, etc.

The following nomination form is suggested:

Communications Manager, ARRL [Place and date]
 38 La Salle Road, West Hartford, Conn.
 We, the undersigned full members of the
 ARRL Section of the
 Division, hereby nominate
 as candidate for Section Communications Manager for this
 Section for the next two-year term of office.

Elections will take place immediately after the closing dates specified for receipt of nominating petitions. The ballots mailed from Headquarters to full members will list in alphabetical sequence the names of all eligible candidates.

You are urged to take the initiative and file nominating petitions immediately. This is your opportunity to put the man of your choice in office.

— F. E. Handy, Communications Manager

Section	Closing Date	SCM	Present Term Ends
Utah-Wyoming	June 15, 1949	Alvin M. Phillips	May 1, 1949
Western Florida	June 15, 1949	Luther M. Holt	July 2, 1949
Indiana	July 1, 1949	Charles H. Conway	Resigned
British Columbia*	July 1, 1949	J. Hepburn	Resigned
Yukon*	July 15, 1949	W. R. Williamson	Mar. 17, 1949
N.Y.C. & L.I.	July 15, 1949	Charles Ham, jr.	July 31, 1949
North Dakota	July 15, 1949	Paul M. Bossoletti	July 31, 1949
Eastern Florida	July 15, 1949	John W. Hollister	July 31, 1949
Southern New Jersey	July 15, 1949	George W. Tunnell	July 31, 1949
East Bay	Aug. 1, 1949	Horace R. Greer	Aug. 16, 1949

* In Canadian Sections nominating petitions for Section Managers must be addressed to Canadian General Manager Alex Reid, 169 Logan Ave., St. Lambert, Quebec. To be valid such petitions must be filed with him on or before the closing dates named.

ELECTION RESULTS

Valid petitions nominating a single candidate as Section Manager were filed in a number of Sections, as provided in our Constitution and By-Laws, electing the following officials, the term of office starting on the date given.

San Diego	Dale S. Bose, W6BWO	Mar. 1, 1949
Oregon	J. E. Roden, W7MQ	Mar. 1, 1949
Mississippi	J. C. Wallis, W5DLA	Mar. 8, 1949
Western Pennsylvania	Ernest J. Hlinsky, W3KWL	Mar. 17, 1949
Md.-Del.-D. C.	Eppa W. Darne, W3BWT	Mar. 21, 1949
Maine	Manley W. Haskell, W1VV	Apr. 15, 1949

• All operating amateurs are invited to report to the SCM on the first of each month, covering station activities for the preceding month. Radio Club news is also desired by SCMs for inclusion in these columns. The addresses of all SCMs will be found on page 6.

ATLANTIC DIVISION

EASTERN PENNSYLVANIA—SCM, Jerry Mathis, E3WBES—VMF has resigned as RM for the E. PA. Net. QEW is acting as RM meanwhile. LZP is enthusiastic about his new VFO, which enabled him to get his WAS certificate. The Harrisburg Radio Club is preparing for Field Day. Nominations for an EC for the Harrisburg area should be forwarded to BXE. ADE is on the Penn Harris Emergency Net. CUU visited AXA to see his new VFO. OAO is practicing for his ORS ticket. EU is traveling around the country to get first-hand electronic information. BBV and AQN put on an impressive demonstration of communication for Red Cross officials in York. BBV has an all-band mobile. BBV is AQN's chief assistant. NHI made a swell total considering she was off three weeks in March. OWP is a new ham in Lehighton. OP, AVMI, JFR, BYF, and ATI attended the Old Timers Nic. banquet in Trenton, N. J. MAC worked his 100th country on 28-Mc. phone with a pair of 6L6s in about two years. The Delaware-Lehigh Amateur Radio Club of Easton had a very successful exhibition on Window Shopping Hobby Night, having a pair of transmitters in a large department store in the center square. The local amateurs handled more than 100 messages to all parts of the world. The calls of the participants are: 3NF, 3IHD, 3IPS, 3MAC, 2TKV, 2ZQK, 2KFR, 2TAV, 2WXX, 2PMP, 2RXL, and 2PXU. Several members of the Chester Radio Club and the Frankford Radio Club visited the Wilmington, Del., Radio Club to hear John Reinhardt's talk and demonstration on T.V.I. Dis gave a similar demonstration at the York Road Radio Club. The York Road Club is to divide into small groups for Field Day. The local brethren are much concerned as to measures to combat T.V.I. and its associated problems. Traffic: W3DZ 333, CUL 240, QEW 147, NHI 106, OAO 91, VMF 90, ADE 49, EU 37, AXA 32, WTS 31, OML 29, AQN 19, CAU 5.

MARYLAND-DELAWARE-DISTRICT OF COLUMBIA—Eppa W. Darné, W3BWT—The Chesapeake Amateur Radio Club, organized Dec. 14, 1948, meets in the hall at the rear of 120 W. Penna. Ave., Towson, Md., on the first and third Tuesdays of each month. Officers are: LZM, pres.; FLG, vice-pres.; MTE, secy.; MIB, treas.; KOU, sgt. at arms. Programs have included demonstrations on infra-red image tubes, 1220-Mc. equipment, grid-dippers, and "Souping up HRO by AFM." Thirteen are registered for code class. 144-Mc. activity has been resumed, with activity guaranteed at 8:00 p.m., Wednesdays and Fridays. Mobiles include MZA and LMC on 28 Mc. and KRJ and MTE on 144 Mc. DL is airborne. The Washington Mobile Radio Club's newly-elected officers are IZL, pres.; 4KYT, secy.-treas.; and ENR, tlc. mgr. The Club held an outing at Rehoboth Beach, Del., on Mar. 27th with eleven members present. Many stations were worked including a G and a GM on 28 Mc. At its first March meeting the Washington Radio Club enjoyed a talk and demonstration on an amateur teletype system by NL. At the second March meeting the Club held an auction of spare gear brought in by the members. A code class was started prior to the second regular meeting with HHN as chairman. At the first March meeting of the Baltimore Amateur Radio Communications Society, a talk was given on the Civilian Mobile Radio Service of the telephone company by AFR. The second March meeting was highlighted by ARRL films on "Inductance" and "Triode Amplification." Application for a club call has been made for use at club headquarters, 4 West Mt. Vernon Place, Baltimore Red Cross Headquarters. MWY is chairman of the committee on Red Cross and club station. The Argument Radio Club of the Eastern Shore of Maryland meets the first Monday of each month at a designated member's home. DL, airborne, using less than 1 watt input, worked LFF in Delaware on 144 Mc. Also, while over Towson, Md., he worked MTE, mobile, with same power, and LXX and OTG. PFR is ex-5NBN. PFF is ex-9ZML/3. NIJ is looking for evening contacts on 28 Mc. (no T.V.I.), and building mobile 28 Mc. LFG has a

new Clapp Circuit V.F.O. on 3.5 and 7 Mc., worked 16 new countries and received 25-w.p.m. Code Proficiency certificate. VT has new HT-19 transmitter and is on 28 Mc. mostly. LSX and FWP are newly-appointed ORS. MHH, ex-9HSK, now is located in Hyattsville, Md. EYX visited VPCC in Bermuda. AFR is new OBS for the Baltimore area and sends Official Bulletins at 7:00 p.m. Monday through Friday on 3790 and 3860 kc., c.w. and voice. GZH had trouble with his final. JCS is new OBS for Baltimore area and sends Official Bulletins on 29-Mc. phone. FWP is rebuilding rig. LVJ has brought his "countries worked" total up to 143. OPG and ECP have BLP certificates. Both are A-1 Operators. HG and BBU are mobile-equipped. CDQ continues schedule with VP4TZ and is on 14,066 kc. CIQ has a whole room full of radio gear and is mostly on 3.5 and 14 Mc. He also has both phone and c.w. CIS still is chasing DX on 7 Mc. and recently worked two new countries. LUE is waiting for the 21-Mc. band to open in order to get away from T.V.I. KRJ will graduate from Johns Hopkins University this June. NB has been running schedule with ZL3AB for two years on 14-Mc. c.w. Traffic: W3ECP 332, GZH 312, UF 301, OPG 241, MJQ 146, ARK 128, JZY 69, MCG 38, CIQ 26, QL 20, FWP 12, JHW 11, NB 9, AKR 5, EYX 5, BWT 4, CDQ 4, VT 2.

SOUTHERN NEW JERSEY—SCM, G. W. (Bill) Tunnell, W2OXX—Results of the Delaware Valley Radio Association elections are as follows: UPS, pres.; GOK, vice-pres.; SMP, secy.; and Charles Rehman, treas. Our Section Emergency Coördinator, ORS, has openings for Emergency Coördinators in Cape May, Cumberland, Salem, Somerset, and Sussex Counties. Any volunteers? Ed Tilton, 1HDQ, made a fine speech and demonstration at the last meeting of the South Jersey Radio Association. Your SCM expects to be on the way to his new QTH in Pennsylvania by the time you read this and of course will reapply for 3DVC. This also means that you fellows had better get ready to nominate and elect a new SCM. 3NF/2, now the proud owner of 2ZVW, lost his antenna three times during the past thirty days but gets traffic honors anyway. RXL just received his OBS appointment. YAO received his WPR Certificate. We welcome 3MXS to his new residence in Ocean City. WCY joined the gang on 144 Mc. UKS reports hearing Philadelphia and Maryland quite often on 144 Mc. at Ocean City. BEI entertained G6GMN and his XYL as house guests. The 3700-ke. c.w. net now has YSP as the Atlantic City outlet. OSV has organized a Gloucester County emergency net. Tip your hat to him, fellows. Traffic: W2ZVW 187, ZI 109, QUH 76, RFF 57, RPH 57, ORS 22, YSP 21, RG 18.

WESTERN NEW YORK—SCM, Harding A. Clark, W2PGT—SEC: SJV, RM: FCG. New appointments: BLP as EC; YGW as ORS; QZI and YQI as OO; PZC and TEX as OBS. Approximately 100 attended the special meeting held by the Rochester Amateur Radio Assn. on March 14th, at which Communications Manager F. E. Handy, of ARRL, explained League policies and functions. The RARA is offering its regular bulletin broadcast service to any club or group to broadcast any news or notice of meetings. Address requests to Special Broadcast Bureau, P. O. Box 1388, Rochester, N. Y., giving at least one-week notice prior to the date of the event. QHH worked PY7WS for country Nr. 51 on 3.0 Mc. and PK4KS for Nr. 164 post-war—both with 18 watts. He is now WAC on all bands 3.5 through 28 Mc., with this low power. UPH/2 had rigs on 3.85, 14, and 144 Mc. at the Eastman Kodak hobby show and handled traffic for visitors. To prove to himself that he wasn't dreaming BLP worked JAZAT three more times this month on 3.85 Mc. There is much talk from all parts of the section about preparations being made for the coming Field Day in June. This one promises to be the biggest so far. Don't forget to originate a message to either the SEC or SCM for extra scoring points. ERCA, of Syracuse, is planning on 100 per cent battery operation. The Oneida Amateur Radio Club's Annual Stag Party, held April 6th, was the biggest and best so far. FCG complains that 144 Mc. is losing ground to 28 Mc. in the Binghamton area. However tests still are being conducted with the Elmira and Scranton, Pa., gangs. Twenty-six from Binghamton and twenty-five from Scranton attended recent annual get-together of the two clubs at Montrose, Pa. New officers of RAWNY are CUU, pres.; UBR, vice-pres.; SSS, rec. secy.; BZE, corr. secy.; and IUF, treas. CIL spoke on manufacture of T.V. and cathode tubes at KBT meeting. QWS is organizing 28-Mc. mobile emergency net in Erie County. HQB built rig with 4D32 final for emergency work. Emergency Coördinators are needed in several localities. Contact SJV for information. The Amsterdam Radio Club holds meetings the last Monday of each month in the club rooms of the Amsterdam Veterans of World War II. Contact SRI for

(Continued on page 74)

160 Meters

IN VIEW of the recent Federal Communications Commission authorization allowing amateur operation in sections of the 160 meter band, subject to certain qualifications and restrictions*, it appears appropriate and timely to devote space on this page to give 160-meter band calibration and bandspread data to users of existing National Communication Receivers. The table shown below provides this information. It will be noted that on the receivers employing two dials, such as NC-33, NC-57, NC-173 and NC-183, the setting of the main dial for each of the 25 Kc. sections occurs at a point where there is a division mark on the dial, making it easy to set and reset. It is also evident, from the chart, that the NC-33 and NC-57 provide more than 1 division per kc., the NC-173 and NC-183 provide more than 2 divisions per kc. and the HRO provides about 3 large divisions for every 10 Kc. in each of the 25 Kc. sections.

J. H. IVERS, W1HSV

NATIONAL CO. RECEIVER TYPE	BAND SECTION KILOCYCLES	MAIN TUNING DIAL SETTING	BAND SPREAD NUMERICAL DIAL
NC-33 and NC-57	1800-1825	1850	31-57
	1875-1900	1900	60-100
	1900-1925	1950	38-62
	1975-2000	2000	65-100
NC-173 and NC-183	1800-1825	1850	30-102
	1875-1900	1900	109-180
	1900-1925	1950	50-114
	1975-2000	2000	120-180
HRO	1800-1825	"D" Coil General Coverage	36-43
	1875-1900		56-63
	1900-1925		63-70
	1975-2000		82-89

* For more detailed and complete information on regulations, see *QST*, March 1949, page 28.



further details. RUF, WZQ, and PGT made BPL this month. Traffic: W2RUF 851, WZQ 580, PGT 287, QHH 166, YGW 138, SJV 55, WFU 50, YRF 47, ZPC 40, FCG 36, WOE 28, VIQ 27, BLP 14, QZI 11, BLO 4.

WESTERN PENNSYLVANIA — Ernest J. Hlinsky, W3KWL — Our new SEC is Robert Blackburn, MPO, Ingomar. Let us all extend our sincerest gratitude to 3UST, our former SEC, for his splendid work and cooperation while in office. Many thanks for reflecting me as your SCM. It is a great honor to serve you all again. The ATA News tells us that OB did a swell speaking job on propagation and DX predictions at the last ATA meeting. A new emergency net has been organized in conjunction with the Ohio Valley Emergency Network with NUG as NCS. First drill showed the following reporting: AVY, GEG, LIW, LOD, MJK, NCJ, USM, VMR, and OXO. New members of the club are LKZ, MTA, 5OCU, KVV and QVG. NUG wants to try 144 Mc. KSR piled up 11,568 points in the DX Contest. USM is cutting records of the Pole Cat Net. LFK says that with the help of PY and KSP he will get on 28 Mc. The Fort Necessity Radio Club call is PIE. The rig runs p.p. 5514e on 14- and 28-Mc. 'phone. 7-Mc. c.w. uses two full-wave long-wire antennas. The Horseshoe Radio Club reports via *Hamateur News*. IQD is responsible for FB code classes. WBD is on 14-Mc. 'phone, LIV on 14-Mc. c.w. LJQ and RYN are on 144 Mc. NJH is putting finishing touches to his kw. final. MKH is perfecting his new electronic bug. KWR is in Scottsdale. ORP is n.f.m. on 28 Mc. UVD wants to try same. VRC will try converting his BC-459 to n.f.m. In Dubois, MOT reports listening on 144 Mc. and hearing Pittsburgh and Cleveland. NCJ reports from Miami, Fla. VNE, our ever-alert OO, reports NGW has p.p. 75T on 28 Mc. MLG is using 80 watts to 826 final on 7 Mc. and worked 30 countries in two months. KKV is now mobile marine on the *SS Sue Lykes* using folded dipole 60 watts on 28,604.8 kc. LSW says his poor little 807 will retire in favor of a pair of 826s. GJY manages to report into W. Pa. Traffic Net again. Your SCM, together with QCN, GEG, ODB, 80AJ, KQA, and LNA, motored to the ATA special meeting to hear ARRL National Emergency Coordinator, Doc Hayes, speak to the Pittsburgh gang on emergency preparation. Traffic: (Mar.) W3MJK 194, GEG 175, KWL 151, NUG 93, DNO 38, LIW 31, IWH 17, NCD 20, GJY 15, NCJ 10, (Feb.) W3LSS 2, ODB 2.

CENTRAL DIVISION

ILLINOIS — SCM, Lloyd E. Hopkins, W9EVJ — ERX tops the section with the largest traffic total of the season. JVC is building all-band rig. YNE has joined the IVRA gang. OBB is trying to get r.f. into his antenna. DLO had measles. YBY tried a couple of transformers. PBY is having beam trouble. IQC is burning the midnight oil designing a new rig. The Illinois Valley Radio Association was host to Illinois Council of Amateur Radio Clubs at La Salle. MZW is the only active ham in his county. QKJ/DL4 reports from Germany and expects to be home in July. TAL can't find time for OO work. CRB was licensed in 1946 but just recently found QTH where he can operate his 807 at 50 watts input. NN is working on T.V. I. cures and schedules 6CG bi-weekly. FRP finally missed a night on ILN. EVJ is QRL work around the house and doesn't get on the air much. KFI is getting good results on 144 Mc. BRX conducts code class each Tuesday night. The Kickapoo Radio Operators has a nice code class going with ZST and AJJ as instructors. BRY reports that GTR, ex-DGR, is a new call in Rockford. ASN returned to the air and spends part of his time on 144 Mc. WEA has 32V-1 rig and 75A-1 receiver with folded dipole antenna. CZB visited SYZ. GME is new YL operator in Chicago. HON, with the help of PBJ and DWD, put on a nice ham radio demonstration at local church men's club. HKA reports the Iroquois County AEG group will hold Field Day operations two miles west of Crescent City. RSM is getting ready to move to Boston. We will miss you, Rudy. QLE made WAS and WAC at last. CDO has p.p. 24Gs on 14 Mc. BUK reports 42 members in local code class. BON is all set for 160 meters. KMN worked six new countries during the last part of the DX Contest. TPA is announcer at WILA. KQL reports the Sangamon County Radio Club smoker a success with 43 hams attending. The Midwest VHF Club picnic is scheduled for July 31st at Thatcher Woods near Chicago. Further information can be obtained from OBW. June promises to be a big month for hamfests in this section. The Starved Rock Club will hold one June 5th and Peoria follows with another on June 12th. After Field Day the big picnic at Weldon Springs Park near Clinton will be held on June 26th. BIN is now a member of MARS. JGC obtained BC-348 receiver. CRW made WAC three nights in a row on 7-Mc. c.w. ATA has new Packard car. NGG is getting ready for 3.85-Mc. 'phone. JAU has new rack job with 812 p.p. and final 811 with Class B modulator. TLC is working on speech amplifier and modulator. QLZ is QRL remodeling house. ZPC put up a new folded dipole and from reports received it is really hot on 3.85-Mc. 'phone. Traffic: (Mar.) W9EBX 2122, QIL 610, KQL 442, FLQ 281, SYZ 255, EVJ 208, CMC 115, SXL 90, RSM 70, ZPC 68, DUA 41, LIN 29, BUK 24, FKI 18, PST 17, MRQ 17, FRP 13, QKL 7, ASN 6, BRY 6, UIN 3, HON 2, HKA 1. (Feb.) W9QKJ/DL4 24.

INDIANA — SCM, Charles H. Conway, W9FSG — BKJ, Fort Wayne, has new NC-183 receiver. The Tri States Amateur Radio Society, Evansville, is having a rat race on DX with QLV, BBC, and GFO running ahead. HUV, Stillwell, worked ZC4AC for a new country. AQO, Ft. Wayne, has 35 watts on 3.85-Mc. 'phone and what's more he is getting out. Spokane, Wash., is his best DX. Fort Wayne area hams are invited to join the Maumee Valley Muskrat Net on Sunday mornings. The gang congregates around 3905 kc. after the close of the Indiana 'Phone Net. UIA, Evansville, rebuilt his 522 for the fifth time. CLY rebuilt final to eliminate B.C.I. The B.C.I. in CLY's case was merely 2200 students in and around Cary Hall, Purdue. The Cary Hall Radio Club has approximately 50 members and theory classes and code learning groups are being held. AST, East Chicago, is on 7180 kc. with 50 watts to an 807. GUX is new ham in Gary with a 6L6 running at 21 watts. NH again makes BPL, this time through the front door. Sam has some secret plans for the future, having bought a windmill tower and some aluminum tubing. GHK is a new ham in Evansville. GFS is a member of the Ohio River Emergency Net. Traffic: W9NH 550, TT 208, BKJ 71, HUV 43, PMT 32, QLV 18, DGA 9.

WISCONSIN — SCM, Reno W. Goetsch, W9RQM — Ex-9HSK is now 3MHH in Maryland. RSR needs plate transformer for new 803 final. WEN, new OO found 5 new countries in DX Test for a total of 78. FXA worked 14 countries with 8 watts to Meissner VFO. CWZ is RM in charge of 15-w.p.m. net. SIJ built new 150-watt 'phone and c.w. rig with RK-4D32 final. ESJ was kept busy with incoming traffic during Wisconsin Simulated Emergency Test. Another Racine regular on the c.w. net is BVG. SFL reports into both c.w. and 'phone nets, and reports the LaCrosse Club has code classes on 27 Mc. for new-comers. DND transmits Official Bulletins on 3775 kc. Mon., Wed., and Fri. from 6:25 to 6:35 p.m. RLB finished new bandswitching emergency rig. CXY, a new ham at Kenosha, holds 35 w.p.m. Code Proficiency and RCC certificates. ILR has a new Meck T-60. Milwaukee, Green Bay, and Wausau were declared disaster areas in April 3rd Wisconsin Simulated Emergency Test which was planned by the SEC. LZU, VHA, new EC for Wausau, and WLZ, Green Bay EC, both report splendid local cooperation in the test. OCT, LaCrosse EC, has appointed LKL, SFL, and GCT as Asst. ECs. RBI worked PK4DA for country #143 on 'phone. Another good one worked on 'phone by RBI, RNK and LNM is XZ2KN. FCF, new ORS, received 20-w.p.m. endorsement on 14W transmission. CIJ and KPG are trying to work the Fox River Valley gang on 144 Mc. KXX has 67 QSLs verified out of 78 worked. JBF, new OES, has p.p. 24Gs on 50 and 144 Mc. AFT is working on a 'phone patch. BZU completed 3.5- and 7-Mc. portable rig for Field Day. QJW puts out bulletins for Central Wisconsin and Marshfield Radio Clubs. CBT has a new 32V-1. WVRA installed new beam rotator and indicator for CTD. Traffic: (Mar.) W9ESJ 230, IQW 108, SZL 91, CWZ 59, SIJ 55, LFK 51, CBE 42, FCF 39, DND 31, SFL 31, EIZ 25, FXA 16, LVR 16, BVG 13, TOA 11, BZU 5, AFT 2, YCV 1. (Feb.) W9CBE 40, LVR 4.

DAKOTA DIVISION

NORTH DAKOTA — SCM, Paul M. Bossoletti, W9GZD — The West Slope Amateur Radio Club was organized in Dickinson. Officers are ZNM, pres.; KAI, vice-pres.; PGO, secy.; and A. K. Scott, treas. UGM now is located in Fargo. The Fargo Club has 3-kw. generator for Field Day. YSJ is shooting at 50 Mc. again. PYG is giving 7-Mc. c.w. a whirl. FKP and PGO vie for 28-Mc. honors. SKI, Grand Forks, is on 3.5 Mc. OEL broke down and tried 3.85-Mc. 'phone. AAU puts in an FB signal from Portland. EFJ was one of the first on 160-meter 'phone. JAM switches from 3.5- to 7-Mc. c.w. RRRR handled 220 messages at the hobby show in Moorhead. GBE is building a half gallon. LHS is back in Fargo. HKM is on 28 Mc. attempting to steal some of WFO's DX. DM has gone 28-Mc. 'phone crazy. RGT replaced 101X with HQ-129. KAI and ZNM are mobile on 3.85-Mc. 'phone. OYM is trying 144 Mc. with JNP. Note the announcement of the Dakota Hambores in the Hamfest Calendar elsewhere in this issue. See you June 12th! Traffic: (Mar.) W0LHB 22, ZNM 13, GZD 9, AAU 3, CAQ 3, GWU 2, OCI 1. (Feb.) W0CAQ 2. (Jan.) W0CAQ 18.

SOUTH DAKOTA — SCM, J. S. Fosberg, W0NGM — New calls are TBH and STY in Huron and SZO in Mitchell with FJS now Class A. Plans for Field Day are taking form in many localities and it looks as if many clubs will be on this year. The main topic this month is the sleet storm that struck the southeastern part of the State the night of the 30th and took out land wires and power in many localities. Traffic was handled for the power company repair crews and their switching orders, for the AP and UP, and for the telephone company. The amateurs speeded up the repair work after this storm and rendered a great service to the towns in the stricken area. Among those taking part were GCP, ILL, SRX, DIY, and PRR. Your SCM would like the reports to come in the first of each month so that a more accurate report can be sent Headquarters. Traffic: W0GCF 162, WUU 3.

(Continued on page 76)

MINNESOTA — SCM, John B. Morgan, W0RA — Asst. SCM, Jean E. Walter, KYE, RM; RJF, SEC. BOL, PPK moved to W6 Land. HFF says no more traffic till fall after two BPLs in a row. RQT has a new SCR-522. MSNet is getting fine service in Duluth from RXL, CZO, and KLR. BRA is on again after a nine-year lapse. BOL rebuilt his 3.85-Mc. rig and added 28.5 Mc. mobile and 144 Mc. fixed to spur along the EC group. Let's go on Emergency Corps applications, fellows. After last winter who's to say "it can't happen here"? All of us should be Emergency Corps members. Send a card to BOL for an application form. OGB has a new Stancor mobile job. DUS is sporting a new S11 modulator. SCZ likes his new B9-cr. JCL has a new Signal Shifter. EPZ had 274N units working on 3.5, 7, and 28 Mc. with antennas for each. HTD installed a high-output generator in his car so no more pushing after calling CQ. PIH and KYE have daughters in CZO's high school radio classes. GVO is president and Mrs. ISB is secretary of the Lake Regions Radio Club. PNQ is really DXing; nearly 150 countries postwar. The Minneapolis Radio Club has decided to acquire a building to house the 3 kw. rigs given by CO. Both the Minneapolis Radio Club and the St. Paul Radio Club are running hidden transmitter hunts monthly with marked improvement in speed and accuracy. 2ZZA (ex-0MPW) asks his Minneapolis friends to watch for him. The Arrowhead Radio Club's refresher course at Duluth High has about 90 regular attenders, including two XYLs and some high school boys, all heading for their first licenses. DSF was laid up in VA hospital for a month but is much improved. CZO QSOed KYE via handy-talkie while CZO was in the Duluth Playhouse seeing the show! RA visited CWB and BGY, and was shown around Duluth by NRV, who really knows the town. Fifteen Minneapolis Clubbers visited the St. Cloud Radio Club at its recent meeting. Traffic: W8HFF 698, GHN 331, ITQ 214, CZO 70, ANU 58, MXC 47, BGY 45, VJH 39, IXR 38, EPJ 33, LDI 28, RA 27, RXL 26, GUS 24, ORJ 22, CWB 16, RJF 13, RQT 11, BOL 6, UCV 4, TKX 2, DUS 1.

DELTA DIVISION

ARKANSAS — SCM, Marshall Riggs, W5JIC — NCM AU is blasting away at 28 Mc. JIN is busy with new station. AUU is playing with 3.85- and 28-Mc. 'phone. OCX is trying to hold his own on 28 Mc. DRW really is playing hob with traffic totals. OQS is coming out with p.p. 24Gs to the tune of 150 watts. HNU is plowing up 14 Mc. new two-element beam. HOT is getting 28-Mc. mobile fired up. GWT is assembling the kw. with p.p. VT-127As. GTS is running a gallon on 7 Mc. with p.p. VT-127a. OXL is rebuilding for some T-40s. The Ft. Smith Club is building p.p. 806 all-band rig. OXR has been bitten by the DX bug. IRY is working p.p. 807 and has new antenna on 14 Mc. AQD has new antenna and is getting the DX on 14 Mc. DI is disgruntled. Why? Well, he dismantled three-element beam to his sorrow. The Texarkana Club has a new antenna. MJC is burning the wax at both ends teaching code. EGY is working on 28-Mc. beam. ILP puts the 813s in the junk in favor of 304TLs on 28 Mc. KKM, with all his big bottles, sticks to the touted 807. AVH has polished off the brass on 7 Mc. CEO, what's gone from your receiver? Traffic: W5DRW 512, LUX 313, FMF 118, OXU 49.

LOUISIANA — SCM, W. J. Wilkinson, jr., W5VT — SEC: KTE, PAM; CEW. The Radio Club of Southwest Louisiana (Lake Charles) has been assigned a permanent club house by the Calcasieu Parish Police Jury. In conjunction with the expansion, the Lake Charles Trade School has assigned the fellows a 3-kw., 110-volt, 60-cycle, a.c. generator, gasoline driven. IHR, FDC, JFR, IYG, and JBW are new Assistant ECs. MOQ, the EC, is doing a fine job. KYK has been using his new Vibroplex on 7 Mc. LVG listens occasionally on 3.85-Mc. 'phone. Will all licensees in Shreveport, Bossier and Barksdale Field with calls from W50A on through the alphabet please advise the SCM of their full QTHs. MGJ can be found on the low end of 7 Mc. chewing the rag. INL has about completed a rack-mounted pair of 813s which he will have on 14-Mc. 'phone and c.w. USN sends in some fine dope on the operations from the Baton Rouge Levee break. BRR, NOA, FMO, MFH, JKT, and LNU all took part operating K5NRR, WZBR-2, W5-USN/5. EM is getting through to Baton Rouge via 144 Mc. HEN is on 7 Mc. with a VFO and an 807 with about 70 watts. MXP is working 27 Mc. OVM has just received a new NC-173. BPL is working the Gs on 14 Mc. K5FAG is new station for 307 Air Division HQ. Operators are W5FTW, BPL and W6WSC. KRS has a 28-Mc. mobile job mainly for emergency use. BSR urges all hams in the Delta Division to drop him a line giving their views on present-day questions confronting us. VT has been on 14 Mc. quite a lot. CGC has been working DX on 14 Mc. with 15 watts and a two-element beam.

MISSISSIPPI — SCM, J. C. Wallis, W5DLA — The Jackson Amateur Radio Club, Inc., is planning to sponsor a Mississippi section Field Day Contest. The club president reports that they recently have been incorporated, and a drive for additional members is under way. CUU, DNV, and DNW were hosts for a get-together of Magnolia Net members at Meridian on March 13th. The good time had by those who attended will long be remembered. 7JHS/5

and 4KQW/5, Keesler Field, work 28-Mc. schedule with DL2NX, ex-5NRM, of Keesler. IBO has re-designed that beam again. LPL has 28-Mc. traffic schedule with KZ5CG every Saturday. You will find ANP on 3.85 Mc. from 6:30 to 7:30 every morning. OBC and NYV now are Class A. PSS is a new station in Biloxi. KYC is building a new rig. LN is remodeling shack and rig. HAV is building new shack. By now GLZ should be working that new rig. For information about the Emergency Corps contact your SEC, JHS, Box 491, Gulfport. Traffic: W5LEP 66, JHS 29, DLA 9.

TENNESSEE — SCM, Ward Buhman, W4QT — Special sessions of the Nashville and Memphis Clubs were called for the purpose of meeting the National Emergency Co-ordinator and the Delta Division Director. At the Nashville meeting the Alternate Director, SCM, SEC, and many others from elsewhere in the section were in attendance. Vic also visited Chattanooga and Oak Ridge. Maybe he will visit us again now that he has found the way. The gang at Jackson renamed their club the Jackson Radio Club. AQV is president of the club. EC, and chairman of communications for his local Red Cross chapter. NCC calls in Jackson are CUK and HCP. JMV is giving s.s.s.c. a try. LNN is new OO. NPS, ex-1BIV, is new OES and OPS. Other recent appointments include EDF as SEC, NNH as ORS, and CVM, ETN, and MJJ as ECs. MKS is operating /5 at Keesler Field. NIO has new Class A license and occasionally operates AQL at Georgia Tech. PBK is new Chattanooga call. GND is on several bands with 32V, and HRO. Traffic: W4PL 1843, NNJ 303, APC 298, ETN 209, CVM 66, CZL 29, LCB 24, HOJ 23, FCU 21, NPS 19, ONX 13.

GREAT LAKES DIVISION

KENTUCKY — SCM, W. C. Alcock, W4CDA — Activity still is booming in Kentucky. Eighteen stations came through with reports. MVX winds up the slow-speed net (KYW) for the summer. NUQ was heard on 3582 kc. but he was on 7 Mc. PKM reported on KYNet 25 times, twice each on KYP and KYB nets. He is our feeder to Trunk Lines "S" and "J." JQV worked both nets and ran up a good message total. CDA and ALR are carrying on extensive correspondence on T.V.I.-proofed finals. NWQ works Trunk Line "S" and is an MARS member. JCN has T.V.I. under control (the assys). MSC did mobile work with BEW. The Ashland Club gives classes for hams-to-be. KWO is keeping his hand in on both nets, including KYB (night 'phone net). CRI is handling traffic and broadcasting special bulletins to the 3.85-Mc. gang. 0ZZW/4 says OYI is new at Owensboro and reports the following MARS members: MO, VP, NIX, NFH, MZB, LMN, RNY, NOT, KBL, BZS, MPA, NNL, JHE, LVP, NWQ, KTA, KGV, NVK, UTN, MVN, PIP, WZU, and 0ZZW/1 (Where's the Navy?) EDV keeps activity report cards coming through FBI VP is up and after parts for s.s.s.c. (Watch your propagation! He's a new Official Observer.) BPE says 145.8-Mc. net (KXX) now counts a new town. Erlanger, with JDN reporting in as a regular. FBJ says OXC is a new call, having worked 144 Mc. for the first time. CNE quit listening and went on 144 Mc. Louisville is planning for Field Day. Traffic: W4BAZ 117, MWX 88, FKM 82, JQY 80, CDA 39, NWQ 37, JCN 32, MSC 32, KWO 17, VD 13, CRI 11, EDV 10, 0ZZW/4 10, 4VP 7, BPE 1.

MICHIGAN — SCM, Robert B. Cooper, W8QAQ — SEC: GJH, RMs; GSJ, NOH, UKV, PAM; YNG. New appointments: ORS goes to RJC, OO Class IV goes to DLZ, and KOS has been issued an OBS. BPL cards have been issued to NOH, UUS, TRN, and UKV. We regret to announce the passing of ZKR. The belated acknowledgment of the passing of YFT is regrettable. MCV reports election of officers of the Metropolitan Radio Club as follows: RPM, pres.; LUR, vice-pres.; NFQ, treas.; RJJ, corr. secy. Nickel secy. TNO is back on QMN and is cleaning up T.V.I. from 28-Mc. 'phone. SCW invites listeners to use the code practice sessions by BDF. DOI has converted a 696 and is running 75 watts on QMN. The 459-A converted for 14 Mc. is filling every expectation. FX is busy with conversion work for the new station, ZD. TBP is driving a 250TH with a 457-A. CNN in Grand Rapids for the talk by F. E. Handy. DLZ made WAS on 7 Mc. in 72 days. LR is running the Buzzards Roost on 3.85-Mc. 'phone with a 32V-1 and a 75-A which replaces an RME-99 and a BC-610. AAM also has a 32V-1 and a 75-A combination. The CMAR in Lansing has had a nice increase in membership, according to AHV. DSE has an impressive list of DX on 7 Mc. YMO, as NCS, for the 5-P.M. QMN Net, boosts this section to a 6-day schedule. The Tortoise Division of the QMN has completed its third year of continuous operation. K8NAG is the new Naval Electronic Co., in Mt. Pleasant. GSJ reports DX in the form of FO8AC and UC2CD. QGZ relayed Red Cross traffic during an emergency in New Mexico. ZCI has been working on an electronic keyer and cleaning up key clicks. UAL reports on his 200-watt c.w. rig and some good contacts on 28 Mc. with a three-element beam. NQ is installing a mobile rig in his boat. YLS is active on the Paul Bunyan Net. New hams on 28 Mc. are BZM in Negaunee and CLW in Marquette. TCD has push button control for his 28-Mc. beam. YOO has finished his three-element 14-Mc. beam. CSI has a new Collins exciter on 14 and 28 Mc. Traffic:

(Continued on page 78)

MALLORY HAM BULLETIN

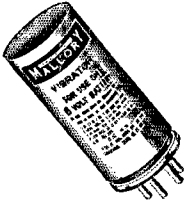

Vibrator

We all like to experiment with new circuits, and designs on our gear, but I wonder if you know how many of the parts you need are included in the Mallory line. Learning this has saved me lots of time and trouble in the design and construction of my new rig. I found that the Mallory distributor was only too glad to help, too. He has a wealth of information at his fingertips, in all the books and catalogues that Mallory has published to help amateurs like you and me.

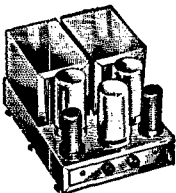

VP-555
Vibrapack

When you look at his stock of capacitors, you'll probably be surprised—the Mallory line has every type you could possibly want—dry electrolytic or ceramic—mica or paper—transmitting or receiving—even high voltage TV styles!

If it's a volume control or a wire-wound resistor that's needed, you'll find no more complete list than Mallory's. There isn't a manufacturer in the business with as many styles of volume controls as Mallory has.

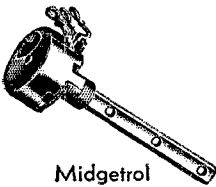

Midgetrol

Then switches! Multi-section and single-section types with bakelite or ceramic wafers—HAMBAND Switches—PUSH BUTTON, LEVER ACTION and JACK TYPES—name your style and Mallory has it.

The same thing goes for vibrators and Vibrapack** power supplies—you will find this part of the Mallory line is complete, too. And you can get good, usable technical details on each and every unit.

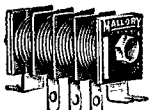

Rectifier Stack

Maybe you're thinking of a new low voltage DC for relay control circuits in your transmitter. Now you know where to get the rectifiers—Mallory, of course! They have a full line of MAGNESIUM-COPPER SULFIDE DRY DISC RECTIFIERS, and BATTERY CHARGERS.

You can depend on Mallory for everything I've mentioned as well as phone plugs, jacks, dial plates, knobs, soldering iron tips. And, of course, for those highly special items such as the Mallory INDUCTUNER*, GRID BIAS CELLS and VIDEOCOUPLERS.



FP Capacitor

If you haven't visited your Mallory distributor lately, get started! We're betting you'll be surprised at the complete service he's prepared to give you.

**Registered trademark of P. R. Mallory & Co., Inc., for inductance tuning devices covered by Mallory-Ware patents.
**Reg. U.S. Pat. Off.*

P. R. MALLORY & CO., Inc.
INDIANAPOLIS 6 INDIANA

P. R. MALLORY & CO. Inc.
MALLORY

(Mar.) WSNOH 664, UUS 520, RJC 385, TRN 379, UKV 221, TBP 176, WYO 147, SCW 102, QBO 87, GSJ 81, YMO 75, CNN 69, IV 60, AQA 49, CPY 40, DPE 36, IHR 35, DSB 34, CRH 33, DWB 26, ATB 24, UBS 20, DOL 18, KOS 13, LR 12, QP 12, BVY 11, MGQ 11, TQP 11, AHV 10, EGI 10, YNG 10, JUQ 9, YER 9, DLZ 7, GJH 7, ZHB 7, ZKZ 7, BGY 5, LHH 5, TTY 5, QGZ 4, UPH 4, DKU 3, DNM 2, FX 1, HM 1, INF 1, ZCI 1. (Feb.) W81HR 122, BYV 21, FOV 18, DNM 17, TQP 10, YER 7, QGZ 6, UAL 4, BLR 3, VWL 2.

OHIO — SCM, Dr. Harold E. Stricker, W8WZ — Asst. SCMs. C. D. Hall, 8PUN (phone), Charles F. Lohner, 8RN (c.w.), SEC: UPB, RM: PMJ, PAM: PUN, 8PUN, new Asst. SCM., will handle all OPS applications and other matters pertaining to phone organization. Following are new appointments: ORS: EIU, LJJ, LOT, OPS: ATK, OBS: POK, OES: POK, OOs: Class 1, GJU and NCO; Class 3 and 4, UDR; Class 4, BIF, BQH, POK, and WAV. UPB appointed the following ECs: ICX, DXY, and TRX. The Ohio Council of Amateur Radio Clubs met in Columbus Mar. 19th. Various matters were discussed and presented to our director, DPE. Your SCM met informally with DPE, QQ, TRX, and IVC the preceding evening. The Westpark Radiops of Cleveland is newly-affiliated with ARRL. Our Communications Manager, IBDI, visited clubs in Ohio and passed out the latest information on the 160-meter band, license extension, 11- and 21-Mc. bands, s.s.s.c., portable regulations, and T.V.I. Our SEC also visited several clubs in Ohio; and spoke on ARRL and EC work at Mansfield. Congratulations are in order to JNF for the fine work that he is accomplishing as QSL Manager. From the *Carascope* of the Columbus Amateur Radio Assn.: At the Ohio Council meeting the following officers were elected: EYE, chairman, ENH, vice-chairman, EQN, secy, NDN, treas. FJN had the highest score for the Columbus area in the DX Contest. The Franklin County 144-Mc. Net added CPA, BAX, ABO, and WXY. GL made 7-Mc. WAC. WYH is back on the air. AOP is experimenting with kite-supported antennas. From the *GCARA*, Greater Cincinnati Amateur Radio Assn.: New officers are PBX, pres.; MGP, vice-pres.; RJD, secy.; NDN, treas. PNJ has new n.f.m. unit. From the *CORC News* of the Central Ohio Radio Club: OUR now is located at Athens. BYE and NQF received their Class A tickets. NAI is back on the air with 250 watts. CNY received his long-sought Asian card for WAC. CBI discussed the conversion of the Command Set 274 series at the March meeting. Field Day location is to be near Marysville. From the Q-5 of the Springfield Amateur Radio Club: HB9GV now is located in Springfield. EDY has built a c.w. and 'phone transmitter utilizing 2E26 tubes. Field Day will be held at George Rodgers Clark Park. OG is code class instructor. ENS is conducting theory classes for would-be Class A and B boys. From the *Bulletin* of the Dayton Amateur Radio Assn.: The Dayton C.W. Net met for the first time March 21st. QUS is NCS, ACE, ENH, CEA, ZQU, CUJ, and HB reported in. RHG made WAC the afternoon of March 19th. CTI is active in Solon. WDQ has new three-element beam on 28 Mc. YFJ made WAS. UW received radiotelegraph 1st-class license. LJJ worked VP2AL, CT3AB, and YV4AW on 3.5 Mc. with 50 watts input. CDS moved to W6 Land. The Carmar Radio Club is raffling off a 12" v.v. set on Field Day. CRE is the Red Cross station of Cleveland. QBF is getting set for 160 meters. UJ now is 7UJ and PZA is 7FKS in Eugene, Ore. HMX has organized a slow B called SBN which meets at 6:30 p.m. on 3730 kc. BLI got 7-Mc. WAS. BIF is using indoor folded dipole for 14 Mc. DAE has been reporting into BN, TLAP, NYS, and ESN. FNX says crystal-control on 3.85-Mc. 'phone is tough going. LBH added three new states on 50 Mc. WRN worked 9UCI and 9UDD solid on 144 Mc. AVH, former Central Division Director, announces the birth of a jr. operator, Paul Joseph, on Feb. 17th. Fellows, let's have those reports by the 1st or 2nd of every month even if activity is practically nil. Traffic: WSHOX 412, SJF 234, DAE 133, CBI 148, GZ 139, PIH 123, EBJ 115, UPE 102, RN 87, PMJ 80, BEW 49, IVC 45, YFJ 42, F4Q 38, LJJ 32, RLF 29, OUR 26, LOT 19, PUN 14, ROX 14, QIE 12, VWX 12, WXA 11, BZK 10, DZO 5, FFK 4, WYH 4, BLI 3, PNJ 3, BEW 2, UW 2, WAB 1.

HUDSON DIVISION

EASTERN NEW YORK — SCM, Fred Skinner, W2EQD — CLL and TYC made BPL this month. Nice going fellows. New appointments: ORS — TYC, NHY, and PHO; OES — PCQ; OO, Class IV — CLL; EC for Greene County — FVP. The Schenectady gang had big antenna-raising party putting up CRE's new 144-Mc. beam. It was originally half of ACY's beam which was cut down to keep the house from taking off. The SARA gang worked out to New York City and Northern New Jersey on 144 Mc. GYV even worked Springfield, Mass. KUJ and RYT have been putting on a road show to acquaint the Middle West boys with the virtues of phasing type s.s.s.c. equipment. Schenectady AEC drills Thursdays at 7 p.m. EST on 3950 kc., 3640 kc., and 144 Mc. Respective NCS are PFU, NHY, and GYV. CAZ and TYC are alternates. With the Albany gang, AWF and HCS are having T.V.I., SUL is building for 144 Mc., DSK is on 3.85 Mc. with f.m., ILI is building a super-small half

gallon. FEN has a new antenna. WIK still is making it rough for the boys with lots of traffic and no break-in. Rensselaer-Albany-Schenectady 3.5-Mc. Net meets on 3525 kc. and 144 Mc. CTH is stalking DX on 7 Mc. The Westchester gang is going strong with an average of 17 stations in the weekly AEC drills. RH has his shack half in New York and half in Connecticut, and works in the Westchester, Middletown, and Nassau-Brooklyn-Queens Nets, all on 144 Mc. PHO is one of NCS for slow-speed section of NYS Net. He just installed 3-kw. gas-driven alternator in the cellar. EQD is NCS for Southern New England and Long Island MARS Net. The Eastern New York section must be a suburb of both places! Traffic: W2CLL 532, RH 450, LRW 382, TYC 224, WIK 165, EQD 140, PHO 96, QGH 44, YBK 15, IN 10, SQW 10, BSH 7, NJF 5.

NEW YORK CITY AND LONG ISLAND — SCM, Charles Ham, jr., W2KDC — BPV heads the Brooklyn AEC now that OHE has been promoted to SEC. ODS is back on after a long QRL. OHE met with the Nassau County gang and ironed out some frequency problems. AJF gradually is getting used to filling CJZ's place in Suffolk. Frank really will be missed. Ed says he averaged nine members per drill. The Suffolk gang favors 3995 kc. with 3600 kc. each Monday at 1900. CSO, in Oyster Bay, formerly was 3HQE and was at sea for six years, but now is well land-locked. He now uses a BC-610 and a Collins receiver. 3.85-Mc. mobile is really working out on Long Island. It is very popular and is replacing 28-Mc. mobile, say the gang. QBS is using "half" of ten-element beam on 144 Mc. RTZ/4 handles traffic for one fair after another. Hope hopes to get to NLI banquet on June 11th. PF worked KX6AF on 14-Mc. 'phone and Dave also reduced T.V.I. to allow 7 Mc. at night. VSU had a little trouble with published pin number of certain tubes used in VT keyer. KV4AF/2 joined the MARS Net, but he still likes NLI. Any applicants for AEC in Manhattan who have not received cards, please contact WHB. Dave also asks that all Group 1 stations operate on 3600 kc. Wednesdays at 2000. ZNM was "exceptionally" QRL this month. TYU is hemmed in with T.V.s, but Pop vows to cure the trouble. His score proves something. BO will take G.I. traffic for Japan or Europe via regular schedules. YDG hit low operating level in March but will improve or give it up, says Jack. DBQ hopes to give NLI more of his time soon. VJZ now is manager of SSN and handled traffic direct from 4NC/4 at Broward County Fair, Ft. Lauderdale, Fla. TUK is building but not operating. T.L.S. (Trunk Line Slow) now is official, says OUF, who is outlet. AFC is a new call on Long Island. K2NRK has QSLed every station worked, says 2HAE. Traffic: W2TYU 671, VNJ 424, OBU 222, OUF 146, VNO 143, BO 93, YSU 75, QBS 69, EG 39, KV4AF/2 26, WZZNM 26, PF 16, VDG 14, VAF 8, DBQ 5, WEB 3.

NORTHERN NEW JERSEY — SCM, Thomas J. Lydon, W2ANW — SEC: INN. RM: CGG, LFR, and NKD. PAM: DRA. The N.N.J. Net meets daily except Sunday, on 3630 kc. at 7 p.m. The JN Net meets Monday through Friday on the same frequency at 9 p.m. The 40-Meter Net meets Monday, Wednesday, and Friday on 7260 kc. at 7:30 p.m. KUS is building new high-power final and using BC-696 as pinch-hitter. EWZ is a charter member of MARS. ODA has 14 countries on 28-Mc. mobile. He now is building high-power home rig. VOH is on 3.5-Mc. c.w. with 20 watts VFO and VC-183. RIG is off the air for the time being. QLF and YXM are on 28 Mc. ANG has a half-kilowatt with single 8000 final. WCF now is operating on 14 and 28 Mc., both 'phone and c.w. ZWV, of Ridgewood, received his license. VJN worked 4 new countries for a total of 61. NCY is working like a beaver getting Field Day rigs ready. CWK got his 3.5-Mc. c.w. WAS certificate. NRG made 118 contacts on 3.85-Mc. 'phone during the first three months of operation, running only 18 watts. MTV is having T.V.I. trouble and will be back when he gets those traps working. Traffic: W2CGG 420, KUS 335, NKD 183, ZCL 163, LFR 148, HII 82, QCB 77, OXL 65, NCV 62, BRC 47, PQC 31, VIN 25, LMB 23, NOZ 23, EWZ 19, ANG 6, CJX 6, OUS 6, CWK 4, NIY 3, WCF 1.

MIDWEST DIVISION

IOWA — SCM, William G. Davis, W0PP — New officers of the North Iowa Radio Club are WLY, pres.; QZP, vice-pres.; PUE, secy. The Club had almost 100 per cent attendance at its last meeting. Thirteen reported in on the Club's last 28-Mc. ground-wave net. On Jan. 15th the TLN held a one-watt contest with great success. SCA demonstrated ham radio at a hobby show held in conjunction with the State Dental Society May 2nd-4th. PTQ says she's going to get that antenna higher now that spring is here. ATA is looking for hams in their teens. QAX is a new ham at Waterloo. TWX reported a swell vacation in Florida. HMM still is high traffic man in the State. QVA reports Burlington had two excellent speakers this past month in DEA, our Director, and "Doc" Hayes, IIN. Doc met with the Des Moines Club the 18th. LAC has an ARC-4 on 144 Mc. PP was reflected NCS of the Iowa 75 Net, with SQQ, CPU, and VCM as alternates. IFX is chairman of the board of directors, which includes FP, UFL, JUL, and SRR. EPI and NXW, his XYL, attended the Council Bluffs Club meeting

(Continued on page 80)

Follow the Leaders to

Eimac
TUBES
The Power for R-F

TAKE OFF YOUR KID GLOVES



Here's a tube that can really take a beating.

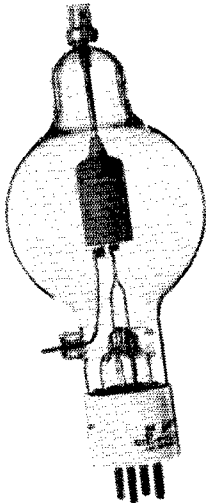

For over a decade the Eimac 100TH has proven its superiority in many thousands of transmitters. Regardless of how you make a comparison . . . it is the **TOP** triode in its power class.

You can build a 1 kw CW rig for a total final-amplifier tube cost of \$33.00 (two Eimac 100TH triodes). In this service each tube can handle 500 watts input with plenty of efficiency . . . and not only that . . . you don't have to baby them along. There will be a real thrill the first time you hit the key . . . the exclusive Eimac Pyrovac plate extends operational safety beyond expectation. You can tune-up and operate with complete peace of mind knowing your Eimac 100T's can handle unexpected momentary overloads.

There are similarly rugged Eimac tubes in every power category, covering all the popular frequencies . . . a "quick reference" price and data sheet is available upon request. Write today.

EITEL-McCULLOUGH INC.

728 SAN MATEO AVE., SAN BRUNO, CALIFORNIA

Export Agents: Frazar & Hansen, 301 Clay St., San Francisco, California

March 9th. The Manila Hamfest will be held the last Sunday in July. The Council Bluffs Hamfest and 144-Mc. transmitter hunt will be held Sunday, July 17th. Bill Copeland is making the rounds again. The Council Bluffs Sparks and the North Iowa Club's *Splatter* are fine club papers and a good source of news for the SCM. Traffic: W0HMM 951, PP 221, WMY 191, SCA 138, SCW 82, HCH 64, AUL 50, TWX 50, NYX 47, SRR 36, PTQ 32, SQV 31, QVA 30, AYC 21, KYX 10, LKK 9, ATA 6.

KANSAS — SCM, Earl N. Johnston, W0ICV — The Eldorado Amateur Radio Club has just been organized with YEC, pres., and ONI, secy-treas. Charter members are YEC, ONI, HZZ, HVL, HVC, MKR, and IKE. The Club's first project will be to revive an old 110-volt a.c. generator belonging to the Red Cross. WARC, Wichita, held open house for new station in Red Cross Building April 4th. An HT-9 and HQ-129X comprise major equipment. Members of KVRC, Topeka, are engaging in volunteer work with Winter Veterans Hospital, holding code and theory classes for prospective hams. QKS and QKS SS nets ceased regular activity on 3610 kc. April 8th. NCV urges the gang to get on 7220 kc. this summer when possible. The Kansas Phone Net now has over 100 members. BNU visited 5MED while in Eureka Springs, Ark. BPL got in on 50 Mc. opening in March working ten stations and five states in one evening. The rig is 150 watts to p.p. 24Gs into four-element beam. Receiver is VHF-152, SX-25. CXP reports Frisco expressed gratitude to stations handling their traffic in January ice storm. IYR and MYG received Public Service certificates from Western Union. LIX is building flip-flop for work into dual antennas. OOU takes NCS on TL "K" once a week. QV has completed kw. job on all bands with p.p. 4-250s in final into Mims Squirter on 60-ft. tower. SEC, new station in Lawrence, is on 3.5-Mc. c.w. Watch the nets for dope on hamfests. Traffic: W0DRB 177, N1Y 169, O1U 116, WGM 92, AHA 80, CXF 27, IYR 26, FRK 23, ICV 18, FDJ 11, LIX 10, KXL 7, AHW 6, BNU 2.

MISSOURI — Ben H. Wendt, W0ICD — Appointments and renewals: BQL and QMF as ECs, NNH as ORS, and BCD as OBS. June 12th is the date of the ham picnic to be held at Camberton on the banks of the Lake of the Ozarks. All hams are welcome. The Tri-State Radio Society of Joplin elected QJE, pres., MZA, vice-pres., and Dick Davis, reporter. Tri-State Club attendance is on the increase. HARC's recent guest speakers were 9JIM, 0DEA, and ILIN. QXO is keeping traffic moving on the Hit and Bounce Net, 7155 kc. PLJ and YKR hold the honors with Perryville's first QSO on 144 Mc. GEP, SKA, JSR, HJO, and QMW represent Columbia on MON. The membership of the Ozark Amateur Radio Club now is 100 per cent A.E.C. The Show Me Net needs outlets north of the Missouri River. PMI is in charge of communications on the Cape County Red Cross Disaster Committee. ARH brought his total number of countries worked to 95 by adding GD, TA, PX, ZD2, HA, and SV. WAP's Clapp oscillator doesn't have bugs but has fleas and jumps about 300 cycles at regular intervals. EBE is conducting code practice sessions on 29,500 kc. each Mon., Wed., and Fri. at 8:00 p.m. ICP constructed a combination 14.2- and 28-Mc. beam at a cost of \$4.20 in which bamboo fishing poles were used to support the elements. The kw. rig at CKS gets the traffic through on c.w. VMI is working on the modulator. NNH is battling a wild pair of 829s intended for 28-Mc. operation. JSR is putting a pair of 24-Gs in the final. OUD is trying various types of antennas. EBE, HUI, ERU, and CGZ still handle traffic with WRQ in the Stockton area because of damage caused to communications in the January ice storm. UYO, YAR, PLJ, QMF, and SKA are on 144 Mc. GNX is on 7, 27, and 28 Mc. with 100 watts c.w. to a four-element beam. Traffic: W0CKS 204, QXO 202, SKA 182, JSR 135, GEP 128, CGZ 94, KIK 82, WAP 71, OUD 59, ICD 7, QMF 7, VMI 3, PMI 2, NNH 1.

NEBRASKA — SCM, William T. Gemmer, W0RQK — Ham radio again proved its worth by being on the job when twenty towns were isolated by the April 1st storm. IXL and GMZ are new ORS appointees. FAM renewed ORS appointment. FQB is pounding out code practice three nights a week on 27,312 kc. AY is converting a BC-458A to a Clapp oscillator and is building p.p. 813 final. From GJM we hear that the SENRC enjoyed the ARRL film "Electron Theory and the Diode Tube," plus a power supply talk by ex-9AVX. WKP, VOL, and NWC were elected trustees of the SENRC transmitter. THF can switch his NC-46, Sonar VFO and 175-watt p.p. TZ-40s to emergency 110-v. a.c. gas-driven power plant on a moment's notice. BRO is building seven transmitters in one rack using 829Bs paralleled in the finals. RXU is a new ham in Hastings on 7-Mc. c.w. HARC bought a Micro-Match for club use. The HARC, over LJO's rig, discussed ARRL club affiliation with FQB using EUT's rig and RQK, all on 3.85-Mc. phone. KJP is on 3.85-Mc. phone with BC-457 VFO, TZ-40 driving p.p. HK-54s running at 250 watts modulated by 807s and an NC-173 receiver. JLD rebuilt 6L6-807 rig with two power supplies in less than a cubic foot of space. DNW worked South Dakota and Wyoming during Aurora opening on 50 Mc. IOS has new 10 over 20 beam. VHR sold 28-Mc. portable mobile to EAQ. UPY added 144-Mc. beam over 28 Mc. Traffic: (Mar.) W0TQD 565, FAM 227, FMW 143, GMZ 107, SA1 90, OZC 78, KDW 71, KJP 66, AY 56, KON

29, JLD 28, FQB 27, THF 27, IXL 26, LJO 13, DMY 11 (Feb.) W0THF 34.

NEW ENGLAND DIVISION

CONNECTICUT — SCM, Walter L. Glover, W1VB — The SCM wishes to acknowledge the various monthly reports received from the OOs in the section. These boys are doing a good job with very little publicity. QIX and EJI are celebrating the arrival of jr. operators. SAQ is a new ham in Mansfield. Q1S received his 30-w.p.m. sticker, EDL and LMK are on 144 Mc. The Manchester Club is conducting a junior radio class with QUJ in charge. KUO finally fixed his T.V.I. by running four and a half watts. That's one way to do it. RWS schedules 3GQF and made BPL on deliveries. NJM has run out of hands now that his lift is going glassy — so he says. JTD is putting finishing touches on new exciter. BVB applies for ORS, as does KW. BDI has another ham in the family, his son, RZP. RVE opened up from New Haven with 500 watts to p.p. 8005s, is suffering from T.V.I. and getting used to a new electronic key. CGD received OPS, OBS, and OO appointments, and is particularly interested in frequency measuring. LKF, our SEC, is visiting various clubs in the section to get acquainted and to establish a state-wide Emergency Corps. Your cooperation will be appreciated. The Nutmeg Net is going strong, but could use a few more stations around the State. If interested, get in touch with ORP, your RM. PCH has new Collins receiver. NEK is vacationing in Florida with a portable rig. RPQ is on 28-Mc. c.w. Traffic: W1RWS 230, CTI 222, LIN 190, VB 164, NJM 130, LKF 107, DAV 98, BIH 88, KUO 39, RUP 38, BDI 36, KV 34, EFW 22, BVB 19, JTD 13, NYC 6, AH 1.

MAINE — SCM, F. Norman Davis, W1GKJ — QEQ is doing a fine job as editor of the bimonthly *Emarc News*, club paper of the Eastern Maine Amateur Radio Club. 144-Mc. activity is beginning to build up for the summer. ATC, OIN, OHU, RJL, and TO are among those now on 144 Mc. CPH has such a big rig and such a small shack he has to stand outside and key through the window! NXX now has a VHF-152; he also has so much line and ignition noise he can't use it! LXE now is 2WVQ and is on 3.85-Mc. phone. JNL is back on 28-Mc. phone after having been off the air for several months. Field Day is not far off now. Are you ready for it? Traffic: W1OHT 93, NXX 88, YA 73, NGV 42, LKP 41, KYO 35, ODA 20, AFT 18, GKJ 10, ROM 9, AMR 6.

EASTERN MASSACHUSETTS — SCM, Frank L. Baker, jr., W1ALP — The following renewed their appointments: As ORS — PLQ, QMJ, As OPS — DHX, IN, ERH, MRK, As ECs — NSP, QNJ, BKR, BVL, KYX, As OBS — FXH, KNI. As PAM for 50-Mc. band — IN, As OO — NF, MIT, DMS and ILN are new ORS. Active on the 144-Mc. band: PX in Newtonville; QKW, GWE, RWO, and CUY in Plymouth; OTZ in Dorchester; JLR in Weymouth; RFE in Whitman; QFD in Marlboro; OIZ in Weymouth. AKD moved to Watertown and is on with f.m. RYB is a new ham in Boston. HHH, in Lexington, is on 3.5 Mc. The Wentworth Institute Radio Club has four beams on the roof on one tower. QMJ made BPL last month. QVC's XYL got her call, SAJ. Morris Allen, of Hull, got his call, SA1. QOI has a rig for his club on 144 Mc., a 522. RSY is a new ham in Bedford. Ex-IDQG, formerly of Stow, writes from Washington, D. C., where he is working at N.R.L. MIT is busy with T.V.I. ERH is busy with T.V. ROQ is on 28-Mc. mobile. RZE is Frank Pugsley of Malden. 2KDQ/I has a rig in his car for 3.85 Mc. PSF has new auxiliary ketch. LD is back on the air. RIP is going to radio school. BID will be on 160 meters. FNO is building converter for 144 Mc. JTR is waiting for a pole for his beam. GWE is going to visit W6 Land. IIV has new Hammarlund transmitter. NBS gets on from Dedham. The Hi-Q Club visited WBZ-TV. DHX will have a sixteen-element beam on 144 Mc. PUJ, at Bedford Air Base, is on 28 Mc. and is working the Air Lift in Germany. RKS is a new ham in Bedford. ONZ sends in this: The Newton Amateur Radio Assn. elected the following officers: RM, pres.; PX, vice-pres.; LMU, secy.; OMU, treas.; EK and BL, directors. The Club has the rig on 3.85 Mc. KVX and LMU visited VP9G in Bermuda. AGR is on 3.85 Mc. KVX got rid of T.V.I. FUR blew a modulation transformer. SAI gave a talk on Loran and movies at South Shore Club. John Huntoon, of ARRL, spoke at the Eastern Mass. ARA meeting. KNI has a new jr. operator, his third. NF reports a new civilian net at Boston Naval Shipyard on 7100 kc. at 1 p.m. on Sundays. One hundred have signed up. JCY is custodian at So. Boston. PSF spoke on mobile marine on 144 Mc. at the Quannapowitt Radio Assn. An auction was held at the April meeting. DOX has a Meissner Signal Shifter and reports a new ham in the Town of Amesbury, RYJ. The Brockton Radio Club had an auction. PLQ is a member of MARS. IAE gave a talk on underwater sound with movies at the South Shore Club. BGW has postwar DXCC certificate, has rig in his car, and has QSO with FH from his car on the way from work. The T-9 Radio Club held election of officers and Ladies Night in April. BB has 600-watt gas generator in the cellar for emergency work. MRK has a new beam, BC454, 28-Mc. converter ahead of SX-28, has 12 new countries all on 28 Mc., and worked JA3AA and

(Continued on page 88)

NOW YOU CAN ENJOY TOUCH-TO-TALK OPERATION WITH YOUR FAVORITE MICROPHONE

NEW "BREAK-IN" Touch-to-Talk STAND

FIRST TO FIT ANY MIKE
WITH 5/8"—27 STAND COUPLER

Never before such ease, such versatility! *Ideal* for communications, paging, dispatching. Specially designed lever-type switch for relay operation or microphone "On-Off."

Combines handsomely with E-V microphone, as shown, to give you *complete*, ready-to-use "BREAK-IN" operation . . . or available separately for use with your present mike. Action is quick, finger-tip. Self-contained switch removes easily from round die-cast base. Single-pole, double throw. Satin Chromium finish; gray plastic switch lever.

Model 428. "BREAK-IN" Touch-to-Talk Stand with Switch. List Price . . . \$12.50

Model 328. Touch-to-Talk Switch only. SPDT. List Price . . . \$9.50

Model 628. Complete with E-V 605-8 Hi-Z Dynamic Mike, 8 ft. cable. List Price \$37.00

Model 629. Complete with E-V 606-8 Hi-Z patented Differential Dynamic Mike, 8 ft. cable. List Price . . . \$49.00

(Double Pole, Double Throw available on special order at \$1.00 list extra.)



- Press lever lightly for "On". Switch closes.
- Release pressure for "Off" Switch opens.
- To lock in "talk" position, press red locking button.
- To release lock, touch lever lightly; switch returns to "Off" position.

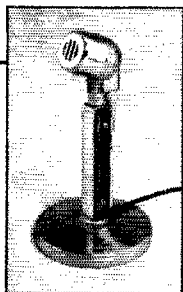

Switch in "Off" position ready for effortless touch-to-talk operation.

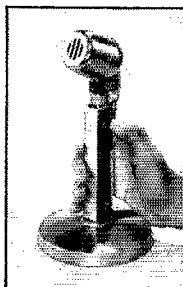

Switch locked after pressing red button. Touch lever for release.

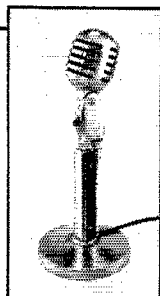

"On-Off" switch on mike for voice control. "Break-in" switch for carrier control.

Ask Your E-V Distributor or Send for Bulletin No. 150

Research-Engineered by

Electro-Voice

ELECTRO-VOICE, INC., BUCHANAN, MICH.

Export: 13 East 40th St., New York 16, U.S.A.

Cables: Arlab

KR6AM. WU has the kw. rig ready. MDU is in MARS. KKJ handled traffic for MPP with her OM. PS. QMJ has 61 countries on 7 Mc. EMG has e.c.o. in the b.c. band. PU is on 14-Mc. c.w. ZR has her SSN certificate. Traffic: (Mar.) WJQM 535, ZP 185, EMG 161, KKJ 126, LM 117, TY 116, PYM 52, WU 31, QJ 14, RBK 14, BB 10, MDU 10, PU 9, DHX 4. (Feb.) W. L. BK 104, BB 11, MRK 4.

WESTERN MASSACHUSETTS — SCM, Prentiss M. Bailey, W1AZW — RM; BVR, SFCG; UD. New officers of the Wachusett Radio Club of Pittsburg are: OBU, pres.; NBL, vice-pres.; QCV, secy.; R.C.C. treas.; Robert Bond, act. mgr. The new club call is RYI. Code practice is held at the club each Monday and Wednesday evenings. All clubs are making plans for Field Day. The Pittsfield Radio Club will operate as W1QSA from atop Washington Mt. The Worcester County Radio Assn. will operate as W1RO, and the Hampden Radio Club will have three transmitters, one a BC6101. Congratulations to the youngest ham in Western Massachusetts, RZG, of Springfield, takes the honors at 13. He is after WAS already and is a traffic hound. RHU sure has a nice traffic total. Russ has SS Net certificate. BVR would like to see more activity in Western Massachusetts Net. JE finally made WAS. LTA has new t.v. receiver. JE made BPI, on deliveries. MUN and ODU are altar-bound — so I am told. RDB has to sidetrack radio for homework. More power to you, Dick. BDV is looking forward to his session with the garden. Jim expects to be on for Field Day with his portable rig. GZ is having his Super-Pro souped up some more. Nes takes an active part in SSN and ESN, as is shown by his traffic total. GVJ visited in Philly for a few days. BOB expects to move to Springfield shortly. COI got a few new countries in the DX scramble. SAN is a new ham in Pittsfield. Wiz works 3.5- and 7-Mc. c.w. OAZ, of Dunton, is active on 3.5-, 7-, and 14-Mc. c.w. RUX is gaining countries fast in his quest for DX. 2MEW now is living in Pittsfield and has joined the PRC. He won a McMurdo-Silver 701 transmitter at a recent raffle held by PRC. AZW now has 1st-class commercial ticket. PYR received Class A ticket. Traffic: W1JE 242, GZ 164, BVR 147, RHU 92, NY 69, IHI 40, AZW 35, JGY 31, BDV 10, GVJ 10.

NEW HAMPSHIRE — SCM, Gilman K. Crowell, W1AQO — EWF now is running a kw. on 14 and 28 Mc. CRW reports increased activity on the c.w. net. MCS has his 2nd-class commercial license. JB is ready to go on 160 meters. BFT has his kw. final completed. AOQ WACED in 36 minutes during the DX Contest. AIJ is recovering from a long illness. LVG, KMH, and HOV are in MARS. POK has been appointed OO, Class 4. Watch for future announcements from the Manchester Radio Club on the 1949 Hamfest. See you on Field Day from OC/L. Traffic: (Mar.) W1CRW 631, BWR 136, QJY 68, MXP 50, ANS 26, CVK 17, QJX 13, EWF 10, PFU 8. (Feb.) W1EWF 8.

RHODE ISLAND — SCM, Roy B. Fuller, W1CJH — HLK, president of the NAARO, has accepted a call to Washington and it was with deep regret that his resignation was accepted. KHZ will fill the unexpired term of the president. NCX reports that T.V.L. has been eliminated by rebuilding his rig within a completely enclosed metal cabinet. The T.V. antenna is nearer his beam than he is. The NAARO will apply for a club call as soon as a station trustee can be selected. BFB's claimed score in the DX Contest is the highest ever recorded by a Rhode Island contestant. A tribute to international ham radio is due, for several of the personnel of a carrier on winter cruise in the Mediterranean area were able to talk to their families from several different countries with hams in the Quonset area on the receiving end.

VERMONT — SCM, Burtis W. Dean, W1NLO — PYO had an FB article on converting SCR-522 in April QST. CUN, in Richford, has been heard on 144 Mc. in Williston. KJG is on 28 Mc. with n.f.m. and three-element beam. PAL is going back into the Navy. AC and ORO are sporting new 1949 four-wheeled buggies. RCO hopes to be on 7 Mc. soon. EKU has DXCC Certificate for 28-Mc. 'phone; he had worked 117 countries with 107 confirmed. Your SCM attended the April meeting of the Concord Brass Pounders. EKU, MMV, and OKH have been handling traffic for GIs overseas. AVP, NWW, and PTB are on 144 Mc. AAJ, AVP, and NWW have 28-Mc. mobile rigs. AVP has six-element beam on 144 Mc. AVP and NDL are busy with CAP. PSD has resigned as RM because of illness. KRV is the new RM. MMN is handling traffic on 3.5 and 3.85 Mc. Don't forget to get that emergency rig ready and give it a tryout on the annual ARRL Field Day, June 18th-19th. Traffic: W1KRV 41, NLO 18, AEA 14, AVP 14, ELJ 6, KJG 4.

NORTHWESTERN DIVISION

ALASKA — SCM, Charles M. Gray, KL7IG — The boys in Ketchikan are publishing a nice monthly paper on the activities in that area. From this paper we quote the following: "KB is on 28-Mc. 'phone. FP is the proud possessor of a 28-Mc. three-element beam. WH is new chief engineer at KTKN and has 2 wats on 28 Mc. and an NC-183. SQ is on 3.5-, 7-, and 14-Mc. c.w. running 80 wats to a 616. W3LQR is offering a room for the Ketchikan Club in which to meet. A real club program is in the making." VJ now has his Collins 150-watt job going and really likes it. All he needs now is a few acres of land. BD has another jr. operator, a

boy. He is the new OBS in the Moses Point area. He is running 500 wats, and the receiver is an HQ-129X. Traffic: KL7RI 16, BD 4.

IDAHO — SCM, Alan K. Ross, W7IWU — Downey: LQU is putting mobile in his recently-purchased Chevy coupe and in the meantime finding conditions good on 14-Mc. c.w. Moscow: MYA has done some "bloss-trading" of his 8X-24 on an ARR-7 which is a 1945 surplus 6X-28. A 36-ft. steel mast on top of school hall is used for local 29-Mc. contacts using a 6V6 final at 2 wats input. FLH is Moscow area EC, so you fellows up there report to him for emergency work. FRM is Lewiston EC. Nampa: New hams are NFG, NGP, and NGA (Meridian). Twin Falls: LNC is on 160 meters. JMX has new Gon-Set 3-30 in car. KEK is on 29 Mc. with 12 wats. Boise: New hams are NLI, SHN (formerly 8G1F of Nebraska) and IYD from McCannnon. You 7-Mc. fellows, how about organizing a 7-Mc. Idaho Net? Write me and I'll compile the data so we can get started. Don't forget the June Field Day. Traffic: W7EMT 85, GHT 29, BAA 18, JMH 13, BDL 9, IWU 9, JMX 8, GTN 7.

MONTANA — SCM, Fred Tintinger, W7EGN — The Billings gang is preparing for Field Day this year by planning a simulated field day prior to the real one. KGJ has been assisting AYG in the construction of a new home. COH was in New York on business, and while there visited 2NMM and took in the Radio City Television Studios. The SMARA, of Billings, will have an amateur radio booth at the Midland Empire Fair this fall. CT is rebuilding his old rig to 350 wats so he can use it while changing his newer 250-watt rig to a kw. KIY visited with IYC and EYO at Ft. Peck and secured a crystal for the CAP Net. LEP needs Delaware for WAS. HBM is putting ART-13 on 28 Mc. FTO is building an electronic key. KL7KU has been issued his old call, FEE, and is active from Kalispell again. HMT finished a vertical bread-board rig with 81.5 in the final. Nailed to the wall, it's neat and also reminiscent of the past. It is time to fix your horns so they will key nicely, etc., and prepare to head for the Waterton-Glacier International Hamfest at East Glacier July 16th and 17th. Traffic: (Mar.) W7CT 145, EGN 57, KGJ 45, BNU 44, FTO 35, KIY 16, LEP 10, AFM 6. (Feb.) W7EGN 65.

OREGON — SCM, Joe E. Roden, W7MQU — Astoria: COZ reports that the Astoria Radio Club is overhauling its emergency set-up to function on a moment's notice. KNM is attending Navy Radio School on Treasure Island. 6ARK/J9, located at Okinawa, is ex-W7CRA, and is looking for contacts on 7-Mc. c.w. to handle messages to his wife in Spokane. MMJ got hold of a 5-mfd. filter condenser only 2600 volts. Bend: GNJ is doing a wonderful job for the Bend Radio Club, which is sponsoring over-the-air code class. Eugene: LVN, Valley Radio Club secretary, promises to keep Eugene on the map with regular monthly reports. New officers are FBO, pres.; AHZ, vice-pres.; LVN, secy.; FHM, treas.; PQO, sgt. at arms. LaGrande: CHN reports increasing activity from Blue Mtn. Radio Club. Grants Pass: MGO reports that v.h.f. bands are tough on crystals, MKA built a Q-5er for his receiver. MQY worked 23 countries in DX 'Phone Contest. AWI is on 28 Mc. with a kw. Medford: LNG reports the Club holds code and theory classes each meeting. KUI has new rig with 813s. MMI is active on 28 Mc. Newport: LPZ represents OBN on 3600 kc. SK is active on 3.85-Mc. 'phone. GEJ is active on the Dipsey Net, and works lots of DX on 14-Mc. 'phone. Pendleton: BEE has moved to Everett, Wash. His son, Cliff, jr., just received his call, NCZ. Portland: MUJ is new EC. FY, GXO, ADH, HDN, LT, and ACZ are active in OEN on 3865 kc. Please send in news and traffic reports. Traffic: W7JEG 182, JRU 114, DIS 79, FY 50, HDN 38, DZT 35, MQ 24, BDN 16, GNJ 16, ASK 14, LT 14, MGO 12, II 9, GZV 7, JVO 3.

WASHINGTON — SCM, Clifford Cavanaugh, W7ACF, — RM; CZY, SEC; GP, PAM; CKT, KAA is new OES. Following stations made BPL: EAU, LFA, ZU, FRU, CZY, FIX, KCU, CKT, JZR, and IOQ. GHI, Seattle EC, has his gang taking first act. CWN is on 14 Mc. GEU and MTJ, members of the Walla Walla Radio Club, put on an FB entertainment recording all those hot bugs in the club. This club has a fine program and is doing amateur radio a lot of good. After handling over 2800 messages this month CZY's rig was ready to fall apart. LVB has had his shift at post office changed so that he can spend more time on WSN. JJK takes care of Puyallup traffic while LEC is in California. FWD says grounding screens of his BC-610 rig makes an FB room heater. FWK says you ought to hear Tate growl when her signals get into his wire recorder. APS says the guys on WSNBT are hogging all the Seattle traffic. KCU, the XYL on WSN who handled over 1100 messages this month, deserves a round of cheers as she was mainly responsible for some of our gang making BPL this month. Between being net manager for WSN, making BPL, and publishing WSN Bulletin, FIX is a very busy man. FRU is swamped as usual. BG is handling traffic on 3.5 Mc. after many years on the high frequencies. KTL and EGR are new ECs. GP, the SEC, made a tour of Southwest Washington. DXZ and FIX send in nice OO reports. LEN, a physics major at WSC College, still has time to handle traffic. GRM's beam blew down. We know who is boss at ETO's

(Continued on page 88)

VARIACS



for Smooth, EFFICIENT VOLTAGE CONTROL

● THE VARIAC — the original continuously adjustable auto-transformer — is designed to give years of trouble-free service. The Type V-10 (*illustrated*) will handle up to 1.725 kva . . . meeting the total voltage-control needs of most amateur stations. It can be used for either behind-the-panel or table mounting. Unique unit brush construction makes brush replacement simple without tools; new molded terminal plate with barriers to prevent short-circuits; both solder and screw terminals provided; wiring diagram on terminal plate shows normal voltage between terminals; large, easy-to-grasp knob with extra large voltage calibration figures easy to read at a distance . . . these are only

some of the many features found only in the VARIAC.

The Type V-10 has a rated current capacity of 10 amperes and a maximum of 15. Its no-load loss is only seventeen watts, compared to the usual high loss in a rheostat type of control. Output voltages are essentially independent of load with the VARIAC. VARIACS are correctly designed to provide the ideal method of varying a-c voltage . . . and to give output voltages 17% higher than that of the line.

TYPE V-10 VARIAC \$33.00
WRITE FOR "VARIAC BULLETIN"



GENERAL RADIO COMPANY

Cambridge 39,
Massachusetts

90 West St., New York 6 920 S. Michigan Ave., Chicago 5 1000 N. Seward St., Los Angeles 38



THE NEW JOHNSON

GREATEST ADVANCE IN ANTENNA ARRAYS

Available with
Parasitic or
Driven Elements
(both unidirectional)

- High Gain
- Light Weight
- Precision Engineering
- Unrivalled Efficiency
- Simple Erection
- Rugged Strength

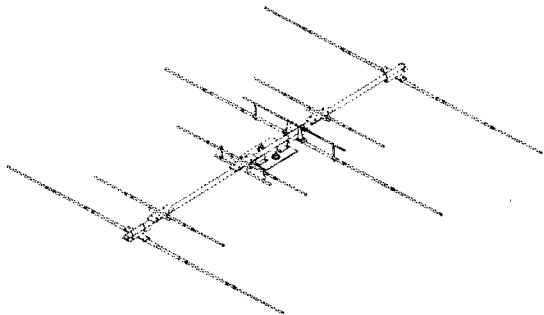

The JOHNSON Rotomatic has been designed and built expressly for those who want the very finest. High gain and excellent front to back ratio are easily achieved without endless hours of adjustment. The most flexible beam ever offered the ham, the JOHNSON Rotomatic is available with two, three and four element parasitic arrays for 10, 14 or 20 meters as well as dual element parasitic arrays for any two of these bands. Also available are two and three element phased arrays, all elements powered. Hardware is offered for mounting additional VHF or television antennas.

ALABAMA

Birmingham

Ack Radio Supply Co.
2205 3rd Ave. North

ARIZONA

Phoenix

Radio Parts of Arizona
34-36 West Madison St.

ARKANSAS

Fort Smith

Wise Radio Supply
1001 Towson

CALIFORNIA

Long Beach

Larry Lynde Radio Supply
Co.
835 Pine Avenue

Los Angeles

Henry Radio
11240 W. Olympic Blvd.

Kierluff's Ham Shack
828 W. Olympic Blvd.

L. A. Ham Shack
6813 S. Hoover Street

Oakland

Electric Supply Company
149 12th St. at Madison

JOHNSON JOBBERS

Participating In ROTOMATIC Advertising Program

Pasadena

Dow Radio Inc.
1759 E. Colorado St.

Empire Electronic Dist. Inc.
37 East Union Street

Sacramento

E. M. Kemp Co.
1115 R Street

San Bernardino

Arrowhead Radio & Tele-
vision Sy. Co.
1216 "D" Street

San Francisco

San Francisco Radio &
Supply Co.
1282 Market Street

Zack Radio Supply Co.
1426 Market Street

South Gate

Mac's Radio Supply
8320 Long Beach Blvd.

COLORADO

Denver

Radio Products Sales Co.
1237 16th Street

CONNECTICUT

New Haven

Congress Radio Co.
207 Congress Avenue

DELAWARE

Wilmington

Almo Radio Company
6th & Orange

Radio Electric Service Co.
4th and Tatnall

FLORIDA

Jacksonville

Kinkade Radio Supply Inc.
1412 Main Street

Pensacola

Grice Radio & Electronic Sy.
358-360 E. Wright Street

Tampa

Kinkade Radio Supply Inc.
1323 Franklin Street

GEORGIA

Augusta

Prestwood Electronics Co.
727 Reynolds Street

Columbus

Radio Sales & Service Co.
1326 First Avenue

ILLINOIS

Chicago

Allied Radio Corp.
833 W. Jackson Blvd.
Chicago Radio Apparatus
Co. Inc.
415 South Dearborn Street
Concord Radio Corp.
901 W. Jackson Blvd.
Newark Electric Co. Inc.
323 W. Madison Street

Peoria

Klaus Radio & Electric Co.
707 Main Street

Rockford

Mid-West Associated
506 Walnut Street

INDIANA

Evansville

Castrup's
1014 W. Franklin St.

Indianapolis

Van Sickle Radio Supply Co.
34 W. Ohio St.

Kokomo

George's Radio
125 N. Buckeye St.

Lafayette

Holmes Radio Supply Co. Inc.
217 Main Street

IOWA

Council Bluffs

World Radio Laboratories
Inc.
740 West Broadway

Universal

ROTO MATIC

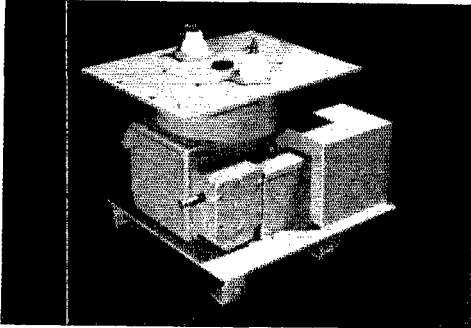

New Johnson Rotomatic Rotator

ALL WEATHER CONSTRUCTION

Rotator assembly is housed in a sturdy; light weight aluminum casting, will safely handle arrays weighing 125 pounds. Beam is instantly reversible, turns at 1 1/2 RPM, has foolproof locking, large safety factor on wind loads. Drive motor causes no radio interference. Starting torque will turn beam during lowest temperatures. Design is truly all weather.

EFFICIENT COUPLING

Uniform, efficient performance is achieved on several bands by method of coupling transmission line to antenna. Slip rings and relay box have no large value of capacity or inductance which have complicated beam tuning in the past.

DE LUXE MULTIPLE BEAM

May be used as a dual beam assembly requiring but one transmission line. RF relay housed in a weatherproof box. Elements for two frequencies mounted on the same boom. Interaction minimized.

Rotomatic Selsyn Direction Indicator

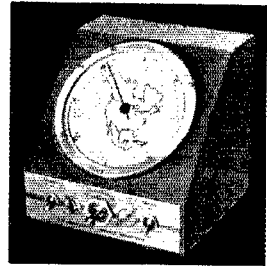

JOHNSON JOBBERS

Participating In ROTOMATIC Advertising Program

Des Moines

Radio Trade Supply Co.
1224 Grand Avenue

Springfield

Harry Reed Radio & Sy. Co.
805 Boonville Avenue

Ottumwa

Radio Trade Supply Co.
115 West 2nd Street

MAINE

Auburn
Radio Supply Co. Inc.
23 Cross Street

Muskegon

Fitzpatrick Electric Supply
Co.
444 Irwin Ave. Cor. Wood

MONTANA

Great Falls
George Lindgren Company
109 Central Avenue

KANSAS

Topeka

Overton Electric Co. Inc.
522 Jackson Street

MARYLAND

Baltimore
Kann-Ellert Electronics Inc.
9 South Howard Street

MINNESOTA

Duluth

Northwest Radio
109 East First Street

Minneapolis

Lew Bonn Company
1211 LaSalle
Northwest Radio & Elec-
tronic Sy. Co.
52 South 12th Street

NEW HAMPSHIRE

Concord
Evans Radio
10 Hills Avenue

Wichita

Amateur Radio Equipment
Co. Inc.
1215 East Douglas

MASSACHUSETTS

Boston
Harty & Young
42-46 Cornhill

MISSISSIPPI

Meridian
Radio Supply Co.
Meridian, Miss.

NEW JERSEY

Camden
Radio Electric Service Co.
513-515 Cooper Street

KENTUCKY

Lexington

Radio Equipment Co.
377 E. Main Street

MICHIGAN

Ann Arbor
Purchase Radio & Camera
Shop
605 Church Street

MISSOURI

Butler
Henry Radio
Butler, Mo.
Kansas City
Burstin Applebee Co.
1012 McGee Street

NEW YORK

Amsterdam
Adirondack Radio Supply
32 Guy Park Avenue

Louisville

Universal Radio Supply Co.
715 South 7th Street

Detroit

Radio Specialties Co. Inc.
456 Charlotte Avenue

St. Louis

Walter Ashe Radio Co.
1125 Pine Street

Brooklyn

Stan-Burn Radio &
Electronics
558 Coney Island Ave.

LOUISIANA

Shreveport

Interstate Electric Co.
616-630 Spring

Laurium

Northwest Radio of Michigan
435 Tamarack Street

Buffalo

Genesee Radio & Parts Co.
205 E. Genesee Street

JOHNSON *Universal*



CONSTRUCTION

Three lengths of support booms available. Twenty meter elements extremely heavy telescoping aluminum, tapering from 1 1/8" to 5/8". Rotomatic will safely handle 2 1/2 kw of RF at impedances as low as 50 ohms.

SELSYN DIRECTION INDICATOR

Accurately follows antenna rotation. Controls: power switch, motor reversing switch and antenna relay switch. Dial illumination indicates when power is on.

TUNING THE ARRAYS

Tuning of both parasitic and driven arrays is simple. In fact, driven elements can be preset on the ground and used without further adjustment, being less affected by proximity of surrounding objects and height above ground.

T MATCH

"T" match adjustable to permit use of any type transmission line from 50 ohm coax to 600 ohm open wire line. May be used over the entire 10-meter band without seriously changing low standing wave ratio. All holes located, drilled and tapped. U bolt element clamping permits easy adjustment of spacing.

ROTOMATIC IS "TIPPABLE"
for adjustment of element length and spacing.

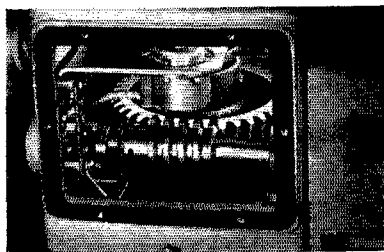

Interior of rotator showing worm gear, selsyn, oiling chain and terminal board.

JOHNSON JOBBERS

Participating In ROTOMATIC Advertising Program

Flushing

Milo Radio & Electronics
160 Northern Blvd.

Jamaica

Harrison Radio Corp.
172 Hillside Avenue

Kingston

Arace Brothers
562 Broadway

New York City

Federated Purchaser Inc.
80 Park Place

Harrison Radio Corp.
10 West Broadway

Harvey Radio Company Inc.
103 West 43rd Street

Milo Radio & Electronics
200 Greenwich Street

Newark Electric Company
Inc.

115 West 45th Street

Newark Electric Company
Inc.

212 Fulton Street

Newark Electric Company
Inc.

Mail Order Department
242 West 55th Street

Sun Radio and Electronics
Corp.
122-124 Duane Street

Stan-Burn Radio &
Electronics Co.
1697 Broadway

Terminal Radio Corp.
85 Cortlandt Street

Syracuse

Stewart W. Smith Inc.
325 E. Water Street

NORTH CAROLINA

Raleigh

Southeastern Radio Supply
Co.
411-415 Hillsboro Street

Winston Salem

Dalton Hege Radio Supply
Inc.
340 Brookstown Avenue

NORTH DAKOTA

Fargo

Fargo Radio Service Co.
515 3rd Avenue North

OHIO

Cincinnati
Mytronic Company
121 West Central Pkwy

Cleveland

Northern Ohio Laboratories
2073 West 85th Street

OKLAHOMA

Oklahoma City
Radio Supply Inc.
724 N. Hudson

Tulsa

Radio Inc.
1000 S. Main St.

OREGON

Medford
Verl G. Walker Co.
205 W. Jackson

PENNSYLVANIA

Allentown
Federated Purchaser Inc.
1115 Hamilton Street

Radio Electric Service Co.
1042 Hamilton Street

Bethlehem

Buss Radio Electric Supply
61-63 East Broad Street

Easton

Radio Electric Service Co.
916 Northampton Street

Philadelphia

Almo Radio Company
509 Arch Street

Radio Electric Service Co.
NW Cor. 7th & Arch Sts.

Radio Electric Service Co.
3412 Germantown Avenue

Radio Electric Service Co.
5390 Market Street

Pittsburgh

Cameradio Company
963 Liberty Ave.

Tydings Company
632 Grant Street

ROTO MATIC

THE NEW ROTOMATIC IS UNIVERSAL

All Components Available Separately

The purpose in furnishing antennas with all elements driven (phased arrays) as well as conventional parasitic arrays is two-fold. First, tuning the phased array is very much simpler. Further, it offers unlimited possibilities for experimentation. Many hams will want to use components which they already have. For that reason the ROTOMATIC is available as a complete unit or all parts are available separately.

See the new JOHNSON Rotomatic at your JOHNSON jobber. You'll agree, its miles ahead of any beam in the field. Or write your jobber for Rotomatic brochure.

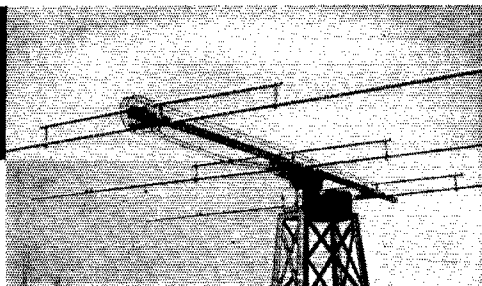

New Johnson Phased Array employing driven elements.



Interior view of rotator showing efficient RF slip rings.

JOHNSON • • • *a famous name in Radio!*
E. F. JOHNSON CO., WASECA, MINNESOTA

JOHNSON JOBBERS

Participating In ROTOMATIC Advertising Program

SOUTH DAKOTA

Sioux Falls
 Power City Radio Co.
 209 S. First Avenue

TENNESSEE

Memphis
 Bluff City Distributing Co.
 905 Union Avenue
 W & W Distributing Company
 647 Madison Avenue

TEXAS

Austin
 The Hargis Co.
 706 W. 6th St.
 Beaumont
 Montague Radio Dist. Co.
 220 Willow Street
 R. C. & L. F. Hall of
 Beaumont
 961 Pearl Street
 Dallas
 Crabtree's Wholesale Radio
 2608 Ross Avenue

Denison
 Denison Radio Supply
 124 West Maine Street

Fort Worth
 The Electronic Equipment Co.
 301 East 5th St. Ledger Bldg.

Galveston
 R. C. & L. F. Hall of
 Galveston
 1803 Tremont Street

Houston
 Gulf Coast Electronics
 1110 Winbern Street
 R. C. & L. F. Hall Inc.
 1306 Clay Street

San Antonio
 Amateur Headquarters &
 Supply
 828 Brooklyn Avenue
 Amateur Radio Supply Co.
 746 East Myrtle Street

Texarkana
 Lavender Radio Supply Co.
 Inc.
 520 East 4th Street

Waco
 The Hargis Co. Inc.
 1305 Austin Street

Wichita Falls
 Clark & Gose
 1204B Ohio Ave.

UTAH

Salt Lake City
 Standard Supply Co.
 531 S. State Street

VIRGINIA

Norfolk
 Radio Supply Co.
 711 Granby Street
 Richmond
 Radio Supply Co.
 3302 W. Broad Street

WASHINGTON

Bellingham
 Waitkus Supply Co.
 110 Grand Avenue
 Seattle
 Western Electronic Supply
 Co.
 2609 First Avenue
 Spokane
 Northwest Electronics Inc.
 North 102 Monroe Street

Tacoma
 C & G Radio Supply Co.
 714 St. Helens Ave.

WISCONSIN

Appleton
 Valley Radio Distributors
 518 N. Appleton Street
 Milwaukee
 Electro-Plance Distributors
 2458 W. Lisbon Avenue

ALASKA

Anchorage
 Alaska Radio Supply Inc.
 Box 84, Anchorage

ONTARIO, CANADA

Hamilton
 Crawford Radio
 King Wm. & Hughson Sts.
 Ottawa
 Radio Television
 Laboratories
 308 Laurier West

HAWAII

Honolulu
 Radio Wholesale & Supply
 Co.
 817 Alakea Street

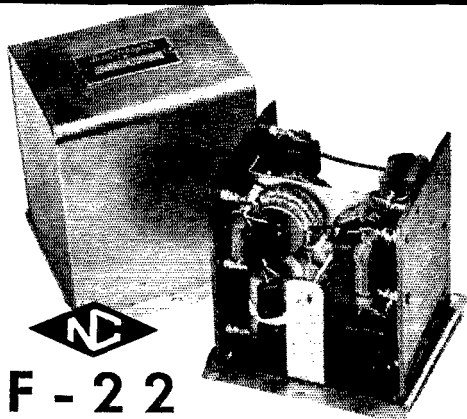
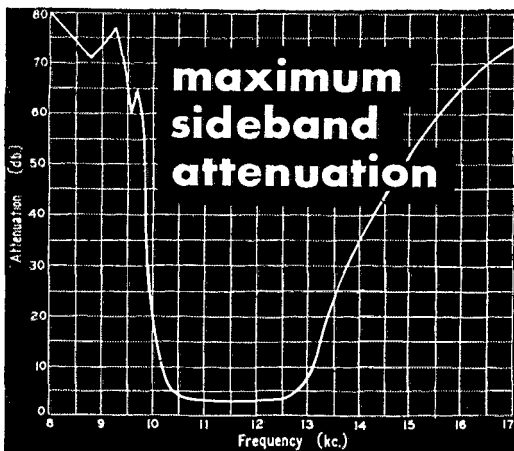

**F - 22
FILTER**

The F-22 filter has been especially designed for maximum sideband attenuation. Careful selection of capacitors and coil adjustment make the F-22 filter ideal for use in The Single Sider unit as described by C. F. Bane, W6WB, in the May issue of CQ (p. 13).

\$59.40

(See your National dealer or write to)

National

EST. 1914

NATIONAL COMPANY, Inc.
MALDEN, MASSACHUSETTS

(Continued from page 88)

place — he bought a new car instead of that 32V-1 he wanted. CKT says traffic is hard to get since everyone is out to get BPL cards. GRM is handling lots of traffic on WARTS Net. MGG says there is lots of traffic around his neck of woods. HDG is back on the air using clothes line for antenna. WY QSPed W1AW direct with 30 watts on 7 Mc. ZU says this was his biggest traffic month. JC made WAC with 75 watts. Officers of new Clallam County Radio Club at Port Angeles are CQK, pres.; JZB, vice-pres.; LDZ, secy. At Vancouver Club: IOU checks into Oregon Emergency Net regularly. DNB was elected president and MQC vice-president. KBX and KTL are trying to iron out links in 28-Mc. mobile rigs. Traffic: (Mar.) W7CZY 2828, CKT 1238, KCU 1145, EAU 776, IOQ 707, FRU 699, ZU 627, LFA 565, FIX 384, HWK 300, JZR 211, ETO 168, MCW 116, LVB 88, MGG 70, FWD 64, FXD 62, KAA 56, GRM 52, WY 47, AMZ 45, FWR 43, JC 42, GEU 37, LEN 31, EGR 22, HDG 22, ACF 21, JJK 14, LNW 11, BBK 8, BG 5, APS 4, DGN 4, KTL 2, JER 1, LIL 1, LLE 1. (Feb.) W7 EGR 31.

PACIFIC DIVISION

SANTA CLARA VALLEY — SCM, Roy E. Pinkham, W6BPT — ZRJ is handling traffic on Mission Trail, Southern California, and Pioneer Nets. Doc was elected secretary of SCCARA. ZBY has just returned from a trip to Europe as a ship radio officer. Jack is busy working DX and contacting his brother, BAX. ONL is on 14 Mc. chasing bugs in a 500-watt rig. DJG reports using 829-B mobile on 28 Mc. Hary uses an ARR/7 as receiver installed in '49 Chevy. VIQ's XYL made a fast trip to Iowa and return, bringing back their daughter, Linda. DAE has been heard tuning up on 3.5-Mc. c.w. HC gave a talk before the Monterey Bay Radio Club on April 19th. His subject was Class C amplifiers. JKN has moved back to San Francisco so San Jose loses a 50-Mc. station. PON is new licensee in San Jose. Pop is the father of AVJ. CEK enjoyed a week's vacation traveling in Southern California visiting spots where he and his XYL spent their honeymoon. RYX is QRL with military reserve work. IXJ has been on 14 Mc. lately working DX. ZIO is on a trip to Los Angeles so he has not checked into the Mission Trail Net. SCCARA wishes to thank the members of the Mission Trail Net for the invitation to attend their hamfest to be held at JTE's ranch the first week in July. Traffic: W6ZRJ 167, WJM 95, WGO 80, VZE 18.

EAST BAY — SCM, Horace R. Greer, W6TI — Asst. SCM, Charles P. Henry, 8E1A. SEC: OBJ. ECs: AKB, EHS, NNS, IT, IDY, QDE, WGM, Asst. EC u.h.f.: OJU. RMs: FDB, ZM, IKQ is the second 'phone postwar DXCC man in these parts. Considering the limited time Phil can spend on the air, this is an FB job. Under the guidance of UZX, the Hayward gang really have a swell club and on April 6th they celebrated their first anniversary with a big bean feed in their club rooms. TI has new three-element beam. The tower-lifting took place on April 9th with the assistance of a dozen experts. ITH now has more time for ham radio so he has requested Class 1 OO, OBS, and ORS appointments. AKB held an emergency dinner meeting for the Oakland Radio Club on April 1st and it was well attended. UPV is getting ready to rebuild beam. In the DX ARRL Contest TT won on 'phone and RM won on c.w. for the East Bay section, with scores of 116,523 and 253,800. OBJ is planning on some new antennas. MFZ says the honeymoon is over and he has more time for radio. PB is planning a new tower for his house. AED likes his new QTH and will have a real antenna farm. BUY hopes to get back on the air soon. DUB has new three-element beam up on a new 64-ft. steel tower. YMO finally is getting some good DX cards. MVQ raised power to 1 kw. MNG has 20 watts on 3.85-Mc. 'phone. TCU keeps schedule with HDT. ERA is building a new transmitter. 9KAV is a new-comer to the East Bay section and is putting up a 28-Mc. beam. HD is on 3.85-Mc. 'phone and is dusting off the 28-Mc. rig. RRH is on 7-Mc. c.w. ZKC is tinkering with radio gear. HSY is mobile on 144 Mc. RUZ is building c.w. rig with plenty of bugs. LGW is on 3.85-Mc. mobile. CX is experimenting with mobile antennas for 3.85 Mc. IO has feed back. CUG, on 3.85-Mc. 'phone, is on the Garbage Net. OT received two Russian SWL cards on their overseas Official Bulletins. YDI has a new Collins 75A. DQL is working on new voice-operated transmitter for nets. WII has new HT-18 installed. QXN rebuilt final. OJW has new five-element Yagi beam up. NJO and DNX are on 28-Mc. 'phone. EEI is chasing DX. JZ has some new gear. KEK is putting up new beam. EY still is on low power. EE is active on 14- and 28-Mc. 'phone. GIZ has new final with a pair of 813s. The Mission Trail is getting larger with each month. LDD sounds FB on phone and the nuts on c.w. Traffic: (Mar.) W6OT 224, QXN 148, DQL 63, BF 20, YDI 15, TI 9, WII 9. (Feb.) W6YDI 28.

SAN FRANCISCO — SCM, Samuel C. Van Liew, W6NL — Phone JU 7-6457. SEC: DOT. CECS: BYS, SLX. ABEY still is working on his rig. DQA is with the U. S. Forest Service. FBK is building modulator for his rig. VDP will be in Eureka for the summer. VRK is rebuilding

(Continued on page 80)



**Monitor Modulation
Percentage and
Speech Quality**

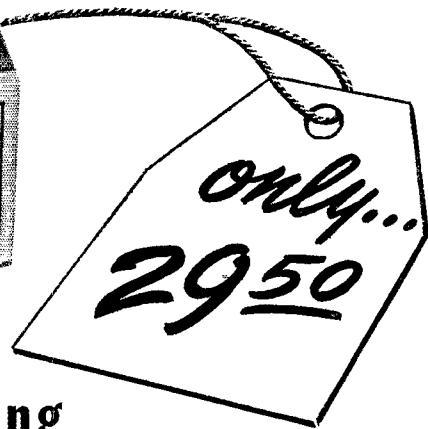

Sylvania's Outstanding MODULATION METER

TYPE X-7018

NOW you can monitor your modulation percentage *and* speech quality with a fine instrument available at low cost. Percentage modulation can be read directly on the meter. Headphone jack, conveniently provided, also permits monitoring your signal quality to check for hum or audible distortion.

Compactly designed to fit the most cramped operating table, this precise Modulation Meter will be of great assistance in complying with FCC regulations on overmodulation. It will also help keep your average modulation percentage up in the effective region between 60% and 90%. Indicates carrier shift.

Take advantage of this new low price! See Sylvania's Modulation Meter Type X-7018 at your distributor today! *Sylvania Electric Products Inc., Radio Division, Emporium, Pa.*

SYLVANIA ELECTRIC

ELECTRONIC DEVICES; RADIO TUBES; CATHODE RAY TUBES; FLUORESCENT LAMPS, FIXTURES, WIRING DEVICES, SIGN TUBING; LIGHT BULBS; PHOTOLAMPS

APPLICATION ENGINEERED "PRECISION"

Circuit Tester

20,000 Ohms per Volt

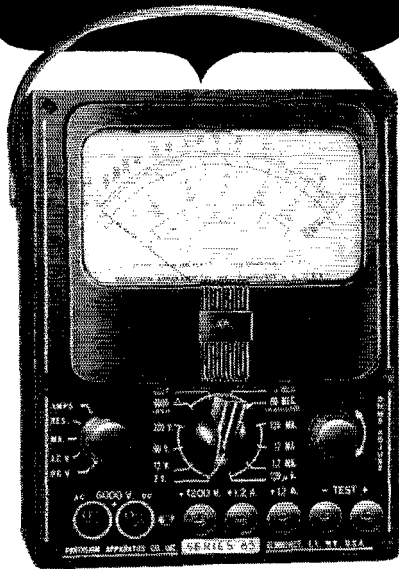

SERIES "85"

Compact, laboratory styled, high sensitivity test set "Application Engineered" for test and service-maintenance phases of modern amateur radio-electronics-communications.

20,000 Ohms per Volt D.C. • 1000 Ohms per Volt A.C.

VOLTAGE RANGES: 0-3-12-60-300-1200-6000 A.C. & D.C.

CURRENT RANGES: 0-120 microamps; 0-1.2-12-120-MA.; 0-1.2-12 Amps D.C.

RESISTANCE RANGES: 0-6000-600K-6 Meg-60 Megohms.

DECIBEL RANGES: From -26 to +70DB.

Complete with batteries and test leads. . . . **\$3875**

PLUS superior physical features:

- ★ 4 1/2" wide angle meter.
- ★ Heavy duty bakelite case size 5 1/2 x 7 1/4 x 3".
- ★ Heavy gauge, anodized aluminum panel.
- ★ Rotary Range and Function Selection.
- ★ Recessed 6000 volt safety jacks.
- ★ Only two pin jacks for all standard ranges.

LC-1 LEATHER CARRYING CASE—Custom designed top-grain cowhide case with tool and test lead compartment. **\$8.75**

See this and other "Precision" Application Engineered instruments, on display at leading radio parts and ham equipment distributors. Write for latest catalog.

PRECISION APPARATUS CO., INC.

92-27 Horace Harding Blvd., Elmhurst 13, N. Y.

Export: 458 B'way, N. Y. City, U.S.A. Cables: MORHANEX

375 transmitter. CWR is working c.w. for the present. SLX is handling emergency stuff and building up the emergency network. BME is installing new radio gear. ZHE is remodeling surplus gear 654. FCL is building plumber's delight. ZSE is building rig for 7 Mc. BWV got Vermont and WAS. AUB is teaching theory at Humboldt Radio Club meetings. FYY is working c.w. instead of phone. NAO is trying to find out who used his call and got QSL card from Japan. ØJSD is working for KHUM and rebuilding gear. EQQ is building up code speed. BOT is rebuilding new gear. DQY is devoting all his time to 27 Mc. using 829B final and is plenty consistent in his schedule with his old pals back home in W2. YME recently worked a DL4 in Heidelberg, who gave the usual R9 report. On the next transmission DL4 about blew the cone out of Bob's speaker with a wire recording of his signal, so Bob knew he had "arrived." VEJ is working on a new "killer diller" after perfecting the one-tube phone transmitter. EAX has moved to a new location high on the side of Mt. Baldy with a line of sight shot at most of the Bay area. KA1AI, formerly from Hamilton, has left Manila and will be back on the air in Marin County. We haven't heard a squeak out of PVC since his opening at Harvey's. ZUB is getting the fever to give 160 a whirl. Wonder if this will mean the revival of Marin's famous Fish Net. GPB has received the new elements for his Amphenol signal squitter so we should hear the big noise on East 3rd St. soon. ADV is sporting a new Class A ticket and giving 3.85 and 14 Mc. a whirl. DIX lost his beam and tower recently and says when it goes back up it will have the proportions of a 14-Mc. job. He's already worked 111 countries, made WAC on 14 and 28 Mc.; WAS on 7, 14, and 28 Mc., and WAVE, WAAP, and WBE. OE is going strong on 28 and 144 Mc. He's using a twelve-element beam on 144 Mc. TEL still is up in the air over T.V. PPL is waiting for some good weather to fix his beam. YDI is back from Moses Lake and should be heard on 3.5 Mc. soon. IZR now has an antenna for 3.5 Mc. and can be heard on 3.5 and 7 Mc. RSI has a super clipper limiter gadget working his n.f.m. rig on 28 Mc. FZG, after giving 28, 50, and 144 Mc. a thorough workout, can now be heard on 7 Mc. JB is working some nice 7-Mc. European DX in the wee small hours of the morning with his new kw. rig. JZJ is working East Coast schedules on 7166 kc. VKT worked all states but North Dakota. Field Day should furnish plenty of competition, as many clubs are on the hunt for good locations early and plans are well under way for the event. I am indeed happy to be able to report that our Pacific Coast Director, Mr. William A. Ladley, is improving as fast as possible from his illness. Bill is a hard worker and attacks each and every problem with his entire personal vigor. His past record has been one of continuous activity in business and for the betterment of ham radio. The entire Pacific Division and the thousands of other amateur friends join in wishing you a complete and speedy recovery. Bill. Traffic: KG6DI 734, W6NL 152.

SACRAMENTO VALLEY — SCM, Ronald G. Martin, W6ZF — Asst. SCMs: Northern Area, Ray Jensen, 6REB; Central Area, Willie Van deKamp, 6CKV. SEC: KME. ECs: Metropolitan Sacramento Area, BVK; Walnut Grove, AYZ. RM: REB. OES: PIV. PIV replaced pentodes with 6J6s in 522 r.f. and mixer, claims less noise and better sensitivity. **Northern Area:** JDN has HRF, EWG, APR, CVQ, CFU, BDU in AEC says emergency plans for Shasta, Dunsuir and McCloud are complete. Mt. Shasta Club's president, HRF, and secretary EWQ, announce Mt. Shasta Hamfest will be held Sept. 10th-11th at City Park. REB completed full emergency gear. The Redding gang dedicated new club house. **Central Area:** GERC has formulated plans for Butte County Fair and Chico Hamfest, to be held June 19th. RZW is on 144 Mc. Flash! Using 522 and three-element beam at Pitt River Power House in a deep canyon near Fall River Mills, NTG worked VZK and LYQ by reflecting signals off Mt. Lassen. CLG built 7F8 converter for 144 Mc. RAQ is on 28 Mc. with three-element beam. KUI works AJF over the mountains in Sonoma on 144 consistently. **Southern Area:** MIW, SOB, and ZYV are experimenting on reduction of fifth harmonics of 28 Mc. BVK reports Sac. V. 28-Mc. Emergency Net has 25 members. Roseville blossoms with GHP, UNT, ASE, and OXG on 144 Mc. YMZ, WZB, EXP, and AL are on 144 Mc. JA2AAN now is on 28 Mc. in Sacramento. HGW is on 28 Mc. AYK is on Sac. V. 28-Mc. Emergency Net. RF is on 3.5 Mc. with 120 watts and quarter-wave antenna. DJL uses 6J6-6J6-832 on 144 Mc. DBP schedules KH6JG and W7LUP daily. GHN is busy with two code classes. QYQ has kw. on 3.85-Mc. phone. WLI put up new 144-Mc. beam with coax. RMP's cubical quad worked Japan, Alaska, and Guam. BTY has new 28-Mc. rotary. AYZ is forming Sac. V. 3.5-Mc. Emergency Net. AUO is active in 28 Mc. Emergency Net. JN has new scope equipment. CQK built remote control unit. OKZ works Valley hams on 144-Mc. while flying his plane on week ends. ASI is putting up new 28-Mc. rotary. BCI is new MARS station at McClelland. ZF is putting up new 3.5-Mc. skywire. Traffic: W6REB 2158, PIV 145, ZF 50, BTY 11.

SAN JOAQUIN VALLEY — SCM, Ted R. Souza, W6FKL — Asst. SCM, James F. Wakefield, 6PSQ. SEC: JPS. ECs: PHL, VTZ, WBZ, EXH, VKD, BHI, YGZ.

(Continued on page 94)

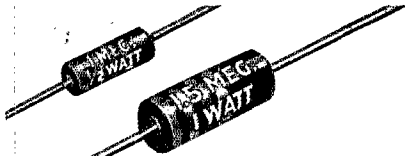

"LITTLE DEVIL" RESISTORS

For quick, easy identification, resistance and wattage are clearly marked on every one of these tiny, rugged insulated composition resistors. In three sizes — 1/2, 1, and 2-watt and all RMA resistances. Tolerance ± 5 and $\pm 10\%$.

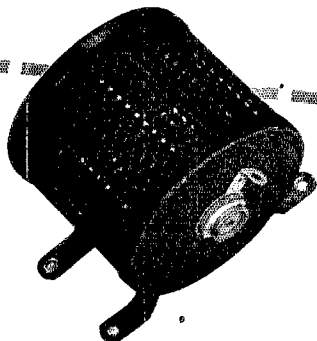

DUMMY ANTENNA RESISTORS

Improved frequency characteristics make Ohmite Dummy Antenna Resistors particularly useful for loading radio transmitters or other radio frequency sources. Both the 100 and 250-watt units are available in resistance values of 52, 73, 300, and 600 ohms. Tolerance $\pm 5\%$.

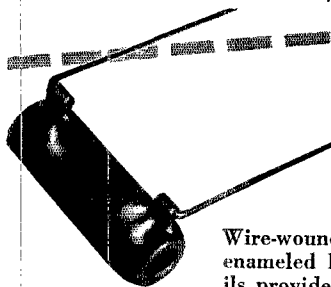

"BROWN DEVIL" RESISTORS

Wire-wound, vitreous-enameled Brown Devils provide utmost dependability in a size small enough to fit most installations. Easily mounted by 1 1/2" tinned wire leads. Three sizes: 5, 10, and 20 watts. Tolerance $\pm 10\%$.

CLOSE CONTROL RHEOSTATS

Available in 10 sizes from 25 to 1000 watts, Ohmite rheostats can be relied on for close control and long life. Ceramic and metal construction. Windings are locked in place by vitreous enamel, and the metal-graphite brush provides unsurpassed smoothness of action.

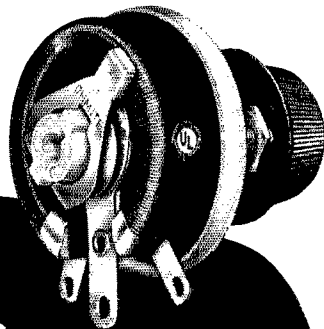

IT'S
OHMITE
FOR
DEPENDABILITY

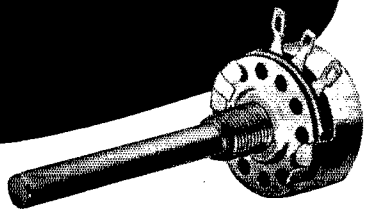

MOLDED COMPOSITION POTENTIOMETER

It's quiet! This Type AB Potentiometer has a resistance unit that's solid-molded. As a result, the noise level often becomes less with use. Has a 2-watt rating, good safety factor.



Write for Bulletin 137
"Ohmite Ham Hints"
and Catalog 21

Be Right with **OHMITE**

OHMITE MANUFACTURING CO.

4865 Flournoy St.

Chicago 44, Illinois

RHEOSTATS • RESISTORS • TAP SWITCHES

NEW

NEW

Have YOU Your Copy of the ARRL ANTENNA BOOK!

THE PRESENT EDITION of the ARRL Antenna Book represents an accumulation of ten more years of the amateur's experience in both war and peace in making the all-important, ever fascinating "sky wire" carry signals to the ends of the earth. The data contained in this book are the result of practical experience both of the authors and hundreds of amateurs who have contributed to the practical know-how that this book expresses.

The book has two principal divisions. Chapters 1 through 5 deal with the principles of antennas and transmission lines, wave propagation and its relationship to antenna design, and the performance characteristics of directive antenna systems. These five chapters might be called a textbook on antennas; they enable the reader to design a system of his own to fit his particular needs. Beginning with Chapter 6, there is a series of chapters in which complete data are given on specific designs for the various amateur bands. The amateur who has not studied the first section, or who wishes to avoid the necessity for making his own calculations, will find in these chapters the information necessary for putting up the system that appeals to him. The remaining chapters deal with the highly important mechanical features of construction and related subjects such as determining geographical directions.

This required twice as big a book as the previous edition but we are sure you will find it well worth more than the nominal cost.

\$1.00 U.S.A., Its Possessions and Canada
\$1.25 Elsewhere

AMERICAN RADIO RELAY LEAGUE, INC.

West Hartford, Connecticut

NEW

92

NEW

THE

Radio Amateur's Library

THESE ARE THE PUBLICATIONS WHICH EVERY AMATEUR NEEDS. THEY FORM A COMPLETE REFERENCE LIBRARY FOR THE AMATEUR RADIO FIELD; ARE AUTHORITY, ACCURATE AND UP TO DATE

<i>Title</i>	<i>Price</i>
<i>QST</i>	\$4.00 per year*
Operating an Amateur Radio Station — Free to members; to others	10c
The Radio Amateur's Handbook	\$2.00**
The Log	50c
How to Become a Radio Amateur	25c
The Radio Amateur's License Manual	25c
Hints & Kinks for the Radio Amateur	50c
Lightning Calculators:	
a. Radio (Type A)	\$1.00
b. Ohm's Law (Type B)	\$1.00
A.R.R.L. Antenna Book	\$1.00
The Minilog	25c
Learning the Radiotelegraph Code	25c
A Course in Radio Fundamentals	50c

* Subscription rate in United States and Possessions, \$4.00 per year, postpaid; \$4.50 in the Dominion of Canada, \$5.00 in all other countries. Single copies, 40 cents.

** \$2.00 U. S. A., Its Possessions and Canada, Elsewhere \$2.50. Buckram Bound \$3.00 U. S. A., Its Possessions and Canada. Buckram Bound \$4.00 Elsewhere.

The American Radio Relay League

• INCORPORATED •

WEST HARTFORD 7

CONNECTICUT

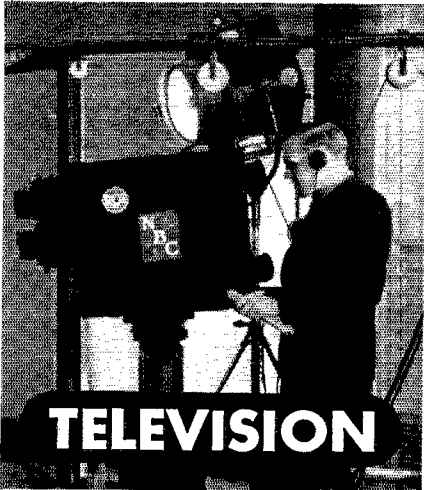

Offers YOU Good Pay, Security and Bright Future

■ Get in and *get ahead* in Television! You can make your own opportunity if you start preparing now. No need to tell you how fast Television is expanding — or, of the great number of jobs that are being created. One of industry's leaders predicts:

1 Million Persons in TV within 4 Years! He estimates 12 Million TV sets by 1953!

If you are now in radio, CREI offers the very training you need to go after — *and get* — a good TV job. CREI can show you the way with spare-time study at home that gives you the up-to-date technical understanding you *must* have for Television. CREI courses are designed to give you a thorough grounding in basic principles and take you step-by-step through the more advanced subjects. *Don't wait another day.* Television won't wait for you. In all our 22 years of association with professional radiomen, we know that the man who acts *promptly* is the man who *succeeds*.

WRITE FOR FREE BOOKLET

Let us prove to you we have the training you need to qualify for a better radio job. To help us answer intelligently your inquiry — *please state briefly your background of experience, education and present position.*



VETERANS! CREI TRAINING AVAILABLE Under G. I. Bill

CAPITOL RADIO ENGINEERING INSTITUTE
Dept. 166A, 16th & Park Road, N. W.
Washington 10, D. C.

Mail me your FREE 24 page booklet.

Check field of greatest interest:

- TELEVISION PRACTICAL RADIO-ELECTRONICS
 BROADCASTING AERONAUTICAL RADIO ENGINEERING
 RECEIVER SERVICING INDUSTRIAL ELECTRONICS

Name.....

Street.....

City..... Zone..... State.....

I am entitled to training under the G.I. Bill.

(Continued from page 90)

and OYF are among those in Stockton who are on 50 Mc. The Stockton gang had a live-wire bunch out in March reporting the county election from outposts without communications facilities. Among those participating were APL, BHI, JGR, MDQ, NDJ, RWI, VSJ, SF, SAH, BNW, INP, UWY, VPV, WBZ, and YGZ. NDJ made the *The Flysheet*, picture and all, as one of Stockton's outstanding hams. PSQ still is fussing with dishpans and square plumbing. WKT has a TBS-50. KUT found one of his long-lost DX QSL cards among his papers while filing his income tax returns! KPW now has a nice put-put turning an emergency power generator. Somebody cut CLU's antenna halyard and he hasn't even been on the air postwar yet. PHL and MEY attended Philco's T.V. school in Fresno at which QOS was one of the instructors. KBP has moved to Oakdale. OHB has been doing 3.85-Mc. mobile work with good results. QON is moving back to Fresno. FKL is doing some 3.85-Mc. work with a surplus TCS while building a modulator for the big rig. The SJVRC is preparing for Field Day with JPS, VTZ, and SRU as committeemen. KMI has forsaken the big rig for a Navy TCS. ZOE is looking for Valley contacts on 144,529 Mc. each Tuesday after 10 p.m. SAH and VPV are looking around for gear and a location for Stockton's participation in Field Day. Traffic: WGSF 100, SAH 85, UWY 38, BNW 33, WBZ 26, VPV 25, MDQ 24, INP 21, YGZ 18.

ROANOKE DIVISION

NORTH CAROLINA — SCM, W. J. Wortman, W4CYB — The Greensboro gang is making plans for an enlarged clubhouse with AGD in charge. BHA is planning a big Field Day with equipment out in the wilderness. NHW is running 200 watts on 144 Mc. to a beam 54 feet up. GG has 140 confirmed countries. AJT has confirmation of 100 countries but is working on p.p. 4-205As. LAY is proud possessor of Collins 75A and his old HRO reposes in IOH's shack. CS is working DX on 28 Mc. AIT has confirmation of 171 countries but is sweating out the last zone for WAZ. GXB is practically 100 per cent Collins-equipped. KYR is putting the finishing touches on his beam. MR has dropped all the skywires but the 14-Mc. job. FXU is running a code class a couple of nights a week. JQO manages some traffic work. NAP, over Reidsville way, has a new NC-240D and has worked 18 countries for his first trip down to 14 Mc. The following are Assistant Directors to Ev Battey: CFL, CVQ, CYB, FXU, JPY, KJS, and OHC. KJS states that interest in the Emergency Corps seems almost impossible of attainment. MDE is a new ham in Morganton to keep DSO company. LPK now is Class A. EJQ is constructing a new shack in the rear of the house. EYI has built a new steel tower to handle a new beam. OXG, a new ham in Hickory, is on 28-Mc. 'phone. DSO is planning 160-meter operation. NC is punching a hole in 3.85-Mc. 'phone. The 75-Meter 'Phone Net has been reorganized and will be known as the Tar Heel Net. Frequency is 3865 kc. Monday through Friday. DLX is present NCS. Traffic: W4CFL 645, KJS 88, DLX 68, JQO 12.

SOUTH CAROLINA — SCM, Ted Ferguson, W4BQE/-ANG — New Greenville Amateur Radio Club officers are Earl Brannon, ex-HCZ, pres.; LNI, vice-pres.; NVQ, secy.; KEC, treas.; MET, act. mgr. AUT divided his time between traffic and rag-chewing on 3.5-Mc. c.w. KZ reports that the Greenville Club has started code classes. LNI operates 28 Mc. and schedules Alaska every day. GZO works 3.85-Mc. 'phone. DBT schedules FST and ECW on 7-Mc. c.w. NVQ elevated his beam to forty feet and is using RL-42B antenna reel to turn. BPD, OJM, MSS, and DPN conducted a round table on amateur radio over station WRNO. DNP is on 3.85-Mc. 'phone. BPD is working DX on 7 Mc. ANK reports the Charleston gang already is making plans for next Field Day. HTR is South Carolina outlet to Puerto Rico. CSP is on 3.5 and 7 Mc. BIZ has just finished a kw. for his brother. HHO, the club station, has a new kw. transmitter. AUT helps to keep the South Carolina net going. CHD is Greenville outlet for net traffic. LJJ operates 7-Mc. c.w. Rock Hill Radio Club officers are NTD, pres.; Webb A. White, vice-pres.; Ralph Buddin, secy.-treas.; Claude Pate, custodian of property. NTD operates 3.5-Mc. c.w. BQE, CE, DQY, KZ, MCY, and MYM are Asst. Directors. Traffic: W4ANK 190, AUT 24, GZO 4.

VIRGINIA — SCM, Victor C. Clark, W4KFC — New officers of the Ocean View Amateur Radio Club are JSR, pres.; OGZ, vice-pres.; BLU, secy.; and INJ, custodian. At PVRC it's LRI, pres.; NNN, vice-pres.; IWO, rec. secy.; 3FQB, corr. secy.; 3KZQ, treas.; and 3EIV, act. mgr. OWF, in Falls Church, is ex-KL7ES. Director IA advises that following have been appointed as Assistant Directors in Virginia: AKN, PJ, IUU, IWO, KAK, KFC, and KWY. EBH, a new member of VN, reports five hams present at the home of IV in Winchester for the first meeting of the Winchester-Front Royal Radio Club. PCC is the call of the Blue Ridge Amateur Radio Assn. in Roanoke; club station is on 3.85-Mc. 'phone with 1 kw., with 7-Mc. gear being installed. CQW is installing a pair of 257Bs in p.a. IUU schedules friends in Mexico City and Manila on 28-Mc. 'phone several times a week. KVM advises that OVH is new.

(Continued on page 96)

TERMINAL offers you MORE in QUALITY-VALUE-SERVICE!

Terminal is your Best Bet for Better Buys

LYSCO 10 METER Mobile Transmitter

MODEL 129—Extremely compact size (4 x 5 x 5 1/2 inches) for easy under-dash mounting in your car. Delivers 8 watts A-3 emission on 27-29.7 Mc. Uses 7 or 9 Mc. crystal. Power requirements are 6.3 volts AC/DC @ 2 amps and 350 volts DC @ 110 Ma. Uses three type 6AG7 tubes for oscillator, amplifier and modulator. Antenna termination for 50 ohm coaxial line and antenna changeover relay. Microphone may be T-17 or any single button carbon type. Supplied less tubes and accessories **23⁹⁵**
Also available! Model 114 for 20 meter band and model 175 for 75 meter band.

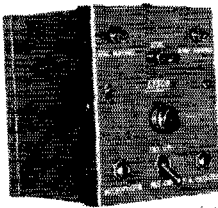

NEW YORK'S LEADING RADIO SUPPLY HOUSE

LYSCO 10 METER CONVERTER

MODEL 210—A simple and efficient converter for 10 meter band reception through your automobile radio or any superhet receiver. Measures only 2 1/4" high, 6 1/2" long, 4 1/2" deep. Illuminated slide rule dial for easy logging of 27.1-29.7 Mc. I.F. output frequency is 1500 Kc. Tube complement: 6AK5—RF amplifier, 9002—mixer, 9002—oscillator. Power requirements are 150 volts DC maximum @ 20 Ma., 6.3 volts AC/DC @ .75 amp. Has antenna transfer switch. Less tubes, your cost **25⁵⁰**



LYSCO NOISE LIMITER

MODEL NX1—A fully adjustable peak noise limiter for use with any superhet receiver. Uses one 6AL5 tube. **4⁵⁰**
Size: 2 1/4" long, 1 1/2" wide, 2 1/2" high. Less tube.

MAKE TERMINAL YOUR HEADQUARTERS FOR MOBILE GEAR! DROP IN NOW!

LEECE-NEVILLE A-C Generating Systems for Automobiles

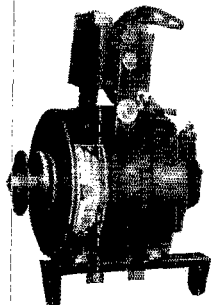

For adequate power from your car battery, replace your generator with a Leece-Neville A-C alternator. Used by police and other mobile communications services. Now available in a 45 ampere model at a considerably lower price; besides standard 60 and 80 ampere models. This new system gives 25 to 35 ampere output with engine idling and full output from 15 mph to top car speed. Alternator has no commutator with commutating brushes nor rotating armature windings to cause sparking, as do D-C generators. Radio noise level is held to an absolute minimum—no radio "fade-out" and range reduction caused by weak batteries—prolongs life of radio equipment as well as your batteries.

Write to attention of Frank Miller, W2BUS, for complete information and prices. Be sure to state make and year of your car. Let us show you how your 6 volt or 12 volt D-C system can be economically operated at full efficiency—always!

GUARANTEE—Every item sold by Terminal Radio Corporation is fully guaranteed.

HARVEY-WELLS TBS-50 TRANSMITTER

50 watts on phone and CW. Covers 8 bands from 2 to 80 meters without plugging coils! Crystal controlled on all bands, requires no oscillator or multiplier tuning. Ideal for fixed station or mobile operation. Tubes: 6AQ5 crystal oscillator, 6AQ5 buffer-multiplier, 807 final amplifier, two 6L6 class B modulators. Weighs only 20 lbs., size 8" x 12" x 8". Complete with tubes, but less power supply, carbon microphone and crystals. **9⁹⁰**
Net

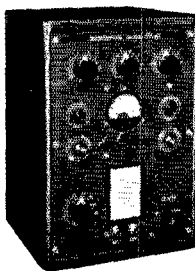

TBS-50A—Same as above, but with added built-in 3-tube preamplifier for use with high impedance crystal or dynamic microphone. Net . . . **121²⁵**

APS-50—Power Supply—delivers 425 volts @ 275 Ma. DC and 6.3 volts @ 4 amperes. Has Hi-Lo switch. For 110 volts 50/60 cycle operation. Complete with dual rectifier tubes, power cable. **3⁹⁰**

DPS-50—For portable-mobile operation. Delivers same output as APS-50. Has heavy duty generator and filter base.

DPS-50/6—6 volt DC input **87⁵⁰**

DPS-50/12—12 volt DC input **54³⁰**

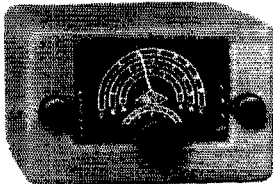

GONSET 3-30 Mobile Converter

A new high sensitivity mobile converter with continuous bandspread coverage from 3 to 30 Mc. in three bands. Same compact size as the popular Gonset 10-11 (5 1/4" x 3 1/2" x 5 1/4"). Easily attached to your automobile set or any BC superhet. Complete with tubes and connecting cables **3⁹⁵**

STANCOR ST-203A Mobile Transmitter Kit

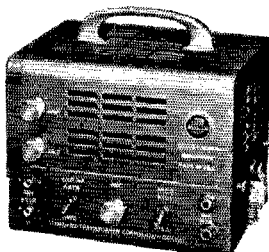

25 watt crystal controlled phone transmitter covering 27 to 32 Mc. Will give reliable service in your car or as fixed station. Requires 400-500 volts DC @ 200 Ma. and 6 volts AC/DC @ 2.8 amperes. Uses 6V6 harmonic oscillator working from 7 Mc. crystals, 2E26 class C amplifier, 6J5 grounded grid speech amplifier and push-pull 6V6 modulators. Press-to-talk mike switch operates transmitter. Front panel has all controls, including jacks for antenna, mike and meter. Will operate with any 1/4 wave vertical whip or conventional antenna. Accessories needed but not supplied are: tubes, crystals, single-button carbon microphone with switch, power supply and antenna. Furnished complete, all parts, assembly and operating instructions. **44⁷⁰**

SONAR Model MB-611 NBFM Mobile Transmitter

22.5 watts output on 10 and 11 meter bands. Exclusive Sonar Phase Modulator uses 6-8 Mc. crystals. Input for high impedance microphone. Dual indicator for RF tuning and deviation, 2.3 Kc. adjustable frequency deviation. Tubes: 3—6SL7GT, 2—6SK7, 1—6AF6C, 1—2E2b. Power requirements are 250 to 600 volts DC @ 100 Ma., and 6 volts AC or DC. Size is 10 1/8" x 7" x 5". Complete with tubes, less crystal and power supply **72⁴⁵**

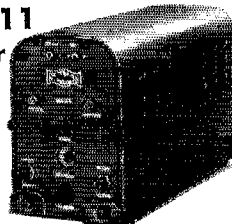

25% deposit required with mail orders. Regular terms to rated firms. Prices are F.O.B. New York.

TERMINAL RADIO CORP.

85 CORTLANDT STREET • NEW YORK 7, N. Y.

Phone: WOrth 4-3311

Cable Address: TERMRADIO

24 HOUR CLOCK

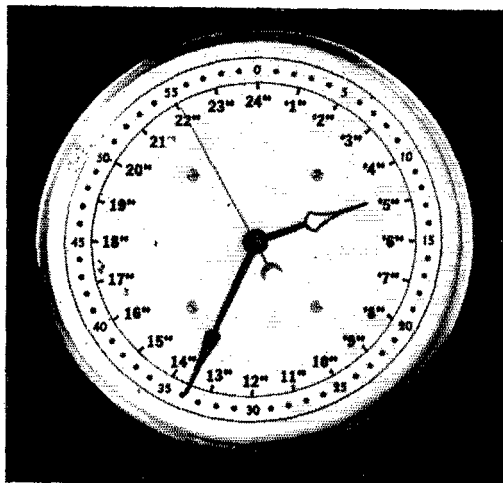

**Reads Directly to
2400 Hours**

**ENGINEERED BY
ENGINEERED FOR
SOLD EXCLUSIVELY TO** } **THE
HAM**

\$10 including Fed. Tax
only and Shipping

- 9" Dial
- Convex Crystal
- Sweep Second Hand
- Steel Case (Black Finish)
- Chromium-Plated Bezel
- Self Starting
- 110 Volt - 60 Cycle A.C.
- Wall, Table or Panel Mounting

OPTIONAL
Additional Red Hour Hand for GMT
Table Mount or Panel Drilling

To AMERICAN TIME CORP.
15 Park Street, Springfield, Mass.

Please send:

- 2400 Hour Clock (\$10.00)
- Stand For Table Mount (50c)
- Am Forwarding Panel To Drill Out (50c)
- Include GMT Hour Hand (50c)

Total \$.....

Check Money Order

Name Call Letters.....

Address

Falls Church ham with 6L6 on 7- and 3.5-Mc. c.w.; also that 6C0D is working at WAR transmitter station. KVM has new 813 final with 250 watts. ORA is new member of the AEC. KPK and DGK are new-comers to Annandale. JLW tucked away 70 countries in the first three weeks of operation at new QTH! FV has been DXing on 28-Mc. c.w. with 10 watts. JJK is active in Alexandria, reporting on VN for the first time in March. IPC has materials on order for skywire to be erected at his new QTH. ITA modified a BC-457 for exclusive use on VN and other 3.5-Mc. activities. KYD visited VP5MU in Jamaica during Naval Reserve cruise. JLW is new ORS. JDL is forsaking the long waves for 144 Mc. and higher for a while. CC is recruiting Falls Church youngsters into the ham ranks. LAP has a spook in his PA which defies analysis! MQM will be at Maxwell AAB, Ala., until December. Traffic: W4KVM 141, FF 131, FV 63, LAP 51, IUU 49, IA 47, KYD 44, KFC 41, ITA 37, NPG 33, II 30, LRI 16, QWM 15, JAQ 7, CQW 5, EBH 1, JLW 1.

WEST VIRGINIA — SCM, Donald B. Morris, WBJM
— 4LA, our Division Director, has announced the appointment of the following as Assistant Directors: BDD, BTV, CSF, GBF, HUK, JM, and OXO. Congrats to GBF on making BPL and the highest traffic score in West Virginia since the war. OXO made a lot of amateurs happy by his portable operation in Tucker, Pendleton, Pocohontas, and Grant Counties during W. Va. QSO Party. VAN came through with 57,000 in C.W. DX Contest and 58,000 in 'Phone DX Contest and made 28-Mc. 'phone WAC in two hours without missing a call. QG handled several important messages between Germany and the States. FMU has been inactive because of illness. JRL, former SCM, has returned to 3.5-Mc. c.w. after a long absence. WSL has new three-element beam for 28-Mc. work. HUG is a member of the Ohio River Flood Net with drills every Sunday. CSF, one of the WVN's NCS, reports work interferes with schedules. EBG, now in Ohio, reports into the W. Va. 'Phone Net on 3890 kc. Your SCM would like to hear from any active amateurs in the State. Let me know what you are doing and what bands you operate. West Va. QSO Party scores will be given next month. Traffic: W8GBF 603, OXO 336, AUJ 55, CSF 39, DFC 22, QG 14, KWL 9, VAN 7, JM 6.

ROCKY MOUNTAIN DIVISION

COLORADO — SCM, M. W. Mitchell, W0IQZ — SEC:
C KHQ, RM: IC. The IUN Net will change to 7080 kc. beginning May 2nd. LZV would like to have more Colorado stations in on the TLS now that it is official, on 3560 kc. between 8:00 p.m. and 8:15 p.m. DD is designing engineer for new rig for KHQ which will run 200 watts when finished. OPF is attending school in Boulder. SFS is a new ham in Brush, and has HT-17 on 7 Mc. HAF is back in McCook, Nebr. KHQ, DD, PGX, OPF, and OWP hold schedules nightly on 3800 kc. SGG, FPL, and DYS are new ORS. IPJ has left for Panama to work for the CAA. He plans on getting a KZ5 call as soon as he can arrange it. Doug says he will miss the IUN gang and I know that we will miss him. Only seven cards were received this month, while last month the total number of cards received was 18. Looks like "Sprig has sprug." Traffic: W0IC 223, LZV 85, SGG 52, FPL 38, KEQ 4, OWP 3.

UTAH-WYOMING — SCM, Alvin Phillips, W7NPU —
Asst. SCM, Charles M. Conley, 7UOM. Our sincere thanks to the few who sent in reports this month. MWR is 'phoning on 28 Mc. and pounding brass on 3.5 Mc. He says he needs a beam as his long wire is hard to rotate. UTM made BPL. Congratulations, Floyd, BED is handling traffic in his spare time. Spring Fever seems to have overcome the Ogden gang. Incidentally, this probably will be the last report by your Asst. SCM. For goodness sake, gang, give our new SCM the support he needs and deserves. LKM and RPX have been running a number of tests on 3.8-Mc. mobile. RPX is leaving for Seattle. JVV is kw. dreaming. NPU finds time to ham now and then. UOM has curtailed activities because of other work and activities. 73, fellows, and be seeing you on 3.94 Mc. — W7UOM. Traffic: W7UTM 527, BED 280, LKM 9, MWR 8.

SOUTHEASTERN DIVISION

ALABAMA — SCM, Dr. Arthur W. Woods, W4GJW —
A GLR has stacked two three-element beams rotary and tiltable for 28 Mc. FSW has 304TTs on 28 Mc. DID worked Japan for WAC on 28 Mc. DFE has recovered from a long illness and is back on 28 Mc. The Birmingham Club meets at Courthouse the first Thursday of each month. NQK is mobile 28 Mc. and surplus 7 Mc. OLG's Federal transmitter soon will be ready with 1/2 kw. DYM is trying for WAC before shipping out on SS *Wild Ranger*. GSO has new rig with p.p. 8005s. DMV is building a Clapp oscillator. DXB uses an 810 Class B linear on 14 Mc. OGV is new in Decatur. BFM works 3.5 and 3.85 Mc. MXU made BPL this month. OHA is new in East Gadsden. KIX is working a rack-mounted receiver with converters for high frequency bands. JYB is experimenting on 28 Mc. while awaiting new Taylor rig. EBZ has new jr. operator, a girl this time. GJW is the baby's doctor. KCQ has a large stack of QSLs to attest to his DX achievements on 14 Mc. ELX is building a band-

(Continued on page 98)



HENRY

HAS

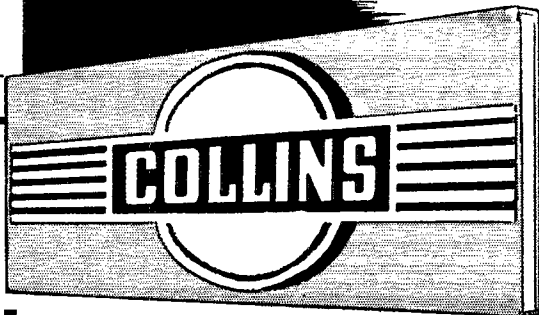

Henry Radio stores in Butler, Missouri and 11240 West Olympic Blvd., Los Angeles, California have complete stocks of all Collins amateur equipment for immediate delivery. Also complete stocks of all other amateur receivers, transmitters, and parts. I promise you that you can find nowhere else lower prices, more complete stocks, quicker delivery, easier terms or more generous trade-ins. I give you 10-day free trial and 90-day free service. I promise that you will be satisfied on every detail. Write, wire, phone or visit either store today.

Bob Henry
W6ARA

A FEW ITEMS I STOCK ARE:

National NC-33	\$ 57.50
National NC-57	89.50
National NC-173	189.50
National NC-183	268.00
National HRO-7	292.50
National HRO-7C	372.45
National HFS	142.00
Hallicrafters S38	39.95
Hallicrafters S53	89.50
Hallicrafters S40A	99.50
Hallicrafters SX43	189.50
Hallicrafters SX42	275.00
Hallicrafters SX62	269.50
Hallicrafters HT18	110.00
Hallicrafters HT19	359.50
RME HF-10-20	77.00
RME VHF-152A	86.60
RME DB22A	71.00
Hammarlund HQ-129X	177.30
Signal Shifter EX kit	49.75
Telvar T60-2	150.00
Harvey-Wells TBS-50	99.50
Harvey-Wells TBS-50A	121.25
Hunter 20A Cyclemaster	169.50
Subraco MT-15X	79.95
Hallicrafter & National TV sets	

Gonset, Silver, Meissner, Millen, Sonar, Stancor, Bud, Mon-Key, Vibroplex, B & W, Johnson, RCA, Gordon, Amphenol, Hy-Lite, Elinor, Workshop, Premax; I have everything for the amateur.

Some prices higher on west coast

FOR EXAMPLE:

Collins 75A-1 receiver	\$ 375.00
Collins 32V-2	575.00
Collins 30K-1	1450.00
Collins 70E-8	40.00
Collins 310C-1	85.00
Collins 310C-2	100.00
Collins 310B-1	190.00
Collins 310B-3	215.00

COMPLETE STOCKS

Henry has *everything* in the ham field.

QUICK DELIVERY

Shipments 4 hours after receipt of order. Send \$5.00 with order and shipment will be made at once C.O.D.

TRADE-INS

You can't beat Bob Henry for trade-ins. Write, wire or phone today about your equipment and Bob Henry will make you a better offer than you can get anywhere else.

TIME PAYMENT

Because Bob Henry finances the terms himself you get a better break. Save time and money, deal with Bob Henry on his personal, profitable time payment plan.

Butler, Missouri

HENRY RADIO STORES

11240 Olympic Blvd.
LOS ANGELES 25
CALIF.

"WORLD'S LARGEST DISTRIBUTORS OF SHORT WAVE RECEIVERS"

LOOK

MOBILE POWER SUPPLY

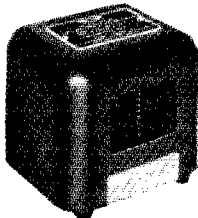

The original E-L Model 2606 "HAMPAK" delivers full 30 watts output (300 volts at 100 ma.) complete hum filtering and RF noise suppression. 6 volt DC 8 amp. input, 4 1/2" x 5 1/2" x 5", weight 6 1/2 lbs. Regular amateur net \$15.00, special buy.

\$9.95

IMMEDIATE DELIVERY FROM STOCK

SONAR MB-611 MOBILE XMTR.	\$72.45
SONAR XE-10 NBFM.	39.45
HARVEY WELLS TBS-50.	99.50
HARVEY WELLS POWER SUPPLY.	39.50
HALLICRAFTERS S-38.	39.95
HALLICRAFTERS R44 SPEAKER.	19.50
HALLICRAFTERS T-54 TV.	139.50
HALLICRAFTERS T-64 TV CHASSIS	
Complete with 10BP4.	203.50
Complete with 12LP4.	240.50
HUNTER CYCLEMASTER 20A.	169.50
LAMBDA 2-inch SCOPE.	24.95
MON-KEY.	29.95
NATIONAL NC-57.	89.50
BUD VFO.	35.00

THORDARSON

MULTI-FILAMENT TRANSFORMER

2.5 Volt 10 Amp., 6.3 Volt 5.5 Amp., 6.3 Volt 1 Amp. 5000 Volt insulation, hermetically sealed, ceramic feed thru connections, 110 Volt, 60 cycle primary, 4 1/2" x 3 1/2" x 5 1/2". **\$2.95**

STRUTHERS-DUNN RELAY

110 VOLT AC

Control all of your equipment with this one relay. 110 VAC coil, 4-pole, 2 double throw, 2 single throw, 6 Amp. contacts, screw terminals, insulated base, 3" x 3 1/2", a terrific bargain at **\$2.00**



BC-221 CRYSTAL

1000 KC crystal, in FT-243 holder, ground to exact frequency to duplicate performance of original crystal in **\$3.50**
BC-221 Frequency Meter. New.
Special frequency crystals, outside amateur bands, \$5.00. Specify exact frequency.

73, JULE BURNETT, W8WHE

Steinbergs

633 WALNUT STREET • CINCINNATI 2, OHIO

switching 150-watt rig. ONT and ITZ are on from the North- ington Campus of U. of Alabama. IMK is a steady customer on AENB. AENP continues to function competently and efficiently. Now is the time for everyone to complete plans for Field Day. Traffic: W4MXU 507, GLR 150, GJW 37, KIX 28, BFM 18, DID 13.

EASTERN FLORIDA — SCM, John W. Hollister, jr. W4FWZ — 1280 messages were sent from West Palm Beach Exposition. There was plenty of fun for all, including MVJ, LXY, IUJ, JQ, TH, BRB, KGJ, ISF, BNK, and 2RTZ/4. Special thanks go to 2RTZ/4, MNT, CFL, 8GBW, 5LSN, 2SXX, ANK, NNJ, RP, BVK, 5WZ, 5KTE, 2LR and the helping nets. To top it off a big ham picnic will be held at WPB to celebrate. Don't forget Field Day June 18-19. The SCM wants your activity reports on this event. 160-meter activity reports are wanted. BPL Certificates were issued to MNT, MVJ, ZC, and 2RTZ/4. Congrats on the nice traffic jobs. A nice letter from ES says that CG has worn his nose down to a nub on the grindstone. Why not devote some of your time to the various communications auxiliaries? We have the USCG, USNR, and MARS station opportunities if you can qualify. Clearwater: AXX now is running 225 watts with VT-127A. AXX is in the v.h.f. group on 144.1 Mc. at 8 p.m. Tuesday. Lake City: IQV is working on v.h.f. link to Tampa on 144.7 Mc. with HAD and LAW at 7:15 p.m. Tuesday. Lake Placid: BYR receives Miami WTVJ Right now he is practically 100 per cent T.V. experimental. Miami: The Dade Club bulletin points out the necessity for bearing down on eliminating T.V.I. now that pictures are a reality in Miami. That is food for thought elsewhere where T.V. is being installed. Tampa: NRT and IWT are organizing a slow-speed traffic net. This will open up opportunities for the inexperienced to gain some practice. Winter Park: Route Manager RP, 3675-kc. net, writes that his plans for next fall are being made and will include additional outlets. While the 3675-Mc. net is closed for the summer the 7290-kc. net should offer some good possibilities. Additional c.w. and 'phone net stations are needed. Traffic: (Mar.) W4MVJ 744, 2RTZ/4 586, 4ZC 577, MNT 503, IQV 206, RP 165, DES 86, ES 25, AXX 9. BYF 5, BT 1, (Jan.) W4AYX 4.

WESTERN FLORIDA — SCM, Luther M. Holt, W4DAO — NRL is the wife of LDT, ACB, OKD, TL, LDT, GQM, and GAA are forming a 144-Mc. net in Tallahassee. OTN visited Mississippi. OYC is newest Pensacola ham. OWN plans 7-Mc. operation. GTR works 3.85-Mc. 'phone. MUX increased power. QK sold his car. MS, EQR, and CNK worked Shalimar on 54 Mc. ODO took part in a play. DAO moved away from B.C.I. and T.V.I. LRC is flying model radio-controlled airplanes. MUQ opened a radio store. MFY attends PARC meetings regularly. NGS is active with Goslin Radio Club. 5PKS/4 joined the PARC. LRX is selling out. EQR bought an HRO. CNK built 3.5-Mc. doublet. JPA built a new beam. NOX is increasing power to 200 watts. DLO, AXP, CNK, OKD, and others formed the Western Florida C.W. Net, operating on 3600 kc. Monday, Wednesday, and Friday nights. They want additional members. JV visited Chicago on business. HQ operates several bands. GAA renewed his ORS appointment. Traffic: W4AXP 73, OKD 50, DLO 40, CNK 35.

GEORGIA — SCM, Clay Griffin, W4DXI — Reports to the SCM were slim this month. FBH and LNG worked South Carolina on 50 Mc. for their 41st and 31st states, respectively. PAZ is on 144 Mc. with a handy-talkie. Reliable sources say that JPW is getting ready to sell out and quit ham radio. DXI and LJB have been trying 160 meters. This should be a good band for Georgia contacts at night. LXE is back on after a stay in the hospital. The Atlanta Club will hold a hamfest June 5th at Grant Park. Traffic: W4GGD 30, BOL 15, DXI 6.

WEST INDIES — SCM, E. W. Mayer, KP4KD — AM and HR report routine operation for the month. EZ is selling out preparatory to transfer. HK also is selling out and is awaiting orders out. DJ, NCS of AEC Net, advises that the net meets on 3559 kc. at 8 p.m. IL, with HJ as chief, completed WAS and WAC and sweats out confirmations. W4OLC returned home and KD resumed the Miami schedule again. IG's schedule with W4ESQ on Sundays is working 100 per cent. FU resumed operations on 28-Mc. 'phone and 14-Mc. c.w. after a layoff. PRARC held annual hamfest and elections March 27th. Following are new officers: DV, pres.; BL, vice-pres.; HZ, secy.; BV, treas.; DJ, ES, FJ, GP, and JA, directors. DV and KD had fun in the C.W. DX Contest, while ES had everything his own way in the 'Phone DX Contest, with a bit of friendly competition from FJ. KD received DXCC 140 sticker and WPR-175 sticker. Traffic: KP4EZ 21, DJ 19, KD 12, DV 4, IL 3.

SOUTHWESTERN DIVISION

LOS ANGELES — SCM, Vincent J. Haggerty, W6IOX L — Asst. SCMs: William J. Schuch, CMN, and Irvin O. Hege, 6PYW. SEC: ESR. The AEC continues to expand under the leadership of our SEC, ESR. Note the community areas and their Emergency Coordinators where nets are in operation and drills are held regularly: Bay Cities, ESSX; Centinella Valley, RIT; San Gabriel Valley-Covina, FMO/FFN; Glendale-La Crescenta, BTA; Hollywood-

(Continued on page 100)

HARVEY for variety for bargains

VARIETY-BARGAINS



AIRCHARGER MODEL 616

6 volt wind charger, with 5 ft. tower and universal mounting brackets. Built-in brake assembly for remote shut-off of unit. Automatic governor built-in, cannot over-run or over-charge. Complete with control panel,

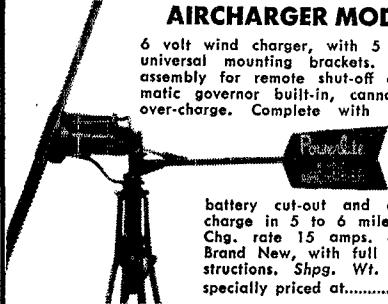

battery cut-out and ammeter. Will charge in 5 to 6 mile breeze. Max. Chg. rate 15 amps. at 1100 RPM. Brand New, with full installation instructions. Shpg. Wt. 85 lbs. Very specially priced at.....**\$34.95**

Regency Signal Booster

Extremely stable, high-gain, wide band pre-amps using push-pull RF, self-powered. Either 300-ohm line or coaxial cable may be used on either input or output. Proper impedance match and push-pull performance maintained under all conditions. Amazing improvement in signal to noise ratio under all receiving conditions. Models: SB-29, 27-30 mc; SB-52, 50-54 mc; SB-69, 44-48 mc; SB-98, 88-108 mc; SB-146, 144-148 mc; SB-157, 152-162 mc; SB-189, 174-216 mc (SB-69 for TV channels 2-6; SB-189 for TV channels 7-13). Any model, each.....**\$11.95**

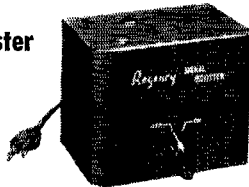

NEW SB 2-13 all TV channels, 2 thru 13.....**\$17.95**

GENERAL ELECTRIC 1 MFD CONDENSER

15,000 working volts DC. Pyranol filled. Brand New. Shpg. Wt. 35 lbs.....**\$14.95**

1/2 MFD. Condenser, 25,000 working v. D.C. Pyranol. Brand New. Shpg. Wt. 35 lbs.....**\$18.95**

Cornell-Dubilier TJ-20040 oil-filled condenser. Rated 4 mfd. at 2000 V. D.C. working. Shpg. Wt. 3 lbs.....**\$3.75**

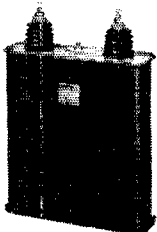

XTALS

20 meter xtals for a buck! Mounted in holder with 1/2" pin spacing. Also 40 and 80 meter and 6 and 13 mc bands at the same low price. Specify your frequency.....**\$1.00**

5 mc precision xtal, as shown, many uses.....**\$1.95**

Special 8 mc xtals for 2 meter xtal control..... **1.50**

Lucite adapter for 1/2" xtal holders..... **.35**

Include 10¢ postage with your crystal order.

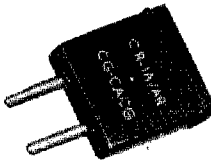

160 METERS NOW OPEN

Harvey has in stock a complete assortment of B&W coils in all types and ratings. Also 160 meter xtals made by Bliley, Petersen, etc.

In stock—the new **NATIONAL MODEL TVB-1** all-band television preselector, booster amplifier. We highly recommend this unit as one of the best. Shpg. Wt. 5 lbs.**\$28.00**

NEW 1949 TECHMASTER TV KIT

Don't confuse this with cheaper kits! This kit has all RCA parts, including pre-wired and aligned genuine RCA front end, punched chassis with all major components mounted as shown; all RCA tubes including kine, complete manual with service notes all RCA. New simplified instructions. (Free circuit and parts list on request.) Shpg. Wt. 85 lbs.....

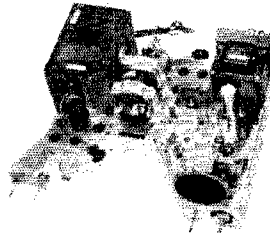

\$198.50

Less kine **168.50**

10BP4 **29.50**

12LP4 **49.50**

15AP4 **89.50**

16AP4 **79.50**

Collins 75-A

\$375.00

80, 40, 20, 15, 11 and 10 meter ham receiver. Automatic noise limiter, high sensitivity, double conversion. With speaker in matched cabinet. Shpg. Wt. 93 lbs.

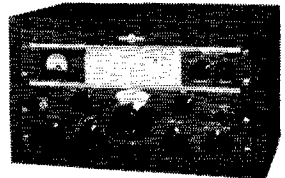

GE FM TUNER

Only a few left of this unusual buy. Covers 88-108 mc range, uses guilotine tuning. Designed for export and tropicalized, has power inputs for 110 to 250 volts 60 cyc. Shpg. Wt. 30 lbs. **HARVEY SPECIAL PRICE**

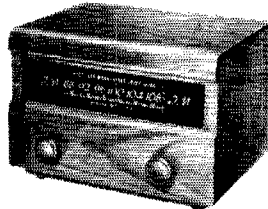

\$4950

AMERTRAN TRANSTAT

250 watts. Input 115 volts, 60 cy; commutator range 103-126 volts. Shpg. Wt. 15 lbs.....**\$5.95**

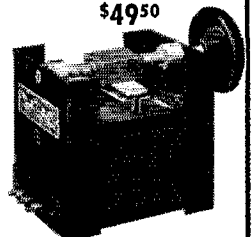

MILLEN 90651 GRID DIPPER

Versatile test and design unit. 1.5 to 270 mc. Transformer power supply plus battery operation. Frequency calibrated drum dial. Measures only 3 1/2" x 3 1/2" x 7" plus inductor length. Complete with tube and inductors. Shpg. Wt. 5 lbs.....

\$55.00



Telephone:  Luxembourg 2-1500

HARVEY
RADIO COMPANY, INC.

103 West 43rd St., New York 18, N. Y.

All in stock
for immediate
delivery.

NOTE: All prices are
Net, F.O.B. N.Y.C. and
are subject to change
without notice.



Prices Slashed—Save up to 80%

TRANSMITTING SPECIAL PURPOSE TUBES

Terrific Reductions on BRAND NEW TUBES from Our Regular Stock—All JAN Inspected

3CP1/S1	3 for \$.89	805	2 for 6.95	3.65	
211	6 for 1.59	813	2 for 12.95	6.95	
803	2 for 6.95	815	2 for 2.59	1.39	
E1148	\$.39	331A/805†	3.65	931A	1.98
VR150	.49	WL677	6.95	954	.19
2C44	.59	705A	1.59	955	.19
2X2A	.79	801A	.49	957	.19
2X2/879	.27	803	3.65	958A	.19
3CP1	.99	804	2.95	1616	.19
3CP1/S1	.89	805	3.65	1619	.19
3C24/24G	.29	807	1.15	1625	.19
3EP1*	1.39	809	1.59	1626	.19
3E29	3.29	811	1.29	1641*	.75
5BP1	1.75	813	6.95	2050	.39
10Y	.29	814	1.39	7193	.49
211	.29	815	3.95	9001	.19
285A†	.75	830B	2.85	9002	.19
286A†	.69	838	2.85	9004	.19
3041L*	1.29	845W	2.95	9006	.19
316A	.29	872A	1.25		

*From Chicago Only.

†From New York Only.



NEW MILLEN 90651 GRID DIP OSCILLATOR

Just out—The most versatile Test Instrument for Amateur and Lab. use. Frequency range: 1.5 to 270 Mc. Ideal for measuring harmonic content in the elimination of TVI. Transformer type power supply, plus provision for battery operation. Direct frequency calibrated, anti-backlash gear driver dial with uniform scale lengths.

No. A19413, complete with tube and inductors, Net \$55.00

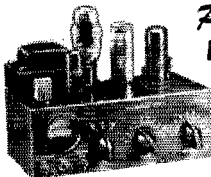

Price Slashed... FAMOUS MICAMOLD XMTR KIT

Now \$19.95
Reg. \$34.00

Model XTR-1
Save \$14.05 on this Complete 45 Watt Telegraph Transmitter Kit. Complete from power supply to antenna matching network. A flip of the switch puts you on 3.5, 7, or 14 mc. with a suitable crystal. No Coils to Plug In. No Extra Coils to Buy! The 6AG7 crystal oscillator circuit is extremely stable and easy on the crystal, which results in a clean cut signal. Band switch controls both a tapped broad-tuned oscillator plate coil and final output circuit. Through a pi-network, the final will match any antenna. Grey chassis is punched and marked with dial scales, etc. Requires one each type 83, 6AG7, and 6L6 tubes. Less tubes, crystal, and key. No. S-1132, 10 lbs. Sale Price \$19.95

RCA POWER SUPPLY BARGAINS

Two Big Buys! Completely assembled power units—ready to operate from 110 V. 60 cycles AC! Made for high quality use.

No. S-977, Delivers 250 V @ 50 ma, 100 V @ 15 ma, 6.3 V @ 2.5 amps, and 24 V bias. 4 1/4 x 8 x 2". Less \$73 rect. 8 lbs. Special \$6.95

No. S-978, Output: 250-300 V @ 2-8 ma, or 280-320 V @ 8-16 ma. Filament: 6.0-6.3 V, adj. @ 1.5 amps. 3 1/2 x 10 1/4 x 6". Less 80 rectifier, 6 lbs. Special \$4.95

NEWARK FOR RADIO & TELEVISION

NEWARK ELECTRIC CO., INC.

3 GREAT STORES! Uptown: 115 West 45th Street
Downtown at 212 Fulton Street in NEW YORK
323 West Madison Street in heart of CHICAGO

MAIL ORDER DIVISIONS: 242 W. 55th St., N.Y. 19
and 323 West Madison Street, Chicago 6, Illinois.

Beverly Hills, GFI; Long Beach, AOT; Owens Valley, L1Y; San Fernando Valley, KEI; San Bernardino, HKD; San Luis Obispo, LKF; Venice-Culver City, TSN; Santa Barbara, TWT; Ventura County, PYV; Riverside, WGT. Twice during March the units under EC BTA were called into active service on emergency missions to provide communication for rescue parties in mountainous areas. On each occasion the AEC units showed the results of their training by successfully completing their assignments. Prospective AEC members should contact the EC listed above, in their area, for information relative to becoming a part of this constructive program. Traffic reports were heavy this month with CE at the top of the list with a total of 1891; he scheduled 4PL, 5LSN, 7CZY, and IOX, and the PN, SCN, and SBN Nets. Also in the BPL are DDE and CZF with nice totals. ZMZ, DDE, and CZF reported by radio. The March meeting of the YLRL Los Angeles Chapter was held at the home of CBA. NAZ and YRL are preparing a YLRL directory to be available soon. BHG, on 147,497,22 kc., transmits Official Bulletins Sun. 1100 PST, Tues. and Fri. 2000, PST and code practice Mon. through Fri. 1900-2000 PST and Sat. and Sunday 1000-1100 PST. He would appreciate reception reports on these transmissions. DGA reports the Slow Speed Trunk Line needs a relay station between Colorado Springs and Barstow. AM just added EA8MC, Canary Islands, to his DX collection as country number 182. To his 28-Mc. rig VAQ hooked a 16-ft. coil of wire, tossed it on the floor, one foot above ground, and proceeded to get 579 reports from KH6, VE3, and W8. With a more orthodox array VAQ made a good score and had lots of fun in the DX Contest. KEI reports that DJN is back from the hospital, feeling fine, and receiving the well-wishes of the Golden State Net gang. HJL is on the air in Paso Robles. FSA is a new call at Atascadero. FYW says the Paso Robles Club's training classes are going well with several prospective new hams enrolled. YSK is all set for OO work on 160 meters. 1QMI/6 received ORS and RM appointments. AI, ex-8JQB, is confined to 7-Mc. operation at present, where he is trying to organize a traffic net. CMN was a visitor in Santa Barbara during March and he reported that he is giving his rig a thorough revamping. 7AIB/6 sent in a traffic report from Long Beach, where he acts as a PN outlet while his Coast Guard ship is in port. Traffic: W6CE 1891, DDE 716, CZF 540, IOX 352, ZMZ 85, ZQV 59, 7AIB/6 48, 6TFC 42, NAZ 25, BHG 20, DGA 17, MU 10, AM 8, VAQ 8, QAE 6, KEI 5, OHM 5, ASW 4, FYW 4.

ARIZONA—SCM, Gladden Elliott, W7MLL. LSK now is operating from Kingman, KWO and KTP are running July 420-Mc. tests from Mogolion Rim to Roosevelt Dam. They plan August tests from San Francisco Peak on 420 and 144 Mc. For contacts over Arizona and to the Coast. LAD and LQB have made it three contacts, between Tucson and Phoenix in a month on 28 Mc. KWO reports rigs on 1250 and 3300 Mc. and a 6J6 mobile rig on 420 Mc. and as many as seven some evenings on 420 Mc. in Phoenix. The Phoenix gang staged a nice party on April 2nd. JMQ needs only Africa for WAC on 3.85 Mc. NBP is a new ham in Bisbee operating on 28 Mc. Phoenix hams again assisted the Dons' Club in its annual trek to the Superstition Mt. on a gold hunt by supplying communication on 3.85 and 7 Mc. Those making the trip were OLF, LPA, OFX, RIJ, KOY, MAE, and 6EAS. NDJ is working 7-Mc. e.w. from Wickenburg. The Radio Club of Arizona is awarding a Cup for the highest club Field Day score. UPR has his new kw. on 14- and 28-Mc. phone. Both LJV and HXY have increased their power in Prescott. LOJ is on the 3515-kc. e.w. net as alternate outlet in Tucson. LFN and LLD have two extremely neat dual beam layouts. TCQ has a new 300-watt rig with 828 finals.

SAN DIEGO—SCM, Dale's S. Bose, W6BWO—Asst. SCMs, Gordon W. Brown, 6APG, and Shelley E. Trotter, 6BAM. RM: BGF, SEC, DUP. Congratulations to CG for a job well done as SCM for the last two years. DBZ reports antenna trouble; also lots of recruits and trainees at Training Center going up for tickets. Ex-4KJT now is 6FJF at La Mesa. LYF is NCS for Southern Border Net on Tues. and Wed. KD, BVY, UNU, DEY, EWU, PFQ, AD, and BWO are all on 3.85-Mc. mobile with excellent results. JXF is mobile marine and sure puts out a sock. FMZ is NCS for Southern Border Net on Monday. The San Diego YLRL had a National 1-10 receiver as a prize at its March meeting but we have no report on who got it! VUK and AWW, plus their harmonics, went mobiling with VJQ and YXI via a trailer. KH6QJ, formerly W6YYM, is back in San Diego to stay. YTH and his XYL have a new baby girl. PNU now is signing HZ1AB. The Imperial Valley Club reports that CNZ gave a nice talk on teletype. CQW presented rules for the 40-, 75-, and 80-meter Marathon Contest for members of the club. AWZ, QUS, RDI, CNZ, BSP, and DLN are members of the AEC in the Valley. LVN is visiting other shacks to keep in practice. CGF is set up for battery operation on 3.5, 3.85, and 144 Mc. LDJ is spending a big part of his time in Santa Barbara as FRJ. DUP calls AEC Net drill on the first Sunday of each month on 3940 kc. The April drill was attended by DUP, CGF, PFQ, AD/m, EWU, KD/m, FMJ, AD-fixed, DLN, and BWO. Time for drill is 0800 for mobile stations and all others who wish to check in at that time, and 0900 for those who sleep

(Continued on page 102)

**NEW LOWER TERMS at the Radio Shack
ONLY 10% DOWN!**

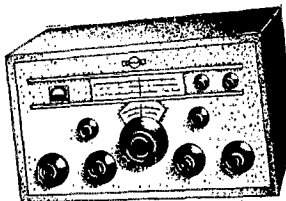

COLLINS 75A-1 RCVR

Easier "play while you pay" terms make it possible — at last — for you to put the Collins 75A-1 Receiver you've always wanted in your Ham Shack for only \$37.50 down!

BRAND NEW G.E. BC-645A

Get going on 420 with this "hot" xmtr-rcvr for phone and i.c.w. Originally priced over \$2000, they cost you less than the price of the 15 tubes you get with the outfit. Full conversion instructions furnished.

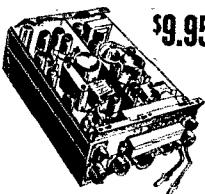

\$9.95

A RARE BUY in VHF GEAR
SCR-522 XMTR-RCVR \$33.95

The ideal set for 100-156 mc work . . . receiver is 10-tube superhet with 3-microvolt sensitivity . . . 7-tube, 15-watt xmtr. Used, but very clean. With full set of tubes. Price only \$33.95.

Spare 832's for SCR 522 . . . \$2.65 each

**HI-FIDELITY
12" CO-AXIAL
SPEAKER**



\$11.95

Famous-make 12" speaker with 3" co-axial tweeter give you full range coverage from 50 to 15,000 c.p.s. Brand new 1949 model with a list price of \$27.50, excitingly low-priced at \$11.95

CO-AXIAL DIPOLE



Was \$12.50
now only
\$6.50

For 2 meter fixed-station or mobile use. Matches 50-55 ohm coax cables. Easily mounted on auto. Rhodium-plated brass and poly. Brand new!

RG-62U CO-AXIAL CABLE

For antennas, feed, interstage coupling, etc. 93 ohms, 13½ mmf cap. per foot, 1.87 db loss per 100 feet at 40 mc., diameter .242". Save one-third at the Radio Shack!

6c per foot
\$5.50 per 100 ft.
50.00 per 1000 ft.

**OUTDOOR
TV FM ANTENNA**

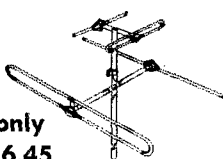

only
\$6.45

Here's a famous-make top quality all aluminum duo-orienting double folded dipole with reflectors at a price that even amazes us!

**OIL XMITTING
CONDENSER**

Super-special bargain . . . famous make. Quantity limited, so it's first-come first-served.

2 mfd—1000 volt \$.89
2 mfd—3000 volt 2.95

**TUBE SPECIALS
FOR JUNE**

(Minimum order \$2.00)

VR150 — 2 for \$.75
2X2 — 2 for .49
830B — 2 for 3.95
872A — 2 for 1.95
1616 — 2 for .89
3C24/24G — 2 for .55

NOTE: All surplus tubes are guaranteed to be new and unused. All tubes are inspected for mechanical breakage before shipment.

TERMS ON NEW GEAR

Deposit only 10% . . . and take a year to pay the rest.*

CHECK CHOICE HERE	NET PRICE	SEND US ONLY
COLLINS		
75A rcvr	\$ 375.00	\$ 37.50
30K xmtr	1450.00	145.00
32V-1 xmtr	475.00	47.50
310B-1 exctr	190.00	19.00
310B-3 exctr	215.00	21.50
310C-1 exctr	85.00	8.50
310C-2 exctr	100.00	10.00
70E-8 exctr	40.00	4.00

HALLICRAFTERS

S38 rcvr	39.95	4.00
S40A rcvr	99.50	9.95
S47 rcvr	229.50	22.95
S51 rcvr	149.50	14.95
S53 rcvr	89.50	8.95
SX42 rcvr	275.00	27.50
SX43 rcvr	189.50	18.95
HT9 xmtr	350.70	35.00
HT18 xmtr	110.00	11.00

NATIONAL

NC-33 rcvr	57.50	5.75
NC-57 rcvr	89.50	8.95
NC-173 rcvr	179.50	17.95
NC-183 rcvr	269.00	26.90
NC240D rcvr	241.44	24.14
HRO-7 rcvr	279.00	27.90
HFS	125.00	12.50

HAMMARLUND

HQ129X rcvr	189.15	18.92
SP400X rcvr	450.00	45.00

R. M. E.

HF-10-20 rcvr	77.00	7.70
VHF-152A rcvr	86.60	8.66
DB22A	77.00	7.70
RME-84	98.70	9.87
RME-45	198.70	19.87

MILLEN

90800	42.50	4.25
90881	89.50	8.95
90281	84.50	8.45

• IMMEDIATE SHIPMENT of the gear you want is assured by our complete stocks of receivers, transmitters, instruments and other amateur apparatus.

• EASY, MONEY-SAVING TERMS require only a small service charge on time payments.

• *TERMS on merchandise costing \$50 or less, 10% down, 6 months to pay balance. C.O.D. orders filled promptly at The Radio Shack with 20% deposit.

Send for your FREE 108-page Radio Shack Catalog today!

The RADIO SHACK Corp.

CABLE ADDRESS - RADIOSHACK
167 WASHINGTON ST., BOSTON, MASS., U.S.A.

**Have you ever
really heard FM?**

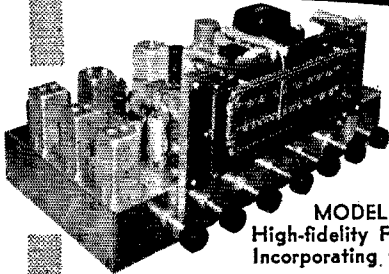

MODEL RJ-20
High-fidelity FM-AM Tuner
Incorporating tone controls

To truly enjoy FM . . .

and the unmarred brilliance Armstrong-circuit FM alone makes possible — you need the performance of the RJ-20. The man who knows radio knows nothing less will give equal performance.

Music is flawless, noise-free — every instrument sounds true . . . speech is clear, with astonishing "presence". Tuning is precise and drift-free.

And for better AM . . .

Superior performance with maximum tonal quality. Wide-range tone control to suit your taste; 20 db. treble and bass boost.

Also available: RJ-12A FM-AM tuner with triple tuned IF transformers in AM, RV-10 FM tuner only. All with same Armstrong FM circuit.

Free Bulletin 449H gives performance curves and data on these high-fidelity tuners.



BROWNING
LABORATORIES, INC.
WINCHESTER, MASS.
ENGINEERED FOR ENGINEERS

NOW . . . AMAZING NEW Super De Luxe

VIBROPLEX

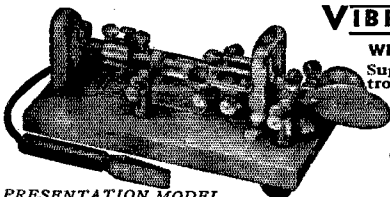

WITH
Super-Speed Control
Main Spring
and
Other Great
Features
24-K
Gold-Plated
Base Top
\$27.50

PRESENTATION MODEL

Sends easily as pressing a button. Suits any hand or any style of sending. No tiring arm-effort. Instant speed regulation 10 to 40 w.p.m. and beyond. Clear, uniform signals. Sets firmly on table. Don't deny yourself the pleasure of sending with this amazing new Vibroplex another day. **ORDER NOW!** Other models from \$9.95 up.

THE VIBROPLEX CO., Inc.

833 Broadway

New York 3, N. Y.

in late. How about more reports on doings in your area fellows? Traffic: W6BGF 193, LYF 72, DBZ 36, FMZ 27, BAM 20, LDJ 11.

WEST GULF DIVISION

NORTHERN TEXAS — SCM, Joe G. Buch, W5CDU — PRN is the latest call in Commerce and is on the air with a Meissner Signal Shifter and 8-40A receiver. LGY again is active as OO, OBS, and EC after vacationing in Houston. W. H. Propst, 8KCG, of Cleveland, Ohio, now is in Dallas. NTX, the c.w. net, lost a most faithful prewar and postwar member with the death of FMZ, of Swenson. JHX has completed a three-month GCA and surveillance radar course in Oklahoma City. The first Sunday afternoon extra meeting of the Dallas Club resulted in a fine display of mobile equipment by club members and late-type portable gear was demonstrated by CAP personnel. ISM has a new 32V Collins, LSN and GZU again make BPL; it's getting to be a habit with these big league traffic handlers. HBE won the SLF Contest held by the DARC and proved to be most proficient in the art of left-foot keying. ENE was a close second and MA rates third. ASA has raised power input to 200 watts. ARK is now EC for the Ft. Worth area. PED is active on 3.5-Mc. c.w. JDZ is ready to go on 160 meters. NFT visited friends in Dallas and took his Class A exam. 144-Mc. interest appears to be on the upgrade. A power supply failure caused considerable damage to components and wiring in NRE's 610 rig. Traffic: W5LSN 1026, GZU 742, ARK 140, CDU 92, BKH 39, ASA 15, ISD 12, LGY 1.

OKLAHOMA — SCM, Frank E. Fisher, W5AHT/AST — SEC: HGC. NMM spent some time in New York on T.V. business. He welcomed a new daughter, Jean Marie, on his return. LGI has a job in Washington, D. C. AGM resigned EC appointment because of increased demands of his job. GCM has a new 28-Mc. beam. GCK moved to Oklahoma City from Texas. EHC built a modulation meter. BZI is installing teletype on 27 Mc. This is an interesting activity and other Oklahoma amateurs may be interested. JHI is operating on 7 Mc. LF, NS, DPU, HFY, HKI, JNG, OOI, OP, and LEI are among Tulsa amateurs active on 50 Mc. with the cubical quad a favorite antenna array. HTZ, IOW, HXI, and APG also are doing nice work on 50 Mc. HTZ and IOW worked LU6DO on 50 Mc. since the band opened March 19th. The Tulsa h.f. gang is watching the 50-Mc. band for QSO with other stations on extended ground wave. Our SEC, George Bird, was guest speaker at Pawhuska Rotary and Ada Kiwanis clubs. His subject was "Amateur Radio and Emergency Communications." JKQ and WQ, at Canton, and HFW and HXC, at Blackwell, moved traffic from the tornado area in their respective localities. HGC and NHD have been experimenting with 144 Mc. and are learning things about antennas. Lee Kline at MBV and FOM has really gathered in traffic for OLV. Traffic: W5MBV 370, FOM 356, KDH 243, NMM 242, OWV 196, K5NRJ 148, W5PA 119, AST 112, PCL 85, IOW 51, LHP 36, ADB 35, GVS 14, EHC 3.

NEW MEXICO — SCM, Lawrence R. Walsh, W5SMA — SEC: ZU. RM: NXE. PAM: FAG. The SARA and Albuquerque Radio Clubs held an Emergency Field Test March 13th. BYX and FAG were field control stations for their clubs. OMR operated in the field near Espanola. The 40- and 80-meter c.w. nets and the 75-meter 'phone net were very active. MYQ has a new portable regenerative receiver for Field Day use. OMR is building a new rig. UFA is rebuilding his Signal Shifter with a PM modulator and larger power supply. KWP is rebuilding his emergency rig. PSV reports that the Four Corners Club has applied for affiliation with ARRL. MMX is building an 813 final and has a new rotary beam. MMX, PIB, PDQ, and other members of the Belen Radio Club were in the field on March 13th. CA is now located in a home in the mountains at Tijeras. Mid is on 3.5- and 7-Mc. c.w. at present. 6UVA has a new 3-30 Mc. converter in his station wagon. NRE, EN, and KXX relayed play-by-play description of basketball games via c.w. MMX reports that his XYL now is PUZ. Kip also has started work on a cubical quad. MSG is now an OO Class II. Traffic: W5ZU 189, BYX 132, NXE 54, NRE 45, OCK 35, OPN 34, OMR 31, MYA 30, KUP 29, SMA 28, JXH 17, PEJ 14, MYM 13, CTP 10, MMX 6, JYW 3, NJR 2.

**CANADA
MARITIME DIVISION**

MARITIME — SCM, A. M. Crowell, VE1DQ — SEC: FQ. RM: GL. OBS: RR. Listen for RR on 3840 kc. each Mon.-Wed.-Fri. at 6:45 p.m. ADT. All HARC news and convention information will be handled as received. TH and DQ have acquired R-9ers. JV is the call of the new Glasgow Club. ZZ has worked CR9AG. ES built 1851 pre-selector and has been doing some phono-amplifier building-neg. feedback and phase inversion stuff. DB held the usual spot on 14 Mc. UN, ME, GC, and NO have been active on 3.8-Mc. 'phone. QG now is in St. John. AX is back on 14 Mc. with n.f.m. and is working on new "pitchfork"
(Continued on page 104)



GET ON THE AIR FOR LESS THAN \$90 WITH THIS COMPLETE ALLIED STATION

Now—ALLIED makes it easy for the beginning Amateur to get on the air at amazing low cost! Here's the complete station setup—absolutely tops for quality and dependability: Hallicrafters S-38 all-wave receiver (4 continuous bands, 540 kc to 32 mc); Hallicrafters HT-17 transmitter complete with coils for 80, 40, 20, 15 and 10 meters; good quality handkey; 2000 ohm double headset; Bliley 40-meter crystal; 2 antenna insulators; 200 ft. coil No. 14 antenna wire; ARRL station logbook; Amateur Radio Callbook. This equipment—and your Amateur License—is all you need to start your two-way radio contacts! **\$87.50**

SPECIAL AT ONLY.....

Terms: 17.50 down, 6.18 monthly for 12 months

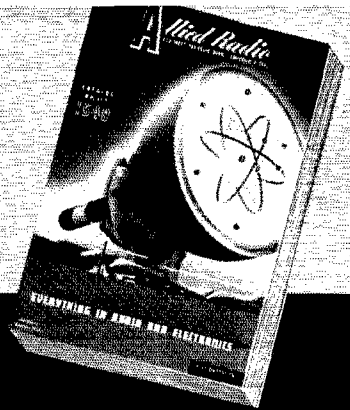

Send for the Leading Amateur Buying Guide

You'll find everything you want in receivers, transmitters, instruments, parts and station equipment in our up-to-the-minute 180-page Catalog. Get it today. And get every buying advantage at ALLIED—fast shipment, money-saving values, top-quality equipment, ideal easy-payment terms, square trade-in deals and down-to-earth help from ALLIED's old-time Hams. For full satisfaction, get and use the ALLIED Catalog!

HERE'S YOUR BEST BUY IN A HIGH-QUALITY WIRE OR TAPE RECORDER

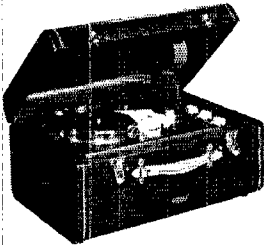

Knight Wire Recorder

Makes and plays high-quality wire recordings; plays any 10" or 12" 78 rpm disc recording; serves also as PA system or as wireless phono oscillator. Easy to operate. Ruggedly constructed. Complete in compact simulated leather case; with crystal hand mike, playback pick-

up, all tubes, and 2 half-hour spools of wire. For 105-125 v., 60 cy. A.C. Shpg. wt., 29 lbs. **\$99.50**

96-172. Only.....

Knight Tape Recorder

A top-grade taperecorder and playback unit at amazing low cost. May also be used as 6 watt PA system. Excellent frequency response. Easy to record; stable constant-speed mechanism. Exceptional playback quality. In sturdy portable case; with crystal handmike,

600 ft. reel of tape, take-up reel, and all tubes.

105-125 v., 60 cy. A.C. Shpg. wt., 36 lbs. **\$127.50**

96-187. Only.....

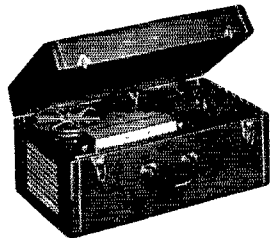

ALLIED RADIO

Everything for the Ham

FREE

ALLIED RADIO CORP., D. L. Warner, W918C
833 W. Jackson Blvd., Chicago 7, Ill., Dept. 15-F-9

Send FREE ALLIED Catalog

Enter order for.....

Enclosed \$..... Full Payment
 Part Payment (Bal. C.O.D.)

Name.....

Address.....

City..... Zone..... State.....



Beginners

HERE'S THE SHORTCUT TO THAT PERFECT FIST

Automatic Dots and Dashes With the Modern Key.

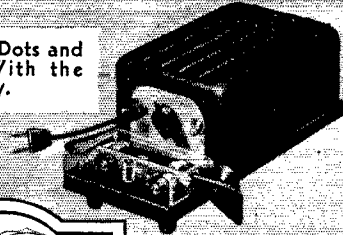

The MON-KEY is a favorite with beginners and veteran cw operators alike.

In a very short time, beginners send faster, smoother code with the MON-KEY. The MON-KEY is complete. There's nothing else to buy; it's key, code practice oscillator, monitor — all in one.

Other features include:

- Automatic dots and dashes
- Dashes equal to three dots in duration
- Speed approx. 8 to 45 words per minute
- No weights to adjust
- Monitor with volume control
- Operation 115 v AC or DC

ILLUSTRATED FOLDER ON REQUEST

Amateur Net, Only..... **\$29.95**

If your dealer can't supply you, send check for \$29.95 direct to us. Immediate shipment on Money Back Guarantee.

ELECTRIC EYE EQUIPMENT CO.

8 West Fairchild St., Danville, Ill.

EXPORT: Rocke International Corp.,
13 E 40th Street
New York 16, New York

EASY TO LEARN CODE

It is easy and pleasant to learn or increase speed the modern way — with an Instructograph Code Teacher. Excellent for the beginner or advanced student. A quick, practical and dependable method. Available tapes from beginner's alphabet to typical messages on all subjects. Speed ranges 5 to 40 WPM. Always ready, no QRM, beats having someone send to you.

ENDORSED BY THOUSANDS!

The Instructograph Code Teacher literally takes the place of an operator-instructor and enables anyone to learn and master code without further assistance. Thousands of successful operators have "acquired the code" with the Instructograph System. Write today for full particulars and convenient rental plans.



INSTRUCTOGRAPH COMPANY

4789 SHERIDAN ROAD, CHICAGO 40, ILLINOIS

vertical antenna. FQ holds down tri-weekly schedules with VE8s on 14-Mc. 'phone. HJ got his noise under control with 1N84 limiter. We think the LCARC Bulletin is by far the finest club bulletin we have seen to date. AK works 3.8-Mc. 'phone with the local net. FN is getting up his code speed on 7 Mc. AYL is on 14-Mc. 'phone. EE is the *Bulletin* editor. ET thinks about 3.8-Mc. 'phone again. EC got the n.f.m. going. IZ has low-power rig complete with VFO. FL is building small transmitters. GP is active in the Fundy Net on 3.8-Mc. 'phone. IE is pounding out an outstanding signal. XE has a new VHF-152. Traffic: VE1MK 89. HJ 88. FQ 15. DB 2.

ONTARIO DIVISION

ONTARIO — SCM, Thomas Hunter, jr., VE3CP — Asst. SCM, M. J. McMonagie, 3AWJ. SEC: KM. RMs: ATR, AWE, BUR, TM, WX. PAMs: DD, FQ, RG. IA leads in traffic this month. AWE again is active on 3.5 and 14 Mc., having finished his exams. VD now is a member of the A-1 Operators Club. BPE is active on Hamilton 7-Mc. emergency net and is looking for stations in the vicinity of Owen Sound, Collingwood, and Barrie. The new executives for the Frontier Radio Club include AVI, AHL, BQC, BUR, BZ, CP, FP, LA, WA, and ZO. BVC is a member of the RCC. BWK is hard after WAS on 7 Mc. OR is on 28-Mc. 'phone. BQT rebuilt for 50 Mc. BSX has his 28-Mc. rotary folded dipole working. ARF and LT are operating 28-Mc. mobile. The new CAROA executives include DJ, APS, MJ, ANO, BMG, RH, WX, 4AAZ, FQ, CP, YS, HP, RG, and ZE. BMG is president of the Hamilton Television Club. QE, BNQ, QU, ABP, and BQF enjoyed the last DX Contest. AQQ reports that the Chicago 50-Mc. gang have gone vertical. DS is working on 50 Mc. BTE worked her first ZS6. BQF has new modulator. CP is using a 4-250 with 700 watts on 3.8 and 14 Mc. ABP now has 76 countries. ZM is awaiting confirmation for his 100 countries. FT is modulating a 807 on 14 Mc. EAB is on 14-Mc. c.w. BOW is after traffic on 7 Mc. SG, a former SCM of Ontario, again is active from Cookville. BHS is QRL with the Air Force cadets. AWJ has taken up residence in Toronto. AKS, BHE, and BPB are active on 144 Mc. HK visited DD. ZO is working FB DX with an indoor antenna. Traffic: VE3IA 163, ATR 143, BUR 135, WY 87, APS 85, RG 80, KM 66, WK 63, AWE 56, NI 56, YJ 50, AZZ 43, BQL 36, DU 33, BMG 32, BMM 30, CP 29, AQB 28, AG 21, TM 20, AFL 19, DH 17, ADN 16, ASL 13, YS 12, DD 11, BPE 10, IL 10, VD 10, APM 9, AUJ 9, AZW 8, SG 8, AKJ 7, HK 5, VU 4, LO 3, FQ 2.

QUEBEC DIVISION

QUEBEC — SCM, Gordon A. Lynn, VE2GL — GAI reports increasing activity on both PQN and QEN. A total of 18 VE2s report into PQN. On the QEN, four stations are now battery-equipped for emergency operation. BB has A-1 Operator certificate. He continues traffic schedules as far as shift work allows. AAK is new in Montreal with 15 watts to 6F6 and is adding an 807. ACU is an old-timer with a new call and AHL is his son. They are on 7- and 3.5-Mc. c.w. exclusively and have had over 600 contacts during the past year running 80 watts to an 804. LO continues with PQN and reports AAF is new in Drummondville. EC sticks closely to 3812 kc. and 146.8 Mc. with the Quebec 'Phone Net. TR also is on 146.8 Mc. VE and VH have 144-Mc. mobile rigs. PV is very active with n.f.m. ZG appears to be the backbone of 144 Mc. in the St. Maurice Valley district, having converted ten 522a to 144 Mc. for the gang. It is suggested that those who are operating VFOs on 160 meters doubling to 80 check carefully for third harmonics of VFO falling in the 5250-6000-Mc. band to eliminate the possibility of interference on airline frequencies. Traffic: VE2BB 237, GM 119, XR 106, VA 51, LO 53, IG 40, EC 26, QR 7, SC 7, AGG 6, AEH 5.

VANALTA DIVISION

ALBERTA — SCM, Sydney T. Jones, VE6MJ — Final A plans for a real bang-up hamfest in Edmonton July 30th and 31st are about complete. Hotel reservations should be made well in advance. VX is busy building converter for 14 Mc. IK is running 100 watts to 809s. BX is assisting local prospective hams. NA and YD are building handy-talkie rigs for 50 Mc. VS has converters on 3.5 to 28 Mc. KC is operating portable on 3.8 Mc. PE reports exceptional DX on 28 Mc. late at night. The NARC annual banquet was a real successful affair as a result of well-laid plans by PV and his executive. HM and his XYL are visiting England. EH has returned from a business trip to the U.S.A. and reports seeing some FB rigs. The latest issue of Government QSLs now is available, thanks to LG. RU pounds brass on 7 Mc. and reports good results. The Calgary gang is doing an excellent job in AEC planning and drill under EG Rothwell. MJ worked two new countries. BG is constructing new antenna. EN, QC, and NR are active on 14-Mc. 'phone. WS gave an interesting talk on beams at the recent NARC meeting. EY has switched his affects to photography. Traffic: VE6NA 31, QC 18, MJ 8, LZ 1.

(Continued on page 106)

SUN RADIO'S

ANNUAL CLEARANCE!

HAM SPECIALS

BC 728—2 6MC PB RECVR.—6 tubes—4 PB preset to any frequency. Conversion instructions for BC band supplied. Speaker supplied. Used, but A-1.....**\$9.95**

AN/CPN-8 AUTOMATIC TRANSDUCER BEACON—contains the following units—Monitor scope unit, receiver coder unit, transmitter monitor, for 115v-60cy operation, units are mounted in 46" x 27" x 23" enclosed heavy steel cabinet, complete except less voltage control unit and less tubes.....**\$149.95**

SPERRY AMPLIFIER—with 4 tubes and many parts, with diagram new...**\$3.95**

VHF—NAVY CW TRANSMITTER—80-105 mc, battery operated, with 2—1G4 tubes and instruction manual, less battery.....**\$6.95**

BENDIX—100 watt transmitter, 4 ECO's, 4—12SK7's and 3—807's, with complete conversion instructions for operation on 10, 20, 40, 80 meters. New.....**\$39.95**
Used.....**\$29.95**

WALKIE-TALKIES—52-65 mc complete with spare parts, for portable or mobile use, NEW, per pair.....**\$115.00**

AM/26 INTERCOM AMPLIFIER—with 28v dynamotor, 2—12A6, 2—12J5 Tubes and instructions for conversion to HI-FI amplifier. New.....**\$4.95**

ANTENNAS: 420-450 mc ant. for BC 645.....**.99c**

4 section telescopic, opens to 3 feet...**.99c**

22" tapered for 150-200 mc with coax connector.....**\$2.69**

less coax connector.....**\$1.95**

PORTABLE AMPLIFYING MEGAPHONE, complete with carrying case, tripod, extra mike.....**\$29.95**

TUNING UNITS—from BC 375-TU 9B, TU 10B.....**\$1.95**

TRANSMITTER—RADAR—BC-1072A, 150-210 mc, was originally used with BC-1068A Rec. & BC 1073A Wavemeter, complete with tubes and 115v-60cy power supply.....**\$19.95**

MAGNETRONS—2J38.....**\$18.95**

CATHODE RAY TUBE—5BP4...**\$3.89**

CATHODE RAY TUBE—12GP7, directly interchangeable with 7JP4 for 12" picture.....**\$12.95**

3E 29-8 29 B TRANSMITTING TUBE.....**\$3.89**

Socket for above.....**.79c**

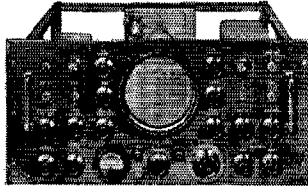

MONITOR SCOPE UNIT—TS-121/CPN8—ideal for building a high quality, Precision, laboratory 5" oscilloscope, contains 115v-60cy power supply, high voltage power supply, C.R. tube shield—condensers, resistors, controls, and almost everything else needed to make this conversion. **\$39.95** with conversion diagrams, less tubes...

CRYSTALS

All crystals have Army MC harmonic ratings but Sun encloses directions for deriving the correct fundamental frequency in kilocycles.

CRYSTALS WITH A MILLION USES

Fractions Omitted											
kc	kc	kc	kc	kc	kc	kc	kc	kc	kc	kc	kc
412	422	433	442	462	477	490	498	504	508	515	519
413	423	434	443	466	479	491	501	505	509	516	522
414	424	435	444	468	481	492	502	506	511	518	523
415	425	436	445	470	483	493	503	507	512		
416	426	437	446	472	484	494					
418	427	438	447	473	485	495					
419	429	440	448	474	487	496					
420	431	441	451	475	488	497					

49¢ each

Crystal Frequency Standards	For Crystal Controlled Signal Generators
98.356Kc	525Kc
Easily altered for 100kc Standard. Mounted in low loss 3 prong holder.	526.388 533.333 537.500
\$3.89 each	527.777 534.722 538.888
	529.166 536.111
	530.555 531.944
	99¢ each

I.F. Frequency Standards	200 KC CRYSTALS
450 461,111 99¢ each	Without Holders
451,388 464,815	2 1/2" x 2 1/2". Each 69¢
452,777 465,277	3 for \$2.00

Assorted Miscellaneous Crystals	For Ham and General Use
Fractions Omitted	Fractions Omitted
370kc 377kc 384kc 387kc	390kc 396kc 403kc 408kc
372 379 386 388	381 387 404 409
374 380	392 398 405 411
375 381	393 400 407
376 383	394 401
Each	395 402
priced at a fraction of the cost of their holders alone.	79¢ each

CRYSTALS FOR SCR 522	CRYSTALS FOR HAM USE	Crystals from BC 6 10 Spacing—2 Banana Plugs
5910kc 7480	Fit 243 Holder	2045 2305 3202 3550
6370 7580	1/2" Spacing	2105 2320 3215 3570
6450 7810	ea.	2125 2360 3237 3580
6610 7930	3735 KC... .69c	2145 2390 3259 3595
7350	4190 KC... .39c	2155 2415 3322 3955
\$1.29 each	5030 KC... .39c	2220 2435 3510 3995
	5485 KC... .39c	2258 2442 3520
		2260 2532
		2282 2545
		2300 2557
		Each

• Payments must accompany order. Enclose 20¢ for postage and handling. Minimum order—\$2.00 plus postage. Crystals are shipped packed in cloth bags inasmuch as they are shock mounted. All shipments guaranteed.

TERMS All Items F.O.B., Washington, D. C. All orders \$30.00 or less, cash with order. Above \$30.00, 25 per cent with order, balance C.O.D. Foreign orders cash with orders, plus exchange rate.

SUN RADIO
OF WASHINGTON, D. C.
938 F STREET, N. W. WASH. 4, D. C.

HAM SPECIALS

CATHODE RAY TUBE—2AP1.....**\$2.89**

ANTENNA RELAY UNIT—BC442A with R.F. Ammeter & Vacuum cond.....**\$2.89**

BC-746 TUNING UNIT—contains antenna & tank coils, tuning cond. ideal foundation for miniature transmitter—with 2 xtals.....**.99c**

with 2 xtals, 1 in 80 meter band...**\$1.29**
less xtals.....**.39c**

METERS:
Weston 2" rd. 500 micro-amp, with scale for 0-15/600v.....**\$2.97**

J.B.T. Reed Freq. Meter—56 to 64 cy.....**\$9.95**

Triplet—2" sq. 0-40 v. DC METER.....**\$2.97**

Sun 2" rd. 0-300 V DC.....**\$2.97**

Westinghouse 3" sq. 0-150 V AC.....**\$3.49**

Simpson—2" rd. 0-15 V DC.....**\$2.97**

Simpson—Foundation meter for I-177 mutual conductance tube tester—Calibrated in Micromhos, with diagram.....**\$3.49**

Weston—2 range ohmmeter, new with case, 0-10/1000 ohms.....**\$14.97**

HEADPHONES:
HB-4—High-impedance with PL55 plug.....**\$2.49**

P-20 High-impedance with phone tips.....**\$3.99**

ALUMINUM RODS—36" by 3/4" Diam. for constructing antennas, 10 for...**\$1.99**

BC-1073A—WAVEMETER—150-210 mc, contains cavity wavemeter, 115v-60 cy. Power Supply, less tubes....**\$12.95**

BC-1298—INTERCONNECTOR UNIT—same as above less cavity with 115v-60cy Power Supply, less tubes....**\$7.95**

.005—2500 W.V. MICA CONDENSERS.....49c ea.....3 for...**\$1.25**

G.I. PORTABLE WINDUP PHONOGRAPH, heavy duty case, Adj. speed, heavy duty motor, New, Original Gov't. cost \$67.90.....**\$9.95**

HANDSET TS-13—Brand New...**\$3.95**

JACKS for handset plugs, PL-68...**30c**
PL-55...**30c**

MICROPHONE T-17, new.....**\$1.29**

PRAIRIE DIVISION

MANITOBA — SCM, A. W. Morley, VE4AM — Congrats to DU on the birth of a daughter. DP joined the ranks of the benedicts and is leaving for VE7 Land. EG followed suit and spent his honeymoon in VE7 Land. YW is next. The WARC reflected TJ, pres.; LC, treas.; and L. Young, secy. New vice-president is G. Williams. Several new-comers are heard. Please drop me a line, fellows. Among them are OS, in Carman, who runs 100 watts on 7 Mc., and IA, in St. Vital with crystal oscillator to a 6L6 and uses a converter 1155 for receiver on 7 Mc. FD, in Transcona, is using an 807 to a dipole and an RME-84. GI is moving to VE5 Land. LF joined the Manitoba 'Phone Net on 3775 kc. LS, in Miami, has beam up and is working DX, but brother HS prefers to stay on 3.5 and 3.8 Mc. LC has VFO and has extended his OBS to cover 27 Mc. XO is settled in new QTH. Ray Carlson, who became interested in amateur radio while on a course with the Army through VE3BON, has applied for a call and will sign VE4 from Shilo. QC has 814 running on 3.5 and 7 Mc. after a tough spell with parasitics. TM is building new receiver. EN has left Rivers. The ARRL Field Day will be held shortly after you read this. How about getting on during the Test and getting Manitoba represented for a change? Traffic: VE4AM 52, JO 18, GY 14, DN 3.

SASKATCHEWAN — SCM, J. H. Goodridge, VE5DW — GC worked Japan at about 5 o'clock in the morning on 3.8-Mc. 'phone. MA is active on 3.8-Mc. 'phone. AB now has 28-Mc. Hammond beam and works DX. AW has new 125-watt bandswitching rig and worked 7HJ, ex-5AX. IC, PA, and VB make plans for portable-mobile. Let's hear more of this. FY dismantled mobile job and is constructing another with bandswitching. KJ is on "TL" "I" and cleared traffic from the East Coast direct. HR reports the c.w. net is coming along fine indicating a bang-up season beginning next fall. If interested, contact HR. JV now has 98 countries. OC is working DX on 28-Mc. c.w. and 'phone. RV returned to the air at Cudworth after four months of silence and reports he is being heard in the telephones. RA, now in the USAF, was home on leave. The Saskatchewan 'Phone Net has 20 registered members. HR hopes to run 300 watts next fall. 6PP plans to make a journey by boat along the North Saskatchewan River from Edmonton to Prince Albert during July using mobile equipment. Listen for him. There will be special QSL cards for the occasion. VB works 7XV, ex-5XU, frequently on 14-Mc. 'phone at noon. Traffic: VE5HR 36, KJ 23.

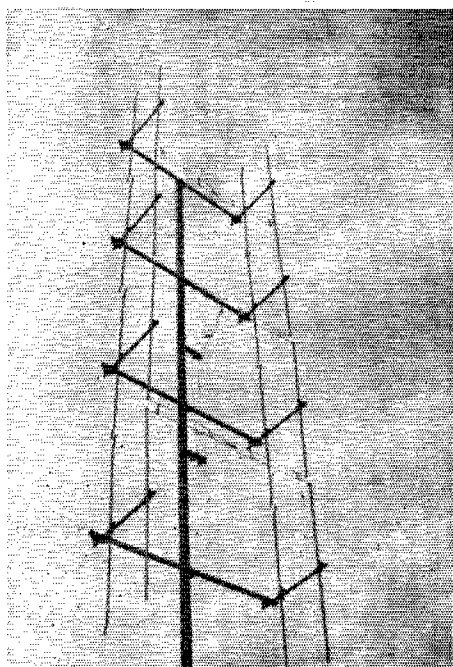

16 Element 2-meter Beam

Vertical and horizontal 16 and 32 element beams; 16 el: 10 lbs., \$35.00, power gain 40 over dipole; 32 el: power gain up to 127 over dipole.

Also, wide spaced 3, 4, 5, and 8 el, ten meter beams, wide spaced 20 meter beams.

FM and TV beams, 8 to 32 el.

Send for folders

U.H.F. RESONATOR CO.

Guion Road Rye, New York
W2BAV, W. F. Hoisington

BOOK REVIEW

Basic Mathematics for Radio, by George F. Maedel. Published 1948 by Prentice-Hall, Inc., New York, N. Y. 339 pages + viii pages. 203 figures. 6 × 9½ inches. Price \$4.75.

The book covers the following topics, which the author states are necessary for the technician to be able to understand the radio textbooks and literature necessary to improve his knowledge and keep him abreast of his subject: solution of algebraic equations; rules of variation; geometric representation of machine elements and assemblies and the characteristics of electrical circuits; trigonometric functions of sine, cosine and tangent; solutions of the right triangle; use of tables of functions; use of slide rule and logarithms; complex-number notation.

The beginner will find that the questions which naturally arise are deftly anticipated and answered in the text. There are many illustrative examples with adequate instructions. Mathematical proofs are present only where absolutely necessary; the author feels that some proofs are not essential to practical application of mathematics in radio and electricity and has omitted them. The written material is easier to follow and less formal in style than in the usual mathematics book. While the text is kept practical by basic problems in electricity and radio, additional problems of this sort would enhance the text from the aspect of interest as well as learning. About three-fourths of the problems given are pure mathematics and the remainder deal with radio and electricity, a general working knowledge of which is presupposed. A list or partial listing of answers in the back of the book to the problems would be helpful.

This book would make a good guide for study by a group of amateurs under the guidance of one versed in mathematics allied to radio. — John Merrill, W1CGS, Radio Engineering & Maintenance School, U. S. Coast Guard Training Station, Groton, Conn.

CODE SENDING SPEED CODE RECEIVING SPEED

HAVE SKILL, ACCURACY

SEND and RECEIVE CODE this EASY — FASTER WAY! The CANDLER SYSTEM has developed expert Amateur and Commercial Operators, and Code Speed Champions. In a few weeks you can pass the code examination for license. You can send and receive with amazing skill and speed, without tension. Long hours of practice unnecessary to acquire proficiency. The WAY YOU

LEARN is ALL IMPORTANT! By simple progressive lessons Candler teaches you at home to send and receive as easily as you talk or read — FAST, ACCURATELY. SEND Now For FREE BOOK — explains how fine amateurs and radio-telegraph experts learned code and developed skill and speed.

CANDLER SYSTEM CO.

Dept. 4-G, P. O. Box 928, Denver 1, Colo., U. S. A.
and at 121 Kingsway, London, W. C. 2, England

Our 26th Year



QUALITY - PRICE
DEPENDABILITY

**ITEMS YOU MAY BE
LOOKING FOR**

Multiple Contact Telephone Type Relay
No. A2-2—
Windings 125 ohms. Each \$.49
No. A1—
Single winding 12,500 ohms..... .49
Heineman 5 amp. circuit breaker..... .95
Crystal Mike and Stand 5.50
Sockets for 813, 82973
1/4 watt Neons bayonet base20
Sockets for 83249

GREENLEE PUNCHES—

Cuts to 1/8" thick metal.
1/2" \$1.94
3/8" \$1.94
5/8" \$2.12
1" \$2.25
1 1/8" \$2.25
1-3/16" \$2.88
1 1/2" \$2.88
We carry a complete line of all sizes of punches up to 3 1/2" diameter.

ALUMINUM CHASSIS—

Heavy Duty
7 x 7 x 2 94c
7 x 9 x 2 \$1.06
5 x 10 x 3 \$1.00
7 x 11 x 2 \$1.15
7 x 13 x 2 \$1.23
10 x 17 x 3 \$1.88

**SCOPE & TELEVISION
TRANSFORMERS & CHOKES**

2500V. RMS @ 5 Ma D.C.—6.3V. @ 3 amps
tapped at 2.5V. @ 3 amps; 2.5V. @ 2 amps;
Type P-3171 \$6.76
1700V. RMS @ 2 Ma D.C.—6.3V. @ 9 amps
tapped at 2.5V. @ 2 amps; 2.5V. @ 2 amps;
Type P-3170 \$5.14
2 Hys @ 250 Ma D.C. 50 ohms \$1.62
type C-2991
2 Hys @ 200 Ma D.C. 50 ohms \$1.92
type C-2974

VERTICAL BLOCKING OSC. turns ratio pri.
to sec. 1:4.2
Unshielded type A-3000 \$1.18
Shielded type A-4000 1.62
HORIZONTAL BLOCKING OSC. turns ratio
pri. to sec. 2:1
Unshielded type A-3002 \$1.32
Shielded type A-4002 1.76
VERTICAL OUTPUT turns ratio pri. to
sec. 10:1 \$3.09
Unshielded. type A-3035

FILAMENT TRANSFORMERS

Type 940 2.5VCT @ 10 Amps. 7500V Ins \$2.79
Type 040 5. VCT @ 3 Amps. 2500V Ins \$2.06
Type 941 5. VCT @ 6 Amps. 2500V Ins \$3.38
Type 943 5. VCT @ 20 Amps. 2500V Ins \$5.29
Type 946 6.3VCT @ 3 Amps. 2500V Ins \$1.91
Type 947 6.3VCT @ 6 Amps. 2500V Ins \$2.79
Type 948 6.3VCT @ 10 Amps. 2500V Ins \$3.67
Type 960 7.5VCT @ 4 Amps. 2500V Ins \$2.35
Type 143 7.5VCT @ 8 Amps. 2500V Ins \$4.12
Type 146 10 VCT @ 10 Amps. 3000V Ins \$4.99
Type 961 Dual 6.3VCT @ 3 Amps 2500V Ins \$3.38
Type 041 5VCT @ 3 Amps. 2500V Ins \$3.38
6.3VCT @ 3.6 Amps.

SUPERIOR POWERSTATS



Smooth, efficient voltage control. 0 to 135V.
output from 115V. AC line.
Type 20 (illustrated 3 amps) \$12.50
116 for table mtg 7.5 amps 23.00
116U for panel mtg 7.5 amps 19.00
1126 15 amps 46.00
1156 45 amps 118.00
Also available for 230 volt input. Write
for descriptive literature.

**GENERAL ELECTRIC
PYRANOL CONDENSER**

1 Mfd 15000 V.D.C. Brand New. Ship-
ping Weight 35 lbs. \$10.95
A Terrific Value

BIAS TRANSFORMER TYPE KS8779

Completely shielded, Insulator Ter-
minals. Primary: 115 Volts 60 cycle
@ 500 Ma.
Secondaries:
180 V. @ 20 Ma. Special
300 V. @ 20 Ma. \$1.95
6.3 V. @ 1.2 amps.
5.1 V. @ 7 amps. C.T.



SELSYN MOTORS

115 V.A.C. 60 cycle #C-78248.
Can be used to turn small an-
tennas or as indicators. Size
3 1/2" x 5 1/2".
Price per pair \$6.95

STEEL CHASSIS 16 GAUGE

4 x 17 x 3 Black Crackle \$1.17
4 x 17 x 3 Cadmium 1.44
4 x 14 x 3 Black Crackle 1.94
10 x 17 x 3 Black Crackle 2.35
13 x 17 x 3 Black Crackle 2.70
13 x 17 x 4 Black Crackle 2.70
Complete stock of steel & alumi-
num chassis & panels on hand.

**GRID DIP METER
LYSCO "DIPMETER"**



3 Mc to 150 Mc frequency
range; calibrated dial. Ideal
for Signal generator, 3.4
to 300 Mc range phone
monitor, F.S. meter, or ab-
sorption wavemeter. Com-
plete power supply and
tubes. Really a \$33.50
good buy at

CONVERTERS

Mobile or Fixed. RF Gain control. Sim-
ple installation. Size 2" x 6" x 5".
Model 210—
27 to 30 Mc-10 meters \$25.50
Model 202—
144 to 148 Mc-2 meters 25.50
3 tubes for converter 3.49

TRANSMITTERS

Mobile or Emergency, 8 watt output
crystal control, push to talk. Power re-
quirements 6.3V. at 2 Amp; 350V. at
110 Ma. without dynamotor.
Model 129—
27 to 29.7 Mc (10 meters) \$23.95
Model 175—
3750 to 4000 Kc (75 meters) 23.95
3 tubes for transmitter 4.98
Noise Limiter—Model NXL—adjustable
threshold control. Power 6.3V—150 Ma.
100V. 6Ma. D.C. \$4.50
6AL5 tube 1.11

ISOLATION TRANSFORMERS

All 117 Volts to 117 Volts 60 Cy.
P-96, 40 watts \$3.60 P-98, 100 watts \$9.30
P-97, 80 watts \$5.10 P-99, 250 watts \$17.70

RELAYS CS DIFFERENTIAL

Dual coil with armature pivoted normally open. Oper-
ates 220-250 Volts. > 8000 ohms each coil, contacts
S.P.D.T. Controls rated 2 amps. at 110
VAC. Ideally suited for balanced or
bridge type circuits where limited
current or power is available 88c



**OIL FILLED
CONDENSERS**

1.78 Mfd 200 V.A.C. \$.29
1 Mfd 600 V.D.C.29
2 Mfd 600 V.D.C.39
7.5 Mfd 330 V.A.C.98
10 Mfd 330 V.A.C. 1.23
2 Mfd 1000 V.D.C.59
HEAVY
.25 Mfd 6000 V.D.C. 1.69
1 Mfd 5000 V.D.C. 2.95
1 Mfd 15000 V.D.C. 10.95

TRANSFORMER SPECIAL

870 volt CT @ 250Ma with 80V bias tap
5 volts @ 3 amps
2 1/2 volts CT @ 10 amps
2 1/2 volts @ 3 amps
6.3 volts @ 1.5 amps
115V. 60 cycle primary
\$5.88

RAYTHEON VOLTAGE STABILIZERS

Positive Stabilization $\pm 1/2\%$
Input 95-130 volts, 60 cycles single phase; out-
put 115 volts stabilized to $\pm 1/2\%$. *Output 6.0 or
7.5 volts stabilized $\pm 1/2\%$.



Catalog No.	Cap. wgt. Watts lbs.	Net Price
VR-6110	15 4	\$15.00
VR-6101*	30 5	\$17.00
VR-6111	30 5	\$24.00
VR-6112	60 8	\$31.00
VR-6113	120 14	\$48.00
VR-6114	250 25	\$75.00
VR-6115	500 45	\$125.00
VR-6116	1000 92	\$215.00

If not rated 25% with order, balance C.O.D. All prices
F.O.B. our warehouse New York. No order under \$2.00
We ship to any part of the globe.

LEEDS RADIO CO.

75 Vesey Street Dept. QS 6
Cortlandt 7-2612 New York City 7

RADAR, COMMUNICATIONS and SONAR TECHNICIANS WANTED

For Overseas Assignments

Technical Qualifications:

1. At least 3 years' practical experience in installation and maintenance.
2. Navy veterans ETM 1/c or higher.
3. Army veterans TECH/SGT or higher.

Personal Qualifications:

1. Age, over 22—must pass physical examination.
2. Ability to assume responsibility.
3. Must stand thorough character investigation.
4. Willing to go overseas for 1 year.

Base pay, bonus, living allowance, vacation add up to \$7,000.00 per year. Permanent connection with company possible.

Apply by Writing to
C-3, P.O. Box 3552
Philadelphia 22, Pa.

Men qualified in RADAR, COMMUNICATIONS or SONAR give complete history. Interviews will be arranged for successful applicants.

What! No Antenna?

(Continued from page 17)

Conclusions

Although the sample is small, it still seems valid to draw several conclusions from the different indoor antennas just described. It is apparent that you don't require anything approaching an ideal location for satisfactory low-frequency results with an indoor antenna. Far more important are a little ingenuity and some time to prune the antenna. Because the entire system is indoors, it is not difficult to adjust the antenna length until the system is exactly resonant or provides a good match for your feedline (if you use one). This careful adjustment pays off in results.

So, if you're a one-band man because you "don't have room for an antenna" — forget it! Look over the antennas in this article, then put up your own "improved" version, and meet an entirely new gang of fellows and conditions on some of our other bands.

— B.G.

Teletype Reception

(Continued from page 24)

clips the peaks as shown in Fig. 3. When the carrier is "on," the limiter operates and the locally-generated noise of the blocking oscillator is squelched. The carrier "on" condition thus becomes the teletype "space" position. The carrier "off" condition permits the blocking oscillator and any received noise to make the "mark" signal.

The system will operate successfully until the signal drops below the level of limiting or until local noise becomes so continuous that it keeps the receiver squelched all the time. The random nature of most received noise makes this an extremely unlikely occurrence.

Multiple-Circuit Tuner

(Continued from page 28)

harmonics. A rectifier-type wavemeter using a 200- μ a. meter as the indicator was link-coupled to the antenna coupler for this test.

Miscellaneous Data

The amplifier-antenna coupler has been laboratory tested while coupled to loads of 75, 500, 2400 and 6000 ohms impedance. Series tuning was used for the 75-ohm load at 3.5 and 7 Mc. Parallel tuning was used on all six bands when working with the three loads of higher impedance. In order to give the antenna coupler a reasonable test, the dummy loads were shunted with both capacitance and inductance to simulate the effects of capacitive and inductive reactance that would be present with a feeder system having a fairly high standing-wave ratio. The coupler passed the test with flying colors — with

(Continued on page 110)

LEARN CODE!

SPEED UP Your RECEIVING
with

G-C Automatic Sender

Type S—\$24.00 Postpaid in U. S. A.

Housed in Aluminum Case. Black Instrument Finished. Small—Compact—Quiet induction type motor. 110 Volts—60 Cycle A.C.

Adjustable speed control, maintains constant speed at any Setting. Complete with ten rolls of double perforated tape. A wide variety of other practice tapes available at 50c per roll.

GARDINER & COMPANY

STRATFORD

NEW JERSEY



ELECTRONIC WHOLESALERS IS
WASHINGTON, D. C. HEADQUARTERS FOR

Hallicrafters



Hallicrafters SX42 and
S40A always in stock!

Hallicrafters S-38
NOW ONLY

39.95

Hallicrafters model S-38 has four wave bands, continuous frequency range from 540 kc. to 32 mc. Precision quality, long range exciting performance. In addition to splendid regular broadcast reception and police calls you can listen in on all sorts of land, sea, and air communications from the most distant points of the globe. The whole world's your neighbor! Now, a new low in price!

Hallicrafters T-64 Chassis

169.95

COMPLETE, LESS
PICTURE TUBE

Bracket for 12" tube \$8.50 extra

A factory-built chassis for 10 or 12-inch tube, at a price no more than you would pay for a regular 7-inch set. Completely wired and tested. It has Hallicrafters new larger picture—56 sq. inches on 10-inch tube—plus new exclusive DUAL-FOCUS switch; one position gives completely linear 56 sq. in. picture; the other big 64 sq. in. telescopic view for dramatic closeups. 19 TUBES, 3 RECTIFIERS (CR tube not included)

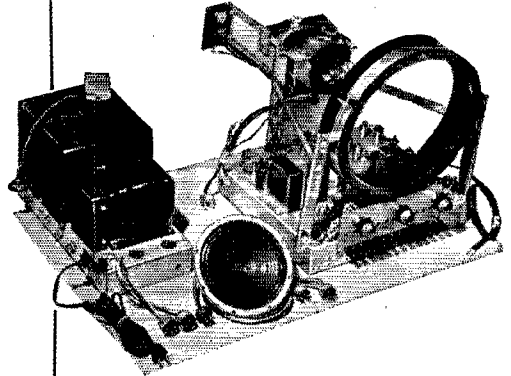

★ ALL MAJOR RECEIVERS AND XMTR. LINES
ALWAYS IN STOCK

★ Washington's Big Radio Parts Distributor Has All The
Greatest Names In Radio!

★ Products of all National Manufacturers in stock — 25%
deposit on C.O.D. orders, F.O.B. Washington, D. C.

ANNOUNCEMENT!

With pride we announce that
Harry A. Wise is now con-
nected with our firm.

Electronic *wholesalers, inc.*

2010 14th STREET, N. W. • WASHINGTON 9, D. C.

DEcatur 9041

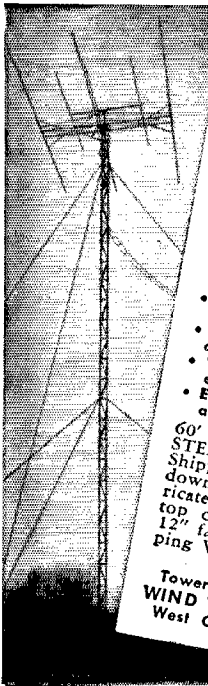

TRYLON TOWERS FOR AMATEURS

Buy only the genuine, lightweight TRYLON Steel Ladder Towers. Easily adapted to Amateur use, they employ the same basic design of the famous TRYLON Vertical Radiators. Look for these features:

- Designed and engineered for 100 mph winds.
- All steel parts hot dip galvanized after fabrication to rigid Army and Navy specifications.
- Easy-to-climb ladder on all towers.
- Prefabricated guys with factory assembled compression sleeves.
- "PALNUTS" supplied with each and every bolt.
- Easy to install on small ground area.

60' TYPE 1245 TRYLON STEEL LADDER TOWER. Shipped completely knocked down with 2 sets of 3 prefabricated guys, 3 earth anchors, top castings and top plate. 12" face size. Approx. Shipping Wt., 420 lbs.

Wire, write or call Tower and Antenna Division
WIND TURBINE COMPANY
West Chester, Pennsylvania

TRYLON LADDER TOWERS

MM-2 MODULATION MONITOR



3" x 5" x 10"

ADD SIGHT TO YOUR SOUND . . .

with this basic oscilloscope featuring calibrated modulation percentage scale, linear 60 cy sweep with return trace blanking, trace intensifier window, complete controls, reversible panel, rack mounting provisions and many other outstanding features. See the MM-2 at your dealer or write Dept. 6-9.

ONLY \$24.95

COMPLETE WITH THIS REVERSIBLE PANEL-CALIBRATED TRACE INTENSIFIER WINDOW INSTRUCTION BOOK

LAMBDA ELECTRONICS CORP.
BOX No. 55 CORONA, N.Y.

one exception. If the reactance was *highly* capacitive at 28 Mc., it could not be completely compensated for by the tuner and the final-amplifier tank circuit was affected to the point where it would not tune the entire 28-Mc. band. Just as an experiment we removed a turn from each of the plate coils, L_6 and L_7 , to see if the band could be covered under the above conditions. This did allow the full band to be covered, but we can't say that the stunt should be duplicated because the mismatch between coupler and feeders certainly is not corrected by operating on the final amplifier!

Several hours of operation will convince most operators that multiple-circuit tuners provide one of the neatest and most rapid methods of getting from band to band. But, like nearly everything else, the system isn't foolproof. One *must* remember that the tuners will resonate at frequencies *in between* the amateur bands. Get the idea? Well, be sure and keep it in mind for although the tuners won't mind being tuned to an out-of-the-band harmonic, the FCC might not like it. Come to think about it, we're going to *color code* our tuning controls in terms of ham bands right away.

50 Mc.

(Continued from page 40)

points keep him in mind when conditions are good.

Hamilton, Calif. — Participating in the 2-meter mileage contest of the V.H.F. Institute of New York, April 23rd and 24th, W6ZOE (Hamilton Field Radio Club station, operated by Jack Drummond, W6YHI) worked 47 different stations, for a total of 2368 miles. Average distance was 50.3 miles, and the greatest was 198 miles, to W6IFE, Reedley, Cal.

Brockton, Mass. — Whether it was aurora, the eclipse, or an overrunning warm air mass, a number of W2s were coming in nicely at W1JMU on the night of the 12th. Notable was W2NGA, who was seeing what he could do with low power that night. With 5 watts input to his 829 final he was solidly readable, at S3, for some time. The distance is about 175 miles.

Council Bluffs, Iowa — The Council Bluffs Radio Operators Club will have 144-Mc. equipment in this year's Field Day activities, with W0CCY providing 4-channel operation on 144.1, 144.9, 146 and 147.96 Mc. with two 522s, which are also available for emergency use or hidden-transmitter hunts. A hunt is scheduled for the summer hamfest on July 17th, and another for the Midwest Division ARRL Convention, to be held at Omaha, Neb., Oct. 8th and 9th. W0CCY is now using vertical polarization on 2, to facilitate work with mobile stations. His antenna system is two 5-element arrays mounted side by side, a half wave apart.

Doings on 220 and 420 Mc.

Burton, Ohio — With a new home just about ready for occupancy, and a 100-foot steel tower

(Continued on page 118)

YOUR DOLLAR IS WORTH MORE AT WRL!

Deal With "The World's Most Personalized Radio Supply House"

SPECIALS

WRITE FOR OUR BIG LIST OF SPECIALS!
 New 5.3 — 7 MC Arc 5 (BC458A) XMTR. 6.95
 New BC-456 Modulator (for phone) 2.95

OIL FILLED CONDENSERS

1MFD — 1500V — 49c	1MFD — 5000V — 2.95
.5 — 2000V — 95c	1MFD — 2000V — 1.55
.25 — 2500V — 95c	2 x 1MFD — 3000V — 3.95
4MFD — 600V — 59c	8MFD — 1500V — 1.95

TRANSFORMERS

Completely Shielded

6.3 @ 6 amp. 2.49 6.3 @ 3 amp. 1.75
 24V @ 10 amp. 4.95

TRANSMITTING TUBES

All TUBES Listed Below Brand New In Cartons

810 — 6.95	815 — 2.95	872A — 1.95
VT-127A — 2.95	807 — 1.35	1625 — 59c
805 — 4.95	829 — 3.95	1626 — 59c
809 — 1.50	832 — 3.95	1/4 WATT NEON 12c

(with leads)

WRL BEAM TUBING

Comes in 12' Lengths

Seamless ALUMINUM 24 St. Tubing

1" O.D. — 3.90	7/8" O.D. — 3.57	3/4" O.D. — 3.29
5/8" O.D. — 2.98	1/2" O.D. — 2.40	3/8" O.D. — 1.62

Above tubing will telescope into the next size

NEW GUARANTEED CRYSTALS

Save up to 75% In FT-234 Holders — you name the frequency — we will hit it or come darn close!

FREQUENCY RANGES

3500 to 4000 KC - 79c ea.	14.0 to 14.4 MC - 1.19 ea.
6700 to 7500 KC - 79c ea.	27.185-27 1.95 ea.
12.514 to 13.1 MC - 1.19 ea.	28-29.7 1.95 ea.

New 160 Meter Crystals in FT-243 Holders.

All Frequencies 98c each

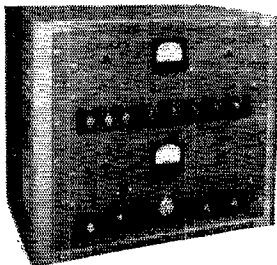

NBFM MODEL
\$199.00

Everyone is talking about the WRL GLOBE CHAMPION

RF Section a complete 150 Watt XMTR — Provisions for ECO — Automatic Bias on Final and Buffer — Full 100% Class B Modulator — 150 Watt input from 10 thru 80 meter band — complete with tubes and meters including 1 set of coils — specially crated for safe shipment.

KIT FORM
\$279.00

WIRED
\$299.00

WRITE—WIRE
PHONE 7795



LEO I. MEYERSON WØGFQ
CU ON 10-20 & 75 METERS



GIANT RADIO REFERENCE MAP

Just right for your control room wall. Approximately 28"x42". Contains time zones, amateur zones, leading short-wave stations, monitoring stations. Mail Coupon Today and **25c**

FREE

The most complete Ham Catalog ever assembled. Send for your copy today!



FAST SERVICE ON FOREIGN ORDERS

WORLD RADIO LABORATORIES
744 West Broadway
Council Bluffs, Iowa

Q-6

Please send me:
 Radio Map
 New Catalog

List of Used Equipment.
 Send "Globe Champion" information

Name
 Address
 City State

World Radio LABORATORIES INCORPORATED
 EVERYTHING IN RADIO
 COUNCIL BLUFFS, IOWA

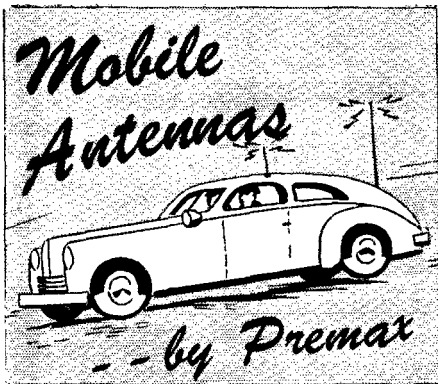

For your mobile rig, use a Premax "whip type" Antenna if you want strong signals at all times. In cadmium-plated or stainless steel, with mountings to fit every job.

Also telescoping tubular antennas up to 35' for field or station use.

SEND FOR BULLETIN

PREMAX PRODUCTS
DIVISION CHISHOLM-RYDER CO., INC.
4904 Highland Ave., Niagara Falls, N. Y.

ATTENTION MOBILE HAMS

Complete mobile package — nothing else to buy. Outstanding mobile signals use motorola equipment — backed by years of communication equipment experience — world's largest producer of 2-way mobile equipment.

A mobile transmitter with a double feature FM or AM at a flip of the switch, the MOTOROLA FMT-30-DMS (27-30 MC.)... **\$130.00**

MOTOROLA P-69-13-ARS receiver with special noise limiter for use with any converter having 1500-3000 KC. **\$60.00**

P-7253 spring base rear — mount antenna. **\$22.50**

3-30 famous Gon-set converter complete to connect to the P-69-13-ARS receiver... **\$39.95**

P-327-F Fire wall loud speaker... **\$5.00**

The above comes complete with all necessary accessories and mounting hardware. Order direct or through the Motorola National Service Organization member in your area.

For further information write to:

MOTOROLA INC.

Amateur Sales Dept. QST-JUN

1327 W. Washington Blvd. Chicago 7, Illinois

Attention: Harry Harrison W9LX
Telephone—Taylor 9-2200 Ext. 161

just about ready for antennas, W8UKS is getting set to go places on 220 Mc., as well as 144 this summer. Knowing something of Sam's past efforts in the antenna line, we have little doubt that something colossal will be appearing above the Burton horizon before long.

London, England — A group of amateurs in the Suburban London area works out on 420 Mc. each Wednesday, beginning at 1930 GCT, according to information received from G3AHB. Those usually active include 5PY, 2WS, 3CU, 2FKZ, 4CG, 2RD, 6HD and 3AIB. A similar group operates in Birmingham and the Midlands, and the two coordinate their activities, just in case conditions should permit the spanning of the 150 miles between them. From results obtained on 145 Mc. in England, we'd say that this is not being overoptimistic. Vertical polarization has been used, but they expect to change to horizontal, as TV and other services in England are vertically polarized. G3AHB cautions anyone working with coaxial-line-fed arrays not to omit the bazooka line balancer between the line and antenna. In a check with G2FKZ over a 15-mile path, installation of the bazooka was found to improve signals by several S units.

Woodhaven, N. Y. — A junk-box wavemeter for the 420-Mc. band is suggested by W2MWB. Wes uses a 100- μ fd. variable, a piece of Twin-Lead, and a 60-ma. pilot lamp and socket, bayonet-base type, to make up a low-cost wavemeter. The Twin-Lead is 11½ inches long, with ¼ inch cleaned of its insulation for soldering to the condenser terminals. A short is soldered across the other end. The center lug of the pilot-lamp socket is soldered to the other stator terminal and the other socket terminal is left floating. The condenser should be mounted on a piece of insulating material. Its tuning range will just about cover the 420-Mc. band. Queens County 420-Mc. activity now includes W2s EK, DKH, MWB and KDB. Polarization is vertical.

How's DX?

(Continued from page 49)

What price DXCC or, go away, mother, you bother me, seems to be the hue and cry. Stuff he's been hearing lately has Bob thinking, at long last, in terms of remotely-controlled rotaries. . . . MI3LZ (W4FGJ) tells W0BNU that the use of 16 and M16 prefixes for Fritrea has been discontinued. Seven MI3s and one MD3 are currently licensed. . . . Stealing some of W1DX's thunder, we hear that VR5PL is contemplating a session with single-sideband soon. Noel is presently employing c.w. and a bit of n.f.m. . . . MD2AC (W4LQQ) is giving 20 a big play lately. Milt's set-up includes a BC-460D rig, a 3-element wide-spaced beam plus SX-28 and Super-Pro receivers. Gosh, the fancy equipment some of the modern rare-DX gang show up with is a far cry from the old days when bloopers and Hartleys were the rule.

Lots of action on the QSL front. The following gents announce they'll positively put out the

(Continued on page 114)

**PUT YOURSELF
IN THIS
PICTURE!**

**WITH A
SUBRACO MT-15X**



Mobile Transmitter

Here's your best mobile transmitter! Compact size (only 4 1/2" x 5 1/2" x 6 1/2" deep) permits mounting in glove compartment or under dash - for finger-tip tuning, metering, and QSY'ing - while you drive. Built-in relay for complete PUSH-TO-TALK control. Stable, crystal controlled oscillator. 2E26 RF amplifier (not a doubler!) can be loaded to 30 watts input, with high output efficiency. Covers 10 and 11 meter bands. Class B Audio for 100% modulation and real battery economy. Ultra-modern in appearance, too! Chrome embossed panel - indirect meter illumination - dark green, slide-in cabinet. (And with an AC pack, it makes an FB fixed station or portable rig!)

Complete \$87.50

(Less tubes and connectors - \$79.95)

SUBRACO POWER SUPPLY



Designed expressly to operate the MT-15X at maximum power. Incorporates quiet, dependable, conservatively rated dynamotor, heavy duty starting relay, HV cut-off relay (for clean, crisp, break-in), ungrounded receiver control contact, hash and ripple filter, etc. Makes a complete push-to-talk station. Input 5.6 Volts DC, Output 400 Volts at 175 MA, 4 3/4" wide (plus 3/8" mounting flange) x 7" x 7" high. Cat. DS-400 \$59.95

grounded receiver control contact, hash and ripple filter, etc. Makes a complete push-to-talk station. Input 5.6 Volts DC, Output 400 Volts at 175 MA, 4 3/4" wide (plus 3/8" mounting flange) x 7" x 7" high. Cat. DS-400 \$59.95

GONSET CONVERTERS

Make any car radio a hot, dual conversion, super-hot! Compact - fit in glove compartment. Latest model 10-11 bandspread converter \$39.95
New "3-30" features continuous tuning from 3 to 30 MC. Vernier dial. \$39.95
Gonset Noise Clipper (easy to install) \$8.25

Premax Mobile Antennas

96" Stainless Steel Police Type Whip AS-196 \$3.53
Type "R" Universal Mount (split ball) \$7.35
Type "NA" Bumper Mount (rugged-economical) \$3.53
Type "SA" Spring Adapter (Use with any mount) \$7.04



**Make your call of
the open road a "CQ"!
Double your vacation pleasure - make
new friends wherever you go!**

Roll away from TV!!

You don't know what a kick you're missing until you join the mobile gang. And the YL's (or the XYL) will "go" for it in a big way, too!

All this, and more, can be yours with a good, dependable installation like this performance-proven Subraco-Gonset combination. Order yours today and get in the fun. Immediate delivery.

COMPLETE MOBILE PACKAGE

The WORLD'S FINEST MOBILE STATION, featuring a custom collection of the best in amateur mobile gear available, including -

- SUBRACO MT-15X, 10-11 meter transmitter and DS-400 dynamotor power supply.
- GONSET 10-11 meter converter and noise clipper.
- PREMEX police type, stainless steel whip with universal "R" mount for easy attachment anywhere. (in many cases without holes in car body).
- Push-to-talk microphone.
- BLILEY crystal and all tubes.
- Coaxial cable, connectors, and power cabling.

Nothing more to buy - EVERYTHING IS FURNISHED - even the log book! Detailed and comprehensive instructions - from mike to antenna. You get the tops in mobile performance, and you save money, too!!!

**ONLY
\$199.80**

**HARRISON
RADIO CORPORATION
12 WEST BROADWAY, NEW YORK 7**

**The Bill
Harrison
MOBILE
TROPHY**



A large, handsome silver loving cup, suitably engraved, to be presented to the first W (or K) Amateur who, starting July 1st, works all continents with his automobile installation. Send for simple rules.

Don't Lose those Good QSO's While Turning Your Beam by Hand

MUNGER

Electro-Beam ROTATOR

Hold those rare DX contacts right through QRM by peaking up your own and received signals in a few seconds. Ruggedly built. Powerful reversible motor. 115V—60 cycles. Swings your beam at 1 r.p.m.

- Price Includes Reversible Electro-Beam Rotator and Accurate Direction Indicator.

- Foolproof Potentiometer and Meter Circuit. Calibrations in Both Degrees and Directions.

Free Inspection Offer!

Order today. If not satisfied, return rotator within 10 days for refund. (Control-power cable supplied at 10c per ft. in 50' or 100' lengths.)

MANUFACTURED AND SOLD
EXCLUSIVELY BY

REX L. MUNGER COMPANY
4701 Sheridan Road, Chicago 40, Ill.

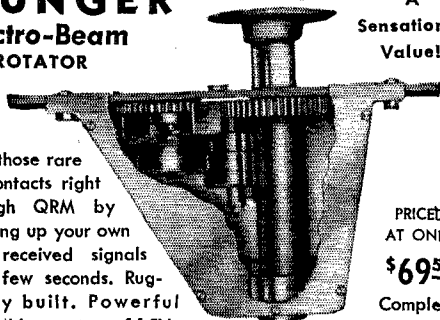

A
Sensational
Value!

PRICED
AT ONLY

\$69.50

Complete

Illustrated Bulletin
on Request
— • —
Time Payment Plan

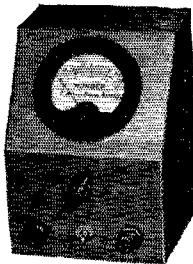

COMPLETE RADIO TRAINING!

Prepare now to accept a responsible position in Commercial Radio. New developments will demand technicians with thorough basic training, plus a knowledge of new techniques discovered during the war. Training open to high school graduates, or those with high school equivalency. Courses 6 to 18 months' duration in RADIO AND ELECTRONICS. Approved Veteran training in Radio. Write for Particulars.

VALPARAISO TECHNICAL INSTITUTE
DEPT. TN Valparaiso, Ind.



JOBS IN TELEVISION

YOUNG MEN 16 TO 60

There is a job opening for every qualified trained television technician.

WE CAN TRAIN YOU
FREE TRAINING TO VETERANS
OF WORLD WAR 2

Visit our modern laboratories and class rooms
Approved under G. I. Bill of Rights

AMERICAN RADIO INSTITUTE
New York Buffalo, N. Y. Syracuse, N. Y.
101 W 63rd St. 640 Main St. 131 Shonnard St.
"TEACHING RADIO SINCE 1935"

pasteboards 100% as soon as practicable: VS2CH, ex-D4AEQ, ZC6UNJ, ZL1GE/P, ex-VP4TY and OX3RG These stations believe they've completed whipping the backlog and will furnish refills for strays: W6PJJN/KG6 (QSL to Box 855, Los Angeles 53, Calif.), VP2GJ (% W1FTX), ZD4AH, MD4JG (QSL to P.O. Box 1313, Nairobi, Kenya), VP7NG, MD1E (QSL to 4 Deer Park Way, Axwell Park, Blaydon-on-Tyne, Co. Durham, England), TA3GVU and MT2E VK9NR, ZP3AW and ZC8PM cards are being distributed and C1DH/C3 has been passing out \$100 bills—QSLs impressed upon Formosan currency, of course.

In the your-guess-is-as-good-as-mine category, we hear that W4MR has been bumping into various PX1As with regularity. The PX1A that W2SHZ has been working claims to be a legit F8. [Say, maybe that's a club station, huh?—Jeeves] As if this were not enough puzzlement for W4MR, along trots one AC5CS. After the latter QSO, Alva talked the fellow over with W8NBK and W5QL, the consensus being that the fellow was a playboy. Then who shoves his 2c in but the "AC5," hollering "I am too legit," or words to that effect. Zooks! never a dull moment on 14 Mc. The YM4AW that sent W0BNU a card states that practically all the prewar Danzig hams are Silent Keys now We could list a few more weirdies but it would only smack of alphabetical mayhem.

Seeking elimination of the stupendous QRM by-product of the standard type of DX contest, Jeeves is now plugging a new idea, the "QRJ Test." Stated simply, stations with the average weakest reports throughout the affair emerge victorious. Obviously (he says), with everyone continually cutting the soup to be weaker than the next guy, 20 will ultimately be dead as a doornail.

I.A.R.U. News

(Continued from page 50)

AUSTRALIA

Australian amateurs are now permitted to use n.f.m. on the 3.5-, 7-, 14- and 28-Mc. bands. Single-sideband emission is also to be allowed on these same bands. The 1215-1300 Mc. band replaces the 1345-1445 Mc. band. These changes became effective May 1st.

FRANCE

Robert Larcher, F8BU, honorary president of the *Reseau des Emetteurs Français*, is compiling a history of international amateur radio. He is very desirous of obtaining all sorts of documents, anecdotes, photographs, texts of regulations, and all else pertaining to the work of amateurs prior to the year 1914. Please address all correspondence direct to Robert Larcher, F8BU, 1 rue des Tanneries, Paris 13, France.

HONG KONG

The past year has seen considerable activity by VS6 stations, and despite the confined area

Hams in Essex County, New Jersey, PREFER ASTATIC MICROPHONES TWO TO ONE

● In Essex County, N. J., as around the world, Astatic Microphones remain the top preference of amateurs. A recently completed survey of that locality—neither instigated nor conducted by Astatic—provides interesting evidence of Astatic Mike popularity. Among 352 Hams, 101 own and operate Astatic Microphones. The figures are still more significant due to the fact that 85 of the 352 include owners of War Surplus units and miscellaneous types. The remaining 166 divide their choice of mikes among six other better known makes. No other make has half the representation in Essex County as that enjoyed by Astatic units. No test of product quality is more conclusive than that of actual use. The continued preference of amateurs for Astatic Mikes is their greatest endorsement.

*Astatic Crystal Devices manufactured
under Brush Development Co. patents*



SOLUTION TO THE TV LEAD-IN PROBLEM!

Federal's
**Shielded Balanced
300-Ohm Lead-in Cable**

INTELIN K-111

Minimizes Noise, "Snow" and "Ghosts"

Due to Transmission Line Pick-Up!

A MAJOR ADVANCE in television technique! Developed by Federal ... offered only by Federal. Now manufacturers can obtain a lead-in that *protects* the quality performance they build into their receivers. Antenna kit makers can greatly improve their products. And servicemen can call a halt to many of the customer complaints that take the profit out of service policies. For information, write to Dept. D-157.

Patent Pending

Federal Telephone and Radio Corporation

900 Passaic Avenue, East Newark, N. J.

In Canada:—Federal Electric Manufacturing Company, Ltd., Montreal, P. Q.
Export Distributors:—International Standard Electric Corp., 67 Broad St., N.Y. C.



MORE SIGNALS PER DOLLAR
From Money Invested in an Antenna

Self-Supporting
STEEL TOWERS
For Rotary Beams, FM, TV

ATTRACTIVE—NO GUY WIRES!

- 4-Post Construction for Greater Strength!
- Galvanized Steel—Will Last A Lifetime!
- SAFE—Ladder to Top Platform
- COMPLETE—Ready to Assemble
- Easy to Erect or Move
- Withstands Heaviest Winds

(We will supply stress diagrams for your building inspector)

EASY MONTHLY PAYMENTS

Up to 12 Months to Pay!

All Vesto Towers are available on a special monthly payment plan which requires only 1/3 down. Write for free details.



Width at
Base Equal
to 1/5 Height

IMMEDIATE DELIVERY

on all 8 popular sizes. Note the low prices for these quality lifetime towers: 22'-\$73.50, 28'-\$92.25, 33'-\$109.75, 39'-\$129.75, 44'-\$149.75, 50'-\$175.00, 61'-\$239.75, 100'-

\$846.50. Towers are shipped to your home knocked down, FOB Kansas City, Mo., 4th class freight. Prices subject to change... so order now! Send check or money order... or write for free information.

WRITE TODAY FOR COMPLETE FREE INFORMATION AND PHOTOGRAPHS

The VESTO Company
101 Main St., Parkville, Mo.

MORE POWER WITH SAME TRANSMITTER AND SAME ANTENNA

Micro-Match

MEASURES SWR AND RF POWER



Micro-Match tells you at a glance what your actual RF power output is in watts. Also tells you SWR of antenna system. MM 1 for open wire lines, price complete \$29.50. MM 2 (shown) for coaxial lines, price complete \$37.45. Contact your distributor.

Other Micro-Match models for operation at 500 KCS to 500 MCS, and power levels of 2 to 50,000 watts.

M. G. JONES ELECTRONICS COMPANY
P. O. Box 1519, BRISTOL, CONNECTICUT

excellent cooperation between neighboring stations has reduced to a minimum the amount of interference experienced. A number of stations have had their licenses modified from the 25-watt c.w.-only permit to 150-watt 'phone/c.w. permits. The Hong Kong society lost a keen supporter when VS6AS, and his wife, were killed in the Macao air-piracy disaster.

BELGIUM

The *Union Belge des Amateurs-Emetteurs* is now issuing the certificate WABP (Worked All Belgian Provinces). The requirement is that the applicant submit written proof of having contacted each of the nine provinces on each of two hands. (The *Call Book* at present lists the province after each call.) Applications for this award should be addressed to the U.B.A., Box 634, Bruxelles.

CZECHOSLOVAKIA

The following v.h.f. and u.h.f. bands are currently available for use by amateurs in Czechoslovakia: 50-54 Mc., 144-150 Mc., 220-225 Mc., 420-460 Mc., 1215-1300 Mc., 2300-2450 Mc., 3300-3500 Mc., 5650-5850 Mc., 10,000-10,500 Mc., and 21,000-22,000 Mc. Class A operators are allowed 100 watts input, Class B operators 50 watts, and Class C operators 10 watts.

HRO

(Continued from page 53)

Antenna Shorting Relay

An additional refinement of particular interest to those who use relatively high-power transmitters is the use of a small, low-current relay for protecting the receiver by disconnecting and shorting the antenna coil during transmissions. A Potter-Brumfield d.p.d.t. relay, Type LM-11, with 10,000-ohm coil, is mounted under

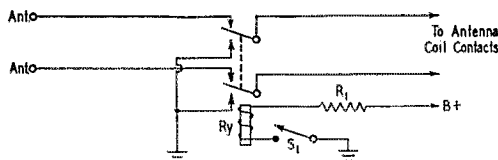
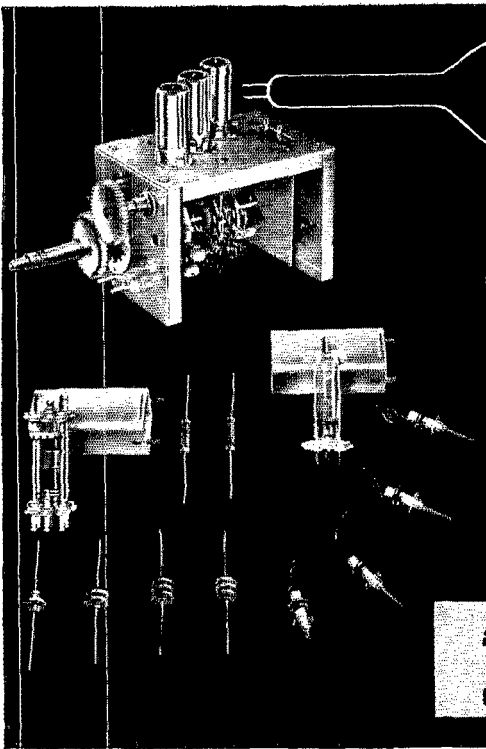

Fig. 4—The relay circuit for shorting the receiver input during "transmit" periods.

- R₁—Adjusted to give operating voltage across relay
- R_y—Its value will depend upon the power-supply voltage available.
- R_y—D.p.d.t. relay, 10,000-ohm coil (Potter-Brumfield LM-11, 10,000 ohms).
- S₁—S.p.s.t. toggle switch.

the chassis directly below the antenna input terminals and connected as shown in Fig. 4. The relay opens the antenna leads and shorts and grounds the antenna coil of the receiver. If desired, the relay can be wired so that removing the plate voltage from the receiver during transmission periods automatically switches the relay to the protective condition. But with the relay wired as shown, and controlled by S₁, the receiver can

(Continued on page 118)



36 mcs IF
 unique video
 RF unit and
 coil kit
 minimizes
 interference

Front end assembly, IF transformers, peaking coils, video choke coils, sound trap and ratio discriminator designed for unique stagger-tuned IF system having a center frequency of 35.8 mcs, instead of conventional 24 mcs. Minimizes many forms of RF interference. Used in National Television sets. Write for complete details.

National
 EST. 1914
NATIONAL COMPANY, Inc.

MALDEN, MASSACHUSETTS

specify

CORNISH

Wires

for **ABSOLUTE UNIFORMITY**
 plus **SUPERIOR QUALITY**
 adding up to **ULTIMATE ECONOMY**

Since the earliest days of Radio, **CORNISH** engineers have kept abreast of electronic developments . . . so as to serve **YOU** better.

"made by engineers for engineers"

CORNISH WIRE COMPANY, INC.
 15 Park Row New York 7, N. Y.

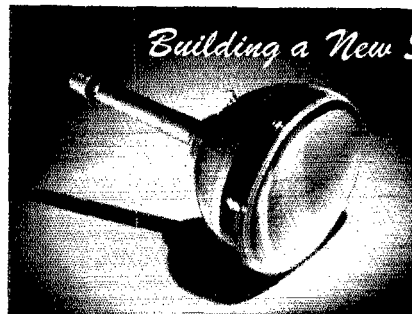

Building a New Scope?

Use a
 large
 9-inch
 C.R.T.

9GP7 only \$3.95

Electromagnetic Deflection
 Long Persistence - Bluish Fluorescence

CHARACTERISTICS

Heater 6.3 Volts 0.6 Amps
 Anode #2 4000 Volts
 Grid #1 Cutoff 110 Volts
 Peak-to-peak Signal Swing . . 25 Volts
 Standard Octal Base

Tube is securely packed in a light plywood crate. Shipping weight 22 lb. Shipment by Express Collect only.

SREPCO

Inc.

STANDARD RADIO & ELECTRONIC PRODUCTS
 135 E. Second St. DAYTON 2, OHIO Tel. FULTON 2174

TERMS: Cash
 with order, or
 25% deposit,
 balance C.O.D.

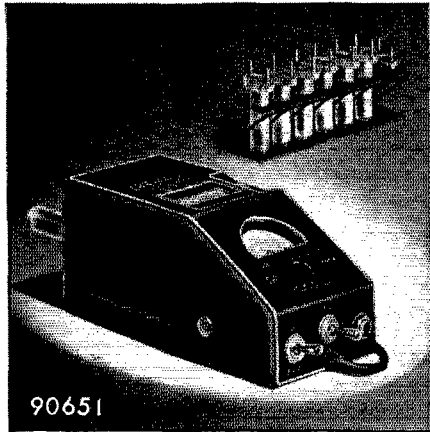

The Millen No. 90651 Grid Dip Oscillator

The most versatile piece of test and design equipment yet available for amateur as well as laboratory and industrial use. Wide frequency range; 1.5 to 270 mc. Compact; 3 1/2" x 3 1/2" x 7", exclusive of inductor. Transformer type power supply; plus provision for battery operation. Direct frequency calibrated anti-backlash gear driven drum dial with uniform scale lengths.

Net price, \$55.00, complete with tube and inductors. F.O.B. Oakland.

W. D. BRILL CO.
198 TENTH ST. • OAKLAND 7, CALIFORNIA
W6KLO W6SSN W6FIX

WE GUARANTEE

that the **HANDY** Converters attached to your car radio will produce stronger 10/11 or 6 meter signals than many standard communications receivers.

The smallest converter made with the greatest band spread dial, at the lowest ham price of \$29.95 with tubes.

Specify band when ordering — Immediate delivery

RADIO TRANSCEIVER LABORATORIES

116-23 Jamaica Ave. • Richmond Hill 18, N. Y.
Makers of the **HANDY TALKY HT-144**

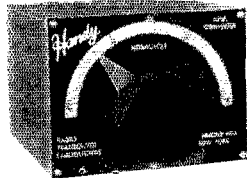

Mass. Radio School

271 Huntington Ave., Boston 15, MASS.

Offers Training Courses for Radio Technician (Pre-Television) and Licensed Radio Operator (All Types) including maintenance and operation of General Electronic Equipment. Over 20,000 Alumni and 30 years radio training EXPERIENCE. Courses approved for G.I. Training for Veterans.

Send for Catalog

Licensed by Commonwealth of Mass.
Department of Education

be used for monitoring. The opening of the antenna leads and shorting and grounding the coil is far more effective than shorting the antenna leads, especially for 28-Mc. operation.

[If the receiver send-receive switch is rewired to leave voltage on the h.f. oscillator and the b.f.o., it will keep the power to these oscillators at a constant value and reduce any tendency to drift when the receiver is switched off during "transmit" periods. — Ed.]

Correspondence

(Continued from page 62)

314 W. Lakewood, Peoria 5, Ill.

Editor, *QST*:

The critics of ARRL's dues increase are living in the past — with the ten-cent loaf of bread. Things cost more today because people earn more. It's ridiculous to expect ARRL or any other organization to render a service at a prewar price. Why should some horns be so dumb about economics? I respect the fellow who says that Junior's shoes come first, but the guy who says the price is too high must be kidding.

And as for the ARRL services, we need them all — unimpaired. Even those of us who disagree with ARRL on minor issues will agree on the need for a strong organization to represent the amateur fraternity. I would certainly hate to see a forty-dollar-a-week man representing the amateurs at, for instance, a frequency-allocation conference where the big corporations send their \$10,000-per-year men.

— Cyrus Rohrer, jr., W9EKL

Wilmington, Ohio

Editor, *QST*:

YOUR ARTICLE ON MEMBERSHIP DUES WAS VERY INTERESTING STOP SOME DOGS BITE THE HAND THAT FEEDS THEM BECAUSE THEY DO NOT KNOW ANY BETTER STOP MORE POWER TO YOU COMMA IF NECESSARY INCREASE THE DUES TO KEEP OUR AMATEUR ORGANIZATION STRONG.

— H. M. Robison, WSHOX

[Many thanks also to W1HWR, W1POL, W2CED, W2ZSK, W3OZF, W4MKB, W4MVM, W5NEQ, W6SJS, W6RZS, KP4GV, VE6HM, VE6LQ, Harold McKay, Mike Schmitz, James Swanson, Robert Del Ciello and others for their comments on the April editorial. — Ed.]

PAGING MR. RAPP . . . WHO GETS AROUND

Estes Park, Colo.

Editor, *QST*:

Reference is made to "A New Approach to Antenna Design," by Larson E. Rapp, April, 1949, *QST*.

I think that a little explanation regarding his findings on standing-wave ratio should be made. The "indefinite impedance" to which he refers actually approaches zero as the antenna is tuned through permeability. This can easily be proven mathematically, thus substantiating his acquired results.

$$\text{Since } \int_{AD}^{BC} \frac{Apr}{1949} \times \frac{1}{73} = \approx 0 \text{ for 73 ohms}$$

$$\text{and } \int_{AD}^{BC} \frac{Apr}{1949} \times \frac{1}{300} = \approx 0 \text{ for 300 ohms,}$$

where Apr is the prospective rate to the antenna, it is readily seen that the mere substitution of a 300-ohm line for a 73-ohm coaxial cable would not affect the standing-wave ratio.

— F. K. Matejka, W0DD

Floundering-on-the-Hudson, N. Y.

Editor, *QST*:

I must call to the attention of Mr. Rapp some oversights which nullify his constructive efforts. In the first place,

(Continued on page 180)

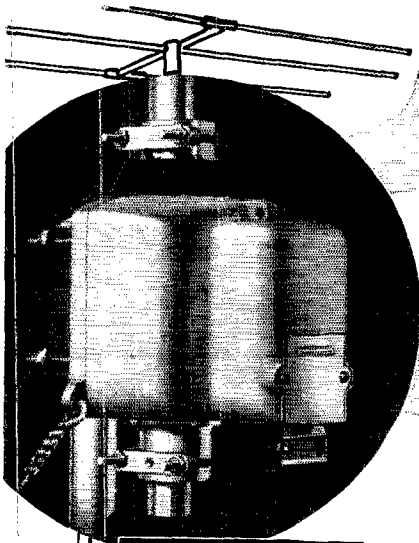

Takes
Max.
Antenna
O.D.
1 3/4"



Model ATR

Fits most types of antenna

Size of rotor unit 7 3/4" x 5 1/4" x 8"
Size of control box 5" x 5"
Approx. weight 12 lbs.
Special 4 conductor interconnecting cable available at 5 1/2¢ per ft. list price.

AMATEURS

Get this first
mass-produced
Antenna Rotator!

GETS

**STRONGER
SIGNALS!**

**ROTATES
TV AND FM ANTENNA**

LIST PRICE **\$39.95**

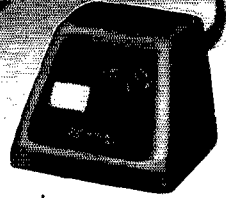

Amateurs—the new Alliance Tenna-Rotor will rotate most antennas from 50 m. c. upwards. Tenna-Rotor is a "beaming" device to give you positive control of rotation—select the exact spot for "peaked" reception! Operates in any weather—is quick and easy to install—consists of a fully enclosed, electrically driven rotor, connected to plastic control box which plugs into any 110 volt, 60-cycle house circuit. A simple two-way selector switch rotates your antenna clockwise or counter-clockwise through 365° and stops it at any desired point on the compass! Rotor unit resists corrosion.

Ask your dealer for Tenna-Rotor!

alliance motors

ALLIANCE MANUFACTURING COMPANY • ALLIANCE, OHIO
Export Department: 401 Broadway, New York, N. Y., U. S. A.

Another Walter Ashe
SURPLUS
Exclusive!

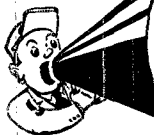

LAST CALL!

PE 103-A DYNAMOTOR

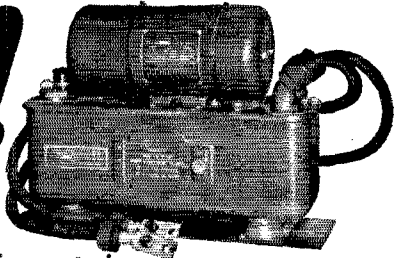

JUST RECEIVED! BRAND NEW in original overseas shipping crates!

(Last Known Quantity On the Surplus Market!) While the quantity lasts, Walter Ashe offers this big value PE-103A Dynamotor. This may be your final opportunity to obtain one of these brand new power units. So don't delay. Wire, write or phone today! 6 or 12 VDC input. 500 VDC output at 160 M. A. Complete with overload relays, filter and connecting cables. Shpg. Wt. 81 lbs. A once-in-a-lifetime bargain at ONLY **\$14.95**

F.O.B. 1125 Pine St. St. Louis 1, Mo No C.O.D.'s, please.

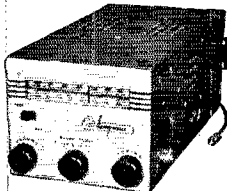

HARVEY WELLS ATR-3

Transmitter/Receiver
JUST THE THING FOR
THAT 75 METER MOBILE
INSTALLATION!

See May issue of QST for complete details.

Regular price. \$159.95

Walter Ashe's original low bargain price... **49.95**

NOW—marked down to...ONLY

\$39.50

F.O.B. St. Louis, Mo.

**Walter Ashe
RADIO CO.
1125 PINE ST. • ST. LOUIS 1, MO.**

Walter Ashe Radio Co.
Bill DuBord W QDF, Mgr., Amateur Div.
1125 Pine St., St. Louis 1, Mo. Q-49-6

Rush (quantity) PE-103A Dynamotor (Brand new— in original overseas shipping crates.) @ \$14.95 each. F.O.B. 1125 Pine St., St. Louis 1, Mo.

Enter my order and ship at once (quantity) Harvey Wells Transmitter/Receiver @ \$39.50. F.O.B. St. Louis, Mo. Remittance for \$_____ is enclosed.

NAME _____
ADDRESS _____
CITY _____
ZONE _____ STATE _____



Founded in 1909

RADIO TELEPHONY RADIO TELEGRAPHY

Courses ranging in length from 7 to 12 months. Dormitory room and board on campus for \$40.00 a month. The college owns KPAC, 5 KW broadcast station with studios located on campus. New students accepted monthly. If interested in radio training necessary to pass F.C.C. examinations for first-class telephone and second-class telegraph licenses, write for details.

PORT ARTHUR COLLEGE PORT ARTHUR TEXAS
Approved for G. I. training

CALL LETTER PLATES

Type A-18 -
For Your Car

Type A-19 -
For Panel
Mounting

W8ENH

\$2.95 POSTPAID

A large, sturdy cast aluminum plate with satin-finished letters and border against

a black baked enamel background. Red, green, blue and gray -- 50¢ extra. Size - 2½" x 3¼" with 1½" letters.

LAPEL BUTTONS

An attractive metal button with highly polished raised letters against a black background. Other colors 50¢ extra.

W9HKZ

ACTUAL SIZE \$1.10 POSTPAID

Type A-26L With Screw Backing
Type A-26P With Pin Backing

SREPCO Inc.

STANDARD RADIO & ELECTRONIC PRODUCTS
135 E. Second St. DAYTON 2, OHIO Tel. FULBON 2174

CASH WITH ORDER
Allow 3 weeks for delivery

ASSEMBLE YOUR OWN STANCOR 203A NOW \$44.70

Now you can assemble the famous Stancor ST-203-A mobile X-mitter. It functions, fixed or mobile, on 10 and 11 meter bands. Has "Press-to-talk" operation, two channel crystal switching, self-contained antenna changeover relay. Amplifier plate input with 500 volt supply -- 27.5 watts.

All components complete in kit, including lead wires already prepared. Easy-to-follow instructions. Kit form, \$44.70 net. Assembled, wired and tested, \$58.90.

10%
CASH
WITH
ORDERS

ALVO
Covers the Globe

PHONE
LOmbard
3-9225

509 Arch Street, Phila. 6, Pa.
Sixth and Orange Streets, Wilmington, Del.

Visit our new branch, 6205 Market Street, Philadelphia, Pa.

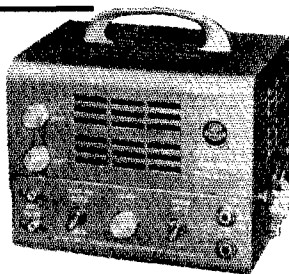

he has not indicated whether the antenna was 142.2 cm. before or after cooling. This would tend to confuse calculations. I am working on a much simpler derivation which will show that since the resistance in a conductor is inversely proportional to $K\sqrt{1/\pi}$, the ideal radiator would be all thickness and no length. I shall further pursue my studies and divulge them in a work entitled, "Life Among the Neutrinos of West Betatron."

Scientifically yours,
Upson Downs. WOOPS
— by S. Leibholz, W2ZDE

171 Kensington St., Brooklyn 29, N. Y.

Editor, QST:

I implore Mr. Rapp to submit another paper dealing with the practical constructional features of his antenna as soon as he thaws out.

— Joel Porte, W2YTR

47-47 39th Place, Long Island City 4, N. Y.

Editor, QST:

It is with regret that the three undersigned tried and true members of the ARRL advise that they are seriously considering resigning from your organization.

For some time we have had a devil of a time operating through the interference from galactic noise, and the League does not seem to be doing anything about the situation. The fact that this galactic noise is variable does not, in our opinion, constitute an excuse for the negligence of your tight, cozy little band of boys in the ivory tower.

Note the experiments in Australia on sources of galactic radio-frequency noise. Our friends "down under" are on the ball. For example, they propose a mechanism of free-free electron transitions in ionized interstellar matter, with a free-space electron temperature of $10^{40} K$. What have you proposed?

Note too, the free use of the word "free" in the above proposal. What do we get free from your League? Free Handbooks? Free liquor? Hell, no!

— Adrian E. Clark, jr., W2PDH
— Murray Mesco, W2UQX
— Irwin M. Dresner, W2TRP

[We deplore our inability to pass along these ideas to Mr. Rapp who, at last account, had secluded himself at his summer home at Eeling-on-the-Thames for further research. — Ed.

Strays

A multicolor wall chart of the Atlantic City frequency allocations, 25 by 40 inches, showing assignments of bands to various services in the three regions of the world, is available from the Communications Division, Mullard Electronic Products, Ltd., Century House, London, W.C. 2, England, at \$1.50 postpaid.

Hints & Kinks

(Continued from page 68)

ANOTHER CRYSTAL-GRINDING KINK

SEVERAL methods have been suggested for getting rough checks on the frequency of a crystal blank during the grinding process, but none of them seems as simple as this:

Take a flat sheet of aluminum or copper about six inches square, and connect it to your receiver antenna post by a short lead. Place the plate glass on which the grinding is being done over this sheet. You can tune in the crystal frequency

(Continued on page 122)

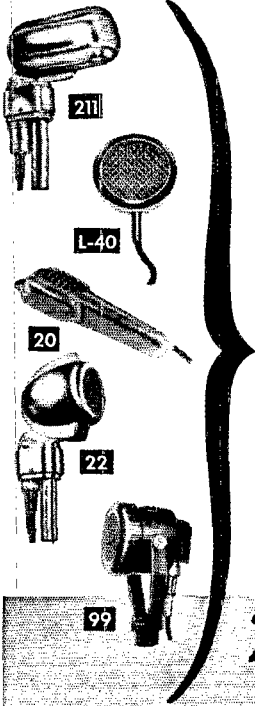

Quality Performance TURNER MODEL 77

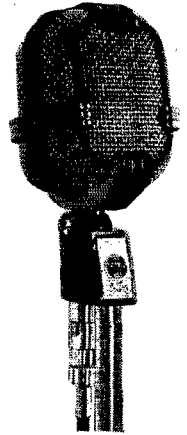

TRU-CARDIOID

Tru-Cardioid pickup pattern and smooth, wide range response make the Turner Model 77 a truly outstanding microphone. Built-in switch gives instant selection of 50, 200, 500 ohms or high impedance. Recommended for highest quality recording, public address and broadcast work.

MODEL 77 • Level: 62 db below 1 volt/dyne/sq. cm. Response: Substantially flat from 70 to 10,000 c.p.s. List price.....\$77.00

Write for Complete Microphone Literature

IN CANADA: Canadian Marconi Co., Ltd., Montreal, P. Q., and branches

EXPORT: Ad. Auriema, 89 Broad Street, New York 4, New York

THE TURNER COMPANY

917 17th Street, N. E.

Cedar Rapids, Iowa

Microphones by **TURNER**



Microphones licensed under U.S. patents of the American Telephone and Telegraph Company, and Western Electric Company, Incorporated. Crystals licensed under patents of the Brush Development Company.

RADIO • ELECTRONICS • TELEVISION



ENGINEER FACULTY — Excellent Laboratory and Technical Facilities. *Limited Classes—Unlimited Opportunities.* DAY—EVENING CLASSES. CRL is Sponsored and under Technical Supervision of CRYSTAL RESEARCH LABORATORIES, INC. Licensed by Connecticut State Board of Education. Approved for Veterans.

Write today for Catalog and copy of Telecaster

SCHOOL OF ELECTRONICS, INC.
29 ALLYN STREET • HARTFORD, CONNECTICUT

W8CFK

ALUMINUM CALL PLATES

Your call cast in aluminum with black background and polished 1 1/2" letters. Plate size 2" by 6 1/2". 3 styles: P for panel mounting, L for car license and D for desk use. \$1.75 each postpaid.

619 Jasper St. P & H SALES CO.
Kalamazoo 31, Michigan



RADIO and TELEVISION

Thorough Training in All Technical Phases

APPROVED FOR VETERANS

WEEKLY RATES DAYS—EVENINGS

RCA GRADUATES ARE IN DEMAND

For Free Catalog write Dept. ST-49

RCA INSTITUTES, INC.

A Service of Radio Corporation of America
350 WEST 4th ST., NEW YORK 14, N. Y.

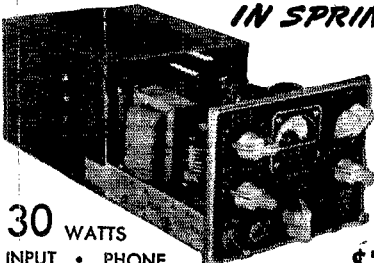

IN SPRING

IT'S **SUBRACO** FOR YOUR
COMPLETE MOBILE ENJOYMENT

SIMPLE TO INSTALL
COMPACT—EFFICIENT

30 WATTS
INPUT • PHONE
CLASS 'B' MOD.

MT-15X
\$79.95
LESS TUBES

AVAILABLE IN 75 MTR. PH.
AS WELL AS THE 10-11 MTR. UNIT

DS-400 ONLY

SUBURBAN RADIO COMPANY

158 CENTRAL AVE. ROCHELLE PARK NEW JERSEY

WRITE
DEPT **\$59.95**
Q-6 COMPLETE

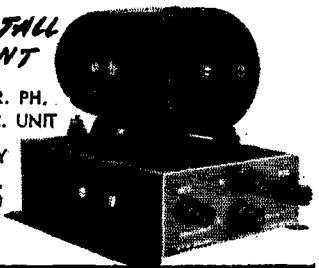



NATIONAL

- **P**roven
- **D**ependable
- **Q**uality

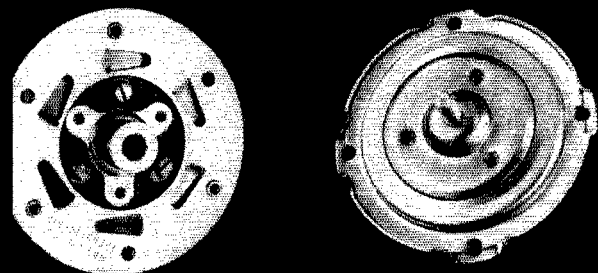

NATIONAL'S POPULAR VERNIER MECHANISMS

Standard AN has an insulated coupling for connecting to 1/4" shaft. Drive shaft fits 1/4" knob. Ratio 5-1. Price **\$1.80** net.

AVD same as AN except coupling is not insulated. Price **\$1.65** net.

Many variations available for commercial applications. Write for particulars.



on the receiver by the scratches you hear as the crystal is being ground. You can then follow the scratching noise along the dial as you grind. When nearing the frequency you desire, the regular methods of crystal checking must be used, but up to this point the scratches will tell you what you want to know. It saves the time usually taken to wash and dry the crystal, replace it in a holder, and fire up the oscillator each time you want a rough check to show just how far you still have to go.

— *Elmer A. Gunther, W0ACC*

SOLDERING-IRON CLEANER

SHOWN in Fig. 3 is a handy tip cleaner for your soldering iron. It is made from an empty solder spool, forming two "cups" by sawing it in half through the barrel of the spool. The cups are then filled with steel wool, and are fastened to the

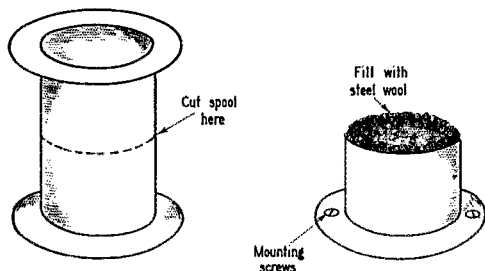

Fig. 3 — A neat soldering-iron cleaner that is made from an old solder spool.

work bench by two screws that pass through the large flange. Just a poke and a twist of the iron into one of the cups will insure a clean, bright iron and greatly simplify the soldering job. In my own shop I found the vertical back of the bench the most useful spot for mounting these gadgets. — *Leon Baldwin, VE2TM*

A SIMPLIFIED ELECTRONIC KEYS

THE idea at this station was to make a keyer as simple and compact as possible and still retain the qualities that make the electronic key a desirable "gadget." The result is shown in Fig. 4. No attempt was made to devise anything radically new but rather to redesign existing circuits for the sake of simplicity. A most necessary feature was that the keyer must be "self-operating" and the key lever was to act only as a trigger. It was found that the timing circuit, once set, needed no further adjustment over the entire speed range, so fixed resistance was used rather than a larger variable control to set the timing circuit. Not only is less space necessary but there is no chance of the control being bumped out of adjustment.

Tests proved that with a little patience in the initial adjustment of the relay arm and contacts plus the proper resistance and capacity in the timing and bias circuit, the intraletter spacing of one unit length can be achieved. This made it

(Continued on page 124)

HAM-ADS

(1) Advertising shall pertain to radio and shall be of nature of interest to radio amateurs or experimenters in their pursuit of the art.

(2) No display of any character will be accepted, nor can any special typographical arrangement, such as all or part capital letters be used which would tend to make one advertisement stand out from the others.

(3) The Ham-Ad rate is 30¢ per word, except as noted in paragraph (6) below.

(4) Remittance in full must accompany copy. No cash or contract discount or agency commission will be allowed.

(5) Closing date for Ham-Ads is the 25th of the second month preceding publication date.

(6) A special rate of 7¢ per word will apply to advertising which, in our judgment, is obviously non-commercial in nature and is placed and signed by a member of the American Radio Relay League. Thus, advertising of bona fide surplus equipment owned, used and for sale by an individual or apparatus offered for exchange or advertising inquiring for special equipment, if by a member of the American Radio Relay League takes the 7¢ rate. An attempt to deal in apparatus in quantity for profit, even if by an individual, is commercial and all advertising by him takes the 30¢ rate. Provisions of paragraphs (1), (2) and (5), apply to all advertising in this column regardless of which rate may apply.

(7) Because error is more easily avoided, it is requested signature and address be printed plainly.

(8) No advertiser may use more than 100 words in any one issue nor more than one ad in one issue.

Having made no investigation of the advertisers in the classified columns, the publishers of QST are unable to vouch for their integrity or for the grade or character of the products or services advertised.

Please note the 7¢ rate on hamads is available to ARRL members only.

QUARTZ — Direct importers from Brazil of best quality pure quartz suitable for making piezo-electric crystals. Diamond Drill Carbon Co., 719 World Bldg., New York City.

QSLs. 100, \$1.50 up. Stamp for samples. Griffith, W3FSW, 1042 Fine Heights Ave., Baltimore 29, Md.

AMATEUR radio licenses. Complete theory preparation for passing amateur radio examinations. Home study and resident courses. American Radio Institute, 101 West 63rd Street, New York City.

QSLs, SWLS. For distinctive cards, write to McEachron, 1408 Brentwood, Austin, Texas.

QSL's, SWL's. Finest stock. Fairest prices. Fastest service. Dossett, W9BHV QSL Factory, 857 Burlington, Frankfort, Ind.

LAPEL pins: your ham call letters engraved in white on black plastic, 1 1/4" by 3/4" with white border. 35¢ each, postpaid. G. Lange, W2IYO, 34 Union Ave., Belleville 9, N. J.

BEAM control cable, new material. Two #16; six #20 rubber insulated, coded, tuned conductors. Weatherproof rubber jacket. Heavy armor shield. 3/4" diameter. Price 10¢ foot. F.o.b. Chicago. Trans-World Radio-Television Corporation, 6639 S. Aberdeen St., Chicago 21, Illinois.

WANTED: Wireless equipment and literature prior to 1925; List ARRL Member Stations, Pink Sheet Supplement "Ban off" Oct. 1919 QST, Franklin Wingard, Rock Island, Illinois.

QSL's, Samples 10¢. Albertson, WAHUD, Box 322, High Point, N. C.

WANTED: AN/PART-13, BC-348, RTA-1B, AN/APN-9, R5A/ARNT, AN/ARC-3, BC-783-C, L-152, MN-26. Test sets with TS- or I-prefs. Dynamotors, control boxes, transmitters, receivers, power supplies, etc. State quantity, condition and best price, first letter. Hi-Mu Electronics, Box 105, New Haven, Conn.

PERSONALIZED book matches. Call letters or name and address. Samples with prices. Miss Amanda Martin, Box 1123, Rochester 3, N. Y.

WANTED: Teletype 1/40TH Hp synchronous motor. W6ITH, Moraga, Calif.

SUBSCRIPTIONS. Radio publications a specialty. Earl Mead, Huntley, Montana. W7LCM.

DON'S QSL's. "The finest". Samples. 2106 South Sixteenth Avenue, Maywood, Illinois.

CRYSTALS: Precision low drift units. Type 100A in 80, 40, and 20 meter bands. Two units plug in one octal socket. Plus or minus 5 Kc. One dollar each. Exact frequency. \$1.95 ea. Rex Bassett, Inc., Ft. Lauderdale, Fla.

10-METER Beams, \$19.50. Send card for free information. Riverside Tool Co., Box 87, Riverside, Illinois.

QSLSI Kromkote cards at a fair price. Dauphinee, WKMP, Box 219, Cambridge 39, Mass.

QSL Quality cards priced right. Samples. Ferris, W9UTL, 1768 Fruitdale, Indianapolis, Ind.

SURPLUS: Deluxe crystal finishing kits containing holders, quartz blanks, abrasive, etching fluid, complete instructions. \$2.00 each postpaid. Formerly sold \$8.75. Vesto Company, Parkville, Missouri.

QSL's! G. L. Taylor, Sumral, Mississippi.

CANADIAN QSL's! Superglass kromkote. Catalog in preparation, samples on request. Write for yours. W. John Chivers, Box 38, Grimsby, Ontario.

QSL's! Snappy new line. Send for free samples. Larry's QSL Shop, Box 59, Opportunity, Wash.

QSL's? SWLS? Distinctive? Cartoons? DeLuxer? Photographic? QSL samples 3¢. Sakers, W8DED, Holland, Michigan (Veteran).

SELL or trade: Super Pro, checked by Hammarlund 2-9-49. Too big for hospital use; magnetograph with oscillator, 2 1/2 taper; Speedx automatic key; 12" world globe; new luggage type combination radio-record player with regular and micro-groove arms. Want: small compact NBFM transmitter and pre-selector. Ralph Harvestine, Lutheran Sanatorium, Wheat Ridge, Colo.

COLLINS 75A-1 receiver, speaker, manual. New, original carton. Received as gift, will sell at reduction. My custom receiver adequate. Best offer over \$300.00. Charles Bramlett, W3NDX, 3808 Florence Drive, Alexandria, Va.

10-METER beams: \$15.95; 3-element .15-.2 spacing, aluminum construction, weight 10 lbs., 304TL filament transformer, 5 volts @ 25 amp., \$5.25. 304TL sockets, \$1.20. Atronic Corporation, 1253 Loyola Ave., Chicago 26, Ill.

SONAR VFX-680, black panel, 40 or 20 meter output, excellent condition. Cost \$82.00. Sell for \$60.00. W2AI, R. Emott, East Madison Ave., Florham Park, N. J.

SELL: Signal Corps BC-412B oscilloscope, made by Western Electric. New condition. Make an offer. W5XSD, Dutton, 527 Cherry Street, Boulder City, Nevada.

FOR Sale: BC-654 with cable and PR-104 receiver supply. Excellent condition. Best offer over \$25.00. All inquiries answered. Jack Branstiter, W6WJM, Talmage, Nebraska.

SELL: BC-610 (Philippine surplus), speech amplifier, and 9 tuning units; 3 covering 20; 3 covering 40, and 3 covering 80-meter bands. \$45.00. F.o.b. Kansas. H. K. Baisley, W5MBJ, Topeka Air Force Base, Topeka, Kans.

ROTARY converter, 110 VDC input, 110 VAC 60 cps 250w. filtered output, used 8 hours — \$25.00. Pair of 81's, used lightly 30 hours, \$5.00. Weston Supersensitive Analyzer, like new, \$70.00. R. O. Endres, 12 South Barrett Ave., Audubon, N. J.

WIHJ QSL Shop. Our QSLs-SWLS are tops. Try some! Samples. H. V. Cushing, Box 32, Manchester, N. H.

FOR Sale: BC-610E, 25X5 rcvr and RME 142A converter, perfect condition. \$695.00. Complete. Harold B. Smith, W6HAA, 1329 Martha Lane, Santa Ana, Calif.

HALLICRAFTERS S-19R, Sky Buddy, in excellent condition. Best offer. A. Simon, 365 Fulton, Farmingdale, L. I., N. Y.

TRADE for xmitter Bolex H-8 with focusing motion lenses F1.9, 1.5 and 3.5 focal length of 1 1/4" and 1 3/4" respectively, with camera in good condition. LCDR M. L. Skelton, USNRIC, 51 Whitney Ave., Binghamton, N. Y.

TRADE RCA630TS, 10" television receiver, perfect condition, for HRO or other good communication receiver. No surplus. E. I., Sielke, Philadelphia State Hospital, Philadelphia 14, Penna.

SWAP or sell: Q5'er converted 110V with speaker. Need beam rotator with indicator or 20 meter beam. Write W5IVF, Monroe, Louisiana.

FOR Sale: HRO, jr. receiver, \$75.00, with 40-20-10 coils and power supply. One power supply is 600 volts, \$20.00 and one power supply 800 volts, \$25.00. W3NRB, 550 South Ave., Verona, Penna.

SELL: VHF 152A, \$60.00. Panadaptor, \$30.00; Abbott TR4 transceiver 2-meters, \$25.00. All in first class condition. J. A. Bailey, W8UJB, 1302-4 First Central Trust Bldg., Akron, Ohio.

FOR Sale: BC-348Q with built-in AC supply, noise limiter, S-meter; manual, like-new, \$75.00. Parts for 1000 v 150 ma. power supply, transformers, chokes, condensers, pair 866jr's, all new, \$16.00 for lot. National 4-gang precision variable condenser PW-4 (225 f) with dial, new, \$11.00; BC-603 FM receiver 20-30 Mc., suitable for TV sound I.F. with manual, less power supply, \$12.00, University Receiver, 4401, \$9.99. Butterfly tuning circuit 70-100 Mc., \$1.25. Altec-Lautens, speaker 603, \$1.00. All f.o.b. Charleston, W. Va., Robert W. Timmerman, W8YIF, 509 Hall Street.

SELL, and in very good condition: Triplett 1696A modulation monitor, \$35.00, and Millen 90700 variarm VFO, \$25.00 and Bud code practice oscillator, \$5.00. W9LQ, 4014 Washington Boulevard, Indianapolis, Ind.

FOR Sale: SCR-522, in new condition, \$22.00. National NC-181X, covers 10 to 160 m. bands, \$15.00. Michael Hart, 87 Sherman Ave., Jersey City 7, N. J.

ALUMINUM tubing: 11 ft. lengths, 3/8" OD, .035" wall, 24ST. \$1.50 per length, Metalcraft Toy Co., Paul Brown Building, St. Louis 15, Mo.

HALF kilowatt Westinghouse CW rig used for airline communications, relay shifted 80 through 10 meters. BC-456 added for VFO. Provision for NBFM. Best offer over \$250.00. W2WQO, 22405 137th Ave., Laurelton, L. I., N. Y.

SURPLUS: BC-221 frequency meters, clean and in perfect condition, \$49.50 each. Send your orders to Monarch Electric Co., 411 Wood Street, Pittsburgh 22, Penna.

Two plate transformers, 2360 volts, 500 Ma., Kenyon T663, crated, never used, cost \$63.60 each or best offer. F.o.b. New York. HCJB, Box 390, Flushing, N. Y.

BC-610E transmitter. In perfect condition; complete with tubes and BC-614E speech amplifier, tuning units and coils for all bands: 30, 40, 20, 11 and 10. Factory converted. Terms: \$725.00 cash, or 20% with order, balance C.o.d. Wire or write M. N. Duff, W8AWJ, 2040 Grand River, Detroit 26, Mich.

WANTED: 300-1000 megacycle or 500-900 megacycle equipment. ASB and APR receivers, 1000 cycle generators, Slicer lines, UHF tuning units, etc. Give details and price. W6LWP, John Poole, 2514 Ocean Blvd., Balboa, California.

FOR Sale: Three 10-meter mobile transmitters complete with mike, cables, control box, and 6-volt power supply — \$45.00 each. K. E. Stokes, 401 Indian Ave., Eufula, Okla.

MILLEN 500-watt final, with pair 5514's, filament trans. \$84.00, P6-103 less base but with relays, \$8.00; 3-6 Mc. command receiver with phones, AC power supply, BFO switch, \$9.00; 750 V. 200 Mill. power supply, \$18.00; 3-30 Mc Gon-Set, new, \$32.50; 60 ft. of new tubular twin-lead, \$3.00. Shipped C.o.d. W9DSV, Dan Daniels, Webster, Wisconsin.

SELL: RA-34 rectifier 1100 volts DC, 350 mill, 14 volts AC, 14 amps 12 volts DC, 4.25 amps, Adjustable AC and DC voltages, \$65.00. 7CS-12 trans. receiver, new, \$475.00. BC-348N, new, \$35.00. BC654, new, \$25.00. BC-223-AX, \$19.00. T. C. Howard, 46 Mt. Vernon St., Boston, Mass. W1AFN.

DB22A Pre-selector, \$40.00; Hallcrafters S-53, \$45.00; 1 8^{1/2} PM speaker, \$5.00. Almost new. George W. McCarthy, Vets Facility, Bath, N. Y.

PANADAPTER wanted, type RBU preferably. Longley, W2ANB, Slingerlands, N. Y.

COLLINS 32V-1 for sale. No time to operate, \$400.00. Complete with D104 mike. Also National HRO-7, complete \$230.00. Both like new. W.K.C. McKee, jr., 240 Moreland St., Worcester, Mass.

FOR Sale: BC610 modulation transformer, \$20.00; 803's, \$5.00 pair, W8UD modulation transformer input and 50 watt output, \$10.00. W8ZDS, Buck, 124 Orchard Drive, Ames, Iowa.

FOR Sale: New: 35TG, 'scope pwr supply kit, 3AP1 tube, four 1200 Mc cavity osc. assemblies for 2C40 and 2C43 tubes, two 17" parabolic antennas. Nearly new; UTC; S-22, S-19 modulation transformers; B & W coils: 10BVL, 40BVL, BVL base. Make an offer for any or all of these pieces. W7IGE, Knipe, Rt. 3, Nampa, Idaho.

ELEMENT One revision complete, Elements Five and Six newly released questions only, with answers for radio-telegraph exams. \$1.00. McKenzie, W2SOU, 245 Poplar, Hackensack, N. J.

SEVERAL top quality AN/ART-13 Autotune transmitters removed from unused aircraft. Complete with dynamotor, tubes, plugs, control box, dynamic mike, manual, \$195.00. Fargo Electronic Engineering, 385 7th Avenue, So., Fargo, North Dakota.

MUST sacrifice: 500 watt transmitter PP813's in 6" enclosed rack. National HFS receiver, Sonar MB611 NBFM transmitter, new PE-103 dynamotor, Vibropack for above receiver, ideal for 10-meter mobile station. No reasonable offer refused. W21SS, H. Rogers, 118-26, 224th Street, St. Albans, L. I., N. Y.

CASH for defective transmitting triode tubes. Broken glass, shorted, in any condition. Electronic Reclamation, Box 786, Redwood City, Calif.

NEW! Ham-band meter switch 7 deck 5 position HV 1 L o-Loss ceramic \$1.49! New RT-5 filter 98¢! Selcyns GE2J1G, used, pair, \$1.49! Free bargain list. "TAB", 109 Liberty St., N. Y. C.

COMPLETE Navy TCS Collins 18Q-3 160-80-40 meter station for sale, including transmitter, receiver, instruction book, remote cables, 115V supply, 40 W CW, 25 W 'phone, \$215.00, or 10" TV, W8TLL. Amber, 18241 Ashton Road, Detroit, Mich.

SELL: SX-24 Hallcrafters receiver, \$55.00, 522 receiver unconverted, \$10.00; Workshop, 10-meter beam, \$15.00; 150-B converted \$275.00. W9BTS, 2405 E. State, Rockford, Ill.

MEISSNER signal shifters in kit form at \$49.75 are regular stock items at northern New England's foremost amateur radio supply house. Write WIBFT, Evans Radio, Concord, N. H.

QSLs. Distinctive designs by hams for hams and priced to meet the ham's pocketbook. Best quality material and workmanship. This is worth investigating. Stamp for samples. Leonard's Print Shop, 854 View, Hagerstown, Md.

CHANGING frequency? Fine commercial units for ARC-3's, SCR-522's, police, taxi, aircraft, marine, geophysical, and other services, except amateur. Commercial regrinding; many crystals can be economically reground to new frequencies. Inquire. Over twelve years of satisfaction and fast service! Try us first. Eidson Electronic Company, 1802 North Third St., P.O. Box 31, Temple, Texas.

SELL: Complete ham station including latest model Collins 32V-1 and 75A-1 in perfect condition. W5RS, 1714 Arlington Drive, Corpus Christi, Texas.

SELL: New Collins 310-B1. Highest cash offer. All inquiries answered. W3AVO, Weaver, R.D. #7, York, Penna.

NATIONAL rack model HRO-7R receiver complete with coils A, B, C, D, E. F. Used only several months, \$275.00. Webster Model 81 wire-recorder with spools for 15-30-60 minute recording, new, \$85.00. Instructograph code machine complete with tapes, oscillator type, \$25.00. All prices F.o.b. Gainesville, Ga. William E. Fennell, P.O. Box 672, Gainesville, Georgia. W4OSH.

FOR Sale: SX-25, Box 286, Haase, Fergus Falls, Minn.

FOR Sale: 400-watt fone/cw transmitter P.P. 812's, modulators 811's. Complete with coils for all bands. With Millen exciter unit, 30-in. high panel, rack-mounted. Practically new. \$300.00. W5KWA, H. Bartlett, 2665 Broadway, Beaumont, Texas.

SELL: \$65.00: Scott marine SLR-F superhet; tunes 80-560, 1900-24000 Kc. Five bands, RF stage, built-in AC power supply. Trade for BC-221 or LM freq. meter with original calibration or SCR-522 complete. Also have TCS-12 and TRC-10 transmitter receiver sets for sale. F. R. Madan, W2CUD, Irvington, New York.

FOR Sale: BC-348-P added stage audio, noise-limiter, S-meter. Separate power supply, \$75.00, plus shipping. W6EHP, D. Asmus, 182 North Minnewawa Ave., Fresno, Calif.

SELL: Supreme AF100 transmitter, \$375.00; Hallcrafters S-29 Sky Traveler receiver, \$40.00; Scott SLR-F receiver, 80 Kc band, converted for BC. \$125.00. R. Adams, W5OKQ, P.O. Box 1729, Meridian, Miss.

RCA mobile transmitter for 10 meters. Removed from police car. 807 final modulated with 46's, Class B. Tested and complete with dynamotor and control box, but less antenna. Carbon mike and xtal, \$60.00. Also have same make tested and with dynamotor and control box but using 1608 in final modulated with a Class B, \$40.00. W8LJO, Jack D. Rodebaugh, R.D. #2, Dorset, Ohio.

FOR Sale: HRO-7, power pack, speaker, coils, original crate, \$245.00. HFS, power pack \$125.00. Both practically brand new. W6DJL, Box 232, Davis, Calif.

TRANSMITTER bargain to nearby buyer! W8DED, Holland, Mich.

SELL BC 459A and BC 696 with common power supply. Ideal 40 & 75 meter ECO's. Unnecessary antenna tuners removed. Best offer cash or trade, F.o.b. Somerset, Ky. I. Kelly, W4TUT.

unnecessary to provide a tube and relay for this. It was decided that the one tube necessary to control the keying relay should be a dual-purpose tube so that the power necessary for the circuit would also be supplied at a minimum of space. A 117N7 answered the purpose nicely and did away with transformer or resistor worries so far as the filament was concerned.

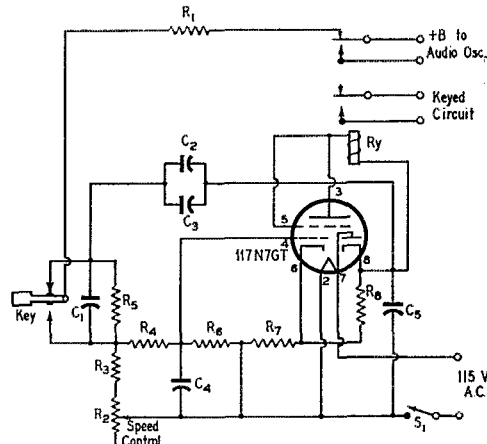

Fig. 4—Circuit diagram of a simplified electronic key.

- C₁, C₃ — 0.04- μ fd. 600-volt paper.
- C₂ — 0.1- μ fd. 600-volt paper.
- C₄ — 0.05- μ fd. 600-volt paper.
- C₅ — 40- μ fd. 150-volt electrolytic.
- R₁ — 500 ohms, $\frac{1}{2}$ watt.
- R₂ — 1-megohm potentiometer.
- R₃ — 75,000 ohms, $\frac{1}{2}$ watt.
- R₄ — 0.27 megohm, $\frac{1}{2}$ watt.
- R₅ — 0.47 megohm, $\frac{1}{2}$ watt.
- R₆ — 2.2 megohms, $\frac{1}{2}$ watt.
- R₇ — 2200 ohms, $\frac{1}{2}$ watt.
- R₈ — 7200 ohms, 1 watt.
- Ry — Sensitive d.p.d.t. relay.
- S₁ — S.p.s.t. toggle switch.

Any good relay with the coil resistance suitable for vacuum-tube operation will suffice. The relay used here is a conventional telephone-type relay purchased through a QST ad for 49 cents. It has a coil resistance of 12,500 ohms and is equipped with d.p.d.t. wiping contacts.

The speed control used gives a variable range from 12 to 40 w.p.m. Use of a higher-resistance control will allow still slower speeds.

It will be noticed that when the "rig" is being keyed the plate-supply voltage is being applied to an "open" contact on the relay. The voltage may be used to operate an audio oscillator used as a monitor and will key the oscillator exactly as the transmitter is keyed.

— C. G. Stuart, WSTZO

COMMERCIAL RADIO INSTITUTE

A RADIO TRAINING CENTER FOR 28 YEARS

Resident Courses Only • Broadcast, Service, Aeronautical, Television, U.H.F., Preparatory Mathematics, Frequency Modulation and Marine telegraphy. Classes now forming for summer term June 1st. Entrance examination May 16th.

Literature upon request. Veteran training

Dept. B, 38 West Biddle Street Baltimore 1 Maryland

FOR Sale or trade: one Zenith "Trans Oceanic" portable receiver. In excellent condition. Will swap for VHF-152-A or late model RC-348; or \$65.00 cash. Also: one Sonar VFX-680 NFM exciter in metal case. Swap for what you got or best cash offer. John E. Lyon, W5NCLM, Box 185, Conway, Arkansas.

AMPLIFIER ACA-100ADC by Amplifier Corp. of America. Like new, with mike, phone inputs. Guaranteed. L. Attwood, Box 1155, Nogales, Ariz.

SELL: 600 watt 'phone transmitter made of standard parts. RME-69 and DB20 preselector, besides several new 810-813-814-2032 and T-125 tubes and many transformers, chokes and miscellaneous equipment. Send for detailed list. WJND, Capwell, Anthony, R. 1.

SWAP or sell Hallicrafters S-20R, SX-25, Command transmitters and receivers, new 1/2" electric drills, ship-shore radiophones, Mar II transceiver, BC-611 walkie-talkie; 7 in. television with cabinet, Weston voltmeter, Seisyn indicators, make offer any or all. Wanted: BC350A Jefferson-Travis transceivers, Gon-Set converter, cables for Bendix TA12 transmitter, Higley, W2OPA, 504 Rosewood Terrace, Linden, N. J.

SELL: Hallicrafters SX-28 and HT6; 1940 Deluxe Signal Shifter with all coils. National "A" scope. Make an offer. Gordon J. Nordstrom W9ICQ, 1651 1/2 St., N.E., Cedar Rapids, Iowa.

BC-348Q, converted 110 A.C. with noise limiter; very good. \$65.00 plus shipping. W9DMM, 1311 E. 60th, Chicago, Illinois.

TRADE or sell VHF152A, BC-455B with volume control, output transformer, 7" P.M. speaker, BC375E, 4 tuning units, tubes, dynamotor, antenna tuner. Interested in 20-meter 3-elec. beam, 1 Kw /one final, K9'er, DB22A. C. Buchanan, Vale Rd., RR 1, Springfield, Ohio.

VFO's: BC457 and BC458's converted for 160, 80 and 40 meters, \$15.00 each. BC458 for 20 meters, tracks, \$18.00. All calibrated. W5IPI, Abe Lincoln, Box 746, Electra, Texas.

COLLINS 30FXB, rebuilt final T7-40's, Millen type exciter, fone/c.w., 250 watts, like new. \$150.00. James Geras, W2MVR, 373 8th Ave., New York, N. Y.

FOR Sale: One new RCA 155-C 3-in. oscilloscope. \$85.00; one volume 15 Riders Service Manual, like new. \$13.00. Merlin Schumacher, Lonsdale, Wis.

AN/ART13 xmt, complete with tubes, L.F. unit and dynamotor. Excellent condition. Make cash offer or what have you to swap? Earl Erb, W9DWJ, 1024 W. Wisconsin Ave., Milwaukee 3, Wis.

FOR Sale, in New York area, Navy National KAOO, with speaker, Hammarlund HQ120X, 522 partly converted. Highest offer. Name your price. Jacob Dubinsky, W2LVR, 9404 Astoria Blvd., Jackson Heights, L.I. (Queens), N. Y.

FOR Sale: BC-348Q, 6AK5's in r.f. stage, separate r.f. and a.f. gain controls, noise limiter, S meter, speaker in separate case, power supply in speaker case, with technical manual. Excellent condition: \$100.00. BC654 with receiver vibrator supply, spare set of tubes, mike, speaker, power cable and technical manual, \$30.00; BC222 6 and 10-meter transceiver, with antenna and tech manual, \$20.00. Pair of new 810's, \$11.00. W6WIT.

SELL: Beautiful 900-watt AM-CW signal shifter, 813-304TL plug-in coils, 5 meters. Triplet modulation monitor, two 66" racks. First \$500 P.o.b. VHF station, \$55.00; 522 rack mounted, all AC power and AC powered broadband converter. Super 1 Kw power supply, 2200 volts, 1.8 amps, 110 or 220 input, all components, \$175.00; push-pull 807 amplifier, tubes, coils, three meters, rack mounted \$35.00; Two ART 13's, make offer. Receivers NC240-D, Q5'er, \$195; RBM complete, \$150.00 LM-7 Taylor 4-125-A final, etc. Make offer. Reason: Moving to smaller quarters. W4IWA, 904 Young St., Richmond, Va.

ALUMINUM tubing, angles, sheets, fittings for complete beam. Write for list. Willard Radcliff, Fostoria, Ohio.

VHF-152A, HF-10-20, DB22A. Bargains. Very slightly used. W8QJC, P.O. Box 218, Holland, Michigan.

SELL: UHF Resonator Co. pretuned 3-element 10-meter wide-spaced beam, complete with 18 feet of 3" dural mast, bearings, delta plates, etc. In original carton, never assembled. Paid \$100. Sacrifice at \$60.00. National Thordarson 300 V. modulator with multi-match, 2032's, etc. parts worth \$87.00, sell: \$45.00. Thordarson 15-watt speech amplifier \$25.00. Triplet 426 type 0-1 M.A., \$5.00; Sonar VFX-680, new plate transformer and choke R.M. Jones, W4WR, 1601 13th Court North, Birmingham 4, Alabama.

FOR Sale: New NC-183, complete with NBFM-83 and speaker. R. Carlton Stewart, Eau Gallie, Florida.

FOR Sale: The famous 167-BV bandswitching transmitter, brand-new, ready to operate on 2 to 24 Mcs. 800 watts CW, 600 watts 'phone, complete with precision VFO and 813's final in beautiful 68" cabinet, power supplies. This is a commercial rig! A buy at \$300. P.o.b. Omaha. Write for photo and details. W9IOS, 3352 N. 57th St., Omaha 4, Nebraska.

1000 watt desk-top compact phone/cw transmitter, precision VFO, plate modulated, clipper, filter, four power supplies, fully metered, shielded, 10-160 meters, with spare tubes. W3NJE, Box 11, Ivyland, Penna.

SELL BC348, converted with speaker, \$85, Charles Liese, 43-17 Howe St., Flushing, L. I., N. Y.

MEISSNER 150B transmitter, in excellent condition. No alterations: \$225.00. P.o.b. Hartford. Paul Comer, 360 Franklin Ave., Hartford, Conn.

QUICK sale: QSTS, \$1.00 per year, plus postage, 1931 thru 1944; 1939 thru 1945. Mrs. F. Hoffman, 47 Lywood Ave., Wheeling, W. Va.

SELL: Silver model 700, 144-240 Mc xmitter, with all tubes and Bliley 12 Mc xtal. \$20.00. W2HFM, 60 Lindgren St., Merrick, N. Y.

FOR Sale: Collins 75A receiver 6 months old, in excellent condition. First check over \$400.00 gets it. Dr. J. A. Selvidge, W0OMC, Poplar Bluff, Mo.

BEST offer takes Hammarlund four-20 transmitter, four-11 modulator, Hallicrafters S-40 receiver. All new. Sell separately or together. Ralph Atherton, Oxford, Ohio.

QSL, SWLS: Best by comparison! C. Fritz, 1213 Briargate, Joliet, Ill.

FOR Sale: One VHF 152A converter, \$65.00; one RME-45 receiver A-1 condition, \$75.00. W2ZGR, 2 Blue Ridge Road, Lodi, N. J.

BARGAINS: New and used transmitters, receivers, parts: Globe King, \$299.00; new 150 watt phone \$199.00; 60 watt phone \$99.00; Globe Trotter, \$75.00; R-9'er, \$15.00; Millen Exciter and VFO, \$25.00; TR-4, \$19.95; HT-9, \$295.00; MB-611, \$45.00; Silver 701, 800, 801, 802, \$29.50 ea.; NC-173, SX-28, \$149.00 ea.; NC-240C, HQ-129X, HRO, \$139.00 ea.; RME-45, SX-25, DB-22A, \$49.00 ea.; S-38, \$29.95, S-41 \$22.50; many others. Large stocks, trade-ins. Free trial. Terms financed by Leo, W0CFQ. Write for catalog and best deal to World Radio Labs, 740-42-44 West Broadway, Council Bluffs, Iowa.

SALE: BC312, 110 volt AC operation. In very good condition, \$40.00. Write to B. Coleman, Capt., 74th Engr. Bn., Camp Campbell, Ky. W4NVT.

SWAP: one 250TH, new; two 100TH new; one UTC VM4 model xmt, used; Want: LM or BC221 freq. meter or what have you. W. Harding, W3KEG, 3021 Fayette Rd., Kensington, Md.

QSL's SWL's "Kromekote" Geo. Beal, jr. W5OXL, 1417 North 36th, Ft. Smith, Arkansas.

SELL: Hallicrafters HT-6 transmitter complete with coils and ECO units 10 to 160 meters. New condition with instruction book. \$125.00. G. J. Killilea, W9ZLM, 314 Cameron Ave., La Crosse, Wis.

HALLICRAFTERS BC-610E, 500 watts phone, 750 watts c.w. all bands 10-80 meters, excellent condition, \$500. New spare parts, exciter deck, choke, ECO xtals, meter, etc. operation. \$75.00. Will accept HT-9 trade. W2BIG, 715 Pacific Ave., Atlantic City, N. J.

SELL: Hallicrafters SX-29, \$100.00; Collins ART-13, \$75.00; W2EXB, F. Fekel, Garden Road, Vineland, N.J.

BC-610E, used, with speech amplifier and antenna tuning unit, in excellent condition: \$550.00; VHF 152A, \$65.00; HT-13, \$85.00; BC-312 with crystal, \$65.00; WIPVB H. Olson, 2 Martha Ave., Worcester 5, Mass.

WANTED: To correspond with amateurs having information concerning conversion and power supply for an SCR-518-A. F. E. Cunningham, W9TZQ, 610 Center St., Waukegan, Ill.

FOR Sale: Antenna relays; Gordon No. 1000, Ward Leonard 507-531; transformers: Thordarson T19D4, 2-119F9D, 2-11A90, T83D21, T19F94, T19F99, Jensen J2155, UTC S48; neutralizing condensers; 2; Johnson N375, 2; Millen 15006. Make an offer. W4NT, Sutcliffe, 914 Jersey Ave., Winston-Salem, N. C.

ENGINEER, many years engaged in design and development of commercial and military communications equipment will design and produce commercial quality equipment for high-class amateurs at amateur prices. Submit performance specifications. Free cost estimate. Lexington Electronics, 118 Lexington Ave., Passaic, N. J.

MUST move. Selling out transmitting gear and parts for complete 750 watt rig, plus BC348Q receiver. \$180 takes all. Send for list. W6BKV, 1158 Sevier Ave., Menlo Park, Calif.

SWAP latest Bolex H-8 camera for Hallicrafters SX-62 speaker and/or other equipment. William Beska, 301 Pitch Road, Hatboro, Penna.

SELL: Vibroplex Champion, \$5.00; Triplet field-strength meter and 'phone monitor, \$10.00; BC-342 receiver, \$80.00; BC-459A, converted, less power supply (VFO, 150-watt 40 meter xmttr) \$25.00; frequency meter, KC-221-C, \$40.00; Code oscillator, key and head, phones, \$10.00; Astatic T-3 mike and stand, \$12.00. All inquiries answered. J. P. Brock, W9EWU, 606 Academy, Kalamazoo 46, Mich.

WESTON meter wanted. 0-25 Ma., 0-30 Ma., or 0-50 Ma., DC. Must be model 301 with seal unbroken. Will pay cash, or what do you want in trade? Albert E. Hayes, jr., c/o ARRL HQ, West Hartford 7, Conn.

SEVERAL 1000 Ma plate xfmrs V-Ct. 110 V 220 V primary. Fourteen (\$14.00) dollars each, or two for \$25.00. Also, BC-375E complete, converted to 110 V AC, \$25.00. F. Sutton, 145 Feeder St., Johnstown, Penna.

COMPLETE station! Hallicrafters HT-9, hand microphone, key, coils for 10, 20, 40, 80. Black crack finish. Being operated nightly. Bargain at \$199.00! Hammarlund HQ-129X with matching speaker. Very nice condition, \$129.00. Both for only \$299.00. Please write or phone for appointment. Seldom home before midnight. Telephone evenings only. Bayside 9-7423W. Suito, W2ZCS, (Ex-W9IJS), 58-47 215th Street, Bayside, L. I., N. Y.

HAVE a few spare plate transformers for 1 Kw final. Primary 115 volts, 60 cycles, secondary (1) 2400/2400 volts .6 ampere, secondary (2) 620/620 volts .5 ampere. 1.75 Kw va 3% regulation. Made by leading manufacturer and beautiful job. \$40.00. G. Philip Stout, 324 Broadmoor Road, Baltimore 12, Md.

QSLs, SWLS, Meade, W9KXL, 1507 Central Ave., Kansas City, Kans.

BC-610E, complete! all bands. Guaranteed A-1 condition, like new. Best offer over \$650.00 takes it. W8LR, Palmer, 511 S. Rosemary, Lansing 15, Mich.

CODE learned easily. Gardiner tape-sender, like new. Ten tapes, instructions, yours complete \$15.00. Malcolm Smith, 233 Orchard Drive, Kenmore, N. Y.

SWAP 68 new, tested receiver tubes in cartons, speakers, universal output transformers, wireless record player, set Supreme service manuals. Want ham gear, oscilloscope. Send for list. What have you? E. Evans, W9ECC, 450, Everett, Washington.

HALLICRAFTERS S-40A for sale for best offer over \$65.00. Original cover, W8CCJ, 26889 Lyndon, Detroit 23, Mich.

SELL HRO-S, 9 coils, 50 Kc to 30 Mc, 680, 697 power supplies, excellent condition, \$200.00. FBXA, 20, 40, 80 meter coils, 5897 supply \$40.00; Hallicrafters S-27, \$75.00; P.o.b. Norwood, Mass. W1KOA, H. A. Johnson, 12 Savin Avenue.

Designed for

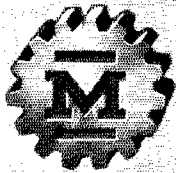

Application

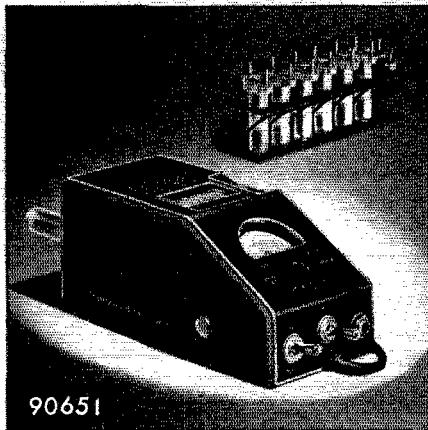

90651

**The No. 90651
GRID DIP METER**

The No. 90651 MILLEN GRID DIP METER is compact and completely self contained. The AC power supply is of the "transformer" type. The drum dial has seven calibrated uniform length scales from 1.5 MC to 270 MC with generous over laps plus an arbitrary scale for use with special application inductors. Internal terminal strip permits battery operation for antenna measurement.

**JAMES MILLEN
MFG. CO., INC.**

MAIN OFFICE AND FACTORY
**MALDEN
MASSACHUSETTS**



Index to Advertisers

Alliance Manufacturing Co.	119
Allied Radio Corporation	103
Almo Radio Company	120
American Lava Corporation	75
American Radio Institute	114
American Radio Relay League	92, 93
American Time Corporation	96
Ashe Radio Company, Walter	119
Astatic Corporation, The	115
Brill Company, W. D.	118
Browning Laboratories, Inc.	102
CRL School of Electronics, Inc.	121
Candler System Company	106
Capitol Radio Engineering Inst.	94
Cleveland Inst. of Radio Elec.	128
Collins Radio Company	2
Commercial Radio Institute	124
Cornish Wire Company	117
Eitel-McCullough, Inc.	79
Electric Eye Equipment Co.	104
Electronic Wholesalers, Inc.	109
Electro-Voice, Inc.	81
Federal Telephone & Radio Corp.	115
Gardiner & Company	108
General Radio Company	83
Hallcrafters Company, The	4, 7
Harrison Radio Corporation	113
Harvey Radio Company, Inc.	99
Henry Radio Stores	97
Hy-Lite Antennae, Inc.	127
Instructograph Company	104
Johnson Company, E. F.	84, 85, 86, 87
Jones Electronics Co., M. C.	116
Ken-Rad	1
Lambda Electronics Corp.	110
Leeds Radio Company	107
Mallory & Company, P. R.	77
Mass. Radio & Telegraph School	118
Millen Mfg. Co., Inc., James	126
Motorola, Inc.	112
Munger Company, Rex L.	114
National Company, Inc.	73, 88, 117, 122, Cov. III
Newark Electric Company	100
Ohmite Manufacturing Co.	91
P & H Sales Company	121
Petersen Radio Company	5
Port Arthur College	120
Precision Apparatus Co., Inc.	90
Premax Products Company	112
RCA Institutes, Inc.	121
Radio Corporation of America	Cov. IV
Radio Shack Corporation	101
Radio Transceiver Labs.	118
Srepco, Incorporated	117, 120
Steinberg's, Incorporated	98
Suburban Radio Company	121
Sun Radio of Washington	105
Sylvania Electric Products Co.	89
Terminal Radio Corporation	95
Turner Company, The	121
UHF Resonator Company	106
United Transformer Co.	Cov. II
Valparaiso Technical Institute	114
Vesto Company, The	116
Vibroplex Company, The	102
Wind Turbine Company	110
World Radio Laboratories	111

HY-LITE'S NEW

SKY-LITE

ALL GROUNDED ARRAY FOR 10-11 METERS

10-11 MTRS COMPLETE WITH "T" MATCH
(ALSO AVAILABLE IN 6 MTRS FOR STACKING ON SAME MAST
PRICES AND LITERATURE AVAILABLE ON REQUEST -)

\$24⁹⁵
NET

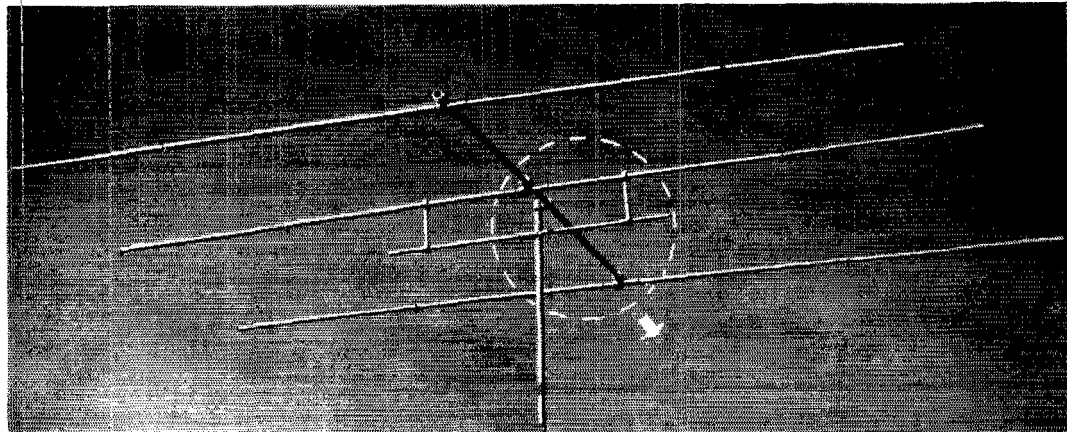

NOW EVERY HAM CAN OWN A BEAM

- STURDY • LIGHTWEIGHT
- ALL ALUMINUM • FULLY ADJUSTABLE ELEMENTS AND SPACING • 300 OHM FEED LINE RECOMMENDED
- WILL MATCH ANY FEED LINE FROM 50 TO 600 OHMS

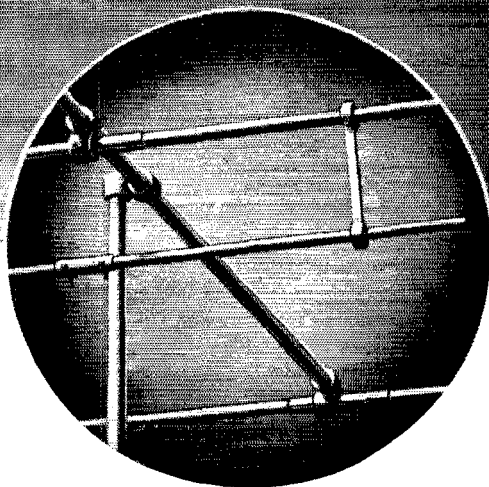

Hy-Lite—ever mindful of the high cost of materials and labor—has again put their designers to work to give the ham best for the least; this fine, sturdy, all-aluminum, all-grounded 3 element beam—the **Sky-Lite**. The **Sky-Lite** is the result of much experimentation and study. It was subjected to the rigors of last winter's storms and winds and has performed handsomely. It is now ready for you—the ham. We know it will "stand-up" and serve you faithfully, both physically and electronically. Combining all the many fine features of the "all-grounded" type array, the **Sky-Lite** is built with the utmost simplicity and is easily adjusted. The **Sky-Lite** weighs under 11 pounds, and is made of dural aluminum throughout. Mast included. Enjoy many hours of DX.

Remember HY-LITE for the finest in antennae

WRITE FOR CATALOG Q-6

HY-LITE Antennae INC.
Makers of Fine Antennas for AMATEUR · FM · TELEVISION
528 TIFFANY ST., BRONX 59, N.Y.



Make Your Hobby Into a GOOD PAYING JOB

Do you know over 50% of Broadcast Station Engineers started as hams? You can become a Broadcast Engineer easily — if you hold an FCC 1st class Commercial operator's license. Many other new jobs now open to FCC Commercial license holders. I can train you to pass your FCC Commercial License Exams in a few short weeks. My time-proven plan can help put you, too, on the road to success. I'll send you the entire story free of charge. Mail coupon for full information today.

Edw. H. Guilford, Vice-President

YOU, too, may EARN \$3,000 to \$7,500 yearly

ADD TECHNICAL TRAINING TO YOUR HAM EXPERIENCE AND

Get Your FCC COMMERCIAL RADIO OPERATOR LICENSE in a Few Short Weeks

It's EASY if you use CIRE Simplified Training and Coaching AT HOME in SPARE TIME

Thousands of new jobs are opening up — FM, Television, Mobile Communication Systems. These are only a few of the radio fields which require Licensed radio technicians and operators. Get your license without delay. Let Cleveland Institute prepare you to pass FCC License examinations, and hold the jobs which a license entitles you to, with CIRE streamlined, post-war methods of coaching and training. Your FCC ticket is always recognized in all radio fields as proof of your technical ability.

Look what Broadcast Engineers Earn

(Average Pay Reported by FCC Nationwide Survey)

Position	Big Stations	Little Stations
Transmitter Engineer	\$4800	\$3000
Studio Engineer	5000	3650
Chief Engineer	7700	4300

CLEVELAND INSTITUTE OF RADIO ELECTRONICS
Desk QT-6 4900 Euclid Building, Cleveland 3, Ohio
(Address to Desk No. to avoid delay)

I want to know how I can get my FCC Commercial ticket in a few short weeks by training at home in spare time. Send me your FREE booklet "Money Making FCC License Information," as well as a sample FCC-type exam and FREE booklet, "How to Pass FCC License Examinations" (does not cover exams for Amateur License.)

Name.....

Address.....

City..... Zone..... State.....

Veterans check for enrollment information under G.I. Bill
NO OBLIGATION — NO SALESMEN



Get This Amazing New Booklet

1. TELLS OF THOUSANDS OF BRAND-NEW, BETTER-PAYING RADIO JOBS NOW OPEN TO FCC LICENSE HOLDERS.
2. TELLS HOW YOU WILL BENEFIT BY HOLDING AN FCC COMMERCIAL LICENSE.
3. TELLS HOW YOU CAN GET YOUR FCC COMMERCIAL RADIO OPERATOR LICENSE IN A FEW SHORT WEEKS — EASILY AND QUICKLY, BY USING CIRE SIMPLIFIED TRAINING AND COACHING AT HOME IN YOUR SPARE TIME.
4. TELLS OF HUNDREDS OF OUR SUCCESSFUL STUDENTS WHO NOW HAVE LICENSES AND NEW, BETTER-PAYING JOBS.
5. TELLS HOW WE PREPARE YOU TO PASS THE NEW FCC COMMERCIAL LICENSE EXAMINATIONS, WHICH NOW INCLUDE FM AND TELEVISION.
6. TELLS HOW WE GUARANTEE TO TRAIN AND COACH YOU UNTIL YOU GET YOUR LICENSE.
7. TELLS HOW WE HELP YOU TO GET A BETTER-PAYING, LICENSED JOB, WITH OUR FREE AND EXCLUSIVE SERVICE, WHICH PREPARES YOUR EMPLOYMENT APPLICATION FOR MAILING TO HUNDREDS OF EMPLOYERS, INCLUDING FM, AM AND TELEVISION BROADCAST STATIONS, RADIO MANUFACTURERS, POLICE RADIO STATIONS, AND RADIO-EQUIPPED TAXI, BUS AND PUBLIC UTILITY COMPANIES.

Get All 3 FREE

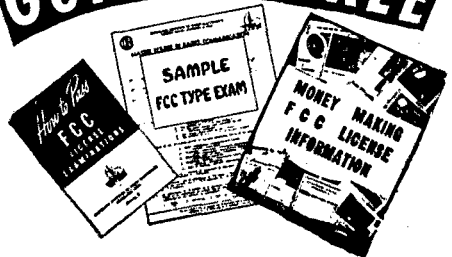

APPROVED FOR VETERAN TRAINING UNDER "G.I. BILL OF RIGHTS"

1

ST in service . . . in re-sale value

Why do National receivers still establish DX records after 10 or 15 years of service? Why — when you're ready to buy a new National — does your old one bring a higher re-sale price? Because National receivers are National-built (not just assembled), using National components specifically designed to out-perform and out-last commercially available substitutes. This tuning condenser — from the NC-183 — is a typical example.

NC
RECEIVERS

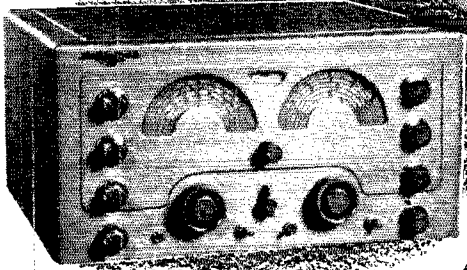
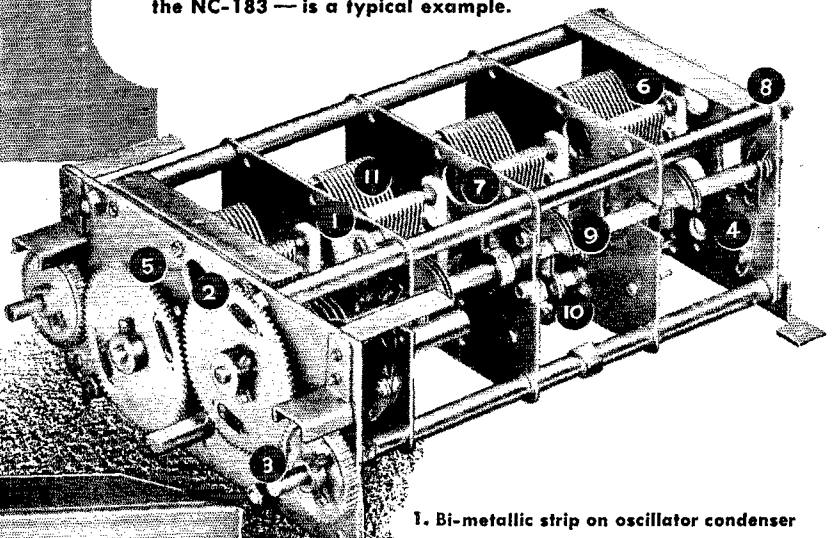

NC-183 FEATURES

540 kc to 31 mc plus 48-56 mc coverage. Bandspread over entire range — calibrated on amateur bands. Two high gain RF stages. Image rejection 40 db at 30 mc. Variable threshold noise limiter. Crystal filter provides 6 steps of selectivity from 4 mc bandwidth to 250 cycles. S-meter with adjustable sensitivity. Temperature compensation and voltage regulation. Push-pull 10-watt audio stage with phono input and tone control. NFM adaptor socket.

\$268

less speaker
(slightly higher west of the Rockies)

- 1. Bi-metallic strip on oscillator condenser compensates for capacity changes caused by radiant heat. Minimizes drift and warm-up time.
- 2. Spring-loaded gears eliminate backlash.
- 3. 5-to-3 ratio on main tuning and bandspread provides vernier action on both.
- 4. Grounding spring in front of every condenser reduces RF resistance, assures quiet operation at highest frequency.
- 5. Ball-bearing at front.
- 6. Conical bearing with tension adjustment at rear.
- 7. Condenser sections shielded from each other.
- 8. Rigid construction eliminates instability.
- 9. Bandspread construction identical to large condensers.
- 10. Antenna trimmer condenser for line match.
- 11. Plate serration for individual capacitor adjustment.

national

©  1914

NATIONAL COMPANY, Inc.
MALDEN, MASSACHUSETTS



The Fountainhead of Modern Tube Development is RCA

In plate-modulated finals it's safety factor that counts . . . and RCA tubes have it

A FINAL AMPLIFIER TUBE in plate-modulated service is subjected to plate voltage peaks approximately *four times* the dc plate supply voltage. Plate voltage and plate current peaks are *double* those encountered in unmodulated service, and input power peaks *four times* as high. No wonder, then, that in plate-modulated finals it's *safety factor* that counts.

RCA power tubes have the extra safety factor required for the most rigorous service . . .

ample reserve of cathode emission to satisfy modulation peaks . . . husky grid structures that permit ample drive without causing grid emission . . . high-voltage insulation.

High safety factor is one of the reasons why experienced phone men . . . and cw men, too . . . use RCA power tubes where the going is tough. To get all the tube power, performance, and life *you* pay for—buy genuine RCA tubes in the familiar red-black-and-white cartons from your local RCA tube supplier



RADIO CORPORATION of AMERICA
ELECTRON TUBES

HARRISON, N. J.