

June, 1947  
35 Cents

# QST

devoted entirely to

# amateur radio

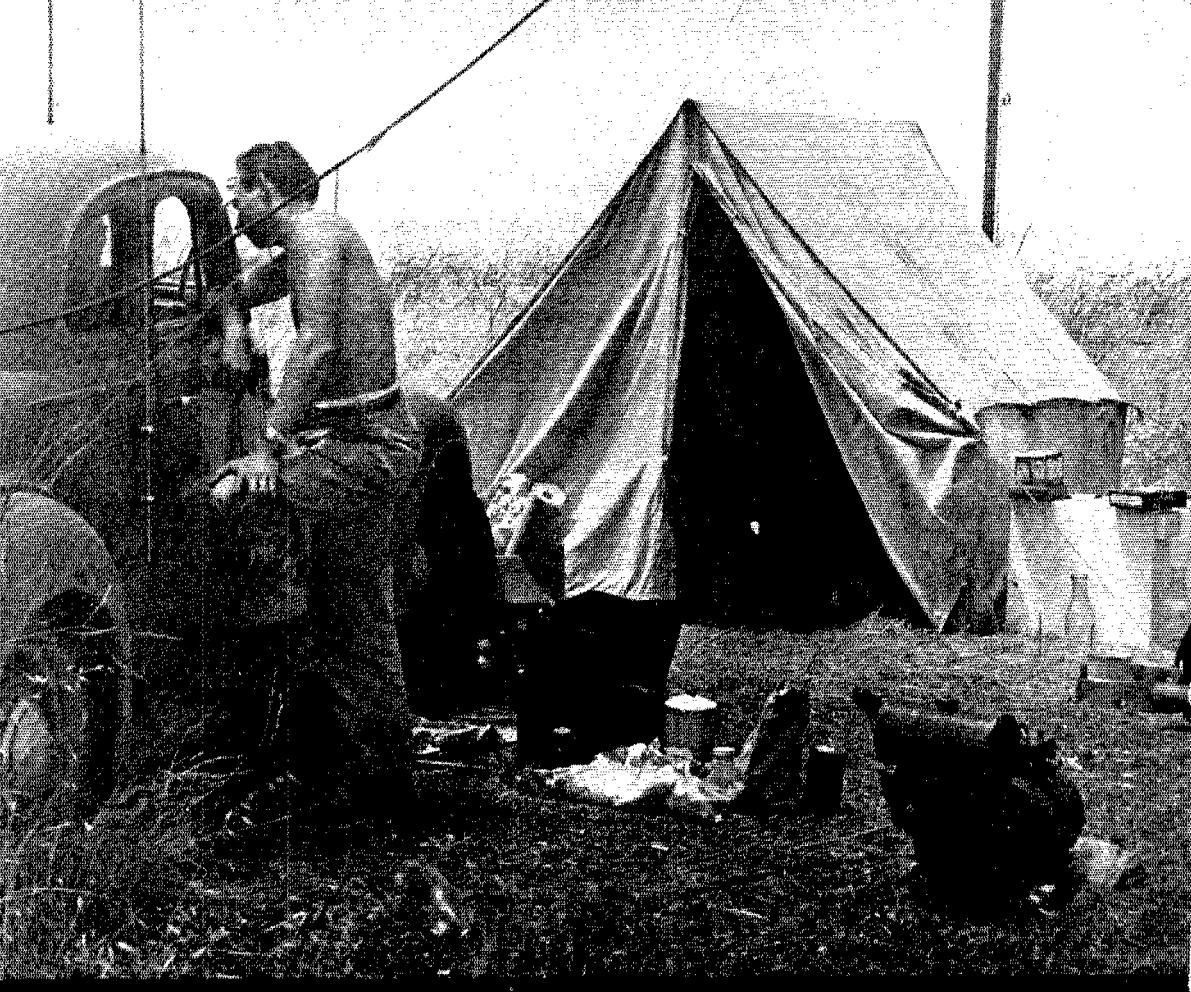

A. R. E. FIELD DAY—JUNE 14, 15, 1947

# LS SERIES

## The Ultimate in Quality

UTC Linear Standard Audio Transformers represent the closest approach to the ideal component from the standpoint of uniform frequency response, low wave form distortion, high efficiency, thorough shielding and utmost dependability. Wartime restrictions having been lifted, and UTC production running at full capacity, we now offer these transformers for immediate delivery.

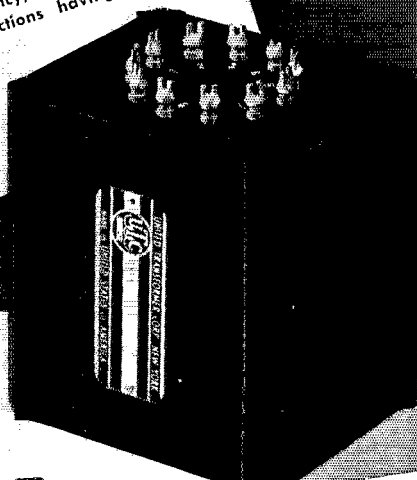

### UTC Linear Standard Transformers feature...

- **True Hum Balancing Coil Structure**... maximum neutralization of stray fields.
- **Balanced Variable Impedance Line**... permits highest fidelity on every tap of a universal unit... no line reflections or transverse couplings.
- **Reversible Mounting**... permits above chassis or sub-chassis wiring.
- **Alloy Shields**... maximum shielding from induction pickup.
- **Multiple Coil, Semi-Toroidal Coil Structure**... minimum distributed capacity and leakage reactance.
- **Precision Winding**... accuracy of winding .1%, perfect balance of inductance and capacity; exact impedance reflection, material.
- **Hiperm-Alloy**... a stable, high permeability nickel-iron core material.
- **High Fidelity**... UTC Linear Standard Transformers are the only audio units with a guaranteed uniform response of  $\pm 1.5$  DB from 20-20,000 cycles.

For Immediate Delivery

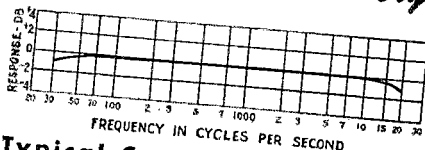

Typical Curve for LS Series

Type No.	Application	Primary Impedance	Secondary Impedance	Max. Level	Relative hum-pickup reduction	Max. unbalanced DC in primary	List Price
LS-10	Low impedance mike, pick-up, or multiple line to grid.	50, 125, 200, 250	60,000 ohms in two sections				
LS-10X	As above	333,500 ohms		+15 DB	-74 DB	5 MA	\$25.00
LS-21	Single plate to push pull grids	As above	135,000 ohms; turn ratio 1.5:1 each side, Split Pri. and Sec.	+14 DB	-92 DB	5 MA	\$32.00
LS-30	Mixing, low impedance mike, pick-up, or multiple line to multiple line	50, 125, 200, 250	50, 125, 200, 250, 333, 500 ohms	+17 DB	-74 DB	0 MA	\$24.00
LS-30X	As above	333, 500 ohms				5 MA	\$25.00
LS-50	Single plate to multiple line	As above	As above	+15 DB	-92 DB	3 MA	\$32.00
LS-55	Push pull 2A3's, 6A5G's, 300A's, 275A's, 6A3's	8,000 to 15,000 ohms	50, 125, 200, 250, 333, 500 ohms	+17 DB	-74 DB	1 MA	\$24.00
LS-57	Same as above	5,000 ohms plate to plate and 3,000 ohms plate to plate	500, 333, 250, 200, 125, 50, 30, 20, 15, 10, 7.5, 5, 2.5, 1.2	+36 DB			\$28.00
		5,000 ohms plate to plate and 3,000 ohms plate to plate	30, 20, 15, 10, 7.5, 5, 2.5, 1.2	+36 DB			\$20.00

The above listing includes only a few of the many units of the LS Series. For complete listing - write for catalogue.

**United Transformer Corp.**

150 VARICK STREET

NEW YORK 13, N. Y.

EXPORT DIVISION: 13 EAST 40th STREET, NEW YORK 16, N. Y.,

CABLES: "ARLAB"

# PLANNING TO GO TO BEAM POWER?

Here's **VALUE** in a low-cost  
beam power tube with wallop!  
(450 w CW input for a pair.)



THE HIGH WATTS-PER-DOLLAR  
**GL-814**



**N**OW that the winter-spring flurry of DX-operating is over, summer finds amateurs ready to rebuild in order to get greater range, a cleaner signal, or some other desirable result.

Is a change to beam power part of your program? Beam power means low drive. A tube of this type "makes the electrons behave," so that maximum output is attained with reduced driving power.

The question arises . . . which tube? Probably a majority of hams prefer a medium-power transmitter calling for a beam power tube in the "average" input-output class. The GL-814 falls directly within this area, with input of 225 w when used singly, and nearly 1/2 kw input in push-pull.

The GL-814's economical price—your G-E tube distributor will be glad to give you the exact figure—makes it a smart "buy". And G-E quality manufacture, G-E painstaking inspection and testing, ensure that you will get 100 cents *plus* of dependable service for every dollar you invest. Check into the value-giving GL-814 beam power tube today! *Electronics Department, General Electric Company, Schenectady 5, New York.*

The best and quickest way to secure G.E.'s popular, helpful Ham News—now eight pages in size—is to see your G-E tube distributor. He has your free copy of the latest issue waiting for you. Furthermore . . . he will give you the prices of tubes mentioned in the magazine, and often can assist with information or advice where this would prove helpful. Remember—your G-E distributor is local ham-tube headquarters!

ELECTRICAL CHARACTERISTICS	
Filament voltage	10 v
current	3.25 amp
Interelectrode capacitances:	
grid-plate	0.15 mmfd
input	13.5 mmfd
output	13.5 mmfd
Frequency at max ratings	30 mc
Ratings for typical operation (ICAS) r-f oscillator, Class C telegraphy	
Plate voltage	1,500 v
Screen voltage	300 v
Grid voltage	—90 v
Plate current	150 ma
Power output	160 w

ELECTRONIC TUBES OF ALL TYPES FOR THE RADIO AMATEUR

**GENERAL**  **ELECTRIC**

101-F12-0050

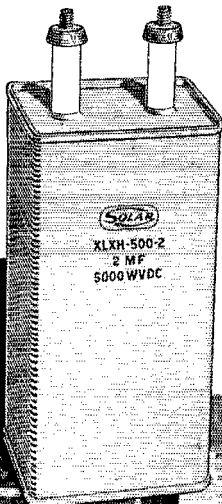

**LARGE**

or

**SMALL**



**SOLAR CAPACITORS TYPIFY**

**"QUALITY ABOVE ALL"**



Whether you need mica, paper or electrolytic capacitors for the rig you're building or for replacement in present equipment, Solar's complete line is tops to choose from.

Built to rigid specifications, and to stand-up under the most severe service and operating conditions, Solar capacitors are the obvious choice for dependability.

Get the Solar catalog for your shack today.



**CAPACITOR SALES CORP.**  
285 MADISON AVENUE • NEW YORK 17, N. Y.



PUBLISHED, MONTHLY, AS ITS OFFICIAL ORGAN, BY THE AMERICAN RADIO RELAY LEAGUE, INC., AT WEST HARTFORD, CONN., U. S. A.; OFFICIAL ORGAN OF THE INTERNATIONAL AMATEUR RADIO UNION

### STAFF

#### Editorial

KENNETH B. WARNER, W1EH  
(Managing Secretary, ARRL)  
Editor

HAROLD M. MCKEAN, W1CEG  
Assistant to the Editor

GEORGE GRAMMER, W1DF  
(Technical Director, ARRL)  
Technical Editor

DONALD H. MIX, W1TS  
BYRON GOODMAN, W1DX  
Assistant Technical Editors

EDWARD P. TILTON, W1HDQ  
V.H.F. Editor

RICHARD M. SMITH, W1FTX  
C. VERNON CHAMBERS, W1JEQ  
JOHN W. PADDOON, VE3BLZ

#### Technical Assistants

JOSEPH E. GRAHN, W1CH  
Contributing Editor, "How's DX?"

WALTER E. BRADLEY, W1FWH  
Technical Information Service

#### Production

RALPH T. BEAUDIN, W1BAW  
Superintendent

NANCY P. PORTEUS  
Assistant

#### Advertising

F. CHEYNEY BEEKLEY, W1GS  
LORENTZ A. MORROW, W1VG  
EDGAR D. COLLINS

#### Circulation

DAVID H. HOUGHTON  
Circulation Manager

RALPH T. BEAUDIN, W1BAW  
Assistant Circulation Manager

### OFFICES

38 La Salle Road  
West Hartford 7, Connecticut

Subscription rate in United States and Possessions, \$2.50 per year, postpaid; \$3.00 in the Dominion of Canada, \$4.00 in all other countries. Single copies, 35 cents. Foreign remittances should be by international postal or express money order or bank draft negotiable in the U. S. and for an equivalent amount in U. S. funds.

Entered as second-class matter May 29, 1919, at the post office at Hartford, Connecticut, under the Act of March 3, 1879. Acceptance for mailing at special rate of postage provided for in section 1103, Act of October 3, 1917, authorized September 9, 1922. Additional entry at Concord, N. H., authorized February 21, 1929, under the Act of February 28, 1925.

Copyright 1947 by the American Radio Relay League, Inc. Title registered at U. S. Patent Office.

## CONTENTS

"It Seems to Us . . ."	11
Our Cover . . . . .	12
Feedback . . . . .	12
Overmodulation Splatter Suppression <i>Oswald G. Villard, jr., W6QYT</i>	13
A New Noise-Reducing System for C.W. Reception <i>Don L. Hings, VE7BH</i>	21
Multielement Radiators in Close-Spaced Arrays <i>G. N. Carmichael, W4GCA/9</i>	24
Southeastern Division Convention	26
Happenings of the Month . . . . .	27
Technical Topics "Why Don't they Build Better Receivers?" . . . . .	31
An Antenna for 7-Mc. DX <i>Richard R. Schellenbach, W6TKX</i>	32
The Eleventh ARRL Field Day . . . . .	33
The Dialless Converter . <i>James H. Creutz, W2PMQ and Donald F. McAvoy, W2PRT</i>	34
Choosing a Transmission Line . <i>R. M. Purinton, W9SZ</i>	39
Foreign Notes . . . . .	43
Amateurs and the United Nations . . . . .	46
F.M. on Two Meters . . . . . <i>J. C. Geist, W2STZ</i>	48
Thirteenth ARRL Sweepstakes Results . . . . .	51
The "Barracks Bag VFO" . . . . . <i>F. R. Nichols, W6JJI</i>	54
The 13th ARRL DX Contest — High 'Phone Scores . . . . .	56
Silent Keys . . . . .	56
How's DX? . . . . .	57
Massachusetts State Convention . . . . .	59
Adapting the Car Radio to a Converter <i>Basil C. Barbee, W5FPJ</i>	60
The World Above 50 Mc. . . . .	62
'Phone Spoutin' . . . . . <i>Sourdough</i>	66
In QST 25 Years Ago This Month . . . . .	67
Hints and Kinks . . . . .	68
Correspondence from Members . . . . .	69
Operating News . . . . .	70
Station Activities . . . . .	78
Hamfest Calendar . . . . .	112
WVW Schedules . . . . .	154

# WANTED

## One highly qualified amateur operator to accompany the Gatti-Hallicrafters Expedition to the Mountains of the Moon in Africa

---

**I**N the fall of 1947 the Hallicrafters Company of Chicago will launch a spectacular, six months' radio-equipped expedition to the romantic Mountains of the Moon in the heart of Africa's Belgian Congo. The commander of the expedition is Attilio Gatti, famed author and explorer, veteran of ten previous African expeditions. Heart of the expedition will be mobile radio units similar to the famous SCR-299's and 399's developed by Hallicrafters during the war. The expedition will establish a base camp, 6500 feet up the slopes of the Ruwenzori Range, some 30 miles W.S.W. from Fort Portal. The camp will be centered around a stationary radio shack from which regular schedules will be kept with all parts of the world describing the progress of the expedition, the nature of its findings and all the other glamorous details surrounding this scientific safari. From the base camp the mobile radio

units will travel in all directions as the explorers extend their investigations into all phases of the flora and fauna of the Mountains of the Moon. The expedition's helicopter will carry a Hallicrafters Skyfone. Marine transmitters will be installed in the expedition's floating craft, completing a land, sea and air radio network that will wring new secrets from the jungle and relay them to the world. Amateurs all over the globe, will be in regular contact with the expedition as it operates through the last three months of '47, the first three months of '48. Prefixes like OQ5 for the Belgian Congo, VQ5 for the Uganda Protectorate, VQ4 for Kenya Colony, VQ3 for Tanganyika territory and VQ1 for the Zanzibar Protectorate will become more familiar than ever to the hams who know the thrills that come with successful long distance communications.

Since the central scientific core of the expedition is radio and radio experimentation and the main intent is to stimulate further international recognition of all amateur radio, the key figure, next to Commander Gatti, will be the amateur radio operator chosen to keep the expedition in touch with the outside world during its six months of operation. The Hallicrafters Co. is therefore inviting applications for this fascinating assignment from amateur radio operators in accordance with the terms of application and selection as set forth on the opposite page. This invitation is made exclusively in the pages of QST.

*Deadline July 1*

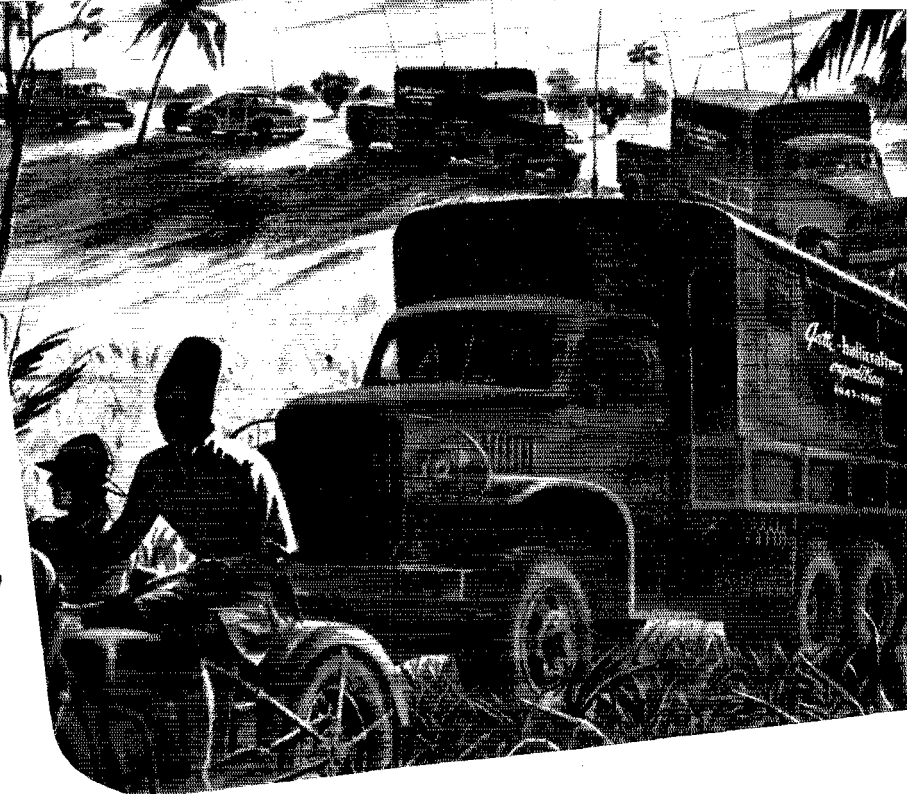

## REQUIRED QUALIFICATIONS . . .

### Conditions for application and acceptance

Licensed amateurs in the United States and Possessions are eligible to apply for assignment as official operator to accompany the Gatti-Hallicrafters expedition to Africa.

All applications are to be made in writing to the Hallicrafters Co., 4401 West Fifth Avenue, Chicago, Illinois.

Letters must be limited to 250 words. Snapshot or suitable photo must accompany letter. Neatness and legibility of your letter will help your case but "fancy" entries or elaborate presentations will be discounted.

Your letter must state your qualifications for the job with specific reference to your radio experience. In addition you can state any added qualifications that might make you a valuable expedition assistant: flying, photography, etc. Qualifying candidate must be able to pass a physical examination.

All candidates must hold a Class "A" amateur ticket and the applicant finally selected must have or be able to qualify for (by June 20th) a second class commercial telegraph ticket and an ARRL code proficiency certificate.

For the applicant finally selected the Hallicrafters Co. will pay all expenses to and from his place of residence for the duration of the expedition, approximately six months. The Hallicrafters Co. will provide complete insurance coverage on

the life and health of the candidate selected and a moderate salary will be paid during the term of employment.

The applicant chosen will become part of a specialized corps of engineers, photographers, pilots and other technicians under the direction of Commander Gatti.

Applications for this assignment will be passed on by a Board of Review. Attilio Gatti, leader of the expedition, and W. J. Halligan, president of the Hallicrafters Company will serve on this board. F. E. Handy, Communications Manager of the ARRL, acting on behalf of the American amateurs who will be in radio contact with the expedition, has agreed to consult with the Board of Review when the successful applicant is being chosen.

Final selection will be made from a group of six applicants chosen by the Board of Review. The five finalists not selected for the assignment each receive a Model SX-42 communications receiver and matching speaker (net value more than \$300.00).

No letters of application will be returned and under no circumstances will the Board members enter into correspondence regarding your application or talk with you in person or on the phone concerning it. Decision of the Board will be final and announcement of the candidate selected will be made as soon as practical after the deadline, July 1st.

MEMBERS OF

Skystone

INITIATION RADIOTELEPHONE

# hallicrafters RADIO

THE HALLICTRAFTERS CO., MANUFACTURERS OF RADIO  
AND ELECTRONIC EQUIPMENT, CHICAGO 16, U. S. A.

Sole Hallicrafters Representatives in Canada:  
Rogers, Majestic, Limited, Toronto, Montreal

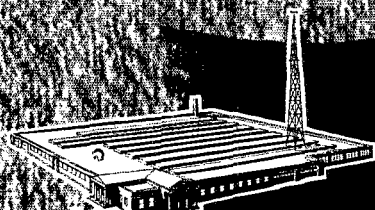

## Section Communications Managers of the ARRL Communications Department

Reports Invited. All amateurs, especially League members, are invited to report station activities on the first of each month (for preceding month) direct to the SCM, the administrative ARRL official elected by members in each Section. Radio Club reports are also desired by SCMs for inclusion in QST. All ARRL Field Organization appointments are now available to League members. These include ORS, OES, OPS, OO, and OBS. Also, where vacancies exist SCMs desire applications for SEC, EC, RM, and PAM. In addition to station and leadership appointments for Members, *all amateurs* are invited to join the ARRL Emergency Corps (ask for Form 7).

ATLANTIC DIVISION			
Eastern Pennsylvania	W3BES	Jerry Mathis	623 Crescent Ave.
Maryland-Delaware-D. C.	W3BWT	Enna W. Darne	132 Tennessee Ave., N.E.
Southern New Jersey	W2GCU	Raf Tomlinson	623 E. Brown St.
Western New York	W2JPH	Charles L. Otero	4138 Ridge Road, West
Western Pennsylvania	W3KWL	Ernest J. Hlinsky	509 Beechwood Ave.
CENTRAL DIVISION			
Illinois	W9AND	Wesley E. Marriner	624 College Ave.
Indiana	W9SWH	Ted K. Clifton	550 Eben St.
Wisconsin*	W9DKH	Ralph Klein	1106 Manitou St., R.F.D. 3
DAKOTA DIVISION			
North Dakota	W0EVP	Raymond V. Barnett	406 17th St.
South Dakota	W0QVY	P. H. Schultz	118 N. Vankton Ave.
Minnesota	W0CWB	Walter G. Hasskamp	116 3rd Ave., S.W.
DELTA DIVISION			
Arkansas	W5JIC	Marshall Riggs	4405 Howell Ave.
Louisiana	W5V7	W. J. Wilkinson, jr.	Room 313, Jefferson Hotel
Mississippi	W5IGW	Harold Day	Route 1, Box 111
Tennessee	W4FLS	James W. Watkins	220 North Howell St.
GREAT LAKES DIVISION			
Kentucky	W5IEZ/4	Joseph P. Colvin	1653 Beechwood Ave.
Michigan	W8SCW	Joseph R. Beljan, jr.	13059 Tuller Ave.
Ohio	W8PNQ	William D. Montgomery	1290 Coolidge Ave.
HUDSON DIVISION			
Eastern New York	W2HZL	Ernest E. George	3044 Lexington Parkway
N. Y. C. & Long Island	W2KDC	Charles H. Harn, jr.	151-06 84th Drive
Northern New Jersey	W2IIN	John J. Vitale	57 Sayre St.
MIDWEST DIVISION			
Iowa	W9PJR	Leslie B. Vennard	2712 Washington St.
Kansas	W0AWP	Alvin B. Unruh	842 N. Terrace Drive
Missouri	W0GUD	Mrs. Letha A. Dangerfield	411 Moffett Ave.
Nebraska	W0POB	Roy E. Olmsted	101 Artkari Ave.
NEW ENGLAND DIVISION			
Connecticut	W1KQV	Edmund R. Fraser	90 Atwater St.
Maine	W1GKS	F. Norman Davis	RFD 1
Eastern Massachusetts	W1ALP	Frank L. Baker, jr.	91 Atlantic St.
Western Massachusetts	W1AZW	Prentiss M. Bailey	62 Dexter St.
New Hampshire	W1AXL	John H. Stoughton	RFD 2
Rhode Island	W1HRC	Clayton C. Gordon	70 Columbia Ave., Gaspee
Vermont	W1NDL	Gerald Benedict	23 Foster St.
NORTHWESTERN DIVISION			
Alaska	K7CBF	August G. Hiebert	c/o KFAR
Idaho	W7WU	Alan K. Ross	1017 East Jefferson St.
Montana	W7EGM	Albert Beck	2226 Amherst Ave.
Oregon	W7HAZ	Raleigh A. Munkres	Box 744
Washington*	W7EHQ	Lloyd Norberg	P. O. Box 281
PACIFIC DIVISION			
Hawaii	KH6EL	John Souza	Box 2025
Nevada	W7CXN	N. Arthur Sowie	1061 Fremont St.
Santa Clara Valley	W6BPT	Roy E. Pinkham	414 Fairmount Ave.
East Bay	W6JH	Horace R. Greer	215 Knowles Ave.
San Francisco	W6NL	Samuel C. Van Liew	5240 Jay St.
Sacramento Valley	W6MGC	John R. Kinney	25 Roosevelt Road
Philippines*	KA1CB	Craig B. Kennedy	San Francisco Del Monte
San Joaquin Valley	W6PSQ	James F. Wakefield	2940 Adoline Ave.
ROANOKE DIVISION			
North Carolina	W4CVB	W. J. Wortman	c/o Duke Power Co.
South Carolina	W4BOE/ANG	Ted Ferguson	3422 Rosewood Drive
Virginia	W4HKR	Walter R. Bullington	1120 Oak Hill Lane, Rt. 1,
West Virginia	W8JM	Donald B. Morris	303 Home St.
ROCKY MOUNTAIN DIVISION			
Colorado	W0QVT	Glen Bond	2550 Kendall
Utah-Wyoming	W7LLH	Victor Drabble	1024 Oak St.
SOUTHEASTERN DIVISION			
Alabama	W4GBV	Lawrence J. Smyth	808 Winona Ave.
Eastern Florida*	W4BVF	W. E. MacArthur	899 N. E. 92nd St.
Western Florida	W4MS	L. Comdr. Edward J. Collins	1003 East Blount St.
Georgia	W4HYW	Thomas M. Moss	570 Oak Drive
West Indies* (Cuba-P.R.-V.I.)	KP4ED	Everett Mayer	P. O. Box 1061
SOUTHWESTERN DIVISION			
Los Angeles	W6QWZ	Ben W. Onstenk	9631 3rd Ave.
Arizona	W7MLL	Gladden C. Elliott	1408 West Fresno St.
San Diego	W6GC	Irvin L. Emig	4852 Marlborough Drive
WEST GULF DIVISION			
Northern Texas	W5DAS	N. C. Settle	2911 Elm St.
Oklahoma	W5HXI	Bert Weidner	Box 14
Southern Texas	W5HIF	Ted Chastain	3037 So. Staples St.
New Mexico	W5HJF	J. G. Hancock	110 S. E. Nevada St.
MARITIME DIVISION			
Maritime (Nfld. & Labr. att.)	VE1DQ	A. M. Crowell	69 Dublin St.
ONTARIO DIVISION			
Ontario	VE3DU	David S. Hutchinson	827 Lovett St.
QUEBEC DIVISION			
Quebec	VE2SU	Gordon F. J. Phelan	4829 Isabella Ave.
VANALTA DIVISION			
Alberta	VE6LQ	W. W. Butchart	10740-107 St.
British Columbia	VE7WS	W. W. Storey	3915 W. 32nd Ave.
Yukon	VE8AK	W. R. Williamson	P. O. Box 137
PRAIRIE DIVISION			
Manitoba	VE4AM	A. W. Morley	26 Lennox St.
Saskatchewan	VE5CO	Norman Thompson	1120 7th Ave., N. W.

\*Officials appointed to act temporarily in the absence of a regular official.



*A Tribute*  
**TO RADIO AMATEURS  
IN THE  
STRICKEN TEXAS CITY AREA**

● ONCE AGAIN the radio amateur has rendered valuable emergency service in time of disaster. Official news dispatches which came out of the stricken Texas City area immediately following the terrific explosions and fires of a few weeks ago, told repeatedly of the heroic work performed by radio amateurs. In summoning doctors, nurses, medical supplies and help of all kinds; in directing rescue work; issuing warnings and otherwise giving necessary aid, ham rigs were kept constantly open for the sending and receiving of radio communications. Certainly your fellow short-wave enthusiasts, The Astatic Corporation and good people everywhere appreciate your work in the tragic hour of Texas City's recent holocaust.

THE *Astatic* CORPORATION  
ASTATIC CONNEAUT, OHIO

IN CANADA: CANADIAN ASTATIC LTD. TORONTO, ONTARIO

Astatic Crystal Devices Manufactured  
under Brush Development Co. patents.

# GRID MILS tell the story!

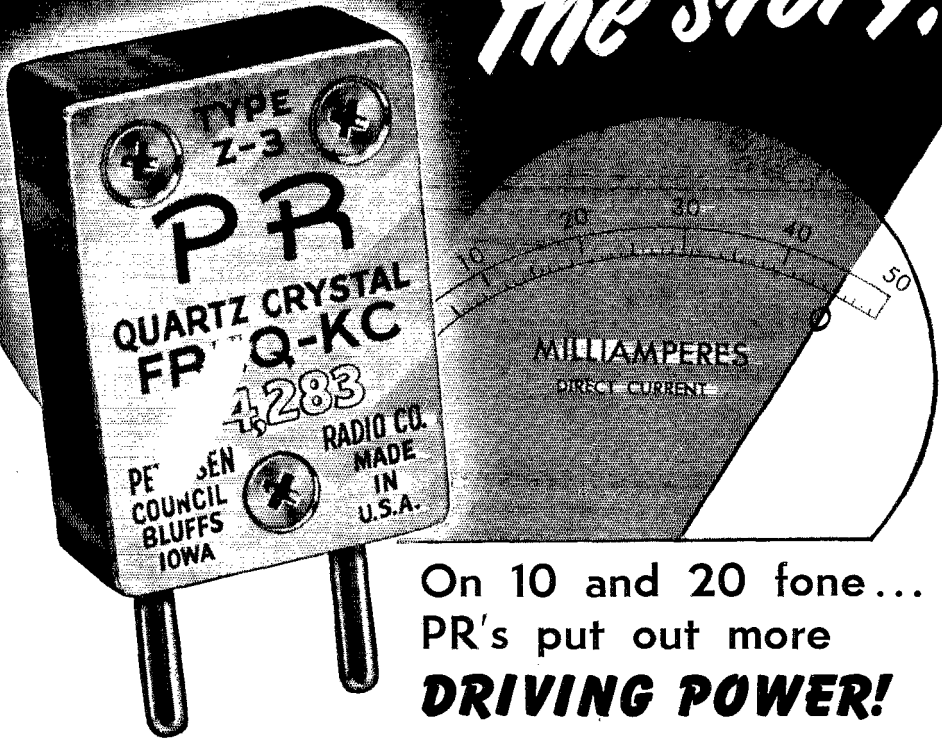

On 10 and 20 fone...  
PR's put out more  
**DRIVING POWER!**

On the higher frequency fone bands DRIVE is the problem! Plenty of grid mils to the final means top efficiency... full modulation capability... longer life for the big bottles... more watts in the antenna. Drive begins with your crystal stage! That's why rugged PR Precision Crystals are designed to deliver high power output under gruelling amateur conditions... negligible drift

over wide temperature range... amazing activity... sealed against contamination and moisture... accurately calibrated. Yes, low cost PRs deliver MORE POWER! Available from your jobber for all bands, including ten and eleven! Every crystal unconditionally guaranteed! — Manufactured by PETERSEN RADIO CO., INC., 2800 WEST BROADWAY, COUNCIL BLUFFS, IOWA. (Telephone 2760.)

SINCE 1934

# PR Precision CRYSTALS



10 METERS PR Type Z-5.	Harmonic oscillator. Ideal for "straight through" mobile operation. High activity. Heavy drive without damage in our special circuit ..... \$5.00
20 METERS PR Type Z-3.	Harmonic oscillator. Low drift. High activity. Can be keyed in most circuits. High power output. Just as stable as fundamental oscillators ..... \$3.50
40 & 80 METERS PR Type Z-2.	Rugged, low drift fundamental oscillators. High activity and power output with maximum crystal currents. Accurate calibration \$2.65



The most  
complete  
line of  
Loud Speakers  
and Reproducers  
is illustrated  
and described  
in the new  
**Jensen**  
catalog



JENSEN MANUFACTURING CO.  
6811 SOUTH LAHARIE  
CHICAGO 38, ILLINOIS

Please send me a copy of the 1947 Jensen catalog as  
soon as it comes from the press.

NAME \_\_\_\_\_

ADDRESS \_\_\_\_\_

CITY \_\_\_\_\_ ZONE \_\_\_\_\_ STATE \_\_\_\_\_

# THE AMERICAN RADIO RELAY LEAGUE, INC.,

is a noncommercial association of radio amateurs, bonded for the promotion of interest in amateur radio communication and experimentation, for the relaying of messages by radio, for the advancement of the radio art and of the public welfare, for the representation of the radio amateur in legislative matters, and for the maintenance of fraternalism and a high standard of conduct.

It is an incorporated association without capital stock, chartered under the laws of Connecticut. Its affairs are governed by a Board of Directors, elected every two years by the general membership. The officers are elected or appointed by the Directors. The League is noncommercial and no one commercially engaged in the manufacture, sale or rental of radio apparatus is eligible to membership on its board.

"Of, by and for the amateur," it numbers within its ranks practically every worth-while amateur in the nation and has a history of glorious achievement as the standard-bearer in amateur affairs.

Inquiries regarding membership are solicited. A bona fide interest in amateur radio is the only essential qualification; ownership of a transmitting station and knowledge of the code are not prerequisite, although full voting membership is granted only to licensed amateurs.

All general correspondence should be addressed to the Secretary at the administrative headquarters at West Hartford, Connecticut.



## Past Presidents

HIRAM PERCY MAXIM, W1AW, 1914-1936  
EUGENE C. WOODRUFF, W8CMP, 1936-1940

## Officers

**President** . . . . . GEORGE W. BAILEY, W2KH  
Washington, D. C.

**Vice-President** . . . . . J. LINCOLN MCCARGAR, W6EY  
Oakland, California

**Secretary** . . . . . KENNETH B. WARNER, W1EH  
West Hartford, Connecticut

**Communications Manager** . . . . . F. E. HANDY, W1BDI  
West Hartford, Connecticut

**Treasurer** . . . . . DAVID H. HOUGHTON  
West Hartford, Connecticut

• • • • •

**General Counsel** . . . . . PAUL M. SEGAL  
1026 Woodward Building, Washington 5, D. C.

**Assistant Secretaries** . . . . . ARTHUR L. BUDLONG, W1BUD  
JOHN HUNTOON, W1LVQ, LEROY T. WAGGONER, W1PEK  
West Hartford, Connecticut

## DIRECTORS

**President**  
GEORGE W. BAILEY . . . . . W2KH  
921 19th St., N.W., Washington, D. C.

**Vice-President**  
J. LINCOLN MCCARGAR . . . . . W6EY  
86 Hamilton Place, Oakland 12, Calif.

**Canadian General Manager**  
ALEX REID . . . . . VE2BE  
240 Logan Ave., St. Lambert, P. Q.  
**Alternate:** Leonard W. Mitchell . . . . . VE3AZ  
78 Kaslan Ave., Toronto, Ont.

**Atlantic Division**  
EDWARD G. RASER . . . . . W2ZI  
315 Beechwood Ave., Trenton 8, N. J.  
**Alternate:** J. Victor Brotherson . . . . . W8BHN  
1743 Ottawa Drive, Erie, Pa.

**Central Division**  
CLYDE C. RICHELIEU . . . . . W9ARE  
4901 So. 30th St., Milwaukee 14, Wisc.  
**Alternate:** Harold H. Jansen . . . . . W9DJG  
3519 California Ave., Alton, Ill.

**Dakota Division**  
TOM E. DAVIS . . . . . W0SW, ex-W9VVA  
915 W. Becker Ave., Willmar, Minn.  
**Alternate:** Harold B. Love . . . . . W9ZRT  
Box 426, Mandan, N. D.

**Delta Division**  
GEORGE S. ACTON . . . . . W5BMM  
Plain Dealing, La.  
**Alternate:** Eugene H. Treadaway . . . . . W5DKR  
P. O. Box 44, La Place, La.

**Great Lakes Division**  
HAROLD C. BIRD . . . . . W8DPE  
114 Hickory Dr., R.F.D. 2, Pontiac 2, Mich.  
**Alternate:** John H. Brabb . . . . . W8SPF  
1321 Berkshire Rd., Grosse Point Park 30, Mich.

**Hudson Division**  
JOSEPH M. JOHNSTON . . . . . W2SOX  
427 Lincoln Ave., Avon-by-the-Sea, N. J.  
**Alternate:** Robert A. Kirkman . . . . . W2DSY  
1910 Oak Drive, West Belmar, N. J.

**Midwest Division**  
C. A. COLVIN . . . . . W0VHR  
e/o Omaha & Council Bluffs St. Railway Co.,  
Omaha 2, Nebr.  
**Alternate:**

**New England Division**  
PERCY C. NOBLE . . . . . W1BVR  
37 Broad St., Westfield, Mass.  
**Alternate:**

**Northwestern Division**  
HAROLD W. JOHNSTON . . . . . W7DXF  
2727 Belvidere Ave., Seattle 6, Wash.  
**Alternate:** R. Rex Roberts . . . . . W7CPY  
110 W. Brennan St., Glendive, Mont.

**Pacific Division**  
WILLIAM A. LADLEY . . . . . W6RBQ  
200 Naylor St., San Francisco 12, Calif.  
**Alternate:** Elbert J. Amarantes . . . . . W6FBW  
1675 Dale Ave., San Jose, Calif.

**Roanoke Division**  
H. L. CAVENESS . . . . . W4DW  
2607 Vanderbilt Ave., Raleigh, N. C.  
**Alternate:** J. Frank Key . . . . . W3ZA  
Box 707, Buena Vista, Va.

**Rocky Mountain Division**  
FRANKLIN K. MATEJKA . . . . . W0DD  
P. O. Box 212, Estes Park, Colo.  
**Alternate:** P. Arthur Smoll . . . . . W0KVD  
529 No. Nevada Ave., Colorado Springs, Colo.

**Southeastern Division**  
WILLIAM C. SHELTON . . . . . W4ASR  
527 Revilo Blvd., Daytona Beach, Fla.  
**Alternate:** William P. Slides . . . . . W4AUP  
Fleming Road, Montgomery, Ala.

**Southwestern Division**  
HANS R. JEPSEN . . . . . W6KEI  
6837 Ethel Ave., No. Hollywood, Calif.  
**Alternate:** Arthur E. Schifferman, sr. . . . . W6CGI  
1445 Raymond Ave., Glendale 1, Calif.

**West Gulf Division**  
WAYLAND M. GROVES . . . . . W5NW  
Mail Box 586, Station Humble Pipe Line Camp,  
Odessa, Texas  
**Alternate:** Jack T. Moore . . . . . W5ALA  
4531 Fairway Ave., Dallas 4, Texas

# "It Seems to Us..."

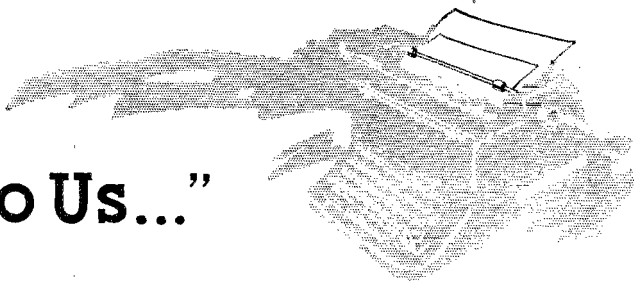

## V.H.F. B.C.I.

There has seldom been reason for being happy about the BCI situation, but through the years we've at least been pretty secure in the knowledge that for the most part the interference has not been our fault. No matter how thoroughly a transmitter is debugged nor how carefully it is operated, it can still cause interference to an inadequately-designed receiver — and receivers in that category are the rule rather than the exception. We have, with justice, argued that the receiver manufacturers and the people that buy their products are to be blamed, not us.

But broadcasting is now getting established "upstairs," and that puts a new complexion on things. Not a favorable one, either. We have no expectation that manufacturers of v.h.f. broadcast receivers will be inspired to turn over a new leaf and incorporate features that will provide protection against amateur interference. The few cents that it costs to do it may seem trivial to us but apparently are vital to the set builders; whether the frequency is 1000 kilocycles or 100 megacycles is beside the point. However, if poor receivers were our only worry we could probably grin and bear it. The thing we have to face is that some of the interference — not all, but enough to cause real concern — that is now being caused and is in prospect for the future is not the receiver's fault. It's ours, whether we like it or not.

We have in mind harmonics, of course. For years we have been able to operate without thinking much about harmonic output, for the simple reason that the services with which our harmonics might interfere usually have been pretty far distant from our transmitters. But when the receiver is in the same apartment building or in the house next door it is an entirely different story. A harmonic that causes no trouble a few miles away can easily be strong enough to wreck reception within a few hundred yards. And with the heat on to popularize f.m. and television the road begins to look rocky.

Amateurs in the New York area already are feeling the bumps. There have been hundreds of complaints from owners of television receivers that amateurs are interfering with their programs, and the number is increasing daily. At this writing no statistics are available on the interference actually attributable to amateur operation — we know, for example, that some "amateur" interference has turned out to be caused by diathermy and even by nearby television receivers. Nor do we know at the moment how much of the actual ham interference has resulted from inadequate receiver design and how much from harmonic radiation. We do know, though, that there have been plenty of cases in which the interference was caused by the second harmonics of ten-meter transmitters. In a smaller number the harmonics came from twenty- and even forty-meter outfits.

It is easy to jump to the conclusion that the whole problem would be solved if the amateur bands were restored to even-harmonic relationship. But would it? Certainly it would help in the New York situation, where channel No. 2 — 54 to 60 megacycles — is in regular use. But what about the odd harmonics? It just so happens that the third harmonics of the ten-meter band fall in a channel unused at present in New York, but that channel eventually is going to be occupied there or in other places. We seem to recall an epidemic of third-harmonic troubles on 75-meter 'phone some years ago, and from all accounts the FCC monitors are finding plenty of ticket material when they look in the 21-megacycle region. Even if the reallocation of frequencies were not loaded down with knotty problems having nothing to do with amateurs, it is an open question whether a reshuffling could be more than a palliative.

At the present stage the urgent need is for the accumulation of factual information: how much interference is our fault, how much the receiver's, remedial methods that have proved effective. We need to know what it is really possible to do in the way of reducing harmonic fields in the immediate vicinity of the trans-

mitter, what the relative effects of the second, third and higher-order harmonics will be. Work along these lines already is under way and will be reported in *QST* as results become available. From what has been done so far it seems indicated that keeping harmonics out of the antenna is relatively a minor problem (the methods outlined in *QST* last November are effective); direct radiation from the transmitter, power wiring, and stray feed to transmission lines are far more serious in the immediate locality. It is safe to say that the number of amateur transmitters in which attention has been paid to reducing direct radiation of harmonics is completely negligible. We just haven't done it, for the quite good reason that until now there has been no real necessity.

Preventing direct radiation is likely to require a complete change in our philosophy of transmitter construction. A basic requirement is really good shielding of that part of the transmitter in which the offending harmonics are generated. But shielding alone is not enough; the best shielding in the world will be rendered useless if there is coupling, either through ordinary induction or through stray voltage drops in chassis or shield, to any of the conductors that necessarily enter the shielded enclosure. This calls for filtering, intelligent design, and patient experimentation on each individual rig. Much as we may long for the good old days of one-tube transmitters on open breadboards, it is in the cards that the increasing use of the frequency spectrum above our long-distance bands is going to force real engineering into ham transmitting gear.

At that, there is no guarantee that the best possible job of reducing harmonic radiation will be good enough to solve the house-next-door problem. There are plenty of competent engineers who sincerely believe that it can't be done. There are also, frankly, hams who don't want to take the trouble. Both groups are plumping for a reallocation that will let us absorb our second harmonics. But reallocation is a last-ditch device; it seems fundamental to us that before we can advance it as the only solution we must be in a position to demonstrate conclusively that there is no possible way by which transmitter harmonics can be reduced to a level that will permit reasonably interference-free reception of v.h.f. broadcasting within the service area of the station on whose channel the harmonics fall.

Interference to f.m. broadcasting can be minimized by avoiding frequencies having harmonics that fall on the local stations. But there is no dodging a television channel; the channels in that service are so wide that a single one will swallow all the harmonics from an amateur band. To make matters worse,

it does not take much harmonic strength to cause ruinous interference, particularly in view of the relatively low powers used in television broadcasting. When the receiver is next door an equivalent power in the harmonic of a few hundredths of a watt will completely spoil the received picture. Our job is thus one of no small magnitude. On the other hand, it has been demonstrated that a high-power ten-meter amateur transmitter can be treated so that at distances measured in feet it will interfere on no channel except the one in harmonic relation, and it has also been demonstrated that *general* interference — over distances of the order of a mile or more — can be eliminated even on the harmonic channel. There is obviously much we can do to relieve the situation with the means now at our command.

Whether or not a complete cure is feasible — and that is yet to be determined — the potentialities of those harmonics that we do not absorb in our own bands are such that we are going to have to give their reduction a good deal of serious attention. Not only broadcasting but the many safety services now in the v.h.f. region are going to demand protection from our harmonic excrescences — just as we ourselves demand that we be relieved from paying any penalty for the shortcomings of b.c. receivers. — G. G.

---

#### OUR COVER

With all the talk going on about generators, portables, batteries, sunburn lotion and citronella, you can't help knowing Field Day is only weeks away. To set the stage for this year's bigger-than-ever outdoor event, we give you this action shot of the 2- and 6-meter positions of the Inglewood Amateur Radio Club entry of last season, as set up in the Palos Verdes (Calif.) hills. Fraternizing with Old Sol — and kibitzing on W6UXN — is W6UXB. W6QIR is holding down the tent position.

---

#### FEED-BACK

In W4JRW's April *QST* article, "A 40-Watt Modulator with Cathode-Coupled Driver," the alternative of using several VR-75 tubes in parallel for biasing the 6L6Gs is suggested. This method will not always work, WIPAD reminds us, because the striking voltages are not identical in all tubes. To make the system "sure-fire," it is recommended that a 47-ohm resistor be connected in series with each of the tubes, to insure that they will strike independently and share the load equally.

An additional caution: In Fig. 4 of this article, the pins of the 6SC7 and 6SN7 are misnumbered. The constructor is referred to the *Handbook* for the correct designations.

# Overmodulation Splatter Suppression

*A New Method for Preventing Spurious Sidebands*

BY OSWALD G. VILLARD, JR., \* W6QYT

• The cause of over-modulation splatter is the sudden break in the modulation envelope when the carrier is swung down to the zero axis. Here is a system that fills in the over modulation "gaps" in the carrier and thereby prevents generation of spurious sidebands. There is no theoretical limit to the usable percentage of modulation if suitable means are used to receive the signal.

IT is well known that overmodulation of conventional a.m. radiophone transmitters produces strong adjacent-channel interference aptly called "splatter." For this reason considerable effort has been expended on devising methods of preventing overmodulation — such as peak-limiting amplifiers and clipping circuits — to keep the channel space occupied by a given transmitter at a minimum. The purpose of this article is to describe a different approach to the problem; one in which the basic mechanism of splatter formation is analyzed, and a remedy worked out on the basis of this analysis. The result is a technique by which the percentage of modulation of any plate-amplitude-modulated 'phone transmitter may be allowed to exceed 100 by any desired amount, *without any accompanying increase in channel bandwidth.*

The least channel width that can be occupied by an a.m. transmitter is a band of frequencies extending above and below the carrier frequency by an amount equal to the highest modulating frequency that is to be transmitted. Voice transmission of high intelligibility is obtained when speech frequencies up to 2500 or 3000 cycles are

transmitted; a voice radiophone need therefore occupy a channel only 6 kilocycles wide at the maximum. It is assumed that any sideband frequencies appearing outside the limits set by the carrier plus and minus the highest modulating frequency are undesirable, since such sidebands cause interference to stations operating on adjacent channels.

Sidebands lying outside the normal channel occupied by an a.m. station are usually caused (1) by incidental f.m. or p.m. on the carrier frequency, or (2) by some form of amplitude distortion in the a.m. characteristic. This amplitude distortion may be composed of any or all of the following: (a) nonlinear distortion in the audio system, (b) nonlinearity of the modulated Class C r.f. amplifier, and (c) overmodulation.

All three are essentially similar in their effects. Just as amplitude distortion in the audio end produces harmonics higher than the highest undistorted audio frequency present, and therefore produces sidebands lying outside the normal channel, so amplitude distortion or overmodulation in the r.f. end also gives rise to sidebands falling in adjacent channels. There is no difference in either the theoretical analysis or the practical effects between the case where an audio signal containing higher-order harmonics is allowed to modulate a perfectly-linear Class C stage, thus producing higher-order sidebands and splatter, or the case where the audio is clean and distortion occurring in the r.f. end produces the same higher-order sidebands and splatter. The user of an adjacent channel would not be able to tell which type of distortion was producing the interference!

However, overmodulation differs from the other forms of amplitude distortion in that its onset is so abrupt. Assuming no audio or r.f. amplitude distortion, and a percentage of modulation less

\* Department of Electrical Engineering, Stanford University, Calif.

◆  
The transmitter at W6YX, in which the splatter-suppression circuit is incorporated.

June 1947

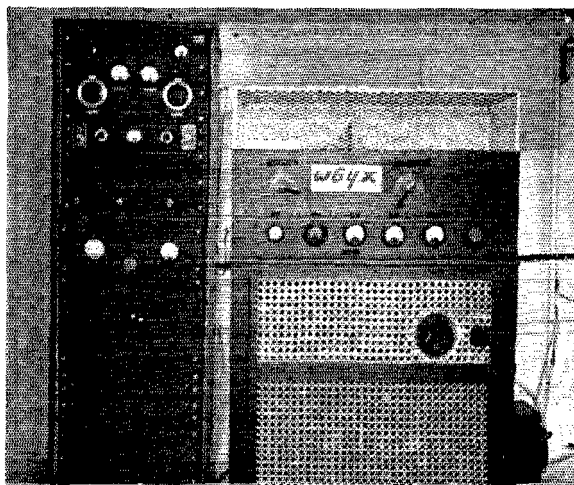

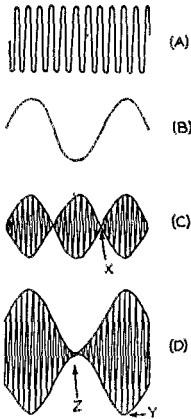

Fig. 1—A—Steady carrier wave,  $E_o \sin 2\pi ft$ . B—Audio-frequency voltage,  $m \sin 2\pi ft$  ( $m = 1$ ). C—Product of A and B:  $E_o m \sin 2\pi ft \sin 2\pi ft$  (during audio-frequency half-cycle  $X$  phase of carrier voltage is 180 degrees different from that of adjacent half-cycles). D—Sum of A and C:  $e = E_o \sin 2\pi ft + E_o m \sin 2\pi ft \sin 2\pi ft = 100\%$  amplitude-modulated wave (phase of carrier constant throughout audio cycle) (A and C add at Y and cancel at Z).

than 100, there will be no spurious sidebands at all, yet if the percentage of modulation exceeds 100 by only a little, vicious splatter appears. The reason for the sudden appearance of these unwanted sidebands is to be found in the sharpness of the bend in the waveform of the r.f. envelope at the zero axis, when overmodulation occurs. As is well known, any waveform having a sharp or rectangular bend must be composed of many harmonics, which in this case manifest themselves as higher-order sidebands. A square wave, for example, has appreciable harmonic components up to the tenth; if a transmitter were so badly overmodulated with a sine wave that at least part of the waveform looked square, we might expect to find at least ten strong pairs of sidebands on both sides of the carrier. If the modulating voltage producing this approximation to a square wave had a frequency of 3000 cycles, the bandwidth of the signal would then be of the order of 60 kc.!

Now let us see what happens when distortion occurs in the audio end of a transmitter. High-level plate modulation, now almost universally used, fortunately interposes a modulation transformer between the audio system and the modulated Class C amplifier. This transformer acts as a low-pass filter so far as the higher audio harmonics are concerned, and simply removes them before they can do any damage. If we have a square wave at a low audio frequency (say 100 cycles) the waveform will be passed by the modulator with its squareness preserved because the tenth harmonic is only 1000 cycles. Note that the corresponding sidebands do not spill outside the normal channel. But if the frequency of the square wave were raised to 3000 cycles the modulation transformer would have to pass 30 kc. in order to preserve the waveform. Since most modulation transformers designed for amateur use fall off in response rather rapidly above 5000 cycles, the

waveform reaching the Class C amplifier for a 3000-cycle square-wave input will be much more nearly sinusoidal than square, and the spurious sidebands will be correspondingly reduced in amplitude. For this reason, audio distortion is by no means as troublesome a source of adjacent-channel interference as overmodulation.

To recapitulate, overmodulation causes sharp edges or bends in the waveform of the envelope of the transmitted signal, regardless of the audio frequency at which the overmodulation takes place, and there is nothing to prevent the radiation of the spurious sidebands thus generated. Overmodulation, therefore, is bad. Let us now see what can be done about it.

### The Theoretical Basis

A good starting point is the conventional equation of a sinusoidally-modulated wave:<sup>1</sup>

$$e = E_o (1 + m \sin 2\pi f_m t) \sin 2\pi f_c t \quad (1)$$

where  $e$  = instantaneous amplitude of wave,  $E_o$  = average amplitude of wave,  $f_m$  = modulating frequency,  $f_c$  = radio frequency, and  $m$  = degree of modulation, defined as

$$\frac{E_{\max} - E_o}{E_o}$$

where  $E_{\max}$  is the maximum envelope amplitude.

Suppose we multiply Equation 1 out. We get:

$$e = E_o \sin 2\pi f_c t + E_o m \sin 2\pi f_m t \sin 2\pi f_c t \quad (2)$$

The first of the two expressions on the right-hand side of this equation is clearly equal to the carrier voltage. The second expression has a term equal to the carrier voltage, multiplied by the quantity  $\sin 2\pi f_m t$ . In addition, the amplitude of this expression as a whole is also controlled by the arbitrarily-selected constant,  $m$ . For a given  $m$ , we may consider the carrier component of the second term ( $E_o \sin 2\pi f_c t$ ) to be acted upon or modulated by the audio component ( $\sin 2\pi f_m t$ ). As time goes on, and the  $t$  in this equation increases, the quantity  $\sin 2\pi f_m t$  varies sinusoidally between minus one, zero, and plus one, as does the sine of any angle. This implies that the polarity of the carrier voltage represented by the right-hand expression of Equation 2 changes by 180 degrees from one half-cycle of audio modulation to the next, since a 180-degree phase change is repre-

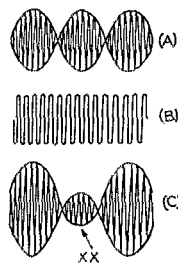

Fig. 2—A—Same as Fig. 1-C. B—Steady carrier, similar to Fig. 1-A, but weaker. C—Sum of 2-A and 2-B (at XX 2-A exceeds 2-B, and r.f. carrier is 180 degrees out of phase with that of adjacent portions of wave).

<sup>1</sup> See, for example, Terman's *Radio Engineer's Handbook*, p. 352.



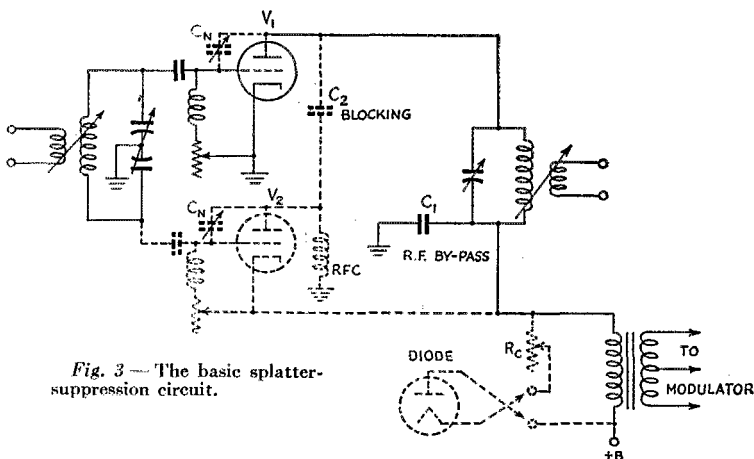

Fig. 3—The basic splatter-suppression circuit.

sented by a change in sign. We may then think of an amplitude-modulated wave as being in reality made up of two components: a steady component of carrier frequency, and a varying component of carrier frequency which reverses phase on alternate audio half-cycles. Thus when the two components are phased alike, they add, and we have upward modulation; when the phase of the varying component changes by 180 degrees, the two components cancel each other and we have downward modulation. Fig. 1 illustrates this action.

Let us look at Equation 2 again. It will be seen that there is no basic reason why the arbitrary constant  $m$  should be no larger than 1; the mathematics are not changed in the least if  $m$  is made equal to 5 or 10 instead of 1. Certainly increasing  $m$  does not bring in any additional frequencies such as would have to be present if any flattening or distortion occurred. If  $m$  increases above 1, we simply have a larger ratio of sidebands to carrier than before; the sidebands themselves are unaffected. It will be remembered that a balanced modulator circuit can be made to eliminate the carrier completely, leaving the sidebands intact, so the possibility of increasing the sideband-to-carrier power ratio above one-half, without introducing distortion, seems reasonable. Let us investigate graphically what happens if  $m$ , in Equation 2, is allowed to increase above 1. The result is plotted in Fig. 2-C. Since the right-hand term of Equation 2 now more than cancels the left-hand term, we find the phase of the total radiated signal changing by 180 degrees during a portion of the audio cycle. This section of the waveform, where the r.f. voltage of reversed phase appears, is that portion where there is no output at all in the case of ordinary overmodulation.

Now to make an ordinary plate-modulated radio transmitter produce an r.f. waveform similar to that of Fig. 2-C, it is only necessary to

provide some means of supplying the tank circuit with r.f. voltage 180 degrees out of phase with that of the carrier, during that portion of the audio cycle when overmodulation makes the plates of the regular Class C amplifier tubes negative with respect to ground. A circuit for doing this is shown in Fig. 3.

#### Splatter-Free Circuit

Tube  $V_1$  is a conventional single-ended Class C amplifier tube. Tube  $V_2$ , the "splatter-suppressor" stage, and its associated circuit components are drawn with dotted lines for the sake of clarity. Tube  $V_2$  is shunt-fed in both grid and plate circuits. The plate of  $V_2$  is grounded through the r.f. choke so far as d.c. is concerned, but is effectively tied to the plate of  $V_1$  for r.f. by blocking condenser  $C_2$ . The cathode of  $V_2$  is connected to the positive high-voltage lead from the modulator, consequently a filament transformer of low capacitance to ground and adequate insulation must be used.  $C_1$  serves as an r.f. by-pass both for the tank coil and for the cathode of  $V_2$ . This condenser should be large enough to give good r.f. by-passing, but not so large that it and the capacitance to ground of the filament transformer supplying  $V_2$  appreciably affect the high-frequency response of the modulator.

So long as the instantaneous plate voltage at the upper terminal of the modulation-transformer secondary winding remains positive,  $V_1$  will operate in the normal way and deliver r.f. of given phase to the load. When overmodulation occurs and the supply potential of  $V_1$  is driven negative,  $V_2$  comes into action and delivers r.f. of opposite polarity to the load, thus satisfying the conditions of Fig. 2-C. Assuming linear operation throughout, splatterless overmodulation results.

There are one or two other points of interest in connection with Fig. 3. Since  $V_2$  is shunt-fed in both grid and plate circuits, r.f. chokes of

widely-different inductance values must be used if low-frequency parasitics are to be avoided. It will be noticed that  $V_1$  and  $V_2$  effectively neutralize each other. If both tubes have the same grid-plate capacitance, neutralizing condensers  $C_N$  could be omitted, assuming the circuit were laid out perfectly symmetrically. Actually, a small neutralizing capacitor would probably have to be connected between grid and plate of one tube or the other, in order to compensate for unbalance because of stray circuit capacitances. If dissimilar tubes are used, as is perfectly possible, the neutralizing condenser is connected from grid to plate of the tube having the lesser grid-plate capacitance, and need have a maximum value only slightly greater than the difference between the capacitances of the two tubes.

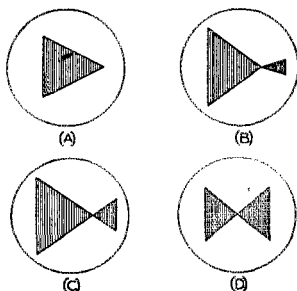

Fig. 4—Trapezoidal oscilloscope patterns of system's operation: A — conventional 100% modulation; B — overmodulation, suppressor tube supplying less output than carrier tube; C — overmodulation, suppressor-tube characteristic matched to carrier-tube characteristic; D — no carrier radiated — pure sidebands only (percentage of modulation equals infinity).

The grid-bias resistors of  $V_1$  and  $V_2$  are shown as being variable; this makes it possible to "balance" two tubes whose characteristics are not alike. The object is to arrange matters in such a way that the same r.f. output (irrespective of phase) is produced by the same plate-supply voltage, either positive or negative in polarity. It is also desirable to have the modulator work into the same load impedance no matter which tube,  $V_1$  or  $V_2$ , is supplying the r.f. output. The easiest way to make sure the r.f. outputs are equal is to make use of the well-known trapezoidal oscilloscope pattern, for which r.f. voltage is applied to the vertical plates and a.f. voltage to the horizontal plates. Fig. 4-B shows a situation which might well be encountered; the suppressor tube is not as efficient as the carrier tube and is not producing the same output at the same plate voltage. Variation of the grid-bias resistors of the two tubes in Fig. 3 should make it possible to equalize the two halves of the pattern as in Fig. 4-C. The biases of the two tubes must always be kept high enough to ensure Class C operation, of course.

If  $V_1$  and  $V_2$  are widely dissimilar tubes, it may be that after they are adjusted for the same r.f. output voltage at the same d.c. supply voltage they will not offer the same load impedance (ratio of d.c. volts to d.c. amperes) to the modulator. If the modulator has poor voltage regulation (and most do) distortion of the output waveshape will result. As an example, Fig. 5 shows a waveform which might occur if the load impedance offered by the suppressor tube were much less than that offered by the carrier tube. The remedy is to connect a diode and a resistance as shown in Fig. 3. The diode simply acts to switch the compensating resistance  $R_c$  in or out of the circuit at the same time the suppressor tube goes in and out of action. The object is to connect the diode in such a polarity that the compensating resistance is effectively in shunt with the tube — carrier or suppressor — that offers the higher load impedance to the modulator. The compensating resistor is then adjusted until the effective load impedances are the same. In this way the load presented to the modulator may be made constant over the entire audio cycle and distortion of the audio waveshape is avoided.

Bringing the tubes into balance will be easier, the more nearly alike they are. However, since overmodulation will normally occur during a relatively small portion of the audio cycle, the average power input to the suppressor tube will be small and this tube need have a plate dissipation rating only a fraction of that of the carrier tube, provided it has adequate insulation and peak-power capacity. In selecting a suppressor tube it is desirable to find one whose characteristics are as nearly like those of the carrier tube as possible, except in point of plate-dissipation rating. For example, a 100-TH would serve as an excellent suppressor tube for a 250-TH; it has very nearly the same  $\mu$  and is, in effect, a scaled-down 250-TH. If dissimilar tubes must be used, it is usually best to pick for the suppressor tube one whose plate resistance is lower than that of the carrier tube rather than the reverse, for the reason that it may otherwise be difficult to get adequate output from the suppressor tube. A 100-TH, for example, would be difficult to use as a suppressor tube with a 304-TL, because both must produce the same output at the same plate voltage. The 100-TH would have to be driven very hard in order to operate as efficiently as a 304-TL, and before the desired condition was reached it might be that the rated grid dissipation of the 100-TH would have to be exceeded. A 75-TL, on the other hand, would be more practical since its characteristics are more nearly like those of the 304-TL.

It is obvious that full advantage of this system of overmodulation splatter suppression cannot be taken unless the modulator has adequate power capacity to take care of the extra demand when overmodulation takes place. In this con-



Fig. 5 — Distortion of modulator output waveform which might result if suppressor tube represents lower load impedance than carrier tube (mild overmodulation).

nection, it should be remembered that the required modulator power varies as the square of the degree of modulation; hence to modulate 200 per cent, four times the audio power needed for 100-per-cent modulation is required. A 1-kw. station modulated 200 per cent would require 2000 watts of audio power. The average power input to the suppressor tube may easily be calculated on the basis of the percentage of time during which it is in operation; a plot of the result appears in Fig. 6. The extra power input to the carrier tube is also considerable, and may be calculated by figuring the total modulator power for the percentage of overmodulation desired, as above, and then subtracting from it the power input to the suppressor tube taken from Fig. 6. Thus if we have a 1-kw. 'phone transmitter modulated 200 per cent, the modulator power is 2000 watts and the input to the suppressor tube is 670 watts, leaving 1330 watts which must be handled, along with the 1 kilowatt of carrier, by the carrier tube or tubes. These power-handling requirements sound excessive until it is remembered that the sideband power generated when a 1-kw. 'phone is modulated 200 per cent is equal to that generated when a 4-kw. 'phone is modulated 100 per cent.

When the ordinary radiophone transmitter is voice-modulated, the normal procedure is to set the audio gain to the point at which overmodulation occurs on peaks. From that point on, the operator must engage in a struggle with his conscience to decide how often overmodulation on peaks may permissibly take place. The higher the gain-control setting, the louder the signal, but the more frequent the overmodulation. With the splatter-suppression circuit described in this article, and sufficient reserve modulator capacity, he may increase gain until overmodulation occurs much more frequently, without setting up splatter

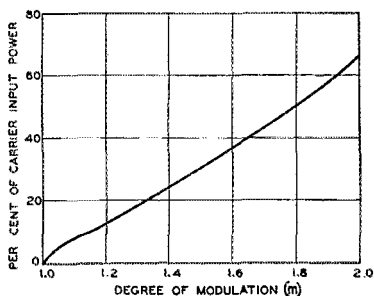

Fig. 6 — Average power input to suppressor tube as a function of degree of (over)modulation for a sine-wave modulating voltage.

and running the risk of a green QSL card from the FCC. A meter in series with the plate-supply lead of the splatter-suppression tube can be used as an indication of overmodulation; however, it cannot be relied upon to give a warning of the overload point of the splatter-suppression system itself. For that purpose an oscilloscope is doubtless the best indication, although metering systems can readily be devised. The 'scope should be connected to indicate either r.f. or a.f. waveshape — whichever overloads first. With a little practice, flattening of the waveform can be quite readily detected even when a complex speech wave is present. Alternatively, the maximum deflection before overloading can readily be calibrated by whistling a sine wave into the microphone, and then placing suitable markers on the face of the cathode-ray tube. The gain should then be so set that the very loudest peaks fall short of these markers.

### Reception

It should be pointed out that a signal overmodulated as shown in Fig. 4-C will be distorted when detected in a receiver using a linear second detector. The action is illustrated in Fig. 7-B. Note

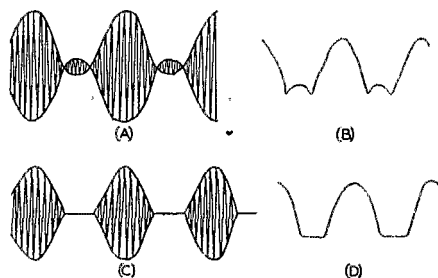

Fig. 7 — Illustrating receiver distortion: A — envelope of overmodulated wave; B — distorted audio signal produced when A is demodulated; C — envelope of distorted overmodulated wave; D — distorted audio signal produced when C is demodulated.

that, although an overmodulated signal of this type results in audio distortion when detected, there is nevertheless no distortion present in the r.f. signal itself, and hence no spurious sidebands. It will be found that audio distortion of the type shown in Fig. 7-B sounds somewhat worse to the ear than that resulting from ordinary overmodulation, illustrated in Fig. 7-D. A Fourier analysis of the waveforms would undoubtedly show that of Fig. 7-B to be richer in harmonics and poorer in fundamental than that of Fig. 7-D.

Now an overmodulated wave such as that of Fig. 7-A merely represents a signal whose sidebands are stronger than those required for 100-per-cent modulation. If by some means these sidebands can be reduced in strength before they reach the second detector of a receiver (the carrier remaining the same) the combined signal will no

longer be modulated as heavily; in fact, it may not be overmodulated at all. This gives a means of reducing the distortion resulting from the linear detection of a signal such as that of Fig. 7-A; it is only necessary to switch in the crystal filter of a communications receiver and adjust it for a narrow i.f. passband. At the higher audio frequencies the i.f. selectivity of the receiver will then tend to reject the excess sidebands, and as soon as the signal reaching the second detector is no longer overmodulated, the distortion disappears.

This effect was first noticed during the course of some laboratory tests of the system. As received on a conventional communications receiver adjusted for the widest i.f. bandwidth, the overmodulated signal sounded distorted but understandable. As the crystal filter was switched in and adjusted for a progressively narrower bandwidth, a point was found at which the distortion very largely disappeared, indicating that the signal reaching the second detector of the receiver was no longer badly overmodulated. The speech quality under these conditions sounded drummy but very nearly undistorted. Since this situation resulted from an excess of low audio frequencies rather than from a shortage of highs, the proper compensation could easily have been obtained by providing the receiver with a tone control that reduces the response to the lower audio frequencies. The audio compensation needed at the receiver, could, of course, have been avoided by high-frequency preemphasis at the transmitter.<sup>2</sup>

It is believed that such an arrangement has interesting possibilities for voice communication where a maximum of intelligence is to be transmitted on a carrier of given strength. Increased receiver selectivity, of course, results in an improved signal-to-noise ratio and a reduction in interference from stations operating on nearby channels. At the same time the extra sideband power at the transmitter is obtained without the necessity of generating carrier power to go along with it. It should be noted that adding the overmodulation circuit to the transmitter does not affect the tuning adjustments associated with frequency changing in any way.

### A Practical Amplifier

Fig. 8 is the circuit diagram of a typical final amplifier arranged for overmodulation splatter suppression. Cross-connected push-pull splatter-

suppression tubes are used in order to preserve the symmetry and balance to ground. HK-254 tubes were selected as suppressors because they happened to be available and have amplification factors and grid-plate capacitances similar to those of the 250-THs. They have much more plate-dissipation capacity than needed; for the service intended (suppression of incidental overmodulation on peaks) much smaller tubes, such as 35-TGs or HK-24Gs, would have been adequate.

The circuit is conventional in design and layout in every way; the only departure from normal practice lies in the cross-connection and reversed-polarity shunt feed of the suppressor tubes. Filament power for the HK-254s is supplied by a surplus transformer, apparently designed for radar service, having a secondary winding well spaced and insulated from the core. This results in an unusually low capacitance to ground, which allows the r.f. by-pass condensers  $C_7$  and  $C_8$  to be made proportionately larger before the frequency response of the modulator is affected. Use of a special transformer is generally not necessary, since the capacitance to ground of the average filament transformer secondary seems to be of the order of 0.002  $\mu$ fd. This is not excessive unless the modulator is working into an unusually-high load impedance.

Note that the grid-bias resistor of the HK-254s is connected back to the center-tap of their filament transformer. Partial fixed bias may be used with the 250-THs, if desired. None is necessary with the HK-254s because they draw plate current only when overmodulation occurs. The grid-current meter of the HK-254s should be adequately insulated from ground, of course, because it is normally at the full positive plate-supply voltage. Switch  $S_1$ , which disconnects the splatter-suppression tubes and permits a check of the operation of the circuit, should be provided with high-voltage insulation and should be connected with the plate-current meter between it and ground, as shown in the diagram.

Because there is a difference of only a tenth of a micromicrofarad between the grid-plate capacitances of the HK-254s and the 250-THs, the tubes very nearly neutralize each other. In fact the minimum capacitance of the smallest available high-voltage neutralizing condenser was found to be too much, so the bottom plates were removed and the circuit wiring itself was used as the other half of each neutralizing condenser! Finding the point of perfect neutralization is done in the conventional way; when the circuit is neutralized for the carrier tubes it is also neutralized for the suppressor tubes.

The photographs show the final amplifier of Fig. 8 as set up for operation. The station is that of the Stanford University Radio Club (W6YX). The grid tank circuit is mounted inside its own shielded box, and the one-plate neutralizing con-

<sup>2</sup> It would seem that this system of modulation could be received with little distortion by the exalted-carrier method of reception with a crystal filter described in *QST* for May, 1947, p. 27, inasmuch as the transmitted signal is quite similar to the signals often received from a normally-modulated a.m. transmitter when selective fading exists. With a sharp off-neutralized filter little or no audio compensation is needed at either the transmitter or receiver for natural reproduction. — Ed.

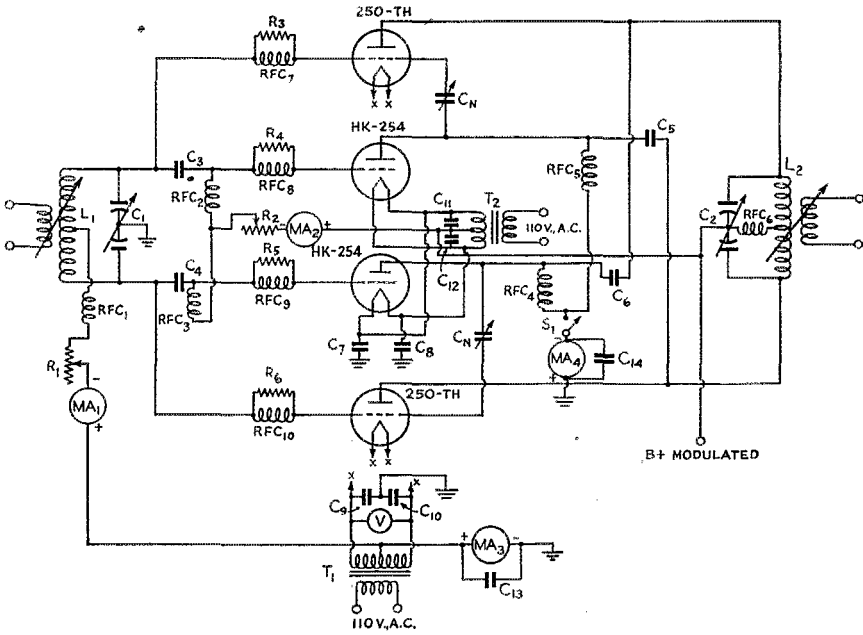

Fig. 8 — Splatter-suppressing final-amplifier circuit used at W6YX.

- C<sub>1</sub> — 75- $\mu$ fd. per section, 2000 volts.
  - C<sub>2</sub> — 100- $\mu$ fd. per section, 10,000 volts.
  - C<sub>3</sub>, C<sub>4</sub> — 0.002- $\mu$ fd. mica, 2000 volts.
  - C<sub>5</sub>, C<sub>6</sub> — 0.002- $\mu$ fd. mica, 12,500 volts.
  - C<sub>7</sub>, C<sub>8</sub> — 0.002- $\mu$ fd. mica, 5000 volts.
  - C<sub>9</sub> to C<sub>14</sub>, inc. — 0.002- $\mu$ fd. mica, 500 volts.
  - C<sub>N</sub> — National NC-300 with bottom plate removed (see text).
  - R<sub>1</sub> — 1500-ohm adjustable, 100 watts.
  - R<sub>2</sub> — 5000-ohm adjustable, 50 watts.
  - R<sub>3</sub>, R<sub>4</sub>, R<sub>5</sub>, R<sub>6</sub> — 50-ohm carbon, 10 watts.
  - L<sub>1</sub> — 28 Mc. — 3 turns No. 12 enam., 2 inches diam., center-tapped, 2-turn link.
  - L<sub>2</sub> — 28-Mc. — 2 turns  $\frac{1}{4}$ -inch copper tubing, 2 inches diam., center-tapped, 2-turn link.
- NOTE: Coils for other bands should be designed to provide proper Q.

- MA<sub>1</sub>, MA<sub>4</sub> — 0-300 ma. d.c.
- MA<sub>2</sub> — 0-150 ma. d.c.
- MA<sub>3</sub> — 0-1 amp. d.c.
- RFC<sub>1</sub>, RFC<sub>2</sub>, RFC<sub>3</sub> — 1-mh. 600-ma. choke (National R-154).
- RFC<sub>4</sub>, RFC<sub>5</sub>, RFC<sub>6</sub> — 1  $\frac{1}{2}$ -inch winding of No. 30 d.c.c. on  $\frac{1}{2}$ -inch diameter ceramic form.
- RFC<sub>7</sub>, RFC<sub>8</sub>, RFC<sub>9</sub>, RFC<sub>10</sub> — 3 turns No. 14 wound on R<sub>3</sub>, R<sub>4</sub>, R<sub>5</sub> and R<sub>6</sub>, respectively.
- S<sub>1</sub> — S.p.s.t. switch, high-voltage insulation.
- T<sub>1</sub> — Filament transformer, 5 volts, 20 amp.
- T<sub>2</sub> — Filament transformer, 5 volts, 25 amp., open frame (low capacitance between primary and secondary).
- V — 0-7.5 volts a.c.

densers may be seen close to this box. Condensers C<sub>5</sub> and C<sub>6</sub> of Fig. 8 are mounted upside down on a wooden support so that the leads connecting them to the plates of the tubes are as short as possible. In this particular layout (which is by no means to be considered as exemplary!) ultrahigh-frequency parasitics were encountered but were eliminated by parasitic-suppressing chokes connected in the grid leads as shown in Fig. 8.

Tuning up the transmitter offers no particular difficulties. The grid-leak resistors, R<sub>1</sub> and R<sub>2</sub>, are first adjusted until both carrier and suppressor tubes are drawing approximately the rated grid current with the available excitation. After the amplifier is neutralized, a positive plate voltage is applied, and the presence of parasitics in the carrier tubes investigated. When these are under control, the polarity of the plate supply is reversed, and the suppressor tubes are deparasitized. Next, the plate-supply polarity is returned

to normal, and the carrier tubes loaded into the antenna in the usual manner. The amplifier is then ready for an adjustment of the modulation characteristic with the aid of an oscilloscope connected to give a trapezoidal pattern.

For this test, no plate voltage (or carrier) is needed, since it is only necessary that overmodulation take place. The output of the modulator can be connected directly between the B+ terminal of the final amplifier and ground. Double sidebands alone will then be generated, and the pattern should look like that of Fig. 4-D. If it does not, the grid-bias resistors R<sub>1</sub> and R<sub>2</sub> should be adjusted until each half of the pattern is the mirror image of the other. Once this adjustment has been made, attention should be turned to the waveshape of the audio voltage out of the modulator.

Here an audio oscillator is desirable. If distortion such as that of Fig. 5 is encountered, it will

be necessary to determine which tubes — carrier or suppressor — are offering the lower load impedance to the modulator. A simple way to do this is to reduce plate voltage, leaving the antenna loading fixed. Then, at the reduced voltage, the ratio of d.c. plate volts to d.c. plate current can be measured for both carrier and suppressor tubes. An equalizing tube and resistance, as shown in Fig. 3, can then be connected across the modulator output terminals in such a way that the extra resistance is effectively shunted across whichever branch of the r.f. circuit shows the higher load impedance. For example, it might be found that the carrier tube represented a resistance of 400 volts divided by 100 ma., or 4000 ohms, when the suppressor tube represented a resistance of 400 volts divided by 125 ma., or 3200 ohms. It would then be necessary to shunt the carrier tube with a resistance of 16,000 ohms in order to make its effective impedance equal to 3200 ohms. The cathode of the diode tube of Fig. 3 would then be connected to the lower side of the modulation transformer and the anode through the resistor to the upper half. The modulator would then have to be matched to the new load impedance of 3200 ohms.

If the carrier and suppressor tubes are identical, or have characteristics very nearly alike, balancing may not be necessary. However, when dissimilar tubes are used balancing will almost surely be required. For the load-equalizing diode, any convenient tube can be used except mercury-vapor rectifiers, which have short life when oper-

ated at frequencies in the audio range. Since the current through the equalizing resistance will be small and most of the modulator output voltage will appear as a drop across this resistance, receiving-type rectifier tubes such as the 5Z3 or the 5R4GY will be satisfactory unless extremely high audio voltages are involved. In this case a rectifier such as the RK-60, with plate connections brought out through the top of the bulb, would be desirable.

It is desirable to have a suppressor tube that can be made to be more efficient than the carrier tube. The equalizing resistance will then be effectively connected in shunt with the suppressor tube, and audio power will be wasted in this resistance only when overmodulation takes place. Fortunately it turns out that most suppressor tubes, being smaller than the carrier tubes, tend to be more efficient than their larger counterparts.

Some additional methods of bringing the suppressor and carrier tubes into balance will be found in another article by the author.<sup>3</sup>

Finally, a word of warning is in order. Since the splatter-suppression circuit involves tinkering with the r.f. end of a transmitter, where distortion is relatively more dangerous than in the audio end, the circuit should not be attempted unless adequate test and measuring equipment are available. It should certainly not be attempted by anyone inexperienced in radiotelephone adjustment procedure. Remember, too, that spurious sidebands can be caused by distortion anywhere in a transmitter. The suppression circuit definitely cannot take care of splatter whose source is audio distortion appearing at the output terminals of the modulator!

Remember, too, that as the amateur regulations now read, it is expressly forbidden to modulate in excess of 100 per cent. Since in all likelihood the intention behind this regulation was to prevent splatter and unnecessary channel width, it does not seem inconsistent with the spirit of the law to use the suppression circuit as a means of preventing splatter accompanying momentary overmodulation on peaks. But before rushing out to buy a 2-kw. modulator to go with that 1-kw. transmitter, better wait to find out how the FCC will define the maximum legal power input to a reduced-carrier double-sideband a.m. 'phone!

#### Acknowledgment

The assistance of various members of the Stanford Radio Club in constructing and testing the final amplifier described in this article is herewith gratefully acknowledged. Particular thanks are due Lester A. Roberts, W6YWX, Bertram G. Ryland, W6BEW, and Rodney O. Beaudette, W7FXI.

<sup>3</sup> O. G. Villard, jr., "Overmodulation without Sideband Splatter," *Electronics*, January, 1947.



Layout of the final amplifier, showing the splatter-suppression tubes.

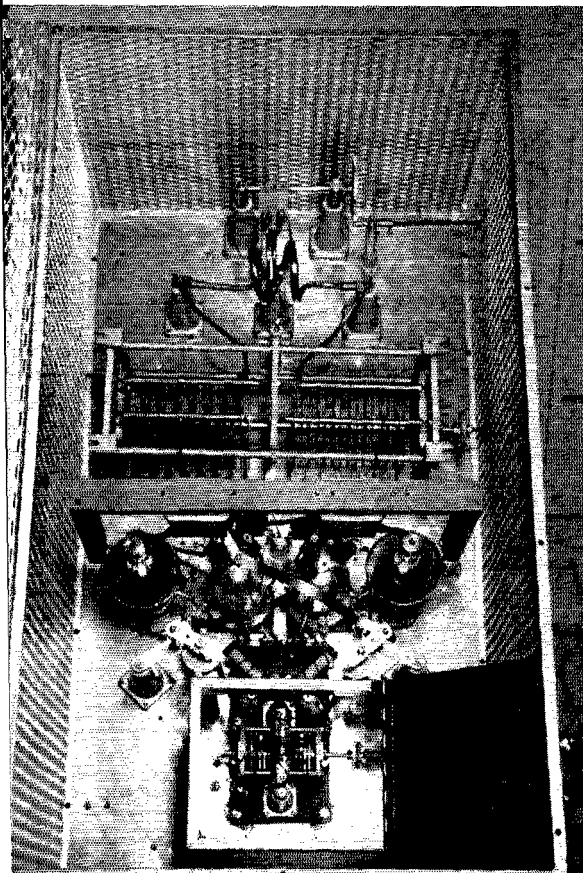



# A New Noise-Reducing System for C.W. Reception

*"Pulse Detection" for Elimination of Impulse Noise*

BY DON L. HINGS,\* VE7BH

• A new approach to the problem of ferreting out c.w. signals from noise. The noise is treated as something that is always existent and therefore is used as an energy source, while the signal is used to detract from that source. The signal is reproduced by a tone back-keyed by the energy during the keying spaces.

THE detection system herein described is referred to as a "pulse detector," and it will soon be apparent to the reader that it differs basically from conventional c.w. reception systems. Pulse detection was developed to fulfill the long-sought requirement for clean demarkation of signals under conditions of heavy background interference such as is caused by man-made static in central areas of cities, as well as by severe atmospheric static. This article will not attempt to consider the application of the pulse detector for modulated-carrier reception.

In the approach to the problem it was reasoned that while electrical interference energy exists at all times in a communications receiver, either from antenna pick-up or from front-end noise in the receiver, in contrast a c.w. signal has on and off intervals as well as fading characteristics. Also, while the interfering impulse noise may vary greatly in amplitude, the duration of the interfering impulses is much shorter than even high-speed c.w. characters.

In referring to impulse interference at the detector, it is necessary to consider these interferences as discontinuous wave trains whose effective time duration varies in accordance with

the amplitude of the original impulse. It is these receiver-generated wave trains that cause portions of the intelligence waves to be obliterated from the detector when the amplitude or audio beat is being detected. In receiving locations having a high ambient impulse background noise it might seem these wave trains could be frequent enough to create a continuous wave if they followed each other very closely. However, considering that each wave train or circuit "ring" is started by an impulse, and that these impulses have no fixed phase relation to each other, it follows that the random phase relation will cause conflicting phase angles between wave trains. Since these phase differences cause the amplitude to fall between each pair of wave trains, the resulting disturbance therefore cannot form a continuous wave. This condition marks the distinction between reception of a continuous wave and reception of impulse wave trains at the detector circuit in receivers of conventional design.

The detector voltage from the discontinuous wave trains may be considerably greater than the voltage from the continuous waves, which not only prevents the use of an a.v.c. system, but may also make it impossible to obtain a readable signal with ordinary b.f.o. detection.

This essential difference between a c.w. signal and random noise is illustrated in Fig. 1, where A, B and C show what might happen with a series of unrelated impulses. The r.f. noise at A is converted by the detector into a varying direct current as shown at B. When the detector output is coupled to a following audio stage the average d.c. component is eliminated by the coupling condenser, leaving only the audio-frequency a.c. signal shown at C. On the other hand, the c.w. signal shown at D is of unvarying amplitude (assuming for the moment that it is not modulated

\* % Electronic Laboratories of Canada, Ltd., 231 N. Howard Ave., Vancouver, B. C.

A pulse-detector unit constructed to operate with a Super-Pro receiver. The unit is complete with power supply and provides adjustable tone in the keyed circuit.

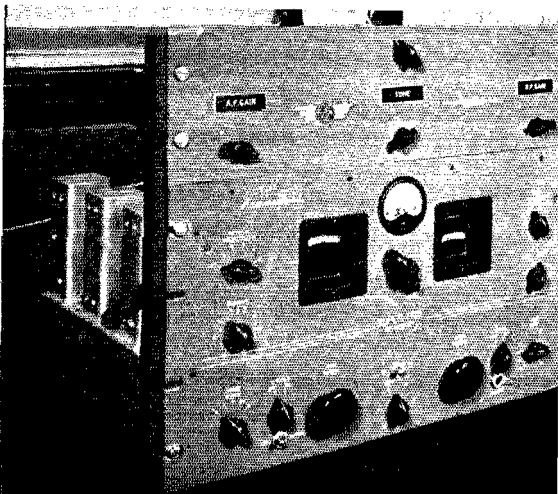

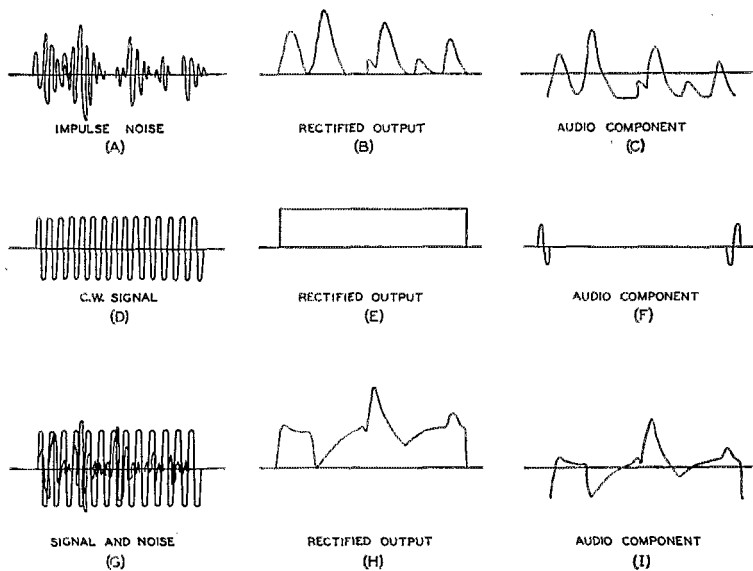

Fig. 1 — Upper line: R.f., rectified d.c., and audio component of noise alone. Second line: Same for signal alone. Third line: Signal and noise combined.

in any respect and that there is no random noise present) and when rectified by the detector produces the steady direct current indicated at E. The unvarying d.c. output of the detector produces no response when coupled to the audio system through a coupling condenser, except at the times when the signal voltage rises or falls; i.e., when the signal is keyed. At these two times there is a key click if the rate of rise and decay of the signal is great enough to produce an audible response.

When both noise and signal are present, as in the lower row of drawings, the random phase relationship between the c.w. carrier and the

impulse waves may result either in addition or partial cancellation of the carrier and noise. A typical case, after rectification, might be as shown in Fig. 1-H. The noise appears as an amplitude modulation on the c.w. carrier, and it is this noise modulation of the carrier that is the audio-frequency output of the detector.

Going now to Fig. 2, the impulse noise alone at A, when combined with a fading keyed c.w. signal as shown at B, might result in a rectified output of the form shown at C. The signal is unrecognizable in the rectified output; it is "buried" in the noise. However, if both noise and signal are drastically amplitude-limited as at D, with the limiting level set below the signal level represented by a deep fade, the voltage fluctuations when the c.w. signal is absent are greater than when it is present. The random phase relationship between the noise impulses and the carrier means that there is just as much chance that the carrier will be modulated upward as there is that it will be modulated downward. Since only the downward modulation is effective in producing audio-frequency output because of the heavy limiting, this means that there is less a.f. voltage from the detector during the c.w. interval than there is when the signal is absent; in other words, there is more a.f. energy during the keying spaces than during the marker intervals. This is indicated in Fig. 2-E. It is this difference in energy that forms the basis of pulse detection.

In the application of the system, the audio energy during keying spaces is amplified, limited, and rectified to produce a d.c. signal as shown at F in Fig. 2. This d.c. component is then used to control an audio tone generator, or to operate automatic equipment directly. "Back-contact"

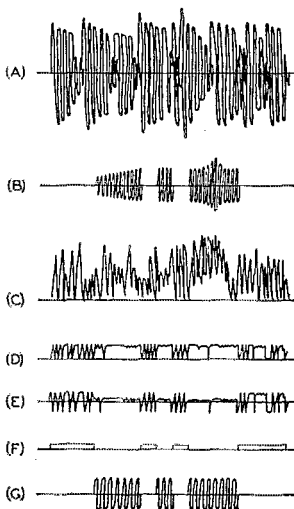

Fig. 2 — Steps in the development of pulse detection. As explained in the text, the system makes use of the fact that there is a difference in the a.f. energy level when the carrier is present and when it is not.

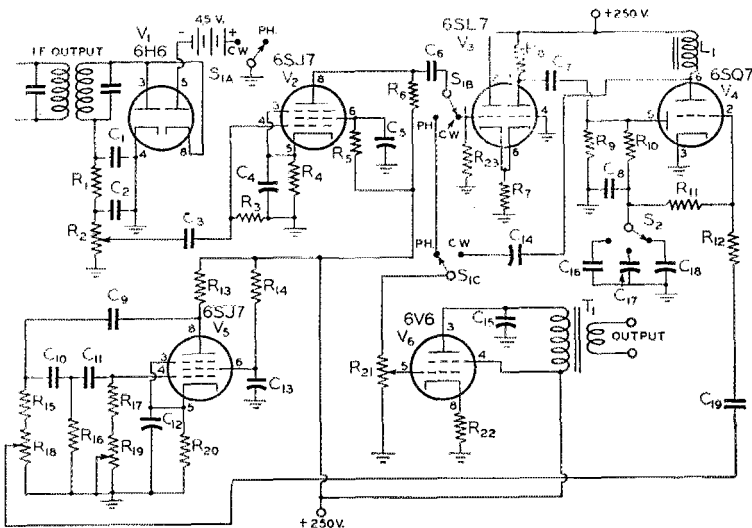

Fig. 3 — Circuit diagram of pulse-detector unit.

- $C_1, C_2$  — 100- $\mu$ fd. mica.  
 $C_3, C_6, C_9, C_{11}$  — 470- $\mu$ fd. mica.  
 $C_4$  — 25- $\mu$ fd. electrolytic.  
 $C_5, C_{12}, C_{13}, C_{14}$  — 0.05- $\mu$ fd. paper.  
 $C_7, C_{15}$  — 0.005- $\mu$ fd. mica.  
 $C_8$  — 0.003- $\mu$ fd. mica.  
 $C_{10}, C_{19}$  — 0.001- $\mu$ fd. mica.  
 $C_{16}, C_{18}$  — 0.02- $\mu$ fd. paper.  
 $C_{17}$  — 0.01- $\mu$ fd. paper.  
 $R_1, R_3, R_{13}$  — 47,000 ohms,  $\frac{1}{2}$  watt.  
 $R_2, R_{21}$  — 0.25-megohm volume control.  
 $R_3, R_6, R_{14}, R_{17}$  — 0.47 megohm,  $\frac{1}{2}$  watt.

- $R_4$  — 1400 ohms,  $\frac{1}{2}$  watt.  
 $R_5$  — 2.2 megohms,  $\frac{1}{2}$  watt.  
 $R_7$  — 1500 ohms,  $\frac{1}{2}$  watt.  
 $R_9, R_{12}, R_{15}$  — 0.1 megohm,  $\frac{1}{2}$  watt.  
 $R_{10}, R_{11}, R_{16}, R_{23}$  — 0.22 megohm,  $\frac{1}{2}$  watt.  
 $R_{18}$  — 0.1-megohm volume control.  
 $R_{19}$  — 1-megohm volume control.  
 $R_{20}$  — 470 ohms,  $\frac{1}{2}$  watt.  
 $R_{22}$  — 330 ohms, 1 watt.  
 $L_1$  — Audio choke (50 henrys or more).  
 $S_1$  — 3-pole 2-position switch.  
 $S_2$  — 1-pole 3-position switch.

keying is necessary, of course, to follow the original signal with the audio tone as indicated at G.

### A Practical Circuit

In the practical application of this system it has been found desirable to have two or three filter time-constant adjustments in the d.c. generating circuit. This permits various speeds of reception, so that even when, for example, 100 w.p.m. cannot be received because of very heavy impulse noise such as vehicle ignition interference, it is still quite satisfactory for perfect reception at 15 w.p.m. The tone frequency should be adjustable to prevent tiring the operator.

The circuit shown in Fig. 3 is adaptable for application to the second detector and audio end of a communications receiver.  $V_1$  is the detector and limiting diode for demodulation of the carrier wave when the amplitude is in excess of the effective bias on the second diode.  $V_2$  is an audio amplifier used to amplify the audio component of

the noise between the marker intervals, and  $V_3$  is a limiting amplifier for holding the noise energy at a relatively constant value. The diode section of  $V_4$ , which rectifies the noise energy, has three settings of filter capacitance to provide the three time constants mentioned above. The triode section of  $V_4$  is biased to cut-off by the d.c. from the diode, and  $V_5$  is a phase-shift audio oscillator that excites the grid of  $V_4$ .  $V_6$  is the power-amplifier tube of the receiver. Switches  $S_1$  and  $S_2$  permit the receiver to be operated in the normal 'phone position or for b.f.o. c.w. reception when there is no noise.

For best results, the a.v.c. should be off and the r.f. gain should be full on. The b.f.o. is not required. At least two i.f. stages are recommended, and a third will improve the results. When using a third i.f. amplifier, a 6SJ7 sharp cut-off pentode type should be used for limiting, as in f.m. receivers. The object of having so

(Continued on page 134)

Chassis view of the pulse-detector unit. Ordinary practice should be followed in layout of the i.f. and audio circuits.

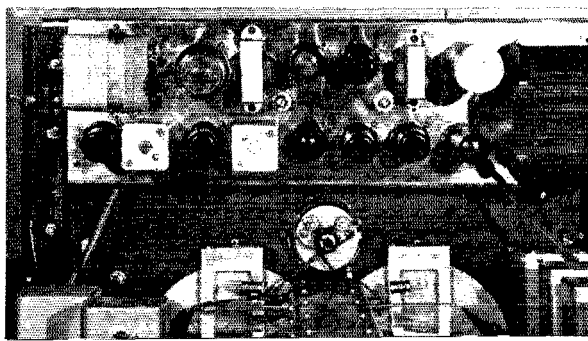

# Multielement Radiators in Close-Spaced Arrays

## Reducing Losses and Increasing Frequency Tolerance in Three- and Four-Element Beams

BY G. N. CARMICHAEL,\* W4GCA/9

THE problem of feeding close-spaced parasitic beams with flat or untuned lines may be approached from two different points of view. An impedance-transforming device such as the delta, the "T," or the quarter-wave matching section may be used between the line and the array, or the effort may be directed at increasing the radiation resistance of the antenna by various means, such as the use of greater element spacing, or of a folded doublet as the radiator.

The slightly-higher theoretical efficiency possible with antennas of reasonably-high radiation resistance is probably not significant. However, since the antenna impedance approaches more closely that of a spaced line, this more efficient type of line may be used with less loss in the matching section; in fact, if the antenna impedance is made sufficiently high, the matching section with its confusing adjustments may be eliminated entirely, even with close-spaced arrays. What is probably more important to the amateur, however, is the fact that as the antenna impedance is increased, the system becomes more frequency-tolerant so that it works efficiently over a larger portion of the band.

The multiple doublet, folded dipole, or cage doublet, as it is variously called, consists of a simple half-wave antenna and one or more elements parallel to it connected only at the ends, as shown in Fig. 1. If such a multielement doublet is substituted for the simple dipole in the conventional close-spaced beam, the radiation resistance of the antenna will be multiplied by the square of the number of elements in the folded doublet. For example, if we consider the radiation resistance of the three-element beam to be 9 ohms, and if the simple dipole is replaced by a three-element folded doublet, the new array will have a radiation resistance of  $3^2 \times 9$ , or 81 ohms; if the radiator is a four-element folded doublet, the radiation resistance becomes  $4^2 \times 9$ , or 144

\* RFD #1, Griggsville, Illinois.

• Because of the great difference between the impedance of a spaced line and that of the usual multielement array, those using antenna systems of this type are faced with the choice of a spaced line with losses in the matching section or a less efficient type of line. Also, a low-impedance antenna system is critically dependent upon frequency and difficult to adjust. By the use of a multiwire radiator, the antenna impedance may be increased to the point where the radiator may be fed directly with a conventional open-wire line and — probably of greater importance — the array becomes more tolerant as to frequency and easier to adjust.

ohms, etc. For the antenna system to match the highly-efficient open-wire line, the radiation resistance must be of the order of 400 ohms or more. This necessitates the use of at least seven elements in the radiator to give a theoretical radiation resistance of  $7^2 \times 9$ , or 441 ohms.

Such an antenna has been in use here at W4GCA/9 for some months and has been completely satisfactory. The present form of the antenna is the result of a series of experimental antennas with different feed lines and different numbers of elements in the radiator. As a final test here, a second antenna was built to see that results could be duplicated in another installation. Finally, the antenna has been copied by several other amateurs, and in every case which has come to the author's attention, the results were as predicted.

### Element Dimensions

The characteristics of the antenna may be summarized as follows: With no change in link coupling to the final, the loading is quite uniform

◆  
A three-element rotatable antenna with multielement radiator in use at W9BIQ.

QST for

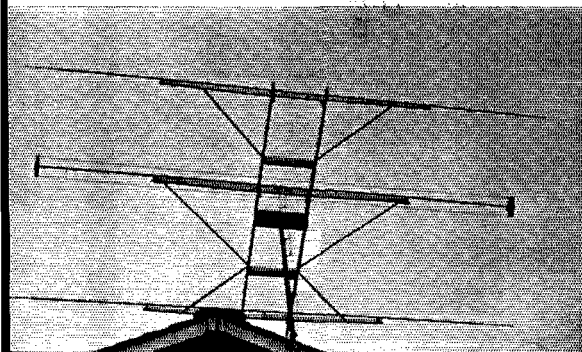

from 28,500 to 29,700 kc. (5-to-15-per-cent variation); the forward gain throughout the ten-meter band is practically constant as based on comparative signal reports on widely different frequencies on ground-wave, normal and DX contacts; the pattern remains unaltered throughout the band, as based on front-to-back and front-to-end ratios reported in numerous contacts, both local and DX; the reactance introduced by the antenna is low throughout the band and is negligible at the resonant frequency of the antenna; the parasitic elements determine the resonant frequency of the system to a large extent so that it is not necessary to provide means for changing the length of the radiator for tuning purposes, and the tuning of the parasitic elements is not at all critical.

The following formulas have been used by the author and with equally good results in other installations:

$$\text{Radiator length in feet} = \frac{468}{f_{Mc.}}$$

decreased by twice the diameter of the cage.

$$\text{Director length} = \frac{(0.96) (468)}{f_{Mc.}} \text{ ft.}$$

spaced 0.1 wavelength from radiator.

$$\text{Reflector length} = \frac{(1.05) (468)}{f_{Mc.}} \text{ ft.}$$

spaced 0.15 wavelength from radiator. All spacing dimensions are center-to-center.

The radiator consists of  $\frac{1}{2}$ -inch tubing, paralleled with six No. 12 wires spaced 4 inches from the center of the tubing, arranged symmetrically around it and connected only at the ends, as shown in Fig. 1. The tubing is separated 2 inches in the center for a 2-inch line. The size of the tubing and wire and the spacing between wire and tubing are not critical. Various construction methods may be used to furnish support for the wires. The author uses small rods, 8 inches in length, arranged like spokes of a wheel, at each end of the tubing. A disc or six-pointed star welded to the ends of the tubing is equally satisfactory. These details are sketched in Fig. 2. Some means of support should be used about one-third of the distance in from each end. Insulators should be of polystyrene or some other good h.f. material.

If the parasitic elements are set to give a fundamental frequency between 28,600 and 29,000 kc., the antenna will give good results throughout the band as well as fair efficiency on 11 meters.

The method of determining the effect of replacing a simple dipole with a multiwire doublet on the radiation resistance is largely empirical. However, on the basis of the various combinations used here and the results obtained by others who have tried the same general method, it seems that the formulas do work out for the case of close-

spaced beams at least. They are also verified in the case of a long wire used as a reference antenna, where the end half-wave is fed as a folded doublet which presents a very good match to a 470-ohm line.

#### Number and Size of Radiator Elements

The following table gives suggested radiators for three- and four-element close-spaced arrays using some of the common line impedances met in practice.

	Line Impedance in Ohms	Elements in Radiator
Two Parasitic Elements	72	3
	150	4
	300	6
	500	7
	600	8
Three Parasitic Elements	72	4
	150	7
	300	8
	500	9
	600	10

In general, the higher the radiation resistance, the broader the frequency response, so that some of the beams with lower radiation resistance will not have the same characteristics as described above. The ARRL *Handbook* suggests the use of



Fig. 1 — Sketch showing the essential plan of constructing a multiclement cage antenna for use as the radiator in a close-spaced array.

two elements of different sizes in a folded doublet to obtain an increase in radiation resistance of more than 4 to 1. There is a feeling on the part of some amateurs that the increase depends entirely on the ratio of the diameters of the two elements. My first sketchy experiments did not show progress in that direction so that method was discarded because of negative results. I understand, however, that some work along that line has been done recently by others. It is my guess, based on admittedly inconclusive experimental data, that the increase in radiation resistance obtainable by such a method will involve not only the ratio of the two diameters but also the spacing between them, and that no great difference will be observed unless the spacing between elements is less than the diameter of the larger element. A possibility which looks interesting is the use of a semicircular trough as the paralleling element with the driven element down the line of centers of the semicircular cross-sections. Again,

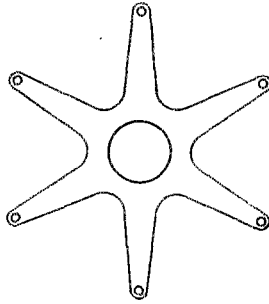
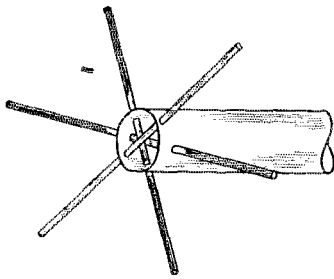

◆  
**Fig. 2** — Details of two types of metal wire-element spacers which are fitted on the outer ends of the tubing element as discussed in the text.  
 ◆

a guess would be that such a set-up would introduce a high capacitive reactance.

#### Adjustment

A word or two about tuning the beam might be useful. It will be found that the parasitic elements are much less critical in adjustment than the conventional close-spaced beam. The formulas shown seem to give optimum forward gain, though a slight improvement in front-to-back ratio may be possible with readjustment with no sacrifice in forward gain. If tests are to be made for adjustment purposes, it is suggested that the parasitic elements be cut to length by formula, and then adjusted with a field-strength meter to attempt to get additional forward gain. (The antenna presently in use has not been tuned.) Then, adjust the reflector only for maximum front-to-back ratio, and recheck to see that there has been no loss in forward gain.

The following is a summarized table of a series of tests made over an extended period of time in ground-wave, normal and DX contacts. The reference antenna is a long wire of nine full wavelengths, current-fed by folding back an additional half-wave at one end and center feeding this half-wave with an open-wire line.

Freq. (Mc.)	S-Meter Readings				Standing-Wave Ratio
	Ref. Ant.	Beam			
		Front	Side	Back	
28.52	9	9 + 30	6	9	1.9:1
29.05	9 + 10	9 + 30	5.5	8	1.4:1
29.69	9	9 + 15	4.5	7	1.7:1

The link coupling to the final was not changed for the beam for the three frequencies indicated. It was necessary to change the link coupling for the long-wire antenna in order to keep the input the same, however.

The transmitter uses a pair of VT-127s in the final with 2200 volts on the plates. The beam antenna is about 50 feet above the ground mounted above the roof of the house on a two-

inch pipe. The pipe extends about 16 feet above the roof of the house and there is probably some excitation of that 16-foot section, resulting in the radiation of some vertically-polarized energy. The discrimination, both front to back and front to end, has proved better in some of the other antennas of this type that have been built to the specifications used here.

I do not believe that such tests as are summarized in the above table are of more than nominal value in determining the worth of an antenna. The only method which seems to indicate the merit of an antenna is its actual performance over an extended period of time. Such results are not subject to being summarized or tabulated, but they were of such nature as to be quite satisfactory here and have led to numerous questions about the installation from those who have heard and worked us.

### SOUTHEASTERN DIVISION CONVENTION

Atlanta, Ga., June 14th-15th

• The Atlanta Radio Club will sponsor the Southeastern Division ARRL Convention in conjunction with the Atlanta Hamfest on Saturday and Sunday, June 14th and 15th. The program begins at 7:30 p.m. Saturday at the Ansley Hotel, where talks by ARRL and other interesting speakers will be presented. Refreshments will be served before and after the speeches.

Outdoor activities will be in a local park Sunday morning, and a turkey dinner will be served at the Ansley at 1 p.m., followed by an address by Captain John Reinartz, world-renowned ham, and by the distribution of prizes. Tickets are \$3.50, or \$1.75 for harmonics under 12, and they may be ordered from Russell Law, W4FKN, 368 Patterson Ave., S. E., Atlanta, Georgia.



# Happenings of the Month

## ANNUAL BOARD MEETING

ARRL's Board of Directors had its regular annual meeting at West Hartford on May 2nd and again we have some minutes to give you and the report of the highlights of a very crowded all-day session of your directors. As you will see from the minutes, there were the usual formal actions of any board of directors in receiving and disposing of many items of business and in making the many necessary appropriations of money to carry on the activities of the League in many departments of its work. We want to refer you to the minutes themselves for exact data on language and on who voted how, etc., but here are the points of most interest that will give you a general perspective on the meeting:

The Board heard last-minute reports on Atlantic City preparations and took another look at its plans. It reiterated the grant of extraordinary powers that it has given ARRL President Bailey to act as a Committee of One to do anything that may suddenly become necessary to protect amateur frequencies, and armed him with \$25,000 to that end.

As all our members know, the Board had already decided, because of the world conference, to give out with no new proposals for the

subdivision of our bands as between 'phone and c.w. but it did direct its Planning Committee to keep this matter under study and to be prepared to come forth with specific recommendations on the subject as soon as the Atlantic City conference ends and our allocations are seen to be stabilized for the next few years. It is the intention then to publish these recommendations in *QST* and to take a poll of amateur opinion thereon, for the information of the Board in considering the matter at its next annual meeting. By this device there will be no delay whatever in getting the earliest possible consideration of this ever-recurrent problem and of doing so in the light of a modern expression of amateur opinion. In the meanwhile the Board decided to ask FCC to open immediately a portion of the Class A 'phone bands for the use of n.f.m. 'phone, both frequency- and phase-modulated, for a test period to run until June 30, 1948, the Board then to examine the situation at its meeting next May and decide in the light of experience to that date whether to ask for the continuation or the expansion or the dropping of the privilege. Fifty kilocycles of each Class A band were selected for the trial run: 3850-3900 and 14,200-14,250 kc. The Board also decided that it would be advantageous



The ARRL Board of Directors and League officials at the annual meeting of the Board in West Hartford on May 2nd. Seated, left to right, Director Acton, Delta; Dir. Jepsen, Southwestern; Dir. Ladley, Pacific; Vice-President McCargar; Communications Manager Handy; Dir. Colvin, Midwest; General Counsel Segal; President Bailey, chairman; Secretary & General Manager Warner; Asst. Secretary Huntoon, Treasurer Houghton, Canadian General Manager Reid; Dir. Raser, Atlantic; Dir. Noble, New England; Alternate Director Smoll, Rocky Mountain. Standing, l. to r.: Technical Director Grammer; Sr. Asst. Secretary Budlong; Dir. Davis, Dakota; Dir. Groves, West Gulf; Dir. Shelton, Southeastern; Dir. Richelieu, Central; Dir. Bird, Great Lakes; Dir. H. W. Johnston, Northwestern; Dir. J. M. Johnston, Hudson; Asst. Secretary Waggoner.

to request the use of n.f.m. in the 6-meter band for the entire portion from 51 to 54 Mc. and it is believed that this will be a great help to the occupants of that band. The Board rejected, however, suggestions to open part of that band to A0 emission and to widen the portion authorized for wide-band f.m. 'phone. Another request that the Board makes of FCC is to open all amateur frequencies to mobile operation, the Board seeing no present reason why those who wish to work mobile on our lower bands should not have the right to do so and believing that such a right will be advantageous in emergency plans in hilly terrain.

You will be equally interested in some of the things that the Board did *not* do. By the parliamentary device of tabling, it killed for the indefinite future any action on the proposal to seek a Class D license for operation on the microwaves without the need to pass the code test. It took similar action in respect of a plan to make Class A privileges available after one year's experience without further technical examination, and thereby it answered an FCC inquiry as to whether it was willing to agree to the elimination of the Class A examination. It did agree with FCC that it would be reasonable to redraw the "Class B circles" with 100-miles radius and permit amateur candidates outside those circles to be eligible for Class C. No changes were proposed in the 10-meter band and the elaborate plan for the rearrangement of that band which was presented for your inspection in December *QST* was similarly put on the shelf.

The Board's study group, of five directors under Director Caveness, known as the Planning Committee, was requested not only to study 'phone frequencies but to look into the feasibility of ARRL publishing an amateur callbook, and to make a study of a certain plan that came up at the meeting for dividing time between 'phone and c.w. on most of the 80-meter band. All these matters are to be given final consideration at the next meeting.

By the same device of "putting on the table," the Board decided against any further consideration at this time of reapportioning ARRL divisions to coincide with FCC call areas. Further on the administrative side, a retirement plan for the Headquarters employees was instituted, providing that the career men and women at 38 LaSalle who work until the age of 65 may be pensioned at 39.3% of their pay if they have worked 40 years for ARRL, and in proportionately smaller percentage for shorter service, employees to contribute 2% of their pay toward the plan. The Chicago fellows having decided that their local situation does not permit the holding of a national convention there for the indefinite future, the Board authorized the holding of an "ARRL National" in Milwaukee in the autumn of 1948 under aegis of the Milwaukee Radio

Amateurs' Club. Because of rising costs all down the line, particularly for paper and printing, the Board increased the membership dues both in the United States and in Canada by fifty cents a year, effective July 1st, feeling confident that this will be understandable to all amateurs and that they will feel that it is still a very small rate to pay for *QST* and for the coordinating and protective activities of ARRL. Plans were drawn for an augmented staff in the Communications Department with particular reference to communication emergencies, in a scheme which it is hoped will permit that department to rush an expert staff communicator to the scene of communication emergencies to coordinate and assist in the remarkable and notable work which hams always accomplish when the wires are down and a community is in distress. The Board was particularly impressed by the excellent work done by amateurs in the recent Texas disasters. Funds were continued to send the SCMs to organizational meetings in their sections and to permit the attendance of both SCMs and QSL Managers at division conventions. Treasurer Houghton having recently reached the 25-year mark in his ARRL service, the Board congratulated him and thanked him for his notable services to our organization.

The Board thinks that it may meet next year in Daytona Beach, Florida, with Director Shelton as host, if conditions permit.

The minutes will be found at the end of this department.

#### ATLANTIC CITY NOTES

Of the three world conferences to be held in Atlantic City this summer, the one which interests us most is the radio administrative conference to revise the Cairo regulations, opening in May. Fifty or sixty countries are participating, with delegations of up to several dozen each, and the central secretariat alone will run 150 to 200 persons, so that it is now apparent that Atlantic City will be a full-scale affair. The United States is sending 30 delegates plus a considerable secretarial staff. Charles R. Denny, chairman of FCC, will head the American delegation and as such will automatically be chairman of the entire conference. Francis Colt deWolf, chief of the telecommunications division of the Department of State, is the vice-chairman of the U.S. delegation. The American group, including the representatives of private agencies, has organized itself into teams to deal with various classifications of the work and is prepared for a long siege. FCC Commissioner E. K. Jett is coordinator of the several technical branches of the work and major spokesman therefor, and other United States spokesmen have been designated for the several teams. These include FCC Commissioner E. M. Webster, Dr. J. H. Dellinger of the Bureau of Standards, H. B. Otterman of the State Department, Capt. G. Caswell, USN, and, for frequency

## ARE YOU LICENSED?

• When joining the League or renewing your membership, it is important that you show whether you have an amateur license, either station or operator. Please state your call and/or the class of operator license held, that we may verify your classification.

allocation matters, Capt. Paul D. Miles, USNR, chief of allocation work at FCC.

The book of proposals apparently will not be out much before the conference opens and so far only two formal proposals are known. Czechoslovakia was first under the wire, with Proposal No. 1R, exclusively about broadcasting. Her proposition would begin broadcasting bands at 7.1 and 21.35 Mc., to the clipping of two of our bands, and would considerably mangle some of the v.h.f. bands, although she is here probably only talking of the European region. No. 2R is by Eire and, without proposing specific allocations, asks for increased allocations for h.f. broadcasting and for aeronautical mobile. A further revision of the tentative proposals of the United Kingdom, as of late February, maintains the same proposals for amateurs as were listed on page 45 of our April issue. The Canadian amateur proposals are almost exactly those of the United States except that she proposes the whole band 28-30 Mc.

By the time you read this item the conference will be well under way and in our future issues this summer there should be much more news to report. It will be our intention, in fact, to give you a report each month on the developments at Atlantic City. Watch for it!

## 11-METER BAND CHANGED

On April 10th the location of our 11-meter band was shifted downward by 25 kc., by means of FCC's Order No. 130-M. The band now runs from 27.160 to 27.430 Mc. instead of 27.185 to 27.455.

The Commission recently decided to increase the width of the "diathermy band" centered on 27.32 Mc. from a width of 270 kc. to 320 kc. but to make the additional 50 kc. available to certain special types of fixed and mobile stations—sharing with industrial, scientific and medical devices as we do. To prevent splitting the assignments of either service it was necessary to move us to one end of the widened band, and hence the shift.

## MORE RESTRICTIONS REMOVED

Two more military restrictions, hangovers from the war, were removed by the armed forces during April and were immediately given effect

in the amateur world by FCC's Order No. 130-N on April 25th:

Ever since the opening of the 2-meter band, the frequencies 146.5 to 148 Mc. have been held back within 50 miles of Washington, Seattle and Honolulu, because of continued military use. This has now ceased, and all FCC amateur licensees now possess rights to the full band, 144 to 148 Mc.

The military authorities have continued to make some employment of the 3500-4000 kc. band in the Pacific and have restored that band to FCC licensees only as far west as 170 degrees west longitude. In Hawaii and west to 170, there was until April a power limitation of 500 watts input. This has now been removed. Although the band is not open to licensees located west of 170 degrees west longitude, all licensees authorized to use the band at all are now authorized to use the legal maximum of 1-kw. input. In other words, the temporary Hawaiian power limit is now off.

## BOARD MEETING MINUTES

MINUTES OF 1947 ANNUAL MEETING OF THE  
BOARD OF DIRECTORS, AMERICAN RADIO  
RELAY LEAGUE

May 2, 1947

1) Pursuant to due notice and the requirements of the By-Laws, the Board of Directors of the American Radio Relay League, Inc., met in regular annual session at the Hartford Golf Club, West Hartford, Conn., on May 2, 1947. The meeting was called to order at 9:36 a.m., EDT, with President George W. Bailey in the Chair and the following other directors present:

J. Lincoln McCargar, Vice-President  
Alexander Reid, Canadian General Manager  
George S. Acton, Delta Division  
Harold C. Bird, Great Lakes Division  
Chester A. Colvin, Midwest Division  
Tom E. Davis, Dakota Division  
Wayland M. Groves, West Gulf Division  
Hans R. Jepsen, Southwestern Division  
Harold W. Johnston, Northwestern Division  
Joseph M. Johnston, Hudson Division  
William A. Ladley, Pacific Division  
Percy C. Noble, New England Division  
Edward G. Raser, Atlantic Division  
Clyde C. Richelieu, Central Division  
William C. Shelton, Southeastern Division  
P. Arthur Smoll, Alternate, Acting, Rocky Mountain Division

Absent: Hugh L. Caveness, Roanoke Division. There were also present Senior Assistant Secretary Arthur L. Budlong, Technical Director George Grammer, Communications Manager Francis E. Handy, Treasurer David H. Houghton, Assistant Secretary John Huntton, General Counsel Paul M. Segal and Secretary & General Manager K. B. Warner. The meeting was welcomed and briefly addressed by the Chair.

2) On motion of Mr. Davis, unanimously VOTED that the minutes of the 1946 annual meeting of the Board of Directors are approved in the form in which they were issued by the Secretary.

3) On motion of Mr. H. W. Johnston, unanimously VOTED that the minutes of the March 14, 1947, special meeting of the Board of Directors are approved in the form in which they were issued by the Secretary.

4) On motion of Mr. Groves, unanimously VOTED that the annual reports of the officers to the Board of Directors are accepted and the same placed on file.

5) On motion of Mr. Colvin, unanimously VOTED that

the Board, having examined its mail action by which it directed the publication in *QST* of an explanation of a certain proposed plan for the subdivision of the 10-meter amateur band by types of emission, and having examined the same, now ratifies the action taken and decides to take this position as of October 7, 1946.

6) On motion of Mr. H. W. Johnston, unanimously VOTED that the Board, having examined its mail actions by which it authorized its representatives to amend one of its proposals before the Federal Communications Commission concerning 'phone frequency assignments and later decided to withdraw the proposals in their entirety, and having examined the same, now ratifies the actions taken and decides as of November 22, 1946, to authorize its representatives to reduce its pending request for 'phone frequency assignments in the 14-Mc. band to read 14,240 to 14,400 kc.; and decides as of December 19, 1946, to withdraw its pending requests for 'phone frequency assignments in their entirety, and to postpone further determinations in this matter until the results of the world conference are known.

7) On motion of Mr. H. W. Johnston, unanimously VOTED that the Board, having examined its mail actions by which it amended and later withdrew its pending request before the Federal Communications Commission for the creation of a Class D license and later directed the publication in *QST* of an article explaining the proposal for further consideration in 1947, and having examined the same, now ratifies the several actions taken and decides as of June 10, 1946, to request that Class D licensees be given distinctive station calls; and decides as of June 11, 1946, that Class D licensees shall not be regarded as eligible to full membership in the League; and decides as of July 15, 1946, to request that Class D licenses be valid only above 1215 Mc.; and decides as of July 25, 1946, to withdraw its pending request entirely; and decides as of January 17, 1947, to consider the matter further at the 1947 meeting and to direct the publication in *QST* of an article explaining the proposal and soliciting membership reaction thereon; and decides as of January 27, 1947, to direct that the said article contain a postcard on which amateurs may state their approval or disapproval of the proposal.

8) On motion of Mr. H. W. Johnston, unanimously VOTED that all acts performed and all things done by the Executive Committee since the last annual meeting of the Board, and by it reported to the Board, are ratified and confirmed by the Board as the actions of the Board.

9) On motion of Mr. Shelton, after discussion, unanimously VOTED that the reception of the reports of the Finance and Planning Committees shall go over until later.

10) On motion of Mr. Richelieu, unanimously VOTED that the annual reports of the directors to the Board of Directors are accepted and the same placed on file.

11) Moved, by Mr. Richelieu, and seconded by Mr. Davis, that the balance of the proceedings of this meeting, whether as an assembly or a committee of the whole, be taken in shorthand and transcribed, a copy of which transcription shall be sent to each member, alternate and assistant director of this Board, and made the basis of a full and complete record for publication in an early issue of *QST*. But, after discussion, the motion was rejected, Messrs.

Richelieu and Davis asking to be recorded as voting for its adoption.

12) At this point supplementary oral reports were rendered by the officers of the League. By request, Assistant Secretary Budlong summarized the proposals of foreign countries for the world telecommunications conference as received to date.

13) Proceeding to a consideration of matters to be raised by directors on their individual initiative, on motion of Mr. Richelieu, unanimously VOTED that the directors are requested to confine their motions to items not already on the agenda of the meeting.

14) On motion of Mr. McCargar, seconded by Mr. Davis, after discussion, unanimously VOTED that the Federal Communications Commission is requested to authorize mobile operation on all amateur bands.

15) On motion of Mr. Noble, unanimously VOTED, because many newly-licensed amateurs use 'phone exclusively and state that they do not use c.w. because so much of the c.w. work seems to be at too high speed for them to understand, that *QST* shall stress at frequent intervals the fact that most c.w. amateurs are perfectly willing to send at any speed desired by the amateurs with whom they are in contact, and that most amateurs are very desirous of working new amateurs.

16) Moved, by Mr. Noble, that the Government Printing Office at Washington be approached by ARRL on the proposition of renewing the printing of an official amateur radio callbook. But, after discussion, the motion was rejected.

17) Moved, by Mr. Noble, and seconded by Mr. Davis, that articles on controversial subjects in *QST*, calling for postcard expression to ARRL, shall in the future be written by two Headquarters men of opposing views, because of the fact that any one man either favors or disapproves the plan being presented and naturally therefore has extreme difficulty in writing a purely unbiased article. After discussion, the yeas and nays being ordered, the said subject was decided in the negative: Whole number of votes cast, 17; necessary for adoption, 9; yeas, 8; nays, 9. Those who voted in the affirmative are Messrs. Bird, Davis, Jepsen, J. M. Johnston, Ladley, Noble, Richelieu and Smoll. Those who voted opposed are Messrs. Acton, Colvin, Groves, H. W. Johnston, Raser, Reid, Shelton, McCargar and Bailey. So the motion was rejected.

18) The Board was in recess from 11:30 A.M. to 11:36 A.M.

19) On motion of Mr. H. W. Johnston, unanimously VOTED that there is hereby appropriated from the surplus of the League, as of this date, the additional sum of three hundred dollars (\$300) for the legitimate administrative expenses of the director of the Northwestern Division for the calendar year 1947, any unexpended remainder at the end of the year to be restored to surplus.

20) On motion of Mr. Ladley, unanimously VOTED that there is hereby appropriated from the surplus of the League, as of this date, the additional sum of two hundred fifty dollars (\$250) for the legitimate administrative expenses of the director of the Pacific Division for the calendar year 1947, any unexpended remainder at the end of the year to be restored to surplus.

21) Moved, by Mr. Smoll, that a research program be set up by this Board, the purpose of which shall be to scientifically determine the possible maximum number of licensed amateurs consistent with available frequencies, satisfactory pursuit of the art by licensees and the fullest possible realization of the accepted purposes of amateur radio. But, after discussion, the motion was rejected.

22) On motion of Mr. Shelton, and by unanimous VOTE, the following amateur radio societies, investigated and applications approved by the respective directors, were declared duly and truly affiliated with the League:

Skyways Amateur Radio Club . . . La Grange, Ga.  
Jamestown Amateur Radio Club Jamestown, No. Dak.  
Metropolitan Amateur Radio  
Society . . . . . Brooklyn, N. Y.  
West Side Radio Club . . . . . Toronto, Ont., Can.  
Piqua Radio Club . . . . . Piqua, Ohio

(Continued on page 134)

## OFFICERS' REPORTS AVAILABLE TO MEMBERS

•In April of each year the officers of the League make comprehensive written reports to the directors. The Board of Directors has made these reports available to the membership of the League. Interested members may obtain copies postpaid at the cost price of 75 cents per copy. Address the Secretary at West Hartford.

# • Technical Topics —

## “Why Don't They Build Better Receivers?”

THERE seems to be some feeling among many amateurs that the receiver manufacturers don't give the ham a “break” when it comes to cooking up new communications receivers — the new ones are all too expensive, they don't have enough selectivity or image rejection or sensitivity or stability or something and, in general, “Why doesn't someone build a good one?” Let's see whose fault it is that “they don't build a good one,” if such is the case.

No one will deny that, with the exception of the few excellent surplus receivers (which did cost plenty to build), the sets *are* expensive these days. So is everything else, for the many reasons the daily papers proclaim, but there is no doubt that the receivers are more expensive than they need be. So why don't they make them for less money? Simply because such a procedure would mean elimination of the broadcast and general-coverage bands, and then no one would buy them! Oh, sure, a strictly ham-band receiver would enjoy some sale in the present amateur market, but not enough to bring the price down far enough, simply *because the consumer insists on these extra bands!* Unfortunately this has been well established by the manufacturers, since many of them have at one time or another tried to sell a strictly amateur-band receiver. Eliminating the bands unnecessary for amateur work would also enable the manufacturer to cut down on the “high-fidelity” audio so “necessary” for broadcast and short-wave reception, *according to the amateur.* And other advantages obtain from forgetting to expect the communications receiver to be a high-fidelity receiver. In one case we know of, a manufacturer who brought out a postwar receiver not too unlike a prewar predecessor deliberately reduced the i.f. selectivity of the postwar over the prewar job because there had been a number of complaints by amateurs that “the audio had no highs” in the earlier jobs! Nuts! The good selectivity of the earlier receiver cut the highs, and the so-intelligent consumer, through his demands, was directly responsible for the somewhat poorer selectivity of the later model. The sooner that the “discerning” amateur realizes that “highs,” completely unnecessary to a good communications receiver, just don't go hand-in-hand with good selectivity, the sooner the manufacturer will be able to give us good i.f. selectivity, with its obvious benefits in crowded bands. What we want in our communications receiver is a darned good crystal filter backed up by an i.f. amplifier just wide enough to give intelligible speech, and preferably with such steep sides to the selectivity

characteristic that the adjacent-channel selectivity is good. It won't be a “high-fidelity” job, but it will be an honest-to-goodness *communications* receiver.

### Sensitivity

Let's look at another popular point of debate, the sensitivity. Some good 28- or 50-Mc. man. who has sweat blue for two years over a hopped-up converter for his pet bands, will almost immediately condemn any new receiver that comes out and can cover those bands because it doesn't have the “sensitivity” or the “image rejection” it should. In all the cases we know of, the receiver also covers the broadcast band, and this almost precludes its being a top performer at 28 Mc. and higher, unless it has separate front ends for the ranges. Separate front ends! Higher price! They can't do that to us! Remember that the “hot” converter covers only a small range, lead inductance and stray capacities can be reduced, and it works into an i.f. around 5 or 10 Mc. that makes the image ratio pretty good. The poor competing “communications” receiver has to work into a 450-ke. i.f., which doesn't give its one or two r.f. stages a chance to reject those images. Why not a higher i.f.? Simply because it would mean a triple-conversion job with two i.f. channels, since we have to get back to 450 ke. to get that good i.f. selectivity and a decent crystal filter, and there goes the price toward the sky again.

Stability costs money, too, since it is generally a question of the excellence of component parts and design. The slickest approach to the stability problem on the frequencies above 14 Mc. is to use a crystal-controlled high-frequency oscillator in a converter which works into a regular low-frequency receiver (acting as a tunable first i.f.). The commercial receiver recently announced that uses this principle (the Collins) has wonderful stability, but it isn't an inexpensive receiver because such things don't come cheap. Always remember that stability on the higher frequencies is a percentage affair, and that 0.5-per-cent drift or error in calibration at the higher frequencies represents plenty more kilocycles at 28 Mc. than it does at 3.5, even though such performance is considered excellent for any production-line product. Good mechanical stability generally requires “battleship” construction, another price-raiser.

What's the answer? There probably isn't one that will make us all happy, but at least we can

(Continued on page 152)

# An Antenna for 7-Mc. DX

*The Ground-Plane Antenna on Forty Meters*

BY RICHARD R. SCHELLENBACH, \* W6TKX

ONE can get rather discouraged by not being able to raise the stuff on 40 meters that he hears others working, even after many different antennas have been tried. Such was the case of the author who, surrounded by other houses and telephone poles, wasn't having much luck on 7 Mc. except locally and in the States. An antenna was needed that could be raised above the surrounding objects, and yet the antenna had to be kept on one small lot. Everything indicated that the room for expansion was straight up, and this suggested a vertical antenna.

The first vertical antenna tried was a quarter-wave wire dropped down from the top of a 40-foot "A" mast, which was on the roof top. It was fed at the bottom with tuned feeders. Despite the fact that the bottom end of the antenna came to the peak of the roof, the antenna worked fairly well and results weren't too bad.

Looking through the textbooks for a low-angle radiator, we kept running across the ground-plane antenna, but there was never any mention

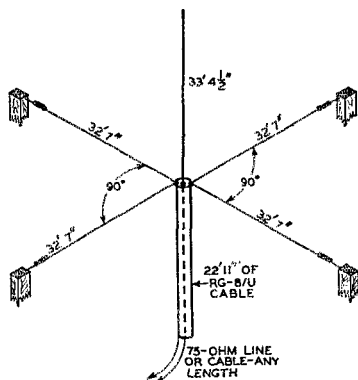

Fig. 1 — Dimensions of the 7-Mc. ground-plane antenna. The radial wires are supported by any convenient means — W6TKX uses two poles, a telephone pole and a tree.

of its performance on low frequencies. It was decided to give the thing a try. An Army-surplus 18-foot whip antenna was fastened to the top of the "A"-frame mast by four large insulators and clamps, and then two paralleled No. 8 wires were connected to the base of the whip and run down the mast until the total length (whip plus wire) was 33 feet, 4½ inches. The ends of the wires at the bottom were tied to a large antenna insulator

• Here is the description of a 7-Mc. antenna that solved one amateur's problem of how to "get out" on 40 without buying up a few acres of land for a rhombic. It seems to be well worth a try by anyone with a desire to work some DX on the band.

which was in turn connected to a strain insulator. Next the whole arrangement was drawn tight with a piece of rope fastened to the bottom insulator.

The four ground radials were made from 32-foot 7-inch lengths of No. 8 wire, all joined together at the junction of the two insulators. A piece of RG-8/U 52-ohm cable was used as a quarter-wave matching section at the bottom of the antenna, to match the antenna impedance to the 75-ohm transmission line that was used to the transmitter. The length of the quarter-wave section works out to be 22 feet, 11 inches, using a velocity factor of 0.66 for the line.<sup>1</sup> The shield braid of the cable was soldered to the junction of the four radial wires, and the inner conductor was soldered to the bottom of the vertical element. Either 75-ohm parallel line or 75-ohm coaxial (RG-11/U) can be used to the transmitter — the parallel line was used in this case.

The four radials were tied to various points that could be found — trees and poles — and they slope down slightly from the junction with the cable shield.

This antenna has been in use for over six months, and results have far exceeded the expectations. We can now call and raise the DX with just a short snappy call, instead of pounding brass for an hour to raise someone in the next state. Results now are better with only 300 watts input than they were with other antennas and a full kilowatt. Some of the DX stations worked on 40 meters from this West Coast QTH are ZL2MM, G3JA, HH2FE, CM2BC, PY1FW, VK3AMP, ZL3FP, PK6AQ, OZ7CC, CM2BC, ZL2GO, ZLAGM, XU1P, CO2SW and ZL2BH. During all of these contacts our signals were reported as S7 or better.

<sup>1</sup> The actual length of the quarter-wave section in use at W6TKX is 29 feet, 9 inches. This length was arrived at by experiment, and may possibly be accounted for by deviations from the correct length in the radiator and ground radials. The proper match can best be obtained by experiment and reference to the McWatters article in the May, 1947, issue of QST. — Ed.

\* 1833 South Bronson Avenue, Los Angeles 6, Calif.

# The Eleventh ARRL Field Day

*June 14th & 15th — Dates for Field Testing Self-Powered Rigs —  
Separate Score Listings for Clubs, Emergency Corps Groups,  
V.H.F. - Only and Home Stations, and Individuals*

COME one, come all! *Every amateur* is invited to take part. Dedicated to advancement of the emergency-readiness of the amateur service, there is no activity to compare with an ARRL Field Day. It offers an opportunity for testing equipment and perfecting operating techniques, with lots of fun and fellowship included for good measure.

To be prepared for communications emergencies requires advance readiness. Every amateur should possess some measure of self-powered equipment and be signed in with his local ARRL emergency coordinator to get the most from his hobby and fulfill the public-interest clauses behind the grant of his amateur license.

**Contest Aim:** Each field-portable set-up is to work as many other amateur stations as possible, at home or afield. In emergencies, every amateur should know how to handle messages, i.e., the correct order of parts, how to check and receipt for a message and record its handling data, how to get fills, etc. These all require skilled operating — not everyday rag-chewing operation. The FD gives practice in tuning up ready-cut antennas in new locations, commands our ingenuity to make the most of low power, challenges operating ability, fosters the discussion and sharing of problems, and calls for organization.

**The Operating Period:** Operating time for the FD, to be shown in all logs, must be between Saturday, June 14th, 4 P.M. your *local time*, and Sunday, June 15th, 6 P.M. your *local time*.

**Home Stations:** If unable to join a FD group, home participation assisting field operators is invited. List contacts with FD stations and send them in for separate score listing. *Home-station* scores will be based (1) on the number of FD portables worked, plus (2) points for FD messages handled. (One point for each message

<sup>1</sup> To comply with FCC regulations for portable station operation, licensees must make advance notification of the location in which the portable will be operated, for work either above or below 25 Mc., to the Engineer-in-Charge of the district representing the original licensing area, and also a second notice to the Engineer-in-Charge of the one of the 23 FCC Districts (see ARRL *License Manual* list) in which the operation will take place. Then in FD operation it is necessary to use proper station identification (DN 1-2 etc.) after the "notified" identifying station call.

<sup>2</sup> Ten points will be deducted from the possible 25 for incorrect check, failure to show full handling data, improper order of sending preambles, or other defects or variance from standard ARRL procedure. Word-count for correct checking is explained in the present and prewar copies of *Operating an Amateur Radio Station*, copies of which will be mailed to ARRL members on request.

received if copy is mailed to Hq.; 2 points for relays — 1 when received, 1 when sent forward.) The stations claimed must be listed with the time worked. Message credits must be substantiated by submitting message copies with complete handling data.

**Field Stations:** *Portable stations operated in the field (away from "home" address) are eligible to submit field scores.* Only portable set-ups may be listed with the FD classification. Individuals or groups under *one call* must be "in the same locality" or "in one group or building or field" constituting a single FCC-notified<sup>1</sup> location. To have points count, all station control points at a FD station must be within 500 horizontal feet of some given point. Report your FD location and circumstances by radio message to ARRL. No advance entry is required. All stations participating will use the calls CQ FD (for c.w.) or "Calling any Field Day station" (for 'phone). Mobile work does not count — this is strictly a test of portables. Manufactured contacts with any station or stations of members of the same field group in the contest do not count. Any or all amateur frequency bands may be used.

**FD Scoring:** Each nonportable amateur station worked counts as 1 point toward the score. Portable-to-portable contacts will count 2 points. The same station contacted again counts again only if the FD-transmitter credit reported was on a different amateur frequency band, e.g., a contact when using 3.5-Mc. c.w. followed by one with the FD set-up on 3.9-Mc. 'phone, or on 7-Mc. c.w., etc. An extra credit of 25 points<sup>2</sup> before multiplier may be claimed for radio origination of not more than one message addressed to ARRL Hq., *only* provided message copy is submitted with claimed score. FD messages to Hq. will include the following data: number of operators, location, conditions and power. Eight additional points (also before multiplier) may be claimed for radio handling of each FD message of another group if copy showing complete handling data is submitted with station list and claimed score (4 points for receiving and 4 points for relaying).

**Multipliers:** Score may be multiplied by 2 if either the receiver or transmitter is independent of commercial power source, by 3 if both transmitter and receiver are supplied from an independent local source or sources. The following additional score multiplier is determined by the

*Continued on page 114)*

# The Dialless Converter

*A New Way To Tune the 10- and 11-Meter Bands*

BY JAMES H. CREUTZ, \* W2PMQ, AND DONALD F. McAVOY, \* W2PRT

**Y**ES, the title is correct. This converter has no tuning dial or any other operating control. Therefore, it is possible to place the converter either in a location remote from its companion receiver, or inside the receiver cabinet itself if space permits.

By this time, the reader undoubtedly has several questions in mind, such as:

If there is no tuning control on the converter, how can you tune in stations operating on different frequencies in the 10- and 11-meter bands?

Are the sensitivity and signal-to-noise ratio of the converter acceptable?

Are construction and initial adjustment difficult?

How about image rejection?

These and other questions are answered in the following text which the authors hope will be of interest and value to the amateur.

## *Principle of Operation*

In a conventional converter, the high-frequency circuits are tuned and the output is fixed at some predetermined frequency, such as 8.5 Mc. The dialless converter, on the other hand, uses fixed-frequency circuits and a broad band of output frequencies. In operation, signals induced in the antenna are amplified as they pass through the r.f. and mixer stages of the converter. These circuits have been designed so that essentially equal amplification is given to all signals between 27.16 and 29.7 Mc., while other signals are attenuated. The high-frequency oscillator in the converter generates a 20-Mc. signal which simultaneously beats with every signal passing through the mixer tube. As a result, one difference-frequency signal will appear at the output of

\*Signal Corps Publications Agency, Fort Monmouth, New Jersey.

• If your receiver doesn't do its stuff on 10 the way it does around 40, here is an excellent way to make a 10-meter receiving system that handles like one on 7 Mc. Designed to take advantage of the performance of the newest tubes and circuits, the dialless converter should prove a boon to the many 28-Mc. operators who want to "hop up" their receiving equipment on that band.

the converter for each 10- or 11-meter station received by the antenna. Moreover, these difference-frequency signals will all fall in the broad band of frequencies between 7.16 and 9.7 Mc. For example, assume that three equal-amplitude signals are being picked up by the antenna and are being fed to the converter. Also assume that these signals are on frequencies of 28.2, 29.0 and 29.7 Mc. All three of these signals will be amplified by the r.f. stage and will appear at the mixer tube as equal-amplitude signals because of the uniform gain of the converter at these frequencies. In the mixer tube, the three signals will simultaneously beat with the 20-Mc. h.f. oscillator to produce three signals of 8.2, 9.0 and 9.7 Mc. in the plate circuit of the mixer tube. When these signals are fed to the antenna terminal of the companion receiver, they appear as equal-amplitude signals which may be tuned in by the receiver tuning control.

Additional advantages of the dialless converter will now be apparent to the reader:

Bandspread is automatically achieved because most receivers have sufficient spread covering the range of frequencies between 7.16 and 9.7 megacycles.

Calibration is automatically achieved because the present frequency calibrations of the receiver

◆

The dialless converter with the shield for the 6AK5 r.f. amplifier tube removed. The center tube is the 9002 oscillator, and at the right is the 6AK5 mixer. The three slugs, top front, tune the antenna input, mixer grid, and mixer plate circuits respectively. The three capacitors, bottom front, tune the antenna input, oscillator, and mixer plate circuits respectively.

**QST** for

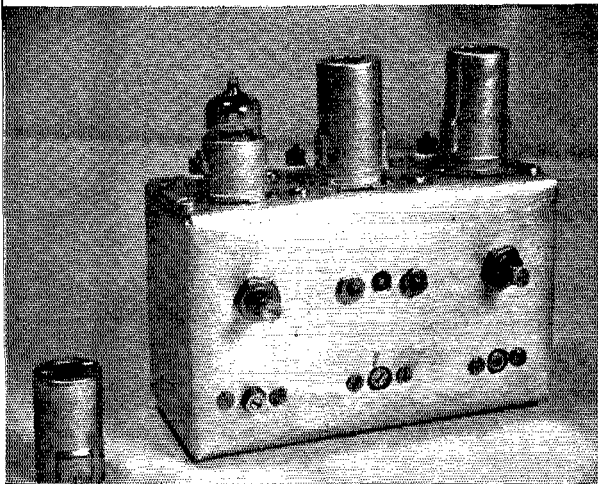



A rear view of the converter. The compartments, from left to right, contain: mixer output circuit; r.f. plate coil and mixer grid coil wound on the top form, oscillator coil air-wound at bottom; and antenna input circuit. The large resistor in the center compartment is  $R_4$ , plate-voltage dropping resistor. Going from left to right, the feed-through insulators at the top are: output ground; hot output lead; B-minus and one side of 6.3-volt a.c. filament; ungrounded side of filament; B-plus 250 volts d.c.; high side of antenna input; and grounded side of antenna input.

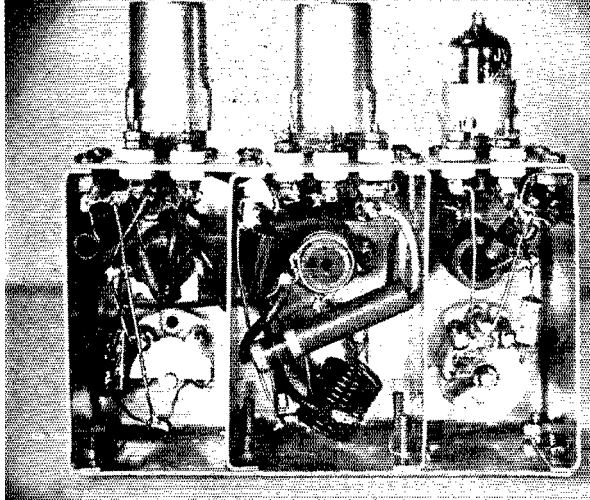

dial will also serve for the 27.16–29.7-Mc. range. All that is necessary is to insert mentally a 2 before each dial reading. For example, 7.5 Mc. becomes 27.5 Mc., 8.2 Mc. becomes 28.2 Mc., etc.

The problem of tracking usually encountered in the adjustment of h.f. circuits is eliminated.

The expense of a tuning dial and ganged capacitors is eliminated.

All other features of a receiver, such as crystal filter, noise limiter, etc., may be utilized, since receiver operation is not affected by the addition of the converter.

#### *Sensitivity & Signal-to-Noise Ratio*

No attempt has been made to develop a high voltage gain in the converter. The reason for this is that most receivers with which the converter will be used already have excess gain. For example, consider a signal that is gradually fading out. As the signal becomes weaker, the gain of the receiver must be increased by advancing the receiver's gain control, if the audio level is to be kept constant. As the signal becomes still weaker and weaker, however, a point is reached where the signal disappears into the noise and further gain will not aid reception. Thus, the limiting factor for the reception of weak signals is usually noise rather than receiver gain. This noise has two origins: that which is developed within the receiving equipment, and that which enters the antenna. The latter type of noise can be discounted for the purposes of this article, because for a given antenna, the noise is dependent on the location of the antenna. Only through the use of a more directional antenna, or by the movement of the antenna to a quieter location, can this noise be attenuated, although sometimes a change in polarization or an increase in antenna height will help.

Of primary concern at 28 Mc. is the noise developed within the receiver. In a good receiver, the noise generated in the input stage of a receiver is responsible for practically all the noise heard in the 'speaker output, since the noise appearing in the input circuit is amplified by each

succeeding stage in the receiver and masks noise generated by these stages. Therefore, the noise generated in the r.f. amplifier of the converter will determine the over-all noise output of the converter-receiver combination. In the r.f. stage, noise is developed as a result of thermal agitation in the circuits and various tube factors.

Care has been taken in the design of the input circuits of the r.f. stage to produce a high-level signal voltage at the grid of the r.f. amplifier tube by providing a means for matching an antenna system to the converter. Two converters have been constructed and each converter has been used with various communications receivers and different antennas. From these operations, it has been found that the signal-to-noise ratio of the converter-receiver combinations compares favorably with that of the better communications receivers and surpasses the performance of the simpler "ham" receivers.

#### *Selectivity Characteristics*

Because of the wide bandpass circuits used in the converter, no gain in selectivity is acquired through the use of the converter. This is of little importance, however, because the selectivity developed in any communications receiver is obtained in the low-frequency i.f. amplifier. The selectivity characteristic of the dialless converter-receiver combination can be predetermined because it will be exactly the same as the selectivity of the receiver itself when tuned to frequencies between 7.16 and 9.7 Mc.

A question has often been asked regarding the lack of converter selectivity and its effect on the noise output of the receiver. Examination shows that although the noise output power of the converter varies directly with the bandwidth, most of this noise does not appear in the 'speaker output. The reason is that the over-all bandwidth of the converter-receiver combination is dependent on the selectivity characteristics of the receiver itself and, therefore, no noise in the converter output will appear at the 'speaker except noise within that range of frequencies which the

receiver i.f. amplifier will pass. For the average communications receiver, this bandwidth is of the order of a few thousand cycles.

### Images

If the companion receiver with which the converter is to be used has at least one stage of r.f. amplification, *no image interference will be obtained* when the receiver is connected to the converter for 27.16-29.7-Mc. operation. This is explained as follows:

First, consider image signals in the converter alone. Assume that a single station is being received on a frequency of 29 Mc. This signal will beat with the converter's h.f. oscillator to produce a 9.0-Mc. difference-frequency signal on the output of the converter. The only other signal which can beat with the oscillator to produce a 9.0-Mc. signal is one that is being received on a frequency of 11 Mc. A signal of such a low frequency, however, will not pass through the converter circuits with any appreciable amplitude because the converter is designed to attenuate signals that do not fall into the 27.16-29.7-Mc. range. Therefore, image rejection in the converter alone is greater than necessary.

Next, consider those images which might possibly be obtained as a result of the large number of signals simultaneously passed to the receiver from the converter. At first thought, it might appear that image interference would result. This is not actually the case, however, because the converter output signals are at frequencies between 7.16 and 9.7 Mc. At these relatively low frequencies, the image rejection of most receivers is excellent. This is especially true of receivers that contain one or more stages of r.f. amplification and, in any event, the signal-to-image ratio of the converter-receiver combination during 27.16-29.7-Mc. operation is exactly the same as the signal-to-image ratio of the receiver alone during 7.16-9.7-Mc. operation.

### Circuit Details

The input circuit of the converter is unique, in that it employs a recently-developed impedance-matching system which, once properly adjusted, assures an efficient transfer of received radio signals from the antenna system to the grid of the radio-frequency amplifier tube, a Type 6AK5 miniature high-conductance tube.

This circuit is an adaptation of the recently-publicized "R-9'er,"<sup>1</sup> which uses a single 6AK5

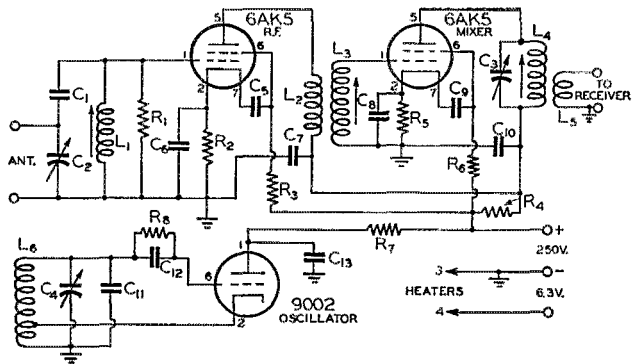

Fig. 1 — Schematic diagram of the dialless converter.

- C<sub>1</sub> — 5- $\mu$ fd. ceramic.
- C<sub>2</sub> — 100- $\mu$ fd. air trimmer, variable.
- C<sub>3</sub>, C<sub>4</sub> — 50- $\mu$ fd. air trimmer, variable.
- C<sub>5</sub>, C<sub>6</sub>, C<sub>7</sub> — 470- $\mu$ fd. 400-volt mica.
- C<sub>8</sub>, C<sub>9</sub>, C<sub>10</sub>, C<sub>13</sub> — 470- $\mu$ fd. 400-volt mica.
- C<sub>11</sub>, C<sub>12</sub> — 100- $\mu$ fd. silver mica.
- R<sub>1</sub> — 7000 ohms,  $\frac{1}{2}$  watt.
- R<sub>2</sub> — 270 ohms,  $\frac{1}{2}$  watt.
- R<sub>3</sub>, R<sub>6</sub>, R<sub>7</sub> — 47,000 ohms, 1 watt.
- R<sub>4</sub> — 4700 ohms, 2 watts.
- R<sub>5</sub> — 680 ohms,  $\frac{1}{2}$  watt.
- R<sub>8</sub> — 0.1 megohm,  $\frac{1}{2}$  watt.
- L<sub>1</sub> — 15 turns No. 20 enam., close-wound on  $\frac{1}{2}$ -inch diameter slug-tuned form.
- L<sub>2</sub> — 15 turns No. 20 enam., close-wound on  $\frac{1}{2}$ -inch diameter form, untuned.
- L<sub>3</sub> — 15 turns No. 20 enam., close-wound on same form as L<sub>2</sub>, but slug-tuned; spaced  $\frac{1}{2}$  inch from L<sub>2</sub>.
- L<sub>4</sub> — 25 turns No. 28 enam., close-wound on  $\frac{1}{2}$ -inch slug-tuned form.
- L<sub>5</sub> — 5 turns No. 20 enam., wound over L<sub>4</sub>.
- L<sub>6</sub> — 13 turns No. 14 enam., air-wound,  $\frac{1}{2}$ -inch inside diameter, close-spaced, tapped 3  $\frac{1}{4}$  turns from ground end.

tube as a broad-band fixed-tuned 23-30-Mc. preamplifier to increase the input and match the antenna to any 10-meter receiver.

As can be seen in Fig. 1, the antenna is matched to the input impedance of the 6AK5 by a capacitor voltage-divider circuit consisting of C<sub>1</sub>, a 5- $\mu$ fd. fixed ceramic capacitor, and C<sub>2</sub>, a variable 100- $\mu$ fd. air-tuned capacitor of the customary screwdriver-adjustment trimmer type. The proper impedance match is secured by concurrent tuning of the variable capacitor, C<sub>2</sub>, and the slug-tuned coil, L<sub>1</sub>, to obtain not only resonance, but the combination of L<sub>1</sub> and C<sub>2</sub> that produces the greatest output at resonance. Any number of combinations of values of L and C can tune the circuit to resonance, but only one combination can tune it to resonance at the point where the ratio of C<sub>1</sub> to C<sub>2</sub> is correct to provide the proper impedance match between the antenna and grid.

The formula for calculating the input impedance of the converter using this circuit is given by G. E. as

$$Z = \frac{7000}{\left(\frac{C_1 + C_2}{C_1}\right)^2}$$

<sup>1</sup> "The R-9'er — A One-Tube Preamplifier," G. E. Ham News, Nov.-Dec., 1946.

Figure 2 is a graphical presentation of calculations using this formula. The graph gives the input impedance in terms of capacitance for  $C_2$ . The curve is marked at 19.2  $\mu\text{fd.}$ , the value of  $C_2$  required for matching a 300-ohm twin line such as is commonly used with folded-doublet antennas.

The converter is aligned at a frequency approximately midway between the band edges; 23.5 Mc. is satisfactory.

For this converter to perform adequately over the entire 10- and 11-meter bands, its response must be approximately equal at all frequencies in the bands. The necessary broad-band effect is obtained by loading the tuned circuit  $L_1C_1C_2$  with a 7000-ohm resistor. This resistor is important if proper bandwidth is to be obtained.<sup>2</sup>

The 6AK5 is ideal for this type of broad-band circuit. This tube gives excellent performance in a conventional converter circuit using ganged tuning capacitors, in which each r.f. circuit is peaked for maximum response at each frequency to which the converter is set. But in the conventional circuit, the capabilities of this tube are being wasted. The 6AK5 is capable of high gain and broad bandpass even in television circuits, where fairly uniform gain is required over bandwidths of 4 Mc. In this converter, where a bandpass of only 2.54 Mc. is required, the tube can do the job easily.

In order that the bandpass feature of the converter may be preserved, the other tuned circuits which pass the received signals must be broad enough to handle all frequencies from 27.16 to 29.7 Mc. without appreciable attenuation. This requires that the coupling circuit between the r.f. amplifier tube and the mixer tube, and also the mixer output circuit, likewise have broad-band characteristics.

The proper response of the r.f. plate and mixer grid circuit is assured by over-coupling of the r.f.-amplifier plate tank coil,  $L_2$ , and the mixer grid coil,  $L_3$ . These coils form an r.f. transformer with untuned primary and resonant secondary. It will be noticed that as high an  $L/C$  ratio as possible is preserved in this circuit, and there is no tuning capacitor across  $L_3$ . Resonance is obtained by adjusting the inductance with a powdered-iron tuning slug until the coil resonates with the tube and stray circuit capacitances.

The mixer plate circuit, the output circuit of the converter, is another over-coupled circuit. Coil  $L_4$  is tuned primarily by the 50- $\mu\text{fd.}$  air capacitor,  $C_3$ . The powdered-iron slug in  $L_4$  is used for inductance trimming; its position is not critical, provided  $C_3$  is tuned exactly to resonance.

<sup>2</sup> This is not strictly true. By using an over-coupled double-tuned circuit and no loading resistor, it is perfectly feasible to obtain an adequate bandwidth. However, the loaded type of circuit is probably easier to adjust and the difference in performance is not too great. — Ed.

The oscillator is of the conventional Hartley type, with the cathode of the 9002 triode connected to the tap on the tank coil. The oscillator operates at a fixed frequency, in this case 20 Mc., and, of course, it has no requirements for gain or bandpass. The main requirement is stability, which can be met fairly satisfactorily by using a high value of capacitance across the tuned circuit. Padding with zero- or negative-temperature-coefficient fixed capacitors, and use of a regulated plate-voltage supply, will give added stability.

To preserve the calibration feature explained earlier in this article, the high-frequency oscillator must be set to operate below the frequency of the received signal. The following table makes this clear:

Signal Frequency	Oscillator Frequency	Difference
27 Mc.	20 Mc.	7 Mc.
28	20	8
29	20	9
30	20	10

If the fixed high-frequency oscillator were set higher in frequency than the incoming signal, e.g. 37 Mc., the receiver dial calibration for use with the converter would be backward.

Oscillator output is coupled to the mixer grid by means of the stray coupling existing between circuit wiring and components in the center of the

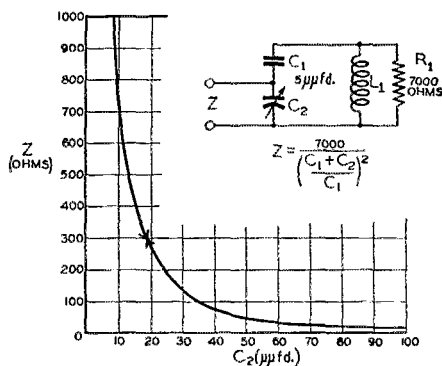

Fig. 2 — Curve showing input impedance in ohms as a function of the value of capacitor  $C_2$ . A match to 300-ohm twin feeder line is obtained at 19.2  $\mu\text{fd.}$

three shielded compartments into which the converter is divided. The oscillator coil,  $L_6$ , and the mixer grid coil,  $L_3$ , are both located in this compartment, sufficient oscillator voltage being injected without using a coupling capacitor.

Incidentally, this converter has none of the disadvantages so often associated with grid injection of oscillator voltage; i.e., "pulling" of the oscillator as the mixer is tuned, inasmuch as the circuits are fixed-tuned.

As the converter was intentionally constructed as small and simple as possible, no effort was made to include a power supply. Drain is less

than 25 ma. plate-and-screen current at 250 volts. The heater demand is 0.5 ampere at 6.3 volts a.c. Most receiver power supplies can handle this additional drain without being over-loaded.

When the converter is permanently installed in the receiver, a front-panel switch should be added to the receiver to turn on converter power, connect the converter into the receiver antenna circuit, and connect the antenna to the converter input.

While this converter was constructed primarily as a 10-meter converter, to tune from 28 to 29.7 Mc. with fairly flat response, it works satisfactorily on the amateur 11-meter band, although the signal response is slightly down at these frequencies when the converter is peaked in the 10-meter band.

A properly-shielded cable between the converter output and the receiver input is of the greatest importance, if serious interference is to be avoided. There are many strong signals in the i.f. range of 7.16 to 9.7 Mc., and the problem of avoiding their reception is far more serious than the simple problem of choosing a single fixed frequency for the conventional tuned-circuit converter. A few feet of lamp cord, twisted wire, or 300-ohm Twin-Lead has served the authors satisfactorily for more than a year while using a converter with a fixed difference frequency of 8.5 Mc. But with the converter described here, shielded coaxial cable, grounded to both the converter chassis and to the receiver chassis, has been found indispensable.

#### Construction Details

Because this converter was constructed for mounting within a receiver, its dimensions are necessarily small. It is constructed on a chassis of thin sheet aluminum, the chassis measuring  $5\frac{1}{4}$  inches long,  $3\frac{1}{4}$  inches wide, and 2 inches deep. Over-all width is increased to nearly 5 inches by the tube shields, and over-all depth to  $2\frac{3}{4}$  inches by the protruding tuning slugs. As shown in a photograph, the converter fits neatly into the dynamotor well of a BC-348. It was necessary to drill a single  $\frac{1}{4}$ -inch hole through one of the rear braces of the receiver in order to reach the output tuning capacitor,  $C_3$ , with a screwdriver. Fastening the converter to the receiver is left to the individual constructor's ingenuity; four machine screws should do it very nicely.

Aluminum shields are fastened beneath the chassis, to isolate circuits. Mounted in the compartment beneath the r.f. amplifier tube are all components associated with the r.f. amplifier stage except  $L_2$ ,  $L_2$  and  $L_3$  are wound on a single form mounted in the center compartment beneath the 9002 oscillator tube. The oscillator components, including oscillator coil  $L_6$ , are mounted in this same compartment. Inside the last compartment are mounted all components associated with the mixer stage except  $L_3$ .

Coils are mounted as close to the tube sockets as possible, to assure short leads. In the center compartment, the coil closest to the tube socket is the r.f. coupling transformer between the r.f. stage and the mixer stage. The oscillator coil is farthest from the tube socket and is soldered directly to the oscillator tuning capacitor. Leads from this capacitor to the tube socket pass the mixer grid coil, aiding in the oscillator-voltage injection.

Seven miniature feed-through insulators, extending across the top of the converter directly behind the tube shields, are used for making connections to the converter. It will be noted that there are three separate ground terminals, in addition to the grounding of the converter chassis to the receiver chassis. Separate grounds are advisable, especially for the signal-input and converter-output connections.

#### Alignment & Adjustment

While coil specifications have been given in Fig. 1, it is not anticipated that all who attempt construction of this converter will follow them exactly, or arrive at the same inductance value if they do attempt exact duplication. Because the tuned circuits use a fairly high  $L/C$  ratio, some experimentation with the number of turns may be necessary. The task will be simplified by following the detailed procedure given below.

Setting of the converter oscillator at its fixed frequency of 20 Mc. is the first logical step. This can be done quite easily by using the communications receiver as a frequency indicator.

First, make certain the oscillator is oscillating. This can be done by measuring the d.c. voltage from the grid of the 9002 oscillator to ground, using a vacuum-tube voltmeter. Presence of a d.c. voltage is an indication of oscillation. The magnitude will be a few volts. If a v.t.v.m. is

*(Continued on page 116)*

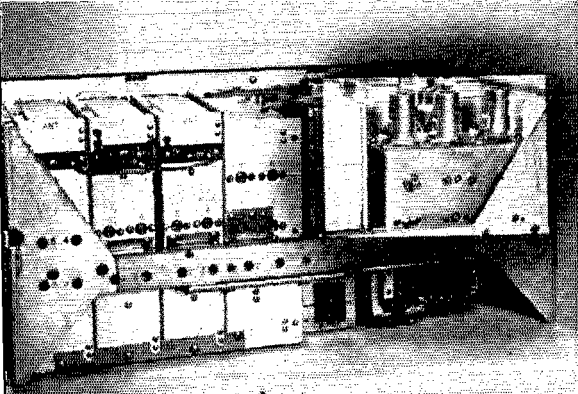

The dialless converter installed in the dynamotor well of a BC-348. The mixer output circuit is tuned with a screwdriver inserted through the hole shown at the right.

**QST** for

# Choosing a Transmission Line

## A Comparison of Various Types of Feeders

BY R. M. PURINTON,\* W9SZ

A COMPLETE discussion of the amateur's problem in choosing a feed system for the transmitting antenna, or more properly the transmit-receive antenna, could contain a great many practical examples and consume far more space than that usually allotted to a single article. Therefore it is the purpose of the author to dwell on fundamental considerations only, leaving it to the reader to apply the fundamentals to his own immediate problems.

The transmission line may take several forms. The most commonly used, by virtue of its low loss and low cost, is the open two-wire line separated by insulating spacers. A popular recent variation is Amphenol's Twin-Lead, in which a good part of the dielectric between the wires is polyethylene rather than air. Another form of transmission line is the coaxial cable in which the fields are confined within the outer conductor. Coaxial cables are manufactured with air or dry gas under pressure as the principal dielectric, or with a solid dielectric such as polyethylene. A now seldom-used feeder is the single-wire type in which we depend on the ground as the "return" side of the circuit.

The amateur's choice of a feeder system is frequently dictated by the cost and by the availability of construction and design information. It is for the latter reason that most of us have almost automatically chosen the two-wire air-spaced feeder, although in doing so it happens that we have picked the system which gives the lowest inherent loss under conditions of incorrect adjustment. The ARRL *Handbook* contains much useful information on the design of two-wire air-spaced feeders either for untuned operation or as part of the resonant antenna system.

### *Twin-Lead for Transmitting*

The recent development of Amphenol Twin-Lead has provided a new convenience in putting up a two-wire feed system. But use of the present receiving-type Twin-Lead necessitates certain precautions which could be neglected with the air-insulated line. Twin-Lead should not be used as a tuned feeder. Why? Because in a tuned resonant system the current at every current loop along the line wire, with moderate power, is high enough actually to heat the conductors, which are equivalent to No. 20 solid wire, and heat in the line is not what we need to work DX. With an untuned line, carefully matched to the load,

\*% American Phenolic Corp., 1830 South 54th Avenue, Chicago 50, Ill.

• Recent years have brought a considerable quantity of solid-dielectric r.f. transmission lines onto the market. This article should serve to clear up some of the confusion which exists in the minds of many hams as to their limitations, advantages and proper application.

the current for 500 watts will be approximately 1.3 amperes for the 300-ohm line, 1.8 amperes for the 150-ohm line and 2.6 amperes for the 75-ohm line. Remember that this applies only to the matched line in which the current and voltage are constant at all points. By comparison, a 2-inch spaced air line made with No. 12 wire and operated untuned would carry a current of about 1.04 amperes.

As a further price to pay for the convenience of Twin-Lead, the 300-ohm line is sensitive to the effects of surface moisture. This will be treated more fully a little later, but it can be emphasized now that the effect is not penetration of the insulation by the moisture. The surface water simply joins with the polyethylene web and the air immediately surrounding the two conductors to become a part of the dielectric. This produces a change in the impedance of the line.

Personally, the author likes air-insulated two-wire transmission line for long runs, and prefers the Twin-Lead type of line for a week-end experiment where the convenience factor is a very important one. But it is believed that, as we learn how to use it more effectively, we shall all be employing coaxial transmission line in our more or less permanent installations. We need go no farther than the local broadcast, f.m. or police installation, to find coaxial cable doing an efficient job, free from weather effects and without most of the BCI problems which are all too common in our experience with wide-spaced two-wire lines. Most of us choose coaxial cable without hesitation for the v.h.f. mobile rig, although we may not stop to reason why.

### *Coaxial Lines*

The war has brought about rapid development of low-loss coaxial transmission lines in which the inferior prewar dielectric materials were replaced by polyethylene, which has loss properties similar to those of polystyrene with which most of us are familiar. Now, in a comparable size and at fre-

quencies below 300 megacycles, the loss of a good-quality solid-dielectric coaxial cable is of the same order as that in an air-dielectric co-ax line, and most of the new f.m., television and police antennas are being fed through polyethylene-insulated solid-dielectric coaxial cables instead of the more costly and troublesome gas-filled co-ax lines.

The remarks made earlier about the necessity for matching Twin-Lead apply with even greater effect to a coaxial line. A good matching job is rewarded with the finest kind of performance over a long period of time. That the matching job requires a bit more attention must be conceded, for we cannot look for standing waves along a co-ax cable with a neon lamp.

Summarizing the general discussion, we can say that our choice of a transmission line will be made after consideration of at least the following factors: (1) whether the line is to be tuned or untuned or a combination of the two; (2) the loss characteristics; (3) the cost; (4) the importance of weather effects; and (5) the convenience or time available for the construction of the feeder system.

If the transmission line is to be tuned, the choice immediately would be the open-wire line with a spacing of not less than 4 inches and a wire size no smaller than No. 12. The *Handbook* does an excellent job of specifying the design and construction of tuned feeder systems. If the feeder is to be untuned, all of the other comparison factors should be examined.

For convenience, Table I has been prepared to provide comparisons in power-loss percentages, approximate amateur costs, and weather effects. It does not take into account the labor expended in construction or installation, since we are dealing with a hobby where the income per hour is of no real significance.

It will be noted that the loss values and costs are approximate, and that they are based on matched lines 100 feet long used at a frequency of 14 to 28 Mc. (for loss determination). At 3.5 Mc. the loss values are so low that they almost cease to be a factor for comparison.

### Impedance Matching

So much for generalities and comparisons. The line chosen must be operated efficiently which means careful matching, or in the case of the tuned line, careful balancing. To achieve best results we can profitably review the performance of all transmission lines in terms of the open two-wire line. An infinitely-long two-wire line will carry power away from the transmitter steadily and with no reaction on the output stage. It may be compared with an unobstructed water pipe draining water from a main. The pressure or voltage across the line will be a maximum at the source, and it will fall gradually as we move to the end of the line. The loss is a combination of simple  $IR$  drop and more-complicated dielectric

loss. The same performance is realized with a line terminated in a pure resistance equal to the characteristic impedance of the line. If the line is not so terminated, or if it contains impedance discontinuities as a result of improper connection through a change-over relay or presence near metallic objects or poor dielectric material, reflection "kick-backs" will occur just as they may be observed in a water or steam system which "knocks."

In the case of an electrical network it is always possible to find an impedance of such value that if it is connected across the output of the network, the impedance of the entire network, including the specific impedance connected across the output, will appear to the source as exactly equal to the impedance connected across the network's output terminals. This value of impedance is called the characteristic impedance of the network and is expressed mathematically:

$$Z_o = \sqrt{Z_{oo} Z_{sc}}$$

where  $Z_o$  is the characteristic impedance,  $Z_{oo}$  the network's impedance with the output open-circuited, and  $Z_{sc}$  the network's impedance with its output end short-circuited. This is illustrated in the simple network of Fig. 1 in which

$$Z_{oo} = 5 + 10 = 15 \text{ ohms}$$

$$\text{and } Z_{sc} = 5 + \frac{10 \times 5}{10 + 5} = 8.33 \text{ ohms}$$

Substituting,  $Z_o = \sqrt{(15)(8.33)} = 11.18 \text{ ohms}$

Fig. 2 shows the network of Fig. 1 with a resistance of 11.18 ohms shunted across the output end. The over-all resistance, looking into the input, will be seen to be

$$Z = 5 + \left( \frac{10(5 + 11.18)}{10 + (5 + 11.18)} \right) = 5 + 6.18 = 11.18 \text{ ohms}$$

In other words, if an impedance equal to the characteristic impedance is connected directly to the source, or if it is connected to the source by means of the network, the source will see, in either case, the same impedance.

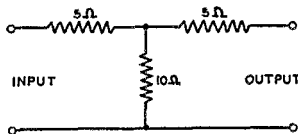

Fig. 1—Simple network.

It can be shown readily that any number of network elements such as indicated by Fig. 1 may be placed in series. The formula for  $Z_o$ , the characteristic impedance, will still be satisfied, and if we make the final circuit element a network section such as Fig. 2, the source, looking into the input, will see a load of 11.18 ohms. It is essential that the electrical properties of a transmission

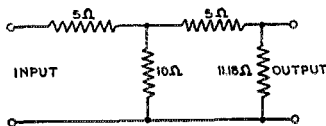

Fig. 2 — Simple network with termination in its characteristic impedance.

line be uniform throughout just as the simple example used for demonstration required that all of the network elements be alike.

### Standing Waves

In a transmission line of infinite length, the input impedance, the output impedance and the characteristic impedance are all equal. The line impedance is composed of series resistance, series inductance, shunt capacitance and shunt conductance. The finite-length lines which we use may be thought of as being made up of a large number of small units in series, each unit having values of series resistance, inductance, shunt capacitance and shunt conductance.

If a normal-length transmission line is left open at the load end, the current and voltage waves sweeping down the line from the source will encounter an infinite impedance at the open end. Since the  $R$  factor in  $P = I^2R$  is essentially infinity and the  $I^2$  factor zero at the open end, the power cannot be absorbed. It can neither remain at the open end nor disappear. Therefore, it is reflected back toward the source. The same situation with respect to reflection is found in a line terminated by a short-circuit, where the  $R$  factor in  $P = I^2R$  is essentially zero. Here again, the power cannot be absorbed, and the current and voltage waves sweep back toward the source.

If the transmission line is open at its load end, the reflected wave of energy will combine with the oncoming wave of energy in a phase relationship which will provide current addition at points along the line and current cancellation at other points. For the open-ended line, the first current maximum will occur one-quarter wave back from the end of the line, and the first point of current cancellation (voltage maximum) will be one-half wave from the open end. These points of maximum and minimum current will then be repeated every half wave on toward the source. For a line that is short-circuited at the load end, the first current maximum will appear one-half wave from the load end of the line, and the first point of current cancellation will be found one-quarter wavelength from the load end of the line.

At points of maximum current, the line voltage is at a minimum, and at points of maximum voltage, the current is at a minimum. These maximum and minimum points do not change position so long as the frequency remains fixed, leading to the description of the waves which they delineate as "standing waves of current or voltage."

Complete addition and complete cancellation of current and voltage in the establishment of a standing-wave pattern are to be found only in a perfectly-tuned lossless line. Where standing waves occur on what is supposed to be an untuned flat line because the line is not terminated in a resistance equal to the characteristic impedance, the addition and cancellation effects may be only moderate. That is, the current measured at a maximum point may be only twice the current measured at a current-minimum point. For such a condition, the standing-wave ratio in current would be two to one.

TABLE I

COMPARISON OF TRANSMISSION LINES				
Transmission Line	Power Loss in % per Hundred Feet		Approximate Amateur Cost	Weather Effects
	14 Mc.	28 Mc.		
Two-Wire Air-Spaced	5.0	9.0	\$7.50	Slight
300-Ohm Twin-Lead	11.0	17.6	3.00	Appreciable
150-Ohm Twin-Lead	13.0	20.0	2.50	Noticeable
75-Ohm Twin-Lead	22.5	35.3	2.00	Slight
75-Ohm Transmitting Twin-Lead	17.5	27.5	7.20	Slight
Coaxial Cables				
RG-8/U, 52 Ohms	13.8	20.0	19.00	None
RG-17/U, 52 Ohms	5.2	8.0	88.00	None
RG-58/U, 52 Ohms	24.3	34.1	11.00	None
RG-11/U, 72 Ohms	12.5	18.5	20.00	None
Amphenol #21-125 72 Ohms	3.5	5.5	79.00	None
RG-59/U, 72 Ohms	24.3	34.1	11.00	None
3/8" Gas-Filled, 72 Ohms	8.3	13.0	50.00	None
1/8" Gas-Filled, 72 Ohms	3.8	6.0	100.00	None

It is easy to see that in a tuned line, which has high-voltage and high-current standing waves along it, we must have large enough wire to hold the series-resistance losses down, and the insulation between the wires must be good to keep the shunt conductance low. The properly-terminated untuned line avoids both of these extremes, but its construction may be such, in receiving Twin-Lead or small coaxial cables, as to develop losses very rapidly if an appreciable standing wave is permitted to exist. It is customary to rate coaxial transmission lines in terms of power-

handling capability and r.f. loss on the basis of unity power-factor operation; that is, with current and voltage in phase and with unity standing-wave ratio. If the operation conditions are such that a standing wave is present, the power rating must be dropped to a level that holds the current and voltage maximums to values which do not exceed those permitted at full rated power with uniform voltage and current along the line.

### Line Section as a Matching Transformer

We know that a line must be terminated in a resistance equal to its characteristic impedance if standing waves are to be eliminated. If the line is terminated in a reactance equal to the characteristic impedance, the standing waves are not eliminated and the line is not nonresonant. If the load is a capacitive reactance, the first voltage peak along the line (measured from the load end) will be less than a half wavelength from the load, and the first current peak will be less than one-quarter wavelength from the load end of the line. Except for the fact that the peaks are shifted toward the load end, the line behaves like a line with the load end open-circuited. If the load is an inductive reactance, the location and distribution of the standing waves are essentially the same as they would be with the end of the transmission line short-circuited. Here the nearest peak to the load end of the line will be a voltage peak and it will be nearer to the load end than one-quarter wave. The first current peak will be less than one-half wavelength from the load end of the line.

When the line characteristic impedance differs from the antenna impedance at the point where it is fed, the impedances may be matched by insertion of a quarter-wavelength matching section of line.

The formula for a quarter-wave section of line is

$$\frac{246V}{f \text{ Mc.}} = \text{length in feet}$$

where  $V$ , the velocity factor, has the following approximate values:

Two-wire parallel line, air-insulated	0.975	
Two-conductor parallel tubing, air-insulated	0.950	
Two-wire polyethylene-insulated Twin-Leads:		
300-ohm	} Receiving types	0.82
150-ohm		0.77
75-ohm		0.69
75-ohm transmitting type		0.71
Coaxial line, air- or gas-filled		0.85
Coaxial line, polyethylene-insulated		0.659

It is seen from this tabulation that the waves in a transmission line travel more slowly than in free space and, as a consequence, a wavelength on a line will be shorter than in free space.

The characteristic impedance which the transformer section must possess is determined by

$$Z_T = \sqrt{Z_L Z_A}$$

where in this formula  $Z_T$  is the characteristic impedance of the transformer section required,

$Z_L$  is the characteristic impedance of the transmission line, and  $Z_A$  is the radiation resistance of the radiator. Taking a typical example, assume that a 300-ohm line is to be matched to the center of a close-spaced three-element beam. If the radiation resistance is assumed to be 8.5 ohms,  $Z_T$  becomes 51.5 ohms. Type RG-8/U coaxial cable, with a nominal impedance of 50 to 52 ohms, is suitable as the transformer section. In choosing transmission line for quarter-wave transformer construction, it is important to remember that the current-carrying capacity of the conductors in the transformer section must be high enough to handle the current expected at the low-impedance end. For 500 watts of r.f., the current at the junction of the transformer and the antenna in this instance would be about 7.7 amperes, although the current at the junction of the transformer and the 300-ohm line would be just about 1.3 amperes.

### The "Bazooka"

Another widespread application is in the construction of a "bazooka" section to transform the normally unbalanced coaxial cable to balanced output for center feed in dipole or other balanced antenna systems. Usually a piece of the same coaxial cable used in the parallel element is employed to form the transformer, as shown in Fig. 3. The extra parallel element should be connected

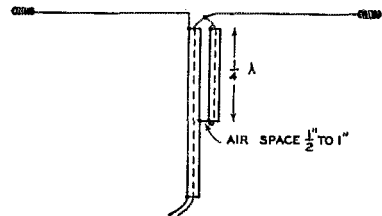

Fig. 3—The "bazooka" section sometimes used between a balanced antenna, such as a doublet, and coaxial cable to maintain antenna balance.

as shown, with the inner conductor soldered to the outer conductor at each end, and with the spacing  $\frac{1}{2}$  to 1 inch. The  $V$  factor chosen in determining the correct length of the quarter-wave section should be 0.95 since the effective elements of the transformer are the outer braids on the two cables. These correspond in action to lengths of tubing. If the parallel sections are strapped together instead of being air-spaced, the  $V$  factor will be less than 0.95, since the vinyl cable jacketing will be a considerable part of the dielectric between the two sections. With the "bazooka" properly designed and installed, there is no radiation from the outer conductor of the coaxial cable, and the outer conductor may be grounded at the transmitter end without disturbing the proper balance to ground in the antenna proper.



### Other Applications

Two other useful applications of quarter-wave transformer sections of transmission line are shown in Figs. 4 and 5. Fig. 4 shows a quarter-wave section or stub connected across the main transmission line. The lower end is shorted and connected to ground as a permanent protection against lightning. A quarter-wave section, or transformer, which is shorted at one end, presents a very high impedance at the other end for the frequency for which it is cut. Thus, there is little or no shunting effect on the main transmission line at or near the operating frequency, although solid ground is provided for the system.

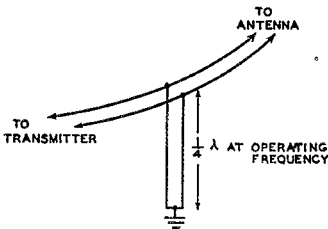

Fig. 4 — Quarter-wave section for grounding a transmission line against lightning.

Fig. 5 shows a low-loss method of transmit-receive switching which is effective for a single band. The transmitter and receiver are connected to the antenna at the same time. The arrangement may be best understood if one considers that the antenna transmission line runs continuously from the antenna to the transmitter. At a point about  $3/8$  wavelength out from the transmitter, the line to the receiver is tapped off. This receiver line also must be longer than  $1/4$  wave. The tap-off point for the receiver line may now be considered as the reference point for further discussion. At a point  $1/4$  wave from the reference point toward the transmitter, a single-pole single-throw normally-closed relay is connected. At a point  $1/4$  wave from the reference point toward the receiver, a single-pole single-throw normally-open relay is connected across the receiver transmission line. When the transmitter is on, both relays should be energized, opening the short on the transmitter line and closing the short on the receiver line.

Since the short on the receiver line is  $1/4$  wave from the reference point, energy from the transmitter traveling toward the antenna will encounter a high impedance looking toward the receiver and very little power will be lost. The neon lamp across the receiver line at the relay is essential for protection of the receiver input in event of failure of the receiver-line shorting relay. When receiving, the signal from the antenna will pass freely to the receiver since that branch of the circuit is no longer shorted, but will lose little

of its energy down the transmitter branch because that branch is now shorted  $1/4$  wave from the reference point or junction, thus presenting a high impedance to any energy which might "prefer" to be absorbed in the transmitter.

The system here described is essentially that used in radar except that special gas-discharge tubes were used in place of the relays suggested herein. This system is practical for operation at 28 Mc. and higher frequencies where the length of the quarter-wave sections is reasonable. It is particularly desirable for u.h.f. operation where the impedance discontinuities introduced by conventional change-over relays cannot be tolerated. The length of the shorting-relay leaves and connections to them must be included in the length of each quarter-wave section from the reference point.

Before connecting the receiver, careful tests should be made to check the voltage appearing across the receiver branch of the transmission line at points  $R$  and  $R$ . Connect a neon lamp across these points and observe it for glow when the transmitter is turned on. It is assumed that the relays will be energized along with application of transmitter plate power, shorting the receiver branch and opening the short across the transmitter branch. If the relays have been placed the proper distances from the reference point, there will be no glow in the lamp across the points  $R$  and  $R$ , although the neon lamp across the line at the relay may show a flash of very short duration if the relay is slow in closing. If there is no glow in the test lamp at  $R$  and  $R$ , the test lamp may be removed and the receiver-branch line connected to the receiver input.

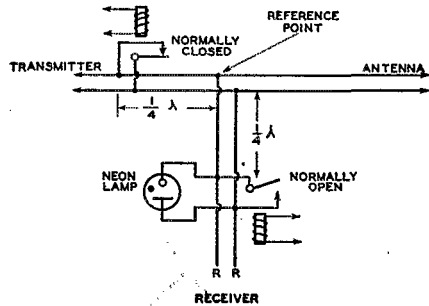

Fig. 5 — A low-loss method of antenna change-over switching for the high frequencies.

### Considerations in Construction

In constructing transformer sections of transmission line, elements may be connected in multiple to obtain lower values of characteristic impedance than may be obtained with one element. It is essential, however, to use identical material for each element. If Twin-Lead or coaxial cable is used, each element should be cut from the same

length of cable. If the elements are Twin-Lead, they should be spaced apart by the spacing distance of the conductors in the Twin-Lead used. If coaxial cable elements are employed, they may be taped together.

Because the velocity of propagation ( $V$  factor) may vary slightly from lot to lot of coaxial cable or Twin-Lead, it is suggested that the transformer section be cut a few inches longer than the length called for in the formula  $\frac{246V}{fMc}$ . The section may

then be trimmed one-half inch at a time until the desired performance is obtained. For precise adjustment of length, an oscillator or an amplifier driven by a VFO with output at the frequency of operation may be used. The arrangement shown in Fig. 6 may be used. The quarter-wave section, cut slightly longer than the formula value, should be connected to a coupling coil and variable condenser in series as shown. The condenser must be large enough to tune the coupling coil to resonance at the operating frequency. As a first step, the condenser-coupling coil circuit must be closed by shorting directly across the end of the quarter-wave section where it connects into the pick-up circuit. The pick-up loop is then tuned to resonance with the output of the oscillator or amplifier at the desired frequency. The coupling must be sufficiently loose to minimize the detuning of the oscillator or amplifier by adjustment of the coupling-coil tuning condenser.

When resonance is obtained, the short across the transformer section should be removed, again placing the pick-up coil and its tuning condenser in series across the end of the transformer section. If the grid-dip oscillator still shows a dip at the same frequency, or if the amplifier output shows maximum loading, the length of the transformer section is correct for that particular frequency. If it is necessary to tune the oscillator or the VFO to a lower frequency to obtain loading or grid dip, the transformer section is too long. The open end of the transformer may then be trimmed in small steps until the desired frequency is reached. During these operations, the variable condenser in series with the pick-up coil must not be touched. Its value, as set in the initial step, will be such as to cancel out the inductance of the pick-up loop and thereby eliminate any effect which the loop might have on the length of the transformer section.

#### Effects of Weather

If we ignore the attenuation in a transmission line, the characteristic impedance is roughly equal to the square root of the ratio of the inductance to the capacitance of the line.

$Z_0 = \sqrt{L/C}$  where  $Z_0$  is in ohms,  $L$  in henrys and  $C$  in farads. The capacitance factor is dependent upon the sizes of the conductors, their spacing, and the dielectric between them. Thus in an air-

spaced line with the conductors supported on insulators, the insulators should be small in cross-section and few in number (within reason) so as to detract as little as possible from the uniform air insulation. Twin-Lead utilizes a continuous web of polyethylene as the insulator between the conductors, but in the 300-ohm type especially, the wires are widely enough separated so that the fields operate in the immediately surrounding air as well as in the polyethylene. Therefore, the dielectric constant which helps to determine the  $C$  factor and thus the  $Z_0$  of the 300-ohm Twin-Lead is connected in part with polyethylene and in part with air. When the line is wet with dew

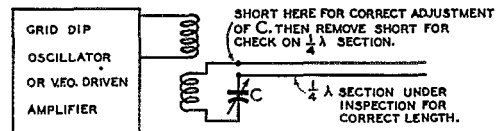

Fig. 6 — Circuit for precise experimental adjustment of matching-section length.

condensate or rain, water joins as a third partner in establishing the dielectric constant, the  $C$  factor and the  $Z_0$ . The water remains on the surface, having no effect whatever on the insulating properties of the polyethylene. But being on the surface, the water does lie in the dielectric field, and if the line is dirty there may be minor eddy-current losses within the dirt layer. The net effect of water on the 300-ohm Twin-Lead is a shift in impedance in the line itself from the impedance of the line when dry. The change in load on the transmitter will be a minimum if there are no standing waves on the line when dry. The effects of surface moisture are much less noticeable with the more closely-spaced Twin-Lead transmission lines where the polyethylene insulation is the principal dielectric.

We have noted before that a transmission line should be uniform throughout its length. This applies to dielectric as well as to the spacing and size of the conductors. A transmission line should not be run closer to other objects than the spacing of the conductors, and Twin-Lead, for example, should not be run in under a closed window because of its convenient form for such handling or because it *seemed* to work all right. Such an abrupt change in the dielectric will introduce an impedance discontinuity which may cause an appreciable power loss.

Coaxial cable, because of the confinement of fields within the outer conductor, offers the ideal solution for a permanent or semipermanent installation. It is not affected by weather nor by mounting, but it must be operated with a low standing-wave ratio to be effective.

Returning to transmission lines in general, improvement in performance is to be had in al-

(Continued on page 118)

# Foreign Notes

## NETHERLANDS INDIES

By government order on March 15th, amateurs in the Indies were closed down until further notice. No reason for the action is given, but the speculation is that the order is a temporary one issued in an effort to locate and weed out a few persons who are operating illegally.

We are told that L. Monfils, PK1EM, at 69 Theresia Kerkweg, Batavia, is secretary of the group reorganizing the N.I.V.I.R.A. PK4DG, now in this country, reports that "the old spirit still exists and those [in the Indies] still alive will certainly be on the air again." We are sorry to learn that OM Leyzers, a former chairman of the society, and the group's former secretary, both died during the war in a Jap concentration camp.

## CZECHOSLOVAKIA

The Ministry of Posts announces that there are approximately 300 amateur transmitting stations in Czechoslovakia. All amateur bands are authorized. Licenses are in three classes — A, B and C — carrying, respectively, power privileges of 100, 50 and 5 watts. The numeral in the call indicates the territory: 1 — Bohemia; 2 — Moravia; 3 — Slovakia. The numerals 4, 6 or 7 indicate experimental stations, which have three-letter suffixes, authorized to communicate with amateurs.

## JAPAN

The Far Eastern Amateur Radio League is a rapidly-growing organization of occupation troops in Japan. Charter members are those licensed amateurs who associated themselves as of the date of organization, February 18th; general membership will be extended to amateurs who join after that date; and nonlicensed persons with an interest in amateur radio will be classed as associate members. F.E.A.R.L. publishes a neat little mimeographed monthly, *FEARL News*.

Present officers are: Major Corwin Q. Wadsworth, J2BRX-W4BRX, president; Joseph E. Whitehouse, J2POY-W8POY, vice-president; Lt.

T. P. Cunningham, J2IBM, secretary; R. W. Liska, J2RWL-W9OBG, treasurer; Iris Colvin, J2AHI, publicity officer; Major Lloyd D. Colvin, J2AHI-W6AHI, QSL manager.

Bands authorized by the Eighth Army are the regular amateur bands from 7 to 148 Mc., except that 10-meter 'phone may be used from 28.1 to 29.5.

## FINLAND

It was a long wait — but the ban is finally off in Finland, effective April 1st. All prewar bands are available, with 50 watts input (200 watts on special application). Licenses will be issued to new applicants as soon as possible. All this represents a fine achievement on the part of *Suomen Radioamatööriliitto r.y.* and especially re-elected President Saino, OH2NM, and Secretary Häkkänen, OH2NQ.

## GERMANY

Last August the military government of the American Occupation Zone in Germany authorized the formation of a radio club of Germans interested in amateur radio, including many former D amateurs. It is called the *Württembergisch-Badischer-Radio-Club*, and has about 1700 members. Possession of a short-wave receiver is authorized, including a b.f.o. for c.w. reception. At present the major activity is sending SWL cards to foreign countries. While the club has applied for transmitting authorization, there is as yet no indication that the military government is ready to grant such licenses. An attractive magazine, *QRV*, appears monthly, under the editorship of Wolfram Koerner.

## LUXEMBURG

The following officers were elected at the annual general meeting of *Association Luxembourgeoise*: H. Sadler, LX1MS, president; M. Schwifflin, LX1SM, vice-president; Jos. Kessler, LX1AI, secretary; C. Conrath, LX1AC, treasurer; and G. Berger, LX1A, Manager.

Snapped at the annual meeting of the A.R.I., in Milan, Italy, late last year. President Montú wields the gavel. Picture courtesy XACJ.

June 1947



# Amateurs and the United Nations

## *I.A.R.U. and U.N.O. Sign Agreement for Support and Coöperation*

**A** LIAISON between amateur radio and the United Nations Organization was formed on April 17th at Lake Success when a formal agreement was entered into between the International Amateur Radio Union and the Department of Public Information of UN. George W. Bailey, W2KH, president of IARU, signed on behalf of the Union, and Benjamin A. Cohen, assistant secretary general of the United Nations, signed for the latter. It is believed that amateurs will find the arrangement of much interest.

United Nation's DPI has the responsibility for spreading, to the farthest ends of the world, the news and reports of the doings of UN. Under the direction of Brig. General Frank E. Stoner, who recently retired as deputy Chief Signal Officer of the Army, as its chief communications engineer, it is establishing a world-wide communications network, including broadcasting facilities that will cover the earth. DPI is interested in all the media whereby information on UN activities can be spread. With General Stoner himself an old ham and knowing that we amateurs are communicators, it is only natural that in his new appointment he would give consideration to the mutual advantages to be had in an association between UN and amateur radio. The International Amateur Radio Union is a federation of the national amateur societies of many nations, a sort of amateur UN and the logical organization for such a liaison. By means of this agreement we shall have the support of UN and there are some interesting things that we can do for them in turn. (General Stoner is to be chief spokesman for UN at the Atlantic City conference and recently publicly pledged their support of amateur frequencies.)

Let us now look at the text of the agreement

itself and then examine how it is planned to make it work:

"WHEREAS among the fundamental concepts of amateur radio are the promotion of international communication and the maintenance of friendships established thereby, it is peculiarly fitting that amateur radio operators should be associated with the United Nations through the Department of Public Information of the Secretariat which is charged with the responsibility for the dissemination of information pertaining to the United Nations activities.

"It is one of the precepts of radio amateurs that they are bonded together for the promotion of interest in international radio communication and experimentation, for the relaying of messages by radio, for the advancement of the radio art and of the public welfare, and for the maintenance of international fraternalism and a high standard of conduct. The International Amateur Radio Union is composed of the representative amateur radio societies of all nations. It is governed by delegates from all nations, and participates in international radio conferences. Its headquarters is now established in the offices of the American Radio Relay League, West Hartford, Connecticut.

"The International Amateur Radio Union whose constituent societies have a membership of approximately 100,000 amateurs throughout the world, many of whom are in daily contact with each other by electrical means of communications, is recognized by the United Nations as being in a position to render service to the United Nations as a distributing agency for material issued and distributed by the United Nations for the peoples of the world. The International Amateur Radio Union operates under the rules and



Benjamin A. Cohen, assistant secretary-general of United Nations, and George W. Bailey, W2KH, president of I.A.R.U., signing the agreement at Lake Success on April 17th.

Mutual felicitations after the signing. Left to right, ARRL Communications Manager Handy, Secretary Warner, Brig. General Frank E. Stoner, UN chief communications engineer, Mr. Bailey and Mr. Cohen, Carlos Palacios, deputy chief of DPI radio division, Hugh Williams, DPI liaison officer, and Peter Ayles, director of DPI radio division.



regulations established by the various countries and conforms to the findings promulgated by the International Telecommunications Union. Each amateur radio operator member of a society affiliated with the Union is licensed under the rules and regulations established by his own government to operate radio transmitting and receiving equipment.

"NOW, THEREFORE, in recognition of this great potential value to the United Nations and its special activities, an arrangement is hereby entered into which will permit the fullest possible use of the aforementioned communications facilities. In order to implement this agreement a joint Board is hereby established with the consent of both the United Nations and the International Amateur Radio Union consisting of four members, two to be appointed by the United Nations and two by the Union, such Board to formulate the policies, methods and procedures for submission to the Assistant Secretary-General for Public Information, United Nations, and to the president of the International Amateur Radio Union for final approval.

"The purpose of this association is to promote the point-to-point or person-to-person communication carrying approved United Nations material. The association will also provide a means of obtaining information concerning reception of United Nations broadcasts throughout the world. The amateurs will handle only that type of written material which would not otherwise be handled by international commercial facilities, such dissemination and collection of information being without prejudice to the amateur code of serving without pecuniary interest.

"This Agreement is for one year with provision that it may be renewed annually, both parties consenting thereto."

#### **How It Will Work**

For the joint board provided for in this agreement, UN named General Stoner and Peter Ayles, director of DPI's radio division. For the amateurs, President Bailey named ARRL Communications Manager F. E. Handy and Secretary K. B. Warner. This board at the moment

is in the process of working out plans, and announcements in detail are to be expected in a few weeks. Here, meanwhile, are the major aims involved, two in number.

We amateurs will be asked, in our foreign DX contacts, to give circulation to news on actions and decisions and activities of the United Nations — in short, to embrace such news as subject-matter for conversation. This is work in which every amateur who engages in international DX can participate. Bulletins are to be sent at brief intervals to the American amateurs who enroll in this work, and three outstanding DX stations in this country are to be appointed to disseminate UN information immediately to amateurs. Amateurs in foreign countries will also be asked, probably through their IARU societies, to enroll as monitors and critics of the DPI's broadcasting efforts, both as concerns programming and on the technical matters of propagation and reception. For all participating amateurs it is planned to make appointments available, perhaps in several classifications, as United Nations Amateur Radio Aide with appropriate certificates. It is also planned to establish a bang-up amateur station at the UN headquarters at Lake Success.

Much of the hopes of the world rest in UN. It deserves the support and help of every man. It is believed that amateurs will feel that they are doing something to help in this work when they can pass along information on UN accomplishments and decisions, that they will find them interesting topics to discuss in international QSOs, and that they will be glad to lend their technical skill as it may help in the UN communication and broadcasting activities. As the work gets under way, detailed announcements of the arrangements and possibilities will be made in our pages.

#### **Strays**

"The ship I'm on is transporting some small T9X diesel tractors. I wonder if these are the original 'rock crushers'?" — W7JFU

# F.M. on Two Meters

*A Simple Rig Which Provides Deviation to Suit All Receivers*

BY J. C. GEIST,\* W2STZ

• Narrow-band f.m., as used on 10 and 6, is not generally useful on 2 as yet, because of the predominance of broad receivers. Here is a simple set-up which will provide substantially distortionless deviation up to the amount required by most superregens, yet it is also capable of narrow-band work with a degree of stability that makes it readable on the sharp superhets. With careful adjustment of the deviation, and a little co-operation on the part of the receiving operator, the signal can be made quite satisfactory on any of the wide variety of receivers now in use on 144 Mc.

SOME time ago an article in *QST* entitled "Simplified F.M."<sup>1</sup> described a method of obtaining narrow-band f.m. by lightly amplitude-modulating a self-excited oscillator which was followed by a Class C multiplier to multiply the frequency deviation and to wipe out the amplitude modulation. The article concluded that the system provided good results when used with an f.m. receiver, but that reception of the signal on most superregenerative receivers was not satisfactory.

Further investigation, along with a review of the results obtained by other amateurs using narrow-band f.m. on the old 2½ and the present 2-meter band, led to the conclusion that while superregenerative receivers were unsuitable for the reception of narrow-band f.m. they might do a reasonable job on f.m. signals of much wider deviation. The actual amount of deviation required would depend on the characteristics of the individual receiver but in general would increase with increases in channel frequency as the selectivity of the receiver was decreased. In simpler language, a 2-meter superregenerative receiver would require less frequency swing than a 1-meter set because in general the 2-meter set would have a sharper selectivity characteristic.

In order to test the validity of these conclusions an f.m. transmitter capable of a frequency deviation of approximately  $\pm 45$  kc. was put in operation on the 2-meter band. After some preliminary tests to determine the proper audio gain-control adjustment to provide the necessary frequency deviation, and with the aid of patient and careful tuning of numerous superregenerative receivers at

stations worked, this transmitter gave a good account of itself. In the period from August 29, 1946, to November 9, 1946, a total of 241 contacts were made, with 97 different stations.

A large number of these contacts were with local stations within a ten-mile radius, but no trouble has been encountered in working regularly up to thirty miles regardless of band conditions. Completely satisfactory communication with stations as far as fifty to sixty miles away was quite commonplace, and the best DX worked included W3HWN at Mechanicsburg, Pa., 150 miles away, and W3GKP at Silver Spring, Md., at a distance of 180 miles. The receivers used at the various stations contacted included every possible type: sharp and broad a.m. superhets, sharp and broad f.m. superhets, and superregens. In all cases the operators using f.m. receivers reported excellent quality when the deviation was adjusted to suit the receiver. Both sharp and broad a.m. superhets also reported very good quality in most cases after the deviation was adjusted to match the receiver selectivity. In nearly every case the operators of rush-box receivers reported satisfactory reception with wide deviation and in those cases where reception was actually unsatisfactory, experience in tuning for best reception of the f.m. signal nearly always resulted in a subsequent satisfactory contact.

The schematic of the transmitter used for these tests is shown in Fig. 1. It consists of a triode-connected 7C5 oscillator on 16 Mc., a pair of 6AG7s tripling to 48 Mc. exciting an 832 tripling to 144 Mc., which in turn drives the neutralized 829-B operating straight through at 144 Mc. The grid of each 6AG7 is operated with a current of about 200 microamperes resulting in 50 volts of grid-leak bias. The drive to the 832 results in a total grid current of about 2.5 ma. or a bias of 125 volts. With the 832 drawing 50 ma. of plate current the 829-B grid current is 10 ma.

In this transmitter, as in the previous model, f.m. is accomplished by simple Heising amplitude modulation of the self-controlled oscillator. The a.m. is wiped out by the succeeding Class C stages while the frequency deviation is multiplied nine times by the two tripler stages. The amount of frequency deviation is adjusted (up to the limit of the 6J5 modulator) by the audio gain control,  $R_2$ .

The amount of reasonably linear deviation available from such a modulator is closely related to the  $L/C$  ratio of the oscillator. Curves of plate voltage vs. percentage of frequency shift for sev-

\*% Link Radio, 125 West 17th St., New York 11, N. Y.

<sup>1</sup> Geist, "Simplified F.M.," *QST*, December, 1945.

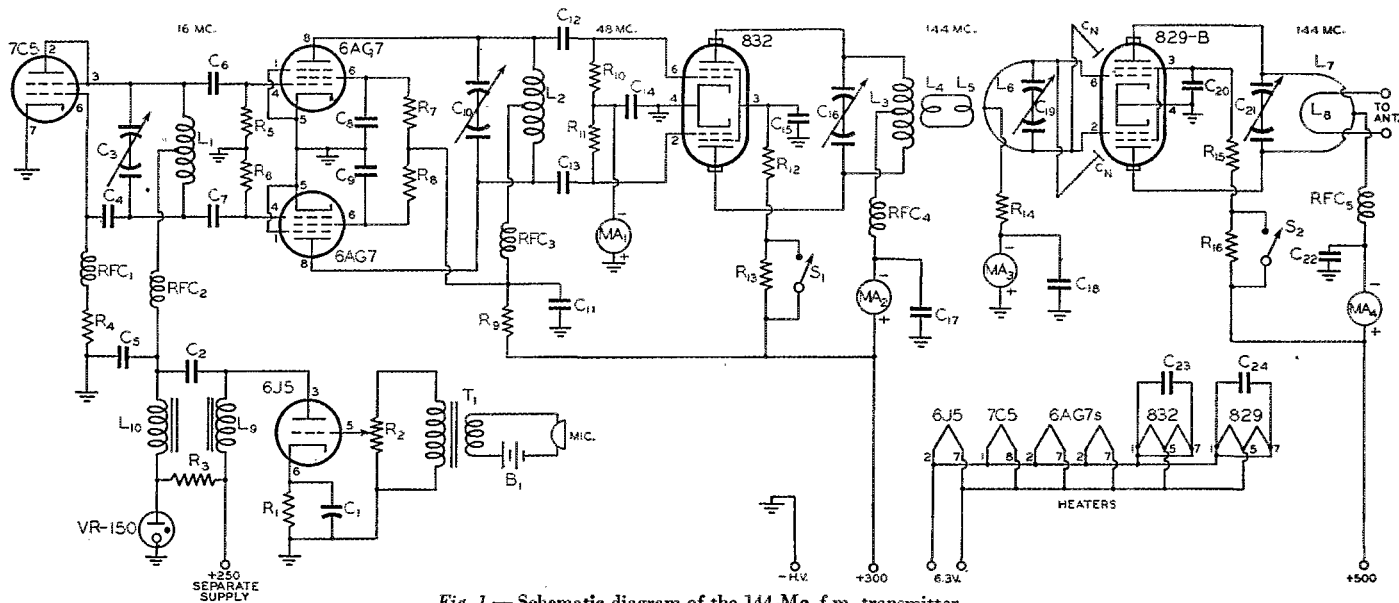

Fig. 1 — Schematic diagram of the 144-Mc. f.m. transmitter.

- C<sub>1</sub> — 10- $\mu$ fd. 25-volt electrolytic.
- C<sub>2</sub> — 3- $\mu$ fd. 400-volt paper.
- C<sub>3</sub> — 35- $\mu$ fd.-per-section variable (should be mechanically and electrically stable).
- C<sub>4</sub> — 100- $\mu$ fd. 400-volt silver mica.
- C<sub>5</sub>, C<sub>8</sub>, C<sub>9</sub>, C<sub>11</sub>, C<sub>14</sub>, C<sub>15</sub> — 0.0022- $\mu$ fd. 400-volt mica.
- C<sub>6</sub>, C<sub>7</sub> — 25- $\mu$ fd. 400-volt silver mica.
- C<sub>10</sub> — 35- $\mu$ fd.-per-section variable
- C<sub>12</sub>, C<sub>13</sub> — 100- $\mu$ fd. 400-volt mica.
- C<sub>16</sub>, C<sub>18</sub>, C<sub>21</sub> — 25- $\mu$ fd.-per-section variable.
- C<sub>17</sub>, C<sub>18</sub>, C<sub>20</sub> — 0.001- $\mu$ fd. 400-volt mica.
- C<sub>22</sub> — 0.001- $\mu$ fd. 1000-volt mica.
- C<sub>23</sub>, C<sub>24</sub> — 470- $\mu$ fd. 400-volt mica.
- R<sub>1</sub> — 820 ohms, 1 watt.
- R<sub>2</sub> — 0.5-megohm volume control.
- R<sub>3</sub> — 5000 ohms, 5 watts.
- R<sub>4</sub> — 15,000 ohms, 1 watt.
- R<sub>5</sub>, R<sub>6</sub> — 0.22 megohm, 1 watt.
- R<sub>7</sub>, R<sub>8</sub> — 15,000 ohms, 10 watts.
- R<sub>9</sub> — 1000 ohms, 10 watts.

- R<sub>10</sub>, R<sub>11</sub> — 0.1 megohm, 1 watt.
- R<sub>12</sub> — 25,000 ohms, 20 watts.
- R<sub>13</sub> — 0.2 megohm, 5 watts.
- R<sub>14</sub> — 6000 ohms, 5 watts.
- R<sub>15</sub> — 10,000 ohms, 20 watts.
- R<sub>16</sub> — 40,000 ohms, 10 watts.
- L<sub>1</sub> — 15 turns c.t., No. 14 enameled wire close-wound on 1-inch diam. ceramic form with turns cemented.
- L<sub>2</sub> — 8 turns c.t., No. 14 enameled wire, 1-inch diam., turns spaced to occupy 1 $\frac{1}{4}$  inches, self-supporting.
- L<sub>3</sub> — 2 turns c.t., No. 10 bare copper, 1 $\frac{1}{2}$ -inch diam., turns spaced to occupy 1 $\frac{3}{4}$  inches, self-supporting.
- L<sub>4</sub>, L<sub>5</sub> — Single-turn loop connected with 300-ohm Twin-Lead.
- L<sub>6</sub> — Hairpin of No. 12 wire, 1-inch spacing, 1 $\frac{1}{2}$  inches long. (Effective length of inductance is about 2 $\frac{7}{8}$  inches because of addition of condenser plates.)

- L<sub>7</sub> — Hairpin of No. 10 wire spaced 1 $\frac{1}{4}$  inches, 3 $\frac{1}{2}$  inches long. (Effective length of inductance is about 5 inches because of addition of condenser plates.)
- L<sub>8</sub> — 3-inch antenna-coupling hairpin.
- L<sub>9</sub> — Primary of 6N7 Class B input transformer.
- L<sub>10</sub> — Primary of plate-to-voice-coil output transformer.
- B<sub>1</sub> — Microphone battery.
- C<sub>N</sub> — Heavy wire near tube envelope opposite flat side of plate.
- MA<sub>1</sub> — 0.5 d.c. milliammeter.
- MA<sub>2</sub> — 0.150 d.c. milliammeter.
- MA<sub>3</sub> — 0.15 d.c. milliammeter.
- MA<sub>4</sub> — 0.300 d.c. milliammeter.
- RFC<sub>1</sub>, RFC<sub>2</sub> — 2.5-mh. choke.
- RFC<sub>3</sub> — No. 28 silk-covered enameled wire wound to a length of 1 inch on a  $\frac{3}{8}$ -inch form.
- RFC<sub>4</sub>, RFC<sub>5</sub> — Ohmite Z-O choke.
- S<sub>1</sub> — Tune-operate switch.
- S<sub>2</sub> — High/low-power switch.

eral values of oscillator-tank  $L/C$  ratio are shown in Fig. 2. These curves were run with the same coil and different condenser settings and show that an increase in this ratio results in a greater available percentage of swing. Curve C of Fig. 2 representing the conditions used in these tests is reproduced in Fig. 3 to show actual frequency vs. plate voltage.

Although this curve is not quite as linear as was hoped for it does show a reasonably straight

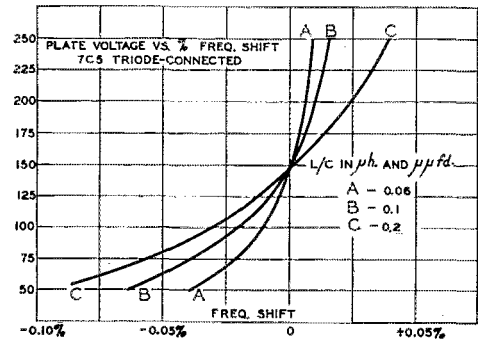

Fig. 2 — Curves showing the percentage frequency shift of the 7C5 oscillator, using different  $L/C$  ratios.

characteristic of about  $\pm 5$  kc. centered around 145 volts. This deviation when multiplied by nine results in a final deviation of  $\pm 45$  kc. Actually the plate voltage was set at 150 volts since this value was convenient to regulate with a VR tube. From a practical standpoint some distortion from this source is not objectionable on voice reproduction. Since the audio equipment is so simple and operating at such a low level its speech reproduction is excellent; hence the plate voltage/frequency characteristic is the only place throughout the transmitter from which distortion can originate.

There is a second reasonably straight portion of the plate voltage/frequency characteristic centered around 70 volts which provides a linear deviation when multiplied by nine of nearly  $\pm 60$  kc. Operation over this portion of the curve with a plate voltage of 70 was also tried and found successful. However, the grid drive to the following stage was, of course, reduced and the very small amount of audio required for proper modulation made the gain control difficult to adjust so that in general the higher plate voltage gave better performance. However, with some additional adjustments this lower-voltage operating range seems to offer the possibility of better performance than the high-voltage range.

With the oscillator-coil dimensions shown, the oscillator resonates around 16 Mc. with a total capacity of only about  $20 \mu\text{fd}$ . Since most of the required capacity is available in the tubes and stray capacity, the tuning condenser is set at near the minimum value. Although the  $L/C$  ratio of the oscillator tank is unusually high, the use of a

large oscillator tube running light, along with careful physical construction, results in good stability. The drift of the oscillator frequency is low enough to be entirely unobjectionable. The oscillator must, however, be built solidly throughout to prevent frequency change because of mechanical vibration (when the table is hit or a door slams, etc.). No claim is made that this oscillator arrangement is the optimum for this type of operation. No other oscillator circuits have been tested, and no circuit parameters have been varied except the oscillator-tank  $L/C$  ratio.

Just to complete the record, the power to the final amplifier of the transmitter was 80 watts. The antenna consisted first of two half-waves in phase and later of 5 extended half-waves in phase stacked vertically. Both were fed with 300-ohm Amphenol Twin-Lead matched with a quarter-wave impedance transformer. The second antenna provided a definite gain over the first, but the difference was not too astounding. The antenna did, however, provide good all-round coverage without the bother of rotation. QRM was in most cases not too bad on a good a.m./f.m. superhet.

### Conclusions

F.m. communication was found to be quite satisfactory on 2 meters provided the transmitter is capable of supplying a wide undistorted frequency deviation. A frequency deviation in excess of  $\pm 45$  kc. should be available to allow reception on all types of receivers to be encountered. The need for wide undistorted swing was

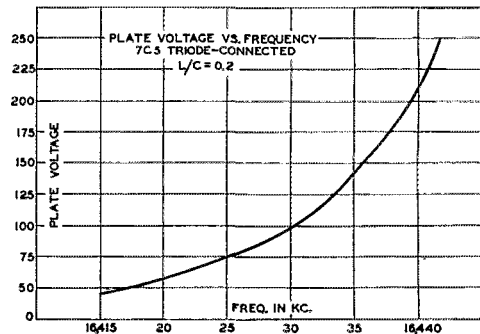

Fig. 3 — Curve C of Fig. 2, reproduced to show actual frequency variation with plate-voltage changes.

brought home most forcibly during initial tests, when the oscillator  $L/C$  ratio was reduced. This change caused the undistorted frequency deviation to be materially reduced. As a result operation on the band immediately became unsatisfactory. Sharp a.m. and f.m. receivers requiring low deviation continued to receive an excellent signal, but stations using broad a.m. superhets and rush-boxes which previously reported good quality began to report that the speech was con-

(Continued on page 118)



# Thirteenth ARRL Sweepstakes Results

*New Scoring Records Established — All Sections  
Worked on 'Phone and C.W.*

**T**HE casual listener who happened to tune across our amateur bands at 6:00 P.M. EST, November 16, 1946, may have been startled by the sudden roar of activity that signified the opening of the Thirteenth Annual ARRL Sweepstakes Contest. It was a long-awaited moment. Not since 1941 had there been the opportunity for amateurs to participate in the SS, always one of our most popular operating competitions. The pent-up enthusiasm of old-time contest hounds found expression once more in the rhythmic call, CQ SS! For LSPH amateurs it was a new experience and a revelation in clean-cut efficient operating. The contest continued for two week-ends. Many an operator with no intention of taking part found himself swept into the SS — and enjoying it immensely!

Like each of its predecessors this Sweepstakes saw previous records broken in a manner that reflects considerable credit on the operating ability of those contestants who placed in the top positions. Final results of the 1941 contest show eight c.w. scores above 100,000. In this SS, *eighteen* brass-pounders are found in that category! Among the 'phones, we find thirty-five scores above 20,000 compared to twenty-three in the previous contest.

It was our pleasure to welcome the return of the Canadian amateurs to Sweepstakes competition in 1946. Ordered off the air in 1939 because of the war, the VE stations were sorely missed in the three succeeding contests. Not only did their reappearance on the contest scene provide large additional numbers of stations to be worked, but their presence made it a truly all-section SS once again.

## *The Winners*

Competition for awards in the Sweepstakes is essentially among participants within each of the ARRL sections. All of the 70 sections were active during this SS. A total of 1416 entries was received; 285 amateurs competed for 'phone awards and 1131 for c.w. awards. Specially-designed medallions with the winner's call engraved thereon were offered to those contestants who made high score for their respective sections. These awards are being presented to 71 c.w. operators and 62 'phone operators. An accompanying tabulation lists the section winners and their respective scores. We extend our heartiest congratulations to these amateurs for their fine performances.

## *High C.W. Scorers*

Leading the field as the top scoring 1946 SS operator, W4FU worked 797 different stations in 69 sections for a total score of 137,482 points. That call W4FU, in case some of you SS addicts don't recognize it, belongs to Bert Brown, ex-W9FS, high man in the November '41 fracas. We thought Bert had attained with his previous record the highest score possible under present rules, but apparently his capabilities are unlimited. Nice work, OM! An 813 amplifier running 90 watts driven by a 6G6 ECO-6V6-807 exciter was responsible for that husky wallop you heard from W4FU.

James W. Ringland, W8JIN, another ardent and high-scoring SSer from way back, made second place with his 132,212 points, 759 contacts, 70 sections. His transmitter utilized an HK-54 driven by a Meissner Signal Shifter and 6L6 doublers; input was kept just under the 100-watt mark.

In third place we find Vic Clark, W4KFC: 129,880 points, 765 contacts, 68 sections. The SS rig at W4KFC was an ECO-807-p.p. 3D23 job running 100 watts input. Vic, you may recall, won the Maxim Award back in 1936 for his contest and traffic-handling activities.

Fifteen other contestants scored 100,000 or more points: W3BES 127,305, W2IOP 124,687, W9RQM 122,230, W9FOI 118,087, W1BFT 112,200, W1TS 111,650, W8RSP 110,925, W1KYK 109,312, W1LWA 108,456, W2SSC 105,357, W3FQZ 104,938, W0ZAR 104,635, W1RY 102,982, W9VKF 100,912 and W3GAU 100,248. Following the exclusive six-figure group, with scores over 80,000, were W6HZZ 99,820, W2OXX 99,110, W3DPA 99,025, W9ERU 96,807, W5KC 96,600, W9TWC 95,642, W9DUY 94,775, W0JNC 94,690, W1OTV 94,462, W9GRV 94,325, W2MEI 92,690, W3GHM 90,915, W4KVX 90,666, W0JRI 88,734, W0YCR 88,389, W3AIZ 87,615, W9MUX 87,267, W8ROX 87,047, W9WFS 86,775, W9VFZ 86,542, W3GHD 86,362, W9CYU 86,295, W3BXE 85,425, W0MPW 85,136, W3ZFA 85,050, W6BXL 84,870, W9UIT 84,456, W1KQY 84,320, W2RDK 83,931, W3KT 83,902, W6KKG/7 82,723, W2QCM 82,305, W3MFM 81,206 and W8UFH 80,874.

The highest-scoring Canadian participant was VE3KE, who worked 571 stations in 63 sections for a total score of 71,631. Second and third places were taken by VE3AVN, 70,402, and VE3JJ, 69,696. Other high VE scores: VE3BCO 68,197, VE4XO 65,057, VE1EP 63,705, VE7ZM 56,595,

# WINNERS, THIRTEENTH A.R.R.L. SWEEPSTAKES CONTEST

## Radiotelephone

### Radiotelegraph

Section	Winner	Bands Used	Total Score — Sections — Stations Worked
E. Penna.	W3BES	3.5, 7, 14	127,305-69-742
Md.-Del.-D. C.	W3FQZ	3.5, 7	104,938-67-627
S. N. J.	W2OXX	3.5, 7, 14, 28	99,110-68-583
W. New York	W2SSC		105,357-67-632
W. Penna.	W3KWL	3.5, 7, 14, 28	51,156-58-441
Illinois	W9FOI	3.5, 7, 14	118,087-67-706
Indiana	W9TWC	3.5, 7, 14	95,642-67-573
Kentucky	W4FU	3.5, 7, 14, 28	137,482-69-797
Michigan	W8UFH	3.5, 7, 14	80,874-67-611
Ohio	W8JIN	3.5, 7, 14, 28	132,212-70-759
Wisconsin	W9RQM	3.5, 7, 14	122,230-68-719
No. Dakota	W8LHS	7, 14	40,170-65-311
So. Dakota	W9YQR	7, 14	60,720-66-371
No. Minn.	W9JRI	3.5, 7, 14	88,734-69-643
So. Minn.	W9JNC	3.5, 7	94,690-68-558
Arkansas	W5KIP/5	7	24,440-52-240
Louisiana	W5KC	3.5, 7, 14, 28	96,600-70-553
Mississippi	W5BK	7, 14, 28	44,352-63-256
Tennessee	W4BAQ	3.5, 7, 14, 28	42,363-63-256
E. New York	W2EWD	3.5, 7, 14, 28	63,363-61-424
N. Y. C. & L. I.	W2IOP	3.5, 7, 14	124,687-70-720
N. N. J.	W2ENZ	3.5, 7, 14	64,768-64-506
Iowa	W9CFB	3.5, 7, 14	68,935-63-443
Kansas	W9BJJ	7, 14	69,772-63-443
Missouri	W9ULM	3.5, 7, 14, 28	60,060-66-364
Nebraska	W9DNW	7, 14	51,545-61-338
Conn.	W1RY	3.5, 7, 14, 28	102,982-69-598
Maine	W1GKJ	3.5, 7, 14	49,775-55-362
E. Mass.	W1OTV	3.5, 7, 14	94,462-65-572
W. Mass.	W1KJO	3.5, 7, 14	64,575-63-410
N. H.	W1BFT	3.5, 7, 14, 28	112,200-68-719
R. I.	W1KYK	3.5, 7, 14	109,312-66-664
Vermont	W1BJP	7, 14	1,330-19-28
Alaska	KL7AD	7, 14, 28	28,497-59-244
Idaho	W7ZN	7, 14	61,446-66-467
Montana	W7FMV	7, 14	30,606-57-269
Oregon	W7DZL	7, 14	70,752-67-537
Washington	W7KEM	7, 14, 28	71,400-68-528
Hawaii	K6CGK	3.5, 7, 14, 28	52,668-63-420
Nevada	W7KEV	3.5, 7, 14	61,238-67-469
Santa Clara V.	W6PBV	3.5, 7, 14, 28	72,778-67-437
East Bay	W6TT	3.5, 7, 14, 28	60,792-68-447
San Francisco	W6BIP	3.5, 7, 14, 28	40,710-69-295
Sacramento V.	W6GHG	7, 14	40,382-61-340
San Joaquin V.	W6OKK	3.5, 7, 14, 28	60,383-67-362
No. Carolina	W4FDV	3.5, 7, 14	46,968-57-434
So. Carolina	W4BFD	7, 14	75,210-69-436
Virginia	W4KFC	3.5, 7, 14	129,880-68-765
West Va.	W8LII	3.5, 7, 14	28,807-46-251
Colorado	W9ZAR	3.5, 7, 14	104,635-68-617
Utah-Wyo.	W6KKG/7	3.5, 7, 14, 28	82,728-71-585
Alabama	W4BGO	7, 14	73,856-65-460
E. Florida	W4BRB	7, 14, 28	78,342-66-597
W. Florida	W4AXP	3.5, 7, 14	2,028-24-63
Georgia	W4DIA	7, 14	60,060-66-455
West Indies	KP4KD	7, 14	54,976-61-361
Los Angeles	W6HZT		99,820-70-720
Arizona	W7QAP	3.5, 7, 14, 28	66,228-63-427
San Diego	W6NJK	3.5, 7, 14, 28	62,142-67-374
No. Texas	W5KPV	7, 14	70,281-65-431
Oklahoma	W5LW	7, 14	57,255-66-347
So. Texas	W6EPZ/5	7, 14, 28	78,472-68-577
New Mexico	W5HJF	3.5, 7, 14	8,648-46-95
Maritime	VE1EP		63,705-62-414
Ontario	VE3KE	3.5, 7, 14	71,631-63-571
Quebec	VE2DR	3.5, 7, 14, 28	41,141-55-300
Alberta	VE6GD	3.5, 7, 14, 28	50,685-62-327
B. Columbia	VE7ZM	7, 14	56,595-66-347
Manitoba	VE4XO	7, 14	65,057-67-489
Saskatchewan	VE5UN	7, 14, 28	25,850-55-189

Section	Winner	Bands Used	Total Score — Sections — Stations Worked
E. Penna.	W3CTA	3, 9, 14, 28	16,762-58-144
Md.-Del.-D. C.	W3FUV	3, 9, 14	22,239-63-177
So. N. J.	W2EQ	3, 9, 14	20,235-57-178
W. New York	W2OVT	3, 9, 14	3,600-30-60
W. Penna.	W3MHD	3, 9, 14	12,342-51-122
Illinois	W9NDA	3, 9, 14, 28	45,402-69-329
Indiana	W9GWL	3, 9, 14, 28	20,140-53-193
Kentucky	W4YNQ	3, 9, 14, 28	45,612-63-370
Michigan	W8REU	14	23,220-60-194
Ohio	W8EHU	3, 9, 14, 28	32,096-59-274
Wisconsin	W9QJZ	3, 9, 14, 28	16,848-54-158
No. Dakota	W9EQX	3, 9, 14, 28	21,597-53-163
So. Dakota	W9KQO	27, 28, 58	2,587-23-46
No. Minn.	W9SCZ	28	18-3-3
So. Minn.	W9DEI	3, 9	20,224-64-153
Arkansas	W5LRE	3, 9, 14, 28	13,624-52-132
Louisiana	W5GHP	3, 9, 14, 28	3,672-34-55
Mississippi	W5LPG	28	2,127-23-37
Tennessee	W4AQR	14	23,482-59-202
E. New York	W2SZ	3, 9, 14, 28	22,896-53-215
N. Y. C. & L. I.	W2EGG	14	13,770-51-140
N. N. J.	W2MIG	3, 9, 14, 28	24,957-59-213
Iowa	W9NTA	3, 9, 14, 28	16,555-55-152
Kansas	W9PAH	3, 9, 14, 28	11,316-46-127
Missouri	W9PVP	3, 9, 14	23,602-63-228
Conn.	W1ATE	3, 9, 14, 28	23,731-61-235
Maine	W1LOA	3, 9, 14, 28	10,365-45-115
E. Mass.	W1KQN	3, 9, 14, 28	28,624-64-209
W. Mass.	W1GUF	3, 9, 14	9,752-46-106
N. H.	W1HRI	14, 28	12,577-43-117
R. I.	W1BFB	3, 9, 14, 28	13,144-53-124
Montana	W1VIV	28	3,968-31-64
Oregon	W7GVX	3, 9, 14, 28, 27	15,065-46-133
Washington	W1AS	28	2,425-25-49
Hawaii	KH6ET	28	10,710-45-121
Nevada	W7JUO	3, 9, 14, 28	24,428-62-201
Santa Clara V.	W6MLY	14	20,345-52-160
East Bay	W6ITH	3, 9	56,800-71-400
Sacramento V.	W6GYM	14	15,548-52-150
So. Carolina	W4BSS	3, 9, 14, 28	21,905-65-171
Virginia	W4IUO	14	9,600-50-97
West Va.	W4MIS	3, 9, 14	7,687-41-75
Colorado	W9FUH	3, 9, 14, 28	24,308-59-206
Utah-Wyo.	W7DTB	3, 9, 14, 28	21,608-56-184
Alabama	W4KCC	3, 9, 28	13,395-47-143
E. Florida	W4KRV	28	19,158-43-95
W. Florida	W4MS	14	3,080-28-56
Georgia	W8LMN/4	27, 28	202-9-10
West Indies	CO2MG		2-1-1
Los Angeles	W6OGZ	3, 9, 14, 28	41,133-59-352
San Diego	W6CHV	3, 9, 14, 28	32,177-61-211
No. Texas	W5FRD	3, 9, 14	9,600-40-122
Oklahoma	W5EHR	3, 9, 11, 27, 28	19,023-57-133
So. Texas	W5FH	3, 9, 14, 28	26,727-59-228
New Mexico	W5HPT	3, 9, 14	336-12-14
Maritime	VE1CM	3, 9, 14, 28	7,245-36-81
Ontario	VE3HC	3, 9, 14, 28	26,304-64-207
Quebec	VE2DD	3, 9, 14, 28	18,526-48-200
Alberta	VE6FK	3, 9, 14	21,808-58-195
B. Columbia	VE7AM	28	281-9-13
Manitoba	VE4LH	14	1,097-21-29
Saskatchewan	VE5OM	14	1,100-16-28

• Space limitations prevent our publishing the complete list of all 1946 SS participants and their scores. However, a complete score tabulation is being mailed to each amateur who submitted a log covering his operation in the Thirteenth Sweepstakes Contest.

## CLUB SCORES

Club	Score	C. W. Winner	'Phone Winner
Frankford Radio Club (Phila.)	1,828,928	W3BES	---
Greater Cincinnati Amateur Radio Assn.	1,006,664	W4FU	W8TRX
Twin City Radio Operators Assn. (Minn.)	495,882	W0JNC	---
Milwaukee Radio Amateurs' Club (Wis.)	456,863	W9UIT	W9TXF
West Side Radio Club (Ont.)	306,709	VE3JJ	---
Wisconsin Valley Radio Assn.	293,346	W9RQM	W9QIX
Washington Radio Club (Wash., D. C.)	292,938	W3FQZ	---
Pasadena Short Wave Club (Calif.)	273,687	W6BXL	W6OGZ
Narragansett Assn. of Amateur Radio Operators (R. I.)	272,836	W1KYK	---
Portland Seven Amateur Radio Club (Ore.)	249,750	W7DZL	---
San Antonio Radio Club (Tex.)	212,598	W5LGG	---
Cahokia Amateur Radio Club (Ill.)	179,241	W9FO1	---
Dade Radio Club (Fla.)	174,119	W4GOG	---
Monmouth County Amateur Radio Assn. (N. J.)	170,440	W2OCC	---
Northern California DX Club	168,096	W6TT	---
New Haven Amateur Radio Assn. (Conn.)	167,267	W1KQY	---
Bloomfield Radio Club (N. J.)	165,086	W2ANG	---
Delta Radio Club (La.)	134,646	W5KTE	---
North Newark Amateur Radio Club (N. J.)	111,805	W2LXI	---
Pittsfield Radio Club (Mass.)	109,799	W1KZS	---
Baltimore Amateur Radio Communication Society	100,189	W3FDJ	W3FUV
Calgary Amateur Radio Assn. (Alta.)	99,853	VE8GD	---
Black Hills Amateur Radio Club (S. Dak.)	85,489	W0YQR	W0EOO
Sioux City Amateur Radio Club (Iowa)	75,311	W0FZO	---
Center Line Radio Club (Mich.)	73,020	W8URM	---
Westchester Amateur Radio Assn. (N. Y.)	70,870	W2QUJ	---
Inter-City Amateur Radio Club (N. J.)	59,501	W2OAE	---
Columbus Amateur Radio Assn. (Ohio)	58,768	W8IVC	W8PSE
Montreal Amateur Radio Club	54,442	VE2DR	---
Hamfesters' Radio Club (Ill.)	51,445	VE5UN	---
Red River Radio Club (N. Dak.)	50,870	W8LHS	---
Kickapoo Radio Operator's Club (Ill.)	50,351	W9AMP	---
Southern Mont. Amateur Radio Assn.	49,046	W7FMY	---
Maui Amateur Radio Club (Hawaii)	46,374	K6SDM	---
Queens Radio Amateurs (L. I.-N. Y.)	45,342	W2LRI	---
Jax Amateur Radio Society (Fla.)	43,415	W4AKH	---
Parkway Radio Assn. (Mass.)	23,208	---	W1GUF
Merrimack Valley Amateur Radio Club (Mass.)	6,959	---	W1PKV

VE1TL 52,338, VE6GD 50,685, VE3EF 49,790, VE3ALO 49,680, VE7AEC 49,236, VE6AO 48,768, VE3AWX 45,375, VE3AGX 45,303, VE1TR 42,258, VE3WY 42,000, VE3VZ 41,925 and VE2DR 41,141.

In no previous single contest had more than three operators reached the 700-stations-worked mark in 40 hours of operating. This time there were no less than ten participants in that class. W4FU heads the list with 797 QSOs, followed by W4KFC 765, W8JIN 759, W3BES 742, W2IOP 720, W6HZZ 720, W1BFT 719, W9RQM 719, W9ERU 708 and W9FO1 706. In the 600-or-over class: W8RSP 670, W1KYK 664, W1LWA 648, W0JRI 643, W3AIZ 639, W1TS 638, W2SSC 632, W0MPW 632, W3FQZ 627, W9UIT 621, W0ZAR 617, W8IWS 612, W8UFH 611, W3DPA 608 and W3GAU 601.

### Sections Worked

The honor of working all sections, a feat unaccomplished since the 1940 SS when there were only 64 to be worked, is divided evenly between 'phone and c.w. All 71 sections active in this contest were worked by W6ITH on 'phone and by W6KKG/7 on c.w. These fellows deserve a big

hand for digging out the rare ones such as Western Florida and KA, one or both of which were missed by all other top-scoring participants. Eleven c.w. operators succeeded in working all but one section: W9GRV, W8JIN, W8WZ, W5KC, W2IOP, W2HHF, W1TS, W1UE, W1ME, W6HZZ and W6NLI. The following each worked 69 sections: On c.w. — W3BES, W9ERU, W9VKF, W9IPT, W4FU, W4KVX, W0JRI, W0YCR, W1RY, W1EOB, W7EVR, W6DJ, W6BIP, W4BPD, W5HBQ, W6BXL and W6SJ. On 'phone — W9NDA.

### 'Phone Highs

For the sixth time in Sweepstakes history W6ITH came out on top with the highest 'phone score: 56,800 points, 71 sections, 400 contacts. His total is an all-time record. Hearty congratulations, Reg! Runner-up W4YNQ of Kentucky worked 370 stations in 63 sections for 45,612 points. Those Kentucky fellows certainly have what it takes! Another consistent contender for 'phone honors, W9NDA, placed a healthy third with 45,402 points, 329 contacts, 69 sections. Other 'phone scores worthy of note: W6OGZ 41,133, W6AM 33,916, W9TAK 33,150, W6CHV

*Continued on page 123*

# The "Barracks Bag VFO"

*A One-Tube Transmitter for Home or Portable Work*

BY F. R. NICHOLS,\* W6JJI

**T**HIS article is not intended to be a cure-all for you rock-bound fellows who want a simple VFO to replace your crystal oscillator, nor is it intended to be the last word in VFO construction. Someone else is certain to come along with a better and easier way to accomplish the same thing, but here it is, to be taken for what it's worth.

The name "Barracks Bag VFO" seemed a logical one, since it is planned to toss the rig into my barracks bag when Uncle Sam sends me on temporary overseas duty for AACCS.

## *The Circuit*

The circuit, shown in Fig. 1, is a version of the Colpitts-type ECO, originally obtained from W6OD back in 1938. It has been modified for use with indirectly-heated-cathode-type tubes. The grid circuit is tuned to one-half the operating frequency, to give better plate-circuit isolation by doubling and thus avoiding magnetic coupling back to the grid. It is imperative that the best grade of low temperature-coefficient mica condensers be used for  $C_1$ ,  $C_2$ ,  $C_4$  and  $C_5$ , since ordinary mica condensers will result in frequency drift.

The screen voltage should be obtained from a good "stiff" source that doesn't change much under "key-up" or "key-down" conditions. A

\* 3431 Comer Avenue, Riverside, Calif.

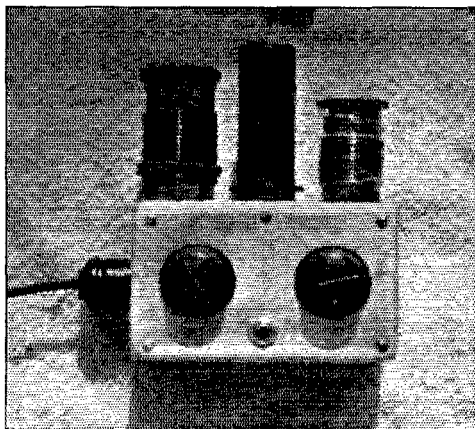

A front view of the "barracks bag VFO." The two knobs control grid and plate tuning, and the jack is for the key. The machine-screw heads in the corners hold the insulating panel that supports the plate condenser.

• One doesn't see many one-tube self-controlled transmitters described in *QST* for a very good reason — poorly-constructed and improperly-adjusted ones will result in signals that clutter up the already-cluttered-up bands. However, the transmitter described in this story has been heard on the air by members of the *QST* staff, and we have no hesitancy in recommending it for 3.5- and 7-Mc. work, if reasonable care is exercised in its construction and operation.

variation of not more than 20 volts seems to be satisfactory.<sup>1</sup> Screen voltage in excess of 150 is not recommended, because it will result in excessive drift caused by the increased screen input. A few experiments with the screen voltage will reveal the best value in relation to the plate voltage.

The plate voltage should not exceed 450. In recent overload tests, the plate voltage was run as high as 700, but the frequency drift at 7 Mc. was 2000 cycles in 3 minutes (with an input of 20 watts), which is far too great to be tolerated.

## *Construction*

The transmitter, as can be seen from the photographs, was built using a small shield can for the chassis. This was done primarily to reduce the over-all size and, wherever possible, space should be provided for shielding of the grid coil. A strip of plastic (Lucite or Plexiglas) was used to insulate the plate condenser,  $C_5$ , from the chassis, the shaft of the condenser passing through a clearance hole on the side of the chassis.

A five-prong socket mounted at one end of the chassis was used for a power connector, and a four-prong socket at the other end of the chassis furnished the connection to the output coil,  $L_2$ . Wherever possible, heavy solid wire was used to make connection between components, in an effort to eliminate any mechanical instability of the wiring. The chassis was not relied upon for grounding; instead a heavy ground bus connects the grounded circuits. The bus is grounded to the chassis at several points.

<sup>1</sup> If 150 turns out to be the best screen voltage for the oscillator, a VR-150 can be used to stabilize the screen. Otherwise, a heavy-duty voltage-divider network should be used. — Ed.

## Tuning

The initial test for spotting the grid coil "on frequency" should be done with the aid of a well-calibrated receiver or a frequency standard and a calibrated wavemeter, to be certain that the grid circuit is tuning the proper range. The grid coil was adjusted so that the VFO will just hit 7000 kc. with the grid condenser fully meshed. This is done by checking the frequency of the oscillator with the condenser fully meshed and the plate circuit resonated (tuned for minimum plate current). If the frequency is found to be below 7000 kc., the top turn or two of  $L_1$  should be spaced apart slightly, the plate circuit retuned and the frequency checked. If the frequency is found to be too high, the top turn or two should be pushed closer together, the plate circuit retuned, and the frequency checked. The process is repeated until the minimum frequency that can be reached is 7000 kc. With 7000 kc. at maximum capacity on  $C_2$ , 7300 kc. will be hit with the condenser about  $\frac{1}{3}$  meshed. A similar procedure can be followed in the adjustment of the 80-meter-band grid coil.

If the VFO is built with the grid coil shielded, all frequency checks should be made with the shield in place, since the shield raises the frequency to which the grid circuit will tune, for the same coil. In either case, the adjustment tests should be made with the oscillator loaded to about 25 ma. A 10-watt lamp bulb makes a good load, and the loading can be adjusted by moving  $L_2$  with respect to  $L_3$  or by changing the number of turns in  $L_3$ .

A coating of coil dope should then be given the grid coil. Before the coat is completely dry, the minimum frequency should be checked again, and any necessary corrections made before the coil dope dries completely. After the first coat dries, a second coat can be applied for good measure.

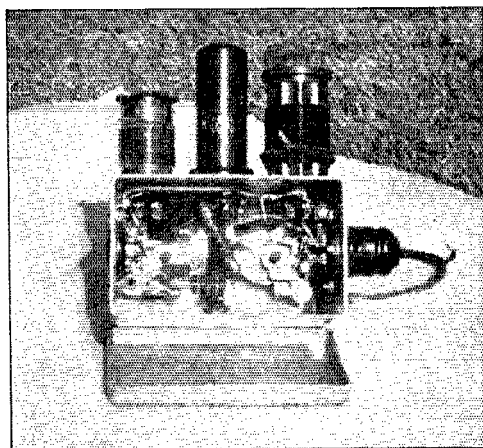

A rear view of the VFO shows the back cover removed and gives a glimpse of the component parts.

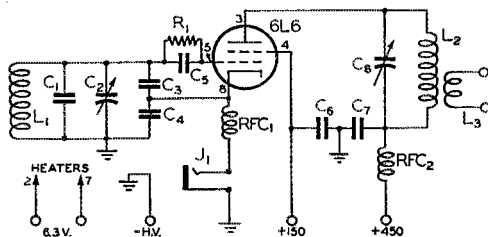

Fig. 1 — Wiring diagram of the "barracks bag VFO."

- $C_1, C_4$  — 500- $\mu$ fd. mica, low temp. coefficient.
- $C_2$  — 140- $\mu$ fd. midget variable.
- $C_3$  — 150- $\mu$ fd. mica, low temp. coefficient.
- $C_5$  — 250- $\mu$ fd. mica, low temp. coefficient.
- $C_6$  — 0.01- $\mu$ fd. mica, 600 volts.
- $C_7$  — 0.002- $\mu$ fd. mica, 600 volts.
- $C_8$  — 75- $\mu$ fd. midget variable.
- $R_1$  — 47,000 ohms, 2 watts.
- $L_1$  — 40-meter band — 8 to 10 turns No. 14 enam., space-wound,  $1\frac{1}{2}$ -inch diam. form.  
80-meter band — 19 turns No. 16 enameled wire, close-wound,  $1\frac{1}{2}$ -inch diam.
- $L_2$  — 40-meter band — 22 turns No. 14 enam., close-wound,  $1\frac{1}{2}$ -inch diam. form.  
80-meter band — 38 turns No. 16 enameled wire, close-wound,  $1\frac{1}{2}$ -inch diam.
- $L_3$  — 2 turns No. 18 push-back, wound on "cold" end of  $L_2$ .
- $J_1$  — Open-circuit jack for key.
- $RFC_1, RFC_2$  — 2.5-mh. 100-ma. r.f. choke.

You are now all set to go, with a small VFO that can be loaded up to 25 ma. at 450 volts. However, do not rely on the calibration of the grid coil, regardless of how carefully you have checked it, and always check the operating frequency — just in case! Don't crowd the band edges, by allowing at least 20 kc. for a safety factor, and you should get along fine with the monitoring stations and OOs.

The VFO has not been tried on 14 Mc., so nothing can be said about its performance on that band. However, on 7 Mc., KL7, ZL and XU have been worked, as well as many stations around the States and Canada, to prove the practicability of this low-powered device.

## Strays

Around the luncheon table at the headquarters of the United Nations recently, with half a dozen nationalities represented, we fell to talking about language differences and the amusing results that can sometimes come from too-literal translations. There we heard this one, about our own word *amateur*, which comes from the Latin *amator*, or lover, derived from the root *amare*, to love — and it's said to be a true story. The proprietor of a camera and photofinishing store in Italy, catering for GI amateur photographers and wishing to advertise his prompt finishing service, labored mightily and got it into English with this rather startling result: "Facilities for lovers. Early developments promised."

# The 13th ARRL DX Contest— High 'Phone Scores

**T**O SOME degree the 'phone section of the 13th ARRL International DX Contest, held during the week-end periods February 21st-24th and March 21st-24th, was not the bloodthirsty knock-down drag-out type of activity which took place on the c.w. bands the preceding week-ends. Since the foreigners work outside the American 'phone assignments, the favorite c.w. technique of sliding right in on their frequency could not be applied. That is not to say all was serene and that 'phone contacts could be knocked off at will. It was a tough fight and those operators who placed in the upper brackets deserve a big hand and a large glass of Dr. Kildare's Tonsil Tonic for their accomplishments in the face of the sort of QRM that only a participant in these contests can appreciate.

Conditions were reported by some contestants to have been slightly better than in the c.w. shindig. Others say the bands were spotty, but just good enough to keep things interesting. Whatever the consensus, the 'phone boys did a bang-up job of producing some excellent scores.

For a fellow who was participating in his first DX Contest, John Ransome, W2SAI, has plenty on the ball. You will note from the high scores published last month that W2SAI submitted the fifth-highest claimed score for the c.w. period. A preliminary check of the high 'phone scores submitted now shows John to be in top place among the U. S. participants. And even with our ruthless contest checkers at work on his log, it's going to take some fancy checking to knock his 135,744 points down to a score that would give him anything but first place! He made 397 contacts with 77 different countries on 14 and 28 Mc. If all the cards come through, he has a very good start toward his postwar 'phone DXCC! The second-highest claimed 'phone score comes from none other than the well-known contest veteran Jerry Mathis, W3BES, who worked 278 stations in 71 countries for a score of 88,917. Jerry, you will remember, also placed second among the high c.w. scorers. Getting away from the Philadelphia area for a moment, we find Wilson Raney, W4SW, of Memphis, in third place with a respectable 74,250 points accumulated from 227 contacts and 64 countries worked. Getting back to Philadelphia again, we're faced with the 73,968 points of Frank Fenimore, W3HFD. And almost a tie with Frank, we find Philadelphian W3DHM with 73,670 points. For fifth place we take a swing out to the land of the kilowatts. Californian W6SA

(yes, he used 1 kw.) reports a claimed score of 73,191 points.

Some other high claimed 'phone scores received up to the time of going to press: W4OM 67,130, W2PWP 63,450, W0AIW 60,556, W5GOC 56,498, W4DQH 55,986, W1JCX 54,708, W6AM 50,540, W6DI 49,248, W9NDA 47,895, W6TF 41,748, W1BFB 40,425, W6EJC 40,110, W0SQO 37,088, W6MLY 36,708, W6RCD 36,675, W2RUI 35,697, W9BCV 35,224, W7ESK 33,760, W2NSD 33,726, W3FUV 33,216, W6WUI 31,824 and VE7AJN 30,976.

The top foreign score received thus far is that of Juan Lobo y Lobo, XE1A: 306,504 points and 1548 contacts. Juan established what looks to us like a new record for QSOs per hour for the contest. In 46 hours of operating he averaged 33.6 contacts per hour!

Interesting sidelights: W4GJO, Orlando, Florida, swapped numbers with OA4AE, Lima, Peru, on 50-Mc. 'phone! W6AM worked XU6GRL, and this is believed to be a record, on each of the low-frequency 'phone bands, 3.9, 14, 27 and 28 Mc. Among the top U. S. 'phone scorers, W2SAI, W3BES, W3HFD, W3DHM and W2PWP are members of the Frankford Radio Club of Philadelphia; it would appear that the group is in line for another gavel, offered to the club submitting the highest aggregate score of members (they already have seven gavels for participation in the ARRL Sweepstakes — see results of the 13th Sweepstakes elsewhere in this issue). — J.A.M.

## Silent Keys

**I**T IS with deep regret that we record the passing of these amateurs:  
Ex-W2QGI, Victor J. Kubanyi, City Island, Bronx, N. Y.  
Ex-W3GU, George A. Bullock, Trenton, N. J.  
W4AAQ, S. Jeff Bayne, Charlotte, N. C.  
W4GYZ, R. E. Bogardus, S. Jacksonville, Fla.  
W6PCA, George B. Young, Maywood, Calif.  
W9TQU, Francis A. Dawson, Kokomo, Ind.  
W9WHA, Rondol P. Cartwright, Glasgow, Ky.  
VE2IF, R. Cecil Parker, Noranda, P.Q.

# How's DX?

CONDUCTED BY JOSEPH E. GRAHN, \* WICH

## How:

It's been a pleasure reading the gang's mail this past month. The entire batch contained only two complaints regarding operating practices, both of which protested the cute trick being pulled nowadays by some of the DX gentry. It seems that certain DX chasers, upon unsuccessfully calling a choice morsel, resort to a drawn-out zero-beat CQ, in hopes that the choice one will call them. Yep, we've heard them too, the snakes-in-the-grass!

Jeeves thinks the lessened QRM can be traced to spring weather, the fishing season, breaking in the new car, etc. However, we disagree and want to go on record as saying that better operating, timing and sportmanship are the factors presently contributing to more enjoyable DX contacts.

Or maybe it's just smarter operating on the part of the DX. Take W3EKK/VK9 in the Admiralty Islands, for example. He uses "LM" to get the wolves off his frequency and "KN" (page 66, April, 1947, *QST*) to let them know he isn't kidding. Of course there are always a few unbelievers who continue to call him on his own frequency after he sends "LM," and maybe it's just as well — it makes it easier to raise him from the low end! And that "KN" deal really shows up the DX hogs, doesn't it?

## What:

It takes a lot of something or other to work DX on 80, and whatever the magic is, W4KVX and W3WJF must have it for they both report QSOs with PK2OL on 3515 kc! KVX also grabbed HB9DD (3520), G6ZO (3520), KL7EP (3595), ON4HC (3515), G4GJ (3515) and G8WF (3520); for extras, WJF reports working G2ATM (3530) and CM2SW (3510). . . . . W2LBM considers his contacts with ZL1DI (3508), ZL2QM (3510), a flock of Europeans, KP4, KV4 and XE1A, as good DXing for 80. We do too, Ferd. . . . .

The gang who stick with 7 Mc. are getting their share of the good ones. W5ACL snagged VK2ANN (7050), TG9JK (7000), ZSSU (7020), ZL1BY (7000), G5GK (7040) and ZL3GU (7060). . . . . W1ZL sez present conditions on 40 are like the banner years of 1927-28; his list includes ZL2FI (7115), SU3GM (7090), SM7HT (7985), CN8BF (7060), OX1G (7010), ZS1M (7090), ZS2CX (7090), ZL2BV (7070), KL7CC (7080) and KH6CV (7075), plus a batch of Europeans. . . . .

W7RT claims the rain gave him his first VU QSO in 18 years of operating — VU2AC (7004) — along with KV4AA (7140). . . . . W0NTA, who made a QSY to 40 for the prime purpose of snagging VR5PL, turned the trick on his first call and adds that that ain't the way it is done on 20. Vince tips us off that after his QSO with the VR5 only two guys went after him. H-m-m, guess I'll go to 40. . . . . W6MUR worked ZM6AC (7100) and ZS6DW (7050); also VR2AN, who wants a sked with Seattle on 20-meter 'phone for contacts with his sister. . . . . W3LPF lost sleep grabbing these rare ones: D4AON, HB9CX, ZS2AL, F8ZW, W3EKK/J2 and VU2AC, which gives Mark his 7-Mc. WAC. . . . . W1JYH states that a few who had supersensitive receivers finally heard him; they include PY7QG (7120), YU7KX (7115), KH6DD (7010), ZC6AA (7060), OK1FF (7030), CT2XD (7010) and HB9CS (7100), for a total of 91 postwar. . . . .

From the reports received during the past few days, it looks as though the 20-meter gang are really out to make the postwar DXCC. W6OBD starts the ball rolling with VS9AN (14,050), VS6AZ (14,018), CR7VAL (14,068), G2NF (14,114), VQ8AD (14,040), PA0LR (14,120), KP4DH (14,070), CX4CZ (14,049), OZ7UU (14,074), EI9N (14,094), GW3ZV (14,115), and proclaims "one country per watt — or bust!" . . . . . Best stuff at W2CYS runs PK6EE (14,110), UQ2AB (14,125), PK1AW (14,000) and ZD1KR (14,050),

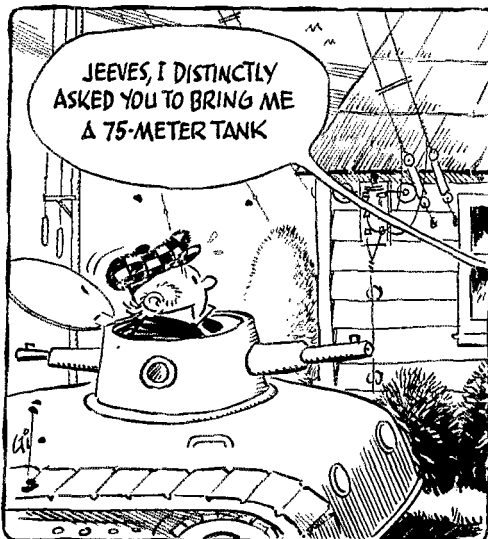

\* 53 Quinapoxet Lane, Worcester, Mass.

with plenty more on 10 'phone . . . . . WØDIB managed to knock off PK6AX (14,070), UA3DS (14,025), J2AAO (14,115), SP3DO (14,060), PK6HR (14,030), KP6AT (14,080) and VS1BX (14,040) . . . . . W3EYF, with not too much time for operating, is tickled to have worked ZD4AB, ZE1JI, W6WDN/KW6, SU1RX, TA1DB, VQ3HJP, KP6AA, CP1AL, J4AAC and EK1AZ, giving him 92 postwar countries . . . . . W9TAL declares it's hard enough to work DX from the Middle West without bucking the W1s and W6s who sneak outside the band edges after the rare ones. However Clarence grabbed O12KAL (14,082), VE8MQ (14,060), OK3AA (14,130), I1UL (14,145) and GI3AXI (14,038), along with numerous VKs and ZLs . . . . . With a Zepp-fed job 15 feet above his roof, CM2SW kept occupied catching VS9AU (14,005), UA9CA (14,120), FT4AN (14,000), LI2BO (14,030), W4GLF/KG6 (14,100), VK4BI (14,040), ZK1AH (14,140), OE9AA (14,025), UB5HO (14,005), WØFTV/KG6 (14,095), UO5VW (14,130), UB5BB (14,040) and PK2AA (14,100) . . . . . W1LVH is finally convinced that a rotary really puts the stuff where you want it, and sends along the following to prove his conversion: VQ5JTW (14,095), VS1BX (14,140), VS7MB (14,180), UG6WD (14,110), YI2AM (14,100) and OY3IGO (14,095), which are the best of a long list . . . . . A recent convert to the DX mob is VE7HP, who has made a good start with ZS6IJ (14,060), SM3ZF (14,060), SM5MP (14,130), HB9AW (14,040), G4KS (14,085), ZS1CN (14,085) and OK1WF (14,075), along with a string of ZLs and VKs . . . . . The pick of the stuff from VK3UM is CT2AB (14,115), CP1AP (14,015), UI8KFQ (14,055), VS4VR (14,060), VS7AP (14,000), ZP4A (14,160), UD6KB (14,070) and HR2IC (14,070) . . . . . W6MVQ reports the choice ones there as XZ2AN (14,120), YS1DS (14,030), VU2BG (14,055), UAØKTU (14,110), HS1AL (14,100) and VP4TW (14,080), and passes the word along that PK6HA needs Rhode Island, South Dakota, Wyoming and Arizona to complete his WAS . . . . . New ones at W4BRB are LX1JW (14,000), W3EKK/VK9 (14,022), YI2AM (14,100) and VR5PL (14,095), giving him 119 postwar . . . . . The since-VJ-Day score at W1GKK, on 20-meter 'phone, stands at 91 countries. The latest are YJ1AB (14,190), KL7FC (14,250), KP6AA (14,290), PK2AA (14,340), W6OQ/KH6 (14,220), W5LEF/KL7 (14,250), YS3PL (14,190), K6ETF/Canton (14,180), TG9RV (14,175) and VQ4ERR (14,325) . . . . . W6UZX isn't at all ashamed of his 2-hour-and-10-minute WAC. They are G6XM, VK4GJ, J2AGA, CN8EA, PY7AG and W3JSI . . . . . Between classes at R.P.I., W2NSD swapped yodels with SM5OH, VK3UP, PZ1UD, EK1AS, EA9AI and O12KAL, for a postwar total of 70 countries . . . . . It's 116 since hostilities for W1ME. The latest are YI2JJ (14,105), VR2AO (14,090),

GC8NO (14,012), UB5AC (14,075), ZC6DD (14,065) and VS7IT (14,024) . . . . . W1FJN has 84 postwar via the chin route, the most recent ones of which are J9KC, SV1AH, VQ4ERR, W6ONP/KW, K6ETF/KC, KP6AA, UA1AB and VS7ES . . . . . W1KWD sends in his 10-meter 'phone WAC of 2 hours and 38 minutes as a challenge to anyone in his area. They were PK1MJ, VK6EL, G5ZT, PZ1A and ZS6BV. Yes, we can only find five. No Ws, Doc? . . . . .

Switching to ten: W8ZBK tells us the pick of the month were YI2AT (28,005), YI2CA (28,380), ZC6WP (28,260), VS9AB (28,180), W6VKV/16 (28,200), SU1WS (28,240), LX1SI (28,300), CT1YT (28,480), HB9DY (28,250) and EL2A (28,050) . . . . . W9FNR now has 65 postwar, the latest of which are YR5V, CN8EA, FA8DX, VQ4ERR, KV4AD, YN1LB, ZB1AC, XU8GRL, W6BWS/KG6, VQ3TOM (28,220) and W4HUR-/C7 (28,215) . . . . . Here is one that is out of the ordinary run of contacts: W2HXM, portable-mobile in N. J., worked W2PRF portable-marine, 180 miles north of Curacao. Total powers: 55 watts; speeds: 35 m.p.h. and 18 knots . . . . . According to W7QAP's list, he has been getting his share. It includes VS1AQ, PY1DH, CR9AG, OK1FF, OK1CG, VP8LK, SM7YE, LU9AX, CE3AJ, CE3FV, ZS6GO, FA8BG, F8EJ, G3VO and F9BU, besides a fist full of ZLs and VKs . . . . . A fine letter from ex-W5AYR, who was with the 4th Byrd Antarctic Expedition, states that during the month of February he hooked up a BC-348 aircraft receiver in his tent and logged the following W stations who had real workable signals down there on the ice: W1RF, W3EOZ, W3FYB, W3MYV, W3IMH, W2DFN, W8LAV, W3RCQ, W5MJQ, W3NSZ, W5IVJ, W1MAK, W2WMM, W2WMV and W6ONP . . . . . It seems that W2PTE (ex-W8AHC) is a little on the modest side. A note from W2PUN lets us in on the 59-minute 10-meter 'phone WAC W2PTE made a short while ago. They were G4CJ, OQ5BA, J9LG, LU3BQ, J9AAK and W7RMB. Nice going, OM . . . . .

### Where:

Requests for QTHs are becoming as long as DX lists! We ask you again, gang: Before writing in for a QTH please check the back issues of QST. From Andy at HZ1AB comes word that their new mail address is 1432 AAFBU, APO 616, C/o PM, New York City . . . . . W6JTA sends along: W2WMV/C9, Box 10, Navy 3930, FPO, San Francisco, Calif. . . . . OK1WY informs us that CZ7O requests QSLs via IIPQ, A. Pagano, Via Alpi, Nr. 9, Rome, Italy. For SP3BC it's Post Box 520, Warszawa, Poland . . . . . Miles Weeks of W6ZZ, ex-W1WV, drops us: W6VIB-/C7, Lt. Byron D. Lott, Peiping Hq. Group, Signal Sections, APO 912, C/o PM, San Francisco, Calif.; KZ5AU, Box 141, Balboa, C.Z.; J2SJS, 8th Army, AMS, APO 343, C/o PM, San



Francisco, Calif.; XZ2DN, Signals Section, RAF Station, Mingaladon, Rangoon, Burma . . . . .  
 From W6AY: VP9E, Box 11, Mangrove Bay, Bermuda . . . . . W2QUJ donates: OH7NG, Post-fack 1287, Helsinki, Finland . . . . . VR2AO, Aeradio, Nandi, Fiji Islands is one we got from W6EUV . . . . . W6BVM sez it's PK4OO, C/o Netherlands Forces Intelligence, Palembang, Sumatra . . . . . XAFQ, a newcomer GI stn in northern Italy, can be QSLed to 350th Infantry Regiment, APO 88, C/o PM, New York City . . . . . From W2NSD: J7ELS (the only active station on the island of Hoikaido), APO 919, C/o PM, San Francisco, Calif. . . . . Our contributions are: YI2AT, RAF Habbaniya, British Forces in Iraq; J4AAQ, Andy O'Neil, Australian Army Signals, Kure, Japan; OX3GE, APO 55, C/o PM, New York City; ZC6DD, Signals Troop, 33 Parachute, Middle East Land Forces, Haifa, Palestine . . . . . W6LHY sent in: XULP, Radio Opr. M/V Wan Cheng, C/o UNRRA, CIWIT Branch, 20 Canton Road, Shanghai, China; VU2CV, 72 British Group Signal Sqdn., Bangalore, India . . . . . From W1JLT we get: WSQZE/KW6, C/o PAA, Wake Island . . . . . A short note from HB9AG requests that no more cards for YR stations or D5FF be sent to him for forwarding. Cards for D5FF are helping to warm HB9AG's shack! . . . . . W1HDQ informs us that ZBIAD, RAF Station, Luqa, Malta, is closing down and returning to England, but has sent cards to all Ws contacted. Cards in the future should go to RSGB . . . . . An urgent request from YR5R via G2MI and W3KDF asks that no more cards be sent to the Roumanian QSL Bureau until further notice. "Political difficulties" is the reason.

**Tidbits:**

A letter from ex-G5BO/SU5BO, who is now located at Georgetown, Ascension Island, definitely places ZD8A in the bootlegger class. The post office there has a big batch of QSL cards for the above louse. However, Mr. Boa promises that a legit ZD8 will soon be on the air . . . . . Last month we reported the present D4ADT as not being legit; however we have received a letter, via W2UCW, from Capt. Samuel W. McCarter, Amateur Radio Officer at Frankfurt, Germany, to the effect that the call D4ADT was immediately reissued. Beg pardon . . . . . Word from XUIYY/W6PUU assures us that all contacts made will receive cards in due time . . . . . We can cross VR4BQ off our DX lists, because word from BRS-9202, who handles the RSGB QSL traffic in the Cape Verde Islands, states that there is no station there using that call. The above came via G2FFO who is as disappointed as we are . . . . . Cards from PZ1FM will soon be showing up, because W4FVI has just mailed a huge batch to the various QSL managers . . . . .

Can anyone enlighten us on FP8A? . . . . . SV1RX reports all British army personnel will soon be using SV0 instead of the NA prefix . . . . . HK1CK, so active in the DX Contest, is ex-HK1AB and can be reached at the HK1AB address given in any postwar *Call Book* . . . . . Bill Gibbs of CN8EE-W1DTS/CT2 informs us that contacts from both of the above locations will have been acknowledged by the time this is in print. Bill is active on 80 'phone and c.w., as well as on 50 Mc., and is looking for schedules . . . . . G8ON suggests that on a CQ DX we add the numerals one to nine; viz., CQ DX 1 through CQ DX 9, the numeral signifying the thousands of miles from which one expects answers! . . . . . W2LJR tells us that EL4A really works the DX, using QRY followed by a numeral. Yes, we had to look it up, too! . . . . . NY4CM informs us he cannot QSL DX Contest contacts but his logs have been sent to ARRL and everyone will receive credit for NY4 . . . . . W4JWA reports working all call areas on the 10-meter ground wave after the band has closed down. Yep, you're right; all were operating portable in his vicinity . . . . . EP3D reported as not legit in April, is apparently okay. We've seen his QSL cards . . . . . HC1OE advises that if you haven't received his card, it's because he has been transferred to Lima, Peru. He will acknowledge all contacts if a card is mailed to Gene F. Smith, F.R.O., Pan American Grace Airways, Lima, Peru . . . . . VY 73 till next month.

**MASSACHUSETTS  
 STATE CONVENTION**  
 (New England Division)

**Framingham, Mass.      June 21st**

Nevins Memorial Hall in Framingham will be the gathering place of New England hamdom for the Massachusetts State Convention on Saturday, June 21st. Registration at 1 P.M. will be followed by demonstrations and technical talks, 2-meter hidden-transmitter hunt, code contests, FCC license examinations (Classes A and B), and a special tea for the gals. Traditional family-style roast turkey dinner at 7 P.M. in the gala Framingham manner. Then guest speakers and prize drawings.

Attendance at the banquet is limited to 600. Complete tickets are \$4.00, and if purchased before June 8th are eligible for a special prize. Those too late for banquet seats may attend meetings and other activities upon payment of registration fee of \$2.00. Contact E. S. Parsons, 29 Pitts St., Natick, Mass.

# Adapting the Car Radio to a Converter

## Home-Station Features for the Mobile Enthusiast

BY BASIL C. BARBEE, \* W5FPJ

**A** HAM in any of the more sparsely-settled sections of the country usually chooses one of the "crystal-controlled" bands, i.e. 6 or 10 meters, for his mobile communications, since he will be able to QSO only himself on 144 Mc. or higher. For satisfactory reception on 6 or 10, he can either (1) build a special communications receiver for the desired band (or for both), embodying probably a double-superhet circuit, a dynamotor or vibrator plate supply, a.v.c., a.n.l., S-meter, etc., all in a very compact cabinet, or (2) build or buy a small converter for making a selective double-superhet out of any good car broadcast receiver. The latter course is the one usually taken, because it is economical in space and cost. Most hams who build or buy converters end up with a fairly selective and sensitive double-superhet system, but they have to do without other desirable features such as an S-meter, noise limiter and full a.v.c.

On extremely strong signals, the omission of a.v.c. on the r.f. and mixer stages of the converter results in "blocking" of the converter and "pulling" of its oscillator. Since we have to tear into the b.c. receiver anyhow in order to make connections for the converter, let's make provision for all these other functions at the same time. It's really quite easy.

### Making Cable Connections

The schematic diagram, Fig. 1, shows the necessary modifications. Only the parts that are added or changed are designated by numbers. It is thought that the tube line-up of the b.c. receiver shown is fairly typical. Somewhere around the chassis will surely be found space for mounting an ordinary octal-type tube socket. A hole about  $1\frac{1}{2}$  inches in diameter is punched in the cabinet to correspond with this socket's placement in the chassis, to permit insertion of an octal plug and cable leading to the converter. To this socket are brought all the individually-shielded leads to the converter with the exception of the antenna, which has its own connector. One prong of the socket is connected to ground. Another is connected to the heater circuit of the receiver, so that the converter can be energized only if the receiver has been turned on. A third is connected to B+ for plate supply to the converter, while another brings out the a.v.c. line. A fifth prong is connected in the common

cathode lead of all r.f. and i.f. stages that have a.v.c. applied to their grids, thus making available a current to actuate the S-meter. No attempt should be made to utilize the cathode current of the mixer, since the variation in current resulting from the changing oscillator voltage will cause the zero setting on the meter to shift. A sixth prong is connected to the coil of the a.n.l. relay,  $Ry_1$  in the schematic. Finally, a seventh prong is connected to the coil of a s.p.s.t. normally-closed relay,  $Ry_2$ , for opening the primary circuit of the dynamotor plate supply during transmission.

### Audio-System Changes

The greatest revision necessary in the receiver electrical circuit is the addition of the series-valve noise limiter. The series-valve circuit has met with almost universal acceptance because of its simplicity and efficacy. It will be necessary to find space on, above, or below the chassis for one additional tube. In the author's case, the existing 6Q7 detector and first audio tube was removed, and a 6H6 substituted. A new socket was installed, and a 6SJ7 high-gain first audio was wired in, incorporating inverse feed-back from the secondary of the output transformer to the 6SJ7 cathode. While inverse feed-back has nothing to do with the a.n.l. circuit, it does result in a reduction in residual hum and distortion, and permits switching in additional speakers without as great consequent reduction in volume to the original speaker. The 40-ohm potentiometer,  $R_3$ , is used to adjust the degree of feed-back. Too much feed-back will result in instability of the audio system. Between 10 and 20 db. of feed-back ordinarily may be obtained readily unless there is undue phase shift in the interstage coupling network and the output transformer. If the audio stages oscillate with only a small amount of feed-back applied, it is probable that the phasing of the output transformer windings is reversed from that shown in Fig. 1, and reversing either the primary or the secondary should clear up the difficulty. If chassis space is limited, the extra tube may be a miniature type. A 6AL5 miniature may be substituted for the 6H6, or a 9001 or similar miniature for the 6SJ7. If it is desired to omit the inverse feed-back feature, a high-gain triode may be used as the first audio stage.

A s.p.s.t. normally-closed relay, of as small physical dimensions as can be found, is placed below the chassis, as near the a.n.l. tube as possible. This relay,  $Ry_1$ , is used to short out the

\* Nacogdoches, Texas.

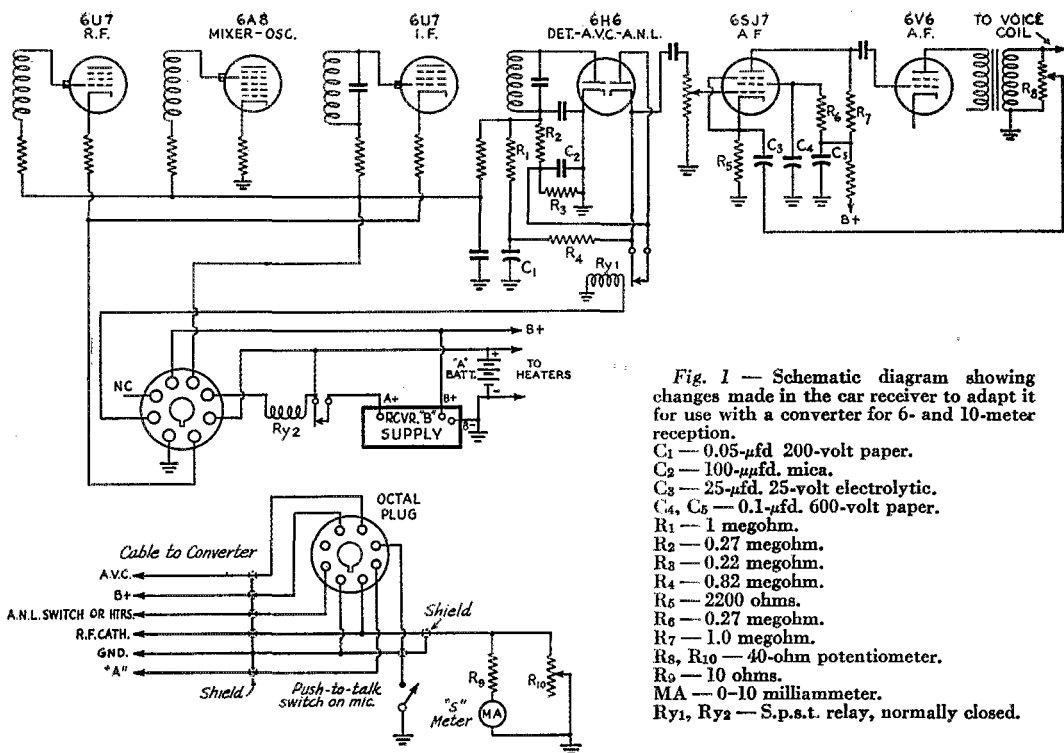

Fig. 1 — Schematic diagram showing changes made in the car receiver to adapt it for use with a converter for 6- and 10-meter reception.

- C<sub>1</sub> — 0.05- $\mu$ fd 200-volt paper.
- C<sub>2</sub> — 100- $\mu$ fd. mica.
- C<sub>3</sub> — 25- $\mu$ fd. 25-volt electrolytic.
- C<sub>4</sub>, C<sub>5</sub> — 0.1- $\mu$ fd. 600-volt paper.
- R<sub>1</sub> — 1 megohm.
- R<sub>2</sub> — 0.27 megohm.
- R<sub>3</sub> — 0.22 megohm.
- R<sub>4</sub> — 0.82 megohm.
- R<sub>5</sub> — 2200 ohms.
- R<sub>6</sub> — 0.27 megohm.
- R<sub>7</sub> — 1.0 megohm.
- R<sub>8</sub>, R<sub>10</sub> — 40-ohm potentiometer.
- R<sub>9</sub> — 10 ohms.
- MA — 0-10 milliammeter.
- Ry<sub>1</sub>, Ry<sub>2</sub> — S.p.s.t. relay, normally closed.

series-valve noise limiter for broadcast reception, since a slight impairment of audio quality may be observed with the limiter in the circuit. This small amount of distortion is of no consequence in communication, however, and if desired, the a.n.l. relay may be connected into the heater circuit of the converter so that whenever the converter is turned on, the a.n.l. is automatically cut into operation.

### Installing the S-Meter

The S-meter lead is brought out of the cable to the meter and its adjustment rheostat, R<sub>10</sub>, which should be placed in a position on the dash or elsewhere convenient to the eye. It may be left connected in the circuit, since it detracts nothing from the performance of the b.c. receiver, and is often useful in conjunction with the receiver as a tuning meter, for comparing signal strengths of b.c. stations, and as an aid in tracking down sources of noise. The rheostat is used to compensate for voltage variations because of differences in state of charge and loading of the battery. It also permits setting the meter to read S=0 (of course there is no such thing) at the no-signal noise level. The meter movement itself need not be very sensitive, because the amount of cathode current drawn by the r.f. and i.f. tubes at no signal is considerable. A 10-ma. move-

ment is specified, although in many cases it will be possible to use even a 25-ma. movement. Since the calibration of the scale will be different for each individual case, the method to be employed will be left to the constructor.

No attempt will be made here to describe a converter for 6 or 10 meters, because a number of suitable converters have already been described in *QST*. One further thought might well be voiced here, however. If the car radio is equipped with push buttons, there is some advantage to be gained in setting one of the buttons to the chosen first intermediate frequency, somewhere near the high end of the band, so that a minimum of time is consumed in changing from broadcast to ham-band reception, and so that the tuning dial of the converter will not have its calibration upset by inaccurate setting of the b.c.-receiver dial.

With a good-quality car receiver to start with, plus the modifications outlined above, the mobile "shack" will be equipped with almost all the comforts and conveniences of home—or does some bug-banger want to include a b.f.o.?

**SWITCH  
TO SAFETY!**





# The World Above 50 Mc.



CONDUCTED BY E. P. TILTON,\* WHDQ

**I**NCREASING activity on 6 is turning up many interesting facts, not the least of them being that the sporadic-E skip season begins much earlier than we formerly believed. With reports on hand covering most of April, we find that skip work was done on April 2nd, 6th, 13th, 14th, 15th, 16th, 17th, 18th, 23rd and 26th, with several minor openings reported in March. In former years we have found space to report these early-season openings in detail, but with more than 400 listed in this April batch, it is obvious that complete reporting is out. A record of such work is important, however, and we wish to thank the scores of workers who took time out to write a summary of their April efforts. Reports of sporadic-E skip work are still being studied with interest in several quarters, and whether such reports make the pages of *QST* individually or not, they are very useful. They provide the best available check on the occurrence of sporadic-E skip, still one of the major question marks that punctuates our knowledge of radio-propagation phenomena.

The first real opening, on April 6th, was confined mainly to the eastern half of the country, although contacts were reported by workers in all call areas except W6 and W7. April 13th was a "quickie," with a few fleeting contacts made over north-south paths in W3, W4 and W8. The 14th provided the West with its first good workout, and here again the skip was north and south. April 15th was another Eastern date, though some evidence of skip was reported as far west as Tucson, Arizona. The skip of April 17th was almost country-wide, only W3 missing mention in the preliminary reports. Reports for the 18th show work by W4, 5, 6, 7, 9 and 0. A few W5-W7 contacts were made on April 23rd, and a noontime opening on April 26th provided contacts for W1, 2, 9 and 0, and perhaps others not yet reported.

\* V. H. F. Editor, *QST*.

With a few notable exceptions, most of these contacts were of the fly-by-night variety. Signals came in abruptly, and often as not disappeared again, before QSOs could be completed. There were not many long rag-chews, but the band was open, and that was all that mattered to most of the gang who had been waiting for months for a crack at 50-Mc. DX. It was a good time for "state hunting," and already several of the leaders in this field are up around the 30 mark. Everyone felt that, if things were going as well as this in April, surely the spring and summer of 1947 were due to be the best v.h.f. season on record.

## The International Scene

OA4AE has done it again! Encouraged by his success in working W4IUJ and W4GJO on March 23rd, OA4AE, Lima, Peru, has been banging away on 6 each weekend. On April 19th (note that this is 27 days after the initial contacts) his regularly-scheduled transmissions (for five minutes, at five minutes past the hour, and each fifteen minutes thereafter) netted a contact with W4QN, Orlando, Florida, who replied to the OA4AE CQ at 3:10 p.m. Contact was maintained for only a few minutes, in the hope of working other stations, but though the signal of W4QN remained audible until 3:29, no other signals were heard. Signals during this QSO were stronger and more solid than those of the March 23rd event, running about S6 most of the time. The following day, at the same time, the signals of OA4AE were heard by W4DRZ, Ft. Lauderdale, Fla.

Another country has moved into the 50-Mc. column. In a recent QSO with LU1DH and LU8ET on 28 Mc., we learned that Argentina has authorized its amateurs to use the 50-54-Mc. assignment. There is considerable interest in the possibility of international DX work in the new band, and several LUs will be going before this



The layout at PA0UN, the station of David Zaayer, Eindhoven, Netherlands, holder of the one-way record for 50-Mc. DX. On March 29th, PA0UN worked ZS1P, Cape-town, South Africa, crossband, with ZS1P on 28 Mc. On the operating table, left to right, are a panoramic adapter (a conversion job), AR-38 receiver, two converters, and a modified BC-348 receiver. The top layer includes an all-band exciter, p.p.-807 final, and 50-Mc. transmitter. This rig includes a phase modulator for n.f.m. and has a pair of TZ-40s in the final.

*QST* for

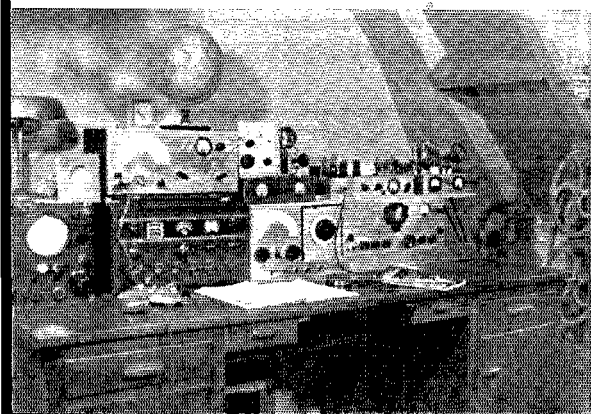

appears in print; LU3DH, LU5CK, LU8BQ and LU9AX, well known for their work on 10, are among them. These fellows ask that W stations looking for South American DX contacts on 50 Mc. use c.w. rather than voice, at least for the initial calls. Numerous weak fading signals, presumably of U.S. origin, have been heard; signals that would have been solid copy on c.w., but which remain below the level at which modulation is readable.

Another South American prospect is CE1AH, Chuquicamata, Chile. Ida and Larry have a converter on the way down from the States, and they are working on their rig for 10 and 20, trying for enough excitation to make it "put out" on 6.

Have you heard about Expedition Kon-Tiki? This expedition, regarding which preliminary announcements have already appeared in *QST*,<sup>1</sup> should be off the coast of Peru by the time this appears in print. Their expected route lies out across the high m.u.f. territory of the Central Pacific, and they will be operating on 27,980 and 49,980 kc., among other frequencies. Though the primary purpose of the expedition is ethnological, LI2B should provide some interesting propagation data. Be on the lookout for LI2B, and report any reception or two-way work to ARRL at once.

Maritime-mobile stations are well known for their ability to work all manner of DX on 10 with low power. It follows that they should do well on 6 also, when conditions are right, and we have long hoped that some of them would become interested in the possibilities of 50 Mc. At least two of them are now trying. W5BSY/MM, aboard the S.S. *Crest-Of-The-Waves*, and W6NSQ/MM, on the S. S. *Joseph Widemeyer*, have been working with ZS1P and others while traveling across the Atlantic in opposite directions. To date, no positive results have been achieved, and it may be too late to do anything now until early fall, but we hope that these fellows and others will keep at it. Since sailing routes and high m.u.f. areas often coincide, it would seem that the MM boys should make the grade if anyone can.

Anyone who has heard the husky 28-Mc. signals of the KP4s cannot but feel that here is good 50-Mc. DX territory too. Ionospheric data bear this out; not only are the KP4s right in the middle of the high m.u.f. territory, but they are in a region where sporadic-E skip should occur very frequently. And wartime experience with radar DX in that area indicates that they should have an interesting time of it in extended-local work. Plenty of KP4s have stated their intention of getting started on 6, but these good intentions have not made any DX contacts, to date. Here are some more who say they are going to do it: KP4CC, KP4CX and KP4DR. Let's go, boys!

Many of the v.h.f. fraternity in Canada have

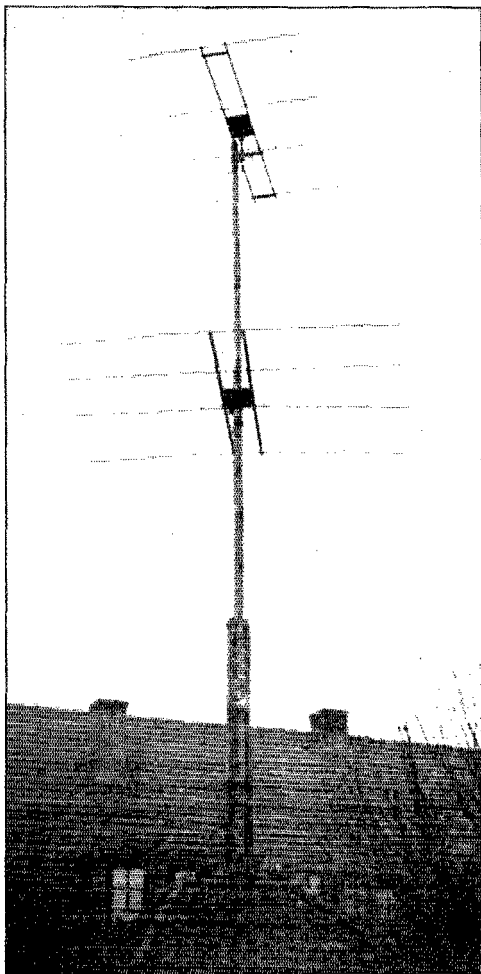

These 4-element antennas for 6 and 10 play an important part in the performance of PAØUN, holder of the 50-Mc. one-way DX record.

◆  
been pulling for a stabilization requirement for 50-Mc. work. The prevalence of modulated oscillators and superregenerative receivers on 6 has been regarded as a barrier that was keeping the more progressive workers off the band. From VE1QZ, Halifax, Nova Scotia, we learn that stabilization of 50-Mc. rigs is now required by law. This will be good news to many Ws, who have found the modulated-oscillator QRM pretty heavy at times when the band has been open in the past. There is quite a bit of activity developing in several Canadian cities. The areas near Halifax, Montreal, Toronto, Winnipeg and Vancouver are among the places that may be expected to provide VE contacts on 6. The Canadian ham magazine, *XTAL*, now sports a v.h.f. department, under the able conductor-

<sup>1</sup> Expedition Kon-Tiki, *QST*, March, 1947, p. 71.

## V.H.F. MARATHON

Contacts Through April 15th  
(Incomplete)

Call	50 Mc.	144 Mc.	255 Mc.	Score	States Worked	50-Mc. WAS
W1AF	60			287	6	6
W1BCT/1		78	4	377	3	
W1CQY	24			233	6	6
W1CGL	78			528	14	27
W1EH*		31		136		
W1FRK		19		91		3
W1HDQ*	65	23		592	14	1
W1KLR		68		287		3
W1LLL	56			557		12
W1LMU		31		114		1
W1FEN		41		267		4
W1PLQ		57		192		1
W2AMJ		72		502	13	
W2BYM	59			451	10	24
W2COT		81		344	4	25
W2DZA		75	5	331		7
W2NLY		120		716		4
W2QVH	57	65		509	7	6
W2BLV	31			473	16	3
W2RPO		14		74		7
W2R50		64		570		2
W2ZD		168		830		3
W3CGY	44	20		425	7	4
W3CKP	4	38		274	1	9
W3HWN**		80		657	5	4
W3IUN	30			216	5	5
W3MBW		60		422		4
W3MNA		62		332		5
W3RUE	27	34		620	15	1
W1KMG/3	42			356	9	21
W4FJ	20	7		370	12	2
W4BVV	31			284	10	16
W4LNG	2	23		133	1	1
W4WMI	19			177	8	8
W5JLY	3			33	2	
W6BWG	63			186	1	2
W6HZ/6	53	115	1	491	1	1
W6OVK	3	71	4	504	1	1
W6WNN	21	5		177	1	1
W6YBP	11			64	2	
W7ACS/ KH6	6			123	0	
W7QAP	3			13	2	12
W8QQS	23			308	8	8
W8RFW	8			28	3	
W8TDJ	11	1		162	10	1
W8UKS		43		362		3
W9AB	26	2		219	8	1
W9AGY		17		49		12
W9ALU	11	6		179	5	1
W9CZO	5			59	1	10
W9DWW						17
W9JMS	26			278	5	5
W9PK	60	9		787	20	1
W9ZHL	34			406	10	10
W9ZJB						30
W0DYG						8
W6DZM						21
W6HXY						15
W6JHS						15
W6QIN	26			426	8	18
W6SV						17
W6YUQ						22
W9ZJB						29

\* Not eligible for award.

\*\* Third-period winner: W3HWN, 352 points.

Island of Guam. They heard a weak fading signal, believed to be a W5, calling CQ, at 0805 Guam Time on April 1st. Guam would appear to be just about an ideal spot to ride the high m.u.f. belt across the Central Pacific to KH6, if not to the Mainland.

Here is another choice bit of DX in prospect: From W6MYS we have word that ZK1AA, at Raratonga, Cook Islands, is on 50 Mc. He is making transmissions hourly, on the half hour, and is hoping to keep this schedule on a 24-hour basis, with the help of other operators. At present he is unable to listen on 50 Mc., but by the time this appears in print he should have a 50-Mc. converter in operation. Look for him also on 28,280.

### Here and There on 6

Need some new states? As recently as March, we listed eleven states from which we had received no reports of 50-Mc. activity. Four of these are now in the active column. Arkansas made the 50-Mc. map when W5LCZ fired up at Benton. At Omaha, W0DYG is doing his best for Nebraska, with 700 watts on 50,020 kc. New Mexico is represented by W5MLE at Los Alamos, and Utah has W7SP at Saltair and W7JPN at Salt Lake City. Who will get things started in South Carolina, Tennessee, Mississippi, Colorado, Wyoming, Montana and Nevada? Maine, long a holdout, now has capable representation supplied by W1DEO, at Portland. Herb made the gang in New England happy during April by putting up a 3-element horizontal rotary and working just about everyone on the band in W1. He has been consistent even as far down as the Hartford area, a distance of 185 miles. Another Maine station now beginning to work out is W1EIO, at Berwick.

Are you one of the gang who work 6 only when it is open for skip contacts? If so, why not take the advice of W7BQX, Port Angeles, Wash., and try it for nightly work? Ernie finds 50 Mc. much better than 28 for extended-local work. On 10 he was unable to cover the 75-mile hop to W7EYS satisfactorily, yet 6 is providing nightly contacts with solid signals. The same goes for W7DYD in Bothell, W7EUI in Kirkland, and stations in Vancouver, B.C. The gang in the Pacific Northwest have been having some fine skip openings, too. The season opened on March 3rd for W7JPA and W7CTY. The best opening to date was on April 18th, when W7HEA worked 23 W6s, W7CAM 17, and W7JPA 14. The band was wide open for more than five hours, starting around 6:30 P.M.

The night of April 17th was a big one for W5FRD, Ft. Worth. With W5LIU operating, 28 stations were worked between 9:05 and midnight. These contacts included W5, 6, 8, 9 and 0,

ship of VE3ANY, and v.h.f. interest and activity are growing rapidly.

From KG6AI, via W1DF, we learn that KG-6AC and KG6AI are active on 50 Mc. on the

## RECORDS

### Two-Way Work

- 50 Mc.: KH6DD — J9AAK  
4600 Miles — January 25, 1947
- 144 Mc.: W3HWN — W1MNF  
390 Miles — September 29, 1946
- 235 Mc.: W6OVK — W9OAW/6  
186 Miles — March 2, 1947
- 420 Mc.: W6FZA/6 — W6UID/6  
170 Miles — September 28, 1946
- 1215 Mc.: W1BBM — W1ARC  
3 Miles — April 7, 1947
- 2300 Mc.: W1JSM/1 — W1ILS/1  
1.6 Miles — June 23, 1946
- 5250 Mc.: W2LGF/2 — W7FOF/2  
31 Miles — December 2, 1945
- 10,000 Mc.: W4HPJ/3 — W6IFE/3  
7.65 Miles — July 11, 1946
- 21,000 Mc.: W1NVL/2 — W9SAD/2  
800 Feet — May 18, 1946

and accounted for 13 states.

Have you tried those new 50-Mc. crystals? W7QAP writes that W5LWP, El Paso, Texas, is on with a rig built entirely of German gear, including a 50-Mc. crystal oscillator and a converted German v.h.f. superhet.

Quite a few of the gang are going to high power on 6. With most of the components available from surplus, the high-power v.h.f. set-up is no longer the costly proposition it once was, particularly if one already has high-powered gear on other frequencies. Out in Brookings, South Dakota, WØUSI, an old reliable from prewar days, has a kilowatt rig on 6, and is working over to the Minneapolis area frequently, a distance of 175 miles. Others in South Dakota include WØs BJV, CJS, KQO, TI, MZJ and DIY, at Watertown, Bryand, Conde, Millbank, Brookings and Sioux Falls, respectively.

Wanted: 6-meter contacts with Georgia stations. W4FGU, Athens, Ga., needs more than an occasional skip-DX contact to keep him happy on 6. He has been transmitting at regular intervals, and monitoring the band, in the hope of working stations in Atlanta, Augusta, or Macon, all within a 70-mile radius. He will be glad to keep schedules with interested parties.

This is the season of the year when it is no longer necessary to plead for activity on 6 in most areas. With the advent of the sporadic-E skip season, and best tropospheric bending months coming up, there will be plenty of stations using the band from here on. The fellows who appear on the band each year about this time are most welcome, of course. The more the merrier. But those of us who like to think of v.h.f. work as a year-round business have soft spots in our hearts for the guys who keep at it when con-

ditions are not so inviting. Expressing such sentiments, W9AB writes: "But I really take my hat off to the few who stayed on the job all winter, when conditions were at their worst. These include W9PK, W8CVQ, W9QCY, W8JLQ and others. A swell bunch of boys." All of us could write similar lists of fellows who take the bad with the good; fellows who are interested in seeing what can be done when the going is not smooth, who want to know their *minimum* working range, as well as their maximum. It is no mere chance that most of these fellows are the leaders when it comes to working the DX, too, for in their daily work they have been ironing out the bugs which are bound to crop up. By working to put out a good signal across a hundred-mile path, they have developed the means for working 1000, 2000, or 3000 miles, as well. They are the men who make v.h.f. endeavor the interesting field that it is!

### Club-Sponsored V.H.F. Contests

To promote interest in v.h.f. activity, a number of radio clubs have sponsored v.h.f. operating contests. These include a 6-week affair conducted by the Rio Grande Valley International Radio Club, of Brownsville, Texas, and an April-December contest under the auspices of the Raleigh (N. C.) Radio Club. The Texas affair ran from April 1st to May 15th, and carried a Cardwell V.H.F. Kit as first prize. The Raleigh Club contest is open to any amateur in North Carolina who has not made contacts on any v.h.f. band previous to April 1st. One point is scored for each station worked on each band. A multiplier of 2 is used on all contacts on 144 Mc. and higher. Two prizes are offered in this part of the contest, and an additional prize is offered to the station (in any part of the country) who works the most North Carolina stations on 50 Mc. and higher during the contest period. The contest runs for the balance of 1947. Entries should be sent to Charles Wright, W4HVV, 2010 Reaves Drive, Raleigh, N. C.

### 144-Mc. News

While the 6-meter men are getting in their first skip contacts, the gang on 2 are having their fun, also. It is just about this time of year when those really good nights begin to show up again. During the first winter on 144 Mc., we had had no experience of good bending (we got going on 2 too late in the fall) to show us what the band was good for, and some of us thought it wasn't going to be good for anything until the spring inversions of last May began to show up. Even then, it was well into the summer before the equipment and antennas used were good enough so that anything like the potentialities of the band were realized. The summer of 1947 is going to be quite a different story. We go into this summer season

(Continued on page 126)

# 'Phone Spoutin'

BY "SOURDOUGH"

COME the end of harvest Martha put her foot down real hard and declared we wuz goin' to spend a spell up at the lake. Weren't no serious argymint about that since the farm is pretty well being run by a coupla ex-GIs. Them young fellers decided they didn't want no more of city life and come down to us to learn. They

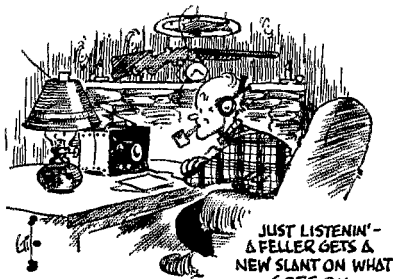

sure are learnin' fast and I figgered it'd do 'em a heap of good to be left on their own to work things out for themselves — specially since I'm goin' to take 'em in as partners come next plantin' — but they don't know that yet.

Wal, I wuz sure lookin' forward to the lake until Martha sez "no radio" (you 'tached fellers will know the sityachin). After some wrasslin' verbally we finally settled for no transmitter but she did allow a two-tube blooper workin' off dry cells. That didn't sound like I'd do much radio but, what with a good aerial and a lotta wire in the lake fer ground, that little pip-squeak worked better'n most superhets down in the city. Allus did say that location wuz the whole battle — and as for DX! — but that's another story.

Evenin' after evenin' I uster just sit and listen. Got pretty irritatin' at first but after a while the yen to yap back fades a bit and a feller gits quite a new slant on what goes on in the bands.

Could be that mebbe the gawp factor is decreasing. One thing is these here 'phone roundtables. Five or six fellers git on the same frequency and chew the fat around the circle. These fellers are more kinda poised like than most. Guess the feelin' that more'n one feller is listening and noting and getting ready to say *his* piece later on may have something to do with it. Howsomever, these fellers on the nets not only have a whole lotta fun but more often than not they got something real useful to say. They behave good too. Perhaps the best operating manners I ever heard was on these nets. If one

feller gets a bit too big fer his britches or tries to crowd in outta turn he soon finds out what's what.

The feeling I get is that these net fellers are really good friends. They get together pretty often and, as fur as I can hear, get around and see each other now'n then. Not only that but their YLs and other feminine folk get together too and it makes out as a nice, decent, completely democratic sorta thing. Everybody has fun. Each guy contributes to the next one's fun and there's sure a lot of cheerful kidding back and forth. Last but not least you got a bunch of fellers all on the same frequency and taking their turns — which sure is better than having them spread across the band howling CQ with no one to talk to.

Didja ever listen to the 'phone procedure on the airline frequencies? That bunch has a whole string of ground stations and Jehoshaphat only knows how many airplanes all on the same frequency. They also got rafts of passengers sailing along in the night fer whom they're responsible. They don't take that responsibility lightly. Just listen to 'em fer half an hour some night. *That* is real superefficiency workin'. Shucks, they don't never waste a syllable let alone a word. Now no one in their senses would want that machine-gun rate procedure on the ham bands. On t'other hand, listenin' to it a bit might show us just how compact and clipped 'phone handling

EVER WATCH  
A COUPLE SPINSTER  
LADIES SAYIN'  
GOOD-BYE TO  
EACHOTHER?

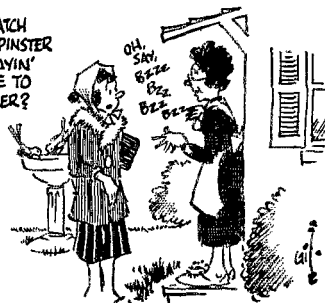

can be and mebbe underline some of the real long-winded time-wasting stuff we do.

Wonder why so many fellers repeat so often on 'phone? If the operator at t'other end is copying solid what in tarnation is the sense of goin' on like an absent-minded parrot.

Then there's the feller what can't really think what he's tryin' to say. His ideas ain't lined up ready to spout so he hems and haws and rambles about and the poor long-sufferin' feller at t'other



end has to sit and take it when you can be sure if he weren't so decent and patient he'd reach out and gently spin the dial to another station.

Sa-ay! did you fellers ever watch a couple spinster ladies sayin' good-bye to each other? They get to the door and stand there fer mebbe half an hour before they break it up. One of 'em starts to go and then t'other remembers a hat she saw in the store window and off goes the gaggle-gaggle-gaggle again. They get the hat all chewed over and start to take off when one of 'em brings up about ain't it awful how the window-cleaner feller behaved at the strawberry festival — gaggle-gargle-gaggle — reckon it's only sheer exhaustion of the larynx that ever gets 'em parted.

Wal — just listen to a couple of citizens on 'phone tryin' to break it off and work someone else. Ye can hear that they both wanta be on their way right now but it ain't to be. They do a heck of an "after-you-Alphonse" routine with final, final, final finals — to each other's discomfort. Seems to me we need to think about this signin'-off business and work out a way so's one feller can run along when the QSO is ended without feelin' that mebbe the other feller thinks he's bein' snooty. Most all the fellers got just so long to be on the air what with their work and families and all, and it seems a pity they get hung up thataway sometimes.

Now comes the character fer whom we oughta sharpen up the Wouff Hong and put a keen edge on the Rettysnitch. You all know him . . . The Final Authority. Fer hours he goes on dishing out technical dope to some poor unsuspecting feller who's sure to be a new op (no old-timer could swallow the stuff). Trouble is that not only are these geniuses possessed of an infinite capacity to go on talking but most always they talk pure guff. Even that wouldn't be so bad but in doin' their lecturing they just accidentally let the new feller know that he's really lucky to be having advice from such a great man with such a whangdingin' top-notch superstation. The facts that their technical laws don't bear any noticeable resemblance to the laws of physics and that their ideas don't work and so leave some young feller open to a lot of heartbreaks when he tries 'em all seem to prove that there shouldn't be any closed season on 'em.

Now as you all know, there are some very hot, sharp radio engineers who are also hams. Never did hear one of these fellers condescendingly dishing out sour dope. Guess a feller who really is at the top of his profession is pretty reasonable and mebbe even humble about it — otherwise he never would have got to the top.

All in all, I figger there's no disputing that a feller who uses the ham bands as a means of showin' off is a punk kind of citizen who should mebbe take up beekeepin' — fer you can push a bee only just so far.



SHADES of the Chicago First National Convention! — Power Factor is back in the pages of QST! But in this June 1922 issue the controversial subject is to be settled for all time — we hope. By invitation, Professor F. C. Blake of Ohio State University has undertaken to enlighten the faithful cohorts of Messrs. Ellery "A-P" Stone and M. B. West, the "Unities" and "Zeroes" respectively. In his article "Power Factor — Some Whys and Wherefores," Mr. Blake learnedly treads the ground in dispute, at times drawing on Morecroft's *Principles of Radio Communication* for support. A reading of Mr. Blake's excellent paper discloses that both factions are mostly in the right, their differences being mainly ones of definition.

The new c.w. transmitter of John L. Reinartz, 1QP, is described this month. It makes use of four U.V. 202 Radiotrons and borrows a bit on the principles of his highly-popular receiver. "A Weagant Circuit Receiver" — a regenerative I-tuber — is the apt technical offering of F. A. Hill, 4GL. S. Kruse's "A Symposium on Aluminum Electrolytic Rectifier Operation" is a compilation of the wealth of information on this timely subject, volunteered by prominent c.w. stations. And now that we're using vacuum tubes, it's important that every amateur be familiar with the circuits available; accordingly, "Circuits," by K. B. W., gives us an insight to the workings of the Colpitts, Hartley, Meissner and reversed-feed-back hook-ups.

Operating activities, current and future, receive prominent play in this issue. In the face of new regulatory legislation, amateur radio proved its public-service worth during the recent Wisconsin ice storm, in the Lackawanna Railroad moving-train telephone experiments, and in the reception of traffic from 6ZZ, on schedule, by 1BGF, 1BHW, 1HX and 1MO, most of the first-district calls being identified with the Headquarters staff. Coming up in July are "Daylight Transcons," announced by Traffic Manager Schnell.

The recommendations of the Hoover Conference have been polished off, preparatory to being made law. Our proposed frequency allocations include a special "long-range" wave at 310 meters plus a partly-shared band of 150 to 275 meters. Other regulations affecting us are those of the National Board of Fire Underwriters, whose new code was formulated with the assistance of Central Division Manager R. H. G. Mathews, 9ZN, and former ARRL vice-president, Charles A. Service, jr.

"Who's Who" introduces to the membership

(Continued on page 158)



# Hints and Kinks

## For the Experimenter



### SIMPLE BEAM-TUNING AID

THE old stunt of using a neon bulb connected across a pair of headphones as a 'phone monitoring device can be put to work in another service, by utilizing it as a one-way communications set-up while tuning a beam antenna. With power applied to the beam antenna, the neon bulb is placed close to one of the elements. When sufficient voltage to ignite the bulb is present, the modulated carrier of the transmitter can be heard in the headphones. Thus, the person making the adjustments at the antenna can receive instructions from the operator at the transmitter. This arrangement, of course, will not work with n.f.m., but for a.m. purposes it is a very useful gadget.

— William C. McWilliams, W4IQL

— . . . . —

### A RUGGED WALL BEARING

IN many ways, a wooden mast is to be preferred over the popular "plumbers delight," especially where cost, weight, and ease of construction are important considerations. The wall bearing shown in the accompanying photograph was designed to permit a wooden mast to be rotated with the least amount of fuss and bother. It is made from two sections of galvanized iron pipe, one of which fits and rotates inside the other. The inner pipe is slipped over the outside of the mast and is fastened to it by the method shown in Fig. 1, while the outer one is held to the side of the building by a steel strap welded to the

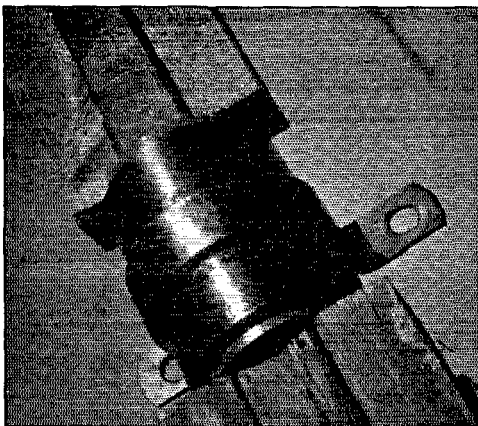

A rugged, inexpensive wall bearing capable of doing heavy duty in rotating mast installations.

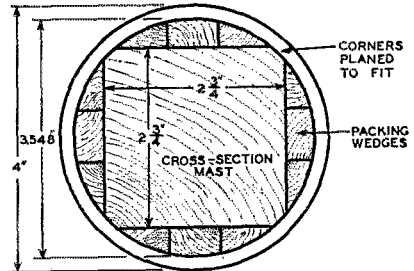

Fig. 1 — Cross-sectional view of the mast bearing showing method of wedging the pipe onto the wooden mast. The dimensions given are those used in one specific instance, and can be changed to suit the size of the mast used.

pipe and bolted to the building. The entire assembly is inexpensive, even if you have to pay the local garage to do the welding job. A little careful planning in the selection of the mast stock and the two lengths of pipe, plus a couple of hours work with simple tools, are all that is required.

Any plumbing house will cut off the six-inch length of pipe required for the mast bearing. Its inside diameter will be determined by the outside dimensions of the mast itself. A five-inch length of the next larger size pipe is used for the wall bearing. The burrs left by the pipe cutter should be filed off of both pieces before the unit is assembled. A one-inch strap, formed to fit snugly around one-half of the circumference of the wall bearing, can be welded in position as shown in the photograph. The ends of the strap are bent around and drilled to take bolts or lag screws.

The assembly process is simple. The mast bearing is slipped over the end of the mast and driven along with a hammer until it reaches the desired position. The hammering should be done via a block of hard wood to prevent the edges of the pipe from chipping. A touch now and then with a spokeshave may be needed to get the bearing over high spots in the mast. When the bearing is in its final position, glued wedges are driven in to fill the spaces between the pipe and the mast, as shown in Fig. 1. When the glue has dried, the protruding ends of the wedges are sawed off flush. A small block should be fastened to each side of the mast directly below the bearing to prevent it from slipping down.

(Continued on page 152)



# Correspondence From Members -

The Publishers of *QST* assume no responsibility for statements made herein by correspondents.

## EMERGENCIES

Iowa Southern Utilities Co., Centerville, Iowa  
Editor, *QST*:

We are forwarding to you a copy of the current issue of the *I.S.U. News*, which contains the story of the help that was rendered to our company by amateur radio operators during the extremely bad sleet storm here in Southern Iowa on the first of February. To say that we appreciate the work done by these people is putting it mildly. We not only appreciate the work of the boys in this vicinity, who did the actual work, but also that of those who monitored the frequency we were using and helped us maintain a clear channel. . . .

— V. C. Price, *Distribution Manager*

FCC, Houston, Texas

Editor, *QST*:

Amateurs [in the Texas City emergency] did a fine job in an orderly manner.

— Joe H. McKinney, *Regional Manager, Field Engineering & Monitoring Division*

FCC, Washington, D. C.

Editor, *QST*:

The Commission wishes to thank all amateurs who had a part in this emergency, including those who handled emergency messages, those who cooperated by standing by and thus helped to keep channels clear, and those who assisted in any way necessary.

— George Turner, *Chief, Field Engineering & Monitoring Division*

U. S. Engineer Office, War Department,  
Louisville 1, Ky.

Editor, *QST*:

This is to extend to you (through SCM Clifton), and through you to the various amateurs, our sincere appreciation for your offer of cooperation in the organization of an amateur emergency radio net for reporting river gauges, rainfall data, etc. We have had some previous experience with amateur radio organizations and your reply to our letter just adds another confirmation to our understanding of the fine spirit of cooperation and service that exists among members of the amateur fraternity. . . .

— John P. Doyle, *Chief Administrative Assistant*

## SKILLS

130 State St., Harrisburg, Pa.

Editor, *QST*:

. . . Gone today is the skill involved in building one's rig. Today, one just buys a ready-made kilowatt transmitter, a three-hundred-dollar commercial receiver, and the operator is on the air. With this type of equipment, that far-off PK, VQ, or what-have-you is not too difficult to snag — if you can break through another kilowatt signal. Relatively speaking, that is. With this type of transmitter, QRM caused by it blocks out the bands. A handful of these signals on a band ruins the band.

Gone today is the thrill of contacting that PK or VQ, etc., with fifty to one hundred watts. Gone is the skill required to contact DX with low power. Gone are the ethics that used to be in amateur radio, i.e., Stateside operators zero-beating on the elusive DX frequency or on the fre-

quency to whom the DX is QSO, and the "quickie" QSOs. . . .

Amateur radio today is getting too commercialized. New operators are swelling the ranks by leaps and bounds. Let's tackle this situation before it gets out of hand. Let's try to perfect what we have first before we ask for more and create more chaos.

— Bruce T. McCoun, *W3MDK, ex-W2HWS*

## G QSLs

29, Keehill Gardens, Hayes, Bromley,  
Kent, England

Editor, *QST*:

It appears that quite a number of your fellows are still unaware that I am the official RSGB Bureau, as we still have a heavy load of QSL mail from U. S. at our Hq. I would appreciate it if you could make it plain that 29, Keehill Gardens, Hayes, Bromley, Kent, is the address of the Official QSL Bureau for Great Britain, and that cards should not be sent to any other address.

Quite a lot of U. S. amateurs put 3-cent stamps on their cards and then mail them to me in bulk, apparently under the impression that (a) I have time to write in the address on each card, and (b) that U. S. stamps are valid for postage in the U. K.! It would be a good idea to point out these two fallacies to them. But as a stamp collector, I have a warm spot for the U. S. amateurs who put commemorative instead of the regular stamps on their mail to me!

— Arthur O. Milne, *G8MI*

## POLLS

1161 Ponce De Leon Ave., N.E., Atlanta, Ga.

Editor, *QST*:

The general amateur polls being conducted from time to time in *QST* serve only to emphasize the progressive and democratic spirit of the American Radio Relay League. I, for one, appreciate that my voice, small as it may be among the thousands concerned, is being heard, and that I have the opportunity to express my thoughts, pro or con, on matters that are of vital interest to us all.

It is heartwarming to know that somewhere among us there are men who are willing to devote their entire time and effort toward creating a strong and influential amateur fraternity, and one that is the result of majority desire. To be associated with such an organization as yours makes my time spent with amateur radio more pleasant, more enjoyable, more worth-while.

— John J. Schuyler, *W4KLE*

1808 Washington Ave., St. Louis, Mo.

Editor, *QST*:

I was surprised and disgusted to read your editorial concerning the dilution of amateur ranks by an influx of doubtful experimenters. I have never seen such a totalitarian bit of whimsy under the guise of editorial policy as you present in this editorial. It is about as un-American democratic way of doing business as I can imagine. Your tactics of raising dissension among the amateur ranks is a communistic trick. This problem was already solved last year and you got the answer in a big way. The answer was "no." Yet you have the gall to raise it again this year and are once again attempting to shove it down our throats.

While you make it look like we are allowed to vote and should have some bearing on the matter, it has about as

(Continued on page 154)



# Operating News



F. E. HANDY, WIBDI, Communications Mgr.  
J. A. MOSKEY, WJIMY, Asst. Comm. Mgr.

GEORGE HART, WINJM, Communications Asst.  
LILLIAN M. SALTER, Communications Asst.

**Emergency Organization Progresses.** Late winter blizzards, heavy spring rains, and other threats to communications facilities have seen the ARRL Emergency Corps members called on for communications assistance in various localities. Once more amateurs were able to give the usual good account of themselves. We repeat our invitation to each and every active amateur to align himself with the ARRL Emergency Corps. A 'phone call to your local emergency coordinator, or a postcard or radiogram to your SCM or ARRL Headquarters, will bring you the appropriate blanks, which should be filed with your community coordinator. With great pride in the recent accomplishments of SCMs and SECs, we report that in the last twelve months the number of emergency coordinators has increased from 225 to 472. Our AEC is the instrument whereby individual amateurs can, as traditionally, supply communications assistance to the relief agencies and officials in their locality. No town or city is immune to Nature's excesses; preparedness is the only answer. It is good to see 472 localities protected by definitive amateur radio leadership. There ought to be 25,000 emergency coordinators! A special hand for Eastern Massachusetts and Northern Texas, leading with 71 and 56 ECs respectively! Amateurs in towns with no EC should recommend such an organizer to the ARRL SCM.

**Collaboration with Additional Agencies.** The League has long had a cooperative understanding with the national headquarters of the American Red Cross. Long-term plans for cooperation with relief agencies by ARRL result from careful and deliberate study and consultation

over a period of time. Arrangements for stand-by facilities during emergencies were requested last fall by the U. S. Weather Bureau, Division of Climatological and Hydrologic Services. This agency has the responsibility for collating data on precipitation, temperatures and flood levels, and for giving advance emergency warnings to the public when necessary. Some parallel emergency responsibilities to the public reside in the Army Engineer Corps, which has more recently requested amateur radio assistance through its branch offices. Several SCMs, ECs and ARRL section nets quickly responded to the requests of the Engineers, and are to be commended. The League has asked SCMs to designate liaison men between ARRL and seven U. S. Weather Bureau administrative offices. The problem of these officials is to recommend to river-center officials, in 86 different regions, amateurs to become regional coordinators. Each of these men will consult with the official in charge of a district river center to line up a stand-by facility for specified watersheds.

**One Amateur Emergency Facility Is Best.** Aside from the work with the agencies mentioned above, ARRL believes it improper for us to divert our operator availabilities and station stand-by facilities to too great an extent. In emergencies, the public interest is paramount. Our effectives, who are organized and skilled in handling relief communications, are not so numerous as to permit their services to be devoted too closely to assisting private or commercial interests that might like to have exclusive service during an emergency. So we say: Join the ARRL Emergency Corps. Build on the principle of *one strong facility*.

**KN — "Go Ahead Specific Station; Others Keep Out."** Did you study the definitions and uses of the five different ending signals listed on page 67 of April *QST*? The signal **KN**, although having particular application to DX work, was tried at once by many hams and found useful for calling or working specific "local" stations, when having no intention of heeding calls from other stations. The new signal "holds others back." W1AW operators report the call generally quite useful, aside from the DX application. Try it yourself and let us know how you like it.

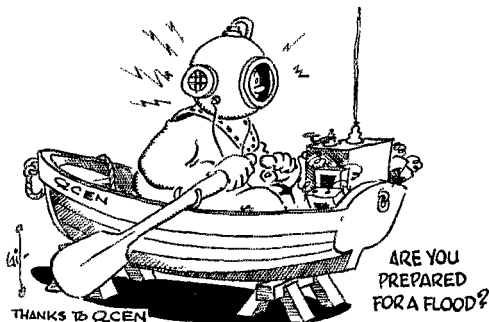

**Log-Keeping a Must.** The 28- and 144-Mc. operator, like other amateur operators, is required by the FCC to *log every transmission*. In the course of a field trip we were not a little disturbed to find several operators ignoring the amateur-service regulations with respect to log-keeping. Their excuse that they were working mobile or portable is *not* an adequate or acceptable reason to FCC. Most of us have a good log at our fixed home station. Many of us are proud of our properly-kept record of portable work, too. This is to recommend that all amateur operators not only obey the regs (lest they be caught short by FCC) and to suggest that pride in station and station records requires accurate and proper log-keeping at all times. We personally keep a separate log for our portable and mobile equipment, a second log that goes where the portable goes. However, all station records can be kept chronologically in a single book unless there is simultaneous operation of station at home and afield. ARRL has provided a Mini-Log to facilitate log-keeping under special field circumstances. But the full-size standard ARRL log does almost as well for everything short of walkie-talkie work, where a pocket-size book is more convenient. *Not* to log any call, CQ, or test invites difficulties with the FCC, now equipped to monitor on all amateur frequencies. FCC permits your record to be kept in any manner that proves the facts, even on scrap paper. Recopying such scraps is not a pleasant task. Our whole point wasn't so much to suggest *how* you do it, as to urge first and foremost that you *do* it. *Keep a log of all transmissions.* Paragraph 386 (FCC regs) states the items required when log-keeping: the date, time, name of the operator, each call made (whether station was worked or not), input power, frequency band, and the location of portable or mobile station. The Communications Act gives FCC authority to suspend operators' licenses for up to two years in addition to possibility of punishment on conviction of violation of FCC regulations "by a fine of not more than \$500.00 for each and every day during which such offense occurs"! FCC check-ups on log-keeping are easy since the FCC is in a position to call several logs to cross-check them at any time. The Commission is constantly engaged in its responsibility of preventing bootleg or unlicensed operations. A complete log is our only defense in case our own operation is questioned! While *any* form of log, even notes on a scrap of paper, may cover the legal requirements set up by the regulations, the book form of log is highly recommended since it contains all the information in a bound form with no loose leaves to get lost or misplaced. A complete record of *all actual operations* of your station is invaluable to each of us as individual amateurs. Keep a complete log. Be able to confirm all reports of your signals! Avoid FCC trouble.

**January Survey.** The 22.3% return from League full members was considered excellent in view of the facts that response required the work of examining logbooks and estimating future operating interest. This survey of over-all band use indicates the following distribution of operation during December, 1946:

Telegraph Band	Per Cent of Total Interest Represented	'Phone Band	Per Cent of Total Interest Represented
3.5 Mc.....	10.8	3.85 Mc.....	11.0
7 .....	18.6	14.2 .....	8.8
14 .....	13.2	27 .....	2.1
28 .....	4.4	28.5 .....	25.2
50 .....	0.2	50 .....	0.9
144 .....	—	144 .....	4.5
235 .....	—	235 .....	0.3
Telegraph.....	47.2%	Voice.....	52.8%

The ARRL divisions strongest in the use of voice predict considerable '47 change toward c.w. Divisions presently highest in c.w. usage show an equal tendency to favor voice operation as this year progresses. Such trends practically cancel. The over-all estimates of 1947 activity are for 51% interest in 'phone, 49% in c.w.

**Class A, B and C — and Power.** Our survey indicated that licensewise, active amateurs now divide as 55.6% Class A, 40.8% Class B and 3.6% Class C. The average power levels: Class A operators, 300.4 watts; Class B, 175.5 watts; Class C, 201.1 watts. The Pacific Division has the highest average power . . . 322.1 watts, while Canada has the lowest, 179.2 watts. *Average power input for all United States stations surveyed was 245.7 watts, a considerable increase from prewar examinations.* The average Class A amateur, during the first half of December, put in a full twenty-four hours of operating activity; average Class B amateur, 31.9 hours. The integrated amount of 'phone and c.w. operation makes up the division of interest shown as percentages in the table. More and more amateurs possess both 'phone and c.w. gear. At some future date nearly all may be able to use either voice or c.w. at will. In fifteen days, 35% used both mediums, 27% voice only, and 38% c.w. only. This gives an idea of the versatile usage during the period. More highlights from this survey next month!

**June 14th & 15th — ARRL Field Day.** The complete Field Day announcement appears elsewhere in this issue. The rules are similar to last year's except that in addition to the 25 points for message originations, four points will be allowed *each time* the message is handled during relaying. This is to encourage more relaying and message-handling practice preparatory to emergencies. The change properly gives scoring recognition for this factor. Plan to join a Field Day group, or get up one yourself. BCNU in the FD.

— F. E. H.

## A.R.R.L.-AFFILIATED CLUB HONOR ROLL

*All members of these clubs are  
ARRL members*

Amateur Radio Researchers, South Gate, Calif.  
Astoria Radio Club, Woodside, N. Y.  
Bridgeport Amateur Radio Association, Bridgeport,  
Conn.  
Central Jersey Radio Club, Chatham, N. J.  
Central Kentucky Amateur Radio Club, Lexington,  
Ky.  
Chattanooga Amateur Radio Club, Chattanooga,  
Tenn.  
Chester Radio Club, Chester, Pa.  
Cleveland Amateur Radio Society, Cleveland, Ohio  
Detroit Amateur Radio Association, Inc., Detroit,  
Mich.  
Enid Amateur Radio Club, Enid, Okla.  
• The 56-Mc. Minutemen, Melrose, Mass.  
Garden City Radio Club, Garden City, L. I., N. Y.  
Grumman Amateur Radio Club, Bethpage, N. Y.  
Illinois Ham Club, Chicago, Ill.  
Intercity Radio Club, Ashland, Ohio  
Iowa-Illinois Amateur Radio Club, Burlington,  
Iowa  
Jackson Amateur Radio Association, Jackson, Mich.  
Maui Amateur Radio Club, Wailuku, Maui, T. H.  
Neosho Valley Amateur Radio Club, Emporia,  
Kans.  
Northern California DX Club, Inc., Oakland, Calif.  
Oh-Pe-Kah, Bartlesville, Okla.  
Pioneer Radio Club, Fremont, Nebr.  
Radio Club of Tacoma, Inc., Tacoma, Washington  
St. Louis Amateur Radio Club, Webster Groves,  
Mo.  
Shy-Wy Radio Club, Cheyenne, Wyo.  
T-9 Radio Club, Danvers, Mass.  
Westlake Amateur Radio Association, Cleveland,  
Ohio  
York Road Radio Club, Elkins Park, Pa.

## UNLICENSED OPERATOR SENTENCED

Unlicensed transmissions brought an eight-month jail term for Robert M. Partridge, of Issaquah, Washington. Partridge was sentenced by a Federal judge in Seattle. Allen Pomeroy, chief assistant United States district attorney, told the court Partridge's operation of the station was a "flagrant violation" of Federal radio laws.

It doesn't always go easy on operators of illegal stations. Minor violations may result in warnings and confiscation of equipment; frequently the offender is placed on probation. The law provides for a \$10,000 fine or a two-year jail sentence, or both. Uncle Sam can and does get tough with such lawbreakers, as the case mentioned above shows. Every licensed radio operator, including the many thousands of amateurs in our country, should note any transmissions believed to originate from an unlicensed source. There should be no feeling of tolerance toward persons who utilize frequencies unlawfully, particularly those who invade our precious amateur bands. Report all cases of unlicensed operation to the nearest FCC office. You'll be doing a good turn for our Government — and for amateur radio.

## MICHIGAN FLOOD

Members of the Grand Rapids Emergency Net were on the job in early April when rains and melting snow caused the Grand River to overflow its banks. The net was holding its regular 28-Mc. on-the-air meeting Monday, April 7th, at 9:00 p.m. Several mobile units were QSO when W8IDZ reported in from local police headquarters. He stated that lack of telephone service and an insufficient number of police radio cars to meet demands caused by flood conditions necessitated the sending of emergency units to certain sections of the city. Net-control-station W8NOH called all net mobile units together at the Ann Street bridge in Grand Rapids where operators were given instructions. The cars then proceeded to the points where communications were required. Numerous important messages relating to the rescue of persons stranded in homes surrounded by water and concerning procurement of relief supplies were handled by the network. Amateurs known to have participated in this work are W8CTC, IDZ, MTF, NCB, NOH, QAM, QQN, ZBH and ZGZ. Equipment used in the mobile units consisted of discarded police a.m. transmitters converted for use on 28 Mc., and for reception converters working into regular auto broadcast receivers.

## BRIEFS

During the summer months the combined Rebel and Pelican Traffic Nets will operate on 7100 kc. on Tuesday and Friday evenings at 7:00 p.m. CST. General call: RBL. W5KUG, Louisiana RM, invites amateurs to join the net or to call in with any traffic for the Southeast, Caribbean area, the Ronne Antarctic Expedition, or other points.

-----

W6VBI writes, "Eavesdropping on the 28-Mc. band I heard W6VOA (now W6UR) saying, 'I can't understand why you fellows in Pittsburgh don't hear the W6s so well because when I was in Pittsburgh. . . .' I perked up immediately because I'm from Pittsburgh myself (ex-W8LED). When W6VOA finished with the W3 I gave him a call. He turned out to be ex-W8UQ and we had a long rag-chew about the home town. But the pay-off was when I received his QSL card — he is John F. Clark III, and I'm John M. Clarke, II . . . both names almost the same, both from same town, and we live about same airline distance apart here as we did back in Pittsburgh!"

-----

W5LKL and W7RIM report the formation of a net on 7172 kc. for former OSS operators. The boys meet each Wednesday evening at 7:00 p.m. CST. All former OSS ops are invited to join by dropping a card to W5LKL, Odessa, Texas.

## TRAINING AIDS

A new slide collection entitled "The ARRL Headquarters Station" will be released on June 1st for free loan to affiliated clubs. This collection consists of sixty 35-mm. 2 X 2 slides including views of WIMK and WIAW from 1919 to the present. The collection is accompanied by an ARRL Lecture Outline giving a complete explanation of each picture. We think that every affiliated club will be interested in seeing the development of the Headquarters station, how it started, Gil cartoons depicting incidents in its history, intimate views of the equipment formerly and now in use and of the personnel using it, and evolution of the present WIAW from excavation to completion. This is the first of a series of contemplated visual aids on subjects exclusively of amateur interest. As a feature for entertainment and general information, this collection should be of interest to any and all affiliated groups everywhere. Three copies are available and additional ones can and will be made if the demand is great.

Five new motion pictures are available in the ARRL Film Library as of May 1, 1947. These films are in addition to the fifteen already announced in March and May *QST*. Bookings of motion-picture films have been very heavy, resulting in the necessity for clamping some restrictions on advance bookings (details in club bulletin). We urge that clubs try film strips as a superior training medium, even if a somewhat less entertaining one.

### *New Training Aids Available:*

*F16:* "Rectangular Coordinates"; 16-mm. sound; U. S. Navy; 13 minutes.

*F17:* "Vectors"; 16-mm. sound; U. S. Navy; 12 minutes.

*F18:* "Tube Tester Operation"; 16-mm. sound; U. S. Navy; 9 minutes.

*F19:* "Signal Generator Operation"; 16-mm. sound; U. S. Navy; 10 minutes.

*F20:* "Elementary Electricity: Series and Parallel Circuits"; 16-mm. sound; U. S. Navy; 8 minutes.

*SC8:* "The ARRL Headquarters Station"; sixty 2X2 slides; ARRL Training Aids. Accompanied by ARRL Lecture Outline. Presentation time: approximately one hour.

Watch this column in *QST* and affiliated club bulletins for additional information on ARRL Training Aids.

Emergency preparedness deluxe! This mobile communications unit has been placed at the disposal of the Oakland Chapter American Red Cross by its owner, W6OBJ. The truck contains a Kaar Model 28 transmitter, RME-69 receiver, and includes even a bed. Antennas are an adjustable vertical and balloon-supported types for which a tank of hydrogen is carried. The power supply was described in November 1937 *QST* and has operated trouble-free for 600 hours. Left to right: W6TI, SCM East Bay and chairman for communications for the Oakland Chapter ARC; W6OBJ, ARRL section emergency coordinator; W6TT, vice-chairman communications ARC.

June 1947

## HAVE YOU RECEIVED YOUR CODE PROFICIENCY CERTIFICATE?

The next opportunity to qualify for a certificate or endorsement sticker in the ARRL Code Proficiency Program is on June 19th. At 10:00 p.m. EST that date WIAW transmits the monthly qualifying run at speeds of 15, 20, 25, 30 and 35 w.p.m. Frequencies: 3555, 7145, 14,150, 28,060 and 52,000 kc., simultaneously.

The text received successfully by ear at the highest speed you can copy should be sent to ARRL for checking. To avoid errors in transcribing send your original copy. *Attach a statement certifying over your signature that the text submitted is direct copy, made from reception of WIAW by ear, without any kind of assistance, personal or mechanical.* If you qualify, you will receive a certificate, or appropriate endorsement sticker for certificate you already hold. Those who qualified in the past should submit copy only if speed is higher than previously certified.

*QST* lists in advance the text to be used on several of the 10:00 p.m. EST (Monday through Friday) CP schedules. This makes it possible to check your own copy. It also provides a means of obtaining sending practice since it permits direct comparison of one's fist and tape sending. To get sending help hook up your own key and buzzer and attempt to send right in step with the tape transmissions. Adjust your spacing in the manner indicated as necessary for self-improvement.

### Subject of Practice Text from April *QST*

#### *Date*

June 4th: *Predicting Amateur "Conditions,"* p. 21

June 6th: *A Low-Cost 9-Meter Transmitter,* p. 26

June 10th: *Gain vs. Element Spacing in Parasitic Arrays*  
p. 30

June 12th: *Atlantic City — 1947,* p. 36

June 16th: *A 40-Watt Modulator with Cathode-Coupled Driver,*  
p. 42

June 18th: *The World Above 50 Mc.,* p. 50

June 19th: *Qualifying Run, 10:00 P.M. EST*

June 24th: *Modernizing the Old Receiver,* p. 54

June 27th: *The Staggering Band Theorem,* p. 60

June 30th: *Emergency at 50 Below,* p. 70



## A.R.R.L. ACTIVITIES CALENDAR

June 14th-15th: ARRL Field Day  
 June 19th: CP Qualifying Run  
 July 14th: CP Qualifying Run  
 July 26th-27th: CD QSO Party  
 Aug. 19th: CP Qualifying Run

-----

Jan. 16th-Dec. 15th: 1947 V.H.F. Marathon

Jan. 1st-Dec. 31st: Most-States V.H.F. Contest

First Saturday night each month:  
 ARRL Officials Nite (Get-together for  
 SCMs, RMs, SECs, ECs, PAMs, Hq.  
 Staff, Directors, Alt. and Asst. Dirs.)

## CHANGES & ADDITIONS — DIRECTORY OF ACTIVE NETS

Alberta **	3730 kc.	7:00 P.M. MST, Mon.-Fri.
Beaver Net (Ontario) **	3535	7:00, 8:00 P.M. EST, Mon.-Fri.
Delta 'Phone Net **	3905	8:00 A.M. CST, Sundays
Eastern Pa. Traffic Net *	3785	6:30 P.M. EST
Illinois Emergency Net *	3940	
Kentucky Traffic Net **	3810	9:30 P.M. CST, Mon., Wed.-Fri.
Kentucky 'Phone Net *	3955	7:00 A.M. CST, Mon.-Sat.
Oklahoma *	3520	7:30 P.M. CST, daily
Ontario 'Phone Net *	3815	6:45 P.M. EST, Tues., Thurs.
Potomac Valley Net *	3935	7:30 A.M. EST, Sundays
Queens EC Net (N.Y.C.) *	3600	3:00 P.M. EST, Sundays
Sagebrush Net ** (Nevada)	3898	8:00 P.M. PST, daily
SARO Net (Calif.) *	3814	8:00 P.M. PST, Thursdays

\* New listing; \*\* change in listing. (See page 82, February QST and page 74, April QST.)

## SECOND 1947 ILLINOIS EMERGENCY

For the second time this year a severe storm in the form of sleet and high winds descended on Illinois, wreaking havoc on normal lines of communication. At 6:00 P.M. CST on March 24th, SCM Wes Marriner, W9AND, received a call from the Illinois Northern Utilities Company requesting assistance in establishing contact between Dixon and Aledo, Illinois. W9AND alerted the Illinois Net (3765 kc.) and asked the State Emergency Net on 3940 kc. to attempt contact with Aledo. At Peoria, W9FST was of assistance in getting W9EQX, Aledo, on the air. Traffic was then handled between W9AND and W9EQX for the I.N.U. company.

Following the setting up of this circuit, W9MRQ called on 3765 kc. to advise he had learned, via W9HPG, that the Commonwealth-Edison Company in Chicago wished contact with Dixon and Belvidere, Illinois. Radio circuits were available to both these points. Before traffic could be filed, however, the Edison company reached necessary points via repaired landlines.

A third emergency request was received through W9JTX on 3765 kc. from the Nickel Plate Railroad, which sought contact with the Bloomington area. Appraised of this need, W9UQT, Springfield, Illinois, telephoned the local police radio station. In his capacity as police radio operator, W9PJJ contacted a state police radio squad car in Bloomington with the request that W9CFV of that city be advised to report into the Illinois Net. W9CFV was on the air in a matter of minutes after the initial request was dispatched from W9UQT and the necessary circuit established.

The next and final call for assistance came from the Chicago & Alton Railroad offices in Chicago. Contact between Joliet and Bloomington was needed for the purpose of directing repair crews. This request was complied with and traffic handled by the following members of the 3765- and 3940-kc. Illinois nets: W9AND AWA BJE CFV EQX ISG KQL LGW PJJ PSL RCJ SYZ UAZ UQT YPS.

## BRIEFS

W5WI employed as his secretary a young lady who served during the war as a Coast Guard radio operator. She was married recently and now signs her name "Mrs. C. W. Sparks"!

In the interests of his personal safety, we won't divulge the identity of the W1 correspondent who sent us this kernel: "On March 6th I heard three dentists, W2NM, W3AN and W3BWH, chewing the rag on 3.85-Mc. 'phone.'"



## W1FH

Charlie Mellen, W1FH, is first to qualify for the postwar DX Century Club Award. Considering his accomplishments over the past many years, it is not surprising to find his station layout compact and efficient — "designed for operating." On the desk shelf are a secondary frequency standard, speech amplifier, loud-speaker and beam-direction indicator. Other equipment includes a Sylvania modulation meter, TR-4 transmitter-receiver, X-EC VFO and home-built transmitter using p.p. 8000s in the final, modulated by Class B 805s. Antennas in use on 14 and 28 Mc. are three-element close-spaced rotary beams, each mounted on its own wooden-lattice-work tower. Charlie's first contact for the new DXCC was made in March, 1946, when he placed postwar W1FH on the air, and his 100th card was received in December, 1946, just nine months later!



Recent issues of *QST* have introduced you to the tallest, oldest, youngest YL and youngest OM amateurs. This month it's the family with the "mostest" hams. The Rudisills (father and four sons) of Gibsonville and Durham, N. C., are the most recent claimants to this distinction. Here they are, left to right: Jason, W4LAC; Arvle, W4KCF; John, sr., W4LAE; Ras, W4KMO; and Bobby, W4LPM.

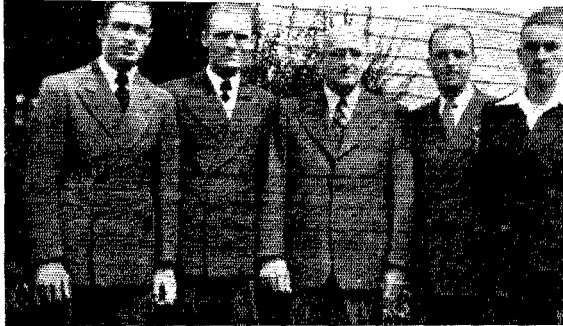

## EMERGENCY NETS

The Eastern Massachusetts Emergency Net held an emergency drill on March 30th. Emergency coordinators originated test messages to the SCM direct or via AEC members with the request that acknowledgment be made by radio. The test proved so successful and popular that it will be made a monthly activity. The 144-Mc. band is used for handling traffic in local areas, while the regular 3745 frequency of the section net is employed for longer-haul relaying. Similar tests are recommended to ascertain the progress of drills at different points as well as net coverage of towns, and also to promote the general knowledge of traffic handling.

The Queen City Emergency Net is now holding regular emergency drills on 144 Mc. each Monday evening at 7:45 P.M. EST, with W8PNQ as net control station. The 28-Mc. section of QCEN meets at 8:00 P.M. Mondays. Tie-ins will be made between the two nets by stations equipped to work both bands. All amateurs in the Cincinnati area are invited to participate in these drills.

The Potomac Valley Emergency Net was reactivated on April 21st. About half of the prewar members reported for the first net session. Drills are held each Sunday at 7:30 A.M. EST on 3935 kc. The net is made up of stations located in the Potomac watershed. Its purpose is to provide stand-by reporting facilities for local U. S. Weather Bureau observers. Amateurs in the Potomac watershed are invited to join. For further information contact O. W. Reed, W3FPQ, 10,702 Lorain, Silver Spring, Md.

Members of the Southern Nevada Amateur Emergency Corps hold monthly drills on 3660 kc. The membership roster includes fifteen stations. Announcements of the regular drill, news items of interest about members and discussions of net plans are published in a monthly bulletin under the direction of SEC W7CX.

The Heart of America Radio Club is sponsor of an emergency net in Kansas City, Missouri. The net communication plan provides for a 144-Mc. rig on the tenth floor of a downtown building to act as control for that band, and also to provide tie-ins with stations on 3.5 Mc.

Under W3UA, the Susquehanna Emergency Net is organized to handle messages for the U. S. Weather Bureau, state police and other agencies. Drills are held at 8:00 A.M. EST the second and fourth Sundays of each month, on 3910 kc. After June 8th and continuing through the summer months, the net will operate the second Sunday only. This group has done important work during emergencies in the past and continues to operate with a high degree of organization.

Among the groups organizing to provide emergency facilities for the U. S. Army Engineers are the Minnesota State Net and the Indiana 'Phone & C.W. Net. MSN members are active on 3795 kc. and 3900 kc. for this purpose. Indiana section members are organizing to use 3656 and 3905 kc. Amateurs in these sections who are willing to assist should contact their respective SCMs for further information. Numerous other groups are organizing for coöperation with the U. S. Engineers, but we have insufficient details as yet to report on their progress.

## BRIEFS

That famous name "Kilroy" was certain to crop up in amateur radio sooner or later! John Kilroy, W1PEO, works 144 Mc. from his bedside operating position at the Robert Breck Brigham Hospital, Boston, Mass. Occasionally during QSO somebody asks John his full name, which he grudgingly gives. The usual comeback: "Well, here *is* Kilroy!" Though this remark undoubtedly will follow him in amateur radio, we trust it won't be long before John's recuperation is complete and the Robert Breck Brigham can retain, in some appropriate manner, the slogan "W1PEO was here."

The postwar roster of the Rag Chewers' Club now numbers 2010 active members, including reinstated prewar members and those who qualified since the war. Have you received a certificate yet? See page 73, December 1946 *QST*, for rules on how to qualify.

The following is a supplement to the list of ARRL Official Broadcasting Stations which appeared in May *QST* (page 79): W1EAW, W2BLP, W2TSZ, W3EYX, W4PB, W6MU, W9HAB and W0ZKM.

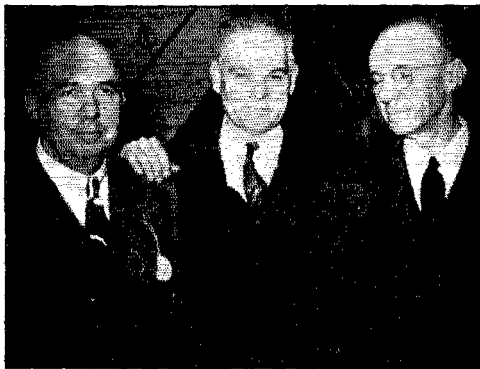

One hundred years of active ham work! The combined experience of these three gentlemen in amateur radio totals 100 years. Left to right: W2VD, active for 20 years; W2GC, 39 years; W2EY, 41 years! Photo taken at the Bloomfield (N. J.) Radio Club's 32nd anniversary dinner in January.

### BRIEF

*Brother Acts:* Kinsmen WØUZE, Lincoln, Nebraska, and WØPP, Mitchellville, Iowa, have been maintaining radio contact, week in and week out without a break, for nine years (except for war shutdown). . . . WØKZL, Bismarck, North Dakota, schedules brothers WØPJT of Ashley and WØSWC of Minot. . . . W2CFB, Trenton, N. J., has daily 3.5-Mc. c.w. schedule with his brother, W2DJ of Hornell, N. Y.

### GENERAL TRAFFIC PERIOD

6:30-8:30 P.M., Your Local Time

### GENERAL TRAFFIC CHANNELS

3575 to 3600 kc. 7150 to 7175 kc.

— — — —

ARRL recommends the above-mentioned hours and frequencies for use by those amateurs who have an occasional message to send but are unable to keep regular schedules or participate in organized networks. ORS and other active traffic handlers will monitor the General Traffic Channels, particularly during the General Traffic Period. They will be watching for your directional CQ to the state your message is addressed (for example: CQ Illinois, CQ Oregon, etc.). If you wish to break into message handling, it should be possible for you to use the general period and channels to pick up traffic from fellows like yourself for relay or delivery. No ARRL nets will be registered in the General Traffic Channels. Those frequencies have been purposely kept free to aid the casual message handler. Use the facilities provided and let us hear of your results.

### A-1 OPERATOR CLUB

We are pleased to announce the following additions to the ARRL A-1 Operator Club roster which appeared in January *QST* (page 70): W1BPY BXC DAV DX EMG HRC HSE IP LHE LV MD PKW ZB. W2APL BGO BO CGG CHK ELK HMJ IXY KH KYO MO OCC PTS RG RIZ RUT TUK ZD. W3ADE APQ ATR AWZ CCO DZ ECP EM EWR GEG JSH MOM QV TA WU. W4AVT AYV FCF GR IJT JDL LAP MG PL TO WO. W5BAM FDR FYZ IZL JPJ VT. W6AM AX CDA FR IOX REB YYU ZZ. W7AMX DXZ TS VO. W8AQ AVH BKE FX GHX IVC JES LCV PIH PWY RD RSW SDD. W9ARE BHV FFD OXP RCQ ZB. WØDEI EFC EPJ OUD QXO YXO. VE1EP 2BU 3CP VT WX WY 7FG. G5SR G6QX GI5UR GI6TK GM6RV NY4CM PAØDC VK2EO.

The A-1 Operator Club is designed to promote a high caliber of operating in the amateur bands. Every good amateur who follows standard operating practice on the air should be a member. Strive to make your operating merit nomination to this select group. Amateurs who already belong should nominate every deserving operator after careful observation of his operating habits.

Any active member of the A-1 Operator Club whose call does not appear above, or was not listed in January *QST*, is requested to so advise the Communications Department by postal or radiogram in order that we may keep our postwar roster up to date.

### BRIEFS

W8BWC reports hearing an operator on 14 Mc. using the following calling procedure: 62 consecutive CQs, 1 sign; 79 more CQs, 1 sign; 53 CQs, 51 signs! This is not the end of the story, however, because the long-winded caller followed with the wait sign AS and a one-minute silent period (to rest his arm, no doubt!) and then signed 15 more times. His transmissions were then concluded with a single K. Since it was midevening when W8BWC tuned in, Merle says, "Perhaps it had been going on all evening, for all I know!"

— — — —

Don't overlook the interesting possibilities of the 28-Mc. band for contacts beyond a strictly local area when conditions are unfavorable for DX work. A round-table took place recently on that band with the following included: W1DIK, Barnstead, N. H.; W1HUIJ, Fairfield, Conn.; W1KGT, Redding Ridge, Conn.; W1MLT, Putnam, Conn.; W2NYQ, Hawthorne, N. J.; W2IND, Hillburn, N. Y. In reporting this six-way contact, W1HUV says, "All stations came through very well and the QSO lasted about an hour and a half. Old acquaintances of 160-meter days were renewed. The 10-meter band sure holds some pleasant surprises."

## BRASS POUNDERS' LEAGUE

(March Traffic)

Call	Orig.	Del.	Rel.	Extra Del. Credit	Total
W4DUG	2450	50	12	25	2537
W4PL	16	83	1940	63	2102
W7FST	63	112	676	—	851
W6LUJ	55	224	3	218	500

The following make the BPL with over 100 "deliveries plus extra delivery credits":

W2CGG	120	W2LR	112
W3TWI/4	108	W3LVY	102

A message total of 500 or more, or 100 "deliveries plus extra delivery credits," will put you in line for a place in the BPL. The Brass Pounders' League listing is open to all operators who qualify for this monthly "honor roll."

### BRIEF

The annual VK-ZL International Contest will be held during the first four weekends of October each year.

### MEET THE SCMs

William W. Storey, VE7WS, is the first postwar SCM of British Columbia. Born in Vancouver, B. C., thirty-one years ago, he received his formal education at Vancouver College and the YMCA in Vancouver. After graduation from college, he obtained experience in radio servicing and as master-control-board operator for CKWX. He then became connected with Hygrade Radio, Ltd., where he now is employed as a salesman.



In 1935 he became interested in amateur radio and his first ticket was dated June 30, 1939. He holds membership in the British Columbia Amateur Radio Association, Vancouver Amateur Radio Club, and the Canadian Amateur Radio Operators' Association.

VE7WS is most often heard on 28 Mc.; station equipment: transmitter — 6L6 crystal oscillator, two

6L6 doublers, 815 final; speech — 6SF5, 6SC7, 6N7, 815 modulator; antenna — 28-Mc. half-wave doublet; receiver — Sky Buddy.

SCM Storey's hobbies are stamp collecting and amateur flying, while his favorite sports are baseball, ice hockey and bowling. His leisure time is spent in swimming, tennis, skating and dancing, and he has more than a little skill in both ice and roller skating.

In spite of his various interests and duties, Bill still finds time to carry on as SCM in an enviable manner, and with him at the helm the British Columbia Section may well look to a bright future.

### ELECTION NOTICE

(To all ARRL Members residing in the Sections listed below:)

You are hereby notified that an election for Section Communications Manager is about to be held in your respective Sections. This notice supersedes previous notices.

Nominating petitions are solicited. The signatures of five or more ARRL full members of the Section concerned, in good standing, are required on each petition. No member shall sign more than one petition.

Each candidate for Section Communications Manager must have been a licensed amateur for at least two years and similarly a full member of the League for at least one continuous year immediately prior to his nomination.

Petitions must be in West Hartford, Conn., on or before noon on the closing dates specified. In cases where no valid nominating petitions were received in response to previous notices, the closing dates are set ahead to the dates given herewith. The complete name, address, and station call of the candidate should be included with the petition.

The following nomination form is suggested:

Communications Manager, ARRL (Place and date)  
 38 La Salle Road, West Hartford, Conn.  
 We, the undersigned full members of the.....  
 .....ARRL Section of the.....  
 Division hereby nominate.....  
 as candidate for Section Communications Manager for this  
 Section for the next two-year term of office.

Elections will take place immediately after the closing dates specified for receipt of nominating petitions. The ballots mailed from Headquarters to full members will list in alphabetical sequence the names of all eligible candidates.

You are urged to take the initiative and file nominating petitions immediately. This is your opportunity to put the man of your choice in office.

— F. E. Handy, Communications Manager

Section	Closing Date	SCM	Present Term Ends
N.Y.C. & L.L.	June 2, 1947	Charles Ham, jr.	June 9, 1947
Maritime*	June 16, 1947	Arthur M. Crowell	.....
West Indies	June 16, 1947	Mario de la Torre	Deceased
Eastern Florida	June 16, 1947	Robert B. Murphy	Resigned
Nebraska	June 16, 1947	Roy E. Olmsted	Resigned
Philippines	June 16, 1947	George L. Rickard	Oct. 15, 1938
Iowa	June 16, 1947	Leslie B. Vennard	Feb. 15, 1947
So. New Jersey	June 16, 1947	W. R. Tomlinson	June 22, 1947
North Dakota	June 16, 1947	Raymond V. Barnett	July 2, 1947
Western Florida	June 16, 1947	Lt. Comdr. Edward J. Collins	July 2, 1947
East Bay	Aug. 1, 1947	Horace R. Greer	Aug. 16, 1947

\* In Canadian Sections nominating petitions for Section Managers must be addressed to Canadian General Manager Alex Reid, 169 Logan Ave., St. Lambert, Quebec. To be valid such petitions must be filed with him on or before the closing dates named.

### ELECTION RESULTS

Valid petitions nominating a single candidate as Section Manager were filed in a number of Sections, as provided in our Constitution and By-Laws, electing the following officials, the term of office starting on the date given.

Yukon	W. R. Williamson, VE8AK	March 17, 1947
Western Pa.	Ernest J. Hlinsky, W3KWL	March 17, 1947

In the Maryland-Delaware-District of Columbia Section of the Atlantic Division, Mr. Eppa W. Darne, W3BWT, and Mr. Albert E. Hayes, W3LVY, were nominated. Mr. Darne received 248 votes and Mr. Hayes received 159 votes. Mr. Darne's term of office began March 21, 1947.

• All operating amateurs are invited to report to the SCM on the first of each month, covering station activities for the preceding month. Radio Club news is also desired by SCMs for inclusion in these columns. The addresses of all SCMs will be found on page 6.

### ATLANTIC DIVISION

**EASTERN PENNSYLVANIA** — SCM, Jerry Mathis, W3BES — GMK reports the following stations active on the Eastern Pennsylvania Traffic Net: EU, QEW, VMF, ELI, OML, HAC, and GMK. EU lost his mast in a wind storm and the landlord agreed to replace it. QEW is NCS on the E. Pa. Traffic Net on Tues. and Wed. AQN is DXing on 28-Mc. 'phone. The Schuylkill, York Road, West Philadelphia and Frankford Clubs are planning a serious Field Day this year. FPC is building a new 3.85-Mc. final using 810s. QP is QRL work. MGL, activities manager of the Susquehanna Valley Amateur Radio Club, reports that a poll of the membership shows that two-thirds reject the idea of the Class D license. BFH, NQE, and MGL are new members of the club. The following members, formerly SWLs, are full-fledged hams: MXE, MXT, and MQE. The Red Cross donated a new club-room to the group. The club has established an emergency net on 144 Mc. for local work feeding into the two 1-kw. 3.85-Mc. rigs of BFH and LAK. Meetings are held each Friday at 9 p.m. at the Red Cross Building at Front and Market Sts., Sunbury. LEI is operating portable-mobile on 144 Mc. in the vicinity of N.Y.C. MFM is in Lawrence, Kans. The Susquehanna Emergency Net did fine duty in the recent floods. The March winds took a heavy toll of antennas, among them those of IXN, ENX, GHM, and CBT. EM is building a motor-tuned VFO. He handled a very nice piece of emergency traffic on 3.85-Mc. 'phone during the telephone strike. The Frankford Club more than doubled the prewar high score in the DX Contest. DZD is well on the road to recovery. DHM and HFD rolled up fine 'phone scores in the DX Test. The Lancaster Radio Transmitting Society ran up a sizeable score in the 'phone DX Contest using AXT's transmitter. New officers of the society are KBZ, pres.; BTP, vice-pres.; EOB, treas.; OY, secy.; AXT and UA, board of directors. Following are some call changes: QD, ex-GOM; BQV, ex-8MDW; HJ, ex-JJP; RB, ex-IBS; OY, ex-DRO; NAH, ex-9PIK. MET, ASW, and JDM are new OOs. Respectable scores in the W/VL Contest were made by AIZ, DMQ, FUF, and BES. DQM and BES used the occasion to test their Field Day rigs. The section needs more activity in emergency work and traffic handling. Traffic: W3QEW 87, EU 50, GMK 15, OML 9, AQN 8, LHI 4, BES 1.

**MARYLAND-DELAWARE-DISTRICT OF COLUMBIA** — SCM, Epps W. Darne, W3BWT — The Washington Radio Club's March meetings included an antenna symposium at the first, and a discussion on predicting DX conditions at the second meeting. Two of the club members, FNG and LVY, will work with the Norwegian "Kon Tiki" Pacific Expedition maintaining regular contact between the section and the Expedition. The Capitol Suburban Club's newly-elected officers are: IZL, pres.; BDN, vice-pres.; FYB, secy.; LFI, corr. secy.; and MCA, treas. The Baltimore Amateur Communications Society enjoyed a Radio "D-F" Technique talk by Charles Ellert, former FCC inspector, at its March 3rd meeting. A proposal is being considered, open to all 50-Mc.-and-down hams of Baltimore area, to establish a WAPZ (Worked All Postal Zones) award. At the March 17th meeting MNC lectured on narrow-band f.m. At the request of the U. S. Weather Bureau and the League, the Potomac Valley Net is resuming operations. Regular drills are held Sundays at 7:30 a.m. on 3935 kc. under the direction of FPQ. FPQ, WN, CIQ, and AHQ are

active in the net. All members in the Potomac Valley should support and work in this most important activity. Communicate immediately with FPQ or the SCM if you can help. FPQ has been appointed regional coordinator for the section, specializing in liaison with the Weather Bureau and the Potomac Watershed. EIS has been appointed EC for the Washington D. C. area. GEB is on 3.5-Mc. c.w. when he has any spare time. EEB is doing considerable work with television, aside from working all the popular bands. MJQ is rebuilding his rig and antenna, and was active in recent DX Contest. EQK has some new tubes in the rig and is using a two-element beam. AIB, FUV, IRA, and IKX have been doing some nice DX. GFI and JHE will be using beams shortly. MHW and EWZ are on 144 Mc. KBE, HWF, and ADQ are heard consistently on 28-Mc. 'phone with nice signals. KBX is newly-appointed OBS and has a Class A ticket. EYX is newly-appointed OBS and OO. MNA is newly-appointed OES. GKP, KUX, MHW, MNA, and FNZ are heard on 144 Mc. consistently with crystal-controlled rigs. KBF has 120 watts on his 144-Mc. rig and a sixteen-element beam. JYS now is a full-fledged member of the Rag Chewers Club. NB has a new VFO on 14 Mc. MKS kept schedules with KP4CD on 28 Mc. while KP4CD was being visited by his dad, KBE. ECP attended "Old Timers Night" at Trenton, N. J., on March 22nd. MPS is on 28-Mc. 'phone. HOP has a new HT-9. GBB has a pre-selector for 28 Mc. EKZ is operating on 144 Mc. BII has a new Gon-Set for 28 Mc. and has gone VFO. MWY has a new two-element beam on 28 Mc. AEG has a three-element beam on 28 Mc. and lives next door to MHY. MDD has a new Gon-Set after a mass sales talk to his XYL by several prominent hams in the area. MAI is now on 28 Mc. with 10 watts. KOL has a new Gon-Set. JUI is running 100 watts to a five-element beam and has worked 41 countries and all continents. ESM finally worked a W5 on 28 Mc. MUU raised his beam four feet higher. FT has increased power. AJX is building a new rig for 28 Mc. The SCM hopes MUU will get that grid coil unsoldered, then perhaps we can have a QSO on 3.5 Mc. Traffic: W3ECP 272, LVY 252, QL 10, MJQ 6, CAB 6, BWT 5.

**SOUTHERN NEW JERSEY** — SCM, Ray Tomlinson, W2GCU — The Southern New Jersey ORS net needs stations north of Trenton. Anyone residing in the following Counties interested in ORS appointment should apply to the SCM: Warren, Sussex, Somerset, Salem, Morris, Mercer, Hunterdon, Gloucester, Cumberland, Cape May, Camden, Burlington, and Atlantic. ASQ has completed his new kw. all-band rig. The N. J. State 75-Meter 'Phone Net meets at 9:00 a.m. Sundays on 3900 kc. Hamilton Twp. Radio Association code classes are showing gratifying progress. OSB is hard at work on a VFO. QKB is getting set for 3.85-Mc. 'phone and CFS is on the band. BEI may be found on the SNJ ORS net, 3700 kc., Mon., Wed., and Fri., 7:00 p.m. ORS is plugging for New Mexico and Vermont for his 3.5-Mc. c.w. WAS. The Hunterdon County Radio Society is planning code and theory classes. PKE has a 522 on the band. QCL netted himself nine new countries in the c.w. contest. QUH is alternate for ZI in the S.N.J. ORS Net and is a very active member of the "TO" Net. PPO is outlet for N. J. 75 Net in Clementon. PWP has three 1-kw. finals for three bands. Newly-elected officers of the DVRA are: 2QKE, pres.; Chas. Rebman, vice-pres.; GCU, secy.; and H. L. Yoder, treas. SIT "sits" on 7 Mc. QGZ is proud possessor of brand-new WAS certificate. Ex-3VG/3FP, now IA, is on 144 Mc. SVV has his new e.o.o. working FB. Traffic: W2RG 28, QUH 26, OXX 20, HX 13, ZI 13, CFB 12, BEI 11, ORS 6, QLP 2.

**WESTERN NEW YORK** — SCM, Charles I. Otero, W2UPH — BLO operated portable at a Hobby Show in Angola. PZF aided greatly. Thirty-one messages were originated and transmitted to the NYS net via RUF, who stood by on 3720 kc. from 5 p.m. to 11 p.m. The Niagara Falls Radio Net is on 144 Mc. with BAG, HNN, KHO, and RGO active. 8LIM now is 2ROR. At a joint meeting of RAWNY and KBT, the speaker was Mr. Dwyer, N. Y. Tel. Co. staff engineer from Albany, who gave a demonstra-

(Continued on page 80)

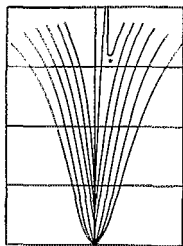

OUR TREND of thought for this page seems to have led us into a series of discussions on interrelated receiver performance characteristics. This time we are going to talk about the conflict between selectivity and audio fidelity.

When listening to music on the Broadcast Band on our communications receiver, we often wish there were more "highs" in the output; but when we put the receiver to work on the crowded amateur bands we are glad the receiver has plenty of selectivity. We would like to have both sharp selectivity and high audio fidelity at the same time. A window screen with a fine mesh that keeps out the flies spoils the scenery, but a coarse screen that gives you a "high fidelity" view will not keep out the pests. A well-designed crystal filter, for example, is a "variable mesh" device.

We have tangled with the side-band and decrement theories on amplitude modulation, but do not want to get mixed up in mathematics here. However, the concept of side-band frequencies aids greatly in understanding the relation between audio fidelity and selectivity. Picture a signal which is amplitude modulated with a 3,000 c.p.s. audio tone as being made up of a constant amplitude carrier frequency, and one side frequency 3,000 cycles lower and another side frequency 3,000 cycles higher in frequency than the carrier. With plate modulation, for example, the modulator supplies the power that goes into the side frequencies. If the selectivity of the receiver is sharp enough to attenuate the 3,000 cycle side-band to one-half of its original voltage relative to the carrier voltage, we have effectively halved the percentage modulation of the signal reaching the detector, producing one-half as much audio output voltage compared to that produced if the receiver had a wide band selectivity characteristic. At higher audio frequencies this effect would be more pronounced while at very low tones no attenuation would be noticed. This, of course, results in "cutting the highs." Thus, it is obvious that sharp selectivity and high audio frequency response cannot exist together.

A variety of operating conditions are encountered in using our receivers. In crowded amateur bands, greater selectivity may result in better readability of the desired signal through QRM, even though the readability of the desired signal has been reduced as compared to that of the same signal "in the clear." The best way to get the sharper selectivity is with the crystal filter. This, also, enables the operator to phase out the interfering carrier which really is the culprit that wreaks the most havoc. More about that another time. The crystal filter is, also, incidentally, a pretty good noise limiter.

How much can we accomplish with a tone control? A very wide band receiver lets through a lot of noise. If a certain degree of "cutting of the highs" is done by using a condenser in the audio circuits, an improved signal to noise ratio is obtained up to a point where the condenser starts to cut the highs in the signal modulation as well as the high-pitched noise. Beyond this point, there is a limit to how much extra cutting of highs can be tolerated. This cannot be carried beyond a point at which the readability of the signal is cut down as fast as the noise. It is still preferable to do this cutting with the selectivity control, as increased selectivity will accomplish the same result and in addition will also discriminate against unwanted signals where tone control action does not. Summed up in a word or two, sharp selectivity is one of the prime requisites of a modern communications receiver.

CALVIN F. HADLOCK



tion on the new mobile f.m. telephone. QWG, UDD, VLI, RU, and BLE were heard on 144 Mc. The TNT emergency net is operating on 144 Mc. The Syracuse AEC was alerted when flood threatened in the southern part of the city. Under the leadership of the EC, 8CYD, the following members stood by: PPS, IEP, OWT, THC, UBL, UND, UFI, JPO, and 8BAL. Mr. K. Levin, senior engineer at the Wurdlitzer Mfg. Co., spoke on modulation and speech amplifier design at a KBT meeting. UPH and 8SSZ won their chess match against 8CSB and 8LRJ on 3.85-Mc. 'phone. FW reports news from Amsterdam: SYA is about ready with the big rig. PGB is rebuilding. OPQ still keeps the room in the Burnt Hills for ham radio. WQW is looking for a modulation transformer. FEU sold his power pack, final and exciter units. LUB is on 14 and 7 Mc. with his remote-controlled final. ODK has a rig for sale. VZB got a pair of 810s for spares. TIE is planning to build a superhet receiver. URM bought a pair of 810s and is building rig around them. URP has a 750-watt rig running on 7 Mc. Lew Tryon hears plenty of DX on his RME. QFB is now on 28 Mc. but will be back on 3.85 Mc. as soon as new antenna is up. The Sidney Amateur Radio Club holds meetings on the third Mondays of each month. UPT, SYN, QOQ, and RZP held a round table on 3.6-Mc. c.w. GFD has 3.85-Mc. 'phone rig remote control. CYV is increasing power on 3.85-Mc. 'phone. RMB has 500 watts to 304FL on 3.85-Mc. 'phone. RME swapped RME-45 for HRO. STJ is working DX on 7- and 14-Mc. c.w. Hams in Sydney and surrounding area who are interested in EC work, please get in touch with SJV, the SEC, 81 King Street, Tonawanda. SHZ worked two Js to make WAC. The Sydney Club showed two ARRL film strips at last meeting. John Reinartz, 81BS, gave an interesting talk at the RARA meeting on 144-Mc. gear. Traffic: W2SAG 86, FCG 65, PGT 62, AOR 46, RIZ 18, QHH 17, GWY 14, QZ1 5.

**WESTERN PENNSYLVANIA** — SCM, E. J. Hlinsky, W3KWL — It is with sincere regret that we lose NCJ as our SCM, but his rest is a reward of a job well done. I will try to carry on where Ray left off. OLM and KBQ are active on 14 Mc. LBP and MJF can be heard on 30 Mc. JCS, CDU, NEE, LBZ, and KVK have antenna trouble in storms. PEI is no longer a bachelor. TGP married "Monie," sweet voice of MHE. MHE has 813 final with 300 watts and HQ-129 receiver. UVD is QRL with chicken farm but active as ORS. VNE has new BC-221. The 75 Meter PF Net meets each Sunday at 9 A.M. on 3978 kc. with CDU, NEE, LBZ, KVK, JLH, LHP, BWH, 8OSV, and 2ROL chewing the fat. BWH blew his 1-kw. modulation transformer yelling his head off on 14-Mc. 'phone. 7KIY, in Wyoming, yekled the following with low power: TVA, LCZ, LQQ, MJK, MOT, LRU, KRY, LGL, RNL, and RKC. LWN hopes to become active as ORS. KEW is planning new 813 final. CB worked Japan on 7 Mc. UVM can be heard on 14-Mc. 'phone c.w. TKU is back on the air. Bob Wallace now is MTF. LSB and JZF can be heard from YA. LRZ left school. KWA says his new baby keeps him QRL. NCJ will soon be heard with p.p. 813. VNE says his triplex beam for 28 Mc. is working fine. RAT is running 300 watts on 14 Mc. BWP has new modulator with 810 and surplus kw. transformer. TOJ reports the WPA ORS net completed its first postwar net operation with KWL as alternate NCS. The following stations report with an average of 7.4 stations per net session: KWL, LOD, LQQ, MJK, NCJ, TW1/4, 8MPG, TOJ, YA, UVD, TVA, 2FCG, KQD, LGD, CKO, MOT, MFD, and 2PGT. Mercer County Radio Association now has 50 members and is planning a club contest for member stations worked. OAJ, KQA, GEG, and KQN work as engineers at WPIC. Mercer County 144 Mc. gang is active again with GEG, KQA, QCN, and KWL heard nightly. KUR, CJF, CJB, 8UCL, LIK, VUR, can be heard QRMing the BCL. On 58 Mc. are KXI, OAJ, 8SFG, with 8SFG working 4 states. BVP did nice work in DX 'Phone Contest. Traffic: W3KWL 294, MJK 154, TOJ 93, KWA 28, YA 25, NCJ 11, LOD 10, UVD 8, BWP 7.

### CENTRAL DIVISION

**ILLINOIS** — SCM, Wesley E. Marriner, W9AND — RMs: North — EVJ; Central — SXL; South — JTX. PAM: UQT. SEC: FIN. "Liaison" Weather Bureau Regional Coördinator: FXB. State Nets: ILN 3765-kc. Traffic Net, 6:15 P.M. daily except Sat. and Sun. Illinois Emergency 'Phone Net, 3940 kc. Sun. 9 A.M. Members C.W. Net: AND, BGC, CEO, CZB, DXL, EOP, FST, JTX, JVC, KQL, MRQ, NGG, NSD, OWT, PTQ, PYC, QZL, SYZ, YTV. Net control: EVJ, FKI, SXL. Members' 'Phone Net: AEX, BIK, BJE, CEO, CFV, DBQ, KQL, KXY, NSD, PNV,

PSL, UAZ, UQT, VFF, YJH, YPS, YXP, YXZ, NHK, SW, FCW, Kankakee, wants to hear from 50 Mc. men in his locality. PKI has done FB work with 20 watts on 7 Mc. SMD is back on the air on 14 and 3.5 Mc. GNU ordered new frequency meter. SZD sends FB letter on Class D question. PBI is operating with State Police at Chicago. VOQ is on 3.5-Mc. c.w. and 'phone. Look for LIN on 3673 kc. He has a BC-221B frequency meter. Postwar 3.5-Mc. DX at AND is: V08F, NY4CM, XE1A, KH6DD, G6ZO, and TG9JK. The Starved Rock Radio Club threw a nice meeting for the gang in Central Illinois. 1HDQ, of ARRL, and your SCM were presented with 89-plus gifts from the club. New appointments: OO: BON. OPS: NDA. ORS: BPU, DBO, TLC. AHV attended the Starved Rock meeting as a guest. SYZ has 350 watts to p.p. 811s. The River Park Club has 200 watts on 28-Mc. 'phone and 7-Mc. c.w. FKI says there is some activity on 50, 144, and 235 Mc. The VFO at FCW developed a chirp. DXL worked TG9RC, Guatemala City, on 3.5 Mc. ACU will be on 50 Mc. The Starved Rock Radio Club, MKS, operated at Tonia, Ill., Hobby Show. EVJ also will operate during the summer. DBO operates regularly on 7225 kc. and has 7162-kc. rock ordered. EBX is in NKP R.R. Net, which is made up entirely of railroad men, on 7174 kc. Thurs. 7 P.M. CKM is on 7 Mc. and visited 8BCJ at Sabula, Iowa. BRX has perfect regulation now with new 220-volt three-wire power line. We understand FUR will have a pair of 800Bs in new rig. Radio club activities keep KA busy. MZW has new HT-9 and is working some nice DX. PHB is attending Rockford College two nights a week. The DEKalb hams did a swell job handling traffic when the city was snow-bound during spring blizzard. Ex-IOE will be back on with new K9 call. NOU is moving to Elgin. PHB has new RME-45. A radio club recently was organized at the Sycamore Community Center. TTW has been awarded the Army Bronze Star. PQH is well settled in South Elgin. New ORS: JYJ and KGO are interested in a.m. and f.m. on 144 and 50 Mc. and pulse modulation, 400 to 1200 Mc. LOK and KQL had first successful two-way 144-Mc. contact in Springfield. Let's have more applications for appointments. Send in your total worked DX score. ERU is new OO. The Fox River Radio Club sends in the following dope: AKF is on 50 Mc. CFH is on 28 Mc. and plans a Sonar rig. EDW has new multi-band final. QBL has a.c.-d.c. c.w. rig on 3.5 Mc. BLT is on c.w. but is interested in narrow-band f.m. QYO and UPW lost antennas in storm. GDZ operates from trailer. FGN is on 3.85-Mc. 'phone. EQC has new antenna. ATQ is on 7 Mc. NE is operating on all bands, 'phone and c.w. EJJ is completing new rig. KRZ got his picture in the paper with DX traffic. DO also handled DX traffic. BFY is on 28 Mc. with Sonar f.m. YOM is back in Batavia. MRP is on c.w., all bands. QBI is on 3520-3540-kc. c.w., ten watts. SXL is running 144-Mc. tests with LMS. Traffic: W9JTX 240, EVJ 170, DXL 119, FKI 55, SXL 49, SYZ 46, MRQ 46, KQL 30, FIN 19, KMN 15, ACU 6, EBX 4, DBO 1.

**INDIANA** — SCM, Ted K. Clifton, W9SWH — HGJ is back at Evansville. TIY is signing XAAJ from Gorizia, Italy. Look for him on 7 and 14 Mc. LJI is president of the new Michigan City Radio Club. MBL reports good results with the R-9er on 50 Mc. Ken now has his four-element beam up 12 feet. Any Indiana club which has not received invitation to take part in the Indiana Radio Club Council should write the SCM. The Kokomo Radio Club holds a pot-luck supper once a month. Plans are being made by the club for Field Day. PWA, Kokomo's newest and youngest ham, and PAP are on 3.5-Mc. c.w. On Mar. 28th the Fort Wayne Radio Club heard an interesting talk by Edward Chmielewski, FPO of Tri State College, Angola. Ed told of his experiences while in the Philippine Islands during the war when, instead of surrendering to the Japanese, he took to the hills with an American missionary. Later on he set up and operated a guerrilla radio station and maintained contact with three other islands in the Philippines, KFS in San Francisco, and KAZ in the Southwest Pacific. The Richmond Amateur Radio Association held its monthly meeting Mar. 24th. YB will use a VFO transmitter for traffic work. 8IU now is 9IW. HUV worked his 93rd country. OXM has 200 watts to an 810 on 14-Mc. 'phone. HC is moving to Michigan. SON took on 900 volts and can tell you about how many feet per volt. PRO is on 28 Mc. with 8 watts and has new HQ-129X. IDZ and SWH attended Chicago meeting to hear Budlong. The new Evansville club has selected the name of Tri-State Mike and Key Club. Following officers were elected: GFS, pres.; MWN, vice-pres.; DGA, secy.; KVE, treas. The Michiana Amateur Radio Club featured

(Continued on page 88)

# GOOD PARTS YOU CAN'T BUILD A GOOD RIG WITHOUT

... As a ham you know from sad experience the number of hours you've had to spend in "signal-tracing" work because some small part did not function properly. By using National parts, with their quality materials and careful workmanship, you insure better performance

and longer life for your rig. Spend your time enjoying QSO's instead of hunting trouble.

Send today for your copy of the new 1947 National catalog, containing over, 600 parts.

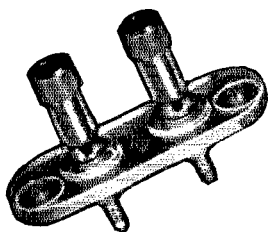

**FWG**—This is a polystyrene terminal strip for high frequency use. The binding posts take banana plugs at the top, and grip wires through a hole at the center — simultaneously, if desired. Amateur Net.... \$ .42

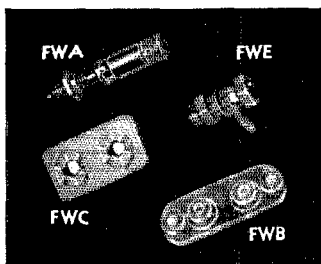

- **FWA** — Post, Brass, Nickel-Plated. Amateur Net ..... \$ .18
- **FWE** — Jack, Brass, Nickel-Plated. Amateur Net ..... \$ .12
- **FWC**—Insulator, Mica Filled Bakelite Insulation. Amateur Net.... \$ .24
- **FWB** — Insulator, Polystyrene Insulation. Amateur Net..... \$ .06

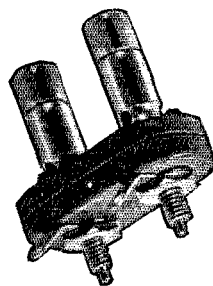

**FWH** — The insulators of this terminal assembly are molded mica filled bakelite, have serrated bosses that allow the thinnest panel to be gripped firmly, and yet have ample shoulders. Binding posts same as FWG. Amateur Net.... \$ .57

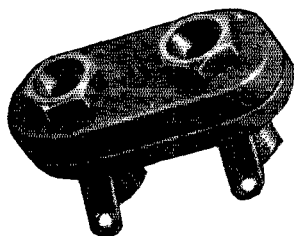

**FWJ** — This assembly uses the same insulators as the FWH but has jacks. When used with the FWF plug, there is no exposed metal when the plug is in place. Amateur Net..... \$ .45



Please write to Department 8, National Company, for further information

**National Company, Inc.**  
Malden, Mass.

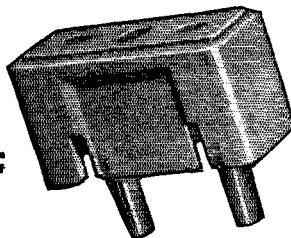

**FWF** — This molded mica filled bakelite plug has two banana plugs on  $\frac{3}{4}$ " centers and fits FWG, FWH or FWJ terminals. Leads may be brought out through the top or side. Amateur Net..... \$ .66

**MAKERS OF LIFETIME RADIO EQUIPMENT**

Prof. Walter Marburger, of the Physics Department of Western Michigan College at Kalamazoo, at its Mar. 26th meeting. The Indianapolis Radio Club, Inc., holds meetings each Friday at the North East Community Center, 30th St., LaSalle. QIN is on 'daily at 6:30 p.m. Traffic: W9RCB 279, NH 122, DEJ 24, ENB 21, HUV 12, SWH 11, NZZ 3, PMT 1.

WISCONSIN — Acting SCM, Ralph Klein, W9DKH — By this time we have a brand-new Section Communications Manager who I am sure is full of enthusiasm and high hopes. What do you say we snow him under with our activities reports, which should be mailed to him on the first of each month. No message-handling or appointments are needed to get listed. UFX, of Stoughton, renewed his EC appointment. Better look your appointments over and see if they require renewal. Applications for appointment as ORS, OBS, OO, OPS, OES, RM, etc. are welcomed. These appointments are all explained fully in the ARRL booklet, *Operating an Amateur Radio Station*. CFP, publicity chairman for the Racine Megacycle Club, reports the following: New officers for the club are BVG, pres.; PTN, vice-pres.; KZV, secy.; and NNNJ, treas. A "Worked All States" Contest was planned for April. Warning is given that the club is out to capture first honors in this year's Field Day and SZL, our capable EC, will be in charge. PPP is QRL with new police radio set-up. TXI and HHM are holding their own on 28-Mc. 'phone. YNB, RCC, and DVR are knocking 'em off on 14-Mc. c.w. BVG, KZV, and KZZ are doing well on 7 Mc. PFH and PTN are having BCI trouble with 'phone. Narrow-band f.m. is a good cure for this. Last but not least, CFP is on 14-Mc. c.w. after almost six years' absence from the air waves. Thanks, Willard, for all the fine dope. The MANCORAD president, BZU, and committee also are planning for Field Day, so Racine you won't be alone. BZU and yours truly made it across town on 50 Mc. and are on the lookout for others in the State. Traffic: (Feb.) W9SZL 5. (Mar.) W9LFK 183, SZL 16, DKH 14, IQW 11, HUI 2.

#### DAKOTA DIVISION

NORTH DAKOTA — SCM, Raymond V. Barnett, W9EVP — The Grand Forks Club has been reactivated. HAA finished new half-kw. rig using HK254s. RGT switched to f.m. on 28 Mc. with full kw. HRE and OCI are on at Grand Forks and WWG, TUF, and YRD are building. MLE visited GZD. VAZ has new three-element beam. PDN, our RM, has been transferred to the Aleutians. Our net suffers accordingly. Bismarck club members are handling flood level reports for Army Engineers. Fargo amateurs, led by EC OUH, were on the air when land lines went out in that area. Contact was badly needed with Jamestown and other points, but none was to be had. I am truly ashamed of lack of amateur cooperation in North Dakota. Traffic: W9GZD 11, GEH 4.

SOUTH DAKOTA — SCM, P.H. Schultz, W9QVY — The Bear Butte Radio Club is building a trailer house for use as a clubhouse and for Field Day and other activities. KEE has re-enlisted in the Army. USV and SVR are new hams in Aberdeen. The Black Hills Radio Club would like an assistant director in that area. SUJ is a new ham in Rapid. BLK has been appointed OO and took part in Frequency Measuring Tests. OIG and IBP are active in Sioux Falls Club. IQD has been visiting in the State but plans to make California his permanent home. 9WZH/4 is working all bands from Glasgow, Ky., on 3965 kc. and is looking for the old South Dakota gang in the evenings. GAU is operating portable at Alcester. ZPJ is new Pierre call. Traffic: W9WUU 3, GCP 1.

MINNESOTA — SCM, Walter Haeskamp, W9CWB — ZWW and BHY are making 3.5-Mc. emergency gear. RPT and YPN are now Class A. BGY is on 3.5-Mc. c.w. with low power from Nopeming Sanitarium. YCR is leading in St. Paul DX Contest. EPJ has new night job. HJR was copied in St. Cloud running one watt on 3.85-Mc. 'phone. ZNE is new ham on 28 Mc. 2MCO is operating portable at Minneapolis while attending U. of M. BOL worked KH6DD on 3.5 Mc. and needs only two more states for WAS on 3.5 Mc. LTN is not the former 9I3N. St. Mary's College has offered the use of a 2-kw. portable motor generator to the Winona Club for Field Day activity. The Mesabi Range Wireless Club has been reorganized. The following have been elected officers: WUQ, pres.; SCZ, secy.-treas.; FNG, technical advisor; ALP, act. mgr. GFC was appointed net coordinator for 7160-ke. net at 9:30 A.M. Sundays. Fairmont reports RPT building new VFO and emergency transmitter. CYA is pounding brass on 7 and 3.5 Mc. The Duluth gang shows

great activity on the high frequencies with GDD on 50 Mc. GKP, KYG, PIH, QVU, NRV, and LNV are on 144 Mc. PQX and GKO are on 144 Mc. f.m. BHH and IHT have 144-Mc. walkie-talkies. WSB has 28-Mc. mobile. YUP is building 28-Mc. mobile. LID now is WUQ. BP is back on 3.85 Mc. 'phone with a kw. The Minneapolis Club is building a ten-watt p.a. system for speakers who have not developed 89 voices. Sponsored by the St. Paul and Minneapolis Radio Clubs, a meeting was held April 1st in St. Paul for all amateurs of the Dakota Division. SW, our director, gave a report of the March 14th special Board Meeting. Mr. A. L. Budlong, Assistant Secretary of the League, was speaker of the evening, giving a complete picture of the frequency allocation situation and answering questions to explain exactly what has been done and will be done to maintain amateur radio status and frequencies. Your SCM has enjoyed meeting personally so many operators this past month. Traffic: W9DNY 212, CWB 43, ITQ 34, KIS 31, BBL 30, EPJ 22, JIE 22, HEO 21, RPT 21, BHY 20, MKI 16, EHO 14, BOL 13, AQU 12, GKP 9, IRO 8.

#### DELTA DIVISION

ARKANSAS — SCM, Marshall Riggs, W5JIC — VXA will have new beam on first warm day. ENH is building Little Rock Club's new transmitter. EKD has new third harmonic — a boy at last. JMZ is doing fine job on 3.85 and 3.5 Mc. IRY's 807's are still oscillating. DFY is playing with ART-13. FWF is active on 3.85 and 28-Mc. 'phone. HNR is using 375-E while rebuilding kilowatt. DVI is knocking 'em off with 600 watts on 14-Mc. 'phone. LUY is new secretary of Little Rock Club. MPD is on 7 Mc. with a pair of TZ-20s. MPI is running 807 at 60 watts on 3.5 and 7 Mc. EA has been appointed RM and SEC. LVO is on 14-Mc. c.w. MRG has new BC-348 and ART-13. KIP has new modulator and is on 14 Mc. with 400 watts. Arkansas has two new-comers — IRC, ex-4FYX, and IRB, ex-4EZQ. HDR has new e.c.o. and is having a fine time. KIP is having BCI with BCL who has a crystal set. Had a nice letter from EGX, who is on 3.5 and 7 Mc. ICS is new ORS. JIC is starting new all-band e.c.o. and speech amplifier. EA is organizing state net on 3.5 Mc. The meeting time is 7:00 A.M. Sundays. HOT has invaded 3.85 Mc. Let's hear from everyone next month. Traffic: W5EA 24, ICS 16, JIC 1.

LOUISIANA — SCM, W. J. Wilkinson, jr., W5VT — SEC: KTE. PAM: CEW. RM: KUG. We need ORS, OPS, and ECs in Alexandria and Baton Rouge. MLU is running 200 watts on 28-Mc. 'phone in Ville Platte. BWZ has 250 watts on same band. KRX is active on LSN along with KUM. FYS is rag-chewing on 7- and 14-Mc. c.w. CEW was active in DX Contest. KC worked HB9DD, G8JR, G6ZO, and F8IH on 3.5-Mc. c.w. KTE has new Class A ticket. KWY made WAC and WAS. KUG handles quite a bit of AYZH traffic. LDH has been QRL on 14- and 3.85-Mc. 'phone. HHT is adding his QRM to 14 and 3.85 Mc. LVG has 35 watts on 28 Mc. JYN has portable-mobile rig. ZV is showing signs of life. LQO and MJT are trying to get rigs on the air. LQV has been trying out all bands. Try high-frequency end of 7 Mc. and get some good QSOs with fellows whom you never thought existed. BSR is reporting in to LSN. KTQ works DX on 14-Mc. c.w. The Caddo Amateur Radio Club of Shreveport meets the 2nd and 4th Fridays of each month. The Delta Club of New Orleans meets on alternate Thursdays. VT was not as active this month but managed to keep schedules. IOP reports activity on 50-Mc. MPK is new licensee. DEJ has new beam. MCV and KRX have been active on Pelican Net. GND is active on 7-Mc. c.w. The LSN plans to continue operation during the summer on 7100 kc. MOQ schedules his son, LJT, at Notre Dame. Club organization is under way in Lake Charles. Traffic: W5KUG 232, KTE 151, VT 61, JPY 18, KUM 18, FYS 16, BSR 4, KWY 2.

MISSISSIPPI — SCM, Harold Day, W5IGW — PAM: VJ. BNW, the only OES in the State, has rotary beam with Selsyn drive. JTI has new rotary beam and speech amplifier. IZC and IZS are on 3.85-Mc. 'phone. VJ is proud papa of three new 250THs. LAK now has 22 countries. HVY has a new HRO receiver. HGL has been re-appointed as OO. HFQ received a nice letter from overseas congratulating him on his swell official broadcasts. The Vicksburg gang is organizing a radio club. JUJ, EC, is building portable-mobile rig for car. KHB has a Gon-Set converter. ITS is working on 28 Mc. HEK switched back to 28-Mc. 'phone. HEJ has a new Collins receiver. GWD is back on 3.85 Mc. The Mississippi section of the Rebel Net is one hundred per cent ORS.

(Continued on page 84)



# ONE HUNDRED KILOCYCLES

*Bliley*  
Type **KV3**



Accurate calibration of signals is assured when you use the new Bliley type KV3 crystal unit at 100 kc. Engineered in the Bliley tradition of quality and craftsmanship the new KV3 unit brings exceptional frequency stability and high precision within easy reach of the budget for your amateur station or experimental laboratory.

The basic assembly features a silver plated crystal rigidly mounted between wire supports which are soldered to the plated surfaces. This structure is mounted on spring loops for protection against shock and is sealed in a compact metal case.

When used in the recommended oscillator circuit the 100 kc signal has sufficient har-

monic content for calibration of receivers up to 40 mc. Simply adjust to exact frequency using the trimmer condenser to zero beat with WWV. In normal receiver operation the special low drift crystal will maintain calibration within very close limits without further adjustment.

Ask your favorite Bliley distributor for the KV3 unit at 100 kc. Instruction sheet includes schematic diagram of recommended oscillator circuit.

Price \$6.95 each

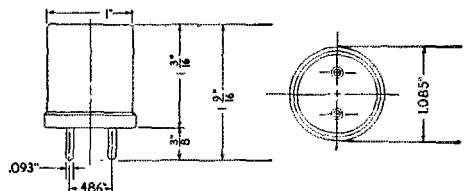

Thanks to VJ, LN, HFQ, WZ, HEJ, LAK, DEJ, and HGL for the dope this month. Traffic: W5IGW 436, WZ 218, EGE 67, LAK 47, HFQ 46, HEJ 9, LN 9, DEJ 4, IGD 2.

**TENNESSEE** — SCM, James W. Watkins, W4FLS — The Nashville Club is holding regular meetings. GQQ, HHC, ILZ, JAF, and EBQ are active on 3.85 Mc. AAW is building a new e.c.o. LRK and GYE are active on 28 and 14 Mc. BMC is active on 14 Mc. EAL contacted AYE, portable-marine, on 27 Mc. GXM has a new rig using a pair of 75Ts. HPA wants to make a schedule on 7 Mc. with someone in Paducah, Ky. HRS is active on 28, 27, 14, 7, and 144 Mc. and can handle traffic to and from the West Coast. FWH has a pair of 829s on 144 Mc. JSM is on 14 Mc. with an 813. IQY is doing well on 14 and 7 Mc. with his antenna lying on the roof. FEI is building a new sixteen-element beam for 144 Mc. FLW recently set up a portable station for demonstration of amateur radio to the Dresden Rotary Club. LRE is on 7 Mc. with a 6L6-807 running about 40 watts. APK has a pair of 813s on 7 and 14 Mc. BID is on 7 Mc. with 25 watts. QT does a good job with his little 10-watt on 3.85- and 28-Mc. 'phone. FZ is looking for stations interested in emergency work. LNB, KBO, and LQL are active on 28 Mc. SW, DQH, and AQR are leading in Memphis DX Contest. DGC, VT, EVK, CV, BCA, and FCF all have equipment on 420 Mc. 3TWI/4 worked G8TK on 3540 kc. during last CD Contest and CN8MZ on 7 Mc. during last ARRL Party. LEB is on 28 Mc. running 45 watts to an 807 and a three-element beam. TIM has 60 watts to a pair of 807s on 3.5, 7, and 14 Mc. Traffic: W4PL 102, 3TWI/4 207.

### GREAT LAKES DIVISION

**MICHIGAN** — SCM, Joseph R. Beljan, W8SCW — OO appointments: GLW, MGQ, Class I; and MTE, Class IV. Section Net certificates have gone to PVB, VPE and YDR. ONK is doing a nice job of NCSing on QMN and TLAP and is top traffic man for this month. IHR is back on QMN and is NCS on QMN Net. Ex-QMNER, VGC, now is 9YCV at Sparta, Wis. BCV is 3BCV and is twisting dials at WCAE, Pittsburgh. PVB is back at Rogers City and reports the passing of IPX, Flint. MQT made WAC on 14 Mc. and reports the new club at Battle Creek is progressing nicely. GP is sending code practice on 3563 kc., 8 p.m. Mon., Wed., and Fri. at speeds of 7, 10 and 13 w.p.m. Pass the word around to those interested. DARA election of officers: RX, pres.; UQR, vice-pres.; and FX, secy. and treas. FJL worked 66 countries during the DX Contest, bringing his postwar total to 88. SAY is working nice DX on 7 Mc. and is putting up beam for 14 Mc. LHH is working DX on 28 Mc. SWF schedules J9AAI and KE6AR on 28 Mc. YCT blew up rig during DX Contest. LSF is building new 600-watt rig and purchased new HQ-129X. UKV reports 5 p.m. QMN Net progressing steadily. Both 5 and 6 p.m. nets are slow speed nets and invite new operators as well as the bashful operators to report in. TYE is doing a nice job as 6 p.m. net manager. FWU is most consistent QMNER, reporting in all three nets. NJH is now at Farmington and will be back on the air shortly. TBO is attending night school at Wayne and is rebuilding for 7 and 28 Mc. GQG is working portable 144 Mc. RLH expects to have a pair of HY5IZs on shortly. PKA is QRX until new house is located. YDR is trying 28-Mc. 'phone. MTE schedules VESMF three times per week handling traffic. QMT Net meets every night after the band folds up on 28.8 Mc. Grand Rapids Emergency Net is going FB and meets every Monday on 29.188 Mc. at 9 p.m. QBO and WWL keep things going on the Buzzards Roost Net and report activity is high. Thanks for the cooperation, gang, but let's hear from more of you the first of each month. Traffic: W8ONK 320, SCW 193, NOH 148, IER 45, DNM 33, KZO 26, DPE 22, FX 22, PVB 22, TQP 22, TYE 22, SWF 20, ABH 17, TRP 16, UKV 15, MGQ 14, VPE 12, YDF 11, RJC 10, WET 9, FWU 7, UGR 6, TBP 5.

**OHIO** — SCM, William D. Montgomery, W8PNQ — Ohio was well represented in the ARRL Frequency Measuring Tests, and as a result of these tests we now have five Class I Official Observers: SDD, JRG, JFC, BFB, and MFV. Other recent appointments include OO, Class II: TJM, ORS: UW, YPS, and PZA. OPS: BFB and BCJ. OES: WRN. New officers of the Dayton Amateur Radio Assn. are PTF, pres.; WYU, secy.; ZOK, asst. secy. ALZ put the Dog House Net to good use in locating a new door for his car. The Net found one for him in Cincinnati. The March 28th meeting of the Dayton Amateur Radio Assn. featured P. E. Murray on "Radio Control Systems for

Pilotless Aircraft." JK was presented a lifetime membership in the Columbus Amateur Radio Assn. for his effort in addressing the group on "Antennas." WRN reports that IVZ now is FK and that ZYU is a newcomer in Columbus on 28 Mc. BKM reports that the officers of the newly-organized Conneaut Radio Club are: MJM, pres.; ZFK, vice-pres.; and BKM, secy. The club meets on the 2nd and 4th Tues. of each month at the Conneaut Harbor Fire Station, 2nd floor, 8:00 p.m. The Central Ohio Radio Club now has a club transmitter, loaned indefinitely by MGM. The Buckeye Traffic Net (on 3730 kc.) is improving more and more as time goes on. It's getting tough to find any State net to beat it in smoothness and results. My compliments to RN, MPG, and all the participating stations. The Dog House Net Picnic was held May 4th at Serpent Mound Park. The Greater Cincinnati Amateur Radio Assn. annual stag hamfest will be held Sept. 14th. EQ says that NN is back on the air, 'phone and c.w., on 4-Mc band. EFW "rescued" himself and some other motorists on March 27th from a snow-bound section of highway by getting off a message via his 28-Mc. mobile unit to GMI and thence to the Highway Dept. From WYN and the Intercity Radio Club we hear that ALC WACed in five hours one day, that PMD has a radiotelephone 1st-class license, that KUW now is Class A., and that NQD is back on the air on 7-Mc. c.w. and 28-Mc. 'phone. SGF reports that the Cambridge Amateur Radio Club has established the Southeastern Ohio Club Net on 3.5- and 7-Mc. c.w., that RVU is enjoying his 28-Mc. mobile rig, that the club is putting out a monthly bulletin to members, and that everyone is invited to meetings which are held the last Thursday of each month. BGU, PUN, PNQ, WAV, and BCJ lost antennas in the recent high winds, snow, etc. The Columbus Amateur Radio Assn. plans a hidden transmitter hunt on 3.5 Mc. and one on 144 Mc. sometime in the future. The Queen City Emergency Net plans its regular schedule of hunts on 144 Mc. and started the season off with a talk by PPK on "Automatic Direction Finding Methods Made Easy for the Amateur" at the last meeting. OGG extends thanks to ITR for his great helpfulness in forwarding reports on OGG's brother, who was seriously ill in Cleveland. Our OOs are doing fine work throughout the State. Their usefulness will increase as soon as call books are available. Lack of these bibles is making it tough to get notification cards out. A swell demonstration of the Baldwin Electric Organ was presented at the last GCARA meeting. Traffic fell off this month, but the reason may have been the smaller number of reports received on time this month. Mail reports early, boys, or we can't get them in this column. Traffic: W8RN 126, PMJ 99, ZAU 94, CBI 79, PIH 66, UPB 64, PZA 62, MPG 52, EQN 33, EBJ 29, DAE 23, EQ 21, VWX 18, PNQ 13, WE 12, BEW 7, PUN 7, TKS 7, JFC 5, EFW 4, QIB 4, UW 3.

### HUDSON DIVISION

**EASTERN NEW YORK** — SCM, Ernest E. George, W2HZL — Complaints from several areas are again being received because the fellows feel representation in the Stations Activity section is unfairly made or entirely missing. Your SCM would like to repeat that if no news is received, no news can go in! Let's get those club secretaries on the ball, fellows, and send in the dope. Hams in the Tri-City area were treated to a party at Uncle Dave's shack in Albany recently. Capt. Reinartz was the speaker. Although confined to bed, Uncle Dave spoke to the crowd over the land wire and p.a. system. GYV has put 20 watts on 144 Mc. from surplus equipment. Must be he is not satisfied with DX on 50 Mc. NOY, in Altamont, also is a newcomer to 144 Mc. Your SCM has been doing some 2nd-harmonic snooping on the 7.7-8-Mc. band. The QRM there from the hams is really getting bad. Suggest you get someone to check your signals before the FCC does. Traffic: W2LRW 92, EQD 45, NHY 44, NAI 18, GWY 16.

**NEW YORK CITY & LONG ISLAND** — SCM, Charles Ham, jr., W2KDC — OQI, Suffolk EC, really is taking hold. Group 3 of the 3.5-Mc. c.w. net holds regular drills Wed. at 7:30 p.m. LCK and CKU are NCS. Suffolk City Radio Club officers are: TDU, pres.; PIA, vice-pres.; CJV, secy.; AJF, treas. All townships are represented on the Board of Directors. The Suffolk Amateur Radio Club plans close cooperation with the new club. UGH has 80 watts on 144 Mc. to a three-element beam. OQI is crystal from 8-Mc. crystal to 829. FCH is using a pair of 127s on 144 Mc. UDP and UFY are using TR4s. Queens County reports a total of 24 on the 144-Mc. net. A new schedule has been successful

(Continued on page 88)

# NOW you can get Sylvania quality in TRANSMITTING tubes too!

## SYLVANIA INTRODUCES THE TYPE 3D24

### BEAM POWER TETRODE WITH ELECTRONIC GRAPHITE ANODE

First of Sylvania's new line of transmitting tubes, the 3D24 is a four-electrode amplifier and oscillator with 45 watt anode dissipation. An outstanding development is the electronic graphite anode, which allows high plate dissipation for small area and maintains constant interelectrode relationship and uniform anode characteristics.

The 3D24 may be used at full input up to 125 Mc—maximum permissible frequency will be announced later upon completion of tests.

#### OTHER FEATURES INCLUDE:

1. **Top cap** providing for short path, greater cooling by radiation and convection, resulting in a cooler seal.
2. **Thoriated tungsten filament**, giving high power output per watt of filament power.
3. **Vertical bar grids.** #1 grid supplied with two leads for better high frequency performance. #2 grid provided with heat-reflecting shield for greater dissipation, low grid-plate capacity.
4. **Low interelectrode capacity.** No neutralizing needed with proper circuit arrangement.
5. **Hard glass envelope.** Permits high power for small size.
6. **Lock-In base.** Short leads, no welded or soldered joints.

The 3D24, a product of the Electronics Division of Sylvania Electric, has interesting potentialities in amateur, police, mobile and marine radio.

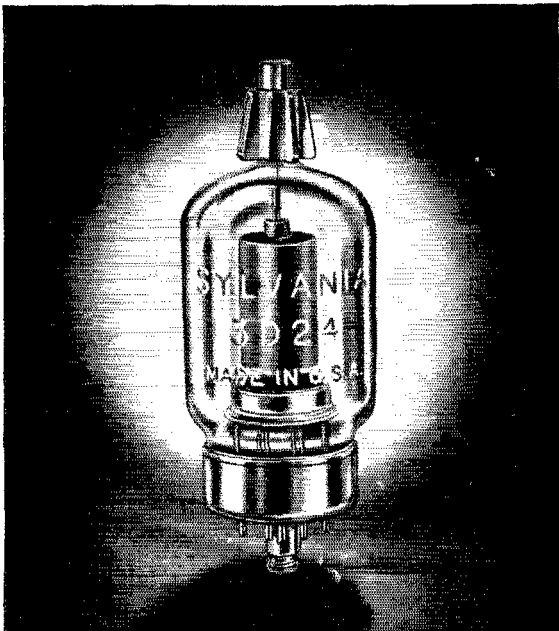

#### MECHANICAL SPECIFICATIONS

Type of cooling	Air—radiation and convection
Mounting position	Vertical, base down or up
Length overall	4.3 inches max.
Seated height	3.769 inches
Diameter	1½ inches
Net weight	1.3 ounces

#### ELECTRICAL CHARACTERISTICS

Filament Voltage	6.3 volts
Filament Current	3.0 amperes
Amplification Factor	50
Direct Interelectrode Capacitances	
Grid-Plate	0.2 $\mu\text{mf}$ max.
Input	6.5 $\mu\text{mf}$
Output	2.4 $\mu\text{mf}$
Maximum Class "C" Power Input	180 watts C. C. S.

*Direct inquiries to Radio Tube Division, Emporium, Pa.*

# SYLVANIA ELECTRIC

MAKERS OF ELECTRONIC DEVICES; RADIO TUBES; CATHODE RAY TUBES; FLUORESCENT LAMPS, FIXTURES, WIRING DEVICES; ELECTRIC LIGHT BULBS

in maintaining interest: The first Monday is reserved for a round table, the second for any activity planned by a member, third is interband internet night, and fourth is all emergency power night, when EK and OJY star with their emergency supplies. On the 3.5-Mc. net Group 1 includes Bronx, Manhattan, and Queens at 8 p.m. Monday, with EQD as NCS. SLD, CIQ, and PRE are new members. Group 2 includes Brooklyn, Staten Island, and Nassau on at 2 p.m. Sunday, with KTF as NCS. At 7:30 p.m. Wednesdays, all NCS get together and compare notes. Don't forget the AEC picnic at Bethpage, June 22nd, 2 p.m. NYC is building a super superhet. SNT now is UVA, and is on 3.85-Mc. 'phone and occasionally on 7-Mc. c.w. TUK is QRL with school but GG keeps shack active. 4HKJ/2 is located at Mitchell Field and is on 28-Mc. 'phone. PMA reports for the YLRL that new gal hams are UTV, SEE, and TTF, and that PHI worked 26 countries using new four-element wide-spaced beam while PMA is getting out FB using 20 watts. 3LHL/2 will operate portable-mobile on 144 Mc. using TR4B in New York City area. ELK is using HQ-129X and pair of 809s. HNG is starting in on 144 Mc. again in Brooklyn and is looking for the gang from the old Bay Ridge Radio Club. OED is on 144 Mc. and hits the brass once in a while on 7 Mc. ITN is 3LOV in Washington, D. C. on 7018 and 7158 kc. and wants to QSO the old New York gang. SLF is on 7-Mc. c.w. with 50 watts to an 807. UGH, secretary of the Grumman Amateur Radio Club, reports: NI is going to crystal on 144 Mc. UGH is on 144 Mc. in Suffolk County and JXP has FB crystal rig on 144 Mc. mobile. UGZ was on the air a month and had 27 contacts with 5 watts. PKD was appointed Liaison Regional Coordinator in accordance with recent trend toward closer cooperation with U.S. Weather Bureau. He is working with the officer in charge of Region 1, located in New York City. Tom is generally available on 27,440 kc. evenings. At the International Philatelic Exposition May 17 to 25 local operators handled all exhibition originated traffic both direct via a transmitter installed and donated by KR and via the N.Y.C.-L.I. Net. MHD worked a few ZLs on 7 Mc. PRE worked a pile of DX on 7 Mc. using 30 watts, but he is still looking for a ZL. EC is bothered by casual users of net frequencies during traffic period. BO calls it a wasted evening if he doesn't work at least one J on 7 Mc. CJI is rebuilding his 14-Mc. 2-watt transmitter. PWJ visited IEMF for a day and met the Owl Net. New members welcomed to the NYC-LI Net during the month were: CIQ, LYH, OBS, PZE, SJC, and TYU. The first postwar Hudson Division Convention will be held in Asbury Park in September. Traffic: W20BU 193, LR 154, BO 132, EC 56, PZE 56, QYZ 50, BGO 10, OUT 10, PRE 10, AYJ 9, MHD 8, FWJ 7, TUK 4, HMJ 3.

**NORTHERN NEW JERSEY** — SCM, John J. Vitale, W2IIN — Asst. SCM, T. Ryan, 2NKD. SEC: GMN, N.N.J. Net: 3630 kc., daily 7 p.m. except Sundays, CGG, NCS, N.J. 'Phone Net: 3900 kc. Sundays 9 a.m., QEM, NCS. NCY built a television receiver. MYY has 97 countries and HZY has 95. ITD is putting 1-kw. 'phone on dual 14- and 28-Mc. three-element beam. LQP is assistant to APL, EC for Jersey City. Both are members of N.N.J. Net. JKH is remote controlling 14-Mc. transmitter via 50- and 144-Mc. radio links, working out OK for c.w. LFR recently made BPL with aid of Florida State Fair and N.N.J. Net traffic. UGM has 200 watts into pair of 804s on c.w. and 'phone. The T-9 Society now is an ARRL affiliated club. NZC is secretary. FKA has been appointed reporter for this column for N.N.J. Radio Assn. The club meets 2nd and 4th Mondays at Hackensack YMCA. FKA, YL, is on 14, 27, and 28 Mc. working DX. PPH is ORS and a member of N.N.J. Net and 3.85-Mc. N.J. 'Phone Net and keeps schedules with CM7AA on 7 Mc. DED is on 7 Mc. CWK is increasing power with some "big bottles" and also has new all-band exciter. NJF was in charge of communication at the International Stamp Show in N.Y.C., May 17 to 25. N.N.J. Net boys cooperated. The Bloomfield Radio Club held its 32nd Annual Dinner recently. HZY is president of the club. SLI, of Hudson County 148-Mc. Net, is a member of N.N.J. Net and will be cross-link between the two nets. OEC, Fort Monmouth Radio Club, handles traffic for all theaters, and ties into N.N.J. Net. ONO runs a ham gossip column in the Dumont Labs publication, *The Roster*. There are 72 hams working there and they have a workshop, code-class room, and four rooms with a 1-kw. transmitter in each on all bands from 3.5 to 28 Mc. on 'phone and c.w. NZC is on 7 Mc. with 250 watts into a pair of 55Ts and HQ-129X receiver. The H.C. 148-Mc. Net meets at 9 p.m. Mondays; NLE is NCS.

The ARC Radio Club of North Hudson is an ARRL affiliated club. Officers are PEG, pres.; NCA, vice-pres.; KPC, secy.; NJI, treas.; MQI, sgt. at arms. The club meets 1st Wed. of month at Weehawkin Town Hall, and on the air Tues. at 8 p.m. on 7 Mc. and 8:30 p.m. on 27 Mc.; Mon. on 144 Mc. at 9 p.m. NIY has WAS. PPH has BC-348Q. CJT works on 7, 27, and 28 Mc. PLN and NJI are DXing on 28 Mc. OOL and BUX have WACed. KPC is on 50 and 27 Mc. NLE has a 40-ft. mast with a 144-Mc. dipole on it. BIG works 27 and 28 Mc. KPC, NJI, EWL, ISY, IVM, and IIN have built television receivers. QMQ has HT-9 on 14- and 28-Mc. 'phone. BDS, on 28-Mc., worked an old friend, AVC. NOY is using Signal Shifter and p.p. 813s, 750 watts, and four folded dipoles on 3.5, 7, 14, and 28 Mc. GVZ has a new Collins 30K transmitter, 500 watts. IIN has three-element beam and 829-B 150-watt final on 28 Mc. Traffic: W2LFR 223, CGG 164, ANW 162, OEC 129, NKD 108, LTP 50, BZJ 43, MLW 35, CQB 34, NCY 30, IIN 17, QEM 15, GVZ 11, CJX 8, PPH 6, BRC 4, NIY 3, PQS 2.

## MIDWEST DIVISION

**IOWA** — SCM, Leslie B. Vennard, W9PJR — MBW is having trouble on 420 Mc. FNF heard Bombay, India, on 28 Mc. and has worked 60 countries, mostly on 28 Mc. POY has worked 67 countries, mostly on 28 Mc. He works ZL2LV with 5 watts on 28 Mc. BGB, working f.m. on 28 Mc., lost his tower (60 ft.) in wind-storm. FZO, GWT, and EQN are working ZLs and VKs on 14 Mc. The Sioux City Club has purchased a BC-221 frequency meter for use of club members. EOE is on 28-Mc. c.w. but wants 160 back. His best DX is F8DX, Algeria, with 60 watts and folded dipole on 28 Mc. AUL, REH, EKN, OSC, TIU, SCA, SCW, SQV, and QVA are active in Iowa Tall Corn Net daily at 7 p.m. REH and HKR are new ORS. PVW, on 3570 kc., would like to contact other 16-year-old hams. GKS and CFB are working DX. UNJ, OQC, PEX, and 20XH/8 are working 144 Mc. and want reports if heard. KZI is on 75 Net. LFF was elected president and TWX secretary of IX Club. SQO is working DX on 14 Mc. NTI is chairman of Tall Corn Hamfest. YBV is at Iowa U. Traffic: (Mar.) W9AUL 692, REH 31, SCW 19, QVA 18, TIU 7, HKN 2. (Apr.) W9AUL 266, REH 61, TIU 38, QVA 23, SCA 22, SCW 19, SQV 12, OSC 8, HKN 5.

**KANSAS** — SCM, Alvin B. Urruh, W9AWP — SEC: PAH. RM: NJS. BQJ is new ORS. YOS was forced to give up QKS activities until fall because of work. PZP has schedule with member of Missouri Net. OZN and OKD built new VFOs. QQQ handled traffic during engineers' open house at State College. NOP worked into QKS Net as outlet for QQQ traffic. BKX has narrow-band f.m. on 29 Mc. Wichita Emergency Corps holds weekly drills using 29-Mc. portable-mobile and fixed stations. UUS has VHF-152 converter and plans 50-Mc. activity. 4MS, SCM of Western Florida section, was Wichita visitor. CLN has BC-610. DJL has portable-mobile 144-Mc. rig. YZB is going into radio business at Pratt. Application has been made for ARRL listing of 3870 kc. for Kansas Emergency 'Phone Net. Don't forget to send your reports on the first of the month. Traffic: W9NJS 177, YOS 42, WKA 31, AWP 28, PZP 18, ZUA 9, TVU 7, OZN 6.

**MISSOURI** — SCM, Letha A. Dangerfield, W9OUD — Fine reports were received from most of the regulars and a few new ones. FSR sends in a traffic total for 7-Mc. work. 2TVL/8, from Long Island, is attending radio school in Kansas City and has an 807 on 7 Mc. GCL is working on new antenna. ARH has new Meissner Signal Shifter and has been using it on c.w. more. DHN worked TG9RC on 3.85-Mc. 'phone. Both ARK and DEN have been working with MON. KIK squeezes in net schedule as often as possible. DEA has new Signal Shifter for big rig — no key clicks this time. PXW has bandswitching for all bands. ZLN, located at M.U. took traffic at the Engineers Annual St. Pat Exhibit. Operators at various times and on different bands were: CKS, GEP, KHD, JHH, UTR, BTW, and ZZW. The last headed the list by clearing 21 messages on 3.5 Mc. QXO took on the job of clearing the remaining hundred or so left over from the exhibit. He spent 6 hours on Sunday relaying for a chess game with Peoria, Ill. — and his side lost. SKA is doing FB with MON, but got mike fright testing out modulator for 28 Mc. CMH, ex-ENP is running 600 volts to his 813. ZIS reports some 144-Mc. activity around St. Louis. BTC left the FCC to work with KXOK/f.m. HARC, in Kansas City, has its emergency set-up with 144-Mc. rig down town and network of 3.5-Mc. stations for relay. He

(Continued on page 88)

**When they come across your frequency  
...they'll STOP...they'll LISTEN  
...result QSO**

The clear call of the CARDAX gets attention. Modulation is clean . . . cuts thru QRM. True voice quality makes them *want* to work you. This means more QSO's . . . and more pleasure from your rig.

Designed to give your signal the last db of performance . . . the CARDAX is a deluxe microphone that pays big dividends for DX or rag-chewing.

The CARDAX, Model 950, lists at \$37

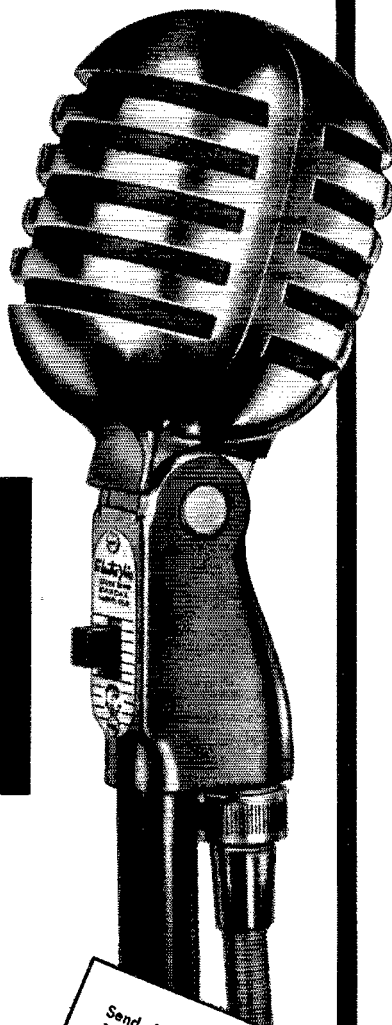

# THE CARDAX

The only cardioid crystal microphone with dual frequency response and high output. Ask your distributor or write for Cardax Bulletin.

**ELECTRO-VOICE, INC., BUCHANAN, MICHIGAN**

Export Division: 13 East 40th St., New York 16, N.Y. Cables: Arlab

*Authorized Distributors Everywhere*

Patent Pending. Licensed under Brush Patents.

NO FINER CHOICE THAN

***Electro-Voice***

Send for Catalog No. 101. Gives data on today's most complete microphone line. Includes handy selection guide.



# "HEY... DON'T FORGET THE VIBRAPACK\*!"

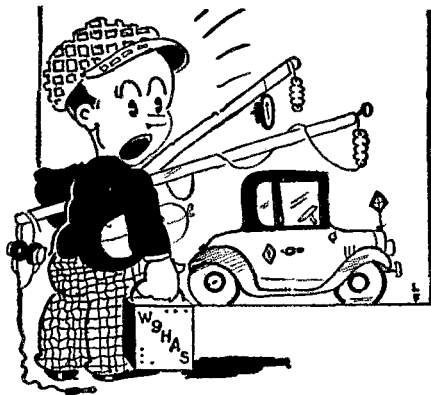

That's right, Charlie! Don't forget the Vibrapack\* provides perfect portable power for radio transmitters, receivers, and P. A. systems.

Vibrapacks have *all* the desirable characteristics necessary for an ideal portable or mobile power supply—

**Dependability** — Proved by the thousands of police radio installations where Vibrapacks operate on a 24-hour-a-day schedule to give unflinching service.

**Efficiency** — Which means noticeably less current drain from the storage battery.

**Compact—light in weight** — Important where space is limited or where weight is important, as in airplane installations.

**Low first cost** — A big investment is unnecessary—you will save by using a genuine Mallory Vibrapack.

**Low maintenance cost—less time required for servicing** — The only part of a Vibrapack which normally ever wears and requires replacement is the long-life vibrator. It requires but an instant to install a new vibrator. Compare this with the elaborate overhaul required by other forms of power conversion equipment.

Ask your distributor for technical data on Vibrapacks, or write for Form E-555.

\*Vibrapack is the registered trademark of P. R. Mallory & Co., Inc., for Vibrator Power Supplies.

**P. R. MALLORY & CO., Inc.**  
INDIANAPOLIS 6 INDIANA

**P. R. MALLORY & CO. Inc.**  
**MALLORY**

(Continued from page 86)

also is sending code lessons on 27 Mc. from 7 to 8 CST nightly, with BCD and UID participating in the project. The club would like to hear from those listening to the lessons. PKB is a new AEC member. YSM broke his net crystal and another for the Illinois Net. YHZ did more work on his 60-watt rig. OUD is plugging away on the traffic net. Traffic: W6QXO 188, DHN 71, OUD 56, CMH 27, ZLN 24, SKA 22, ARH 13, KIK 9, NNH 6, FSR 5, DEA 3.

NEBRASKA — SCM, Roy E. Olmsted, W8POB — Apologies for failing to report the news last month, but have been "out of circulation" for several weeks. Am now living in a high, narrow bed and the "Doc" says I'll be unemployed for quite a while, as he expects to peel out my Adam's apple. So I believe it best to resign as your SCM. Regards, until I can get back on the air again.

## NEW ENGLAND DIVISION

**C**ONNECTICUT — SCM, Edmund R. Fraser, W1KQY — The Nutmeg Net Traffic Net closed for the summer on May 15th. OO's KUK, ON, and VW are logging few second harmonics and out-of-band operation. Club news: NARL — DXT reports club members are shifting frequency to 3850 kc. NARA — C'TI was guest at annual anniversary dinner. PEA is on 50 Mc. The Emergency Net meets each Friday at 10 p.m. on 145 Mc. CQRC — ODG, secretary, reports, the Torrington club adopted Netherlands ham PA8BK and shipped him two packages of parts. WARA — MXZ reports the Wallingford Amateur Radio Assn. organized in January. Officers are: HKF, pres.; MPO, vice-pres.; MXZ, secy.-treas.; and FRK, trustee for club station, HYB. Meetings are held every Tuesday in Town Hall. Rig is Millen exciter on 3.5, 7, and 14 Mc. with receiver donated by KSC. HKF is on 3.5 and 7 Mc. MPO has c.c. rig using 829 on 144 Mc. with AVS and PXA. LFL is on 3.0-Mc. 'phone. MXZ is building rig for 14, 28, and 50 Mc. MRC — FSH reports meetings are held in YMCA, Manchester. BARA — EC reports the club will sponsor the Connecticut State ARRL Convention Sept. 27 and 28. BRAC — LIG reports BRAC Disaster Net with OGS, EC in charge, met on 144 Mc. with JYQ, FSY, MGS, ODW, and LIG. JMI is rec. secy.; ODW, corr. secy.; and FSY, temporary chairman. EHI is running 2 to 1000 watts into p.p. 813s with variac. NKR received cards from UA1AA, VU2CQ, VU2AF, PY2VC, J9AGT, and EL2A on 28 Mc. 'phone. BRL — OKT and LIG attended NHARA meeting in New Haven. SARA — Diets reports club conducting code and theory classes and taking part in Red Cross emergency tests. NHARA — TD has new NC-100XA receiver. MEF is after NC-101X. FMV has new 28-Mc. 'phone rig in his car. News in general: DEP is running 150 watts to 813 n.b.f.m. on 28 Mc. OND and ODY are using four-element beams on 28 Mc. JFN now is BUD. BDI is constructing a beam. QAP, a new ham in Hartford, worked OK for his first QSO. KKS worked his 46th country with a 35-watt rig. Traffic: W1NJM 129, AW 118, VB 96, ORP 51, JQD 49, EFW 45, BDI 41, UE 27, KKS 7, DEP 6, KQY 6, IQE 4.

MAINE — SCM, F. Norman Davis, W1GKJ — In this first report I want to say thanks for the congratulations and ask for your continued support. AQL is on 3660 kc. with a 75-watt rig and has another 50-watt rig on 7070 and 7132 kc. He also reports the Eastern Maine Amateur Radio Club has accepted the offer to have its meetings and transmitter in the YMCA Building. Some work is necessary on the building before occupancy and anyone who wishes to help or contribute should see OLQ, secretary, 24 Grove St., Bangor. MAW is building the club transmitter. LOA reports that OIL is working in Newton, Mass. ODA has new Meissner Signal Shifter. BAV is constructing Gordon three-element beam for 14-Mc. band. NKM is building e.c.o. described in Sept. QST. AI now has 813 in final. You might hear some of these boys and not realize they are old friends: Ex-FAP, now 2AUL; ex-CFO, now 3LJO; ex-HWY, now 3MLI; and ex-KYT, now 6YHK. LNI and MBR have 28-Mc. mobile rigs. NXX has built modulator for his 807 and is on 28, 14, and 3.85-Mc. 'phone. He has been working some DX on 14-Mc. c.w. and is coaching a new ham prospect. CZ wants to hear from any other Maine hams who are, or have been, Exalted Rulers in the Elks. A lot of prewar appointments need endorsement to be valid. Please look at your OPS, ORS, and other certificates and send them to me for endorsement if necessary. Would like to have applications for new appointments. Traffic: W1LKP 5.

(Continued on page 80)

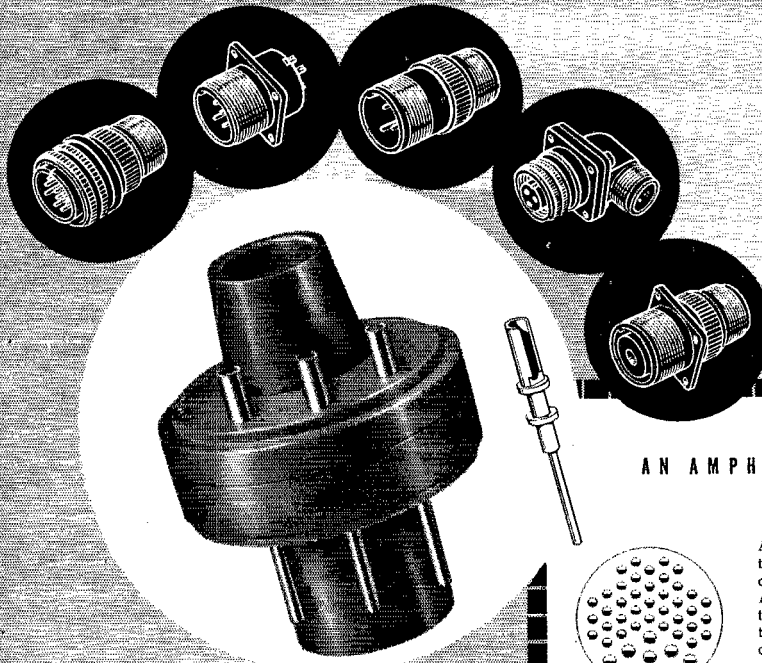

The new 9726-410P high voltage AN connector insert, newest addition to the Amphenol family. It is one of more than 200 types available for use with the five basic shells shown.

### AN AMPHENOL EXCLUSIVE

Non-rotating solder terminals and aligned solder wells

Amphenol terminals do not rotate, and they are properly aligned for fast, easy soldering. Ask the men on your production line how many hours a day this feature will save. Other exclusive features of Amphenol AN connectors will be described in a later issue.

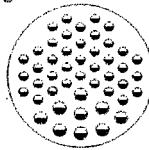

## How **AMPHENOL** AN Connectors

### Step Up Your Profit Potential

Standardized AN connectors provide a fast, fool-proof way to connect any industrial electronic equipment which frequently must be disconnected from associated equipment or power source.

Their use also permits the prefabrication of associated wiring to accommodate one or many circuits. This greatly simplifies and lowers the cost of electronic installations. AN connectors also permit such equipment to be completely tested at the factory before shipment to user. Upon arrival it then can be connected for operation in minutes.

These advantages combine to widen the field in which electronics may practicably be applied. Thus they offer an increased sales and profit potential to makers of electronic devices.

The Amphenol AN connector family offers you a number of important points of mechanical and electrical superiority. It is comprised of over 200 styles of dielectric inserts. These are interchange-

able in any of the five major Amphenol metal shell designs (each of which is available in eighteen sizes). The practically endless variety of possible combinations offers an efficient solution to any industrial electronic connector problem.

Amphenol inserts handle currents up to 200 amperes, voltages up to 22,000. Housings include types which are pressure-proof, moisture-proof and explosion proof. Standard elements also are available for thermocouple installations.

Amphenol, long the leading builder of AN connectors for aircraft, ships, tanks and ordnance, is still completely tooled for large scale production. This makes these connectors available to industry at costs far below prewar levels. Write today for complete technical and cost data.

#### AMERICAN PHENOLIC CORPORATION

1830 SOUTH 54TH AVENUE, CHICAGO 50, ILLINOIS

COAXIAL CABLES AND CONNECTORS • INDUSTRIAL CONNECTORS, FITTINGS AND CONDUIT • ANTENNAS • RADIO COMPONENTS • PLASTICS FOR ELECTRONICS



## DOES IT TAKE MORE POWER TO MODULATE A TETRODE?

Last month we mentioned the not-too-obvious fact that high-level modulation of an Eimac tetrode takes no more audio power than is normally needed to modulate a triode operating at the same plate input. That this is not obvious is evident from the number of questions asked about it. The incorrect reasoning often used goes something like this: The screen must be modulated—modulating the plate requires audio power, therefore modulating the screen must also take audio power. Sounds logical, but it isn't.

Actually, it doesn't take any extra audio power either from the modulator or elsewhere to get modulation on the screen. Below is a diagram similar to the one shown last month. The only difference between the two is in the nature of the circuit element in series with the d-c screen supply. Instead of an inductance, it is now shown as generalized impedance, Z. This Z may be a resistance, a reactance, a combination of the two, or even a third winding on the modulation transformer.

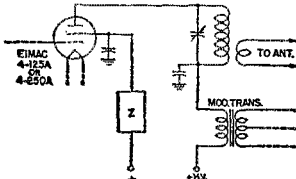

Assume that the plate is being modulated in the normal manner. As the plate voltage rises on positive modulation swings, the screen current drops, the voltage drop through Z decreases, and the voltage applied to the screen increases. On the negative swings of modulation the situation is reversed, the screen current increases and the screen voltage falls. Looking at the screen we now see quite a different situation from that we are accustomed to seeing in the plate circuit. As the voltage applied to the screen increases, the current flowing to it decreases. This is quite a different affair from what occurs in the plate circuit, where the voltage and current rise and fall together, and power is required for the process. The screen looks like a negative resistance. The screen voltage and current are out of phase, and the screen is not taking power from an external source, but is actually delivering it to Z, provided Z has a resistive component.

The amount of audio power developed by the screen is small—on the order of one watt for the 4-250A at full modulation. This power comes from the screen itself, and the screen dissipation actually decreases under modulation. It is for this reason that the screen dissipation rating of Eimac tetrodes is the same for high-level modulated service as it is for CW.

If the audio power developed by the screen is fed back into the plate circuit via a three-winding modulation transformer, it actually takes less, not more, audio power to modulate the tetrode than the triode. Don't throw away that perfectly good two-winding transformer on this account though, the saving in audio power isn't worth it.

No, it doesn't take any more audio power to modulate an Eimac tetrode, not a single watt.

-W6CEM

EITEL-McCULLOUGH, Inc.  
1756 San Mateo Ave., San Bruno, Calif.

(Continued from page 88)

EASTERN MASSACHUSETTS—SCM, Frank L. Baker, jr., W1ALP—We are sorry to have to report the death of IA. On Mar. 30th, an emergency test was held with about one-half of the ECs reporting in. It is planned to hold a test once a month. It is hoped that all the ECs will make an attempt to get on each test. MON, AR, BB, and JGQ have renewed EC appointments. NBS is Dedham EC. New OOs: NF, Class 2-4; GGV, Class 2-3; OJM, Class 2; AYG, Class 1-3-4. MIT now is Class 2-3-4. IIM is OPS, MPP and NXV have Class A tickets. PFJ now is CLS. OH2OK was a visitor at the Eastern Mass. Club. OUD now is AQE. PZA is on 144 Mc. VA was on 144 Mc. Ex-8VVN now is PEA. Ex-LIO is EK. NVR is on 144 Mc. HOM has been on 144 Mc. aircraft. The Merrimack Valley Amateur Radio Club is publishing its monthly *News* again. The staff includes: DOO, NNG, JDU, KNU, and LGG. OJT and PFL sent in OES reports. AJA worked WAC in 5 hours in the DX Contest on 28-Mc. 'phone: GM6RJ, OQ5AR, CX2CO, XU6RRL, 6ONP/EK, and DNL. 2BAV and HDQ gave a talk at the Eastern Mass. Club. PAD spoke at the South Shore Club. The T-9 Club had a supper at Mrs. Pike's in Middleton and then a meeting at CVM's. The Brookton Club held another auction. Ex-5DQD now is 1DQD. The Parkway Radio Club held its annual banquet at the Meadows in Framingham. NRS, a new member, is on 14-Mc. c.w. OUM has new TR4B on 144 Mc. KVH is on 28- and 14-Mc. 'phone. HYG will have a 150B on the air. OBN has applied for ORS appointment. MKX reports that the Lowell Radio Operators Club has been reactivated. Officers are: BPH, pres.; MQV, vice-pres.; AKE, secy.-treas.; MKX and ABG, executive committee. Meetings are held the first Friday of each month. LMU has a schedule with a ham in St. Petersburg, Fla., on 28-Mc. PKH has new BC-211 frequency meter. HXK is in command of the proposed communications center of the Coast Guard Auxiliary Flotilla 412 in Winthrop. MCR, Dorchester EC, had the following report in on our test: KSA, MUD, OTZ, OKK, and MIG. MGP is trying for WAS with six to go. JXU is building a 'scope. MRQ worked two new countries. WI has a BC-348. 4DGS has new rig with handswitching for 14, 7, and 3.5 Mc. and r.f. section for 144, 50, and 28 Mc. LTC is back on the air. MGQ is working on new shack. JFG is working DX. LBY will have 350-watt rig on soon. IIM is working DX on 3.85-Mc. 'phone. BB has adopted a Dutch ham, PAØOM. MDU is working on an emergency transmitter and receiver. Our new QSL Manager is doing a swell job. OJM has three 70-ft. poles for a "V" beam. LVN, Falmouth EC, has his gang all lined up to work on the EMEN, 3745 kc. The Framingham Club is working on its annual hamfest. The Boston Hamfest will be held Saturday, Oct. 18th, at Mechanics Bldg. KB has worked 170 stations on 144 Mc. Traffic: W1BDU 92, CCF 75, LML 58, EMG 42, RM 39, BB 29, MTQ 26, LMU 19, OUD 19, LM 17, AQE 14, BL 14, LBY 12, ALP 11, KTE 10, JDP 7, MDU 7, TY 7, RCQ 6, 4DGS 5, OJM 4, IIM 3, HWE 2, LMB 2, HIL 1.

WESTERN MASSACHUSETTS—SCM, Prentiss M. Bailey, W1AZW—RM; BVR. SEC: UD. OFZ is doing a swell job on Western Massachusetts Net. MJP is new ORS. LUA is back on the net regularly now. Besides attending special ARRL Board Meeting, BVR made WAC. PIR is a new ham in Westfield. EOB made WAC in DX Contest. BIV has been doing well on 14-Mc. 'phone. You will also find Pres on 3.85-Mc. 'phone. NKN is in the throes of building a handswitching exciter. The 144 Club of Springfield is going strong and welcomes contacts from outside stations, permanent or mobile. KUE, OJV, NLE, UD, OBG, and NY are planning to go mobile when the nice weather gets around. NLE is on 50 Mc. JRA, operating from Chaper Tower at Amherst College, has made many FB contacts with its 144-Mc. crystal-controlled rig. KUE schedules NY for release and gathering of local traffic to Western Massachusetts Net. MSN is on 7 Mc. IOL is on 3.85-Mc. with new 150B. JVV is on 27 Mc. with his HT-9. JQ and FOF have new kw. rig almost ready for 3.85-Mc. 'phone. The Fitchburg Club is making good use of ARRL film library. NDR is new member of the club. Several members are interested in getting into EC work. COI worked TR1P and W6ONP/KW6 for new countries. He has a schedule with C1MG. Holly is converting some gear for 144 Mc. JGY has receiver trouble which soon may be solved with a BC-348. JLT has bumped his countries up to 87 postwar. Some new ones are KS, HZ, KG6, KP6. PXN is a new ham in Dalton. KZS worked VK3MZ using 7 watts input to Meissner Sig-

(Continued on page 88)



# LOOK OM . . . . .



## Why Should You Use Eimac Tetrodes?

### TETRODES AVAILABLE FOR AMATEUR USE

#### Type 4-125A

125 watts plate dissipation, radiation cooled, it is the accepted tetrode in its power classification for all fields of electronic endeavor.

Price \$25.00

#### Type 4-250A

Higher power version of the 4-125A, it has all inherent characteristics of other Eimac tetrodes: stability low drive, no required neutralization, and economy of operation. Rated at 250 watts plate dissipation.

Price \$36.00

#### Type 4X150A

An extremely compact tetrode of the air-cooled external anode type. Rated at 150 watts plate dissipation it can be operated at maximum ratings at any frequency up to 500 Mc.

Price \$31.00

**SIMPLE**—You want the most from your transmitter and for a reasonable cost. You want flexibility of operation . . . rapid bandswitching and frequency shifts essential for modern operating conditions, and you want circuit and operational stability throughout the life of your power tubes.

So naturally you want Eimac tetrodes to obtain the maximum in performance. For example, the 4-125A can handle a plate input of 500 watts. Because of its low drive requirements, it can be driven directly from your VFO. A pair will handle a full kilowatt input at 2500 volts, without neutralization, at all frequencies up to and including the 6 meter band. As audio amplifiers, two 4-125A's will provide 330 watts output with zero drive.

The 4-125A data sheet contains a circuit, and component lists of typical cw and high-level modulated r-f amplifiers, with modulator and driver stages. The data sheet is yours for the asking.—Write direct,

Follow the Leaders to

**Eimac**  
REG. U. S. PAT. OFF.  
**TUBES**

**EITEL-McCULLOUGH, INC.**  
1736 San Mateo Ave., San Bruno, California

EXPORT AGENCY: FRAZAR & HANSEN  
301 Clay St., San Francisco 11, California, U.S.A.

# NEW

## OHMITE OHM'S LAW CALCULATOR

Simple-Quick-Accurate!

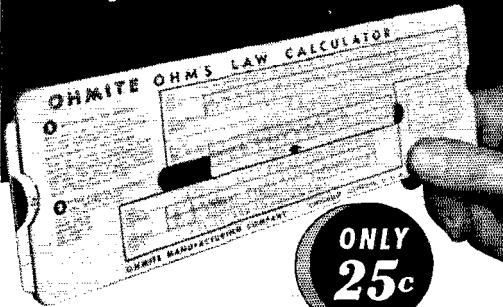

New Pocket Size  
All Computing Scales on One Side  
Also Contains Resistor Color Code

**SOLVES ANY OHM'S LAW PROBLEM  
WITH ONE SETTING OF THE SLIDE**

Here's a new and improved version of the famous Ohmite Ohm's Law Calculator that has been so popular with hams and radio engineers. Solves simple resistance, parallel resistance, and series capacitance problems. It will multiply, divide, and find squares and square roots. The range covers all values encountered in radio and industrial work. Now made in handy pocket size (9" x 3").

### MAIL COUPON FOR YOUR CALCULATOR

OHMITE MANUFACTURING COMPANY  
4863 Flournoy St., Chicago 44, Ill.

I am inclosing 25c in coin or stamps. Please send me a new Ohmite Ohm's Law Calculator.

Name \_\_\_\_\_

Street \_\_\_\_\_

City \_\_\_\_\_ Zone \_\_\_\_\_ State \_\_\_\_\_

Be Right with **OHMITE**  
RHEOSTATS • RESISTORS • TAP SWITCHES

(Continued from page 90)

nal Shifter on 7 Mc. 7EZT now is 1EZT. The Pittsfield Radio Club is planning a broadcast over WBEC, Pittsfield's new b.o. station. LKO and IZN have new BC-348s. Traffic: W1BVR 66, NY 21, EOB 23, OFZ 14, AZW 11, JAH 7, JGY 5, LUA 1.

**RHODE ISLAND** — SCM, Clayton C. Gordon, W1HRC — 4KCW will be in our section in June or July. He is on 28-Mc. 'phone and will settle in Providence. BTV has Meissner Signal Shifter driving an 807 now. DWO is tinkering with a BC-348, ECO, electronic keyer, and a superregenerative for 144 Mc. which can't hear the fellow across the court. PCQ had a copy of the Micromatch built 5 days after reading the article in *QST* and it works according to the promises in the article. INU is the new RM besides being Net Control for the R.I. Net. CAB entertained the PRA with 16 mm. sound movies from the Navy recently and has promised to repeat with more films from time to time. Horace is actively engaged in the postwar outgrowth of the old Naval Communications Reserve, and while he did not put on a recruiting drive, he did give the gang a lot of interesting information about the opportunities in this new NCR Electronics group. He seems to be enjoying his work with the Navy. We understand the Westerly group is planning a hamfest but no definite word has been received. Traffic: WHINU 192, JDX 73, BTV 26, DWO 21, ODJ 12, AJQ 2.

**VERMONT** — SCM, Gerald Benedict, WINDL — AVP now is on 28-Mc. 'phone, GKA is ORS. PTB has new SX-28 and rotatable 28-Mc. doublet coaxial fed. MUK, on 7-Mc. c.w., is located in Rutland. FSV and his XYL have new jr. operator. EKU and his XYL have new jr. operator. MCQ is at Veterans Hospital, White River, for annual tune-up. MEP has 20 watts on 50 Mc., frequency 50827.6 kc. OAK, MMN, and EKU visited NDJ. MMN has db.-20 preselector. CGV is on 28 Mc. with p.p. 812s and dipole antenna. Traffic: W1AVP 12, GKA 5.

### NORTHWESTERN DIVISION

**IDAHO** — SCM, Alan K. Ross, W7IWU — Mountain Home: IY/7 is after DX instead of traffic this time. Using 70 watts to 807s he worked some KL7s, a KH6, and two VKs on 7-Mc. c.w. Kuna: EMT has an excellent location plus full-wave 3.5-Mc. Zepp between two 70-foot poles. The Gem Net now meets at 9 p.m. Mon., Wed., Fri., to escape some of the early evening QRN. Boise: The Gem State Radio Club now is affiliated with the ARRL. APK and IGK have new jr. operators. Would like to hear from those of you who have portables and intend operating in the June Field Day. I will then send the list to each of you so we can all be on the lookout for each other. Suggest 4-Mc. 'phone, 3.5- and 7-Mc. c.w. for best results. State your gear and bands covered. I intend being on that week end, either from the mountains or a butte in the desert. If you haven't tried it before, you are missing something. CU in June. Traffic: W7EMT 27.

**MONTANA** — SCM, Albert Beck, W7EQM — SEC: BWH, Livingston. CT holds regular schedules with 8BTV every Sunday morning. Lewistown reports BYX has a tank transmitter. JRM is full-time 7-Mc. man. HBM has a BC-348. FTO has a new HRO and plans a 28-Mc. mobile rig. CAL is radio-controlling model air planes. Whitefish reports JUN active on FARM Net with 400 watts. FGB, Livingston, reports he's active on the FARM Net working c.w. CRD, in Great Falls for the summer, expects to return to M.S.C. in the fall. Great Falls reports JGG on c.w. with 813. YGE is running a photo shop. BOZ talked to KZ5ND, ex-FYN, his brother in Panama. BUJ is on c.w. The Electric City Radio Club is conducting code and theory classes. EPM is leaving Butte for parts unknown as flight operator for North West Air Lines. JHR keeps schedules with CRD on 3.5 Mc. BAY visited FL in Butte. FOM is busy these days with broadcasting. KKB, of Butte, is completing 813 rig built with rack and panel job. Montana's emergency net is going FB, according to reports from BWH. Don't forget Livingston's first annual hamfest Aug. 8th, 9th, and 10th. Traffic: W7CT 42, JUN 14, FGB 5.

**OREGON** — SCM, Raleigh A. Munkres, W7HAZ — IWU, Idaho SCM, has a good idea in listing news by towns, so am following suit this month. Portland: PARC held its first postwar hamfest recently at the Congress Hotel. The club has formed committees on public relations, BCI, and publicity. The following are active on 28-Mc. mobile: AEF, SF, HTS, ASF, FJZ, HKU, EYA, JQQ, and DEX. New call

(Continued on page 96)

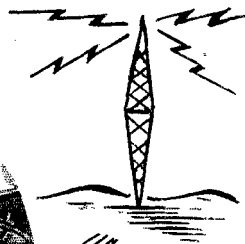
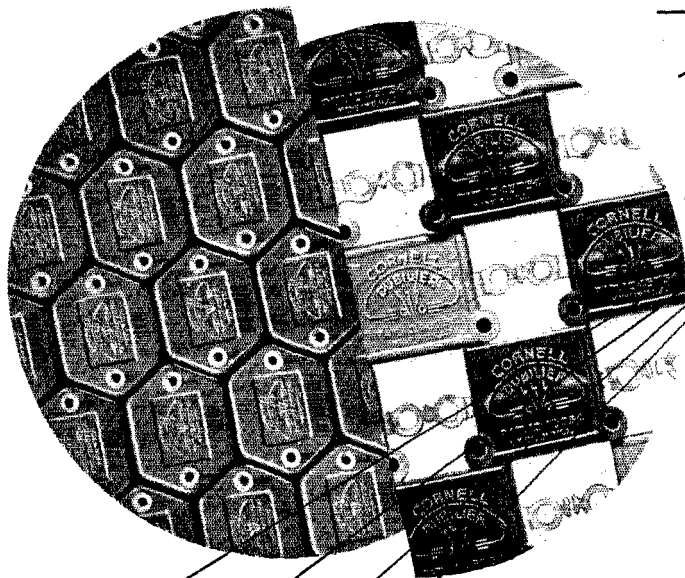

Wherever the schematic  
calls for  a C-D will do the job Best

A FEW OF THE MANY C-D TRANSMITTING CAPACITORS



**TYPES 4 AND 9** — C-D Mica Capacitors Types 4 and 9 are designed especially for grid- and plate-blocking and r-f by-pass functions in low-power transmitters. High stability under the most gruelling conditions.



**TYPE T** — C-D's Type T Dykanol Capacitors feature small size, light weight, low dielectric stress and long life at high operating temperatures. They are the finest and most dependable transmitter capacitors obtainable.

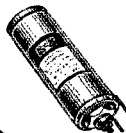

**TYPE TLA** — C-D Dykanol Capacitors Type TLA are ideal for compact high-voltage filter applications in h-f portable transmitters and receivers. They are built to "take it."



**TYPE TQ** — C-D's Type TQ Dykanol Capacitors are designed primarily for filter circuits. They provide extreme mounting flexibility, with insulated terminals and universal mounting rings for placing the unit in any position, either above or below panel assembly.

**CORNELL-DUBILIER**  
world's largest manufacturer of  
**CAPACITORS**

1910



1947

SEND FOR FREE CATALOG NO. 195A — A complete display of the world's most widely used capacitors. Write to: Cornell-Dubilier Electric Corporation, Dept. JA6, South Plainfield, New Jersey.

MICA — DYKANOL — PAPER — ELECTROLYTIC

# For Regular Values... Check the RADIO SHACK

## COLLINS AN-ART-13 XMTR

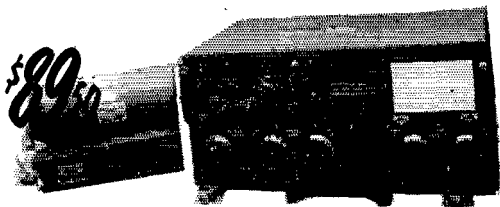

This high quality transmitter, covering 1500 KC to 12 MC represents real value for amateur use. Complete with tubes. Shipping weight, 90 lbs.

**SUPER SPECIAL  
BRAND NEW 807's**  
Westinghouse  
JAN-inspected  
70c  
each

3 for \$1.95  
6 for 3.75  
**THE BUY OF A  
LIFETIME**



## GOVERNMENT SURPLUS TUBES

Type	Net	Type	Net
2AP1A	\$5.25	801	\$9.95
2C34	1.12	802	1.72
2C40	2.62	803	1.57
2D21	.60	809	9.00
35T	1.95	811	1.79
VR75	.90	813	6.75
VR90	.75	814	4.50
VR105	.75	836	1.50
VR150	.75	840	2.70
3B24	3.00	866A	.75
3C24	1.20	872A	2.25
5CP1	6.00	874	1.95
5CP7	9.00	914	5.62
5U4G	.45	860	3.00
5V4G	.85	923	.45
5Y3GT	.28	931A	1.87
5X4G	.55	991	.30
5W4	.55	1614	1.50
6AK5	.90	1619	.75
6C21	13.50	1624	.90
75TL	2.25	1625	.75
250TH	9.00	1626	.60
		1651	.75
		8005	\$3.15
		5R4GY	.94
		8000	6.00
		956	.75
		957	.75
		958	.75
		959	.75
		954	.75
		955	.75
		9001	1.05
		9002	.90
		9003	1.05
		9004	.90
		9005	1.05
		9006	.60
		3B24	3.00
		832	2.25
		(VT118)	2.62
		810	1.20
		3C24	3.00
		3BP1	2.25
		826	.75
		884	.90
		(VT222)	2.25
		2X2A	.90
		815	2.25
		(VT287)	3.00
		3E29	3.00

## Micro Match

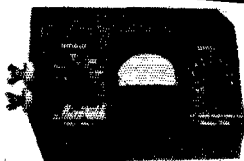

Indispensable for quick, accurate match of impedances and adjustment of your rig to top efficiency.

**\$29.50**

Reads standing wave ratio at any point in 70 to 300 ohm line • reads RF power in line, from 10 to 1000 watts at any frequency from 3 to 30 mc • the indispensable tool for the critical amateur • exclusively at the Radio Shack in Massachusetts.

## LATEST RECEIVERS

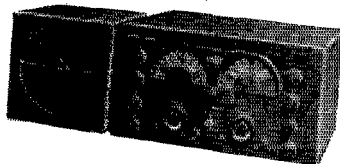

### NATIONAL RECEIVERS

NC-173	\$189.50 complete
NC-240D	241.44
NC-46	107.40
HRO-5TA-1	306.71
Model 1-10A	67.50

### HAMMARLUND RECEIVERS

HQ-129X	\$173.25
SP-400X	342.00

### R M E RECEIVERS

R M E-84	\$98.70
R M E-45	198.70

### HALLICRAFTERS RECEIVERS

SX42	\$275.00
S40	89.50
S38	47.50

All sets complete with speakers except SX42 and 1-10A.

### IMMEDIATE DELIVERY

Time payments available on all standard receivers. \$5.00 deposit will hold receiver of your choice.

We also distribute the complete line of Millen equipment, Sonar apparatus, Supreme Xmtrs, Collins receivers and transmitters.  
Write us for your every requirement.

## XMTG CAPACITORS

Nationally known, high-voltage, oil xmtg capacitors, all in rectangular cases, with stand-off insulators.

Mfd.	Volts d-c	Net Ea.	Mfd.	Volts d-c	Net Ea.
4	600	\$0.71	2	1500	\$1.20
6	600	.79	4	1500	1.59
8	600	1.19	6	1500	1.79
10	600	1.29	2	2000	2.95
2	1000	.71	8	2000	3.75
4	1000	1.19	2	2500	3.25
8	1000	1.49	2	3000	3.45
10	1000	1.79	4	3000	4.25

## BC-456-B MODULATOR

Has carbon mike input to 1625 screen-grid modulator with 12J5GT side-tone oscillator and VR150-30 regulator; also includes 28 v.d.c. dynamotor plate supply with excess output ample for xmtr. Shp. wt. 15 lbs. Net price \$4.95.

# Now... LOWER PRICES on Value Proved Surplus Gear

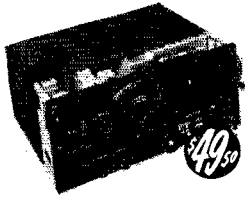

\*The one and only original **RADIO SHACK** is located in Boston and has no branches or affiliates elsewhere.

## BC-348 RECEIVER ...

Easy handling; constant sensitivity on 6 band-switched ranges from 200 kc to 18 mc (less BC band); Xtal filter, AVC, MVC, BFO, automatic noise compensator, temperature-compensated oscillator; output at 300 or 4000 ohms; vernier tuning all bands. Complete with built-in dynamotor, tubes, and instructions for conversion to 110v a-c. Shipping weight, 60 lbs.

COMPLETE A-C CONVERSION KIT FOR BC-348.....\$6.50

## BC-312 RECEIVER

A REMARKABLE

BUY AT ONLY  
**\$19.50**

Complete with tubes

Used — Quantity Limited

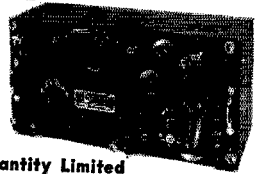

These sensitive, stable, Signal Corps receivers give smooth operation on both phone and CW with continuous, 6-band coverage from 1.5 to 18 mc; easily adapted to 110 volts a-c. Order now — **FIRST COME — FIRST SERVED!** Shp. wt. 60 lbs.

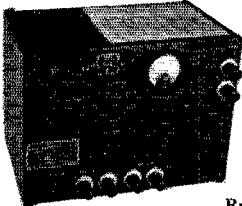

**BARGAIN for BEGINNERS**  
**BC-187-A XMTR**  
**\$9.95**

Rugged MOPA made of finest parts in a style ideal for experimenters. Designed for 2.4-3.7 mc; easily converted to 80-meter band. No new Ham should miss this buy. Shp. wt. 40 lbs.

Speed delivery and save C. O. D. charges — send full amount with order. 50% deposit required on all C. O. D. orders.

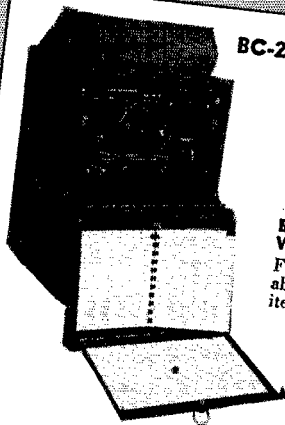

## BC-221 FREQUENCY METER

Fundamental ranges are 125-250 and 2000-4000 kc. Complete with tubes, original crystal and calibration charts. Excellent condition. Order today! BC-221.....\$39.50

**BC-221 MODEL AK WITH MODULATION \$79.50**

Fully equipped as described above. As good as new. Limited quantity.

The BC-221 makes an exceptionally fine VFO — W7NU tells how in March QST.

**RECEIVERS • MOBILE • XMTRS**  
**\$5.95 each**      **\$5.95 each**

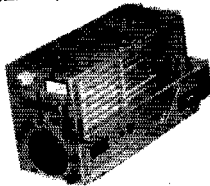
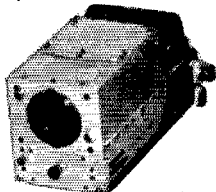

**RCVRS** Great for stand-by on 40-80 meters; phone or CW; ample band-spread; complete with 6 tubes and dynamotor giving 250v. output at 28v.d.c. input.

BC-453-B 190-550 KV \$5.95  
BC-454-B 3- 6 MC each  
BC-455-B 6- 9.1 MC each

**XMTRS** Furnished with 4 tubes, including 1629 magic eye, 1626, and 2-1625's; also calibrating crystal.

BC-458-A 5.3-7 MC \$5.95  
BC-696-A 3-4 MC 9.95  
Shipping Wt. — revr or xmtr — 15 lbs. ea.

## PE-103 DYNAMOTOR — \$9.00

Brand new, in original Signal Corps packing; delivers 160 mils at 500 volts; operates from 6 or 12 volts d-c; complete shock-mounted assembly includes breakers, switches, relays, filters, and cables.



## HS33 HEADPHONES

With head band, rubber cushions, cord and plug. Used, but in A-1 condition. Only **\$1.95**

# The RADIO SHACK Corp.

CABLE ADDRESS • **RADIO SHACK**  
167 WASHINGTON ST., BOSTON, MASS., U.S.A.

# Browning Instruments

## New HAM FREQUENCY METER

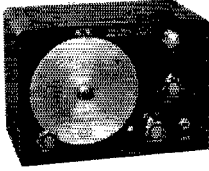

Checks all your operating frequencies with a .05% accuracy. Has direct, frequency-reading dial on seven ham bands. Audio detection of zero beat. Also an accurate ECO with an output comparable to a crystal for driving an exciter. The MJ-9 meter is an essential for your shack.

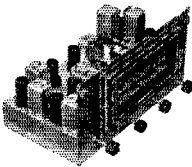

## New BROWNING TUNER FOR FM-AM

Hi-sensitivity unit with Armstrong circuit. Provides distortion-free reception on FM and quality reception on AM. Separate RF and IF systems on both bands. One antenna serves both FM and AM. Tuning eye shows correct tuning.

WRITE FOR DESCRIPTIVE LITERATURE

## OTHER BROWNING INSTRUMENTS

Model RH-10 Frequency Calibrator for full, accurate use of WWV. Model OL-15 Oscilloscope for laboratory work, production testing or research. Model S-4 Frequency Meter for mobile transmitters.



**BROWNING**  
LABORATORIES, INC.  
WINCHESTER, MASS.

(Continued from page 98)

of PARC is KYC. Bend; JUD schedules his brother, JOP, in Hood River. GSI is chief operator and JIP, operator, at KBND. GNJ is working hard to get HHH's 127Aa on the air. Medford: ORS DBZ reports new call in town, KUI, EQ, HLF, and DBZ are on 144 Mc. FSP, JSA, and FYF should be on soon. Forest Grove: FBX reports MA is on with a tank job. BFO, an operator at KEK, Hillsboro, is handling considerable traffic. How about a traffic report to the SCM, OM? Milwaukee: KJE has new receiver and is building new 125-watt transmitter. He has applied for appointment as ORS and EC. LaGrande: HBO is practically on 28 Mc. for the first time. In fact, any stage of his transmitter will go on 28 Mc. independently without benefit of excitation! We understand CHN is going to start listening on more than one band when he calls CQ, thereby not missing any stations that might be calling him! A ZL reports hearing ARZ on 3.85-Mc. 'phone.

## PACIFIC DIVISION

NEVADA — SCM, N. Arthur Sowle, W7CX — Asst. SCM, Carroll Short, jr., 7BVZ. SEC: JU. ECs: TJY, OPP, KEV. RM: PST. PAM: KHU. OBS: JUO. OES: TJL. KVF is on 7-Mc. c.w. JU has a new vertical antenna 50 ft. high coaxial fed from the new final. JUO is working DX on 14-Mc. 'phone with a kw. KRI has low-power 'phone on 3.85 Mc. JLN is on 3.85 Mc. KOH has five-element beam on 28 Mc. DVJ is on 28 Mc. and uses a 4-250A and an S-C beam. PEC has f.m. and a.m. mobile on 28 Mc. KLK has added 3660-ke. c.w. to his rig. 6CE, the Nevada Amateur Radio Assn., sends code instruction on 3898 kc. nightly. KHU now operates 14 Mc. as well as 3.85-Mc. 'phone. GC has a Super Pro. JNZ has 300 watts c.w. on 3660 kc. PST operates with temporary antenna low power, c.w. only, on 3660 kc. JLM is on 14-Mc. 'phone with a kw. QYK is on 3660 kc. with a tank rig. Traffic: W7KHU 146, TJY 45, CX 24, KLK 2.

SANTA CLARA VALLEY — SCM, R. E. Pinkham, W6BPT — Asst. SCM, Geoffrey Almy, 6TBK. RM: CIS. PAM: QLP. After the smoke of the DX battle has cleared it looks as though CHE will be the top man in this section with a score of about one hundred thousand points. MUR is the proud father of a jr. operator. WUI has installed the clipper and filter in his speech amplifier, enabling him to keep his modulation up at the hundred per cent mark with a decided improvement in his DX contacts. JSB is keeping daily schedules with Manila, Saipan, and Mexico City. Anyone having traffic going to these points should contact Cecil for sure clearance. TBK reports that the Oahu Radio Club has been formed in Honolulu. This club wishes to be affiliated with the ARRL. ZZ worked XU6GRL and KH6DD on four bands during the contest. KG is building a 28 Mc. converter using 6AK5s. NYS is wiring transmitters for a living now. QLP has quarter-wave spaced his beam with improved results. HC has been appointed Class I OO. Harry's measurements came within 15 parts of a million. LCF has an R9er to match his antenna to the receiver and reports about 30-db. gain on reception. We are starting our second year as SCM. It has been a pleasure to serve the gang for the past year. Keep the reports coming, being sure to get the dope in the mail by the first of each month. Traffic: W6JSB 80, TBK 7, ZZ 4.

EAST BAY — SCM, Horace R. Greer, W6TI — Asst. SCM, C. P. Henry, 6EJA. SEC: OBJ. RM: ZM. OO: ITH. EC: QDE. Asst. EC u.h.f.: OJU. The Oakland Radio Club is planning a big old-timers' night in the near future. Postwar new countries worked: TT 109, PB 95, BUY 95, and TI 92. WP is building a new converter. UMZ is getting set for rotary beams on 28 and 14 Mc. and is building new 813 final. OHO is back on 3.85-Mc. 'phone with 807 in final. WCQ has new four-element beam for 28 Mc. and worked a ZS for WAC. UZX has 72 countries in 33 zones and worked WAC in 2 hours, 40 minutes, on 28-Mc. 'phone lately. KEK is working his share of DX on 14-Mc. c.w. EJA has new folded dipole for 14 Mc. NRM is on 3.5-Mc. c.w. MQR is back on 14-Mc. c.w. with pair 100THs in final and after 22 years on c.w. is planning a little 'phone. KZF will take traffic to Pacific Islands. Frank Jones gave a very interesting talk on antennas on March 13th to the members of the Northern California DX Club, Inc. IKQ is rolling up the new countries on 14-Mc. 'phone. QLH is working on new beam. The Mt. Diablo Radio Club is planning to affiliate with ARRL. OBJ, the SEC, has new panel Ford truck equipped for radio use. Those interested in emergency

(Continued on page 98)

*Tops in*  
**Value**

**HQ-129-X**

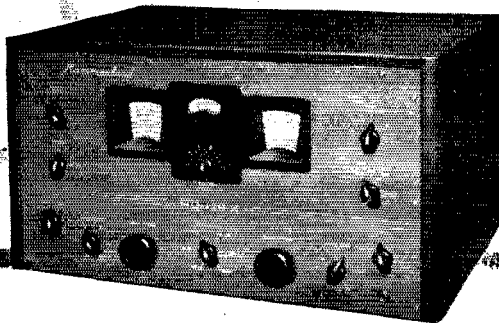

In the shack and on the air, you hear Hams talking about the HQ-129-X —“Best buy on the market.” “More for your money than anything I’ve seen.” “Real dollar value.” Yes sir, the top value of the HQ-129-X is best proved by the amateurs who own them.

And you get added value from any receiver by installing an FS-135-C Frequency Standard. When you zero beat the FS-135-C with WWV, you’ll know it’s “tops in accuracy.”

**FS-135-C**  
FREQUENCY STANDARD

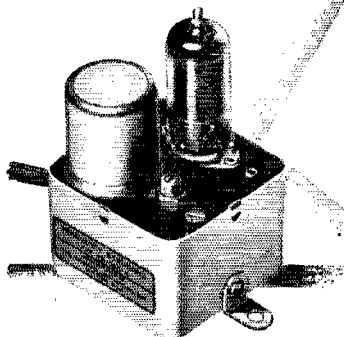

*Tops in*  
**Accuracy**

BACKED BY **37** YEARS OF KNOW-HOW

Now Available  
At Your Dealer's

**HAMMARLUND**

THE HAMMARLUND MFG. CO., INC., 460 W. 34<sup>TH</sup> ST., NEW YORK 1, N.Y.  
MANUFACTURERS OF PRECISION COMMUNICATIONS EQUIPMENT



# Prepare NOW for a Better Job in RADIO ENGINEERING



Don't Delay - Write Today!

## NEW DEVELOPMENTS SPELL NEW OPPORTUNITIES!

Yes, New Electronic Techniques—FM, Television, Micro-wave Relay Systems, Mobile Communication systems for railroads, trucks, buses and automobiles—

offer marvelous, exciting opportunities—if you are qualified! THE TIME TO QUALIFY IS NOW!

LET CLEVELAND INSTITUTE TAKE OVER YOUR PERSONAL UPGRADING PROBLEM! Qualified, competent instructors, ample, personalized instructional aids, orderly, progressively arranged study assignments in recognized, approved technical texts—these are only a few of the many superior advantages of CIRE's plan of personalized spare-time home study training for professional self-improvement.

### Cleveland Institute Courses Offer Complete Technical Training Ranging from Low-Level to College-Level

#### A. Master Course in Radio Communication.

Covers complete preparation for broadcast station employment including preparation for FCC Commercial Operator License Examinations.

#### B. Advanced Course in Radio Communication Engineering.

A college-level Radio Engineering course.

#### C. Specialized Television Engineering.

Including post-war Television Techniques.

All Courses include the remarkable Workbooks of Instructional Aids, prepared by the instructing staff of Cleveland Institute.

Choose the course best suited to your needs—Start with the section you are qualified to enter—Use the economical CIRE "Pay-As-You-Go Plan."

You may enroll for individual sections for highly specialized training. Study any one or more of the following sections if you do not require a complete course—

1. Mathematics of Radio.
2. Fundamentals of DC and AC Theory.
3. Essentials of Radio Communication.
4. Communication Networks.
5. Advanced Radio Telephony for the Broadcast Operator.
6. Audio and Radio Components and Systems (Design of Receiver and Transmitter Equipment).

WRITE FOR DESCRIPTIVE FOLDER

### Cleveland Institute of Radio Electronics

Contractors to the Canadian Broadcasting Corporation  
QT-6, Terminal Tower Cleveland 13, Ohio

#### Cleveland Institute of Radio Electronics QT-6, Terminal Tower, Cleveland 13, Ohio

Gentlemen: Please send information about your home study courses in Radio Electronics.

If a veteran, check here

Name.....

Address.....

City..... State.....

Check Training Desired A  B  C

(Continued from page 96)

work should contact Omar at once. The East Bay Section is looking for a good PAM. SSN is on the air with 1 kw. EY is working 3.5-Mc. c.w., and has new HQ-129X receiver. DUB is getting in on some of this good 14-Mc. 'phone and c.w. DX. UPV likes his new Meissner preselector. QD blew into town and, as usual, was looking for DX news items. ITH had an enjoyable trip and worked some DX while in Mexico. Have you an envelope at the QSL Bureau? If you're on the air and working DX, better keep one on hand as you never can tell. ELW has been trying to raise his son in Germany on 14-Mc. 'phone. Any ARRL member interested in handling traffic can apply to yours truly for ORS or OPS appointment. Several good stations that will send out the official bulletins via radio regularly on schedule are needed as OBS. 144 Mc. seems to be claiming interest of some of the gang. TYF's new QTH is Berkeley. IDY knocks the DX over these days on 14-Mc. c.w. and 'phone. Conditions during the DX Contest were really very poor around East Bay on both the c.w. and 'phone week ends. Traffic: W6QXN 191, TI 40, KEK 30, MQR 9, EJA 8, AR 6, TYF 5, NRM 4.

SAN FRANCISCO—SCM, Samuel C. Van Liew. W6NL—Phone JU 7-6457. Asst. SCM, Joseph Horvath. 6GPB. RM: RBQ. SEC: PTS. ECs: SRT, KNZ. Ex-9QQJ. now 6WHL in San Francisco, is active on 7-, 14-, and 28-Mc. c.w. and 28-Mc. 'phone using 813 in final, 200 watts input. Vic is working out well and needs only Delaware for WAS. EYY is keeping traffic schedules with Guam. His neighbor, 6YEL, moved to New Orleans. OJI reports working a flock of Europeans in DX Contest. RFF changed location to South San Francisco. He now has three antennas up, a 66-foot end-fed Zepp, a 14-Mc. folded dipole and a 28-Mc. folded dipole, with more to come. He still is running the same rig and power, 500 watts c.w., 300 watts 'phone. His operating time is 10 per cent traffic, 50 per cent rag-chewing, 20 per cent DX, and 20 per cent experimenting. Word has been received from our friend 6HJP, now stationed at the University of Minnesota as communications instructor, where he is assigned to the Dept. of Military Science and Tactics for Air. He hopes to have his rig on the air from new location soon. Good luck, Art, and we will be looking forward to contacting you. JWF, on Mission Trail Net, 3854 ko., checks in nightly at 6:50 p.m. He reports ZM, of the East Bay section, is back in the hospital but improving. The entire Bay area wishes you a speedy recovery. Sam. BIP is in the San Francisco Marine Hospital with a broken left ankle. He will be hospitalized for a period of two months. VVF is in the same hospital, same ward, next bed, with a badly sprained ankle. Nick fell from an antenna pole at WVV. He also will be hospitalized for two months. Looks like two months local QSO and code practice. The warning that we hams have got to stick together seems to be taking effect even in the extreme cases. We are all sorry to hear of your unfortunate accidents and hope for your quick recovery. BUG is out of the San Francisco Hospital and recovering rapidly. From Marin County: OBK, vice-president of the Marin Radio Club, who has been at the Ross General Hospital, is out and recovering from an operation. NLQ received a QSL in person from VK3AU, of Melbourne, Australia. NLQ had worked VK3AU only a week before meeting him in person. That should be a record for fast personal QSL delivery from that part of the world. The answer is that Tom Coakely is an official with the Australian National Airways and made the hop here shortly after the QSO. Tom is a 7-Mc. c.w. man. VEJ is working as engineer at the new Marin County b.c. station, KTIM, IZR, of Inverness, is on 7-Mc. c.w. with 807. FVK now has two-letter call, GZ. Thanks for the reports, gang. Traffic: W6JWF 60, EYY 33, RFF 5.

SACRAMENTO VALLEY—SCM, John R. Kinney, W6MGC—Asst. SCM, R. G. Martin, 6ZP. RM: REB. OO: ZF and OJW. OBS: OJW and AF. OES: PIV. ORS: REB, PIV, VDR, OJW, and HIR. With the coming California State Fair August 28th to Sept. 7th, the SARC is working toward its exhibit and ham booth. The SARC held its first annual ladies night April 12th. President GZY will award a beautiful trophy cup to the first member of the SARC who works at least one station in each California county since April 1, 1946. QKJ is conducting code classes for the SARC and has ten regular members at present. The California section of the Pioneer Net now includes VDR as a new-comer, besides PIV and REB as RMs. ZF is working portable with an HK257 in the final while on business in.

(Continued on page 100)



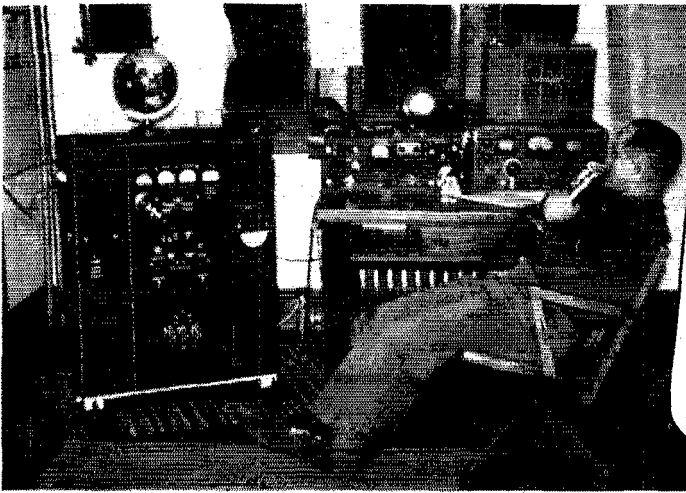

# W9CRP FB—"Equipped by ALLIED"

**W9CRP**—Herb Stamats of  
Warsaw, Indiana. Listen for him on  
10 meter phone and 20 meter CW.

## Order Your Receiver from ALLIED IMMEDIATE DELIVERY

on most models

### Time Payments • Trade-Ins Accepted

National NC-173.....	\$189.50	Hammarlund SPC-400X.....	\$347.25
National NC-46 & Spkr.....	107.50	Hammarlund HQ-129X.....	173.25
National NC-2-40D.....	225.00	RME-45 & Speaker.....	198.70
National HRO.....	274.35	RME-84 & Speaker.....	98.70
Hallcrafters SX-42.....	275.00	RME VHF-152 Conv.....	86.60
Hallcrafters S-38.....	47.50	RME DB-20 Presel.....	68.20
Hallcrafters S-40A.....	89.50	Collins 75A-1 Receiver.....	375.00

Meet Herb Stamats, W9CRP, who writes his own "Who's Who" for us: "First licensed 1930, first rig 210TNT. Then many, many tear-ups and rebuilding up to 1935—all that time on CW. At outbreak of war, everything sold to Signal Corps, so started from scratch again. Have made my WAC on ten phone and find operating the BC-610 a real pleasure. It certainly works fb. Listen for Herb on 10 phone and 20 cw. It is certainly a pleasure, OM, to deal with a house like ALLIED, and the fast, courteous service sure has been appreciated."

The pleasure is all ours, W9CRP! We got a real satisfaction out of helping you start up again. And we're proud to number you among the many top-notch stations we've equipped.

We're out to make these words—"Equipped by ALLIED"—mean something to Amateurs everywhere. We hams at ALLIED share your interests and want you to count on us always for the station supplies and equipment you need. Try us for personal service, speedy action and the kind of help you want when you want it.

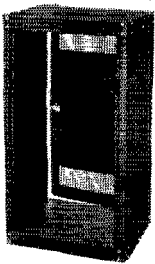

### RELAY RACK SPECIAL

Standard ParMetal Type ER-213 heavy-duty enclosed type cabinet. 42" high, with 36 3/4" panel space. Has full-length door in rear; with sturdy snap-lock. Handsome, all-steel construction, in rich, black wrinkle finish. Brand-new; in overseas packing case. Shpg. wt. 100 lbs. Regular selling price, \$29.95.

AN ALLIED SPECIAL, ONLY... \$18.25

Keep This Buying  
Guide Handy...



ALLIED RADIO CORP., D. L. Warner, W9IBC  
833 W. Jackson Blvd., Dept. 27-F-7  
Chicago 7, Illinois

- Send FREE 1947 ALLIED Catalog.  
 Enter order for.....  
 Enclosed \$..... Full Payment     Part Payment  
 (Balance C.O.D.)  
 Send Literature on Receivers and Time Payment Plan

Name.....

Address.....

City..... Zone..... State.....

# ALLIED RADIO

Everything for the HAM

# FOUR-20

TRANSMITTER



Start  
with the **FINEST**

Stop in at your dealer's and look inside the **FOUR-20**. You'll like the special output coil, the quality components, the built-in keying relay and lots of other features. Ask for a demonstration of **MONO-SEQUENCE** tuning, the new Hammarlund development that combines high efficiency with ease of control.



## HAMMARLUND

THE HAMMARLUND MFG. CO., INC., 460 W. 34TH ST., NEW YORK 1, N. Y.  
MANUFACTURERS OF PRECISION COMMUNICATIONS EQUIPMENT

WRITE FOR DESCRIPTIVE BOOKLET

100

(Continued from page 98)

Yreka. DBP is enjoying the madhouse on 14 Mc. and worked ZK1, ZS6, G3, and OK1 with a half-wave vertical antenna. OJW needs QSOs from Oklahoma and South Dakota for WAS and cards from Tennessee, South Carolina, and Delaware. WTL had schedules with 9NVR and had an hour and one-half QSO with W3KTS/KL7 on Adak on c.w. AK has new Signal Shifter. WSI has a new Meissner Signal Shifter and is on 3.5-Mc. c.w. MGC is fighting bugs out of his 6L6, 807, 35TGs p.p. MGC wishes to thank the fellows that consistently send in their reports. There are others who promise to, but it is hard to make copy from promises. Please send in reports, fellows. Traffic: W6REE 33L, PIV 49, VDR 30, HIR 12, DBP 2, OJW 2, ZF 1.

**PHILIPPINES** — Acting SCM, Craig B. Kennedy, KA1CB — All KA licenses are to be renewed. No new licenses will be issued. The Philippines have taken the first step toward requesting U. S. A. and Philippine government reciprocity in licensing. KA1CB is on 14160 kc. and would like schedules for traffic. There is very little activity in the civilian circles here. KA1ABA, KA1SS, KA1AK, KA1ABM, KA7GC, and KA1CB are most active now.

**SAN JOAQUIN VALLEY** — SCM, James F. Wakefield, W6PSQ — The Stockton Club had a swell outing on May 4th at Angels Camp Fair Ground. The turnout was swell and everybody walked away with something, if not a prize at least the memory of an enjoyable day. While on the get-together subject, Fresno held its first postwar hamfest with a capacity house. It was a miniature convention and up to the prewar standard. Any of you who missed either of these events should have regrets. VPV is on with an e.c.o. and GHS has a 6L6 on the air. INP has been on the valley end of the OVK in Redwood City contact on 144 Mc. JPU and PSQ have been burning the midnight oil trying to make the hop over the mountains to Jim. All they can depend on is UID, in Porterville, and DYJ and RJE, in Bakersfield. That last is 110 miles over the flat country, but don't discount the reflection off the Sierra Peaks. KUT is back in the DX with a new three-element beam and the same old 354-E kicking it out. For the ex-Fresno gang the get-together frequency any night is 3940 kc. 7BVZ, 6NJQ, MVU, LNN, HYG, and 7JEA have met the old gang. From Bakersfield comes the following: LRQ and BKC are on 3.85 Mc. ORT and WC are on 3.5 Mc. low power. DYJ, RJE, and MEL are crystal-control on 144 Mc. DYJ has sixteen-element beam. He is S6 in Fresno. GEI has new XYL and WBO new QTH. QON is on 28-Mc. mobile with a J2 as a result. PLJ is on 7 Mc. RJE and MEL have MBFs on 50 Mc. Appointments still are open for the section. Get your requests in.

### ROANOKE DIVISION

**NORTH CAROLINA** — SCM, W. J. Wortman, W4CYB — Thanks to Lt. Col. Joe Andrew for a report from Germany. EFG and his XYL, HWR, are operating from Wiesbaden, Germany, using the calls D4AAB and D4AIW on 14 and 28 Mc. Joe advises that QSLs should be mailed to Chaplain Andrew, HQ., USAF, APO 633, N. Y. NI has 600 watts on 3.85-Mc. 'phone, but has 28-Mc. ambitions as a new beam is under construction. DGV maintains schedules with CO8BL. BCS is working on a 28-Mc. mast. KDI is kicking up on 14 Mc. KJS is proud possessor of new frequency meter, BC221, and will be on 28-Mc. 'phone shortly. BYA's XYL has been on the sick list, which kept Bill slowed down some. JRZ keeps busy on 14-Mc. 'phone. IZR is the envy of lots of the gang with his FB DX. DCW got the modulator working on the 814. DSO finally got the voltage up, and is going to town on 28 Mc. Our thanks to the Fayetteville-Fort Bragg gang for the swell hamfest. If you missed this one you sure missed a lot of rag-chewing. There definitely was a new idea set forth at the hamfest; namely, no long-winded speeches. LSU is new call in Charlotte. CAY sticks to 3.85-Mc. 'phone. CFL has new broad-tuned exciter working. Who has been working the short-skip 28-Mc. stuff? DCQ has a new beam and reports 100 per cent contacts out of the first dozen calls. Is anyone interested in traffic net operation? A card will bring you some interesting dope. How about a line for this column. Traffic: W4IMH 10, CAY 6.

**SOUTH CAROLINA** — SCM, Ted Ferguson, W4BQE/ANG — KMK reports on the emergency set-up and on the gang at Greenville. Those operating on 28 Mc. at Greenville are KZ, KED, KMK, IPD, IMW, CPB, ILQ, HTT, and AIS. ITP operates on 28 Mc. HWZ has new VHF-152,

(Continued on page 108)

# Here they are! TEMCO'S NEW Series R A BASIC Transmitter UNITS

Can be bought individually or  
in any combination as required

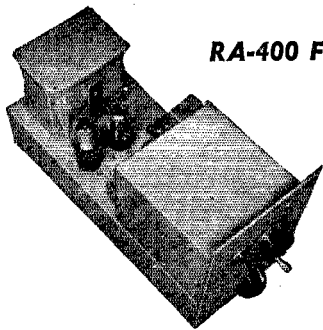

## RA-400 FREQUENCY METER TYPE VFO & CRYSTAL OSC.

This unit consists of a highly stable, temperature compensated Variable Frequency Oscillator followed by a class A isolator and a wide band frequency doubling stage, with complete voltage regulated power supply for all stages. By means of a selector switch, the wide band frequency doubler functions as a crystal oscillator with provisions for two crystals. Approximately 40 volts rms output is obtained from both the VFO and crystal oscillator; more than ample to drive succeeding frequency multipliers. Frequency coverage is continuous from 3.3 to 4.2 mcs. VFO frequency stability is comparable to that obtained from direct crystal control. Resetability is within 100 cycles at the fundamental frequency. Approximately 2000 dial divisions are available for the 900 KC range of the VFO. Plug-in type chassis with all controls mounted on front panel.

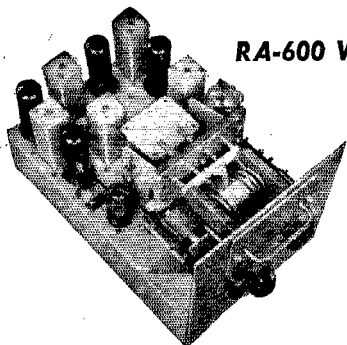

## RA-600 WIDE BAND MULTIPLIERS & POWER AMPLIFIER

The series of amplifiers and frequency multiplier stages preceding the final power amplifier, require no tuning adjustments within a single band of frequencies. Bandpass action is accomplished by coupled circuits, which, once adjusted, require no further tuning. Panel switch for band selection. Final amplifier stage (with either 150 or 250 watt input ratings) employs a panel inserted plug-in inductor. Tuning and vernier, loading by panel controls. Frequency range: 3.5-4 mcs, 7.0-7.3 mcs, 14-14.4 mcs, 21-21.5 mcs, 27.1-29.7 mcs. Output impedance range: 50 to 1000 ohms, balanced or unbalanced loads. Those interested in only one or two bands may economize by buying only required sets of coils. Automatic RF input and output connections.

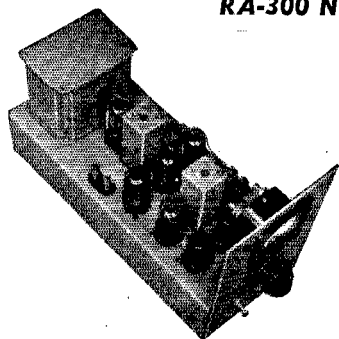

## RA-300 NARROW BAND FM SPEECH AMP-MODULATOR

This NBFM unit employs phase shift modulation of crystal controlled oscillator by means of balanced modulators which substantially eliminate even order harmonics. By the use of a 6 db per Octave PM/FM network, the following overall audio response is obtained: 300 cps-6 db, 500 cps-2 db, 1000 cps-0 db, 3000 cps-2 db, 4500 cps-6 db. Its RF output is 40 volts rms with provisions for both high and low impedance connections. Its deviation is fully adjustable from 0-5 KC at 28 mcs for 1000 cycle input. A built-in frequency deviation meter provides for proper deviation adjustment. This meter is also employed as an indicator of drive to balanced modulators. Accommodates four crystal holders selected by panel switch. All power connections emerge through rear chassis plug. Automatic RF output connection. Write for Series RA Catalog. See these chassis on display at your dealer. Other units available include AM Speech Amplifier-Modulators and Universal Low & High Voltage Power Supplies.

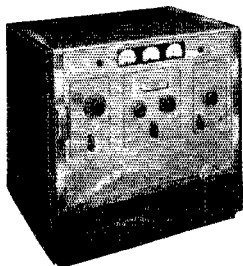

SERIES RA TRANSMITTER CABINET with 6 Basic TEMCO CHASSIS UNITS plugged into position ready to operate. These cabinets are universally wired for all combinations in 150 and 250 Watt input ratings.



TRANSMITTER EQUIPMENT MFG. CO., Inc.

345 HUDSON STREET  
NEW YORK 14, N. Y.

# SILVER

## NOW Available!

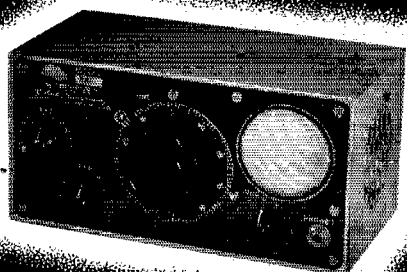

Once again, thanks a million for waiting . . . not always any more patiently than we have for raw materials . . . for the new Model 800 U.H.F. Receiver. We're tickled pink to be able to say your favorite jobber has it in stock now.

First of the new "ATOM-X" line of ultra-compact, super-value, SILVER amateur gear to go into production, we think you'll find it exactly what the doctor ordered for 144, 148 and 235 240 megacycle reception. One good reason is its price . . . only \$36.95 net ready to operate upon addition of five miniature tubes and a simple power supply you've probably got around the shack already. Basically, Model 800 Receiver is W1HDQ's February 1946 QST design for a non-radiating super-regenerator. It has a 6AK5 tuned r.f. amplifier, 9002 smooth . . . and we do mean smooth . . . super-regenerative detector, 6AU6 high-gain pentode 1st a.f. amplifier, 6AK6 a.f. power amplifier and an OB2 voltage regulator. Add 800 dial divisions . . . over 7 feet of effective dial length . . . for gobs of band-spread, built-in PM speaker, triple shielding . . . and then sum up with size only 5" x 10" x 5 1/4" . . . just the thing for portable and mobile work as well as a welcome space-saver in the main station. Operation is as sweet as sensitivity and selectivity are high.

Your jobber will be glad to let you assess the true worth of Model 800 . . . as well as its companion Model 700 Xtal-controlled Transmitter, and the other interesting new "ATOM-X" amateur equipment . . . including the increasingly popular Model 903 Absorption Wave Meter we told you about in last month's ad.

Send postcard for catalog of new measuring equipment, communication receivers, transmitters, kits, parts. See them at your favorite jobber.

OVER 35 YEARS OF RADIO ENGINEERING ACHIEVEMENT

*McMurdo Silver Co., Inc.*

1249 MAIN STREET • HARTFORD 3 • CONNECTICUT

(Continued from page 100)

ILQ and KMK are on 50 Mc. KED has three-element beam. HCZ had a fire that damaged some of his equipment. FNS is back at Clemson College. Lots of luck, Hugh. CZA is busy with his nets and trunk line. IYA is active in the 3.5-Mc. net. BSS operates on 3.85-Mc. 'phone. AZT is busy with his 3.85-Mc. 'phone net and would like to have more members. BFQ is active with the South Carolina Net. LJJ can be heard pounding them out on 7 Mc. HEV reports that he can be heard on 3.85-Mc. 'phone. FMZ is still pranking with the vitals of the 375-E and says "never say die." BEN is teaching night classes, which takes much of his time. HMG is building a new rig using 813 final. GB has moved to Columbia. Welcome back, OM. BZX has new vertical for 3.85-Mc. 'phone. Your SCM needs more reports for this column. Traffic: W4CZA 62, AZT 26, IYA 11, BFQ 8, BSS 1.

VIRGINIA — SCM, Walter R. Bullington, W4JHK — JFV is on 14- and 28-Mc. 'phone and 3.5-Mc. c.w. KAK has a kw. on 3.9- and 14-Mc. 'phone with a new Super-Pro receiver. JXE and OT are on 7-Mc. c.w. JHI has a new SX-42 receiver and a plumber's delight for 28-Mc. 'phone. RQB works on 7-Mc. c.w. BTL has an RME-69 receiver and a kw. on 3.9-Mc. 'phone. JDT has a half-kw. on 3.85, 14, and 28-Mc. 'phone. KQC has a new bandswitching exciter. JSF is on 28-Mc. 'phone with a pair of 812s and a new plumber's delight. KHE is on 7-Mc. c.w. and is experimenting on 144 Mc. JGW is working 'em with low power on 7 Mc. JXJ has a pair 813s on 28 Mc., pair 812s on 7 Mc. and has almost finished his all-band rig with pair of 250THs. IWF is on 7-Mc. c.w. ISA is on 7-Mc. c.w. and 144 Mc. He's building a rig for 28 Mc. EPK has a new two-element rotary beam and is working 3.85 and 14-Mc. 'phone. 3BUR travels but is on 7 Mc. when home. JGO has a kw. on narrow-band 28-Mc. f.m. CZK is on 3.85 and 14-Mc. 'phone. KQD is on 7-Mc. c.w. and is building new rig. JXQ is handling traffic on 7- and 14-Mc. c.w. KQF has a new converted BC-375 on 7-Mc. c.w. CA has an HRO receiver and is on 28 Mc. KPZ is on 7-Mc. c.w. IUW, Ed and Dot, are on 3.85-Mc. 'phone and are building new rig. FPS has a new RME-45 with a kw. on all bands. KSM has a new BC-348Q receiver. 4FOG is ex-3BTJ and has an RK4D32 on all bands. IOR is just back from overseas. JDX is rebuilding. KMS just received his Class A ticket and has an 812 on 3.85-Mc. 'phone. IDA has been transferred to Cincinnati. 3LEM/4 and LNV have a Signal Shifter on from Hampton-Sydney. 2LAO now is 4KXE in Portsmouth. EOP won the last CD Party. JHK has a Pee-Wee on 28 Mc. while rebuilding. Traffic: W4KXE 96.

WEST VIRGINIA — SCM, Donald B. Morris, W8JM — The Charleston (KVARA) Radio Club will hold an all-day hamfest at Kanawha State Park, near Charleston, on July 5th with a 144-Mc. treasure hunt as one of the many features. PQQ has 100 countries confirmed for first West Virginia postwar DXCC certificate. KWI is now up to an all-time high of 148 countries. HI has new 50-, 28-, and 27-Mc. converter. New hams: ACO, Charleston, AEN, Clarksburg. GSN and EYV have new 28-Mc. mobile rigs and, along with 3KUE and 3EWW, are interested in 144-Mc. work from their cabin on Spruce Knob, highest point in the State. YBI, ULA, UOW, and MIS are active on 3.85 Mc. GBF/8, operating from Webster and Nicholas Counties with low power and poor conditions, says now he knows what an island DX station has to go through. KWL, QG, and FMU are active on 28 Mc. and are experimenting with crystal grinding. ZOJ has received WAC on 28-Mc. 'phone. 3CEG keeps in touch with his family through GBF on 3770 kc. JM leads in Worked All Countries with 27, followed by GBF with 18. MOP operated on 3962 kc. DFC has new final with improved signals. Traffic: W8GBF 58, JM 37, OXO 27, DFC 13, CSF 9, MOP 2, UOW 1, YBI 1.

### ROCKY MOUNTAIN DIVISION

COLORADO — SCM, Glen Bond, W8QYT — Ex-9REU now is 6REU in San Francisco and would like to chew the rag with some of the gang on 7100 kc. The Denver Radio Club was entertained at a recent meeting with a talk by Capt. James W. Cheeks, of the Ethiopian Air Force. His call is ET3Y. DRB is again active on 27- and 28-Mc. 'phone and 14- and 3.5-Mc. c.w. Clay is trying to build a net on 3540 kc. with schedules on Sundays 4 p.m., Tuesdays 4:30 p.m. and Fridays, 7 p.m. 6JQB requests a Denver schedule on 3.5-Mc. c.w. to clear traffic from Vet Hospital. WAP schedules 7KIY ØUVL, ØEUY, and ØFEH daily at 1830 MST on

(Continued on page 104)

# MAKING TUBES IS EASY..



Sealed-in Mount

Exhausted Mount

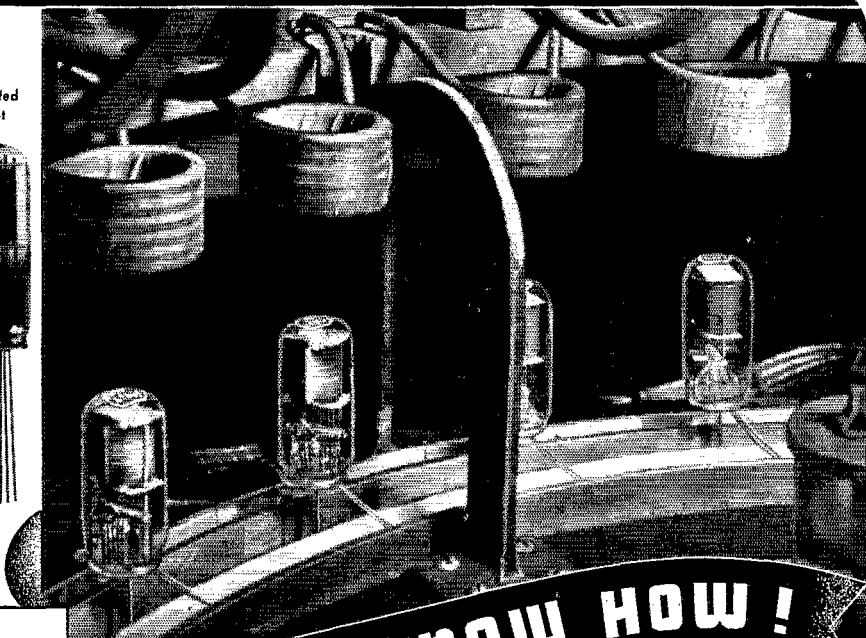

*If YOU KNOW HOW!*

## BIG TUBES MAKE LITTLE ONES

That's right. Big power tubes help build little receiving tubes. Secret of the electronic tube is its ability to pass a controlled stream of electrons through a vacuum. During the intricate exhaust process, electronic induction heating assists in creating that vacuum.

The induction heater (small illustration) is a 750-kilocycle, 6-tube, 10-kilowatt power oscillator whose tank coil is coupled to the exhaust coils. Four of these coils poised over Hytron 12SA7GT sealed-in mounts are caught by the camera a split second before the exhaust machine automatically positions them around the mounts.

High frequency current in the coils quickly heats red hot by induction the internal metal parts of the mounts. Gas driven off is sucked through the exhaust tube of each mount by the vacuum pumps. Heater leads riding in the two circular tracks supply filament power to activate each cathode. Also by induction heating, "getters" are flashed to absorb residual gasses. Fingers of gas flame finally melt and seal off the exhaust tubes.

An intricate machine—assisted by electronics itself—performs the ticklish exhaust job easily, speedily. Again know-how supplants the element of human error with the infallibility of the machine. Machine-paced, a sequence of finely-controlled precision operations gives you Hytron tubes of typically uniform quality.

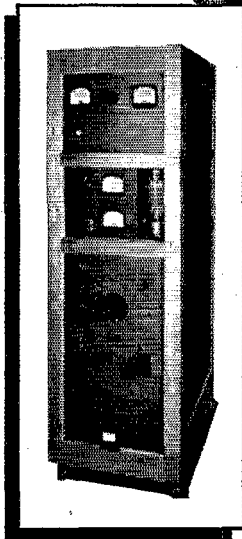

SPECIALISTS IN RADIO RECEIVING TUBES SINCE 1921



# HYTRON

RADIO AND ELECTRONICS CORP.

Have you received your copy of the new, comprehensive Hytron Miniature Tube Reference Guide? If not, write for it today.

• MAIN OFFICE: SALEM, MASSACHUSETTS

# DO YOU INSIST ON THESE ESSENTIAL CHARACTERISTICS ?

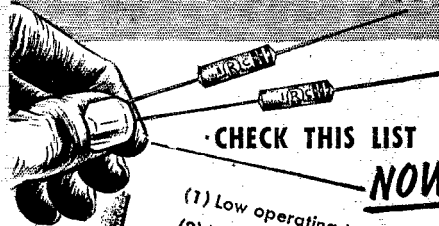

CHECK THIS LIST  
**NOW!**

- (1) Low operating temperature
- (2) Low noise level
- (3) Well anchored, easily soldered leads
- (4) Positive contact between resistance element and wire leads
- (5) Excellent wattage dissipation
- (6) Fully insulated
- (7) Maximum protection against humidity
- (8) Sturdy construction
- (9) Light weight
- (10) Compact size

When buying resistors for your rig, ask for and be sure to get IRC BT or BW Resistors ... with proven excellence in all 10 of these important characteristics.

**FREE**



Big 8-page catalog bulletin with complete technical data on all 10 characteristics plus other valuable information about IRC BT Insulated Composition Resistors and Type BW Insulated Wire Wound Resistors. Write for Bulletin F27 now.

## IRC INTERNATIONAL RESISTANCE COMPANY

401 N. BROAD STREET  
PHILADELPHIA 8, PENNSYLVANIA

In Canada: International Resistance Co., Ltd., Toronto, Licensee

Wherever the Circuit Says  $\Omega$

(Continued from page 108)

7260 and 7271.7 kc. QTC invited. Anyone knowing the address of former 9PPA, of Boulder, please drop me a card, as one of his Navy buddies is trying to locate him. IQZ at last made his Africa 14-Mc. c.w. contact for WAC. All radio clubs are urged to send the SCM activity reports on the first of each month. BCI trouble seems to have taken the DX yearn out of IXM. AAB says the gophers don't think much of the mobile guys; they don't carry any lunch. The Electron Club is planning a pre-Field Day test but we don't know if it is to test the equipment or the eats. It takes both to make a high score. Traffic: W0WAP 124, DRB 80, IQZ 12.

UTAH-WYOMING — SCM, Victor Drabble, W7LLH — DLR has remodeled his 144-Mc. mobile rig to an HY75, 615 receiver, and uses a 6J5-8V6 modulator. DAD is on 28-Mc. 'phone and is installing a new Premax beam. 6WIK/7 is active on all bands. UTM keeps daily schedules on the 7-Mc. band with 9WAP and 9UVL. SBK has a newly-built f.m. 50-watt rig. EWX is on 144 Mc. FST's old windmill tower and the 28- and 14-Mc. beams are ready to erect. KPI has a new narrow-band f.m. exciter for 28-Mc. operation. 4GFC/7 is building a new rig using a pair of 6V6s in his c.c.o. to a 6L6 and an 812 final. HDS has 300 watts on all bands with a new 6SJ7-6L6 c.c.o. ICZ is using narrow-band f.m. on 28 Mc. HLA is on 3.5- and 7-Mc. c.w. 9HVE/7 is getting his rig on 14-Mc. 'phone. The Wyoming Net has the following on 3760 kc. Mon. at 1600 MST: ABO, AEC, AMU, CHE, DXV, FLO, FWU, GSQ, GZG, HDS, HLA, HPE, HRM, HNI, HZI, KFV, KHI, KIY, and KMD. AMU is Net Control. The Shy-Wy Radio Club elected the following: ICZ, pres.; JET, vice-pres. and act. mgr.; JHL, secy-treas. The FARM Net meets daily at 9 P.M. MST and Sundays at 9:30 A.M. PA is Net Control. Traffic: W7FST 851, GBB 75, KIY 66, UTM 59, JPN 12.

### SOUTHEASTERN DIVISION

EASTERN FLORIDA — Acting SCM, W. E. MacArthur, W4BYF — Merf's transfer to Balboa went through and he has resigned as SCM. We will try to carry on until a new SCM has been elected. Meanwhile, let's have reports from everyone. The Tampa Amateur Radio Club elected the following officers: DES, pres.; PT, vice-pres.; EEW, secy.; CRA, treas.; GMJ, act. mgr. Active on v.h.f. are AQ, KM, BNR, BYR, EFK, JFH, KKS, LLP. AQ should be on 50 Mc. now and PT's kw. with an 810 should be giving West Palm Beach some competition. BIF's bandswitching rig with 812s sounds good. AFU and HAD lost 28-Mc. beams to a Gulf zephyr. GEE has gone commercial and is operating at WPD. We hope to catch one of their semi-monthly meetings at the Davis Island club-house soon. The section OBS set-up is a real one with BT, JIS, and JAV holding the 14140-ke. midnight spot and FPK, IKI, JAV, BYF taking 7170 kc. at 8:30 p.m. Monday through Friday. DOO, Martin County EC, is pushing a 3.5-Mc. kw. generator with a 12-h.p. Palmer for all his power requirements. He worked 44 countries in 21 hours during the last ARRL DX Contest. FPK has 100 stations postwar as his contribution to the Dade Radio Club DX Contest. Don't forget that June hamfest at West Palm Beach. Every ham in the State should make an effort to be there. AAR and DQW are moving traffic via Rebel Net and DQW calls into the Florida Emergency 'Phone Net once a week. He is running a 304TH to give us some contest competition. GHP schedules W5BSY/MM across the Atlantic and into the Red Sea. Visitors at HGO were QR, 1JUJ, and 3DQ. IMJ is in the State Legislature. GYZ and WS are two old-timers getting back into the game. HXM is holding his breath for that KA card. Traffic: W4DUG 2537, DQW 143, EEW 72, AFV 55, AAR 39, BYF 33, BNR 25, FWZ 20, GHP 17, IKI 2, DOO 1.

GEORGIA — SCM, Thomas M. Moss, W4HYW — The ARRL Southeastern Division Convention will be held in Atlanta June 14th and 15th, with a hamfest by the Atlanta Radio Club. Capt. John Reinartz will be principal speaker. Complete details are being mailed. HDC, activities manager of the Atlanta Radio Club, can give you more details. His QTH is 651 Collier Rd., N.W., Atlanta. The Atlanta club now is an "up and coming" organization. The staff of *The Atlanta Ham*, official organ of the club, includes HDC, editor; IEO, circulation manager; LNG, IYG, and Hull Teagard, reporters. DXI qualified in the February FMT. LNG is new OES. FXG is N6CAE in NCR NOA-7 net on 2656 kc. at 2000 EST Thursdays. The Valdosta Amateur Radio Club has received its Charter from ARRL

(Continued on page 106)

# IMMEDIATE DELIVERY FROM NEWARK OF THE NEW NATIONAL NC-173 RECEIVER

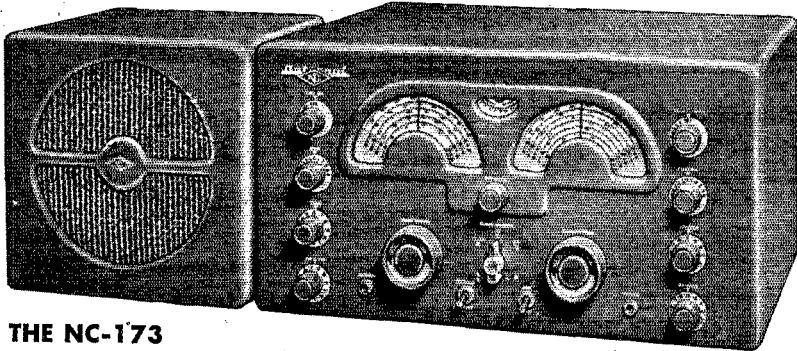

**THE NC-173**

A new and versatile receiver. Frequency coverage from 540 KC to 31 mc plus the 48 to 56 mc range. Calibrated Amateur band spread on 6, 10-11, 20, 40 and 80 meter bands. Double-diode Noise Limiter effective on both phone and C.W. reception. 6 Position Wide Range Crystal Filter. S-Meter with adjustable sensitivity for phone and C.W. reception. Photograph or Microphone pick-up Jack. Amateur Net. . . . . **\$189.50** (with Speaker)

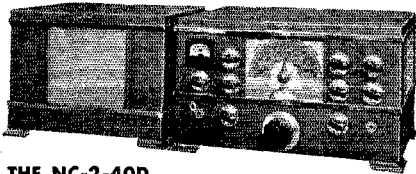

**THE NC-2-40D**

A long-range receiver with frequency coverage from 490 to 30,000 KC. 4 Amateur ranges (10, 20, 40 and 80 meters) with uniform band-spread. Single Dial Control. Temperature Compensation. Automatic Voltage Stabilization. Series Valve Noise Limiter. New, flexible crystal filter. Amateur Net. . . . . **\$241.44** (with Speaker)

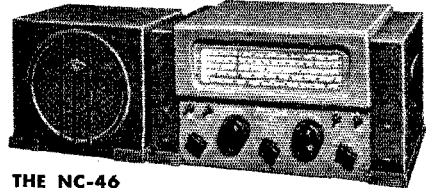

**THE NC-46**

A 105 to 130 Volt AC-DC receiver providing 3 watts of audio output. Frequency Range from 540 to 30,000 KC covered in four bands. Approximately 5 microvolts input provides a 50 Milliwatt output over the entire range. Amateur Net. . . . . **\$107.40** (with Speaker)

This famous receiver has had a number of refinements added to it including a highly efficient noise limiter and a re-designed flexible crystal filter.  
HRO-5A1 Receiver, with tubes and A, B, C, D Coils. . . . . **\$306.71**



**THE HRO-5A1**

**COMPLETE LINE OF NATIONAL RECEIVERS AND EQUIPMENT IN STOCK  
MAIL ORDERS FILLED FROM EITHER NEW YORK OR CHICAGO**

20% DEPOSIT  
REQUIRED WITH ALL  
C.O.D. ORDERS  
  
SEND FULL AMOUNT  
SAVE C.O.D. CHARGES

**NEW YORK**  
Offices & Warehouse  
242 W. 55th St., N.Y. 19

**NEWARK**  
**ELECTRIC COMPANY, INC.**

**CHICAGO**  
323 W. Madison St.  
Chicago 6, Ill.

SEND ORDERS TO  
242-S W. 55th STREET  
NEW YORK 19, N. Y.  
OR  
323-S W. MADISON ST.  
CHICAGO 6, ILL.

New York City Stores: 115-17 W. 45th St. & 212 Fulton St.

# SILVER

## "MICRO MATCH"

### "SIMPLY ASTONISHING"

So wrote QST in introducing the MICROMATCH in its April, 1947 issue. Designed by Mack C. Jones, W1PNX, the MICROMATCH at last lets you directly measure standing wave ratio in antenna—and link coupling—feeders . . . 3 through 30 mc. With it you can now put all the power your transmitter develops into the *only* spot it does any good . . . right into your antenna. We doubt if one amateur in 1,000 can do this without a MICROMATCH . . . with which you can also make your antenna "broad-band" by tuning it to "look" like a pure resistive load.

Because we think the MICROMATCH is the most important thing in amateur radio since the xtal filter, we have obtained from M. C. Jones Co. the only license he will issue to any amateur manufacturer to build it.

So—see the new SILVER Model 908 MICROMATCH at your jobber. Only 5" x 5 1/4" x 10", with big 4 3/4" rectangular meter, attractive litho-black aluminum panel, gray enamel hinged-cover cabinet, licensed and approved by M. C. Jones. We think you'll agree it's the biggest value ever at only \$29.90 net—for this \$29.90 will probably enable you to double the power actually reaching your antenna, maybe even more—and then measure it, too! See April QST for details.

OVER 36 YEARS OF RADIO ENGINEERING ACHIEVEMENT

*McMurdo Silver Co., Inc.*

1249 MAIN ST., HARTFORD 3, CONNECTICUT

(Continued from page 104)

Plans are under way for joint ownership of emergency equipment with civilian authorities. APS, BQT, AAZ, AJ, and BVK are asst. ECs for Lowndes, and the Valdosta EC group is very active under the leadership of JZV. FCZ and TL are new members of Cracker Emergency Net. The Cracker Waves Net meets at 1930 EST Monday and Wednesday, and 2100 EST Friday. QRG is 3535 kc. The March winds brought down beams all over the section. KRL/TG90C is back in TG with PAA. If your club is planning a hamfest, let's have the dope for publication. Traffic: (Feb.) W4GZF 11, EYK 7, JZV 1. (Mar.) W4KV 49, HYW 32, EYK 14, GZF 8, MA 7.

**WEST INDIES** — Acting SCM, Everett Mayer, KP4KD — BE's 15-watter worked D4 and VE3 on 28-Mc. 'phone. AM, with 25 watts on 28-Mc. 'phone, added new country for total of 22. He handled radio chess game with six boards with W9JDE, Chicago. NY4CM made a score of 153,712 in the c.w. DX Contest. AK is on 14- and 28-Mc. c.w. and works nice DX. CO, KD, and KV4AA meet almost nightly on 3559-kc. c.w. at 8 p.m., with "BM" at W1AW occasionally a visitor. DF is CGA Net Control and holds bi-monthly drills on 3559 kc. AU had 4-watt rig on 3.5 Mc. BC visited KD. EG and EK are active on 14-Mc. c.w. DO is working nice DX on 14 Mc. EN has 600 watts on 7 Mc. DT is building 807 rig for 28- and 14-Mc. c.w. AZ sold his HRO. AU, CA, CE, CO, DF, and KV4AA are active on CGA Net. AA has been heard on 3.5 Mc. Attendance on CGA drills has been poor. Traffic: NY4CM 17, KP4AM 8, KD 5, AK 2.

### SOUTHWESTERN DIVISION

**ARIZONA** — SCM, Gladden C. Elliott, W7MLL — KXB lays claim to being Arizona's youngest ham at 13; KWU is not far behind at 15. Other new Tucson calls: KWW, KXE, KXK, and KWT. PDA is running 700 watts on 7 Mc. with 813s. KYZ and KMMI work on 7260 kc. JHY is on 7-Mc. c.w. at Williams Field. KNO is working DX on an HT-9. KAE is running a kw. on 28-Mc. with 250THs. UPR is working DX from his new ranch. New officers of the Old Pueblo Club are KXE, pres.; KWW, vice-pres.; KWU, secy. MAE is temporary RM for the low speed net on 3552 kc. 6RUC/7 is on 7-Mc. c.w. in Tucson. 8UFN/7 works crystal-control on 144, 50, and 28 Mc. KRC is on 28-Mc. f.m. TCQ/KNY and REO are on 28-Mc. 'phone. LYS has a new antenna. QAV is ex-1YZ and is back on 3.5-Mc. c.w. JMB is using a BC-375 as an e.c.o. JIN is working lots of 28-Mc. DX. JOK lacks only Africa for WAC on 28-Mc. f.m. JMQ has 1/2 kw. on 28 Mc. UPM has 300 watts on 3.5 and 7 Mc. JSL is on 'phone. John C. McPhee, pioneer Arizona ham, who operated on 14 and 7 Mc. from Mesa and Window Rock, Ariz., on the Navajo Indian Reservation (6AWD), is general manager and part owner of KARV. Y.L. McPhee will be remembered as 6RZZ on the Navajo Reservation.

**SAN DIEGO** — SCM, Irvin L. Emig, W6GC — New appointments are YYW, Class 1 OO, and NDF. ORS. FVQ is operator on California Maritime training ship, *Golden Bear*. VCD keeps traffic schedules with OA4BB. 6BDU/6 reports he had a fine time in W6-Land. BAM says NRM now is in Berkeley. DCJ moved to Escondido. FMJ is active on Mission Trail Net. MKW lost antenna in windstorm. LUJ is the only amateur in this section to make BPL this month. LRU schedules G5LI on 28- and 14-Mc. c.w. and boasts 57 countries postwar, as does ML. VJQ reports his XYL's call is YXJ and that she will be on 7-Mc. c.w. YTH was heard handling lots of traffic with Japan. RGY has new Selsyn indicators on beam. GCX sounds rather good on m.b.f.m. and gets out FB. SYA is experimenting with antennas. JYJ is attending Fullerton Junior College. LDJ worked XUGRL and G6ZO on 3.5 Mc. RKL, after a long layoff, is rebuilding again! PM is getting out fine on 28 Mc. with 10 watts into classy new beam. QG won V.H.F. Marathon Award for this section. BWO has a new shack and is active on 144-Mc. mobile. DEY is trying crystal-control and sixteen-element beam on 144 Mc. RPI is building an R-9er. WWX is dividing his spare time between 28 Mc. and looking at television pictures. TIK is active on 28 Mc. with lots of Pacific schedules. QG and MKW acquired SCR-522s and are busy revamping them for 144 Mc. The following reported on 144 Mc.: DYG, RWP, SFK, VIH, and SCO. ALD says yard work is cutting into 28-Mc. operating time. YYN completed 50-Mc. transmitter and asks any interested YLs to contact her regarding membership in YLRL. APG is

(Continued on page 108)



# WANTED! Chief Engineers,

Studio Engineers, Transmitter Engineers for  
**700 FM Broadcast Stations**

*the F.C.C. predicts will be in operation by the end of 1947*

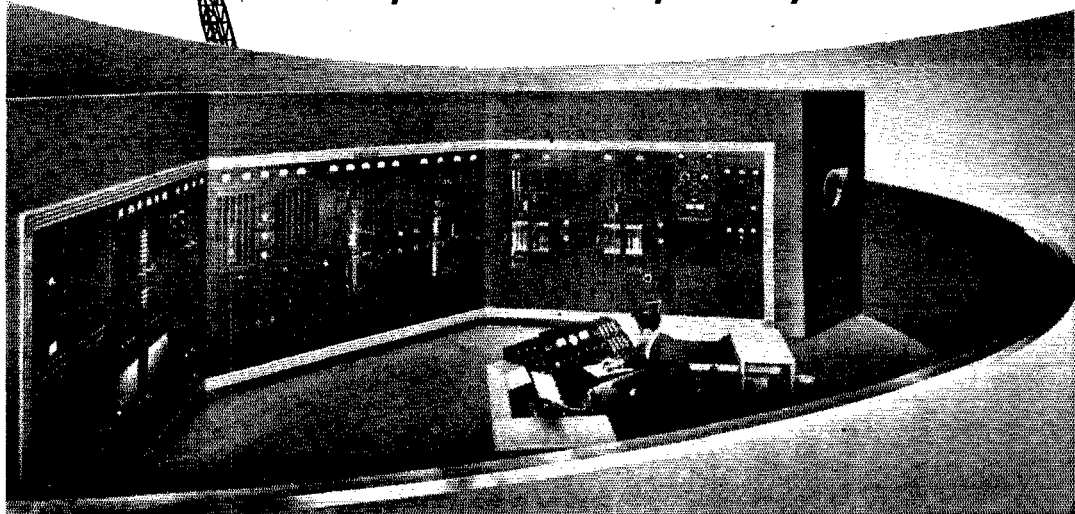

## YES, Plenty of Good-Paying Jobs... But Only for Those Qualified

FM is actually coming into its own this year... 700 new stations, says the F.C.C. Standard broadcast stations have already passed the 1200 mark. By next year there will be 3 times as many broadcasting stations (AM, FM and TV), as there were before the war. Television receivers are rolling off production lines.

Radio is not only expanding in job opportunities but it is also growing in technical complexity. Rapid developments in the field of radio-electronics are leaving many old-time radiomen far behind the parade. These are the men who fail to realize that their technical knowledge must grow with the expansion of radio itself.

What does this mean to you? It means you must study not only to hold the job which you now occupy... but study to qualify for the better job you want. CREI modern technical training can (within a comparatively short time) qualify you for the better jobs and enable you to step ahead of those who have failed to improve their ability through technical training.

Beginning *right now* CREI can provide the on-the-job program that equips you with the ability to go after—and GET—these important high salaried jobs. Get all the facts today about the unprecedented opportunities that await you. Learn how CREI spare time technical training can help you as it has helped thousands of other professional radiomen advance to better jobs during the past twenty years.

**VETERANS! CREI TRAINING AVAILABLE UNDER THE "G. I. BILL!"**

## CAPITOL RADIO ENGINEERING INSTITUTE

*An Accredited Technical Institute*

DEPT Q-6, 16TH AND PARK ROAD, N. W. WASHINGTON 10, D. C.  
Branch Offices: New York (7); 170 Broadway • San Francisco (2), 760 Market St.

If you have had professional or amateur radio experience and want to make more money, let us prove to you we can give you the training you need to qualify for a radio job. To help us intelligently answer your inquiry — PLEASE STATE BRIEFLY YOUR BACKGROUND OF EXPERIENCE, EDUCATION AND PRESENT POSITION.

MAIL COUPON TODAY FOR  
THIS 24 PAGE FREE BOOKLET!



### CAPITOL RADIO ENGINEERING INSTITUTE

16th & Park Rd., N. W., Dept. Q-6, Washington 10, D.C.

Gentlemen: Please send me your free booklet, "CREI Training for Your Better Job in RADIO-ELECTRONICS", together with full details of your home study training. I am attaching a brief resume of my experience, education and present position.

CHECK  PRACTICAL RADIO ENGINEERING COURSE  PRACTICAL TELEVISION ENGINEERING

NAME.....

STREET.....

CITY..... ZONE..... STATE.....

I am entitled to training under the G.I. Bill.

**Control and  
Protect your Rig!**

*with*  
**WARD LEONARD**

# Relays

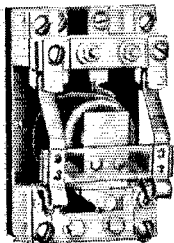

Proper relays provide convenient circuit control and greater operating efficiency. They reduce the length of connecting leads, prevent transfer of stray or transient currents to critical parts of the transmitter circuit. Types available from stock: Antenna Change-Over, Antenna Grounding, Band Switching, RF Break-In, Keying, Overload, Underload, Latch-In, Remote Control, Safety, Sensitive, Time Delay.

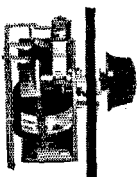

**SEND FOR  
FREE  
CATALOG**

For helpful data and information, write for Amateur Relay Catalog No. D-111.

*Authorized  
Distributors Everywhere*

Radio and Electronic Distributor Division  
**WARD LEONARD ELECTRIC CO.**  
53-B West Jackson Blvd., Chicago 4, U. S. A.

**WARD LEONARD**  
**RELAYS • RESISTORS • RHEOSTATS**

Electric control  devices since 1892

(Continued from page 106)

getting Emergency Corps organized. WNN, San Diego, worked 8ZJB, Gashland, Mo., on 56 Mc. Traffic: W6LUJ 500. APG 11, BAM 11, VJQ 7, FMJ 5, LRU 5, GC 4, OBD 4.

## WEST GULF DIVISION

**NORTHERN TEXAS** — SCM, N. C. Settle, W5DAS/MNL — Asst. SCM, Joe Bonnett, 5111. SEC: QA. PAM: ECE. RM: CDU. IKI will be on 28-Mc. 'phone. GYX is DXing at La Tuna. KIA and LWT are convention-bound. Be sure to note the announcement elsewhere in this issue regarding the West Gulf-Delta Convention.

**NEW MEXICO** — SCM, J. G. Hancock, W5HJF — LYQ is doing a little c.w. FSP is chief of radio maintenance for AACs in the North Atlantic with headquarters in Newfoundland, where he operates under the call VO2T on 3837-ke. and 14196-ke. 'phone and c.w. and 7020-ke. c.w. The Santa Fe gang is organizing a club and the following attended the first meeting: KWP, KWR, MBF, MKZ, MLE, MOI, MPO, SMA, 7AKW, 8LOC, and 8NVR. Officers and other details of the club will appear in this column as they become available. GXL reprimands the SCM for accusing him of being manager of station KFJN. He claims to be "only" chief engineer of the company, which includes the embryo station, KRTN. Dell reports the Las Vegas gang as a whole is inactive. He says JQP gets on 28 Mc. week ends and holidays. LCL is operating on 3.5- and 7-Mc. c.w. from the CAA station at Guadalupe Pass, 60 miles west of Carlsbad. MOX is a new ham at Roy on 7-Mc. c.w. and 28-Mc. 'phone. AAV is located in Wichita Falls, Tex. ENI is on from his barn two miles from Lovington. ENI, HJF, and 0YYD are getting in some chess on 3703-ke. c.w. and HJF is on that frequency at 8 p.m. daily.

## CANADA

### MARITIME DIVISION

**MARITIME** — SCM, A. M. Crowell, VE1DQ — RM: EY. SEC: FQ. EY asks all ORS to give him a buzz after his schedules any night at about 8:30 p.m., 3580-3775 kc. HJ is on 3625 and 3505 kc. ES added key click filter to the rig, per *Handbook*. EP has worked 126 countries since the war and is using break-in system to snag the DX. QU has been getting accuracy reports in the Frequency Measuring Tests of .00325 per cent. BC, QZ, and SF conducted successful 26-mile series of 144-Mc. contacts. Bill also worked XZ2DN on 28 Mc. ET and PB slugged it out during the 'phone DX Contest. FN is dragging in Jc, K6s, and ZKs. KS likes his new HQ-129X. PV and FB visited the Moncton and Lakeburn Clubs. WJ, YL operator, handled traffic on 3.5 Mc. RR raised VS7EV, a visitor to Halifax in '39. FB worked six VKs in two hours. It is possible that the HARC will sponsor its next convention during the celebration of the city's 200th birthday in 1949. PQ hooked a J recently. RH, QZ, EP, and KQ have new jr. operators. Last month's report credited HD with 500 watts. He emphatically denies this and points to his Millen 6L6-807 with pride. Traffic: VE1EY 42, LZ 34, HJ 27, OM 13, WJ 13, BC 12.

### ONTARIO DIVISION

**ONTARIO** — SCM, David S. Hutchinson, VE3DU — HU reports that the Lakehead Wireless Experimenters elected the following officers: RA, pres.; HU, vice-pres.; BIX, secy.-treas.; ANP, BBA, BMN, and UE, executive committee. On retiring, SJ, past-president, reviewed the year's activities. The club plans an active, progressive season. SY and AMC visited QB. AMC, our youngest YL, received an HQ-129X as a Christmas gift, and is working DX on 14 Mc. AWJ, our newest ORS, is active on Beaver Net. OI lost his beam in big blow. WY got bunch of new equipment. GY is rebuilding 'phone rig. ATR is high traffic man this month. QK is having BCI trouble. BHS is trying to inaugurate Transcon Net on 7 Mc., he has new 815 final. VD schedules AFZ at Sioux Lookout. BBQ reports a new ham, BNE, with a BC-375E. AZN has nice new BC-191. BBQ has new homebrew receiver. BGE got gremlins out of 807s. WI is putting 300 watts in  $\frac{1}{2}$ -wave vertical on 7 Mc. BJE, ALT, and BAT are on occasionally, on 7-Mc. c.w. PA is on with p.p. 35T in final. AWW is back in Kirkland Lake. WK is doing FB on 7 Mc. AJE is busy with VE/W Contest. The Beaver Net and the Ontario 'Phone Net are doing FB jobs. BLD and GB are building 28-Mc. portable jobs. BAJ is having trouble with earth currents. ADD writes

(Continued on page 110)

# 2 NEW RAYTHEON SUBMINIATURES

Look over these two new members of the famous RAYTHEON subminiature line. Note in the table below their special characteristics. And remember:

Since 1939 Raytheon has produced some *four million* subminiature tubes for commercial applications. There are more Raytheon subminiatures in use throughout the world than *all other makes combined*.

Remember, too, that all Raytheon subminiatures can be either soldered in, or plugged into commercially available sockets.

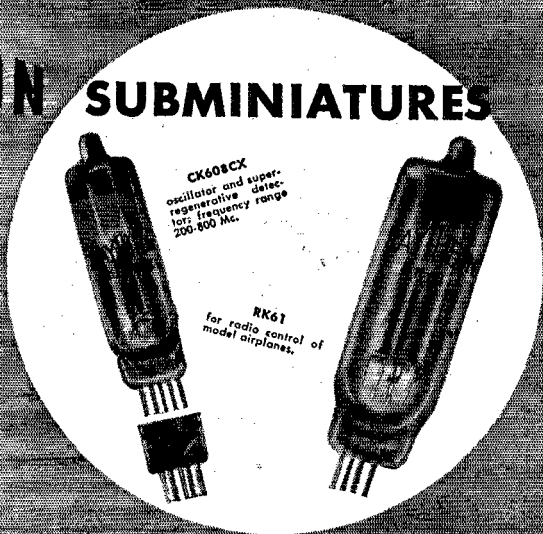

For more information, see your distributor

Characteristics of RAYTHEON Subminiature Tubes

Type No.	Remarks	Bulb Size Inches	Heater Volts	MA	Mutual Conductance Umhos	Power Output MW	Voltage Gain X	Typical Operating Conditions				Grid Volts
								Plate Volts	Plate Current MA	Screen Volts	Screen Current MA	
<b>HEATER CATHODE TYPES</b>												
CK605CX	Characteristics of 6AK5	0.38	6.3	200	5000			120	7.5	120	2.5	-2
CK604BX	Diode, equivalent to one-half 6AL5	0.28	6.3	150				150 ac	9.0 dc			
CK608CX	Triode UHF Oscillator, 1/2 watts at 500 Mc.	0.38	6.3	200	5000			120	9.0			-2
CK619CX	Triode High mu.	0.38	6.3	200	4000			250	4.0			-2
<b>FILAMENT TYPES</b>												
2E31	RF Pentode for pocket radio	0.28	1.25	50	500			22.5	0.4	22.5	0.3	0
2E35	Output Pentode for pocket radio	0.28	1.25	30	385	1.2		22.5	0.27	22.5	0.07	0
2E41	Diode Pentode for pocket radio	0.28	1.25	30	375		20	22.5	0.35	22.5	0.12	0
2G21	Triode Heptode for pocket radio	0.28	1.25	50	75			22.5	0.20	22.5	0.30	
RK61	Gas Triode, Radio Control for model planes, etc.	0.52	1.4	50				45	1.5	special circuit		
CK502AX	Output Pentode	0.28	1.25	30	550	6.0		45	0.6	45	0.15	-1.25
CK503AX	Output Pentode	0.28	1.25	30	550	9.5		45	0.8	45	0.25	-2.0
CK505AX	Volt. Amp. Pent.	0.28	0.625	30	180		30	22.5	1.25	22.5	0.04	0
CK506AX	Output Pentode	0.28	1.25	50	500	25		45	1.25	45	0.4	-4.5
CK507AX	Output Pentode	0.28	1.25	45	575	11		45	0.9	45	0.3	-2.0
CK510AX	Double Space Charge Tetrode Amplifier	0.28	0.625	50	65		150	45	0.06			0
CK512AX	Low microphonic voltage amplifier	0.28	0.625	20	160		28	22.5	0.125	22.5	0.04	0
CK520AX	Output Pentode 1/2 volt filament	0.28	0.625	50	180	4.5		45	0.24	45	0.07	-2.5
CK521AX	Output Pentode 1 mw out at 10 volts	0.28	1.25	50	400	6.0		22.5	0.80	22.5	0.22	-3.0
CK522AX	Output Pentode 20 ma filament	0.28	1.25	20	450	1.2		22.5	0.30	22.5	0.08	0
CK551AXA	Diode-Pentode	0.28	1.25	30	235			22.5	0.17	22.5	0.04	0
CK553AXA	RF Pentode	0.28	1.25	50	550			22.5	0.42	22.5	0.13	0
CK556AX	Triode, UHF Oscillator for radio use	0.28	1.25	125	1600			135	4.0			-5.0
CK568AX	Triode, UHF Oscillator for radio use	0.28	1.25	70	650			135	1.9			-6.0
CK569AX	RF Pentode	0.28	1.25	50	1100			67.5	1.8	67.5	0.48	0
CK570AX	Electrometer Triode Max. grid current $5 \times 10^{-10}$ amps.	0.28	0.625	20	125		1.5	12	0.22			-3

**RAYTHEON**

All Tubes Listed Are Available Without Fulfilling Or Government Clearance

**RAYTHEON MANUFACTURING COMPANY**

Special Tube Section, 42 Chapel Street, Newton 38, Massachusetts

RADIO RECEIVING TUBES • SPECIAL PURPOSE TUBES • TRANSMITTING TUBES

**STATION TESTED\***

*an added  
proof of Quality!*



\*Pres. W. A. Kuehl is shown at his amateur radio station W9EZN. With the war over, Walt is again pursuing his favorite hobby.

## **DRAKE RADIO SOLDERING IRONS**

Yes, Drake irons are right for radio. And these sturdy irons have proved their dependability and worth in use on countless other jobs, too, for over 25 years. That's why we say — whatever your needs, you are certain to find a Drake iron that fills the bill exactly!



**600-10**—the Drake No. 600-10 is ideal for those all important connections when rewiring your rig. Get back on the air fast. Make good dependable connections with this 100 watt 3/4" tip.



**400**—the Drake No. 400 is the perfect iron for work in small places. Only 9 inches long, it is especially designed for tight corners and delicate connections. 60 watt, 1/4" tip.



Ask your nearest supplier or write for the name of the distributor nearest you . . . and give yourself the advantages of these superior irons.

**DRAKE ELECTRIC WORKS, INC.**

3656 LINCOLN AVE.

CHICAGO 13, ILL.

(Continued from page 108)

from Oshawa that HJF is with TCA at Goose Bay, QO is on 28-Mc. 'phone, AKB is on 14- and 3.5-Mc. c.w. and 'phone with p.p. 813s, SZ has pair 801s in final, BIE is on 14- and 50-Mc. 'phone with combination beam, JV is working on 50-Mc. mobile job with 815 final and 815 modulator. AFI is strictly a 28-Mc. 'phone man. PF's XYL received her ham ticket. Traffic: VE3ATR 203, WX 149, HP 134, BCS 118, XO 77, TM 69, CAR 53, CP 46, KM 26, BHS 24, OI 22, WY 18, VD 15, AWJ 14, ATG 13, AXQ 13, AAN 6, FP 6, AYW 3, BAJ 1.

### **QUEBEC DIVISION**

**QUEBEC** — SCM, Gordon F. J. Phelan, VE2SU — RZ heard KN on 50 Mc. at a distance of about three miles. New members of the Emergency Corps include DU, PZ, RZ, TY, UJ, XB, and YG. BY is now ZZ. YG is equipped for emergency low power. DX, TH, SA, XX, OG, KS, OD, DD, and KR are now OBS. JL worked G, LA, HH, KZ, HP4, F8, and CM2 on 7 Mc. With 40 watts to an RK39, he schedules 2FM on Anticosti Island. SU attended the April meeting of the St. Maurice Valley Club. WK is working VK and ZL from an apartment, using an 807. OG worked XZ2, ZS6, ZIA, F8, CE, and VE2 to give him a 'phone WAC in eight hours. UG and JJ came along and grabbed the XZ2 (Burma) right after him. The first OES for the section is RZ. PZ is a new OPS and ORS. OB is on in Lennoxville. UO visited Montreal to chew the rag with II, VN, BB, and NR. LA is trying 50 Mc. in Quebec. TM has Code Proficiency certificate for 20 w.p.m. EA gets out well on 3.8 Mc. with grid-modulation at 150 watts. UO added another 804 in final. BB schedules WIOUW to clear up the Sunday morning traffic lag. HB lost his antenna recently; it "just disappeared." UC runs 24 watts on 28-Mc. 'phone. He broke in on a QSO between ZSIT and ZB2A to make it a round table. LT visited OG. UJ took six months to build 14-Mc. rig, then worked XUE4. OG got WAS. BB accepts traffic any week-day on 3568 kc. 6 to 6:15 p.m. DV gets out well from Arvida. Traffic: VE2BB 278, DR 218, II 77, UO 73, TM 52 SU 48. BG 13.

### **VANALTA DIVISION**

**ALBERTA** — SCM, W. W. Butchart, VE6LQ — CARA has P. O. Box 196 reserved for the club. GD, TM, FK, and AO took part in DX Contest. AO has 45 countries worked postwar, with nearly 400 off-continent QSOs. AO says the Calgary boys are looking forward to attending the Alberta Hamfest in Edmonton this summer. They well remember the FB 'Fest we threw back in '39! LZ, of Innisfail, kicked through with a letter and some news. He says BM, of Vulcan, has been going FB on 28 Mc. Ex-4AMA now uses 7ALP as Grand Forks, B.C., and belongs to AFARS there. LZ has p.p. 807s on 3.5-Mc. c.w. running 140 watts. He is proud owner of C2 frequency meter. LQ worked OAF on 14-Mc. 'phone. MJ needs Africa for WAC. EY built new preselector around 6AK5s. Both NARC and CARA members are getting set for summer work on 50 Mc. DR took six weeks holiday in States. OA, of Vegreville, has new 300-watt rig on 3.85-Mc. 'phone. SAO, of Lac La Barge, makes startling discoveries on folded doublet antennas. LG gets out FB on 14-Mc. 'phone. HM rebuilt his frequency meter around PW dial. EF has rig ready for 3.5 Mc. EL is awaiting arrival of Super Pro. WG is building VFO. Traffic: VE6LQ 20, MJ 8.

**BRITISH COLUMBIA** — SCM, W. W. Storey, VE7WS — Bill Thompson, technical advisor, gave a talk before the Vancouver Amateur Radio Club on the theory of the oscillograph at the Feb. 14th meeting. Ex-G5UB, who came over from Yorkshire on a tramp steamer, is a new member. He had a transmitter with him and used it on 1.8, 3.5, 7, and 14 Mc. Bob Manning has built a vacuum tube voltmeter. 7AEC, 144-Mc. artist from Duncan, now is working at Taylor and Pearson. ACN now is ZZ. ABD and ADB are getting their DX all mixed up. ACP got his GO9s. Verne Wileman and ABK are owners of Collins Auto-tune transmitters. HI has 50- and 28-Mc. beams. ACC may be heard on 3.85-Mc. 'phone. CX has increased his power and is doing quite well on 3.85-Mc. 'phone. HE has been on with his 2.5 watts. He is working from his new Sproat Lake Location. KE may be heard on 7 Mc. ACW is on 3.5-Mc. c.w. 7PY is heard only on 3.85-Mc. 'phone. New members of Collingwood Radio Club are KK and VF. YS is operating on 28-Mc. c.w. XT is on 7- and 14-Mc. c.w. ABP will be on 7097-ke; c.w. soon. VT is on 7-Mc. c.w. AK, on 28-Mc. 'phone, completed his 50-Mc.

(Continued on page 118)



*Custom made*  
TECHNICAL CERAMICS  
FOR ELECTRONIC AND  
ELECTRICAL USES  
SOLD ONLY TO MANUFACTURERS

**AMERICAN LAVA CORPORATION**  
CHATTANOOGA 5, TENNESSEE  
46th YEAR OF CERAMIC LEADERSHIP



BURGESS BRINGS THEM IN BETTER

FIRST CHOICE  
OF HAMS  
EVERYWHERE

# BURGESS BATTERIES

RECOGNIZED BY THEIR  
STRIPES • REMEMBERED  
BY THEIR SERVICE

(Continued from page 110)

superregenerative receiver. ADV purchased an HQ-75 kit. LF is on 50 Mc. with compact transceiver using 19 tubes. AIG was heard on 28-Mc. 'phone. OJ has moved to 14-Mc. c.w. AZ spends most of his time on 50 Mc. ADV is on with HQ-75 kit. AZ is using transceiver on 50 Mc. LF has 50-Mc. modulated oscillator. AJR is on 144 Mc. AC is on 3.5, 7, and 14 Mc. with 350 watts input.

YUKON — SCM, W. R. Williamson, VESAK — Activity was restricted most of March because of poor signal conditions. AS is putting a 10-watt rig on 3.8-Mc. 'phone. AG added an HQ-129X and Panadaptor! He has new VFO, plus rhombic for 28 and 14 Mc. AJ is filling up rack space with oscilloscope, and has to set new VFO on table alongside SX-25. AY is building up p.p. 813s for c.w. work on 28, 14, and 7 Mc. AO gives all bands a good working over. AW, a rabid c.w. man, is getting the urge to try 'phone. Plans for the summer in the Whitehorse area include a good many three-element beams, and much-promised 50-Mc. work should be starting then. AL, BC, BH, and BB have been heard. The Yukon gang, and the YARC especially, feel that special provision should be made in classifying VESAs for contests, both DX and SS. VESs outside Whitehorse, please send a postcard telling about your rig, DX, etc.

### PRAIRIE DIVISION

MANITOBA — SCM, Art Morley, VE4AM — Election of officers of the WARC was held Mar. 28th. JE is new president; NI, vice-president; Miss Leon Young, secretary; and LC, treasurer. New call heard in Winnipeg is JO, ex-5GX. JS will be signing VE7 soon. JF is on 14 Mc. again after being away several months. CX is a new 'phone on 14 Mc. Mrs. NI is knocking off all the DX to be heard. The OM gets his share, too. TV has new VFO. JE is on 28 Mc. with 807 final, 'phone/c.w. BO got commercial ticket and is at Sioux Lookout. If you want a telephone pole erected, call WF. He raises them bare-handed. RB, at Killarney, is on 3.85 Mc., as is EH, JN, and AU. There are about 50 'phone stations in Winnipeg on 14 Mc. and the QRM is terrific. Watch your signal, particularly if working this band, and keep it clean. Visitors to Winnipeg included VO2AK, VE5MW, and JN from Waskada. MM from Portage. SH is working 27 Mc. Is anyone else on this band? JM has new folded dipole up for 14 Mc. Yours truly is QRT 3.5 and 3.8 Mc. temporarily because of BCL. Let's hear from you. Traffic: VE4AM 10, AC 5.

SASKATCHEWAN — SCM, Norman Thompson, VE5CO — The Moose Jaw Amateur Radio Club held its annual supper meeting at the home of 50M. Twenty-one members along with XYLs and YLs attended. Contests included balloon blowing, the old blanket game, a memory guessing game in which the boys had to remember some twenty-odd pieces of radio equipment and write them down after a two-second look. OM and CO performed a shadow-graph operation, which included removing the arms, legs, appendix, etc., from OP. The XYLs prepared an FB lunch. DF is rebuilding and will terminate the rig with a pair of 807s. AR and JS are active on 3.5-Mc. 'phone. CZ is active on 7 Mc. during the day and will look for any of the gang on 7250 kc. LV is on the air with a slug-tuned all-band switching exciter and an 813 final. GH, in Ernfold, is on battery power. BD is running 5 watts in Maple Creek. RC, at Saskatoon, is running 10 watts evenings on 7 Mc. BE is a new ham in Moose Jaw running 50 watts to an 807 with bandswitching. KJ is qualifying for ORS. See you around 7100 kc. Traffic: VE5CZ 5, RC 3, KJ 2, DF 1.

### HAMFEST CALENDAR

NEBRASKA — Amateurs and their families are invited to the North Platte Amateur Radio Club Hamfest, to be held Sunday, June 22nd, at Cody Park, North Platte, Nebraska. An excellent program has been prepared, including the distribution of prizes. Those attending are requested to bring along their surplus gear for the auction sale; also their own family picnic lunch. Coffee will be served free. Registration starts at 10:00 A.M.

WISCONSIN — The Milwaukee Radio Amateurs' Club, Inc., is staging its 18th Annual QSO Party on Saturday, May 31st, at the Milwaukee Athletic Club. This event is always an outstanding affair, attracting hams from all over the Midwest. Prizes, speakers, refreshments and entertainment are on the program. Plan to attend!

# Who can match **UNITED** GRAPHITE ANODE TUBES?

Graphite anode tubes are now receiving hard won recognition for their superiority over metal anode tubes. This is a singular triumph to **UNITED ELECTRONICS** who has been the outstanding champion of the graphite anode idea for more than 10 years.

Present day **UNITED** graphite anode tubes employ the highest quality, most recently improved electronic graphite available. This basic material has been refined through hundreds of progressive steps. Month to month

and year to year for the past decade **UNITED** has led in this research and development. **UNITED** has forged a new era of engineering opinion in the industry.

NOW, who can match **UNITED** graphite anode tubes today? It will take more than new adventure to get apace with a technique which has long been by-passed by the majority of electron tube engineers.

Graphite anode tubes built by **UNITED** are logically your first choice.

## HERE ARE A FEW TIME-TESTED TYPES

*each with getter trap and clear glass bulb*

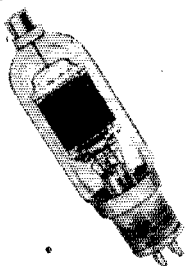

812-H

A mighty Class C amplifier and oscillator-triode. Widely used by amateurs and generally as heavy duty replacement. 300 watts input. 6.3 volt filament.

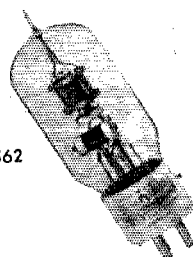

5562

New VHF tetrode: 175 watts input to 120 mcs. First graphite anode tetrode in this power-frequency range. 6.3 volt filament.

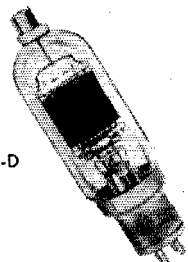

V-70-D

Similar to type 812-H. 7.5 volt filament. 300 watts input. 85 watts plate dissipation.

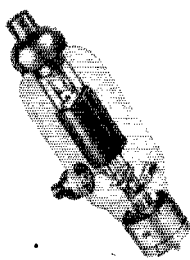

HV-18

Popular Class C amplifier and heavy duty oscillator. Widely used in communications, physiotherapy and electronic heating.

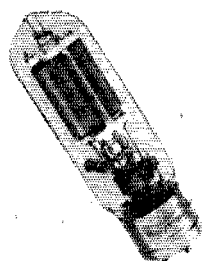

838

Effectively ruggedized to withstand impact and vibration this is the "first choice" 838. Modern design includes new **UNITED** isolated getter trap.

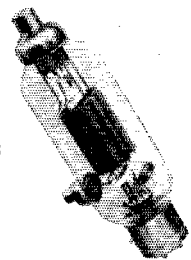

KU-23

This is a husky Class C amplifier and oscillator tube. Wide scope of instrumentation in communications as well as h-f heating fields.

WRITE FOR DETAILED ENGINEERING DATA



**UNITED ELECTRONICS CO.**

42 Spring Street • Newark 2, New Jersey

## NEW **UNITED** ISOLATED GETTER TRAP

Keeps Tube Free From Gas — Preserves Filament Emission — Prevents Getter From Depositing On Bulb.





**Get on the  
Beam to M & H  
for SPECIALS in  
HAM EQUIPMENT!**

**SURPLUS SPECIALS  
TUBES**

832A . . . \$4.95	5CP1 . . . \$4.95
811 . . . \$1.95	5JP1 . . . \$5.95
809 . . . \$1.50	5BP1 . . . \$5.95
15E . . . \$2.95	5JP4 . . . \$7.95
5BP4 . . . \$9.95	

**METERS**

2" RF 0-4 amp., G.E. . . . \$3.95
2" DC 0-300 MA., Bendix \$2.95
2 DC 0-25 amp., G.E. \$2.95

**RECEIVERS**

**IMMEDIATE DELIVERY**

Hallicrafters S38 Complete . . . \$47.50
Hallicrafters S40A Complete . . \$89.50
RME-84 Complete . . . . . \$98.70

**RECEIVERS—**

**COMPLETE WITH SPEAKER**

Hallicrafters SX42 . . . . . \$304.50
Hammarlund HQ129X . . . . . \$173.25
Hammarlund SP-400X . . . . . \$347.25
National HRO-5TA1 . . . . . \$306.71
National NC-240D . . . . . \$241.44
National NC-46 . . . . . \$107.40
National NC-173 . . . . . \$189.50
RME-45 . . . . . \$198.70

PLEASE WRITE FOR OUR NEW CATALOGUE

**M & H**

**SPORTING GOODS CO.**

512 Market St., Philadelphia 6, Pa.

**Field Day**

(Continued from page 53)

power input to the final stage (plate voltage times plate current):

- a) Up to and including 30 watts, multiply score by 3
- b) Over 30, and up to 100 watts, multiply score by 2
- c) Over 100 watts, multiply score by 1

Entries for stations located in the North-western, Pacific, Rocky Mountain, Southwestern and West Gulf divisions may have the score computed as above described multiplied by a final multiplier of 1.5 to assist in equalizing contact opportunity for Field Day set-ups in the less populous areas.

**V.H.F.—Only Score Listings:** Scores of stations using only v.h.f.—u.h.f.—s.h.f. bands will be grouped under one heading.

**Reporting:** Score claims must be shown as the sum of points for each set-up. A stations-worked list for each band must show times for each contact. A statement covering on-off times for bands and transmitters is required. State the maximum number of transmitting units in simultaneous operation at any time. Attach copies of all messages for which any credit is expected, just as handled and with time and stations indicated. Note the source(s) of plate and filament power, along with the power input, for each rig. To count, reports must be mailed on or before July 11, 1947, to constitute an entry.

In the event of any doubtful points the interpretation and evaluation by the rules committee on the matter in question will be final. *QST* listings will be based on the maximum number of simultaneously-operated transmitters used at any time in the contest period by any entrant. All units or set-ups constituting a score group are placed under the call and control of one licensee who has made the required advance notification meeting FCC requirements and who is responsible for the accuracy of all logs and records.

Design your station equipment, especially exciters and receivers, for portability and for quick connection to battery or emergency supply if power fails and necessity arises. Give yourself the ability and pleasure to set up in any location when radio links to agencies served by amateurs in the public interest may be needed. Surprisingly efficient and useful equipment may be operated from vibrator-type, genemotor or battery power supplies. Gas-electric emergency power units are excellent, whether owned or borrowed. Many groups test the machine earmarked by local agencies for the use of amateur emergency-communication leaders.

Don't miss the FD! Enjoy an outing combined with radio results! Here's luck, and let's have your report.

— F. E. H.

**SWITCH  
TO SAFETY!**







# “Particular People--

those folk at Sangamo! They know that top-notch rigs need precise, stable capacitors to stay on the air—and they have been making just such dependable capacitors for a quarter of a century.”

Old-time hams recognize Sangamo Quality . . . Get acquainted with the Sangamo line today. Your jobber can supply you.

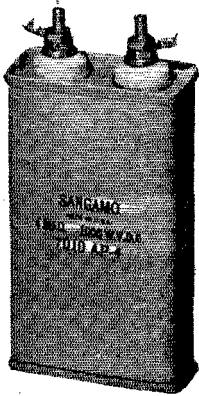

**Type 71  
Diaclor  
Impregnated  
Capacitors**

600 to 6000 W.V.D.C.

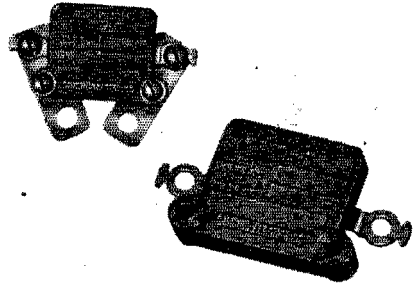

**Type H Mica Capacitors**

600 to 2500 W.V.D.C.

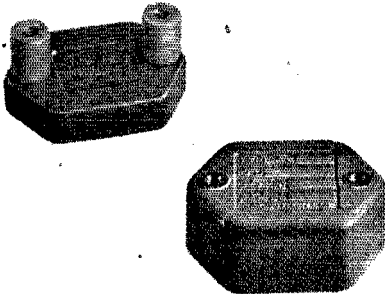

**Type A Mica Capacitors**

600 to 2500 W.V.D.C.

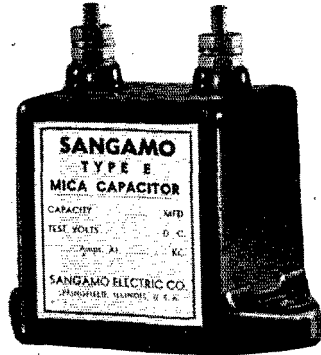

**Type E Mica Capacitors**

Specifically Designed for Hams



**CAPACITORS**  
MICA  
PAPER  
SILVER

# SANGAMO

**ELECTRIC COMPANY**

**SPRINGFIELD • ILLINOIS**

# SUMMER SAVINGS!



**LEO, WOGFQ,  
offers**

a personal service you will find nowhere else. Sooner or later you will be a regular WRL fan. A complete line of ham gear... a personal interest in your problems as an amateur... and prompt answers to your inquiries is all part of LEO'S Service.

## 3 HOT SUMMER SPECIALS

**Crystal Special**—FT 243 type holder in 80 meter band. Specify CW or phone band only. Each..... **79¢**

**Surplus Power Transformer**—220 v primary; 1400 c.t. secondary. Can be used on 110 v primary to deliver 700 c.t. on secondary. 200 MA; fully shielded. Stock No. 14-1D. Each.. **\$1.29**

**Surplus Filter Choke**—250 MA; 2000 v insulation; fully shielded. Stock No. 15-1D. Each..... **\$1.95**

### Immediate Delivery on RECEIVERS

Lowest time payment plan. We carry our own paper. Trade-ins accepted.

SX 38.....	\$47.50	NC 173.....	\$189.50
SX 42.....	275.00	(complete)	
S 40.....	89.50	NC 240-D.....	241.44
Super Pro.....	347.25	(complete)	
(complete)		NC 46 (complete).....	107.40
HQ 129X.....	173.25	National J-10A..	67.50
KP 81.....	342.00	National HRO..	307.50
RME 84.....	98.70	(complete)	
RME 45.....	198.70		

## TRANSMITTERS

WRL is headquarters for the finest in transmitters including the popular WRL kits.

Gordon Beam.....	\$225.00
Meissner Signal Shifter.....	120.00
WRL Exciter Kit (unwired).....	17.95
WRL Exciter Kit (wired).....	23.95

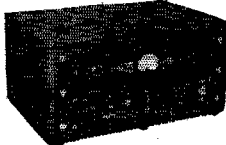

**WRL  
Globe Trotter  
TRANSMITTER  
KITS**

### Breaking Records the World Over!

A 40-watt input kit that is in a class by itself. Nothing in the market to compare in quality and price. Complete including all parts, chassis panel, streamlined cabinets, less tubes, coils and meter. Stock No. 70-300..... **\$69.95**  
Stock No. 70-312—Same as above, wired..... **79.50**  
1 set coils, meter, tubes, Extra..... **15.15**

Send for our NEW Super Value FLYER



Address  
Dept. Q-6  
Council Bluffs  
Iowa

## Dialless Converter

(Continued from page 53)

not available, an ordinary d.c. voltmeter may be used, along with an isolating resistor of approximately 1 megohm in series with the negative voltmeter lead that is to be touched to the grid of the tube. Use a high scale of the meter to decrease loading as much as possible. Although the magnitude of the voltage will be only a few volts, a small deflection of the pointer on the meter will be noticed on a high scale. The exact value of voltage is not too important; it will vary with frequency in most cases.

If a v.t.v.m. is not available, and no indication is obtained with the other type voltmeter, the oscillator may still be functioning properly; it may simply be going out of oscillation because of excessive loading when the voltmeter leads are connected to it.

At any rate, a frequency check must be made with the receiver. Tune the receiver dial to 20 Mc. Tune  $C_4$  until the signal is heard. Be certain the receiver is not responding to an image or stray beat with the receiver oscillator; adjust for the strongest signal. If the signal cannot be heard at 20 Mc., start looking for it above or below that frequency by tuning the receiver. If the frequency of the oscillator is above 20 Mc., and cannot be brought down enough by tuning  $C_4$  to maximum capacitance, either add more turns to the oscillator coil or add an additional small fixed capacitor across the coil. If the frequency of the oscillator is below 20 Mc., and cannot be raised enough by tuning  $C_4$  to minimum capacitance, remove a turn or two from the oscillator coil.

Once the oscillator has been set at 20 Mc., the signal circuits can be aligned at 28.5 Mc. This can best be done by using a 28.5-Mc. signal from a signal generator whose output is loosely coupled into the input of the converter. Or the 10-meter transmitter signal can be used, preferably by using just the oscillator, to avoid too strong a signal. While the ordinary converter which is peaked to the signal at each frequency received can be tuned by adjusting for maximum noise, this method will not work well with the broadband converter. Some signal source is necessary. Steady received signals usually are not available when most wanted for alignment purposes.

When the converter has been aligned, all of the tuning is done by the regular receiver, and station frequencies can be read from the receiver tuning dial by adding 20 Mc. to the receiver calibration. You will find that you have a very convenient receiving system for the 10- and 11-meter range, with no images and all of the sensitivity you will ever need.

## ~~Strays~~

What is believed to be a record for tube life is the continued performance of a pair of RCA-872 mercury-vapor rectifiers installed ten years ago in the transmitter of WSAU. Operating 16 to 18 hours daily in b.c. service, the accumulated time of each tube is well past the 55,000-hour mark.

# KENYON has a "REP" ..

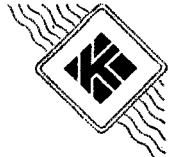

*everywhere!*

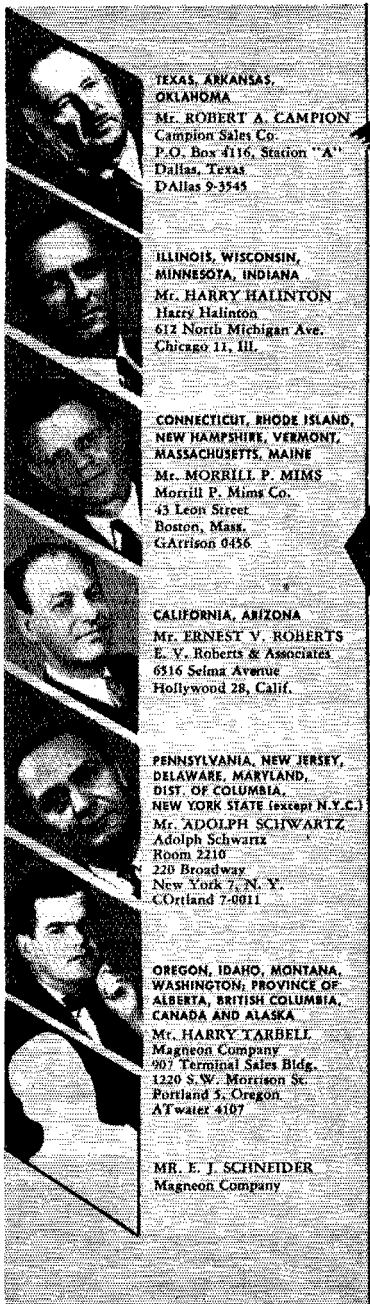

TEXAS, ARKANSAS,  
OKLAHOMA  
Mr. ROBERT A. CAMPION  
Campion Sales Co.  
P.O. Box 4116, Station "A"  
Dallas, Texas  
Dallas 9-3545

ILLINOIS, WISCONSIN,  
MINNESOTA, INDIANA  
Mr. HARRY HALINTON  
Harry Halinton  
612 North Michigan Ave.  
Chicago 11, Ill.

CONNECTICUT, RHODE ISLAND,  
NEW HAMPSHIRE, VERMONT,  
MASSACHUSETTS, MAINE  
Mr. MORRILL P. MIMS  
Morrill P. Mims Co.  
43 Leon Street  
Boston, Mass.  
Garrison 0456

CALIFORNIA, ARIZONA  
Mr. ERNEST V. ROBERTS  
E. V. Roberts & Associates  
6516 Selma Avenue  
Hollywood 28, Calif.

PENNSYLVANIA, NEW JERSEY,  
DELAWARE, MARYLAND,  
DIST. OF COLUMBIA,  
NEW YORK STATE (except N.Y.C.)  
Mr. ADOLPH SCHWARTZ  
Adolph Schwartz  
Room 2210  
220 Broadway  
New York 7, N. Y.  
COrtland 7-0911

OREGON, IDAHO, MONTANA,  
WASHINGTON, PROVINCE OF  
ALBERTA, BRITISH COLUMBIA,  
CANADA AND ALASKA  
Mr. HARRY TARBELL  
Magneon Company  
907 Terminal Sales Bldg.  
1220 S.W. Morrison St.  
Portland 5, Oregon  
ATwater 4107

MR. E. J. SCHNEIDER  
Magneon Company

GEORGIA, FLORIDA, ALABAMA,  
(except MOBILE & BALDWIN),  
EAST TENNESSEE,  
N. CAROLINA, S. CAROLINA  
Stanley K. Wallace  
Sales Agency & Representatives  
Mr. STANLEY K. WALLACE  
Lutz, Florida  
Tampa 99-144

Mr. Y. HUTTO  
2555 Mathews Ave., N.E.  
Atlanta, Ga.  
CRescent 4691  
(S. K. Wallace  
Georgia "Rep")

Mr. AL MANASSA  
2130 E. 5th Street  
Charlotte, N. C.  
(S. K. Wallace "Rep"  
for N. Carolina, S. Carolina  
and Eastern Tennessee)

Mr. H. J. ODOM  
106 Howard Drive  
College Park, Ga.  
(S. K. Wallace  
Alabama "Rep")

MR. W. C. JAUDON  
Lutz, Fla.  
(S. K. Wallace "Rep")

NEBRASKA, KANSAS,  
MISSOURI, IOWA  
Mr. J. C. SOMERS  
F. C. Somers & Co.  
18th & Grand Avenue  
Kansas City 8, Mo.  
GR 1355

Mr. I. C. SOMERS, JR.  
Kansas City 8, Mo.

MISSISSIPPI, LOUISIANA,  
MOBILE & BALDWIN, ALABAMA,  
ESCAMBIA, SANTA ROSA &  
PENSACOLA, FLORIDA,  
WEST TENNESSEE  
Mr. GEORGE H. PIERCE  
George H. Pierce Co.  
715 Camp Street  
New Orleans 12, La.

*Jobbers!  
Manufacturers!*

Contact the  
Representative of  
**KENYON**  
QUALITY TRANSFORMERS,  
in Your  
Territory  
Now!

**KENYON TRANSFORMER CO., Inc.** 840 BARRY STREET  
NEW YORK, U. S. A.

# FIRST

FOR THE  
GREATEST NAMES  
IN  
HAM RADIO



JAMES MILLEN



"Designed for Performance"

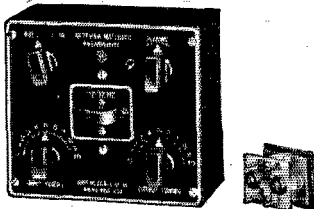

The "R 9 er"

The Millen No. 92101 is the commercial version of the popular Antenna Matching Preamplifier designed jointly by General Electric and Millen engineers. Complete with inductor for 10-11 meter band, less tube.....\$24.75

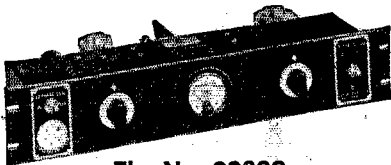

The No. 90800

50-Watt Transmitter-Exciter. Uses 6L6 and 807. Plug-in inductors available for 10-20-40 and 80-meter Ham bands. Net Price with one set of coils, but less tubes and crystal.....\$42.50

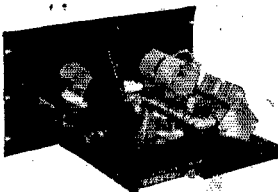

The No. 90881

500 Watt RF Power Amplifier. Uses 812s, T40s, 35Ts, etc. With coils for one band, less tubes.....\$89.50

Ham Radio Suppliers since 1919

## CAMERADIO CO.

963 LIBERTY AVE., PITTSBURGH 22, PA.

## Transmission Line

(Continued from page 44)

most every case by tuning out the inductance of the coupling coil at the transmitter. Where coaxial cable is used, with the outer conductor grounded, the series tuning condenser should be connected between the center conductor and the coupling coil. With balanced feeders, such as Twin-Lead, a series condenser should be connected between each conductor of the Twin-Lead and the coupling coil. The center of the coupling coil may then be grounded.

Good antenna performance is so dependent upon proper feeder design and behavior that we are more than justified in any extra effort expended in making the feeder system as efficient as possible.

### About the Author

● Richard M. Purinton, W9SZ, is now back in private employment as Director of Sales of the American Phenolic Corporation, Chicago, after a civilian wartime stint with the design branch of the Bureau of Ships, Navy Department. During this association his principal work was in the coordination of vacuum-tube development. Dick's first ham call, 9CXT, dates back to 1923. A member of the Eastern Mass. Amateur Radio Association, W9SZ finds his greatest hobby enjoyment in rag-chewing and experimenting.

## F.M. on Two Meters

(Continued from page 60)

siderably distorted. Reducing the audio level to the value at which distortion was no longer present reduced the audio recovery of the broad receivers to an unsatisfactory level. The number of contacts showed a sharp decline. Restoring the oscillator to the  $L/C$  ratio shown in the schematic diagram remedied the trouble and results were again found to be satisfactory.

The need for a large frequency deviation seems to rule out the present use of narrow-band f.m. for general work on the 2-meter band. In order to provide sufficient swing, the limited deviation available from crystal-controlled modulators requires so many multiplications that an unwieldy number of tubes and tuned circuits is involved. The system of modulation used during this investigation seems to offer very good possibility of providing sufficient frequency swing with a small number of multiplications and hence with few tubes and few tuned circuits. This arrangement has been found most useful in making quick frequency changes. The number of tuned circuits could be still further reduced in the transmitter shown in Fig. 1 by using an untuned p.a. grid circuit. Link coupling was used only as a matter of physical convenience. In order to provide better all-round performance of the self-excited oscilla-

(Continued on page 180)

# HERE IT IS!



**40 WATT  
INPUT**

**30 WATT  
OUTPUT**

## THE NEW NBFM MOBILE XMITTER

The MB611, Sonar's newest NBFM creation, is a compact, crystal controlled unit incorporating the exclusive Sonar circuit\* development for NBFM† used in all Sonar products. Built rugged to withstand shock and vibration, the MB611 is ideal for mounting in any moving vehicle. The pie-network system incorporated in the MB611, which will match any antenna from 30 to 600 ohms impedance, makes it an excellent unit for the shack as well.

With the separate mounting and easy accessibility to the connections, the MB611 is easily removed from the vehicle and "hooked up" anywhere.

The exclusive NBFM circuit development using phase modulation, needs NO EXTRA modulation equipment. This feature permits a definite economy of parts and space, as well as permitting phone operation with full CW rating on the final tube, giving extra power over AM operation.

**POWER SUPPLY**—Any external supply of 250 to 600 volts at 100 MA.

**FREQUENCY RANGE**—6 meters or 10 and 11 meters. Specify which when ordering.

**PHYSICAL SIZE**—10 1/8" x 7" x 5".

**RECEIVER**—ANY AM RECEIVER WILL RECEIVE

NBFM SIGNALS. (See QST March, 1947, page 30).

**FINISH**—Sonar Gray baked enamel, inside and outside (for protection against the weather) with red and white lettering for easy readability.

The MB611 is designed with easy accessibility to the lock-nut screwdriver adjusted condensers, which are tuned by means of a dual tuning eye for the prestages and a jack for the 0-100 MA meter for tuning the final and antenna pie-network. Once the unit is tuned there is no need for any further adjusting.

The many advantages of this rugged unit are unlimited. It can be used aboard ship, aboard a pleasure boat, in a car, in your summer camp or cottage and in the shack as a final or to push a hi-powered final.

SEE THE MB611 AT YOUR DEALERS.

WATCH THESE ADS FOR THE LATEST BY SONAR.

Amateur Net **\$72.45**  
(Less crystal and power supply)

\* Patent Pending.

† NBFM at present permitted on 11 meters and above 29 MEGS. In Canada on 27.395 to 27.455 and 29.5 to 29.7 MEGS.

Representatives for SONAR in Canada: Measurement Engineering, Ltd., Toronto: Frank's Agencies, Alberta

**XE-10**  
AMATEUR NET  
**\$39.45**  
LESS XTAL

SEE  
YOUR  
DEALER  
OR  
WRITE US  
DIRECT

**SONAR**  
*Radio*  
**NARROW BAND FM**

SONAR  
RADIO  
CORP.  
Box 445  
BKLYN 1,  
NEW YORK

**VFX 680**  
AMATEUR NET  
**\$87.45**  
LESS XTAL

# Immediate Deliveries!

FROM COMPLETE STOCKS

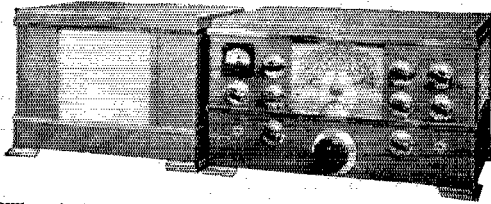

When in New York don't miss the EMI permanent radio show of amateur and professional communication equipment. See the complete NATIONAL line and many others including CML, RME, TEMCO, BUD, MILLEN, WESTON, etc. Whether you order in person or by mail you get courteous and dependable "ship today" service on all stock items.

**NATIONAL NC-2-40D Receiver** for general communication Service. 12 Tube Superheterodyne, coverage 490KC to 30MC. Amateur bandspreads, 5-step crystal filter, ANL, BFO, AVC, full vision dial. Operates on 115/230V 60cyc A.C. Price complete with matching speaker as shown, \$241.44



## CML BROAD BAND CONVERTERS

Offer the most economical and efficient way of stretching your communication receiver to cover the 2, 6, and 10 meter bands. They're fixed tuned — you tune your receiver as usual.

CML-BB 27 Ten Meter } \$27.50  
 CML-BB 50 Six Meter } EACH  
 CML-BB144 Two Meter }

## CML MODEL SS-100

### FREQUENCY STANDARD

Generates crystal-controlled 100KC and 1000KC harmonics up to 60MC for tuning, calibration and test uses. Gives positive "markers" to keep you within the bands. Takes 150V at 15MA and 6.3V at .45 AMP. — CML Model 1120 Power Supply recommended.

Price Complete.....\$27.50

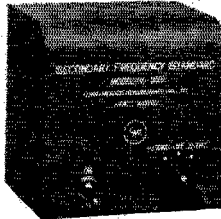

## • SURPLUS BARGAIN SPECIALS • in TRANSMITTING TUBES

NO.	EACH	NO.	EACH	NO.	EACH	SPECIALS	NO.	EACH
24G(HK24)	\$1.20	807	\$1.05	836	\$1.45	OB2		.75
RK34	1.05	814	4.45	837	3.35	6AG7		1.05
1Z40	*1.85	815	2.25	838	3.75	6AK5		.90
211	1.10	826	2.25	845	3.75	2X2		.90
803	8.75	832	2.25	860	3.00	884		.75

All tubes government inspected. Brand new.

Write for Bulletin "Q" listing exceptional bargains in military receivers, transmitters and electronic test equipment.



# ELECTRONIC MARKETERS, Inc.

190 VARICK ST. • NEW YORK 14, N. Y.

(Continued from page 118)

for the final design of this transmitter will also include an untuned push-pull isolating stage between the oscillator and the 6AG7s.

During contacts with a large number of stations using superregenerative receivers it became evident that, given an undistorted f.m. signal of sufficient deviation, good reception depended on careful adjustment of the receiver. Since the superregen is essentially an a.m. detector, audio must be recovered from an f.m. signal on the slope of the selectivity curve and the receiver must therefore be tuned to one side (generally the high side) of the received carrier. Results were found to improve tremendously by proper adjustment of the regeneration control in conjunction with this slight detuning from the center of the received signal. Best reception was usually found to be at that point where the receiver was just beyond the threshold of superregeneration, this being the most selective condition for superregenerative reception. In some cases it was necessary to adjust the antenna coupling to the detector to provide the correct set of conditions for good f.m. reception. General directions for tuning in an f.m. signal on a rush-box are as follows: back off the regeneration control until the receiver is just superregenerating and then tune off the center of the carrier on the high-frequency side until the best compromise between audio level and good quality is obtained.

The information presented in this article is in no way meant to infer that wide-band f.m. is either superior to or preferred over narrow-band f.m. for v.h.f. systems in which control of the type of receiver used is possible. It is meant to show what can be done with f.m. on 144 Mc. under present conditions. Actually the use of f.m. with most of the 2-meter receivers in use at present offers only the advantage of transmitter simplicity. The weak-signal reception and noise-suppression advantages with f.m. may only be realized with a true f.m. receiver and a good one at that. The mere addition of a discriminator to an existing a.m. receiver, while it will give better f.m. reception, will not show the f.m. in its true light. To make use of all the advantages of f.m. for communication work a receiver using a conventional discriminator must have at least one and preferably two good limiters, and the over-all gain must be sufficient to allow complete saturation of the limiters on extremely weak signals. With these requirements fulfilled, f.m. reception takes on an entirely new aspect.

The receiver used at this station consisted of a Hallicrafters S-36 modified for 2 meters. This receiver provides for a.m. or f.m. reception. In its original form the set seemed to lose its pep in the f.m. position, and for weak-signal reception was inferior to a.m. The set was further modified to correct a few obvious deficiencies so that the limiter would operate correctly, and become completely saturated at low signal levels. These changes gave the 2-meter band an altogether new dimension. Complete receiver quieting is now

(Continued on page 122)

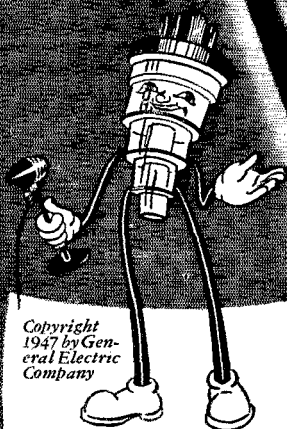

Copyright  
1947 by Gen-  
eral Electric  
Company

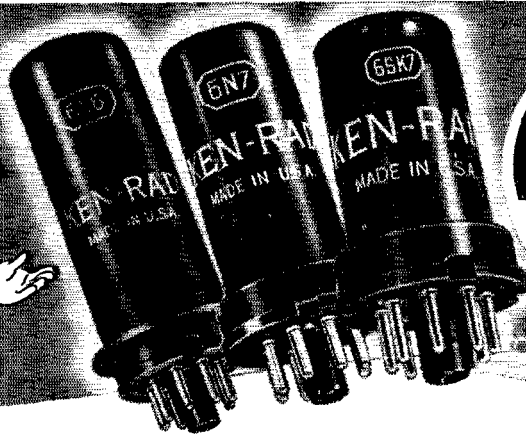

METAL TUBES

# KEN-RAD Radiogram

## Lighthouse Larry Comments:

**I**F YOU are designing a new receiver, converter, or what have you—and intend to use metal tubes—exactly which types should you select?

Here is a practical way to start. First, establish the particular application. Second, ask yourself the question, "Is there one tube better than others in most respects for this application?" Usually a little study will result in "Yes".

For instance, pentagrid converter tubes. Two popular types for this work are the 6K8 and the 6SA7 . . . Which?

Let's compare these tubes on the basis of three performance factors: oscillator transconductance, conversion transconductance, and frequency drift. Big words, but don't let them throw you! What they mean, and their relation to tube performance, follows:

If the tube is to be used at frequencies higher than 6 mc—and especially if there is broad-band tuning—it becomes extremely hard to maintain a high oscillator load impedance. Therefore, the tube should have

high oscillator transconductance, as an off-setting factor, to make sure it will oscillate properly.

High conversion transconductance, in turn, means that a tube will show a good voltage gain. Naturally this is desirable, for the more voltage gain you can get, the fewer tubes will be needed.

Frequency drift explains itself. We all want this to be low.

Now let's put the 6K8 and the 6SA7 side-by-side. You will find that the 6SA7 exceeds its companion both in oscillator transconductance (by 4,500 over 3,000) and in conversion transconductance (by 450 over 350). As to frequency drift, the graph herewith compares the curves of the two tubes, with receiver and tube operating from a cold start and tuned to 18 mc. The 6SA7's superiority is obvious.

Make no mistake—the 6K8 is a good tube, and often is applied in preference to the 6SA7, particularly in manufactured receivers. But for your own design use, you normally will find the 6SA7 better.

Comparative data on metal tubes can readily be obtained from Ken-Rad's Essential Characteristics Booklet ETR-16, which lists and rates the hundreds of different types available. Your Ken-Rad distributor or dealer will be glad to supply you with a free copy of ETR-16. It will prove a useful working guide.

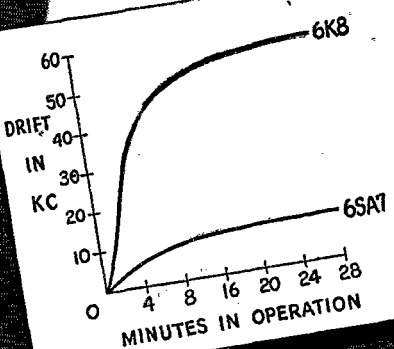

*Lighthouse Larry*

178-F6-8850

# KEN-RAD

DIVISION OF GENERAL ELECTRIC COMPANY

SCHENECTADY, NEW YORK

Make the nearest Ken-Rad distributor or dealer your preferred source for amateur tubes

# A Man-Size Rotator

## ... At a Fair Price!

Plenty husky for any beam antenna a ham can dream up!



U. S. Navy SO-1 radar antenna rotator which was designed to mount atop the masts of light craft of the Navy, and to stand up in the toughest wind and weather conditions.

### Compare These Features!

- Immediate reversing . . . no overswing.
- Sure-fire lock-in prevents antenna drift.
- Husky brackets for boom mounting.
- Extra-rugged worm-gear train.
- Choice of 1 to 2 rpm.
- Beautiful over-all mechanical and electrical construction.

Complete with power supply for 110v 60 cycle operation **\$89.00**

*f.o.b.*

IMMEDIATE DELIVERY FROM STOCK

Place your order today and be one of the lucky hams to get an SO-1 Rotator!

Slip-ring assemblies and selsyn direction indicator units also available. Write for further information.

## Electronicraft

INC.

5 Waverly Place Tuckahoe 7, New York

(Continued from page 120)

accomplished with a weaker signal on f.m. than on a.m. Signals from modulated oscillators which are too weak for comfortable copying on a.m. often jump right out to you as R5 signals when the set is switched to f.m. The broad and narrow i.f. and a.m./f.m. detection make the S-36 a versatile and quite useful receiver on a band where every possible variety of signals will be encountered.

### Sweepstakes

(Continued from page 53)

32,177, W8HHU 32,096, W1ATE 28,731, W0PV 23,602, W5FH 26,727, W1KQN 26,624, VE3HC 26,304, W2MIG 24,957, W7JUO 24,428, W9FUH 24,308, W4AQR 23,482, VE3AQB 23,256, W8REU 23,220, W9GVD/9 23,188, W2SZ 22,896, W3FUV 22,239, W4BSS 21,905, W5IGS 21,888, VE6FK 21,808, W0DD 21,780, W7DTB 21,608, W0EOZ 21,597, W0OMG 21,540, W0GZR 21,228, W8TRX 20,904, W6MLY 20,345, W2EQ 20,235, W0DEI 20,224 and W9GWL 20,140.

Leading in number of contacts on 'phone: W6ITH 400, W4YNQ 370, W6OGZ 352, W9NDA 329, W6AM 231, W8HHU 274, W9TAK 255, W1ATE 235, W5FH 228, W0PZ 228, W2SZ 215, W2MIG 213, W6CHV 211, W1KQN 209, VE3HC 207, W9FUH 206, VE3AQB 204, W4AQR 202, W8TRX 202, W7JUO 201, W6VRC 201 and VE2DD 200.

### Club Scores

Scores were submitted by 38 club groups in competition for the gavel with engraved sterling-silver band offered in each SS to the club having the highest aggregate score. Continuing firm in a determination to win a gavel for each member, the Frankford Radio Club of Philadelphia took first place again. Their total score: 1,823,926 — an improvement of almost 600,000 points over their previous showing! This group has won every club award ever offered in a Sweepstakes. It is a real pleasure to present them with their seventh gavel!

Frankford's biggest threat in '40 and '41, the Greater Cincinnati Amateur Radio Assn., ran up 1,006,664 points to take second place. The Twin City Radio Operators Assn. of Minneapolis, a new contender in the club competition, stepped into third place with a score of 495,382 points. Certificates are being awarded to the leading operators (c.w. and 'phone) in each club having three or more participants. The clubs eligible for these individual awards are listed in order of aggregate score, together with the calls of the winners.

### How To Win an SS Contest — By the Experts

Very frequently correspondents and visitors to Headquarters ask, "How can one operator make

(Continued on page 124)



# We're Still BLUSHING!



## An apology to a Lot of Old Time Hams who are wondering if we don't know a Welcome Mat from a Call Letter

We haven't been so embarrassed since the time we accidentally brushed an elbow across the terminals of a charged transmitting capacitor that hadn't been protected with Sprague Lifeguard Safety Caps!

It happened this way:

For several months now, we've been sending "Welcome!" notes to newly licensed hams as fast as lists of their names were received . . . BUT . . .

Included in these lists without being identified, were the names of old timers who had simply been assigned new call letters or changed addresses. Imagine the surprise of these fellows then, when the postman brought greetings from Sprague telling 'em we had just learned they would soon be on the air for the first time!

To put it mildly, we're still wearing rosy blushes —

the kind that extend right across that shiny dome where the hair used to be. We've been kidded about this *faux pas* in plain, fancy and assorted language. And, boy howdy, we had it coming to us!

Now, we're going over every list with a fine tooth comb. S'help us, it won't happen again! If it does, however, we'll gladly make good to any old timers who get the "welcome" greeting by letting 'em in on an inside tip about where to get the best capacitors and wire-wound resistors on the market today!

And meanwhile, we'll gladly send the complete Sprague catalog to any amateur who wants full details on the very latest developments in these lines.

Sincerely — and still blushing,

*Harry Nathan*  
(Sales Manager)

*P.S.*

Have you heard the News about

\* **MIDGET TUBULAR PAPER CAPACITORS?**

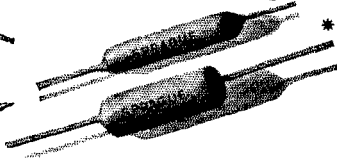

If you're looking for ways to save space in a rig, ask your Sprague distributor to show you the new Sprague 68P\* Midget Tubulars. They're a direct result of Sprague engineering experience in develop-

ing capacitors for the VI fuse and other wartime miniature electronic assemblies. They'll do any job the big, old-style tubulars of equal rating can do. Ranges from .001 mfd. 400V to 0.5 mfd. 100V.

SPRAGUE PRODUCTS COMPANY  
NORTH ADAMS, MASS.  
(Jobbing Distribution Organization for Products  
of the Sprague Electric Co.)

# SPRAGUE

Capacitors  
\* Koolohm Resistors

\*Trademarks reg. U. S. Pat. Office

# S-T-R-E-T-C-H

Your Receiver to Cover  
2, 6, and 10 Meters!

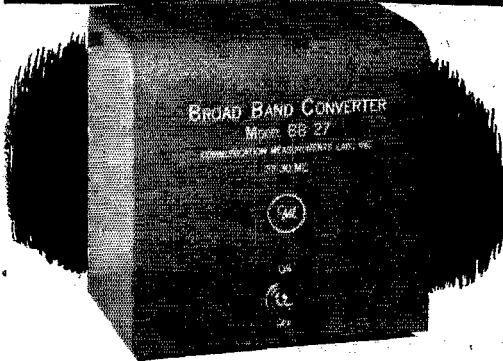

You get "two-way stretch" with CML Broad Band Converters. They extend the frequency range of your receiver

and give greater gain with improved image ratio. They work equally well with all types of communication receivers from military surplus bargain specials to the most expensive types.

Separate converters for each band insure ideal performance and freedom from engineering complications — plus real economy. Powered direct from your receiver or from Model 1120 Power Supply listed below as desired.

MODEL	FREQ. RANGE	DIAL TUNING	} \$27.50 EACH
BB-27	27-30 MC.	11-14 MC.	
BB-50	50-54 MC.	14-18 MC.	
BB-144	144-148 MC.	14-18 MC.	

Prices on special commercial units to cover ranges between 50 and 250 MC. quoted on request.

## MODEL SS-100 FREQUENCY STANDARD

Brand new! Generates strong 100KC and 1000KC crystal-controlled harmonics up to 60MC for tuning, calibration or test uses. Keeps you safely in the bands. Takes 150V at 15MA and 6.3V at .45 Amp. — or our Model 1120 Power Supply can be used.



Price Complete....\$27.50

## MODEL 1120 POWER SUPPLY

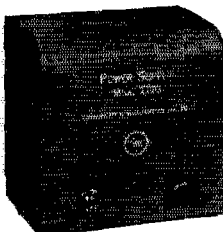

For use with CML Broad Band Converters and Frequency Standards when independent power supply is desired. Also ideal for many laboratory purposes. Selenium rectifier, OA-2 Regulator Tube.

Voltage	Rated Load	Ripple Voltage
200V DC	25 ma.	.4 V
150V DC	25 ma. (Reg.)	.2 V
6.3V AC	1 amp.	—

Price Complete....\$19.75

Write for descriptive bulletins and names of nearest distributors.



**COMMUNICATION  
MEASUREMENTS  
LABORATORY, INC.**

RECTOR 2-2080

Cable Address: "COMUNILAB" NEW YORK

120 GREENWICH STREET • NEW YORK 6, N. Y.

(Continued from page 188)

such a terrific SS score? What's the secret?" We always wanted the answer to that question, too, so after logs for the Thirteenth Sweepstakes were received and checked we wrote to some of the fellows who came out on top and asked for their secret formulas. It was interesting to find that almost all replies conformed to the same pattern, proving that there is a correct way to go after a high score! For the benefit of those who want to be leaders in the next SS we present a list of ten suggestions made by the 1946 SS champions:

1) Put out a healthy signal, at least as strong and clean as the average. Power isn't the only means to this end — antennas help.

2) Use a selective receiver. QRM being what it is during an SS, plenty of selectivity is necessary to dig out those "down under" stations that may be calling you.

3) Employ full break-in or push-to-talk. You'll save yourself a lot of needless calling.

4) Make contacts. If you work enough stations, the law of averages will take care of the sections. Too much time is lost by some contestants in listening for certain sections.

5) Operate during the busiest hours and on the busiest bands. During periods when activity slows down, get yourself some sleep.

6) Use VFO. Work gradually through each band in order to pick up all the rock-bound stations. Shift frequency slightly if your first call in a particular spot doesn't net a reply; zero-beat QRM may be hiding your signal.

7) Send short CQs or calls. On c.w. fast operating (if it's clean and readable) is a help. Don't waste time telling the other guy how glad you are to work him again. You're out to win. Rag-chewing doesn't help.

8) Place all your equipment within arm's reach if possible. Keep a record of transmitter dial settings to facilitate frequency changing.

9) Use a simple log system. This may vary with individual preference. W4FU prepared about 800 (1947 contestants had better prepare a minimum of 1000! —Ed.) postcard-size sheets of paper with headings provided for information on exchanges. During operation he filled in or checked the proper data. After a little experience with this system, it's possible to tell how you're doing by the size of the card pile!

10) Keep plugging! You must expend extra effort to maintain the pace as the final lap approaches.

There you have it, gang. Now that the secrets are out, we look forward to even bigger and better records next November! CU in the 1947 SS.

—J.A.M.

## Strays

The electric motor, converting into service 90% of the energy supplied it, is rated five times as efficient as the steam engine, three times over the automobile motor. — *Municipal Signal Engineer*

# Ready for you... **SURPRISE** TRADE-IN ALLOWANCES BY *Walter Ashe*



Your Receiver or Test Equipment may be worth far more than you think! Allowances offered by Walter Ashe on your used equipment, in exchange for new topnotch receivers and test equipment, are the sensation of the industry! Better get your trade-in deal working right now. Tell us by phone, wire or postcard what you have to trade. Watch us fly into action to make you a money saving deal.

## NEWEST RECEIVERS!

National HRO.....	\$274.35
National NC-240D.....	225.00
National NC-46.....	97.50
National NC-173.....	179.50
NC-173 Speaker.....	10.00
RME-45.....	198.70
RME-84.....	98.70
Hammarlund HQ-129X.....	173.25
Hammarlund SPC-400X.....	342.00
Hallcrafters SX-42.....	275.00
Hallcrafters S-40.....	89.50
Hallcrafters S-38.....	47.50

Prices Subject to Possible Change

## SONAR EXCITER VFX-680

A complete all-band, narrow band, frequency modulated phone or CW exciter, incorporating the Sonar NBFM modulator and VFX oscillator. Either VFO or VFX operation with any type cut crystal, resulting in a rubber crystal. It's new! It's here! It's a real sensation! Complete with tubes and power supply, less crystal.

**\$87.45**

## D & L NARROW BAND F.M. ADAPTER

Designed to enable NBFM reception on A.M. communication receivers. Tunes to any I.F. from 425-475 KC.

**\$15.45**

## WAR SURPLUS 807 TUBES

JAN inspected..... **95¢**

## RG-8/U SURPLUS 51 OHM COAXIAL CABLE

Brand new; Government inspected, 100 ft. lengths... **\$4.95**  
Less than 100 ft.....**\$0.06** per ft.

**THROAT MIKES**, 200 ohm carbon, a real sensation at..... **35¢**

**SHURE HAND MIKES**, brand new surplus type T-17, 300 Ohm, push to talk carbon mikes with cord and plug. **\$1.49**

## JUST ARRIVED! MEISSNER 9-1090 SIGNAL SHIFTER.

Complete—coils included for 10, 11, 15, 20, 40, and 80 Meter operation..... **\$120**

## TRANSMITTING CONDENSERS

Brand new 2 mfd. x 5000 V. Dykanol. Regular \$29.63. Special.. **\$7.51**

Brand new 2 mfd. x 4000 V. Oil filled. Regular \$25.44. Special.. **\$4.50**

## THE ASTOUNDING "MICROMATCH"

NOW AVAILABLE FROM STOCK

**\$29.50**

AS PER APRIL GST

## ELINCOR 400EA-10 METER BEAM

3-element beam with broadly resonant folded Di-Pole driven element. Designed to be fed direct with 51 ohm coax. Complete with aluminum ladder. Wt. 17 lbs..... **\$30.85**

## IN STOCK, ANTENNA WIRE

No. 14 enameled, 100 ft. roll **94¢** No. 12 enameled, 100 ft. roll **\$1.36**

## MILLEN "R-9'er"

### Antenna Matching Preampifier

As described in "G.E. Ham News." Results in approximately 30 db gain when used ahead of any receiver. Complete with coil for 10-11 meters, power cable, input and output connectors, but less 6AK5 **\$24.75**

Coils for 6 or 20 meters, each.. **\$3.15**  
6AK5 tube for above..... **1.49**

**DYNAMOTOR POWER SUPPLY**, brand new, U. S. Army PE-103 operates from 6- or 12-volt battery. Delivers 500 volts DC at 160 Ma..... **\$9.95**

**REVERSIBLE MOTOR**, ½ to 2 r.p.m. with conversion instructions for rotary beam drive, has 50 inch-pounds torque..... **\$4.95**

**WARD SC-8 MOBILE ANTENNA** The right antenna for that mobile installation. 8' 4" collapsible four section element. Two insulators for sturdy, side cowl mount... **\$4.39**

## Transformers & Chokes

These Items F.O.B. St. Louis

**RCA 1 KW. MODULATION TRANSFORMER**, pri. will match class B tubes up to 10,000 ohms plate to plate. Sec. No. 1 450 Ma. for beam tube plate. Sec. No. 2 80 Ma. for screen grids.. **\$14.95**

**THORDARSON SMOOTHING CHOKE**, 200 mills, 12 Hy..... **\$3.50**

**SURPLUS FILAMENT TRANSFORMER**, 5.25 V. @ 25A..... **\$6.15**

**SURPLUS FILAMENT TRANSFORMER**, 110 VAC pri. sec. 6.3 V. @ 3A..... **\$1.08**

**THORDARSON HEAVY DUTY BROADCAST TYPE PLATE TRANSFORMER**, 115 or 230 V. pri., 1510-0-1510 V. @ .5A sec. tapped at 1330 and 1230 V., easily worth 3 times our low price of..... **\$39.50**

Limited Quantity

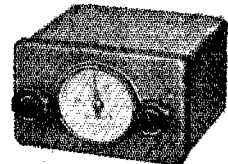

## GON-SET CONVERTERS

Just the thing for mobile or fixed station use. Available for 6, 10-11 or 20 meters. Output: 1500 to 2000 KC. On-off and antenna change-over switch incorporated. Wired and tested, complete with tubes. Specify **\$39.95** band desired..... **\$39.95**  
Special noise silencer..... **\$8.25**

WØGTF • WØJWD • WØWTM • WØPGI • WØULH • WØNRF • WØQDF • WØLYD

**WRITE FOR FREE BARGAIN BULLETIN**

How's This for Service?

Walter Ashe service is a revelation of efficiency! All orders shipped same day... often the same hour... following receipt.

*Walter Ashe* RADIO CO.  
1125 PINE ST. • ST. LOUIS, MO.

# The Radio AMATEUR'S LIBRARY

These are the publications which every amateur needs. They form a complete reference library for the amateur radio field; are authoritative, accurate and up to date.

<i>Title</i>	<i>Price</i>
<i>QST</i> .....	\$2.50 per year*
Operating an Amateur Radio Station — Free to members; to others.....	10c
The Radio Amateur's Handbook, .....	\$1.25**
The Log.....	35c each; 3 for \$1.00
How to Become a Radio Amateur..	25c
The Radio Amateur's License Manual.....	25c
Hints & Kinks for the Radio Amateur.....	50c
Lightning Calculators:	
a. Radio (Type A).....	\$1.00
b. Ohm's Law (Type B).....	\$1.00
A.R.R.L. Antenna Book.....	50c
The Minilog.....	25c
Learning the Radiotelegraph Code..	25c
A Course in Radio Fundamentals...	50c

\* Subscription rate in United States and Possessions, \$2.50 per year, postpaid; \$3.00 in the Dominion of Canada, \$4.00 in all other countries. Single copies, 35 cents.

\*\* Postpaid in U.S.A. Proper — \$2.00, postpaid, elsewhere. *{No stamps, please.}*

**THE AMERICAN  
RADIO RELAY LEAGUE  
INCORPORATED**  
West Hartford 7, Connecticut

## World Above 50 Mc.

*(Continued from page 66)*

### Who's Where on Six

W1AUU	Manchester, N. H.	50.8 Mc.
W1BZN	Medford, Mass.	50.16
W1DBO	Portland, Maine	50.67
W1EKO	Berwick, Maine	51.17
W1IUY	New London, Conn.	50.5
W1IKP	New London, Conn.	50.25
W1MX	Cambridge, Mass.	50.06
W1NEK	Waterford, Conn.	50.36
W2AMJ	Bergenfield, N. J.	50.45
W2OWC	Syracuse, N. Y.	50.4
W3DBC	Mt. Rainier, Md.	50.71
W3HC	Newport, Del.	50.62
W3KFN	Baltimore, Md.	50.32
W3LFN	Washington, D. C.	50.31
W3MWE	Baltimore, Md.	50.27
W4BYA	Winston-Salem, N. C.	50.96
W4FGU	Athens, Ga.	50.8
W4IPZ	Arlington, Va.	50.25
W4JFF	Arlington, Va.	50.85
W5CX	Brownsville, Tex.	50.9
W5EVL	Brownsville, Tex.	51.4
W5GTZ	San Antonio, Tex.	52.0
W5JHW	Brownsville, Tex.	52.5
W5JLY	San Antonio, Tex.	51.4
W5LBG	San Antonio, Tex.	50.4
W5LIV	San Antonio, Tex.	50.0
W5L8O	Brownsville, Tex.	51.2
W5VY	San Antonio, Tex.	51.2
W7EWX	Salt Lake City, Utah	51.6
W7JPN	Salt Lake City, Utah	50.18
W7PJS	Salt Lake City, Utah	51.5
W7QAP	Tucson, Ariz.	50.9
W7QQD	Salt Lake City, Utah	51.7
W7SP	Saltair, Utah	51.6
W7UPF	Tucson, Ariz.	52.52
W8H8B	Springfield, Ill.	50.04
W8DYG	Omaha, Neb.	50.02
W8KYF	University City, Mo.	50.7
W8U8I	Brookings, S. Dak.	50.03
W8BSY	Maritime Mobile	50.4
W8NSQ	Maritime Mobile	50.1
KP4CC	San Turce, P. R.	50.15
KP4CX	San Turce, P. R.	50.25
KP4DR	San Turce, P. R.	50.4
LU8DH	Buenos Aires, Argentina	51.6
LU5CK	Buenos Aires, Argentina	50.02
VE3HC	Guelph, Ont.	50.9

with hundreds of crystal-controlled transmitters in use. Superhet receivers are becoming more popular, and high-gain beams are practically standard equipment.

The results of this advancement are readily discernible. If we look over the reports of the work of the leading stations, we see that 100-mile work has become the order of the day. Plenty of contacts are being made today over distances that were good enough to be world's records a year ago! What is the limit? It's anyone's guess, but we'll take a try at it: we will be surprised if someone doesn't work 500 miles or more on 144 Mc. before the end of 1947. Whether this goal is reached or not, we may be sure that plenty of work beyond 300 miles will be done, and that the next few months will see plenty of excitement for the 2-meter enthusiast.

Occasionally we receive letters berating us for playing up the work of the crystal-controlled-transmitter-and-superhet-receiver school. What of the man who wants to keep on with simple gear? Well, he certainly can do good work, too: Just because equipment is simple is no reason to assume that it must also be a scourge on the band. Much of the simple gear is pretty awful, but it does not have to be so. High-C oscillators

*(Continued on page 188)*

# HARVEY HAS THE NEW GEAR

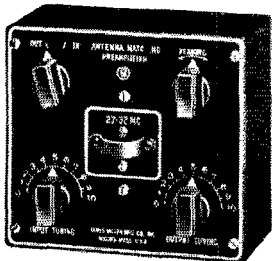

## MILLEN R-NINER

Millen 92101 is an Antenna Matching Preamplifier combining an electronic impedance matching device and broad-band preamplifier. Designed primarily for use on 6 and 10, coils are also available for 20. Uses 6AK5, has power plug for connection to receiver. With 10 meter coils, less tube...\$24.75

- 6AK5 tube .....\$ 1.90
- Coils in stock for 6 or 20 meters, each.....\$ 3.15



## TYPE 1616

Half wave high voltage vacuum rectifier. Characteristics: Filament, 2.5 volts; 5 amps; peak inverse 5500 volts; peak current .8 amps; surge current 2.5 amps; average plate current .130 amps. List price \$7.50; Harvey Special Price, while they last...95¢

## SINGLE BUTTON CARBON MIKE

In desk stand with tiltable head, press-to-talk switch, 6 ft. 3-wire cable, PL-68 plug. Special price.....\$4.95



## HARVEY'S HITS OF THE MONTH

Harvey has 20 meter crystals for a buck! Mounted in holder with 1/2" pin spacing. Also 40 and 80 meter and 6 and 13 mc. bands at the same low price.....\$1.00  
Special 8 mc. xtals for 2 meter xtal control, only.....\$1.50

Also in stock complete line of Billey AX-2 xtals. Include 10¢ postage with your crystal order.

## HARVEY'S HAMFESTIVAL OF VALUES

**Atom-X 800** — UHF rcvr for 144- to 240 MC. 6AK5 trf, 6C4 super-regenerative detector, 6AU6 and 6AK6 audio driving built-in speaker. Less tubes, coil and power supply .....\$36.95

Coils for 144/148 MC or 235/240 MC...per pair \$ 1.40

**Atom-X 700-UHF xmittr.** MOPA xtal control! Uses 12 MC xtal for 144, 13 MC xtal for 235. Panel lamps replace meters showing operating conditions at all times, 832 in final. Less tubes, mike, xtal and power supply. \$36.95

**Handy-Talkie 144** — 2-meter transceiver. Single hand control, telescoping antenna, rapid change battery compartment. Weighs only 4 pounds with batts. Less tubes and batts.....\$34.50;

A batt 50¢; B batt \$1.75; tubes, set \$2.49.

**Hammarlund FS135C** receiver frequency standard. Complete with tube and 100 KC xtal.....\$14.25

**VFX-680.** Sonar's one package VFO, VFX, monitor and FM exciter. Variable deviation, variable freq.....\$84.75

**NEW Sonar 10-11 meter xmittr.** 25 watts, mobile . . . ready soon. Place your order now and be first on list for quick delivery. Approx. \$70.00 less power.

**Gon-Set Converters** for 20 or 10-11- or 6 meter bands. In stock..... \$39.95; noise silencer.....\$8.25

**NEW RCA 2E26** beam power tube, immediate delivery. \$3.50

**Micro-Match** in stock for immediate delivery. Measures standing wave ratios and RF power. See article March QST.....\$29.50

**Supreme Xmittr**—100 watts output on CW or phone; for 10 to 80 meter bands, VFO or 2 xtal positions.\$450.00

## Receivers:

- Collins 75A .....\$530.00
- Hallierafters S38 complete \$47.50
- Hallierafters S40A..... \$89.50
- Hallierafters SX 42.....\$275.00
- Hammarlund HQ 129X and speaker .....\$173.25
- Hammarlund SP-400-X and speaker .....\$347.25
- National NC173 complete..\$189.50
- National NC-2-40D (complete with speaker) \$240.00
- NATIONAL HRQ-5TA complete .....\$306.71

- National NC-46 less speaker \$97.50
- National I-10A with tubes and coils.....\$67.50
- RME-45 complete.....\$198.70
- Hallierafter panadapter complete ..... \$99.50
- Meek 60T transmitters.....\$150.00
- Millen 90700 ECO..... \$42.50
- Millen 90800 exciter..... \$42.50
- Millen 90281 power supply \$84.50
- Millen 90902 scope..... \$42.50

*Note: All prices are Net, F.O.B. NYC and are subject to change without notice.*

Telephone: **Thrc** Longacre 3-1800

**HARVEY**  
RADIO COMPANY INC.  
103 West 43rd St., New York 18, N. Y.

Gordon, Abbott and other rotary beams and rotators.

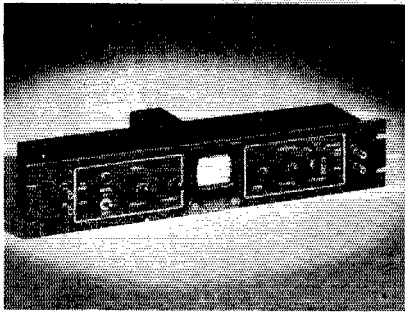

### THE MILLEN No. 90902 OSCILLOSCOPE

The Milen 2" rack panel scope is an inexpensive basic unit comprising power supply, brilliancy and centering controls, safety features, magnetic shielding, switches, etc. As a transmitter monitor, no additional equipment or accessories are required. The well-known trapezoidal monitoring patterns are secured by feeding modulated carrier voltage from a pickup loop directly to vertical plates of the cathode ray tube and audio modulating voltage to horizontal plates. By the addition of such units as sweeps, pulse generators, amplifiers, servo sweeps, etc., all of which can be conveniently and neatly constructed on companion rack panels, the original basic scope may be expanded to serve any conceivable application. Panel size 3½" x 19". Tubes required 2B1 and 2X2. Net price, less tubes, **\$42.50** f.o.b. Oakland.

## W. D. BRILL CO.

198 TENTH ST. OAKLAND 7, CALIFORNIA

WGKLO

WGSSN

WGFIX

## NEW-COMPLETE-ALL BAND SWITCHING

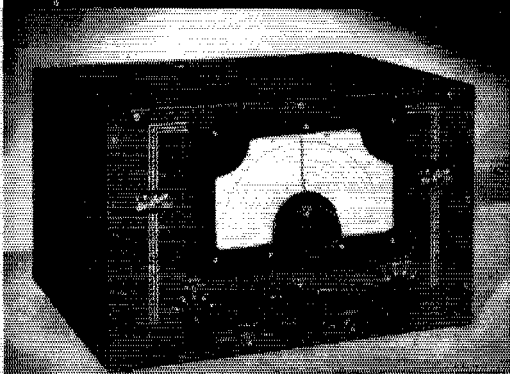

### VFO-XTAL EXCITER OR TRANSMITTER

## 20 WATTS OUTPUT

EVERY UNIT INDIVIDUALLY CALIBRATED

**\$118.50 Net**

The VX-101 DELUXE is an all-band switching VFO or XTAL exciter (employing separate oscillators for each) covering the 80, 40, 20, 15, 10 meter bands. Provisions for four 80 meter statts will give you a total of 20 stat-controlled output frequencies. NO PLUG-IN COILS. The tuning is ganged for all bands and permits fast, simple inter-band and band shifting. The 807 final is a straight thru amplifier. Both oscillators employ compound voltage regulation. For further information on the VX-101 DELUXE, VX-101 JR and the new EM-100 Modulator, write us or see your Ham dealer.

**ELECTRO-MECHANICAL MFG. CO.**  
LONG ISLAND CITY, 5 NEW YORK

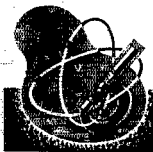

(Continued from page 186)

that are properly designed and operated need not take out a megacycle at a time; superregenerative receivers can be prevented from radiating S9 howls; and simple beams can be made to do good work, provided they are handled properly as to matching and loading. When conditions are good, low power will work wonders, and there is probably no band where the fellow who likes to work at the receiving-tube level can have as much fun as on 144 Mc. We're all for advanced techniques, and we want to recognize every instance of outstanding work along this line, but let no one get the idea that in doing so we are neglecting the possibilities of 2 meters for low-power low-cost fun. Let's see those miles-per-watt-per-dollar records, too!

Speaking of DX: WIPEN, Goshen, Conn., is hearing and working his share. Located in one of the highest towns in Connecticut, he is working out to W1MNF, on the tip of Cape Cod, a distance of 165 miles, when conditions are good. He runs an HY-75 at about 15 watts. On April 23rd he heard a signal believed to have been a W4 in Portsmouth, Va., though he is uncertain of the call.

How about a relay route the length of the Atlantic Seaboard? The possibility arises; now that Washington and Richmond, Va., are linked. In Richmond, W4FJ now works W3ENZ in Washington, about 100 miles, and W3KCA, Baltimore, 140 miles. He has worked W4HVV, in Raleigh, N.C., on 6, so he might also make it on 2. It should not be hard to establish a circuit from Boston to Washington. How about some messages each way now and then, just to see what can be done?

There is a lot of 2-meter interest around Atlanta, Ga., according to W4LNG. Most of the gang have converted 522 rigs, and there are quite a few good antennas, including a 16-element horizontal array at W4LNG. An emergency net operates on 144,138 kc. each Monday at 9 P.M., with W4FBH as control station. More than 20 stations are now active in and around Atlanta. No great DX has been worked, principally because activity is centered in the area. Schedules are desired with Chattanooga, Tenn., Greenville, S.C., and Savannah, Ga.

The Houston (Texas) Amateur Radio Club has been promoting interest in 144 work and more than 30 stations are on 2 in that vicinity, according to W5EAL, W5JML, W5J1Y and W5GLS found communication between Houston and Galveston (approximately 50 miles) so easy that they decided to try something a little more difficult. They drove to Georgetown, about 165 miles from Houston, and set up a portable station. Using a converted 522 rig and a 3-element array they succeeded in putting signals into the Houston area, where they were heard by six stations, including W5s BHIO, KFY, ON, GLS, EAL and AZR, with GLS and EAL making it two-way. None of the stations ran over 25

(Continued on page 180)

# TERMINAL Proudly Presents NATIONAL RECEIVERS-Immediate Delivery

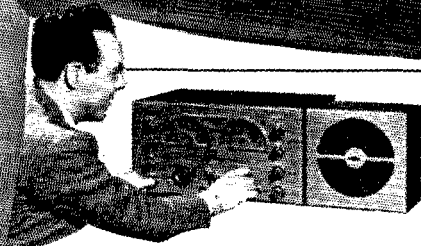

## NC-173

You will find this newest National receiver chock-full of features which will greatly widen your scope of activity.

Frequency coverage includes conventional 540 KC. to 31 MC. range, plus the 48 to 56 MC. amateur six meter band. Calibrated bandspread tuning is provided for the 6, 10-11, 20, 40 and 80 meter bands, with additional logging scale for other bands. A total of 13 tubes provide such features as an R.F. amplifier stage, separate AVC amplifier, voltage regulated power supply and double-diode noise limiter. New crystal filter is highly flexible for wide-band broadcast requirements to sharp single-signal code reception. Operates on 115/230 volts, 50/60 cycles.

**NC-173, complete with tubes and crystal, less speaker..... 17950**  
**PM Speaker in matching cabinet..... 1000**

For dependable, trouble-free operation that extra margin of receiver efficiency invest in a NATIONAL Receiver! For fast delivery — from our large stocks of quality amateur equipment—send your order to

## NC 1-10A

An improved super-regenerative receiver covering all wavelengths from 1 to 11 meters (28 MC. to 280 MC.).

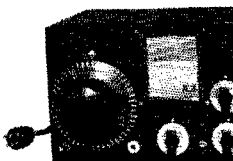

Well-liked by both amateurs and commercial services for its smoothness and reliability. Plug-in coils, easily interchangeable, cover tuning range in six bands. Famous National PW geared micrometer dial has linear scale length of approximately 12 feet! Here is the ideal receiver for your UHF communications!

**1-10A Table Model, complete with tubes and 6 sets of plug-in coils, less speaker and power supply..... 6750**  
**MCS PM Speaker in matching cabinet..... 1200**  
**5886 Power Unit, 115 volts, 60 cycles..... 2243**

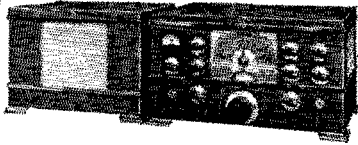

## NC-240D

12 TUBE —490 KC to 30 MC RF STAGE—  
 CRYSTAL FILTER —  
 ANL — BFO — AVC  
 —STABILIZED OSCILLATOR — SLIDING COIL BANDSWITCH  
 —"S" METER

The new National NC-240D is a brilliantly engineered communications receiver widely acclaimed by radio amateurs and general communications services. Competitively priced, yet nothing has been sacrificed to make the NC-240D one of the best communications receivers obtainable.

A 115-230 volt A.C. change-over switch enables the operator to cope with a wide variety of receiving conditions and requirements.

**NC-240D, complete with tubes and crystal, less speaker..... 22500**  
**10" PM Speaker in separate cabinet harmonizing with receiver's trim lines..... 1644**

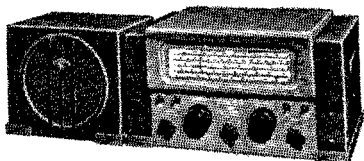

**NC-46** A well-balanced 10 tube superheterodyne for operation on 105-130 volts, AC or DC. Continuous coverage from 540 KC. to 30 MC. in four bands with separate electrical bandspread for vernier tuning. Features include efficient noise limiter, CW oscillator, separate R.F. and Gain Controls, amplified and delayed AVC. The National NC-46 is adapted from U. S. Navy proven, National-made AC-DC communications receiver.

**NC-46, complete with tubes..... 9750**  
**NC-46TS PM Speaker in Cabinet..... 990**



## HRO-5A1

Newest and finest HRO receiver features a number of additional refinements among which are a new highly efficient noise limiter and a redesigned flexible crystal filter. Dependable PW geared dial provides smooth, positive tuning action over normal range of 1.7 MC to 30 MC, including electrical bandspread on 10, 20, 40 and 80 meter bands. HRO coil sets are available (at extra charge) to cover 50-100 KC., 100-200 KC., 180-430 KC., 480-960 KC. and 900-2050 KC.

**HRO-5A1 (Table Model) complete with tubes, crystal and 4 coil sets covering 1.7 to 30 MC..... 27435**  
**Power Supply No. 697, 115/230 volts, 50/60 cycles.... 2036**  
**MCS Table Model Cabinet PM Speaker..... 1200**

Terminal offers you MORE than just Good Values!

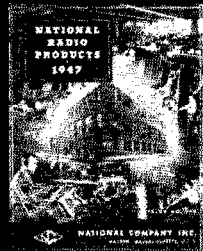

You can count on TERMINAL to be up-to-the-minute with the best and newest radio equipment! You'll find what you want at TERMINAL!

All latest receivers and transmitters for every amateur application are on display and demonstration in our modern Ham Shack.

ASK US FOR NATIONAL'S NEW 1947 CATALOG! DROP US A LINE!

If unable to visit our store, send us your mail orders with 25% deposit. Prices are F. O. B., New York.

# TERMINAL RADIO CORP.

85 CORTLANDT STREET, NEW YORK 7, N. Y.  
 PHONE: WORTH 2-4415

# SREPCO brings you the

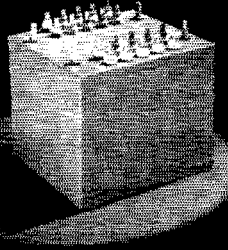

## Best Buy this year

### POWER TRANSFORMER

Operate a complete medium power phone transmitter with this one power transformer.

- 500 Volts at 150 ma.
- 325 Volts at 140 ma.
- 350 Volts at 60 ma.
- 3-5 V. filament windings.
- 2-6.3 V. filament windings.
- Static Shield.
- 5-3/4" x 6-1/2" x 5-3/8" high.
- Net Wt. 22-1/2 lb - Shpg. Wt. 25 lb

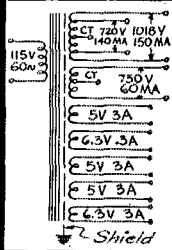

STOCK NO. B-117  
Only \$3.95

TERMS Orders under \$3.00, cash with order; orders over \$3.00 require 25% deposit - balance COD.



STANDARD RADIO & ELECTRONIC PRODUCTS CO.  
135 East Second Street, Dayton 7, Ohio

## TEN-METER BEAM ELEMENTS

Here is the Good News. As a result of a small ad we ran in October, 1946, OST, we sold over 400 10-meter beam elements. We ran out of stock and disappointed a number of good "Hams." Numerous letters indicate that our customers like these elements — AND THE PRICE, so we have located additional aluminum stock for approximately 300 more units, but at somewhat higher price — still a good buy. These are adjustable aluminum alloy (24ST) assemblies and are shipped complete with insulators for mounting. Measurements, 1-pc. 12" x 3/4" OD — 2-pcs. 5" x 3/4" OD will extend to over 18". Three or four elements will be shipped in a 12" x 13/4" thin wall aluminum tube, which can be used for an upright, at no additional cost. Shipped by express only. Weight approx. 18 lbs.

- Three elements with 12' shipping tube, hardware and insulators.....\$9.75
- Four elements with 12' shipping tube, hardware and insulators.....\$12.75

F. O. B. Detroit, Michigan

## TWENTY-METER BEAM ELEMENTS

We also have stock on hand for 50 TWENTY METER BEAM ELEMENTS made as per ARRL Antenna Hand Book. These are heavy aluminum alloy tubes that will stand the "Gaff" and still light in weight and will not require large mast or frame. Shipped complete with four heavy insulators and hardware for mounting. Shipping weight each element approx. 12 lbs. Five sections to each element. 2-pcs. 12" x 3/4" — 2-pcs. 6" x 3/4" — 1 pc. 3" x 1"; all 24ST stock.

## ALUMINUM

### Relay Racks, Cabinets, Panels, Mounting Brackets

Many of our customers have requested aluminum panels, relay racks and cabinets. We have available surplus aluminum to make these units. The price is right and they can be sold for prices to compete with steel assemblies. As examples: 19" x 8 3/4" x 1/4" panel, black ripple finish, \$1.75. Heavy .064 Trans. Chassis 17" x 13" x 3", \$2.79. All parts for a 72" open type relay rack (not drilled or finished), \$7.95. All other sizes at comparable low prices. Send us your requirements or send for literature and complete price list.

Be Wise — Save Labor and Money — Use Aluminum!

## MERLE DUSTON & ASSOCIATES

Electronic Engineers  
8907 Kercheval Avenue Detroit 14, Michigan

watts input. Schedules are now being arranged with stations in San Antonio, Waco, Austin, Fort Worth, Dallas and Beaumont, in the hope of linking many of the larger cities of Texas in a 2-meter net.

The California Coast may soon be the scene of an extended 2-meter relay circuit, if the efforts of W6OVK and others bear fruit. From as far north as Corning and Red Bluff, there are only two hops all the way to San Diego that are not bridged regularly. These include Sacramento and Stockton to Fresno, and Bakersfield to Los Angeles. It is reported that a station in Long Beach was heard in San Mateo, a distance of 350 miles, and W6WDX, who works mobile-marine along the West Coast, is reported to have heard a San Diego station while 35 miles off the coast near San Francisco!

The boys who work 10 should not overlook the possibility of quintupling to 2. W7JPA does it nicely with an 832, which then drives an 829 amplifier at 90 watts input. He reports that crystal control is used for both mobile and home stations by W7AWX. W7HQO at Wapato is a big noise in the Yakima Valley, with a 16-element beam. W7KKR also has a 16-element job. W7-EQG and W7KFM both have potent mobile rigs. Newcomers to the band are W7KXQ and W7KPD. Plans are under way for a 2-meter field day soon.

There is a healthy growth in 2-meter activity in the vicinity of Salt Lake City, according to W7JPN, who has a 200-watt crystal rig and an "H"-array with reflectors. Crystal-controlled rigs are also in use at W7s ONH, PJS, QQD, KMR and UQM. These stations operate nightly at 8 P.M., and newcomers are welcome.

Distances up to 125 miles can be worked from the Kansas City area, and W0DDX has QSOs with W0YUQ in Manhattan, Kansas, to prove it. Contacts have been made on several occasions, and while signals are not loud they are readable on voice. W0DDX is on nightly between 8 and 9 P.M., and will be glad to keep schedules with interested parties. His frequency is 144.4 Mc. W0INI is on at Pleasant Hill, Mo., about 35 miles southeast of Kansas City, and is working DDX with S9 signals.

There is appreciable activity on 144 Mc. in almost all well-populated sections of the country, and it is now reaching the point where one need not miss the fun of working on 2 simply because he does not happen to live in some of our larger coastal or Great Lakes cities. Universal experience has demonstrated that a 100-mile working radius is not exceptional, and that distances well beyond this can be worked with the right gear and antennas. A 100-mile radius encompasses quite a few ham stations in almost any section of this country. They need only get together and set up a regular operating schedule to have at least a measure of success on 144 Mc. Let us know your schedule — we'll run it in



*Announcing*  
**THE NEW ADDITION TO OUR  
 RADIO SCHOOL**

**BE A RADIO  
 TECHNICIAN**

**A PROFESSION WITH A FUTURE**

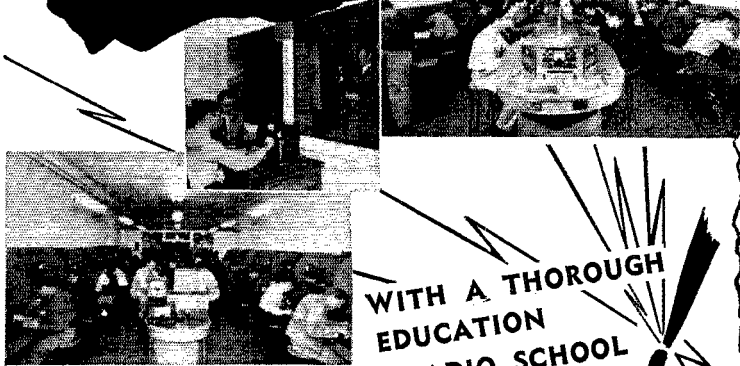

**WITH A THOROUGH  
 EDUCATION**

**FROM OUR COMPLETE RADIO SCHOOL**

Here's an opportunity to break into Radio.

Here's a chance for you to be your own boss, to own your own Radio Shop, to be a Radio Engineer, to enter this constant and ever expanding field of Radio (and its allied branches, electronics, television, radar).

Here's the Tyler Commercial College partial list of their highly specialized radio program. A program that represents the most extensive and complete training they have been able to devise in more than 30 years of experience in the radio-broadcasting field.

Here's an opportunity to examine the contents of the Tyler Commercial College Catalogue and to determine for yourself how radio training at Tyler Commercial College will enable you to find your own place in one of the many interesting and profitable jobs in the vast radio industry.

**TYLER COMMERCIAL COLLEGE**  
**115 South College Tyler, Texas**

APPROVED BY  
 VETERANS ADMINISTRATION

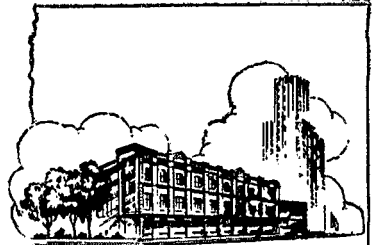

**GENERAL RADIO COURSE**

The course in General Radio is designed to provide a broad foundation for careers in the technical radio field. Among the various job objectives are Radiotelephone Operator (broadcast, police, or airline), Radiotelegraph Operator (marine, zone police, or airline), and Radio-Electronics Technician (industry). Success in qualifying for F.C.C. Radiotelephone or Radiotelegraph License is a requirement for graduation; therefore, an extensive study of radio theory, essential radio mathematics, and laws and regulations governing radio communications is included in preparation for operator license examinations.

*Average Time to Complete Course . . .*  
**12 Months**

**RADIO MAINTENANCE  
 AND REPAIR COURSE**

The Radio Maintenance and Repair Course offers preparation for a career as radio receiver repairman, sound-system technician, and radio service shop operator. Accurate, up-to-the-minute knowledge of radio principles and practice is essential for future success in this important field of radio. After a thorough introduction to radio and electrical principles, emphasis is directed to modern trouble-shooting methods, notable "signal-tracing." A section on facsimile receivers, frequency-modulation (FM) receivers and television sets is provided to bring the repairman up-to-date on recent developments. A wide range of topics is covered in this course, all of which are important to the modern repairman.

*Average Time to Complete Course . . .*  
**10 Months**

*Send for Free Catalogue*

*For full details and catalogue regarding this unique school, write to The Tyler Commercial College, Radio Department, Q, 115 South College, Tyler, Texas.*

*Attach this to your letter head or card.*

**MAIL TODAY** 

A STATE APPROVED  
 INSTITUTION

(Continued from page 130)

these pages, and perhaps help to ring in a few more converts.

### Doings on 235 Mc. and Up

In order to promote interest in 235-Mc. work, W2HG and W2NXT recently made a trip from Brooklyn over to some of the high spots in New Jersey to listen for stations operating on 235 Mc. With a group of 2-meter stations lined up to work crossband, they listened on 1¼. W2KU, W2GWL and W2OHE, all of Brooklyn, were received strongly, as were New Jersey stations W2MLX, W2AFG and W2HWX, the last being a distance of about 40 miles from the receiving point. Simple antennas were employed, but the initial successes stimulated interest and some high-gain beams are in the works. The activity resulted in the formation of the Maspeth 235 club, an informal group under the leadership of W2ER; 12 v.h.f. enthusiasts attending the first meeting on April 22nd. They are planning further tests, and hope to build up some regular activity on 235 Mc. They wish to have it known that horizontal polarization has been agreed upon for the initial efforts on the band.

We wish to correct an error in the April column, in which we reported work done by W2MWB on 420 Mc. His call was given as MWH, in error. The QST report, a listing in Ham-ads, and other missionary work on his part have netted coöperation on the part of W2BMT, Woodhaven, W2-FON, St. Albans, W2CWG, S. Ozone Park, and W2RA, Brooklyn. "You, too, can be one of the 400," says W2MWB. Well, why not?

### 25 Years Ago

(Continued from page 67)

our first president, Hiram Percy Maxim, W1AW. Other personalities in the news are Theodore R. McElroy, new holder of the world's code speed record of 51½ words per minute, and the radio-minded family of First District Radio Inspector Kolster, including son Frederick Charles.

Riverhead, L. I., N. Y. — "Radio Central" — makes its bid for a place on the communications map of the world. The paper of Pierre Boucheron describes this newly-opened super world-covering station. Outstanding amateur stations pictured and described this month are 4EG, Woodruff, S. C. and 5YE, University P. O., Miss.

A new department called "International Amateur Radio" starts with this issue, ". . . in recognition of the rapid approach of the day when American amateurs will work across both oceans with comparative ease." Strays regret the QST staff losses of Charles A. Service, jr. and R. C. Higgs, and announce new additions in the persons of Boyd "Beep" Phelps, 9ZT, and Robert L. Northrop, ex-1COA.

# Look Inside

## 10 FREQUENCIES

WITH A

# "Flick of the Wrist"

## 10 CRYSTALS

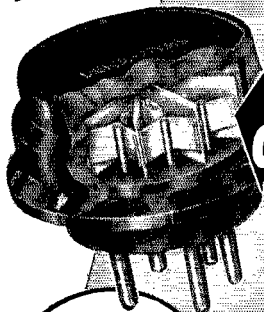

Deka Holder  
less \$5.95  
crystals

Your choice of crystals in  
40, 80 meter bands. . . .  
ea. \$1.35  
20 meter band. . . . ea. \$2.00

Special frequencies available.  
Write for prices.

Plugged into your oscillator, the DEKA-XTAL gives you crystal control, signal shifting. Rugged, compact, moisture and dirt-proof. Order the holder with as many crystals as you want, up to ten, and add other frequencies later.

# SCIENTIFIC

RADIO  
PRODUCTS  
COMPANY

738½ W. Broadway Phone 3-1412  
Council Bluffs, Iowa

## Feather Light

### MINIATURE Test Meter

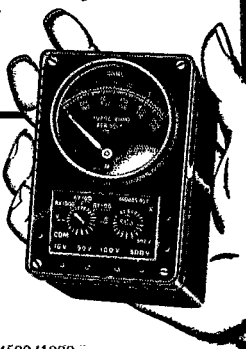

Dependable accuracy plus convenient pocket size make these little instruments most useful and popular aids to better amateur station performance. Self contained standard size batteries supply current for resistance readings. Three models are available in this small size: 3 15/16" x 2 3/4" x 2".

**Model 450A Volt-Ohm-Milliammeter**

The outstanding value in the test equipment field. D'Arsonval movement. Zero adjustment. Rotary range switch. 1000 Ohms per volt.

Volts DC: 0-5/10/50/500/1000

Mils DC: 0-1

Ohms full scale: 5000/50,000/500,000

Ohms center scale: 30/300/3000

Shipping weight 2 lbs. Price only \$10.90 net

**Model 451A AC-DC Volt-Ohmmeter with Output Ranges**

Volts DC: 0-10/50/100/500/1000

Volts AC and Output: 0-10/50/100/500/1000

Ohms center scale: 7200

Price only \$14.90

**Model 452A High Sensitivity Volt-Ohmmeter**

10,000 Ohms per Volt

Volts DC: 0-10/50/100/500/1000

Ohms full scale: 2000/20,000/200,000/2,000,000

Ohms center scale: 30/300/3000/30,000 Price \$14.90

Ask your Jobber or write direct for circular

America's Pioneer Makers of Pocket Test Equipment

## CHICAGO INDUSTRIAL INSTRUMENT CO.

536 West Elm Street - Chicago 10, Illinois

# SWITCH TO SAFETY!



# NEWARK VALUES LEAD THE FIELD

## JONES MICROMATCH

Measures Standing Wave Ratio and R F Power

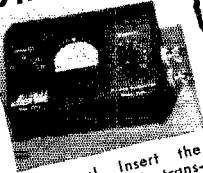

Wonderful for Ham! Insert the Micro-Match at ANY POINT in transmission line of imped. 70 to 300 ohms. . . Reads Directly the Standing Wave Ratio! Also reads R F Power fed down Trans. Line. Many other uses. Wgt. 10 lbs. Complete. . . . .

**\$29.50**

## 440 Mfd. CONDENSER

87 Plates  
.070 Gap

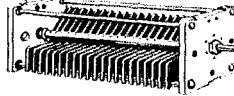

Super quality — Ceramic front and end plates. Silver contacts. One piece construction. 2500 v. insul. 2 x 2 x 7". 1/4" shaft. Only. . . . .

**69¢**

## MILLEN Antenna Matching PRE-AMP

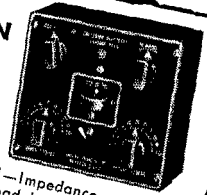

Millen 92101—Impedance matching device and broad band pre-amplifier combined. For 6 and 10 meters, also 20. Compact, 6 1/4 x 5 3/4 x 3". Complete with 10 meter coil, less tube . . . . .  
6 or 20 meter coils, each. . . . .  
6AK5 Tube, each. . . . .

**\$24.75**

**\$3.15**

**\$3.15**

Millen 90800 — 50 watt Transmitter-Exciter, 10 meter coils. Uses 807 and 616 . . . . .

**\$42.50**

## Cornell-Dublier 2 Mfd. 1000 Volt CONDENSER



TJU10020 Oil Impreg. paper filter condenser in metal case. Mtg. flanges. Porcelain insul.

**69¢**

# TRANSMITTING and SPECIAL PURPOSE TUBES

2AP1	\$2.25	10Y	1.50	800	2.25	815	2.25	843	.75	955	.75	1629	.27
3AP1	3.00	OC3/VR105	.75	802	1.58	816	.60	845W	3.75	956	.75	2051	.90
2C40	2.63	OD3/VR150	.75	803	9.00	826	2.25	872A	2.25	957	.75	8005	3.15
2C44	1.50	75TL	2.25	805	3.75	829B	3.00	874	1.95	958A	.75	8016	.53
2X2/879	.90	211	1.13	807	.95	830B	5.25	884	.75	959	.75	8025A	3.90
5AP1	9.00	250TH	9.00	808	3.00	832A	2.25	922	.68	1616	3.00	9001	.90
5CP1	6.00	304TH	12.00	809	1.50	836	1.50	923	.45	1619	.75	9002	.90
6AK5	.90	304TL	3.75	811	1.95	837	3.38	927	.95	1624	.90	9003	.95
3E29	3.00	801A/801	1.73	813	6.75	838	3.75	931A	1.88	1625	.75	9004	.90
				814	4.50	841	1.20	954	.75	1626	.60	9006	.68

## METER SPECIALS



### W. E. 4" MICROAMP

Galvanometer type meter with zero center. Can be reset for use as basic 5000 ohm per volt meter. Panel opening 3 3/4". Blank Dial Scale FREE! Sale Price, Only. . . . .

**\$3.95**

### Westinghouse 3 1/2" AC Voltmeter Rectifier Type

Sensitivity 2000 ohms per volt. Basic movement 0-500 microamps. Enclosed Rectifier. Scale 0-2 volts. Bakelite case. Only. . . . .

**\$3.95**

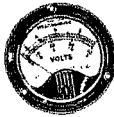

## Standard Receivers Now Available!

HALLCRAFTERS  
S-38 complete. . . . . \$47.50  
S-40A complete. . . . . 89.50  
SX-42 . . . . . 275.00

NATIONAL  
NC-173 w/speaker. . . . . 189.50  
HR0-5Tal complete. . . . . 306.71  
NC-240D w/speaker. . . . . 241.44  
NC-46 with speaker. . . . . 107.40  
1-10A with tubes, less speaker and power supply . . . . . 67.50

HAMMARLUND  
HQ-129X complete. . . . . 173.25  
SP-400X complete. . . . . 342.00  
RME-45 complete. . . . . 198.70  
RME-84 complete. . . . . 98.70  
Panadaptor . . . . . 99.75  
Meck Transmitter. . . . . 150.00

## NEWARK'S Special Filter Condensers

OIL FILLED — OIL IMPREGNATED FULLY GUARANTEED AT RATED VOLTAGES  
Decimated by hams everywhere, these condensers have been favorites with amateurs for ten years. Top quality at Bargain Prices!

Cap. Work V.	DC	H.	W	D	Weight	Price
.15	4000	2 1/4	1 1/4	1	8 oz.	\$.89
2	1000	4 3/4	1 3/4	1	12 oz.	.89
2.5	1500	4 3/4	1 3/4	1	8 oz.	.99
6	3000	3 3/4	1 3/4	3 1/2	2 1/2 lbs.	3.75
8	2000	4 1/2	3 3/4	2 1/2	6 lbs.	3.25
10	3000	4 3/4	6 1/2	3 3/4	2 1/2 lbs.	2.75
13	3000	4 3/4	3 3/4	3 1/4	7 1/4 lbs.	3.95
15	1000	3 1/2	3 1/4	3 1/4	3 1/2 lbs.	4.75
*2	3000	4 3/4	4 3/4	3 3/4	5 lbs.	2.25
*4	600	4 3/4	2 1/2	1 1/4	14 oz.	.80
*5						
*15	1000	3 1/2	4 3/4	3 3/4	4 1/4 lbs.	1.75

## 500 Mil CHOKE

10-20-40-80 Meter Bands Ceramic Core

**19¢**



## Sig. Corps PHONES

New, Guaranteed! 8000 ohms imped. Bakelite caps and shells, rubber cushions, Adjustable band.

Model HS-23, Sale Price. . . . . **\$1.95**

Model HS-33, Same, but low impedance. Sale Price. . . . . **\$1.89**



## Thordarson CHOKE

T-4557 or T-74C29—Leads out of side. 15H, 150 MA. 200 ohm, 2000 volt insulation. 5 1/2 lbs. . . . . **\$2.49**

20% DEPOSIT REQUIRED WITH ALL C.O.D. ORDERS  
INCLUDE POSTAGE  
SEND FULL AMOUNT  
SAVE C.O.D. CHARGES

Prices Subject To Change

NEW YORK  
Offices & Warehouse  
242 W. 55th St., N.Y. 19

**NEWARK** CHICAGO  
323 W. Madison St.  
Chicago 6, Ill.  
**ELECTRIC COMPANY, INC.**

SEND ORDERS TO  
242-5 W. 55th STREET  
NEW YORK 19, N. Y.  
OR  
323-S W. MADISON ST.  
CHICAGO 6, ILL.

New York City Stores: 115-17 W. 45th St. & 212 Fulton St

# COAXIAL CABLE RELAY

for high frequency switching

250 watts capacity — standard coil operating voltages AC or DC.



Write for Literature C35

**SIGNAL**  
ENGINEERING & MFG. CO.  
154 WEST 14<sup>TH</sup> STREET, NEW YORK

## QST YEARLY BINDERS

**ARE WE RIGHT?** You should have at least two of them—one for your complete 1946 file of copies, and one for each 1947 issue as published. Price \$2.00 postpaid. Available Only in United States and Possessions.

THE AMERICAN RADIO RELAY LEAGUE  
West Hartford 7, Connecticut



Founded in 1909

## RADIO TELEPHONY RADIO TELEGRAPHY

Courses ranging in length from 7 to 12 months. Dormitory accommodations on campus. Advanced students eligible for practical training at KPAC, 1 KW broadcast station owned and operated by Port Arthur College. New students accepted monthly. If interested in radio training necessary to pass F.C.C. examinations for first-class telephone and second-class telegraph licenses, write for details.

**PORT ARTHUR COLLEGE** PORT ARTHUR TEXAS

Approved for G.I. training

## Noise Reducing System

(Continued from page 28)

much gain is to permit the tone bias keying energy to be maintained from front-end noise in the receiver and thus make it unnecessary to rely on antenna noise to supply the operating energy. This also increases the threshold sensitivity of the detector.

To prevent interference from transmitters on adjacent channels the i.f. selectivity of the receiver should be high. However, the extreme selectivity represented by a sharp crystal filter cannot be used in the presence of strong impulse noise because in such a case the wave trains are lengthened to the extent that they compare in duration with code characters and consequently also key the tone oscillator. With the normal selectivity of a communications receiver this does not occur.

It is quite normal to get perfect reception from a c.w. signal that is not discernible through impulse noise on orthodox reception systems. For example, the noise can cause a full-scale reading on the S-meter with the a.v.c. on, with the signal level at only the first division of the meter in the absence of noise, yet when the a.v.c. is cut off and this reception system is applied the signal will be apparently S9 with zero background.

## Happenings

(Continued from page 30)

- The El Paso Amateur Radio Club.....El Paso, Texas
- Mid-South Amateur Radio Asso. Memphis, Tenn.
- Alabama Polytechnic Inst. Radio Club.....Auburn, Ala.
- The Key West Radio Amateur Club.....Key West, Fla.
- Calhoun Area Radio Club.....Battle Creek, Mich.
- Michiana Amateur Radio Club.....South Bend, Ind.
- Lancaster Radio Transmitting Society.....Lancaster, Pa.
- North Platte Amateur Radio Club.....North Platte, Neb.
- Caddo Amateur Radio Club.....Shreveport, La.
- Oneida Amateur Radio Club.....Oneida, N. Y.
- Rio Grande Valley International Radio Club.....Brownsville, Texas
- Anniston Radio Club.....Anniston, Ala.
- Radio Club of the Massachusetts State College at Fort Devens.....Fort Devens, Mass.
- Tri-State Radio Society.....Joplin, Mo.
- Garden City Amateur Radio Club.....Gardendale, Garden City, Kans.
- Valley Radio Club.....Puyallup, Wash.
- Gator Radio Club.....Gainesville, Fla.
- Lakeland Amateur Radio Asso.....Wharton, N. J.
- Capitol Suburban Radio Club.....Greenbelt, Md.
- Eastern Maine Amateur Radio Club.....Bangor, Maine
- Ocean County Amateur Radio Asso.....Ocean County, N. J.
- Suffolk County Radio Club.....Blue Point, N. Y.
- Coke Center Radio Club.....Connellsville, Pa.
- The City College Radio Club.....New York City, N. Y.
- Mount Shasta Amateur Radio Club.....Mount Shasta, Calif.
- San Mateo County Amateur Radio Club.....San Mateo, Calif.
- Capital City Radio Club.....Helena, Mont.

(Continued on page 136)



# DOWN! DOWN! DOWN!

## GOES THE COST OF YOUR RIG AT SUN RADIO

Order by mail or in person. Always call on "Buck" Stretcher to keep you supplied—at the lowest cost. Call Sun Radio for all your gear.

### COMPLETE POWER SUPPLY KITS

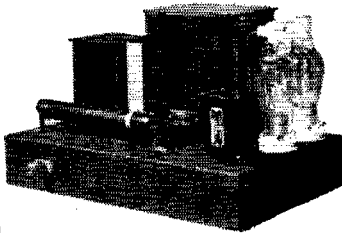

from 500 to 2000 Volts

They're going fast, but you can still get yours. These kits come complete with brand new parts: condensers, tubes, sockets, bleeders, Kenyon transformers, Millen caps and H.V. connectors, and special, heavy-duty chassis with bottom plates. All systems have 4 mfd. filtered choke input.

What a saving! And what a pleasure to get all parts in one package. Order now.

Kit #1—500 or 750 Volts DC @ 300 ma. **\$29.50**

Kit #2—1000 or 1250 Volts DC @ 300 ma. **\$39.50**

Kit #3—1500, 1750, or 2000 Volts DC @ 300 ma. **\$49.50**

Complete wiring diagram with every kit.

### WELLER "SPEED IRON" SOLDERING GUN



Heats in 5 seconds. 100 Watts. Can't overheat. Adjustable replaceable tips. Gets into tight corners.

Complete with 2 extra tips... **\$12.95**

1 lb. spool resin core solder..... **.83**

### POWER SUPPLY KIT FOR THE BC-221

Delivers 135 V DC plus 6.3 AC. Complete set of brand new parts to build your own power supply: 2"x4"x4" metal chassis (fully enclosed), selenium rectifier, switch, resistors, Stancor filament transformer, hookup wire, AC line cord, and neon light.

A real buck stretchin' special, only..... **\$5.95**

including special schematic featuring prevention of AC line to ground short circuit.



### BUCK'S FEATURE LINE OF THE MONTH

(Guardian Electric Mfg. Co.)

### NEW INTERCHANGEABLE RELAY

Built in 2 parts!

Your choice of 2 contact assemblies and 9 coil assemblies, fully interchangeable.

#### COILS

6 V AC \$1.20	6 V DC \$1.20
12 V AC 1.20	12 V DC 1.20
24 V AC 1.20	24 V DC 1.20
115 V AC 1.20	32 V DC 1.20
110 V DC \$1.50	

#### CONTACT ASSEMBLIES

SPDT .... \$ .78 DPDT .... \$1.20

**X-100 Adj. overload relay**—Positive protection against current surges. Adjustable from 150 to 650 ma. Single-hole mtg. with front panel manual reset button..... **\$7.71**

**T-110 Adj. time relay**—Prevents application of plate current before rectifiers and tube filaments are sufficiently heated. Adj. from 10 to 60 seconds. Contact cap. 1250 W on 110 V AC..... **\$5.76**

**K-100 Keying relay**—Standard coils operate on 5-16 V AC. Relay will follow key or bug at highest WPM attainable. Oversize silver contacts handle AC pri. circuit of any induction on power supply delivering up to and including 1 KW. 5000 V insulation to ground..... **\$4.22**

### RING TUNER FOR 2 METERS

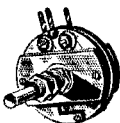

Boy! No coils to wind, no condensers to trim, no sliding or bearing contacts. Tuning range 140 mc. to 160 mc. with 3.5 mmf tube capacity. Made by Clarkstan. Single hole mounting. "Q" is many times greater than conventional coil condenser combination.

Your cost..... **\$4.80**

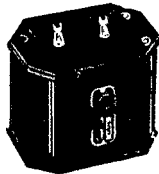

### UTC "PA" SERIES FILTER SWINGING CHOKE

The transformer value that's wowing hamdom. Brand new. 5/25 hy @ 200 ma. 105 ohms DC resistance. 3 1/8" long, 4 1/8" wide, 4 1/2" high. Regular list is \$14.00. Net weight 9 1/2 lbs. Husky, fully cased.

Sun Radio's special price, only..... **\$3.45**

2 for..... **\$6.50**

# SUN RADIO

& ELECTRONICS CO., Inc.

ESTABLISHED 1927

122-124 DUANE ST. · NEW YORK 7, N. Y. · BRay 7-1840

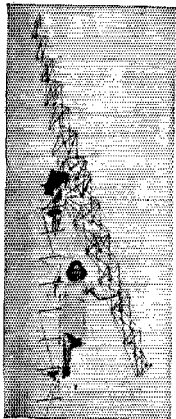
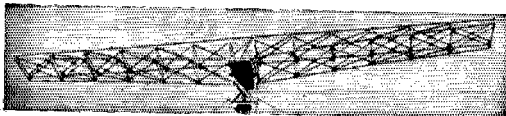

## TRYLON ROTARY BEAM ANTENNA SUPPORT

for 4-element 20-  
meter array

Quick, easy to install on any tower. Stainless steel, spot-welded construction. 19' 2" long, yet weighs only 30 lbs. Adaptable to either manual or motor drive. Ball bearing design provides full 360° traverse. Support can be tilted in either direction for easy accessibility. Has ample safety margin to withstand severe wind and icing conditions. Write for descriptive circular.

### RADIO TOWERS

Standard and special types for amateur and commercial requirements.

**TRYLON TOWER AND ANTENNA DIVISION**  
Wind Turbine Co., West Chester, Pa.

THE

# Micro Match

AN INSTRUMENT FOR MEASURING  
STANDING WAVE RATIO AND RF POWER



FEATURED IN APRIL QST  
**AVAILABLE NOW**

Amateur net \$29.50

Contact your local distributor or write direct  
**M. C. JONES ELECTRONICS COMPANY**

96 North Main Street  
BRISTOL, CONNECTICUT

(Continued from page 134)

23) On motion of Mr. Shelton, unanimously VOTED that there is hereby appropriated from the surplus of the League, as of this date, the additional sum of two hundred dollars (\$200) for the legitimate administrative expenses of the director of the Southeastern Division for the calendar year 1947, any unexpended remainder at the end of the year to be restored to surplus.

24) On motion of Mr. Jepsen, unanimously VOTED that there is hereby appropriated from the surplus of the League, as of this date, the additional sum of two hundred fifty dollars (\$250) for the legitimate administrative expenses of the director of the Southwestern Division for the calendar year 1947, any unexpended remainder at the end of the year to be restored to surplus.

25) On motion of Mr. Jepsen, after discussion, unanimously VOTED that the Headquarters shall investigate the complaints being received from members on delay in receiving QST, particularly as concerns renewals and new memberships, and that an explanatory article on the situation shall be published in QST.

26) Mr. Jepsen read a letter from W6CGI about the case of W6OBH and moved that this matter be given all possible publicity in QST and in the press. But, after discussion, unanimous consent being given, Mr. Jepsen withdrew the motion.

27) Moved, by Mr. Groves, that the President be directed to appoint a committee of three to study the desirability and feasibility of the establishment of an additional Headquarters amateur station, to be located in the Middle West, such committee to make its report to the Board at its next annual meeting; that this report shall contain the recommendations of the committee, together with full supporting data as to possible location, expenses, equipment and all other relevant factors; that the sum of \$1000 be hereby appropriated to defray the proper expenses of the committee, the unexpended remainder to be returned to surplus; that the Headquarters office be directed to furnish such clerical assistance as the committee may require. But, after discussion, the motion was rejected.

28) On motion of Mr. Groves, unanimously VOTED that there is hereby appropriated from the surplus of the League, as of this date, the additional sum of two hundred dollars (\$200) for the legitimate administrative expenses of the director of the West Gulf Division for the calendar year 1947, any unexpended remainder at the end of the year to be restored to surplus.

29) On motion of Mr. Reid, unanimously VOTED that there is hereby appropriated from the surplus of the League, as of this date, the additional sum of three hundred fifty dollars (\$350) for the legitimate administrative expenses of the Canadian General Manager for the calendar year 1947, any unexpended remainder at the end of the year to be restored to surplus.

30) Mr. Reid commended the good work of the United States amateurs in the recent Texas City disaster. It was the sense of the meeting that the Headquarters is directed to publicize this amateur work in the press and in QST.

31) Moved, by Mr. Raser, that the League through QST endeavor to educate the amateur on the subject of the advantages of single-frequency operation by all stations in communication with each other, with the thought in mind of eventually seeking FCC regulations as to its more universal use. But there was no second, so the motion was lost.

32) On motion of Mr. Richelleu, unanimously VOTED that there is hereby appropriated from the surplus of the League, as of this date, the additional sum of three hundred fifty dollars (\$350) for the legitimate administrative expenses of the director of the Central Division for the calendar year 1947, any unexpended remainder at the end of the year to be restored to surplus.

33) Mr. Richelleu reported the inability of Chicago amateurs to sponsor a national ARRL convention in 1947 as authorized, and further that he had been unable to obtain satisfactory assurances from them as to a 1948 national convention. He therefore wished to withdraw the request of the Chicago Area Radio Club Council to hold a national convention. On his motion, after discussion, unanimously VOTED that the Board of Directors authorizes the Milwaukee Radio Amateurs' Club, Inc., to hold an ARRL national convention in Milwaukee, Wisconsin, in the au-

(Continued on page 138)

**NOW  
AVAILABLE!**

**New illustrated  
technical booklet →**

*on uses of—*

# PLASTICON\* GLASSMIKES

*Contains the following subjects:*

- CHART OF RF CURRENT RATINGS
- Glassmike characteristics and design data
- Comparison of Glassmikes and Mica Capacitors
- Uses of Glassmikes for improved RF and Audio bypassing
- Use in Audio and RF coupling
- Glassmikes in television power supplies
- Video coupling
- Vibrator buffer applications
- Geiger Counter Capacitors
- Instrument capacitors
- and many other applications

Enclose nominal charge of ten cents for handling and mailing when writing for this free booklet, or obtain from your local distributor.

\*PLASTICONS: Plastic-Film Dielectric Capacitors

*Your Jobber stocks a complete line of  
PLASTICONS\* in metal cans and Glassmikes*

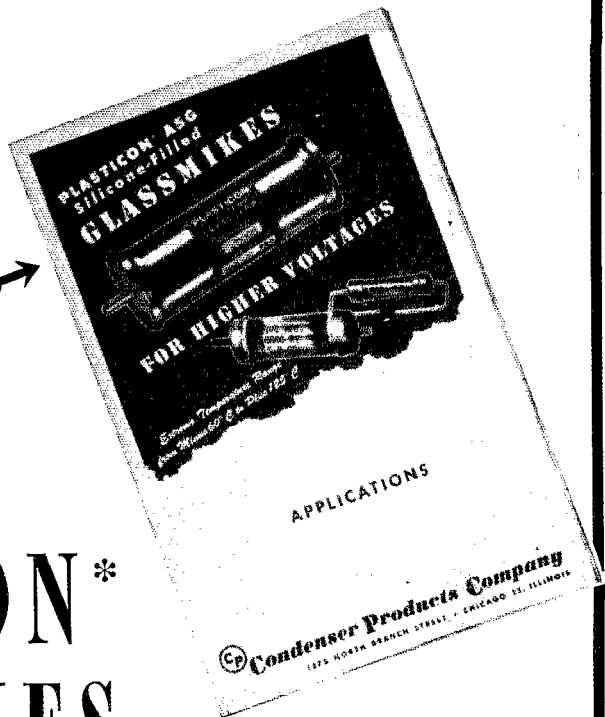

*Partial list of  
PLASTICON\* users:*

Argonne National Laboratory  
Allis Chalmers Manufacturing Co.  
Armour Research Foundation  
Belmont Radio Corporation  
Carnegie Institute of Technology  
Dahlgren Proving Grounds  
Eastman Kodak Company  
Electronic Equipment Laboratory, Wright Field  
Federal Telephone & Radio Corporation  
Federal Telecommunication Laboratory  
Farnsworth Television & Radio Corp.  
Galvin Manufacturing Corporation  
General Electric Company  
Hazeltine Electronic Corporation  
Humble Oil Company  
Massachusetts Institute of Technology  
Monsanto Chemical Company, Oak Ridge,  
Tennessee  
National Advisory Council on Aeronautics  
North American Philips Company  
Naval Research Laboratory  
Naval Ordnance Laboratory  
National Research Council, Canada  
Progressive Welder Company  
Radio Corporation of America  
Russell Electric Company  
Radio Receptor Company  
Rauland Corporation  
Sciaky Brothers  
Sylvania Electric Company  
Sperry Gyroscope Company  
University of California at Los Angeles  
University of California  
University of Michigan  
Victoreen Instrument Company  
Westinghouse Electric Company



## Condenser Products Company

1375 NORTH BRANCH STREET • CHICAGO 22, ILLINOIS

# Valpey tip #1

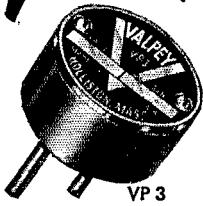

VP 3

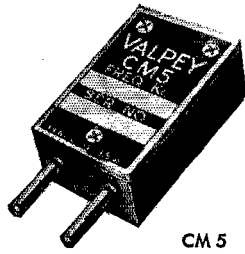

CM 5

## "Oscillator Loading"

Generally you provide means for adjusting the amount of coupling between your final and antenna as loading varies with frequency used. If excessive, the result is lost efficiency and reduced radiation. This also applies to crystal oscillators, particularly at the higher frequencies and with third harmonic crystals.

We recommend the use of a ceramic trimmer 75 to 100 MMFD when capacity coupling to the next stage. Adjust this for quick crystal starting and proper grid current to the next stage.

### VALPEY CRYSTAL CORP.

HOLLISTON, MASSACHUSETTS

Craftsmanship In Crystals Since 1931

W1ATP    W1HVP    W1BZJ    W1PLX    W1ONE

## CLIPPER CHOKES and FILTERS

Triple speech power on carrier without over-modulation, as suggested in QST Nov. 1946, page 23.

**SHIELDED CHOKE**, 3.75 in. 5%, hi-alloy laminations high efficiency. Model C-375 \$4.75

**COMPLETE FILTER ASSEMBLY**, including laboratory selected choke C-375, capacitors C3, C4, C5 and terminating resistor R5, sealed in 1 3/4" x 1 3/4" x 2 1/4" shield can.

Model LP-5000, cut-off freq. 5000 cy. \$5.95

Model LP-3500, cut-off freq. 3500 cy. \$5.95

IMMEDIATE DELIVERY, postpaid in U. S.

Special Chokes, Transformers and Magnetics to Order

**Kenneth Richardson Laboratories**

254 Vincent Avenue, Lynbrook, L. I., N. Y.

### • LEARN CODE •

SPEED UP YOUR RECEIVING

with

**G-C Automatic Sender Type S**

**\$20.00 Postpaid**



Housed in Aluminum Case. Black Instrument Finished. Small—Compact—Silent Induction type motor. 110 Volts—60 Cycle A.C.

Adjustable speed control, maintains constant speed at any Setting. Complete with ten rolls of double perforated tape. A wide variety of other practice tapes available at 50c per roll.

If your dealer cannot supply you — write

**GARDINER & COMPANY • Box 56**

STRATFORD, N. J.

turn of 1948, subject to the terms of a satisfactory contract to be executed between that club and the League, similar in tenor to that for previous national conventions. On his further motion, unanimously VOTED that the authorization to the Chicago Area Radio Club Council to hold a national convention in either 1947 or 1948 is rescinded.

34) Moved, by Mr. Richelieu, that ARRL authorize and establish an academic scholarship award, to be given to a qualified licensed radio amateur member of ARRL, for meritorious achievement in the interests of the American Radio Relay League and the radio amateurs of the world, as determined by a scholarship committee to be appointed by the Chairman from the membership of this Board; this scholarship award, to be known as the ARRL Achievement Award, to consist of full tuition plus residence living expenses of \$1200 per year, for four years' residence attendance at an accredited university; selection of university to be made by mutual agreement between the Scholarship Committee and recipient of the award; the method of award and qualifying requirements to be determined by the Scholarship Committee with the irrevocable stipulations that (1) any aspirant or prospective recipient of the award must demonstrate his ability to successfully pass the regular entrance examination to the school or university selected, prior to the actual presentation of the award; (2) that the American Radio Relay League will, by a three-year contract between the award recipient and ARRL, drawn at the time of the award, have first claim to the service of the award recipient following completion by graduation of his term of study, salary for this three-year period to be predicated upon the existing rate of pay for similar assignments within the Headquarters organization at the time contract is drawn; (3) scholarship shall major in the fields of radio communications engineering or radio communications law; (4) recipient of this scholarship shall not have reached his 26th birthday on the date of the award; (5) first award should be made on or before July 31, 1948; funds in the amount of \$10,000 to be appropriated from the surplus of the League treasury, any unused balance remaining at the time of the regular Board Meeting in 1952 to be returned to the League's treasury. After discussion, the yeas and nays being ordered, the said question was decided in the negative: Whole number of votes cast, 16; necessary for adoption, 9; yeas, 4; nays, 12. Those who voted in favor are Messrs. Bird, Davis, Noble and Richelieu. Those who voted opposed are Messrs. Acton, Colvin, Groves, Jepsen, H. W. Johnston, J. M. Johnston, Ladley, Raser, Reid, Shelton, Smoll and McCargar. So the motion was rejected.

35) The Board was in recess for luncheon from 1:04 P.M. to 2:10 P.M., reassembling with all directors and other persons hereinbefore mentioned in attendance.

36) On motion of Mr. Richelieu, after discussion, unanimously VOTED (1) that the Board of Directors makes an open authorization of twenty-five thousand dollars (\$25,000) for the defense of amateur frequencies; and (2) that the President of the League is appointed as a Committee of One with full power to act at his own discretion and without supervision in the expenditure of this fund, without liability as to anything except misappropriation; and (3) that the President is requested, but not bound, to use the services of Messrs. Warner and Segal at any stage he may think necessary; and (4) if, in the judgment of the President, anything needs to be done, he is fully authorized by the Board — without consultation with it — to speak for and on behalf of the Board in all aspects of protecting amateur operation.

37) Mr. Richelieu moved the adoption of the following resolution: Whereas, the technical advances in the radio communications art during the past decade have been of great proportions; Whereas, there exists at present much uncertainty within the processes of the FCC in defining the term "Good Rules of Engineering Practice" as applies to the amateur radio art; Whereas, there exists no definite Rules of Good Engineering Practice as applies to the amateur radio art; Whereas, in the ever-increasing population of frequency spectrums that are by elemental nature limited and defined, requiring constant effort toward the improvement of the kind and quality of radio transmissions permitted thereon; Be it Resolved: that the American Radio Relay League, as a representative of the United States radio amateur, institute immediately under the direction of

(Continued on page 140)



THE NEW..

# MEISSNER

## Signal Shifter



### *The Outstanding Variable Frequency Exciter For Modern Amateur Requirements*

With more amateurs going on the air almost daily, the ability to dodge QRM has become a matter of utmost importance. As the ham bands become increasingly crowded, amateur operators all over the world have come to regard the new complete Meissner Signal Shifter as their most useful single piece of equipment. Built-in band-switching, six-position switch with no coils to change, five sets of coils for 10, 15, 20, 40 and 80 meter bands, (blank strip for additional band), all controls on front panel, crystal control on all bands... all these and many more new, exclusive features are combined to make this new instrument the finest, most complete, variable frequency exciter ever offered to the modern amateur.

See it at your dealer's today or write for full information to the address below:

# *Meissner*

ELECTRONIC DISTRIBUTOR AND  
INDUSTRIAL SALES DEPARTMENT

## MAGUIRE INDUSTRIES, INCORPORATED

936 N. MICHIGAN AVENUE, CHICAGO 11, ILLINOIS

EXPORT SALES • SCHEEL INTERNATIONAL, INC.  
4237 NORTH LINCOLN AVE., CHICAGO 18, ILLINOIS • CABLE HARSHEEL

#### CHECK THESE FEATURES:

**BAND-SWITCHING** is accomplished by a six position shielded turret. 5 coil strips provide complete coverage on 10, 15, 20, 40 and 80 meter bands (ample 2% overlap on band ends). Blank position in coil turret for 20 and 75M bandsread or 6M band coverage.

**CRYSTAL CONTROL.** Not only does the Shifter function as a variable frequency oscillator, but by plugging in a suitable crystal it may be converted into an excellent crystal controlled exciter for any band (especially desirable for net operations).

**TUNING.** Only two controls select any operating frequency; the band selector switch to move coil strip into position and the precision vernier control to rotate the ganged condensers. Illuminated dials for 0-500 calibration. Exceptionally stable.

**KEYING.** Two jacks for CW or phone. May be keyed in oscillator or amplifier circuits. Tuning eye checks keying.

**POWER.** Input 110V 60 cyc. AC. Output in excess of six watts.

**TUBES.** 6V6GT/G oscillator doubler, 807 amplifier-doubler, 2-5Y3 high voltage, 0D3/VR150 osc. voltage reg., 6U5/6G5 tuning eye.

**COUPLING.** Output impedance 300 ohms. Coupling possible into grid circuit of single-ended or push-pull stage of transmitter; into crystal stage with crystal removed; into plate tank of crystal oscillator with tube removed.

**CABINET.** Gray-wrinkle metal, 13 13/16 by 13 1/4 by 8 3/4. Shpg. Wgt. 30 lbs.

# LOOK

## AT THE BAUMANN ROTATOR

Rugged, reliable, foolproof construction—No possibility of Back-Lash; will withstand highest wind pressures and will handle 10 and 20 meter beams, singly or in combination, without strain.

Full 360° continuous rotation at 1 R.P.M. Reverses instantly from any point.

Quiet operation—both electrically and mechanically—to aid receiving.

Dimensions—13" x 10" x 12".  
Wt. 47 lbs.

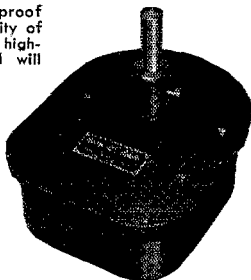

**\$79.95**

Beam-mounting plate  
8" x 8"—\$7.50

Write for latest bulletin. We distribute leading brands of Ham Gear and Equipment.

# Steinberg's

633 WALNUT STREET • CINCINNATI 2, OHIO

(Continued from page 158)

its Technical Director a program of investigation and research to be conducted over the period of the ensuing year, in what will in the light of present-day technical developments constitute a set of rules of Good Engineering Practices as applied to the art of amateur radio; that such recommendations will be submitted to this Board at its regular 1948 annual meeting and, upon approval, such Rules of Good Engineering Practices shall be submitted to the FCC with recommendation for their incorporation into the language and text of the FCC Rules and Regulations governing the radio amateur. After discussion, the yeas and nays being ordered, the said question was decided in the negative: Whole number of votes cast, 15; necessary for adoption, 8; yeas, 2; nays, 13. Messrs. Bird and Richelieu voted in the affirmative. Those who voted opposed are Messrs. Acton, Colvin, Davis, Groves, Jepsen, H. W. Johnston, J. M. Johnston, Ladley, Noble, Raser, Shelton, Smoll and McCargar. Mr. Reid abstained. So the motion was rejected.

38) On motion of Mr. Davis, unanimously VOTED that there is hereby appropriated from the surplus of the League, as of this date, the additional sum of three hundred dollars (\$300) for the legitimate administrative expenses of the director of the Dakota Division for the calendar year 1947, any unexpended remainder at the end of the year to be restored to surplus.

39) On motion of Mr. Davis, after discussion, VOTED, 11 votes in favor to 5 opposed, that a nameplate shall be provided by the League for each director, to be used at Board meetings to identify each director's place at the Board table, this plate to become the property of the director after his term of office expires.

40) Moved, by Mr. Davis, that the Board recommend to the Federal Communications Commission such changes in regulations as may be necessary to put into effect the following plan for dividing time on the 80-meter band: 3500 to 4000 kc., 24 hours daily for c.w.; 3500-3700 kc., 9:00 A.M. to 3:00 P.M. EST daily, 'phone in W1, W2 and W3 call areas; 9:00 A.M. to 3:00 P.M. CST daily, 'phone in W4, W8 and W9 call areas; 9:00 A.M. to 3:00 P.M. MST daily, 'phone in W9 and W5 call areas; 9:00 A.M. to 3:00 P.M. PST daily, 'phone in W6 and W7 call areas; all such 'phone periods to be both Class A and Class B; 3850 to 4000 kc., 24 hours daily, Class A 'phone; 3700-3850 kc., 24 hours daily, exclusively c.w. RULED, by the Chair, that the said motion is out of order because of the decision to postpone consideration of 'phone-frequency matters until after the world conference. Mr. Davis requested to be noted as entering an exception. On the further motion of Mr. Davis, unanimously VOTED that the entire matter as proposed is referred to the Planning Committee for attention and report to the Board next year.

41) On motion of Mr. Acton, unanimously VOTED that there is hereby appropriated from the surplus of the League, as of this date, the additional sum of two hundred dollars (\$200) for the legitimate administrative expenses of the director of the Delta Division for the calendar year 1947, any unexpended remainder at the end of the year to be restored to surplus.

42) On motion of Mr. Davis, after discussion, unanimously VOTED that members of the Board of Directors in their travel by personal automobile in their divisions shall be allowed ten cents per mile expenses.

43) On motion of Mr. J. M. Johnston, jointly on behalf of himself and Mr. H. W. Johnston, after extended discussion, unanimously VOTED that the Board authorizes such expansion of the personnel of the Communications Department as to the General Manager seems desirable, to accomplish the following objectives of the Board in regard to emergencies: (1) Headquarters personnel available for on-the-scene assistance wherever disasters may take place to assist in liaison with authorities, establishment of services, and publicity; (2) expanded training and exercises of the personnel of existing emergency-communications establishments.

44) Mr. J. M. Johnston, jointly on behalf of himself and Mr. Acton, moved the adoption of the following resolution:

WHEREAS, on April 10, 1947, David H. Houghton completed twenty-five years of continuous service to the American Radio Relay League, as Circulation

(Continued on page 148)

## COMMERCIAL RADIO INSTITUTE

A RADIO TRAINING CENTER FOR 26 YEARS

Resident Courses Only • Broadcast, Service, Aeronautical, Television, U.H.F., Preparatory Course, Frequency Modulation and Marine telegraphy classes now forming for July 1. Entrance Exam. June 16.

Literature upon request. Veteran training

Dept B, 38 West Biddle Street, Baltimore 1, Maryland

THE

# Mytronic

COMPANY

W  
8  
A  
N  
T

ANNOUNCES APPOINTMENT

FOR  
**COLLINS**  
TRANSMITTERS  
AND  
RECEIVERS

W  
8  
C  
N  
V

SEND FOR LIST OF HAM  
SPECIALS

CINCINNATI'S ONLY AMATEUR  
OWNED AMATEUR BUSINESS

MYTRONIC  
121 West Central Parkway  
Cincinnati 2, Ohio

## While They Last! Sun's GREATEST OFFERS!

### 100 WATT BENDIX TRANSMITTER

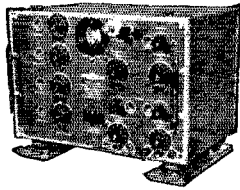

TA12

#### CHECK THESE VALUES

Three 807 tubes, four 12SK7, one 2 inch 5 amp. RF meter, four Separate Master oscillators. (These can be easily changed to cover 20-40-80 meters and by using crystal for the 10 meter band you will have a complete coverage transmitter.)  
Four Separate output tanks.

One 4 Position selector channel switch having seven sections which changes the ECO, IPA and output tanks simultaneously. All the controls are mounted on the front panel. The housing is cast aluminum; shields and case are sheet aluminum. Dimensions 11 x 12 x 15 inches, weighing 35½ lbs. Complete, simple instructions for conversion furnished. Complete with tubes. . . . . **\$49.95**



### SUPERHETERODYNE RECEIVER

This crystal fixed frequency receiver comes with full conversion instructions for variable tuning of all ham bands and broadcast. A highly selective superheterodyne receiver, 110 V. A.C. power supply built in. Using the following tubes: 6K7-RF Amplifier; 6K8 Mixer and Oscillator; 6K7 I.F. Amplifier; 6F7;—Detector and A.V.C.; 6C8 Output and Noise Suppressor; 80 Rectifier. Dimensions—3½ x 19 x 11½ inches. Comes complete, brand new, with one set of coils and **\$16.95**  
Extra set of coils. . . . . **\$2.95**

### HANDIE TALKIE CHASSIS



An ideal unit for building up receiver or transceiver. Comes completely wired with 1-1R5, 1-1T4, 1-1S5, 2-3S4 tubes and 2 455 kc iron core I.F. transformers and antennae less receiving and output coil and crystal. **\$9.95**



### D.C. MILLIAMETER

Brand new General Electric 2" round panel meters 0-300.

**\$2.97**

### MICRO- PHONE

Brand new single button carbon hand mike by "Shure" with push to talk switch.

**\$1.79**



### RHOMBIC RECEIVING ANTENNAE

Complete with all accessories including 2200 feet of No. 14 copper weld wire, 50 feet of heavy twin X lead 72 ohm good up to 2 kw, dozens of insulators, pulleys, neon lighting arrestors, ground rods and everything to erect, less poles. . . . . **\$24.95**

SUN RADIO OF WASHINGTON, D. C.

## WAR SURPLUS EQUIPMENT

At A Fraction of Original Gov't Cost

### WAVEMETER

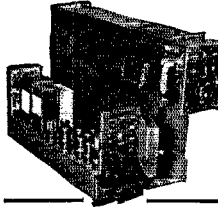

We're closing out the last few of these precision wavemeters which tune from 150-210 mc and which contain a high quality resonant cavity wavemeter, oscillator, heterodyne amplifier, electric tuning eye, complete with 19 tubes, 110v AC power supply. The tubes alone far exceed your close **\$17.95**  
out cost of only. . . . .

### INTER-COM AMPLIFIER

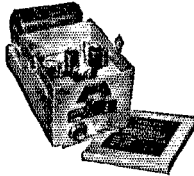

Comes completely wired in aluminum cabinet with following: 2-12A6, 2-12J5 tubes, 1 bathub condenser, 3 can filters, 12 precision resistors, 4 low loss octal sockets, shielded input and output transformers, 2 shielded R.F. chokes, 1 S.P.S.T. toggle, 28v D.C. dynamotor. Sun Radio furnishes the instructions for easy conversion to Hi-Fidelity phone or speech amplifier. . . . . **\$8.95**

### R.F. TUNING UNITS

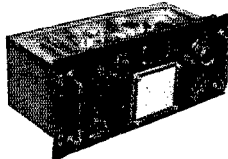

Still the best buy on surplus. . . . . Beautiful black crackled aluminum cabinet with two variable transmitting condensers and two vernier dials, one heavy duty ceramic four position wafer switch, mica condensers, 2,500 working volts and coils wound on porcelain ribbed forms. Available TU5B (1500-3000 kc) TU7B (4500-6200), TU8B (6200-7700 kc) and TU10B (10000-12500 kc). Please specify model. . . . . **\$3.89**

### SPERRY AMPLIFIER

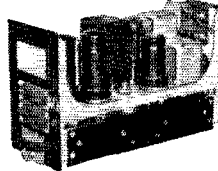

Brand new servo amplifier containing two beam power output tubes (1632) similar to 25L6, two twin triodes (1633 2nd 1634) similar to 6SC7, two mica condensers, dozens of color coded half watt resistors, two dual and four section bathub condensers, three transformers, two wafer switches, one volume control, four octal sockets. Easily convertible. . . . . **\$3.95**

### BC-684 F.M.

### 35 WATT TRANSMITTER

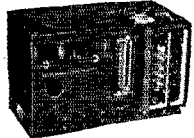

Brand new, complete with eight tubes, crystal control, 10 channel pushbutton, non-lenier modulation coil . . . less cover-plate, crystal and **\$17.95**  
power supply. . . . .

• All items F.O.B. Washington, D. C. Orders \$30.00 or less cash with order. Above \$30.00, 25 percent with order, balance C.O.D.

# SUN RADIO

OF WASHINGTON, D. C.

938 F STREET, N. W. WASH. 4, D. C.

*First*  
**WITH DISCRIMINATING  
 AMATEURS**



**ON STANCOR'S PROGRAM**  
 Transformers and Reactors of all types  
 . . . Versatile Line of Transmitter Kits,  
 Audio Amplifier Kits, and other  
 Electronic Devices to serve the  
 Discriminating Amateur.

**STANCOR** STANDARD  
 TRANSFORMER CORP.  
 ELSTON, KEDZIE AND ADDISON, CHICAGO, ILL.

**COMPLETE RADIO TRAINING!**

Prepare now to accept a responsible position in Commercial Radio. New developments will demand technicians with thorough basic training, plus a knowledge of new techniques discovered during the war. Training open to high school graduates or those with high school equivalency. Courses 6 to 18 months' duration in RADIO AND ELECTRONICS. Approved Veteran training in Radio. Write for Particulars.

VALPARAISO TECHNICAL INSTITUTE  
 Dept. TN Valparaiso, Ind.

**NOW ILLUMINATED  
 Station Call Sign**

Designed to Match Your Most Modern Station Equipment

- Beautifully edge-lighted at turn of switch.
- Distinctive lettering—machine engraved—white filled for unlighted legibility.
- Quality engineering throughout.
- Sign of heavy clear plastic.
- Base of cast aluminum, black baked wrinkle finish with contrasting bright metal trim.
- Plastic cord and moulded plug.
- Scratch and skidproof rubber mounting.



Dimensions:  
 Length 6 1/4" Depth 2 3/8"  
 Height 3 1/4"

**Price ONLY \$8.75**

Postpaid in U. S. A.  
 Black finish is standard. Gray 40 cents extra. Send check or money order with order.

**LECTRO-LAB PRODUCTS CO.**

BOX 6784 • PHILADELPHIA 32, PA.

(Continued from page 140)

Manager of ARRL Publications, and in recent years as Treasurer as well, be it

RESOLVED, that the Board of Directors, meeting at West Hartford, Conn., on May 2, 1947, in recognition of David Houghton's untiring efforts on behalf of the League, does hereby express its deep appreciation of his loyalty, fidelity and intelligent devotion to the best interests of the institution of amateur radio.

Whereupon the said motion was unanimously ADOPTED by a rising vote. Mr. Houghton spoke briefly in appreciation.

45) On motion of Mr. J. M. Johnston, unanimously VOTED that there is hereby appropriated from the surplus of the League, as of this date, the additional sum of eight hundred dollars (\$800) for the legitimate administrative expenses of the director of the Hudson Division for the calendar year 1947, any unexpended remainder at the end of the year to be restored to surplus.

46) On motion of Mr. J. M. Johnston, on behalf of himself and Mr. Noble, after discussion, unanimously VOTED that the Planning Committee is requested to study the feasibility of the publication by ARRL of an amateur call-book and to report its findings to the Board.

47) On motion of Mr. J. M. Johnston, unanimously VOTED that the Regulations Committee is merged with the Planning Committee and that the resultant committee shall be called the Planning Committee.

48) On motion of Mr. H. W. Johnston, unanimously VOTED that there is hereby appropriated from the surplus of the League, as of this date, the sum of four thousand dollars (\$4000), for the purpose of defraying the expenses of holding this meeting of the Board of Directors, any unexpended remainder of same to be restored to surplus.

49) On motion of Mr. Richelieu, unanimously VOTED that there is hereby appropriated from the surplus of the League, as of January 1, 1948, the sum of eight thousand fifty dollars (\$8050), for the legitimate administrative expenses of the directors in the calendar year 1948, the said amount allocated as follows:

Canadian General Manager . . . . .	\$ 350
Atlantic Division Director . . . . .	200
Central Division Director . . . . .	750
Dakota Division Director . . . . .	500
Delta Division Director . . . . .	500
Great Lakes Division Director . . . . .	400
Hudson Division Director . . . . .	1100
Midwest Division Director . . . . .	500
New England Division Director . . . . .	300
Northwestern Division Director . . . . .	600
Pacific Division Director . . . . .	500
Roanoke Division Director . . . . .	300
Rocky Mountain Division Director . . . . .	500
Southeastern Division Director . . . . .	450
Southwestern Division Director . . . . .	500
West Gulf Division Director . . . . .	600

\$8050

any unexpended remainders of these funds at the end of the year 1948 to be restored to surplus.

50) On motion of Mr. Davis, unanimously VOTED that there is hereby appropriated from the surplus of the League, as of this date, the sum of two hundred dollars (\$200) for the purpose of defraying the expenses of the Finance Committee, and the sum of one thousand dollars (\$1000) for the purpose of defraying the expenses of the Planning Committee, any unexpended remainder of either on the date of the next annual meeting of the Board to be restored to surplus.

51) On motion of Mr. Noble, unanimously VOTED that the sum of three thousand dollars (\$3000) is hereby appropriated from the surplus of the League, as of this date, for the purpose of defraying the traveling expenses of the Section Communications Managers and QSL Managers of the League, in the period between this date and the date of the next annual meeting of the Board, as follows: (1) Within the continental limits of the United States and Canada, SCMs to attend one official ARRL convention within their respective divisions. (2) Within ARRL sections in the continental limits of the United States and Canada, SCMs to attend in their own section, in addition to the above, not more than five major ARRL organization meetings per year, to include hamfests only if sponsors schedule an ARRL organization

(Continued on page 144)

*Whatever You Need...  
You'll Find it at Resco!*

**"JUNIOR" INSTRUCTOGRAPH**

Automatic code transmitter with instruction book. Sends telegraphic characters at any desired speed. Anyone can learn Morse code without assistance. As valuable to licensed amateur for increasing speed as the beginner. Complete with 5 tapes



**1650** Less Oscillator

**CODE PRACTICE OSCILLATORS**

For Above Instructograph

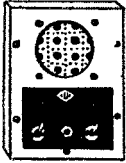

110 V AC or DC Oper. Bud CPO-120 **1250**

Excellent for individual or group code practice. Complete with speaker and tube.

Bud CPO-122 To operate 1-20 earphones. Volume and pitch control provided. Any number of keys connected for group practice. Less Speaker.

**1015**

**BURGESS DELUXE VIBRO-TOOL**

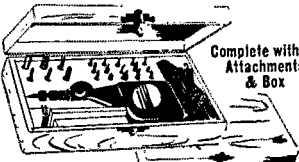

Complete with 22 Attachments & Box

Engraves on metal, glass, stone, plastics. Cuts patterns from cloth, rubber; tools, leather, etc.

110 V AC, 60 cycle No. V 150— **990**

Vibro-Tool with needle, less kit—4.50

**Surplus POWER RELAY**

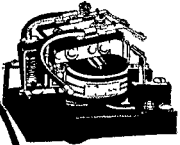

Leach heavy duty, DPST 30 amp. contact. 115 v AC coil. Good relay for the kilowatt. REG. \$11

Resco's Price **495**

Surplus Transformer for single button carbon mike. **149**

Surplus RCA Plate Transformer. 1600-o-1600 volts AC at 250 MA. Adjustable line taps. **895**

Surplus Power Transformer. 340-o-340 AC volts at 150 MA, 6 volts at 2 amps, 10 volts at 10 amps. For exciter with 813 tubes **395**

**CRYSTAL SETS**

Carron Model 100 with built-in earphone **215**

Carron Model 200 with earphone and headband **350**

Philmore "Super" **114**

Philmore crystal detectors complete with crystal and holder. **21¢**

Philmore mounted crystals **8¢**

**Amphenol Polysterene 12"x16" Sheets**

- 1/16" thick ..... 1.44
- 3/32" thick ..... 2.22
- 1/8" thick ..... 2.78
- 3/16" thick ..... 4.11
- 1/4" thick ..... 5.56

**NATIONAL XR-50**



Slug-tuned form. May be wound as desired, for high frequency coils.

**101**

Write for big free bulletin. Include postage with cash orders.

**First Shipment Just Received!**

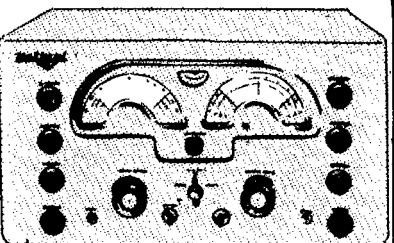

**NATIONAL NC-173**

- 6 meter amateur band coverage. 540 kc. to 31 mc. plus 48-56 mc. frequency coverage.
- Calibrated amateur bandspread on 6, 10-11, 20, 40 and 80 meter bands.
- Double-diode automatic threshold noise limiter effective on both phone and CW reception.
- 6 positive wide range crystal filter AVC for both phone and CW reception. Voltage regulator tube.
- S-meter with adjustable sensitivity for phone and CW reception.

**BUY NOW! LIMITED SUPPLY AVAILABLE 17950**

Speaker ..... \$10

**OTHER RECEIVERS FOR QUICK DELIVERY**

- NATIONAL HRO ..... **274.35**
- Speaker \$12 Power Supply 20.36
- NATIONAL NC-240-D ..... **\$225**
- Speaker 16.44
- NATIONAL NC-46 ..... **97.50**
- Speaker 9.90
- NATIONAL 1-10 ..... **67.50**
- Speaker \$12 Power Supply 22.43
- HALLICRAFTER S-38 ..... **47.50**
- HALLICRAFTER S-40 ..... **89.50**
- HALLICRAFTER SX-42 ..... **\$275**
- Speaker 29.50
- HALLICRAFTER HT-9 (Trans.)... **289.50**
- HAMMARLUND HQ-129X ..... **161.40**
- Speaker 11.85
- HAMMARLUND SUPER-PRO ..... **334.05**
- Speaker 13.20
- RME-84 ..... **98.70**
- RME-45 ..... **198.70**
- PANADAPTOR ..... **99.75**

Most of the Above Receivers Available on Resco Finance Plan. Write for details.

**SURPLUS TELEVISION or 'SCOPE HI-VOLTAGE TRANSFORMER**

115 volt, 60 cycle, primary 4400 volts at 0.0045 amps and 5 volts, 3 amp secondaries. Filament winding is center tapped and insulated for 15,000 **4.95**

SURPLUS FILTER CAPACITORS for above. Round can, hermetically sealed. 0.03 at 7500 V.D.C. working 0.1 at 7500 V.D.C. working. **1.69**

**ALL PURPOSE, FRACTIONAL H. P. SMALL MOTORS**

Brand new, with mounting brackets and studs. For fan and intermittent duty. 1/2" shaft diameter. 115 volts, AC, 60 cycle.

Available in Three Sizes!

- 1/150 H. P. 1 1/8" shaft. 3400 R.P.M. **335**
- 1/100 H. P. 1 1/2" shaft. 3400 R.P.M. **350**
- 1/60 H. P. 1 3/4" shaft. 3400 R.P.M. **350**

**Radio Electric SERVICE CO. OF PENNA., INC.**

7TH AND ARCH STREETS, PHILA. 6, PENNA.  
Branches: 5133 Market St. & 3145 N. Broad St., Phila.  
Also in Wilmington, Del., Easton, Pa., Allentown, Pa., Camden, N.J.

*Crystals for the Critical*

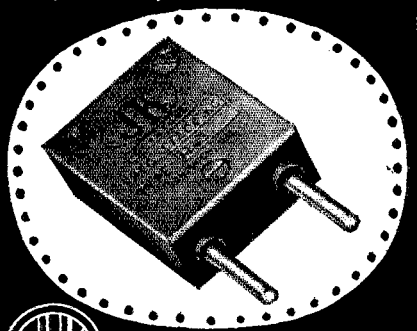

**"STABILIZED"**

**H43 CRYSTAL**

For any amateur frequency between 2,000 and 30,000 KC. Drift not more than 2 P.P.M. per degree cent. from -10 to +60° C. and usually less than 1 P.P.M. per degree cent. Pin Spacing  $\frac{3}{4}$ " Pin Diameter  $\frac{1}{8}$ ". Each crystal checked for active oscillation in typical "ham" oscillator and "Stabilizing" process prevents frequency shifts due to age.

**The JAMES KNIGHTS CO.**  
SANDWICH, ILLINOIS

**AMATEURS  
EXPERIMENTERS  
SUPPLIES & EQUIPMENT**

*Leading Brands*

Headquarters for  
**HALLICRAFTERS  
NATIONAL HAMMARLUND  
RADIO PARTS DISTRIBUTING CO.**  
128 W. Olney Road NORFOLK, VA.

**SENDING  
CODE RECEIVING SPEED**

**Have Skill, Accuracy**



Be a "key" man. Learn how to send and receive messages in code by telegraph and radio. Commerce needs thousands of men. Expansion of air commerce and freight after war should create an even bigger peacetime demand for operators. The famous Candler System, maker of world's champions, teaches you the "knack" of sound sense and sound consciousness that is the secret of speedy sending and receiving. Good pay, adventure. Learn at home quickly.

**FREE 52-PAGE BOOK** explains extra course of training. Rush name for it today. It's absolutely free.

**CANDLER SYSTEM CO.**  
Dept. 4-C, P. O. Box 928, Denver 1, Colo., U. S. A.  
and at 121 Kingsway, London, W.G. 2, England

(Continued from page 148)

meeting. The SCM shall have the option of giving written approval to the attendance of his Section Emergency Coordinator at such a meeting, in his stead. In exceptional cases, with the written approval of both the director (or CGM) and Communications Manager, attendance may be authorized for some other designated appointee as representative of the SCM. (3) Within the continental limits of the United States and Canada, QSL Managers of the League to attend one official ARRL convention within their respective call areas, provided such convention be held within 500 miles of the QSL Manager's residence. And it is further VOTED that reimbursement shall be made in all the above at the rate of ten cents a mile via the shortest commonly-traveled route if personal transportation be used or in the exact amount of the fare if railroad or bus be used. In (1) and (3) expenses may include one night's hotel accommodation at actual cost but not to exceed four dollars, and the convention registration fee. All allowances for expenses shall be subject to approval by the Communications Manager in the case of the SCMs, and by the Secretary in the case of QSL Managers, of a report submitted with the itemized request for reimbursement, covering the representation of ARRL accomplished, the attendance at an organization meeting discussion, questions, recommendations, or QSLs distributed, etc., by the individual attending the meeting. At the end of the designated period any unexpended remainder of this appropriation shall be restored to surplus.

52) The Board was in recess from 3:45 P.M. to 3:54 P.M.

53) On the question of the desirability of requesting a Class D license, on motion of Mr. H. W. Johnston, VOTED that this subject shall lie on the table.

54) Proceeding to an examination of the recommendations of the Planning Committee, on motion of Mr. Davis, unanimously VOTED that the Board at this meeting will refrain from creating and announcing any plans for changes in frequencies authorized for 'phone operation below 28 Mc.; and that the Board authorizes the Planning Committee to make a study of this question immediately upon the conclusion of the world conference; and that, as soon as possible thereafter (but not before the end of the world conference), upon permission of the Board, the plans proposed by the Committee shall be then published in QST and a poll of amateur opinion thereon taken; and that the matter shall then be examined, in the light of the opinions thus expressed, by the Board at its 1948 meeting.

55) On the question of redistricting the ARRL divisions, on motion of Mr. McCargar, VOTED, 11 votes in favor to 3 opposed, that this subject shall lie on the table.

56) On the question of n.f.m. 'phone, after examination and discussion, on motion of Mr. Davis, unanimously VOTED that the Board requests the Federal Communications Commission to authorize narrow-band frequency- or phase-modulated 'phone operation on the 'phone frequencies 3850-3900 and 14,200-14,250 kc. for an experimental period ending June 30, 1948, under the condition that the bandwidth shall not exceed the bandwidth occupied by an amplitude-modulated signal of the same audio characteristics; and that the Board of Directors shall reexamine the question at its 1948 meeting in the light of experience to that date.

57) On motion of Mr. J. M. Johnston, unanimously VOTED that the question of requesting changes in the regulations governing the issuance of Class A licenses shall lie on the table.

58) On the question of arrangements to facilitate operation in the 6-meter band, after discussion, on motion of Mr. Shelton, VOTED without dissent that the League requests the Federal Communications Commission to authorize narrow-band frequency- or phase-modulated 'phone on the frequencies 51 to 54 Mc., Mr. Reid asking to be recorded as not voting. On the Planning Committee's recommendation concerning wide-band f.m. 'phone in that band, on motion of Mr. Richelieu, unanimously VOTED that the subject shall lie on the table. On the Planning Committee's recommendation concerning Type A<sub>0</sub> emission in part of that band, on motion of Mr. Richelieu, unanimously VOTED that the subject shall lie on the table.

59) The Secretary presented an informal request from FCC for the Board's reaction to several proposals concern-

(Continued on page 146)

# HARRISON HAS IT!

# HARRISON HAS IT!

## Harrison Select Surplus

Your assurance of good, usable, guaranteed, surplus material at sensationally low prices—**TOP VALUE ALWAYS!** Come in and browse through the separate HSS Department in our **NEW LARGE STORE!**

### BRAND NEW SPARE PARTS FOR BC 1267-A

<p><b>HIGH VOLTAGE</b> Components — xformers (117 volt, 60 cycle primary), two 2X2 tubes, HV sockets, oil condensers, resistors, 10 ma protective circuit breaker switch — to deliver 5,000 volts for television, scope, etc. Complete with diagram..... <b>\$12.45</b></p>	<p><b>11 MC. IF COIL KIT</b> Five IF stages, Detector, and Tuning Indicator. Slug tuned, shielded. Can be stagger tuned to pass band 4 mc wide. All seven, with diagram..... <b>\$3.75</b></p>
<p><b>CHEST</b> Strong wooden Transit Chest CH-224. Can be used as FB tool chest, camp or field trunk, parts box, etc. Three full size drawers, carrying handles, partitions, gasketed lid with clasps. 23" x 24" x 32"..... <b>\$4.89</b></p>	<p><b>TRANSFORMERS</b> Fully cased 5" x 5 1/4" x 5 1/4" Insulated terminals. Electrostatic shields.  Filament — 6.4 Volts @ 12 Amps, 6.4 @ 10.6, 5 @ 3, 5 @ 3, 5 @ 3, 2.5 @ 1.75..... <b>\$2.78</b></p>

### SURPLUS TUBES

All new, perfect, JAN Gov't tested. Look at the Prices!  
 2C26 — 10 watt UHF triode, 6.3 heater, 400 volt plate. 69¢ each. Three for **\$1.79**  
 HK-24G (3C24) The favorite small tube! \$1.19 each. Four for **\$3.98**  
 3E29 (829-B) — \$2.69    2X2 — 84¢    6AK5 — 84¢  
 9002, 9006 — 62¢    6AG5 — 75¢ each, Three for **\$1.98**  
**IN STOCK!** All other types of JAN Gov't surplus tubes currently available — at lowest competitive prices!!

Order your entire requirements — from Harrison!

### SIX FOOT TRIPOD

Signal Corps MT-128. Sturdy wooden construction. Will support 200 lbs. Folds to 42 inch compact bundle. Ideal for PA Speakers, portable beams, field antenna, etc. HSS SPECIAL... **\$2.46**

### BC-406 15 TUBE UHF RECEIVER

This is the one that the gang have been converting into those HOT 2, 6, and 10 meter super-hets! Like new, complete with tubes **\$19.95** (BC-406-A, 16 Tubes, with motor..... \$29.75)

### MIDGET VIBRATOR PACKS

For Navy models MU, MX, MAB, etc., or any portable equipment requiring 135 volts at 30 ma, 67 1/2 at 8 ma., 1.5 filament or 6.3 heater, bias and mike voltages. Works on any 6 volt battery (or 4 flashlight cells). Compact, weighs only 2 lbs. **\$3.95**

### STORAGE BATTERY

Willard RECHARGEABLE battery to clip into pack. 3 cell, 6 volt, 30 watt hour. NON-SPILL unbreakable plastic case. Com- **\$1.55**

### PRIMARY BATTERY

Willard. To be used in pack when recharging facilities are unavailable. Indefinite shelf life. Each..... **90¢**  
 20 for **\$9.95**

**EVERYTHING** you need to build the micromatch SWR meter — including cabinet with meter hole, meter, 1N34, etc. **\$11.48**

## All STANDARD Lines

I offer you —  
**RECEIVERS**  
**TRANSMITTERS**  
**TEST EQUIPMENT**  
**PARTS, etc. . . .**  
 All Makes and Models available  
 with **QUICKER DELIVERY**  
 at **LOWEST PRICES**  
 and **HIGHEST TRADE-IN ALLOWANCES**

together with my sincere desire to be of friendly, helpful SERVICE.

Send me your orders — I guarantee you'll be well pleased.

TNX ES 73,  
 Bil Harrison, W2AVA

<p><b>VIBROPLEX KEYS</b> The original, and still best, "bugs"! "Champion" \$9.95, "Zephyr" \$12.50, "Lightning Bug" \$13.95, DeLux \$17.50, "Blue Racer" \$15.95, DeLux \$19.50, "Original" \$15.95, DeLux \$19.50. Carrying cases, with lock and key \$5.50.</p>		<p><b>RCA</b> <b>193-A</b>  Volt-Ohmyst <b>\$69.50</b></p>
<p><b>Micromatch</b> Model MM1 <b>\$29.50</b></p>	<p><b>Hallcrafters</b> <b>SX-42</b> <b>\$275</b> R-42 Speaker <b>\$29.50</b></p>	<p><b>UHF Resonator Co.</b> 4-element Beams 10x..... \$50 20x..... 100</p>
<p><b>Hallcrafters</b> <b>Panadaptor</b> "Eyes for your Receiver" <b>\$99.50</b></p>	<p><b>Hickok</b> <b>191-X</b> Xtal Signal Generator <b>\$145.92</b></p>	<p><b>Gordon</b> <b>Beam Rotator</b> <b>\$225.00</b></p>
<p><b>NEW STOCK</b> <b>1N34</b> Crystals <b>\$1.50</b></p>	<p><b>Abbott BM2</b> Five element, all aluminum 2x beam. Works FBI List \$23.50 <b>\$8.82</b></p>	

**HAM HEADQUARTERS**  
 Since 1925!



## HARRISON RADIO CORPORATION

12 WEST BROADWAY • NEW YORK CITY 7

PHONE — BARclay 7-9854 • EXPORT DEPT. — CABLE — "HARRISORAD"

[JAMAICA BRANCH — 172-31 Hillside Ave. — REpublic 9-4102]



# BARGAIN SPECIAL

## RG-8/U Flexible Coaxial Cable

50 FOOT COIL

Fittings Included, ONLY

**\$1.95**

Yes Sir—its the standard Amphenol RG-8/U—52 ohm impedance Coax Cable, complete with Amphenol 83-15P (PL259) connectors on each end, and an 83-1J (PL238) junction, so you can readily connect together as many 50 ft. coils as you wish for any desired length. Fittings alone are regularly worth far more than the price asked for the complete assembly. **BRAND NEW PERFECT.**

No. 4A497, Per Coil with Fittings.....

**\$1.95**

No. 2A163, RG-8/U in Bulk, Per ft. 7c  
In Lots of 100 feet and over, per ft.....

**5c**

## The "Tops" in Headphones

8000-ohm impedance, highly sensitive. Best quality Alnico magnets in molded black bakelite cases, concealed terminals. Headband fully adjustable, leather-covered spring steel. 12" cord with PL54 plug attached at side out of way. Jack and rubber cord supplied to extend to 5 1/2 ft.

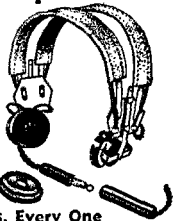

Extremely lightweight, only 9 oz., with removable ear cushions of comfortable design.

Made to Air and Signal Corps. specs. Every One **BRAND NEW.** A \$13.50 Value.  
Stk. No. 17A37, Special Per Pair .....

**\$2.49**

ORDER NOW, from this ad Add Postage

**BURSTEIN-APPLEBEE**  
1012-14 MCGEE STREET, Company  
KANSAS CITY 6, MISSOURI

## EASY TO LEARN CODE

It is easy and pleasant to learn or increase speed the modern way — with an Instructograph Code Teacher. Excellent for the beginner or advanced student. A quick, practical and dependable method. Available tapes from beginner's alphabet to typical messages on all subjects. Speed range 5 to 40 WPM. Always ready, no QRM, beats having someone send to you.

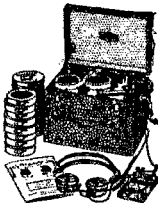

**ENDORSED BY THOUSANDS!**

The Instructograph Code Teacher literally takes the place of an operator-instructor and enables anyone to learn and master code without further assistance. Thousands of successful operators have "acquired the code" with the Instructograph System. Write today for full particulars and convenient ren all plans.

## INSTRUCTOGRAPH COMPANY

4709 SHERIDAN ROAD, CHICAGO 40, ILLINOIS

## ELECTRICITY

FOR RADIO AND ELECTRONIC APPLICATIONS

ONAN ELECTRIC GENERATING PLANTS supply electric service for electronics applications and general uses, mobile or stationary. Driven by Onan 4-cycle gasoline engines, they are of single-unit, compact design and sturdy construction.

ONAN Electric Plants are available in many sizes and models. **ALTERNATING CURRENT:** 350 to 35,000 watts in all standard voltages and frequencies. **DIRECT CURRENT:** 600 to 10,000 watts, 115 and 230 volts. **BATTERY CHARGES:** 500 to 3,500 watts; 6, 12, 24 and 32 volts. Write for detailed literature or engineering assistance.

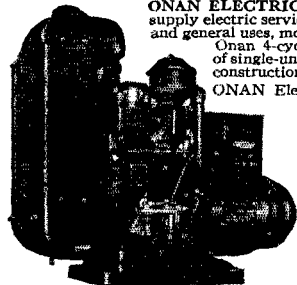

**D. W. ONAN & SONS** 666 Royalston Ave. Minneapolis 5, Minn.

(Continued from page 144)

ing amateur licensing. On the question of eliminating Class A privileges or of conducting the examination by radiotelephony, after discussion, with unanimous consent the Chair DIRECTED the Secretary to convey to the FCC the views of the Board as represented by its previous determinations in this matter, together with the reasons therefor. On the possibility of increasing the area of Class C examinations, after discussion, on motion of Mr. Richelieu, unanimously RESOLVED that the League would offer no objection to the reduction of the Class B circles to a radius of 100 miles airline, Mr. Reid requesting to be recorded as abstaining.

60) On the question of the desirability of the plan proposed in the QST article entitled "A Plan for the 10-meter Band," upon motion of Mr. H. W. Johnston, seconded by Mr. Davis, unanimously VOTED that this question shall lie on the table.

61) On the question of establishing a pension arrangement for ARRL Headquarters employees, the Secretary outlined the provisions of a plan that had been created as the result of extensive investigation and which he had reported and now recommended to the Board. Moved, by Mr. Shelton, that this Board provide a pension plan for the ARRL employees as outlined by the Secretary, employees participating to the extent of 2% of their future salaries. Extended discussion followed, with every director participating. A careful examination was made of the costs of the proposed plan and of the assets and funds of the League, and it was the sense of the meeting that the plan was compatible with the financial position of the League. After further discussion, Mr. Shelton moved that the Previous Question be now ordered. On this matter of whether now to vote on Mr. Shelton's original motion, the same was decided in the negative, 8 votes in favor to 9 votes opposed. So it was agreed that voting on the original motion should go over until after dinner. At this point the Board recessed for dinner from 6:23 p.m. to 8:15 p.m., reassembling with all directors and other persons hereinbefore mentioned in attendance. Moved, by Mr. Richelieu, that the pending motion be committed to a committee for a period of three months, be referred back, and be voted upon by the Board by mail. The yeas and nays being ordered, the said question was decided in the negative: Whole number of votes cast, 16; necessary for adoption, 9; yeas, 4; nays, 12. Those who voted in favor are Messrs. Bird, Davis, Richelieu and Smoll. Those who voted opposed are Messrs. Acton, Colvin, Groves, Jepsen, H. W. Johnston, J. M. Johnston, Ladley, Noble, Raser, Reid, Shelton and McCargar. So the motion was not committed. The original question then being called for, and the yeas and nays being ordered, the said question was decided in the affirmative: Whole number of votes cast, 16; necessary for adoption, 9; yeas, 14; nays, 2. Those who voted in favor are Messrs. Acton, Bird, Colvin, Davis, Groves, Jepsen, H. W. Johnston, J. M. Johnston, Ladley, Noble, Raser, Reid, Shelton and McCargar. Those who voted opposed are Messrs. Richelieu and Smoll. So Mr. Shelton's motion to provide a pension arrangement was adopted. To implement this decision, Mr. McCargar moved the adoption of the following resolution:

**RESOLVED:** That the Secretary and Treasurer of the League, acting jointly, are hereby authorized to take all necessary steps to institute a pension plan for the retirement of employees of the League at age 65 on a basis yielding as retirement pay a percentage of salary computed at 1 1/2% for each year of service following the first 5 years of employment and after the attainment of 30 years of age by the employee, such employees to contribute 2% of their salaries toward the expense of such plan and the remaining expenses to be borne by the League; and that the sum of one hundred and twenty-five thousand dollars (\$125,000) is hereby appropriated from the surplus of the League, as of this date, to be available for paying the expenses of this plan as concerns the services of employees prior to the adoption of this plan, any unexpended remainder of same to be restored to surplus; and that the Secretary is authorized to incur, as operating expenses of the League, the necessary charges as they concern future services of League employees after the adoption of

(Continued on page 148)



Bob Henry calling . . . .

# COMPLETE STOCKS QUICK DELIVERY

IN BOB HENRY'S code of doing business "CQ" means *Complete stocks, Quick delivery*. Bob Henry offers the finest, fastest service in the land to all amateurs *plus* personalized, individual attention to all orders by an amateur who knows what amateurs want. He says:

"The delivery situation is now good. I can ship immediately nearly all items. For fastest service send five dollars and I will ship COD *at once at wholesale prices*. Or order on my easy time payment plan. I finance the terms myself to give you better service and *save you money*. Trade-ins welcome. Tell me what you have to trade and we can make a deal. Attached is only partial listing of my complete stocks. I have almost everything an amateur wants. Good bargains in war surplus. *Send to me for anything*. Orders and inquiries handled with speed and efficiency. *Write, phone, wire or visit either of my stores now.*"

*Bob Henry*  
WØARA

Models listed are in stock . . . for immediate shipment:

Hallicrafters S38 . . . . .	\$ 47.50
Hallicrafters S40A . . . . .	89.50
Hallicrafters SX42 . . . . .	275.00
Hallicrafters SP44 . . . . .	99.50
Hallicrafters HT9 . . . . .	350.00
Hammarlund HQ129X . . . . .	161.40
Hammarlund SPC400X . . . . .	334.05
National NC240DT and NC240DR . . . . .	225.00
National HRO5TA and HRO5RA . . . . .	274.35
National NC46 . . . . .	97.50
National NC173 . . . . .	179.50
RME84 . . . . .	98.70
RME45 . . . . .	198.70
RME VHF152 . . . . .	86.60
RME LF90 . . . . .	29.70
Pierson KP-81 . . . . .	367.65
Gon-Set converters . . . . .	39.95
Collins 30K-1 . . . . .	1250.00
Collins 75A-1 (soon) . . . . .	375.00
Collins 32V-1 (soon) . . . . .	475.00
Collins 70E-8 (soon) . . . . .	40.00
Meissner Signal Shifter . . . . .	120.00
Bud VFO-21 . . . . .	52.50
Temco 75GA . . . . .	495.00
Temco 500GA . . . . .	1800.00
Supreme AF-100 . . . . .	450.00
Harvey 100T . . . . .	583.00
Millen 90700ECO . . . . .	42.50
Millen 90800 exciter . . . . .	37.50
Millen 90281 power supply . . . . .	84.50
Millen 90881 500 watt RF unit . . . . .	89.50
Millen 90902 scope . . . . .	42.50
Sonar XE-10 . . . . .	39.45
Sonar VFX-680 . . . . .	87.45
Gordon rotary beam . . . . .	225.00
Directo-O-Beam . . . . .	117.00
Premax 28MC beam kit . . . . .	29.40
Work Shop 28 MC beam kit . . . . .	39.50
Ranger 905 Trans-Meter . . . . .	49.50

Priced Subject to Possible Change

Butler, Missouri **HENRY RADIO STORES** Los Angeles 25, Calif.

"WORLD'S LARGEST DISTRIBUTORS OF SHORT WAVE RECEIVERS"

# ★ YOUR FUTURE IN ★ RADIO . . .

May depend on the integrity and ability of your School's Administration.

At MELVILLE no effort is spared to provide the best in facilities and service for the serious student of RADIO, TELEVISION, FREQUENCY MODULATION, TELEGRAPHY, SLIP TRANSCRIPTION, RADIO MATHEMATICS, etc.

Approved for Veterans  
Licensed by the State of N. Y.  
Write or call today for FREE  
Bulletin B

**MELVILLE  
RADIO INSTITUTE**  
45 W. 45th St., New York 19, N.Y.  
BRyant 9-5080  
"Managed by Radio Men"

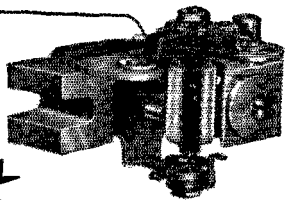

**PRECISION MOVEMENT  
DEPENDABILITY UNLIMITED**

**Burlington  
INSTRUMENTS**

● Alnico Magnets in all DC Instruments—phosphor bronze control springs—perfectly aligned jewel supports—non-shifting balance weights—added to many other superior construction features enables Burlington to maintain critical characteristics.

All ranges AC or DC available in 2½", 3½", 4½" sizes, rectangular and round.

Inquiries invited for your specific requirements.

**BURLINGTON INSTRUMENT COMPANY**  
815 Fourth Street • Burlington, Iowa

(Continued from page 146)

this plan, the Board of Directors reserving the right to terminate or modify the future operation of the plan at any time.

Whereupon the said resolution was ADOPTED, Mr. Richelieu requesting to be recorded as voting opposed. Secretary Warner then thanked the Board, on behalf of the members of the Headquarters staff, for establishing this provision for employee retirement, stating that the Headquarters career men and women were very grateful for it and that it was a great contribution to their morale which would be much appreciated. He was sure that they would continue their very best efforts on behalf of amateur radio, and that the Board's action would redound to the benefit of the League. (Applause.)

62) On the matter of the need for increasing membership dues, moved, by Mr. Jepsen, that the Board postpone consideration of an increase in membership dues for three months and reexamine the financial condition of the League at that time. But, after discussion, the said motion was rejected. After further discussion, moved, by Mr. Noble, to amend the stipulation of membership dues in By-Law 3 to read \$3.00, the same to be effective July 1, 1947. The yeas and nays being ordered, the said question was decided in the affirmative: Whole number of votes cast, 15; necessary for adoption, 10; yeas, 10; nays, 5. Those who voted in favor are Messrs. Acton, Bird, Davis, Groves, H. W. Johnston, J. M. Johnston, Ladley, Noble, Raser and Smoll. Those who voted opposed are Messrs. Colvin, Jepsen, Reid, Richelieu and Shelton. The President and Vice-President abstained as required. So the amendment was adopted. On the question of setting the dues in Canada at fifty cents more than in the United States, because of additional costs involved, after discussion, moved, by Mr. Davis, to further amend By-Law 3 to read as follows, effective July 1, 1947:

3. The dues shall be \$3.00 per year in the United States & Possessions, \$3.50 in the Dominion of Canada, payable annually in advance.

The yeas and nays being ordered, the said question was decided in the affirmative: Whole number of votes cast, 15; necessary for adoption, 10; yeas, 11; nays, 4. Those who voted in favor are Messrs. Acton, Bird, Davis, Groves, Jepsen, H. W. Johnston, J. M. Johnston, Ladley, Noble, Raser and Smoll. Those who voted opposed are Messrs. Colvin, Reid, Richelieu and Shelton. The President and Vice-President abstained as required. So the by-law was amended. On the matter of increasing "family membership" dues to \$1, after discussion, moved, by Mr. Groves, that By-Law 4 be amended to read as follows:

4. Provided that a Full Member is the husband or wife, brother or sister, son or daughter, father or mother of another Full Member living at the same address, paying dues at the rate of \$3.00 per year in the United States & Possessions or \$3.50 per year in the Dominion of Canada, he may at his request pay dues of \$1.00 per year, in advance, but without the right to receive "QST"; said membership to be concurrent with that of the member receiving "QST."

The yeas and nays being ordered, the said question was decided in the affirmative: Whole number of votes cast, 15; necessary for adoption, 10; yeas, 13; nays, 2. Those who voted in favor are Messrs. Acton, Bird, Colvin, Davis, Groves, Jepsen, H. W. Johnston, J. M. Johnston, Ladley, Noble, Raser, Shelton and Smoll. Messrs. Reid, and Richelieu voted opposed. The President and Vice-President abstained as required. So the by-law was amended.

63) Communications Manager Handy retired from the room at the request of the Board. After discussion, on motion of Mr. J. M. Johnston, unanimously VOTED that the salary of Francis E. Handy as Communications Manager is increased to \$8400 per year. Mr. Handy rejoined the meeting and spoke briefly in appreciation. (Applause.)

64) On the matter of several necessary minor amendments of By-Laws:

a) Moved, by Mr. Shelton, that By-Law 39 be amended to change the reference to "West Hartford Trust Company" to read "Hartford-Connecticut Trust Company." The yeas and nays being ordered, the said question was decided in the affirmative: Whole number of votes cast, 15;

(Continued on page 150)

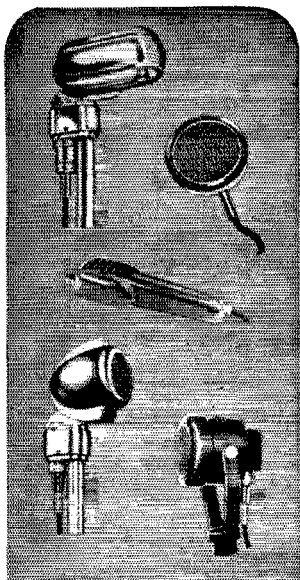

# DEPENDABLE AS NIGHT AND DAY

## Turner 99 Dynamic

A true professional, the Turner Model 99 Dynamic is always ready to pick up your message and deliver crisp and clear. Engineered for utmost in dependability with smooth response not affected by changes in climate, humidity, or temperature. Built-in features minimize feedback, eliminate blasting. Adjustable saddle permits semi- or non-directional operation. Fits any standard microphone stand. Response: flat within  $\pm 5$  db from 40-9000 c.p.s. Level: 52 db below 1 volt/dyne/sq. cm. at high impedance. Available in 50, 200, 500 ohms, or high impedance. Complete with 20 ft. removable cable set. Ask your dealer

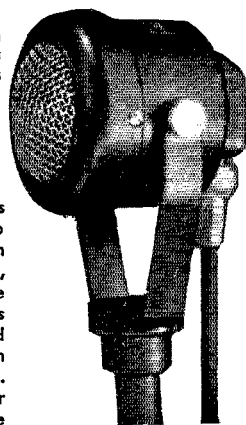

Write for Literature

## THE TURNER COMPANY

917 17th STREET, N. E. . . . CEDAR RAPIDS, IOWA



# Microphones BY TURNER

Microphones licensed under U. S. patents of the American Telephone and Telegraph Company, and Western Electric Company, Incorporated. Crystals licensed under patents of the Brush Development Company.

## P R E C I S I O N   C R Y S T A L S

# New!

Actual  
Size

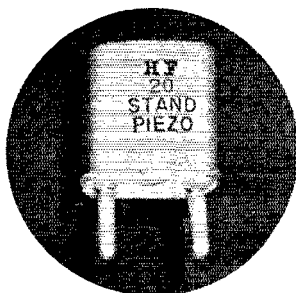

48 mc to 54 mc

\$6.95 NET

*Frequency multiplication  
eliminated in the 6 meter band;  
reduced to a minimum in the 2 meter band.*

*A complete line for the amateur*

6796-6864 KC

14000-14850 KC

25000-27000 KC

3500-4000 KC

48.-49.3 MC

7000-7425 KC

24000-24666 KC

27185-27455 KC

50.-54. MC

# STANDARD PIEZO Co.

Office and Development Laboratory  
Write for our new catalogue

CARLISLE, PA., P. O. Box 164  
W3HWN . . . W3BML



## Q-Dope Ruf-Koat

Electronic Chem. Lab. • Lubriplate

### G-C RUF-KOAT AIR DRY WRINKLE VARNISH

Only wrinkle finish that will air dry.  
Baking not required. Easy to use. Gives  
wrinkle finish, No. 80-2, — 1/4 pt. — List 43c



### G-C ELECTRONIC CHEMICAL LABORATORY

Ideal for "hams," servicemen, experi-  
menters, etc. 19 different bottles and  
chemicals in heavy steel rack (FREE  
RACK) No. 998—List. . . . . \$11.12

### G-C LUBE-REX "LUBRIPLATE"

Best contact cleaner available. Prevents  
corrosion. For switches, attenuators, contacts,  
etc. Moisture-repellent, rust-preventing. No.  
1209—2-oz. bottle—List. . . . . 50c



### G-C Q-DOPE

Made from Polystyrene. For high frequency  
work. Fast-drying. Maintains coil characteris-  
tics. No. 37-2—2-oz. bottle.—List. . . . . 35c

Sold by all Jobbers  
Write for complete catalog today

RADIO DIVISION DEPT. C

**GENERAL CEMENT Mfg. Co., Rockford, Ill., U. S. A.**  
Manufacturers of over 3,000 products • Sales offices in principal cities

**FOR THE BETTER TYPE OF HAM GEAR**  
**WILLARD WILSON, W3DQ**  
is a good fellow to know.

**COLLINS — HAMMARLUND — RME — NATIONAL —**  
**HALLICRAFTERS — MILLEN and other top lines.**

**A super-buy: RCA 30 WATT MOBILE XMTR.**  
Completely modified with tubes, xtal,  
cables and mike . . . . . \$75.00  
6 volt input — 27-30 MC FM OUTPUT  
GONSET CONVERTER AND NOISE LIMITER \$48.20

### DELAWARE RADIO SALES

505 Delaware Avenue

WILMINGTON, DELAWARE

### WHAT IS HIS HANDLE "GUIDE"

**AVOID EMBARRASSMENT  
KNOW HIS NAME  
INSTANTANEOUSLY**

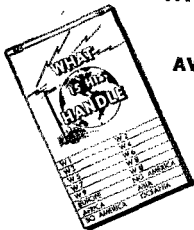

**WORLD WIDE  
DX Prefixes also**

PRICE 3 FOR \$1.00  
DELUXE MODEL \$4.00 POSTPAID

**GREENE PLASTICS, INC.**

WAKEFIELD

RHODE ISLAND

(Continued from page 148)

necessary for adoption, 10; yeas, 13; nays, 2. Those who voted in favor are Messrs. Acton, Bird, Colvin, Davis, Groves, Jepsen, H. W. Johnston, Ladley, Noble, Raser, Reid, Shelton and Smoll. Messrs. J. M. Johnston and Richelieu voted opposed. The President and Vice-President abstained as required. So the by-law was amended.

b) Moved, by Mr. Acton, that By-Law 6 be amended to change the reference to "Philippine Islands" to read "Republic of the Philippines." The yeas and nays being ordered, the said question was decided in the affirmative: Whole number of votes cast, 15; necessary for adoption, 10; yeas, 15; nays, 0. Every director present voted in the affirmative, except the President and Vice-President who abstained as required. So the by-law was amended.

c) Moved, by Mr. Richelieu, that By-Laws 5(a) and 22 be amended to read respectively as follows:

5. (a) In the United States and possessions — ATLANTIC . . . ; CENTRAL DIVISION, the states of Illinois, Indiana and Wisconsin; DAKOTA . . . ; GREAT LAKES DIVISION, the states of Kentucky, Michigan and Ohio; HUDSON . . . New Mexico.

22. A Director shall be elected in each even-numbered year in each of the following divisions: Central, Hudson, New England, Northwestern, Roanoke, Rocky Mountain, Southwestern and West Gulf. A Director shall be elected in each odd-numbered year in each of the following divisions: Atlantic, Dakota, Delta, Great Lakes, Midwest, Pacific and Southeastern. The terms of all Directors shall be for two years, or until their respective successors are duly elected and qualified.

The yeas and nays being ordered, the said question was decided in the affirmative: Whole number of votes cast, 15; necessary for adoption, 10; yeas, 15; nays, 0. Every director present voted in the affirmative, except the President and Vice-President who abstained as required. So the by-laws were amended.

d) Moved, by Mr. Reid, that By-Law 2 be amended by dropping the proviso, so that it reads as follows:

2. Members in arrears shall be carried on the League records for thirty days, but if they have not renewed their membership by that date they shall be dropped.

and that the following resolution be now adopted:

**RESOLVED:** that any member of the League who served in the armed forces of the United States or of the Dominion of Canada between September 1, 1939, and May 3, 1947, and who became in arrears in dues while so serving, shall not be deemed to have made himself ineligible to hold office in the League, insofar as concerns continuity of membership, if within those dates he resumed his League membership within the 90 days following his release from active military duty.

The yeas and nays being ordered, the said question was decided in the affirmative: Whole number of votes cast, 15; necessary for adoption, 10; yeas, 14; nays, 1. Every director present voted in the affirmative except Mr. Davis, who voted opposed, and the President and Vice-President who abstained as required. So the by-law was amended and the resolution was adopted.

65) On motion of Mr. Smoll, unanimously VOTED that there is hereby appropriated from the surplus of the League, as of this date, the additional sum of three hundred dollars (\$300) for the legitimate administrative expenses of the director of the Rocky Mountain Division for the calendar year 1947, any unexpended remainder at the end of the year to be restored to surplus.

66) On motion of Mr. Shelton, after discussion, VOTED, 11 votes in favor to 4 opposed, that the next annual meeting of the Board of Directors shall be held in Daytona Beach, Florida, provided arrangements can be made.

67) On motion of Mr. Noble, unanimously VOTED that there is hereby appropriated from the surplus of the League, as of this date, the additional sum of one hundred dollars (\$100) for the legitimate administrative expenses of the director of the New England Division for the calendar year 1947, any unexpended remainder at the end of the year to be restored to surplus.

68) Mr. J. M. Johnston invited the directors to the Hudson Division convention to be held in Asbury Park, N. J., September 27th-28th next. Mr. Shelton invited the directors

(Continued on page 148)

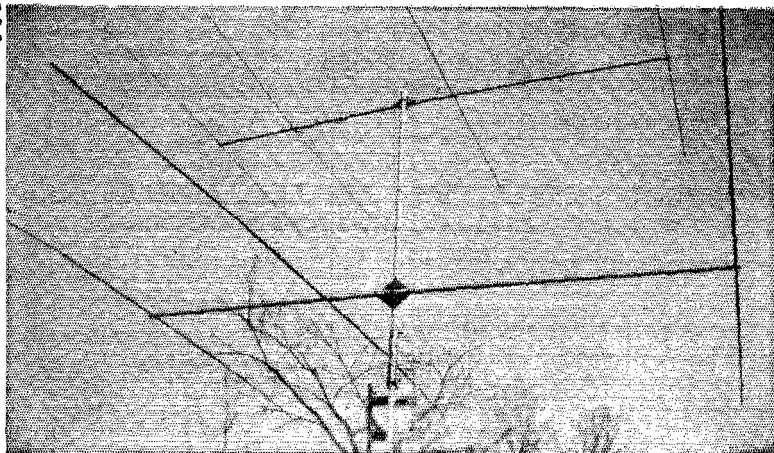

## U.H.F. RESONATOR CO. "TEN-OVER-20"

Print shows our combination duralumin beam mounted on our duralumin rotating mast complete with 2-inch open line flex. connection, changeover relay ten to 20, Dural fixed mast (up to 34 feet in 9- or 18-ft. sections), linen bakelite block bearings, stop, rotator (only \$65), and indicator. Any of above parts sold separately also. Available in 6-Over-Ten, and 6-Over-Ten-Over-20. **You and Rotator stay on ground!** ALL OUR BEAMS ARE PRE-TUNED, PRE-SPACED and PRE-MATCHED, and USE WIDE, MAXIMIZED Spacing, for MAXIMUM FORWARD GAIN.

**No Reaction AT ALL** between the above beams! You may use our beams 200 feet from shack and get full power out front! Amateur net prices, 10-meter beams: 3 el. beam, length 12 ft.,

weight, 8 3/4 lbs., \$35. 4 el. beam, length 20 ft., weight 13 1/4 lbs., \$59. 5 el. beam, length 29 ft., weight 25 lbs., \$65. 3 el. 20-meter beam, 23 ft. long, 39 lbs., \$100. For shipping prepaid anywhere in U.S.A. or Canada add \$10 deposit on strong wood box. Refund on return of box, less outgoing shipping charges. Send for literature "10-20".

54 and 72 foot duralumin masts for 75, 40, and 20 meter, wire antennas. I personally have raised and fastened these alone. Very light, super strong, will not fall down even if guy wires let go! Send for literature "DM."

Beams for 50, 144, 235, 425, and parabolas, including 16 and 32 el. on 2 meters, 32 el. on 425MC. Send for literature "50 UP."

GUION ROAD, RYE, N. Y.  
Telephone Rye 2030

U.H.F. RESONATOR CO.  
W. F. Hoisington, W2BAV

Factory at Portchester, N. Y.  
Telephone P. C. 959

## WHY WIND COILS? *on Air!*

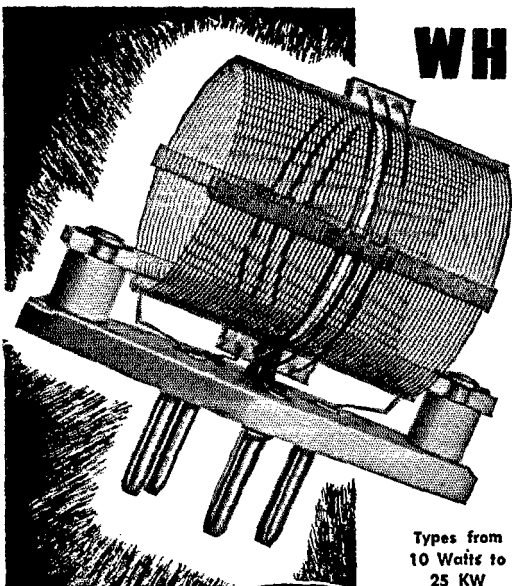

Types from  
10 Watts to  
25 KW

B & W "Air Wound" Inductors are sturdily supported by plastic strips, not conventional winding forms. Here's what this B & W development means to you:

### NO COIL FORM TO CAUSE DIELECTRIC LOSS . . .

There's an absolute minimum of extraneous material in the coil field.

### LIGHTER IN WEIGHT YET LESS SUBJECT TO DAMAGE . . .

Nothing much about them to break. Even if dropped and bent, B & W "Air Wound" Inductors can easily and quickly be repaired without tools.

**EASIER TO MOUNT . . .** Ideal for plug-in services, turrets, etc., wherever quick, easy mounting is a factor.

**GREATER ADAPTABILITY . . .** Many special design features can be supplied, including internal or external coupling links, etc.

Write for B & W Amateur Radio Inductor Catalog.

# B&W

**BARKER & WILLIAMSON, Inc.**  
237 Fairfield Ave., Upper Darby, Pa.

# ELINCOR ALL ALUMINUM BEAMS

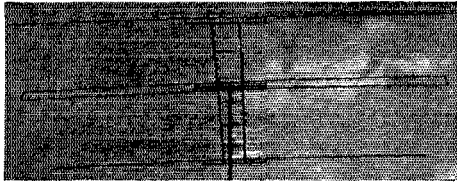

Model 400-EA

- Model 400-EA. 3-ELEMENT FOLDED DI-POLE 10 METER BEAM KIT. Feed with RG8/U coaxial cable. Amateur net price..... **\$31.20**
- Model 400-RA. 3-ELEMENT 10 METER BEAM KIT. Feed with 300 ohm twinax line. Amateur net price..... **\$27.00**
- Model 400-BA. 2-ELEMENT 10 METER BEAM KIT. Feed with RG8/U coaxial cable. Amateur net price..... **\$20.40**

All of the above antennas are furnished complete with all aluminum supporting ladder, 2 1/4" steelite standoff insulators, hardware and instructions. The elements are 3/4" aluminum tubing telescoping to 1/2" and are adjustable over a range of several feet.

- Model 200-EA. 5-ELEMENT 2 METER BEAM KIT. Folded di-pole driven element. All aluminum construction. Feed with low impedance coaxial cable. Amateur net price..... **\$8.40**

We also manufacture a complete line of FM, Television, Broadcast and shortwave antennas. Send for literature.

Prices slightly higher on West coast

SOLD BY DEALERS ONLY

## ELECTRONIC INDICATOR CORP.

35-44 61st STREET

WOODSIDE, L. I., N. Y.

# Mass. Radio School

271 Huntington Ave., Boston 15, Mass.

For over 27 years the educational radio center of New England. Prepares for all U. S. Government Radio Operators' Licenses. Also gives Radio Technician Training. Approved courses for Veteran Training under G.I. Bill.

Licensed by Commonwealth of Mass.  
Department of Education

**Ham Post!**

Millen R-9ER. Less Tubes.	\$24.75	R.M.E. 45.	\$198.70
6AK5 Tubes.	3.15	Hammarlund 129 X.	173.25
Hammarlund FS-135C — 100K C Standard	14.25	Hallierafters SX-42.	275.00
Sonar VFX 680 with Tubes	37.45	National NC 2-40-D.	240.00

Delivery from Stock — Cash with Orders or C.O.D.



**CONTINENTAL SALES COMPANY**

195-197 CENTRAL AVENUE, NEWARK 4, N. J.

(Continued from page 150)

to the Southeastern Division convention to be held in Atlanta June 14th-15th. Mr. Acton invited the directors to the joint Delta-West Gulf Divisions convention to be held August 16th-17th in Texarkana. Mr. Colvin invited the directors to the Midwest Division convention to be held in Cedar Rapids May 24th-25th. Mr. Jepsen invited the directors to the Southwestern Division convention to be held in Phoenix in October. Mr. Richelieu asked the directors to keep in mind the national convention to be held in his division in the fall of 1948.

89) On motion of Mr. H. W. Johnston, the Board adjourned, *sine die*, at 9:29 P.M.

*H. Warner*

Secretary

## Technical Topics

(Continued from page 51)

be a little more intelligent in our appraisals of communications receivers, and possibly put the blame where it belongs — on the consumer, which means you and me. If we want good amateur-band receivers, let's ask for them and nothing else, and not insist that our receiver be two or three receivers built into one. Then if the manufacturers can't build the kind of receiver we want, let's buy good surplus receivers, work them over until they are the way we want them for ham-band use, and then build good converters for the missing high-frequency ranges. Or, if we can't build the converters ourselves — perish forbid! — let's have no objections to extending the range of a low-frequency receiver with a good manufactured converter, and not expect the manufacturer to build a receiver for \$99.50 that does everything including minding the baby and indicating the direction of the three-element rotary!

— B. G.

## Hints and Kinks

(Continued from page 68)

The wall bearing is then slipped in position over the mast bearing. Work of rigging the antenna on the mast can then be completed. The small space between the mast bearing and the wall bearing should be packed with a good grade of waterproof pump grease before the mast is swung into position.

In order to allow rotation of the mast, the wall bearing is secured to a 4 x 4 block, which in turn, is fastened to the wall. The finished product is shown in the photograph. The additional 2 x 4 strips shown on the mast in this picture are for reinforcement of the mast, and also serve to keep the mast bearing from slipping down.

If desired, the same sort of bearing could be used with the familiar "plumber's delight," in which case the pipe used for the wall bearing is one size larger than that used as the rotating member.

The bearing shown was constructed at Headquarters for use with an experimental rotary antenna.

— John Paddon, VE3BLZ

# WORKSHOP BROAD-BAND BEAM ANTENNAS

*High Gain - Optimum Performance*

## 2-METER BEAM ANTENNA — Model #146AB\*

A highly efficient 6-element array with two driven elements. The power gain is 6 (7.8 db.). The antenna is matched to give maximum efficiency when coupled with 50 ohm coaxial line. The following low loss coaxial cables are recommended: RC-8/U, RG-9/U, RG-58/U. Price, including all necessary hardware and instructions for quick assembly, \$21.50

## 6-METER BEAM ANTENNA — Model #52AB

A high-gain, 3-element, directional antenna to be used with rotating mast equipment. Its superior performance is indicated by a standing wave ratio of less than 1.1 over the entire band using 72 ohm cable and less than 1.4 using 50 ohm cable. Standard low-loss coaxial cable such as RG/8U, RG/11U, and others, are recommended for use with this antenna. Price, including all hardware and instructions, \$9.00

## OTHER AMATEUR ANTENNA EQUIPMENT

	Price
10-Meter Dipole Antenna — Model #29AD .....	\$ 8.00
10-Meter Dipole-to-Beam Conversion Kit — Model #29B .....	31.50
10-Meter 3-Element Beam Antenna — Model #29 .....	39.50
6-Element "Dual-Ten" Beam Antenna — Model #29X .....	100.00
20-Meter 3-Element Beam Antenna — Model #14 .....	120.00
Antenna Mast and Mount — Model #AM .....	8.25
Accessories for Rotating Mast — Model #AM2 .....	5.00
Workshop Rotator .....	157.50

\*See QST, August 1946.

*Catalogue on request*

*Available at Better Dealers Everywhere*

## THE WORKSHOP ASSOCIATES, INC.

*Specialists in High-Frequency Antennas*

66 Needham Street • Newton Highlands 61, Mass.

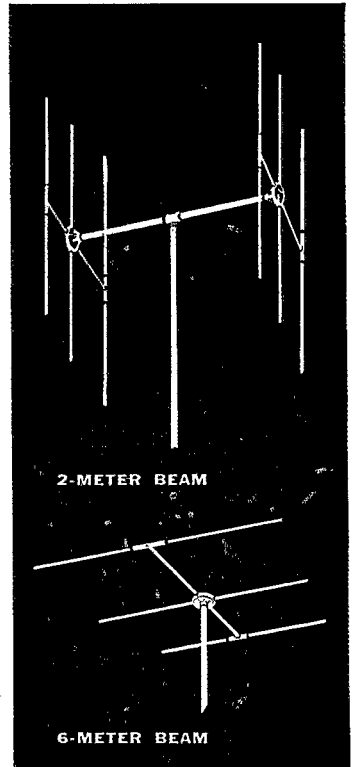

## LINE VOLTAGE BOOSTER

Are you troubled by low line voltage and loss of power? Plug in the new VARI-VOLTER and restore voltage to normal. Protects equipment — boosts efficiency. Handles 1000 watts, 115 volts, 50/60 cycles. Complete in handsome cabinet, ready to operate, only \$19.95.

**GAMMA ELECTRIC COMPANY**

1523 Forty-First Street

Brooklyn 18, N. Y.



THAT PERSONAL TOUCH — by W0ANZ

*"The Pioneer 14 Mc. Phone Amateur of the World"*

### RECEIVERS

RME45 .....	\$198.70
HQ129X .....	173.25
5X42 .....	275.00
S40A .....	89.50
NC240D .....	241.44

### EIMAC TUBES

35TC .....	\$8.00
75TH and TL .....	10.50
100TH and TL .....	15.00
250TH and TL .....	27.50
4-125A .....	25.00

LEUCK RADIO SUPPLY, LINCOLN, NEBRASKA

PROFESSIONAL TRAINING  
IN A MINIMUM OF TIME

## RADIO-ELECTRONICS TELEVISION • BROADCAST ENGINEERING

An Accredited Technical Institute nationally recognized for high calibre training. Prepares high school graduates for technical careers. Classes start every Monday. Comprehensive courses in Radio-Electronics Engineering, Broadcast and Television Engineering, Broadcast and Television Servicing; 2,100 hours classroom and laboratory study. Write today for free informative booklet, "Radio Engineering as a Career."

### CAPITOL RADIO ENGINEERING INSTITUTE

DEPT. QS-6, 16th STREET & PARK ROAD, N. W. • WASHINGTON 10, D. C.

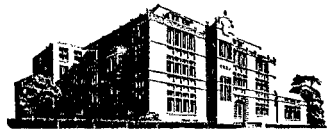

## Electronic Volt-Ohmmeter, Model 406

Accurately Tests All F. M. Circuits

We invite comparison of this instrument with any at any price for appearance, ruggedness, accuracy, stability. 0-1 to 1,000 volts U.H.F., A.C., D.C., 0-1,000 megohms. Pen-type dual-diode A.C. probe. No extras to buy. Send for details or order today.

**\$89<sup>50</sup>**  
NET

from jobber or  
F.O.B. Cincinnati

**Clippard**

**INSTRUMENT  
LABORATORY, INC.**

Dept. 8, 1127 Bank Street,

Cincinnati 14, Ohio



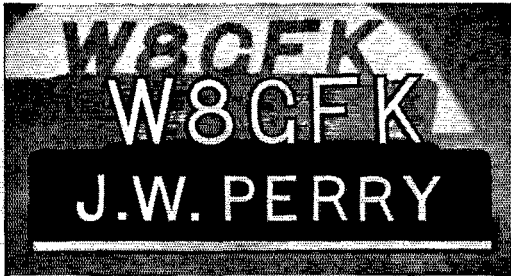

**CAST ALUMINUM  
CALL AND NAME PLATE**  
\$3.50 Postpaid

This new style Call Plate is cast to your order in everlasting aluminum. It is 3" high by about 9" long. Your name or your city, as you prefer, can be had. The call letters are 1 1/4" high and are cast in silhouette. The name letters are 3/4" high and are raised from the black lacquered background. All letters are polished.

This plate is furnished in your choice of four styles, for desk use it has a cast support on the back, studs on back for panel mounting, cast brackets for use on your car license or drilled holes for mounting at your door. Price is only \$3.50, postpaid. Please add 10c for each letter in name or city over a total of 10. Print call and name desired and specify style wanted.

**DESK OR DOOR NAME PLATES**

We can furnish cast aluminum name plates with 3/4" letters (same style letter as above) on black background with border all around plate. \$1.75, postpaid. Add 10c for each letter over total of 10. Specify desk or door use.

P & H SALES CO.

619 Jasper Street Kalamazoo 31, Michigan



**Aluminum  
Call Plates**

Your call cast in aluminum with black background

and polished 1 1/4" letters. Plate size 2" by 6 1/4". 3 styles: P for panel mounting, L for car license and D for desk use. \$1.75 each, postpaid.

P & H SALES CO.

619 Jasper St. Kalamazoo 31, Michigan



**RCA INSTITUTES, INC.**

Offer thorough training courses in all technical phases of

**RADIO and TELEVISION**

WEEKLY RATES

DAYS—EVENINGS

**VETERANS:** RCA Institutes is approved under G. I. Bill of Rights

For Free Catalog write Dept. ST-47

**RCA INSTITUTES, INC.**

A Service of Radio Corporation of America  
75 Varick Street, New York 13, N. Y.

**NEWS ABOUT**

**THE LATEST IN RADIO  
PARTS—EQUIPMENT—ELECTRICAL  
DEVICES—brought to you in our  
monthly bulletins. ABSOLUTELY  
FREE! No obligation.**

WRITE TO

MANUFACTURING DIVISION

**HERBACH & RADEMAN, INC.**

ELECTRONICS SPECIALISTS

522 MARKET ST., PHILA. 6, PA. • DEPT. A

**Correspondence**

(Continued from page 68)

much bearing as in Nazi Germany for a person to vote anything but "ja." Our vote merely indicates our thinking and has no power or authority of a binding nature upon the directors and therefore means nothing.

In your attempt to hypnotize us into thinking that your editorial has been fair minded and presented both sides of the picture, you present it in such a lie as to be a farce. You would have done well writing propaganda for Professor Goebbels. I have never seen such a poorly-written lopsided job of editorial writing. You claim that the knowledge of a code is a nonessential part of amateur radio. At the same time you build up the value of taking the examination; written examination, that is. I doubt if you really realize what a farce QST magazine has made of the examination. Twenty-five cents will purchase the *License Manual* with all the answers written in there ready to be memorized in a very short time. I think I ought to know about this because in 1937 I passed the Class A examination merely by spending a couple of hours memorizing the answers although I had no true knowledge of the subject at all. . . .

— E. Q. Johnson, W8PXH

**WWV Schedules**

STANDARD-FREQUENCY transmissions are made available by the National Bureau of Standards over its standard-frequency station, WWV, on the following schedules and frequencies:

Mc.	EST	Power Output (kw.)	Audio Freq. (cycles)
2.5	7:00 P.M.—9:00 A.M.	1.0	440
5.0	7:00 P.M.—7:00 A.M.	10.0	440
5.0	7:00 A.M.—7:00 P.M.	10.0	440 and 4000
10.0	continuously	10.0	440 and 4000
15.0	continuously	10.0	440 and 4000
20.0	continuously	0.1	440 and 4000
25.0	continuously	0.1	440 and 4000
30.0	continuously	0.1	440
35.0	continuously	0.1	440

A 0.005-second pulse may be heard as a faint tick every second, except the 59th second of each minute.

The audio frequencies are interrupted precisely on the hour and each five minutes thereafter, resuming after an interval of precisely one minute. This one-minute interval is provided to give Eastern Standard Time in telegraphic code and to afford an interval for the checking of radio-frequency measurements free from the presence of the audio frequencies. Ionospheric-disturbance warnings applicable to the North Atlantic path are given at 20 and 50 minutes past each hour. If a disturbance is in progress or is anticipated within 24 hours, the time announcement is followed by 6 Ws; if conditions are quiet or normal, the time announcement is followed by 8 Ns. The announcement of the station's services and of the station's call (WWV) is given by voice at the hour and half hour.

The accuracy of all the frequencies, radio and audio, is better than a part in 50,000,000. Transmission effects in the medium may result in slight fluctuations in the audio frequencies as received at a particular place; the average frequency received, however, is as accurate as that transmitted. The time interval marked by the pulse is accurate to 0.000001 second. The beginnings of the periods when the audio frequencies are off are synchronized with the basic time service of the U. U. Naval Observatory.



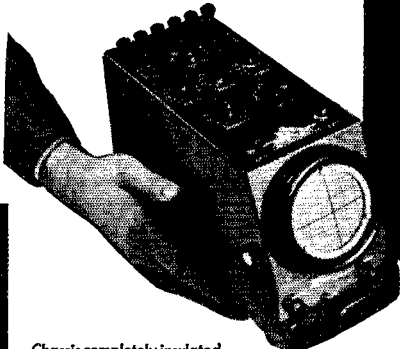

# HERE'S THE NEW INDUSTRIAL and TELEVISION POCKETSCOPE MODEL S-II-A

Chassis completely insulated from input circuits assures safety in industrial applications . . . Direct connections to deflecting plates and intensity grids from rear . . . Retractable light shield . . . Detachable graph screen . . . Handle . . . Functional layout of controls.

8 3/4 lbs. . 11" x 7" x 5 1/4"

by **WATERMAN!** — An OSCILLOSCOPE of UNUSUAL VERSATILITY, UTILITY and PERFORMANCE  
**A 3 INCH OSCILLOSCOPE for MEASURING AC and DC!**

AMPLIFIERS for vertical and horizontal deflection as well as intensity . . . Linear time sweep from 4-cycles to 50-kc with blanking of return trace . . . Sensitivity up to 100 mv/in . . . Fidelity up to 350-kc through amplifiers . . . Attenuators for AC and for DC . . . Push-pull amplifiers . . . Anti-astigmatic centering controls . . . Trace expansion for detail observations. Completely stable regarding line voltage fluctuations and manipulations of controls, either **\$99** internal or external . . . . . **F. O. B., PHILA.**



**WATERMAN PRODUCTS CO., INC.**  
PHILADELPHIA 25, PA.

## RADIO

TECHNICIAN and RADIO SERVICE COURSES  
FM and TELEVISION

Approved under G. I. Bill of Rights  
**AMERICAN RADIO INSTITUTE**  
101 West 63rd St., New York 23, New York  
TEACHING RADIO SINCE 1935

## USE SIGNAL WIRELESS AND TELEGRAPH INSTRUMENTS

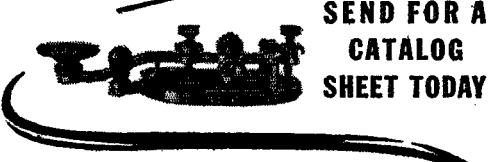

SEND FOR A  
CATALOG  
SHEET TODAY

Also send for our Booklet on "Radio Keying and Telegraphy for Beginners" —

**15¢**  
POSTPAID  
COIN, OR  
STAMPS

This Booklet gives the fundamentals of keying. . . . It contains codes, and how to learn them.

**SIGNAL ELECTRIC MFG. CO., Menominee, Mich.**

ESTABLISHED  
1892



## Sending Made Easier!

Genuine Easy-Working

## VIBROPLEX

Reg. Trade Marks: Vibroplex, Lightning Bug, Bug

"Original" DeLuxe Model

WITH  
PATENTED  
JEWEL  
MOVEMENT

**\$19.50**

SEMI-AUTOMATIC  
RADIO KEY

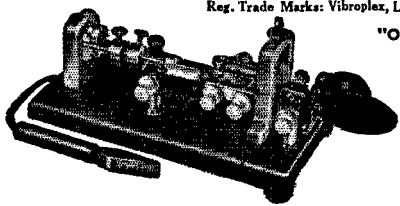

The "BUG" Trade Mark identifies the Genuine Vibroplex. Accept No Substitute

PATENTED JEWEL MOVEMENT is an exclusive DeLuxe Vibroplex feature—a feature that has so completely eliminated tiring sending effort that sending is no longer a task but astonishingly easy. No special skill required. Polished chromium base and parts. DIE CUT contacts and main spring. Colorful red switch knob, finger and thumb piece. 3/16th contacts. Circuit closer, cord and wedge. DeLuxe finish also available in "BLUE RACER" and "LIGHTNING BUG" models. Get a DeLuxe JEWELLED movement VIBROPLEX NOW! Money order or registered mail. FREE catalog.

**THE VIBROPLEX CO., Inc.**

833 Broadway New York 3, N. Y.

## HAM-ADS

(1) Advertising shall pertain to radio and shall be of nature of interest to radio amateurs or experimenters in their pursuit of the art.

(2) No display of any character will be accepted, nor can any special topographical arrangement, such as all or part capital letters be used which would tend to make one advertisement stand out from the others.

(3) The Ham-Ad rate is 30¢ per word, except as noted in paragraph (6) below.

(4) Remittance in full must accompany copy. No cash or contract discount or agency commission will be allowed.

(5) Closing date for Ham-Ads is the 25th of the second month preceding publication date.

(6) A special rate of 7¢ per word will apply to advertising which, in our judgment, is obviously non-commercial in nature and is placed and signed by a member of the American Radio Relay League. Thus, advertising of bona fide surplus equipment owned, used and for sale by an individual or apparatus offered for exchange or advertising inquiring for special equipment, if by a member of the American Radio Relay League takes the 7¢ rate. An attempt to deal in apparatus in quantity for profit, even if by an individual, is commercial and all advertising by him takes the 30¢ rate. Provisions of paragraphs (1), (2), (4) and (5), apply to all advertising in this column regardless of which rate may apply.

(7) Because error is more easily avoided, it is requested signature and address be printed plainly.

(8) No advertiser may use more than 75 words in any one issue.

*Having made no investigation of the advertisers in the classified columns, the publishers of QST are unable to vouch for their integrity or for the grade or character of the products or services advertised.*

**QUARTZ**—Direct Importers from Brazil of best quality pure quartz suitable for making piezo-electric crystals. Diamond Drill Carbon Co., 719 World Bldg., New York City.

**CRYSTALS:** Precision low drift units. Type 100A in 80, 40, and 20 meter bands. Two units plug in one octal socket. One dollar each. Rex Bassett, Inc., Ft. Lauderdale, Fla.

**QSLs** in colors. Stamp for samples. Glenn Griffith, W3FSW, 1042 Pine Heights Ave., Baltimore 29, Md.

**DEKA-XTAL.** New compact 10-crystal unit for standard 5-prong socket. Looks and operates like a dial-knob. Just plug it in and turn to any of 10 frequencies, your selection. Ask your dealer or write us. Also other low TC ham crystals in PT cases to fit octal sockets. 80 and 40  $\mu$  k. \$2.65; 20  $\mu$  k. \$3.50. Scientific Radio Products Co., 738 1/2 W. Broadway, Council Bluffs, Iowa.

**IN Stock:** new and used Hallcrafters, Hammarlund, National, RCA, Meck, Harvey, Millen, Pierson, RME, Collins, Temco, other rcvrs and xmtrs. All other amateur parts. Trade-in accepted. Terms financed by me. Write: Henry Radio, Butler, Mo. and Los Angeles 25, Calif.

**WANTED:** "Wireless" apparatus prior 1925; early books, catalogs, magazines, etc., Franklin Wingard, Rock Island, Ill.

**AMATEURS,** experimenters, industrials and export accounts. Write for catalog and monthly bulletins. Buy the "TB" guaranteed way and save. TAB, Dept. Z, 6 Church St., New York 6, N. Y.

**AMATEUR** radio licenses. Complete code or theory preparations for passing amateur radio examinations. Home study and resident courses. American Radio Institute, 101 West 63rd Street, New York City.

**COMMERCIAL** radio operators examination, questions-and-answers. One dollar per element. G. C. Waller, WSATV, 6540 E. Washington Blvd., Tulsa 15, Okla.

**DON'S QSLs.** "Leaders in the field." Samples, 2138 So. 16th Ave., Maywood, Ill.

**SURPLUS** bargain catalog. Send for the bargain ham catalog everyone is talking about. Surplus Radio, Inc., 30 Munson St., Port Washington, N. Y.

**QSLs,** samples, Albertson, W4HUD, 705 So. Hamilton, High Point, N. C.

**PHOTOSTATS** of rcvr schematics: BC-224 F, K, H; 312 N, NX; 314 G; 342 N; 344 D; 348 E, J, K, L, M, N, P, Q, R, 75¢ ea. Specify model. WQED/9, Box 525 Sta. A, Champaign, Ill.

**SELL** slightly used Natl. NC-100 with unmounted spkr. First offer over \$200. Harry Gray, Searsport, Me.

**QSLs.** Good service, samples, 10¢. Central Printing Co., Box, Huntington, Ind.

**PANADAPTOR,** never used. Swap for SX-25 in perf. condx, or nw \$40. Cash acceptable. Bert Neuman, 1001 Ave. H, Brooklyn, N. Y.

**MUST** sell my fine-c.w. rig, 250 watts, Ft. P. 357s modulated by 811a. Nothing but best was used building it. In 42" steel cabinet, can be remotely controlled. Comp. with all tubes, some spares, xtals but no mike, \$325. l.o.b. Miami, Fla. Full details and pix on req. All ansd. Write Box 86, Coral Gables 34, Fla.

**FULTON** television video kit, less pwr supp. Features continual tuning, chromed steel chassis, new 5" pix tube. Most parts mounted and wired. First \$50. Parts alone worth more. Gordon W2MPT, 182 Hegeman Ave., Brooklyn, N. Y.

**SELL** Abbott TR-4 with tubes, \$27. Clayton DeWitt, W9PHB, Kingston, Ill.

**VARIABLE,** filter, fixed condnrs, resistors, tubes, sockets, chokes, filament trimers, spkr, Naal, pwr supp, panels, chassis, more, \$17. W2EQS, 169 Jewel Ave., Jersey City, Bergen 3-1891.

**TRANSIMITTER**-phone-CW 3-meter speech Class B T220s, RF T21 3D23 PP 24 (or T240s) coils 80 and 10 meters, 250-watts, all bands, \$250. Write for descript. M. Shaw, W6BO, Rte 3, Los Gatos, Calif.

**TRANSFORMERS,** PPI units, cathode ray, xmtg tubes. Write for bargain bulletins. Ham and experimental surplus. Unbelievable prices. Lectronic Research, Howell & Hegeman Sts., Phila., Pa.

**SELL** HRO W unused, 9 coils A.C. and 6 V supplies. Reasonable. Set of HRO coils, 50 Kc, 2050 Kc., \$50. HRO 6V supply, \$15. Want: Harvey 100T xmtr, Norton, 7200 Ridge Blvd., Brooklyn, N. Y.

**SELL** 6 RK65s, three 803s, three RK48s, \$5 each. W1GR.

**SELL** 6P6, T20 xmtr, 866 supply. Highest quality. \$40 complete for 30, 40, 20 H. Olsen, W9TGE, Escanaba, Mich.

**COLLINS** xmtr Model 30J, 400 watts fone. Factory tested. All new tubes. Complete set of individual plug-in coils for each band, 80-40-20-10 and 6 meters. Final 2-813s, push-pull. Remotely controlled including push to talk, receiver, antenna, filament and plate supply relays. Meissner Deluxe Signal Shifter remotely wired into transmitter. Fully guaranteed like new. \$1000. Chas. W. Boegel, jr., W0CVU, P. O. Box 224, Cedar Rapids, Iowa.

**QSLs? SWLs? No cheap trash! What's your desire? Samples 20¢.** (Biley crystals? VHF-152.) W8DED, Sakkers, Holland, Mich.

**QSLs,** highest quality, samples free. VYS Print, 1704 Hale Ave., Ft. Wayne, 6, Ind.

**QSLs,** New designs, samples 10¢. QSL Printers, Box 974, Ft. Wayne, Ind.

**QSTs** wanted: December 1916 thru Aug. 1917, June 1919 thru Oct 1919; Sept. 1925, For Sale: Jan. 1916, Sept. 1927, Nov. 1927, Oct 1928, Dec. 1931. Make offer. Johnnie Mulligan, W2RTW, 819 Clairmont Ave., Elmira, N. Y.

**QSLs,** personal stationery, colors. Quality printing, 24 hr. service. Stamp for samples. Reber Print, R.D. #1, Sewell, N. J.

**CRYSTAL** kit: Includes 4 finished, highly active "BT" crystals; state preferred frequencies in 3.5 to 8.4 megacycle range; 2 holders, abrasive, instructions, treatise, \$1. Breon Laboratories, Williamsport, Penna.

**FOR Sale:** BC-610 xmtr, AT-3, antenna tuning unit and speech amplifier. Never been in use. New. Selling out. Only \$5 takes all. Luther Bevans, 706 Market St., Pocomoke City, Md.

**SET** of nine hexagon keys for hollow head set screws with holder. 75¢ postpaid. Drill and tap sets. Write for folder. Riverside Tool, P.O. Box 87, Riverside, Ill.

**BUY,** sell or trade surplus complete xmtrs and rcvrs. F. D. St. Clair, Port Jefferson, N. Y.

**FOR Sale** Hallcrafters Model S40A, \$75. Millen Exciter complete with 10, 20, 40, 80 coils, bridge-rectified power supply, \$55. Both \$130, or best offer for each. WJUTJ, P.O. Box 53, Cactus, Arizona.

**EIGHT** new light steel antenna masts. Telescope construction; length telescoped approx. 9', erected height 40'. Guy rings. Easily raised by one man. Pictures. A strong practical factory-built mast. \$50, each l.o.b. John Rugar, W7KCB, 304 E. Charleston Blvd., Las Vegas, Nev.

**SELL** Amperite PGL 50 ohm microphone, A-1 condition, \$12. Nathan Williams, 20 Algoma Blvd., Oshkosh, Wis.

**SELL:** Army Super-pro, rack mounting, perfect factory alignment, less speaker, \$195; AN/ARR-5 Hallcrafters VHF rcvr, 27-145 Mc. New, \$95; BC-221 without case, \$25. W2OXR, 71 Crosshill St., Staten Island, N. Y.

**WANTED:** Super-pro power supply and speaker. Perfect condition. Age not important but looks will help. Bert Neuman, 1001 Ave. H., Brooklyn, N. Y.

**I** want to buy: old Model HRO with or without tubes, power supply or coils. HRO jr. or sr. but must have mother-of-pearl push button switch on (S/R) meter. State price. W. H. Martin, P.O. Box 30, Leesburg, Va.

**WINNERS** 1946 F.D. Jersey Shore Amateur Radio Assn. desire to QSL, all their contacts with special QSL. Address your QSLs to W2FC, 75 Bennett Ave., Neptune City, N. J.

**BEAM** antenna, all aluminum. High efficiency with minimum weight and torque. 2-20 meters. Write for information. Housekeeper, W2KMQ, 956 Paulding St., Peekskill, N. Y.

**12-Volt** 10 Amp filtered D.C. power supply. Operate surplus equipment from 115 V. A.C., \$34.50. Other voltages available. W2CRB, 1523 41st St., Brooklyn, 18, N. Y.

**HRO rcvr** with coils noise limiter added, \$140; also Echophone EC-2 \$37. R. Graham, 25 Jasper Ave., Teaneck, N. J.

**WANTED:** BC-610 xmtr. Have Kw final for sale, complete, \$95. W7BWD, Box 683, Philomath, Ore.

**SELL** QSTs: Jan. 1925 thru 1944, excellent condition, in ARRL binders. 2 issues missing. Make offer. W1PDP, 308 Westfield Ave., Bridgeport, Conn.

**FOR Sale:** First check for \$350 gets new Super-pro 400X complete: Sky Chief rcvr; new Shure Uniplex cardioid mike, 730B; Shure 70H xtal mike; 20-watt c.w. oscillator. Send check or m.o. to P. Farrell, 95 Tremont St., Central Falls, R. I.

**SELL:** Power supplies which formerly powered 750 watt xmtr. Kravitz, 7919 20th Ave., Brooklyn, N. Y.

**SX-28 rcvr** and ART-13 Collins Autotune xmtr with tubes, \$300. W0JVJ, 610 Brown, Pueblo, Colo.

**CRYSTALS:** Where quality and not price is the main consideration, demand Edison crystals. Fine commercial units for Aircraft, Police Marine, Geophysical and other services; crystal regrounding. Also broadcast station monitor service. Over a decade of satisfaction and fast service! Try us first. Edison Electronic Co., Temple, Texas.

**SELL:** New Hammarlund SP-400-SX, \$260. R. Long, 184 L St., So. Boston 27, Mass.

**NATIONAL** 1-10 Rcvr. for sale: Complete with tubes, coils, speaker and national power supply. Reasonable. W2OHE, 1156 E. 40 St., Brooklyn 10, N. Y.

**SELL** new HQ-129X with speaker. Holstein, 246 East 148th, Bronx, N. Y.

**PHOTOFASH** triggering xfmrs can be used with OAS trigger tube or alone. Schematic supplied, \$2.50 ea. postpaid. Write for quotes on quantity lots. General Laboratory Associates, Guilford, N. Y.

MARK I tank xmtr-rcvr, perfect, less batteries, antenna. Best offer. W1ZIM, 215 Delaware, Nampa, Idaho.

TRANSMITTER Kits 40-watts, \$69.95, Exciter kit, \$17.95, 175 watt xmtr soon. All makes and models new and reconditioned rcvrs. Trade-ins accepted low payment plan terms financed by Leo, W0GFO. Write for specials. World Radio Labs, Council Bluffs, Iowa.

BC-312M, excellent working condition, internal RA20 a.c. supply. First \$55 takes it. Ross, 2105 East 35th St., Brooklyn, N. Y.

PRIZE announcement: win free seven-section Cardwell by submitting best suggestion for its use, sending postal for information. 1500 Cardwell condensers,  $\mu$ fd/sec, plates/sec, airgap, price etc., price two; splitator 27-15-70, \$1.22; 25-15-30, \$1.05; \$1.30; 32-9-30, 95¢; 1.75; 150-35-80, \$1.35; 2.35; 26-7-84, \$1.05; \$1.80; 285-27-30, 55¢; \$1; 300-29-30, 64¢; \$1.10; 395-38-30, 65¢; \$1.20. Slightly used, fully guaranteed 6L6 metal tubes, \$1. Hieronymus Radio, 100-35 201st St., Hollis 7, N. Y. W2GWS.

ROTARY beam indicators. Weston model 606 2 1/4"; 500-0-500 dc microamps with three separate scales. One is calibrated 5-0-5, second is 100-0-100, and third is calibrated in direction for use as a rotary beam indicator complete with instructions and circuit diagram, \$2.39 shipped c.o.d. with 20% deposit, H. S. Mitchell, 3804 13th South, Seattle 8, Wn.

SELL: Transmitter; 807 in final, 3 bands on one crystal, meter switching all stages, excellent condition. 348 converted for AC. ARR5 with power supply. BC-221 with regulated power supply. L. C. Hoffman, 821 Vendome, L. A., 26, Calif.

TRADE Bausch & Lomb microscope (value \$155) for complete ten-meter fone rig. M. V. Vostatek, Palisade, Colo. W0KJA.

WANTED: Thordarson xfmers 1T9F77 filament, T19P56 plate, T19D03 driver, C. H. Robinson, E. T. Patuxent River, Md.

SELL: Abbott TR4B transceiver, two, with tubes, never turned on. \$55. \$100 takes both. Latest Hickock dynamic tube tester Model 532, \$10. Vector 10 antenna, \$6. Austin, 145 W. Broad, Westerly, R. I. USE: SWR crystal, test tubes, panels, etc. Write Dossett. W9BHV, 857 Burlington, Frankfort, Ind.

FIRST \$100 takes my NC100A complete, less speaker, A-1. J. Oliveri, 447 So. Ocean Ave., Patchogue, L. I., N. Y.

CHASSES: all sizes. Write for price list. John Heim, 713 W. Third, Williamsport, Penn.

WANTED: 10-meter Gonset converter for similar converter; BC-610E, 2-meter transceiver; late model signal shifter, Harold Dillon, M.D., W3EXV, 3101 Wylie Ave., Baltimore 15, Md.

TRADE or sell brand new 1000-v. 350 Ma dynamotor for hi voltage 110 V 60 c. power supply or what have you? W2UMR, J. M. Niehaus, East Lake Rd., Dunkirk, N. Y.

WANTED: Stancor 10-P xmtr. Percy C. Noble, W1BVR, 37 Broad St., Westfield, Mass.

PAY new price for Thordarson chokes, #T19C36 and T19C43. W9PVS, Moorhead, Minnesota.

FOR Sale: BC-375 xmtr. Complete with 110 V. conversion data, \$35 or would accept 2-meter xmtr or transceiver. Phil Steen, W3MXG, 208 Burrwood Ave., Collingswood, N. J.

RADIO interference and key click filters, 2 chokes 4 bypass cond. sealed metal case. Will pass 1 amp, 60° ea. for \$1. Wound slug tuned coils on ceramic forms specified for the R9ER, 4 for \$1. See April Ham-Ad. Add 15¢ shipping chrg. Minimum order \$1. Deflection and focus coils, television & cathode ray tube use. Write Ed. Doherr, W3CIR/1, 96 Highland, Hyde Park, Bos., Mass.

COMPLETE issues QST, 1934 thru 1946, 34-39 in binders. Also several issues of Radio; CQ, April 1946 to date. Best offer over \$35. W2HVR.

ONE kilowatt power supplies, 1320 volts, 800 Ma, ripple less than 1%, assembled from new surplus with new 872As, \$95; unassembled, \$70. 2300 volts at 300 Ma. \$85. P. O. B. Stone, 44 Garfield, Cambridge 38, Mass.

HT-4 Hallcrafters, prewar, 500 watt phone/xmtr, complete. Excellent condition, \$500. W0WYK, 988 E. Green St., Pasadena, Calif.

HAMS! Books for hams supplied by mail. Operating, math, UHF, television—all latest titles. Postcard brings free illus. catalog. D. Neighbors Pub. Co., 300 Pacific St., Dept. 29, Brooklyn 2, N. Y.

KENTUCKY Values! New, fully guaranteed, factory-cartoned filament, \$1.90; \$2.10; \$1.90; 807, 95¢; 810, \$2.55; 811, \$1.05; 816, \$6.95; 872A, \$1.95. Any other type tubes at comparable prices. 3500 cycle clipper filter kit, \$2; 6.3 V., 8.5 A., filament xfrm, \$2.40; 20 H. 200 Ma. choke, \$2.85; 4520 V. 700 Ma., CT, Kenyon, \$49.95; 11 H. 500 Ma. choke, \$7.95; H-23/U telephone handset, switch, new, \$2.95; Special this month: desirable standard shape, 116  $\mu$ fd, 3800 V. peak, or 156  $\mu$ fd, 3500 V. peak xmt. variables. 11. Inquiries send U.S. Kentucky Radio Supply Co., Lexington, Ky.

FOR Sale: Hallcrafters SX-17, complete with spkr. Perfect condition. First \$100 takes it. Bayrer, c/o ARRL, West Hartford, Conn.

SELL complete xmtr, 140 watts CW rack & panel, external plate modulator, coils, crystals, crystal microphone, new bug, \$100. W9CAL.

OSCILLOGRAPH RCA 155C, \$50; Hewlett-Packard audio oscilator 200C, \$50; RCA VoltOhmvt, \$40; Simpson VOM, \$25; RCP multimeter 492, \$40; National 100X, \$60. Kirchhuber, 73 Harrison, L. L., N. Y.

WANTED: Following QSTs: Dec. 1915; All but Oct. 1916; Jan. Feb. 1917; April, May, 1920; both covers. Your price. W1AAT, 100 Bay View Ave., Salem, Mass.

HOWARD 437A, 9-tube, Rf stage, 550 Kc to 35 Mc, xtal filter, self-contained power, crystal National 1-10, Sidney Ross, 1414 W. Pratt Blvd., Chicago 26, Ill.

ONE 1940 Stromberg-Carlson FM table model rcvr, converted for 6 M. band. Best offer. A-1. Ed. Brush, W2PJC, Germantown, N. Y.

BEST offer will take brand new Hallcrafters S40, no more than 10 hrs. use. Also selling instructograph (electric motor type) for best condition. Like new, with 10 orig. tapes and book of instructions. V. Kelly, 113 W. 57th St., N. Y. C., Co: 5-2271.

WANTED: commercially built medium power fone/cw xmtr, 80-10 meters. Have Contax 35 mm model III camera f/2 lens, 1.5 M.M. f/4 telephone lens, enlarger and other photo equipment. All excellent condition. Will pay cash, trade or sell with adjusted cash difference. Major Weir, W3AI, 306 Normandy Dr., Silver Spring, Md.

MEISSNER signal shifter in deluxe cabinet (with drawer for coils) \$50. Brand new Millen Exciter comp. with tubes and coils for direct output on 80-40-20-10, \$52. One Meissner 5 B & 10 meter converter in cabinet and in A-1 condition, \$30. One BC 348N converted and works like charm, \$62.50. Two Rodgers model airplane motors, new. Chas. Rodgers, 727 Market St., Mt. Carmel, Ill.

TUBES: 6V6GT, 75, 396 ea.; 1 H6G, 49¢; 25Y5, 59¢. Write for list. S & S Radio Co., 140 Derby St., Salem, Mass.

NEW Meissner 150B xmtr complete, signal shifter, spares; continuous 100 to 20 M., easily converted to 10 M.; \$300 or best offer above plus freight from New Hampshire; Phil Collins, c/o Pan American Airways, San Juan, Puerto Rico.

FOR Sale: National NC-2-40C and WRL Globe Trotter, both in excellent condition. Best offer. Bob Hathaway, W0EQZ, Eustis, Nebr. PANADAPTOR, Hallcrafters SP44. Never used. Original condition. Any reasonable offer. W2NCY, Dumont, N. J.

WANTED: New or used SW3 power supply; W2COG, 213 So. Third Ave., Highland Park, N. J.

SELL: Complete 30-watt CW xmtr with coils for 40, 20, 15, \$30; improved Ecophone BC-3 with xtal filter, \$45. W1PHC, 230 Homer Newton Centre, Mass.

ATTENTION CW operators: special pad prevents any "bug" from walking across any tabletop. Long-lasting, highly endorsed. Two postpaid 50¢. Howard Severeid, 2924 Station St., Indianapolis, Ind.

CHOPPER, \$20, 450 cycle note precision model by watchmaker, Wightinghouse motor, Rf ammeter in metal case, 1.5 amps, \$2.50. W8KJ.

NEW surplus parts: relays, meters, etc. Send for parts list. G. Tiller, 5330 Village Rd., Long Beach, Calif.

SELL: ARC-3 17 tube 8-channel VHF rcvr. 100-156 Mc. plus continuous 2-meter coverage. W. Fisher 43-28 217th St., Bayside, L.I.

FOR Sale: Nearly new master Telex for \$60 or best offer. Includes factory cut tapes and number blank tapes. Henry S. Guichard, W7HVM, 225 Alverson Blvd., Everett, Wash.

SX28As complete. Used one month. In orig. carton, \$215. J. K. Gossland, W2BJK, 8 Jones, N.Y. 14, N.Y. Chelsea 2-1507.

SELL R-44/ARR-5 rcvr. 27 to 145 Mc. AM-FM. Less power supply, \$75. Russell M. Short, 1509 No. 10th St., Boise, Idaho.

WANTED: Audax microdrive pick-up, prefer PRO-5, PRO-2-L, or D-39-H, used or new. State price. W9PGB, Box 653, Lake Bluff, Ill.

FOR Sale: RME-45 and DB-20. W9CFV, 1318 No. Linden, Bloomington, Ill.

WANTED: No. 5 unit, Utah xmtr modulator. Chas. M. Boyd, W4GND, Tracy City, Tenn.

SELL: Waterman Pocketcase, like new. Best offer takes it. C. F. Sherman, 10 S. Spooner, Madison, Wis.

FOR Sale: National One-Ten rcvr. Write Bob, \$50. Would consider trade for DB-20 or other SW rcvr. W1CJL, 23544D, Lahser, Detroit, Mich.

WANTED: schematic and wiring diagrams for BC-375E. Buy; rent, either or both your price. W7KQX, Box 292, Moscow, Idaho.

SELL several vibrating reed frequency meters, 48-62 cycles, 10 reads, 125 volts, perfect condition. Want \$2.50 ea. or miniature and transmitting tubes. W6PZW, 15709A Brighton Ave., Gardena, Calif.

SELLING Deluxe Par-Metal 82" enclosed cabinet, \$48; like new Meissner signal shifter, \$42; signal spotter, \$17; realigned Hallcrafters SX-17 \$90, xmtr 2 1/2 Kw., 5000 V. C.T., \$25. Charles F. Ribera, 639 E. 12th St., New York 9, N. Y.

BREITING 14 \$35. Want 6 meter converter. C. Steavenson, jr., Junction City, Kansas.

ALUMINUM tubing 15/16" O.D. (lightweight) for 10, 20 meter beam antennae. W2PUK, Bloomfield, N.J. Bl. 2-1549R.

SALE: B-29 transceiver, accessories. Brand new, \$50 or highest bidder. Power supply commercial built, 115 Ac. input, 275-500 output. Harry Wason, 57 Dartmouth, Dedham, Mass.

CONDENSERS 2ufd 600VDCW, 35¢; 4 ufd 600VDCW, 45¢; 10ufd 600VDCW, \$1; 4ufd 1000VDCW, 75¢; 4ufd 1500VDC, \$1.35; 4ufd, 5000VDCW, \$6.50; 10ufd, 7500VDCW, \$9.25. HamRad, Bedford, Mass.

WANTED: Instruction book for BC-348R. E. Nettelton, W5ZN, Port Aransas, Texas.

FOR Sale: Complete W0KQW, HRO and 600 watt fone on 75; separate RF section for 10 and 20 at 300 watts. Dysart, Iowa.

HALLCRAFTERS S-36 rcvr. New condition. 27 to 143 Megs. AM/FM/CW, \$155. BC-312 Rcvr, 1500 to 18,000 KHz, \$45, with R20 power supply for 110 v.a.c. \$55. C. Talaska, 714 Junction Toledo, Ohio.

TRADE: 100-watt 67.5 volt D.C. portable 2 H.P. generator, also forty dollars for new good condition National or Hammarlund rcvr. Stanley Cates, 1304 Vineville, Macon, Georgia.

SELL QST 1928 thru 1945 for best offer in 30 days. W9FXM, 133 South 14, Richmond, Ind.

SELL: 80-watt CW/Xmtr, ant. unit, coils, complete, \$42. N.Y. Area only W2JZL, Box 55, Brooklyn 28, N.Y.

CUSTOM-building of ham equipment, your specifications. Medium power xmtrs, VFOs, etc. Inquire Chatel, W2RSC, ex-W1D1F, 235 Dufiled St., Brooklyn 4, N.Y.

SELL only: Hallcrafters S-40 rcvr, new condition, used only few hours. Bargain at \$82.50. Jacob Frederick, 141 Nesmith, Lowell, Mass.

WANTED: July 1916 QST. Will pay \$10 if in good condition. Col. F. J. Elser, Quarters 322, Maxwell Field, Ala.

QSLs on kromekote and colorfilm cards. W1KMP, P. O. Box 219, Cambridge, Mass.

WANTED: Code-sending machine in good condition. Dan Pilarczyk, 1938 Dempfle Ave., Dayton, Ohio.

SELL: commercial xmtr, complete, ready to operate. 75 W CW, 20 w fone. Stamped envelope for details, or best offer. Billings, W2BIV, 2114 Albemarle Rd., Brooklyn 26, N. Y.

Designed for

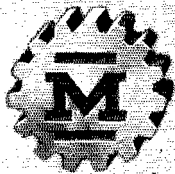

Application

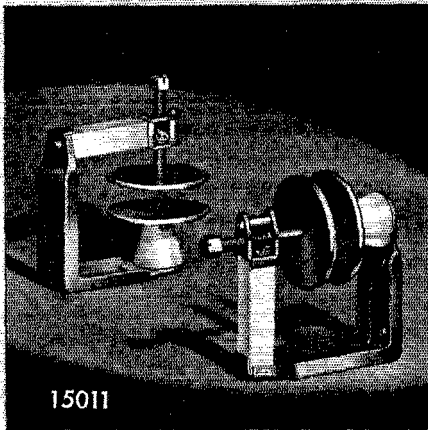

15011

**Disc Type  
Neutralizing Capacitor**

Designed originally for use in our own No. 90881 Power Amplifier, the No. 15011 disc neutralizing capacitor has such unique features as rigid channel frame, horizontal or vertical mounting, fine thread over-size lead screw with stop to prevent shorting and rotor lock. Heavy rounded-edged polished aluminum plates are 2" diameter. Glazed Silexite insulation.

**JAMES MILLEN  
MFG. CO., INC.**

MAIN OFFICE AND FACTORY  
**MALDEN**  
MASSACHUSETTS



**Index of Advertisers**

	<i>Page</i>
Allied Radio Corp.	99
American Inva. Corp.	111
American Phenolic Corp.	89
American Radio Institute.	155
Ashe Radio Co., Walter.	125
Astatic Corp., The.	7
Barker & Williamson	151
Bliley Electric Co.	83
Burgess Battery	112
Burlington Instrument Co.	148
Burstein-Applebee Co.	146
Brill Co., W. D.	128
Browning Laboratories	96
Cameradio Co.	118
Candler System Co.	144
Capitol Radio Eng. Inst.	107, 153
Chicago Industrial Instruments Co.	132
Cleveland Inst. of Radio Elec.	98
Clippard Instruments Laboratories	153
Collins Radio Co.	160
Communication Measurements Labs.	124
Commercial Radio Inst.	140
Condenser Products Co.	137
Continental Sales Co.	152
Cornell-Dubilier Electric Corp.	93
Delaware Radio Sales	150
Drake Electric Co.	110
Duston & Associates, Merle	130
Eitel-McCullough, Inc.	90, 91
Electronic Indicator	152
Electronic Marketers	120
Electroncraft, Inc.	122
Electro-Mechanical Manufacturing Co.	128
Electro-Voice	87
Gamma Electric Co.	153
Gardiner & Co.	138
General Cement Mfg. Co.	150
General Electric Co.	121
Greene Plastics, Inc.	150
Hallcrafters Co., The	4, 5
Hammarlund Manufacturing Co., Inc.	97, 100
Harrison Radio Co.	145
Harvey Radio Co.	127
Henry Radio Stores	147
Herbach & Kademan	154
Hyttron Radio & Electronics Corp.	103
Instructograph Co., The	146
International Resistance Co.	104
Jensen Manufacturing Co.	9
M. C. Jones	136
Kenyon Transformer Co.	117
James Knights Co.	144
Lectro-Lab Products Co.	142
Leuck Radio Supply	153
M & H Sporting Goods Co.	114
Maguire Industries	139
Mallory & Co., P. R.	88
Mass. Radio & Television	152
Melville Radio Institute	44
Millen Manufacturing Co., Inc., James	158
Mytronic Co., The	140
National Co., Inc.	79, 81, Cov. III
Newark Electric Co.	105, 133
Ohmite Manufacturing Co.	93
Onan & Sons, D. W.	146
P & H Sales Co.	154
Petersen Radio Co.	8
Port Arthur College	134
RCA Institutes	154
RCA Manufacturing Co., Inc.	Cov. IV
Radio Electric Service Co. of Penna.	143
Radio Manufacturing Engineers	159
Radio Parts Distributing Co.	144
Radio Shack Corp.	94, 105
Raytheon Manufacturing Co.	109
Richardson Labs, Kenneth	138
Sangamo Electric Co.	115
Scientific Radio Products	132
Signal Electric Manufacturing Co.	155
Signal Engineering & Manufacturing Co.	134
Silver Co., McMurdo	102, 106
Solar Capacitor Sales Co.	2
Sonar Radio Corp.	119
Sprague Products Co.	123
Standard Piezo Co.	149
Standard Radio Electric Products Co.	130
Standard Transformer Corp.	142
Steinberg's	140
Sun Radio & Electronics Co. (N. Y.)	133
Sun Radio Co. of Wash.	141
Sylvania Electric Products Co.	85
Terminal Radio Co.	129
Transmitter Equipment Manufacturing Co.	101
Turner Co., The	149
Tyler Commercial College	131
U.H.F. Resonator	151
United Electronics	113
United Transformer Corp.	Cov. II
Valpey Crystal Corp.	138
Valparaiso Technical Institute	142
Vibroplex Co., The	155
Ward Leonard Electric Co.	108
Waterman Products Co.	155
Wind Turbine Co.	136
Workshop Associates	153
World Radio Laboratories	116

ADD TWO AND SIX METERS TO YOUR SCHEDULE

the **VHF 152**  
FOR 2, 6, 10 and 11 METERS

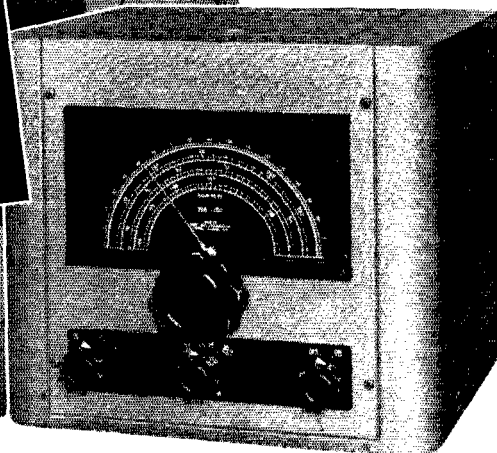

**BE PREPARED FOR THE INCREASED  
ACTIVITY ON TWO AND SIX METERS**

**SPRING** and **SUMMER** will provide a new high in VHF interest and activity — and a VHF 152 Converter will enable you to get on these bands efficiently and economically. Six meters will be good for "Sporadic E" this Summer. In the Fall F2, long distance skip, will also prevail.

Because many are going to crystal control on 144 mc., the VHF 152 is a must. It employs the extremely efficient double detection system when used with any communications receiver—at a low price and with high efficiency.

What's more, amateurs are discovering that two and six meter bands are best for local rag chews—eliminating QRM on the crowded bands when they are open for DX.

In order that imageless operation on the eleven meter band can also be enjoyed, the VHF 152 has now been redesigned to include this band also. Features include a regulated power supply and provision for four separate antennas.

Yes, the VHF 152 will greatly improve reception on the high frequencies, and it's an especially vital adjunct to those receivers that tune only to 18 MC.

**ILLUSTRATED  
FOLDER  
ON REQUEST**



**RME**

FINE COMMUNICATIONS EQUIPMENT

**RADIO MFG. ENGINEERS, INC.**  
*Provia 6, Illinois U. S. A.*

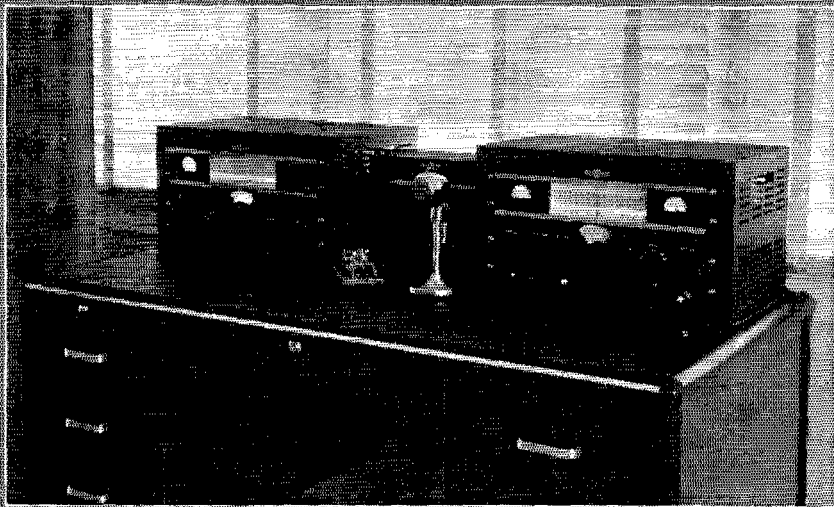

*This can be your complete ham shack*

**Y**OU will have an outstanding station with a Collins 75A receiver and a Collins 32V transmitter. You'll have good quality on phone, clean keying on cw.

The transmitter is rated at 150 watts input on cw, 120 watts on phone. Bandswitching is employed in all stages, and all circuits are ganged except the final. The final stage utilizes a universal output network, with only two controls—one for loading into the antenna and one for tuning the final.

The 75A receiver utilizes a double conversion (triple detection) circuit to give you a minimum of 50 db image rejection on all bands. Sensitivity is 1 microvolt for a 6 db signal to noise ratio. A clean, easy-to-use crystal filter and calibrated BFO are additional advantages. *The pitch of a cw signal is unchanged by any control except the tuning dial and BFO control.*

The Collins band-lighted dial is used in both the receiver and the transmitter. It gives you a direct reading of frequency. Receiver accuracy is within

1 kc or better at all frequencies below 22 mc, and within 2 kc on the 11 and 10 meter bands. The transmitter accuracy is within  $\frac{1}{2}$  kc. on 80 meters and directly proportionate on other bands. Stability of both units is included in the accuracy specification. Furthermore, *the band-lighted dial shows only the band in use*—no other band is lighted. This new dial eliminates the usual "getting used to it" time, and shows you the correct frequency at a glance.

The 75A and 32V make a complete station right on your desk. Everything is there. You have no power supplies or spare coils to store or hide. Your shack will be neat, attractive, efficient, and dependable. When you want to operate, your rig will be ready. Components used are sturdy, substantial, and are operated conservatively.

Let us send you detailed illustrated bulletins describing these units. Place your order soon for prompt delivery.

FOR BEST RESULTS IN AMATEUR RADIO, IT'S . . .

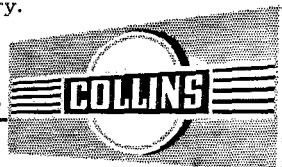

**COLLINS RADIO COMPANY, Cedar Rapids, Iowa**

11 West 42nd Street, New York 18, N. Y.

458 South Spring Street, Los Angeles 13, California



# HOW'S YOUR DX OM?

...FOR BETTER COVERAGE...

## THE NEW NC-173

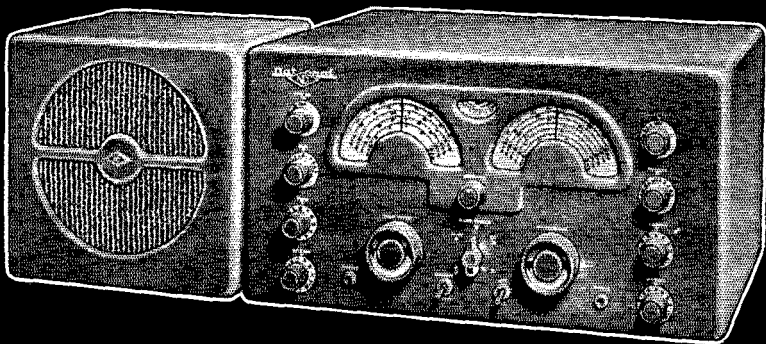

**National**  
EST. 1914

...As restrictions are lifted by one country after another and amateurs return to the air all over the world, working DX on a Sunday morning becomes a real test of skill and equipment.

With the new National NC-173 you can step up the percentage of your successful QSO's to a new high. Its range and stability are helpful in holding your contact when the boys from England, South America, and Honolulu start crowding the bands.

Send today for your copy of the 1947 National catalog, containing complete description of the new NC-173.

**National  
Company, Inc.**  
Malden, Mass.

- Frequency Coverage from 540 KC to 31 mc plus 48-56 mc.
- Calibrated Amateur Band Spread on 6, 10-11, 20, 40, and 80 meter bands.
- 6 Position Wide Range Crystal Filter.
- Double-Diode Noise Limiter For Both Phone and C.W. Reception.
- AVC for both Phone and C.W. Reception.
- S-Meter with Adjustable Sensitivity for Phone and C.W.
- AC-Powered . . . 110/120 or 220/240 volts, 50/60 Cycle.

Please write to Department 8, National Company, for further information

MAKERS OF LIFETIME RADIO EQUIPMENT

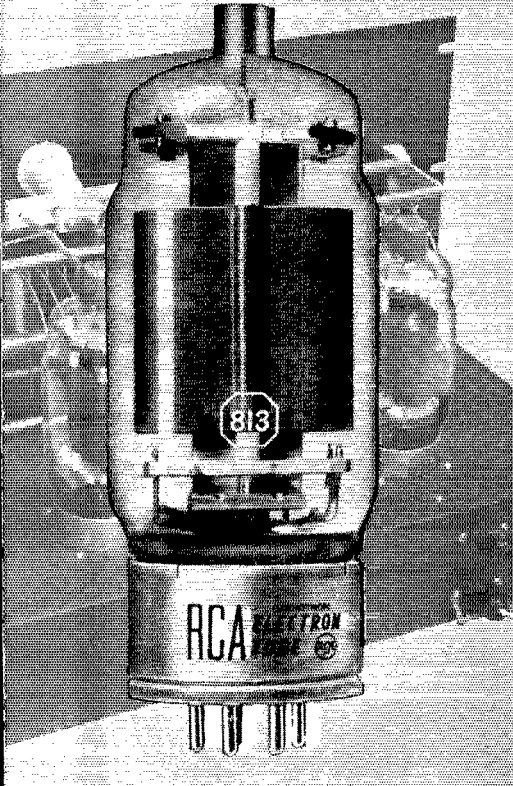

Handles more watts  
for your dollar  
than any other beam  
transmitting type

# RCA-813

AMATEUR NET PRICE ONLY \$14.50

Compare these facts about the RCA-813

- It takes full input with a plate voltage of only 2250 volts.
- It takes full input *without* forced air-cooling.
- It takes full input up to 30 Mc . . . with full plate-circuit efficiency.
- It takes full input with less than 5 watts of grid-driving power.

## NOW! THE RCA-813 IS RATED FOR CLASS AB<sub>2</sub> MODULATOR SERVICE.

A pair of 813's will fully modulate a one kilowatt rig. Typical data follows.

	CCS	ICAS	
DC plate volts . . . . .	2000	2250	2500
DC grid No. 2 volts* . . . . .	750	750	750
DC grid No. 1 volts . . . . .	-90	-90	-95
DC grid No. 3 volts . . . . .	0	0	0
Peak of grid No. 1 to grid No. 1 volts . . . . .	230	230	235
zero-sig. dc plate ma . . . . .	40	45	35
max.-sig. dc plate ma . . . . .	315	315	360
zero-sig. dc grid No. 2 ma . . . . .	1.5	1.5	1.2
max.-sig. dc grid No. 2 ma . . . . .	58	58	55
effective load resistance (ohms) plate-to-plate . . . . .	16000	18500	17000
max.-sig. watts drive (approx.) . . . . .	0.10	0.10	0.35
max.-sig. watts output (approx.) . . . . .	455	515	650

\*From source of good regulation.

**F**OR high-power work using fewer stages . . . for full input at reasonable plate voltages . . . for normal operation with natural air cooling, RCA-813 is your tube. Under ICAS ratings it will take 200 ma at 2000 volts for class C 'phone, and 225 ma at 2250 volts for class C telegraphy . . . more than 34 watts per dollar. And driving power? One RCA-6L6 doubler will more than handle a pair of 813's at 800 watts input on 'phone and a full kilowatt on cw . . . with power to spare.

Designed by RCA from plate cap to base pin, the 813 features a heavy 50-watt filament, a hard glass bulb, an oversize graphite plate, short internal leads. *In well-designed circuits the tube needs no neutralization.*

Complete information on the RCA-813 is yours for the asking. See your local RCA Tube Distributor or write RCA, Commercial Engineering, Section M-54F, Harrison, N. J.

Have you seen  
HAM TIPS? There's a  
copy waiting for you  
at your local RCA  
Tube Distributor.

THE FOUNTAINHEAD OF MODERN TUBE DEVELOPMENT IS RCA



TUBE DEPARTMENT

**RADIO CORPORATION of AMERICA**

HARRISON, N. J.