

QST 

October, 1946

25 cents

35c In Canada

devoted entirely to

amateur radio

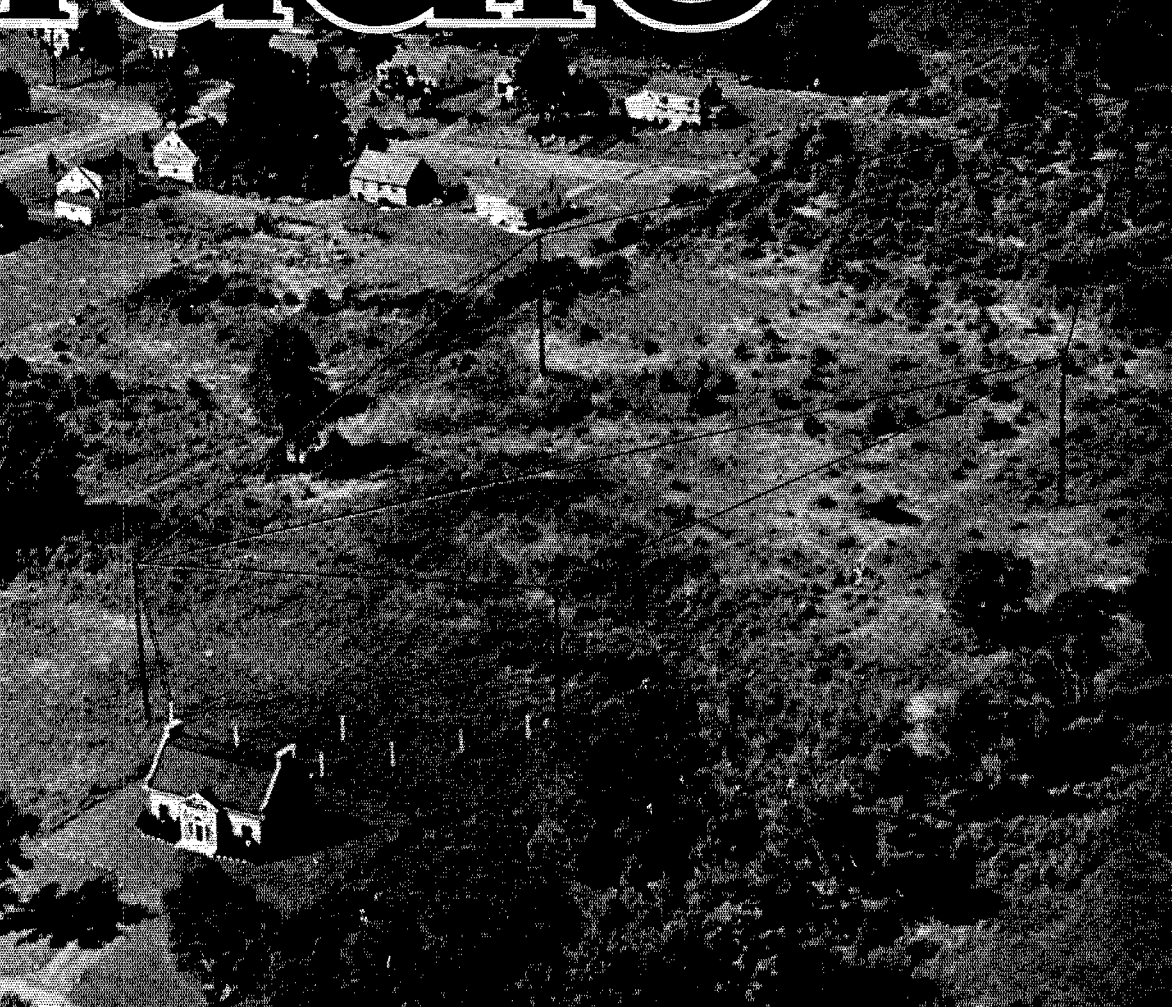

LS SERIES

The Ultimate in Quality

UTC Linear Standard Audio Transformers represent the closest approach to the ideal component from the standpoint of uniform frequency response, low wave form distortion, high efficiency, thorough shielding and utmost dependability. Wartime restrictions having been lifted and UTC production running at full capacity, we now offer these transformers for immediate delivery.

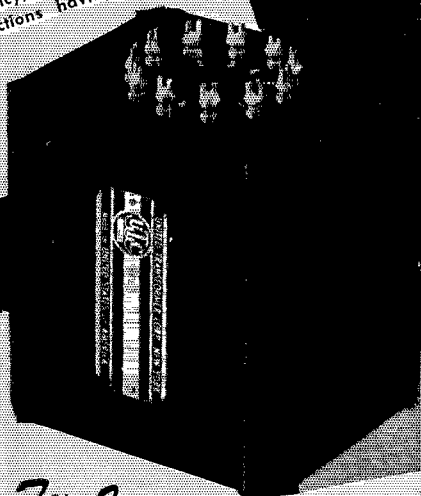

UTC Linear Standard Transformers feature...

- **True Hum Balancing Coil Structure**... maximum neutralization of stray fields.
- **Balanced Variable Impedance Line**... permits highest fidelity on every tap of a universal unit... no line reflections or transverse couplings.
- **Reversible Mounting**... permits above chassis or sub-chassis wiring.
- **Alloy Shields**... maximum shielding from induction pickup.
- **Multiple Coil, Semi-Toroidal Coil Structure**... minimum distributed capacity and leakage reactance.
- **Precision Winding**... accuracy of winding .1%, perfect balance of inductance and capacity; exact impedance reflection.
- **Hiper-Alloy**... a stable, high permeability nickel-iron core material.
- **High Fidelity**... UTC Linear Standard Transformers are the only audio units with a guaranteed uniform response of ± 1.5 DB from 20-20,000 cycles.

For Immediate Delivery

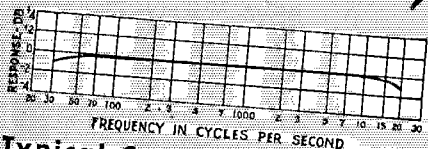



Typical Curve for LS Series

Type No.	Application	Primary Impedance	Secondary Impedance	Max. Level	Relative hum-pickup reduction	Max. unbalanced DC in primary	List Price
LS-10	Low impedance mike, pick-up, or multiple line to grid.	50, 125, 200, 250 333, 500 ohms	60,000 ohms in two sections.				
LS-10X	As above	As above	50,000 ohms	+15 DB	-74 DB	5 MA	\$22.50
LS-21	Single plate to push pull grids	8,000 to 15,000 ohms	135,000 ohms; turn ratio 1.5:1 each side.	+14 DB	-92 DB	5 MA	\$28.10
LS-30	Mixing, low impedance mike, pickup, or multiple line to multiple line	50, 125, 200, 250 333, 500 ohms	50, 125, 200, 250, 333, 500 ohms	+14 DB	-74 DB	0 MA	\$21.25
LS-30X	As above	As above	As above	+17 DB	-74 DB	5 MA	\$22.50
LS-50	Single plate to multiple line	As above	As above				
LS-55	Push pull 2A3's, 6A5G's, 300A's, 275A's, 6A3's	8,000 to 15,000 ohms	50, 125, 200, 250, 333, 500 ohms	+15 DB	-92 DB	3 MA	\$28.10
		5,000 ohms plate to plate and 3,000 ohms plate to plate	500, 333, 250, 200, 125, 30, 30, 20, 15, 10, 7.5, 5, 2.5, 1.2	+17 DB	-74 DB	1 MA	\$21.25
LS-57	Same as above	5,000 ohms plate to plate and 3,000 ohms plate to plate	30, 20, 15, 10, 7.5, 5, 2.5, 1.2	+36 DB			\$25.00
				+36 DB			\$17.50

The above listing includes only a few of the many units of the LS Series. For complete listing — write for catalogue.

United Transformer Corp.
 180 VARICK STREET
 EXPORT DIVISION: 13 EAST 40TH STREET, NEW YORK 16, N. Y.
 NEW YORK 13, N. Y.
 CABLES: "ARLAB"

Why use a  if a  will serve?

With miniature tubes you save in space occupied —gain in electrical efficiency.

TYPE 6BE6
(ACTUAL SIZE)



This is an actual-size outline of standard Type 65A7-GT. Miniature Type 6BE6, at left, though much smaller, has similar performance ratings!



miniatures ARE MODERN

YES, they're modern, space-saving, and *efficient*, these beautifully-made G-E miniature tubes such as Type 6BE6.

They'll do everything standard-type tubes will do, PLUS! For their very compactness means shorter internal leads, and this lowers lead inductance, permitting use at *considerably higher frequencies*. (You can get good performance from a 6BE6 at 100 megacycles!)

G-E miniature tubes have no bases, so r-f losses are sliced. And they're plenty long-lived, because new manufacturing techniques

have made possible a glass-metal seal structure that's as strong as in the larger types.

Also—miniature tubes take up only a fraction of the space required by standard-type tubes! That means greater physical compactness for your rig... and closer side-by-side tube mounting. Both are important in high-frequency rig design.

Learn more about G-E miniature tubes, and the important *new* advantages they offer, from your G-E tube distributor. Or write to *Electronics Department, General Electric Company, Schenectady 5, New York.*

RATINGS OF TYPE 6BE6

Filament voltage	6.3 v
Filament current	300 ma
Max plate voltage	300 v
Conversion trans-conductance	455 mhos

• • •

G.E.'s "HAM NEWS"

for September-October, shows in detail an ultra-compact audio amplifier which employs miniature tubes. The unit is completely contained in the base of the microphone stand!

ELECTRONIC TUBES OF ALL TYPES FOR THE RADIO AMATEUR

GENERAL  ELECTRIC

161-KTB-8850

A Streamliner FOR YOUR AMATEUR RIG



● Any radio amateur interested in improving the appearance and performance of his radio rig will enjoy owning and using Astatic's new, semi-directional, all-purpose Crystal Microphone "The Conneaut," Model 600. With relatively high output and a wide frequency range exceptionally smooth up to 10,000 c.p.s., "The Conneaut" is also ideal for public address and paging systems and many other communication uses. Combination bright chrome and blond plastic. Available with S-Switch or Grip-to-Talk Desk Stand.

See Your Jobber or Write for Catalog



DN
SERIES
Dynamic
Microphones
available in
four models.

"The Conneaut"
MODEL
600-S



THE **Astatic** CORPORATION
ASTATIC GONNEAUT, ONTARIO

IN CANADA CANADIAN ASTATIC LTD TORONTO ONTARIO

Astatic Crystal Devices Manufactured
under Brush Development Co. patents.

OCTOBER 1946

VOLUME XXX

NUMBER 10



STAFF

Editorial

KENNETH B. WARNER W1EH
(Managing Secretary, ARRL)
Editor

HAROLD M. MCKEAN, W1CEG
Assistant to the Editor

GEORGE GRAMMER, W1DF
(Technical Director, ARRL)
Technical Editor

DONALD H. MIX, W1TS
BYRON GOODMAN, W1JPE
Assistant Technical Editors

EDWARD P. TILTON, W1HDQ
V.H.F. Editor

RICHARD M. SMITH, W1FTX
C. VERNON CHAMBERS, W1JEG
Technical Assistants

WALTER E. BRADLEY, W1EWF
Technical Information Service

Production

RALPH T. BEAUDIN, W1BAW
Superintendent

ELSYE C. HOCHMEISTER
Assistant

Advertising

F. CHEVNEY BEEKLEY, W1GS
Advertising Manager

Circulation

DAVID H. HOUGHTON
Circulation Manager

RALPH T. BEAUDIN, W1BAW
Assistant Circulation Manager



OFFICES

38 La Salle Road
West Hartford 7, Connecticut

Subscription rate in United States and Possessions, \$2.50 per year, postpaid; all other countries, \$3.00 per year, postpaid. Single copies, 25 cents. Foreign remittances should be by international postal or express money order or bank draft negotiable in the U. S. and for an equivalent amount in U. S. funds.

Entered as second-class matter May 29, 1919, at the post office at Hartford, Connecticut, under the Act of March 3, 1879. Acceptance for mailing at special rate of postage provided for in section 1103, Act of October 3, 1917, authorized September 9, 1922. Additional entry at Concord, N. H., authorized February 21, 1929, under the Act of February 28, 1925.

Copyright 1946 by the American Radio Relay League, Inc. Title registered at U. S. Patent Office.

QST

devoted entirely to

AMATEUR RADIO

PUBLISHED, MONTHLY, AS ITS OFFICIAL ORGAN, BY THE AMERICAN RADIO RELAY LEAGUE, INC., AT WEST HARTFORD, CONN., U. S. A. OFFICIAL ORGAN OF THE INTERNATIONAL AMATEUR RADIO UNION



CONTENTS

"It Seems to Us . . ."	11
Our Cover	12
A Medium-Power Bandswitching Transmitter Richard M. Smith, W1FTX	13
Preventing Self-Oscillation in Tetrode Amplifiers Paul D. Frelich, W9ECO	22
A New Kind of Skyhook D. T. Ferrier, WILLX, and W. G. Baird, W9RCQ/1	24
Happenings of the Month	26
In QST 25 Years Ago This Month	28
A Simple "Wien Bridge" Audio Oscillator Howard T. Sterling	29
Hamfests Scheduled	32
A Soup-Can Wavemeter for the 24-Cm. Band Frederic A. Jenks, W2MTH	33
Foreign Notes	37
Technical Topics	
Impedance Matching with an Antenna Tuner	38
Amateur F.M.	40
ARRL Conventions	42
How's DX?	43
Silent Keys	46
Hints and Kinks	47
Looking Over the Postwar Receivers	
The RME-45	48
The World Above 50 Mc.	50
Correspondence from Members	55
Operating News	56
Station Activities	64

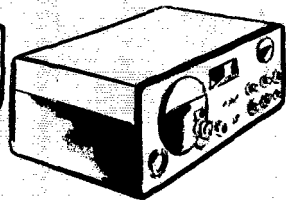
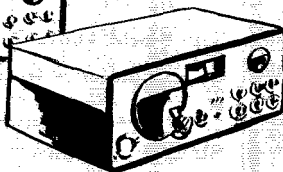
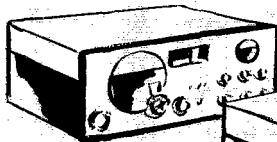
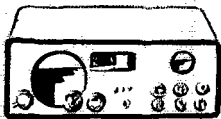
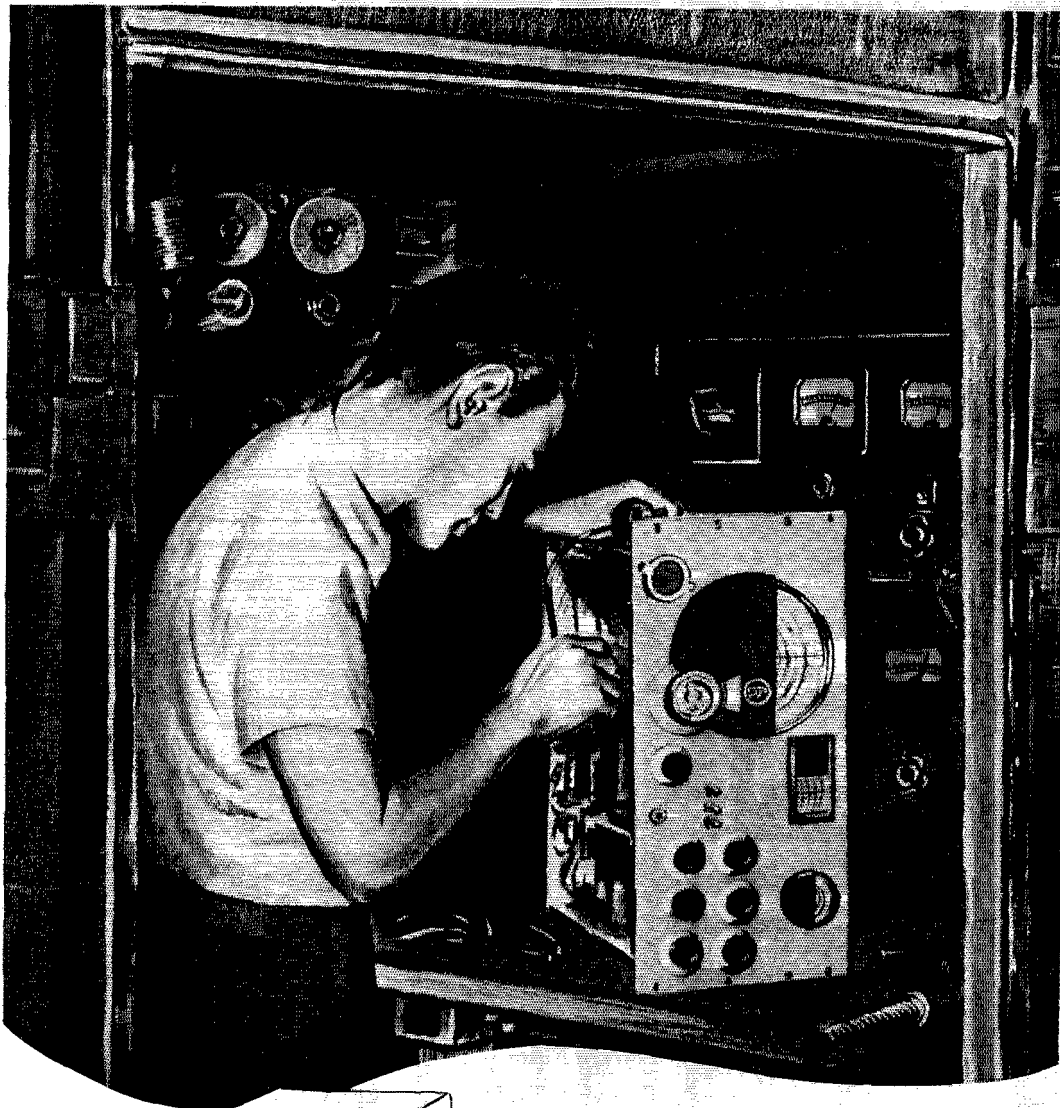

COPYRIGHT 1946 THE HALLICRAFTERS CO.

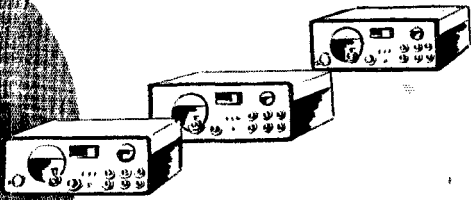

The first hundred sets are the hardest...

YOU can take it from Hallicrafters: the first hundred radio sets of any new model are the hardest. Hallicrafters is completing a run of 100 of the new Model SX-42. This extraordinary set has been more than a year in the making and behind it are more than 20 years intensive experience in the manufacture of high frequency communications equipment. The first 100 SX-42's have been checked, re-checked in a thousand and one testing operations. Because the set covers from 540 kc to 110 Mc *continuously* in six bands it must be as delicately balanced and precisely aligned as an expensive watch. One out of every five persons on the SX-42 assembly line is an inspector, watchdog over the strictest Hallicrafters standards. The first 100 SX-42's are now being placed in the hands of radio technicians, engineers, amateurs all over the world. These qualified critics will submit to Hallicrafters detailed reports. This final field testing of this great new receiver will bring the SX-42 one step closer to reality for you. Watch for the SX-42, wait for the SX-42 . . . the radio man's radio . . . the radio that's remembered by the veteran . . . preferred by the amateur . . .

BUILDERS OF

Skyfone

AVIATION RADIOTELEPHONE

hallicrafters RADIO

THE HALLICRAFTERS CO., MANUFACTURERS OF RADIO
AND ELECTRONIC EQUIPMENT, CHICAGO 16, U. S. A.

Sole Hallicrafters Representatives in Canada: Rogers Majestic Limited, Toronto - Montreal



Section Communications Managers of the ARRL Communications Department

Reports Invited. All amateurs, especially League members, are invited to report station activities on the first of each month (for preceding month) direct to the SCM, the administrative ARRL official elected by members in each Section. Radio Club reports are also desired by SCMs for inclusion in QST. All ARRL Field Organization appointments are now available to League members. These include ORS, OES, OPS, OO, and OBS. Also, where vacancies exist SCMs desire applications for SEC, EC, RM, and PAM.

ATLANTIC DIVISION				
Eastern Pennsylvania Maryland-Delaware-District of Columbia Southern New Jersey Western New York Western Pennsylvania	W3BES W3CIZ W2GCU W2UPH W3NCJ	Jerry Mathis Hermann E. Hobbs Ray Tomlinson Charles I. Otero R. R. Rosenberg	623 Crescent Ave. 9701 Monroe St. Silver Springs P. O. 623 E. Brown St. 4158 Ridge Road, West 927 East 23rd St.	Glenside Gardens Linden, Maryland Trenton 10 Spencerport Erie
CENTRAL DIVISION				
Illinois Indiana Kentucky Michigan Ohio Wisconsin*	W8NUX W9SWH W5IEZ/4 W8DPE W8PNO W9ARE	David E. Blake, II Ted K. Mason Joseph P. Colvin Harold C. Bird William D. Montgomery C. C. Richelieu	4501 N. Malden St. 550 Eben St. 1653 Beechwood Ave. R.F.D. 2, Box 228 1290 Coolidge Ave. 4901 S. 30th St.	Chicago 40 New Haven Louisville 4 Pontiac 2 Cincinnati 30 Milwaukee 14
DAKOTA DIVISION				
North Dakota South Dakota Northern Minnesota Southern Minnesota	W0EVP W0BOVY W9FUZ W9OMC	Raymond V. Barnett P. H. Schultz Armond D. Brattland Vernon G. Fribyl	406-17th St. 118 N. Yankton Ave. Birchmont Drive 15 Glen St., South	Bismarck Pierre Bemidji Hutchinson
DELTA DIVISION				
Arkansas Louisiana Mississippi Tennessee	W5JIC W5DWW W5HAV W4FLS	Marshall Riggs W. J. Wilkinson, jr. P. J. Clement James W. Watkins	4405 Howell Ave. Room 313, Jefferson Hotel 224 S. Miami St. 220 North Howell St.	Fort Smith Shreveport Birmingham Chattanooga 4
HUDSON DIVISION				
Eastern New York N. Y. C. & Long Island Northern New Jersey*	W2HZL W2KDC W2IIN	Ernest E. George Charles Ham, Jr. John J. Vitale	2044 Lexington Parkway 151-06 84th Drive 57 Sayre St.	Schenectady 8 Jamaica, L. I., 2 Elizabeth 3
MIDWEST DIVISION				
Iowa Kansas Missouri Nebraska	W9PIR W0AWP W0OUD W0FQB	Leslie B. Vennard Alvin B. Unruh Mrs. Letha A. Dangerfield Arthur R. Gaeth	2712 Washington St. 842 N. Terrace Drive 411 Moffett Ave. 6105 N. 37 St.	Hurlington Wichita 6 Joplin Omaha 11
NEW ENGLAND DIVISION				
Connecticut Maine Eastern Massachusetts Western Massachusetts New Hampshire Rhode Island Vermont	W1KOY W1AOL W1JAK W1JAH W1AXL W1HRC W1NDL	Edmund R. Fraser G. C. Brown Alan K. Ross William J. Barrett John H. Stoughton Clayton C. Gordon Gerald Benedict	90 Atwater St. 379 No. Main St. 1017 East Jefferson St. 239 Columbia St. RFD 2 70 Columbia Ave., Gaspee 23 Foster St.	West Haven Brewster North Quincy 71 Adams Claremont Plateau, Providence 5 Montpelier
NORTHWEST DIVISION				
Alaska Idaho Montana Oregon* Washington	K7CBF W7IYW W7EQM W7BEE W7FWD	August G. Hiebert Alan K. Ross Albert Beck Cliff Tice O. U. Tatro	c/o KPAR 1017 East Jefferson St. 18 Laird St. McKay Dam 513 N. Central	Fairbanks Boise Ramsay Pendleton Olympia
PACIFIC DIVISION				
Hawaii* Nevada Santa Clara Valley East Bay San Francisco Sacramento Valley Philippines San Joaquin Valley	K6PHD W7CX W6BPT W6TI W6CVP W6MGC KA1GR W6PSQ	John Souza N. Arthur Sowle Roy E. Pinkham Horace R. Greer Samuel C. Van Liew John R. Kinney George L. Rickard James F. Wakefield	Box 2025 1061 Fremont St. 414 Fairmount Ave. 215 Knowles Ave. 5240 Jay St. Box 849 1548 L St.	Wailuku, Maui Reno Santa Clara Oakland 11 Daly City Sacramento 16 Manila Fresno
ROANOKE DIVISION				
North Carolina South Carolina Virginia West Virginia	W4CYB W4BOE/ANG W4JFK W8JM	W. J. Wortman Ted Ferguson Walker R. Bullington Donald B. Morris	c/o Duke Power Co. 3422 Rosewood Drive 1203 E. Brookland Pk. Blvd. 303 Home St.	Charlotte 1 Columbia 25 Richmond 22 Fairmont
ROCKY MOUNTAIN DIVISION				
Colorado Utah-Wyoming	W0OYT W7LLH	Glen Bond Victor Drabble	2550 Kendall 1024 Oak St.	Denver 14 Ogden, Utah
SOUTHEASTERN DIVISION				
Alabama Eastern Florida Western Florida Georgia West Indies (Cuba) (Puerto Rico-Virgin Islands)*	W4GBV W4IP W4MS W4HYW KP4KD	Lawrence J. Smyth Robert B. Murphy Lt. Comdr. Edward J. Collins Thomas M. Moss Everett Mayer	808 Winona Ave. 3302 S.W. Grapeland Blvd. 1215 N. 12th Ave. 570 Oak Drive P. O. Box 1061	Montgomery Miami 33 Pensacola Hapeville San Juan 5, P. R.
SOUTHWESTERN DIVISION				
Los Angeles Arizona San Diego	W6W0W W6MLL W6CHV	Ben W. Onstott Gladden C. Elliott Ralph H. Culbertson	9631 3rd Ave. 1408 West Fresno St. 7172 Eads St.	Inglewood Fucson La Jolla
WEST GULF DIVISION				
Northern Texas Oklahoma Southern Texas New Mexico	W5ALA W5AYL W5JC W5HJF	Jack T. Moore Ed Oldfield James B. Rives J. G. Hancock	4529 Fairway Ave. 2141 N.W. 35th St. 1721 Kentucky Ave. 110 S. E. Nevada St.	Dallas 4 Oklahoma City 6 San Antonio 1 Portales
MARITIME DIVISION				
Maritime	VE1DQ	A. M. Crowell	69 Dublin St.	Halifax, N. S.
ONTARIO DIVISION				
Ontario	VE3DU	David S. Hutchinson	327 Lovett St.	London, Ont.
QUEBEC DIVISION				
Quebec	VE2U	Gordon F. J. Phelan	4829 Isabella Ave.	Montreal, Que.
VANALTA DIVISION				
Alberta British Columbia	VE6LO VE7WS	W. W. Butchart W. W. Storey	10740-107 St. 3915 W. 32nd Ave.	Edmonton, Alta. Vancouver
PRAIRIE DIVISION				
Manitoba Saskatchewan	VE4AM VE5SY	A. W. Morley Arthur Chesworth	36 Lennox St. 1084 Redland Ave.	St. Vital Moose Jaw

*Officials appointed to act temporarily in the absence of a regular official.

TELEPHONE PORTSMOUTH 7600
CODE WORD ● JERAD

Jensen
*Fine
Acoustic
Equipment*



MANUFACTURING CO.
6601 SOUTH LARAMIE AVE.
CHICAGO ILLINOIS

"ALL THE JENSEN SPEAKERS YOU WANT"

During the war...when we were building and shipping thousands of loud speakers every week for the Armed Services ...we would have staked our last dollar on our ability to continue our large-scale production when the war was over. We would have promised our customers eagerly, "You'll have all the JENSEN speakers you want when the war ends." Little did we know then that the postwar period would be so difficult.

There's no use reminding you that strikes and shortages of material have resulted in a scarcity of steel and copper wire and all of the parts needed for making loud speakers. Nor can we console ourselves with the thought that other manufacturers are in the same boat. We know our customers need merchandise and we're truly sorry that our production is a trickle instead of a flood; that our deliveries are slow; that our new products are not yet in full production. Some day soon materials will become more plentiful and our production will catch up with our backlog.

Then we can truthfully and honestly promise...and deliver ..."all the JENSEN speakers you want."

Now all we can tell our customers is, "We appreciate your patience."

Thomas A. White
President

RED: The Name Insures the Quality   

MANUFACTURING COMPANY • 6611 South Laramie Avenue, Chicago 38, Illinois
CANADA • J. R. LONGSTAFFE, LTD., 11 KING STREET, WEST, TORONTO

YOU NAME
IT!

**EXACT
FREQUENCY
AT NO EXTRA COST!**



Why pay a "premium" for the exact frequency you want? Why be satisfied with "plus or minus" the spot you pick? PR will furnish you EXACT FREQUENCY (integral kilocycle) AT NO EXTRA COST. This offer holds good for all amateur ranges ... 80, 40, 20, and 10 meters ... and for all frequencies doubling and quadrupling into the other frequencies, including 11 meters! PR can do this because of the tremendous stocks carried by PR jobbers and at the factory. We have actually in stock 7,057 different frequencies ... and that's every frequency an amateur has available to him at the

present time. See your jobber. It's ten to one he will have the exact spot you want ... if not, the factory is giving 24-hour service. You don't have to wait. All PR Precision CRYSTALS are low drift ... less than 2 cycles per MC per degree centigrade. Get the new PRs for accuracy ... maximum power output ... activity ... stability ... protected from contamination and moisture ... unconditionally guaranteed. Be exactly where you want to be on all bands ... with PRs. Petersen Radio Company, 2800 West Broadway, Council Bluffs, Iowa. (Telephone 2760)



**PR Precision
CRYSTALS**

10 METERS PR Type Z-5.	Harmonic oscillator. Ideal for "straight through" mobile operation. High activity. Heavy drive without damage in our special circuit\$5.00
20 METERS PR Type Z-3.	Harmonic oscillator. Low drift. High activity. Can be keyed in most circuits. High power output. Just as stable as fundamental oscillators\$3.50
40 & 80 METERS PR Type Z-2.	Rugged, low drift fundamental oscillators. High activity and power output with maximum crystal currents. Accurate calibration \$2.65

The Collins 75A...A new standard for amateur receivers



The Collins 75A is a hot new amateur receiver with all the distinctive features that hams have read about, talked about, and dreamed about. It features accuracy of calibration, stability of operation, double conversion (triple detection), pinpoint selectivity, effective automatic noise limiter, positive image rejection.

The smart new dial is accurate to within one kilocycle (2 kc. on ten and eleven meters). The smooth action of the crystal selectivity circuit provides a bandwidth that is variable from 200 cps to 4 kc. Proper design of the circuit and precise control of the crystal frequency greatly simplify the

customary "getting used to it."

Image rejection is more than 50 db, even on 10 meters. Signal to noise ratio is approximately 10 db with a 1 microvolt r-f signal and normal audio output. Six amateur bands—80, 40, 20, 15, 11, 10—are completely covered. A speaker is available in a matching cabinet.

Step up the quality and quantity of your QSO's with the new Collins 75A receiver. Write us for detailed information.

FOR RESULTS IN AMATEUR RADIO, IT'S . . .

COLLINS RADIO COMPANY, CEDAR RAPIDS, IOWA

11 West 42nd Street, New York 18, N. Y.

458 South Spring Street, Los Angeles 13, California

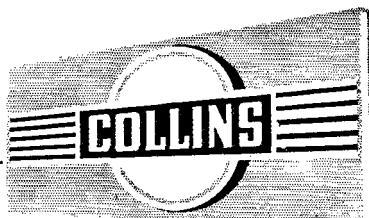

THE AMERICAN RADIO RELAY LEAGUE, INC.,

is a noncommercial association of radio amateurs, bonded for the promotion of interest in amateur radio communication and experimentation, for the relaying of messages by radio, for the advancement of the radio art and of the public welfare, for the representation of the radio amateur in legislative matters, and for the maintenance of fraternalism and a high standard of conduct.

It is an incorporated association without capital stock, chartered under the laws of Connecticut. Its affairs are governed by a Board of Directors, elected every two years by the general membership. The officers are elected or appointed by the Directors. The League is noncommercial and no one commercially engaged in the manufacture, sale or rental of radio apparatus is eligible to membership on its board.

"Of, by and for the amateur," it numbers within its ranks practically every worth-while amateur in the nation and has a history of glorious achievement as the standard-bearer in amateur affairs.

Inquiries regarding membership are solicited. A bona fide interest in amateur radio is the only essential qualification; ownership of a transmitting station and knowledge of the code are not prerequisite, although full voting membership is granted only to licensed amateurs.

All general correspondence should be addressed to the Secretary at the administrative headquarters at West Hartford, Connecticut.



Past Presidents

HIRAM PERCY MAXIM, W1AW, 1914-1936
EUGENE C. WOODRUFF, W8CMP, 1936-1940

Officers

President GEORGE W. BAILEY, W1KH
Washington, D. C.
Vice-President J. LINCOLN McCARGAR, W6EY
Oakland, California
Secretary KENNETH B. WARNER, W1EH
West Hartford, Connecticut
Communications Manager F. E. HANDY, W1BDI
West Hartford, Connecticut
Treasurer DAVID H. HOUGHTON
West Hartford, Connecticut

General Counsel PAUL M. SEGAL
1026 Woodward Building, Washington 5, D. C.

Directors

President
GEORGE W. BAILEY W1KH
1530 P St., N.W., Washington 25, D. C.

Vice-President
J. LINCOLN McCARGAR W6EY
66 Hamilton Place, Oakland 12, Calif.

Canadian General Manager
ALEX REID VE2BE
240 Logan Ave., St. Lambert, P. Q.
Alternate: Leonard W. Mitchell VE3AZ
78 Raglan Ave., Toronto, Ont.

Atlantic Division
EDWARD G. BASER W2ZL
315 Beechwood Ave., Trenton 8, N. J.
Alternate: J. Victor Brotherson W8BHN
1743 Ottawa Drive, Erie, Pa.

Central Division
JOHN A. KIENER W8AVH
3462 Edison Rd., Cleveland Heights,
Cleveland 21, Ohio
Alternate: Earl S. Nelson W8DS
22,551 Hadden Rd., Euclid 17, Ohio

Dakota Division
TOM E. DAVIS W9VVA
915 W. Becker Ave., Willmar, Minn.
Alternate: Harold B. Love W9ZRT
Box 426, Mandan, N. D.

Delta Division
GEORGE S. AXTON W5BMM
Plain Dealing, La.
Alternate: Eugene H. Treadaway W5DKR
P. O. Box 44, La Place, La.

Hudson Division
ROBERT AKERIDGE KIRKMAN W2DSY
1910 Oak Drive, West Belmar, N. J.
Alternate: George Rulfs, Jr. W2CJY
38 Brookwood Drive, Manhasset, L. I., N. Y.

Midwest Division
FLOYD E. NORWINE, JR. WØEFC
7405 Hiawatha Ave., Richmond Heights 17, Mo.
Alternate: C. A. Colvin W9VHR
% Omaha & Council Bluffs St. Railway Co.,
Omaha 2, Nebr.

New England Division
PERCY C. NOBLE W1BVR
37 Broad St., Westfield, Mass.
Alternate: Clayton C. Gordon W1HRC
70 Columbia Ave., Warwick, R. I.

Northwestern Division
KARL W. WEINGARTEN W7BG
3219 N. 24th St., Tacoma 7, Wash.
Alternate: R. Rex Roberts W7CPLY
110 W. Brennan St., Glendive, Mont.

Pacific Division
J. L. McCARGAR W6EY
66 Hamilton Pl., Oakland 12, Calif.
Alternate: Elbert J. Amarantes W6FBW
1675 Dale Ave., San Jose, Calif.

Roanoke Division
H. L. CAVENESS W4DW
2607 Vanderbilt Ave., Raleigh, N. C.
Alternate: J. Frank Key W3ZA
Box 707, Buena Vista, Va.

Rocky Mountain Division
Acting Director:
HOWARD R. MARKWELL W9TFP
355 Monroe St., Denver 6, Colo.

Southeastern Division
WILLIAM C. SHELTON W4ASR
527 Revilo Blvd., Daytona Beach, Fla.
Alternate: William P. Sides W4AUP
Fleming Road, Montgomery, Ala.

Southwestern Division
JOHN E. BICKEL W6BEY
1834 E. Whittier Blvd., Whittier, Calif.
Alternate: Eldridge E. Wyatt, Jr. W6ARW
P. O. Box 3597, Long Beach 3, Calif.

West Gulf Division
WAYLAND M. GROVES W5NW
% Humble Pipe Line Co., Odessa, Texas
Alternate: Jennings R. Poston W5AJ
P. O. Box 848, Curundu, Panama Canal Zone

"It Seems to Us..."

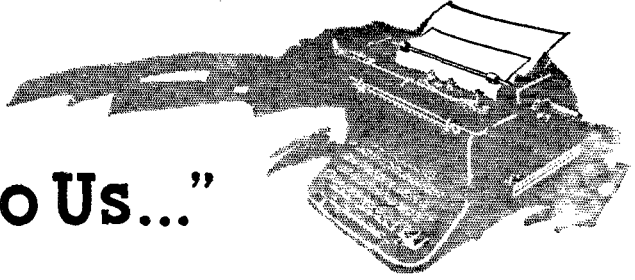

COMPLEXITY

George was hopping us the other day for wasting the technical department's time every morning wailing about W1EH's technical difficulties the night before or talking over new brainstorm and asking for advice. "Dad burn it," he said, only that isn't what he said, "you're as bad as the rest of these guys. Why don't you read *QST* and the *Handbook*?"

We're all alike. Most of the Hq. gang have had as many troubles as the rest of you getting going again after the war. There's too much that we've forgotten, even about the simple things. And the literature of our art is now extensive and difficult. Very few of us seem to remember what has been published in *QST* in the past or to be willing to make the necessary search to find the answer to our problem. In planning the contents of *QST* at Hq. we sometimes think that if we republished old articles most of the gang wouldn't know the difference and that perhaps we really ought to do it to review some of the lost ground. There's too much to it for most of us to keep up with. It has been said that the number of instruments that an airplane pilot has to watch comes close to being the utter limit of what the human mind can cope with. Sometimes we feel the same way about amateur radio — that it is simply becoming too complex for the average ham, including ourself. We still seem to be geared to the early 30s when we had oscillator transmitters and two-tube receivers, and our minds have difficulty accumulating enough engineering knowledge to do the required job on present-day radio equipment. In our own lab here we can remember when we used to be able to plan, build and test a bread-board transmitter or receiver in a single day. Now we have such things as bandswitching rigs that may take an expert amateur not only weeks but months to plan, lay out, build, remove bugs, and rebuild, until he is satisfied that the design is good and duplicable — and then the wiring diagram takes the greater part of a *QST* page and the parts list reads like the specifications for a battleship. One reason why more and more manufactured equipment is being

sold — a trend that we can't help deploring — is probably this fiendish increase in complexity that seems necessary to get the results we demand today.

To many of us, the "good old days" were the days when we could build all our own gear and understand what we were doing, and when we were just as well posted technically as the next ham. For each of us there is a limit, and meanwhile the requirement for complete knowledge grows higher and higher and is attainable by fewer and fewer.

Anybody any idea what we can do about it?

BUM SUPERHETS

We take for our text the opening clause of the new language in §12.152 of our regulations, about quiet hours: "If the operation of an amateur station causes general interference to the reception of transmissions from stations operating in the domestic broadcast service when receivers of good engineering design including adequate selectivity characteristics are used to receive such transmissions . . ."

There are a couple of little things that first may be pointed out. "Domestic broadcast service" is a broad term that includes f.m. and television broadcasting as well as standard a.m. And if you remember the old language about receivers of "modern design," you'll note that the expanded description of receivers entitled to consideration gives us amateurs continuing protection.

We wish we had means for informing the whole general public that when they buy cheap receivers having inadequate preselection and inadequate shielding they are not entitled to protection from interference from well-adjusted amateur stations operating in compliance with extensive regulations. They haven't done their part. We wish we had the ability to impress the set-building industry with the great desirability of confining their output to sets that are good enough to retain the goodwill of the amateur fraternity — and of the public, too, after enough time has gone by for them to realize what they've bought. Because, in our own interests, we shall have to tell them when they have a cluck. There will

probably be tough competition in the BCL-set market and the industry will be interested in every place it can save a nickel; but the public is entitled to some protection and we amateurs are entitled to some protection, and there decidedly should be a limit to how frowsy a job is put on the market. The spectrum is so crowded now, and so many categories of stations work within small geographical separation, that in our opinion, the day has passed when the uninformed public should be offered receivers so short-changed in design and materials that they are certain to encounter trouble.

The amateur does not like to cause interference to listeners and lookers-in, regardless of how poor their equipment is. He knows that some people cannot afford expensive receivers. He'll do his best to help them, and he knows from experience that a certain amount of unpleasantness, annoyance and loss of time is inescapable. But the amateur also wants to operate, and not be put upon, and not be blamed for troubles that come from skimmed designs and cut corners in the set factory rather than from his transmitter. The present standard is the only possible one: to recognize that when interference comes on a BCL set of poor design, inadequate selectivity and insufficient shielding, the poor set owner is not entitled to relief and the amateur is entitled to continue operating. Receivers can be good; when the amateur generally interferes on decent sets, the fault is his and he must rectify it. The general public will be well advised if they confine their purchases to receivers that enjoy this protection.

The whole amateur fraternity would be no end grateful if the set-building industry would take these factors into account in planning its postwar wares.

HOW ABOUT F.M.?

We wonder why we fellows don't give f.m. more of a play for our short-range communications, particularly 10 meters on short skip and local work, and 6 meters. It seems to offer many advantages, yet "intentional" f.m. is still a rarity in our midst.

We have no f.m. standards yet, for lack of experience under our own conditions, but we see no point in our ever going in for the big deviation ratios used in broadcasting. Narrow-band f.m. seems much better suited to communication jobs and can be much more easily accomplished. We were interested in reading recently a wartime Army report on some comparative tests between narrow-band f.m. and amplitude-modulated 'phone. For the best response on weak signals, the best deviation ratio was found to be between 1-to-1 and 2-to-1, somewhere about $1\frac{1}{2}$ -to-1. It was said that this small-deviation f.m. gave fifty per

cent more range (for the same signal/noise ratio) than the same power amplitude-modulated, and at its midrange gave a hundred per cent better communication as measured by intelligibility tests. We ought to find that definitely interesting. And for many of us it should offer a means to escape BCI.

It can't be the transmitters that are holding us back, for they are much simpler than a.m. jobs. It is, of course, the receiver problem. However, even the ordinary a.m. superhet will deal quite well with these small-deviation f.m. signals. It seems to us we'd find it profitable to make a beginning on that basis, and we commend the idea to those looking for improved results.

And now we wonder why we started out talking just 10 meters and 6. Narrow-band f.m. would definitely have the aspects of a blessing on 2 meters because, properly done, it would occupy vastly less spectrum space than the average modulated-oscillator signal and would be receivable in good quality on narrow-band superhet receivers and on converters feeding communications receivers, something true today only of the carefully-stabilized a.m. signal. The problems, of course, are a great deal more severe, requiring a more stable oscillator (percentage-wise) in the receiver and less drift in the transmitter than we are accustomed to. In fact, we're not at all sure small-deviation f.m. is the best answer for 2 meters. The kind of f.m. that the police service calls narrow-band may be a better solution. But we do think that the effort to find the right application for this band will prove as much worth while as on 10 and 6.

How about it, fellows?

Edwin

OUR COVER

We present an aerial eyeview of that ethereal earful, W1AW, ARRL headquarters station, shot by Staff Photographer Frank Beaudin while flying at 600 feet. To the rear of the W1AW building are the five 65-foot antenna poles and the feed-line supports. The station occupies a 7-acre site at Newington, Conn., 4 miles from Hq.

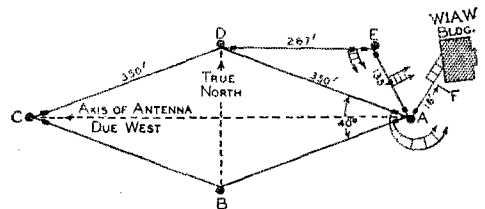

Diagram of W1AW antennas: AE, 3.5 Mc.; DE, 7 Mc.; AF, 28 Mc.; ABCDA, rhombic used mainly on 14 Mc. A 50-Mc. horizontal "Q" is mounted atop Pole E.

A Medium-Power Bandswitching Transmitter

Four Bands with a 4-125A Tetrode Output Stage

BY RICHARD M. SMITH, * W1FTX

• The work that goes into a bandswitching transmitter pays large dividends in operating convenience. Further, if some thought is given to reliability in the circuit design, the rig will be trouble-free as well as easy to operate. Here's a transmitter that combines bandswitching, reliability and fairly large power output, with the ability to operate with plate modulation as well as on c.w.

FOR operating convenience nothing can compete with a bandswitching transmitter. Anyone who has ever used one will back this statement to the limit, and for those who have never been able to change from one band to another without tearing half of the station apart, a new experience is in store. Gone are bothersome plug-in coils, the risk of grabbing a "hot" tank coil when changing bands, the need for crawling behind a rack, and the reluctance to move from one band to another. The time saved by band-

*Technical Assistant, QST.

Front view of the bandswitching transmitter. The controls along the bottom of the panel are, left to right, the crystal selector switch, oscillator key jack, final key jack, low-power stage band-switch, plate-meter switch and grid-meter switch. Above, in the same order, are the tuning controls for the 6V6, the two sections of the 6N7, and the 807 plate. The 270-degree knob to the left of the main tuning dial is the excitation control. The knob just below the meters controls bandswitching in the output stage. The plate meter is on the left, the grid meter on the right.

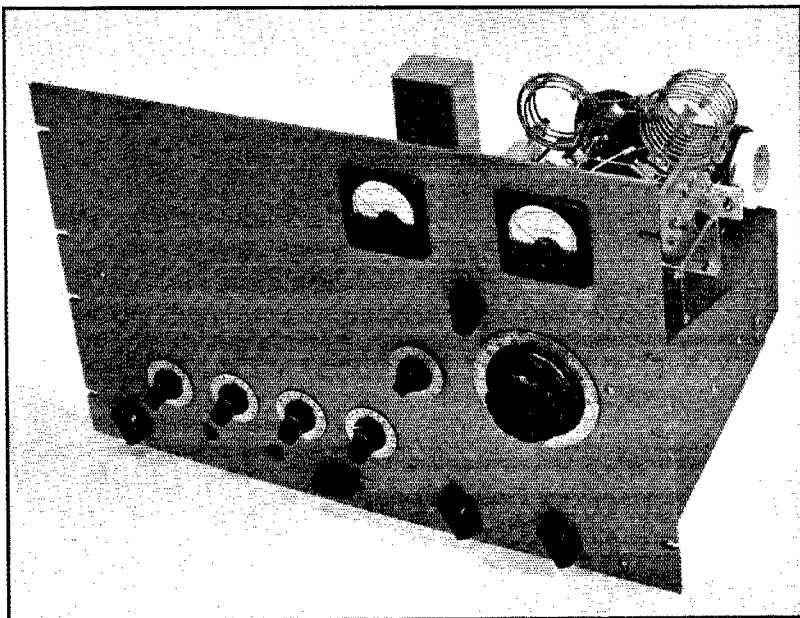

switching is worth a lot of points in any operating contest, and can mean the difference between catching some of that elusive DX and being left at the post.

The transmitter illustrated combines complete bandswitching from 80 meters through 10 meters with moderately high power — a feature that is usually lacking in most bandswitching rigs. A 4-125A beam tetrode is used in the output stage, driven by frequency-multiplying stages which, because of the low driving-power requirements of the final, can loaf along at considerably below ratings. This adds to the reliability of the set because tube failures and other breakdowns are reduced to absolute minimum. The final can be operated at 375-watts input for c.w. operation, or 270 watts in 'phone service.

The Circuits

The circuits are straightforward as shown in Fig. 1, and include no special tricks. A Pierce crystal oscillator is used, operated at low plate voltage to permit maximum frequency stability. No effort is made to use the oscillator as a power generator, and as a result it keys well without

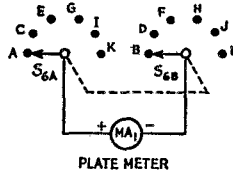
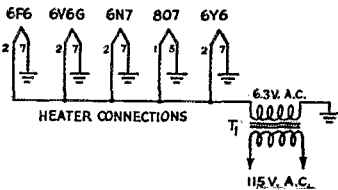
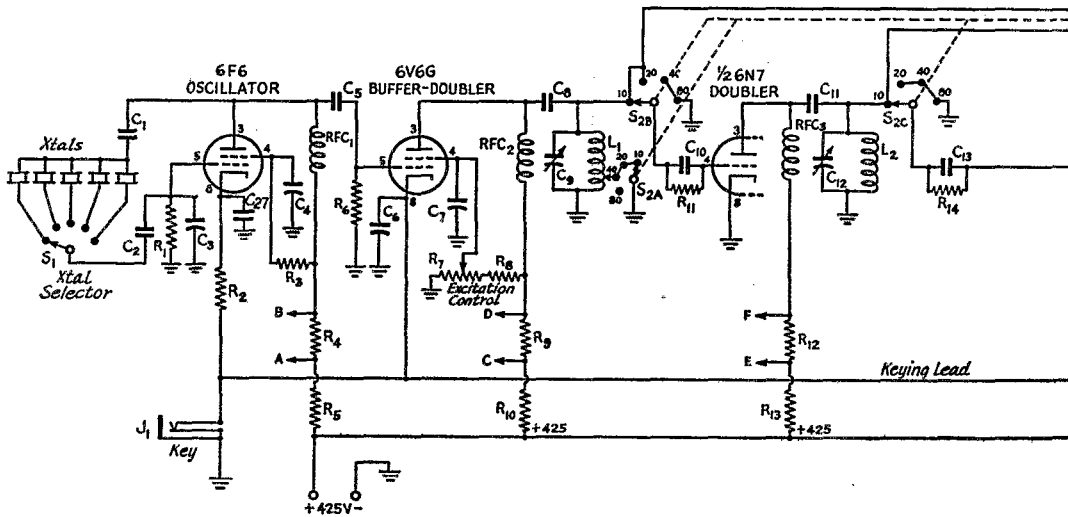

Fig. 1 — Circuit diagram of the bandswitching transmitter.

- C₁, C₂, C₁₆, C₁₉ — .001- μ fd. mica.
- C₄, C₆, C₇, C₁₇, C₁₈, C₂₂, C₂₃, C₂₇ — 0.01- μ fd. 600-volt paper.
- C₅, C₈, C₂₁ — 150- μ fd. mica.
- C₉ — 140- μ fd. receiving variable (Hammarlund MC-140-S).
- C₃, C₁₀, C₁₃ — 100- μ fd. mica.
- C₁₁, C₁₄ — 0.002- μ fd. mica.
- C₁₂, C₁₅ — 50- μ fd. receiving variable (Hammarlund MC-50-S).
- C₂₀ — 100- μ fd. receiving variable (National ST-100).
- C₂₄ — 220- μ fd. mica, 5000 volts d.c. working.
- C₂₅ — 0.001- μ fd., 5000-volt mica.
- C₂₆ — 120- μ fd. variable, 0.10-in. air gap (Cardwell XE-120-XS).
- R₁ — 47,000 ohms, $\frac{1}{2}$ watt.
- R₂ — 1000 ohms, $\frac{1}{2}$ watt.
- R₃ — 68,000 ohms, $\frac{1}{2}$ watt.
- R₄, R₉, R₁₂, R₁₅, R₁₇, R₁₉, R₂₂, R₂₄ — 22 ohms, $\frac{1}{2}$ watt.
- R₅ — 50,000 ohms, 3 watts (three 0.15-megohm 1-watt units in parallel).
- R₆ — 0.1 megohm, $\frac{1}{2}$ watt.
- R₇ — 75,000-ohm wire-wound potentiometer.
- R₈ — 50,000 ohms, 10 watts.

- R₁₀ — 15,000 ohms, 10 watts.
- R₁₁, R₁₄ — 22,000 ohms, $\frac{1}{2}$ watt.
- R₁₃ — 7500 ohms, 10 watts.
- R₁₆ — 5000 ohms, 10 watts.
- R₁₈ — 68 ohms, $\frac{1}{2}$ watt.
- R₂₀ — 30,000 ohms, 10 watts.
- R₂₁ — Meter shunt; see text.
- R₂₃ — 20,000 ohms, 5 watts.
- R₂₅ — 50,000 ohms, 50 watts, with slider.
- R₂₆ — 50,000 ohms, 50 watts.
- R₂₇ — Meter shunt; see text.
- L₁ — 31 turns No. 22 d.s.c., 12 $\frac{1}{2}$ turns $\frac{1}{2}$ -inch long between ground end and tap; 18 $\frac{1}{2}$ turns close-wound between tap and plate end. Wound on 1-inch diam. form (Millen 45000).
- L₂ — 11 turns No. 22 d.s.c. 1 inch long on 1-inch diam. form (Millen 45000).
- L₃ — 4 turns No. 20 d.s.c. 1 inch long on 1-inch diam. form (Millen 45000).
- L₄ — 7 turns No. 18 bare, 1 $\frac{3}{8}$ -inch diam., 1 $\frac{3}{8}$ inches long, tapped 3 turns from ground end. (National AR-16-10E with link and 1 turn of coil removed. Link connection on plug-in base used to bring out tap.)

chirps and will not drift when left on for long periods of time. Five of the crystal sockets provided are of the type that accommodate the new crystals with $\frac{1}{2}$ -inch spacing between pins. The sixth is a six-prong ceramic socket for use with the older-type crystal holders that most of us have on hand from prewar days. This arrangement may be modified to suit individual needs. Ten-meter output can be obtained with 80-, 40-, or even 160-meter crystals, and output in our new 11-meter band can also be obtained with suitable crystals. The plate potential applied to the

crystal tube is about 125 volts, which permits crystals of several different degrees of activity to be used with equal success. With some of the newer crystals it was found that plate voltage could be dropped still further, but 125 volts is required if old crystals of somewhat less activity are to be used. The crystals do not heat at all at this voltage, thus frequency drift is not a problem.

The output of the crystal oscillator is coupled to the grid of a 6V6 which acts as either a straight amplifier or as a doubler stage, depending upon

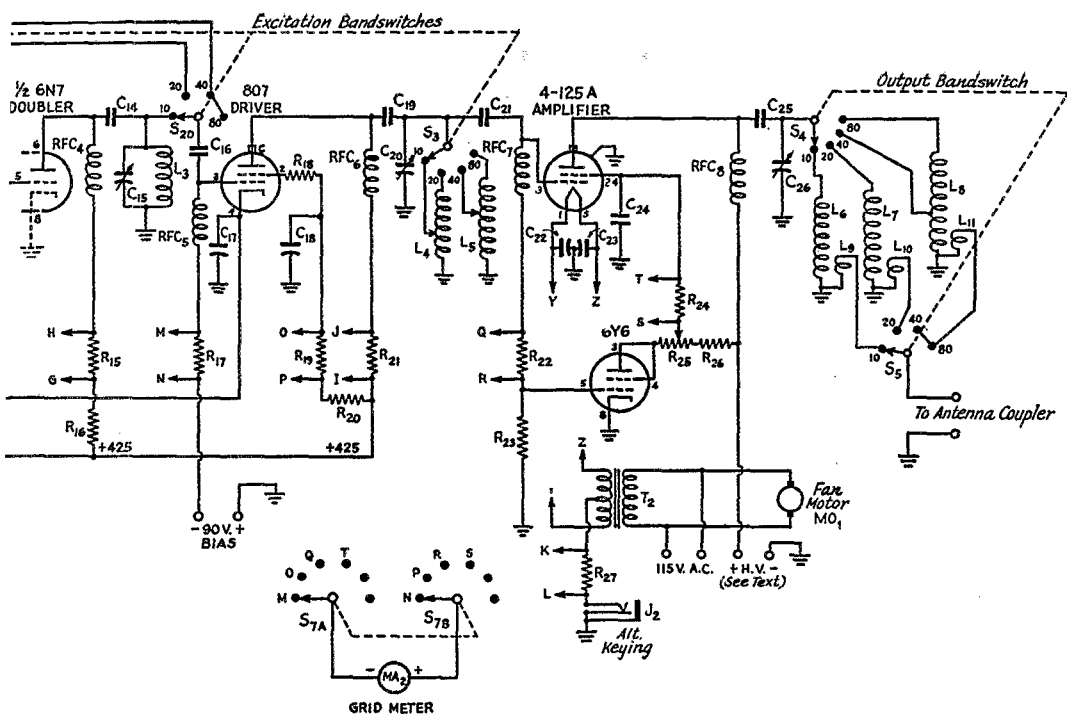

- L₅ — 35 turns No. 20 d.s.c., 16 turns $\frac{7}{8}$ -inch long between ground end and tap, 19 turns close-wound between tap and plate end. Wound on $1\frac{1}{4}$ -inch diam. ceramic form (National XR-16).
- L₆ — $2\frac{3}{4}$ turns No. 14 bare tinned, 2-inch diam., 2 inches long, air wound (B & W 10-BEL with $3\frac{1}{4}$ turns removed).
- L₇ — 8 turns No. 14 bare tinned, 2-inch diam., 2 inches long (B & W 20-BEL with 2 turns removed).
- L₈ — 26 turns No. 14 enam. tinned 15 turns from plate end, $3\frac{1}{2}$ inches long, $2\frac{1}{2}$ -inch diam. ceramic form (National XR-10A).
- L₉ — 2 turns No. 14 bare tinned, $2\frac{1}{2}$ -inch diam., wound over ground end of L₈ and spaced $\frac{1}{4}$ inch from it. (Part of B & W 10-BEL assembly.)
- L₁₀ — 2 turns No. 14 bare tinned, $2\frac{3}{8}$ -inch diam. wound over ground end of L₇ and spaced $\frac{1}{4}$ inch from it. (Part of B & W 20-BEL assembly.)
- L₁₁ — 4 turns No. 14 bare tinned, wound over ground end of L₈ and insulated from it by spaghetti tubing.
- J₁, J₂ — Closed-circuit jack.
- MA₁, MA₂ — 0-50 ma., 2-inch-square case.

- MO₁ — Fan-and-motor assembly (Barber-Colman Type Yab 569-1, with Type Yab 355-2 $2\frac{1}{2}$ -inch fan).
- RFC₁ to RFC₇, inc. — 2.5-mh. r.f. choke (Millen 34102).
- RFC₈ — 2.5-mh. 500-ma. r.f. choke (Hammarlund CH-500).
- S₁ — 5-position single-pole ceramic switch (Centralab 2501).
- S₂ — 4-section single-pole 4-position ceramic switch (Mallory 164-C).
- S₃ — Single-section single-pole 4-position ceramic switch (Mallory 161-C).
- S₄, S₅ — Single-pole 4-position ceramic switch, heavy-duty contacts (Ohmite T-504).
- S₆, S₇ — Two-section double-pole 6-position ceramic (Centralab 2511).
- T₁ — Filament transformer, 6.3 volts, 4 amp. (Stancor P-4019).
- T₂ — Filament transformer, 5 volts, 10 amp. (Stancor P-6135).

the fundamental frequency of the crystal and the position of the bandswitch. The plate tank coil for this stage is tapped, with the entire coil being used when the bandswitch is set for 80-meter output, and only a portion of it when output at higher frequencies is desired.

Plate voltage for the 6V6 is reduced to approximately 360 by dropping resistor R₁₀. The screen voltage of the tube is made adjustable by means of a 75,000-ohm wire-wound potentiometer, the excitation control, which, with the usual dropping resistor, forms a voltage divider across the plate

supply. By changing the screen voltage, the output of the tube is adjusted to whatever level is required for adequate drive to the 4-125A.

When the bandswitch is set in either the 80- or 40-meter positions, the output of the 6V6 is fed to the grid of the 807. For 20- and 10-meter operation, the output of the 6V6 is switched to the grid of the first section of the 6N7 frequency multiplier. The 6N7 stages are arranged so that the grid not in use is grounded. For 20-meter operation only the first section of the 6N7 is used while for 10-meter operation both sections are

used, operating as doublers from the 40-meter output of the 6V6.

The 807 operates straight through on all frequencies. Because low plate voltage is used the plate-tank components can be kept small, a receiving-type tuning condenser being used with no danger of breakdown. The 80- and 40-meter ranges are covered by one coil, wound on a ceramic form and housed in a shield can above deck. The 20- and 10-meter ranges are covered by an air-wound coil, the plug-in type being used solely to permit removal of the 807 tube from its socket. Bandswitching in the 807 stage is accomplished by a ceramic switch similar in construction and contact arrangement to the multiple-section switch used in the earlier stages, and ganged to it through a right-angle drive mechanism. The screen circuit of the 807 includes a parasitic-suppressing resistor, R_{18} , inserted ahead of the usual screen by-pass condenser. No instability was experienced in the 807 stage with this arrangement, but in some instances it may be necessary to add a small grid choke as described in previous *QST* articles.¹ Bias for the 807 is obtained from two series-connected 45-volt Mini-Max batteries which are held to the side of the chassis by a thin metal strap. Since the grid current is small the battery life should be adequate, but if larger batteries are desired, they can be placed externally. Ninety volts of bias is not actually needed to cut off the plate and screen currents in the event of excitation failure, but is used because in some instances the grid current would be excessive if less bias was employed.

With about 425 volts on the plate and 325 on the screen, the 807 delivers more than enough drive for the 4-125A final on all bands. In operation, the excitation is adjusted by means of the potentiometer in the 6V6 stage. While the 807 screen voltage is higher than is customary, the manufacturer's rating for screen dissipation is not exceeded, even when the plate circuit is unloaded. If the grid drive becomes too high, the screen current through the 30,000-ohm dropping resistor is sufficient to drop the screen voltage to a very low value.

The circuit of the 4-125A final amplifier is designed to permit plate-and-screen modulation of the tube if 'phone operation is desired. Hence, a screen dropping resistor is used to furnish screen voltage from the plate supply. To stay within the manufacturer's ratings it is necessary to drop the screen voltage to 350 or 400 from whatever potential is used on the plate. This calls for a pretty husky dropping resistor. Space limitations would not permit mounting a single 100-watt resistor inside the chassis, so two 50-watt units were mounted side by side and connected in series to obtain the required 100-watt rating.

¹ Mix, "Unstable Signals," *QST*, August, 1946.

Operating bias for the final is obtained by means of a grid resistor, no fixed bias being required. To keep the screen voltage from soaring to the full plate-supply value under key-up conditions or in the event of excitation failure, a 6Y6 tube is used as a protective device. As shown in Fig. 1, the 6Y6 is triode-connected, with its plate connected to the screen end of the screen dropping resistor, and its grid connected to the grid side of the grid leak for the 4-125A. When excitation is present, about 200 volts of bias is applied to the grid of the 6Y6 from the *IR* drop across the grid resistor — more than enough to keep the tube nonconductive. However, when the key is up, excitation is removed, and the 6Y6 grid is without bias. Thus it draws plate current through the screen dropping resistance. The current drawn, in the neighborhood of 20 or 30 ma., is sufficient to reduce the screen voltage on the 4-125A to a very low value. As a result, the final plate current falls to 8 or 10 ma. — much better than relatively enormous amounts of fixed bias could do under similar conditions.

Three coils are used in the plate circuit of the final. The first, wound on a ceramic form, is used for 80- and 40-meter operation. Commercial air-wound coils with the plug strips removed are used in the 20- and 10-meter tanks. Bandswitching in the final amplifier is accomplished by a pair of ganged single-pole four-position switches of the heavy-duty type. One switch connects the desired coil to the plate tuning condenser while the other switches the ungrounded ends of the output links. Particular care should be taken to insure good insulation in mounting both switches because the r.f. potentials encountered are very high, especially when the final is unloaded during tune-up.

The use of fixed links for output coupling, a mechanical necessity, requires that an antenna tuning unit having a variable link be employed for proper adjustment of loading. A unit of the type described in recent editions of *The Radio Amateur's Handbook* will be suitable.

Metering & Keying

The meter-switching is straightforward, with 22-ohm $\frac{1}{2}$ -watt resistors used in the circuits to be metered. The meters are switched across these resistors by double-pole ceramic switches. Both meters are 0-50 ma. range, additional shunts being used to extend the ranges to 100 ma. for the 807 plate circuit and to 500 ma. for the 4-125A cathode. The shunts and the 22-ohm resistors are mounted on the switch contacts. The shunt for the 807 stage is wound with resistance wire, but if this type of wire is not available a suitable length of No. 30 insulated wire may be used. A short length of the latter is all that is required for the shunt for the 4-125A. The metering circuits are arranged as follows:

Rear view of the transmitter showing placement of parts mounted above the chassis. Adequate space for the later addition of a VFO unit is available in the center of the chassis.

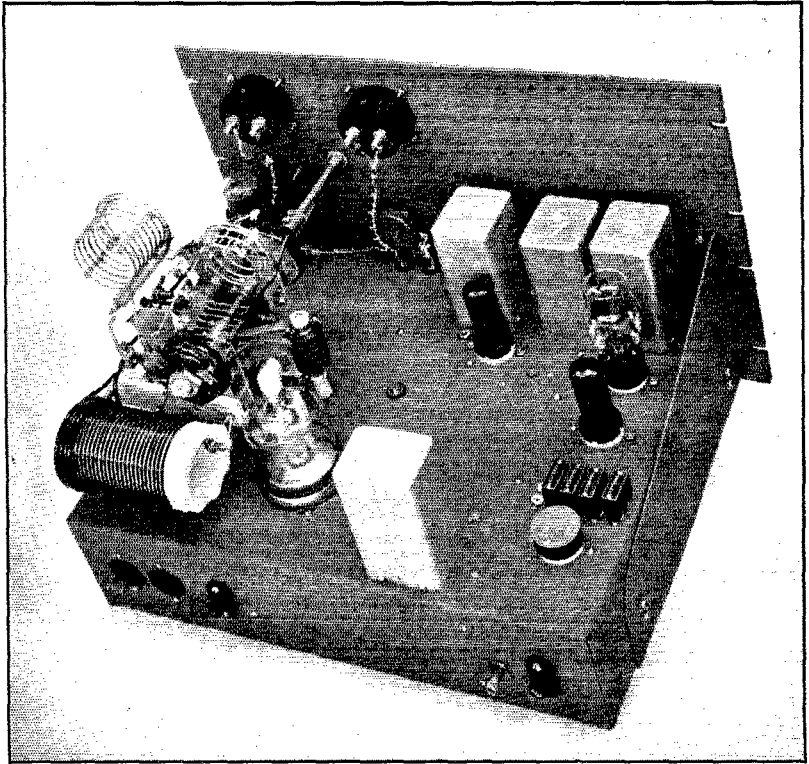

TABLE I

PLATE METER		
Position	Circuit Read	Scale
AB	6F6 plate and screen	50 ma.
CD	6V6 plate and screen	50 ma.
EF	6N7 plate (20 meters)	50 ma.
GH	6N7 plate (10 meters)	50 ma.
IJ	807 plate	100 ma.
KL	4-125A cathode	500 ma.
GRID METER		
Position	Circuit Read	Scale
MN	807 control grid	50 ma.
OP	807 screen	50 ma.
QR	4-125A control grid	50 ma.
ST	4-125A screen	50 ma.

This arrangement may be modified to suit the individual operator's taste, but by having plate circuits covered by one switch and grid and screen currents by the other, the plate current in one stage can be observed by one meter while the grid or screen current of the same stage or the following stage can be observed simultaneously on the other.

Two keying jacks are provided, one permitting simultaneous keying of the oscillator, the 6V6, and the 807 for break-in operation, the other for cathode keying of the final amplifier. Keying the oscillator should result in clean signals if the crystal is active and a stable oscillator. Keying the final will give a slightly better keying characteristic, but without the break-in feature.

Construction

The physical layout of the rig is shown in the photographs. The entire transmitter is built on a standard 17 × 13 × 4-inch steel chassis, with a 19 × 12¼-inch Masonite panel to permit rack mounting. While maximum use of the below-chassis space is required, there is enough space left above deck and on the front panel to permit the subsequent addition of a VFO unit if desired. In fact, the layout was planned with this in mind. Space was left on the panel for a National Type ACN dial, and clearance was provided between two of the coil shields for a shaft to tune the VFO.

The tube line-up, shown in the top view, has the 6F6 Pierce oscillator located about half-way back along the right-hand chassis edge, the 6V6 buffer-doubler immediately in front of the oscillator, the 6N7 frequency multiplier to the left of the 6V6, the 4-125A final in the left foreground, and the 6Y6 screen-protecting tube in the corner,

near the front panel. The 807 driver stage, mounted below the chassis, is visible in the bottom view of the unit. The bottom view also shows the arrangement of the bandswitching system used for the low-power stages. A four-section ceramic switch is ganged to a similar single-section switch through a Millen right-angle drive mechanism.

The two ceramic switches at the lower left in the bottom view are for switching the meters. The small fan near the submounted socket for the 4-125A serves the dual purpose of cooling the final-amplifier tube base seals and the screen dropping resistors. The 807 driver is mounted parallel to the chassis surface in a Millen shield-and-socket assembly to prevent feed-back from plate to grid, and a second shield plate runs from the 807 socket to the rear wall of the chassis to prevent stray coupling from the 807 plate circuits to the oscillator and doubler circuits. The crystal selector switch is mounted on a bracket bolted to the right-hand chassis edge, close to the oscillator tube and crystal sockets. The terminal board mounted near the meter switches holds all the plate and screen dropping resistors. The filament transformers and bias batteries are mounted near the left-hand edge of the chassis where they,

too, obtain some benefit from the ventilating fan. Tuning condensers for the 6V6 and the 6N7 stages are mounted along the front edge of the chassis, while the tuning condenser for the 807 plate circuit is mounted near the rear, between the 807 plate cap and the grid connection of the 4-125A. The shaft for this condenser is brought out to the front panel at an angle by means of two National couplings of the "universal joint" type.

Plate voltage for the low-power stages is brought in through a Millen safety connector mounted on the rear chassis wall near the shield partition. The high voltage is brought in through a similar connector near the 4-125A and its screen dropping resistors. Power for the filament transformers and the fan is supplied through a male connector mounted on the left side of the rear chassis wall, with a female connector wired in parallel mounted alongside to permit the 115-volt source to be transferred elsewhere if desired.

All of the coils in the low-power stages, except that used for the 20- and 10-meter ranges in the 807 stage, are mounted above deck in National Type RO shield cans. The location of the three coils and the output links used in the final amplifier is shown in the photographs.

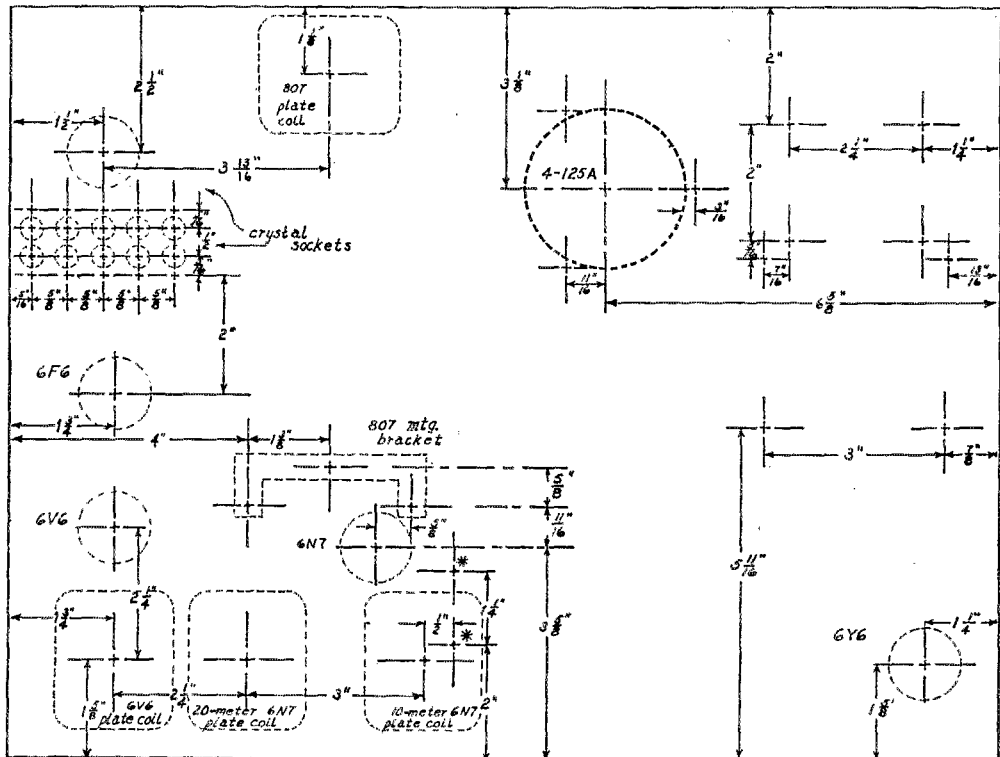

Fig. 2 — Layout of the top surface of the chassis. The holes marked with an asterisk are for mounting the right-angle drive. Others, which are included for the convenience of the constructor, are less critical and may be re-arranged slightly to suit individual needs.

The most important mechanical consideration in building the transmitter is the proper location and ganging of the bandswitches for the low-power stages. The usefulness of the rig will be greatly impaired if the switching system becomes balky or develops slippage. Thus any amount of time spent in properly mounting the switches, and the right-angle drive shaft which connects them, is worth while.

Fig. 2 shows the location of the more important holes to be drilled in the chassis. The holes marked with an asterisk are those involved in mounting the right-angle drive mechanism, and are critical. The others are less critical and are included only to serve as a guide in construction.

Drill the holes for the posts which support the right-angle drive first. These posts are supplied by the manufacturer, and can be removed to facilitate mounting by releasing the Allen set-screws. Extreme care should be taken to insure that the holes drilled for the posts are lined up at exactly right angles to the front edge of the chassis, otherwise the entire switching system will be askew. After the holes are drilled, insert the posts, tighten them so that they are firm, and slide the drive mechanism on them with the U-shaped opening pointing in the direction shown in the bottom view of the chassis.

When certain that the posts are placed correctly and that the gear box will slide on them with ease, remove the two short shafts that hold the bevel gears inside the frame of the drive unit. Replace one of these shafts with a $9\frac{3}{4}$ -inch length of $\frac{1}{4}$ -inch brass or aluminum shafting. This piece is to be the main drive shaft which runs through the front panel, through the right-angle drive assembly, to the single-section bandswitch S_1 , which is to be mounted at the rear of the chassis, near the 807. The other shaft is replaced by the shaft of the four-section bandswitch, S_2 . Saw off all but $\frac{1}{2}$ inch of this shaft, measuring from the point where the shaft enters the bushing on the front of the switch. Insert it in the drive mechanism and replace the gear so that it meshes with the gear on the other shaft of the drive.

The rear of the four-section bandswitch should be supported by a bracket made of $\frac{1}{8}$ -inch aluminum. The dimensions of this bracket are shown in Fig. 3. The rear section of the bandswitch is held $\frac{3}{8}$ inch away from the bracket by $\frac{1}{4}$ -inch spacers plus a couple of fiber washers. The mounting holes for the bracket can be located after the switch-and-drive assembly is placed in position.

The single-section bandswitch used in conjunction with the 807 stage is supported from the rear as shown in the bottom view. These holes can be lined up by coupling the switch to the drive mechanism and seeing where the mounting screws strike the chassis edge. The rear of the ceramic switch wafer should be held about $1\frac{1}{2}$ inch from the chassis wall by small metal spacers.

After the low-power stages' bandswitching sys-

tem is installed and operating satisfactorily, the mounting holes can be drilled for the other parts to be located below deck. The location of these parts is not critical, and can be determined from the photographs.

The fan motor is mounted on one of the brackets supplied with the new Millen 807-tube shield-and-bracket assembly. The bracket itself is bolted to the chassis with screws which pass

Fig. 3—Dimensions of the angle bracket used to support the rear of the four-section bandswitch.

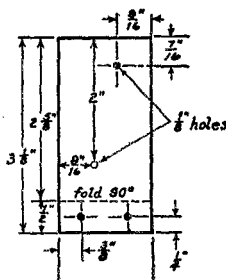

through small rubber grommets. This mounting, which reduces the amount of vibration transferred to the chassis, will be a necessity if the addition of a VFO to this transmitter is contemplated. Incidentally, a bottom plate for the chassis, with a few ventilating holes drilled near the rear of the fan motor, should be used to insure maximum effectiveness of the fan. Considerable heat is generated within the transmitter, and care must be taken to insure an adequate flow of air around the tube base to avoid cracking the seals.

The socket for the 4-125A is mounted below the chassis on $\frac{1}{2}$ -inch spacers. Small spring contacts, made from shim stock or thin phosphor-bronze and formed to contact the grounding ring on the base of the tube, are fastened under the screws that hold the socket in place. The tube itself is inserted in the socket through a $2\frac{3}{4}$ -inch hole in the chassis. This arrangement provides the necessary shielding between plate and grid circuits to prevent oscillation.

The final tank assembly is constructed as a single unit, removable from the chassis, and built entirely on the framework of the tuning condenser. The 80- and 40-meter coil form is mounted on the rear frame of the condenser. Tapped holes are already located in just the right position to permit the ceramic bar supplied with the coil form to be mounted on the condenser bracket, held away from the frame by $\frac{1}{2}$ -inch spacers. The 20- and 10-meter coils are mounted on Y-shaped brackets made of $\frac{1}{8}$ -inch aluminum, and are positioned so that the link end of the coil will be nearest the front panel. The brackets are bolted to the frame of the tuning condenser. The two Ohmite heavy-duty switches are supported by small angle brackets bolted to upright pieces of polystyrene. The polystyrene uprights are in turn bolted to the tabs at the ends of the condenser frame. The shafts of the switches are joined by a

bakelite rod and two rigid shaft couplings. An insulated connection is required to avoid the possibility of flashover through the switch shafts to the grounded output-link connections on the link switch.

Connection of the switch shafts to the knob on the front panel may be through a $\frac{1}{4}$ -inch brass rod if the panel is Masonite, but if a steel panel is used an insulated shaft will be required. The switches are coupled to the shaft by fitting a small metal tab into the slot in the rear of the ceramic bushing which surrounds the rear of the switch arm. This tab fits into a similar slot sawed in the end of the shaft running to the front panel.

The entire tuning-condenser-and-tank-coil assembly is supported by two U-shaped brackets which need only be high enough to permit the rotor plates of the condenser, when swung open, to clear the chassis surface by a fraction of an inch. Since the condenser rotor is grounded, there is no danger of voltage breakdown at this point.

The output connectors are banana jacks mounted on a $2 \times 3\frac{3}{4}$ -inch piece of polystyrene which replaces one of the two Mycalex bars on the tuning condenser. The centers of the jacks are spaced $\frac{3}{4}$ inch to fit a standard banana-plug assembly.

Wiring

The winding specifications for the coils used in the low-power stages are given in Fig. 1. These coils should be wound and mounted before any of the wiring around the bandswitch is started, otherwise the coil leads will be inaccessible. Slight modification of the National coil used for the 20- and 10-meter plate coil in the 807 stage, and of the B & W coils used in the final tank assembly, is required as indicated in the table. The coil forms used in the 6V6 and 6N7 stages are mounted about $\frac{1}{2}$ inch above the chassis by small spacers. The ceramic form used in the 80- and 40-meter coil for the 807 is held away from the chassis by small angle brackets. Where it is necessary to run leads from the coils through the chassis, Millen ceramic bushings are used. Note that in winding the coil for the 6V6, and the 80- and 40-meter coil for the 807, the portion of the winding that is to be used for the 40-meter band is wound with spaced turns, while the 80-meter portion of these coils is close-wound. This arrangement produces a coil which has a fairly high Q in both bands, while if both parts of the coil are close-wound the Q on 80 meters will be satisfactory, but that on 40 will be much lower.

Besides the usual cautions concerning short leads and good soldered connections, a few points should be observed before the wiring is begun. Wiring will be simplified if the bandswitch assembly is removed temporarily while the connections around the sockets are made. Some of the wiring on the bandswitch itself can be done while the switch is out of the chassis. By marking the

sections of the switch and the various positions of the switches on the wafers, considerable confusion can be avoided. In cases where it is necessary for wires in the bandswitch assembly to cross, a ceramic sleeve obtained by cutting the metal away from a Millen bushing is slipped over one of the wires and held in place by a drop of solder at each end. All wiring in the bandswitch assembly is done with No. 16 bare tinned wire.

The connections to the dropping resistors mounted on the terminal board near the meter switches should be arranged so the common B+ lead is nearest the chassis edge. This permits test prods to be applied to the more-accessible ends of the dropping resistors when voltage measurements are made in testing the unit.

So far as possible, d.c. leads should be cabled and color-coded to make a neater appearance and to save time should trouble-shooting be needed later.

A $\frac{3}{4}$ -inch ceramic feed-through bushing is used to carry the high-voltage lead through the chassis to the plate connection of the final tube. The junction of the two screen dropping resistors is mounted on this bushing with a National GS-10 stand-off insulator to prevent shorting. The other ends of the screen resistors are supported by two more of these stand-offs from the rear chassis wall.

Power Supply Requirements

The low-power stages can be operated from a single supply capable of delivering 400-450 volts at 150 ma. The final amplifier was designed for use with 1800 to 2000 volts on its plate, but as much as 2500 volts can be used if only c.w. operation is planned. If it is desired to run the final in 'phone service at more than 2000 volts, a tuning condenser with wider spacing between plates will be required. It should also be noted that the 807 stage was designed for operation at no more than 450 volts, as this is more than enough to secure the output required to drive the final. If operation at higher voltage is planned, a larger tuning condenser will be required in this stage.

Adjustment & Operation

After checking the wiring carefully, power may be applied to the low-power stages of the transmitter. Turn the excitation control to maximum and set both bandswitches to the 10-meter position, one meter switch to the position which reads plate-and-screen current in the 6V6 stage, and the other to read grid current in the 4-125A. Tune the 6V6 plate circuit to resonance as indicated by a slight dip in the meter reading. Turn the meter switch to read plate current in the 20-meter section of the 6N7. The dip in plate current as this stage is tuned to resonance should be pronounced. A similar procedure is followed in tuning the 10-meter section of the 6N7. Plate current in this

Bottom view of the chassis showing location of parts and wiring. The crystal selector switch and the sockets for the 6F6 oscillator and the 6V6 buffer-doubler are on the right. The 6N7 socket is visible between the four-section band-switch and the 807 mounting bracket. The 6Y6 protective tube, the meter switches and the terminal board for the plate- and screen-dropping resistors are in the lower left-hand corner.

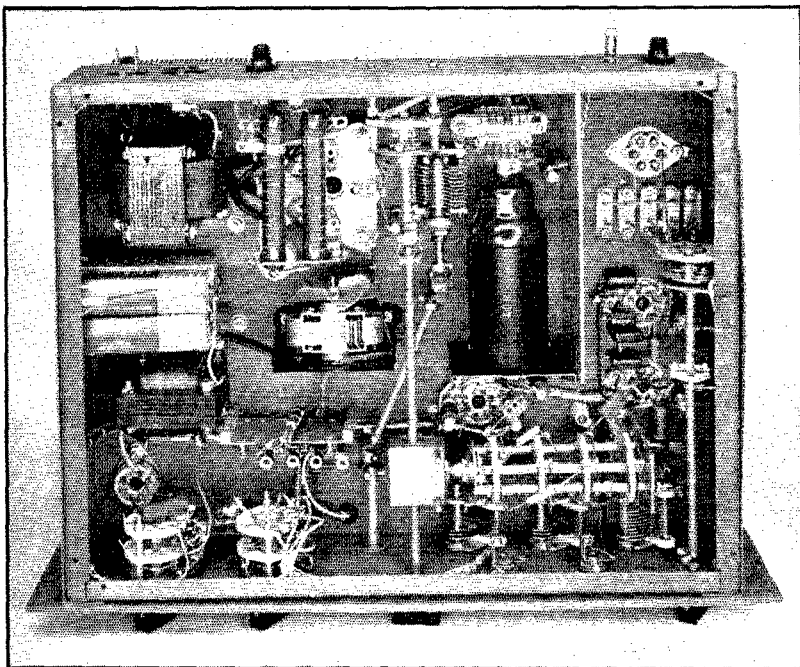

stage will be considerably higher than in the 20-meter section. The dip in plate current as the 807 plate circuit is resonated should also be pronounced, dropping from about 80 or 90 ma. to 30 or 40 at resonance. Grid current to the final stage should be measured at this time. If everything is as it should be, there should be at least 10 ma. of grid current. If more than 10 ma. is indicated, back off the setting of the excitation control until it falls to 10 ma. The control exerted by this potentiometer is not linear, and it may be found that there is little or no change in grid current over a considerable portion of the adjustment; in fact, the grid current may increase somewhat at first as the control is backed off. This is an indication that the drive to the 807 grid is excessive, causing its screen current to rise higher than normal, and reducing the output of that stage.

Once the low-power stages have been adjusted to give the rated amount of grid drive to the 4-125A, plate voltage may be applied to the final. When tuning up, reduced plate voltage is advisable to prevent the tube from being damaged should the final tank coil fail to resonate. A dummy load — a 200-watt lamp bulb, for example — should be connected to the output terminals of the transmitter before plate voltage is applied to the final. This is a "must," since the screen dropping resistance must be adjusted to provide rated screen voltage with the final loaded. Adjustment under any other condition will be useless. Tune the final tank circuit to resonance. The plate current at this time, with the load

coupled to the final, should not exceed 150 ma. It should be remembered that the meter reads both plate and screen current, so the screen current, which can be read on the other meter, must be subtracted from the indicated value to get the true plate current.

If plate current is too high the probable reason is excessive screen voltage. The slider on the screen dropping resistor should be adjusted to apply 350 volts to the screen when the tube is operating at full plate voltage, with rated grid drive, and working at full load. Be sure to remove the plate voltage from the final before adjusting the resistor! If the plate current is excessive after the screen voltage is set at the right value, decrease the loading on the final, remembering that with a change in loading the screen current changes and therefore the screen voltage will have to be readjusted. This is one of the penalties that has to be paid for the otherwise convenient use of a screen dropping resistor.

Under normal operating conditions, the plate of the 4-125A should show just a faint blush when operating in the 10-meter band with 2000 volts at rated plate current. Too much screen voltage will result in excessive plate current and consequent overheating of the plate. Too much grid drive will cause a sharp drop in output because the screen current increases with grid excitation, in turn reducing the screen voltage. Optimum grid drive can best be determined under actual on-the-air conditions, using feeder current as an indication of maximum output. Those who plan

(Continued on page 108)

Preventing Self-Oscillation in Tetrode Amplifiers

Cathode Followers as Drivers for Beam Tubes

BY PAUL D. FRELICH,* W9ECO

ANYONE who has tried to operate a tetrode at the higher frequencies must wonder why the claim "neutralization usually unnecessary" doesn't read "neutralization unusually necessary"!

It is an accepted fact that the grid-to-plate capacitance, though small, is the chief cause of instability in tetrode amplifiers, especially at the higher frequencies. This small capacitance feeds energy from the plate circuit back to the grid circuit and can readily set up oscillations of the tuned-grid tuned-plate variety, because of the high gain of the tubes. To stabilize such an amplifier, it is necessary to prevent this fed-back energy from setting up any voltage in the grid circuit. There are two ways of doing this: to neutralize, or to short the grid to cathode. The first method is well known, but neutralization of tetrodes is sometimes difficult because of the small value of capacitance involved, and many of the advantages of the tetrode are lost if the circuit is complicated by neutralizing. The second method introduces the problem of exciting the grid and at

• Here is a step in the right direction toward taming wild or even house-broken tetrode amplifiers. One way, of course, is to neutralize the beastie, but W9ECO uses another approach which shows considerable promise when handled properly.

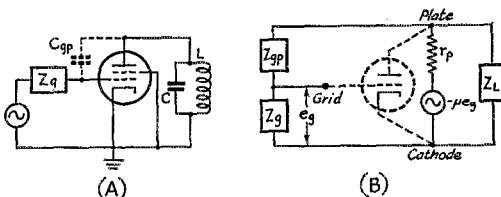

Fig. 1 — The simplified diagram of a tetrode amplifier is shown at (A). The grid circuit is represented by a generator and an impedance Z_g . The diagram in (B) shows another way of drawing the circuit to illustrate feed-back from the plate circuit of the tube through the grid-plate capacity (represented by Z_{gp}). The tube has been replaced by its equivalent diagram and the plate load is represented by Z_L . Note that Z_g and Z_{gp} form a voltage divider, and that the voltage developed at the grid is proportional to the ratio of Z_k to ($Z_{gp} + Z_k$). Obviously if Z_k is very small or zero, there will be little or no voltage developed from grid to cathode.

the same time shorting it to the cathode. Although this may seem paradoxical to the uninitiated, the solution is to use a zero-impedance generator. Fig. 1 shows the basic circuit of a tetrode amplifier drawn in two different ways, and it is obvious

from Fig. 1-B how effectively the theoretical $Z_k = 0$ shorts the grid. In practice, however, it is impossible to find a generator of zero impedance, but fortunately when a cathode-follower driver is used, then Z_k will be equivalent to only a few hundred ohms.¹ If Z_{gp} is many times this value, the resultant voltage division is practically the same as if a zero-impedance generator were used.

A good way to evaluate the effectiveness in preventing oscillation of the low Z_k presented by a cathode-follower driver is to use the equation quoted on Page 112 of June *QST*, which can be rearranged to state that the maximum R_g (Z_g) a tube can have without oscillating is

$$R_g = \frac{2 \left(1 + \frac{r_p}{R_L} \right)}{2\pi f \mu C_{gp}} \quad (1)$$

where r_p = plate resistance of tube

μ = amplification factor of tube

R_L = plate-tank impedance at resonance

$R_g = Z_g$ = shunt grid impedance

C_{gp} = grid-plate capacitance of tube

f = frequency

Suppose an 807 is excited by a 6V6 cathode-follower driver where, for the 807,

$r_p = 0.1$ megohm,

$\mu = 600$,

$R_L = 50,000$ ohms (unloaded tank impedance),

$C_{gp} = 0.2 \mu\text{mfd. max.}$,

$R_g = Z_g$ presented by 6V6 cathode follower,

and

$f = 30$ Mc.

Substituting in (1) above, $R_g = 265$, and hence Z_g must be greater than 265 ohms for the 807 to oscillate. Since it is practicable to build a 6V6 cathode-follower driver which presents a Z_g of less than 265 ohms, the 807 will definitely not oscillate.

When R_L is 3000 ohms, corresponding to a

* 54 Canterbury Road, Waltham 54, Mass.

¹ Henry, "Improved Driver Stages for Class-B Amplifiers," *QST*, Nov., 1945.

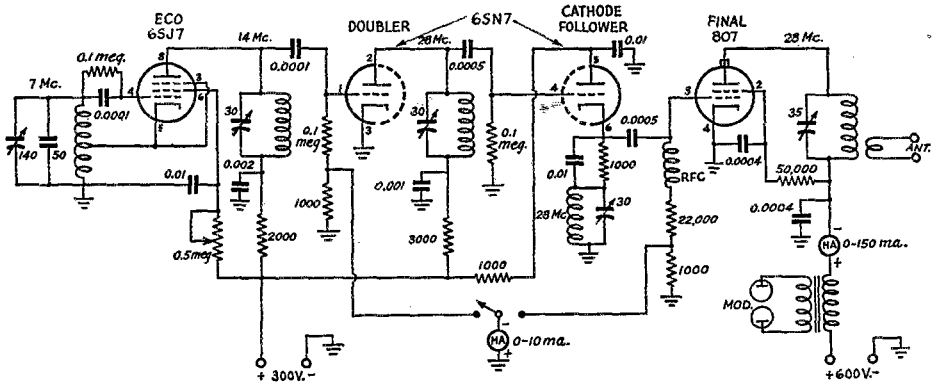

Fig. 2 — The author's 28-Mc. transmitter, illustrating the application of the cathode-follower driver.

loaded tank circuit, Z_g can be as high as 3035 ohms before oscillations begin, and, since the Z_g is less than 265 ohms, a large margin of safety exists.

Cathode-Follower Drivers

When considering a cathode follower as a driver, the following must be known:

- 1) C_{gp} of tube to be excited.
- 2) Z_g presented by the cathode follower.
- 3) Total shunt capacitance in the cathode-follower cathode circuit.
- 4) Peak grid swing required for the excited tube.
- 5) Grid-drive power required for the excited tube.

Items 1 and 2, used in conjunction with the equation discussed above, determine the maximum frequency at which the cathode follower will prevent oscillations. In Item 2

$$Z_g \approx \frac{1}{g_m} \quad (2)$$

where g_m is the mutual conductance of the follower. Item 3 will determine the maximum frequency at which useful power can still be obtained from the cathode follower. Suppose, for instance, the total cathode shunt capacitance is 30 μfd . At 28 Mc. this represents approximately 200 ohms and is not a good load for a follower to work into. But by resonating this capacitance in parallel with 200 ohms of inductive reactance having a Q of 200, the load into which the follower will work will be 40,000 ohms in parallel with the resistance load of the amplifier grid (about 20,000 ohms for the 807), and the resultant 13,330-ohm load is quite adequate.

Items 4 and 5 will determine the type of cathode follower to use and how much d.c. power it will need. For example, from published characteristics, an 807 requires a peak grid swing of approximately 115 volts, with approximately 0.4 watt of grid-drive power. One half of a 6SN7GT, operating as a Class A cathode follower with a d.c. input of 3 watts (300 volts at 10 ma.) is capable of a little

better than 115 peak volts and about $\frac{3}{4}$ -watt output; its efficiency is 25 per cent and the Z_g it presents to the 807 is about 400 ohms. The grid-drive power required by the follower is negligible, since the grid does not draw current. All that is needed is voltage swing (approximately 120 peak volts). A quadrupler should therefore work nicely into the cathode-follower grid.

If more voltage swing and power output are needed, perhaps to drive an 813, a 6V6 tetrode-operated cathode follower will give about 200 peak volts and approximately 4.5 watts output, with 12.5 watts input (250 volts at 50 ma.). It will have a plate efficiency of 36 per cent and will present a Z_g of 250 ohms.

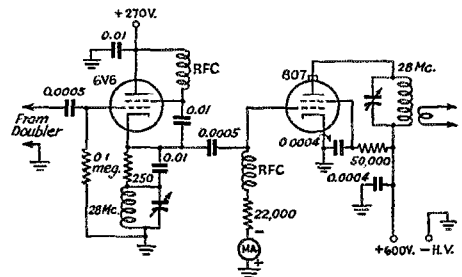

Fig. 3 — A 6V6 or other tetrode can be used as a cathode-follower driver where more drive is required.

In my own case, after prolonged testing of the 6V6 and 6SN7GT for driving an 807 rig, I finally settled on the 6SN7GT because one section could be used as a doubler and the other section as the cathode-follower driver, thus cutting down the number of tube envelopes as well as the amount of d.c. power required.

The 6V6 has reserve excitation, while the 6SN7GT has only just enough power output to drive the 807 for 'phone operation, or twice the grid drive needed for c.w. All these measurements were made at 30 Mc., which is about the upper limit for the 6SN7GT as a cathode follower. Although no difficulty should be encountered at

(Continued on page 108)

A New Kind of Skyhook

Combining the Kite and Balloon

BY D. T. FERRIER,* WILLX, AND W. G. BAIRD,** W9RCQ/1

MOST amateurs at one time or another have dreamed of owning skyhooks to support their antennas. Very little amateur work has been done with balloon- or kite-supported antennas — at least the only published reports are articles in *QST* for April and November, 1940, describing the use of meteorological sounding balloons and kites as supports for antennas. While both methods achieved moderate success, many shortcomings were self-evident.

Balloons and kites were supplied with the Gibson Girl life-raft transmitter during the war for carrying antennas, but again the balloons and kites had serious drawbacks. Balloon-supported antennas tended to be blown down into the water or toward the ground in high winds, and the kites could not be flown without a wind. Satisfactory performance was possible only over a very narrow wind-velocity range with either.

The Kytoon¹ which we used in the recent Field-Day Contest is an air-foil balloon which flies partly on the principle of a balloon and partly on the principle of a kite, and thus incorporates the good qualities of both. It is inflated with hydrogen or helium and, in a dead calm, exerts its lifting force as does a balloon because it is lighter than air. As soon as the wind rises, kite action exerts an upward pressure on the air foils, increasing the lifting ability of the Ky-

• Here's a new wrinkle on getting a Field Day antenna high up in the air in a hurry. This "skyhook," with its accessories, makes up a compact unit when not in use and can be conveniently transported with the rest of the gear.

toon by three or four times that of the free-balloon lift alone.

The construction of the Kytoon is illustrated by the accompanying photograph and Fig. 1. It is 6½ feet long and 39 inches in diameter, tear drop in shape. The casing is made of light, strong Nylon fabric which encloses a specially-shaped bladder or balloon made from Neoprene. The foil wings are made of a lightweight cotton balloon cloth and are supported by aluminum-alloy struts which fit into sockets on an aluminum spider at the stern of the Kytoon. The filling valve projects through a hole in this spider. The Kytoon itself weighs 1.62 lbs., and when folded can be carried in a package 14 inches long and 3 inches in diameter. No special claims as to lightweight portability are made because the separate cylinder for charging the balloon weighs in the vicinity of 25 pounds.

Filled with hydrogen under a pressure of 4 inches of water, the Kytoon has a volume of 40 cubic feet, and a net (or free) lifting force in a dead calm of 1.23 lbs. In a 3-m.p.h. wind, the lifting force is increased by the action of the air foils so that it will carry a net load of 2.6 lbs. Under these or more favorable conditions of load, and wind velocity, the angle with the horizontal at which the Kytoon flies is never less than 45°. The objections to kites and spherical balloons are thereby overcome. The substitution of helium for

*Harvey Radio Laboratories, Inc.

**Dewey & Almy Chemical Co.

¹ Trade-mark Reg. U. S. Pat. Off.

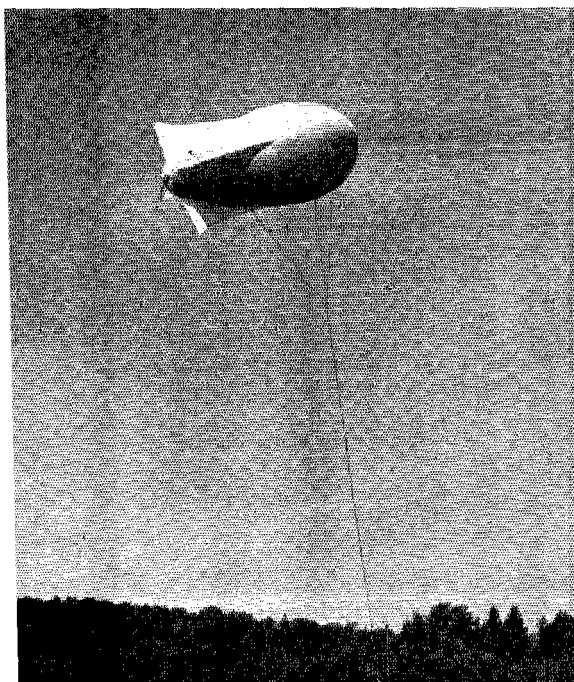

◆

The "Kytoon" in action. The combined balloon and kite action ensures proper flight under varying wind conditions and keeps the antenna more nearly vertical than is ordinarily possible with either a kite or balloon.

Fig. 1 — Outline sketch of the Kytoon. The length is 6 ft. 6 in., diameter 3 ft. 3 in., and wingspread 4 ft. 3 in. Labeled parts are as follows: A, casing; B, Neoprene bladder; C, wings; D, wing struts; E, flying bridle; F, rubber band to allow stem to rise in a strong wind; G, flying line.

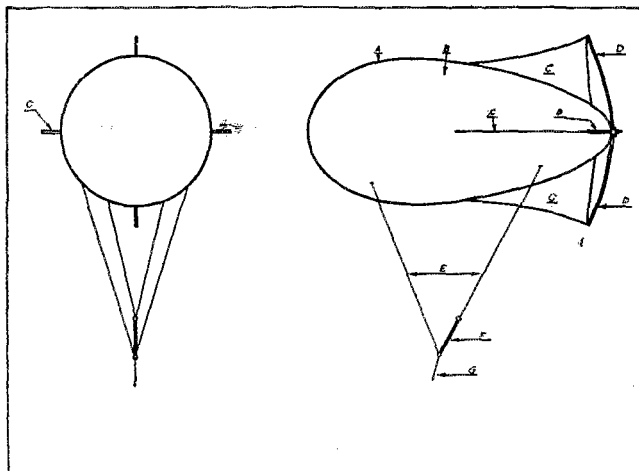

hydrogen results in reduction of the free lift by about 10 per cent.

During the recent Field-Day Contest, a Kytoon was used by the authors at WILLX/1, Winchester, Mass., with a vertical antenna 132 feet high (No. 18 enameled copper wire), and at W9RCQ/1 at Wayland, Mass., with a vertical antenna 396 feet high (No. 18 braided copper wire). Our results on 80 meters were so good that we both say that the Kytoon gave us the best 80-meter antenna we had ever used.

At W9RCQ/1, a 132-foot horizontal was used as a comparison antenna, and at distances up to 300 miles, the vertical brought much better signal reports. Both were end-fed antennas, and 25 watts was fed to the 807 final. One-hundred-and-thirty-two stations were worked on 80-meter c.w. by one operator. The Kytoon flew for 30 hours with no attention throughout the contest, and stayed within 20 degrees of the vertical in winds estimated to have been 20-30 miles per hour.

The Kytoon should be a handy device for emergency transmitter set-ups, obviating the need for carrying around bulky portable antenna masts. It is, of course, tops for Field Days and should prove an interesting gadget for elevating high-frequency antennas, test instruments, and a host of other things in which amateurs and experimenters are interested. Perhaps long-wire vertical antennas can now be exploited with outstanding results.

About the Authors

• William G. Baird, jr., W9RCQ/1, has been an active DX-er, rag-chewer and experimenter since receiving his ticket in 1934. Bill's collection of the exclusive DXCC, WAS, WAC, and Al Operator certificates attest to the successful activity he has enjoyed. W9RCQ/1 served as a 1st Lt. in the Army's C.W.S., where he did research and development work on the incendiary bomb. He is a graduate of Washington University, St. Louis, with B.S. and M.S. degrees in chemical engineering, and at present is employed as a chemical engineer with the Dewey & Almy Chemical Co.

• David T. Ferrier, WILLX, isn't the newcomer to our hobby that his call suggests. He started in the game early, in 1921, as 9BMN, and since then has also been W6BHV and W3GKZ. A graduate of the U. S. Naval Academy, '29, and Harvard, '39, he holds B.S. and M.S. degrees. He's WAS, WAC, ORS, and an Al Operator Club member. During the war WILLX was a Navy liaison officer at MIT's Radiation Lab and at Harvard's Research Lab.

Strays

W4EFH tells of an interesting short-skip experiment successfully carried out on 28-Mc. 'phone on June 8th. Calling CQ at 6:50 P.M. and announcing that he would endeavor to work as many stations as possible within an hour's time, W4EFH worked 22 stations in rapid-fire succession, for an average of one contact every 2 minutes and 42 seconds. Stations cooperating in the effort were: W3CRY, EAI, IAG; W4AIT, AJT, BVD, CYU, DIS, EIW, FT, CIA, HMG, HSM, HZG, IEO, IRY, ITY, ML; W5GBA; W6-PCK/4; W9JML, KRY. Many others were heard calling but could not be QSOed within the hour.

Happenings of the Month

LICENSING & RENEWALS

Under the heading "New Licensing Plan" we had an item in last month's "Happenings" reporting the adoption by FCC of a simplified amateur application form and a "paper" amateur license the mechanics of which would greatly speed up the issuing of amateur licenses. The new form is now in distribution at the FCC field offices but at this writing there is some doubt whether the new form of license will ever see the light of day. The reason is that it was devised as a means to speed up the output and in the meanwhile, before it had gone into effect, FCC has succeeded in getting substantially current on the big job that confronted it. Amateur examination papers are now being graded within a week of their receipt in Washington and the big backlog of applications has melted away. We shall have a further report on the future of the "paper" license in our next issue.

Because of the favorable status of its work in amateur licensing, FCC is now able to invite renewal applications from certain categories of amateurs: (1) *All amateurs located at addresses other than those specified in their licenses, and regardless of call area or date of expiration, are now requested to file their renewal applications immediately with FCC.* This will permit the amateur to escape from signing the portable indicator, and from FCC's standpoint it will put the correct address on file. (2) *All amateurs in locations where the station call is due to be changed, because of a change in call areas, and regardless of whether there has been a change in actual location and regardless of date of expiration, are now requested to file renewal applications with FCC.* Thus amateurs whose calls must be changed will get their new calls sooner than previously anticipated, can begin building their reputations under their new calls, and we'll get correct listings in the callbook that much sooner. Get a Form 610 from your inspector, fill it out and attach your old licenses, and send direct to FCC at Washington.

You will have no difficulty with the new application form. It is only a page long and eliminates many of the previous questions. It is a combined application for station and operator licenses, which hereafter will automatically be issued in combination — so that the applicant is given a station call and authorized to operate a station whenever he acquires the apparatus.

Amateurs still living at the licensed address, and in locations where the call area has not been

changed, are not yet requested to file renewal applications before they are due. You should, however, keep your expiration date in mind and file your application at FCC a couple of months before that date.

FCC orders in the 115 series automatically have so extended the terms of operator licenses that the first of them valid at the time of Pearl Harbor are not due to expire until December 7, 1946. By its Order 130-F, the Commission has extended the term of your station license to coincide with that of your operator ticket, so that both are due to expire simultaneously.

Let us now reexamine the situation concerning when renewal applications should be filed — other than the special cases previously discussed. Dig out your operator ticket and look at its date of issuance. You can then determine, from the table below, the date of expiration of your license and the period during which your renewal application should be submitted:

I	II	III
<i>Date of Issuance:</i>	<i>Valid Until:</i>	<i>Apply for Renewal:</i>
Between December 1st and December 7th in each of the years 1939-1944, inclusive.	Same day and month in 1947 as day and month of issue.	Apply for renewal sometime in the 120-day period prior to date determined in Column II.
Between December 7th and December 31st in each of the years 1938-1943, inclusive.	Same day and month in 1946 as day and month of issuance.	Any time from now to date of expiration this December.
Between January and November, inclusive, in each of the years 1939-1944, inclusive.	Same day and month in 1947 as day and month of issuance.	Apply for renewal sometime in the 120-day period prior to date determined in Column II.

After December 31, 1946, proof of use as a condition for renewal is required. Proof of use is established by submitting evidence of three contacts, using radiotelegraphy, some time during the last six months of the license period.

STAFF NOTES

Vernon Chambers, W1JEQ, after war service in Jim Lamb's Remington-Rand laboratory at Middletown and as an AAF sergeant on special assignment with guided missiles, has returned to our staff as an assistant in the technical department. He was a popular prewar *QST* author of constructional articles on simpler equipment, and with his additional wartime schooling and ex-

perience in new fields he will be branching out in *QST* and the *Handbook* before long.

The headquarters staff now numbers 60 persons but still we can't keep up with our workload. Membership is currently growing nearly 2000 a month and *QST* distribution is at an all-time high. All our little problems multiply accordingly. For instance, the thousands of returning service men and the wholesale relocations following the war are resulting in the greatest load we have ever had in changing the addresses of members. A simple enough problem, you might think, but it requires the full time of several clerks and we wish we had more. We plead for your patience until we can get "out of the woods." It will help to get you prompt service if you will send membership applications and renewals direct to ARRL rather than through a magazine subscription agency, most of the latter being themselves so overloaded that they frequently delay the matter several months; and it will also speed things up if your orders for other publications and "membership supplies" are sent in separately from your membership application.

CALL-LETTER PHONETICS

Earlier this year, the Commission put into our rules a prohibition against using the names of countries, states or cities when employing phonetic aids for call-letter identification while using telephony. The idea was to avoid confusion between such names given in the call and the actual location of the station, but a lot of the boys didn't like it and the League's Board at its meeting this year voted to ask the Commission to withdraw the restriction. It has now done that, by amendment of §12.82(d) so that it now reads simply:

§12.82(d) When using telephony, phonetic aids to identify the call of the station may be employed.

TWO-LETTER CALLS

If you ever held a two-letter call in any district and would like to have one again, you can — providing there are still some unassigned in your district now — under the terms of a new amendment added last month to §12.81 of our rules by the Commission. The new provision reads:

§12.81(a) (5). An unassigned two-letter call (a call having two letters following the numeral) may be assigned to a previous holder of a two-letter call.

What this means is that not only may a new or

ARE YOU LICENSED?

• When joining the League or renewing your membership, it is important that you show whether you have an amateur license, either station or operator. Please state your call and/or the class of operator license held, that we may verify your classification.

DX QSLs

• "Claim your old QSL cards now or never," says page 31 of July *QST*, because all prewar cards not applied for by next January 1st will be disposed of at that time, by order of the ARRL Board of Directors.

If you did any hamming prewar, some of these DX cards may be for you! Look up the July article and submit the required self-addressed stamped envelope to your QSL Manager now.

renewing amateur applicant ask for such a call, if he has previously held a two-letter one, but that existing holders of three-letter calls who want to exchange them may do so, if they have ever held two-letter calls. The procedure is to apply to the FCC at Washington for a modification of station license, on the usual form, requesting a two-letter call instead of the existing three-letter one, and giving information on the former two-letter call held by the applicant. If there are any available, you'll get one.

FCC, while it will honor such applications as long as two-letter calls last, hopes that many three-letter holders eligible under the new rule will prefer to keep their present calls; they're still pretty heavily loaded and all these special cases mean just that much more work.

HIGH-SEAS MOBILE

Sometimes a ham has occasion to operate his station mobile on board either a ship or aircraft when outside the limits of any of the call areas set up by the FCC. How he signs to indicate his status under such conditions has always been a problem. This spring the FCC asked the League for its recommendations and at its May meeting the Board produced some which have now been incorporated by the Commission in a new subsection (e) to §12.82 of our rules:

§12.82(e). In addition to complying with the requirements of paragraph (a) above, an operator of an amateur station operated as a mobile station aboard a vessel on the high seas, or aboard an aircraft en route in an international voyage, shall, when the vessel or aircraft is outside the 10 call areas prescribed by the Commission in §12.81(b), comply with the following calling procedure:

(1) Mobile operations aboard a vessel.

(i) When using telegraphy the amateur operator shall transmit immediately after the call of the station the fraction bar DN followed by the designator MM to indicate that the station is being operated as a mobile station aboard a vessel. In addition, the name of the vessel and its approximate geographical location shall be transmitted at the end of each transmission immediately prior to signing off. If the vessel does not have a name, the number of the vessel shall be transmitted in lieu of the name of the vessel.

(ii) When using telephony the call of the station shall be preceded by the words 'this is', or the word 'from' followed by the words 'maritime mobile', to indicate

that the station is being operated as a mobile station aboard a vessel. In addition the name of the vessel and its approximate geographical location shall be transmitted at the end of each transmission immediately prior to signing off. If the vessel does not have a name, the number of the vessel shall be transmitted in lieu of the name of the vessel.

(2) Mobile operations aboard aircraft.

(i) When using telegraphy the amateur operator shall transmit immediately after the call of the station the fraction bar DN followed by the designator AM to indicate that the station is being operated as a mobile station aboard an aircraft. In addition, the number of the aircraft and its approximate geographical location shall be transmitted at the end of each transmission immediately prior to signing off.

(ii) When using telephony the call of the station shall be preceded by the words 'this is', or the word 'from' followed by the words 'aeronautical mobile', to indicate that the station is being operated as a mobile station aboard an aircraft. In addition, the number of the aircraft and its approximate geographical location shall be transmitted at the end of each transmission immediately prior to signing off.

HANDPRINTING CODE

Referring to our item in last month's "Happenings" on this subject, the FCC has now formalized the matter by an amendment to §12.47 of our amateur rules so that it now reads "Code tests shall be written or *hand printed* with either pen and ink or with pencil." (Italics ours to indicate the new material.)

EXAMINATIONS CANCELED

Since early in the war, the FCC examining points for the amateur license have included the primary monitoring stations at Grand Island, Nebr.; Allegan, Mich.; and Kingsville, Tex. Now, because of the need for these stations to concentrate all their efforts on their primary function of monitoring, FCC announces that, effective October 1st, all license examinations and related functions are discontinued at these three points.



OCTOBER, 1921, *QST* — the biggest to date — arrived late, but we'll accept the editor's apologies. He was at Chicago, too! Our ARRL First National Convention & Radio Show is glorious history. Over 1200 amateurs, representing every U.S. district and Canada, attended along with several hundred of the Chicago gang, and only now is the smoke clearing from the immense Sixth Regiment armory and the Edgewater Beach, Sheridan Plaza and Drake hotels. The greater part of this issue records the convention story.

Chairman Mathews, 9ZN, called the delegates to order, followed in turn by many addresses of welcome, including one by Chief Radio Inspector Terrell, representing Secretary Hoover of the Commerce Department. Keynoting the convention, our ARRL president, Hiram Percy Maxim, spoke in part:

... I cannot but feel that in the years to come much will be said of what we do here at this first convention. We are striking out into the unknown, and even the smaller actions which we take here during the next few days will weigh heavily in the future, for they will establish precedents and standards. We must try our best to regard things in a large way, with the perspective of the coming years before us. Let us not forget that we are pioneers, blazing a way that many are to follow. . . . Let us strive to overlook those things which are petty and small.

"Power Factor!!" The double exclamation marks are those of *QST*'s editor, registering the heat of the West-Stone debate on this long-smoldering subject, a convention highlight. For months now, top authorities have been arguing the power-factor question. Is it zero, unity, or what have you? *QST*'s pages have presented both sides of the argument, with M. B. West, prewar SAEZ, and Ellery W. "A-P" Stone leading the

opposing factions. Hardly had the first evening's spark meeting started, with Mr. West speaking on "Spark Transmitters," when a slight digression introduced mention of power factor. The fuse was lit. The dapper Mr. Stone, who had come east from San Francisco especially to discuss the explosive subject, followed Mr. West on the rostrum, and things began to happen. Reports *QST*, "Staunch supporters of the two main participants rushed to their respective colors, the air was full of cries to the chairman for recognition, and at one time we witnessed the spectacle of six good men and true talking their respective versions of Power Factor at the same time, three of them on the platform trying to draw diagrams on the same blackboard while they talked."

Other authorities, Messrs. Simpson, Wiggin and Robinson, joined the melee, but it eventually became evident that the principals were widely separated on definition. As the night wore on, it was decided to put the question up to the Bureau of Standards. Next day came a learned telegraphic reply which was hastily adopted by both sides as favoring their cause. To preserve order, a committee consisting of Messrs. Maxim, Jansky, Robinson, Skifter and Stewart was chosen to decide the issue with the information at hand. Their decision: ". . . it is the unanimous opinion of the Board that the two gentlemen are not using the same nomenclature and that they are not reasoning from the same premise." The decision made no settlement of the argument. We should be hearing more about power factor.

As temperatures returned to normal, convention routine was resumed. Speeches followed

(Concluded on page 114)

A Simple "Wien Bridge" Audio Oscillator

Good Waveform and Uniform Output Amplitude

BY HOWARD T. STERLING*

WHEN considering building an audio oscillator it pays to think twice. There are three major types of audio oscillators: the *LC* oscillator with which we are familiar from work with r.f., the beat-frequency oscillator, and the resistance-capacitance tuned oscillator. The *LC* oscillator will produce a very satisfactory note for code-practice work and the like, but for test purposes its waveform usually leaves much to be desired; also, when the frequency is varied the amplitude does not remain constant, and the necessary components for tuning are not conveniently obtainable. The beat-frequency oscillator is very satisfactory in operation when properly designed electrically and mechanically, but the fine points of this design are rather subtle and not readily understood by most of us. To get proper frequency spread with a beat oscillator it is necessary to use a peculiar condenser-plate shape

• That ever-useful device, the audio-frequency oscillator, in simple and reliable form. Where continuous tuning is not required, any desired number of spot frequencies can be provided by a selection of resistors and a multiposition switch.

mystery to most of us and hence is in our minds surrounded with an aura of superstitious awe. Some of us have built them with very unsatisfactory results, and we have the feeling that choice of components or arrangement must be far too critical. It is unfortunate, too, that much has appeared in the literature that is confusing, including circuits that look as though an engineer would be needed to untangle them.

The Wien bridge oscillator need be only a very simple device, as shown in Fig. 1. It would be hard to improve on at least one explanation² of the operation of this circuit, but a little simplification might be to the point. The two-tube resistance-coupled amplifier is straightforward enough, and it will be seen that we carry the output back to the input. This output is fed to the cathode of V_1 through a voltage divider, and this feed-back is degenerative and constant with frequency. But we also carry it to the grid through the *RC* network. Now this feed-back voltage at the grid is regenerative and is different with different frequencies, and varies also in phase. Fig. 2-A gives a rough idea of this characteristic. Again referring to Fig. 1, it will be seen that to make the circuit oscillate it will be necessary to introduce a signal between grid and cathode of V_1 in the same phase as the voltage at the plate of V_2 and of sufficient amplitude (output voltage/amplifier gain) to maintain oscillation. The voltage between grid and cathode of V_1 will be equal to the algebraic sum of the voltages on the grid and the cathode with respect to ground. Now when we are far from the frequency of oscillation the net voltage between the grid and cathode will be opposite in phase to that necessary for oscillation; that is, the negative feed-back will predominate. This is because the regenerative signal to the grid is small and is also in the wrong phase (by almost ninety degrees) to be a significant factor in the algebraic sum. Only at "resonance" will the phase of the signal at the grid be exactly opposite to that on the cathode, and only then — if the degenerative voltage fed back to the cathode

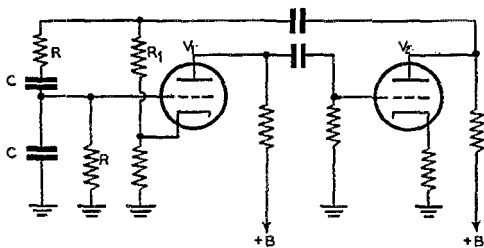

Fig. 1 — Essentials of the "Wien bridge" oscillator circuit. Frequency is determined by the values of *R* and *C*; oscillation amplitude by the proportion of the output voltage fed back to the cathode of V_1 .

(which is very hard to obtain commercially), and there remains the constant headache of properly setting the oscillator to zero.

But the *RC* oscillators suffer from few of these disadvantages. The phase-shift oscillator is a very pretty little device that will be appreciated by anyone having an understanding of *RC* theory, and its one-tube simplicity would recommend it to one and all were it not that there is no immediately practical way of regulating its output. But in the so-called Wien bridge¹ oscillators even this objection is overcome.

The Wien bridge oscillator has long been a

*70 Morningside Drive, New York City.

¹ The circuit discussed is not truly a Wien bridge oscillator. We realize this, but bow to popular usage which has named this oscillator because of the resemblance between its frequency-determining circuit and that of the Wien bridge.

² Terman, *Radio Engineers' Handbook*, page 505.

is properly adjusted — will there be sufficient net regenerative feed-back to make the circuit oscillate. Fig. 2-B shows the effective regenerative voltage fed to the grid at a level just below oscillation. Comparing this with Fig. 2-A gives some indication of the importance of the phase relationship in the algebraic sum.

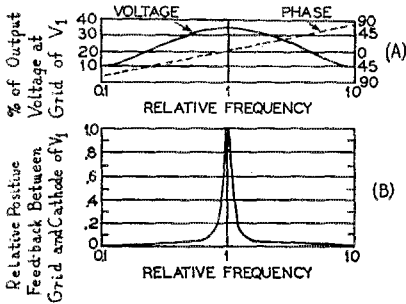

Fig. 2 — (A) Relative amplitude and phase of the positive feed-back voltage between the grid of V_1 and ground, with reference to output voltage of V_2 . (B) Effective positive feed-back voltage between grid and cathode of V_1 for the same conditions as in A.

It will now be seen that the circuit is critical in just two respects; the constants of the frequency-determining circuit and the amount of degenerative feed-back. The amplifier can be anything so long as it has negligible phase shift over the range to be used and provided that it can drive the low impedance offered by the degenerative voltage divider and the Wien bridge network. If we replace the lower member of the degenerative voltage divider with a filament-type bulb whose resistance will increase as the oscillation amplitude increases, thereby increasing the proportion of the feed-back voltage present at the cathode and stabilizing the oscillation level, we can set the degeneration level once (with R_1) and forget about it.

Frequency Determination

The frequency of oscillation is determined by the values of R and C , and

$$f = \frac{1}{2\pi\sqrt{R_1R_2C_1C_2}}, \text{ or } f = \frac{1}{2\pi RC}$$

in the case where the R s are equal and the C s are equal. It doesn't matter from the standpoint of waveform exactly what proportion the R s and C s bear one another (because the circuit will balance with nearly any values) just so long as when the values are changed to vary the frequency they are changed proportionally. On this point depends consistency of waveform and amplitude with change of frequency, and this is where most builders of Wien bridge oscillators fall by the wayside. When tuning is done by means of a variable condenser it is essential that the two sections track, at least proportionately, when stray capacitances, particularly those from rotor to ground, are considered. And when resis-

tors are switched, or variable resistors are used, the members of each pair must maintain the same proportion to one another. It will be seen that the easiest solution to the problem is to keep the C s and R s equal. The only other point to be remembered is that the R s should be kept high enough (a thousand ohms or so) so that the Wien bridge network does not load the amplifier too heavily.

The problem of how to tune a Wien bridge oscillator is an interesting one. Most of those in recent literature have been modeled after the Hewlett-Packard oscillators and call for four-gang condensers. A four-gang condenser wired as two-gang will provide a capacitance range and hence a frequency range of over ten-to-one, which permits the audio band to be split up into decades. Since four-gang condensers are not readily available a two-gang condenser may be used instead, and will provide a frequency range of about 3-to-1, or two ranges per decade.³ This results in better

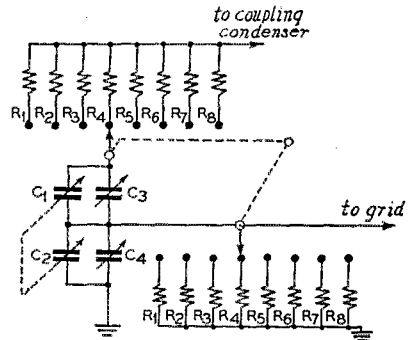

Fig. 3 — RC network for continuous frequency coverage from 15 cycles to 150 kilocycles per second. C_1 and C_2 are sections of a two-gang 450- μ fd. per-section variable condenser. C_3 and C_4 are 150- μ fd. trimmers. The following table gives resistor values and frequency ranges:

Resistors	Values	Frequency range
R_1	20 megohms	15 to 50 cycles
R_2	6 megohms	50 to 150 cycles
R_3	2 megohms	150 to 500 cycles
R_4	600 kilohms	500 to 1500 cycles
R_5	200 kilohms	1.5 to 5 kc.
R_6	60 kilohms	5 to 15 kc.
R_7	20 kilohms	15 to 50 kc.
R_8	6000 ohms	50 to 150 kc.

bandsread, although it does require more bands to cover the audio spectrum. Such an arrangement is shown in Fig. 3, and may be substituted for the frequency-determining network in any circuit calling for a four-gang condenser.

Tuning by use of ganged potentiometers is perfectly satisfactory provided that the pots can be made to track. This throws out any thought of

³ By the exercise of extreme care in regard to stray capacitance and the like it is possible to tune this type oscillator over a range of ten-to-one with a two-gang condenser. This requires that the total capacitance from stator to ground does not exceed about 40 μ fd. This care is justified when it is desired to build an oscillator of wide frequency range into a very small space.

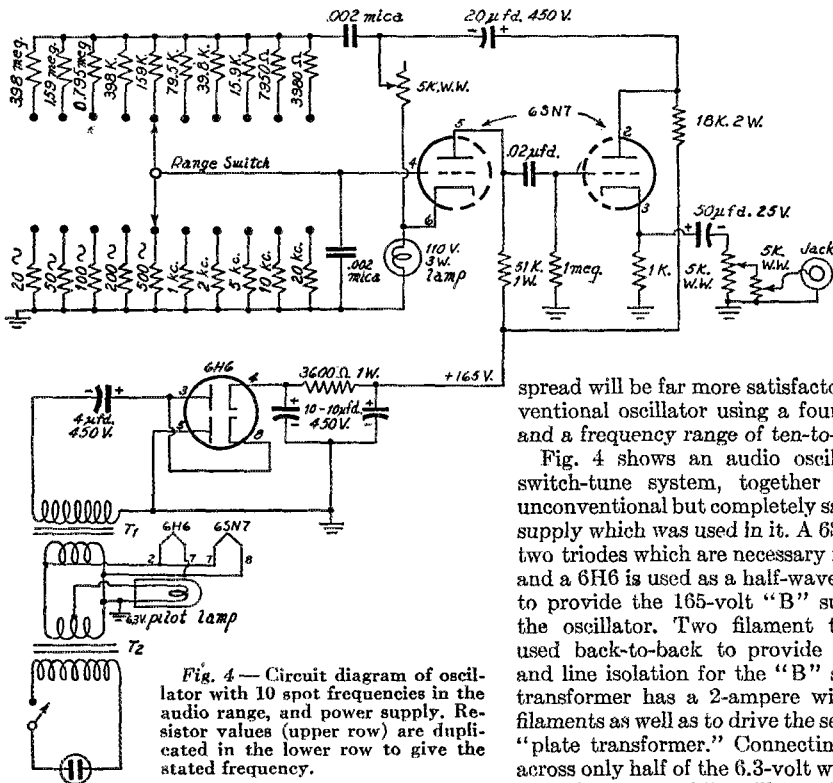

Fig. 4 — Circuit diagram of oscillator with 10 spot frequencies in the audio range, and power supply. Resistor values (upper row) are duplicated in the lower row to give the stated frequency.

using carbon pots; they have been mentioned in the literature, but their use is incompatible with consistency of waveform and amplitude. Wire-wound pots, particularly of the type made by General Radio, are satisfactory when ganged and can be made to cover frequency ranges of one-hundred-to-one or even more. Unfortunately such pots are not usually available in any but a linear taper so that the second decade is seriously crowded. This is because the frequency curve is linear with respect to resistance.

Spot Frequencies

One of the most useful tuning systems is a switching arrangement that provides spot frequencies at three or more points per decade throughout the audio spectrum. This is very convenient for measuring amplifier frequency response because it gives you your plot points without having to tune them. It is also handy for waveform and distortion measurements. Such a system can be very compact, mechanically, and one swing of the switch carries from one end of the band to the other. The only application where it is less satisfactory than the continuously-variable type is in running response curves on highly-selective audio circuits and in checking resonance points. For this purpose, however, the scheme of Fig. 3 with its good band-

spread will be far more satisfactory than the conventional oscillator using a four-gang condenser and a frequency range of ten-to-one.

Fig. 4 shows an audio oscillator using this switch-tune system, together with a slightly unconventional but completely satisfactory power supply which was used in it. A 6SN7 provides the two triodes which are necessary for the oscillator, and a 6H6 is used as a half-wave voltage doubler to provide the 165-volt "B" supply needed by the oscillator. Two filament transformers are used back-to-back to provide filament voltage and line isolation for the "B" supply. The first transformer has a 2-ampere winding to supply filaments as well as to drive the second (1-ampere) "plate transformer." Connecting the pilot light across only half of the 6.3-volt winding eliminates annoying glare while still providing ample visibility. With a two-pole ten-position switch the frequency range is 20 to 20,000 cycles. One of the

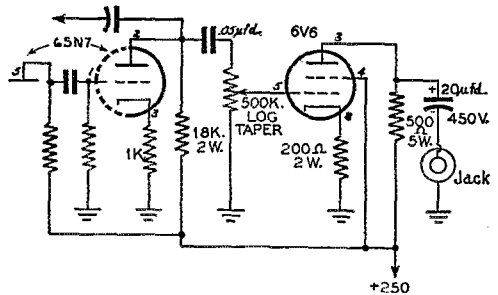

Fig. 5 — Suggested amplifier circuit for increasing the output voltage from the oscillator.

little Mallory wafer switches (2 pole, 9 position) may be used at the sacrifice of one frequency. So long as the members of each pair of resistors are equal the thing will work perfectly; the accuracy of frequency will be as good as the accuracy of resistance. It is suggested that the resistors be checked on a bridge, although an ohmmeter will serve to make sure they are equal. The feed-back control is adjusted for maximum output commensurate with waveform, as observed on a 'scope. If one is not available an a.c. thousand-ohm-per-

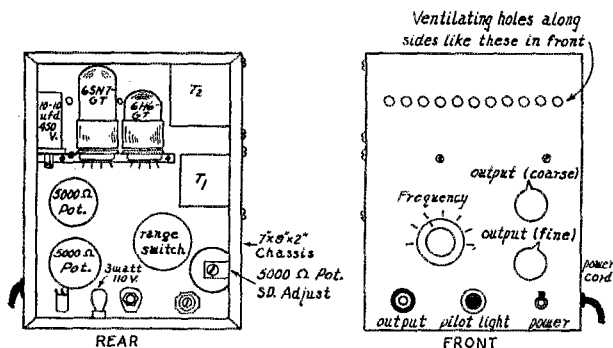

Fig. 6—Layout of the 10-frequency oscillator circuit given in Fig. 4. The unit can be built inside a 7×9×2-inch chassis.

volt meter may be connected to the output (frequency set at 100 cycles and both attenuators all the way up) and the amplitude set at about one-half maximum.

Output is taken from the amplifier cathode so that loading will not affect oscillation. The amplitude will be about two-volts peak. A double attenuator was used so as to make possible vernier adjustment of low levels for speech-amplifier adjustment and the like.

An alternative arrangement is shown in Fig. 5, using a power amplifier if more output is desired.

This oscillator was built inside a 7×9×2-inch chassis with the controls projecting through the chassis face. Fig. 6 shows the approximate mechanical arrangement. The two tubes and the double ten- μ f. condenser are mounted on a small bracket and ventilating holes are cut to keep them cool. The 3-watt bulb (which, contrary to popular superstition, does not light) and the feedback adjustment resistor are both inside. When

a standard bottom plate is screwed on, the unit is a very handy thing to have on the bench.

About the Author

• Howard T. Sterling has kept pretty busy during the past few years, going to school and working in the war effort. After a year at RPI (1941) he went to work at Radiation Lab, MIT. Postwar, he is working for his degree at Columbia, and in his spare time is trying to gain those last few w.p.m. for his ham license. He holds a radiotelephone first-class ticket. His interests, strictly radio, of course, are developmental work on test equipment and remote control devices. OM Sterling's major project, though, is a broad-band exciter to give a constant output of 2 watts on all bands through two meters, with no tuning other than the ECO tank condenser! We'll welcome it!

HAMFESTS SCHEDULED

October 5th, Scotia, N. Y.: The Annual Hamfest of the Schenectady Amateur Radio Association will be held at the 10-01 Club, Scotia, N. Y., on October 5th. Tickets, \$3.75, with 50 cents extra for late registration. A principal feature will be a talk, "New Developments in Superhigh-Frequency Antennas," by L. M. Leeds, Consulting Engineer, General Electric Co., formerly consultant to the Secretary of War.

October 18th, Queens Village, N. Y.: The Federation of Long Island Clubs announces its Tenth Annual Hamfest, to be held at 8:00 p.m., October 18th, at the Commercial House, 96-43 Springfield Boulevard, Queens Village, N. Y. Admission will be by ticket only and price is \$1.00. Each of the member clubs will put on a "skit." It is hoped there will be prizes for everyone. Clubs in the Federation are the Amateur

UHF Club, Astoria Radio Club, Nassau Communications Association, Northern Nassau Wireless Association, Sunrise Radio Club, and Tuboro Radio Club. Tickets may be obtained from any of these clubs, selected radio stores, or from Louis H. Roth, 163-18 Jamaica Ave., Jamaica, New York. The sale of tickets will be limited, so it will be a case of first come, first served.

October 19th, Boston, Mass.: The Ninth Annual Boston Hamfest is scheduled for Saturday, October 19th, at Mechanics Building, 135 Huntington Ave., Boston, Mass. It will be under the sponsorship of the Eastern Massachusetts Amateur Radio Association and the South Shore Amateur Radio Club. Further information and tickets may be obtained from Frank L. Baker, W1ALP, 91 Atlantic Street, North Quincy 71, Mass.

A Soup-Can Wavemeter for the 24-Cm. Band

Frequency and Field-Strength Measurements at Low Cost

BY FREDERIC A. JENKS,* W2MTH

• For the experimenter, the 24-cm. band (1215-1295 Mc.) probably offers more possibilities than any of the other amateur u.h.f. assignments. But before you can use the band you need to know how to find it. This article tells how to make a 24-cm. wavemeter that also can be used for checking antenna patterns—at little more cost than the price of a 1-ma. meter which you've probably got already. No special tools—and no machining!

ONE of the most interesting of the new ultrahigh-frequency bands available to the ham is the 80-Mc. spread located between 1215-1295 Mc. This 24-cm. band is located in the radio spectrum at just about the point where the operating ranges of three tube types—magnetrons, klystrons, and lighthouse triodes—overlap, which is fortunate because it offers the opportunity to get acquainted with three different u.h.f. operating techniques. However, 24 cm. is a sufficiently short wavelength to permit the use of highly-directional antenna structures, thereby effectively increasing the transmitter power.

Before attempting to set up a station on this band, it is wise to become familiar with the circuit components used at these wavelengths. It is obvious that resonant circuits using coils and condensers would be impracticably small.

*Engineering Dept., Raytheon Mfg. Co., Waltham, Mass.

Instead, short sections of transmission lines whose principal dimensions may be a large fraction of the wavelength are used. Transmission lines in the ultrahigh and superhigh regions are either coaxial or waveguide systems where the traveling energy is contained entirely within a metallic enclosure. Resonant circuits made from sections of these lines have decided advantages, in that they provide nearly perfect shielding and can have a much higher Q than is possible with ordinary coil-condenser combinations.

The experimenter will want to familiarize himself with at least one type of resonant circuit or "resonator" which tunes over the 24-cm. band. The simplest and probably the most useful gadget for early work at these frequencies is a wavemeter. The photograph shows one that can be made from parts found in every household. (Notice I said household and not ham shack! This is because the wavemeter is made from tin cans, copper pipe, and some nuts and bolts.) It can be used as a relative field-strength meter for taking antenna-pattern measurements as well as for frequency measurement.

The wavemeter is essentially a quarter-wave section of coaxial line short-circuited at one end. By adjusting the length of the center conductor the resonant frequency can be varied over the 24-cm. band.

As shown in Fig. 1, the magnetic lines of force set up inside the enclosure are circular about the axis, while the electric lines of force are radial along the length of the center post and then distort at its free end to fill the space beneath it. A

◆
Disguised in black crackle, the tin-can wavemeter has a very professional appearance. This is the unit complete with dipole antenna, crystal detector and indicating meter.
◆

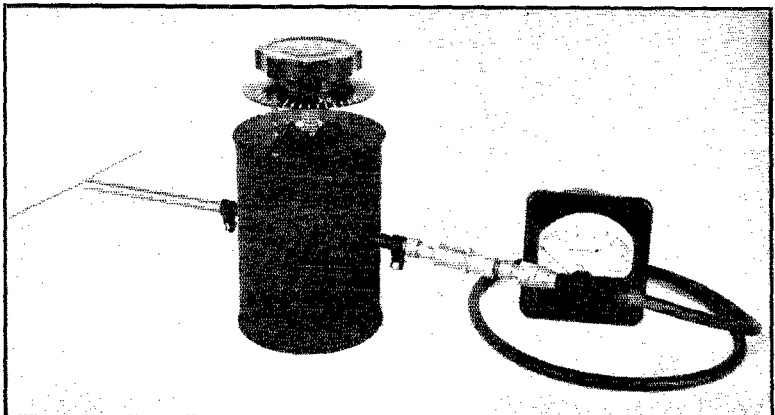

single-turn coupling loop is used to feed energy into the wavemeter through a short coaxial line. Another single-turn coupling loop is used to extract energy from the resonator to feed a crystal

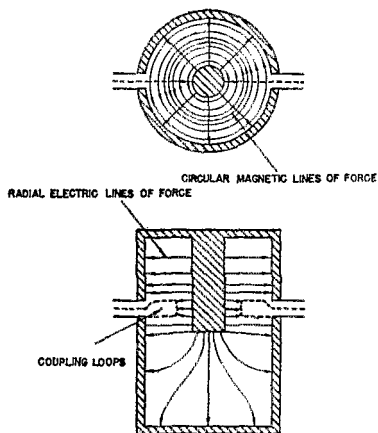

Fig. 1 — Electric- and magnetic-field configuration inside the resonator.

or other detecting device, as shown in the equivalent circuit, Fig. 2. This method of coupling is similar to the standard ham practice of "link" coupling between tuned circuits. Since the loops depend upon magnetic coupling to transfer energy, it is necessary that they be oriented properly within the resonator to link some of the magnetic lines of force. Maximum coupling is obtained when the loops are entirely within the resonator and their "windows" are parallel to the axis, as shown dotted in Fig. 1. Either rotating or withdrawing the loops will reduce the coupling.

How to Build It

The construction of the wavemeter is shown in cross-section in Fig. 3, while an "exploded" view of the various parts in their relative positions is given in the photograph. Notice that the adjustable section of the center conductor does not make physical contact with the larger diameter pipe, thus avoiding troublesome finger contacts. However, the opening between the two appears as a short-circuit to u.h.f. waves because the distance from this gap along the center pipe and down between the two cans to the shorting ring is an electrical half wavelength. One of the properties of transmission lines is that an impedance seen at a particular point is repeated every half wavelength along the line. Since there is an electrical short-circuit between the inner and outer cans at the soldered ring, then one-half wavelength away, at the opening between the two pipes, another short-circuit appears. The large can acts as the outer conductor for a portion of the half-wavelength line, as well as providing protection to prevent denting or distorting the inner can (the actual resonator) after calibration.

The tools necessary for building the wavemeter are familiar, and include tin snips, hacksaw, files, a soldering iron, and a drill. A 4-40 tap and a drill press equipped with a flycutter will be of help in the preparation of the parts, but are not essential. A $\frac{1}{8}$ to $\frac{1}{4}$ -inch-thick steel plate about 6 inches square is very useful in the assembly soldering operations on the kitchen stove.

Choose a clean, undented soup can (Part A) of the Campbell or Heinz variety, $2\frac{3}{8}$ -inch diameter rim by 4 inches long, and remove the top and bottom with a rotary-type can opener. This operation produces smooth edges and leaves a strong rim. Now choose a medium-sized vegetable can (B), $3\frac{3}{8}$ -inch diameter rim by $4\frac{1}{2}$ inches long, and remove the top and bottom as before. Be sure both cans have a bright finish and not the dark wartime finish, because it is much easier to solder to the tinned surface. Clean the cans thoroughly with hot water and soap before attempting to do any soldering.

From $\frac{1}{32}$ -inch-thick sheet brass or copper cut two disks (C and D) $3\frac{1}{16}$ inches in diameter. These disks should be a trifle larger than the top of the vegetable can to allow space for soldering. Cut another disk (E) $2\frac{1}{16}$ inches in diameter, which again is slightly larger than the top of the soup can. Drill or punch a $\frac{3}{4}$ -inch diameter hole in the center of the small disk (E) and in one of the larger disks (D). A $\frac{3}{4}$ -inch socket punch for filter condensers is useful here. Next, cut a ring from the $\frac{1}{32}$ -inch sheet material with an inside diameter equal to the outside dimension (not the rim) of the soup can, and an outside diameter equal to the inside dimension of the rim of the vegetable can. With the tin snips cut this ring into two half-ring segments (F). When these two segments are soldered in place between the two cans, as shown

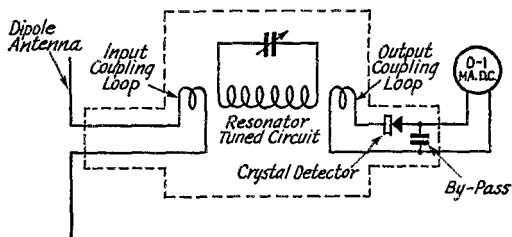

Fig. 2 — The wavemeter circuit in terms of low-frequency symbols. The actual tuned circuit is a coaxial resonator of the type shown in Fig. 1.

in Fig. 3, they form the actual short-circuit at one end of the half-wavelength line mentioned earlier.

Obtain a piece of brass pipe having an outside diameter of $\frac{3}{4}$ inch with a wall thickness of $\frac{1}{16}$ inch. Cut and file the ends square to a final length of $1\frac{3}{4}$ inches (G). Be sure the inside surface is smooth and clean. Take a $\frac{1}{2}$ -inch outside diameter brass pipe (H) and cut it to $2\frac{1}{16}$ inches in length. Solder a scrap of the $\frac{1}{32}$ -inch sheet stock

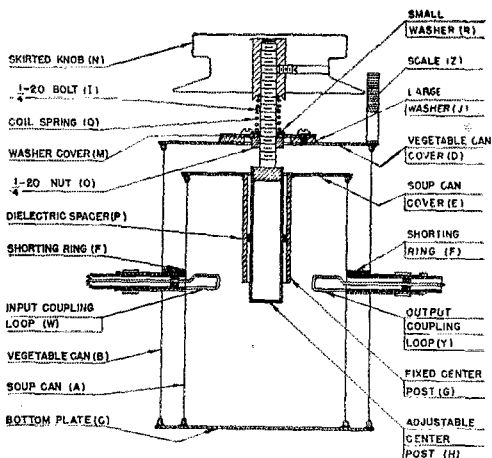

Fig. 3—Cross-section drawing of the assembled wavemeter. Letters in parentheses correspond to the lettered parts in the photograph.

across one end and file smooth, making a metallic cover for the end of the tubing. Fasten the head of a two-inch $\frac{1}{4}$ -20 brass fillister or hex-head machine screw (I) into the other end either with small screws or by soldering, allowing the threaded portion to protrude from the pipe. (It may be necessary to cut additional threads up to the base of the head.) Be sure the machine screw is in exact alignment with the axis of the pipe, as this assembly is the adjustable center-conductor section.

With a piece of fine emery cloth polish the small disk (E) and the $\frac{3}{4}$ -inch diameter pipe (G). Tin the inner and outer edges (one side only) of the disk and around one edge of the pipe with the soldering iron (a 150-200-watt iron is desirable). Rosin-core solder could be used, but plain solder and an acid flux will produce better mechanical results. It is important to clean off all traces of the acid flux after soldering, however, to prevent corrosion. Now tin the top and bottom rims of the two cans to insure a clean soldering surface and a

good electrical bond between the rims and the insides of the cans. Some cans have a sealing gasket under the rim, so this solder bond is necessary. Place the 6×6-inch steel plate on the kitchen-stove burner and heat until it browns a piece of paper. Drop the small disk (tinned side up) on the plate and stand the $\frac{3}{4}$ -inch pipe in the hole. Add slightly more heat to the plate until the tinned sections turn shiny. Touch the disk-pipe joint with some solder until it flows in a clean ring around the pipe. Now place the soup can (A) on the disk, and solder the outer edge in a similar manner. When the joints are complete, turn off the heat and allow the whole assembly to cool *slowly*. Do not attempt to move anything on the plate during this cooling process!

Measure down $1\frac{1}{2}$ inches from the disk on the outside of the soup can and tin a strip $\frac{1}{2}$ inch wide around its circumference with the soldering iron. Emery the two half-ring segments (F) and tin their inner and outer edges. Solder these pieces to the soup can at this tinned strip. Also solder the places where the ring was cut in half. When the segments are held in place, a solid bond can be obtained by holding the iron against the joint and slowly moving it around the can.

Polish the top disk (D), and solder a $1\frac{1}{2}$ -inch brass washer about $\frac{3}{32}$ inch thick (J) at its center. Be sure the washer is in the middle, and has a hole at least as large as the inside diameter of the pipe soldered to the soup can. Drill and tap three 4-40

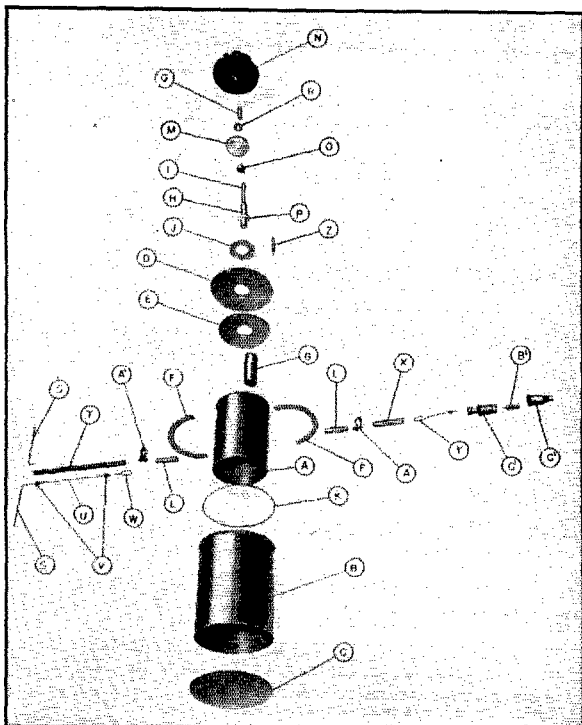

Exploded view of the parts entering into the wavemeter assembly. Tin snips, a hacksaw, files and a soldering iron are the principal tools required.

holes 120 degrees apart into the washer-disk assembly on a $1\frac{1}{8}$ -inch diameter circle. If no tap is available, drill clearance holes through the washer and solder brass nuts to the underside of the disk.

Tin a $\frac{1}{4}$ to $\frac{3}{8}$ -inch-wide strip two inches down from one edge on the *inside* of the vegetable can (B). Slide the soup-can assembly into the vegetable can so that the ring coincides with the tinned strip and the open edges of the two cans are flush. Put several wooden spacers between the cans to keep them aligned. Make a thin ring of

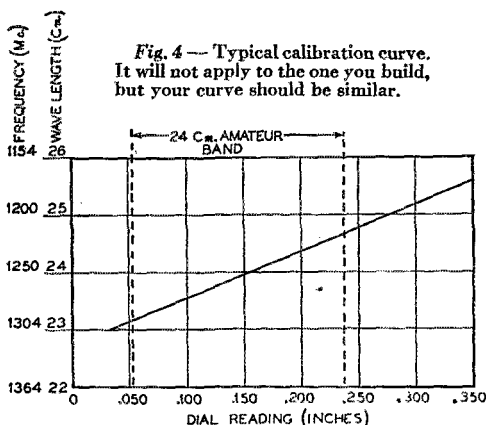

solder (K) and place it around the tinned area inside the large can so that it rests on the brass piece soldered to the soup can. Now hold the whole assembly horizontally over a medium gas flame, and rotate the work until the ring of solder has melted and formed a solid joint between the brass ring and the outside can. It is essential that a good electrical contact be made between the two cans at this point by the brass ring (F). A small blowtorch would be useful for this soldering operation.

While the wooden spacers are still in place, the holes for the coupling-loop guides (L) should be drilled. Choose two sizes of copper tubing such that one slides snugly inside the other, or better yet purchase two pieces of brass "telescoping" tubing which are purposely made to slide one inside the other. In either case the inside diameter of the smaller piece should be about $\frac{1}{4}$ inch. Drill two holes in the sides of the cans diametrically opposite each other so that they come just below the brass ring (F). The holes should be the size of the outside dimension of the larger of the two pieces of tubing. Be sure to drill through both cans.

Cut two $1\frac{1}{2}$ -inch lengths of this outside tubing. Square both ends and saw six thin slots 60 degrees apart and $\frac{3}{8}$ inch deep in one end of each piece. A wooden dowel inside the tubing during slotting might help. After polishing with emery, tin about $\frac{1}{2}$ inch on the smooth ends. Slide these

pieces (L) into the holes in the cans until the tinned ends are just flush with the inside of the soup can, and solder both inside and outside joints with the iron.

Remove the wooden spacers near the bottom of the assembly. With the upper spacers in place, solder the large, solid disk (C) to the bottoms of the cans, using the metal-plate-over-stove-burner technique. It is especially important that the soup can (A) make good contact with this bottom disk. Proper tinning of the cans and the disk will insure a good joint. Next, remove the upper spacers and solder the top disk (D) to the large can, with the washer on the outside. Use a wooden dowel to align the washer with the pipe (G) inside the small can. After "tacking" the disk in place with the soldering iron, the final soldering can be done on the plate. Allow time for the heat to flow through the disk to the joint, however.

On a $1\frac{1}{4} \times \frac{3}{16} \times \frac{1}{32}$ -inch piece of sheet brass scratch lines at one end across the $\frac{3}{16}$ -inch face, $\frac{1}{20}$ inch (0.050") apart. Ten or fifteen lines should be enough. Now bend the other end at right angles, making a $\frac{3}{16} \times \frac{3}{16}$ -inch foot for the scale (Z). Solder the scale in an upright position on the top disk (D) along a radius at a distance from the center just slightly larger than the dial (N) you plan to use. India ink or black paint in the scratched lines will make them easier to read. A more elaborate scale can be made by taking a $\frac{3}{16}$ -inch diameter brass rod and cutting grooves around it 0.050 inch apart. Every fifth groove is cut wider to allow easy reading. Mill or file a flat section along the rod and stamp numerals at each wide line. Fill the grooves and numerals with white wax. A 4-40 thread at the base makes it easy to mount on the cover plate (D). The wavemeter in the illustration uses this type of scale.

Cut a brass disk (M) the size of the large washer (J), and drill a hole in its center to pass the machine bolt (I) fastened to the $\frac{1}{2}$ -inch pipe (H). Drill three holes spaced 120 degrees apart on a $1\frac{1}{8}$ -inch diameter circle to pass the 4-40 screws. Solder a $\frac{1}{4}$ -20 brass nut (O) to the underside of this disk (M) at its center.

About $1\frac{1}{2}$ inches down the $\frac{1}{2}$ -inch diameter pipe (H) use as the adjustable center conductor, build up several layers of coil dope or polystyrene tape about $\frac{1}{8}$ inch wide. Build up enough to act as a dielectric spacer (P) between this pipe and the one inside the soup can. When the material becomes hard, shape it so that the adjustable section will turn inside the other pipe without wobbling. A ring of polystyrene or other good u.h.f. dielectric turned on a lathe is equally satisfactory.

Now thread the bolt into the nut and through the disk (M). Mount the whole unit in the resonator assembly, with the pipe going through the other center conductor (G). Fasten the brass

(Continued on page 114)



Foreign Notes



QSL BUREAUS

Here's how to get best service on delivery of your QSLs to foreign stations: simply mail cards direct to the bureau of the proper country, as listed below. These bureaus are operated by foreign amateur societies as a service to their members. Do not send foreign cards via ARRL except those for which no bureau is here listed.

Alaska: J. W. McKinley, Box 1533, Juneau.
Antigua: A. Tibbits, 27 St. Mary's St., St. Johns.
Argentina: Radio Club Argentino, Av. Alvear 2750, Buenos Aires.
Australia: W.I.A., Box 2611 W, G.P.O., Melbourne.
Belgium: U.B.A., Postbox 634, Brussels.
Brasil: L.A.B.R.E., Caixa Postal 2353, Rio de Janeiro.
British Honduras: D. Hunter, Box 178, Belize.
Canal Zone: Signal Officer, KZ5AA, Quarry Heights.
China: K. L. Koo, P.O. Box 409, Shanghai.
Chile: Luis M. Desmaras, Casilla 761, Santiago.
Colombia: L.C.R.A., P.O. Box 1266, Bogota.
Costa Rica: F. Gonzalez, Box 365, San Jose.
Cuba: James D. Bourne, Lealtad 660, Habana.
Czechoslovakia: C.A.V., Vlacavske Nam 3, Prague II.
Denmark: E.D.R., Box 79, Copenhagen K.
Eire: R. Mooney, Aughnacloy, Killiney, Co. Dublin.
Finland: Tatu Kolehmainen, Kasarminkatu 25.C.12, Helsinki.
France: R.E.F., 1 Rue des Tanneries, Paris 13^e.
Germany: (D2 calls only) Capt. J. Blackwood, R. Signals, P. & T. Section, HQ. Mil. Govt., Hamburg, BAOR.
Germany: (D4 calls only) Signal Division, HQ. USFET, APO 757, c/o Postmaster, New York, N. Y.
Greece: C. Tavaniotis, 17-a Bucharast St., Athens.
Great Britain: A. Milne, 29 Kechill Gardens, Hayes, Bromley, Kent.
Guam: Box 30, Staff Com. Marianas, c/o FPO, San Francisco.
Guatemala: W. P. Boyer, c/o PAA Communications, Guatemala City.
Italy: A.R.I., Viale Bianca Maria 24, Milan.
Luxembourg: W. Berger, 20, Louvigny St., Luxembourg.
Mexico: L.M.R.E., Av. Juarez 104-22, Mexico, D.F.
Morocco: C. Grangier, Box, 50, Casablanca.
Netherlands: V.E.R.O.N., Postbox 400, Rotterdam.
Newfoundland: N.A.R.A., Box 660, St. Johns.
New Zealand: N.Z.A.R.T., P.O. Box 489, Wellington C-1.
Nicaragua: R. Argenal, P.O. Box 78, Managua.
Norway: N.R.R.L., P.O. Box 898, Oslo.
Panama: R. D. Prescott, P.O. Box 32, Panama City.
Paraguay: R.C.P., Palma 310, Asuncion.
Peru: Radio Club Peruano, Box 538, Lima
Philippine Islands: G. L. Rickard, 48 Ortega, San Juan, Rizal.
Porto Rico: E. W. Mayer, P.O. Box 1061, San Juan.
Salvador: J. F. Mejia, 7a Calle Poniente No. 76, San Salvador.
South Africa: S.A.R.R.L., P.O. Box 7028, Johannesburg.
Sweden: S.S.A., Stockholm 8.
Switzerland: U.S.K.A., Postbox, Berne.
Uruguay: R.C.U., Casilla 37, Montevideo.
U.S.S.R.: Central Radio Club, Postbox N-88, Moscow.
Venezuela: R.C.V., Apartado 1247, Caracas.

Following usual custom, the May and October issues of *QST* each year will carry the above list, with revisions and additions as necessary.

U.S.S.R.

We've been hearing U and UA stations in increasing numbers recently, so it was not a surprise to learn that the Central Radio Club is again active, with address still Postbox N-88, Moscow. Individual chapters are being formed in the larger cities, with each group operating a club station. The following bands have been allocated: 1715-2000 kc., 7000-7200 kc., 14,000-14,400 kc., 21,100-21,500 kc., 23,000-29,700 kc.

Authorized power depends upon operator competency. Holders of a first-class license may have 100 watts output; second-class privileges include 20 watts output; and third-class, 5 watts output.

The society's magazine seems to be going strong; we only wish we could read it! Ernst Krenkel, chairman of the Central Club, expects a bright future for amateur radio in his country.

PORTUGAL

A second country heard from for the first time since the war is Portugal, with the R.E.P. reporting it is again fully active. At a recent Council meeting, the following officers were elected: president, Manoel C. V. Antunes, CT1CO; vice-president, Jaime V. dos Santos, CT1QA; first secretary, Pedro C. Martinho, CT1AG; second secretary, Alberto R. dos Santos, CT1QF; treasurer, Tomaz C. de Figueiredo, CT1KN.

The Portuguese government has not yet authorized postwar amateur operation, but the Society expects release of frequencies and reinstatement of licenses soon. No information is available about licenses for newcomers.

FRANCE

Supplementing an item in a previous issue, we now report that French amateurs were given the 40-meter channels of 7150-7200 kc., power input of 50 watts, in addition to half the 20-meter band as in other countries. The top limit of the 40-meter assignment may be indicative of the French government's attitude at the coming world conference, in not wishing to permit amateur operation on the channels 7200-7300.

American servicemen-hams in France are being licensed for amateur operation, with operator tickets issued by the Chief Signal Officer and station authorizations by the French Minister of the P.T.T. Call signs will be issued in the block F7AA-F7ZZ. That regulations will be similar to those in Germany is indicated by the fact that Lt. Ralph Dage, W8PHZ-D4ADX, amateur radio officer in the U. S. zone of Germany, journeyed to Paris to set up the licensing procedures.

• Technical Topics —

Impedance Matching with an Antenna Tuner

THE link-coupled antenna tuner shown in Fig. 1 is a useful device because it not only provides needed selectivity for preventing transfer of harmonics to the antenna but offers a means for obtaining symmetrical coupling between a single-ended tank circuit and a balanced feeder system. It is also commonly regarded as a means for matching the impedance of the feeder to the required transmitter load, the theory being that the load is adjusted by changing the spread between the feeder taps on L_2 and the coupling between either or both of the two tank coils and their associated link coils, L_3 and L_4 . When the transmission line is matched to the antenna so that the standing-wave ratio is near unity — that is, when the line is flat — the matching is relatively simple. However, it doesn't always work out so nicely when a resonant line is used. On occasions it proves to be difficult, if not impossible, to load up the final stage; tuning is sluggish; part or all of the antenna tank coil, L_2 , heats; and results generally are unsatisfactory.

It is common knowledge that a transmission line terminated in a resistive load equal to its characteristic impedance can be any length and the impedance looking into the sending end always will be a pure resistance equal to the line impedance. But if the load has any other value the impedance looking into the sending end will be complex — that is, it will have both resistive and reactive components. The magnitudes of both components will depend upon the electrical length of the line, the characteristics of the load, and the characteristic impedance of the line itself. Matching the transmitter to the input end of such a line entails two separate operations: (1) "tuning out" the input reactance by supplying

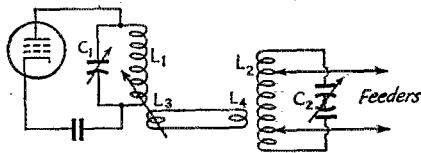

Fig. 1 — The link-coupled "universal" antenna coupler.

an equal amount of reactance of the opposite kind, and (2) adjusting the coupling so that the desired power is transferred to the resulting purely-resistive component of the line's input impedance.

In the coupling circuit of Fig. 1, a resistive load readily can be matched to the transmitter by changing the spread between the taps on L_2 .

When the line has reactance as well as resistance the reactive component is reflected across the whole tank in proportion to the ratio of the impedance, as measured across the ends of the tank, to the impedance of the load between the taps. Since the taps generally are not at the extreme ends of L_2 , the reactance reflected across the tank as a whole is usually higher than the reactance of the line. The reflected reactance is equivalent to an inductance or capacitance (depending upon whether the line is inductive or capacitive) shunting the whole circuit. The circuit is consequently detuned, and C_2 is supposed to be readjusted to resonate it.

To a limited extent, this scheme for tuning out the line reactance will work quite satisfactorily. It is at its best when the reactive component of

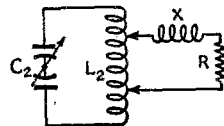

Fig. 2 — Except at voltage and current nodes, the input impedance of a transmission line with standing waves can be represented by a reactance in series with a resistance. In this drawing the reactance, X , is assumed to be inductive.

the line's input impedance is small compared to the resistive component. However, when the line reactance is comparable to or larger than the resistance, the circuit is at a disadvantage because it is inherently incapable of making the line itself "look like" a resistance. As an example, suppose that in Fig. 2 X and R in series represent the input impedance of the line, X being the inductive reactance and R the resistance, and that X is five times as large as R . (This is by no means an extreme case.) The line impedance, Z , is equal to $\sqrt{X^2 + R^2}$, or 5.1 times the resistance. In order to supply a given amount of power to R we need a definite value of current through it, and this in turn means that there will be a definite voltage drop across R . But to get the desired current through R it is necessary to supply 5.1 times as much voltage to X and R in series as R alone requires.

The only way to get the larger voltage is to use more spread between the taps on L_2 than would be necessary if the circuit were working into R alone as a load. But as the taps are moved farther apart the reactance reflected across the tank decreases. In the example of Fig. 2, moving the taps apart would be equivalent to shunting L_2 with a coil of increasingly smaller inductance.

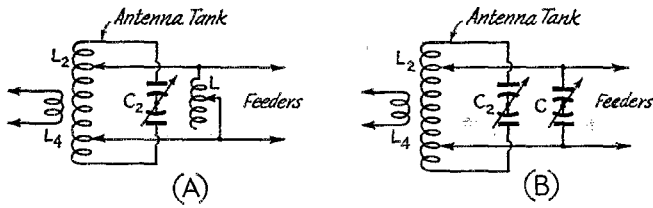

Fig. 3—Compensating reactances connected across the input terminals of the transmission line to tune out the line reactance. When a condenser, C , is required it need not be the balanced type shown, particularly when the larger values of capacitance are needed. However, the balanced type is preferable for maintaining symmetry.

Consequently, reresonating the circuit in such a case requires increasingly larger values of capacitance at C_2 , and it is not unusual to find cases where the resonance point is thrown completely off the condenser scale. If additional shunting capacitance is used and a working adjustment finally achieved, the common result is that the L/C ratio is so low that the circulating current becomes undesirably high and the sections of L_2 between the taps and the outer ends get hot. The inner section may remain cool, since the current is divided between it and the line. When the line reactance is capacitive rather than inductive the story is much the same, except that in that case it may be necessary to operate C_2 at minimum capacitance and reduce the inductance of L_2 until it is possible to find resonance.

When difficulties of this sort are encountered normal operation can be restored by confining the function of the taps on L_2 to matching to the resistive component of the feeder input impedance and making the reactance cancellation a separate operation. The process is simple and has the single disadvantage that an additional coil or condenser is required. The problem, if it can be called such, of tuning out the reactance component is simply that of shunting an appropriate amount of reactance, but of the opposite kind, across the input terminals of the line. It isn't necessary to make any calculations; the whole thing can be done by a simple cut-and-try process. Fig. 3 shows the circuits, A being for the case where the feeder has capacitive reactance, B for a feeder showing inductive reactance at its input end.

To tune up the system, first disconnect the feeder taps from L_2 , loosen the coupling as much as possible, and tune C_2 to resonance as indicated by a kick in the current of the plate tank, L_1C_1 being adjusted for minimum plate current as usual. In effect, L_2C_2 is being used as a wave-meter and the plate-current kick should be quite small. There is considerable danger here of using too much coupling, which will show up as a reaction on the tuning of the amplifier tank. The coupling should be so loose that C_1 does not require readjustment for minimum plate current when C_2 is brought to resonance. Note the resonance setting on C_2 's dial.

Next, tap the feeders on L_2 , using a small number of turns for a starter. Retune C_2 to determine whether more or less capacitance is required to

bring the circuit to resonance. If the capacitance must be increased the feeders are inductive and a compensating condenser, Fig. 3-B, must be used; if less capacitance is required at C_2 the feeders are capacitive and Fig. 3-A applies. Let us assume that a compensating condenser, C , is required. Connect it as shown, reset C_2 to the resonance point determined without the feeders connected, and adjust C until the whole system is resonant as indicated by the kick in final plate current. It should now be possible to connect or disconnect the feeders from L_2 without changing the tuning of the L_2C_2 circuit. That's all there is to tuning out the feeder reactance. In case an inductance, L , is required, the process is the same, the most convenient arrangement being a coil that can be tapped at every turn.

The next step is to match the resistive component of the line, to the transmitter. As the spread between taps is increased, the load on L_2C_2 becomes greater and the resulting decrease in the Q of the circuit makes it necessary to use closer coupling between L_1C_1 and L_2C_2 . It should be possible to find several combinations of tap spread and coupling that will load the final amplifier to rated plate current. However, it is advisable to use that combination that gives the proper loading with relatively loose coupling, since loose coupling means less harmonic transfer. When the coupler is working properly, detuning C_2 to either side of resonance should cause the final plate current to decrease—a distinctly advantageous feature of this type of antenna tuner in that accidental detuning in the antenna system will not overload the amplifier.

How much L or C will be required depends on the line length, the characteristic impedance of the line, and the standing-wave ratio. In general, excessively large condensers or coils will not be necessary. The worst cases in this respect occur at certain line lengths with high standing-wave ratios and low-impedance feeders. Fig. 4 gives the minimum reactance required for the worst case is $0.22 \times 600 = 132$ ohms, or if the standing-wave ratio is 2-to-1 on a 70-ohm line the minimum reactance required is $1.05 \times 70 = 73.5$ ohms. The latter case corresponds to a condenser of about 500 $\mu\text{mfd.}$ at 4 Mc., and considering the ways in

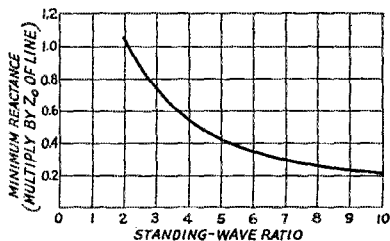

Fig. 4—Minimum values of reactance required by the circuits of Fig. 3 as a function of standing-wave ratio and line characteristic impedance. For any particular frequency the reactance may be converted into inductance or capacitance by the formulas or charts given in the ARRL *Handbook*. With standing-wave ratios higher than 10, the minimum reactance required is very nearly equal to twice the characteristic impedance of the line divided by the standing-wave ratio.

which high- and low-impedance lines are used it does not seem likely that a larger condenser would

ordinarily be needed. In most cases much smaller values will be called for. Very high values of shunt reactance need not be used (that is, very large coils or very small condensers) because in such cases the reactive component of the line's input impedance is small and the ordinary coupler alone is capable of handling the situation.

The compensating reactance need not be used, of course, unless poor performance of the coupler by itself requires it. When it is used, it is generally not necessary to readjust it for working through a band, provided it is adjusted for a frequency near the center. Minor departures from the pure-resistance load condition can be taken care of by C_2 . There may be exceptions to this in the case of long lines with high standing-wave ratios, but usually the reactance can be set at a median value for each band and left alone.

— G. G.

Amateur F.M.

SOME new things have to simmer a while before really starting to cook — or maybe there has to be a really pressing need before Old Man Inertia gives way. Whatever the reason, there is evidence that interest in f.m. is on the increase. In contrast, the few years immediately preceding the close-down saw a lot of material in *QST* on the principles of f.m. and its advantages and application in amateur work, but for all the enthusiasm it stirred up the space seemingly could have been used to better advantage.

In the metropolitan areas f.m. is working itself in through the back door. When there are hundreds of broadcast receivers within a stone's throw of a ham transmitter it's no fun trying to operate with amplitude modulation, particularly during the evening hours. Fellows in that situation have found that f.m. gives them the means for operating 'phone without becoming the neighborhood scourge, since with f.m. the stuff picked up in the audio system of a bum superhet doesn't come out as recognizable interference the way a.m. does. It can't, because ordinary rectification of an f.m. signal simply produces an unvarying d.c. voltage that does not go through an audio amplifier.

Most of the present interest in f.m. is on 28 Mc. Since there are very few 28-Mc. f.m. receivers extant in ham stations, reception is of necessity on regular communication receivers. The inherent advantages of f.m. in the suppression of noise cannot be realized to any extent by such makeshift reception, but that isn't the real point — reduction of BCI is what counts cur-

rently. In any event, quite good reproduction of the modulation on the incoming signal can be secured by detuning the receiver so that the carrier falls on a fairly straight portion of the sloping side of the i.f. selectivity curve. The only requirement is that the transmitter's frequency swing must be kept within sufficiently narrow bounds so that the limits of linearity in detection by this method are not exceeded. This means that the deviation ratio should be 1 or less at the highest modulating frequency. In itself this is advantageous because it simplifies the problem of modulation and actually can result in a better signal-to-noise ratio on weak signals than is possible with wide-band f.m.¹

Anticipating the future a little, it seems quite obvious that if f.m. provides a real solution to the BCI problem in the present 28-Mc. assignment there is going to be a growing feeling that it should be extended to all parts of the band where a.m. is permitted — and possibly to lower-frequency bands as well. As for the latter, the same advantages as to BCI² will hold for the same type of pick-up, naturally. R.f. pick-up in the audio system of the broadcast receiver probably is considerable at 14 Mc. and may be appreciable at 4 Mc. if the receiver is close enough to the transmitter. On the lower frequencies, however, the interference more commonly is of the tunable type, where the signal is picked up in the receiver's front end and mixes with an oscillator harmonic to produce the intermediate frequency. The chances are that there is little to choose between f.m. and a.m. in such cases, because the f.m. signal will be detected if the carrier falls on the slope of the i.f. curve — exactly the method that is presently being used for 28-Mc. f.m. reception.

¹ Crosby, "Band-Width and Readability in Frequency Modulation," *QST*, March, 1941.

² Grammer, "Some Thoughts on Amateur F.M. Reception," *QST*, March, 1941.

Until now we have avoided any attempt to set standards for amateur f.m. transmission because its use has been largely experimental and has been confined to portions of bands not ordinarily used for a.m. But should f.m. invade a.m. territory the establishment of standards becomes necessary immediately, and it seems to us that the only possible standard is that no sideband of significant amplitude should fall outside the channel occupied by an a.m. transmission having the same upper limit of audio frequency. Such a standard should be fair enough to all concerned.

The question then becomes this: What deviation ratio is permissible if such a standard is to be met? From the nature of frequency modulation it is apparent that the maximum frequency deviation cannot be greater than the highest audio frequency in the modulation, because any larger deviation than that would go outside the limits of the a.m. sidebands. However, there is more than that to consider. A frequency-modulated signal can be resolved into a carrier and a series of sideband pairs, each pair being spaced nf above and below the carrier frequency, where n is any integer and f is the audio modulating frequency. At any frequency deviation, however small, there is an infinite number of these sideband pairs, so the theoretical spectrum of a frequency-modulated signal is as wide as the radio-frequency spectrum. In amplitude modulation, in contrast, there is only one pair of sidebands with a spacing of f above and below the carrier frequency. At 100-per-cent modulation these sidebands also have an amplitude of one half the carrier amplitude. In the frequency-modulated signal the first pair of sidebands also appears at a frequency f above and below the carrier ($n = 1$), and if the channel occupied is to be no wider than the a.m. channel the amplitude of any sidebands above the first pair must be insignificant.

The amplitude of an f.m. sideband varies with the deviation ratio as shown in Fig. 1.² With a deviation ratio of 1, the amplitude of the second sideband ($2f$ above and below the carrier frequency) is about 12 per cent of the unmodulated carrier amplitude and the third sideband is only 1 per cent of the carrier. The second sideband is thus about 19 db. below the unmodulated carrier and the third is 40 db. down. At this point the amplitude of the first sideband is very nearly the same as the sideband amplitude in a 100-per-cent-modulated a.m. signal. Thus insofar as the first sideband is concerned, the f.m. signal will have just about the same power to cause interference as an a.m. signal. The second sideband, although not completely negligible, is far enough down so that its possibilities for causing interference are not too serious. The third sideband, of course,

is too far down to warrant any consideration.

If the deviation ratio is reduced to 0.5 the amplitude of the second sideband drops to under 5 per cent of the unmodulated carrier (30 db. down) and the first sideband has about 25 per cent of the carrier amplitude. With this deviation ratio the second sideband is practically negligible and the first sideband will cause less interference than the corresponding a.m. sideband. Although the smaller amplitude of the first sideband means less modulating energy in the signal, the peculiarities of f.m. reception are such that this is not ordinarily nearly so important as the effect of a similar reduction in sideband power in amplitude modulation. It seems reasonable, then, to conclude that although f.m. definitely does not take less spectrum space than a.m., it may actually cause less interference (to a.m. reception)

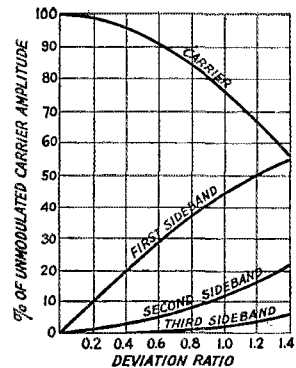

Fig. 1 — Variation of carrier and sideband amplitude with frequency deviation in frequency modulation.

than an a.m. signal if the deviation ratio is kept below 1. Actual listening tests confirm this; with a single-tone modulating signal it is difficult to detect the second sideband on a crystal filter receiver used as a "spectrum analyzer" until the deviation ratio gets up toward 1. With the deviation ratio in the vicinity of 0.5 to 0.6, anything beyond the first sideband pair is undetectable even with an extremely strong carrier. Under these conditions the power in the first sideband is down 5 to 6 db. as compared to 100-per-cent amplitude modulation.

It looks as though it should be possible, in view of the above, for a.m. and f.m. to live together. It will be necessary, obviously, for the operator of the f.m. transmitter to take steps to see that his deviation ratio does not become high enough to bring the extra sidebands up to appreciable amplitude. Practically, this means that the maximum deviation should not exceed 2 to 3 kc. at the carrier frequency. A method for checking deviation was described some time ago in *QST*³, and by making use of an accurately-known audio frequency, such as the modulation carried by the WWV transmissions, it is possible to make a quite good measurement. A small scope hooked across the speech amplifier will

² Data taken from Hund, *Frequency Modulation*, McGraw-Hill Book Co., New York City.

³ Grammer, "Getting on 56-Mc. F.M.," *QST*, June, 1940.

provide a continuous check on the voice amplitude, which in turn determines the deviation. Even a magic-eye indicator might do the trick.

With a reactance modulator some such measuring means is a necessity. However, automatic protection can be obtained by using a modulating system which inherently is incapable of too much deviation. The circuit shown in Fig. 2 appears to fill this order. Developed and patented by Hammarlund engineers some years ago for an amateur transmitter which was just in the final stages when the war broke out, it uses a reactance modulator operating on a crystal oscillator. The frequency deviation obtainable depends upon the crystal cut; at 3.5 Mc. it is possible to secure a total swing of 2500 cycles with a Y-cut crystal and 1000 cycles with an X cut. Of greater interest, however, is the fact that a swing of 400 cycles (200-cycle deviation) can be obtained with the AT-cut crystals now so widely used; when multiplied up to 28 Mc. this comes out to be a deviation ratio somewhat over 0.5, based on an upper limit of 3000 cycles for speech. The value of R_1 may have to be varied somewhat with different crystals, and in any event the voice amplitude must be kept below the point that causes the crystal to drop out of oscillation. No audio power

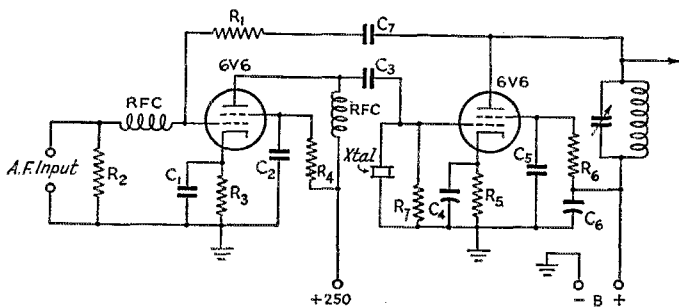

Fig. 2 — Reactance modulation of a crystal oscillator. The oscillator itself is conventional and may be operated at the normal voltages, with tank-circuit constants suitable for the frequency. AT-cut 3.5-Mc. crystals are recommended for 28-Mc. output.

C_1, C_2, C_5 — 0.001- μ fd. mica.
 C_3 — 1000- μ fd. mica.
 C_7 — 5.5- μ fd. (fixed mica or 3-30 ceramic trimmer).
 C_4, C_6 — 0.01- μ fd. paper.
 R_1 — 0.5 megohm, 5 watts.

R_2 — 0.5 megohm, $\frac{1}{2}$ watt.
 R_3, R_5 — 400 ohms, 1 watt.
 R_4, R_6 — 25,000 ohms, 1 watt.
 R_7 — 5000 ohms, $\frac{1}{2}$ watt.
 RFC — 2.5-mh. r.f. choke.

is required to drive it, the 6V6 modulator being a Class A amplifier running at normal ratings. An input signal of 15 volts peak amplitude should be ample. As an interesting sidelight, the circuit was not dormant during the war period; it was used by OWI for simultaneous frequency-shift keying of their short-wave broadcast transmitters by shifting the d.c. bias on the modulator!

If f.m. transmission is going to catch on, the next step will be to incorporate modifications in receivers to take advantage of the noise reduction that f.m. makes possible. Something more satisfactory than tuning an a.m. receiver off resonance is called for. But that is another story.

— G. G.

A.R.R.L. CONVENTIONS

VERMONT STATE

(New England Division)
 Burlington, Vt., October 5th

The first postwar annual Vermont State ARRL Convention, sponsored by the Burlington Amateur Radio Club, will be held at the Hotel Vermont, Burlington, on Saturday, October 5, 1946. Speakers, exhibits; 'phone, traffic and emergency meetings; ARRL club code award and quiz contests; dancing; Vermont turkey dinner with all the fixings. Registration fee, \$2; with XYL, \$3.75. Write: Burtis W. Dean, W1NLO, P. O. Box 81, Burlington, Vt.

MIDWEST DIVISION

Topeka, Kansas, October 5th-6th

The first postwar ARRL Midwest Division Convention will be held October 5th and 6th under the sponsorship of the Kaw Valley Radio Club, at the Hotel Jayhawk, Topeka, Kansas.

Numerous speakers and demonstrations highlight the program, plus a buffet supper Saturday evening and grand banquet and prize drawing Sunday. Advance registration and hotel reservations are urgently requested, with a special prize drawing being held for advance registrants. Write S. D. Thacher, 522 Jackson, Topeka, Kansas. Registration, \$6.00.

NEW HAMPSHIRE STATE

(New England Division)
 Manchester, N. H., October 26th

The Manchester Radio Club is working hard to make the "best ever" New Hampshire State ARRL Convention in their city, October 26th, at the Hotel Carpenter. Full program planned, including speaker from ARRL Hq. Registration \$4.25, but \$4 before September 30th by writing Henry Izart, W1AUY, Box 98, Mast Road, Manchester, N. H. Make your reservations early!

How's DX?

How:

The guy who owes Jeeves all that back salary and wears the suit that Jeeves doesn't keep pressed must confess to more than the normal amount of naïveté. For many years he has been of the impression that the DX gang is 100 per cent a swell bunch of guys, the salt of the earth, ipsis-pipsis Yankee Doodle boys — and the few instances of bad practices that have shown up have been blamed on newcomers to the game who don't understand the rules. Why a guy like that hasn't a basement full of gold bricks and Brooklyn Bridges is one of the mysteries of life, but it is becoming more and more apparent that we have in our midst a small group of self-conscious, deliberate, Grade A stinkers who flagrantly violate the rules every time they think it will give them a slight advantage. This isn't just our own private opinion, as indicated by the number of letters received over the last month from guys who play the game clean and are burned up about those who don't. Let's list the cute practices of some of these darlings that we choose to call "DX hogs," just for the record. The number-one complaint is about the guys who sneak outside the band to call some DX. Even when they get called on it by someone and are told they are out they ignore the warning, so the only possible conclusion is that the aberrations are deliberate. Mind you, we aren't talking about the guys whose enthusiasm carries them out once and when they discover it they scurry back inside and don't dare go within 20 kc. of the edge for days, but about the DX hogs who do it intentionally over a long period of time. Then there is the number-two complaint, about the guy who stretches a QSO until the DX fades out and no one else can get a crack at it. Naturally there is no objection to a good DX rag-chew — sometimes we think there should be lots more of them — but they shouldn't be with one- or two-station countries until the masses have had a fair crack at that country. And there is the DX hog who, when he spots a DX station calling CQ, tunes up smack on the weak one in the hope that no one else will hear it and he will thus stand a better chance. When he gets called on this practice, such a DX hog invariably claims that he was getting everything lined up "on the nose" in preparation for his call, which is so much malarkey, obviously, since he could tune up 5 or 10 kc. away and his antenna ammeter would never know the difference when he eased over, and any rig that takes that long to tune up should be junked anyway.

That's enough to give you the general idea. Naturally no one who might see this will have been guilty of any of these practices, so we suggest that he clip out the above paragraph and send it to the several fellows he undoubtedly knows who are violators.

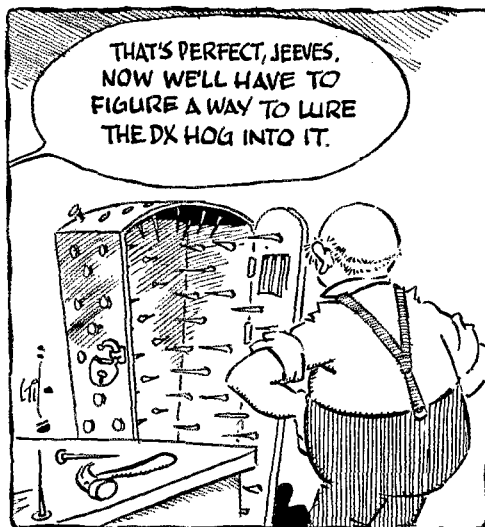

Lots of the stuff that goes on we blame on the receiving habits of the DX stations. One prize example is this business of calling the DX on its own frequency, for two minutes or so, in the hope that you'll outlast your rivals. The result is that the DX is covered up unless it comes back to the guy with the longest call, and by that time the others are calling again. The consequence is QRM galore on the DX and three or four minutes between ending a CQ and replying to a call. The sooner the DX stations get wise to *not answering* calls on their own frequency, the sooner they will speed up their contacts-per-hour. When they use LM, ML, HM and MH to indicate how they're tuning, they'll see their contacts-per-hour go up in a hurry. For example, UA3AW is just one guy who has control of the situation all of the time. And those long CQs by the DX! There are plenty of stations in this country who can hear two wires scratched together in Tibet or Niue, and those long CQs just waste time. Sure, we know, it's a swell feeling to find the whole band calling you, but it doesn't pay off in more contacts.

So let's all take a look at our operating, Ws and DX alike, and polish off some of those rough

edges. Who knows? We may end up with something that's a lot of fun — for everybody.

When:

Not much on 80 this month, except a note from W8NSR to say that he and a bunch of W2, W3, W8 and W9 were heard by ZL419 back in May, and W1OKU reports a contact with KS4AA (3690), who claimed to be on Swan Island. Could be, but "Jeeves, pass the salt!" The prefix is strictly from hunger, not the FCC. W5LDH raised KZ5AD and VO3O on the low-frequency band.

On 40, W1JLJ got S9 reports from HH2FE (7055), F3KH (7148), CM8DL (7140) and CM2BU (7210). He puts question marks after AO6E (7142) and TIMR (7155), quite justifiably. W5LDH worked FMSAC on 40, and W8PMJ grabbed off VK7DS (7180). At W5LIU it was ZL2PM (7190), J2AAF (7180) and VE8AS (7175), on 25 watts.

There is lots of stuff on 10 these days, although too many guys are keeping mum about it. But W8PMJ passes along CR7AD (28,020), ZE1JJ (28,200) and CX4CZ (28,000), and W2KIK adds VQ2FR (28,350), ZL1MQ (28,300), HK3DD (28,060), OQ5AE (28,290), CE1AH (28,250), PY1DE (28,255), KZ5AB (28,120 T9), CX2CK (28,620), VP6MR (28,280), ZS1BD (28,340), ZS6FU (28,080) and F8TU (28,450). W5LDH adds OA4F, OA4AI, LU2DM, LU5CZ, YV5AN, and CX5AY to the argument for 10, and W8TOB makes it ZS1T, YN1RA, VP6LN, HK3DD and KA1AW/MM. To clinch the whole thing, W5KUC lists VP4TK, VR2AB, VP3F, TG9LP and VP9F worked.

For all the DX-jaded lads who have lost their interest because there is no new stuff on these days, we have fellows like W6KIP reviving their interest by mentioning VU2AK (14,085), ZK1AB (14,125), K6HOT/KC6 (14,100) on Canton, VP8AD (14,085), PK6HA (14,060) and W6VDG/KW6 (14,170) on Wake. Alex says if you call VS7ES long enough, VS7AX will take pity on you and come back, on the same frequency. At least that's how KIP got 7AX! And if you've been hearing rumors of the West Coast working AC4YN (14,135), you have been hearing alright! W6VFR, ex-W9ANS, turned the trick one night at 0300 GCT and so breaks into the very select society of the TWA. W5ASG brought his postwar total to 65 and his all-time to 122 with stuff like ZP8CN (14,085), CP5EL (14,075), ZD8A (14,075), FMSAC (28,050), W6VKV/16 (14,080) in Eritrea, PK6TC (14,060), VS1BX (14,085), ZC4NX (14,080), VP8LK (28,000 T8), K7JFE/KG6 (14,120), W2LFI/FF8 (14,375 f) in Dakar, CR9AN (14,055) and J9AND (28,500 f). Bill heard PK1RI (14,050), EL3A (14,080), UAOKA (14,085) and VQ8AE (14,090). W4BPD, who struggles along with only three rhombics

and two Sterba curtains, managed to get a fair portion of the *Call Book* into his log. Here are a few: PZ1FM (14,170), VK4OS (14,150) in Papua, W6JIM/C1 (14,190), OE1XBC (14,075), EK4AZ (14,340), VS7AX (14,025), LZ1XX (14,090), C3YW (14,090), J9ABF (14,110), PK6AW (14,340 f), M1YS/VU2 (14,070), ZP6AB (14,035), UA9CB (14,070), PK5JN (14,100), W9CAC/TF (14,200 f), HH3L (14,080), and OE3WD (14,085). He missed YS1X (14,100), SP2RD (14,080), KA1AK (14,115), XU8NR (14,020) and OX1A (14,150 f). Gus worked VS4JS on JS' last day in Borneo, so there goes your North Borneo contact unless something else turns up. W7EYS kept busy with ON4PW (14,060), CX1DZ (14,075), PAONG (14,060) and G8UY (14,075), with VS1QB (14,090), I1KN (14,080), CR9AG (14,080) and XU1MB (14,150 f) in the heard column. Bob says the Africans should dig a little deeper around 2400 GCT for W6 and W7. Also he is quite conversant with the high type of operating on the band. For example, he heard LU9AX work a W2, a W9 in Chicago and a VE7 on three successive calls of "CQ Dakota only," and his own "CQ QSP I7" added two new states for WAS before he got what he wanted! W4BRB has all the makings of a good DX man. He grouches about a lousy location, how the guys in other districts have a better crack at the stuff, never has enough power or enough antennas, and in between times works CN8AB (14,090), ZC1AR (14,080), UA3CA (14,070), VP4TD (14,090), UA3AW (14,095), TI2MAR (7150 T5), WIDTS/CT2 (7155) and SUIUS (14,140). He missed OX3BB (14,075), EZ4X (14,045), PK6UA (14,065), VP2AT (14,040), OQ5LL (14,085), SV1AZ (14,055), Y13CE (14,055) and VQ4CRB (14,020). Gene likes 40 for Europe but says there aren't enough of them on. From WIDTS/CT2 he heard that the ZS and VQ gang is on the low end of 80 between 0600 and 0800 GCT looking for Wa. Any takers? W6PBV managed to keep his hand in by snagging OZ7UU (14,090), SM5OV (14,045), ON4WY (14,080), OK1FF (14,080), W5HHO/J2 (14,160), XU1YK (14,190) and W3BKU/J9 (14,085) in Okinawa, while W0NCS was busy with OZ3HR (14,080), CX1CX (14,085), WIDTS/CT2 (14,120), VO1G (14,080), TI2FG (14,040), XSM6UC (14,090) a ship in the Baltic, ZS5U (14,130) and W4FGW/J2 (14,080). W9VDA scared up VQ2GW (14,090), and W1KFV added UA3DA (14,030), YR5C (14,060) and TF5Z (14,030). Bob suggests times of QSOs instead of frequencies as being more useful information, which is OK with us if you guys want it that way and will pass along the dope. W5IOA in New Mexico likes the improvement his 200 watts appears to be over the previous 10 watts, but we imagine his next 13 db. will come a little harder. Anyhow, Mac latched on to OZ3J (14,035), W8WHW/KG6 (14,130), VP7N (14,005), J2ABC (14,100) and G2HD

(14,085) ····· At WSPMJ it was VK7LJ (14,125), ZE1JU (14,150) and VE8MR (14,150) at Resolution Island; and W1KMY added YR5X (14,050), LA2UA (14,173), UA3BH (14,080), CN8MZ (14,120) and a little gem calling himself YO5WZ, who drifts 40 kc. during transmissions ····· G6RH has a nice list of stuff heard or worked, the cream of which includes ET3Y (14,090), VS9AN (14,140), PZ1A (14,310 f), CR6AM (14,250 f), AC3SS (14,300 f, 14,200 cw), W3JLW/KH6 (14,120), FK8OSL (14,120), YI2CA (28,200 f), LX1BG (7090 f) and GC3GS (7250 f). Bob reminds us that we never told where that OY4C was who cropped up before the war. For those who have been wondering, he was undercover in — of all places — Germany! You may recall that he had QSL cards but no QTH on them.

The 'phone contingent is represented this month by a small but select group. For example, W1HKK is up to 78 postwar on 'phone with W5IBE/J5 (14,170), J9AAR (14,240), W2CDJ/J3 (14,340), W6QEE/J9 (14,250), VU8GA (14,055) and W9HJW/Saipan (14,190). Dana was having trouble with the neighbors, but from the looks of his list, those neighbors now won't come within a half mile of his whirling rotary! He says W1HMH heard AC4YN (14,080) and FN2A (14,130)! ····· W2MPA has a very long list, including ZP2AC (14,365), PZ1GB (14,280), W8QEN/CT2 (14,310), HC1FE (14,080), I1MT (14,070), VK6HL (14,140), W9NLF/J9 (14,225) in the Marshalls, W8CHT/J7 (14,180) at Hokioto, XAAP (14,340) in Greece, LH2A (14,100) in Trondheim, Norway, LX1AX (14,330) and VP7NF (14,335), and Ted heard AC3SS (14,300 and 14,170) ····· W6ITH also got some good ones, like D4OOU (14,350), VS1BV (14,270), D4ACR (14,310), G2PU (14,150), VR2JI (14,260), K6SCJ/KP6 (14,250), PK1AM (14,165), VS2BF (14,150) and YN1LB (14,020).

Where:

Let's run over the QSL business in a hurry, for the benefit of some of the newcomers to the DX racket. W cards for foreigners can go singly to a *Call Book* address, or in a bunch to a foreign QSL Bureau (see addresses in "Foreign News" in *QST* for forwarding). If you can't find an address or a QSL Bureau, send the card to ARRL Hq. and we'll try to forward it for you. To receive your own cards, be sure to have a self-addressed stamped envelope at your QSL Manager's (see any *QST* for addresses). Cards for GIs overseas using their own calls with a portable suffix are being sent to the district QSL Manager. For example, cards for W9HJW/Saipan that come through ARRL Hq. are sent to W9HLF, the W9 QSL Manager, unless we are notified otherwise, and HLF holds them for HJW's envelope.

We have a few cards on hand that we can't forward because we've lost track of the addressee or we never did get his address. If you have any information on the following, please let us know so we can clean out our cards: Prewar EL2R, HI7GW, HP1X, PJ1BV, PJ3CO, PJ5EE, PZ6ZK and YN9G, and postwar EP1A, FASB, HA4EA, TF1AA, TR1P, YR5W, ZA2X, 3A, X2CC, X2XX.

Speaking of QSL Managers, W1CH asks us to put in a plug for W1BGY, the W1 QSL Manager, and the swell service he gives the gang. We know that, but we'll go one better — we'll put in a word of praise for all of the QSL Managers, who have such a tough job and give of their time so willingly. The next time you send in your envelope and your hopes, tell the guy you appreciate what he's doing.

If you hear OK1AWX, it's OK1AW operating portable in the mountains, says W4ITR ····· The QSL address of VS7ES (14,060) is Nr. 5 Elibank Road, Havelock Town, Colombo, Ceylon ····· VP5AD, QSL Bureau for Jamaica, says VP5AR is a pirate, which is his polite designation for what we'd call a phony. The new *Call Book* gives the complete list of VP5 calls, with the exception of VP5JC ····· Advance dope from the W.I.A. is that the VK Contest will be held during the first two weekends of November. We don't have the rules in time for this issue, but presumably they will be the same as other years ····· W5ACL is a staunch champion of the underprivileged, and is firm in his belief that too many little fellows are letting the big guys override them with their modern plastic-and-chrome kilowatts. His cry is "Don't surrender to the California kilowatts and the six-element rotaries!" To show that he isn't giving up, he eases 200 watts into an old pair of 800s — remember them? — and comes up with all kinds of stuff. Myron says a card addressed "VK4OS, Port Moresby, New Guinea" is adequate ····· QSL TA1DB via HB9U, and YR5X via HB9AG ····· During recent contacts, W8HGW collected some addresses that may help: W6VKV/I6, A.P.O. 843, N.Y.C.; ES5K (14,090), Box 273, Parnu, Estonia; EO4DC (14,165), QSL care of W9RRRT; EK1AZ (14,140), D. Crews, Box 57, British Post Office, Tangier Zone ····· W1DTS/CT2 cards should go direct to W1DTS, 18 Veazie St., Oldtown, Maine, according to W9IHN ····· That address we gave for W1KUY/MM a few months ago — care of Bob Evans, Balboa, C.Z. — was intended only for flight officers of PAA working in Central America. Your cards should go to C. B. Mould, W1KUY, Williamstown, Vermont.

Who:

W9VES/3 had access to 10 rhombies while in Washington, and he says with 100 watts he could really work some of the stuff. He worked some-

thing like 300 Gs, and a lot of other Europeans. Now he's back at Chicago and undoubtedly missing the rhombics — or building one! Last month we accused TG9PB of passing out "mass-production" contacts, because that was how it was told to us. We were called on it, and rightly so, because PB does not do as we claimed, but specifically states during his transmissions that the reports cannot be considered two-way contacts. The heard calls are not logged and thus no QSL card can be forthcoming. We're very glad to apologize, since our faith is completely restored W5LDD has the prize item this month. Now get this. There will be no more c.w. from TG. The government can't monitor it! Anyone volunteer for the job? Lou also says that W5 Little Dew Drops is now W5 Little Drool Drops, after meeting four YL student hams at W5GMG. If he gets tangled too much, he will be W5 Little Dead Duck Ex-D4AKO has a little about the D4s in Frankfurt. D4ACD with only 40 watts and a 700-foot wire had over 50 countries on 10. AKO got up to 39 on 10 'phone with 500 watts and a three-element beam that had only two elements because he ran out of tubing W9FO of the *Call Book* gang ten years ago is now W1ONV in Hingham, Mass. VS9AN gave him his WAC from the new location W1FH has 114 countries — 83 on 'phone — post-war. W3BES has 111, W1CH is up to 104 with 150 watts, and W9FS has 93 Cards for EL4A should go to Cliff Evans, APO 605, PM, Miami, Fla. W2IOP takes care of the outgoing cards — Larry gets lists from the EL and shoots out the cards. EL4A is old W1BYG, has 31 countries from Liberia, and will be there for a year or more G6KS urgently wants New Mexico for WAS, according to G6KS. W5IOA is your man There are two active stations in Mhow, Central India: VU2AB and VU2AD. QSLs should go care of R.S.G.B. Other VU stations known to be active are VU2WP, VU2WM, VU2LR, VU2BC, and in Burma, XZ2DN, XZ2DA, XZ4AR, and XZ4AQ W6WN was sorely tempted — but resisted, to his eternal credit — to sneak outside the band in an effort to raise XU4B (14,120) in Mongolia. Art says the guy gives his home address as 604 Gurley Avenue, Downey, Calif. . . . It is not uncommon these days to hear DX men discussing the reasons for their not getting out as well as they used to. W1TS, a philosopher and DX man of the old school, is satisfied with his explanation. He admits that his antenna is made of old prewar copper wire, and he thinks the old copper is acting as a copper-oxide rectifier — it allows the signals to come in but nothing can go out! It always happens this way. W6TZB/K6 was up to 50 countries and still no WAC, Europe being tougher than somewhat from Hawaii. Finally, after several months of stalking, Bob snagged PA0NG for the sixth continent and, to clinch

the deal, raised a G on his next CQ! W2MPA ate three orders of chop suey and came up with this thought-for-October: "This Month's Celestial Observation — DX stations transmitting on honorable rhombic and receiving on 2-meter 'J' should blow fuse!"

— W1JPE

Silent Keys

IT IS with deep regret that we record the passing of these amateurs:

W2EPM, Paul Pfeffer, Brooklyn, N. Y.
 W2LXY, Emanuel B. Finkel, Elizabeth, N. J.
 W3GWI, William R. Potter, Kensington, Md.
 W4GBW, Ensign Roger M. Allen, Sumter, S. C.
 W4VL, George E. Olson, sr., Columbia, S. C.
 W5DZU, Andrew A. Ellis, Edmond, Okla.
 W5KFR, William B. Gaydosik, Houston, Texas
 W6MXX, Ralph E. Henry, San Gabriel, Calif.
 W8FO, James W. B. Foley, Toledo, Ohio
 W8UXP, James B. Joslin, Toledo, Ohio
 W9PGT, Donald A. Spaulding, S1c, USNR, Chicago, Ill.
 W9QI, Lawrence Barregarye, Springfield, Ill.
 W3KRM, Lt.(jg) Frank J. Weiland, Washington, D. C.
 G15MZ, Wing Commander F. N. MacDowell, RAF

Strays

Aircraft receiver QRN, artificially created by metal planes in flight, is eliminated by the use of an Army-Navy wartime development, a dozen small whip dischargers trailing from the wing and tail surfaces of the plane. The whips are made of cotton rope-like material, 10 inches long, impregnated with a silver compound which affords a high-resistance unit. United Airlines is replacing trailing-wire tail-cone dischargers with the new device.

—

Novelty, Missouri, is the only Class-C QTH in the state (farther than 125 miles from an FCC examining point), according to our map at Hqs.

—

A snowflake carries a static charge that is estimated to be equivalent to 17,500 electrons.



Hints and Kinks

For the Experimenter



FOLDED DOUBLET FOR 3.9 MC.

FIG. 1 shows a folded doublet for 3.9 Mc. constructed of 300-ohm Twin-Lead. Electrically this antenna has done a fine job, permitting a

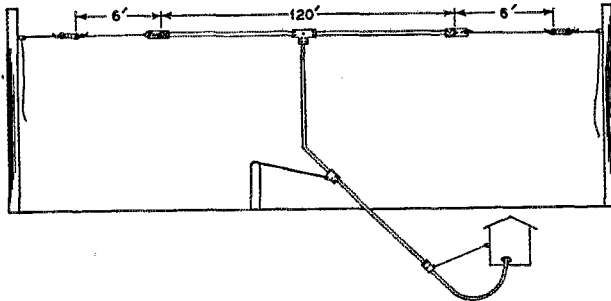

Fig. 1 — Dimensions of a folded doublet using 300-ohm Twin-Lead. Details of the center and end attachments are shown in Fig. 2 and 3.

low-power signal to get out through the QRM in the crowded 75-meter band. Mechanically, it has a few novel wrinkles that have solved the problem of how to prevent the 300-ohm line from fraying and eventually breaking at the vulnerable joints.

A T-shaped clamp made of two sheets of $\frac{3}{16}$ -inch canvas-base Formica bolted together with 6-32 brass machine screws is used at the junction of the flat top and the feeders, as shown in Fig. 2. At the ends of the flat top clamps made of $\frac{1}{16}$ -inch aluminum are used as shown in Fig. 3. This construction permits the use of a 6-foot length of No. 14 solid enameled wire at each end of the antenna for adjustment of antenna length. It is much simpler to adjust the length this way than by

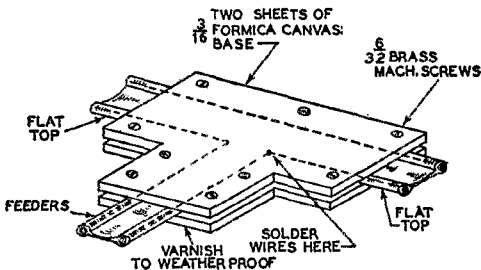

Fig. 2 — The center bracket used to relieve the strain from the junction of feed line and antenna.

clipping and then resoldering the Twin-Lead. Similar clamps of $\frac{3}{16}$ -inch Formica are used to support the feed line. At the entrance to the shack, a standard large-size porcelain tube feeds the line through the wall. The length of the feed line does not seem to be critical.

I found it necessary to cut this type of antenna longer than would be expected using the customary length formulas; about 132 feet total (including the 6-foot trimming pieces) produced optimum loading at 3.9 Mc. Another station using a similar set-up found the same thing, making use of the solid-copper-wire ends almost imperative if any length-trimming is contemplated. — Philip S. Rand, W1DBM.

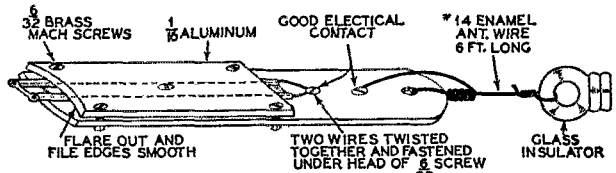

Fig. 3 — The end clamps are used with a 6-foot length of solid wire to permit length adjustments as described in the text.

WEATHERPROOFING 300-OHM TWIN-LEAD

THIS may help some of the gang who are experiencing serious detuning of their 300-ohm Twin-Lead feeders during wet weather. The venture is not at all costly, and no doubt will solve the difficulty in most cases.

The Twin-Lead was snaked through some spaghetti tubing with a wire. Thus the entire feed line was encased, and the end sealed tightly at the junction between the feed line and the antenna.

During a recent heavy rain, no change in loading of the final amplifier was noted over a period of two hours, whereas changes in plate current up to 50 ma. had been caused by even a slight drizzle before the line was encased. The losses (if any) in my case seemed negligible. — Gordon W. Brown, W1LLL

Looking Over the Postwar Receivers

The RME-45

THE first unit of postwar receiving equipment to be announced and widely distributed by Radio Manufacturing Engineers, Inc., is the RME-45 communications receiver. In general, it seems to be no great departure from prewar technique, although it has some interesting innovations and definitely shows the influence of modern trends. The receiver and its companion speaker cabinet are both finished in gray crackle with dull black trim, in conservative modern styling. The receiver chassis doesn't occupy every available inch in the cabinet, and this fact coupled with the inclusion of generous louvres on the sides and back of the cabinet should result in a low temperature rise and consequent low drift.

In general, the receiver is built along conventional lines:

one stage of r.f. amplification, converter and two stages of i.f. amplification, with the crystal filter between the converter and first i.f. stage; diode second detector, b.f.o., noise limiter, and two stages of audio amplification. All of the tubes in the receiver proper are of the lock-in type, and the full complement is shown in Fig. 1, a block diagram of the receiver.

The 7B7 is a remote cut-off tube resembling the 6K7 in characteristics. The 7J7 is similar to the 6K8, the 7B6 is a duo-diode high- μ triode, the 7A6 is the lock-in version of the 6H6, the 7C7 is

almost identical to the 6J7, and the 7C5 is a 6V6 counterpart. The use of the duo-diode triode for second detector and b.f.o. is unusual, in contrast to the more conventional use of the dual-purpose tube as detector and first audio, and it is shown in detail in Fig. 2.

Panel controls include a combination line switch and tone control, r.f. gain control and a.v.c. switch, headphone jack, band-selector switch,

b.f.o. pitch control, b.f.o. switch, audio gain control and noise limiter switch, and send-receive switch. The panel also includes the S-meter, the main tuning dial, the crystal-selectivity switch and the crystal-phasing control. The headphone jack is on the left-hand side of the panel, where the headphone cord is least likely to interfere with one's

operations of brass-pounding, log-keeping, note-scribbling and such. The band-selector switch and the send-receive switch both use lever-type knobs which make the business of using these two controls less of a chore. Six bands are available through switching: 0.54 to 1.6 Mc., 1.6 to 2.9 Mc., 2.9 to 5.4 Mc., 5.4 to 9.8 Mc., 9.8 to 18.0 Mc., and 18.0 to 33.0 Mc. Line cord, speaker plug, S-meter adjustment and balanced- or single-wire input antenna terminals are provided at the rear of the chassis.

The RME-45 features full mechanical band-

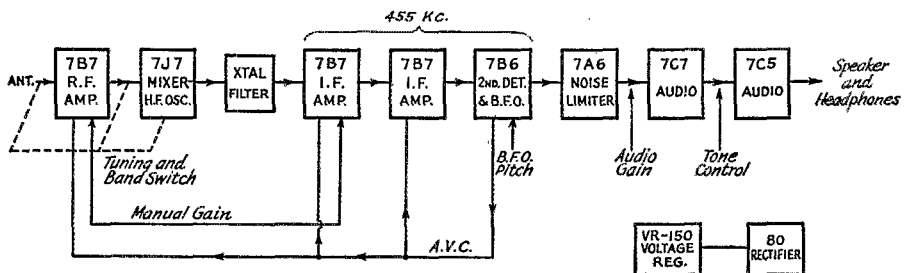

Fig. 1 — Block diagram of the RME-45 receiver.

spread, instead of the more common electrical bandspread. Two coaxial knobs are used for tuning — a large one set against the panel requires 80 revolutions to tune the condenser gang 180°, and a smaller knob in front of the large one is used for fine tuning and requires 385 revolutions to tune the condenser through its range. The receiver we examined showed absolutely no trace of backlash with either knob, a rather amazing condition considering the magnitude of the reduction. The dial is a full-vision affair with a pointer, and each scale is directly

calibrated in frequency. All ranges are visible at any time. As the pointer moves across the dial and through an amateur band, a smaller dial rotates behind a fixed pointer and, since this small dial is graduated in 5- and 10-kc. divisions, close readings of frequencies in any amateur band can be obtained. It is unlikely that the calibration of every receiver is exact — our sample was 50 kc. off in the 14-Mc. band — but it should be no trick for the owner of the receiver to adjust the oscillator trimmer on each range to bring the amateur-band dial into close agreement with the true frequencies, since the trimmers are readily available at the bottom of the receiver. Once this has been done, the ability to switch between bands without having to reset any additional tuning control should be a rather handy feature, although all of the amateur bands do not fall in the same portion of the dial and it is necessary to spin the fast-tuning knob to get from one ham band to another. An idea of the bandspread obtained can be gained from the knowledge that 6.6, 2.0, 1.5 and 3.6 revolutions of the large knob are required to cover the 80-, 40-, 20- and 10-meter bands respectively. Using the smaller knob for tuning, these figures of course increase in the ratio of 385 to 80, or about 5 times.

The r.f. gain control changes the cathode bias on the r.f. and the first i.f. stages, while the a.v.c. controls these stages and the second i.f. amplifier. The crystal-filter selectivity can be varied through five steps by the selectivity switch, and the range varies from usable 'phone selectivity to good single-signal c.w. reception. The "off" position throws the crystal filter out of the circuit. The filter is of the type introduced by Hammarlund in 1938, that seems to be widely used in communications receivers these days.

The a.v.c. voltage is derived from the second-detector load, and consequently there is no delay bias for the a.v.c. This may have been done to enable the S-meter to work at the very lowest signal levels. The S-meter circuit is the usual bridge affair, and this one measures the voltage drop across the cathode bias resistor of the second

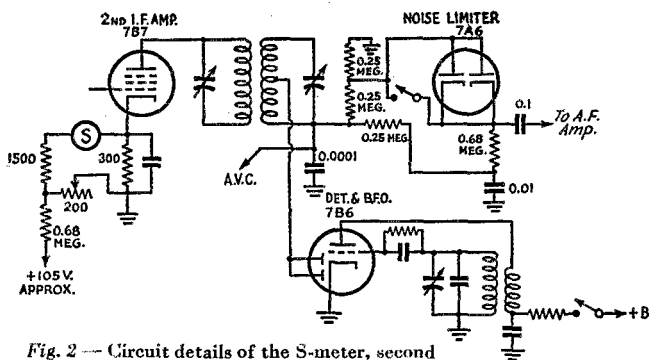

Fig. 2 — Circuit details of the S-meter, second detector and b.f.o., and noise limiter.

i.f. amplifier stage, as shown in Fig. 2. The dual meter scale is calibrated in db. above S1, up to 96 db., and it also has a conventional "S" scale from S0 to S9, in 6-db. steps. The meter is illuminated, and dignified by the title "Carrier Level Indicator." The designation is probably more accurate than "S-meter" because, like all such available devices, it can't be used with the b.f.o. turned on.

The noise limiter is of the series-diode type, using both halves of the 7A6 in parallel. The limiter adjusts itself automatically for different carrier levels, and this feature renders it useless when the b.f.o. is on. The noise-limiter switch is connected to the audio gain-control shaft so that when the gain-control knob is pulled out about ¼ inch the limiter is turned off. Pushing in the knob turns on the limiter, and in either position the audio control is used in the normal manner.

Regulated voltage from the VR-150 is fed to the high-frequency oscillator plate and to the screens of the converter and second i.f. stages. Mica trimmer condensers are used in the i.f. transformers and the signal-frequency stages.

The send-receive switch has three positions: "Standby," which leaves only the heaters of the tubes turned on; "On," which turns on the plate power, and "Transmit," which removes the plate power. Through terminals at the rear of the receiver, an external circuit can be closed in the "Transmit" position, permitting complete station control through the receiver switch, or through another set of terminals the receiver plate power can be controlled by an auxiliary relay or switch if the receiver switch is left in the "On" position.

The instruction book furnished with the receiver is complete in its servicing recommendations, alignment procedure description and parts list. However, no information is available from it as to production-test limits of sensitivity, selectivity, a.v.c. and gain-control action, or any of the other performance characteristics that might be of interest.

— B. G.



The World Above 50 Mc.

CONDUCTED BY E. P. TILTON, * W1HDO

THE plight of the Class B 'phone men still seems to be getting a lot of attention. It is said that, with the 160-meter-band withheld, the Class B man has only the 10 meter band where he can do business. In correspondence coming in to Headquarters almost daily we see evidence that the radio spectrum begins at 30 Mc., in the opinions of a great majority of all amateurs — yet hundreds of us have been doing all right on another band. On our band many have done outstanding work with less than 50 watts input; many make out all right in isolated and otherwise “poor” locations; scores of us have worked 20 or more states; quite a few of us have excellent nightly coverage up to 150 miles, and some of us work up to 350 miles more often than you'd think possible. QRM is almost unknown, and there is an “esprit de corps” in our gang that is unexcelled in amateur radio. There's room for every “displaced person” from the 160-meter band or any other band, and newcomers are welcomed with open arms. It's 6 meters, of course — come up and see us some time!

Let's look over the record and see what's been done on 6 meters in the first six months of its existence as an amateur band. Bearing in mind that every piece of gear used to date on 50 Mc. had to be adapted from something else, or built from scratch for the purpose, we think that the boys on 6 have every reason to be proud of the accomplishments listed below:

1) More contacts have been made at distances beyond 2000 miles than were made in the entire history of v.h.f. operation before the war.

2) At least six stations, WØYUQ, WØZJB, WØBJV, W9ZHB, W5JGV/7, and W2BYM, have worked all call areas, W2BYM being the first Eastern station to make it in the history of v.h.f. work.

3) At least seven transcontinental contacts have been made. These include W2BYM-W6OVK, W6NAW-W1LLL, W6NAW-W8CIR/1, W4HVV-W6ANN, W4HVV-W6FMH, W4HVV-W6QG, and W4CYW-W6ANN. Only one transcontinental contact (W1EYM-W6DNS) was made in all the years of work on 56 Mc.

4) An all-time v.h.f. record for miles-per-watt was set by W6RVL, Los Angeles, California, in working W8QYD, Dayton, Ohio, a distance of

RECORDS

Two-way Work

50 Mc.: W6OVK-W2BYM
2500 Miles — June 14, 1946

144 Mc.: W3HWN-W1KOE
310 Miles — July 5, 1946

420 Mc.: W6VQB/6-W6URA/6
96 Miles — July 5, 1946

2300 Mc.: W1JSM/1-W1LLS/1
1.6 Miles — June 23, 1946

5250 Mc.: W2LGF/2-W7FOF/2
31 Miles — December 2, 1945

10,000 Mc.: W4HPJ/3-W6IFE/3
7.65 Miles — July 11, 1946

21,000 Mc.: W1NVL/2-W9SAD/2
800 feet — May 18, 1946

1900 miles, with a power of 3.5 watts.

5) Work is going on in several localities, over distances up to nearly 400 miles, without the aid of sporadic-E skip.

A glance at the “states-worked” column in this issue shows that eleven of the contestants in all parts of the country had worked 15 or more states on 50 Mc. before the end of July, and these who report their contacts are but a fraction of the active stations. Many fellows, some of whom never hear a signal on 6 except when the band is open for skip, have worked 50 or more different stations. Who does this work, and with what sort of gear? No, these fellows are not supermen, with mountain-top locations, kilowatt rigs, and acres of antennas at their disposal. Most of them are just garden-variety hams, who are really interested in what they are doing — fellows who are riding their hobby for all it's worth, and having a swell time of it, as a result. Like W6RVL, quite a few are using as little as 3 or 4 watts input, and practically all are running “low power,” in comparison to the layouts used for the QRM battle on the lower frequencies. No place for the Class B ham?

- - - - -

What is the DX season on 6? After the big blowout in late July, a traditional feature of the v.h.f. DX season, we looked for the beginning of the end, for another year. By the first week in August it used to be all over, and experience on 50 Mc. is somewhat similar, but the sporadic-E

* V.H.F. Editor, QST.

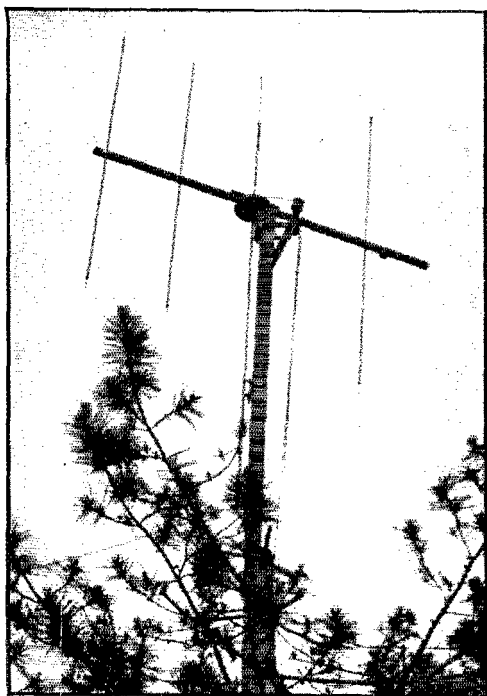

Not all 50-Mc. arrays are horizontal. W2EUY, Riverton, N. J., uses this 4-element rotary to work the vertically-polarized stations down Washington way.

skip has been holding up longer than we expected. During the month of August, skip-DX was worked on at least 16 days, with the last opening reported to date being on the 24th. Openings have been brief, and signals none too strong or steady, but contacts have been made almost daily, even so.

Observation of the 28-Mc. band showed it to be open for F_2 skip regularly during the month of August, often with signals running very strong and steady for long periods at a time. The maximum usable frequency is reaching 40 Mc. already, and before long it will be passing 50 Mc. in some sections of the world. By the time this appears in print, there should be a definite possibility of DX contacts on 50 Mc., if stations are on in the right places at the right time.

The right places include the southern part of the United States, Puerto Rico, the Azores, the Hawaiian Islands, and the many other tropical and semi-tropical locations. We hear that W1DTS/CT2 is interested in the possibilities of work from the Azores, and W1NSS, recently returned from the Hawaiian Islands, says that there is a certain amount of interest out there. We hear KH6AR running listening tests with W6PBD on 10 and W5JGV/7 on 6, and understand that Ken is getting set to do some transmitting on 6 as well. In Puerto Rico, K4KD and others promise to be working on 6 before the

peak of the fall season.

In England, G5BY continues his schedules, still without positive results, as far as reception in this country is concerned, though he is working into the Continent occasionally. On July 21st, F8RSN, F8BC and F3JB were worked with S9 reports. Several "heard" reports have been received from Switzerland, but no HB contacts have been made by G5BY. On July 8th a new inter-G record was set by working G8UZ, a distance of 256 miles. Skip often is in evidence on 50-54 Mc. when signals are not heard in the 58.5-60 range, as evidenced by the presence of numerous commercial harmonics, which always appear on 50 Mc. first, and then, a few minutes later, on 58 Mc. if a good opening is coming. On August 3rd, between 2012 and 2030 GCT, the following c.w. was heard on 50.7 Mc.: "NBBY V NBVW QTC OP OM OP K." The call NBWW also figured in one transmission. On Aug. 4th, at 1745, the following was heard on approximately 52.5 Mc.: "W?? de KYL QTC K." These signals were obviously harmonics, apparently of U.S. origin. Can anyone tell us more? The Sunday transmissions of G5BY (see July *QST*) will be continued into the fall, in the hope of contacts, or reports, via F_2 skip.

A note from HB9AT, Berne, Switzerland, says that he is active on v.h.f., but gives no details.

From at least a dozen sources we have word that signals are being heard in South Africa on 50 Mc. All our efforts to track this rumor down have availed us very little in the way of concrete information. From ZS6Z we learn that a listener "heard W1JLK on 5 meters at approximately 3 A.M. in early November, 1945," but no other details are given. Another signal reported heard by the same listener was W7EYN. ZS6Z has no information on any 50-Mc. reception in recent months, and ZS6DW, from whom the reports emanate has nothing more than the report that signals have been heard.

— . . . —

Around the Country on 6

An antenna helps! To get going on 6 quickly, W1HDF, Elmwood, Conn., rigged a temporary set-up using an RK-34 in the final stage, running 24 watts input. The antenna was an indoor doublet. Results: not much. Then a duplicate of the 4-element horizontal array described in these pages in June *QST* was erected. Results: plenty! Even with this low power, Carl is putting a very respectable signal into the Boston area, and into New Jersey, both points 100 miles or more distant. With a 3-element horizontal, W1KJC, in nearby Wethersfield, is also working out well with 30 watts or so to an 815. Both these fellows worked W8CIR/1 at Mt. Agamenticus, near York, Maine, on August 24th, a night when conditions were below average. W1KJC and W1HDF

are both below 100 feet elevation. The Maine location of W8CIR/1 was only a few hundred feet above sea level, and Ed's mobile job was running about 12 watts input. He, too, had a beam — 3 elements, horizontal, arranged for portable use. Maine contacts were provided for many other W1s, and W8CIR's prize contact was with W2BYM, Lakehurst, N. J., a distance of 280 miles. All this with no help from any favorable propagation conditions!

On another expedition earlier in the month, W8CIR/1 operated from Mt. Washington, N. H., highest point in the Northeastern part of the country. This trip would have been a complete flop, but for the fact that Ed had the foresight to equip his mobile job for keying. At the mountain top the speech amplifier quit, and yet W8CIR/1 contacted stations all over New England, and worked W2AMJ and W2BQK, both of Bergenfield, N. J., a distance of 285 miles, pounding out the whole session on c.w.!

Something quite different from the famous California Kilowatts is used on 6 meters in the Los Angeles area. Many of the gang are using converted MBF transmitter-receiver units. With one of these 3.5-watt jobs, W6RVL worked W8QYD, Dayton, Ohio, and quite a number of contacts have been made with W7s and VE7s by the L.A. gang, including W6s VIC, DMK, TJV, AOR, BWG and VDE, who are all using the MBF rigs. W6GQ, Santa Ana, was using one, and he worked his share of the DX with it, even with a simple dipole antenna 18 feet above ground. Ray has since graduated to a 100-watt rig, with some improvement in the percentage of stations raised.

What would we do without those commercial harmonics? Some of those fellows really get out on 50 Mc., even if the harmonic is the third. The stations reported by G5BY (see above) are probably in that category. Two who make a lot of noise around these parts, and are reported occasionally in the Middle West, are WKR, heard almost constantly on about 51.5, usually with m.c.w., and WCC, about 50.6. A station running foreign-language broadcasts has been heard by WØZJB on 53.6. This one is probably here in the East, as it is heard in W1 now and then also. Still another, as yet to be identified, runs high-speed telegraphy near the high end of the band. It might be well to keep watch for those 34-Mc. air beacons from "Down Under," as a clue to high m.u.f. in that direction. W5LIU, Fort Worth, Texas, has heard SY, Sydney, Australia, recently.

Looks like big doings at Topeka on October 5th and 6th. The Midwest Division Convention is being made the occasion of a big v.h.f. meeting. Latest reports indicate that v.h.f. enthusiasts, including the writer, are coming from far and wide, and "See you in Topeka" is becoming the watchword.

V.H.F. MARATHON			
Call	Contacts Through July		States Worked
	50 Mc. 144 Mc.	285 Mc. Score	
W1AEP	47		395 14
W1BDI/1*		14	36 2
W1BCT*		119	526 4
W1CGY	35		287 14
W1DXL		46	216 5
W1EJN	44		366 14
W1EDQ ¹	37	99	1478 24
W1JNX*	7	83	298 1
W1KLR		48	354 2
W1LLL	35		573 23
W1LMU		106	384 3
W1MBS*		113	353 2
W8CIS/1	102		864 22
W2AMJ	78		641 23
W2BQK			454 17
W2BYM	93		755 22
W2COT	9	8	51 3
W2DZA		141	598 5
W2EFO		127	790 5
W2EKO		173	714 8
W2PWP	69	15	603 17
W2QVH		172	685 4
W3BKB		31	158 4
W3BTP*		40	187 1
W3CGV	26	39	267 7
W3GKP*		72	451 5
W3HWN		105	392 7
W3KIE		61	291 3
W3LN*		113	590 5
W3RUE	21	6	328 12
W4CDG/3*	9	90	532 6
W4HVV	32		574 15
W6SLO/5	17		181 11
W6ANN	61		688 11
W6BWG	16		37 1
W6NJJ*		194	950 1
W6OYK	9	23	274 6
W6QG	31		342 8
W6RVL*	96	138	648 4
W6TGY*		33	88 1
W9LLM/6	11		58 3
W7QAP	27		528 11
W5JGV/7 ²	52		1212 19
W8NJK	15	4	85 7
W8NOR	6	35	265 3
W8WKE		7	30 1
W9AB	12		77 5
W9ACU	8		84 2
W9ALU	10		102 5
W9NCS	28		228 8
W9PK	37		324 14
W9UNS	16		213 11
WØYUQ	55		678 18
WØZJB	85		942 22

* Includes portable or mobile operation.

¹ Not eligible for award.

² W5JGV/7 winner for July with 822 points.

The promotion of interest in extended-local work goes on meanwhile. WØZJB and WØYUQ now have WØJCQ, Riley, Kansas, in on their nightly skeds. These fellows are also running tests with WØNFM, Solon, Iowa, and contact has been made on several occasions by ZJB and YUQ, the distance being about 250 miles for ZJB and more than 300 for YUQ. WØJCQ, 18 miles from Manhattan is hearing NFM, but no contact has been made, as yet. W9ZHB, about 400 miles, is the next target. Another jump over which tests are being made is the rough jump from

Tucson to Douglas, Arizona. Mindful of the workouts of W6QLZ and W6OVK over a similar distance in the opposite direction from Tucson, W7QAP and W5JGV/7 hope to make it, eventually. There is plenty of rugged country in between, but it should not be impossible.

The best distance worked in the East on 5 in prewar days was the hop from New England down to Washington, D. C., managed, on occasion, by stations situated in the better locations. No one has yet made it on 6, except by means of aurora or sporadic-E skip, but the signals of W1KMZ/3 have been heard, and Rick is hearing several W1s occasionally. From Waltham, Mass., to Washington is close to 400 miles, yet W8CLS/1 and W1KMZ/3 have heard each other several times. W1EYM, Fairfield, Conn., has worked W1KMZ/3, a distance of about 275 miles, and W1LLL and your conductor have heard, and been heard by, W1KMZ/3, 315 miles. This all started after W1KMZ/3 turned his array over horizontal, matching the horizontal beams of the W1s.

Getting that radiation angle down is the primary aim in this sort of work. WØYUQ uses two 3-element arrays, one a half wave above the other, fed in phase. This gives an improvement of 6 db. or more in the long-haul work. Thinking to improve matters, WØZJB raised his 4-element job from 24 to 40 feet (with the able assistance of YUQ and JCQ, who made the 300-mile round-trip for the purpose) and now signals are not as good as they were with the array at the lower level. Sufficient time has not yet elapsed to determine whether this is the result of antenna height or propagation conditions, however.

Last month we listed Kentucky as one of the states where no resident activity had been reported on 6. Now we hear from W4JML, High Splint, Ky., who will be on just as soon as he can get a converter. That has held a few others back that we know of, too! He wants to know if there is any activity elsewhere in his state.

We often hear of 2-meter gear being used to assist in timing and checking of athletic events of various sorts, but here is an instance reported by W6NAW, where 6 was used effectively for such work. At a recent water sports carnival, the Santa Monica Mike and Key Club had transmitters in boats and at the public-address system, used to relay information to the spectators direct from the scene of action.

What About Two Meters?

As an amateur band, 144 Mc. is also new. When the allocation was first announced many of us didn't think too much of the idea. We had enough trouble getting gear to operate efficiently on 112, without moving another 32 Mc. higher in frequency. Yet move we did, and with surprising results. We have now completed a summer season, and we've had a chance to see what really

More 50-Mc. Frequencies

W1GLH Bridgeport, Conn.	52.0 Mc.
W1IYO Milford, Conn.	50.005
W1JLK Woods Hole, Mass.	50.32
W1LQO E. Providence, R. I.	50.1
W2OPQ Schenectady, N. Y.	50.4
W4FNR Miami, Fla.	52.8
W4JML High Splint, Ky.	50.5
W6QQ Santa Ana, Calif.	50.7
W6RVL Los Angeles, Calif.	51.6, 51.84
W6UHC Glendale, Calif.	51.5
W6JQC Riley, Kansas	50.4
VE7AEC Ioco, B.C.	51.6
VE7MB Burnaby, B.C.	52.0
VE7BQ Vancouver, B.C.	50.8
VE7NM Vancouver, B.C.	50.6
VE7VY Vancouver, B.C.	50.2

can be done. Literally thousands of stations have flocked to the band, and in several areas work beyond 200 miles has become quite common. Several contacts have been made beyond 300 miles, and it is probably only a matter of time before the 355-mile record for 112-Mc. work will be equaled, or even surpassed.

While a large part of the work has been done with the simplest sort of gear, there have been sizeable groups in some parts of the country, notably in W3 and W6, whose transmitters, receivers, and antennas have reached a stage of development comparable to the best to be found on any amateur band. We had an opportunity to observe this fine state of affairs first hand recently, when we attended the York (Pa.) Radio Club hamfest. Visiting the shacks of W3HWN, Mechanicsburg, and W3BKB, York, was an enlightening experience. There we found whole station layouts devoted entirely to 2-meter gear, and they would stand comparison with the finest low-frequency stations. Nicely-built crystal-controlled transmitters, selective smooth-working superhets, high-gain beam antennas with automatic rotating devices — such things are almost standard equipment for 2-meter work in that area. We had the novel experience of being able to copy practically every signal we could pick up on our mobile superhet, without asking anyone to back off on the audio. Even quite a few of the mobile jobs at the Hamfest were crystal-controlled. These fellows do it *right*, and the results they get are the best justification of their technique!

From them, and from others interested in the advancement of the art, we hear expressions of concern over the future of the 2-meter band. Anyone who has operated in any of the areas where there is appreciable activity cannot but realize that 2 will soon reach the state that overcame 5 in the days before the stabilization. The very ease with which fellows can have fun on the band may soon turn out to be a curse as well as a blessing. Already we have reached the saturation point, where QRM is the limiting factor rather than conditions, location or equipment. What is the answer?

Not a few are arguing for stabilization regulations, but we feel that this is not the solution. On the basis of present conditions, at least, we are unalterably opposed to any such move, and we know that the vast majority of 2-meter men feel the same way. A likely suggestion is offered by W6OVK. Let those of us who use crystal control or its equivalent concentrate our activity in the first megacycle of the band, or within 200 kc. of the high end, and those who use modulated oscillators, or other rigs incapable of being received on a sharp superhet, stay between 145 and 147.8 Mc. It is hard to see how this could do anyone any harm, and it would work to the advantage of both groups. The low-powered oscillator rigs would be free of QRM from the more potent crystal-controlled stations, and the boys who want to use advanced techniques will be able to do so without the hash (and it is a pretty awful sounding mess!) of the modulated oscillators smearing their every effort.

The important angle in all this sort of thing is that it is a matter of individual cooperation and initiative. There should be no compulsion about it — it must be a matter of all of us working together for a common end. We've talked it up a bit already, and find no objections on either side. Let's think it over!

— . . . —

Needed: more careful listening! Many opportunities for long-haul contacts are being missed because so many fellows fail to appreciate the possibilities of the band. The boys in Pennsylvania and Maryland told us that they hear W2s and even W1s, night after night, and only occasionally are they able to work them. W3GKP, Silver Spring, Md., says that time and again he hears W2s coming through with good readable signals, working each other and gloating over "DX" contacts of 40 miles or so, when they are actually getting out to distances of 200 miles or more! W3BKB, W3HWN, and others join in the plea: "Tell those fellows up there to look around the band once in a while, and not stop at the first S9 signal they hear!"

Another of those Pennsylvania W3s who is going places on 2 is W3KIE, Lancaster. John has solved the vertical-horizontal question in a novel manner, and is set to give anyone "the works" with either polarization, with one array. You've guessed it — a plane reflector, with vertical elements on one side and horizontal on the other. The array at W3KIE is something to behold: the vertical portion is composed of 12 half-wave elements in phase, 4 high and 3 wide. The horizontal side has 10 half-waves in phase, 5 high and 2 wide. The screen is chicken wire, 2-inch mesh. Despite the fact that the location of W3KIE is lower than much of the surrounding terrain, signals from the New York area are heard on the better nights,

The work of these W3s is the more impressive when one considers that they are well inland, and consequently are not blessed with the degree of bending that is an almost nightly affair along the coastal areas. When the right conditions are set up (and this happens pretty often close to the seacoast) you can work 200 miles or more with almost anything. Farther inland it is definitely a different story. You don't work DX from Mechanicsburg, Lancaster, or York with 5 watts input and a folded dipole in the attic!

— . . . —

Two meters is a late band. The summer and early-fall temperature inversions take no account of the need for sleep, and much of the best DX is worked by the night owls who stay with the band until the last signal is gone. Practically all our records and near-records are in this category, and here are a few examples of DX work done during the wee small hours in the month of August, and in late July. July 30th-31st: W2VH/1, Scargo Hill, E. Dennis, Mass., worked W3GQS, Feasterville, Pa., 280 miles, W3BM, Minotola, N. J., 295 miles, and several others beyond 200 miles, using an HY-75 mobile rig and a 5-element beam. Aug. 6th-7th: W2ATK, Pt. Pleasant, N. J., worked W1KIM, Winthrop, Mass., 245 miles. Both stations were at sea-level locations and used simple dipole antennas! W1NXJ, Mattapan, Mass., worked W2LXO, West Orange, N. J. W1NXJ was running 12 watts input and using an indoor dipole. Aug. 9th-10th: W1EHH/1, atop Mt. Wachusset, near Princeton, Mass., worked W3GMY, Vineland, N. J., 280 miles, as well as W2s ADW, EBT, DPB, FI, LBA, DZA and OHE. This with an HY-75 and a folded dipole! W3GMY has an f.m. rig with an 829 in the final and a 4-element beam.

The log of W1KOE, Wakefield, R. I., shows 45 stations beyond the normal working range worked during the period between July 28th and Aug. 8th. These include 1 in New Hampshire, 8 in the Boston area, 6 in Western Connecticut, 13 in New York, 14 in New Jersey, 2 in Pennsylvania, and 1 in Delaware. Several of these are beyond 200 miles, and they give W1KOE a total of eight states worked on 144 Mc. He repeats the familiar plea: "What can we do to get fellows to sign carefully and to look around the band?" He hears W2s and W3s tied up in local rag-chews, some of them fully convinced that there is no point in looking around because their signals "don't get out anyway!" W1KOE, W1LPO, and W1JFF, all in that elusive and seemingly hard-to-work little state of Rhode Island, have this trouble almost nightly during the summer and fall months.

Who is the leader of states-worked on 144 Mc.? Several have 8 that we know of, and W2JWO, Patchogue, L. I., has New Hampshire, Massa-

(Continued on page 126)



Correspondence From Members -

The Publishers of *QST* assume no responsibility for statements made herein by correspondents.

THE VFO PROPOSAL

11,904 Thornewood Ave., Cleveland, Ohio

Editor, *QST*:

I have been very much interested in your editorial comment in recent issues of *QST* on desired improvements in VFO control and on automatic tracking methods. W5CAT's idea and your editorial in the August issue led me to describe a system which occurred to me several years ago. It has, I believe, all of the desirable features you mention and few of the undesirable. It is not a beginner's problem but would not be too difficult for the skilled amateur. It has been used and is of proven merit, the basic idea being incorporated in ionosphere-sounding transmitters and receivers used by the Carnegie Institute. A transmitter using this system is now under construction here at W8QZP/8 but probably will not be completed for several months because of lack of time.

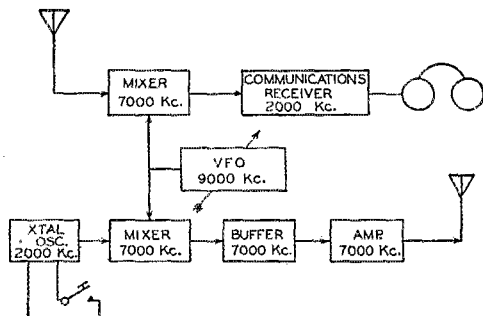

The system, as modified for amateur use, is illustrated in the block diagram. The regular communications receiver acts as an i.f. and is tuned to zero-beat with the crystal oscillator. Thereafter, tuning the VFO will automatically track the receiver and transmitter. If it be desired to keep the transmitter 2 kc. to one side of the received signal, the receiver is simply set 2 kc. off zero-beat. If the operator calls CQ he listens for a call by leaving the VFO alone and tuning the receiver (the i.f.). The VFO runs continuously and is not keyed. Keying is done in the crystal oscillator at intermediate frequency. The VFO operates at the same frequency on all bands. The frequency is not harmonically related to any of the transmitter frequencies and thus interaction and r.f. feed-back should not be troublesome. The VFO bandwidth is uniform on all bands. Its full spread should be 500 kc. — say 9000 to 9500 kc. This will give 100 per cent coverage on 80, 60 per cent coverage on 40, 80 per cent on 20, 100 per cent on 15 (when we get it). Ten kc. on the VFO dial is 10 kc. on any and all bands. No ganged circuits are necessary. The VFO is the only tuned (tunable) circuit. Broad-band amplifiers can be used in the mixer and transmitter circuits, or ordinary circuits are practical since only slight "touch-up" tuning will be required between one end of a band and the other. The 9000-kc. VFO frequency was chosen to allow a fairly uniform i.f. for the different bands:

Band	VFO Range	I.F.
3500- 4000	9000-9500	5500
7000- 7300	9000-9300	2000
14,000-14,400	9000-9400	5000
21,000-21,500	9000-9500	12,000

Selection of the proper sum or difference frequency should be easy because of the high i.f.

One simple possibility is a two-band rig with the VFO on the mean frequency:

Band	VFO Range	I.F.
7000- 7300	10,500- 10,800	3500
14,000-14,400	10,500- 10,900	3500

However, the thought of image interference and 3500-kc. pick-up made me decide against trying this latter scheme.

— Omar E. Snyder, W8QZP/8

Corona Naval Hospital, Corona, Calif.

Editor, *QST*:

In regard to the August *QST* editorial, I'd like to point out that 99 per cent of the features you've been daydreaming about can be found in the set advertised on page 137 of the same issue, for only \$34.50. This surplus tank rig has been pretty thoroughly ballyhooed here on the coast, so I suspect quite a number of hams will be buying it.

You spoke of using a master oscillator of 455 kc. mixed with the receiver oscillator to furnish the exciter frequency. This rig has just that — with tuning of the local oscillator, receiver r.f., and two transmitter buffers, all on the same condenser shaft! For break-in operation, your receiver is always on and xmtr warmed up. The 455-kc. osc. is variable, being also the b.f.o. and controllable from the front panel, though perhaps not as much as 5 kc. These sets cover the 40-80-160-meter bands and have in addition an entirely separate 1 $\frac{1}{4}$ -meter four-tube transceiver as well as an intercom system.

In short, the set-up has everything you want with the exception of a ganged antenna tuner, and optional crystal control, which could be provided easily. Another drawback is the low-power dynamotor supply, but with a.c. power the output could be raised to perhaps 30 watts. . . .

— Walker V. Clute, RM3c

72 Bowler St., Lynn, Mass.

Editor, *QST*:

To cope with the present situation and also future amateur operating, I believe that KBW has the right dope: the use of one channel (same frequency) in communication by VFO or other means. So let's all square away, plan to play fair, and help make room for all with the least QRМ.

I second the motion proposed under "How's DX," page 57, July *QST*, on using "NS" and "SN," where NS indicates all replying should stay clear of the CQer's frequency by at least 1 kc. Yes, by all hi-power and little QRP rigs, let's play the game for the most fun. Fight fairly, break clean, and no cussing. Here's to DX!

— Harold Ryall, W1NKW

CODE-PRACTICE QRM

3417 W. Palmer St., Chicago 47, Ill.

Editor, *QST*:

From time to time I have heard the rumor that, for some psychopathic reason or other, there were about a dozen quote hams unquote who were "anti-League." I never knew just what they stood for (or against), or what "anti-League" really meant, but I tried to find this out at ham-
(Concluded on page 138)



Operating News



F. E. HANDY, WIBDI, Communications Mgr.

E. L. BATTEY, WIUE, Asst. Comm. Mgr.

GEORGE HART, WINJM, Communications Asst

J. A. MOSKEY, WIJMY, Communications Asst.

LILLIAN SALTER, Communications Asst.

3575-3600 kc. for General Traffic Work.

It was great to be able to use 3.5-, 7- and 14-Mc. in summer operating — like old times to hear all these bands hot with activity! Fall is now upon us. With so much of amateur radio back to normal, operators are now busy with net planning, DX, and general activity. Note the announcement of Traffic Plans elsewhere in these columns. The *General Traffic Channels* (3575-3600 kc.) are the place to go (6:30-8:30 p.m. local time daily) to stand best chance of getting a message for your locality, or to move one to domestic points afar. Use this time and frequency and report traffic results monthly to your SCM! With fall here, all Emergency Coördinators have as first business on their slate review of the necessary Emergency Operating Plan for their communities — with a September meeting bringing this to the attention of all amateurs. This seems essential to be sure we are ready for any emergency-radio needs, as well as for the national tests and local activities that are coming up.

Last Call for October Emergency Test.

Attention is invited to a box announcement regarding the simulated-emergency (nation-wide) plans that were mentioned first in these columns last month. On either October 12th or 13th some "incidents" calling for amateur radio facilities and special local operation will develop in your community. Both 144-Mc. rigs and low-frequency links may be called on. You will not know all about this as the Test goes along unless you are lined up with the ARRL Emergency Corps and in contact with your community Emergency Co-ordinator. Right up to those October dates we'll do our best to give prompt service on sending AEC applications (Form 7) to all who want to get lined up. We know every SCM and EC will do the same. Your EC will appreciate your participation on and around those dates so you can enjoy the test opportunity and become part of the dependable group he is organizing to do necessary things either now or when a real emergency strikes! If you haven't yet indicated your equipment and interest, to help amateur ability-to-perform in emergency, why not do so today? A postcard or radio message to Hq. will bring you a Form 7 application.

On Getting the Most from Amateur Operating. Amateur radio is all things to all people, and we're not one to try to convert anyone from one form of activity to another. It's our hunch that sooner or later all of us try them all, and enjoy them all. Practically all amateurs build stations to *communicate* or at any rate it is only through using our brain children that we can find out what they can do, and consequently improve adjustments for maximum performance!

Two weeks of operating from a vacation spot with a 6L6 final (leaving bigger bottles behind) were a lot of fun. Several improvements in the portable set-up were developed that we never would have found time for, except by leaving our more ambitious gear behind. But the high point of station testing was participation in our first postwar party (operating test) open to *all* CD appointees on July 27th-28th. It brought home the fact that in almost all ARRL activities and station tests, *organization* makes it possible for us to obtain results in a week-end or so of operation, that would take the nonorganization amateur some months of average amateur working to accomplish. *Organization* is the magic that gives superior results or QSO-report-knowledge to each member through mutual cooperation and collaboration toward common ends.

ARRL is a mutual-benefit association for the representation of the amateur, striving in every way possible to add to the effectiveness of the individual station and to increase the pleasure and profit of the member in his hobby. While certain general activities are announced for all amateurs, additional dividends in pleasure and results are available to members of groups holding *appointment*, looking to specific objectives. Why not let *organization* work more concrete magic for you by lining up for the appointment that appeals to you. A high standard of operation, telegraph or voice, is called for in each "station" appointment. In general each appointee offers some specific service to other appointees, or even the whole fraternity. Leadership in our groups of course brings its own reward through fraternalism and increased organization strength and success.

This is all by way of saying that with the fall season at hand all amateurs whose stations,

operating, and objectives meet the descriptions set down in *Operating an Amateur Radio Station*,¹ are invited most cordially to secure the appropriate appointment application forms from their SCM² or ARRL Hq. so they may fully participate in their operating organization. By so doing they will get the most from their operating efforts along the lines of natural amateur inclinations. For general reader information abbreviated descriptions of the types of ARRL-SCM appointments that can be made, with the purpose of each, are given below:

LEADERSHIP AND STATION APPOINTMENTS

- SEC Section Emergency Coordinator. Promotes and administers Section Emergency-Radio Organization.
- EC Emergency Coordinator. Organizes amateurs of a community or other area for radio emergency service; liaison with officials of agencies served and with representatives of other communication facilities locally.
- ORS Official Relay Station. Traffic Service, operates nets and trunk lines.
- OPS Official Phone Station. Voice operating, assists in establishing high operating standards.
- OES Official Experimental Station. Experimental operating, collects reports v.h.f.-u.h.f.-s.h.f. propagation data or contacts, some engage in fax, f.m., tv, etc. experiments.
- OBS Official Broadcasting Station. Transmits ARRL Bulletins to amateurs.
- OO Official Observer. Sends mail (or radios) cooperative notices to amateurs to assist in frequency observance, insure high quality signals, and prevent FCC trouble for the individual or the fraternity.
- RM Route Manager. Organizes traffic nets and coordinates schedules.
- PAM Phone Activities Manager. Organizes activities for OPS.

W1AW Expands Schedule. Attention is invited to the new fall operating-visiting hour schedule for Hq. station W1AW. See page 58 this issue. "Bill" Matchett, W1KKS, joins our station staff having already made a name for himself brass-pounding in the Arctic on Mac-Millan's *Bowdoin*, KLPO. The summer cruise and equipment were described (with photo of Bill) in September *QST*. With October here we are glad to be able to increase the periods specified for general contact with "any amateur" on the different bands, to add bulletin transmissions Sat.-Sun., and later-night periods that will clear coast-to-coast traffic.

CD Staff Notes. Additional personnel at W1AW are Bill Matchett, W1KKS, and Tom York, W1JBJ, a prewar member of the CD staff. The Communications Department also takes pleasure this month in announcing the return of George Hart, W1NJM-D4ALS. Until his separation from the AAF, Lieut. Hart served with Hq. AACS, and with Hq. 5th ACS Wing overseas.

¹ Sent free on request of any ARRL member. Operating Practice, Activities, Emergency Communication, Field Organization, Leadership and Station Appointments, Handling Messages, Network Organizing and NCS Functions, Ham Abbreviations, FCC Regulations & Orders are included in this booklet.

² For full list of SCMs with addresses see page 6, any *QST*.

George needs no introduction to operating amateurs, having worked so many from W3AMR, and W1AW (since 1938), and having carried the ball as Acting CM in '43-'44. "Geo" will give full time to a Training Aids project designed to assist all Affiliated Clubs with their lecture and visual programs.

A.R.R.L. OFFICIALS NITE, Oct. 5th. A club-convention itinerary places us at the West Gulf Division Convention September 22nd, so we're going to miss the expected fun in the Get-Acquainted Party unless we can make it on-the-air from W5. But we're slated to be home for, and bound we're *not* going to miss some contacts in, the first postwar *ARRL Officials Nite*, October 5th.

What's an Officials Night does someone ask? 'Tis the monthly time when all ARRL leadership appointees (SEC, EC, RM, PAM) and the elected-appointed officials (Director, SCM, Hq. Staff, Asst. and Alternate Director personnel) get together informally on the air to work each other and "talk it over." It combines fraternalism with station operating and a chance to keep in touch with friends in and beyond each ARRL Section. The *Nite* promotes sectional and national League solidarity and progress. There's no scoring. It's not a contest, but Hq. issues a list of those who were on, and who they worked. Any frequency band that's open can be used, come early or late. "Eighty" is a favorite band but skeds on others are sometimes made. It's easy to remember to be on. *The first Saturday night* in each month is generally the night. Formerly *RM Nite*, the ECs

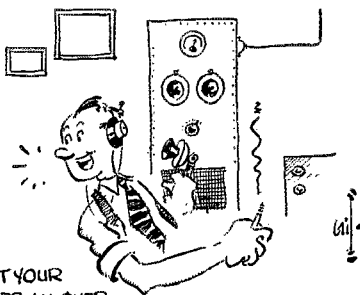

DON'T LET YOUR
GAZE WANDER ALL OVER,
VARYING SPEECH INPUT

The efficient operating position is one where interest may be concentrated on the objective at hand — *operating!* Distractions in the operating room simply cause confusion at both the transmitting and receiving ends. Establish your ham shack for communication purposes. It's a rare individual who can successfully combine clean-cut acceptable communication with a "party in the radio room." It's not good hamming, either. Show the operator you are working the respect of keeping your mind on the QSO, not on what is taking place in your shack. Keep your modulation level constant by maintaining a standard distance from the microphone. You cannot do this, if you try simultaneously to hold a double-header conversation with your radio contact and the folks at home.

have now outnumbered other "dignitaries." To make this truly of, by and for all ARRL officials, the official call for establishing contact with others of the group will be "CQ ARRL." The letters of your appointment or post can be added to your call in getting acquainted, but are not necessary in working old friends. Some QSOs are snappy, some very long. We're announcing ARRL Officials Nite here just this once in starting it off so all hands will know what's going on, and so every officer and official will know the Nites are being resumed. 73. BCNU.

— F. E. H.

CODE/THEORY INSTRUCTION

Attention of ARRL-affiliated club secretaries is invited to the listing in June *QST* (page 75) of clubs giving instruction in radio code and theory. It is desired to compile an up-to-date list of affiliated clubs conducting such programs for all local operators and beginners (members and nonmembers). If your club has code and/or theory lessons under way, please advise us so that we may pass the word to those interested. Be sure to indicate whether the program is "open to all."

— ... —

CALENDAR OF A.R.R.L. ACTIVITIES

- Oct. 12th-13th: Emergency Corps Test
 Oct. 17th: CP Qualifying Run
 Oct. 26th-27th: CD QSO Party (Open to all appointees and officials)
 Nov. 16th: CP Qualifying Run
 Nov. 16th-18th and 23rd-25th: Sweepstakes Contest
 Dec. 15th: CP Qualifying Run
 Jan. 11th-12th: ARRL-Member Party
 Jan. 14th: CP Qualifying Run
 Jan. 25th-26th: CD QSO Party
 Feb. 13th: CP Qualifying Run
 Feb. 14th-17th: DX Competition (c.w.)
 Feb. 21st-24th: DX Competition (phone)
 Mar. 14th-17th: DX Competition (c.w.)
 Mar. 17th: CP Qualifying Run
 Mar. 21st-24th: DX Competition (phone)

— ... —

- May 1st-Dec. 31st: 1946 V.H.F. Marathon (complete details in May *QST*)
 Mar. 1st-Dec. 31st: WAS Competition Above 50 Mc. (see page 80, May *QST*)
 Started Mar. 1st: Competition for First WAS on 50-Mc. Band (See page 58, May *QST*)
 First Saturday Night Each Month:
 A.R.R.L. OFFICIALS NITE (Get-together for SCMs, RMs, SECs, ECs, PAMs, Directors, Alt. and Asst. Dirs.)

WIAW OPERATING SCHEDULE

(Effective October 1, 1946)

Operating-Visiting Hours

Monday through Friday, 8:30 A.M.-1:00 A.M.
 Saturday, 7:00 P.M.-2:30 A.M.
 Sunday, 3:00 P.M.-9:00 P.M.

Staff:

John T. Rameika, W1JJR, "JR"
 Thomas W. York, W1JBJ, "TY"
 Wm. H. Matchett, W1KKS, "BM"

Official ARRL Bulletins containing latest FCC information relating to amateur operation and reactivation, and other bulletins on matters of general amateur interest, are transmitted on regular schedules, as follows:

Frequencies: 3555, 7145, 14,150, 23,060, and 52,000 kc. (Voice — 3950, 7145, 14,280, 52,000 kc.)

Times: Monday through Friday, 8:00 and 11:30 P.M. EST. (0100 and 0430 GCT, Tuesday through Saturday)

Sunday, 1:00 A.M. and 8:00 P.M. EST (0600 Sun. and 0100 Mon. GCT)

Starting at the times indicated, bulletins are transmitted by telegraph simultaneously on all frequencies. Bulletins are sent at 25 w.p.m. and repeated at 15 w.p.m. to facilitate code practice. Telegraph bulletins are followed, in turn, by voice transmissions, except that 3950 is substituted for 3555 kc., and 14,280 is substituted for 14,150 kc. Changes from this schedule will be announced by the operator.

Code-Proficiency Program: Practice transmissions at five speeds, 15 through 35 w.p.m., are made Monday through Friday on the above-listed frequencies, starting at 10:00 P.M. EST (0300 GCT, Tuesday through Saturday). Approximately ten-minutes practice is given at each speed. Next certificate-qualification run is scheduled for Thursday, October 17th.

General Operation: WIAW engages in two-way work with amateurs as follows:

<i>Monday through Friday, all times EST —</i>		
3:00 P.M.-3:30 P.M.		29,150 kc. voice
3:30 P.M.-4:00 P.M.		28,060 kc. c.w.
4:00 P.M.-4:30 P.M.		14,280 kc. voice
4:30 P.M.-5:00 P.M.		14,150 kc. c.w.
6:00 P.M.-7:00 P.M.		7250 kc. c.w.
7:00 P.M.-7:30 P.M.		3950 kc. voice
7:30 P.M.-8:00 P.M.		3555 kc. c.w.
9:30 P.M.-10:00 P.M.		3555 kc. c.w.
12:15 A.M.-1:00 A.M. (Tues.-Sat.)		7250 kc. c.w.
<i>Saturday and Sunday (excepting dates of official ARRL activities)</i>		
Saturday: Midnight-1:00 A.M. (Sun.)		3555 kc. c.w.
Sunday: 1:45 A.M.-2:30 A.M.		7250 kc. c.w.
6:00 P.M.-7:00 P.M.		3950 kc. voice
7:00 P.M.-8:00 P.M.		7250 kc. c.w.

CD QSO PARTY

The first postwar get-together of Communications Department appointees and ARRL officials was one of the most lively midsummer QSO parties we can remember so far as c.w. participation (ORS, etc.) is concerned. OPS and others who spent their time on voice reported 'phone participation below that of previous parties.

The scores, made under a new system, are the equivalent of some of the "million-total" scores of years gone by. Many veterans of prewar ORS and OPS Parties are still in there punching, and most of them will be found in their normal positions of leadership!

Some of the lads were hiding behind new calls. W4EOP is none other than well-known W3EOP. W4JIZ is "Vic," ex-W6KFC, W9DVO, W7IXH. W2OXX is ex-W3DVC, W3KWL is ex-W8AOE, and ex-W3IAY added to the available sections with W2OOU/VE5.

Now that all appointees and officials are eligible for the ORS and OPS Parties, we are going to call our quarterly get-together the "CD QSO Party." To encourage contacts between all members of our "official family," the separate ORS and OPS Parties will be combined into a "one-group" party. The call "CQ CD" will be tried for the first time in this party and participants will vote on the preferred call. The Fall party is scheduled for October 26th-27th. Details will reach you by mail before those dates.

C.W. Scores

Station	Score	Contacts	Sections	Different Stations
W3BES	70,145	266	51	173
W4EOP	67,066	265	49	181
W3DGM	58,652	228	50	152
W4JIZ	55,755	235	48	167
W6PBV	44,248	107	43	87
W0TQD	41,306	177	45	131
W1BFT	40,244	178	43	125
W1UE	40,189	186	41	132
W8ROX	39,346	171	43	130
W2IOP	38,392	180	41	139
W3BXE	37,758	178	40	118
W5JTC/6	36,611	95	42	71
W1EOB	36,176	149	46	112
W8UZJ	35,222	145	46	112
VE3CAR*	32,032	152	42	112
W1BIH	28,483	145	37	104
W8ONK	28,359	122	44	111
W1AW**	27,446	143	38	124
W2OXX	25,016	142	33	101
W8SCW	24,941	121	39	98
W9NCS	24,724	115	40	84
W6SID/7	23,539	73	32	52
W5NW	23,346	103	42	78
W0JNC	23,014	110	39	82
W1LLX	22,245	131	32	101
W3ADE	21,674	122	33	92
W6RFF	20,878	56	37	47
W2OOU/VE5	20,330	98	38	76
W1TS	20,324	113	34	94
W3KWL	20,222	122	30	122

Others with scores of over 10,000: W3AVJ 19,901, W3HUM 19,881, W9YAH/3 18,725, W6JRI 18,574, W4DWB/5 18,499, W3GQW 18,378, W3JSU 18,028, W2LAO/3 17,877, W5AQE 17,531, W8HCO/1 16,712, W6IFW 14,966,

W4BYF 14,733, W8AQ 13,999, W6HIR 13,617, W8TOJ 13,567, W5DWW 13,248, W2EC 12,701, W1BDI/1 11,484, W1JPE 11,483, W0VEE 11,346, W9SAG 11,130, W7JQU 10,381.

*VE3QK opr.

**W1JJR principal opr.; 29 QSOs by W1JBJ

'Phone Scores

Station	Score	Contacts	Sections	Different Stations
W4DCQ	2,973	31	19	28
W3CWG	2,358	22	16	22
W9CLF	1,226	16	11	16
W4FUM	1,214	14	12	14
W8EQN	754	16	9	16
W9SWH	525	8*	7	7
W1AW***	510	10	10	10
W4BIW	217	7**	6	7
W8JFC	216	4	4	4
W1HIL	150	5	5	5
W8MOP	144	6	4	6
W2JKH	138	3	3	3
W8NDN	105	5	4	5
W6DZE	61	1	1	1
W6FMJ	60	1	1	1

*2 contacts by c.w.

**1 contact by c.w.

***W1JBJ opr.



W3DGM, ORS, long-time ORS Party enthusiast and third-high in the July get-together. The SW-3 is used as a preselector for the NC-101X. The VFO unit atop the receiver uses 6SK7-6V6-807, is self-contained, running 30-40 watts input, and makes an ideal FD rig. The main transmitter is handswitching, 3.5 to 28 Mc., with p.p. 812s, 200-watts input.

BRIEFS

Ham radio has come through again — this time in the "apartment hunting" field. W2KNP in N. Y. C., in need of an apartment in Baltimore, made contacts with the following amateurs, requesting their assistance: W3GF, W3KBX, W6OXM/3, W3JEI and W2BZB/3. Contacts were on 3.5 Mc. over a six-week period, and an apartment was finally secured, thanks to amateur cooperation.

W9USA — MILWAUKEE CENTURAMA

The Milwaukee Radio Amateurs' Club operated W9USA at the Milwaukee Centurama, which was held from July 12th to August 11th, commemorating the 100th anniversary of the city. The "shack" housing the station was erected by the Centurama committee, and was a neat affair as shown in the photo.

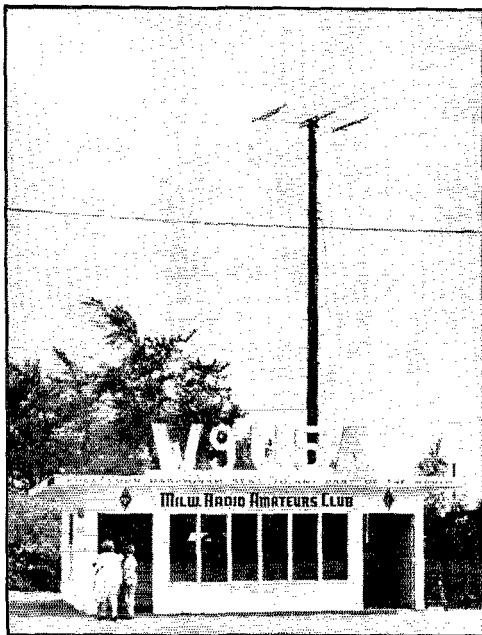

Ralph O. Koenig, W9RUF, MRAC president, was in charge of the project, with Al Kroner, W9UIT, responsible for the actual operation of W9USA. The mainstays in handling the operating load were W9GVL, W9SQK, W9RKP, W9HPZ, W9CCD, W9LZU, and W9KCY.

Traffic was accepted from Centurama visitors, with a total of 1139 messages handled: by W9UIT 271; W9LZU 170; W9KCY 168; W9RKP 152; twenty-one other operators, 378.

A total of 1096 contacts were made by W9USA: 7-Mc. c.w., 362; 28-Mc. 'phone, 209; 3.9-Mc. 'phone, 147; 14-Mc. c.w., 127; 3.5-Mc. c.w., 94; 144-Mc. 'phone, 93; 14-Mc. 'phone, 52; 28-Mc. c.w., 6; 27-Mc. c.w., 6. Effort was made to send QSL cards to all contacts, but because of incomplete QTHs it was not possible. Cards were sent out representing 723 QSOs with all W districts, as well as VE1, VE3, VE5, VO, TI, LU, CM, OA, TG, K4, KP4, PY and CT2. A second QSL card is being mailed showing a picture of W9USA.

The equipment consisted of a BC-610 transmitter used on 14, 7 and 3.5 Mc., a 200-watt

composite transmitter on 28 and 27 Mc., two HQ-120s and two BC-312s, and a 144-Mc. receiver and HY-75 transmitter. Antennas were a 3.5-Mc. half-wave, end fed with $\frac{1}{4}$ -wave feeders, several 300-ohm flatline folded dipoles for 7 and 14 Mc. transmitting and receiving, a 28-Mc. 3-element rotary beam, and a 144-Mc. J.

E. W. Kreis, W9HRM, MRAC secretary, who sent us this report, expresses the thanks of the W9USA crew for the fine cooperation of amateurs handling Centurama traffic.

CODE-PROFICIENCY PROGRAM

W1AW conducts practice transmissions nightly Monday through Friday, 10:00 P.M. EST, at speeds of 15, 20, 25, 30, and 35 w.p.m. Once each month a special transmission is made to enable you to qualify for a Code Proficiency certificate or endorsement sticker indicating progress above your first certified speed. See W1AW schedule for details on frequencies.

The next qualifying run will be on October 17th. The text transmitted on that date, received successfully by ear at the highest speed you can copy, should be sent to ARRL for checking. To avoid errors in recopying, send your original copy. Attach a statement certifying over your signature that the copy submitted is direct copy, made from reception of W1AW by ear, without any kind of assistance, personal or mechanical. If you qualify, you will receive your certificate, or appropriate endorsement sticker for certificate you already hold. Those who qualified in the past should submit copy only if speed is higher than indicated on certificate or endorsement sticker.

QST lists in advance the text to be used on several of the CP schedules. This makes it possible to check your own copy. It also provides a means of obtaining sending practice since it permits direct comparison of one's fist and tape sending. To get sending help hook up your own key and buzzer and attempt to send right in step with the tape transmissions. Adjust your spacing in the manner indicated as necessary for self-improvement.

Date	Subject of Practice Text from August QST
Oct. 1st:	An Amateur-Band Eight-Tube Receiver, p. 13
Oct. 3rd:	Our Best DX — 800 Feet!, p. 19
Oct. 9th:	Unstable Signals, p. 23
Oct. 11th:	An Inexpensive 5-Element Beam for 28 Mc., p. 27
Oct. 15th:	It's Fascinating Work, p. 32
Oct. 17th:	Qualifying Run, 10:00 P.M. EST
Oct. 18th:	Permeability-Tuned Oscillators, p. 42
Oct. 21st:	Raising the Efficiency of the V.H.F. Linear Oscillator, p. 48
Oct. 23rd:	For Beginners Only, p. 53
Oct. 28th:	The World Above 50 Mc., p. 66
Oct. 31st:	Speed-Key Adjustment, p. 76

BRIEF

W9DGA's first VK QSO was VK3XK, his second VK3KX.

TRAFFIC PLANS

As announced in May *QST*, we have been working on a master frequency plan to provide for the operation of 3.5 Mc. traffic networks. A channeling system has been devised to allow maximum use of the available frequencies with a minimum of interference. This plan is predicated on the assumption that nets will operate on 5 kc. points, starting at 3525 kc. (the upper limit of the 3.5 Mc. emergency-calling segment). We urge traffic organizers to keep this in mind. C.w. nets should confine operations to the lower 300 kc. of the band to avoid interference with stations operating in the newly-expanded U.S. and Canadian 'phone bands. By sharing of frequencies among nets geographically isolated from one another and carefully timing the schedules of those located within interference range, several nets may be accommodated on the same frequency.

In meeting our objectives the utmost cooperation of all will be required. The initial channeling has been accomplished, based insofar as possible on frequencies employed by established nets prior to the war. All SCMs, RMs, and PAMs will receive a copy of this initial plan for comment. In the case of nets using frequencies not registered with ARRL, it is important to notify us of your net plans, giving the proposed

frequency and times of operation. Reference to our master net register will allow us to determine whether you will run into interference with other nets that will be resuming operation. We'll add your own net to the plan and advise other network organizers of the best frequencies and times to choose for their operations.

General Traffic Period & Channels

To facilitate movement of messages from stations that wish to send an occasional message, but that are not affiliated with traffic nets, and to enable regular traffic-handlers to pick up such messages, we recommend a daily General Traffic Period, 6:30-8:30 p.m., your local time. In this connection, our frequency plan provides for the frequencies 3575 to 3600 kc. to be used as *general traffic channels*. All members of organized networks and official appointees are requested to work general, when possible, during this period, and to monitor the *general traffic channels*. In this manner operators who are unable to maintain regular schedules or whose operating time is limited may get on the air during the General Traffic Period and clear their traffic through ORS, TLS and others who keep schedules on established traffic routes. Make use of this arrangement to further delivery of traffic and dependability of service. Directional CQs also will be found useful during this period.

To coordinate all amateur traffic-handling activities and make best use of facilities available, the Communications Department requests that all amateurs having good traffic connections with points outside the U.S., or who have transcontinental schedules, notify us of same. We want information on all *reliable* traffic routes, outlets and schedules. Let's start off postwar traffic activity with a bang!

Become an ORS

This will be an interesting season for traffic! Every amateur station, operated by an ARRL member who is interested in traffic work and worthwhile operating-organization activities, and who can meet the qualifications, is eligible for appointment as Official Relay Station. Brass-pundlers handle traffic because they enjoy such work! Get in on the fun of keeping schedules, taking part in Section Net activities, and associating with good operators. Become an ORS! Write ARRL for details on how to qualify for appointment.

TRUNK LINES

In prewar days ARRL Trunk Lines worked on spot frequencies to provide speedy and reliable traffic movement during each active radio season. These "main line" routes were laid out East-West and North-South and connected with local networks and overseas points. Functioning at high efficiency, they were the backbone of the

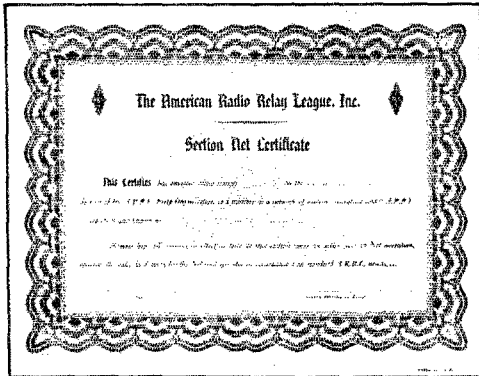

This is the season when ARRL organizers are making plans for formation or resumption of Section Nets. Under the leadership of Route Managers, traffic nets are operated in practically every Section. Phone Activities Managers may organize networks for contact and fraternal purposes. There is much satisfaction in being part of a well-conducted net. ARRL nets have a nucleus of high-class well-operated stations (ORS-OPS), insuring "tops" in enjoyable operation. For the most part, nets organized by RMs and PAMs work in the 3.5-4 Mc. band, usually on a spot frequency. All amateurs are invited to participate, whether or not they hold appointments. The certificate shown here is issued to each active station by the SCM. It is a pleasure to operate with an objective and to work with a group of fellow amateurs toward a common goal. You get all this in network operation. Get in touch with your RM, PAM, or SCM at once to determine what plans are being made in your Section. Line up your station for the maximum in operating enjoyment and effectiveness.

ARRL message-relaying organization.

The Trunk Line System currently is in the process of complete overhaul. There is much to be done before the lines can operate with the same precision as they did in the prewar period. Many reliable stations will be needed to hold down trunk positions. Already we have many requests from traffic-minded amateurs for appointment as TLS. We are anxious to appoint every interested traffic-handler who is located where he can fit into one of the routes. Our aim is to have the best possible system in operation by the time the fall operating season is in full swing. Former trunk-line stations will be given first consideration. If you previously held appointment, and desire to resume activity as TLS, please *get in touch with ARRL as soon as possible*. Other amateurs who wish to be placed on the list of TL candidates should likewise write or send a radiogram to Hq., indicating their interest. The qualifications are not simple. Applicants must be ORS. Ability to work in the 3.5-Mc. band with good signal coverage is prerequisite and you will be required to maintain schedules at least five days per week. It is important, too, that you have good outlets to and from organized networks in your area so that incoming and outgoing traffic can be handled with a minimum of delay.

The Trunk Lines long have been the pride and joy of our whole ARRL traffic set-up. We are anxious to continue their reputation for reliability. If you are genuinely interested and can meet the qualifications, let's hear from you just as soon as you read this, OM! Address your inquiry to National Trunk Line Manager.

OLD TIMERS CLUB

June QST invited applications for the ARRL Old Timers Club (formerly called 20-Year Club). The present-day calls of those who have so far received membership certificates are listed below according to the year in which their first amateur licenses were received. There appears to be plenty of life left in these OTs!

Any member of the 20-Year Club who has not received a certificate of membership under the new name is requested to send us a postal stating that he is a member and giving present call and date of first amateur ticket. He will then be added to the new OT Club roster.

The Old Timers Club is open to any operator who holds an amateur call at the present time, and who held an amateur license (operator or station) 20-or-more years ago. Lapses in activity during the intervening years are permitted. If you can qualify, send us a brief chronology of your ham career, being sure to indicate the date of your first amateur license (year and month, if possible), and your present call. If you are found eligible, you will receive one of the attractive certificates.

Address all correspondence to the Communications Department.

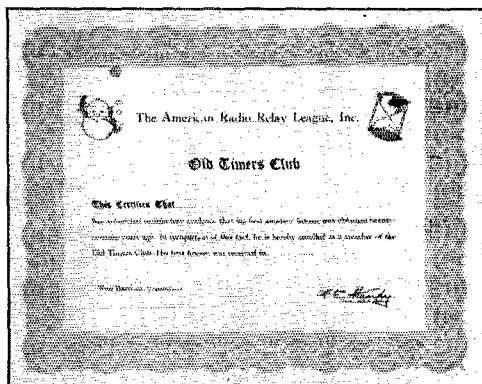

- 1912: W2BO W5GNT W9YBS
1913: W1CK W1DIU W1EH W1FPP W1GDY W1GS
W2FH W2PC W6GYV W6LFD W6CVU KP4KD
1914: W2BR W2DYT W2ZI W3DRO W4GVC W6AVT
W6DEP W6GS W6IJ W6OZY W8AAF W8FRY W8QDU
W9TEB
1915: W1MU W2HCO W8AL
1916: W1BHM W1HGX W1KWH W1MLT W1OGF
W2ELN W2OCH W2OYU W2RNH W6NQI W6QE
W6QYI W7DXV W9CS W9OSQ W9VKF W9WZE
W9DGM
1917: W1BB W1JFN W2IP W2PF W2RA W6ANM
W8APD W9AEP
1919: W1BPH W1JXE W1MD W1RP W2CJX W2KPU
W2OC W3HH W4WT W8AYS W9AHP W9GNU
1920: W1BDV W1DF W1NWK W1OMT W1TS W1ZL
W2AWW W2BEI W2GVZ W2LWZ W2PHO W3HBZ
W3KP/W4ES W5HF W6MRT W6PB W6RNO W6SVF
W6TI W6TTS W6ZCN W7HLZ W8CUZ W8GER W8JDV
W8VBM W9EVG W9LFK W9VD W9UXI
1921: W1BDI W1BVR W1LLX W1MOK W1OJH
W2BLP W2DJT W3FRS W3JB W3JW W3VT W5BAM
W6APE W6MHT W6MJB W6MKW W6TNH W8GGA
W8JWC W8MPG W8MRD W9ASN W9BUK W9DZG
W9EWH W9IFS W9IND W9JTW W9OAB W9SV W9ZNN
G2HG G5LH KP4AZ XE1KE
1922: W1AJI W1MCT W2BCL W2CMX W3CDQ
W3IEG W3NUG W3WU W4AAR W4IVJ W4MS W5AHD
W5CVA W5HUT W5WR W6CAG W6NKM W7AIE
W7CE W7KK W8BN W8ERE W8TKZ W9AC W9ACM
W9BRX W9NHN W9NZZ W9VBR W9GEB VE3OI
VE5AC VK5BF
1923: W1AH W1BAV W2ADC W2ARP W2BEZ W2JA
W3ADE W3AQM W3IKS W3QP W3VD W4KL W5AJG
W5NW W5RZ W5WX W6AAE W6JDN W6JTN W6VPP
W7FGB W7GXP W7HJZ W8KPL W9AKP W9BRY
W9FUB W9PNH W9YS/W9YOL W9YZN W9AQO
W9CCE W9EIT W9VEE VE2WM VK4DO
1924: W1AL W1ALP W1AY W1CJZ W1KZT W1MFC
W2KHM W4IJQ W5AUB W6LMY W6SGZ W8AVH
W8BSR W8FJN W8FMU W8WMJ W9AQI W9BQZ
W9WR W9DIB W9WO VE3EF
1925: W1AQ W1BFT W1BZJ W1EPC W1LSR W1UE
W2ANN W2ARO W2CC W2CW W2KS W2MV W2NIY
W3CVJ W3EVW W4KG W4QT W4TK W4TZ W5ABM
W6DIT W6HG W6LN W6MQR W6MUF W6SBD W7JHS
W8GBF W9ANB W9CRA W9DCD W9JPX W9UC
W9AWP W9WU G5BY VK2NS
1926: W1AJ W1TD W2AXP W3AQN W3ASW W4AIL
W5AQN W5HTL W8DED W8JV W9AJU W9DAR
W9ECK W9DBC

NORTH CAROLINA-VIRGINIA FIELD DAY—OCT. 5TH-6TH

The Raleigh Amateur Radio Club announces a Fall Field Day for all amateur radio clubs in North Carolina and Virginia. Patterned closely after the ARRL FD, the Raleigh club's affair has a twofold purpose: (1) to increase interest and activity in FD operation and familiarize members with auxiliary operations, and (2) to establish closer ham relationships between the various clubs participating and between Virginia and North Carolina amateurs.

The activity will run from 6:00 P.M. EST, Saturday, October 5th, to 6:00 P.M. EST, Sunday, October 6th. Any and all authorized amateur frequency bands may be used. Portable stations operated in the field (away from "home" address) are eligible to submit scores. Other interested amateurs are urged to cooperate. For credit, all station control points at a Field Day station must be within 500 horizontal feet of some given point.

Scoring: Virginia clubs will count 1 point for each contact with stations outside North Carolina; 2 points for each contact with other Virginia clubs participating in the event; 3 points for each contact with North Carolina clubs participating in the event; and 2 points for each contact with other North Carolina stations.

North Carolina clubs will count 1 point for each contact with stations outside Virginia; 2 points for each contact with other North Carolina clubs participating in the event; 3 points for each contact with Virginia clubs participating in the event; 2 points for each contact with other Virginia stations.

Multippliers: The following multipliers apply to contact points, if frequencies used are below 30 Mc. — 1 for power input to final stage of over 100 watts; 2 for power input in excess of 30 watts, but not over 100; 3 for power input not over 30 watts. These multipliers shall be *doubled* for all contacts made above 30 Mc. An additional multiplier of 2 shall be used, if either transmitter or receiver is operated on auxiliary power, 3 if both receiver and transmitter are operated on auxiliary power.

Message credits before multiplier will be allowed as follows, if copies are submitted with log: 25 points for radio origination of not more than one message addressed to ARRL Hq. This message shall include number of operators, location, conditions, power. One point may be claimed for radio handling of each FD message of another group ($\frac{1}{2}$ point for receiving, $\frac{1}{2}$ point for relaying).

Reporting: All reports, to count, must be mailed on or before October 20, 1946, to Raleigh Amateur Radio Club, c/o WAAVT—FD Committee, 2110 Reaves Drive, Raleigh, N. C. Score claims must be shown as the sum of points for each set-up. A station-worked list for each band must show contact times for each contact. A statement covering on-off times for bands and transmitters is required. State the maximum number of transmitting units in simultaneous operation at any time. The final tally of results will be compiled jointly by FD Committees of the Raleigh club and the Richmond Amateur Radio Club.

Ed Day, who will be remembered by old AARS members as one of WLM's best operators, is now in the Philippines. He reports that his new call, KA1AW, was especially selected by him to keep our traditional call, 1AW, on the air from the Orient.

ELECTION NOTICE

(To all ARRL Members residing in the Sections listed below:)

You are hereby notified that an election for Section Communications Manager is about to be held in your respective Sections. This notice supersedes previous notices.

Nominating petitions are solicited. The signatures of five or more ARRL full members of the Section concerned, in good standing, are required on each petition. No member shall sign more than one petition.

Each candidate for Section Communications Manager must have been a licensed amateur for at least two years and similarly a full member of the League for at least one continuous year immediately prior to his nomination.

Petitions must be in West Hartford, Conn., on or before noon on the closing dates specified. In cases where no valid nominating petitions were received in response to previous notices, the closing dates are set ahead to the dates given herewith. The complete name, address, and station call of the candidate should be included with the petition.

The following nomination form is suggested:

Communications Manager, ARRL (Place and date)
38 La Salle Road, West Hartford, Conn.

We, the undersigned full members of the.....
..... ARRL Section of the.....
..... Division hereby nominate.....
..... as candidate for Section Communications Manager for this
Section for the next two-year term of office.

Elections will take place immediately after the closing dates specified for receipt of nominating petitions. The Ballots mailed from Headquarters to full members will list in alphabetical sequence the names of all eligible candidates.

You are urged to take the initiative and file nominating petitions immediately. This is your opportunity to put the man of your choice in office.

— F. E. Handy, Communications Manager

Section	Closing Date	Present SCM	Present Term of Office Ends
Eastern New York	Oct. 1, 1946	Ernest E. George	Oct. 15, 1946
Nebraska	Oct. 1, 1946	Arthur R. Gaeth	Oct. 15, 1946
Northern Texas	Oct. 1, 1946	Jack T. Moore	Oct. 15, 1946
South Carolina	Oct. 1, 1946	Ted Ferguson	Oct. 16, 1946
Philippines	Oct. 15, 1946	George L. Rickard	Oct. 15, 1938
Mississippi	Oct. 15, 1946	P. W. Clement	Apr. 1, 1945
Rhode Island	Oct. 15, 1946	Clayton C. Gordon	Apr. 15, 1945
No. Minnesota	Oct. 15, 1946	Armond D. Bratland	June 15, 1945
San Diego	Oct. 15, 1946	Ralph H. Culbertson	Apr. 15, 1946
Maine	Oct. 15, 1946	Grover C. Brown	June 15, 1946
Oklahoma	Oct. 15, 1946	Ed D. Oldfield, jr.	Aug. 15, 1946
Kansas	Oct. 15, 1946	Alvin B. Unruh	Oct. 29, 1946
*Maritime	Oct. 15, 1946	Arthur M. Crowell
*Saskatchewan	Oct. 15, 1946	Arthur Chesworth
West Indies	Oct. 15, 1946	Mario de la Torre	Deceased
Oregon	Nov. 15, 1946	Carl Austin	Nov. 22, 1946

* In Canadian Sections nominating petitions for Section Managers must be addressed to Canadian General Manager, Alex Reid, 169 Logan Ave., St. Lambert, Quebec. To be valid such petitions must be filed with him on or before the closing dates named.

ELECTION RESULTS

Valid petitions nominating a single candidate as Section Manager were filed in a number of Sections, as provided in our Constitution and By-Laws, electing the following officials, the term of office starting on the date given.

Montana	Albert Beck, W7EQM	June 1, 1946
Northern New Jersey	John J. Vitale, W2IN	June 17, 1946
Idaho	Alan K. Ross, W7IWU	June 17, 1946
Quebec	Gordon F. J. Phelan, VE2SU	Aug. 15, 1946
Tennessee	James W. Watkins, W4FLS	Aug. 15, 1946
Ohio	William D. Montgomery, W8PNQ	Aug. 17, 1946

• All operating amateurs are invited to report to the SCM on the first of each month, covering station activities for the preceding month. Radio Club news is also desired by SCMs for inclusion in these columns. The addresses of all SCMs will be found on page 6.

ATLANTIC DIVISION

EASTERN PENNSYLVANIA — SCM, Jerry Mathis, W3BES — 3QP schedules VE8MR, a weather station on Resolution Island, and OA4U. 3GMMK's v.f.o. conked out in the ORS Party and he finished with crystal, SADE enjoyed himself in the ORS Party. 8QEW, Scranton, now is 3QEW. New hams in his area are 3KLZ and 3KGB. 3KKP is new ham in South Langhorne. He operates on 3.5-Mc. c.w. 3EVW worked VS9AN and 9HJW/Saipan with 400 watts to an 813 on 14 Mc. 3BRZ is working DX on 14-Mc. 'phone with a 300-ohm line folded dipole. 3DGM operated all through the ORS Party with an infected ear but got 230 contacts! 3BXE is on with a new rig using an 809. He worked five continents with his 807 doubler. 3GQW worked VS7JX on 14 Mc. with 40 watts input. 3FLH is on 14 Mc. with a pair of T55s. 3GHD is having antenna trouble these days. 3GHM's NC101X folded up during the ORS Party. 3JSU surprised us all with a fine performance in the ORS Party. 8EHR/3 is setting up a fine station, 'phone and c.w., 250 to 500 watts. 3IPC put up a new three-element beam for 28 Mc. at his new QTH. 3KT is resorting to directive antennas in order to snare some of the rare DX on 14 Mc. The Frankford Radio Club now holds the call W3FRY as a memorial station to the late Jim Hodgman. 3EVT, famous DX hound from Virginia, "boiled the Owl" at 3BES over the week end. 3HFD is on 14-Mc. 'phone mostly these days and has over fifty countries to his credit. 3BES has over ninety on 'phone and c.w. 3HA is ex-8GV and 3ZN is ex-3HRE, both old ORS. There are thirty-three ORS/OPS in the section now. OPS activity is at a very low ebb. 3AQN had a very swell write-up of his station in a local magazine. 3BBV is a new OO. Activity reports are on the increase but could be improved upon. The ORS/OPS Party brought a lot of the old-timers. 3EU is ex-8EU. 3CAU is interested in OO work. 9FSA/3 is a new ham in Philadelphia. Traffic: W3QP 18, 3BXE 6, 3BES 5, 3KKP 1. 73. *Jerry.*

SOUTHERN NEW JERSEY — SCM, Ray Tomlinson, W2GCU — Section EC: 3BAQ. ECs: 3ABS and 3JNZ. Please send ORS/OPS reports by the first of each month. When you send your prewar ORS/OPS certificates for endorsement, please advise us of your ARRL membership expiration date. 3HWO and 3FNL are heard regularly on 28 Mc. Bob is using a BC-343-Q and Joe an HQ-129-X. 3GEV moved to Mortonville, Pa. 2AQW is building rig for full kw. 'phone and c.w., all bands. 3FXN is on 3.5-Mc. 3AIR is on 50 Mc. in vicinity of Silver Springs, Md. 3GRW grabbed off a brand-new Army surplus Hammarlund receiver. 3EUH has worked several Cubans on 40 cross-band on 3.5-Mc. 3BED received commercial telegraph first, and telephone second-class tickets. Ex-3BAP bought a Navy RAK receiver. 2IJC has been working 3.9-Mc. 'phone. 2PBR is working 3.5-Mc. from his new QTH in English-town. 3GQX is building for 14 Mc. with a view to scheduling his son, ex-3FMU, who will sign KL7 on 28 Mc. from the Aleutians. 2OVO is operating portable 3.5-Mc. 3AHN is on 144 Mc. 2QHM is on 3.5, 28, and 144 Mc. 2PLD migrated to 14 Mc. to work some D4s. 2PFQ has eight-element beam. 2OQH and 3CKA are pumping out on 28 Mc. 2OTI upped his power almost double. 2OQH has forsaken c.w. for 28-Mc. 'phone. 3AVJ was heard working cross-band 3.5-Mc. c.w./27-Mc. 'phone. 2ORN doubled power to 50 watts on 3.5 Mc. The *SJRA News* will add a new department in the form of a UHF/VHF section by

2PAU. 3BM holds the S.N.J. h.f. records with his 144-Mc. QSO with Harwich, Mass., 300 miles, using a TR-4 with 8 watts and coax antenna on a 68-ft. steel mast. On the u.h.f. 3BBB uses a 616 with 4 watts and indoor antenna and worked 3JDF, Holy Oak, Del. 3GOI is looking for contacts on 50 Mc. 2PWB is working on 2300 Mc. 3UK has sixteen-element rotary beam for 144 Mc. 3FWP and 3JZR have new mobile rigs on 144 Mc. Additional new W2s: 2QCM, ex-3HYT, 2RDK/8JSU, 2QZF/3IFT, 2QHM/3GZS, 2PPI/3FAF, 2PLD/3GLZ, 2QLM/8TEO, 2OZO/3ILX, 2CEU/3CEU, 2AQM/3AQM, 2APB/3APB, 2QCU/3JAU, 2QGZ/3AFH, 2QKY/3JOL, 2QCC/3HYO, 2QUH/3CCC, 2QLP/3IDY, 3GFS/3GFS, 2EFF/3EFF, 2PYH/3BXA, 2FBC/3FBC, 2RLY/3GQX, 2QKI/3JWX, 2IMA/3IMA, 2QVH/3HOH, 2BEI/3BEI, 2PWD/3EPF, 2QOC/3BPH, 2EZM/3BYK, 2QPZ/3IFV, 2PTM/3COT, 2PRG/3GPFU, 2PSZ/3JNZ, 2PWD/3EPF, 2ZX/3ZX, 2BGF/3BGF, 2HV/3CES, 2PSY/3EPN, 2BQO/3BQO, 2DMU/3DMU, 2DBD/3DBD, 2PRG/3GPU, 2JAV/3JAV, 2PPW/3AUA, and a new call, 2QJO. Traffic: W2AQW 7, 2PCF 6. 73. *Ray.*

WESTERN NEW YORK — SCM, Charles I. Otero, W2UPH — PWY was vacationing in the Adirondacks and heard sad news about the family in town. Not being able to get through on the land wire he called Rochester anxiously on 3.9-Mc. 'phone with 20 watts. MRO picked him up and called for a clear channel. ECM was in QSO on the frequency and promptly signed and offered to help. UPH called in and, with the help of ECM and MRO, PWY's message was received, delivered, and a reply sent back assuring him that everything was OK at home. Heard on 144 Mc. in the Rochester area are 8RTB, OTW, OWF, 8DJW, TXB, TWM, OXK, WKE, 8NOR and 8JV would like to contact the Rochester gang on 144 Mc. from Buffalo. A Buffalo-Rochester-Syracuse network on 144 Mc. is now possible. The newly-elected officers of the Sydney Amateur Radio Club are 8LUR, reflected pres., 8UPT, reflected treas., and 8KKP, secy. The Club held an interesting DX contest for its members, paying cash prizes for the best ten contacts. 8TEW and 8LUR are mostly on 3.9-Mc. 'phone. 8FOB works 'phone and c.w., also 8UPT, 8SYN and 8KKP are strictly c.w. The Club took part in the Field Day and made fifteen contacts with about 18 watts on c.w. 8APD bought three ARRL *Handbooks*; he sent one to Shanghai, one to Poland, and one to Denmark. 8SJV reports the following: 9HHM worked portable-mobile on 144 Mc. in the Niagara Frontier; 3GIO QSOed QAG, PBU, and NOR on 144 Mc. from Darian Center; SZK is looking for traffic on 3.5 Mc. c.w.; FMH is rebuilding with a pair of V7ODs in final; VE3BBH led a discussion on antennas at the Niagara Falls Radio Club meeting; NW is back on 3.9 Mc. after a vacation; NOR worked five Erie, Pa., stations, 3AQY, KKK, NBV, NMP, and KKT on 144 Mc., also his first W9 on 50 Mc.; AYN jumps up on 144 Mc. when 3.9 Mc. gets too hot; PRI, SBN, DHZ, HQC, and SIC are back on the air; UHI and PJJ are rebuilding for high power; SB is EG at Dunkirk (an EC is needed in each locality; contact SJV or UPH); QLK and IIE have new 6IOEs; GHU and NNP are on 3.9 Mc.; NOR, OJ, IRU, PZL, and SJV work portable-mobile on 144 Mc. 8WKE/2 reports operation on 3.5-, 7-, and 14-Mc. c.w. and 3.9- and 28-Mc. 'phone. His transmitter, which is a low-power compact rig, running 6V6GT crystal oscillator, 6L6GX final with 30 watts input, modulated with 6N7 Class B, 6N7 Class A driver, and 6AU6 microphone preamplifier, is now complete except for a temporary modulation transformer. Traffic: (June) W8WKE/2 4. 73. *Charlie.*

WESTERN PENNSYLVANIA — SCM, R. R. Rosenberg, W3NCJ — Section EC: AVY. RMs: TOJ, KWL, KWA. TOJ reports Western Pennsylvania ORS net activity for July; twenty net sessions held, fifty-one messages handled, and following stations participating: AXD, KWL, HKU, KQD, TXQ, TOJ, and KSQ. BOZ is installing 28-Mc. transmitter in his car. VMW, PMY, RMM, and BOZ have received their old calls with numeral "3." NDE writes that the Boys' Club of St. Marys station is 3KYR. KQD,

(Continued on page 66)

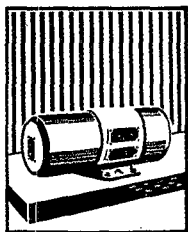

PROBABLY the most interesting feature of amateur radio at the present moment is the large quantity of surplus government equipment that is being offered for sale. Most of us have spent a good many hours poring over the displays of wartime gadgets and weighing values. It combines all the fun of bargain hunting with the best features of a mystery thriller — for what in heck some of those gimmicks were ever used for only the Army knows, and the Army has probably forgotten.

As you have probably discovered, the items that are priced really low are the ones that are so specialized that they have no peacetime use, apparently. These are the ones that are fun, because ingenuity really pays off. For instance, there are a number of aircraft servo units currently selling for less than \$15.00 new, though they may well have cost the government fifty times that figure. This gadget consists of two units, one of which is a compact assembly of a hydraulic pump, motor-driven, a pair of solenoid valves and a hydraulic piston geared to rotate an output shaft. This is just what the doctor ordered for turning a beam antenna. It even has a self-contained, thermostatically-controlled heater to keep the unit from freezing in winter. The second part of the unit is a control box full of gears and electrical parts, including electrical equipment such as might be used as a remote indicator to show where the antenna is aimed. We have not figured out how to do it yet but we plan to have a lot of fun trying.

There are so many different surplus items that there is not much use in trying to review them here. However, dynamotors are available in large quantities and they are useful in portables. Many of these are for operation on 12 or 24 volts which is highly inconvenient, and most take so much current at rated load that they would run down a car battery very quickly, but they can be operated very satisfactorily at reduced input.

One type offered by many jobbers is designed to run from either a 6 volt or 12 volt battery. It supplies 160 ma. at 500 volts and draws 22 amperes from a six volt battery. Even at no load it draws $5\frac{1}{4}$ amperes. However, if you connect the armature for 12 volts but run it on 6 volts, and run the six volt field direct from the battery, the no load current is 3 amperes. With an output of 80 ma. at 255 volts, the drain is about 7 amperes. This is better efficiency than the small dynamotors intended for this output. Furthermore, in emergency you can step up power by throwing a switch.

The dynamotors intended for 12 volts only can be operated at 6 volts if the two field coils are connected in parallel instead of in series. (Watch your polarity!) This cuts the output voltage in half, of course. It makes a very sweet-running, efficient unit with which power can be increased when necessary.

A parallel connection for the field coils will usually let you run 24 volt dynamotors on 6 volts. This provides half the normal ampere-turns in the field but should cause no trouble if the output current actually used does not exceed one-half the rated current. Of course, with only a quarter of the normal input volts to the armature, you will only get a quarter of the normal output volts. However, many of these jobs are intended to deliver a thousand volts or more so you still get 250 volts. This should do very well for your portable and will not punish your battery too much. And if the day should come when you really have to push out a signal, when the wires are down and the river's high, then you can borrow some extra batteries and really sock power into the old rig.

DUD CAMPBELL



Widely imitated...
but still
FIRST CHOICE

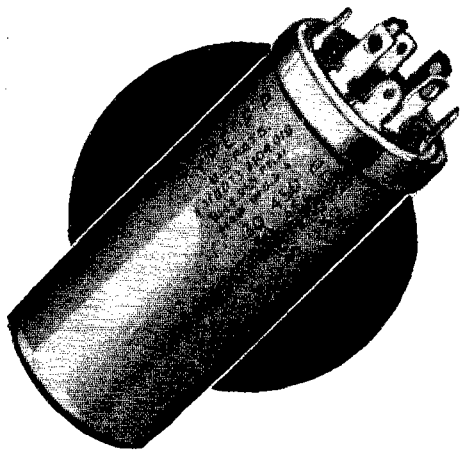

Mallory FP (Fabricated Plate) Capacitors have been widely imitated, but when it comes to performance characteristics, they're still the first choice of radio men.

Low R.F. impedance... better filtering efficiency... surge proof construction... smaller sizes without sacrifice of safety or efficiency... freedom from corrosion... are just a few of the FP features. They explain, among other things, why Mallory FP's are an official standard of the RMA.

Mallory FP Capacitors are available in ratings from 10 mfd. to 3000 mfd., at operating voltages from 10 volts (3000 mfd.) to 450 volts. See your Mallory distributor, or write for the new 1946 Mallory Capacitor Catalog.

P. R. MALLORY & CO., Inc.
 INDIANAPOLIS 6 INDIANA

P. R. MALLORY & CO., Inc.
MALLORY

(Continued from page 64)

formerly EYY, is a member of A-1 Operators Club, AOE has been issued new call, KWL. HKU reports that UAJ is on the air with pair of T40s. KEW, MIE, and UVM are active Meadville stations, according to KEW. MJK keeps 5 a.m. traffic schedule with 4PL, 2CGG, and 1BDU. During month of July BWP worked 25 countries on 14 Mc., using three-element beam antenna and home-made receiver with 1852 and 1853 tubes in r.f. stages of 12-tube superhet. PUT is on the air. VNE is rebuilding for 28 and 14 Mc. SZU is on with 35Ts in final. RAT, SKH, and DXN are on 14 Mc. RIS is QSYing to 14 Mc. after working nice DX on 28 Mc. For 28 Mc. he uses four-element beam and for 14 Mc. a two-element beam antenna, running about 800 watts input on both bands. WKD maintains schedule with W8QEN/CT2. BWP reports that W8SIR/VP9 puts strong signal into Pittsburgh on 14 Mc. At August 4th PARCC Hamfest, traffic and net problems were discussed during meeting held by following ORS members: KWA, KWL, KQD, TXQ, NDE, KXP, CKO, VYU, TOJ, and PER. NBV and WBM are using crystal-control with 815 tube in final transmitter stage. On July 13th contact with 8NOR at Cheektowaga, N. Y., 100 miles from Erie, was made on 144 Mc. by following Erie stations: AQY, NBV, NMP, KKJ, and KKT. Again on August 5th, with band open for DX, contact was made with 8NOR by GV, NBV, NCJ/3, KKJ, and WBM. NCJ/3 was operating portable-mobile from car on hill southeast of Erie. NMP, of Erie, is OPS and handled incoming traffic for the SCM. Other Erie stations heard on 3-9-Mc. 'phone are SLC, SJX, and VHP. Traffic: W8TOJ 60, 3MJK 34, 8HKU 24, 3KQD 24, 8BPW 4, 8AXD 2, 8NMP 2. (June) 3MJK 27, 8KXS 2. 73. Roy.

CENTRAL DIVISION

INDIANA — SCM, Ted K. Clifton, W9SWH — AB has a "boughten" receiver — a BC-348-Q which he uses with converter on 50 and 28 Mc. ZYK has a new mast up for his beams. EGQ is off until he gets more parts. HDB, DLI, and RHL worked fifteen miles north of Milwaukee on 144 Mc. RHL has worked over 100 miles with 9 watts to his portable-mobile rig on 144 Mc. SNF is building a new 600-watt amplifier with modulator. DUT has new 250-watt job finished. MVZ is working out on 14-Mc. 'phone with a low doublet (c.w.) and has a kw. to a 4-250-A. PBS is gathering parts for a rotary 8JK. EBQ has a three-element beam on 28 Mc. and is planning a two-element beam for 14 Mc. TIY is back in this section again. Where? The North Eastern Indiana Radio Club is active again. EGV has lost his key so spends all his time on 3.9 Mc. QRMing the boys. He is most interested in the AEC. 6PKM/9 worked a VK on 7 Mc. QLW has new beam on 14 Mc. DGA is using 30 watts on 7 Mc. with good results. EHU put up twenty antennas on 14 Mc. in one week. (He will publish book on antennas soon.) ERN has new rig which sounds FB. MOK will have rig going for the fall season. UIA has WAC and has worked a number of states on 50 Mc. BLF is on 3.5-Mc. c.w. GGP has been on the same frequency, 14290 kc., since 1934. YWE is now at WHOT, South Bend. He is using a 616 on 3.5-Mc. c.w. BKH is new OPS. NGS is to be on with new antenna on 3.5 Mc. which will be a vertical 1/8-wave, top-loaded. He now has his portable rig on 3.5 Mc. SAG soon will leave us after receiving his Master's Degree in E.E. at Purdue. After seeing the score he made in the ORS Party in nine hours I could not understand why I mailed my score in to Headquarters. NZZ is on with e.o.o. on 3.5, 7, and 14 Mc. Gramps, DLI, is said to be on 3.5 Mc. now. LSX reports for the Delphi gang. Traffic: W9DHI 4, NZZ 2.

KENTUCKY — SCM, Joseph P. Colvin, W5IEZ/4 — 3FWV now is a 4 in Ashland. 9NGN is operating KLFU, Galveston, Tex. 9EPI has a new transmitter. 9PWB is working at WLEX, Lexington, Lt. Col. 9HAX is in Frankfurt, Germany. 4IQY is active in Mayfield. 9WMI/4 is active on 28 and 50 Mc. in Raleigh, N. C. 9TXC has three mobile rigs in his car: No. 1, 2-8 Mc.; No. 2, 235 Mc.; No. 3, 21-30 Mc. 9JYL/KH6 wants Kentucky hams to listen for him on 28.5 Mc. Jack is at Hickam Field with 150 watts and a three-element beam. First Louisville-Lexington 28-Mc. QSO: 9QLF/4 and 9LNU, 43 minutes, July 15th, 75 miles. 9MRF, LNU, and 4JEB hold scheduled QSOs with 9WUC, Indianapolis, Ind., 90 miles airline. 9YXF and MRF have new 28-Mc. beams. 9LPB is recovering after a long spell of sickness. 4RBN, who reënlisted as captain,

(Continued on page 68)

✓✓
**ONLY HAMMARLUND RECEIVERS
 HAVE THIS FEATURE...**

UNITED STATES PATENT OFFICE 2,222,043

2,222,043
SELECTIVE WAVE TRANSMISSION
 Donald K. Oram, Forest Hills, N. Y., assignor to
 The Hammarlund Manufacturing Company, In-
 corporated, New York, N. Y., a corporation of
 New York

Application June 28, 1939. Serial No. 281,612
 8 Claims. (Cl. 178-44)

This invention pertains to electrical apparatus and circuits of the type known as filters and more especially to such apparatus and circuits of the type referred to as band pass filters. One object of my invention is to incorporate in such receiver to such a degree as may be found necessary, and to make such re- duction quickly and to a predetermined degree. Another purpose is greatly to attenuate

HQ-129-X



The variable crystal filter used in the "HQ-129-X" and the "Super-Pro" is an exclusive Hammarlund patent. It provides wide band crystal selectivity for use in crowded amateur phone bands and single signal code reception.



HAMMARLUND

THE HAMMARLUND MFG. CO., INC., 460 W. 34TH ST., NEW YORK 1, N. Y.
 MANUFACTURERS OF PRECISION COMMUNICATIONS EQUIPMENT

Now You Can See The Performance of Your Circuits

With the
HAR-CAM
Visual Alignment
SIGNAL
GENERATOR

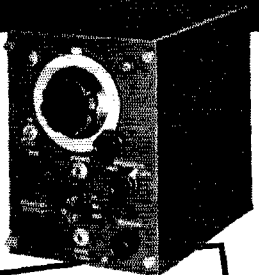

The HAR-CAM Visual Alignment Signal Generator instantly shows up the misalignment in the I-F circuit shown above.



With the assistance of the HAR-CAM Signal Generator, the performance of the circuit is easily and correctly adjusted.

The HAR-CAM Visual Alignment SIGNAL GENERATOR provides the swiftest and surest method for the adjustment and alignment of tuned circuits. With it the complete radio frequency response curve of any circuit under observation can be presented on an oscilloscope screen. Variations in circuit alignment can be accurately evaluated and necessary changes made in a matter of seconds—a far simpler, more precise method than the old technique of tuning for maximum audio or voltage output which often leads to improper alignment of I-F, discriminator or other circuits.

For complete specifications
write for bulletin H-40



**HARVEY RADIO
LABORATORIES, INC.**
451 Concord Ave., Cambridge 38, Mass.

(Continued from page 66)

is headed for Germany, via Ft. Monmouth. 9MWR is temporarily at Oak Ridge, Tenn. 9ALD has a new beam on 28 Mc. KYN, temporarily inactive, should be hitting on all six (at least) by this time. 4TFK, 4NGZ, 8JVI/4, 9FZL, and 9KVE are holding up their end Down State. The SCM wishes to thank his many friends for the kindnesses shown during his recent illness. 9NJY and 4IUP are still in QSO. Kentucky hams: Please send me the name, address and call of every active ham you know in the State. The ARTS meets at Canary Cottage, second Saturday of month, 6:30 p.m. Other clubs, please give me your meeting information. Traffic: W4IQY/4 14, 9BAZ 5. 73. Joe.

MICHIGAN—SCM, Harold C. Bird, W8DPE—8NLV finally has an oscillator running. 8NQ has been working 7 Mc. but expects to be back on 3.5-Mc. soon. 4IIP is working in QMN net (3663 kc.) from Lansing. 8TBP gets on week ends. 8SOX is old 9EXT. 8MCB is spending considerable time with experimental television. 8KPL is on with 20 watts on 3.5 kc. 8DUA calls our attention to an error. He is secretary-treasurer of the Kalamazoo Radio Club, not the president. The president is 8YIA. 8GQF has his old letters with the new 8 symbol for the Upper Peninsula. 8YCT is located in Rochester, Mich., and can be heard on 3507.5 kc. 8AW received his SWL card from New Zealand, giving him a very good report on 3.9-Mc. 'phone. 8LHH reports 8YDR and 8YJE new-comers to Wayne and ham radio. 8YHA has been doing fine work on 3872 kc. with ten watts and reports working the sixth district. 8DED is working on 28 Mc. 8SWF now has his BC-610 on the air and is working hard to get his 28-Mc. net going. 8EGT is on 28 Mc. using 807 in final with "V" beam antenna. 8MVCV is on QMN and looking for traffic his way. 8OXM is working 28 Mc. 8KNP can be heard on 7 and 14 Mc. 8UFS is on 14-Mc. station located at WCAR plant and has new three-element beam going up on 60-foot pole. 8CSL is working low power on 28 Mc. and is enjoying the Oakland County Radio Club meetings. 8ZAI is new-comer to the amateur ranks. 8YDT spends his time experimenting with v.h.f. beam antennas. 8UMI schedules Lakewood, Ohio, nightly on 14,500 kc., also 8WJC same time. He is running 60 watts on 829 three-element beam superhet 13-tube receiver. He also has 28-Mc. mobile rig. 8FQW spends his time copying code. 9ZBN constructed the filter recently described in QST. He is working on antenna coupling. 8TZD reports 8PHO back from the Army and combined stations at same location, building all-band transmitter. 8RJC can be found on 7 Mc. 8GQZ reports running only 10 watts but working Georgia, Kentucky, and Iowa. 8RXX can be found on 3.9-Mc. working 'phone. 8SAY has been trying 7 Mc. and reports doing fairly well down there. Jerry has ORS appointment again. 8UCG reports lots of cooperation on Field Day. 8URM has been working 7 Mc. since opening up. 8ONK, 8VWL, 8SCW, 8FX, 8FPK, and 8TRP report. Traffic: W8DAQ 128, 8UGR 103, 8SCW 41, 8TBP 30, 8TYE 26, 9GJX 25, 8FX 21, 8KNP 19, 8DPE 18, 8URM 14, 8TRP 7, 8ONK 6, 8RJC 5, 8KPL 3, 8YHA 2, 8MVCV 1. 73. Hal.

OHIO—SCM, Carl F. Wiehe, W8MFP—1ONV, ex-8RY, is eager to QSO the old Ohio gang and promises a card with big red call letters for each QSO. NDN has a new beam fired up on 14 Mc. AYS is looking for 14- and 3.5-Mc. traffic. AQ had a portable rig with an 807 in the final with him on his vacation, which was spent in Maine. LCY has his newly-overhauled rig all fired up and ready for traffic. DAE has 600 watts on 14 Mc. working into a doublet made from Amphenol 300-ohm line. EQN, 4TFK, 9QLF, 9NDY, 8PUN, 8DZO, 8TRX, 8STZ, 8LOF, 8THJ, 8TYX, and their families, had a wonderful time at the Dog House Net picnic held at Serpent Mound Park in southern Ohio on July 21st. KQE is burning up 144 Mc. with a new rig. RN is spending his spare time between QSOs redecorating his home. WE, while waiting for his new receiver, is spending his time helping to reorganize the Findlay Radio Club. 9YAH/8 is busy fixing up his new home in Celina. The Greater Cincinnati Amateur Radio Association is engaging in an enormous amount of activity that is without precedent for Cincy. Picnics, stag hamfests, contests, code classes, raffles, and well-attended meetings are the order of the day. JKW and QHZ now are working in double harness. Congratulations, fellows. VVL, the new net control station of the Queen City Emergency Net, is ready for action on all low-frequency bands and is to be dedicated to the memory of Dudley Outcault, a prominent Cincinnati judge

(Continued on page 70)

RECORD - SMASHING DX AHEAD

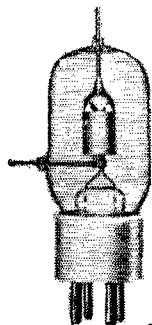

3C24

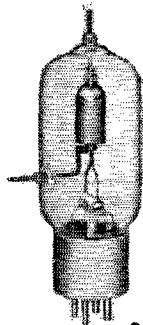

35TG

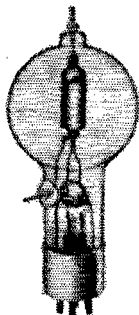

75T



152T

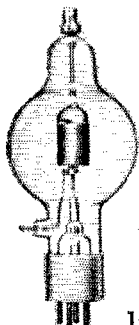

100T

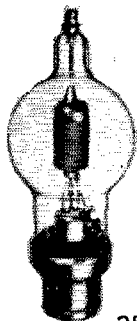

250T

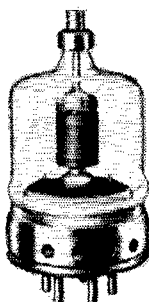

4-125A

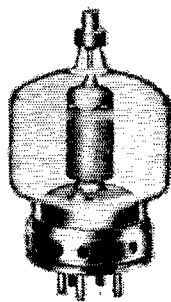

4-250A

These are the Tubes for Champions

Look at the record of DX champions over the past ten years, and you'll find Eimac tubes the predominant favorite. And why not? . . . It's natural, after all, that in seeking top performance you're just bound to end up with Eimac tubes, whether for a new rig or rebuilding an old one. You can't pass by Eimac tubes, because their outstanding performance capabilities, their dependability, and long life make them vastly superior for DX work . . . truly the tubes for champions. Today Eimac tubes, incorporating many new features, are better than ever. Get back on the air with Eimac tubes for the record-

smashing DX ahead. Write now for latest information. Eitel-McCullough, Inc., 1292M San Mateo Ave., San Bruno, California. Export Agents: Frazar and Hansen, 301 Clay St., San Francisco 11, California.

Follow the leaders to

Eimac
REG. U. S. PAT. OFF.
TUBES

THE COUNTERSIGN OF
DEPENDABILITY IN ANY ELECTRONIC EQUIPMENT

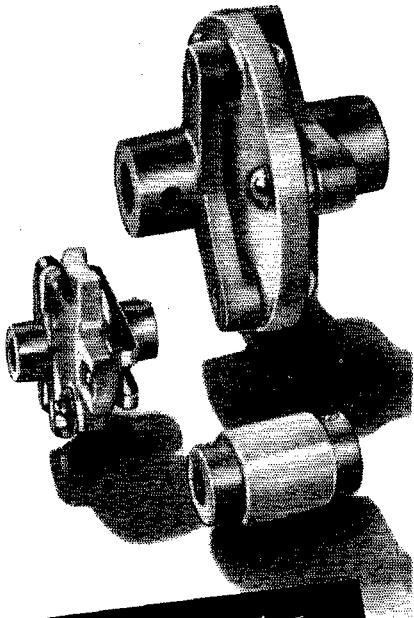

Shaft Couplings

A link between control and variable circuit element, shaft coupling design can be an important factor in proper functioning of electronic equipment.

Illustrated are but three of many Johnson insulated shaft couplings; among them units providing a high degree of flexibility but freedom from backlash common to others resembling them; rigid types where accurate shaft alignment is required and torque may be high; bar types for high voltages or very high frequencies. All are characterized by best steatite insulation properly proportioned for electrical and mechanical strength, by accurate metal parts finished to stand salt spray test, and by those little evidences of Johnson engineering and manufacturing skill that are most appreciated only after use and comparison.

Ask for Latest Catalog

JOHNSON
a famous name in Radio

E. F. Johnson Co. Waseca, Minn.

(Continued from page 68)

and well-known ham, who was a World War I casualty. TAJ reports great activity by the Intercity Radio Club, which represents the hams in the counties of Richland, Ashland, Knox, Morrow, Crawford, and Huron. Each meeting is held in a different town and the club organ. "Drips from the Grid Pan," is mailed to an exclusively-ham membership, which is also entirely ARRL. Traffic: W8EQN 37, AQ 16, RN 14, WE 9, DAE 1. 73, and so long. Carl.

WISCONSIN — Acting SCM, C. C. Richelieu, W9ARE — W9USA, operated by MRAC at Milwaukee Centurama, handled record amounts of traffic on all bands and proved most popular exhibit at the exposition, which ended Aug. 12th. MUM, DIR, SZL, IQW, and IGC renewed ORS/OPS certificates. DRN worked Milwaukee from Twin Lakes on 144 Mc. after changing to vertical antenna. CIH, with elaborate frequency-measuring equipment, is new OO. PEC is new Section EC for Wisconsin and will be contacting all stations interested in emergency work. PFH is new OBS. RQM worked 293 stations in Field Day using 400-ft. sky wire 100 feet high. IGC is active and reports HBF, a blind ham, active on 3.5 and 7 Mc. LFK has new v.f.o. This section news can only be as interesting as your reports to me make it. Send them in by the 1st to 4901 S. 30th St., Milwaukee 14. Traffic: W9ARE 81, RQM 20, LFK 4. 73. Rich.

DAKOTA DIVISION

NORTH DAKOTA — SCM, Raymond V. Barnett, W0EVP — JVP and LUP have received their discharges from the armed forces. KET, of Minneapolis, Minn., is moving to Jamestown, N. Dak., where he will be on the Northwest Airlines staff. KZL is helping EVP build his new house. GJJ has acquired a National 101X receiver and has a new center-fed antenna hoisted. FSA is a new call at Grand Forks. OCI is radio operator for Department of Justice Border Patrol. RGT has installed fan "blowers" to cool his HK254s. VAZ has most of the parts accumulated for a 1k kw. rig. DM was leader at a summer scout camp. 73. Ray.

SOUTH DAKOTA — SCM, P. H. Schultz, W0QVY — WUU sold his Howard 430 and now has a new RME-45. FJR got his SX-25. ADJ has a new HQ-129-X. BLK got an SX-28A in place of an SX-25. JLS, new ham at Rapid, is secretary of the club and sends copy of BHARC minutes after each meeting to SCM. OQQ reports that he is new president of Bear Butte Amateur Radio Club. Members are from Lead, Tiford and Sturgis. A contest was held with Rapid on Field Day. (He says the Bear Butte operators won.) Didn't see any reference to it in minutes of BHARC meeting. KEE, FKX, RWX, KTS, YTE, AGL, MRP, YYJ, OQG, and OQQ are a few of the Bear Butte members, with RWX, vice-pres., and KEE, secy-treas. EC and other appointments are open in all sections of the State. Why not make application? ADJ and KTS have been suggested from Rapid and Sturgis Clubs. How about some suggestions from central and eastern South Dakota? 73. Phil.

SOUTHERN MINNESOTA — SCM, Vernon G. Pribyl, W9JMC — JNC reports he had a good time in the ORS Party in spite of the fact that his transmitter went bad and he had to finish up with 25 watts to a "V" beam. VKF now is in Peoria, Ill. RJP blew his big power transformer but it took two days of experimenting before he was convinced. He now is on with 70 watts using his exciter. He tried ORS Party but decided a v.f.o. is the only thing for contests. OMC enjoyed a nice week's vacation and is now working on a new exciter. DRG stopped in to see the SCM while on vacation. Traffic: W9JMC 7.

DELTA DIVISION

ARKANSAS — SCM, Marshall Riggs, W5JIC — QI is sure going to town on 14-Mc. phone with fifteen countries in fifteen days. KVV is winding plate transformer. HEW is doing OK with low power on 3.9-Mc. phone. JSR has left us for San Francisco and the fair State of California. CPV is building new rig at Camden. HPL finally broke the ice and got a pea squitter on 3.5-Mc. c.w. CTS has gotten all the bugs out and is working on 7 Mc. GWT is back with us before going on another job. HDR was a visitor in town recently and is making every effort to get 600 watts on soon. 9WXE and 9ZAW were visitors of JIC and are going to spend vacation in the Ozarks. IVY is in paradise with 7 Mc. back. IWL has new portable emergency rig which works in nice shape. JIC is just finishing up new rack and panel

(Continued on page 72)

SEE YOUR **BLILEY DISTRIBUTOR**

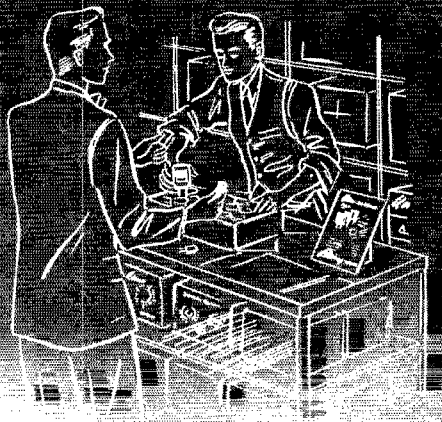

FOR *Techniquality* FREQUENCY CONTROL

Like all other famous predecessors each of these Bliley crystals has been engineered to do a special job—and do it well.

Frequency control units like type AX2 are tops in "techniquality" for the amateur bands. The same design integrity and product quality is found in types FM6-S and SMC100 units for frequency measurement applications, types CF3 and CF6 units for filter circuits and aircraft units such as types MC9 and VX2. Most of these units are stocked by your favorite Bliley distributor. See Bulletin No. 31 for complete details.

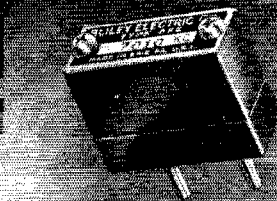

TYPE AX2



TYPE CF6
455 kc.



TYPE VX2
3105 kc.

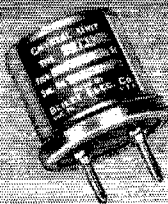

TYPE FM6
70-400 kc.



TYPE CF3
455 kc.

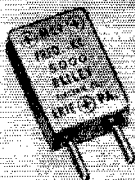

TYPE MC9
3000-11,000 kc.

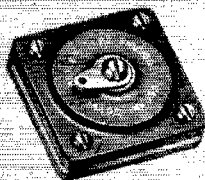

TYPE SMC100
100 and 1000 kc.

Bliley

CRYSTALS

With **BLILEY TECHNIQUALITY** "at the controls" frequency precision is never a problem on the amateur bands.



LOW DRIFT
70 MC
ALS

Only
\$150
Perisoid
in U.S.A.

Our Engineering Department
is available
for consultation
on any
commercial crystal problem.
Write us!

(Continued from page 70)

job all-band affair with p.p. 35TG in final. JPY is on 3.9-Mc. 'phone with his HT-4 rig and wants somebody to talk to. Let me hear from you, boys, on what is happening in your neck of the woods. 73. Marshall.

LOUISIANA — SCM, W. J. Wilkinson, Jr., W6DWW — RM: KTE. PAM: CEW. JPJ is looking for hams to take part in Civil Air Patrol in major Louisiana cities. KUG and KTE want traffic schedules. EGK is putting 400 watts on 14 Mc. CNG has 850 watts on 3.9-Mc. 'phone. JEY has new mobile rig on 28 Mc. IDK has revamped for 28 Mc. AKJ is keeping 28-Mc. schedules. KUZ and JET are on 7 Mc. HCV got a Class A ticket. Officers of Ouachita Valley Amateur Radio Club are: HEJ, pres.; HOS, vice-pres.; JET, treas.; FJW, secy.; IVF, publicity. LDL is putting 14-Mc. rotary on roof top. KUM wants rag-chewers on 7 Mc. FJO, QH, ABA, HAH, IHR, and KMD are active. LJT and LMN are new hams. HHV is busy with EC work. FDC has new 100-watt rig. BSR is on 3.9-Mc. 'phone. LAE worked three VKs and two ZLs in an hour on 28-Mc. 'phone. Correction: The Delta Radio Club meets every second Thursday. IHN worked Persia, Java, Japan, and Surinam on 14-Mc. 'phone. QJ is back on 28 Mc. IXL worked CX4CS with only 4½ watts input. KXP has worked all districts with 50 watts. KTB has new four-element beam. GJO has an HT-9 running 125 watts on 'phone bands. 29-Mc. boys are LAE, KXP, KXU, HTU, KOQ, and LDH. KKK is on 28 Mc. AEN worked 9SMA. on Christmas Island. KMN is on 7-Mc. c.w. KEK is working mobile. ILB worked his first Central American, YNIRA. LET works forty-mile DX to Shreveport. KTE is organizing traffic net for Louisiana. The SCM wants applicants for ORS, OPS, OES, and EC appointment. CEW, our PAM, is lining up 'phone net. Traffic: W5KUG 4; DWW 5.

TENNESSEE — SCM, James B. Witt, W4SP — MP, ex-GLP, sends in the following: EVX worked VE2 and 1st, 2nd, 3rd, 5th, 6th, and 7th districts on 14-Mc. 'phone with 25 watts. ERJ has a kw. on 3.9 and 14-Mc. 'phone. ILZ has 250 watts on 7-, 14-, and 28-Mc. c.w. MP has a new BC-610E transmitter on 14 Mc. 'phone and an SX-25 receiver; also a TR4A on 145 Mc. EAI is on the air again on 7 and 14 Mc. 'phone with pair of 813s p.p.

HUDSON DIVISION

EASTERN NEW YORK — SCM, Ernest E. George, W2HZL — LXX reports NOF and LDS are on 144 Mc. in the Poughkeepsie area with CGT expected on soon. Monthly report from NJF for Westchester area is packed with the following dope: 8LO/2 with two twin-three beams to match 300-ohm Twin-Lead, one E-W and one N-S. WACed in eight hours from Harmonic Hollow. 9PEI/2, Skunk Ridge, has the only 28-Mc. vertical in Westchester. AN works 71TF regularly. DRH rebuilt and now has three-element gutter pipe on 28 Mc. driven by a tiny motor the size of a hand. ISG is coming back into hamdom and has been appointed chairman of WARA Hamfest. AKJ is driving a pair of 813s into a selsyn-controlled beam. DOM is moving to Long Island. AD is back on in Scarsdale with 60 watts until kw. is ready. 1LAS/2 now is in Maine. JFA, now out of the Navy, is looking for a place to live. NJF has a new center-fed antenna, three half waves on 14 Mc. fed with RG22/U. PNO, PME, and QDM are new hams. AQK is filling the air with Spanish. CNS devised an automatic tuner for his MRT 4 on 144 Mc. He tunes the band every two minutes while he sits back and waits for something to happen. The WARA is offering a prize to members for the best portable rig. The SARA is vacationing during July and August. A few Schenectady hams are getting out on 3.9 and 14 Mc. KLM got his first G card. (HZL worked the rig for him. Hi.)

NEW YORK CITY-LONG ISLAND — SCM, Charles Ham, Jr., W2KDC — BGO, Section EC, reports a general summer let-down although the activity on the bands doesn't reflect this. OHE, Brooklyn EC, now is on the mend but has carried on nevertheless. Press has about fifteen stations reporting each drill night. BVP rounds out seventeen years as chief radioman at Floyd Bennett Field. PFA also is there. JSJ operates sporadically due to B.C.I. NXT has overcome the same problem by going to f.m. QNH is latest addition to EC net. DUS is plugging away at beam antenna research. OHE finally neutralized his 829. NKO runs 250 watts on 144 Mc. and does well. LG joined the 3.5-Mc. EC gang who can be heard on 3530 kc. Sunday at 3 p.m. In Suffolk DOG continues associations with Red

(Continued on page 74)



Amphenol AND RADIO AMATEURS HAVE ALWAYS WORKED TOGETHER

Radio amateurs are the most versatile technical experimenters known—and so are Amphenol engineers. Amateurs have pioneered the greatest share of electronic developments since the dawn of radio—and Amphenol has pioneered in the development of components used by hams.

Amateurs have an appreciation of the electrical engineering problems in the production of components to give the best performance. They agree that Twin-Lead, pioneered by Amphenol, is one of the most important and useful new products in the field of electronics.



AMERICAN PHENOLIC CORPORATION
CHICAGO 50, ILLINOIS
In Canada • Amphenol Limited • Toronto, Ontario

75 OHM TRANSMITTING TWIN-LEAD

Amateurs asked for it—now here it is! It's the new heavy duty 75 ohm Amphenol Twin-Lead transmission line. Conservatively rated at 1000 watts for 30 Mc. or lower frequency. Available—now—at your distributor's.

Attenuation	Megacycles	75 ohm DB per 100 ft.	
		3.5	0.29
		7.0	0.49
		14.0	0.82
		28.0	1.40

Receiving Twin-Lead is available in 75 ohm, 150 ohm and 300 ohm impedances. Get a copy of Amphenol's new Twin-Lead bulletin from your dealer.

Other Amphenol products of interest to amateurs available at your dealer's:

Radio Tube Sockets. Industrial, standard, miniature and sub-miniature—plugs and accessories. Octal angle sockets for cathode ray applications.

Connectors. All types, with fittings—from 1 to 50 contacts.

Cables. Coax and Twinax (also connectors). Microphone cables (also connectors).

Plastics for Electronics. Plastic sheets, rods and tubes. Flexible tubing and spaghetti. Coil Dope. Molded coil forms, stand-off insulators, knobs and dial pieces.

Antennas. UHF dipoles and arrays.

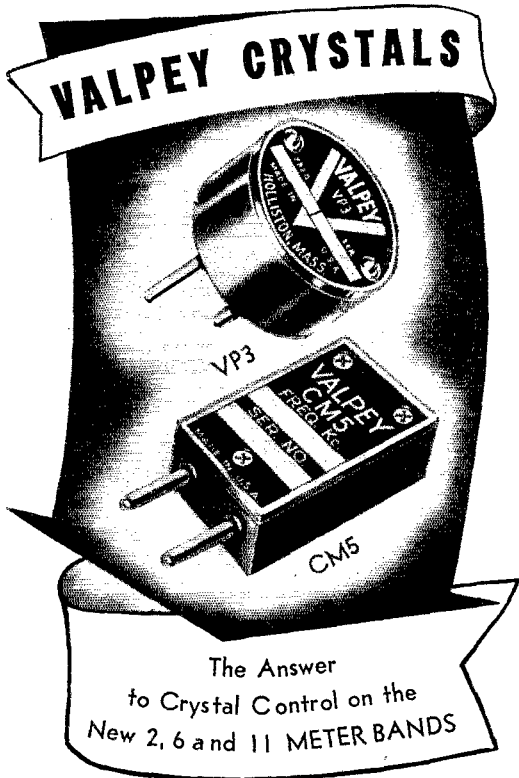

Ready for IMMEDIATE DELIVERY and furnished in your choice of frequency ranges:

				Amateur Net Price	
80 meters,	3500	Kc to	4000	Kc	\$2.80
40 "	7000	" "	7425	" "	2.80
20 "	14000	" "	14850	" "	3.50
10 "	28000	" "	29700	" "	4.50
6 "	6250	" "	6750	" "	2.80
6 "	12500	" "	13500	" "	3.50
6 "	25000	" "	27000	" "	4.50
11 "	6796.25	" "	6863.75	" "	2.80
11 "	13592.5	" "	13727.5	" "	3.50
11 "	27185	" "	27455	" "	4.50
2 "	9000	" "	9250	" "	2.80
2 "	12000	" "	12333	" "	3.50
2 "	24000	" "	24666	" "	4.50

Write for prices on spot frequency "nets". Specific frequency prices on request. Contact Your Local Dealer.

VALPEY CRYSTAL CORP.
 Craftsmanship In Crystals Since 1931
 HOLLISTON, MASSACHUSETTS



WIATP • W1BZJ • W1HVP • W1LQ1 • W8HMJ

(Continued from page 72)

Cross; he's looking for stations on Shelter Island. KNA handles the job in Babylon. FCH leads the North Fork Chapter and Monday night always shows a good turnout on 144 Mc. HQB is lining up the Huntington gang. JWO gets out very well from Patchogue, where he is net control. DOG is adding 21Gs to final. (That is some acceleration!) ADW has improved his signal with an 829. FCH has new antenna location and EBT has a four-element beam. OQI complains of business interfering with hamming, but one must work to ham. Queens County reports via the new EC, BSP, who is sponsoring a new member contest which is going strong. BKZ was forced to QRT because of house hunting. Bill sends in an imposing list of twenty-two regulars and promises more. The Staten Island gang is becoming more active and OFD, the EC, promises more and better activity and is appointing GHK assistant EC. Stu reports ADJ has moved to Rochester. JIX to Red Bank, and HIY temporarily to California. MQS is new call. OBN is on 3.5-Mc. 'phone. All Staten Island hams interested in the postwar SIARA should contact GHK at DO6-1483M. KJY is moving to Franklin Square. He has some fine new gear and hopes to work 7 and 14-Mc. c.w. JYJ still is under construction, as is KD. NAZ had big time in ORS Party working forty-seven stations in twenty-seven sections. She also received her 35-w.p.m. sticker and says her ambition is to work all U. S. counties. Ex-NIL, formerly of College Point, now is 6VOQ and on 3552-kc. c.w. from 2100-2300 PST and would like to renew old Eastern contacts. JAU is on 3.5-, 7-, and 14-Mc. c.w. IXZ is using 8 watts to 25L6s from 110 d.c. line. Dan is looking for an SW-3 and awaits the NYC-LI net on 3710.2 kc. KIK, now at Ft. Dix, is going to Japan and hopes to schedule KOK on 28 Mc. if Tom can stop the fuses blowing. Don't say Selenium to OG. QUT is new call in Jackson Heights; Andy uses a 316A on 144 Mc. OBU acted as relay between 8RZK/3 and 3KIT for three hours. George also is taking north-south traffic with 11IN/3 at Baltimore and is seeking New England contacts. LGK is on 144 Mc. IUD is on 28-Mc. c.w. with 400 watts. FRD is building 144-Mc. mobile. MYR, in the Catskills, is working FB. IAG is back to reporting fire signals as in WERS days. JYR is busy on several bands including 144 Mc. OLM, using 25 watts on 7 Mc., worked four countries. FJU is recovering from Field Day. BO scheduled EL4A and 9USA and is on for daily traffic. HPB is at South Charleston and expects to be discharged in September. GUR has been out since March and is manufacturer's representative now. LGK joined Tu-Boro and is struggling with 2A3 on 144 Mc. AYJ is building 75 watts mobile. HXT is busy with 14-Mc. Q antenna and worked his first 8, who turned out to be an old buddy at Sioux Falls, S. D. PMA reports many new YLRL members, including QVM on 7-Mc. c.w. QJC, PBI, and RAQ. Traffic: W2BO 38, OLM 10, DOG 4, KDC 3, OBU 3, JAU 2.

MIDWEST DIVISION

IOWA — SCM, Leslie B. Vennard, W9PJR — #KZI, of the 75 'phone net, renewed his EC appointment and says there are only four hams in Ottumwa now. GKS has renewed his ORS appointment and says "BPL, here I come" TKG has renewed ORS appointment, but has been very busy on his job. VFM joined the ranks of the OES and wants 144-Mc. contacts. GLR reports from Mason City that their club meets the first Monday in the month. We attended the EF1-NXW picnic at Manilla and a fine time was had by all. CVU thinks someone should use the big club to some of the hams around here — too many rotten signals. #OCEE is getting his Emergency Corps gang lined up. #MFX was called an old ham in error. He is sixteen years old and would like contacts with other high school boys. YDX reports a new jr. operator. TIO reports a Central Iowa picnic will be held at Log Cabin City Park, Slater, Iowa, Sept. 29th. NTI will demonstrate Collins transmitter and receiver. There will be free coffee and no admission cost, but some prizes. AHP is very active on Iowa 75 net. TMY still is waiting for his Class A ticket. Let's have more EC nominations, fellows. We are only half ready for that communication failure here in Iowa. Traffic: W9YBV 34, 9EF1 8, #QVA 4, 9AHP 2, 73. Les.

KANSAS — SCM, A. B. Unruh, W0AWP — PAH and family are vacationing in Colorado. YUQ is working into Kansas City from Manhattan almost every night, on 50 Mc. He uses two three-element beams, stacked. UWN and his YF purchased new home, and are making their annual

(Continued on page 76)

NEW Electro-Voice CARDYNE

Now You Get More Features Than Ever Before... in a Single-Head Cardioid Dynamic Microphone

New E-V developments bring you true cardioid unidirectionality... smooth, wide-range response... high output... and other desirable advantages in a rugged single-head dynamic.

Through the exclusive new E-V *Mechanophase** principle, the CARDYNE substantially reduces background noise and reverberation. Increases effective working distance from microphone. Stops feedback. Permits increased loudspeaker volume. Can be used with back close to wall. Gives extremely accurate pick-up and reproduction of speech or music... indoors and outdoors. Highly suitable for the most exacting sound pick-up work... in broadcasting, recording, public address, and communications.

Trim, modern, functional design, finished in rich satin chromium. Smooth, firm tilting action. "On-Off" switch. Available in 50, 250, 500 ohms impedance, or Hi-Z (direct-to-grid, 25,000 ohms). Low impedances balanced to ground. Also available without "On-Off" switch.

CARDYNE II. Model 731. List Price... \$75.00
Frequency response, substantially flat, 30-12,000 c.p.s.

CARDYNE I. Model 726. List Price... \$55.00
Frequency response, substantially flat, 40-10,000 c.p.s.

*Patents Pending

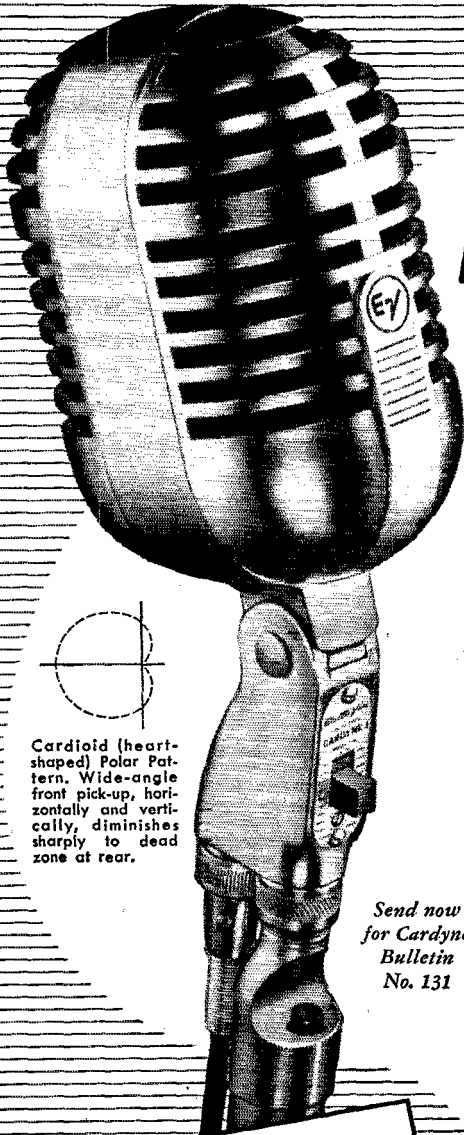

Cardioid (heart-shaped) Polar Pattern. Wide-angle front pick-up, horizontally and vertically, diminishes sharply to dead zone at rear.

Send now
for Cardyne
Bulletin
No. 131

Only the CARDYNE Gives You All This!

- New E-V Mechanophase* Principle
- True Cardioid Unidirectionality
- Reduces Background Noise and Reverberation
- Stops Feedback—Permits Greater Volume
- Relatively High Output
- New E-V Acoustalloy Diaphragm
- Substantially Flat Response

No finer choice than

Electro-Voice

MICROPHONES

ELECTRO-VOICE, INC.

1241-A South Bend Ave., South Bend 24, Ind.
Export Division: 13 E. 40th St., New York 16, N.Y., U.S.A.
Cables: Arlab



RIGHT FOR YOUR RIG—

IRC "Precisions"!

See for yourself how IRC Precision Wire Wound Resistors meet your rig requirements. Look into these six specific IRC advantages:

1. Wide selection of ranges and types
2. Standard tolerance $\pm 1\%$
3. Non inductive
4. Extra humidity protection
5. Low noise level
6. Positive terminal connections

These are typical reasons why IRC has long maintained leadership in the manufacture of Precision Wire Wound Resistors.



GET YOUR COPY OF
THIS FREE CATALOG

IRC Catalog 50 lists a resistance unit for every ham-rig requirement. It's available at your local IRC Distributor.



INTERNATIONAL RESISTANCE CO.

401 North Broad St., Phila. 8, Pa.

In Canada: International Resistance Co., Ltd., Toronto, licensee

(Continued from page 74)

Minnesota trek again this August. Quote. Will fish, loaf, and look for those tall masts. Unquote. 90WZ/7 visited in Kansas. He is in Wyoming now. TVU was Wichita, Salina, and Hutchinson visitor. EPX is ex-AJD and 5KSF, and has 220 watts on 3.5- and 7-Mc. emergency rig. He asks for EC and ORS application blanks. Occupation: Commercial operator for Braniff at Kansas City. A demonstration of 144-Mc. walkie-talkie to fixed station was given at August Wichita Club meeting and local radio supply houses now report brisk demand for 144-Mc. components. Two more KGPZ operators are making application for ham calls. This will bring the total to six. Plans are being made to attend Midwest Division Convention in Topeka October 5-6. The Eager-Beaver 50-Mc. Net held a hamfest in Manhattan August 4th, meeting at QTH of YUQ. Members of the net include ZJB, YUQ, ICV, and VWU. See you in Topeka Oct. 5-6. *Abie.*

MISSOURI—SCM, Mrs. Letha A. Dangerfield, W0UD — ARH has a new four-element beam on 28 Mc., made five DX contacts, and delivered a message from KZ6AB to St. Jo. ZKY has a new speech amplifier but no driver for modulators so far. IDN is cussing 3.5-Mc. QTN. HQI is grinding crystals. SNM got his old call back. TDDH has an 807 on 3.5-Mc. c.w. with 813 in prospect. VYO has a new HRO and is building push-pull TZ40s for 14-Mc. c.w. ZVS has an 807 on 3.5 Mc. and 6L6 on 7 Mc. OFB, now in Oklahoma City, is on 7 Mc. from 7 to 8:30 A.M. and 9 P.M. to 9 A.M. with an 807 and would like Kansas City QSOs, schedules, and traffic. GBJ, on 14 Mc. with 300 watts, took traffic from D4ADN, a local ham now in Berlin. ZJB reports the Eager Beaver v.h.f. 50-Mc. net had a Field Day at Manhattan, Kans., on Aug. 4th. ZIS, in St. Louis, is the second Missouri OES. YHZ received OO appointment; he works into New York and Pennsylvania with 12 watts on 28 Mc., but does not have much luck on 3.9 Mc. PPD/ β , back from Tinian, is building rig for 14 and 28 Mc. and needs receiver. GOL works 3.5 Mc. when not on the road for CAA. HUZ is QRL getting cobwebs and muddaubers out of the old rig, which he will use on 3.5 Mc. while building new one for 3.9 and 14 Mc. for a whirl at 'phone. EYM has accepted appointment as PAM and can arrange schedules after 11 p.m., and is on 3.9 Mc. KIK has 30 watts on 3.5-Mc. c.w. and wants dope on nets and traffic. IMZ is program manager for the new CBS station, KSWM, in Joplin, but has a little time for 3.9-Mc. 'phone. OUD is using an 812 on 7 Mc. but finds QRM too heavy. If you like to read it — send it in. Thanks, gang. Traffic: W0ARH 3, W0GBJ 2.

NEBRASKA — SCM, Arthur R. Gaeth, sr., W0FQB — TQD reports JEE, of Hebron, a Silent Key. DMY is all set with an all-band antenna. BAF, of St. Louis, dropped in to see Lyle while on the way to Estes Park and saw the e.c.o. which helped raise ZS1BM. EWO reports observation of atomic effects nil, because of local h.f. QRM, trying to stir up interest on 144 Mc., and using 7193 oscillator and 829B amplifier, modulated by pair of 6L6s. Ex-DFF is signing 5JPJ and lives at 3696 Louisiana Ave., Parkway, New Orleans 15, La. OKF bought some butterfly condensers from Army surplus and will try out some u.h.f. oscillator circuits and work out a continuously variable test oscillator. RQK, not RQK as previously reported, is vice-president of the Western Nebraska Radio Amateurs. RQK reports as follows: EXP put up two 65-ft. masts and won two 807s at a hamfest held at TMK's. TMK is on 28 Mc. with a commercial-looking home-built rig with an 812 final. KNW has telephone pole on which to build mast. GPX has 6L6 Tri-tet and 807 final on 28 Mc. OHU has semi-e.c.o., 12 crystals, all switched. BIW is looking for 14-Mc. DX with paralleled 807s. RQK has three half-waves on 14 Mc. and telephone pole on which to build beam. He worked 6TSW, ex-9ZNA. Ex-LTL reports ex-LPA now 6VKC, not UKC as previously reported. Pfc. LIQ, Ft. Monmouth, wants to schedule someone in Omaha on 3.5 Mc. The Ak-Sar-Ben Radio Club held an FB hamfest at Linoma Beach on August 25th. Let's have your inquiry regarding appointments. *Art.*

NEW ENGLAND DIVISION

MAINE — SCM, G. C. Brown, W1AQL — Those who were unable to attend the Hamfest and Field Day at Trenton on July 28th sure missed an FB time. We take off our hats to DPJ for the swell job he did as chairman of the committee. Much credit also goes to Mrs. CBV for her help in typing and mailing out the notices. HLE was on the beam

(Continued on page 80)



RME Owners Say!

Mr. L. A. Morrow,
RME, Inc.,
Peoria 6, Illinois.

18 July, 1946
Berkeley, California

Dear Mr. Morrow:

I sincerely apologize for not having written you sooner, thanking you for sending me the RME booklet "Get The Most Out Of Your Receiver."

The only thing I can say about my new, beautiful receiver is just about what others, having one, have said and are saying about it — it's a real honey; it pulls 'em in fb and with a real "sock"! My 800 watts on 75 and 20 meter phone would be for naught without it. Naturally, I am proud not only of its sterling performance but of its professional appearance.

Already I have become quite accustomed to logging all the stations I work using your revolutionary Cal-0-Matic system; it is indeed very convenient and infallibly accurate.

"On the air" and "off the air" recently, from chaps who own RME's and from those who don't I have all sorts of high praises of your famous "DB-20" preselector. So persistent and convincing has this "by-word-of-mouth" advertising been that I have determined to ask you _____.

Many thanks to you for all your help and courtesy.

Respectfully yours,
(Signed) Edgar Malcolm Cameron, Jr.
161 Ardmore Road W6FJH

Mr. L. A. Morrow,
Sales Manager,
RME, Inc.,
Peoria, Illinois.

Mt. Oread Aerie No. 309
R. R. #5
Lawrence, Kansas

Dear Sir:

In receipt of your letter of June 4th in which you say you are sending me Part 1 of "Get The Most Out Of Your Receiver" which I sure am looking forward to receiving in the near future.

I have had the receiver only a very short time but sure am in love with it already. Boy that crystal filter on the new RME 45 sure is a honey. Also on ten meters the 45 does a better job than the old receiver did with a preselector ahead of it. The Cal-0-Matic tuning system sure is a very fine feature also.

Let me be one to say that I personally can say that you at RME can well be proud of the new RME 45.

Sincerely
(Signed) O. H. Baker W0VBQ



FINE COMMUNICATIONS EQUIPMENT

RADIO MFG. ENGINEERS, INC.

Peoria 6, Illinois U. S. A.

Imagine Yourself

The TEMCO 75 GA brings amateur radio into the living room

Goodbye to attics — cellars — shacks. Now you can put a transmitter into your living room that will surely meet with your family's approval, for here at last, is an instrument that is a thing of beauty.

The Temco 75 GA is a 75 watt telephone — 100 watt CW transmitter, completely self-contained in a gray crackle finished cabinet, so compact it only measures 29" wide, 20" deep, and 13" high. Appropriately small to rest attractively on the library table or fit conveniently into the library bookshelf.

It rivals in appearance any expensive radio console or radio record player. Its metal etched, gray baked enamel instru-

ment panel with modest size meters and gracefully formed knobs, possesses a quiet dignity which will enhance its surroundings like a fine piece of furniture. Your family will approve of the important appearance of the 75 GA...will take pride in the air of distinction that it imparts to the living room.

No finer amateur radio transmitter has ever been built. It is an investment for generations to enjoy, key to a magic hobby that will open the doors of your home to all the world of communication...a prized possession for any youngster to inherit from his father. Plan now to own a 75 GA by asking your dealer to demonstrate this latest Temco masterpiece.

PERFORMS AS TRANSMITTER OR EXCITER

The 75 GA is designed to operate within the 3.5, 7, 14, 21, and 28 megacycle bands. It is an engineering achievement which places at your fingertips the ease and facility of radio communication in its highest state of perfection. Engineered and built to Temco's higher standards, it represents the ultimate in a complete... all-in-one-unit transmitter. The only accessories needed to go on the air are microphone, key and antenna. When stepping up to higher power the 75 GA becomes the exciter unit for the 500 GA. Thus your investment in a 75 GA is good forever. For further details read previous ads in this publication.

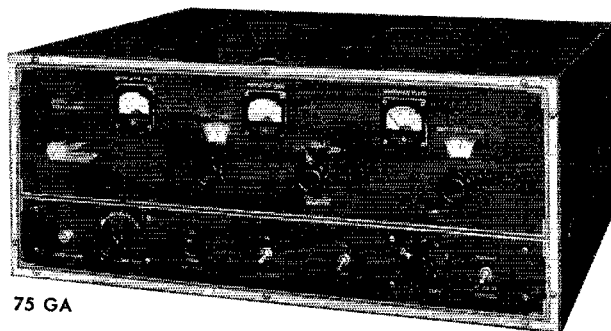

75 GA



500 GA

TRANSMITTER EQUIPMENT
MANUFACTURING CO., INC.

345 HUDSON STREET • NEW YORK 14, N. Y.



n this Chair !



***Everything at your fingertips
and everything in one cabinet***

THE Radio Amateur's Library

THESE ARE THE PUBLICATIONS WHICH EVERY AMATEUR NEEDS. THEY FORM A COMPLETE REFERENCE LIBRARY FOR THE AMATEUR RADIO FIELD; ARE AUTHORITATIVE, ACCURATE AND UP TO DATE

Title	Price
<i>QST</i>	\$2.50 per year*
Operating an Amateur Radio Station — Free to members; to others	10c
The Radio Amateur's Handbook,	\$1.00**
The Log	35c each; 3 for \$1.00
How to Become a Radio Amateur ..	25c
The Radio Amateur's License Manual	25c
Hints & Kinks for the Radio Amateur	50c
Lightning Calculators:	
a. Radio (Type A)	\$1.00
b. Ohm's Law (Type B)	\$1.00
A.R.R.L. Antenna Book	50c
The Minilog	25c
Learning the Radiotelegraph Code ..	25c
A Course in Radio Fundamentals ..	50c

* In the United States and Possessions
— other Countries \$3.00 per year.

** Postpaid in Continental U. S. A. —
(No stamps, please.)

The American RADIO RELAY LEAGUE

• INCORPORATED •

WEST HARTFORD 7, CONNECTICUT

(Continued from page 76)

in handling the sports. The c.w. boys won the ball game. The Club is very grateful to AUC and ex-BYI for obtaining and arranging the grounds. 2HNP was winner of the field prize. JSY took the prize for having traveled the longest distance. GKT reports the following visitors: MSJ, MGP, 4GPW, 2OKN, APX, VE2RD, and VE2WC. ERZ says that BEZ is using a Tri-tet on 3.5, 7, and 14 Mc., and also that the Lewiston-Auburn Ham Club meets every Tuesday evening in Auburn City Hall. OEN is a new-comer located in Pittsfield. MUY is back on the air. MLP is lobster fishing and DXing on 3.5 Mc. KYT is attending U.C.L.A. NXX is using a German receiver. IIA is radio manager at Sears and Roebuck. EZR visited MLP and met IIE and LUK. 2UL called on EZR. MGP is located in Saugus, Mass., and spent his vacation in Maine. During his trip he called on AWZ, LKP, GKJ, FBJ, MVD, AUC, DHD, ATS, KNJ, MPK, JJN, and many more. BGU is living in Boston. KVK is back at WABI. MIR is pounding brass at WBF. DEG is in Newton Highlands, Mass. MBV is located in Winthrop, Mass. BFA is with the CAA at Augusta. Traffic: WIEZR 2, 73. "G.C."

EASTERN MASSACHUSETTS — SCM, Frank L. Baker, jr., W1ALP — The BOSTON HAMFEST, sponsored by the South Shore Amateur Radio Club and the Eastern Mass. Amateur Radio Assn., will be held on Oct. 19th at the Mechanics Building, 135 Huntington Ave., Boston. ALP has charge of the tickets and we expect to have them available at all ham radio stores in Boston. GYZ is chairman; HLX, vice-chairman; OLP, secy. New ECs: LMS, Stoneham; WS, Natick; JUL, Framingham; LJT, Brockton; 8BHY/1, Dover. New OES: ILS, WS, LJT, and LNX. New OPS: NXY and LLX. EMG renewed his ORS and RP his ORS and OBS appointments. The Watson Lab Amateur Radio Assn. in Cambridge received the call ORT and will have rigs on all bands. The club holds OBS appointment. Guy Migliore has call ONZ and is on 144 Mc. We heard MKN/2, in Syracuse, on 3.9-Mc. 'phone. 6RQI is on 28 Mc. OQO is on 144 and 28 Mc. OJM is ex-5HQN. 9FO has new call, ONV. Harold J. A. Street, of Dedham, is OMR. OGG, OEF, and 9JSU are on 144 Mc. OLC is on 28 Mc. KIM is on 144 Mc. and had 9TKW and 9NZM at his shack. OOK is on 14 Mc. PX is on 3.5-Mc. c.w. in Falmouth. 2VH, in Dennis, is on 144 Mc. and has been working the gang around Boston. BUG is on with a new rig on 3.9-Mc. 'phone. ALP has a rig on 144 Mc. and a receiver like Ed Tilton's in Feb. QST. Phil Labombarde, a member of M.I.T. Radio Society, has call OMZ and will be on 28 Mc. 7GIL, the secy., reports that MX will be on 14-Mc. c.w. with 1-kw. rig and will have separate rigs on all bands. JSM, LNX, and ILS are on 2400 Mc. and established a new record. 2NAB gave a talk at the El Ray Amateur Radio Club, OMI. Get ready, gang, for the Sweepstakes. BDU has a weekly schedule with BVR in Westfield. Dick Harvey, ex-4IHA, has call OSX. HDJ sent in his OPS certificate for endorsement. HWE is on 28 Mc. but will be on 3.5-Mc. c.w. later. LXQ is on 3.5 and 14 Mc. IPK, secretary of the T9 Radio Club, reports the last meeting was held at BVL's. LLX was in the ORS/OPS Party; he has a 700-wattier on 3.5 and 7 Mc. NXY has a schedule with GZ/3 in Washington, D. C. and 2LRP in New York City, and is building a pipe receiver for 144 Mc. LQQ worked VS9AN and would like his QTH. MCC has new 300-watt rig. OMM has new HT-4 and is waiting for Super-Pro. BDU wants a game of chess by radio. CTW is working on 230-Mc. crystal job. PI is back on 144 Mc. IID, NXO, and IKW are in Hull for the summer and on 144 Mc. IID is working on 50-Mc. t.r.f. converter. AWA says his beam is working swell on 144 Mc. WK has a beam on 28 and 14 Mc. on the same frame. EMG has an RK4D32 on the air and is going to join an Air Wing of the National Guard. KUJ has a rig ready to go on the air. LJH has 28-meter job in his car. HXX and NBV visited site of old WCC at Wellfleet. OKB is on 3.5-Mc. c.w. OID is new ham in Malden on 144 Mc. MGP is on 144-Mc. mobile, also LVV. HZ and OSX are building a 14-Mc. beam for ORT. JWU is living in Texas. MIH would like to see an amateur radio club started down Hyannis way. 3HCE/1 is active on 144 Mc.; MRU is back on. Traffic: WINXY 20, BDU 10, LQQ 4, OJM 3, LLX 3, EMG 2.

WESTERN MASSACHUSETTS — SCM, William J. Barrett, W1JAH — KFY ran country total up to forty-six, including WAC on 14 Mc. in a week. Bob's DX included YI5AL, YR5X, UA9KAA, and ZD8A. Bob also got his old

(Continued on page 82)



EVERY TERMINAL
PROTECTED
by Life Guard
Safety Caps

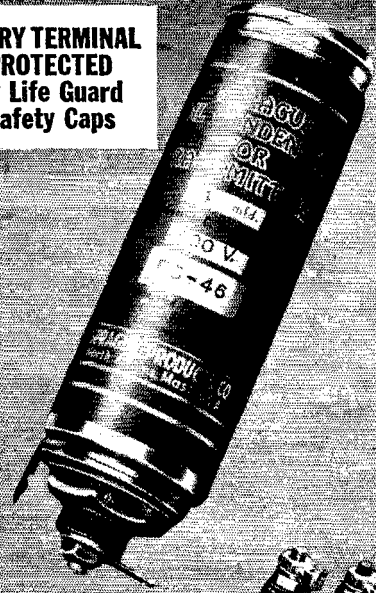

KVO
REG. U. S. PAT. OFF.



THINK of getting a .1 mfd. 7500 v transmitting capacitor in a size no larger than 2¼" wide x 3¾" wide x 3¾" high — conservatively rated and fully guaranteed in the bargain! Or a 2 mfd. 1000 v round job that is only 2" diameter x 2½" high!

These sizes are typical of the new Sprague types filled and impregnated with KVO, the famous wartime oil development. They're absolute tops for performance and they're modest in price. See them at your jobber's today. Streamline your new rig with compact, modern components that give you full benefit of engineering progress achieved during the critical war years!

SPRAGUE PRODUCTS COMPANY, North Adams, Mass.

SPRAGUE TRANSMITTING CAPACITORS

UNCONDITIONALLY GUARANTEED WHEN USED AS SPECIFIED

STATION TESTED*

*an added
proof of Quality!*



*Pres. W. A. Kuehl is shown at his amateur radio station W9EZN. With the war over, Walt is again pursuing his favorite hobby.

DRAKE RADIO SOLDERING IRONS

Yes, Drake irons are right for radio. And these sturdy irons have proved their dependability and worth in use on countless other jobs, too, for over 25 years. That's why we say—whatever your needs, you are certain to find a Drake iron that fills the bill exactly!



600-10—the Drake No. 600-10 is ideal for those all important connections when rewiring your rig. Get back on the air fast. Make good dependable connections with this 100 watt $\frac{3}{8}$ " tip.



400—the Drake No. 400 is the perfect iron for work in small places. Only 9 inches long, it is especially designed for tight corners and delicate connections. 60 watt, $\frac{1}{4}$ " tip.



Ask your nearest supplier or write for the name of the distributor nearest you . . . and give yourself the advantages of these superior irons.

DRAKE ELECTRIC WORKS, INC.

3656 LINCOLN AVE.

CHICAGO 13, ILL.

(Continued from page 80)

call back — a relief after signing KF6SJJ/W1 for so long. MVV is out of the Navy and is struggling with a pair of 812s. Clayt is anxious to get in touch with HQZ. GJJ is swimming instructor at YMCA camp. NKN is looking for a sunspot eliminator. EOB is dreaming up a new receiver with triple detection. BVR took a fling at 14 Mc. and worked seventeen countries during the month. BIV has modulator nearly ready to go. The Western Massachusetts net is meeting Monday and Thursday at 7 p.m. on 3760 kc. Active so far, under the direction of Route Manager BVR, are EOB, KZS, LTA, FOI, MKR/2, JAH, and BIV. If interested in traffic-handling, drop in on the net any night. If your frequency is a little off, just drop a card to BVR and we will work you in. JAH extended antenna to full wave, with far end only three feet off ground, pending acquisition of a new pole. BSJ is doing nice job lining up emergency communications for the section. It's a slow job, but a vital one. If you have facilities for emergency work on any band, contact BSJ. Traffic: W1KFV 5, FOI 4, JAH 4, NKN 4, BVR 3, EOB 2, LTA 1. 73. Bill.

NEW HAMPSHIRE — SCM, John H. Stoughton, W1AXL — Again we remind you of the New Hampshire State Convention which will be held at the Hotel Carpenter at Manchester on Oct. 26th. Tickets are \$4.25 per, or \$4.00 if purchased before Sept. 30th. Get your tickets early and be sure of a seat. ORN, of Whitefield, has received his new call but reports that he won't be active until early next year. He still is on active duty with the Army as an instructor and is stationed at Fort Monmouth, N. J. A few of the gang had an outing in the White Mountains recently. Among the group were 2NSD, 2NYC, 2LEP, 1MCS, 1LUD, 1NMM, and 1LTS. They had two mobile rigs and two walkie-talkies and report 144-Mc. reception good on the summit of Mt. Washington. FZ has a new five-element 146-Mc. beam. AUY and LYS have new RME-45 receivers. AVJ will be back on the air soon from Canterbury with his new HRO and a pair of 4-125As in the final. APK is our new Section Emergency Coördinator. All of you who are interested in emergency work, please contact Basil for AEC membership. 30.#4.

RHODE ISLAND — SCM, Clayton C. Gordon, W1HRC — QR put up new antenna with no better reports. He finally has his 3642-kc. crystal for Nutmeg Net. DWO vacationed in Maine for ten days, acquired a 1N21 crystal absorption-type meter, made some 14-Mc. QSOs with England, France, Cuba, and Netherlands, and expects to move to Massachusetts soon. AQ submits a combined report showing twenty members and a code class running on Thursdays. CPV is on 144-Mc. 'phone and 3.5-Mc. c.w. AOP has a 50-Mc. receiver. NMV is working fixed portable on 144 Mc. and is chief radioman, USN. KWA and IMY are mobile on 144 Mc. AKA has an all-band transmitter partly finished. AWE is on 3.5 Mc. HCW is on 144, 14, and 7 Mc. BGA is active on all bands. JMT is on 144 Mc. EJ is active on 144, 7, and 3.5 Mc. MNC is mobile on 144 Mc. and claims new title — HEWN. 'heard everybody, works nobody. CH pays AQ a visit now and then. HRC rebuilt the exciter for band-switching and then interrupted the program to do the annual mountain climbing. Got a Sky Ranger and took it to Vermont and was really surprised at some of the short-wave reception in valley towns like Manchester. Stopped at BVR's for a short visit and now we know what he means when he says "power-leak." Traffic: W1QR 3.

VERMONT — SCM, Gerald W. Benediet, W1NDL — 4DZV/1, located at Bomoseen, has Signal Shifter on 14, 7, and 3.5 Mc. 9WSF/1, the Reverend H. E. Allen, is located in Brattleboro, and has 7 watts to 6V6 on 3.5 Mc. MIEP now is in Bennington and has rigs on 144, 50, and 28 Mc. KNC, in North Bennington, has rigs on 144 and 28 Mc. FPS is on 3.5 Mc. in Brattleboro. IQG is located at Orleans. IQG built an HRO from parts. MCQ and KJG spent Field Day at Lake Elmore. KJG is building new shack. MCQ has new RME-45. NDB has new taxi business. NDL visited MCQ. OQB is new ham in Barre, and will be on 3.9 Mc. with 30 watts. NLO spent a day in Montpelier with NDL. Traffic: W1AVP 11, NDL 3. 73. Jerry.

NORTHWESTERN DIVISION

ALASKA — SCM, August G. Hiebert, K7CBF — Another Alaskan amateur club has been revived at Juneau. There are fifteen members, with ENA, pres.; AE, vice-pres.; and FBN, secy-treas. Meetings are held once a month at

(Continued on page 84)



Centralab

Division of GLOBE-UNION INC., Milwaukee

PRODUCERS OF



Ceramic Trimmers
Bulletin 695



Ceramic High Voltage Capacitors
Bulletin 814



Variable Resistors
Bulletin 697

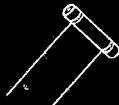

Tubular Ceramic Capacitors
Bulletins 630 and 586



Selecto? Switches
Bulletin 722

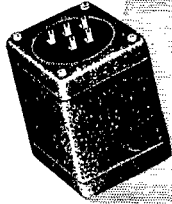

IMMEDIATE ATTENTION



given short order
samples and special
transformer runs!

Power transformers up to 5 KW and audio transformers in a complete range to suit any specification.

Peerless maintains many thousands of specifications on file—many with tooling already set up... thus your transformer development cost can often be reduced through modification of Peerless standard tooling. Call or write

PEERLESS

**ELECTRICAL
PRODUCTS CO.**

6920 McKinley Avenue
Los Angeles 1, California



Send today for
your copy of
FREE CATALOG

(Continued from page 82)

members' homes. AB and BN are on 3.5-Mc. c.w. with 807s while GIN is getting along with flea power. BA works 3.9-Mc. 'phone. AF works 3.5 and 14 Mc. with a Signal Shifter and an 813 final, while AE dims the lights in Juneau with half a kilowatt on all bands. AR warms up on 3.5-Mc. now and then. While awaiting the arrival of a BC-610 from the States, 9TOM/KL7, at Annex Creek, is using low power on 3.5-Mc. 'phone and c.w. AQ is heading Stateside. Cape Nome's only representative, GBF, has been getting good results from his 5-wave rhombic. AFG, Alaska's high man in Band Warning Contest, celebrated by visiting Fairbanks. CF, newest licensed operator in Fairbanks, is burning up 3.5 Mc. with flea power. *Augie.*

MONTANA — SCM, Albert Beck, W7EQM — Section EC: BWH. Our heartfelt sympathy to CPY and CBY on the death of Mrs. Rex Roberts. Best wishes to CPY for a speedy recovery from serious injuries received in the same car accident. Hamfest history was made at Two Medicine Lake, Glacier Park, July 20th and 21st, when VEs and Ws organized the Waterton-Glacier International Hamfest. Officers elected were FL, pres.; BOZ, vice-pres.; VE6SR, secy. About fifty hams registered this year. IRP, newly arrived from Helena, while listening heard JFR on 28 Mc. JFR gave his QTH and IRP was surprised to find out that he was living upstairs over JFR. BWH is proud of new transmitter. DXQ, teeth chattering, was heard working his portable rig from camp site near Livingston. FL worked J3, KA, and VSI with single RK20A on 14 Mc. CJN and EMF are experimenting with new tubes on 144 Mc. How about some reports, gang? Get them in by the first of the month. 73. Al.

OREGON — Acting SCM, Cliff Tice, W7BEE — Bend reports the new three-element rotary beam for 28 Mc. used by HHH is working fine. Others active are JHF with a forty-watt rig, and JIB on 3.9-Mc. c.w. Don Peters, who has received his operator's license but not the station call, has a new SX-25 receiver and has a 150-watt rig nearly finished. A late report from Medford gives the results of their Field Day. They assembled on Roxy Ann Mountain, about three miles east of Medford. Those with rigs were HLF, FUN, DBZ, FSP, FRO, and HWH, while FMQ, FRL, AZZ, and GUP did the heavy looking on. Best DX was by FRO, who worked Enid, Okla. Second best was by FSP. The gang was rained out the second day. Lots of fun and plenty of work was had by all. FUN will erect a tent the next time just in case it rains. Most of the activity of the Pendleton bunch has centered around MQ's new transmitter. Quite a few Europeans have been contacted on 14 Mc., mostly on c.w. One of our more active members is due to go to work for Uncle Sam on the first of September; EQ1, manager of the local broadcasting station, is due for induction into the Army. Little, except listening, for BEE. I have noticed, however, that the ZLs are coming in with a good signal strength in the afternoons. The PARC soon will have about ten members on a spot frequency for local contacts on c.w. All will be on low power so as to cause as little QRM as possible, but it will help to keep up the practice on c.w., which is slightly neglected while on 'phone. 73. Cliff.

WASHINGTON — SCM, O. U. Tatro, W7FWD — Everett: MH, ex-GUU, has been endorsed as ORS. He is on 28 and 3.5 Mc. when not at KRKO. CZY is the first to apply for OES blanks. He holds daily schedule with DYD on 144 Mc. CSK is on 14 Mc.; JFB, 3.5, 14, 28, and 144 Mc.; DYD, 3.5, 28, 50, and 144 Mc.; CHZ, 14 and 28 Mc.; CEC, 28 and 50 Mc.; JIQ, 28 Mc.; BTN, 28 Mc.; IXT, 28 Mc.; BWC, 3.5 Mc.; DQX, 28 Mc.; GEZ, 28 Mc. JIQ is portable-mobile on 28 Mc. and IOQ is portable-mobile on 28 and 144 Mc. Olympia: ORC is on summer schedule with meetings on the fourth Thursday, but regular schedule of second Tuesday and fourth Thursday will begin in October. CBS and QB, of Spokane, were recent visitors and had to hold their hamming in abeyance until they completed a government installation at McChord Field. JFD and family suspended 3.5-Mc. activity for a vacation and dropped in on us en route. HPU did likewise. He is on 3.5 and 14 Mc. EFI and CQJ hold nightly schedule on 28 Mc. between Olympia and Centralia. HML sent FWR a "First Day Cover" from Bikini on the day of the first bomb test. A dead 28-Mc. band defeated her attempt to contact her son on Saipan. GP stopped construction on the new transmitter to report his house. Pullman: ITR is on 7 and 3.5 Mc. and reports FIR building a kw, and GND on 3.5 and 7 Mc. with a Stancor P10. Seattle: CWN was in the ORS Party. JEA

(Continued on page 88)

HERE'S A *New Line* OF D-C CAPACITORS

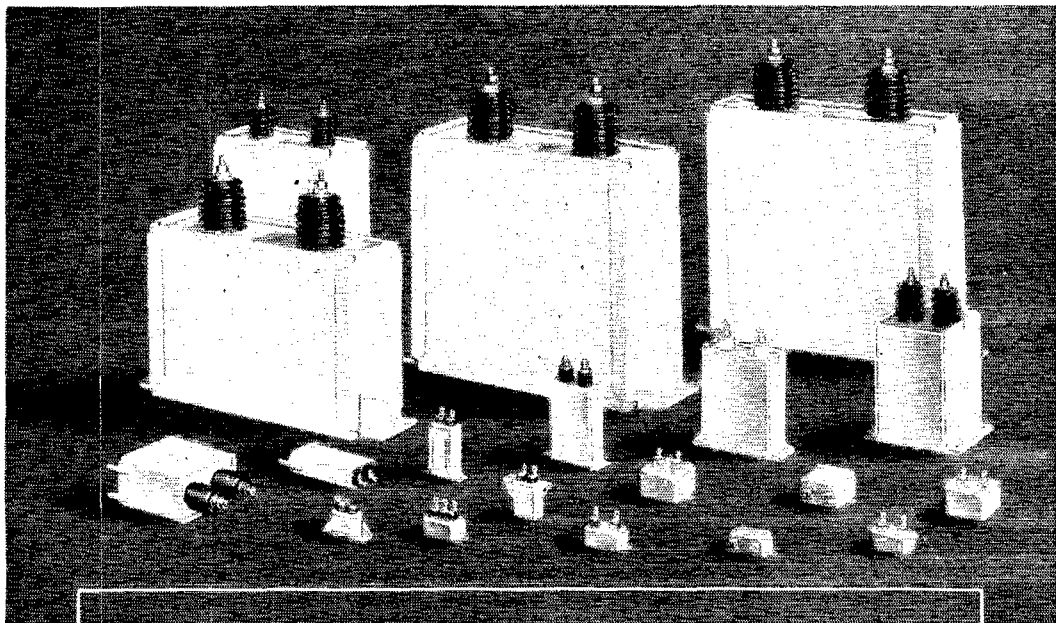

BETTER IN "*Civvies*" FOR HAVING WON THEIR SERVICE STRIPES

It's an open secret among the trade that G-E Pyranol capacitors, which enjoyed such an enviable reputation before the war, are now better than ever.

The reason for this is obvious. Some pretty tough demands had to be satisfied during the war. The strict quality control methods, new manufacturing techniques, and improved materials, instituted at that time have produced outstanding results which General Electric has now incorporated in a new line of Pyranol capacitors designed to meet commercial requirements.

This new listing makes available a wider range of sizes, ratings, and mounting arrangements with characteristics for operation over wider temperature ranges (-55°C to

$+85^{\circ}\text{C}$), at altitudes up to 7500 ft.

These G-E *Pyranol-treated fixed paper dielectric capacitors range in size and shape from bath-tub and small rectangular case styles to large, welded steel case designs. Capacity ratings from .01 muf to 100 muf, and voltage ratings from 100 to 100,000 volts are listed. The high dielectric strength and stable characteristics of the special Pyranol-impregnated Kraft paper are hermetically sealed into these nonflammable units, thus assuring long life.

*Pyranol is General Electric's nonflammable liquid dielectric for capacitors.

D-C Capacitors

GENERAL  ELECTRIC
407-102-5700

GENERAL ELECTRIC COMPANY
Apparatus Department, Sec. 407-102
Schenectady 5, N. Y.

Gentlemen: Kindly send me further information on "Fixed Paper Dielectric Capacitors for D-c Applications".

Name.....
Organization.....
Address.....
City..... State.....

Why this team sets the

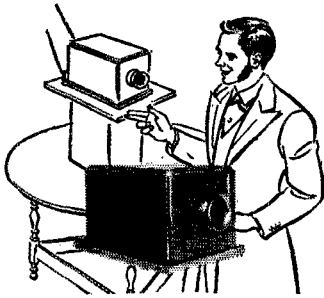

1877: Grand-daddy of all microphones was Alexander Graham Bell's box telephone, into which Thomas A. Watson shouted and sang in the first intercity demonstrations of the infant art of telephony.

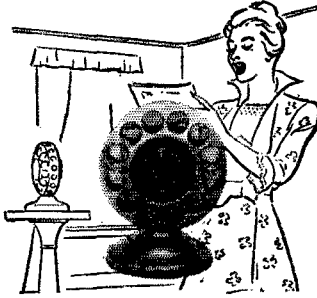

1920: Telephone scientists developed the first successful commercial mike — the double carbon button air-damped type. Used first in public address systems, it later became the early symbol of broadcasting.

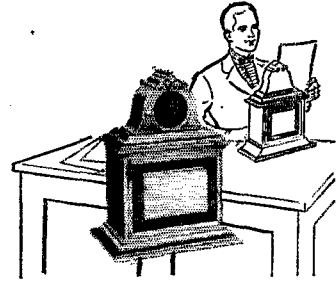

1921: The condenser microphone, designed by Bell Laboratories for sound measurement in 1916, entered the public address and broadcasting fields. It provided a wide frequency range and reduced distortion.

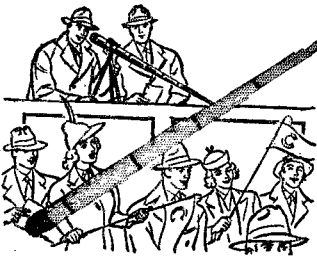

1937: The Western Electric "Machine Gun" mike does for sound pick-up what the telephoto lens does for photography. Sharply directional, this microphone makes sound "close-ups" at unusually long range.



1938: Cardioid directional microphone, with ribbon and dynamic elements, was the first mike ever to combine 3 pick-up patterns in one instrument. The later 639B, with 6 patterns, is also one of the finest all-purpose mikes ever made.

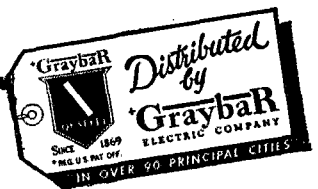

pace in Microphone Development

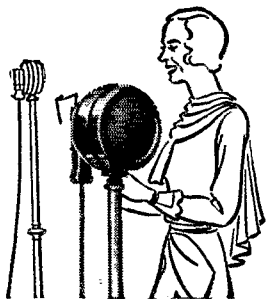

1931: Bell Telephone Laboratories developed the Western Electric moving coil or dynamic microphone. The first of its kind, it was rugged, noiseless, compact, and needed no polarizing energy. Many are still in use.

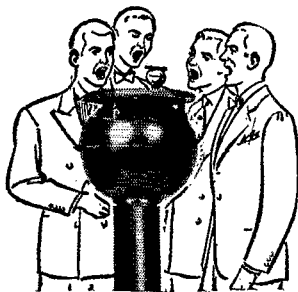

1935: The first non-directional mike—the famous Western Electric 8-Ball, designed by Bell Laboratories. Small, spherical, it provided top quality single mike pick-up of speech or music from every direction.

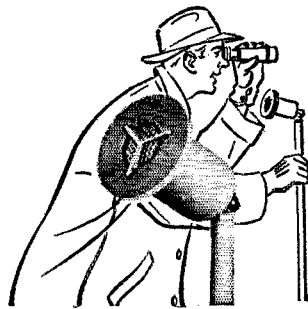

1936: Directional with slide-on baffle, non-directional without it, the Salt Shaker gave highest quality pick-up at low cost. Widely used in studios and remotes as well as in high quality sound distribution.

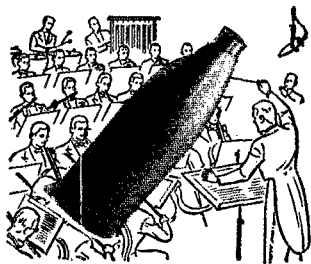

1946: No larger in diameter than a quarter, the 640 Double-A condenser mike (shown with associated amplifier) is ideal for single mike high fidelity pick-ups. Originally designed as a laboratory test instrument.

What is a microphone? Fundamentally it's a device which converts sound into electrical energy—just what Bell's original telephone did for the first time away back in the seventies.

Today's Western Electric mikes—the Salt Shaker, Cardioid and 640 Double-A—are a far cry from the first crude, close-talking telephone transmitter. But they're its direct descendants.

Year after year, Bell Telephone scientists—through continuing research—have developed finer and finer telephones and microphones. Year after year, Western

Electric has manufactured these instruments, building quality into each one.

Together these teammates have been responsible for almost every important advance in microphone development.

Whether you want a single mike, a complete broadcasting station, or radio telephone equipment for use on land, at sea or in the air, here's the point to remember:

If Bell Telephone Laboratories designed it and Western Electric made it, you can be sure there's nothing finer.

BELL TELEPHONE LABORATORIES

World's largest organization devoted exclusively to research and development in all phases of electrical communications.

Western Electric

Manufacturing unit of the Bell System and the nation's largest producer of communications equipment.



NOW in New Plastic Protective Case!
POWER CUTTER KIT
 with a cutting range of
 5/8" to 2 1/2"



Only
\$785
 Complete

Two Bruno Adjustable Hole Cutters in one convenient, permanent case that keeps tools clean and blades sharp.

High speed steel blade cuts clean, fast holes in metal, wood, plastics. Quickly adjustable and easily sharpened...

Designed by tool engineers to operate efficiently in bench drill, drill press, or portable drill.

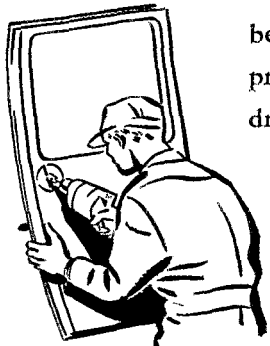

Ask your jobber or write Dept. QST-10

POWER CUTTER KIT CONTAINS			
MODEL	SHANK SIZE	EXPANSION	PRICE
100	1/4" st. shank	5/8"—1 1/2"	\$3.00
101	3/8" st. shank	1"—2 1/2"	\$5.00
790 KIT		5/8"—2 1/2"	\$8.00*

*Fair Trade Minimum \$7.85

BRUNO TOOLS
 2933 Santa Monica Blvd.
 Beverly Hills, Calif.

(Continued from page 84)

has been assigned to sea duty so will not be heard with his OBS duties for sometime. Spokane: EEN, the EC, reports the construction and testing of a few transmitters and receivers for emergency use, also a 500-watt gas-driven generator to supply 110 volts for same. In addition he had a 28-Mc. portable-mobile unit in his car using a converter feeding into the car receiver at 1500 kc. It is designed for all bands on 'phone and c.w. The antenna for all bands below 28 Mc. is an Army type box kite. JNP, SROC secy., reports a club banquet was held June 15th with 135 members present. ARRL Field Day was observed by having a portable-mobile rig located on high ground manned by JIK and EEN and contacts were made with a number of California and Central U. S. stations. Walla Walla: FPP, the EC, reports via 3.5 Mc. (a good way to report; watch for bulletins at 9:15 p.m. and give me a call; I listen over the entire band after a bulletin) that EMP is portable-mobile on 28 Mc. and BEE on same breed of contraption. GUN is on 7 Mc. FDN and EX are on 3.5 Mc. FPP gave Class C exam to four prospects. Woodville: FRU is on 7 and 14 Mc., and is checking up to make sure he was in right spot. 73. Tcte.

PACIFIC DIVISION

HAWAII — Acting SCM, John F. Souza, jr., K6PHD — The K6 gang is very slowly rolling into shape because of the acute shortage of equipment on the market. CGK is knocking over DX with a kw. feeding a "V" beam atop 75-footers. LKN raised AC4YN on a CQ and almost had convulsions waking up the neighborhood with the commotion. While on vacation IQN camped on 14 Mc. throughout his waking hours and sneaked in a bit of DX in the process. FAZ has finally tamed his pair of 807s p.p. and is doing nicely on 14-Mc. c.w. but feels that more power would help, consequently a pair of 35Ts is taking shape. QBI is on 14-Mc. c.w. with a push-push pair of 807s. SDM is now found on 7 and 14 Mc. with a single 814 and is looking for South America for WAC. NSD is on 28 Mc. with a vertical half-wave doublet. The Maui Amateur Radio Club is holding classes on theory and code for new members. The Hilo gang has formed a new radio club. 73. Johnny.

NEVADA — SCM, N. Arthur Sowle, W7CX — Asst. SCM, Carroll Short, jr., W6BVZ, RM: 7PST. ECs: 6MRT, 7TJY. On July 20th a simulated break occurred in the 287-kv. Boulder Dam Los Angeles power line at a point thirty miles west of the dam in the desert. 6MRT went to the break, set up and established communication on 7 Mc. with 6OPP and 6BVZ in Boulder City. These stations were in direct contact with the power dispatcher at the dam. While in California, MRT, Official Observer, kept daily schedule with OPP and BVZ, Boulder City. LAJ and TYX are on 7 Mc. ONG, TFF, and PGD now have same calls with 7 prefix. 9ZTX/7 will be on in Boulder City with p.p. 807. EJC is on 14 Mc. HB was in our mountains on 3.9-Mc. portable on July 4th. 8ERG/7's first contact was a W8. QAY now is W7. TEI is 7BNX again. UHR is on 3.5- and 7-Mc. c.w. KGR has new 8X-25 and operates on 3.5-Mc. c.w. UIZ has 74-foot vertical drain pipe antenna. 73. Art.

SANTA CLARA VALLEY — SCM, Roy E. Pinkham, W6BPT — Assistant SCM, Geoffrey Almy, W6TBK — The SCCARA held its monthly dinner meeting at Vahl's Club with an attendance of seventy-five. CEO showed moving pictures of the Eimac plant and the construction of lighthouse tube. NX showed a reel which was taken twenty-five years ago of the amateurs in the Santa Clara Valley at that time. The old-timers got a chance to see themselves as they were many years ago. JTE has resigned as secretary of the Club and 1WV/6 has been appointed to serve for the remainder of the term. Miles has worked a total of forty-seven states and twenty-nine countries from the West Coast. LCF and BPT are trying to work 14-Mc. DX. JSB can be found on 14 and 7 Mc. with his BC-810. OKQ also is using a BC-610. CFK has a new RME-45. Dick makes his vacation trip to the East by air. LXA has been working 14-Mc. DX on 'phone and keeps schedules with the GIs in Japan. HC is planning a kw. for the near future. TBK is spending time on 140 Mc. and has been heard in Sacramento and Mendocino National Forest. PBV has been elected treasurer of SMCARC at San Mateo. He has worked thirty-seven countries postwar. SYW has worked his first XE contact on 28 Mc. 'phone. UHN was a recent visitor at Ed's shack. FBW enjoying vacation at Carmel. Traffic: W6PBV 12, TBK 3, SYW 1. 73. "Pinky."

EAST BAY — SCM, Horace R. Greer, W6TI — Section

(Continued on page 80)

Shack up with these nifties

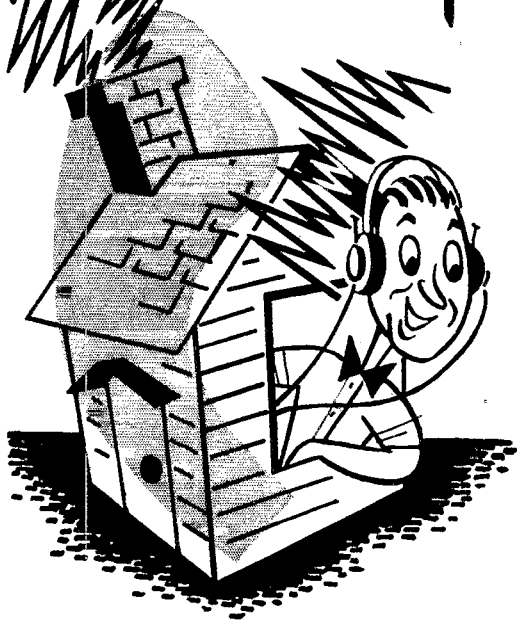

Your ham shack, whether a veteran of war service or a newcomer to the field, deserves the very best in radio equipment. In capacitors, that means only C-D. You can always count on C-D capacitors for long life and dependable performance in your rig.

There's a C-D capacitor type for every radio function — each manufactured under strict quality control and close engineering supervision. Insist on C-D, and you'll be sure of getting the best capacitor value your money can buy.

Write today for free catalog No. 195A — complete data on the most widely used capacitors in radio. Cornell-Dubilier Electric Corp. South Plainfield, N. J. Other large plants in New Bedford, Worcester, Brookline, Mass.; and Providence, R. I.

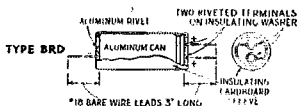
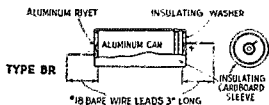
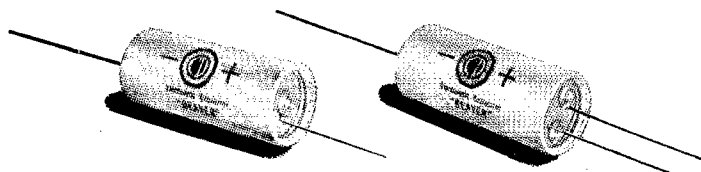

TYPE BR AND BRD "BLUE BEAVER" ELECTROLYTICS

for the ham who wants top flight appearance plus dependability. Hook these units up anywhere in the circuit for efficient by-pass and coupling applications. Available in all popular capacities at 25, 50, 150, 250, 350, 450 and 500 V.D.C.

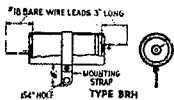
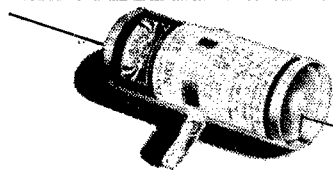

TYPE BRH HIGH CAPACITY, LOW-VOLTAGE ELECTROLYTICS

Compact electrolytic capacitors designed for high capacity, low-voltage D.C. applications. Hermetically sealed in aluminum cans and enclosed in insulating cardboard sleeve. Available in capacities ranging from 100 to 2,000 mfd. at D.C. working voltages from 6 to 50 V.D.C.

CORNELL-DUBILIER
world's largest manufacturer of
CAPACITORS

MICA • DYKANOL • PAPER • ELECTROLYTIC

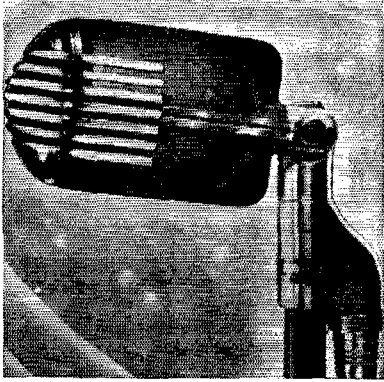

Does the Shure Stratoliner Crystal Microphone have a high output level?

The Stratoliner Crystal has an output level of 49.7 db below one volt per bar. This makes it ideal for Transmitters, Recording, and other general-purpose use.

Can the Stratoliner be used for both semi-directional and non-directional pickup?

The swivel head permits pointing the microphone at the source of sound for semi-directional pickup. Pointing the microphone upward, gives non-directional pickup in the horizontal plane. In this position performers can group around the microphone.

What are other advantages?

The Stratoliner Crystal is equipped with a cable connector which permits quick change of various detachable cables. The high output level permits fairly long lengths of cable to be used. Genuine Bimorph Crystal.

Is it as expensive as it looks?

The list price is only \$21.35... although its appearance would lead you to believe the price is much higher.

Crystal Microphones licensed under patents of The Brush Development Company

SHURE BROTHERS, Inc.

Microphones and Acoustic Devices

225 W. Huron St., Chicago 10, Illinois
Cable Address: SHUREMICRO



(Continued from page 38)

EC: EE. RM: ZM. EC: QDE. EC u.h.f.: FKQ. Asst. EC u.h.f.: OJU. OO u.h.f.: ZM. OO: ITH. OBS: TT, IDY, ZM, ITH, RMM, and UZX. We were all sorry to hear that ZM is very much under the weather. Sam had a stroke in July and is at the Oak Knoll Hospital. Some of the gang moved his gear out to him so try and work him on 28-Mc. 'phone. Yours truly, TI, is running for director of the Pacific Division. Voting is now under way and all ballots must be in Hartford by October 20th. I would like to have this honored position, having the time that is necessary to do a bang-up job for you, my fellow amateurs. However, gang, let's get those ballots in regardless of who your favorite candidate may be, as the Pacific Division is tops. Let's keep it that way by a 100 per cent vote. BUY, PB and TT are trying to knock off all the good 14-Mc. DX on c.w. QLH's XYL receiver her call, WBK. EJA is active on all bands. DUB is active on 3.9 Mc. 'phone. FLW says 3.9-Mc. 'phone is one of his favorite bands. EY should be active on the air lanes by the time this hits the East Bay. ITH still knocks them off on 14-Mc. 'phone. VOS is moving to the Hawaiian Islands as this goes to press, so the Richmond Radio Club will have to elect a new president. FCF hopes to have a 257B on 3.9 and 3.5 Mc. in the near future and has plans for the organization of a nation-wide ARRL/AVC net on 3.5 Mc. and he says "The American Veteran's Committee is a fast-growing organization and should be looked into by every ham/vet of World War II." Interested persons are requested to contact him at present QTH in Oakland. SAN is back at sea after six weeks' vacation. He has increased his power a 35T with 150 watts to a 250th running 600 watts on 3.9-Mc. 'phone and requests the gang to be on the lookout for him on 144-Mc. 'phone mobile on the S. S. J. L. Hanna with 15 watts to a one-half antenna, while on the high seas. Let's have that news each month. Traffic: W6ITH 34, EJA 4, TI 3. 73. "TI."

SAN FRANCISCO — SCM, Samuel C. Van Liew, W6CVP — Phone — Juniper 7-6457: Asst. SCM, Joseph Horvath, W6GPB. RM: RBQ. ECs: DOT, KZP. OO: NJW. OBS: FVK, KNH, DJI. ORS: RFF, BIP, ATY, RBQ. CVP. OPS: OZC, NYQ. DOT returned from vacation and fired up the rig on 14 Mc. with fine signal. DJI and family returned from Lake Tahoe too late for the ORS/OPS Party. MOD is on 7- and 14-Mc. c.w. AUN is on 28-Mc. 'phone and 7-Mc. c.w. WCD is on 28,824-ke. 'phone. AOV is running 'phone and c.w. on 28 and 14 Mc. GTI has kw. on 14-Mc. c.w. JDP is going in for h.f. 144 Mc. and up. PKI, now of Redwood City, is completely rebuilding shack from ground up. At present Joe is on 144 Mc. only. We have a fine active bunch of h.f. men and it is my pleasure to report another h.f. record broken by this section. On July 5th VQB and URA made 96-mile two-way contact on 420 Mc. On the same day VQB made contact one way with 90AW, a distance of 126 miles. Receiver failure at one end prevented this from being the 420-Mc. record. RBQ is going out with his sixteen-element beam to boost the 144-Mc. record again. RBQ has new two-element 14-Mc. beam and a new Super-Pro receiver. VQB is installing high-power 420-Mc. rig at home QTH. He intends to run it as automatic beacon band-spotter at the center of the 420-Mc. band, 425 Mc., plus or minus 1 Mc. ZF dropped in July 12th to say hello to some of the San Francisco gang. He has his discharge from the Air Service and is anxious to get going again, but is unsettled as to just where he will locate. R. G. Martin, Wm. Ladley, J. L. McCargar, and I visited the Marin Radio Club the same evening. J. L. McCargar gave a talk on the recent ARRL Board Meeting and Headquarters activities and answered questions on past and proposed actions concerning the League. The usual bang-up meeting was enjoyed by all present. At the July 26th meeting of the San Francisco Radio Club an excellent talk was given by Dr. Warren on microwave technique in regard to transmission lines and wave guides and their use as impedance matching transformers, tank circuits, and reactances. Nominations were in order for new officers of the club to be voted on in forthcoming meeting. Have received no reports on ORS/OPS Party scores to date. 14 Mc. was very poor because of sun spots. However, 7 Mc. seemed alive with competition. Now that the excitement is over on the opening of the 3.5-, 7-, and 14-Mc. bands let's have some good monthly reports and news items. Drop me a postal before the first of the month. Thanks. Traffic: W6RBQ 170. Sam.

(Continued on page 92)

**Another SENSATIONAL BUY
6 and 11 Meter Crystals**

Sorry—but have only a limited quantity of these precision cut crystals, accurately calibrated to within plus or minus 500 cycles of specified frequency. Better grab some right away!

Type X3—6250 Kc to 6750 Kc—6 meter
Type X4—6797 Kc to 6886 Kc—11 meter
Type X5—8335 Kc to 9000 Kc—6 meter

Specify frequency range desired; order filled from nearest stock value. Your cost each.....

88¢

Three for **\$2.40**



Signal Corps HEADSETS

A quality headset at a truly BARGAIN price! 8,000 ohms impedance. Comfortable rubber cushions. Adjustable headband. Built to Signal Corps specifications. 2,000 ohms D.C. Your cost, While They Last.....

\$1.95

**10
of NEWARK'S
HAM-TOMIC
BUYS!**

**All Brand New Surplus
Specials**

(Prices subject to
change without notice)

**SIGNAL CORPS
COMMUNICATIONS RECEIVER**

For more data on this BC-312 job, see our ad on page 141 of Sept. QST. For 12V operation, complete with tubes, at the sensationally low price of

\$44.50

**SIGNAL CORPS
COMMUNICATIONS RECEIVER**

BC-342, same as BC-312 described in our August QST ad, but for 110V AC operation. Complete with tubes only.....

\$69.50

**Signal Corps
DYNAMOTOR**

PE-103-A delivers 500V at 160 ma. from 6V source. See our ad in August QST, page 137. Special price of

\$14.95

NEWARK'S FAMOUS FILTER CONDENSERS

Cap. Mfd.	Working Volts D.C.	H	W	D	Your Cost
1	1500	2-3/16	1 3/4	1"	\$.79
4	1000	3 3/4	2 1/2	1 1/4	1.50
4	3000	3 3/4	1 3/4	3-5/16	3.75
8	2000	4 1/2	3 3/4	2 1/2	2.75
.15	4000	2 7/8	1 3/4	1	.89
.15	2000	3 3/4	1 3/4	1	.69
.25	1000	2 7/8	1 3/4	1	.59
10	3000	4 7/8	3 3/4	3 1/4	4.75
13	1000	3 3/4	3 1/2	1 3/4	2.25
15	3000	4 3/4	4 5/8	3 7/8	5.25
8	3000	7 3/8	5 1/8	3 3/8	3.95
2+4	600	4 7/8	2 1/2	1 1/4	1.80
5-5-15	1000	4 5/8	3 1/2	3 3/4	1.75

CRYSTALS

Use as converters in h.f. equipment, and as rectifiers for low voltages and currents. Plug-in type. Originally developed for radar circuits, now within your reach for all kinds of experimentation.

- 1N21—General Purpose
- 1N22—Instrument Crystal
- 1N27—Video Crystal

Your cost, any type, each only

39¢



**Special 0 to 500
MICROAMMETER**

Terrific buy! A round-face 2 1/2" meter with 0-500 movement. Scale 0-600 DC volts. Every ham can use at least one in his rig. We have a limited quantity at the socko price of

\$2.95

EICOR ROTARY DYNAMOTOR

A great bargain! Dual windings supply 275V at .110 ma. and 500V at 5 ma. from 12V source. Super special.....

\$4.95

**Signal Corps
TRANSCIVER**

SCR-284 complete with antennae, two dynamotor tube sets—ready to operate. A real smash value for

\$87.50

NEW YORK

242-50 W. 55th St.
New York 19, N. Y.

NEWARK

CHICAGO

323 W. Madison St.
Chicago 6, Ill.

ELECTRIC COMPANY, INC.

Visit all three of Newark's famous bargain counters!

New York City Branches: 115-17 W. 45th St. & 212 Fulton St.

Write for free bargain bulletin listing latest hot buys!



PREFERRED
BY ENGINEERS

BURGESS BATTERIES

RECOGNIZED BY THEIR
STRIPES • REMEMBERED
BY THEIR SERVICE

(Continued from page 90)

ROANOKE DIVISION

NORTH CAROLINA—SCM, W. J. Wortman, W4CYB—Thanks to the Greensboro gang for a swell hamfest. Those of you who missed this one missed a real good time. The fellows must have had more than a hundred prizes as we won our first in almost fifteen years of hamfest attendance. Official registration was 279. The next meeting is to be held in Winston-Salem. 9WMI/4 has been active on 50 Mc. as has HVV and HUT. It is reported that four states have been worked including Arizona, which is fair DX for this band. The fellows will be sorry to hear of the untimely death of FJS, who lost his life in an airplane crash. MR is grabbing the DX on 14-Mc. 'phone with 800 watts and a 7/2 wave Q. DSO spent considerable time in the hospital, but now is out. ANU, AAU, CYN, DGU, CTP, AHH, and DKG are active on 3.9-Mc. 'phone. Be sure to take part in the North Carolina-Virginia Fall Field Day Contest October 5th-6th. Let's try to beat the gang in Virginia. This contest is sponsored by the Raleigh Amateur Radio Club, and details will be available from this Club. All organized clubs that have not already done so should send in recommendations for EC. Other applications are invited. There is a small amount of traffic being reported. Please let's hear of your activities. Thanks, fellows.

SOUTH CAROLINA—SCM, Ted Ferguson, W4BQE/ANG—JGM is new ham for this section. DPN is working 3.9-Mc. 'phone and building u.h.f. gear. DX reports activity at Camden. BAT is EC for Charleston area. HSM has new BC-610 rig and works 28 Mc. GFP is doing nice job with pair of 812s on 3.9-Mc. 'phone. IZQ, with his 809 final and folded dipole, is really working them on 28 Mc. GTW is using an 812 and has swell signal on 28 Mc. ITJ works 3.5-Mc. c.w. and 28-Mc. 'phone. HOY is on 3.5-Mc. c.w. and is looking for the 3.5-Mc. gang. FNS and AFQ are looking for material for their ORS and c.w. nets. 9ZZW/4 and the bunch at Ft. Jackson are keeping things going. BPD has a kw. for each band with a 48-tube receiver. FBD works 3.9-Mc. 'phone. BEN works 28-Mc. 'phone and 14-Mc. c.w. CEL works 3.9-Mc. 'phone. BQE has new rig ready for all bands. CXO is beating them out on 3.9 Mc. 9QHS/4 is back at Ft. Jackson. HJR works 3.5 and 7 Mc. and finds traffic handling a lot of fun. FNT sends nice list of DX worked from Okinawa and is looking for W4 contacts. The Palmetto Amateur Radio Club has inaugurated a 28-Mc. local night net known as the "Hoot Owl Net." We need ORS, OES, and ECs. Traffic: W4HJR 8. 73. Ted.

VIRGINIA—SCM, Walter R. Bullington, W4JHK—EOP, 3308-A Second Avenue, Richmond, is new RM. Anyone interested in traffic handling or starting a net, contact him. 3GKL now is J4HK. BZE has been conspicuous by his absence of late because he acquired an XYL June 10th. Congrats, Tom, from the gang! EOP just received his Code Proficiency Certificate for 35 w.p.m. BZE has new handswitching exciter. The SCM would appreciate the cooperation of all Virginia hams, especially ORS and OPS, in sending in their monthly reports. Traffic: W4EOP 44. 73. "Monk."

WEST VIRGINIA—SCM, Donald B. Morris, W8JM—DFC has resumed duties as RM for Southern West Virginia and all in that part of the State interested in nets and traffic are asked to contact Hutch. MOP blew filament on 250TH just before OPS Party. QFN, formerly of Huntington, now is 4LIV, in Orlando. SPY is new OES and active on 50.1 Mc. The Fayette Radio Club meets 3rd Sunday of each month. USO has new HQ-129-X. UDB has new 150-watt 7-Mc. rig and a new HRO. VAN, CHP, and AHZ are DXing on 14 Mc. QHG is on 3.9 Mc. CSF, Kanawha County EC, has a swell portable rig using 807 and a 500-watt generator mounted in a truck. The Charleston Radio Club reorganized with thirty present at the first meeting. SEN and ORD work at WMON. GBF, REH, GAD, JM, MIS, KWL, FMU, YGL, FEO, BTV, DYB, TCP, CWY, JDJ, and AZD attended Pittsburgh hamfest on Aug. 4th. BOK, DFC, and SPY are new ECs. YLE is new station in Clarksburg. Interest is picking up in the WACWV Contest with several stations getting on the air in counties that heretofore were vacant. 'Tis rumored that there may be a nice prize along with the certificate to the first one getting fifty-five. Traffic: W8KWL 6 GBF 5, JM 4, DFC 2. 73. Don.

(Continued on page 94)

Amateurs

A NEW MULTIPLE CRYSTAL UNIT

SPECIALLY DESIGNED FOR AMATEUR USE

Positive contact, low capacity, excellent for switching to four different frequencies instantly and accurately. Operates in any position and requires a minimum of space. Improves the appearance of any transmitter in either front or behind panel mounting. Over-all dimensions, 2" high, 1 1/4" diameter with octal socket base. Frequency range 3000 KC to 9000 KC supplied in any combination.

When ordering, please state the FOUR frequencies you desire.
 TYPE 275-M(A)—within 10 KCs of frequencies ordered.....\$16.95
 TYPE 275-M(B)—within 5 KCs of frequencies ordered..... 17.95
 TYPE 275-M(C)—within .01% of frequencies ordered..... 19.95



40 METER AMATEUR UNITS



Stable crystal blanks furnished within 10 KC of your specified frequency and guaranteed to within .01% of marked frequency. Supplied in either of the convenient versatile types of holders, 153 AC for 5-prong or 162 PM for octal socket. Frequency range 7000 KC to 7500 KC.

- TYPE 205 RF FOR OCTAL SOCKET
- TYPE 206 RF FOR 5-PRONG SOCKET
- (Note)—Same crystals are available for 80 Meter Band.
- TYPE 210 RF FOR OCTAL SOCKET
- TYPE 211 RF FOR 5-PRONG SOCKET

\$2⁸⁰
 ANY
 TYPE

20 METER THIRD HARMONIC

A 20 meter crystal operating on a third harmonic fundamental. Mounted in compact holder 1 1/8" x 3/4" x 3/8" for octal socket. Crystal blank is guaranteed to be within .01% of marked frequency. Frequency furnished to within 10 KC of your specification.

TYPE 209 TH . . \$4.00

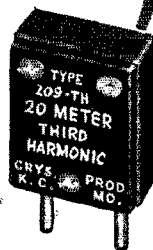

Crystal
PRODUCTS COMPANY

MAIN OFFICE 1519 MCGEE STREET

Phone Victor 9203

KANSAS CITY 8, MISSOURI

ALL CRYSTALS ARE PRE-AGED

Canadian Distributors
MEASUREMENT ENGINEERING

61 Duke Street
 Toronto 1, Canada



JUST OUT . . .

Walter Ashe

SMASH HITS!

What We Advertise, We Deliver — Fast!

AMERTRAN PLATE TRANSFORMER—rated at 2 KVA.
Primary 105/110/115, 60 cycle, Secondary 6200 V. ct.
Freight prepaid anywhere in Continental U. S. A. . . **\$39.95**

SMASH PRICES—INSTANT DELIVERY

Chicago Electric Test Instruments

- Multi-range AC-DC VOM, Model 458 **\$26.00**
- Model 433 Sensitive Volt Ohmmeter **23.40**
- Model 431 AC-DC VOM, a "buy" of **15.34**
- Model 312 AC-DC VOM now only **5.88**

AMERTRAN PRIMARY CONTROLS—adjust input voltage.
Pri. from 95 to 130 V. @ 9½ A. Type 32415. . . **\$14.95**
Pri. from 102 to 128 V. @ 16 A. Type 31970. . . **17.95**

- Simpson Model 215 meter, immediate delivery **\$32.50**
- Simpson Model 260 VOM, immediate delivery **38.95**
- Talkie Xtal Kits to grind your own 40 meter crystals **.98**

- 4 Mfd. 2500 V. Condensers, GE Pyranol **\$3.75**
- 2 Mfd. 4000 V. Condensers, GE Pyranol **6.95**

- Raytheon Transmitting Tube RK 4D32 **\$9.80**
- Eimac Transmitting Tube 4-250A **36.00**
- Eimac Transmitting Tube 4-125A **25.00**

BALENTINE PHONO MOTOR and turntable, a quality,
velvet-smooth precision motor **\$4.44**

ARMY & NAVY SURPLUS SPECIALS!

- FILAMENT TRANSFORMER**—5 V. 25 Amps., a bargain **\$6.15**
- SMOOTHING CHOKE**—12 Hy @ 200 MA, 110 Ohms
DC resistance **2.98**
- SWINGING CHOKE**—5-25 Hy @ 200 MA, 110 Ohms
DC resistance **2.98**

Millen 90800 Transmitter-Exciter, 75 W. Input, packed
and ready for 10 Meter operation, less tubes and
crystal **\$37.50**
Coils Available for Any Other Band

WRITE FOR OUR BIG NEW CATALOG
WOLDO WQDF WOZIP WOYD W9ULH W9GT

WALTER ASHE RADIO CO.
1125 NINE STREET ST. LOUIS 1, MO

ROCKY MOUNTAIN DIVISION

COLORADO—SCM, Glen Bond, W0QYT — 0EGH, in Colorado Springs, sends this dope in. He has a pair T555 on 3.5-Mc. c.w. KKY should be on 3.5-Mc. c.w. by now. SWM is on 3.9-Mc. 'phone with an experimental rig. EVT and GBX (XYL and OM) are doing an FB job handling traffic from the Pacific Islands on 28-Mc. 'phone. HDU is on 14-Mc. 'phone at 3.9-Mc. 'phone. FBF and IHO are on 3.5-Mc. c.w. YLT is on 3.9-Mc. 'phone and 3.5-Mc. c.w. JVR and IOH are on 28-Mc. 'phone and 3.5-Mc. c.w. KMS is building a 500-watt rig with 75THs in the final. IQL is also building. NWQ has a 1-kw. rig in the building stage. ZKM is working 7-Mc. c.w. and 28-Mc. 'phone. KVD has a new rig on 14-Mc. 'phone. IMMO/0 is on 28-Mc. 'phone. 0EHC came up from Oklahoma City and visited HDU, EGH, JB, and FXQ. Carl has an NC-200 receiver. 4AXG/0, at Canon City, has a new HQ-129-X and is putting up a plumber's delight at his new QTH. 0BZV, 0THQ, and another ham at Akron, Colorado, are planning some 400 Mc. work in the near future. All three worked for CAA. BZV is on 3.5-Mc. c.w. but expects to be on 14-Mc. 'phone soon with an 814 in the final. THQ is on 3.5-Mc. c.w. now but will be on 14-Mc. 'phone later. 0YTY was up on Mt. Evans a few nights back and his mobile 28-Mc. rig sure put an FB signal into Denver. QYT was on Pikes Peak August 4th with a 28-Mc. mobile rig, 12 watts input, and worked IMMO/0 in Colorado Springs, IXM in Littleton, AAB, KPT, 7JDB/0, and mobile YTY in Denver, but could not raise the W5s that were coming in on short skip. 73. *Glen.*

UTAH-WYOMING—SCM, Victor Drabble, W7LLH — 7FST, of Sandy City, a real old-timer, writes that he handles over three hundred messages a month. 9NFX is going to school in the East. 7RIM is getting on with an 812, 'phone and c.w. 7JSN just got his license. 9FVO now is 7JQU. 6HUT just returned from the Navy. 6SID has a new relay rack for his rig. 7CKI gets on 14 Mc. with a pair of T40s and a rotary beam. 6SID and 7JQU participated in the ORS Party. 7DTB is having bug trouble, but in the hay and beets, not in the rig. 7RIM joined the ranks of the benedicts. 1RK is stationed at the Clearfield Navy Depot. 7DLR's call was changed from W6 to W7; he has his centered antenna connected to the skyhooks. 7LLH's call was changed from W6 to W7. He gets on 7-Mc. with about 60 watts. 7UOM has his 28-Mc. antenna working and got a ZS contact with it. 0IUG, in Cheyenne, is waiting for his passport to the Philippines to hold down an electrical engineering job for the G.E. Co. While in the Islands he plans to get on the air with a kw. on the 14-Mc. 'phone band and expects to beam his signals at Cheyenne. 81FB, of Claysville, Pa., is in Cheyenne and tells of his experiences in a Jap prison camp with a hidden receiver. 73. *Vic.*

SOUTHEASTERN DIVISION

ALABAMA—SCM, Lawrence J. Smyth, W4GBV — Asst. SCM, Charles L. Herman, Jr., W4APJ. EDR is rebuilding. IDZ sold out to GWF. GOX has a brand-new XYL. 6ANM/4 entertained the Montgomery Club with color movies he made in New Mexico at the firing of the German V-2 rocket bomb. EW is pounding brass at WCLB. GBV visits clubs all over the State in the course of his travels. AUP took a small portable rig along on his Florida vacation. Thanks to HFL and AKP for the Tuscaloosa report. IAT works 3.5 Mc. every night. BEB says he is on 3.9 Mc. and broadcast band. GET is on 3.5 Mc. when sky-wire is off the ground. ELX is building a concrete block shack and has 250 watts ready to go. HAI, 8WAT/4, and DAQ are attending U. of A. HFL is back on 3.5 Mc. JX has a new SX-28 and HT-6 stored. HCV wants to hear from GVG. DMV has received his old call and is looking for a place to live in Dothan. FUM gets into Montgomery FB when skip is right on 28 Mc. What has happened to DGS? IVC is building a modulator for his 807 final. GWF doesn't get enough time in front of a mike at WSFA; he also works on 28 Mc. GAG is very active on 7 Mc. DPX says the new rig is slowly nearing completion. Traffic: W4DXB 5. *Charlie.*

EASTERN FLORIDA—SCM, Robert B. Murphy, W4IP — Both 'phone and c.w. nets are in the process of organization under the guidance of BYF and ACZ. The ORS Party was a humdinger for BYF, 14,733 points, 79 stations in 32 sections. Mac now is EC, OBS, ORS, RM, and president of the local ham club. Activity is requested in various parts of the section for some v.h.f. experimental

PLASTICON* ASG Silicone-Filled GLASSMIKES



1-3/8 x 3-1/2

FOR HIGHER VOLTAGES

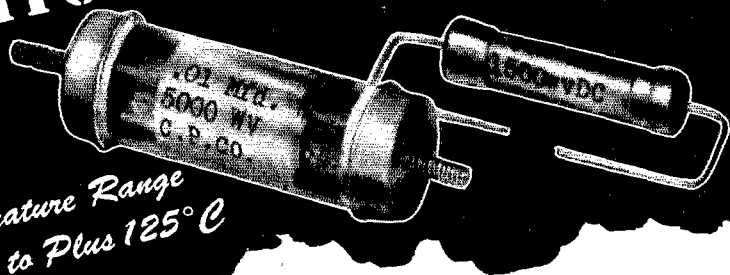

*Extreme Temperature Range
from Minus 60° C to Plus 125° C*

From 600 to over
30,000 Volts

Modern functionally designed capacitors. Metal ferules are soldered to silver bands fused to each end of heavy-walled glass tubes. This vacuum tight assembly is fungus-proof and passes Signal Corps, Air Corps and Navy thermal cycle and immersion tests.

Applications

- For low and medium power coupling and bypass circuits where mica capacitors have previously been required
- Television and Oscilloscope Circuits
- Vibrator Buffer and Arc Elimination
- Geiger Counter and Instrument Capacitors

* PLASTICONS: Plastic-Film Dielectric Capacitors

Write for illustrated literature featuring our complete line of Glassmike Capacitors.

Order from your jobber: If he cannot supply you, order direct



Condenser Products Company

1375 NORTH BRANCH STREET • CHICAGO 22, ILLINOIS

FIRST

FOR THE
GREATEST NAMES
IN
HAM RADIO



Here they are—the newest Post-War "Ham" Receivers with all the latest improvements in technique and design.

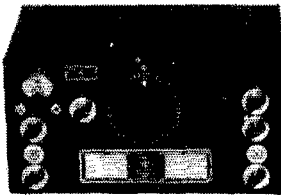

NATIONAL HRO-5TA-1 • Net \$274.35
697 Power Unit \$20.36 • MCS Speaker \$12

A Receiver, designed for the Amateur, to provide dependable communications, under most severe conditions. New Noise Limiter incorporated. Band spread on all "Ham" Bands—Coverage 1.7 to 30 MC.

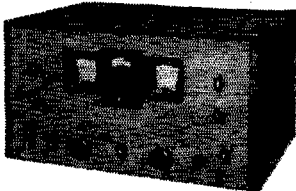

HAMMARLUND HQ-129-X • NET \$173.25
Price Includes Cabinet Speaker

A "Ham" Receiver with the professional touch, providing flexibility of operation. Six bands for easy location of stations. Has all "Ham" features with sensitive and stable performance.

HALLICRAFTER S-40 • Net \$79.50
With Built In Speaker

Performance and beauty are combined in this outstanding Receiver value. Many circuit refinements never before available at this price. Electrical Bandsread Dial—Coverage 540 KC to 43 MC.

HAM RADIO SUPPLIERS SINCE 1919

CAMERADIO CO.

963 LIBERTY AVE. • PITTSBURGH 22, PA.

(Continued from page 94)

work on 50 Mc. with QN, 1NWE/4, and GIY. VV, FVW, and BYF are on 144 Mc. with some time devoted to 50 Mc. IPW is working some DX in a mobile unit on 29 Mc. EYI sends in clippings and items as follows: HUY has a 14-28-Mc. beam; EPW has old call, GA, back; FJC reports the JARC is active; FJC, HWA, and FRG are on 29 Mc.; the Knights of the Kilocycles is getting new members from the Jacksonville crowd — FJC, FWZ, IVX, and EEZ; DLL has his old call again; UJ has code class going for JARC; FWZ is Duval County EC; FJC is OBS. Lake County may have an EC with AYV returning from Johnson City, Tenn. IP, your SCM, is on 3615.5 kc. and is looking for all QSOs from his "flock." ASR is Volusia EC. ACZ is Palm Beach County EC. K6IRS is Monroe County EC. The TARC is active on all bands. New officers are AFU, pres.; DES, vice-pres.; GEE, treas.; and ALP, secy. DUG will be the club station call. The Dade Radio Club closed its contest for working all states. GNT made a liberal prize donation from PAA surplus. VV and IMI are doing good with QSLs. By sending a self-addressed envelope or attending DRC meetings you may obtain W4-Miami QSL cards. DKA has worked his sixtieth foreign country and is looking for a special receiver, single signal, to cut the QRM on 14 Mc. HLV, in Balboa for PAA, reports 14 and 29 Mc. coming in fine. DQW now is ORS. Applications for OPS have gone out to the Knights of Kilocycles. ACZ will promote this as PAM. Traffic: W4BYF 65, GVC 9, BNR 8, EEW 6, AFV 5, BIF 2, DQW 2, GNS 1, 73. *Merf.*

WESTERN FLORIDA — SCM, Lt. Comdr. Edward J. Collins, W4MS — JNP is active on 7 Mc. JBI is fighting bugs in his rig. AXP and DAO are rebuilding into FB cabinets. FHQ is enjoying 7 Mc. 2OTU/4 and 5LAO/4 are enjoying 28 Mc. 6OHN/4 is unmarried and the XYL takes to ham radio. 4QK is gradually building to high power. VR and EQZ are busy with police radio. JV is pulling in the DX. EQR has new HQ-129-X. HX is heard working 14 Mc. HJA is pounding the best signal on the air. 3IHC/4 now is 4JJU. IDBT/4 is building a beam. HIZ is on 7 and 144 Mc. EGN works 14 Mc. with an attic antenna. DZX works on transmitter between reels at the movie theater. QG and BFD are applying for their old calls. ECT and FJR are having FB time on 7 Mc. IVY is after a bigger sock on the air. BKQ just about has the big "peanut whistle" ready. AXF wants OM to leave her transmitter on 28 Mc. MS still is assembling 14-Mc. "peanut whistle," but finds time for 7-Mc. QSOs. 73.

GEORGIA — SCM, Thomas M. Moss, W4HYW — The Emergency Corps is active in several of our counties. New Ware EC is ERS, who also is an OPS. GCD is new Lowndes EC. BAC, GZV, GEG, and GJZ are active in Emergency Corps. IKJ is new OO (Class I). HYW is new OO (Class III). FIJ has been appointed ORS. Our newest OBS is BQU, brother of BOL, our Bleckley EC. We are glad to announce the return of GLE (Marietta), INO and JGP (Atlanta), GEG (Cartersville), HD (Hapeville), GFJ (Hiwassee), and ALW (Savannah) to ham radio after serving in the armed forces. GQR and GEG are planning to join the ultra-high gang on 50 Mc. soon, and ERS is exploring 144 Mc. JBW is a student at Tech III (YC). His dad is ex-4DG. OA4M has been in Augusta and was a visitor at the Savannah Hamfest. TO now is in Atlanta. 9RPA is on from Decatur. IAB is now in Cartersville. KS4AA, on Swan Island, is interested in schedule with the Atlanta gang. His QRG is 3690 kc. The Savannah gang had a very nice hamfest. If you missed this one, it will be worth the time to attend next year. The Old Timers Club is open to those who held a ticket twenty years ago. Prewar members of the Twenty Year Club should apply for membership in the new club. See June QST. U.H.F. stations are urged to take part in the V.H.F. Marathon. Rules in May QST. Don't forget to send your envelope for QSL cards to W4MS in Pensacola. Prewar cards will be destroyed on January 1st. Best of luck and DX. Traffic: W4HYW 16, 73. *Tom.*

WEST INDIES — Acting SCM, Everett W. Mayer, KP4KD — KP4AB passed away after a short illness. New KP4 calls: BD, ex-K4GNC; BL, ex-K4EMG-W20JV; B3, ex-K4HEB; BK, ex-W4DYX; BL, ex-K4HQU; BM, ex-W3JGG; BN, ex-W3JOD; BP, ex-W3JLH; BW, ex-W4DAN. New-comers are KP4AC and KP4AW. UG has RME-45. JA has 300-watt p. p. 812s on the air. 4AM, new OPS, added three new countries for a total of eighteen, and installed new rotary coax-fed dipole. BJ added three new countries for a total of twenty-three. BK has FB home-

(Continued on page 98)

ANNOUNCING THE NEW...

MEISSNER *Signal Shifter*

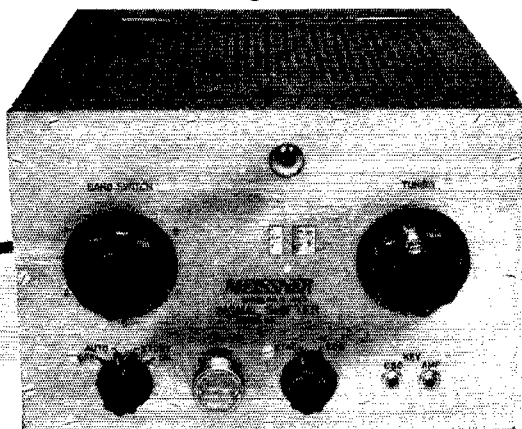

The Number One requirement for the complete "Ham Shack," this new Meissner Signal Shifter has built in band switching.

No coils to change—6-position switch. Normally equipped with five sets of coils for 10, 15, 20, 40 and 80 meter bands plus a blank strip for any additional new band. All controls placed on front panel. Reduced warmup time... thermostatically controlled. Minimum power output 6 watts on all bands. Choice of built-in or separate power supply. For complete specifications write to the address below.

THORDARSON TRANSFORMERS

The name Thordarson is your assurance of transformer quality... backed by 51 years of outstanding transformer manufacture. For every electronic requirement.

ELECTRONIC DISTRIBUTOR AND INDUSTRIAL SALES DEPARTMENT

MAGUIRE INDUSTRIES, INCORPORATED

936 N. MICHIGAN AVENUE • CHICAGO 11, ILLINOIS

AMATEURS! Leo W6GFQ Offers

Immediate Delivery

On His New, Exclusive, Low Priced

WRL GLOBE TROTTER TRANSMITTER KIT

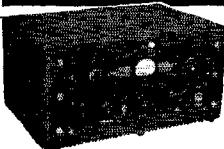

**Users Acclaim
Its Superior
Performance!**

Actual field reports of amateurs using the Globe Trotter testify to its excellent performance. It's the hottest ham equipment on the market today. The WRL Globe Trotter is capable of 40 watts input on C.W. and 25 watts input on phone on all bands from 1500 KC through 28 Megacycles. Incorporates the Tritet Oscillator using a 40 meter X-tal; Heising choke modulation; three bands, all pretuned; 10, 20, and 80 meters; two power supplies, one for 807 final and modulator tubes, one for speech amplifier and oscillator stage.

40 WATT INPUT
Cat. No. 70-300..... **\$69.95**

Complete including all parts, chassis panel, streamlined cabinet, less tubes, coils, and meter.

No. 70-312 same as above, wired by our engineers..... **\$79.50**

1 Set Coils, Meter, Tubes..... **\$15.15 Extra**

For Fast Delivery order your receiver now from World Radio. Here are a few more:

RME 45.....\$186.50 RME 84.....\$98.70

Hammarlund HQ129X.....\$173.25

Hammarlund PC-400-SX.....\$323.25

Hallcrafters S-38.....\$39.50

National HRO-5TA-1 or 5RA-1.....\$274.35
(Less speaker and power supply)

TELESCOPING ANTENNA

Perfect for 10 meter beams. Telescopes
Up to 12 feet. Cat. No. 0-255..... **\$3.95**

SPECIAL

15-TUBE TRANSCEIVER

Complete Transmitting and Receiving Set. 3 SETS IN ONE. 6 tube receiver for 80 and 40 meter bands; 235 Meg. transmitter; Interphone system. Complete with dynamotor. Includes parts kit worth about \$400 (itself)

Cat. No. 70-298..... **\$78.50**

FREE! OUR LATEST FLYER

Packed with real buys in radio, electronic, and general merchandise.

Giant Radio Map

(Size 31 ft. x 41 ft.).....15c

Handy Tube-Base Calculator.....25c

Tube and Circuit Book.....10c



Formerly Wholesale Radio Laboratories
Address Dept. QST-10 Council Bluffs, Iowa

(Continued from page 98)

grown 802-807 v.f.o. W4BZA/KP4, on 14-Mc. 'phone/c.w. with HT4, also works 7-Mc. c.w. W8VRD/KP4 is working on 1-kw. rig. Rd has new Navy RAK receiver. K4EYP is on 14-Mc. c.w. portable in W2. 4LW, 4BI, and K4EJG is active on 28-Mc. 'phone. EJG is on 14-Mc. c.w. Get your envelopes in to the KP4 QSL Manager, fellows. AZ is knocking out WACs on 28 Mc. with choice ones like EL1A, XV2VV, and KG6. Traffic: KP4AZ 2, KP4KD 2, 73. Ev.

SOUTHEASTERN DIVISION

LOS ANGELES — SCM, Ben W. Onstenk, W6QWZ — The Tri-County Amateur Radio Association is affiliating with the League. This club maintains radio communications with the Boy Scout camp at Camp Tulakes and has for many years. VZF was operator at the camp and QE operated in Pomona. 1WU was the call used at the camp. UFJ and VU are sharing the rig on 3.9 Mc. The Poothill Radio Club is sponsoring the AEC in that area. ON, MJU, EBK, FFN, VXM, and VQO are on 144 Mc. in the Poothill area. MEP is using a three-element beam on 28 Mc. feeding it with seven hundred feet of six hundred ohm line and says long wire is no good down in the canyon. VOZ is arranging schedule with 8ECN for fast coast-to-coast traffic on 14 Mc. Traffic-minded hams should contact VOZ or IFW on 3810 or 3830 kc. VOZ is in Victorville and IFW is in Hollywood. FHQ is reporting again and is on 14 and 3.9 Mc. with a kw., handling So. Pacific traffic. TZD reports traffic from Greece. CMN reports that GJP, LBM, and UVB are back on. AM worked six J stations with his Japan rhombic on 14 Mc. VTC, ex-3IVZ, has moved to Roscoe to experiment with antennas. MSO, the Centinella Valley EC, reports contacting the local Red Cross and making plans to serve as their communications. They continue to hold regular Monday night drills and emergency runs. The net consists of MSO, QJR, RNN, EKM, VES, URN, EKW, PNH, QXB, USK, 50H, BOB, RZK, JFJ, UXN, and SQC. all on 144 Mc. That's all for this time. Traffic: W6QE 60, TZD 19, VOZ 10, AM 9, CMN 8, FHQ 8, 73. Ben.

ARIZONA — SCM, Gladden C. Elliott, W6MLL — Most of the gang have their 7 calls now. QWG is on 3.5, 7 and 14 Mc. 5JFG/7 has all districts on 50 Mc. QAP has six districts on 50 Mc. and is going on 3.5, 7, and 14 Mc. JLZ, TCQ, and JKK are on 3.5 and 7 Mc. NRP is on 7 and 14 Mc. UMF works 3.5 to 14 Mc. SYK works 3.5 to 28 Mc. at Williams and has a fine club going there. TJH and 5GZR/7 are on 3.5, 7, and 28 Mc. GS has a revamped rig on 28 Mc. JKN and OWX have gone on 50 Mc. New Calls: JMA, JMB, JMR, JJW (ex-6ACN), JPY (ex-6JHF), JMC (ex-8PXQ). QLZ has a mobile rig on 160-2. JHF is mobile on 28-Mc. c.w. BMC is back on 3.5 and 7 Mc. with his old call. OPV and SOG are on the air. KMM worked twenty-one districts in the ORS Party. LSK is new Phoenix EC. The Phoenix Club sponsored a Salt River Valley QSO contest Aug. 10-11. JFW is on 7-Mc. with vibrapack. JQP works 7 and 14 Mc. JFG, GS, JIW, UCP, and PEY get good results on 28-Mc. folded dipoles. RMB has rig gremlins on 28 Mc. NOY is visiting friends in Arizona. RXP is on 7 Mc. SCK is on 7 and 28 Mc. JGZ and SBN are on 3.5 Mc. QNC is airborne on 144 Mc. MAE handles Phoenix Boy Scout traffic to Prescott. UPF is on 14 Mc. UPR is building a rig for SMZ. 73. G.C.

SAN DIEGO — SCM, Ralph H. Culbertson, W6CHV — LUJ is on 7- and 14-Mc. c.w. working some very FB DX, including VS4JH, W8LZK/NY4, VK6FL, ZS6GF, W4FGW/J2, LU7CD, KA1AE, W6TZB/J9, and F3LK. LUJ is one of the section's outstanding traffic stations of pre-war days and he is all set to resume his FB record. ACW is reported to be back on 14-Mc. 'phone at the Naval Air Station. He has a new FB rig going with a pair of 250THs and is building a new three-element rotary beam which should be up very shortly. He also reported working some FB DX the first night on the air, HK3 and a portable J3. BAM reports working his rig over and replacing his 100TH with a pair of 127As with about 800 watts input. FGU is on 14-Mc. 'phone with about 350 watts and an FB three-element beam and worked D400U in Germany and 8QEN/CP-2 in the Azores. SIG is proud papa of a 9-lb. jr. operator, named Don Fredericks. PAX has just completed a new FB 56-foot tower and is working on a 28-14-Mc. three-element rotary to put on top very shortly. LUJ and PAX renewed their ORS appointments. ACW is new OPS for the section. QEZ, in New York City going to school, received his new call 2QPZ, and expects to be on 14 Mc. soon with about 500 watts and would

(Continued on page 100)

MAKING TUBES IS EASY...

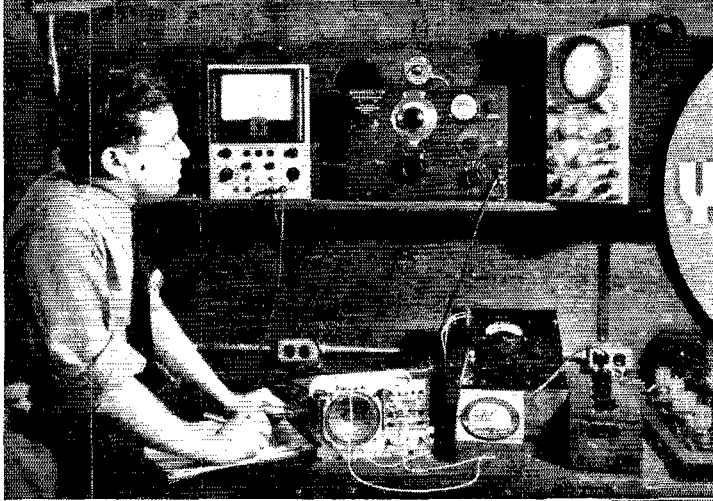

IF
YOU KNOW
HOW!

Hytron commercial engineer makes precision measurements of 50L6GT performance in many typical radio receivers. He then compiles weighted averages of tube characteristics selected to be correlated for functional testing.

Out of the commercial engineer's investigations grows this functional production tester. Combined functional and standardized tests are quicker. Operator can be even more accurate, and you are assured of more uniform performance.

FUNCTIONAL TESTING ..

You may have discovered that a tube rigidly inspected by standardized testing procedures (JAN, RMA, IRE) still may not perform satisfactorily in your equipment. Ordinary control of basic characteristics may not be enough. Functional dynamic tests—selected and correlated to simulate performance in typical equipment applications—may have to be added.

Simple analogy explains why. Testing of fundamental tube characteristics is like inspection of individual components of multi-ganged tuned circuits. When the tuner is assembled or the tube connected into a circuit, coils and condensers or tube characteristics may not combine properly. Individual variations within tolerances may be in opposition. Operational tests are the only positive checks.

Hytron commercial engineers, therefore, developed functional testers like the illustrated 50L6GT production test kit

Another HYTRON EXTRA!

—essentially a customary equipment circuit. Whether or not a part of the standardized tests, 50L6GT characteristics related to power sensitivity and output are simultaneously checked for smooth dynamic interaction. This comprehensive functional test automatically includes additional minor tests—pertinent but usually omitted from production testing. Hum itself is also measured, because no basic characteristic test controls it adequately.

Functional testing is another Hytron extra. Based on painstakingly acquired know-how, it is often the best and easiest way to assure you of uniform, reliable tube performance in your equipment.

SPECIALISTS IN RADIO RECEIVING TUBES SINCE 1921



HYTRON

RADIO AND ELECTRONICS CORP.

MAIN OFFICE: SALEM, MASSACHUSETTS





WE'VE GOT EVERYTHING in RADIO PARTS

Practically every part or piece of precision equipment you need is in our warehouses ready for immediate shipment . . . representing a cross-section of the country's finest manufacturers. We're famous for fast service and low prices. Try us and see.

THE NEW MILLEN 2" OSCILLOSCOPE

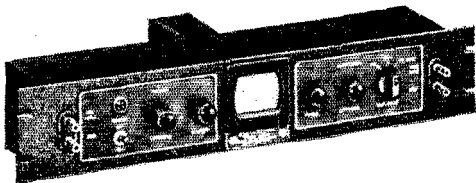

Use it as a transmitter modulation monitor with no additional equipment or accessories. Compact — mounted on standard 3 1/2" rack, panel. Complete with tubes.

MODEL 90902

42⁵⁰

SHUR ADJUSTABLE INTERCEPTOR

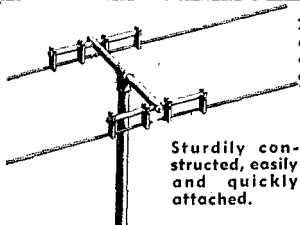

- 2 element beams for
- 60-66 mc-television
- 88-106 mc-FM
- 144-148 mc-2 méter band

Sturdily constructed, easily and quickly attached.

A Real Value at

634

Save on BRAND NEW GOV'T. SURPLUS

We have a large stock of surplus items at amazingly low prices. Brand new equipment and parts in perfect condition . . . ready for immediate delivery.

Here Are Some Typical Savings!

- | | | | |
|---|------|---|------|
| 866 filament transformer, fully cased, hermetically sealed. Feed through bottom terminals | 2.77 | Single button mike transformer, fully cased, sealed | 1.35 |
| Bias supply transformer, 170-0-170 volts, 5V-3 amp, 6V-2 amp. 1.95 | | Socket for four new type crystals | 30¢ |
| 813 sockets | 75¢ | Shield for ceramic socket for 6 AK 5 type tubes | 27¢ |

Send for Bulletin "C" — "Hot" Values Galore

Radio Electric

SERVICE CO. OF PENNA., INC.

7TH AND ARCH STREETS, PHILA. 6, PENNA.
Branches at 5133 Market St. and 3145 N. Broad St., Phila. Also in Wilmington, Del., Easton, Pa., Allentown, Pa.

(Continued from page 96,

like to have the gang keep an ear out for him. EZM has moved to La Mesa and reports an FB location for shack and antenna. APG has a new HQ-129-X receiver and reports working his first TG9 in Guatemala on 28-Mc. 'phone. How about some reports from you fellows in the San Diego Section? Traffic: LUJ 14, BAM 2, CHV 2. 73. Ralph.

WEST GULF DIVISION

NORTHERN TEXAS — SCM, Jack T. Moore, W5ALA — Section EC: DAS, RM: CDU, PAM: ECE, Helen Douglas, of Commerce, now is LGY and advises the following LSPH have received their calls: KUV, Earl Herndon; KUP, Jerry Murray. JBD has a Class A ticket. FRD is doing good work on 50 Mc. EVI attended the Field Day together of the East Texas Radio Club at Caddo Lake. BNQ has a new NC-240 receiver. Now that EHZ has received permission to erect an antenna he can't find anything but knotty 2x4s to use for poles. Ross sends the following: SP is awaiting delivery of a Super-Pro; AAO has a new BC-610 transmitter and reports working Christmas Island on 28 Mc.; GFL is looking for a power supply for an 813; QA is ready to go on all bands as soon as the weather cools down; DUZ has rebuilt his rig, is running 200 watts to a pair of TZ40s and has put up a new antenna. NW is working 3.5, 7, and 14 Mc. and has agreed to run for reflection as director. GFN and HVQ are working lots of DX on 28 Mc. KUC has worked fifty-seven countries on 28-Mc. 'phone. CWW now is 6UUD. CVW has a new S-36A receiver and has increased power. Dale Westbrook (LSPH) has received the call LLK. CF is an old-timer gone modern with a new Panadapter and a BC-610. Fellows, this report completes my term of office as your SCM and I want to thank you for your fine cooperation. Since I have been nominated as candidate for alternate director I will not run for SCM, so please nominate someone for this job. 73. Jack.

SOUTHERN TEXAS — SCM, James B. Rives, W5JC — KVD has a new rig with 150 watts on 7 and 3.5 Mc. Other active stations at Austin are DCS and LDA. All members of this section will be grieved to know that IQU was electrocuted while working on his rig. It should remind all of us to practice safety at all times. LMA is a new station in San Antonio on 7 Mc. HME has 75 watts on all bands. EUL is collecting the necessary items for an elaborate antenna system. HJY has constructed a number of rigs using 813s for the fellows around San Antonio. HBQ got a bad burn off of his high voltage supply. The Houston Club has an active and enthusiastic membership with present officers as follows: IGS, pres.; IGJ, vice-pres.; HAQ, secy.; FWC, treas. Meetings are held each Friday in the Houston Chamber of Commerce Building. Those active on the 144 Mc. band are: FQQ, HFO, GSL, IYF, 6UOR/5, IGS, ON, GLS, BHO, HAQ, FI, EAL, JMI, KFY, EIB, JIY, AZR, IGL, LGR, and LGE. Also UW, of Missouri City, and KFD, of Cedar Bayo, are contacted regularly in Houston. The Galveston gang is taking steps to reactivate the club there. ADZ has an 813 final and a beam in the attic with which he worked all continents in two hours. TG is moving to Houston. LBH is having difficulty with the new receiver under construction. LLH is active on 7 and 14 Mc. with 60 watts. IGJ is constructing a kw. with all the trimmings. EEX has taken time out for a honeymoon. EIB is on all h.f. bands with separate antenna for each. LCL and LDI are with the CAA, stationed 120 miles east of El Paso at a lonely outpost where amateur radio really means something. Their activity so far has been confined to 28-Mc. 'phone. LDD has moved to 14 Mc. to compete with the QRM. He advises there are a number of kw. rigs under construction at Brownsville. EWZ recently completed his four thousandth QSO. 73. Jim.

NEW MEXICO — SCM, J. G. Hancock, W5HJF — Louis, senior operator at ZA has been under the weather with a strep infection of the lung the past few months but is improving now. He and Eunice (the chief operator at ZA) are building a new 900-watt rig to work on 3.9, 14, and 28-Mc. 'phone and c.w. ICD is planning on settling down in the Verde Valley of Arizona and he and JXL (the XYL) have applied for W7 calls. They send regards to all the New Mexico gang. 9NGL is located at Carlsbad. Mr. White, ham-to-be of Altus, Okla., visited the SCM on his way to Carlsbad Caverns and delivered some "war surplus" to HJF from 5BHD. HJF is having lots of fun on 14 Mc. I can at least hear other people calling the gang there. Why "don'tcha" come down to 3.5 and 7 Mc. and be sociable, gang. 73. Jake.

(Continued on page 102)



Mr. Radioman! Don't Be A "Pre-War Model!"
 Add CREI Technical Training to Your Present
 Experience—Then Get That Better Radio Job

Make More Money — Enjoy Security!

CREI Offers You a Planned Program of Modern Technical Training That Equips You to Handle Intricate, New Post-War Equipment



DURING, and now after the war, *thousands of new men* have joined the ranks of the radio industry creating new competition. New developments create demands for more advanced technical ability. Where do you fit into this picture?

If you are wise, you will look ahead and prepare for the good-paying jobs in radio-electronics. Every man in radio today has the opportunity to see the amazing developments that are taking place, as well as to see the unlimited opportunities available to those with *modern* technical training. CREI can show you the way by providing the "tools" to build a secure foundation for your future based on our proved method of home study training.

It is up to you to decide if you will be a "screwdriver" mechanic or capable of holding a responsible engineering position. Here's a typical example of progress made possible by CREI home study training.

"The fact that I am studying with CREI impressed my new boss very favorably and I feel it only fair to give CREI a good deal of credit for my securing this position." — Alex M. Steinberg, 420221

FILTERING

The filtering process applies to men and equipment alike. There comes the day when men are re-shuffled and only the "fittest" survive. Today's and tomorrow's opportunities in radio-electronics are so great, that no man should ever allow himself to be caught in the "filtering out" process by being caught unprepared for his job.

E. N. Pfeiffer
 President of CREI

CAPITOL RADIO ENGINEERING INSTITUTE

Dept. Q-10, 16th and Park Road, N. W., Washington 10, D. C.

New York (7): 170 Broadway

Branch Offices:
 Chicago (2): 30 N. LaSalle St.

San Francisco (2): 760 Market St.



If you have had professional or amateur radio experience and want to make more money, let us prove to you we have the training you need to qualify for a better radio job. To help us intelligently answer your inquiry—PLEASE STATE BRIEFLY YOUR BACKGROUND OF EXPERIENCE, EDUCATION AND PRESENT POSITION. (Veterans! Training available under G.I. Bill.)

CAPITOL RADIO ENGINEERING INSTITUTE Q-10
 16th and Park Road, N. W., Washington 10, D. C.

Gentlemen: Please send me your free booklet, "Your Opportunity in the New World of Electronics", together with full details of your home study training. I am attaching a brief résumé of my experience, education and present position.

Name

Street

City Zone State

Occupation

I am entitled to training under the G.I. Bill

The
**RADIO
 AMATEUR'S
 LICENSE
 MANUAL**

Before you can operate an amateur transmitter, you must have a government license and an officially assigned call. These cost nothing — but you must be able to pass the examination. The examinations are based on the multiple-choice type of questions. The "License Manual" has been written to make it as easy as possible for the individual to acquire the necessary knowledge to pass the examination with flying colors. Whether you are going up for your Class C, B or your Class A ticket, "The License Manual" will provide the most direct path to getting that ticket. If you are one of the thousands who always wants a "License Manual" around the shack for ready reference for amateur regulations, it will please you to know that the regulations are very thoroughly indexed.

Twenty-Five Cents

POSTPAID ANYWHERE
 (No Stamps, Please)

**American Radio
 Relay League**

WEST HARTFORD
 CONNECTICUT

(Continued from page 100)

**CANADA
 MARITIME DIVISION**

MARITIME — SCM, A. M. Crowell, VE1DQ — Some nice DX cards await the following: NX, DR, KU, RA, PJ, LT, AE, AW, CE, CK, CU, CW, DB, DR, EA, JP, EL, EP, HI, ID, MV, EV, FB, GU, KN, KS, KX, KU, OD, LY, NC, NX, NY, PB, PK, PT, PV, QJ, and RH. Please send in stamped return envelope to FQ, QSL Manager. TH, new Halifax man, has home-built super. Ex-KG, now VE2SU, in Montreal, handles some VE1 traffic. V04F has returned to VE3-land. RF pounds out with 813 final. HARC will buy a gas-powered generator with money recently raised for emergency gear. HJ has vibrapak rig and is AEC member. 1AYL sends nice report on St. John gang. LARC meets the second Tues. each month and welcomes visiting hams. Ken Cox, sporting new receiver, is awaiting new call. FC is on 3.9-Mc. c.w. JO also is on the 3.9-Mc. band. GQ is active on 28-, 14-, and 3.8-Mc. 'phone bands. GP is using the super antenna with 450-ft. Zepp feeders. 1E is working on his 3.8-Mc. 'phone. FK is on 3.8- and 28-Mc. 'phone. HL and LL are rebuilding. FL and AYL are active on 3.8-, 14-, and 28-Mc. 'phone and c.w. New St. John calls: PI, RQ, and SJ. EI is going strong on 3.8-Mc. 'phone. AK chats regularly with AU on 28-Mc. 'phone. FU is rebuilding for 14-Mc. 'phone and c.w. CO has been on vacation with portable 3.5-Mc. rig. BD is knocking 'em off on 14 Mc. RG is doing some constructing. CW is active on 3.5 and 7 Mc. CW called on GK, JD, and DZ while on a flash tour to Nova Scotia. Traffic: VE1HJ 7. 73. Art.

ONTARIO DIVISION

ONTARIO — SCM, David S. Hutchinson, VE3DU — OI got tubing for 14-Mc. beam. TM can't find ambition to rebuild in hot weather. WA worked four continents one evening. CP is on but is looking for a good receiver. AHL is busy making plans for new QTH. WD is coming on with 814 final. AQC is new Amherstburg station. FP has FB skywire. AEP and his XYL visited with WX. PU is increasing power. MY's XYL wants a mike after hearing Mrs. AEP. ALE has new Millen exciter. CP, his XYL, and his jr. operator paid WX a visit. OI has been entertaining the Windsor gang. WA would like an invisible skywire. QK is searching for a place to live. TB, GT, and QK ran GT on Field Day along with BCZ, ATB and ANY work 50 Mc. ADR, AAG, QW, BAD, CAR, AXQ, KE, 2FG, 3ARS, BCZ, and HP formed a net to assist Ontario Flying Club at Air Show in Oshawa. AVA and AZA are on from Malton. AZI is building large high-power rig. KM called until he was hoarse during the ORS Party and then didn't make a QSO. Yours truly paid a visit to QK, GT, WK, and SG while on vacation and in turn was visited by ZE while staying at the Hotel. Sorry I could not get around and see more of the gang. AUQ is working on 14 and 28 Mc. HI, BEV, AJE, CM, ADC, and GB are active on 14 Mc. KC was home on a visit while awaiting posting with RCN, and doing some brasspounding on the side. BJI and BLD were heard on 7 Mc. How about some reports of activity from eastern Ontario? I cannot fill up our quota of space without news from the gang, so what say, fellows? It may be the hot weather, but the C.D. appointees are not sending in their reports as required. So, boys, please report even if there is no activity, as reporting is necessary if you want to hold your appointments. We still are looking for applications for ORS, OPS, RM, EC, and OBS appointment. There is plenty of room for new appointees. Traffic: VE3ATR 6, OI 6, VD 1.

QUEBEC DIVISION

QUEBEC — Acting SCM, W. Stephen, VE2LC — TH has transferred his powerful 'phone to 14 Mc. LL has a self-excited oscillator on 7 Mc. EP has scuttled his 828s and is trying out a pair of 814s. HS has been demobbed from the Air Force and is back at Sun Life. He is on 3.9-Mc. 'phone. LV gives up hamming in favor of golf in the summer. SU is trying hard to iron out the bugs in his v.f.o. If gets out well with a pair of 46s. "It's all in the antenna," he says. VN and VV are new Montreal calls. Old-timer FQ now is located in Mont Joli. IY has a new home in Mount Royal, where he has put up a 14-Mc. rotary beam. SM has antenna trouble, because of lack of roof space. VK2JR, chief design engineer with Amalgamated Wireless, is staying in Montreal for a few months and gave an interesting talk on hamming in Aus-

(Continued on page 104)

A PROFESSIONAL TRANSMITTER *for the Amateur!*

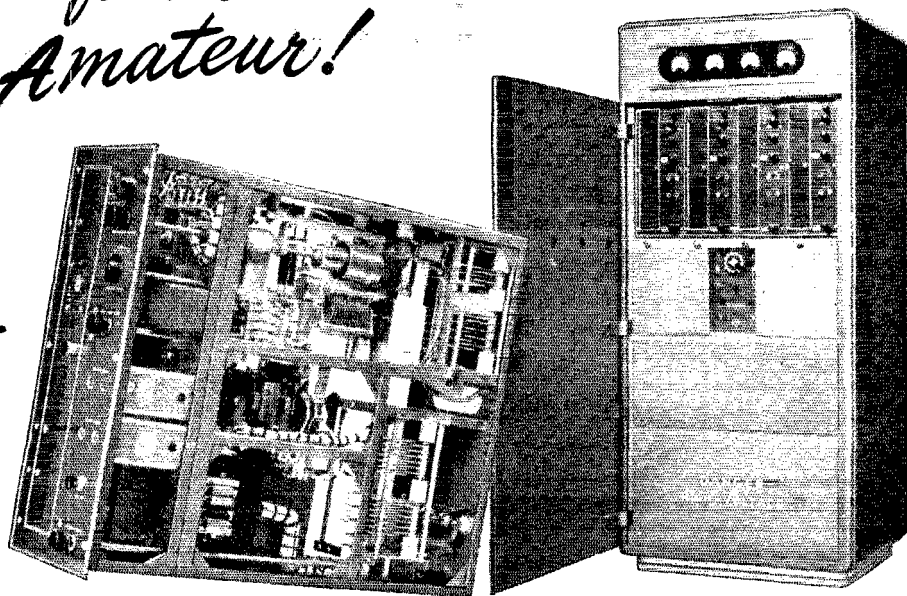

The latest developments in communication science are incorporated in the Wilcox 99A Transmitter. This advanced multi-frequency, 400 Watt carrier unit is now in use by major airlines in the United States. Rectifier, Modulator, Remote Control equipment, and four R.F. Transmitter Channels are housed in one modern steel cabinet. Bands can be instantly selected by telephone dial. Write for complete information.

WILCOX STAFF DEVELOPING AMATEUR EQUIPMENT

A staff of 22 licensed amateurs under the direction of "Vince" Dawson, W9ZJB/3JSL, is developing amateur equipment of the same high quality that has brought fame and universal use to Wilcox commercial and airline products. Watch for these developments from Wilcox.



Amateur Division of
WILCOX ELECTRIC COMPANY, INC.
14th AND CHESTNUT STS. • KANSAS CITY 1, MO.

AMATEUR GEAR

8 CONNECTICUT AND MASSACHUSETTS HAM STORES

Quick as you can say "Ham," you'll find the first-choice makes, the elect in electronics, at Hatry & Young. Eight conveniently located stores . . . dozens of lines . . . and the best names, such as . . .

Amphenol • Bud • Cardwell • G.E. Hallicrafters • Hammarlund • Mal-lory • Millen • National • Ohmite Panoramic • Par-Metal • Petersen RCA • R.M.E. • Silver • Shure • Stan-cor • Taylor • Turner • Valpey and many others

CONNECTICUT:

Hartford, New Haven, Bridgeport, New London, Stamford, Waterbury. MASSACHUSETTS: Boston and Lawrence

HATRY & YOUNG

The Elect in Electronics

• LEARN CODE •

SPEED UP YOUR RECEIVING
with

G-C Automatic Sender Type S
\$20.00 Postpaid

Housed in Aluminum Case. Black Instrument Finished. Small — Compact — Silent induction type motor. 110 Volts — 60 Cycle AC.

Adjustable speed control, maintains constant speed at any setting. Complete with ten rolls of double perforated tape. A wide variety of other practice tapes available at 50c per roll.

If your dealer cannot supply you — write

GARDINER & COMPANY • Box 56
STRATFORD, N. J.



(Continued from page 108)

tralia at the July meeting of the MARC. II, SU, and LC are ORS. HF made a trip to the Pacific Coast and rag-chewed with 7TD, who was 2CX prewar.

VANALTA DIVISION

ALBERTA — SCM, W. W. Butchart, VE6LQ — HM has new HRO and has pair of 831Bs in final. 8AG is new call of 6IJ at Whitehorse. Y. T. He is busy erecting rhombic antenna. MJ works out FB on 3.9-Mc. 'phone. EL, of Camrose, has license endorsed for 14- and 3.9-Mc. 'phone. LG dragged home first prize for v.h.f. equipment at Calgary 'fest. QE lives in Edmonton but works in Calgary. 5DW (ex-4ADW) is visiting the Edmonton gang. IR is new Edmonton call belonging to "Perk" Perkins. EA is experimenting with new type final amplifier. PP is using QRP rig at Sea Cadet Camp on Lake Wabamun. DN, of Glenwood, puts terrific signal into Edmonton on 3.9-Mc. 'phone. AH has new rig practically complete. SZ has rig on 3.9-Mc. 'phone, using single 813 to good advantage. AO is back on the air with a rebuilt rig. He is getting out FB on 7 Mc. LQ has gone v.f.o. WS has combination 14-28-Mc. beam ready for action. HQ, of Calgary, and LQ, of Edmonton, worked 3.9-14 Mc. cross-band QSO (200 miles) with S8 to S9 reports, then worked straight 14-Mc. contact. EL, of Camrose, worked UT, of Edmonton, on 14-Mc. c.w. short skip, with S9-plus signals both ways, and they were heard in Calgary S9 at the same time. Traffic: VE8AO 48, 6LQ 18.

BRITISH COLUMBIA — SCM, W. W. Storey, VE7WS — The new SCM wants the "tops" in regard to active news from all clubs in B. C. Please try to appoint a member in each club to be held responsible for gathering the active news. Come on, fellows, show what you can do. You know I can't do it all — it takes cooperation! So, what say, BCARA East Kootenay, Point Grey, Royal City, Victoria, West End, UBCARA Vancouver, Kelowna, Dawson Creek, Langley Prairie, Collingwood, Totem, ARC. 7AIG is back in the RCAE. 7JK heard PZIA (Dutch Guiana) on 14-Mc. 'phone frequency 14,325 kc., 9:30 P.M. (D.T.). 7AEZ worked two W6s on 50 Mc. The Air Force Amateur Radio Net is really going full blast now. 7BQ is trying crystal-control on 50 Mc. Hi Totem Club had a crystal-grinding beg and plans to put on another one. 7XS has just finished building a new transmitter and receiver. 5AEY has put up a 28- and 14-Mc. three-element beam. W6s are looking for contacts on 50 Mc. every night up to 5 P.M., including Saturdays and Sundays. Did you hear the latest, gang? 7OT (Jack Benny) and TA (Edgar Bergen) went to town on July 21st. (It sounded like Jack was trying to play "The Old Rugged Cross" with a bit of arthritis added to it, while Edgar took it painfully, with tears rolling down his cheeks.) The Vancouver Amateur Radio Club meets at the home of 7FB. Membership now is twenty-five and rising rapidly. Officers are: 7TR, pres.; 7ADF, vice-pres.; and Tom Grant, secy.-treas. Let's have lots of dope, gang. 73.

PRAIRIE DIVISION

MANITOBA — SCM, A. W. Morley, VE4AM — With the return of 14 and 7 Mc., activity hit a new high. The following are active on 14-Mc. 'phone: KU, AC, QV, EK, KX, WF, QI, KF, SR, CC, MN, and AD. CW finds RO, TV, BQ, and AH hard at it. HI (ex-IH), SH, and TJ are dividing their time, 'phone and c.w. 7 Mc. is not so popular. So far the following have been heard: JM, RO, and BN. RO has worked quite a bit of DX on this band. ABV is now signing XO. DM is signing VE1. 56 Mc. is showing some activity but it is low now because of holidays, etc. The following are active: CD, DG, HW, KO, XH, GM, and BI. DG has turned in a nice list of DX heard on 56 Mc. and it includes a W2. Crystal-control and superhets are in line for the fall and it is expected that 56 Mc. will be a "hot" band this winter. The WARC has its constitution thrashed out and now is down to brass tacks. Meetings are held every month and some very interesting talks are scheduled. CU next month. 73. Art.

Strays

A. Claudet, F8AJ, invites W hams on duty at (or traveling through) the airdrome at Orly, France, to visit his home. QTH: *Fallie des bots*, Orly, 50 yards from *Chateau Feugeas*, a villa reserved for the U. S. Army.

**YOU DON'T
HAVE TO WAIT
WITH NEWARK**

**IMMEDIATE DELIVERIES
ORDER NOW
AND GET IT NOW!**

also
**Complete Stocks of
PARTS FOR YOUR RIG!**

- Barker & Williamson
- James Millen
- Allen D. Cardwell
- National
- Hammarlund
- Thordarson
- Stancor
- UTC
- Bud
- Ohmite
- IRC
- Taylor Tubes

New Amphenol cable
in stock.

NEW YORK
242-50 W. 55th St.
New York 19, N. Y.

NEWARK CHICAGO
ELECTRIC COMPANY, INC.

New York City Branches: 115-17 W. 45th St. & 212 Fulton St.

See our other
advertisement
for new hot bargains!

Send for bar-
gain bulletins.
Just drop us a postcard.

BRAND NEW SETS BY LEADING MANUFACTURERS!

- A. HAMMARLUND HQ-129X, with speaker.....\$173.25
- B. RME-45\$186.00
- C. ABBOTT TR-4B, less tubes and power supply \$52.00
- NATIONAL NC-2-40D, less speaker.....\$225.00
- HALLICRAFTERS S-42.....(Approximately)\$250.00

(All prices subject to change without notice)

A HAMMARLUND HQ-129X.

Exclusive, patented variable selectivity crystal filter. Adjustable S-meter. Send-receive switch. Many other unique features in this popular 11-tube job.

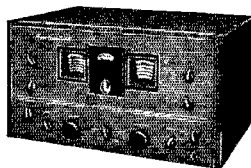

B RME-45.

The set they write about! Two-speed Tuning. Single dial control with calibration on 5 ham bands. Voltage regulation, improved noise limiter. A real ham receiver!

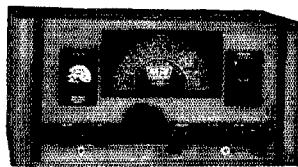

C ABBOTT TR-4B.

The complete rig that makes 2½ meters a lively band every day in the week. An inexpensive way to introduce yourself to new operating experiences.

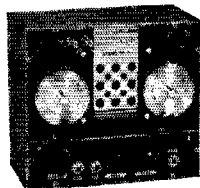

IMMEDIATE DELIVERY! GON-SET CONVERTER!

See Waterproof Electric Company, QST ad.

Write, Wire, Phone, or come in for a demonstration.

This splendid unit complete for.....\$39.95

General Purpose Transmitter Relay

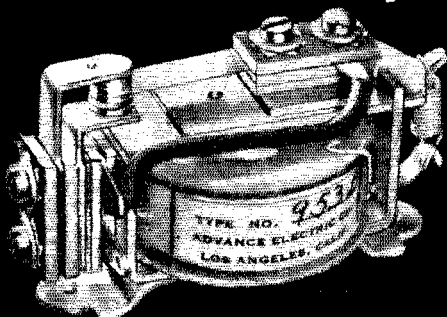

TYPE 953B

The Advance type "953B" SPDT relay is a good, low cost, general purpose relay for such applications as A.C. power line switching on amateur and commercial transmitters. In addition to its exceptionally rugged construction, it has the advantage of small size (1½-in. x 1½-in. x 2 11/16-in.). Contacts are pure silver ¼-in. diam. rated at 10 amps. on 110 v. A.C.

Coils are obtainable for any voltage from 1 to 440 v. A.C. — 2 to 150 v. D.C.

Amateur Net Price (at your jobber)

TYPE 953B — \$2.31 (up to 115 v. A.C. or 60 v. D.C.)

Advance Relay Catalog free on request.

Advance Relays



ADVANCE ELECTRIC & RELAY CO.

1260 West 2nd Street
Los Angeles 26, Calif., U. S. A.

Phone Michigan 9331

Mass. Radio School

271 Huntington Ave., Boston 15, Mass.

For over 27 years the educational radio center of New England. Prepares for all U. S. Government Radio Operators' Licenses. Also gives Radio Technician Training. Approved courses for Veteran Training under G.I. Bill.

Licensed by Commonwealth of Mass.,
Department of Education

Bandswitching Transmitter

(Continued from page 21)

to use the rig on c.w. only may find the use of a fixed screen supply more satisfactory than the screen dropping-resistor method, although means must be provided to remove screen voltage whenever plate voltage is removed to prevent damage to the tube.

Table II gives representative voltages and currents under operating conditions. Some variation from these figures can be expected depending upon the actual supply voltages used, but they will serve as a general indication, useful in checking performance.

TABLE II

Operating Voltages & Currents			
Conditions of measurement: transmitter tuned for 10-ma. grid drive to 4-125A, 28-Mc. output. Supply voltage, 430. Readings obtained with 20,000-ohms-per-volt meter.			
Tube	Element	Volts	Ma.
6F6	Plate	128	6
	Screen	70	
6V6	Plate	360	6
	Screen	9	
6N7	Plate 1	340	12
	Plate 2	300	28
807	Plate	430	28
	Screen	340	3
	Grid	-90	*
4-125A	Plate	2000	150
	Grid	-200	10
	Screen	350	30

Note: Plate current, and screen voltage and current, in 4-125A, are dependent upon external loading.
* Less than 1-ma. grid drive to 807 required to produce 10-ma. drive to grid of 4-125A.

With the layout used no instability was observed when the crystal was removed with all circuits tuned up. As a check, with the crystal removed, apply plate voltage to the low-power stages, and rotate each of the tuning condensers through its range while observing the plate current of the stage to determine if self-oscillation occurs. Plate current should remain constant if the desired stability has been achieved. Rearrangement of some of the wiring to eliminate stray coupling may be necessary if oscillation is present under these conditions.

The transmitter may be operated with a separate VFO unit as its frequency control by removing the crystal-oscillator tube from its socket and feeding the output of the VFO between the plate pin of the oscillator socket and ground. Adequate drive for either 'phone or c.w. operation can be obtained on all bands with a VFO such as that

(Continued on page 108)

"HET IS HIER VROEG IN DE MORGEN."
 "It's early morning here."

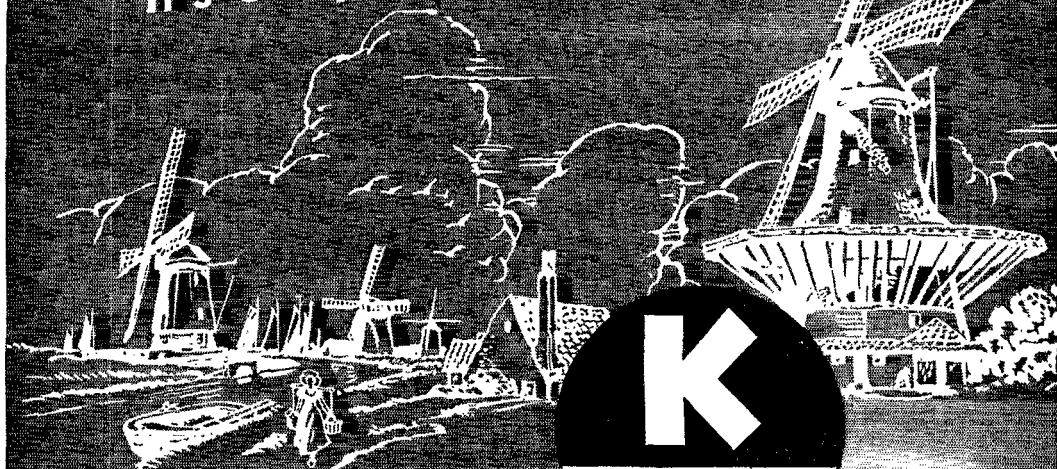

For more and clearer QSO's...



HOLLAND'S signal will be clear and steady in your earphones while you drink your midnight coffee. Before *he* bicycles off to work and *you* go to bed, there'll be a friendly exchange—spanning the Atlantic—of topics of mutual interest. *Ken-Rad tubes, war-tested and proved, will play a leading part.* . . . Type 6N7, versatile twin triode, is typically Ken-Rad, sturdy, and modern in its compact all-metal, self-shielding design with short lead lengths. Your Ken-Rad distributor or dealer will be glad to give you complete facts about this and other types.

Characteristics of Type 6N7

Heater voltage	6.3 v	Max plate current, per plate	... 125 ma
Heater current	0.8 amp	Max avg plate dissipation,	per plate
Max plate voltage	300 v		... 5.6 w

178-K4-8850



Type 6N7
\$1.90

KEN-RAD

DIVISION OF GENERAL ELECTRIC COMPANY
 OWENSBORO, KENTUCKY

Make the nearest Ken-Rad distributor or dealer your preferred source for amateur tubes

CAST ALUMINUM CALL LETTER PLATES

MADE TO ORDER—YOUR OWN LETTERS

Cast Aluminum, letters and borders raised and satin finished. Background, baked crackle enamel. Black is standard, —red, gray or blue 40c extra.



\$2.50

Add 20c For Packing and Postage

LAPEL BUTTONS — TYPE A-26

Letters are raised, sharp and clear, and are highly polished.



\$1.00

Add 10c for packing and postage

Standard
RADIO & ELECTRONIC
PRODUCTS COMPANY

135 E. SECOND STREET • DAYTON 2, OHIO

RADIO INSTRUCTORS ●

Receiver servicing experience. College degree preferred. \$3600 a year to start. \$4200 after four months. Work in the heart of the Radio Industry. We will teach you practical television. Write Raleigh G. Dougherty, 158 Market Street, Newark 2, New Jersey, c/o New York Technical Institute of New Jersey. America's foremost Television school.



U
P
A
N'

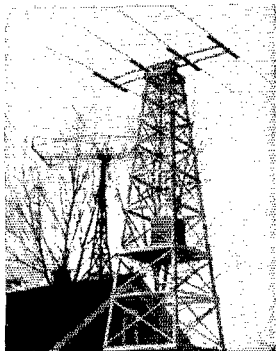

A
T
'E
M

Full trussed wooden towers for your rotary.
Priced for the amateur.

Write for Bulletin T-101

SKY-LANE PRODUCTS

IRONWOOD, MICHIGAN

(Continued from page 106)

described in September, 1946, *QST*.²

It should be noted that this method is satisfactory only in cases where direct coupling will not short-circuit the plate supply. In other cases, the VFO should be coupled through a 0.001- μ fd. blocking condenser.

² Mix, "A Simple VFO Crystal Substitute," *QST*, September, 1946.

Preventing Self-Oscillation

(Continued from page 28)

14 Mc., satisfactory operation at 50 Mc. might be hard to obtain.

At present my rig has the following tube lineup: 6SJ7 ECO; half of a 6SN7GT, doubler; half of a 6SN7GT, cathode-follower driver; and an 807 final amplifier. The circuit is shown in Fig. 2.

A tetrode can be used as a cathode-follower driver, as shown in Fig. 3. Note that the screen grid is tied to the cathode through a large condenser, and the screen voltage is fed from the plate through an r.f. choke. Otherwise the circuit and operation are similar to a triode-follower circuit.

There are no tricks to the tuning procedure, but it must be accurate, as mentioned later. In Fig. 2, the 14-Mc. tank circuit is tuned by adjusting for maximum grid current in the 6SN7GT doubler, and then the doubler plate circuit and the follower cathode circuit are tuned for maximum grid current to the 807, about 4 ma. It will be found possible to obtain a set of conditions where the follower will act as an ultra-audion oscillator, but this is not the case when the cathode and grid circuits are tuned to exact resonance. If the grid circuit is tuned off to the high-frequency side or if the cathode circuit is detuned to a lower frequency, self-oscillation will probably start. However, if the grid current of the 807 falls to zero when the VFO is turned off, it indicates a stable condition of the cathode-follower stage. The final plate voltage is then turned on and the output circuit tuned for a dip in the usual manner.

For proper operation of the cathode-follower driver, observing the following precautions should keep one safely out of trouble: First, the magnetic coupling between the doubler tank and the follower tank should be held to a minimum, to avoid the possibility of oscillation in the cathode-follower stage. Small-diameter coils mounted at right angles and separated by several coil diameters will do the trick. Secondly, the final tank should be isolated from all other tuned circuits by placing it above the chassis and keeping the other circuits below the chassis. This is the usual precaution of minimizing the magnetic coupling between plate and grid circuits.

If the oscillator in Fig. 2 is to be keyed for break-in operation, several changes must be made. First, the ECO should be replaced by one that keys well, or by a crystal oscillator. Second, protective bias must be added to the doubler by using battery

(Continued on page 112)



Be Right with.. OHMITE

AMATEUR ITEMS

Accurate—Dependable—Long Lived

Vitreous Enameled Rheostats

Available in 10 sizes, from 25 to 1000 watts. Winding is permanently locked in vitreous enamel. The metal-graphite brush provides unmatched smoothness of action. Engineered for long, trouble-free life.

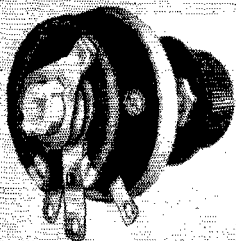

Non-inductive Resistors

Used as dummy antennas, load resistors, and terminating resistors. Available in vitreous-enamel type wound on a tubular ceramic core, and in hermetically sealed-in-glass type. Sizes from 50 to 250 watts.

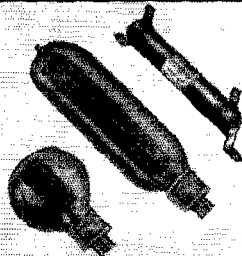

Transmitter Band Change Switch

For the rapid, convenient changing of transmitter frequency by front-of-panel knob control. Designed for circuits up to 1 kw rating. Low loss porcelain and metal construction. Units can be mounted in tandem on a single frame.

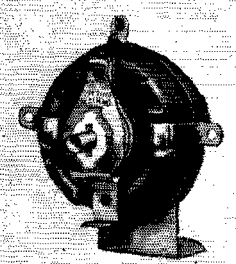

Parasitic Suppressor

Designed for the suppression of unwanted ultra-high frequency parasitic oscillations. Consists of a 50-ohm vitreous enameled non-inductive resistor supporting a choke of 0.3 microhenries and .003 ohms d-c resistance.

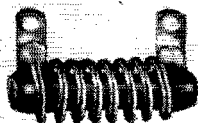

Radio Frequency Plate Chokes

A complete line of wire wound vitreous enameled resistors, from 10 to 200 watts. Available in the fixed type and adjustable "Dividohm" type. "Little Devil" 1/2, 1, 2-watt composition resistors also available.

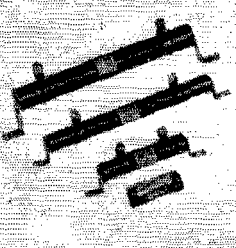

Dependable Resistors

These chokes have a single layer winding on a steatite core, protected by a moisture-proof coating. Five sizes available to cover 2 1/2, 5, 10-20, 20-40, 20-40-80-160 meter bands. All chokes have a 1000 ma rating.

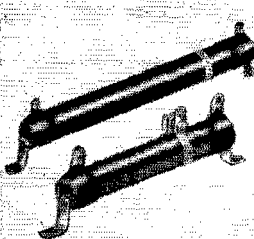

OHMITE MANUFACTURING CO., 4863 Flournoy Street, Chicago 44, U. S. A.

OHMITE

Write for Catalog No. 18

Provides useful data on the selection and application of rheostats, resistors, tap switches, chokes, attenuators, and other components.



RHEOSTATS

RESISTORS

TAP SWITCHES

CHOKES

FOR REGULAR AND SURPLUS AMATEUR GEAR

CALL THE RADIO SHACK FIRST



**BRAND NEW
with Tubes
ONLY**

\$4500

Another Amazing Value!

AAF XMTR BC-375-E

Here's more transmitter than you ever dreamed of for so little money. Covers 200 KC to 12,500 KC (except broadcast band) with seven, hand-calibrated tuning units. Power output 30 to 75 watts, depending on frequency. Antenna tuning unit BC-306-A comprising variometer and tap switch. Dynamotor unit PE-73-C with relay, fuses, filter; *complete modification details furnished for conversion to 110-volt a-c operation.* Five tubes are 211 master oscillator, 211 RF power amplifier, 10 speech amplifier or tone oscillator; 2 - 211's p.p. modulators. Plate meter 0-500 ma; RF ammeter reads antenna current. And you get 2 copies of the 100-page AAF instruction book covering every detail of use and maintenance. Don't miss this amazing value - - - - - Order Now.

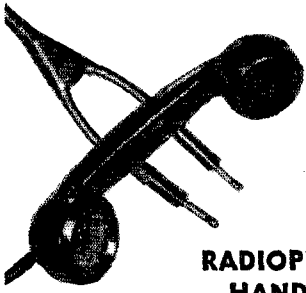

**RADIOPHONE
HANDSET**

Bakelite-cased handset with push-to-talk switch, heavy rubber cord, separate mike and phone plugs. **\$3.95**

**ELECTROVOICE
HAND MIKE**

Model 600C high impedance dynamic mike with push-to-talk switch, 9-foot heavy rubber cable, and Amphenol 3-circuit plug. **\$4.95**

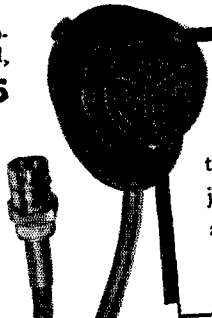

In our surplus stocks, you'll find meters, condensers, resistors, transmitters, receivers, power supplies, tubes . . . just the kind of gear you're looking for; and the latch-string is always out here at the RADIO SHACK.

WHEN ORDERING C. O. D. PLEASE REMIT 20% OF TOTAL AMOUNT

RECEIVERS - RECEIVERS

HIGH FREQUENCY SUPERHET for 2-5-10 METERS

Famous radar-type BC-406, 15-tube superhet complete with broad-band I.F.'s, power supply with 4-section filter, and 15 tubes, including 5 acorns. Net price **\$22.50**

NATIONAL 1-10-A

Latest super-regenerator for one to eleven meters; complete with tubes and 6 sets of coils, less power supply and speaker. **\$67.50**

Power supply only \$22.43
 Speaker only 9.90

HAMMARLUND SUPER-PRO Gov't Surplus

Four lucky amateurs can get this famous receiver at rock-bottom price. Full coverage .54 to 20 mc in five bands, selected by single switch. Rack mounting, complete with tubes and power supply, less speaker **\$225.00**

Write us for ALL NATIONALLY ADVERTISED AMATEUR RECEIVERS

We are distributors of NATIONAL — HALLICRAFTERS — HAMMARLUND — R.M.E., and are now delivering many popular models.

TEST EQUIPMENT

We stock all popular makes and styles of test equipment, also have many surplus specials in meters and instruments. Write for bulletins.

500 Volt DYNAMOTOR

Delivers 160 mils at 500 vdc from input of 6 or 12 vdc; shock-mounted assembly includes circuit breakers, relays, interference filters, cables. Used slightly; fully guaranteed. **\$14.95**

TUBE SPECIALS

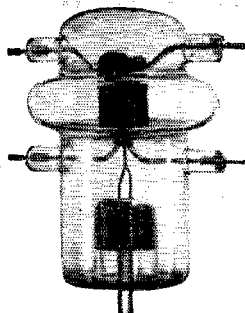

EIMAC VT-127A

Comparable to 100 TL

Balanced grid and plate structure; ideal for Class C and long-line oscillator service; can be used on 144 mc; brand new. Sig. Corps. insp.

\$3.50 each

KEN-RAD 829-B

In original packing, these Signal Corps inspected tubes are a real bargain at only **\$4.95**.

PLUS THESE TUBE VALUES

Type 813\$9.95.
 Type 838 4.95
 Type 832A 5.95
 Type 211 4.95

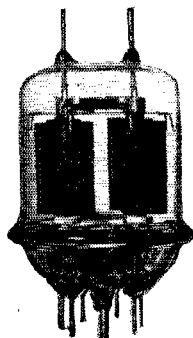

HIGH GRADE XMTG CAPACITORS

G.E. 4000 volt

2 mfd. Pyranol

\$5.95

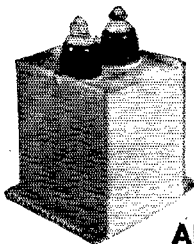

AND THESE ADDITIONAL "BUYS"

Mfd.	Volts d-c	Net ea.
.1	2000	\$0.49
2	1000	.71
2	600	.59
4	600	.71
8	600	1.19
10	600	1.29
8	660 a-c	1.50

The RADIO SHACK

★ 167 WASHINGTON ST. BOSTON, MASS., U.S.A. ★

Large Catalog FREE - Get on our mailing list for new edition

HAMS, EXPERIMENTERS

TRY THIS NEW TWO METER RING-TUNER

A COMPLETE variable tuning unit having a tuning range of 140 m.c. to 160 m.c. (with 3.5 uuf tube capacity) designed for single hole mounting on receivers, wave meters, frequency meters, low power transmitters and oscillators. Manufactured expressly for use in the amateur 144 m.c. to 148 m.c. band. Compact and easy to assemble . . . no condensers to trim, no coils to wind, no sliding contacts. "Q" is many times greater than conventional condenser combinations. Send check or money order for a Clarkstan Ring Tuner today! Write for free technical bulletin 110Q.

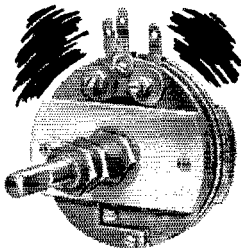

YOUR NET PRICE
\$4.80 NO C.O.D.

CLARKSTAN

CORPORATION
11927 W. Pico Blvd.
Los Angeles 34, Cal.

W8CFK

**Aluminum
Call Plates**

Your call cast in
aluminum with
black background

and polished 1 1/4" letters. Plate size 2" by 6 1/2". 3 styles: P for panel mounting, L for car license and D for desk use. \$1.75 each, postpaid.

P & H SALES CO.
619 Jasper St. Kalamazoo 31, Michigan

YOU ASKED FOR IT Here It Is!

A directional Telecurve great circle map of the world giving shortest route curves with great circle compass directions, airline distances, and corresponding world time. Maps in stock based on the following cities:

Wichita	Chicago	Hartford
Denver	Kansas City	San Francisco
New York	New Orleans	Rochester
Seattle	Forth Worth and	Washington
St. Louis	Dallas	Los Angeles

Price per map only \$2.00 including illustrated Telecurve information folder. (California residents please include sales tax.)

• **NOTHING LIKE IT ON THE MARKET** •

Numerous other starting areas now in preparation. If your city is not listed above write for full information about same.

Order today

JOHN A. GRUTZIUS, W6FZ
2640 St. George St., Los Angeles 27, Calif.

(Continued from page 108)

bias (22 1/2 volts). Next, the Class A cathode follower must be left running all of the time, but make sure the doubler plate and cathode-follower cathode circuits are tuned to the same frequency, as mentioned previously. A 15,000-ohm dropping resistor should be used between plate and screen of the 807, with a 20,000-ohm bleed from screen to ground. About 45 volts of fixed grid bias should be added to the 807, to limit the current under key-up conditions. This will not be enough to cut off the plate current when the key is up, but more isn't necessary because the 807 won't oscillate, no matter where you set the plate tuning!

About the Author

• You'd never expect a fellow with a shifty call like W9ECO to complain about DX, but Paul D. Frelich says the best stuff he has been able to chase down are the U.S. and Canada. Hi! ECO is an engineer in the Sonar Engineering Dept. of the Submarine Signal Co. His wartime projects included instructing at Chicago Signal Corps schools and work as a research technician at Harvard Underwater Sound Laboratory. He has attended Wright Junior College, Chicago, and the Illinois Institute of Technology. Paul is a member of the Waltham Amateur Radio Assn. and the Eastern Mass. Amateur Radio Assn.

Strays

Q) "Dear Editor, *QST*: I believe it would be greatly appreciated by all if you would get the facts and publish them about the effects on our rigs of the new bug killers, DDT and kin. They are sure to be squirted around promiscuously and who knows what damage they can do?" — *Peyton R. Randolph, W6GJ*

A) Well, W6GJ OM, we read in *The Boston Sunday Post* recently (tnx to W1MD) of the experience of Bill Renault, W1MTH, who is also an amateur seismologist of renown. Seems that one evening last summer Bill noticed a very fancy series of lines on his homemade seismograph indicating an earthquake of gigantic proportions. Since MTH felt his place in the universe was secure for the moment he puzzled the chart. Eureka! a spraying of his delicate scientific apparatus with DDT and he had restored the world's equilibrium. Of course the mosquitoes that caused the unbalance of his gear's delicate wires are no longer concerned with happenings on this planet. — *Ed.*

BCI to Philco receivers can usually be cured (if the set is otherwise normal) by the addition of a line choke in each a.c. power lead, just inside the chassis.

— W6AM



Free!

WIN A NEW SYLVANIA MODMETER!

ALL YOU HAVE TO DO is jot down your ideas on applications of Sylvania's two new germanium crystal diodes.—the 1N34 and 1N35. Send to Dept. 6X, address below. For every idea—see example below—published in Sylvania Electric's QST advertisements — Sylvania will award to the contributor one X7018 Modulation Meter! See your September QST for full description of this sensational meter.

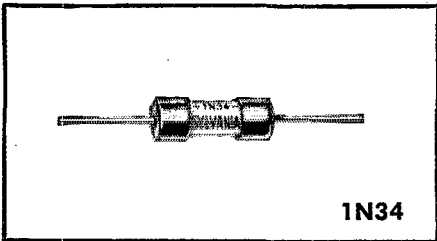

Check your May QST for applications and features of the 1N34 crystal diode.

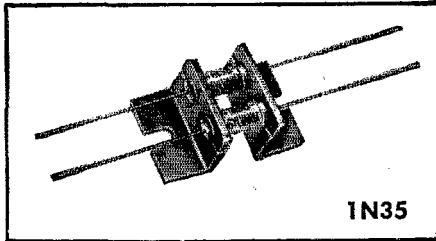

Your July QST will give full details of this new germanium crystal duo-diode.

EXAMPLE OF PRIZE-WINNING CRYSTAL DIODE KINK

Loosely couple link to final amplifier, using usual safety precautions. Turn on transmitter and listen in phone while modulating. Vary link to obtain correct headphone volume.

- L two turn link
- C1 0.001 mfd.
- T audio input transformer (not critical)

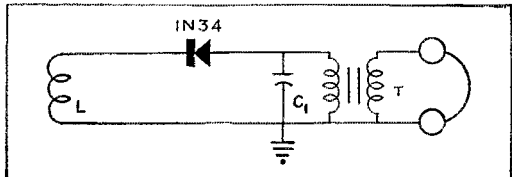

Check your quality with this simple monitor circuit.

SYLVANIA ELECTRIC

Electronics Division . . . 500 Fifth Avenue, New York 18, N. Y.

MAKERS OF ELECTRONIC DEVICES; RADIO TUBES; CATHODE RAY TUBES; FLUORESCENT LAMPS, FIXTURES, WIRING DEVICES; ELECTRIC LIGHT BULBS

NOW IN STOCK AT ALL LEADING RADIO DISTRIBUTORS

CODE PRACTICE

OSCILLATOR

WITH
**ADJUSTABLE
RESONATOR**

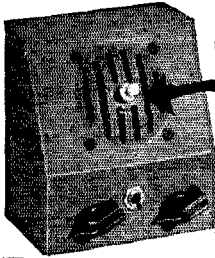

For Greater **VOLUME**
and Better **TONE!**

Adjustable Resonator (optional) increases volume five times. Tone frequency variable from 600 to 1500 cycles. Volume control from 0 to FULL ON. "PM" DYNAMIC speaker may be disconnected during operation. Up to 300 headphones may be used. Has phone jack for headphones. Optional built-in key. 110 V. AC or DC. Uses a 117N7G1 tube. Gray crackle finish.

MS 710PR • Del-uxe Master Oscillator with resonator and built-in key. Amateur net price... \$13.00

MS 710P • With built-in key but less resonator. Amateur net price... \$11.50

MS 710R • With resonator but less built-in key. Amateur net price... \$10.50

MS 710 • Less resonator and less built-in key. Amateur net price... \$9.00

Designed by
**THE WORLD'S
CHAMPION
RADIO
TELEGRAPHER**

TELEGRAPH
Apparatus Co.

412 SOUTH GREEN ST

CHICAGO 7, ILLINOIS

.. LEARN RADIO CODE WITH THIS ..
BASIC RADIO CODE KIT

\$35.00 Complete • Prepared by U.S. Army Signal Corps to teach radio code (up to 10 words per minute). Kit consists of 17 twelve-inch standard phonograph records with manual and self-scoring practice sheets. Can be used with your own phonograph. No other equipment needed.

NOBLE & NOBLE, Publishers, Inc.
72 Fifth Avenue, N. Y. 11, N. Y.

**CONNECTICUT
HAM HEADQUARTERS**

Complete stocks of nationally known
amateur gear — radio electronic parts
— tubes — sets and equipment.

Wholesale Only

R. G. SCELİ & CO.

Pete De Pasquale, W1GUC Roger Amundsen, W1HYF
George Lappe, W1LWW Roy Walkins, W1MHH
Porter Noe, W1LWZ Ernie Johnson, W1FSY
Art Lundeen, W9PZI John Yacovelli, W1IKB

317 Asylum St.
Hartford 3, Conn.
Tel. 2-1144

84 Elm St.
Bridgeport 3, Conn.
Tel. 6-1811

ASK FOR OUR BARGAIN BULLETIN

25 Years Ago

(Continued from page 88)

speeches, including one by 12-year-old Jack Coligan, the young squirt from Dallas. Prof. Jansky presented firm evidence of the superiority of c.w. over spark in his address. Traffic-handling matters were reviewed under the direction of Traffic Manager F. H. Schnell. C.w. Night was managed with better strategy than Spark Night, and as a result a c.w.-spark conflict was averted, r.f. amplification, the IDH c.w. circuit, and antenna discussions keeping the delegates busy. Our ARRL Board of Directors held a busy meeting, during which a decision was reached to send Paul F. Godley to England for the second Transatlantics. Complete test schedules are listed in this issue. And then there was the ball game, the gigantic radio show with over 50 exhibitors, and the boat ride on the *S. S. Theodore Roosevelt*. The grand finale was the banquet at the Drake, with all guests joining in a rousing vote of thanks to the Chicago Executive Council, and then home.

There was room left in this convention issue to feature a bit of the new apparatus shown at the conventions (Portland, Maine, played host to the N. E. Convention recently). The Connecticut Detector Tube and Tuning Unit, the Grebe CR-8, the Paragon Telephone, and the Amrad Regenerator are all detailed. Stations described in this *QST* are 6OH, 3CS, and 9ZL.

Strays mentions that Dr. Lee deForest is going to Germany for a few years, away from the cares of business, to carry on special research. . . . MUU, Carnarvon, Wales, will transmit Godley's reception reports daily during the Transatlantics. . . . Try using tinfoil in back of your receiver panel, OM, to reduce hand-capacity effect.

24-Cm. Wavemeter

(Continued from page 86)

disk, with the nut on the underside, to the washer (J) with three 4-40 machine screws. The bolt should now turn rather easily and without binding.

Make a coil spring (Q) of music wire (about 0.050" wire) with a one-inch free length and an inside diameter of $\frac{9}{32}$ inch. Bend or grind the ends of the spring square, so that it stands up straight when placed on a flat surface. Slide a washer (R) over the bolt, add the spring (Q), and then fasten a regular dial to the end of the bolt. It is best to choose a fluted dial with a skirt or flange. For convenience in taking measurements it is desirable to make and label 50 lines on the skirt, spaced 7.2 degrees apart around its periphery. Each division is now 0.001 inch motion of the tuning member when using a $\frac{1}{4}$ -20 bolt. A dial with 360 degrees marked on it would also be suitable. A fair approach to this can be achieved by taking two protractors and mounting them underneath but protruding beyond the skirt of the dial.

(Continued on page 116)

HARRISON HAS IT!

HARRISON HAS IT!

HARRISON SELECT SURPLUS

Your assurance of good, usable, guaranteed, surplus material at sensationally low prices — **TOP VALUE ALWAYS!** Come in and browse through our large HSS Department.

CRYSTAL CALIBRATOR and MONITOR

(Navy Type CGQ-61033)

A very handy piece of equipment around any ham shack, lab, or service department! Use it for tuning transmitter or receiver to spot frequencies, checking edge of band, determining crystal frequency with receiver or frequency meter. Put 1000 KC crystal in and use to calibrate signal generators or receivers, etc.

Electron coupled Pierce crystal oscillator using 3A4 tube covers all frequencies. Sockets for 10 crystals, with ceramic selector switch. Head phone jack for monitoring transmitter. Self-contained batteries: 1-No. 5540, 1-No. 2. All in aluminum cabinet 2 1/2" x 4 1/2" x 6". Weighs 2 1/4 lbs. Brand new, complete with instructions, diagrams and kit of spare tube and parts. **\$4.95**
Less crystals and batteries.....

(With Batteries \$5.95)

HSS TUBES

All new, perfect, Government inspected.

HK 24G (3C24) \$1.49
814.....\$5.95
257-B (4E27).....\$6.90
3E29 (829B).....\$4.79

5000-Volt 1 MFD

Aerovox oil fill-capacitors. **\$3.95**

F B XTALS

3.5 to 8.7 MC. in FT-243 holders. Wide selection (specify frequency range) **\$1.19**

COAXIAL CABLE

RG-8/U 52 Ohm Impedance. FB for feeding beams, etc. Handles a KW with high efficiency. New, perfect cables.

110-foot length with two PL-259 coaxial plugs. Total list price **\$39.281** HSS **\$4.98**

Cut to size in one piece within -0% to +20% of length ordered. Full measure!

Size	Price per foot
1-100'	9¢
100' and up	6¢
75 Ohms	10¢
74 Ohms	14¢
73 Ohms	11¢
55 Ohms	8¢

VHF GROUND PLANE ANTENNA

Navy Surplus. Folding, adjustable, compact. Complete with PL-259 Coaxial plug.

A — Elements 17" to 29", with 6 foot RG-58/u coaxial cable. **\$1.98**
B — Elements 9" to 13", with 10 foot cable..... **\$1.19**

MAIL ORDERS?

Certainly! Just list everything you want (items in this ad, or any ad, magazine, or catalog) and include deposit.

73 de

Bill Harrison, W2AVA

ALL STANDARD LINES

We are

Factory Authorized Distributors

for the top quality manufacturers and we now have in stock lots more new, latest improved production Ham gear! Visit our stores today, for everything you need. We promise you fresh clean material — quicker — at the lowest current prices — and, above all, our sincere desire to be of friendly, helpful service.

As one of the world's largest distributors of Communications Equipment, we are delivering plenty of

RECEIVERS

Right now! **ALL MAKES** — practically all models. If you want your new set in the quickest possible time send your order to HARRISON!

For example: —

HALLICRAFTERS —
S-38.....\$39.50 S-40.....\$79.50
S-36A, FM-AM-CW. 27.8 to 143 Mc.....\$97.50
S-37, 130 to 210 Mc.....\$91.75
SX-42, New FM-AM. .54 to 110 Mc. Approx. \$250.00
HAMMARLUND — New "Super-Pro"
SPC-400-SX, 1.25 to 40 Mc.....\$310.05
SPC-400-X. .55 to 30 Mc.....\$334.05
Speaker in Cabinet.....\$13.20

NATIONAL —
NC-240-D. Complete with speaker.....\$240.00
HRO-5TA-1. Complete with pack and speaker.....\$303.00
RME-45 —
Complete, with speaker.....\$186.00

LITERATURE ON ANY RECEIVER GLADLY SENT UPON REQUEST

MECK MODEL T60-1 TRANSMITTERS

A modern, post-war, phone — CW Transmitter with a conservative input power rating of 60 watts. Crystal control — 9 tubes — dual power supplies — antenna change-over relay — meter switching — metal cabinet 15" x 11" x 9" — high efficiency on all bands. Complete with tubes and coils for 10 meters, less only microphone, crystal and antenna. **\$150**

SONAR **XE-10**
NARROW FM **XCITER**
BAND **\$39.45**

NEW ABBOTT TR-4B

Harrison has the new, improved version of this most popular 2-meter transmitter-receiver. Now uses a 955 acorn tube for even greater sensitivity and stability. Ideal for mobile or fixed station. Order yours NOW! Immediate **\$52** shipment.....

Electronic Labs new Vibrator Pack No. 2606, 6-volt DC input. Delivers 300 volts at 100 MA, fully filtered. Compact — efficient! **\$14.95** Complete..

BEAM ANTENNA

Premax is on the beam with this new rotary 3 element beam kit. Tapered, seamless, telescoping, dural elements for maximum efficiency with minimum weight and sag. All metal frame drilled for exact spacing for 6, 10, and 11 meter bands. 1 match for 300 ohm spaced line feed; or feed with coaxial cable. **\$29.40**
Complete Kit KB 6109.....

PREMAX ROTOMOUNT

Will support and turn the heaviest beam **\$21.46**
by hand. BM 46.....

HAM HEADQUARTERS
Since 1925!

HARRISON RADIO CORPORATION
12 WEST BROADWAY • NEW YORK CITY 7
BARCLAY 7-9854
JAMAICA BRANCH — 172-31 Hillside Ave. — REPUBLIC 9-4102

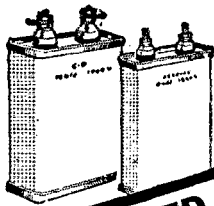

10 MFD.—1000 volts,
No. 17A268\$3.95
4 MFD.—1500 volts,
No. 18A227\$2.94
Plus 20c each postage
and pkg. charges.

OIL FILLED • HI-VOLTAGE CONDENSERS

EXTRA SPECIAL VALUE

Limited quantity of these fine condensers with ceramic insulated terminals. Place your order at once.

18 YEARS IN RADIO

Latest developments in radio and electronic parts and devices, newest "Ham" gear, gadgets to delight the heart of the experimenter, bargains in selected war surplus radio items. Some of the best values we have offered in our 18 years in business.

WRITE FOR CATALOG

Get on our mailing list and receive our bulletins and catalogs as issued.

BURSTEIN-APPLEBEE CO.
1012T McGee, Kansas City 6, Mo.

Now—a really
high-powered



RADIO ENGINEERING LIBRARY

- especially selected by radio specialists of McGraw-Hill publications
- to give most complete, dependable coverage of facts needed by all whose fields are grounded on radio fundamentals
- available at a special price and terms

THESE books cover circuit phenomena, tube theory, networks, measurements, and other subjects—give specialized treatments of all fields of practical design and application. They are books of recognized position in the literature — books you will refer to and be referred to often. If you are a practical designer, researcher or engineer in any field based on radio, you want these books for the help they give in hundreds of problems throughout the whole field of radio engineering.

5 VOLS.
3319 PAGES
2289
ILLUSTRATIONS

1. Eastman's Fundamentals of Vacuum Tubes.
2. Terman's Radio Engineering.
3. Everitt's Communication Engineering.
4. Hund's High Frequency Measurements.
5. Henney's Radio Engineering Handbook.

Free Examination • Special Low Price • Easy Terms

McGraw-Hill Book Co., 330 W. 42nd St., New York 18
Send me Radio Engineering Library, 5 vols., for 10 days' examination on approval. In 10 days I will send \$2.50, plus few cents postage, and \$4.00 monthly till \$26.50 is paid, or return books postpaid. (We pay postage on orders accompanied by remittance of first installment.)

Name.....
Address..... Company.....
City and State..... Position..... QST 10-46

(Continued from page 114)

The divisions on the dial together with the marks on the vertical scale mounted on the cover plate provide means for taking fairly accurate readings.

The Pick-up Antenna

It is necessary to make a simple antenna (S) that can be used to pick up signals from the transmitter. Cut a piece of the small or inner telescoping tubing (T) to a length of 5 inches. Pass a straight copper wire (U) (about No. 16) through its center using one or two polystyrene "beads" (V) to support it, making a small coaxial line. At one end of this line make a loop (W) about $\frac{1}{2}$ inch long by $\frac{1}{4}$ inch wide, and solder its end into a small saw-cut in the edge of the tubing. Shape the loop and file the solder joint smooth so that it can slide through the larger tubing and into the resonator chamber. At the other end of this coaxial line bend the wire at right angles and cut it off at $2\frac{1}{2}$ inches. Now solder another $2\frac{1}{4}$ -inch piece of wire to the tubing in the other direction, thus forming a doublet or "dipole" antenna (S).

Cut another piece of this tubing $1\frac{1}{2}$ inches long (X) and make a similar loop (Y) at one end. Arrange the other end of this short coaxial section with a suitable fitting to connect to the particular type of crystal holder you have available. The holder should use the standard-type crystal cartridge (B¹) such as the 1N21 or 1N22 silicon detectors. The photograph shows a typical crystal holder (C¹) which is made to couple to a $\frac{1}{4}$ -inch coaxial fitting. If a crystal holder is not on hand, it is necessary to provide some means for connecting the crystal in series with the center conductor of this pick-up-loop section. (Do not solder to the crystal cartridge at all!) The cartridge should be entirely shielded, and polystyrene tape or other dielectric material should be wrapped around the large end to provide a capacitance to and yet prevent it from shorting to the outer conductor. A small 500- μ fd. "button"-type condenser may be used as this by-pass capacitance. The indicating instrument (usually a 0-1 ma. d.c. meter) is now connected between the large end of the crystal and the outer conductor. The small or pin end of the crystal connects to the inner conductor and completes the circuit both for r.f. and d.c. through the loop to the outer conductor. It is important to remember that there must be a low-resistance d.c. return path for the crystal current via the loop circuit, otherwise the meter will not read.

Put the antenna loop (W) into one side of the resonator and the crystal detector loop (Y) into the other side. Orient the loops so that they are in line with the axis of the wavemeter and are protruding part way into the inner can. Make some simple strap clamps (A¹) from the $\frac{1}{32}$ -inch sheet brass stock to go around the slotted sections of the loop guides to prevent the loops from sliding or turning after the unit has been calibrated. When the crystal and meter are connected, the wavemeter is ready for operation.

(Continued on page 118)

Good-bye
to Battery Expense!!
**RECHARGEABLE
POWER PACK**

for Portable Receivers • Walkie-Talkies • Transmitters
Remote Controls
Test Equipment, etc.

COMPACT!—only 1 3/4" x 3 5/8" x 6 1/2" high

LIGHTWEIGHT!—3 lb., 10 oz., complete!

POWERFUL!—Delivers

- 135 volts at 20 ma in continuous Military service or 30 ma, or more, in intermittent Amateur service.
- 67 1/2 volts at 5 to 8 ma.
- 1.5 filament or 6.3 heater, bias, and microphone voltages.



Brand-new, Navy-Inspected, in original cartons with fully charged battery, diagram and instructions. Complete, ready to go.

\$5.50

For little more than the cost of *one* set of regular dry batteries, you can get a new, modern rechargeable power pack that will save you space, weight and money! Ruggedly made for Navy radio equipment, this pack will give excellent service under the roughest field conditions.

Smooth, dependable power comes from a 6-volt storage battery which clips into bottom of pack and which can be recharged over and over again for only a penny or two. Unbreakable plastic NON-SPILL (even if turned upside-down!) CASE. Can give over 6 solid hours of *continuous* operation at full rated load before requiring simple recharge by any half amp trickle charger or our special inexpensive charger.

The vibrator pack has such desirable design features as neon voltage regulator, complete filtering, remote load start relay, etc.

STORAGE BATTERY

6-volt, 3 cell, 30 watt hour Storage Battery — as used in pack. 1 3/4" x 3 5/8" x 2 1/2". Hundreds of uses! (Keep spare to use while charging other). Fully charged, complete..... **\$2.00**

BATTERY CHARGER

A simple, inexpensive trickle charger for these or any other small storage batteries. Available for 110 v AC, 110 v DC or 32 v DC. Noiseless, efficient, economical!..... **\$2.97**

Rush your order in for immediate shipment.
Please remit exact amount.

73 de

Bill Harrison, W2AVA



HARRISON RADIO CORPORATION

12 WEST BROADWAY • NEW YORK CITY 7

BARCLAY 7-9854

JAMAICA BRANCH — 172-31 Hillside Ave. — REPUBLIC 9-4102

HAM HEADQUARTERS
Since 1925!

(Continued from page 116)

Adjusting & Calibrating

Place the antenna in the field of a low-power 24-cm. transmitter, and slowly turn the dial of the wavemeter until a reading is obtained on the meter. If the meter goes off scale, back out or rotate the loops to reduce the coupling, and retune the resonator. Adjust the coupling until the meter reads about $\frac{1}{2}$ to $\frac{3}{4}$ of full scale when placed several feet away from the transmitting antenna. Another way to reduce the coupling is to reduce the size of the loops. If the crystal is not very sensitive, a 100- μ a. meter may be needed.

The job of calibration comes next. Before going into this, however, it must be pointed out that the loops cannot be moved after calibration without spoiling the dial readings, so be sure they are adjusted to your satisfaction and then clamped in place before going further. The simplest method of calibration is to obtain readings on a previously-calibrated 24-cm. wavemeter. If this is not possible, it is then necessary to take the alternative step. Make a Lecher-wire system several wavelengths long (about one meter) with two parallel copper wires spaced $\frac{3}{4}$ to 1 inch apart. Stretch them between two wooden posts or on a device like a bow. At one end connect the wires together and loosely couple this loop to the transmitter. Take a small dial lamp (2 to 6 volts, depending upon the transmitter power) with wires soldered to its terminals, and slide it along the transmission line. It will light at certain points and will go out altogether at others as it is slid along. Now loosely couple the wavemeter to the system and tune for a peak on the meter. Measure the distance (in centimeters) between two adjacent points where the bulb is extinguished, and this will be equal to *one-half* wavelength. The reading of the wavemeter dial now corresponds to the wavelength just measured. By repeating this procedure for several different wavelengths in the 24-cm. band, calibration points for the wavemeter dial can be obtained. Refer to the ARRL *Handbook* for further information on using Lecher-wire systems.

It is quite useful to plot a graph of the dial readings against wavelength (or frequency) to simplify interpolation between the calibration points. To convert from wavelength to frequency use the following formula:

$$\text{frequency in Mc.} = \frac{30,000}{\text{wavelength in centimeters}}$$

A typical calibration curve is shown in Fig. 4. If the dimensions of the wavemeter are followed rather closely, the slope or tuning rate of its calibration curve should be the same as the one illustrated. About five turns on the dial are required to cover the entire band of 80 Mc.

The Q of the experimental wavemeter was 850. Since Q is related to bandwidth by the following

(Concluded on page 122)

Quality PRODUCTS
Since 1923

A complete line of
WIRES, CABLES, HOOK-UP WIRES,
RADIO HARDWARE, SHIELDED
MICROPHONE CABLE and S. J. CABLE
Complete Stock of Your Dealer

BIRNBACH

BIRNBACH RADIO CO., Inc.
145 HUDSON ST. NEW YORK 13, N. Y.

Our High Forward Gain, Wide-Spaced, 4-Element,
All-Aluminum

10 METER BEAM

and High Forward Gain, Wide-Spaced,
3-Element, All-Aluminum

20 METER BEAM

are both now available with

A PERFECT MATCH, NO STANDING WAVES

We are glad to announce that we can now furnish on demand with our beams a diagram of a matching system with which standing waves can be eliminated. No fiddling with stubs, or complicated formulas for series sections which may leave you with standing waves when you get all thru. Connect according to simple diagram and use. Excellent for co-ax cable, ground outside of cable, use rotating joint, etc. Incidentally the system matches any line to any ant.!

These end-fire arrays are wide-spaced and so have much greater gain than the old-fashioned close spaced variety. Check with articles in late issues of various magazines. They are made entirely of hard aluminum, and do not use any wood, brackets, cradles, etc., as the elements pass directly through the central boom and are fastened there. Very strong and very light.

No tuning or adjustments of any kind are necessary on the beam. That has been done for you by months of work. Just put it up, connect feed-line, and use.

Up to ten times power gain over $\frac{1}{2}$ wave ant. Greatly reduces QRM, ignition noise, feedback, and BCI (except out front in line of fire). Shipped in wood boxes, express prepaid within 1000 miles, 10 meter beam \$50, 20 meter beam \$100. Only needs screw-driver and pliers to assemble.

Send for literature on the above and our beams for 50 MC. and up, including 18" parabola ("dish," or paraboloid of revolution) for 1200 MC. and up.

U.H.F. RESONATOR CO.

W. F. Hoisington, WILAS/2

GUION ROAD, RYE, N. Y. Telephone Rye 2030

**Thanks
WØFBS!**

Post-war WØFBS—equipped
by ALLIED. Listen for him on 10
and 20 meter phone.

Communications Equipment

for earliest delivery order from ALLIED

Time Payments Available
Trade-Ins Accepted

Hallcrafters S-38	\$39.50	RME DB-20 Preselector	\$59.30
Hallcrafters S-40	79.50	Hammarlund HQ-129X	168.00
National NC-46	97.50	RME-45	186.00
NC-46 Speaker	9.90	National HRO	274.35
RME-84	98.70	National NC-240D	225.00
RME VHF-152 Converter	86.60	Hammarlund SPC-400X	342.00

Net F.O.B. Chicago. Prices subject to possible change.

ALLIED HAM "SCOOPS"!



Army Surplus RG-59U Flexible Coaxial Line.
For low-loss link lines between xmitters and antenna tuning units, for between-stage link lines, heavy-duty speech lines, etc. Genuine RG-59U cable. Nominal capacity, only 22 mmfd. per foot. Will handle RF output of xmitters up to 600 watts. Nominal impedance, 73 ohms—just right for doublet feed lines.
X71-784. Per foot **6 1/2c**
100 feet for **\$6.00**

Army Surplus RG-8U Flexible Coaxial Line.
Famous 54-ohm, 1-KW coax for feed-lines, rotary beam matching sections, etc. Brand-new stock.
X71-783. Per foot **9c**
100 feet for **\$8.50**

866/866A Gov't Inspected Rectifier Tubes. Xmitting tube prices are UP, but you can save money on these brand-new 866's! You can't beat the price. Sorry—only 4 to a customer.
X7-949. Net each (limit 4) **\$1.05**

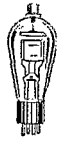

Here's what Tom Atherstone (ex-W7IV) writes us from Denver: "I would like to take this opportunity to express my complete satisfaction with the fine service ALLIED has given me in the equipping of my amateur station, and to assure you that you may expect more orders from me in the future. The Hallcrafters BC-610-E Transmitter and Hammarlund HQ-129-X Receiver were received promptly and in good order, and have been the source of many fine contacts since."

Thanks a million, Tom. We enjoyed equipping WØFBS. We're getting a kick out of helping hundreds of other amateurs to get back on the air. Whether you're starting "from scratch," rebuilding, or newly licensed, you can count on ALLIED for all the help you need—for earliest delivery of the latest available gear, for guaranteed quality at the lowest prevailing prices, for preferred personal service from ALLIED'S staff of licensed hams, each of whom shares your interest in amateur radio.

Send for Allied's 1946 Radio Catalog

FREE

Here's the *Buying Guide* that lists everything for the Ham . . . communication receivers, xmitters, Ham gear, code apparatus, parts, kits, tubes, test instruments, etc. Send for your **FREE** copy.



ALLIED RADIO CORP., D. L. Warner, W9IBC
833 W. Jackson Blvd., Dept. 27-KK-6
Chicago 7, Illinois

- Enter order for Model
- Enclosed \$ Full Payment Part Payment (Balance C.O.D.)
- Send Literature on Receivers and Time Payment Plan.
- Send **FREE** 1946 Catalog.

Name

Address

City Zone State

ALLIED RADIO

Everything for the HAM

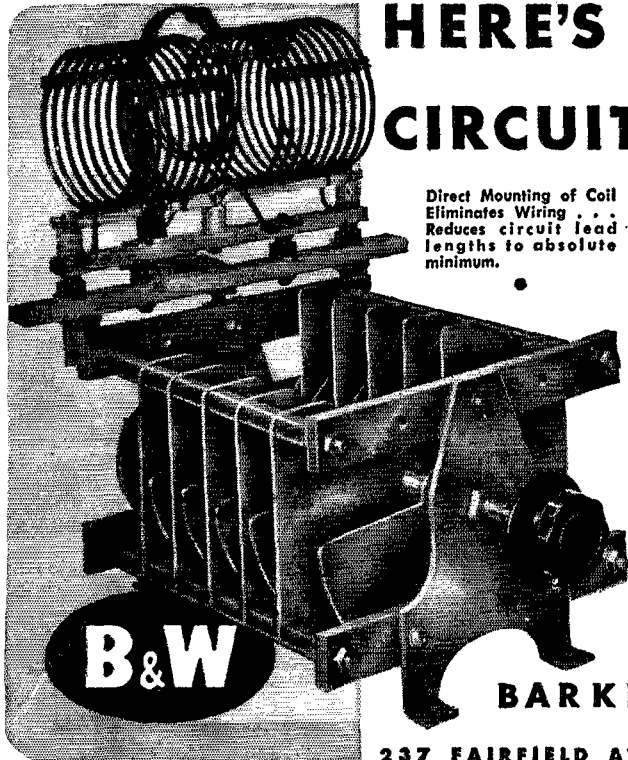

HERE'S REAL TANK CIRCUIT Efficiency

Direct Mounting of Coil Eliminates Wiring
Reduces circuit lead lengths to absolute minimum.

"Radically different" only a few years ago, B & W Type CX Variable Capacitors with their perfect design symmetry are now standard in many of the finest of the new commercial Xmitters. And they're "tops" for amateur use as well.

Unique design permits mounting coils directly on capacitors for absolute maximum efficiency. Opposed stator sections provide desirable r-f paths. Butterfly rotor construction permits grounding rotor at the center r-f voltage point with respect to stators. Built-in neutralizing capacitors can be mounted on end plate. Standard types rated at 500, 750 and 1,000 watts. Write for Catalog 75-C.

BARKER & WILLIAMSON
Inductor Coil Headquarters

237 FAIRFIELD AVENUE, UPPER DARBY, PENNA.



A. A. Ghirardi's RADIO PHYSICS COURSE book has been more widely used for home study, for Army-Navy training and by more civilian schools than any other of its kind.

KNOW WHAT YOU'RE DOING ... and why!

Ghirardi's COMPLETE COURSE IN BASIC RADIO-ELECTRONICS (including Basic Electricity)

You'll understand ham circuits and problems better! You'll know every component, its function and purpose! You'll be better equipped for FCC examinations — and you'll have the proper basic training for a clear understanding of helpful ham manuals such as the ARRL Handbook!

Ghirardi's 972-page RADIO PHYSICS COURSE starts at the very beginning. Nothing is omitted. Nothing condensed. You'll understand every word — even without previous training. To the beginner, it is

ideal basic training — at only \$5 complete. To the "old timer" it offers a splendid way of brushing up on specific problems or forgotten fundamentals.

Over 300 pages cover Basic Electricity. From here this big, 3 1/2 lb. book carries you through components, tubes, circuits and radio and audio amplification to every factor on which modern Radio-Electronics is based. 508 illustrations, 856 self-check review questions. Read it for 5 full days on our Money-Back Guarantee offer!

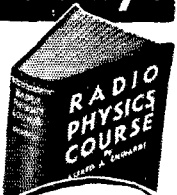

Only \$5.
Complete

36 Courses in one — Easily Worth \$50 if Sent to You in Monthly Lesson Form.

LEARN TO SERVICE ALL TYPES OF EQUIPMENT PROFESSIONALLY ... at home ... without an instructor

Ghirardi's MODERN RADIO SERVICING is the only complete 1-vo. course in Radio-Electronic servicing by modern, scientific methods. Invaluable "background" training for Hams, it can also fit you for a profitable Radio-Electronic professional

future. Explains Test Instruments — how used and why — even how to build your own. Covers Troubleshooting Procedure; Circuit Analysis; Component Test and Repair; Installations; Adjustments, etc., etc. 1300 pages, 706 illus. Only \$5 complete.



Learn Exactly How to REPAIR OVER 4800 RADIO MODELS without costly test equipment

4 out of 5 common radio troubles can be repaired simply by referring to Ghirardi's RADIO TROUBLESHOOTER'S HANDBOOK! Bothered with fading? Poor volume? Noise? Just look up the make and model. Covers practically every radio in use — over 4800 of them. Tells what to do, how to do it. Leading servicemen repair two sets in the time normally required for one. Beginners overcome obstacles that would take hours of study and tedious testing. Over 300 additional pages contain tube charts, graphs, service data compilations, etc. Weighs over 4 lbs. 744 pages. \$5. 5-Day Money-Back Guarantee.

5-DAY MONEY-BACK GUARANTEE

Dept. Q106, MURRAY HILL BOOKS, INC.
232 Madison Ave., New York 16, N. Y.

Enclosed find \$_____ for books checked; or send C.O.D. (U.S.A. only) plus postage. If not fully satisfied, I may return books within 5 days and get my money back.

MODERN RADIO SERVICING \$5 (\$5.50 foreign)

RADIO TROUBLESHOOTER'S HANDBOOK \$5 (\$5.50 foreign)

RADIO PHYSICS COURSE \$5 (\$5.50 foreign)

MONEY-SAVING OFFER Modern Radio Servicing and Troubooter's Handbook \$9.50 for the two. (\$10.50 foreign)

Name _____
Address _____
City and Dist. No. _____ State _____
(Please write or print plainly)

SEE
SPECIAL OFFER
IN COUPON

*Expertly ENGINEERED
by GATES*

"KNOW HOW" . . . SINCE 1922

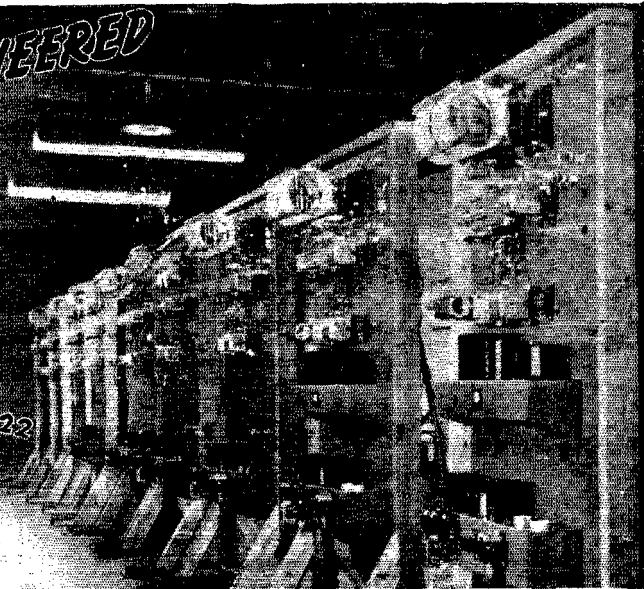

Now **PRECISION BUILT** *in the*
MODERN ASSEMBLY LINE MANNER
IN OUR UP-TO-DATE, ENLARGED FACTORY

The GATES 250C-1 TRANSMITTER MEETS EVERY DEMAND

The above unretouched photograph taken in the modern, GATES factory, shows how 250C-1 Transmitters are produced in the modern, assembly-line manner. No, GATES Transmitters are not built one at a time, though each individual Unit is engineered as if it were a custom built job.

GATES up-to-date methods in engineering are your assurance of high transmission efficiency of each Unit with the added advantage now of mass production to assure a service which will be better than ever when prevailing shortages and other restraining conditions improve.

GATES 250C-1 Transmitters—like all other GATES Broadcasting Units—are in mass production to meet the increased demand of operating Stations and of those now planned, when the time comes.

You may always look to GATES for leadership—in engineering perfection as exemplified in the GATES 250C-1, for new developments—and now modern factory methods for final production.

**WRITE FOR DETAILED SPECIFICATIONS ON THE 250C-1
and Other GATES TRANSMITTING EQUIPMENT**

GATES

**RADIO CO.
QUINCY, ILLINOIS**

**SOLD IN CANADA BY:
Canadian Marconi Co.,
Ltd., Montreal**

**NEW YORK
OFFICE:**

9th Floor • 40 Exchange Place

A "STAR" PERFORMER

The fundamental circuits of the 250C-1 are straightforward, properly applied to obtain the best operation. Added is the distinguishing feature of MOTOR TUNING for the tuning adjustments of the final stage and leading to the antenna—another EXCLUSIVE for this GATES UNIT. Also, there are but TWO controls for the entire tuning procedure, for simplicity. These features characterizing its integrated design are but a few of its outstanding superiorities in engineering design.

EXCLUSIVE MANUFACTURERS OF RADIO TRANSMITTING EQUIPMENT . . . SINCE 1922

expression:

$$Q = \frac{\text{frequency in Mc.}}{\text{bandwidth in Mc.}}$$

the bandwidth to the half-power points of the resonance curve was 1.48 Mc. for the soup-can wavemeter. It is possible to regard the bandwidth of this type of circuit in exactly the same manner as with low-frequency resonant circuits using conventional coils and condensers.

To dress up the appearance of the wavemeter a coat of black wrinkle paint provides a durable finish. Be careful not to get any paint on the inside where it could cause poor contacts, especially in the loop guides. Again it must be mentioned that moving either the loops or the location of the dial on the shaft will affect the calibration.

In general, the wavemeter is used with the dipole antenna to measure the frequency of an oscillator or to determine an antenna pattern. A small loop section similar to that on the crystal detector can be used, however, for coupling to a coaxial line input. If this is desired, it would be well to calibrate the wavemeter with the loop in place, and then make a dipole antenna which would couple to this loop section like a coaxial line. Either the antenna or a coaxial line can then be used on the input at will, without seriously affecting the calibration.

World Above 50 Mc.

(Continued from page 54)

chusetts, Rhode Island, Connecticut, New York, New Jersey, Pennsylvania, Maryland and Delaware, a total of 9! Can anyone top this?

Under the right conditions it is possible to work long distances with even flea power. W6VNI/6, operating from Grouse Ridge, 45 miles northwest of Lake Tahoe, worked W6PVT/6 at Castle Rock, near Santa Cruz, a distance of 182 miles. From Oakland, he worked W6BLP/6, 8 miles east of Lake Tahoe, a distance of 135 miles. The power: W6VNI — 0.5 watt; W6BLP — 0.86 watt; W6PVT — 7 watts! This sort of power works in the East, too. WISS/1, Arlington, Mass., put a solid signal into West Hartford recently with a 3-watt mobile rig. W2QAN, Williston Park, L. I., has worked W3BM, Minotola, N. J., a distance of 110 miles, with a 2C44 oscillator, running 5 watts input.

The cities bordering the Great Lakes are alive with 2-meter stations, and Helen Harris (Mrs. W8UKS, Cleveland) writes that the gang have been dismayed that nothing of their activities has appeared in *QST*. (This department is not the least bit psychic — we have to be told these things!) She lists the calls of 36 stations active around Cleveland. Since the middle of June, many of these folks have been working stations in and around Detroit, and as far north as Pontiac, 110 miles. W8UMI, Highland Park, Mich., and

(Concluded on page 126)



... PRECISION IS BASIC
WITH Burlington INSTRUMENTS

These are the features that make Burlington Instruments your logical choice — Alnico Magnets used in all DC Instruments — Large clearances for all moving parts — Perfectly aligned Jewel Supports — Phosphor bronze control springs — Ceramic pointer stops — non-shifting balance weights.

All ranges AC or DC available in 2½", 3½", 4½" sizes, rectangular and round. Inquiries solicited.

BURLINGTON INSTRUMENT COMPANY
 810 Fourth Street • Burlington, Iowa

COMPLETE RADIO TRAINING!

Prepare now to accept a responsible position in Commercial Radio. New developments will demand technicians with thorough basic training, plus a knowledge of new techniques discovered during the war. Training open to high school graduates or those with high school equivalency. Courses 6 to 18 months' duration in RADIO AND ELECTRONICS. Approved Veteran training in Radio. Write for Particulars.

VALPARAISO TECHNICAL INSTITUTE
 Dept. TN Valparaiso, Ind.

RADIO

RADIO Technician and Radio Communications courses. Register now for new classes starting first Monday of each month. Day and Evening Classes.

A AMERICAN RADIO INSTITUTE
 101 West 63d St. New York 23, N. Y.
 Approved under GI Bill of Rights

ELECTRICITY
 FOR RADIO AND ELECTRONIC APPLICATIONS

ONAN ELECTRIC GENERATING PLANTS supply electric service for electronics applications and general uses, mobile or stationary. Driven by Onan 4-cycle gasoline engines, they are of single-unit, compact design and sturdy construction.

65 basic models ranging in capacity from 350 to 35,000 watts. Standard A.C. models, 115-volt, 60-cycle, single-phase. Standard D.C. models, 32 to 115 volts. Special voltages to 660 A.C., and 6 to 4000 volts D.C. 5 KW to 35 KW units available in 3-phase. High frequencies to 800 cycles. Combination A.C.-D.C. types. Write for detailed literature or engineering assistance.

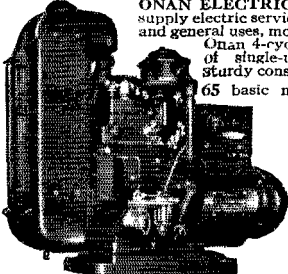

D. W. ONAN & SONS 4651 Royalston Ave. Minneapolis 5, Minn.

Look-

at these HARVEY values!



MILEN 90800 XMITTR-EXCITER

Flexible exciter for high power, or use alone as a 50 watt rig. 10-20-40-80 meter bands. Regularly supplied for 10 meters using 40 meter xtal or ECO. Coils for all bands are available . . . specify band when ordering, 6L6 and 807 not included.

Price\$37.50
 Biley Xtals, 40 or 80 meter..... 2.80
 Extra Coils, per band..... 3.00
 Tubes..... 3.10

TYPE 1616 HALF-WAVE HIGH VACUUM RECTIFIER

We have limited quantities of this tube. Send your order in at once!
 Characteristics:

Filament.....2.5 volts, 5 amps.
 Peak Inverse Voltage.....5500
 Peak Current......8 amp.
 Surge Current.....2.5 amps.
 Average Plate Current.....130 amp.

List Price, \$7.50

HARVEY SPECIAL PRICE,..... **95c**

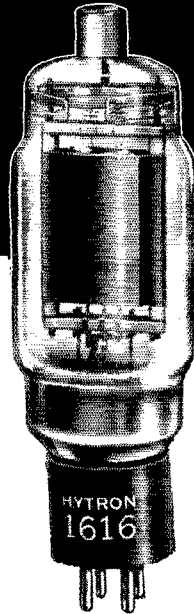

HARVEY'S HIT OF THE MONTH

Thordarson Driver—For push-pull 6F6 to four 6L6 in push-pull parallel. Ratio 1.3-1. Secondary has separate push-pull connections. Cased; brand new. Quantity limited! Harvey Special Price, \$3.95

HARVEY'S HAMFESTIVAL OF VALUES

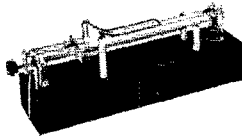

Hytron HY-Q 75 1 1/4 and 2 Meter Kit. All "plumbing" done for you, shorting bar with spring contact fingers

driven by micrometer screw. All RF parts silver plated, mounted on ceramic stand-offs. Completely assembled, wired and tested.....\$11.95
 HY75 Tube..... 3.95

5 Mc. precision crystal, in mount. Harvey Special Price.....\$1.95

Plastic pilot light housing. base with built-in miniature s.c. bayonet socket has screw lugs for back of panel mounting. Red or white indicator screws in from front for ease of changing. Specify color.
 3 for.....\$1.00



Dial and knob. Engraved metal dial 2 3/4" diameter, calibrated 0-100 clockwise. Black, skirted knob 1 1/2" diameter. Three screws hold knob firmly to dial. Shaft hole 1/4".....3 for \$1.00

Telephone: **Three** Longacre 3-1800

HARVEY RADIO COMPANY INC.

103 West 43rd St., New York 18, N. Y.

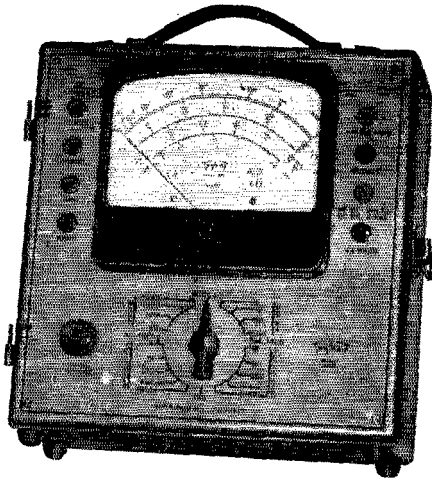

MODEL 2405

Volt • Ohm • Milliammeter

25,000 OHMS PER VOLT D. C.

STANDARDS ARE SET BY



SPECIFICATIONS

NEW "SQUARE LINE" metal case, attractive tan "hammered" baked-on enamel, brown trim.

■ **PLUG-IN RECTIFIER**—replacement in case of overloading is as simple as changing radio tube.

■ **READABILITY**—the most readable of all Volt-Ohm-Milliammeter scales—5.6 inches long at top arc.

■ **RED•DOT LIFETIME GUARANTEE** on 6" instrument protects against defects in workmanship and material.

NEW ENGINEERING • NEW DESIGN
NEW RANGES • 30 RANGES

Voltage: 5 D.C. 0-10-50-250-500-1000 at 25000 ohms per volt.
5 A.C. 0-10-50-250-500-1000 at 1000 ohms per volt.
Current: 4 A.C. 0-5-1-5-10 amp. 6 D.C. 0-50 microamperes—
0-1-10-50-250 milliamperes—0-10 amperes.
4 Resistance 0-4000-40,000 ohms—4-40 megohms.
6 Decibel -10 to +15, +29, +43, +49, +55.
Output Condenser in series with A.C. volt ranges.

*Model 2400 is similar but has D.C. volts
Ranges at 5000 ohms per volt.*

Write for complete description

Triplet

ELECTRICAL INSTRUMENT CO.

BLUFFTON, OHIO

SURE we're HAMS!

Kierulff's brand new HAM SHACK is designed for the exclusive display of amateur radio supplies and fully stocked with the best ham equipment. We have all top lines of receivers, transmitters, amplifiers and recording equipment in operation. Every member of the gang is an active amateur—fully qualified to help you with your problems. Come in and talk things over, or drop us a card.

We're waiting to serve you.



Our Staff
Includes—

W6SJ

W6IFW

W6KRM

W6PCX

W6SEX

W6TFC

W6VLN

W9YQE

Kierulff AND COMPANY
WHOLESALE RADIO DISTRIBUTORS
828 WEST OLYMPIC BLVD., LOS ANGELES 15, CALIF.

Receiver Sensitivity

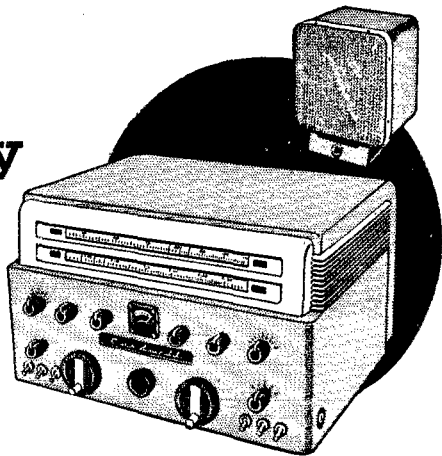

CONSIDERABLE INTEREST has been shown recently in methods of measuring and specifying sensitivity of communications receivers. We would like to explain a system for measuring receiver sensitivity which we believe will be accepted as standard by the industry.

First we would like to point out that the term sensitivity encompasses two receiver characteristics, overall gain, and signal to noise ratio.

The sensitivity in terms of overall gain is defined as the input signal required for a given AF power output. It might be expressed as one microvolt input for 50 milliwatts output. This figure becomes meaningless when, as is frequently the case, the receiver gain is sufficient to produce the standard AF power output with no signal input, i.e., from the receiver noise alone.

The sensitivity in terms of signal to noise ratio is the most important performance figure and the one for which there is no generally accepted test. Existing methods for measuring signal to noise ratio become involved in such terms as percentage modulation, receiver band width, audio amplifier response, receiver input impedance, type of dummy antenna, standard reference conditions, methods of making test, etc. Unless all of these items are strictly specified, the results are meaningless.

During the war, a method for measuring the sensitivity of radar receivers came into general use. The method involved a comparison of the signal to noise ratio of the receiver in question with the signal to noise ratio of a perfect receiver under the same conditions. Perhaps, you wonder why the signal to noise ratio of a perfect receiver is not infinite. It would be, except for the thermal agitation noise generated in the radiation resistance of the antenna itself. Thermal agitation noise is the noise voltage generated by the movement of free electrons within any conductor. Its magnitude depends on the resistance of the conductor, the band width of the amplifier used to measure the noise, and the temperature of the conductor. Knowing these factors, its value may be readily calculated.

The resultant sensitivity is expressed as a ratio between the performance of the receiver under test and the performance of the perfect receiver. The performance of the receiver under test is limited by the actual receiver noise while that of the perfect receiver is limited by the thermal noise of the antenna radiation resistance. Since both receivers have the same signal impressed on them, the ratio of their signal to noise ratios is simply the ratio of the actual receiver noise to the thermal noise of the antenna. This figure is called the Noise Factor and is expressed as, say "10db from thermal noise."

The advantages of this method of measuring

and expressing sensitivity are obvious. Here are a few:

1. The performance of the entire receiver can be expressed as a single ratio without any qualifying statements.
2. The performance of the receiver can be instantly judged because best obtainable performance figures, up to several thousand megacycles, are known. Also, the receiver is being compared with perfection so the maximum improvement which could possibly be made is always known.
3. Data from various receivers of widely different input impedance, band width, etc., can be compared directly.
4. Performance of a receiver with an entirely new band width, input circuit, etc., can be instantly judged since these factors have no appreciable bearing on the results.

This method of measuring the sensitivity, or noise factor, of a communications receiver is very simple. First the equivalent noise of the receiver is measured. This is the carrier input required to double the noise power output. In a typical case this might be 0.3 microvolt. Then the thermal noise generated in the antenna resistance is calculated. For a receiver with 5KCS band width and 300 ohm input resistance, this is 0.15 microvolt. The receiver in question then has a noise factor of 0.3 divided by 0.15 or 2. This may be expressed as "6db from thermal noise." This example happens to be the performance data taken on the Cardwell Fifty-Four.

The performance of 6db from thermal noise means several things:

1. This is about the best performance obtainable at the present state of the art over the frequency range covered by the Cardwell Fifty-Four.
2. This same performance holds for all positions of selectivity, and for all frequencies within the range.
3. It will never be possible to make a receiver more than 6db better than the CR-54. In order to accomplish this 6db improvement over the CR-54 it would be necessary to use noise-free vacuum tubes and have infinite input and interstage coupling resistances. These things are considered impossible at the present state of the art.

Complete technical bulletin describing the Cardwell Fifty-Four sent on request. Allen D. Cardwell Manufacturing Corporation, 97 Whiting Street, Plainville, Connecticut.

Mack C Jones

HOW TO PASS Commercial Radio Operators' FCC LICENSE EXAMINATIONS...

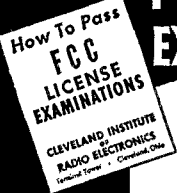

FREE BOOKLET

Tells you the Government Requirements for all classes of commercial licenses. Tells where to apply for and take the examinations, examining offices, scope of knowledge required, extracts from FCC Rules and Regulations, extracts from FCC Study Guide and Reference Material, approved way to prepare for FCC

examinations, positive method of checking your knowledge before taking the examinations.

CLEVELAND INSTITUTE of RADIO ELECTRONICS

QT-10, TERMINAL TOWER CLEVELAND 13, OHIO
Approved for Veteran Training under GI Bill of Rights

MAIL THIS COUPON

Cleveland Institute of Radio Electronics
QT-10 Terminal Tower, Cleveland 13, Ohio
Gentlemen: Please send your FREE Booklet, "How to Pass FCC License Examinations." (NOTE: This booklet does not cover examinations for Amateur Licenses.)

Name.....Address.....
City.....State.....
 Check here, if a veteran

COMMERCIAL RADIO INSTITUTE

A RADIO TRAINING CENTER FOR 26 YEARS

Resident Courses Only • Broadcast, Service, Aeronautical, Television, U.H.F., Frequency Modulation and Marine telegraphy classes now forming for term February 1st.

Literature upon request. Veteran training

Dept. B, 38 West Biddle Street, Baltimore 1, Maryland



RCA INSTITUTES, INC.

Offer thorough training courses in all technical phases of

RADIO and TELEVISION

WEEKLY RATES DAYS — EVENINGS

VETERANS: RCA Institutes is approved under G. I. Bill of Rights

For Free Catalog write Dept. ST-46

RCA INSTITUTES, INC.

A Service of Radio Corporation of America
75 Varick Street, New York 13, N. Y.

TWO-METER "J" ANTENNA

Adjustable 144-148 Mc. Lightweight assembly — complete with insulators, hardware and instructions for mounting as shown. Ship- \$3.95
ping weight 4 lbs. Price F.O.B. Detroit
(Postpaid 25¢ extra)

TEN-METER BEAM ELEMENTS

Adjustable aluminum assembly, complete with insulators and hardware for mounting.
Price per element.....\$2.95
Three elements.....\$7.00

F.O.B. Detroit

MERLE DUSTON & ASSOCIATES

8907 Kercheval Avenue, Detroit 14, Michigan
W8NEC W8YBC
Experimental W8XDX W8XDW W8XFC



W8UKS have been running polarization tests, and have worked with horizontals where verticals appeared ineffective under similar conditions. Contacts were made with Toledo stations, as long as vertical polarization was used at both ends, but the vertically-polarized stations have not been heard since W8UKS went horizontal. They go in for antenna height out there, apparently, as W8ML is building a 150-foot tower!

A nightly test period is maintained for contacts between Toledo and Detroit. About 15 stations are active in the Toledo area, and they listen nightly for calls from Detroit between 10 and 10:15. The calling and listening are reversed between 10:15 and 10:30. W8YKF, who sends in this information, has a 16-element array, and has worked W8s YGG, GYF, VIO, UMI, and TSB in Detroit.

As a means of keeping the gang in the Chicago area informed of 144-Mc. doings, W9NFK is publishing and distributing the *Midwest VIII News*. Circulation is growing by leaps and bounds (in two issues) and the paper increased from one sheet to four, in the same period. Looks like Bill has taken unto himself a job! The little paper is filled with newsy stories of the doings on 2 around Chicago — a lot of the sort of stuff we'd like to run in this department, if the United States wasn't such a big country!

There are now about 25 stations active on 144 Mc. in Erie, Pa., according to W3NCJ, SCM, Western Pennsylvania. Most of these are using HY-75 rigs, and operation is normally confined to local and semilocal work. A few times conditions have permitted contacts with W8NOR, near Buffalo, a distance of nearly 100 miles. W8NOR observes that such doings are far from being a nightly affair, at the present state of the art in that area, as schedules for 8 nights in a row, after one of these sessions, resulted in no contacts whatever.

Does your antenna relay actually serve its purpose, when used with coax or 300-ohm line? W1LD reports that he had a very high standing-wave ratio on his line when it ran through the antenna relay. This cleared up, as did very troublesome broadcast interference, when the line was connected directly to the transmitter. All this points up the need for TR-box technique in v.h.f. work. Has anyone any suggestions?

Is anyone around New York City interested in promoting some work on 2400 Mc.? League-president Bailey, W1KH, has a 2C40 lighthouse rig and is looking for customers to work.



W4ILT (a newly-issued call) was a 1st Lt. during the war, W1MSG was a M. Sg., and W7ART an ART. Heard the one about the full-colonel who took his amateur examination recently while on terminal leave and passed with flying colors, only to have the FCC demote him to W-PVT? Now you tell one!

WELL, WHAT'RE YA WAITIN' FOR?



Only 2 weeks left to:
GIVE ME A NAME
and **WIN** this
Hammarlund "SUPER-PRO"
FREE!  **FREE!**

NO ENTRY BLANK NEEDED!

YES, we're GIVING it away, this wonderful, new Hammarlund "Super-Pro"; the first Model SP-400-X that comes off Hammarlund's production line!

But hurry, hurry, hurry! Time is growing short. You have only 2 more weeks to win it. And it's so easy. All you have to do is make up a winning name for the little character who appears above.

WHO IS THIS CHARACTER? He's going to appear in all future advertisements of Sun Radio, always bringing you specials, bargains, and the latest gear. His appearance will mean good news for you. Watch for him every month.

PLEASE READ THESE IMPORTANT RULES

- 1. This contest is for licensed operators only. All entries must be accompanied by the contestant's call letters. Entries received without the contestant's call letters will be discarded. We're keeping this a contest for real hams only.
- 2. A contestant may NOT submit more than ONE suggestion. If you have several ideas, choose the best one and send it in.
- 3. The contest is open to all American and foreign hams, except employees of Sun Radio and their families.
- 4. Send entries to Contest Dept. Sun Radio & Electronics Co., Inc., 122-124 Duane Street, New York City 7, N. Y.
- 5. All names will be judged primarily for originality and aptness. The decision of the judges is final.
- 6. In the event of a tie, duplicate prizes will be awarded.
- 7. All entries must be postmarked before midnight, October 15, 1946.
- 8. The winning entry and the winning contestant's name, call, and picture will be published on Sun Radio's page in the December issue of QST.
- 9. All entries become the sole property of Sun Radio & Electronics Co., Inc.

TIME IS GROWING SHORT! The contest closes October 15, so act fast. The only restrictions are that the name you suggest be original and appropriate, and that your call letters be sent with your entry.

AND WHAT A LINE-UP OF JUDGES WE'VE GOTTEN:

- ★ Walter Jablon — Sales Manager, Hammarlund Mfg. Co.
- ★ Win Allen — New York Sales Representative, RCA
- ★ Glenn H. Browning — Pres., Browning Laboratories, Inc.
- ★ Leon Adelman — Sales Mgr., Eastern Amplifier Corp.
- ★ Larry LeKashman — Managing Editor, C Q Magazine

Remember, your call letters **MUST** be sent in with your entry. This contest is being run exclusively for licensed operators.

SUN RADIO

& ELECTRONICS CO., Inc.

ESTABLISHED 1922

122-124 DUANE ST. · NEW YORK 7, N. Y. · BArdclay 7-1840

HAM SPECIALS

From Ham Headquarters

Order	Net Price
Panoramic Adapter	\$99.75 Each
Cabinet: 24 1/2" Wide, 29 1/2" Deep, 72" High, Gray Crackle Finish, Ideal for Transmitter	90.00 Each
Choke: 300 MA Swing 9-19 Henry, Smooth 9-henry	7.50 Pair
Choke: 2 1/2 MA R.F.	.19 Each
Code Oscillator: Complete with Speaker, Telegraph Operated, MS-700	9.95 Each
Coil Assembly: R.F. from Army Receiver BC-224M	.75 Each
Condenser: 1x.1x.1 Mfd. 600-Volt Tobe Metal Case, Bathtub	.49 Each
Condenser: .5 and .2 Mfd. 600-Volt Bathtub	.19 Each
Condenser: 2 Mfd. 600-Volt Solar DC Aluminum Can, Oil Filled	.89 Each
Condenser: 100 MMF. Midget Variable	.50 Each
Condenser: 2 Mfd. 1000-Volt, Oil Filled, Round Can, C.D.	1.50 Each
Condenser: 10 Mfd. 1400-Volt, Oil Filled, Rectangular Type	6.75 Each
Condenser: 10 Mfd. 1000-Volt, Oil Filled, Rectangular Type	6.75 Each
Condenser: 3 Mfd. 2000-Volt, Oil Filled, Rectangular Type	3.25 Each
Condenser: 35 MMF.	.35 Each
Condenser: 8 Mfd. 600-Volt C.D. Oil Filled	2.75 Each
Condenser: .001 Mfd. 5000-Volt Mica	2.40 Each
Condenser: 6 Mfd. 600-Volt Oil Filled	.75 Each
Condenser: 3x3 Mfd. 600-Volt Oil Filled, Rectangular Type	.99 Each

Order	Net Price
Condenser: 4 Mfd. 600-Volt C.D. Aluminum Can, Oil Filled	\$1.50 Each
Converter: Gonssett New 10-11 Meter, Ideal for above BC-348Q	39.95 Each
Crystals: IN24	.50 Each
Handy Talkie: Complete with Batteries, 3885 K.C. Frequency	49.50 Each
Chassis: for Handy Talkie	10.00 Each
Insulator: 3" Feed Through	1.00 Each
Meter: Westinghouse 2" D.C. MA 0-10-25-50-100-150-200-250-300-400-500	3.50 Each
Meter: Burlington, 2" A.C. 0-150 2" Round	2.25 Each
Meter: Time Hour 110-Volt 60-Cycle	3.50 Each
MANY OTHER METERS UPON REQUEST	
Mike: Breast Mike	\$1.95 Each
Mike: T17B Carbon Hand Mike	2.50 Each
Plug: P1-55 Army Type Plug, (100-Lots \$1.25 Each)	.35 Each
Receiver: BC-348Q Frequency 200 to 500 KC. — 1500 KC. — 20 MC.	60.00 Each
Relay: D.P.D.T. 6-Volt D.C. Coil, Each 1/4" Silver Contact	1.75 Each

MAIL ORDERS PROMPTLY FILLED

Amateurs to Serve You

(20% Must Accompany All C. O. D. Orders)

Write to Dept. Q5T

W65CQ • W6UXN • W6NAT • W6VHZ • W6VIW

Radio Products Sales Company

238 WEST 15TH STREET

LOS ANGELES 15, CALIFORNIA

PRospect 7471

NEW!

35-WATT SINGLE DIAL TUNED BAND SWITCHING EXCITER UNIT

ECO-1 Exciter Unit, 35 watts, output R.F. on 10, 15, 20, 40, and 80. Gang tuned, Band switching, Single dial control. Type 807 power output tube is straight R.F. amplifier on all bands. Oscillator keying for break-in operation. Stabilized oscillator circuit, clean chirpless keying. Regulated power supplies. Phone-CW switch. Remote control connections. Tubes (3) 6AG7 (1) 807, (2) 816, (1) 5T4, (1) VR150, (1) VR105.

Price \$160.00 for rack mounting
Table mounting cabinet \$7.50 extra

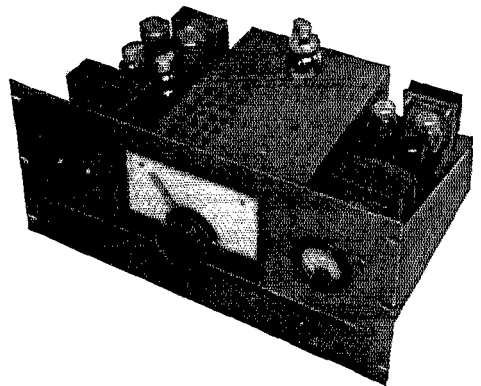

DESIGNED BY HAMS—FOR HAMS

BY THE MANUFACTURING DIVISION OF

THE HAM CENTER

HERBACH & RADEMAN, DEPT. Q-1
522 MARKET ST. PHILA. 6, PA.



R. C. (Dick) Hall
W5EIB

R. C. & L. F. HALL, INC.

"THE HAM SHACK"

FOUR GREAT STORES TO SERVE YOUR EVERY NEED

HOUSTON: 1306 Clay Avenue. Tel. C-9731
BEAUMONT: 961 Pearl St. Tel. 4740
DALLAS: 2123 Cedar Springs Ave. Tel. C-6632
GALVESTON: 1803 Tremont St. Tel. 2-4807

We now have four stores for you: convenience. Drop in to see us. Of the new Hallicrafter receivers listed, only the S-38, S-40, SX-42 will be available this year and in limited quantities. Hammarlund and RME are shipping on fairly regular schedules and we expect further shipments from National soon.



L. F. (Lillian) Hall
W5EUG

SEND MAIL ORDERS TO HOUSTON

RECEIVERS

HALLICRAFTERS

SX-42 — 540 KC to 110 MC. Approx.	\$250.00
SX-43 — 540 KC to 108 MC. Approx.	* 150.00
SX-46 — 540 KC to 43 MC. Approx.	* 115.00
S-47 — AM/FM (535 KC to 108 MC)	135.00
S-38	39.50
S-40	79.50
HT-9 Transmitter (1500 KC to 28 MC)	250.00
S-37 FM/AM/CW (130 MC to 210 MC)	591.75
S-36-A — FM/AM/CW (27.8 to 143 MC)	307.50

* Speakers not included (\$15.00 Up)

HAMMARLUND

HQ-129-X with speaker	\$173.25
Super Pro — SP-400-X with speaker	342.00

MECK TRANSMITTER

Model T-60-1, Efficient performance on any Amateur Band. 10 to 80 Meters. Phone or CW. 60 watts. \$150.00

Wire, write or phone your order. We will ship C.O.D. with a \$5.00 deposit. We also offer easy terms and trade-in allowances for used equipment. State Tax not included in above figures.

NATIONAL

NC-2-40-C — (Speaker, \$10.44 extra)	\$225.00
HRO-5TA-1 — (1700 KC to 30 MC)	247.00
Speaker, \$10.95; Power Supply	17.70
HRO-5RA-1 — (Rack Model)	274.35
Speaker, \$19.80; Power Supply	33.00
NC-46 — (Speaker, \$9.90)	97.50
1-10-A — (Power Supply \$19.50)	56.10

RME

RME-45 with crystal, meter and speaker	\$186.00
RME-84	98.70
DB-20 Preselector	68.20
VHF-152 (2, 6, and 10 Meter Converter)	86.60

McELROY TRANSMITTER EXCITER KIT UNIT

McElroy Model Fu-40, ECO/crystal exciter unit or 50-watt transmitter unit. Complete with foundation kit and three tuning units. \$27.25

TEST EQUIPMENT IN STOCK

Monitor Crystalline, Signal Generator	\$57.50
Silver Vomag, V.T.M. and V.O.M.	59.85
Silver Model 904, Cap.-Res. Bridge	49.90
Silver Model 905, SPARX, Signal Tracer	39.90
Silver Model 906, FM/AM, Signal Generator	89.90

The complete Silver catalogue is now ready. Showing radically new receivers, transmitters and components

Ask for other brands and models since Test Equipment is arriving in larger shipments

RCA — MICROPHONES

RCA Ribbon Mikes — Junior Velocity — Type 74-B	\$24.00
RCA Aero Dynamic Mike — 100-8,000 cycles ..	14.40

NEW CATALOGUE SOON TO BE OFF PRESS

Our complete catalogue for 1946 will soon be off the press. A postcard to Dept. Q will reserve your copy today.

"ACROSS THE OPERATING TABLE"

Our latest amateur bulletin is now at the press and a postal card to Dept. Q will place you on the mailing list.

A FEW OF THE MANUFACTURERS WHOSE PRODUCTS WE DISTRIBUTE

Aerovox	Claroostat	GE	Kaar	Meissner	Pioneer	Setchell-Carlson	Trimm
Amphenol	Drake	Hallicrafters	Kainer	Millen	Precision	Silver	Triplet
Astatic	Dumont	Hammarlund	Kelnor	Mueller	Premax	Simpson	Turner
B&W	Echophone	Hytron	Kwikheat	National	Radel	Speed-X	Vaco
Belden	Elmac	Instructograph	Leach	Newcomb	Raytheon	Stancor	Vibroplex
Billey	Electronics Lab.	Insuline	Lectrohm	Ohmite	RCA	Supreme	Walsco
Bud	Erie	Jensen	Les Logan	Panoramic	Robson-Burgess	Taylor	Ward
Centralab	Gammatron	JFD	Littelfuse	Peerless	RME	Thermador	Weiler
Cinaudagraph	General Cement	Johnson	John Meck	Petersen	Sangamo	Thordarson	Weston

RECEIVERS

HALLICRAFTERS

SX-42 — 540 KC to 110 MC. Approx.	\$250.00
SX-43 — 540 KC to 108 MC. Approx.	* 150.00
SX-46 — 540 KC to 43 MC. Approx.	* 115.00
S-47 — AM/FM (535 KC to 108 MC)	135.00
S-38	39.50
S-40	79.50
HT-9 Transmitter (1500 KC to 28 MC)	250.00
S-37 FM/AM/CW (130 MC to 210 MC)	591.75
S-36-A — FM/AM/CW (27.8 to 143 MC)	307.50

* Speakers not included (\$15.00 Up)

HAMMARLUND

HQ-129-X with speaker	\$173.25
Super Pro — SP-400-X with speaker	342.00

MECK TRANSMITTER

Model T-60-1, Efficient performance on any Amateur Band. 10 to 80 Meters. Phone or CW. 60 watts. \$150.00

Wire, write or phone your order. We will ship C.O.D. with a \$5.00 deposit. We also offer easy terms and trade-in allowances for used equipment. State Tax not included in above figures.

NATIONAL

NC-2-40-C — (Speaker, \$10.44 extra)	\$225.00
HRO-5TA-1 — (1700 KC to 30 MC)	247.00
Speaker, \$10.95; Power Supply	17.70
HRO-5RA-1 — (Rack Model)	274.35
Speaker, \$19.80; Power Supply	33.00
NC-46 — (Speaker, \$9.90)	97.50
1-10-A — (Power Supply \$19.50)	56.10

RME

RME-45 with crystal, meter and speaker	\$186.00
RME-84	98.70
DB-20 Preselector	68.20
VHF-152 (2, 6, and 10 Meter Converter)	86.60

McELROY TRANSMITTER EXCITER KIT UNIT

McElroy Model Fu-40, ECO/crystal exciter unit or 50-watt transmitter unit. Complete with foundation kit and three tuning units. \$27.25

PUBLICATIONS IN STOCK

Radio Amateur Handbook — 1946 Edition	\$1.00
Radio Amateur Call Book — Latest Edition	1.50
The Radio Handbook — 10th Edition	2.00
Fundamentals of Radio — Compilation	5.00
How to Become a Radio Amateur25
License Manual — Postwar Edition25
Log Books35
Learning the Radiotelegraph Code25
ARRL Antenna Handbook50

(Add \$.10 for postage)

CRYSTALS

BLILEY

80 and 40 Meter	\$2.80
-----------------------	--------

PETERSEN

80 and 40 Meter	\$2.65
20 Meter	3.50
10 Meter	5.00

WORKSHOP ASSOCIATES ANTENNAS

2 Meter 6 Element Beams	\$19.00
Rotating Accessory Kits	4.25
Antenna Mast Kits	7.25
Extra Four Foot Sections	1.30

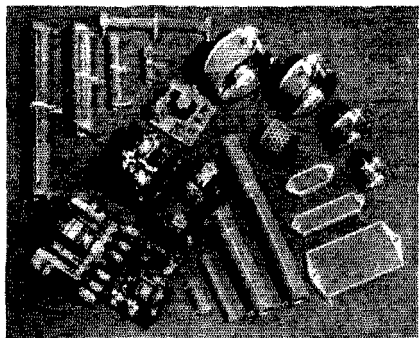

FOR THE AMATEUR

The Ward Leonard Line of dependable Resistors, Relays and Rheostats are more popular with the amateur than ever before. Get the latest information on new and improved types. Send for the bulletins recently printed.

On Resistors and Rheostats see Bulletin D-2
For Relays see Bulletin D-11

WARD LEONARD

RELAYS • RESISTORS • RHEOSTATS

Electric Control Devices Since 1892

WARD LEONARD ELECTRIC COMPANY

Radio and Electronic Distributor Division

53B WEST JACKSON BLVD. CHICAGO, ILLINOIS

RADIO COURSES

- RADIO OPERATING
- RADIO SERVICING
- CODE
- ELECTRONICS

REFRIGERATION SERVICING

Personal Counselling Services for Veterans
Write for Latest Trade & Technical Catalog

Y. M. C. A. TRADE & TECHNICAL SCHOOLS
4 W. 64th Street New York City

SAVE YOUR ARM

WITH
THE GENUINE
EASY-WORKING

VIBROPLEX

Reg. Trade Marks: Vibroplex, Lightning Bug, Bug

"Original" DeLuxe
Model

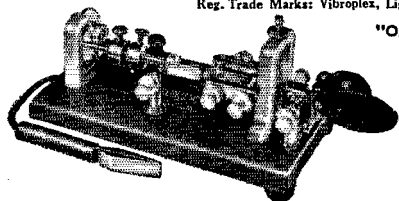

WITH
PATENTED
JEWEL
MOVEMENT

\$19.50

For downright easy sending — there's nothing to equal this "Original" DeLuxe Vibroplex key. Famous the world over for its effortless action, superior signals and ease of operation. The only key equipped with PATENTED JEWEL MOVEMENT. Actually cuts sending effort in half, prevents "glass" arm and develops the highest degree of sending skill attainable. Try this labor-saving key and you will agree with thousands of other operators that it is the finest key you ever used. Polished chromium parts and base. Red switch knob, finger and thumb piece, DIE CUT contacts and main spring. 3/16th contacts. Circuit closer, cord and wedge. Also available in "Blue Racer" and "Lightning Bug" models. Order yours to-day! Money order or registered mail. FREE catalog.



The "BUG" Trade Mark identifies the Genuine Vibroplex. Accept No Substitute

THE VIBROPLEX CO., Inc.

833 Broadway

New York 3, N. Y.

Navy Day Receiving Competition

To Be Held on October 27th

A MESSAGE to radio amateurs from the Secretary of the Navy will be transmitted on Navy Day, October 27th. In connection with this message ARRL will conduct its eighteenth Navy Day Receiving Competition. All amateurs are invited to take part in this activity, which constitutes amateur radio's participation in the celebration of Navy Day.

Two messages will be transmitted, one from Radio Washington (NSS), the other from Radio San Francisco (NPG). These messages will be substantially the same in thought but will vary slightly in wording. A letter of appreciation from the Navy Department will be sent to every amateur who makes perfect copy of the text of one message. Should characters for any reason be transmitted with improper spacing such as from tape-punching errors, words containing such characters will not be counted in the grading of papers. Both messages may be copied, but only the best copy should be submitted in the competition. It is not necessary to copy both stations, and no extra credit is given for so doing. However, if both stations should be copied, please mention the fact when submitting your best copy so that the number of operators copying each station may be ascertained. Only the text (including any punctuation therein) of each message will count (not the preamble, break, signs, and the like). Copy what you hear. Do not guess! Credit will of course be deducted for logging anything that was not actually transmitted!

Mail copies for grading to the ARRL Communications Department, West Hartford, Conn. Send your original copies — recopying invites errors. An Honor Roll of letter winners and all other participants will appear in QST. In submitting copy please mention if you are, or have been, a member of the Naval Service.

Transmissions will be approximately 25 words per minute and will be preceded by a five-minute CQ call on the following schedule: From Washington: NSS, 9:00 P.M. EST (0200 GCT), simultaneously on 122, 4390, 9425 and 12,630 kc. From San Francisco: NPG, 7:30 P.M. PST (0330 GCT), simultaneously on 115, 4390, 9255 and 12,540 kc.

X-Trol

Multi-Switch
 for Quick Change of Frequency
 in any Transmitter . . . Facilitates
 Operation in any one of
 Four Channels.

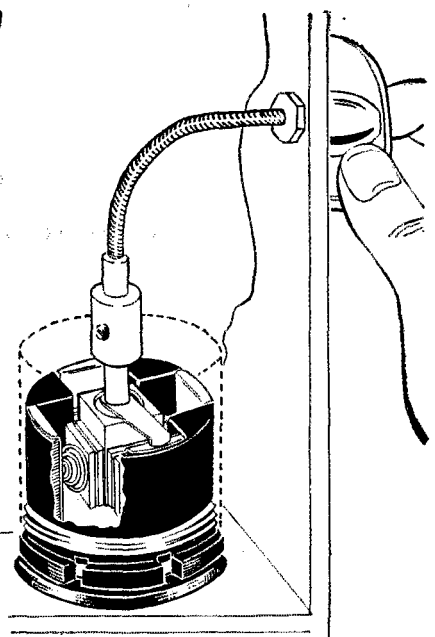

Flexible Cable for neat chassis mounting available on request at additional charge.

X-Thermotrol

Keeps Frequency Stable under all Temperature Conditions

Constant temperature maintains exact tolerances resulting in stabilized frequencies

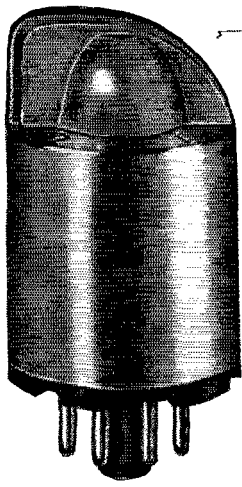
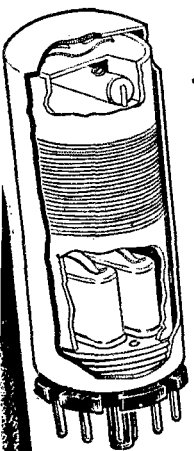

If you are operating on a channel that becomes crowded, a turn of the knob will put you on a new channel.

Ideal for Amateurs who are constantly rebuilding sets to operate on various popular frequencies.

XT-4 X-TROL CONTROL SWITCH houses 4 standard 5x5 crystals with frequency range from 3000 kc. to 9000 kc. Low capacity, close frequency tolerance.

Bakelite, ceramic and metal construction with coin silver positive contacts. Complete with electrodes and springs for mounting crystals in unit. Mounting area, 1 1/4 in. Ht., above chassis, 2 3/8 in. Over-all ht., 2 3/8 in. Easily installed in any oscillator circuit. Unit mounts in front or behind panel. Fits any standard octal socket.

Contact us or your distributor for immediate delivery. Postpaid from factory.
 List price less crystals..... **\$9.95**

XT-100 Small, compact unit. O.D., 1.3". Ht., over chassis, 2 3/4". Holds two 4 m.c. to 9 m.c. crystals. Operates on AC or DC . . . 6, 3, 12, 24 and 32 volts at 12 watts. Cavity temperature adjustable. Almost all aluminum. Octal base plug-in permits quick change. Complete with pressure mount holders less crystals.

XT-200 Same size and operating voltage as the XT-100 but houses one FT-243 crystal holder . . . complete with holder, less crystals. Has dual thermostat, dual heaters.
 Both numbers at your dealers . . . or postpaid from our factory.
 list price
 less crystals

\$19.95

FOR ADDITIONAL INFORMATION WRITE

GASKET ENGINEERING COMPANY, INC.

Manufacturers of Crystal Holders for the Radio Industry

2440 CHARLOTTE

KANSAS CITY 8, MO.



World's Largest DISTRIBUTOR OF SHORT WAVE RECEIVERS

Do business with the biggest and one of the best in the field. Enter your orders for the following:

Hallicrafters 538 complete.....	\$39.50
Hallicrafters 540 complete.....	79.50
Hallicrafters 536A.....	307.50
Hammarlund HQ-129X complete.....	173.25
SP-400-SX Super Pro complete.....	318.00
SP-400-X Super Pro complete.....	342.00
National NC-46 complete.....	107.40
HRO Sr. noise silencer, 4 bandspread coils.....	274.35
National NC-2-40D complete.....	240.00
National 1-10A.....	56.10
RME-45 complete.....	186.00
RME-84 complete.....	98.70
Pierson KP-81 complete.....	318.00
BC-348Q 110 V AC model NEW.....	85.00
SCR-211 NEW.....	86.50
Temco 75GA transmitter.....	495.00
Panoramic PCA-2 panadaptors.....	99.75

Prices subject to change.

Other receivers, transmitters, etc.; as available

Delivery of receivers is much better. Many models I can ship at once from stock. By dealing with the world's largest distributor of short wave receivers you are assured of the fastest delivery and the best service.

Send your orders now. Trade-ins solicited. You can buy on my 6% terms. I have a large stock of test equipment, amateur transmitters and parts, government surplus bargains, etc. Write for lists. Let me know your needs. I will try to give you better service and help. Your inquiries and orders invited. Write, phone, wire or visit either of my stores.

Bob Henry

W0ARA

BUTLER, MISSOURI

HENRY RADIO SHOPS

LOS ANGELES 25, CALIF.

"WORLD'S LARGEST DISTRIBUTOR OF SHORT WAVE RECEIVERS"

The New GON-SET CONVERTER

For Fixed—Mobile Use. Built In Pre-Selection

NOW AVAILABLE FOR EITHER 20, 10-11 OR 6 METERS

IMMEDIATE
DELIVERY

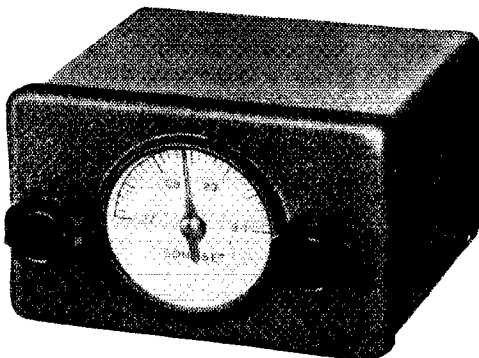

- ★ Tubes: 6AK5, R.F.—6AK5 mixer—6C4 OSC. OB2 Voltage Regulator
- ★ Complete Bandspread
- ★ Output: 1500-2000 KC.
- ★ 8-1 Vernier

- ★ Illuminated Dial
- ★ Weight: 2 lbs.
- ★ Size: 3½" x 5½" x 5½"
- ★ Single Dial Control
- ★ On-Off Switch Provided

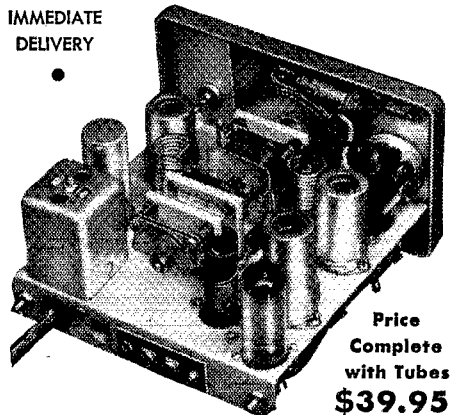

Price
Complete
with Tubes
\$39.95

Special Noise Silencer.....\$8.25
HIGH FREQUENCY Antenna lead cable \$0.08 per foot
W6VR • O.P.A. APPROVED

SEE YOUR JOBBER

WATERPROOF ELECTRIC CO.
70 East Verdugo Ave., Burbank, Calif.

SUN RADIO — The Home Of Nationally Known Radio Parts

WAR SURPLUS EQUIPMENT--

At A Fraction of Their Original Government Cost!

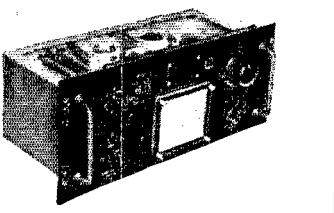

TUNING UNIT. This brand new tuning unit for MOPA use designed and manufactured for the United States meets to their rigid specifications is offered at a fraction of its original cost, 19 tubes. **\$4.95**
 TU6B, 3000 to 4500 KC, 60 Watts
 TU7B, 4500 to 6200 KC, 75 Watts
 TU8B, 6200 to 7700 KC, 75 Watts
Please Specify Model

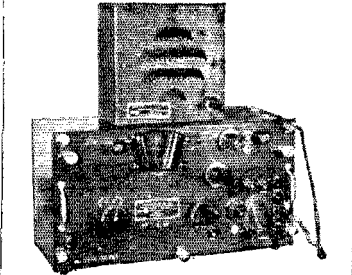

LOW FREQUENCY RECEIVER, BC-344
 Operates on 110 volts A.C. complete with 10 tubes, including rectifier, 6" P.M. speaker encased in black metal baffle — tunes 150 to 1500 KC. A "hot" low frequency receiver at the lowest price ever offered. **\$85.60**

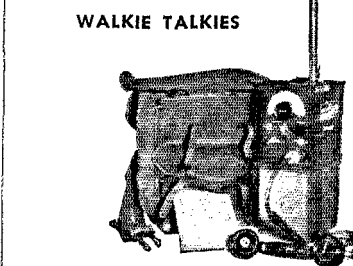

WALKIE TALKIES
 SCR195 Walkie Talkies, brand new, weight 27 1/2 pounds including knapsack. Range up to 25 miles in open country. Frequency 52.8 to 65.8 MC. Transmitter and receiver with regular hand set. Now ready to operate.
\$69.95 each — \$129.90 set

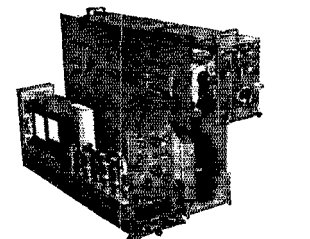

WAVEMETER
Interconnection Unit BC-1073A
 High quality resonant cavity wavemeter, oscillator, heterodyne amplifier, electric tuning eye, complete with nineteen tubes. 90-volt A.C. power supply. 150 to 210 megacycles. Original cost \$550.00, your cost. **\$24.95**

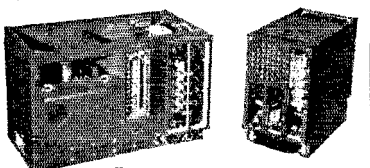

F. M. TRANSMITTER and RECEIVER BC-683 and BC-684
 Complete with 9 tubes, 10 push buttons, squelch circuit. The BC-684 Transmitter provides 35-watt output, 10 channel push button crystal control. Complete with 8 tubes. Tune from 27 to 38.9 mc. Complete with tubes less power supplies and crystals.
 Separate Units, each. **\$39.95**
 Both. **\$69.95**

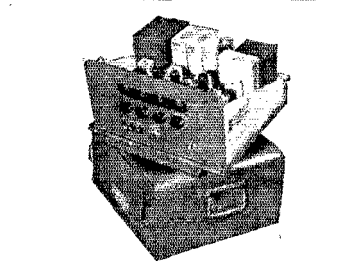

RADAR RECEIVER BC-1068A
 174 to 210 mc television band. Covers individually slug tuned antenna, R.F., Detector and Oscillator circuits; contains 2 R.F. and 5 I.F. stages. Complete with 110 volt AC power supply and tubes. . . **\$39.95**

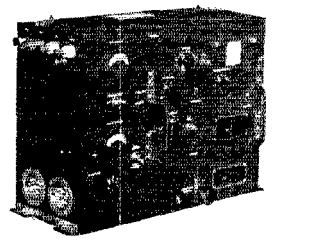

Army Released TRANSMITTER—New with Tubes
 BC223 Transmitter tunes 2000 to 4000 K.C. easily changed to 80 meters. 25 watts C.W. 17 watts phone. New with tubes less crystals and power supply. Each. . . . **\$37.50**

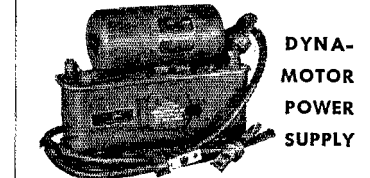

DYNAMOTOR POWER SUPPLY
 Brand new. U. S. Army PE-103 operates from 6- or 12-volt battery, will deliver 500 volts D.C. at 160 ma. Your cost. **\$29.95**



OHM METER
 Weston No. 689. Scale 0-10 ohm and 0-1000 ohm scaled to read 1/20 of an ohm with ease. This 2 1/4" round meter is housed in a black bakelite case 1 3/4" x 2 1/4" x 5". Complete with heavy duty felt-lined leather case and lock. SPECIAL. **\$14.95**

All items F. O. B. Washington, D. C. Orders \$30.00 or less cash with order. Above \$30.00, 25% with order balance C. O. D.

SUN RADIO

OF WASHINGTON, D. C.

938 F STREET, N. W. WASH. 4, D. C.

LEARN ▼▼▼▼ WIRELESS and TELEGRAPHY!

A BOOK EVERY AMATEUR
SHOULD HAVE —

Send Now!

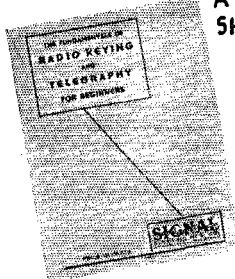

Hundreds of amateurs have
learned from this book,
so can you.

15¢
POSTPAID
COIN, OR
STAMPS

This book gives you the fundamentals of wireless and telegraphy. It contains the codes and how to learn them. Mail your order now to:

SIGNAL ELECTRIC MFG. CO., Menominee, Mich.

ESTABLISHED
1892



IRON CORE TUNERS

For Broadcast Band Superhets. Replace 2-gang condenser and oscillator. One compact tracked unit. Includes hookup diagrams and instructions.

Only \$4 Postpaid

Send for FREE price list of Standard radio coils

MAGNA-METAL PRODUCTS CO.

Room 1048, 70 E. 45 St., New York 17, N. Y.



Founded in 1909

RADIO TELEPHONY RADIO TELEGRAPHY

Courses ranging in length from 7 to 12 months. Dormitory accommodations on campus. Advanced students eligible for practical training at KFAC, 1 KW broadcast station owned and operated by Port Arthur College. New students accepted monthly. If interested in radio training necessary to pass F.C.C. examinations for first-class telephone and second-class telegraph licenses, write for details.

PORT ARTHUR COLLEGE PORT ARTHUR
TEXAS

Approved for G.I. training

Simulated-Emergency Test

October 12th or 13th

The Community Plan. A community plan for the amateur radio service is the responsibility of each ARRL Emergency Coördinator. Many factors enter into EC Plans: Recruitment of and disposition of fixed, portable and mobile stations, establishment of 144 Mc. and lower-frequency links, contact with agencies served, alerting plans, suburban coverage, liaison with other communication services, the number of amateurs and their facilities. All these things ECs must consider. Old plans are under review; new fall plans will count you in if you will help! (ARRL bulletins, December, 1945, *QST*, and a letter of July 3rd to ECs, sets up the ARRL plan for Emergency Corps organization. This provides for community needs, for collaboration with the Red Cross, for liaison with other communications.)

The Test. On or before October first your Emergency Coördinator will have received the plan for this simulated-Emergency Test from ARRL Hq.

Part I: Your Emergency Coördinator can inform you at any time about his General Plan of emergency work . . . how the amateur service will operate, the special needs of your community, the alerting plans, how you can fit in. It is only necessary for you to sign up, tell your EC about your station and what you can do.

Part II: The EC cannot tell you *in advance* when a real emergency will develop. He can tell you whether your test will be on the 12th or 13th of October, and the alerting and general plan can be reviewed. If and when the "emergency" does develop the amateurs who have joined the ARRL Emergency Corps will be advised by the EC and will know what to do. On the 12th or 13th the EC will have Incidents, hour-to-hour developing problems, liked sealed military orders, representing progressive happenings in a real emergency. Some of these may involve changes from his prearranged plans necessary to meet unexpected contingencies. You will have to be in the AEC to be given a part, and to know about Part II.

Hams in Communities and Clubs. If you haven't an Emergency Coördinator, get one. Drop a card or letter to the SCM/SEC. Recommend a "provisional" EC who can put your town on the map in this Test, and in radio doings to follow.

All Individual Amateurs. If you haven't an AEC card, get Form 7 from the EC, from the SCM, or from us. It is the blank on which you tell about your gear and join up with AEC. Give this when filled out to the EC (or Section official when no EC has yet been designated). As soon as you are in the Emergency Corps ask for details on the general local preparatory plans so you will be familiar with them and your part.

Emergency Coördinators. If your bulletin files are incomplete advise us what you need. You should now have all needed supplies. If cards, applications or report forms are low, advise ARRL promptly. Should mail go astray: SCMs/SECs will have extra copies of Incidents for the October Test. Don't write or wire Section officials or Hq. for such before October first please. Best of luck in the Simulated Test. We'll be looking for your report.

— F. E. H.



TERMINAL

IS *HAMDOM'S* FAVORITE
SHOPPING CENTER!

Radio amateurs for miles around New York City find **TERMINAL** a gold mine for choice values and many hard-to-get items! Plenty of salesmen

with ham know-how to wait on you! You'll like **TERMINAL'S**

hamfest atmosphere and super-service, friendly both to you and your pocketbook! Drop in and meet the gang!

COMMUNICATIONS MICROPHONES—Now Available!



Astatic D-104 — Preferred by phone operators for professional quality and appearance. New type Graphoil element. Solid bronze case, bright chrome finish.

NET.... **\$14.46**

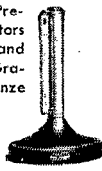

"G" Stand—"Grip-to-Talk", chrome, NET **\$ 6.45**

GD-104—D-104 and G stand, SPECIAL... **17.70**

ELECTRO-VOICE "COMET" CRYSTAL MICROPHONE AND STAND

You'll like its smooth, wide-range response, its unbreakable plastic construction in deep lustrous gray, AND—you'll like its low price, only.....



\$7.79

RECEIVERS!

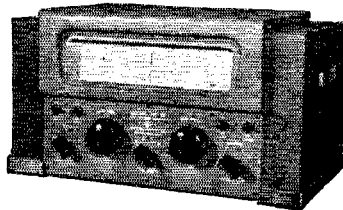

NATIONAL

- HRO—5TA1, complete..... **\$303.00**
- NC-240D—with speaker..... **241.44**
- NC-46—with speaker..... **107.40**
- 1—10A, complete, with national selected tubes, less speaker and power supply. **\$67.50**
- 1—10 power supply No. 5886.. **19.10**

HALLICRAFTERS

- S-38, complete..... **\$39.50**
- S-40, complete..... **79.50**
- SX-42, with speaker..... **265.00**

RME

- RME-45, complete..... **\$186.00**
- RME-84, complete..... **98.70**

HAMMARLUND

- HQ-129-X, complete..... **\$173.25**
 - SP-400-X, complete..... **342.00**
- Prices subject to change

MECK TRANSMITTER

Complete 60 watt rig, phone or CW. Efficient operation on 10, 20, 40 and 80 meter bands. Complete with tubes, self-contained power supply and one set of coils. NET..... **\$150.00**

MILLEN EXCITER

50 watt transmitter or exciter for high power PA stages. Model 90800, less tubes..... **\$37.50**

U.T.C. HIGH VOLTAGE TRANSFORMERS

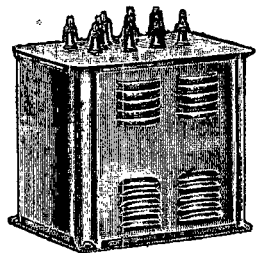

No.	DC Volts	Current	Net
S-44	470/430	500 Ma DC	\$11.80
S-45	750/620	200 Ma DC	9.25
S-46	825/600	300 Ma DC	11.40
S-74	1000/400	200 Ma DC	12.55
S-47	1275/1050/825	300 Ma DC	14.85
S-48	1300/1075/850	500 Ma DC	21.30
S-49	1815/1540/1275	300 Ma DC	20.55
S-50	2625/2175	300 Ma DC	28.55

U.T.C. CASED FILTER CHOKES

No.	Henries	Current	Net
S-31	20	225 Ma	\$4.00
S-32	5/25	225 Ma	4.00
S-33	20	300 Ma	5.70
S-34	5/25	300 Ma	5.70

No.	Henries	Current	Net	No.	Henries	Current	Net
S-35	20	400 Ma	\$8.35	S-37	20	550 Ma	\$11.40
S-36	5/25	400 Ma	8.35	S-38	5/25	550 Ma	11.40

BRENTWOOD 14-WATT AMPLIFIER

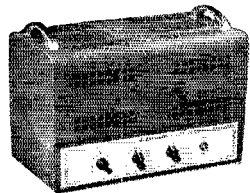

MODEL K-14—Besides its many P.A. applications, the Brentwood K-14 is ideal for use as a low power modulator or speech amplifier driving higher power.

POWER OUTPUT: 14 watts normal.

GAIN: Microphone input 110 db.; phono input 70 db.

INPUTS: 1—Microphone, 1—Phono (both high impedance). Separate gain controls for mixing and fading.

TONE CONTROL: Full range bass and treble compensator.

TUBES: 1—7C7, 1—7F7, 2—7C5's and 1—5Y4G.

SIZE: 13" x 8½" x 8½". Net wt. 15 lbs.

YOUR COST COMPLETE **\$33.80**

IF UNABLE TO VISIT OUR STORE, SEND US YOUR MAIL ORDERS WITH 25% DEPOSIT. PRICES ARE F.O.B., NEW YORK

TERMINAL RADIO CORP.

85 CORTLANDT STREET, NEW YORK 7, N. Y.

PHONE WORTH 2-4415

LINE SPACER

- LOW LOSS
- EASILY ATTACHED
- NOISELESS

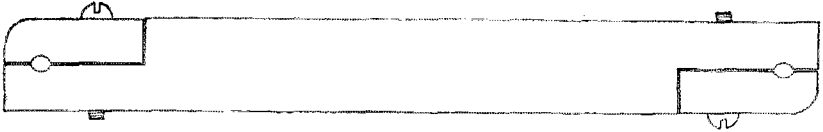

PATENT APPLIED FOR

Type LX-2 (2 in.)	.35 list	.21 net
Type LX-4 (4 in.)	.45 list	.27 net
Type LX-6 (6 in.)	.60 list	.36 net

Amateur's net price at your jobber — or direct if he does not stock them

- **LOW LOSS.** Fabricated from Amphenol 912-B (a crystal clear, hard, tough acrylic thermoplastic, light in weight, strong and durable) possessing excellent electrical characteristics at high frequencies — low power factor — low loss factor.
- **LOW MOISTURE ABSORPTION.** Possesses excellent water and weather resistance. Will not discolor from sunlight or outdoor exposure.

● **EASILY ATTACHED.** A feature of the Type LX Line Spacer is that it is easily attached to line without threading wires through holes.

● **NOISELESS.** There is no metal contact between line wire and spacer to cause noise or changes in line characteristic. The use of tie-wires or set screws in direct contact with line wires is a contributing cause of unsuspected high noise level.

SEE THEM AT YOUR DISTRIBUTORS!

FREE — Ask your jobber or write for pamphlet "How To Feed You Antenna Directly with a 500-Ohm Line" by A. L. Munzig W6BV.

MR. JOBBER: if you do not stock this fast moving item write or wire for samples and discounts.

The **ARTHUR L. MUNZIG MANUFACTURING CO., Redlands, California**

Factory: Laurelwood and Tippecanoe Ave., Loma Linda, California

Munzig COMMUNICATIONS EQUIPMENT

DEPENDABILITY PLUS

Professional in appearance — professional in performance, the Turner Model 99 Dynamic Microphone is always ready to pick up your message and deliver crisp and clear. Engineered for the discriminating user who wants utmost in dependability and performance, its smooth response is not affected by changes in climate, temperature or humidity. Built-in features minimize feedback, eliminate blasting. Adjustable saddle permits semi- or non-directional operation. Gunmetal finish case fits any standard stand.

RESPONSE: Flat within ± 5 DB from 40-9000 cycles.

LEVEL: -52DB at high impedance.

Available in all standard impedances. Complete with 20 ft. removable cable set.

Ask your dealer or write

The **TURNER Model 99 DYNAMIC MICROPHONE**

Licensed under U. S. Patents of the American Telephone and Telegraph Company, and Western Electric Company, Incorporated.

Complete Microphone Catalog Write for Your Free Copy

TURNER

Pioneers in the communications field

Microphones

Crystals licensed under patents of the Brush Development Co.

THE TURNER COMPANY
917 17th Street N.E.
CEDAR RAPIDS, IOWA

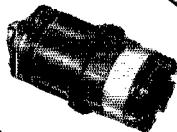

SELSYN MOTORS

Can be used very successfully for rotary beam to note the position of same remotely. Originally designed for 115 volt 400 cycle as a motor. Works perfectly on 10 volt 60 cycle as transmitter and indicator. **\$6.95 pair**



METERS

0-4 Amps. R. F. 2" Thermocouple round bakelite case **\$3.95**
0-200 Microamp DC 2" round bakelite case **\$3.95**
Output meter 10-0-20 D.B., 1.9 volts at zero level, 6 millivolts 600 ohm line, 2" round bakelite case **\$3.95**

GE VIBRATOR

Vibrator 2 volt for use with General Electric portable receivers or other portable equipment **\$1.95**

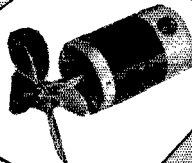
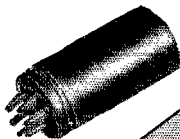

BENDIX AC-DC MOTOR

Small universal AC-DC motor No. E11-500-1 designed for 28 v. DC operation. Performs beautifully on A.C. 10 to 24 volts. Brush type. Fine for cooling tubes and transmitter when used with 3" fan. Fan .10. Motor **\$2.95**

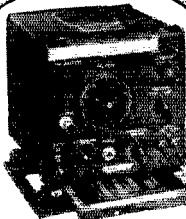

CRYSTAL CALIBRATED FREQUENCY METER MONITOR

Type LM-14—400 cycle Mod. switch. Adjusts any equipment in the 125 Kc-20 Mc range.
Accuracy: .01% at 2 Mc to 20 Mc
.02% at 125 Kc to 2 Mc
14 Mc Harmonic used for 28 Mc checking. Power requirements—260 to 475 volts DC. Complete with operating manual, cord and plug. **\$59.50**

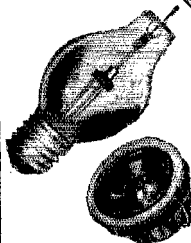

CHARGER BULBS

GE #189048—6 amp charger bulb. **\$1.95**

DYNAMIC MIKE UNIT

Small, compact high-quality mike. Flat from approx. 40 to 13,000 cycles. Lends itself nicely to replacement unit for that burned-out mike. **\$1.95**

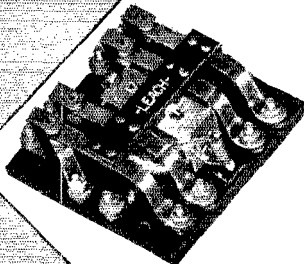

LEACH AC RELAY

Type 2128-G, 4 pole double throw. 110 volt AC 50-60 cycle 1/4" contacts. Perfect for multi circuit switching. Large size and spacing permits antenna switch-over use. **\$2.95**



HEAD SET

Type P23—4000 ohm, long 5-Ft. cord and PL-55 plug, no extension necessary. Rubber ear cushion and leather-covered band. **\$2.50**

*The West's Largest
Radio Parts Distributor
Established 1932*

RADIO SPECIALTIES COMPANY

1956 So. Figueroa Street—Los Angeles 7, Calif.

Please ship..... Cash \$.....C.O.D.

- | | | |
|---|---|--|
| <input type="checkbox"/> Leach AC Relay | <input type="checkbox"/> Crystal Calibrated | <input type="checkbox"/> Charger bulbs |
| <input type="checkbox"/> Headset | <input type="checkbox"/> F.M. Monitor | <input type="checkbox"/> Selsyn Motors |
| <input type="checkbox"/> Bendix AC-DC Motor | <input type="checkbox"/> GE Vibrator | <input type="checkbox"/> Dynamic Mike Unit |
| <input type="checkbox"/> Meter 0-4 | <input type="checkbox"/> Meter 0-200 | <input type="checkbox"/> Meter Output. |

Name.....

Address.....

City.....Zone.....State.....

RADIO SPECIALTIES COMPANY
1956 SOUTH FIGUEROA STREET • LOS ANGELES 7, CALIF.

NOW IN STOCK!

The New 10-11 meter GON-SET Converter—for fixed or mobile use. Fits into the glove compartment of most cars. Uses: 6AK5—RF. 6AK5—mixer 6C4—Osc. OB2 regulator. Complete band spread 27-30 mc. Output 1500-2000 kc. Ideal for putting that Surplus Rec'ver on 10 meters.

Complete price.....\$39.95 Net
fob. Oakland, Calif.

★ ★ ★

Hytron HY-Q 75 VHF XMITTER KIT. Complete less tube.....\$9.95 Net

HY-75 tube for above.....\$3.95 Net

★ ★ ★

SYLVANIA 1N35 matched dual Germanium Crystals.....\$4.00 Net

★ ★ ★

MAIL ORDERS GIVEN PROMPT ATTENTION ON ALL HAM GEAR

W. D. BRILL CO.
198 TENTH ST. OAKLAND 7, CALIFORNIA
WGKLO W6SSN W6FJK

DYNAMOTORS

To Power Your Mobile Rig!

Get lightweight, efficient, dependable rotary power for your mobile rig. Choose from a wide range of Carter Dynamotors, Magmotors, DC to AC Converters and Generators to meet every receiving and transmitting need. Used by leading State and City Police networks. Write for Free Bulletin.

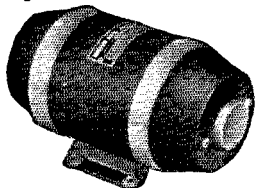

Carter Motor Co. (A Well Known Name in Radio for Over 20 Years)
2648 N. Maplewood Ave. • Chicago 47, Illinois

CODE SENDING SPEED RECEIVING SPEED

Have Skill, Accuracy

Be a "key" man. Learn how to send and receive messages in code by telegraph and radio. Commerce needs thousands of men. Expansion of air commerce and freight after war should create an even bigger peacetime demand for operators. The famous Candler System, maker of world's champions, teaches you the "knack" of sound sense and sound consciousness that is the secret of speedy sending and receiving. Good pay, adventure. Learn at home quickly.

FREE 52-PAGE BOOK explains extra course name for it today. It's absolutely free.

CANDLER SYSTEM CO.

Dept. 4-L, P. O. Box 928, Denver 1, Colo., U. S. A. and at 121 Kingsway, London, W.C. 2, England

(Continued from page 55)

festivals and other places where amateurs gather in large numbers. Since I never met any such persons, I finally concluded they were just guys who liked to be "agin" anything. Let the majority of the population favor fresh air and these folks will oppose the movement on the grounds that air contains oxygen and that oxygen is a stimulant — or maybe they'll just be "agin" it on general principles. By degrees, then, I began to think the whole thing was a myth, and that there really could be no such thing as a ham who was against the League.

But I have learned lately where to find these "aginers" — the whole twelve of them! I learned how they spend their operating time, their frequencies, and their favorite pastime. They will be found on, or very close to, 3555, 7145, 14,280, 29,150 and 52,000 kc. — the frequencies used by W1AW for the ARRL Code Proficiency Program. They begin transmitting daily, Monday to Friday, at the moment W1AW begins the code practice — and they continue throughout the hour, switching to 999.9 watts during the 35 w.p.m. period. During the remaining 23 hours and on week-ends, they probably get together and exchange notes on how well they QRMed the other 60,000 lowly hams who were diligently trying to "make 15" or some higher speed.

These "aginers" are probably gainfully employed during the daytime. I can imagine what they work at: probably in a laundry, distributing pins in the shirts; or as carpenter's helpers, putting squeaks in doors and windows; or perhaps stripping threads on screws; or reading commercials in the middle of radio mystery serials. . . .

— E. J. McNiel, W9SEI

QRP

401 Dryades St., New Orleans 13, La.

Editor, QST:

In a recent issue, the fact was stressed that during a 'phone QSO, one station reduced power in steps until only a few watts input remained, the contact being maintained 100 per cent.

Ho, hum — you must know the final plate switch can be turned off and the QSO maintained; tho the quality will be somewhat impaired and it isn't particularly good for the modulator. But I'm fed up on hearing some gent with a half kw. say he's reducing power . . . "now down to three watts" . . . etc. What about that 250 watts of speech?

— Robert B. Stiener, W51VO

MASS-PRODUCTION CONTACTS

716 N. 3rd Ave., St. Charles, Ill.

Editor, QST:

I heard a test by TGD —, and think it a bum idea. He stood by and had stations call him while he tuned the band to log calling stations. He then read the list of calls, with reports. He got no acknowledgment from them.

Such a procedure clutters up the band and prevents legitimate communication between stations actually working two-way. If it became widespread, the ham bands would certainly be pretty awful. . . .

— M. A. Lavery, W9EJX

Ham Post!

George E. Burghard W-2GEC and Joseph I. Stantley EX-W2SC in business since 1919 invite you to visit their HAM DEPT. with Payne W2LP and Andy W2BPK. Write Dept. 2.



CONTINENTAL SALES COMPANY

195-197 CENTRAL AVENUE, NEWARK 4, N. J.

SILVER

Announces -

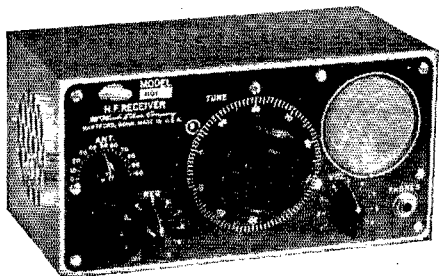

MODEL 800 RECEIVER

MODEL 800 144-148 and 235-240 mcs. U.H.F. receiver. Edward P. Tilton's Feb. 1946 QST design modified by Byron Goodman's inductive r.f. tuning, built-in PM speaker, 88" band-spread, all in new "ATOM-X" construction. Factory built or kit for easy home construction, compact.

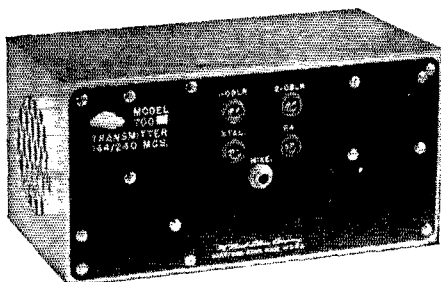

MODEL 700 TRANSMITTER

MODEL 700 xtal controlled transmitter. 144-148 and 235-240 mcs. 6AQ5 Tritet drives 6C4 doubler, 6C4 doubler/tripler, 832 long-line push-pull final. Built-in 14 watt 6AQ5 push-pull voice modulator. New "ATOM-X" construction, size only 5" x 10" x 5 1/4". Matches MODEL 800. Makes serious home-station or mobile rig. Factory built or kit.

HI-Q AIR CAPACITORS

Of unusually high-Q, extraordinary mechanical and electrical stability, easy of adjustment, small in size and useful to beyond 500 megacycles for trimming or tuning, a new air-dielectric capacitor is now available.

Less than one-half inch in diameter, less than 1 7/16" in length, SILVER Model 619 capacitor provides 3 to 30 mmfd. with air and high quality ceramic insulation. Rotor and stator are one piece, low inductance, multiple aluminum cups. Rotor meshing with stator gives a linear capacitance range of 27 mmfd. over three full rotations.

Produced at the famous Philips works in Holland, it is brought to American amateurs and experimenters. Price 30c each, net, at your favorite jobber.

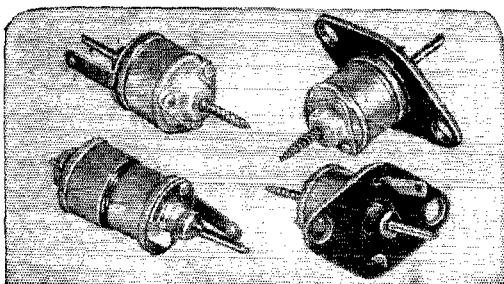

New ULTRA COMPACT HIGH-Q AIR CAPACITOR

Illustrated and high spotted above are but two of many fresh, **post-war** receivers, transmitters, factory built or kits and parts designed by and for serious amateurs. Prices are as low as quality is high. A penny post-card will bring you catalog of what's new . . . your favorite jobber will have them soon.

OVER 35 YEARS OF RADIO ENGINEERING ACHIEVEMENT

McMurdo Silver Co., Inc.

1249 MAIN STREET • HARTFORD 3 • CONNECTICUT

In Canada—McMurdo Silver Division, General Radionics Ltd., 465 Church St., Toronto, Ont.

HAM-ADS

(1) Advertising shall pertain to radio and shall be of nature of interest to radio amateurs or experimenters in their pursuit of the art.

(2) No display of any character will be accepted, nor can any special typographical arrangement, such as all or part capital letters be used which would tend to make one advertisement stand out from the others.

(3) The Ham-Ad rate is 30c per word, except as noted in paragraph (6) below.

(4) Remittance in full must accompany copy. No cash or contract discount or agency commission will be allowed.

(5) Closing date for Ham-Ads is the 25th of the second month preceding publication date.

(6) A special rate of 7c per word will apply to advertising which, in our judgment, is obviously non-commercial in nature and is placed and signed by a member of the American Radio Relay League. Thus, advertising of bona fide surplus equipment owned, used and for sale by an individual or apparatus offered for exchange or advertising inquiring for special equipment, if by a member of the American Radio Relay League takes the 7c rate. An attempt to deal in apparatus in quantities for profit, even if by an individual, is commercial and all advertising by him takes the 30c rate. Provisions of paragraphs (1), (2), (4) and (5), apply to all advertising in this column regardless of which rate may apply.

(7) Because error is more easily avoided, it is requested signature and address be printed plainly.

(8) No advertiser may use more than 75 words in any one issue.

Having made no investigation of the advertisers in the classified columns, the publishers of QST are unable to vouch for their integrity or for the grador character of the products or services advertised.

NOT MORE THAN 75 WORDS

Owing to shortage of space in QST it is necessary to limit Ham-ads to not more than 75 words for any one advertiser.

OIL filled condensers, new; Cornell-Dubilier and Sprague. 4 μ fd, 1500 v., \$1.85 each; 2 for \$3.50. Paul Wandelt, 32 East 40th St., Bayonne, New Jersey.

QUARTZ — Direct importers from Brazil of best quality pure quartz suitable for making piezo-electric crystals. Diamond Drill Carbon Co., 719 World Bldg., New York City.

AMATEUR radio licenses. Complete code or theory preparation for passing amateur radio examinations. Home study and resident courses. American Radio Institute, 101 West 63rd Street, New York City.

WRL Transmitting kits — 15, 35, 70, and 150-watt units — low price. All makes of receivers, both new and reconditioned. Leo offers best trade-in deal, and easy time payment plan. One of the country's largest parts supply houses. Write today for free catalog, special radio and office tube-base calculator offer, and other items. Leo, at World Radio Labs, Dept. HA, Council Bluffs, Iowa.

RADIO tubes, parts, condensers, free bargain lists. Potter, 1314 McGee, Kansas City 6, Mo.

COMMERCIAL radio operators examination questions-and-answers. One dollar per element. G. C. Waller, W5ATV, 6540 E. Washington Blvd., Tulsa 15, Okla.

OLD amateur, commercial radio sets, parts, catalogs, wanted. Will trade new gear or pay cash. McMurdo Silver, Simsbury, Conn.

QSL samples. H. L. Carter, Jr., W8JOT, 749 S. Plymouth, Rochester 8, N. Y.

CRYSTALS: Precision low drift units. Type 100A in 80, 40, and 20 meter bands. Two units plug in one octal socket. One dollar each. Rex Bassett, Inc., Ft. Lauderdale, Fla.

EIMAC 100 TS VT-127 triode hf. tubes, 5-volt filament, 500-watt input, \$4.50. Petersen crystals, 10-meter, \$5; 20-meter, \$3.50; 40 meter and 80-meter, \$2.80. Hallcrafters transmitter, complete, ready to go on 10, 20, 40 and 80 meters, \$535. Many surplus items available. Radio & Electronics Supply, P. O. Box 1171, Jaredo, Texas.

W2PTS is former W8CJJ.

FOR SALE: transmitter receiver combination, mobile type, for 10, 40 and 80-meter bands. \$125. To buy: we pay best prices for National, Hammarlund, Western Electric, Collins a/c, and Hallcrafters transmitters and receivers. GI Radio Exchange, Box 431, Coral Gables, Florida.

We have the machinery, skill and the desire to do an excellent job on that new equipment you are planning or building. We cut any size round or oblong holes for meters, speakers, dials, and transformers. We build special cabinets, parts for dial mechanisms, rotary beams, etc. We engrave or letter panels, dials, and meters. We duplicate most equipment in Handbook and QST. Write for information and prices. S & G Instrument Co., Box 1461, Tulsa 1, Okla.

QSLs, samples free. Radio Headquarters, 1704 Hale Avenue, Ft. Wayne 6, Indiana.

HAM Crystals: \$2.25 (2 for \$3.75) mounted FT243 type holder, 3 Mc to 9 Mc, within 10 Kc. of requested frequency. Klipp, 277 B'way, NYC 7.

RADIOTELEPHONE first class sample tests, \$10. We correct. New correspondence course. Box 1298, Hollywood, Calif.

ROTARY beam antenna indicators. Use 2 Bendix servos as automatic antenna direction indicators. Will operate satisfactorily on 60-cycle supply. Price \$7.50 per pair. Instructions included. Genera Developments, 521 Fifth Ave., NYC.

WAR Surplus radio parts: condensers. Sprague 1 μ fd, 600 volt oil-filled, metal encased tubulars, 10 for \$1.85. Micamoids 0.50 μ fd 400 volt, molded in bakelite, 10 for 95¢. Sprague 1 μ fd 150 DCWV, oil-filled, filter condensers, \$1.09. IN21 Sylvania silicon crystal, 98¢. Free circular for outstanding bargains. Erie Supply 88 Exchange St., Rochester, N. Y.

QSLs in colors. Stamp for samples. Glenn Griffith, W3FSW, 104 Pine Heights Ave., Baltimore 29, Md.

PORTABLE BC receiver wanted. Write Hulse, 1547 Cole St. Baltimore 23, Md.

IN STOCK: HQ-129Xs, SuperPros, S38s, S40s, HROs, One-Ten RME-45s, transmitters, rotary beams, large stock amateur apparatus. Inquiries and orders invited. Henry Radio, Butler, Mo., and Los Angeles, Calif.

SELL RME-45s Panadator 1942 signal shifter, used 4 months. Best offer. Power supplies, W2KPH, 22 Riverside, Rensselaer, N. Y.

QSLs? — SWTs? No cheap trash! 10¢ for samples. Biley Crystals: RME-45, \$186.00; RME-84, \$98.70; OB-20, V1-152, "CG" or "OST" subscription, \$2.50 year. Sakkers, W8DED, Holland, Mich. (Veteran).

GON-SET converters for mobile or fixed station, voltage regulator, one-stage pre-selection, instructions and schematic, complete, \$39.95. Shipped same day. Murray Black, W6UVF, 839 N. June, Hollywood 38, California.

LOCAL hams! Sacrifice complete kilowatt phone/c.w. transmitter. Reason: marriage. As is, \$200. 129 QSTs, 1932-44. Make offer. W2EQS.

PANEL engraving, nameplates. Reasonable prices, good service. Small jobs welcome. W E Gilpin, Box 63R4, Mt. Clemens, Mich. QSTs, 126 thru 1938 complete. First \$25 dollars. W2PE, 104 Phyllis Ave., Buffalo, N. Y.

SELL National SW45 10 coils, speaker, power supply. Complete, \$28. W. H. Goodell, Jr., 152 E. Fifth Ave., Roselle, N. J.

McELROY G813A keying unit and tape puller, no tapes, \$50. Gordon Johnson, 60 Sixth Ave., North Fargo, N. Dakota.

FOR SALE, nearly new UTC transmitter, 100-watt phone, 130 wattsw. w. crystals, coils for all bands, dynamic mike, \$130. W0KKU, Box 452, Arvada, Colorado.

FOR SALE, new communications receiver, model BC3480, 9 tubes, 2 RF stages, 3 IF stages, crystal filter, frequency range, 200 to 500 kilocycles, 1/2 to 18 megacycles, 28 volt DC, using 6 volt tubes. Simple conversion to AC. Government price over \$200 — my price, \$80. F.O.B. Oak Ridge, Tenn. Address: Al Threadgill, W5FDS, Box 2468.

SALE: 800-watt 10 meter phone transmitter, including two element rotary beam antenna. Must be seen to be appreciated. J. Mlynzak, 2042 Griffith St., Phila., Penna.

SOLAR oil-filled 8 μ fd, 600 v.d.c. 99¢; Solar oil-filled 2 x 4 μ fd, 1500 v.d.c., \$2.50. Sichel midget variable condensers with shaft, assorted capacities, 5 for \$1. Mounted acorn sockets, 3 for \$1.10. Budd OLS 80-meter coils, 89¢. Add 10¢ postage. William Radio Supply, 207 French St., New Brunswick, N. J.

1 — AN/ART-13 Collins (ATC) xmtr, complete and new, \$240 (0.2 to 18.1 Mc) 1 — BC-375-E (2 to 12.5 Mc) complete and new, \$60. W9VRO, 2035 Broadway, San Diego 2 Calif.

S30R Hallcrafters, six months old. Excellent condition, \$50. E. Kirdaby, 211 Smith St., Brooklyn 2, N. Y.

WILL trade silver-plated gold bull, Boscher B-flat-A cornet in factory condition for Hallcrafters S-40 receiver in factory condition. G. Thurston, Culpeper, Va.

FOR SALE: Hallcrafters, S-40, like new, \$68. You pay freight. Write William Catron, W9NQC, Mauckport, Ind.

SELL SX28, \$175 F.O.B. Worcester, Mass. James Fernane, W1JOP, c/o FCC, 838 U. S. Court House, Kansas City, Mo.

WANTED: Small transmitter, Holstein, 246 E. 148th, Bronx, N. Y.

QSLs the way you want them. Vern, W9OMC, Hutchinson, Minn.

SEND 3¢ stamp for sample QSLs to Harrison, 8001 Piney Branch Road, Silver Spring, Md.

1/2 h.p. back-gearred with servos, \$24. \$10 relays, \$1. W7RK, Everett, Washington. Many other items.

2-meter TR-4 transmitter/receiver, like new, complete with tubes, 110-v AC and 6-v DC power supply, microphone. Value \$85. \$60 takes it. W4GJO, Route 1, Box 762, Orlando, Fla.

1M-14 frequency meter, brand new, complete: \$90; several new RCA 813s, \$6.50; BC-348? receiver 110 AC, \$75; Collins AN/ART-13 xmtr., new, converted 110 AC operation, \$310. Selling out. Write for list. W9YFJ, R. Knochel, Lincoln, Ill.

SELL new Thordarson 11M77 300-watt and 11M78 500-watt multi-math modulation transformer. W9SKR, 1522 West 18th St., Chicago 8, Ill. Tel. Canal 5129.

\$1.00 brings you plans spec. for 16-element high-gain rotary beam. Werner, 128 So. Brighton, Burbank, Calif.

WANT to hear from my CCC and AAF radio friends. Wes Bell, W0QB, 3030 W. Garland Ave., Spokane 12, Wash.

CALL letters for windows. Professional, 2" imm. gold-leaf, black border. Not decal companies, 20¢ each letter. D. I. Cole, W2PIY, 127 Murray St., Elizabeth 2, N. J.

SELL 500-w. phone xmtr. Best offer. W3HUL, 3433 Piedmont Ave., Baltimore, Md.

SELL: CW monitor. Bound volumes "Radio" 1936 to 1941; "QST" 1936 to 1945. WINKW., P.O. Box 92, Lynn, Mass.

FOR SALE: Entire station: BC312 receiver with xtal filter and regulated supply; ten meter converter; two meter trf; power supplies; PP807 rf section; much miscellaneous gear. Write for list. W9TWW, 736 Buena Ave., Chicago 13, Ill.

WANT 500-watt modulation transformer. Sell 100-watt modulation transformer with input, FB7A receiver, 20M coils. W2DNN, Eudopedon Farm, Clarksville, Tenn.

SELL 9-tube receiver, xtal filter, bandspread, with speaker, 1.5-30 Mc. Andrews, 49 Summer St., Andover, Mass.

WANTED: Signal generator, Al Stark, 927 W. Boylston St., Worcester 6, Mass.

WANTED: DuMont 208 oscilloscope, any condition. W6A1X, 391 Truman Boyd Manor, Long Beach 6, Calif.

SELL two 4000-v. 2 μ d C-D filter condensers, \$5 each. RK20, 804, \$2; RK20A, \$3; Custom-built 2500-v. 1 kw. transformer, \$20. Other parts for sale. Want beam rotator, microphone. HK354. What have you? W9ERU.

FOR SALE: Variety of meters, flush type, 3/4" and 2"; AC, DC, and RF; Weston, Westinghouse, General Electric, and others. State your needs. W3JSP, 1305 46th St., S.E., Washington 19, D. C.

COLLINS 147/ART13 xmt., new. Good ham rig. 811s modulate 813, 12 tubes, Autotune, freq. standard. \$200. L. A. Rekow, 42-66 Phlox Pl., Flushing, L. I., N. Y.

FOR SALE: Stancor 60-N transmitter, complete with deluxe cabinet. Crystal and coils for one band, \$75. Paul Trued, W4HXM, Box 311, Sanford, Florida.

SELL S-20R receiver. Also Motorola T19-23 'phone transmitter, 35 watts to 807, built for police station installation. Operates on 10-meter. Both to be new. Write for details or make offer. W9PFD, 820 N. Duntun, Arlington Heights, Ill.

COLLINS transmitter for sale: relay broadcast type 32G, 75 watts, perfect shape, all new tubes. Complete coils for all bands, 40-40-40-40-10 M. Replacement cost, \$395. Best offer takes it. WOCVU, Chas. W. Boegel, Jr., P. O. Box 224, Cedar Rapids, Iowa.

EXCEPTIONALLY well-built, 125-watt c.w. xmt., 20-40-80, complete, \$80 cash. 15 Smith St., Wellesley, Mass. Moses.

FOR SALE: Echophone EC7; Hallcrafters S20R Sky Champion; 20-watt amplifier with mounted turntable, pickup, 'phone-mike mixer, Compact radio work-bench, BC-221 frequency meter; 67" enclosed rack; bass reflex speaker; broadcast tuner; field strength meter; hi-fi speaker; carbon mikes; variacs; power supplies; 6L6 oscillator transmitter; 2500V 0.01 mica condensers; several 8 μ d 600V oil, 2 μ d 200V oil assortment; rectifying tubes, resistors, condensers, potentiometers, jacks. Odd frequency crystals; transformers, chokes. Budd wave-meter; code oscillator; phono-oscillator; 2" 0-1 Ma. meters; record player. Complete list sent. All inquiries answered. Gerog George Kravitz, 7919 20th Ave., Brooklyn, N. Y.

SALE: 4 comb. PM mikes and phones; 12-v. dynamotor, 275 and 500 v. filtered; antenna variometer; antenna mounting basis and antenna rods for portable use. Need: Kenyon 656 and 352; 6 V.A.C. pdt. and 6 V.A.C. 3 pdt. keying relays; 7 TMS-250, Trade or cash. Gerald Esterson, 2922 Norfolk Avenue, Baltimore, Md.

SELL, trade, 125 watt xmt., Abbott DK2; Marks, 97 South 8th St., Brooklyn, N. Y.

HOWARD 450A receiver, full coverage (0.5 to 65 Mc (incl. .6 meters) 12 tubes, S-meter, xtal. W8WPW/W2, 51 Tarance, Rockville Center, L. I., N. Y.

WANTED: CW transmitter, 40-meters, approx. 300-watts, good condition. A. Lukach, 35 E. 84th St., New York City.

WANTED: Best rig \$200 will buy. Phone and c.w. 10 to 80 meters. J. King, 2311 Allston, Louisville, Ky.

FOR SALE: Unused Army microphone and receiver headgear No. 1 assembly (Zenith) \$4.50. W2TG, 146-13 58th Road, Flushing, L. I., N. Y.

50 paper and mica condensers, \$1.00. Brand new. Fine assortment. Popular sizes. Some high voltage. Cash, check or money order. Hal Dabrin, 855 E. 175th St., Bronx, N. Y.

SIGNAL CORPS unused microphone and phones No. 1 assembly. Bargain at \$4.50. Unused dynamotor input 12 volts, 10 amps. Output 275 v. 10 Ma. and 500 v. 50 Ma. Make offer. H. Wray, 159 Stanton Court, Pittsburgh 1, Penna.

WANTED: Thordarson transformers #T80A02; T-19D06, T-19M13. Edward F. Doland, 1308 W. Madison St., Chicago, Ill.

HALICRAFTERS S-29 portable, less batteries. Overhauled by factory in 1945. Best offer takes. W8ZAI, P. D. Mosser, Oxford, Michigan.

SELL: National receivers, NC-200, also 100 ASD, complete. C. Horn, 325 E. 163rd St., New York 56, N. Y.

QSLs, Samples. Albertson, W4HUD, 705 So. Hamilton, High Point, N. C.

SELL: rcvr 11 tube custom-built 5-550 M. complete, \$30. Exciter 6L6, 7 μ d built only, \$20. 2-meters xmt./rcvr tubes, mike, ant. \$25. Shure 5c, hi-imp. mike new, \$25. J. E. Bright, 33-1 St., Jackson Heights, L. I., Phone HAV-8321, Jackson Heights, L. I., N. Y.

XUIVT will QSL all QSOs. Any station worked desire any QSL, notify W6TMT by QSL. Tnx, 738, ex. cal. Address: XUIVT, Don R. Bocoast, W6TMT, Rt. 1, Box 350, Chico, Calif.

SELL: transmitter/receiver, 'phone, key, Portable or A.C. New. Reasonable. Shimshak, 27 Sartori, Mount Ephraim, N. J.

56 Selygn generators, 110AC 60 cycle, 3 1/2" x 5 1/2". Ideal antenna or wind direction indicator. Diagram furnished. \$12 per pair. New meters. Low prices. Write for list. Westchester Electronic Products, 29 Milburn St., Bronxville 8, N. Y.

BC-312 Signal Corps communication receivers, 9 tubes, freq. range 1.5 to 18.0 Mc. With dynamotor 12 to 14 V.D.C. operation. Easily converted to A.C. \$65 each. International Electronics Corp., 4145 Commerce St., Dallas, Texas.

HEADSETS: miniature type HS-30. Finest little 'phones you've ever used. Compact, featherweight, extreme sensitivity and at a new low price. \$3.49 complete with matching transformer. Check or money order for postpaid delivery. Cathode Ray tubes, 3BP1, new original cartons. Special \$5.95. Electronic Supply Corp., 4014 Greenpoint Ave., Long Island City 4, N. Y. (Att: W2ASA).

COAXIAL cable, RG8/U, 76 per ft., RG59/U, 66 per ft. See QST April, 1946, P. 51 for detailed description. Coaxial Cable Co., Box 19, Woodside, N. Y.

TUBE checkers, immediate delivery RTL, Model 130, \$52.45. RME-45s. Dearborn Wholesale Co., 5710 Schaefer Road, Dearborn, Mich. Dick McNutt, W8CAT.

400 cycle dynamotors, 28VDC input, 115VAC output, 485VA. Shaft extension, black crackle, \$28.50. Ampidrive motor generators, 28VDC to 60 VDC, 530-watts, \$10.50. Generators 30 VDC 300 amps, \$22.50. Free list aircraft, electrical, radio parts. Erecor, 1006 Hewitt, Everett, Wash.

ELECTRONIC volt-ohmmeter, \$11.85. Twenty ranges. Thousand megohms, 3000 volts. Complete kit. Free circular. Sterling Electronics, Pasadena, Calif.

EDISON crystals are still going strong! Fine commercial units for Aircraft, Police, Marine, Geophysical and other services. Now, tailor-made crystals to your needs at no extra cost, with special attention given. Over eleven years of satisfaction and fast service. "Edison's," 1309 No. Second, Temple, Texas.

ELECTRONIC surplus: Ham, experimental, laboratory. Write for bargain bulletins, wholesale, retail. Lectronic Research, 5832 Hegerman St., Philadelphia, Penna.

CRYSTAL processing kit: as advertised April QST, 4 crystal blanks, AT and BT cuts, covering all popular amateur bands including 10-meter, high activity guaranteed if you follow processing instructions. All equipment necessary to process your own crystals accurately and change frequency of your rig. Quickly, easily, economically. Free: 1000 Kc var surplus crystal without holder with each kit. Offer, time only. Special price, \$8.75, f.o.b. General Electronics B., 116 West 5th St., Kansas City 6, Mo.

CRYSTALS: low drift, etched finished to your exact frequency, 40 and 80 meters. The new FT 243 with socket, \$2.50. Regular ham size fit to five-prong socket, \$2.80. 24 hour service. Tedford Crystal Labs (Ted, W8AKW), 1626 Chase St., Cincinnati 23, Ohio.

CATHODE ray tubes 5CP1s, brand new, \$7.95 (plus 6 shipping); socket with tube, 45¢, otherwise .90¢; 5CP1 steel shields, 85¢ (34), brand new 95¢, 95¢ acorn tubes, not rejects, 89¢ ea. postpaid. Free electronic bargain list. Ohmeyer Engineering, Dept. A, Fairview Blvd., Hempstead, N. Y.

SELL Motorola FMT-50-B 117-volt, 50-watt FM transmitter. 30-40 Mc. \$150 without crystal. W5GNM, 2502 Tilton, Dallas, Texas.

QSLs, SWLs, Samples, guaranteed printing. Prompt delivery. Franzen, W2DEE, Box 103, Maple Shade, N. J.

SELL: New Meck 60-watt transmitter, bias battery, extra coils, \$150. 6F6, 6L6, 812 100-w. c.w. xmt. meter, tubes, coils, built-in power, rack mounting, \$75. 1500-v. 500 Ma. power transformer, pri. control, \$15. Meissner deluxe Signal Shifter with tubes, 80 and 20 meter coils, \$40. N. F. Doyle, W4HEN/2, 75 Madison St., Lynbrook, L. I., N. Y.

HRO, Jr. power supply, coils 1.7 to 7.3 Mc, with bandspread on 7.0 Mc, \$60. W0DHN, 116 W. North, Warrensburg, Mo.

GIFFORD-BROWN specials: 1250-CT-1250 volts, 250 Ma. hermetically sealed, \$8.50; 675-CT-675 volts, 350 Ma, hermetically sealed, \$7.50; 10 Henry 250 Ma. choke, sealed \$3.00; Thordarson cased 550 Ma. chokes @ \$6.95, both swinging and smoothing; 813 tube, modulation transformer and driver transformer, all for only \$14.75. Write for our BARGAIN Bulletin including many items like above. Orris Wise, W9YCF, will personally represent you at Gifford-Brown, Inc., Cedar Rapids, Iowa.

BEST Offer: Supreme Model 563 audio oscillator bought new this year, used about 20 hours. Perfect condition. R. H. Collins, W3CSC Christiansburg, Va.

SELL: RME-69 DB20 gray rack, needs slight repair, home-made 6L6-807 exciter, new 810. Best offers. W2KXP, 21 W. Moshulu Parkway, New York, N. Y.

RME-45s, Immediate delivery. The new KP-81 now available. All receivers can be purchased on the time payment plan. RTL-tube checks, \$52.45. Supreme Radio, McNutt, W8CAT, 5728 Schaefer, Dearborn, Mich.

SELL Amperite PGL 50-ohm microphone, A-1 condition, \$12.00. Nathan Williams, 20 Algoma Blvd., Oshkosh, Wis.

"BT" crystal blanks precision ranging from 8 to 8.5 Mc. 6 for \$1.00. Breon Laboratories, Williamsport, Penna.

NAVY TBY (pack type walkie-talkie) phones, microphone, tubes, 28-80 Mc. easily converted 2-meters. \$32.50. Arrow Appliance & Radio, 391 Broad, Lynn, Mass.

"LUCITE" call-letters, ruby, blue, or green; white or clear base. \$2.50 postpaid. Bernard Hartz, Frackville, Penna.

NEW: unused National Union 5FP7 cathode ray tube, one 250th QSL! Samples, 25¢. License photocopies, \$1.00. Best offer. Earl F. McFarren, 12 Torque Way, Baltimore, 20, Md.

FOR SALE: transmitter, National 600 W, 'phone-c.w. 80, 40, 20, 10 meters. Complete \$900 or best offer. (Refused Govt. offer of \$1050). H. W. Merideth, M.D., W9JYS, 1432 Granville Ave., Chicago 26, Ill.

NEW 6-meter band (8th frequency) crystals, holders, \$1.50-7 Mc. build, \$1.50. FM mobile transmitter/receiver, 10 meters, SCR-659, \$50. 5-10 meter transmitter, BC-222, \$25. W2AOP, 24 Hawthorne St., Williston Park, L. I., N. Y.

PROUD of your station's appearance? Then invest in quality QSL! Samples, 25¢. License photocopies, \$1.00. Novelty Ham-stationery and cards. Kernze, Route Three, Fulton, N. Y.

WANTED: G-E series 50 (wire recorder) playback amplifier with or without 30-volt 2.8 amp. power supply. Herbert Hoch, 469 E. 52nd St., Brooklyn 3, N. Y.

QSLs, quick delivery, Pleasant, W9UDZ, Mattoon, Ill.

SELL 3-852s slightly used, \$5 each, 2-860s slightly used, \$7 each; 1-100th new, \$7; 1 0-150-v. projecting Roller-Smith ac voltmeter, \$4; 1-110 volt ac to 1000 volt DC motor generator 400 milliamps, \$25. T. H. Kemp, 51 Helen Street, Fanwood, N. J.

RECEIVERS, RME-9D good condition and home-made 10 and higher frequency, 12 tubes. Write for details. Cheap. C. G. Prior, 2224 Hillcrest, Ft. Worth, Texas.

Designed for



Application

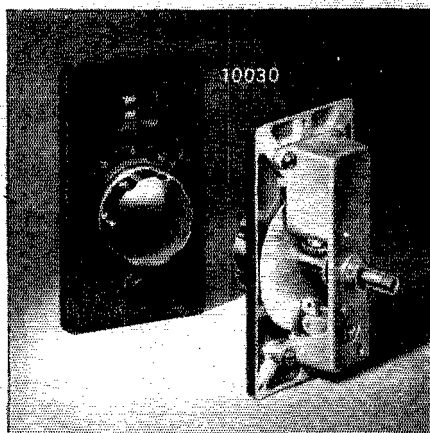

The No. 10030

INSTRUMENT DIAL

An extremely sturdy instrument type indicator. Control shaft has 1 to 1 ratio. Vee-drum type counter is direct reading in 99 revolutions and vernier scale permits readings to 1 part in 100 of a single revolution. Has built-in dial lock and 1/4" drive shaft coupling. May be used with multi-revolution transmitter controls, etc. or through gear reduction mechanism for control of fractional revolution capacitors, etc. in receivers or laboratory instruments.

JAMES MILLEN MFG. CO., INC.

MAIN OFFICE AND FACTORY
MALDEN
MASSACHUSETTS



Index to Advertisers

	Page
Advance Electric & Relay Co.	106
Allied Radio Corporation	119
American Phenolic Corporation	13
American Radio Institute	122
Ashe Radio Co., Walter	94
Astatic Corp., The	2
Barker & Williamson	120
Bell Telephone Laboratories	86, 87
Birnback Radio Company	118
Bitley Electric Company	118
Brill Co., W. D.	138
Bruno Tools	88
Burgess Battery Co.	92
Burlington Instrument Co.	122
Burstein-Applebee Co.	116
Cameradio Co.	96
Candler System Co.	138
Capitol Radio Eng. Institute	101
Cardwell Mfg. Co., Allen D.	125
Carter Motor Co.	138
Centralab	83
Clarkstan Corporation	112
Cleveland Inst. of Rad. Elec.	102
Collins Radio Company	7
Commercial Equipment Co.	72
Commercial Radio Institute	126
Condenser Products Co.	95
Continental Sales Co.	138
Cornell-Dubilier Elec. Corp.	89
Crystal Products Co.	93
Drake Electric Co.	82
Duston, Merle	126
Eitel-McCullough, Inc.	69
Electro-Voice Corp.	75
Gardiner & Co.	104
Gasket Engineering Co.	131
Gates Radio Co.	131
General Electric Co.	1, 85
Grutzius, John	112
Hall, R. C. & L. F.	129
Hallicrafters Co.	4, 5
Hammalund Mfg. Co., Inc.	67
Harrison Radio Co.	115, 117
Harvey Radio Company	123
Harvey & Young	68
Hatry & Young	104
Henry Radio Shop	132
Herbach & Rademan Co.	128
Hytron Radio & Electronics Corp.	99
International Resistance Co.	76
Jensen Manufacturing Co.	7
Johnson Co., E. F.	70
Ken-Rad	107
Kierluff & Co.	124
Magna-Metal Products Co.	134
Maguire Industries	97
Mallory & Co., P. R.	66
Massachusetts Radio & Television	106
McGraw-Hill Book Co.	116
Millen Mfg. Co., Inc., James	142
Munzig Mfg. Co., Arthur L.	136
Murray-Hill Book Co.	120
National Co., Inc.	65, Cov. III
Newark Electric Company	91, 105
New York Technical Institute	108
New York YMCA Trade & Technical School	130
Noble & Noble	114
Ohmite Mfg. Co.	109
Onan & Sons, D. W.	122
P & H Sales Co.	112
Peerless Electric Prod. Co.	84
Petersen Radio Co.	8
Port Arthur College	134
RCA Institutes	126
RCA Mfg. Co.	Cov. IV
Radio Electric Ser. Co. of Penna.	100
Radio Manufacturing Engineers	77, 143
Radio Shack Corp., The	110, 111
Radio Prod. Sales Co.	128
Radio Specialties Co.	137
Scell & Co., R. G.	114
Shure Brothers	90
Signal Elec. Manufacturing Co.	134
Silver Co., McMurdo	139
Sky-Lane Products Co.	108
Solar Capacitor Sales Co.	144
Sprague Products Co.	81
Standard Radio & Electronic Products	108
Sun Radio & Electronics Co.	127
Sun Radio of Washington	133
Sylvania Electric Products Co.	113
Telegraph Apparatus Co.	114
Terminal Radio Co.	135
Transmitter Equip. Mfg. Co.	78, 79
Triplet Elec. Inst. Co.	124
Turner Co., The	136
UHF Resonator	118
United Electronics	Cov. II
United Transformer Corp.	Cov. II
Valparaiso Technical Institute	122
Vaipey Crystal Co.	74
Vibroplex Co., The	130
Ward Leonard Electric Co.	130
Waterproof Electric Co.	132
Western Electric Co.	86, 87
Wilcox Electric Co.	103
World Radio Labs	98

Precision *
•
•

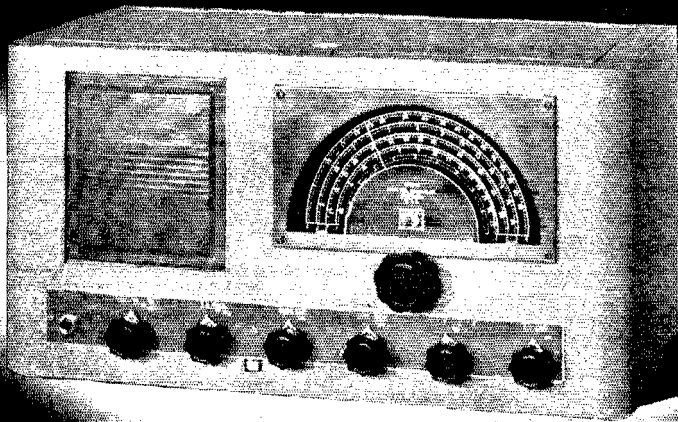

••• *the New* **RME 84**

High In Quality - Low In Cost!

You'll find that the new RME 84 is a precision instrument — built to RME's rigid specifications of quality components and quality workmanship.

No low priced, "average" components are used anywhere in this instrument. The vernier bandspread scale, for instance, is operated integrally with the main scale indicator through a planetary drive mechanism, spring loaded to eliminate all backlash. This feature means accuracy and ease of tuning. What's more, you'll be delighted with the calibration — held to an accuracy of one-tenth of one per cent in the final test procedure.

PORTABILITY BUILT IN

For portable operation, the RME 84 is a natural for those many field days to come.

Provision is made for connection to either a B battery and an A battery supply or a vibrapack. Drain on the B battery is only 22 mls at 135 volts, on the A but 1.2 amps.

To mention but a few of the other features there's a new series noise limiter that really works on cw as well as fone, sensitivity of two microvolts over the entire range, provision for doublet or single wire antenna, provision for an S meter, and a host of others.

You'll find that the RME 84 is full of pleasant surprises, the receiver in the lower priced field which will give you the most for your money.

Specification Sheet
on Request



RME

FINE COMMUNICATIONS EQUIPMENT

RADIO MFG. ENGINEERS, INC.

Provia 6, Illinois U. S. A.

SOLAR PROUDLY PRESENTS

SUPEREX

A NEW

Capacitor Dielectric

SUPEREX*, Solar's superb new oil-impregnant for paper dielectric capacitors, is the result of a long-time program of research and development. Its entry into mass production under rigid standards of quality control marks another Solar contribution to the electrical industry.

SUPEREX gives to the electrical industry a capacitor dielectric material with the following outstanding properties: 1. Low Power Factor; 2. Long Life; 3. High Flash Point; 4. Non-Inflammability; 5. Non-Corrosiveness; 6. Stabilized for Operation at High Temperatures, 85°C for DC, 75°C for AC; 7. High Insulation Resistance; 8. High Dielectric Constant.

Now available to the electrical and electronic manufacturing industries after months of heavy pilot plant production and test by leading capacitor users in the United States, **SUPEREX** stands forth today as the ideal capacitor impregnant for most applications. Tests by those who have already used **SUPEREX** capacitors have won this new material unqualified approval. **SUPEREX** assures outstanding performance in motor phase-splitting capacitors, energy storage capacitors, all light and heavy-duty capacitors used in communication and industrial electronic equipment, and in capacitors for power factor correction.

SOLAR has now completed a new plant for mass production of **SUPEREX** capacitors. This ultra-modern plant with the latest developments in high-vacuum processing equipment, is supplying daily increasing quantities of **SUPEREX** capacitors to those who need the utmost in capacitor performance and reliability.

SOLAR will be glad to tell you how you can utilize the advantages of **SUPEREX** capacitors in your applications. A letter today will bring you the benefit of Solar's authoritative experience in solving capacitor problems.

*Trade Mark

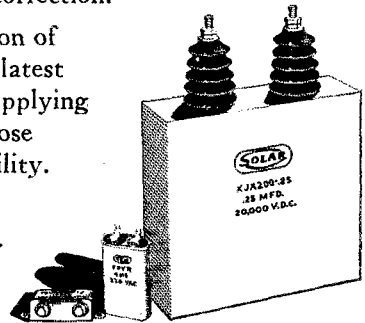

SOLAR CAPACITOR SALES CORP.

285 Madison Avenue · New York 17, New York



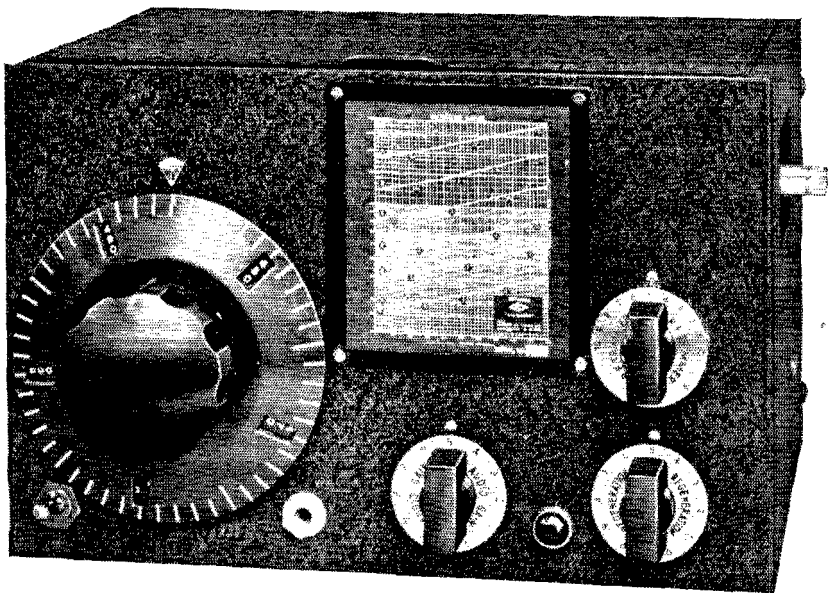

THE 1-10A

The ONE-TEN-A is a complete redesign of the ONE-TEN, retaining all the proven design features of the older model but with improved performance and smoothness of control.

For many years the ONE-TEN has been the "standard" receiver for work in the range from one to ten meters. Although many advances in high frequency technique have been made since this little receiver was first introduced, it has easily held its place in the affections of experienced amateurs by its consistent dependability under actual operating conditions and its high usable sensitivity.

The new ONE-TEN-A inherits the fine qualities of its predecessor brought up to date by a complete restudy of circuit, mechanical arrangement and constructional details.

The ONE-TEN-A is a fine receiver.

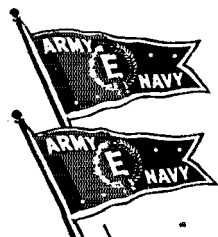

Still the leaders

in price and performance

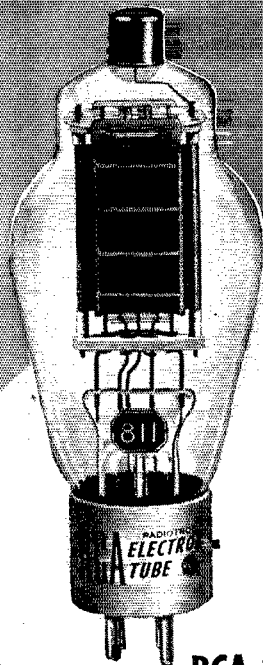

RCA-811
\$3.50

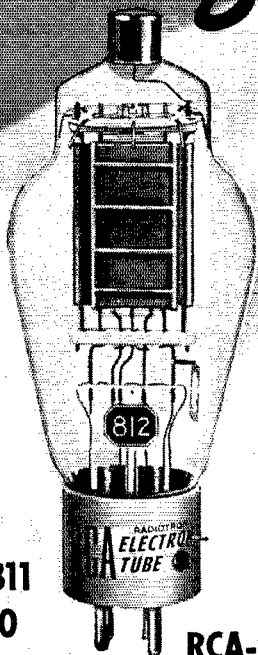

RCA-812
\$3.50

Why you get more from these RCA transmitting triodes

1. The husky, 25-watt, thoriated-tungsten filament used in both the RCA-811 and 812 provides a tremendous reserve of emission and insures long tube life.

2. The zirconium-coated anode has remarkable heat-dissipating qualities which permit high plate current input.

3. Either tube will deliver 170 watts of RF, Class C telegraphy (ICAS). A pair of 811's in Class B will provide 225 watts of audio power.

4. Full power input to 60 Mc. makes these tubes tops for "multi-band" operation.

5. Extra stability and efficiency because of

rigid "dome top" construction and low-loss Micanol base.

That's why the RCA-811 and 812 remain the most popular types for medium-power cw and phone transmitters.

For further details, see your local RCA Tube Distributor or write RCA, Commercial Engineering, Section A-21J, Harrison, N. J.

**THE FOUNTAINHEAD OF MODERN
TUBE DEVELOPMENT IS RCA**

**HAM TIPS keeps you up to date.
Get your copy from the
local RCA Tube Distributor.**



TUBE DEPARTMENT

RADIO CORPORATION of AMERICA

HARRISON, N. J.