

June, 1946

25 cents

35c In Canada

QST

devoted to

amateur radio



F. B. FIELD DAY — JUNE 22-23 — 1946

FOR HIPERM ALLOY TRANSFORMERS

The UTC Hiperm alloy audio transformers are specifically designed for portable and compact service. While light in weight and small in dimensions, neither dependability nor fidelity has been sacrificed. The frequency characteristic of the Hiperm alloy audio units is uniform from 30 to 20,000 cycles. These units are similar in general design and characteristics to the famous Linear Standard audio Series.

UTC Hiperm Alloy Transformers Feature

- True Hum Balancing Coil Structure
- Balanced Variable Impedance Line
- Reversible Mounting
- Alloy Shields
- Multiple Coil, Semi-Toroidal Coil Structure
- High Fidelity

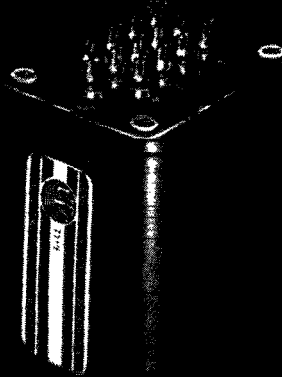

FOR IMMEDIATE DELIVERY

From Your Distributor

... CYCLES PER SECOND
... for HA Series

Type No.	Application	Primary Impedance	Secondary Impedance	± 1 db from	Max. Level	Max Unbal. DC in primary	List Price
HA-100	Low impedance mike, pickup, or multiple line to grid.	50, 125, 200, 250, 333, 500 ohms	60,000 ohms in two sections	30-20,000	+22 DB	5 MA	16.25
HA-100X	Same as above but with tri-alloy internal shield to effect very low hum pickup.	50, 125, 200, 250, 333, 500 ohms	120,000 ohms over-all, in two sections	30-20,000	+22 DB	5 MA	20.90
HA-101	Low impedance mike, pickup, or multiple line to push-pull grids.	50, 125, 200, 250, 333, 500 ohms	120,000 ohms over-all, in two sections	30-20,000	+22 DB	5 MA	18.55
HA-101X	Same as above but with tri-alloy internal shield to effect very low hum pickup.	50, 125, 200, 250, 333, 500 ohms	120,000 ohms over-all, in two sections	30-20,000	+22 DB	5 MA	23.20
HA-108	Mixing, low impedance line.	8,000 to 15,000 ohms	135,000 ohms 1.5:1 ratio, each side	30-20,000	+22 DB	0	16.25
HA-106	Single plate to push-pull grids	8,000 to 15,000 ohms	50, 125, 200, 250, 333, 500 ohms	30-20,000	+22 DB	1 MA	13.90
HA-113	Single plate to multiple line.	8,000 to 15,000 ohms	50, 125, 200, 250, 333, 500 ohms	30-20,000	+32 DB	5 MA	15.65
HA-134	Push-pull 89's or 2A3's to line.	5,000 to 10,000 ohms	30, 20, 15, 10, 7.5, 5, 2.5, 1.2	30-20,000	+32 DB	5 MA	17.40
HA-135	Push-pull 2A3's to voice coil.	3,000 to 5,000 ohms	30, 20, 15, 10, 7.5, 5, 2.5, 1.2	30-20,000	+32 DB	5 MA	16.25

The above listing includes only a few of the many Hiperm Alloy Transformers available... write for catalog.

United Transformer Corp.
 NEW YORK 13, N. Y.
 150 VARICK STREET
 EXPORT DIVISION: 13 EAST 40th STREET, NEW YORK 16, N. Y.
 CABLES: "ARLAB"

Techniquality



Get the *most* out of your transmitter with the *foremost* crystals—tops in “techniquality” for over 15 years.

In type AX2 *plated* crystals Bliley craftsmen have chalked up another “first” in creative engineering.

Designed specifically for the 80-40-20 meter bands, type AX2 *plated* crystals boast a long list of technical accomplishments, most important of which are *better grid current stability over a wide temperature range*, plus, *improved frequency stability under high drive conditions*.

For better transmitter performance, you'll want to know more about Bliley Type AX2 *plated* crystals. Ask your Bliley distributor for Bulletin 30.

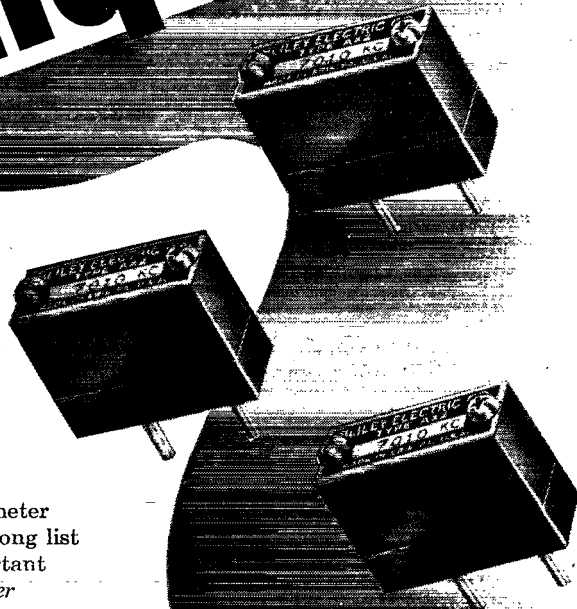

Bliley
CRYSTALS

Type AX2 units, 80-meter band \$2.80 Ea.
Type AX2 units, 40-meter band \$2.80 Ea.
Type AX2 units, 20-meter band \$3.95 Ea.

BILLEY ELECTRIC COMPANY • UNION STATION BUILDING, ERIE, PENNSYLVANIA

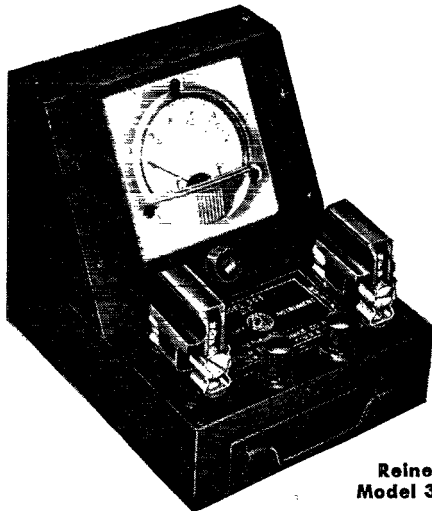

**Reiner
Model 333**

More and more manufacturers are switching to Marion "hermetics". It makes sense to specify these instruments—whether you're a manufacturer, consumer or dealer. All Marion "hermetics" incorporate the new "Bulldozer" moving system, and are built in conformity with JAN standards... they're dust-proof and moisture-proof... they're economical and they last longer... they're available with interchangeable round or square colored flanges at no extra cost... and they're 100% guaranteed. Write for 12-page booklet.

Thousands of Marion Glass-to-Metal Truly Hermetically Sealed Electrical Indicating Instruments are now out in the field. Where are they going? Who's using them? And for what purposes? The scores are coming in... and here's one we thought you might be interested in.

Illustrated is the Reiner Model 333 Volt-Ammeter, developed by the Reiner Electronics Co. of New York. It's a new, versatile piece of equipment for laboratories, schools, repair shops, amateur radio operators, experimenters, etc. One unit can serve 20, or more, different instruments. Used exclusively in the DC Model 333 and the combination AC-DC Model 334 are Marion Glass-to-Metal Hermetically Sealed Instruments.

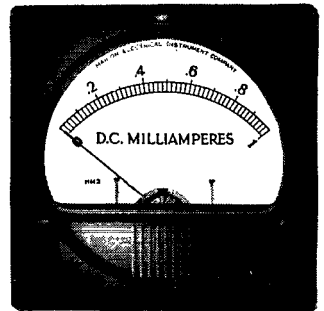

Marion Glass-to-Metal Truly Hermetically Sealed 2½" and 3½" Electrical Indicating Instruments



MARION ELECTRICAL INSTRUMENT CO.
MANCHESTER, NEW HAMPSHIRE

EXPORT DIVISION

• 458 BROADWAY • NEW YORK 13, N. Y., U. S. A.

CABLES. MORHANEX

IN CANADA: THE ASTRAL ELECTRIC COMPANY, SCARBORO BLUFFS, ONTARIO

JUNE 1946

VOLUME XXX

NUMBER 6



STAFF

Editorial

KENNETH B. WARNER, W1EH
(Managing Secretary, ARRL)
Editor

HAROLD M. MCKEAN, W1CEG
Assistant to the Editor

GEORGE GRAMMER, W1DF
(Technical Director, ARRL)
Technical Editor

DONALD H. MIX, W1TS
BYRON GOODMAN, W1PFE
Assistant Technical Editors

A. DAVID MIDDLETON, W2OEN
RICHARD M. SMITH, W2FTX
Technical Assistants

EDWARD P. TILTON, W1HDQ
V.H.F. Editor

WALTER E. BRADLEY, W1PWH
Technical Information Service

Production

RALPH T. BEAUDIN, W1BAW
Superintendent

ELSIE C. HOCHMEISTER
Assistant

Advertising

F. CHEYNEY BEEKLEY, W1GS
Advertising Manager

Circulation

DAVID H. HOUGHTON
Circulation Manager

RALPH T. BEAUDIN, W1BAW
Assistant Circulation Manager



OFFICES

38 La Salle Road
West Hartford 7, Connecticut

Subscription rate in United States and Possessions, \$2.50 per year, postpaid; all other countries, \$3.00 per year, postpaid. Single copies, 25 cents. Foreign remittances should be by international postal or express money order or bank draft negotiable in the U. S. and for an equivalent amount in U. S. funds.

Entered as second-class matter May 29, 1919, at the post office at Hartford, Connecticut, under the Act of March 3, 1879. Acceptance for mailing at special rate of postage provided for in section 1103, Act of October 3, 1917, authorized September 9, 1922. Additional entry at Concord, N. H., authorized February 21, 1929, under the Act of February 28, 1925.

Copyright 1946 by the American Radio Relay League, Inc. Title registered at U. S. Patent Office.

QST

devoted entirely to

AMATEUR RADIO

PUBLISHED, MONTHLY, AS ITS OFFICIAL ORGAN, BY THE AMERICAN RADIO RELAY LEAGUE, INC., AT WEST HARTFORD, CONN., U. S. A.; OFFICIAL ORGAN OF THE INTERNATIONAL AMATEUR RADIO UNION



CONTENTS

It Seems to Us	11
High Power in Two Stages Donald Mix, W1TS	13
Ten-Meter Observations	17
Miniature Tubes in a Six-Meter Converter Richard W. Houghton, W1NKE	18
June 22nd-23rd — Tenth ARRL Field Day!	22
Silent Keys	23
Looking Over the Postwar Receivers The Hammarlund HQ-129-X	24
Happenings of the Month	26
In QST 25 Years Ago This Month	30
A Mobile Rig for 50 and 28 Mc. Edward P. Tilton, W1HDQ	31
Long-Wire Antennas Walter van B. Roberts, W3CHO	36
A Field-Intensity Meter for V.H.F. D. C. Summerford, W9AYH	40
ARRL QSL Bureau	42
Getting Started on 420 Mc. W. F. Hoisington, W1LAS/2	43
Technical Topics	
Standardized Component Values	46
Frequency-Shift Keying	46
“No Neutralization Required”	48
Making the Most of It Eugene A. Hubbell, W9ERU	49
How’s DX?	51
ARRL Code-Proficiency Program . F. E. Handy, W1BDI	53
Long Leads Aren’t Necessary George W. Shuart, W2AMN	55
The World Above 50 Mc.	58
I.F. Amplifiers in Television Receivers Marvin H. Kronenberg, W2IJU	62
Hints and Kinks	66
Foreign Notes	68
How Much Inductance? George H. Floyd, W60JK/2	69
Correspondence from Members	70
Operating News	72
Station Activities	82
Book Reviews	146
WWV	152



THE NEW S-38's

4 Bands—540 kc. to 32 Mc.

\$39.50
ADD 3%
IN
ZONE 2

The Model S-38 meets the demand for a truly competent communications receiver in the low price field. Styled in the post-war Hallicrafters pattern and incorporating many of the features found in more expensive models, the S-38 offers performance and appearance far above anything heretofore available in its class. Four tuning bands, CW pitch control adjustable from the front panel, automatic noise limiter, self-contained PM dynamic speaker and "Airodized" steel grille, all mark the S-38 as the new leader among inexpensive communications receivers.

FEATURES

1. Overall frequency range—540 kilocycles to 32 megacycles in 4 bands.
Band 1—540 to 1650 kc.
Band 2—1.65 to 5 Mc.
Band 3—5 to 14.5 Mc.
Band 4—13.5 to 32 Mc.
Adequate overlap is provided at the ends of all bands.
2. Main tuning dial accurately calibrated.
3. Separate electrical band spread dial.
4. Beat frequency oscillator, pitch adjustable from front panel.
5. AM/CW switch. Also turns on automatic volume control in AM position.
6. Standby/receive switch.
7. Automatic noise limiter.
8. Maximum audio output—1.6 watts.
9. Internal PM dynamic speaker mounted in top.
10. Controls arranged for maximum ease of operation.
11. 105-125 volt AC/DC operation. Resistor line cord for 210-250 volt operation available.
12. Speaker/phones switch.

CONTROLS: SPEAKER/PHONES, AM/CW, NOISE LIMITER, TUNING, CW PITCH, BAND SELECTOR, VOLUME, BAND SPREAD, RECEIVE/STANDBY.

EXTERNAL CONNECTIONS: Antenna terminals for doublet or single wire antenna. Ground terminal. Tip jacks for headphones.

PHYSICAL CHARACTERISTICS: Housed in a sturdy steel cabinet. Speaker grille in top is of airodized steel. Chassis cadmium plated.

SIX TUBES: 1—12SA7 converter; 1—12SK7 IF amplifier; 1—12SQ7 second detector, AVC, first audio amplifier; 1—12SQ7 beat frequency oscillator, automatic noise limiter; 1—35L6GT second audio amplifier; 1—35Z5GT rectifier.

OPERATING DATA: The Model S-38 is designed to operate on 105-125 volts AC or DC. A special external resistance line cord can be supplied for operation on 210 to 250 volts AC or DC. Power consumption on 117 volts is 29 watts.

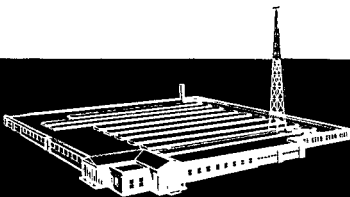

hallicrafters RADIO

THE HALLICTRAFTERS CO., MANUFACTURERS OF RADIO AND ELECTRONIC EQUIPMENT, CHICAGO 16, U. S. A.

AND MORE TO COME



the hallicrafters co.

DESIGNERS AND MANUFACTURERS OF RADIO COMMUNICATIONS EQUIPMENT

TO ALL AMATEURS:

The Model S-38 described on the opposite page and the Model S-40 previously announced are among the first of a long line of new and exciting pieces of communications equipment that will be coming forth from Hallicrafters radio laboratories. Compact in size, moderate as to price the Model S-38 is nevertheless expensively and beautifully engineered and it is a prime example of the kind of workmanship that will keep Hallicrafters pre-eminent in the amateur field.

The two planks in the platform that will continue to uphold the great Hallicrafters tradition are: 1. The conception, design and engineering of all receivers and transmitters to meet the most exacting standards of amateur radio. 2. The custom-built reproduction of these units in quantities large enough to assure economical distribution and a real saving to the ultimate user -- the ham. Where others could only dream about or build by hand expensive equipment, Hallicrafters by virtue of 20 years' experience in the field and a severe adherence to the likes and dislikes of the amateur, can continue to bring into the market place the finest equipment available at the lowest possible price.

For Hallicrafters the introduction of the S-38 and the S-40 is only a beginning -- the beginning of a new phase of development that will see more and more models available with the latest improvements. Working side by side with the ham for the extension of the whole science of communications, Hallicrafters will continue to deserve the reputation as builders of "the radio man's radio".

Sincerely

Bill Halligan

W9WZE



Section Communications Managers of the A.R.R.L. Communications Department

Reports Invited. All amateurs, especially League members, are invited to report station activities on the first of each month (for preceding month) direct to the SCM, the administrative ARRL official elected by members in each Section. Radio Club reports are also desired by SCMs for inclusion in QST. All ARRL Field Organization appointments are now available to League members. These include ORS, OES, OPS, OO, and OBS. Also, where vacancies exist SCMs desire applications for SEC, EC, RM, and PAM.

ATLANTIC DIVISION				
Eastern Pennsylvania	W3BES	Jerry Mathis	623 Crescent Ave. 9701 Monroe St. Silver Springs P. O.	Glenside Gardens
Maryland-Delaware-District of Columbia	W3CIZ	Hermann E. Hobbs	623 E. Brown St.	Linden, Maryland
Southern New Jersey	W3GCU	Ray Tomlinson	4158 Ridge Road, West	Trenton 10
Western New York	W8UPH	Charles I. Otero	927 East 23rd St.	Spencerport
Western Pennsylvania	W3NCJ	R. R. Rosenberg		Erie
CENTRAL DIVISION				
Illinois	W9NUX	David E. Blake, II	4501 N. Malden St.	Chicago 40
Indiana	W9SWH	Ted K. Clifton	550 Eben St.	New Haven
Kentucky	W5IEZ/9	Joseph P. Colvin	1653 Beechwood Ave.	Louisville 4
Michigan	W8DPE	Harold C. Bird	R.F.D. 2, Box 228	Pontiac 2
Ohio	W8MFP	Carl F. Wiehe	122 St. Albert St.	St. Bernard 17
Wisconsin	W9RH	Emil Felber, Jr.	1625 N. 18th St.	Milwaukee 5
DAKOTA DIVISION				
North Dakota	W8EVP	Raymond V. Barnett	406-17th St.	Bismarck
South Dakota	W9QVY	P. H. Schultz	118 N. Yankton Ave.	Piuteau
Northern Minnesota	W9FUJZ	Armond D. Brattland	2802 S. Western	Los Angeles, Calif.
Southern Minnesota	W9OMC	Vernon G. Prybil	560 Brown St.	Hutchinson
DELTA DIVISION				
Arkansas	W5GED	Ed Beck	2503 Bishop St.	Little Rock
Louisiana	W5DWW	W. J. Wilkinson, Jr.	Room 313, Jefferson Hotel	Shreveport
Mississippi	W5HAV	P. W. Clement	524 Santini St.	Biloxi
Tennessee	W4SP	James B. Witt	R.F.D. 6, Shady Dell Trail	Knoxville
HUDSON DIVISION				
Eastern New York	W2HZL	Ernest E. George	2044 Lexington Parkway	Schenectady 8
N. Y. C. & Long Island	W2KDC	Charles Ham, Jr.	151-06 84th Drive	Jamaica, L. I., 2
Northern New Jersey	W2CQD	Winfield G. Beck	617 Spruce St.	Roselle
MIDWEST DIVISION				
Iowa	W9PYR	Lealie B. Vennard	2712 Washington St.	Burlington
Kansas	W9AWP	A. B. Unruh	1617 S. Seneca St.	Wichita 12
Missouri	W9OUD	Mrs. Letha A. Dangerfield	411 Moffett Ave.	Joplin
Nebraska	W9PQB	Arthur R. Gaeth	6105 N. 37 St.	Omaha 11
NEW ENGLAND DIVISION				
Connecticut	W1KOY	Edmund R. Fraser	48 Willow St.	West Haven 16
Maine	W1AOL	G. C. Brown	379 No. Main St.	Brewer
Eastern Massachusetts	W1ALP	Frank L. Baker, Jr.	91 Atlantic St.	North Quincy 71
Western Massachusetts	W1JAH	William J. Barrett	239 Columbia St.	Adams
New Hampshire	W1AXL	John H. Stoughton	RFD 2	Claremont
Rhode Island	W1HRC	Clayton C. Gordon	70 Columbia Ave., Gaspee	Plateau, Providence 5
Vermont	W1NDL	Gerald Benedict	23 Foster St.	Montpelier
NORTHWESTERN DIVISION				
Alaska	K7CBF	August G. Hiebert	c/o K FAR	Fairbanks
Idaho	W7AVP	Don D. Oberbillig	P. O. Box 486	Boise
Montana	W7CPY	Rex Roberts	Box 1088	Glendive
Oregon *	W7BEE	Cliff Tice	McKay Dam	Pendleton
Washington	W7FWD	O. U. Tatro	513 N. Central	Olympia
PACIFIC DIVISION				
Hawaii	K6RLG	Howard S. Simpson	2068 Wells St.	Wailuku, Maui
Nevada	W6CWW	N. Arthur Sowie	Box 2025	Reno
Santa Clara Valley	W6BPT	Roy E. Pinkham	1061 Fremont St.	Santa Clara
East Bay	W6TI	Horace R. Greer	414 Fairmount Ave.	Oakland 11
San Francisco	W6CVP	Samuel C. Van Liew	215 Knowles Ave.	Daly City
Sacramento Valley	W6MGC	John R. Kinney	5240 Jay St.	Sacramento 16
Philippines	KA1GR	George L. Rickard	Box 849	Manila
San Joaquin Valley	W6FSQ	James F. Wakefield	1548 L St.	Fresno
ROANOKE DIVISION				
North Carolina	W4CYB	W. J. Wortman	c/o Duke Power Co.	Charlotte 1
South Carolina	W4BOE/JANG	Ted Ferguson	3422 Rosewood Drive	Columbia 25
Virginia	W3AKN	Walter C. Walker	217-51 St.	Newport News
West Virginia	W8JM	Donald B. Morris	303 Home St.	Fairmont
ROCKY MOUNTAIN DIVISION				
Colorado	W9OYT	Glen Bond	2550 Kendall	Denver 14
Utah-Wyoming	W6LLH	Victor Drabble	1024 Oak St.	Ogden, Utah
SOUTHEASTERN DIVISION				
Alabama	W4GBV	Lawrence J. Smyth	808 Winona Ave.	Montgomery
Eastern Florida	W4IP	Robert B. Murphy	3302 S.W. Grapeland Blvd.	Miami 33
Western Florida	W4MS	Lt. Edward J. Collins	1215 N. 12th Ave.	Pensacola
Georgia	W4HYW	Thomas M. Moss	570 Oak Drive	Hapeville
West Indies (Cuba) (Puerto Rico-Virgin Islands)*	K4KD	Everett Mayer	P. O. Box 1061	San Juan 5, P. R.
SOUTHWESTERN DIVISION				
Los Angeles	W6QWZ	Ben W. Onetnik	9631 3rd Ave.	Inglewood
Arizona	W6MLL	Gladden C. Elliott	1408 West Fresno St.	Tucson
San Diego	W6CHV	Ralph H. Culbertson	7172 Eads St.	La Jolla
WEST GULF DIVISION				
Northern Texas	W5ALA	Jack T. Moore	4529 Fairway Ave.	Dallas 4
Oklahoma	W5AYL	Ed Oldfield	2141 N.W. 35th St.	Oklahoma City 6
Southern Texas	W5JC	James B. Rives	1721 Kentucky Ave.	San Antonio 1
New Mexico	W5HJF	J. G. Hancock	110 S. E. Nevada St.	Portales
MARITIME DIVISION				
Maritime	VE1DQ	A. M. Crowell	69 Dublin St.	Halifax, N. S.
ONTARIO DIVISION				
Ontario	VE3EF	Dr. Donald R. Gunn	1007 Lakeshore Road	New Toronto, Ont.
QUEBEC DIVISION				
Quebec	VE2CO	L. G. Morris	4114 Hingston Ave.	Montreal 28, Que.
VANALTA DIVISION				
Alberta	VE4GE	C. S. Jamieson	581 W. Riverside Drive	Drumheller, Alta.
British Columbia	VE5DD	C. O. I. Sawyer	2634 West 31st Ave.	Vancouver
PRAIRIE DIVISION				
Manitoba	VE4AM	A. W. Morley	26 Lennox St.	St. Vital
Saskatchewan	VE4SY	Arthur Chesworth	1084 Redland Ave.	Moose Jaw

*Officials appointed to act temporarily in the absence of a regular official.



Now!

**RESISTANCE RANGES RIGHT AT YOUR FINGERTIPS
EASY TO TELL AT A GLANCE!**

**NEW...
HANDY...
QUICK...
ACCURATE...**

HERE'S SOMETHING NEW—The RESIST-O-GUIDE, a practical aid in resistor range identification for every Radio Serviceman, Ham, Electrical Designer and Electronic Engineer.

To use the pocket size RESIST-O-GUIDE simply turn its three wheels to correspond with the color code on any composition-type resistor—the standard RMA range is automatically and accurately indicated. Readings are direct... no cumbersome calculations! Or, turn the wheels to indicate any desired standard range, and you are immediately shown the correct color coding.

The RESIST-O-GUIDE is convenient and accurate—and varnished for durability. To get the RESIST-O-GUIDE contact your IRC distributor—it's not sold elsewhere.

THE
Resist-O-Guide
10¢ at all IRC Distributors



INTERNATIONAL RESISTANCE CO.

401 N. BROAD ST., PHILADELPHIA 8, PA.

Canadian Licensee: International Resistance Co., Ltd., Toronto

CABLES

**For Use
in Transmission of
High Frequencies**

CONNECTORS

● Amphenol Twinax and Coax RG cables, produced to standards that surpass the high Army-Navy specifications for critical wartime uses, are ideal for the myriad of peacetime applications in all phases of the rapidly expanding electronic industries. Rigid laboratory tests and notarized affidavits on every shipment give final assurance of extra quality and dependability.

● Amphenol special low-loss V.H.F. connectors are available in a complete line for all practical applications of RG cables and other uses. Mechanically efficient and electrically correct, these easily assembled connectors and adapters provide the utmost efficiency in circuits in which they are used.

AMPHENOL ASSEMBLY SERVICE

An important part of Amphenol service to users of cables and connectors is a complete Assembly Service. Rigid specifications and performance requirements, plus thorough scientific testing of each part and process, assures users of satisfactory service. For cables, connectors and complete assembly service, look to the world's largest producer - Amphenol.

AMERICAN PHENOLIC CORPORATION
CHICAGO 50, ILLINOIS
IN CANADA
AMPHENOL LIMITED • TORONTO

AMPHENOL

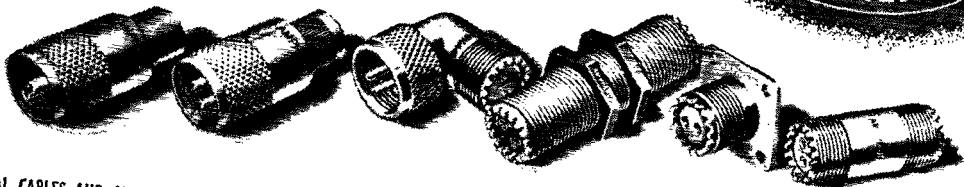

COAXIAL CABLES AND CONNECTORS • INDUSTRIAL CONNECTORS, FITTINGS AND CONDUIT • ANTENNAS • RADIO COMPONENTS • PLASTICS FOR ELECTRONICS



Favorite rectifier

FOR HAM RIGS

Type GL-866-A/866

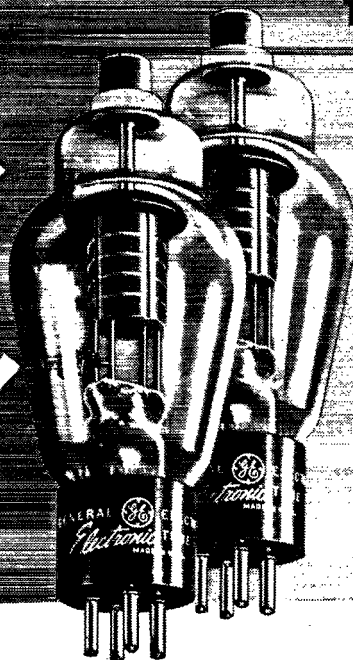

\$1.50

AMATEURS BUY PLENTY of these mercury-vapor rectifiers—and for a good reason. In dollar-value the GL-866-A/866 stands alone. A pair will deliver 3,180 volts at 0.5 ampere (full-wave rectified d-c)! Usually that's more than enough for your transmitter.

The GL-866-A/866 is sturdily built. Also, an edgewise-wound ribbon filament provides a large emission re-

serve, which contributes importantly to the tube's long life.

Check with your ham friends as to the all-around staunch performance of Type GL-866-A/866. Condensed ratings are given at the right. Your nearest G-E distributor will supply you with further information, or write direct to: *Electronics Department, General Electric Company, Schenectady 5, New York.*

CHARACTERISTICS of Type GL-866-A/866

Cathode type	filamentary
Cathode voltage	2.5 v
Cathode current	5 amp
Peak voltage drop, typical	15 v
Max anode voltage, peak inverse	10,000 v
Max anode current, instantaneous	1 amp
Max anode current, average	0.25 amp

ELECTRONIC TUBES OF ALL TYPES FOR THE RADIO AMATEUR

GENERAL ELECTRIC

161-E2-8850

THE AMERICAN RADIO RELAY LEAGUE, INC.,

is a noncommercial association of radio amateurs, bonded for the promotion of interest in amateur radio communication and experimentation, for the relaying of messages by radio, for the advancement of the radio art and of the public welfare, for the representation of the radio amateur in legislative matters, and for the maintenance of fraternalism and a high standard of conduct.

It is an incorporated association without capital stock, chartered under the laws of Connecticut. Its affairs are governed by a Board of Directors, elected every two years by the general membership. The officers are elected or appointed by the Directors. The League is noncommercial and no one commercially engaged in the manufacture, sale or rental of radio apparatus is eligible to membership on its board.

"Of, by and for the amateur," it numbers within its ranks practically every worth-while amateur in the nation and has a history of glorious achievement as the standard-bearer in amateur affairs.

Inquiries regarding membership are solicited. A bona fide interest in amateur radio is the only essential qualification; ownership of a transmitting station and knowledge of the code are not prerequisite, although full voting membership is granted only to licensed amateurs.

All general correspondence should be addressed to the Secretary at the administrative headquarters at West Hartford, Connecticut.



Past Presidents

HIRAM PERCY MAXIM, W1AW, 1914-1936
EUGENE C. WOODRUFF, W8CMP, 1936-1940

Officers

President..... GEORGE W. BAILEY, W1KH
Washington, D. C.

Vice-President

Secretary..... KENNETH B. WARNER, W1EH
West Hartford, Connecticut

Communications Manager..... F. E. HANDY, W1BDI
West Hartford, Connecticut

Treasurer..... DAVID H. HOUGHTON
West Hartford, Connecticut

General Counsel..... PAUL M. SEGAL
1026 Woodward Building, Washington 5, D. C.

Directors

President

GEORGE W. BAILEY..... W1KH
1530 P St., N.W., Washington 25, D. C.

Vice-President

Canadian General Manager

ALEX REID..... VE2BE
240 Logan Ave., St. Lambert, P. Q.
Alternate: Leonard W. Mitchell..... VE3AZ
78 Reglan Ave., Toronto, Ont.

Atlantic Division

EDWARD G. RASER..... W3ZI
315 Beechwood Ave., Trenton 8, N. J.
Alternate: J. Victor Brotherson..... W8BHN
1743 Ottawa Drive, Erie, Pa.

Central Division

JOHN A. KIENER..... W8AVH
3462 Edison Rd., Cleveland Heights,
Cleveland 21, Ohio
Alternate: Earl S. Nelson..... W8DS
22551 Hadden Rd., Euclid 17, Ohio

Dakota Division

TOM E. DAVIS..... W9VVA
915 W. Becker Ave., Willmar, Minn.
Alternate: Harold B. Love..... W9ZRT
Box 426, Mandan, N. D.

Delta Division

GEORGE S. ACTON..... W5BMM
Plain Dealing, La.
Alternate:

Hudson Division

ROBERT AKERIDGE KIRKMAN..... W2DSY
Werah Pl., R.F.D. No. 1, Box 61, Long Branch, N. J.
Alternate: George Rulfs, Jr..... W2CJY
38 Brookwood Drive, Manhasset, L. I., N. Y.

Midwest Division

FLOYD E. NORWINE, JR..... W9EFC
7405 Hiawatha Ave., Richmond Heights 17, Mo.
Alternate: C. A. Colvin..... W9VHR
% Omaha & Council Bluffs St. Railway Co.,
Omaha 2, Nebr.

New England Division

PERCY C. NOBLE..... W1BVR
37 Broad St., Westfield, Mass.
Alternate: Clayton C. Gordon..... W1HRC
70 Columbia Ave., Warwick, R. I.

Northwestern Division

KARL W. WEINGARTEN..... W7BG
3219 N. 24th St., Tacoma 7, Wash.
Alternate: R. Rex Roberts..... W7CPY
110 W. Brennan St., Glendive, Mont.

Pacific Division

J. L. McCARGAR..... W6EY
66 Hamilton Pl., Oakland 12, Calif.
Alternate: Elbert J. Amarantes..... W6FBW
1675 Dale Ave., San Jose, Calif.

Roanoke Division

H. L. CAVENESS..... W4DW
2607 Vanderbilt Ave., Raleigh, N. C.
Alternate: J. Frank Key..... W3ZA
Box 707, Buena Vista, Va.

Rocky Mountain Division

Acting Director:
HOWARD R. MARKWELL..... W9TFP
355 Monroe St., Denver 6, Colo.

Southeastern Division

WILLIAM C. SHELTON..... W4ASR
527 Revilo Blvd., Daytona Beach, Fla.
Alternate: William P. Sides..... W4AUP
Fleming Road, Montgomery, Ala.

Southwestern Division

JOHN E. BICKEL..... W6BKY
1834 E. Whittier Blvd., Whittier, Calif.
Alternate: Eldridge E. Wyatt, Jr..... W6ARW
P. O. Box 3597, Long Beach 3, Calif.

West Gulf Division

WAYLAND M. GROVES..... W5NW
% Humble Pipe Line Co., Odessa, Texas
Alternate: Jennings R. Poston..... W5AJ
P. O. Box 848, Curundu, Panama Canal Zone

"It Seems to Us..."

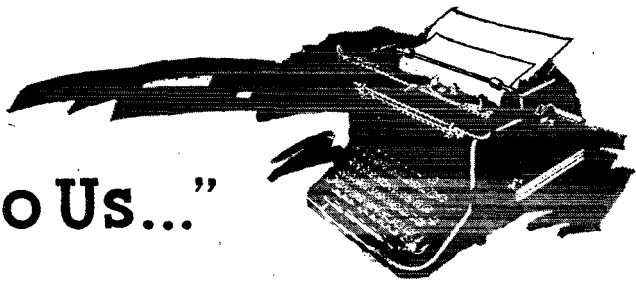

AN IDEA AND A PROPOSAL

Highway engineers are expecting unprecedented automobile traffic as soon as more cars are available, and are planning superhighways, cloverleaves, by-passes and whatnot to deal with it. If the interference we amateurs are experiencing in our first few months back on the air is any indication of what is in store for us after parts become freely available for station construction and after the rest of the GIs return and get housed, we'll have to do something about our problem, too. It's fierce already and it's going to be worse. We have an idea that we think may help, and we want to outline it to you and see what you think of it. In essence it is the old idea that it would be helpful if all the parties to a QSO were on the same frequency, but we have some new variations on the theme. Our twin problems are to reduce interference and to assure easier and more reliable QSOs, and we believe our idea would help in both respects. While we shall describe it in terms of c.w., it seems to us that it is equally applicable to 'phone.

We believe everybody will admit that if two amateur stations in QSO use the same frequency, they make the most efficient use of amateur facilities. They occupy only one frequency, and they employ it continuously, and that discourages others from intentionally using the same spot and so reduces interference somewhat; and if another amateur wants either station when they finish, he knows where they both are. If you are tempted to think that two frequencies used half the time are just the same thing, consider the number of times you have opened up on what seemed a likely spot, only to find another station come back to his correspondent about the time you got well started. If the channel were occupied the whole time (or if you'd listened long enough) you'd never make that mistake. But as it is, you ask for repeats or have your man stand by until the channel is clear, and frequently you spend most of your QSO time doing only that, so time is wasted and the contact spoiled and much extra QRM created. If each pair of stations used a single common frequency, most of those things wouldn't occur.

So we think, as a beginning point, that in the

days to come it is going to be absolutely essential for the well-equipped amateur station to be able to move practically instantly, and with high precision, to any spot in an amateur band. That means a high-quality variable-frequency oscillator, it means the elimination of every possible adjustment in the intermediate stages of the transmitter, and it means arrangements for the automatic or very-rapid adjustment of the final and the antenna loading. We have some technical ideas along that line that are under exploration in the ARRL laboratory right now, and which offer the promise that ultimately all of us can have transmitters of that nature. Meanwhile all of us with v.f.o.s can approximate that performance within a portion of a band, even though we have to retune to reach some other part of the band.

Now supposing we all had such quickly-variable transmitters, how could we employ them to better ourselves? Let's first examine how we get together in contacts. Some QSOs are by appointment — schedules between two or more stations on a predetermined frequency, or trunklines or nets opening on schedule on a spot frequency. Those cases take care of themselves. The rest of us — and that means most of us — make our contacts either by CQing or by answering CQs. As some experienced amateurs know, both CQing and answering are arts in which success comes only to those with skill and judgment: knowing where to call, when, and for how long. Many amateurs call too long, or call with predestined futility, and so needless QRM is caused. Of the many who answer, only one is chosen; and the others butterfly their way to a new CQer to repeat the performance. And so the night is full of calls on unwise frequencies, and of futile responses, and there is much interference that would never exist if we had a better system. That's where our suggestion comes in, and here is how it would work:

A station about to call CQ looks over the band and carefully selects a spot where he would like to work somebody. He chooses the spot in terms of the prevailing interference pattern, with the thought of *receiving* on that frequency. He spots his v.f.o. on that frequency and calls CQ. The bandcombers looking for a contact then move their transmitters near him

— but not on him — and answer. He chooses one of them and replies. The chosen one on his next transmission then moves on to the CQer's own frequency for the rest of the contact. Immediately all the advantages we have visualized are in full operation.

At this point a bunch of you lads are going to say that this is old stuff for v.f.o. men, that it has been v.f.o. technique for years to move to the caller's frequency, and that it looks to you as though *QST* were just discovering there was such a thing. But read the preceding paragraph again and note that we are proposing that it become standard practice to do the deed in two steps, the first one close to but not "on," the second one dead on the nose.

Now let's break down this study a bit and see why we propose it this way. The answers to a CQ should not be made on the CQer's exact frequency. Much grief has been caused by that practice, particularly in DX contests. Nobody can read anything. But suppose we stay near to him but not on him. Immediately there are two sides, and two little bands, and the six or eight repliers that could be expected under good conditions will naturally be spread out so that, except by misadventure, they can all be read. We'd suggest, for example, that answers to CQs be made within 5 kc. of the caller's frequency but not closer than 1 kc. Another reason beside unintelligibility for making answers a little off the frequency is that otherwise the CQer would have to wait until the longest-winded answerer finishes before the frequency would be free for his QSO with the selected one — whereas if they are spread out he can pick his man, break him, and get going immediately, perhaps while the windy ones are still calling him too long. This system is designed to save time.

It may suggest itself to you that for the QSO itself the CQer should move on to the frequency of the station he selects. But no, for many reasons. The listening gang would not hear who had been chosen and couldn't be expected just to sit silently listening on their own frequencies in hopes. And the answerer's initial frequency hasn't been carefully chosen and may be in use; the only frequency desirable for the contact, by our first defining of the problem, is the one selected by the CQer himself before he called. So the chosen one, on his next transmission, moves on to the CQer's exact frequency, and away they go with one channel occupied solidly by them but only one.

If we had the foregoing as our operating technique, CQs would be much briefer, for one could repeat as necessary in the knowledge that as the gang moved in they would be within beat note. The CQer could even be broken in the act of calling. Answers would be much briefer, too, since they would be inter-

cepted almost at once. It wouldn't be like answering now away from the frequency and wondering how long it will take the guy to get to your spot or whether he ever will. He would get you and select you right away or not at all, so there would be no sense in a long answer. QSO could be established in a matter of seconds. Then as the one selected moved to the CQer's frequency, the rest of the gang would drift away to another part of the band with minimum time lost on that fruitless attempt, and only one frequency would be in use for both sides of the continuing QSO. Calling QRM and working QRM would both be minimized.

Well, palpitating world, there it is. What do you fellows think of it? Want to get out your nutpicks and take it apart? Or do you want to try it first?

WHO'S ON 11?

While the radio art and the practices of amateurs have always changed rapidly, the speed with which they can make a bum out of us on this page still amazes us. Here last month we wrote an exuberant little piece to express our delight over the speed with which our gang had occupied the new 11-meter band, and our further delight with the good performance of the band. With the same speed, the gang moved out in a week or two, so that before the ink was dry on last month's editorial there apparently wasn't a cockeyed soul left on the band. We've listened a total of many hours in recent weeks and heard nothing but W images and foreign commercials; and we've called CQ-11 until we were out of spit and nary an answer.

So we'll start all over. What's the matter, fellows? Not enough answers per call? It's a good little band, with performance frequently better than 10, and diathermy QRM isn't at all bad. And we can use both A2 and duplex 'phone. Let's get in there and give it a whirl! Receiver won't tune down there? It takes only a little capacity loading to shove you to 11. Or if your receiver is of the popular two-dial type, set your band-selection dial at exactly 28 Mc. and get a few calibration points from WWV on your tuning dial — seventh harmonics of your 80-meter calibration. Band limits are 27.185 to 27.455. The diathermy is supposed to be on the center frequency of 27.32 but it ain't — most of it is in the 10-meter band. A month ago we called on foreign amateurs to search on 11 for us; they should be listening now. Both the fun of pioneering a new band and the rewards of greater reliability await those who will now fire up on 11. CU there!

Asbury

High Power in Two Stages

A Crystal-Oscillator Beam-Tetrode-Amplifier Transmitter for Four Bands

BY DONALD MIX, * WITS

• New high-power beam tetrodes requiring only a few watts of driving power offer a solution to the ham who wants a lot of power in a small package. This two-stage transmitter will handle a power input of 600 to 800 watts and yet it occupies less than a cubic foot of space.

IF POSTWAR low-frequency ham transmitters are going to look different than those in general use prior to the shutdown, it is almost certain that most of the changes will be brought about through the use of tubes with more than three elements. Although, admittedly, pentodes and beam tetrodes introduce some problems which are not encountered with triodes, it is impossible to ignore the fact that their low driving-power requirements offer certain advantages which cannot be realized without them. These advantages become more apparent when one attempts to lay out a high-power transmitter for several bands. For a final amplifier which will handle a half kw. or more, there may be more than a ten-to-one difference between the

power required to drive a stage using one or two multi-element tubes and that needed to accomplish the same job with triodes.

A handswitching exciter which must deliver 100 watts or so on several bands is a formidable project to contemplate when compared with one which need produce only 10 watts to put the same final-stage power into the antenna. Another problem which has always been with us, but the seriousness of which has been fully appreciated only recently because of our confinement to the 28-Mc. band, is that of eliminating radiation at frequencies lower than the desired operating frequency — frequencies which are generated in the exciter and which find their way into the antenna. A considerable reduction in power in the exciter stages will go a long way toward decreasing unnecessary QRM in amateur bands in which the transmitter is not supposed to be operating — not to mention the reduction in the quantity of green tickets issued by the FCC, which has been altogether too high since the reopening of the 10-meter band.

The rig shown in the photographs has only two stages, with not over 5 watts required on the grid of the final amplifier for efficient operation, yet it has a power-handling capability of 600 watts — or more, with a small amount of forced-

* Assistant Technical Editor.

◆
Front view of the 4-250A transmitter. Along the bottom of the panel, from left to right, are the controls for the oscillator tuning condenser, the crystal switch and the metering switch. The large dial is for the output tank condenser.

◆

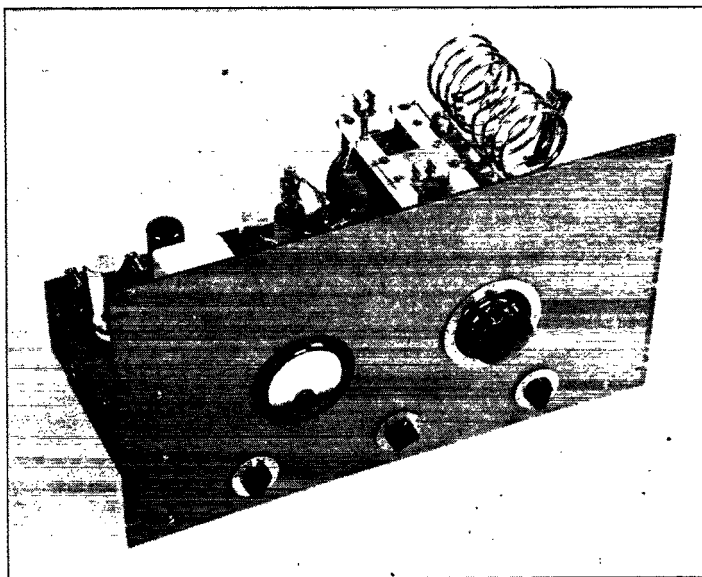

changed often, necessitating frequent retuning.

Although a fair amount of power is wasted, a series dropping resistor from the plate supply seems to be the best method of supplying screen voltage. Not only does this system automatically keep the screen dissipation within reasonable limits, but the dropping resistor, or a voltage divider which wastes even more power, is required if the amplifier is to be plate-screen modulated without a special modulation transformer. This system also guarantees the simultaneous application of plate and screen voltages which reduces wear and tear on the screen. For a 2000-volt supply, the resistor should be a 15,000-ohm 200-watt unit. Since considerable heat is generated by the dropping resistor, it should not be placed under the r.f. chassis but external to it — possibly in the power-supply unit.

The transmitter is built on a 10x17x3-inch chassis with a 10½-inch standard rack panel. The mechanical arrangement shown in the photographs should be followed as closely as possible, since upon the placement of parts may depend the stability of the amplifier. The oscillator-circuit components are grouped at the left-hand end of the chassis. The Millen crystal sockets are lined up with their centers 1½ inches in from the rear edge of the chassis in the left-hand corner. The sockets for the 6L6 and the plug-in cathode coil, L_1 , are in line with their centers, 3½ inches from the back edge of the chassis, while the oscillator plate coil is in line with the 6L6, 6 inches from the rear edge of the chassis and 3½ inches from the left-hand end. The crystal switch is placed near the 6L6 socket and set at an angle with respect to the edges of the chassis. It is controlled by a knob at the center by means of a

long ¼-inch shaft, which runs diagonally across the chassis, and a Millen 39005 all-metal flexible shaft coupling of the "universal joint" type.

The socket for the 4-250A is centered 7¼ inches from the left-hand end of the chassis and 3 inches from the rear edge. It is spaced 1⅛ inch below the chassis on metal pillars so that the base of the tube is shielded from the plate. A spring contact is fastened to the socket so that the metal ring around the base of the tube will be grounded when the tube is inserted in the socket. The amplifier plate-tank condenser is placed with its shaft 5¼ inches in from the right-hand edge of the chassis, while the coil-base assembly is elevated on 3-inch cone insulators centered 2½ inches from the edge. The clips for the padding condenser, C_{13} , required for the 3.5- and 7-Mc. bands, are mounted on top of the condenser on 1-inch tubular spacers. A pair of long 6-32 mounting screws, substituted for two of the stator-assembly screws, passing through the spacers, serve to make the connection between the stators of C_3 and the terminals of C_{13} . The Hammarlund CH-500 r.f. choke, RFC_2 , is mounted alongside the tank condenser, near the center, with the plate blocking condenser, C_{12} , fastened to the top. High power sometimes shows up deficiencies which are not noticed when operating at low power. In this instance chokes which had been used previously with apparent success at lower power, burned up at 14 or 28 Mc. with higher power when the indication of loss became visible. The Hammarlund CH-500 was the only choke of several tried which stood up satisfactorily on all bands.

Plate voltage is fed from a Millen safety ter-

◆
Rear view of the two-stage high-power transmitter, showing the vacuum-type padding condenser in place on top of the tank condenser.
◆

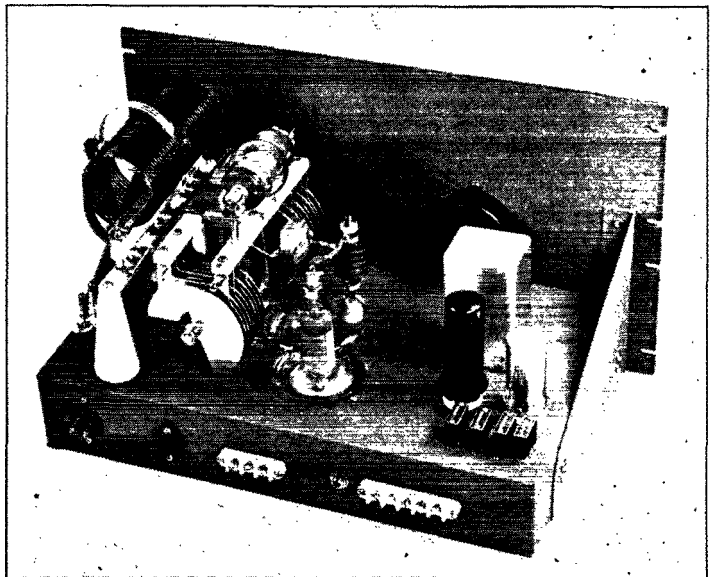

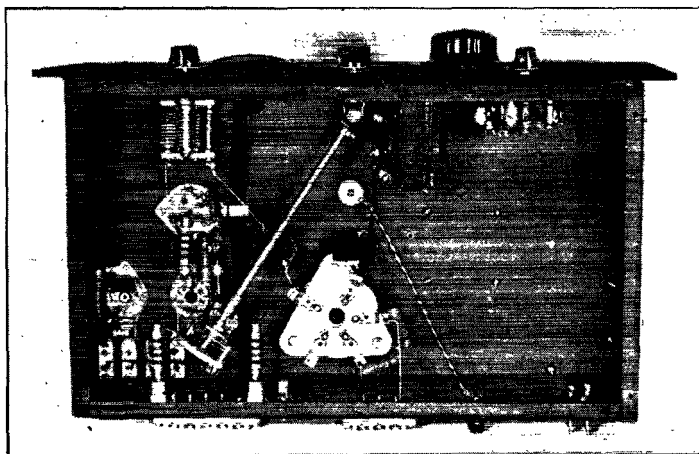

Bottom view showing the arrangement of parts under the chassis. Mounted off the rear edge of the chassis are the oscillator (left) and amplifier (right) grid chokes. The oscillator plate choke is above. The condenser under the crystal-switch control shaft is the coupling condenser, C_s . The oscillator tuning condenser, C_2 , the 6.3-volt filament transformer and the metering switch are along the front edge of the chassis.

minimal in the rear edge of the chassis to the bottom end of the r.f. choke through a Millen 32101 steatite bushing. The hole for the safety terminal should have a clearance of about $\frac{1}{16}$ inch around the part which goes through the chassis, to decrease the danger of a voltage break-down at this point. The link output terminals are in the right-rear corner, insulated from the chassis on a National FWG polystyrene terminal strip.

Underneath, at the amplifier end of the chassis, are the metering switch, S_2 , and the 6.3-volt filament transformer. Because none of the available filament transformers for the 4-250A would fit under the chassis, a transformer was not included in the unit. Since this filament requires 14.5 amperes at 5-5.25 volts, the transformer should be located as close to the transmitter chassis as convenient and the leads run with wire not smaller than No. 10. Before operating the transmitter, it is important to check the filament voltage to make sure that it is within the required limits.

It should be mentioned here that there is a reason for specifying mica condensers for C_5 and C_{11} . Paper condensers at both points proved to be unsatisfactory under test. It was found that it was impossible to prevent self-oscillation in the output stage under certain conditions until the paper condensers were replaced by mica units.

On the panel, the milliammeter is placed to balance the amplifier tuning dial, the meter-switch knob to balance that of the oscillator tuning condenser, while the crystal switch is at the center, near the bottom edge. Along the rear edge of the chassis, from left to right, as viewed from the rear, are a terminal strip for making connections to the oscillator supply, the amplifier screen-voltage dropping resistor and to the biasing-voltage source, if one is used, the key jack, filament terminals for the 4-250A including a center-tap connection, a safety terminal for the high-voltage connection and a male plug for

the 115-volt line to the 6.3-volt filament transformer.

The cathode coils (L_1) are wound on Millen metal-base shielded forms without tuning slugs. A change in cathode coils is required only with a change in the band in which the crystal lies. The coil for use with 3.5-Mc. crystals requires an additional 100- μ fd. mica condenser, C_x , connected across the winding as shown in the dotted lines in Fig. 1. This condenser is placed inside the plug-in shield along with the 3.5-Mc. coil. The 100- μ fd. capacitor, C_1 , which is connected permanently in the circuit, is sufficient for use with 7- and 14-Mc. crystals. Since larger coils are desirable for the plate circuit of the oscillator, the coils for L_2 are wound on 1-inch diameter forms enclosed in National type PB-10 plug-in shield cans. The shield should be grounded to the chassis through one of the available pins in the base.

External connections to the unit are indicated in Fig. 1. If both stages are to be keyed as shown, no fixed bias is necessary and all that is required is a grid leak of 5000-ohm 5-watt size, connected across the biasing terminals. This biasing system will serve also in case only the amplifier is to be keyed. Keying of the oscillator alone is not recommended because of the effects of soaring screen voltage mentioned previously, which makes it impossible to cut off plate and screen currents without exceeding the normal operating bias. For this reason, it is highly advisable to use an overload relay in the plate-supply circuit of the amplifier, to protect the tube in case the oscillator fails to function.

After the proper coils for the desired band have been plugged in and the crystal switch turned to select the proper crystal, the key may be closed with the low-voltage supply turned on, but with the high-voltage supply turned off. The combined oscillator plate and screen current at

resonance should be between 35 and 75 ma., depending upon the crystal frequency and whether or not the oscillator is doubling frequency. If the oscillator is operating at the crystal fundamental frequency, oscillation will cease abruptly when the plate tank circuit is tuned to the high-capacitance side of resonance. For reliable operation this circuit should be tuned slightly to the low-capacitance side of resonance—never to the high-capacitance side. When doubling frequency this characteristic disappears so that the plate circuit may be tuned to exact resonance where maximum output should occur.

Tuning the oscillator plate circuit to resonance should result in a grid-current reading when the meter is switched to the second meter-switch position. The reading will vary between 30 or 35 ma. and 50 ma. or more, depending upon the frequency and whether the oscillator is doubling frequency or working "straight through." The potential of the high-voltage supply should be reduced during preliminary adjustments. If no other means of reducing the voltage is available, a 200-watt 115-volt lamp may be connected in series with the primary winding of the high-voltage transformer. The plate circuit of the amplifier should be tuned to resonance first with the antenna link swung out to the minimum-coupling position. The output tank circuit of the amplifier may be coupled through the link coil, either directly to a properly-terminated low-impedance transmission line, or through an antenna tuner to any type of antenna system. With the antenna system connected and the link swung in for maximum coupling, the plate current should increase when the antenna system is tuned through resonance. Every adjustment of the coupling or tuning of the antenna system should always be followed by a readjustment of the tuning of the amplifier tank circuit for resonance. As the loading is increased the plate current at resonance will increase. The loading may be carried up to the point where the plate current (cathode current, minus grid and screen currents) is 300 ma. at 2000 volts. If a small blower is used to force air through the shell at the base of the tube, plate voltage may be increased to 3000 volts, since the tank condenser has sufficient spacing for plate-screen modulation at this voltage. With normal operating conditions under load at 2000 volts, 300 ma., the screen current should not be over 100 ma. Under these conditions the screen voltage should be between 400 and 500 volts.

Once the oscillator plate and amplifier screen by-pass condensers and the amplifier r.f. choke had been changed as described previously, the amplifier settled down to an entirely stable condition. No difficulty was experienced with parasitic oscillations of any type and there was no tendency toward self-oscillation, even at 28 Mc. with the excitation removed and the bias reduced in an attempt to make the stage oscillate.

A pair of 150-watt lamps connected in parallel as a dummy load looked like photofloods with the input running about 600 watts.

Ten-Meter Observations

ORGANIZATION of the 28-Mc. observing program announced last month¹ now is getting under way, and the Bureau of Standards is in the process of preparing log forms and similar material. Those who intend to participate are invited to write to the Bureau expressing their interest. Until regular forms are available, copies of log entries containing the type of data wanted, as outlined in May *QST*, will serve. Logs and communications should be addressed to the Radio Section, National Bureau of Standards, Washington 25, D. C.

In amplification of the collection and reporting of data, Dr. Dellinger writes: "Although it is recognized that few amateurs will be able to adopt the rigorous schedules necessary for a statistical analysis of data on a monthly basis, it is believed that schedules covering the same period each day for as many days as possible during a given month would be desirable. As pointed out previously, a report of complete failure to make any distant contacts for an entire schedule period on any one day would be just as important as a report of successful contacts. Only supposedly sky-wave contacts should be reported.

"It is desired tentatively that each amateur choose to operate regularly in accordance with one or more of the three following plans, in order of importance as follows:

1. Regular schedules with other chosen amateurs.
2. Random contacts with as many different amateurs in an area as possible during a regularly-observed period each day.
3. Random observations with a receiver only on the same basis as (2) above.

Plan 3 would be open to enthusiasts who do not have transmitters.

"Although it is expected and desired that most of the amateurs who participate will choose the daytime and early evening hours when contacts will be most probable, it is hoped that a few venturesome persons will try a tedious night vigil on the chance of obtaining long-distance contacts via sporadic-E, which should occasionally be possible on northern latitudes, especially during the summer.

"We would like to keep all log sheets submitted. Therefore, participants should submit copies if they wish to retain their original log sheets."

Let's keep the dope rolling in to the Bureau!

¹ "Attention: Ten-Meter Operators!" *QST*, May, 1946, p. 35.

Miniature Tubes in a Six-Meter Converter

A Simple Two-Tube Unit With 10.5-Mc. Output

BY RICHARD W. HOUGHTON,* WINKE

IT is possible that more fellows might be tempted to try the new 50-54-Mc. band if they realized that the receiver end, at least, can be handled quite simply and inexpensively — provided a good low-frequency receiver is at hand. It requires nothing more than a converter, the output of which may be fed into the antenna terminals of the already-available communications receiver. In such a unit, the essentials are an oscillator and mixer; a radio-frequency stage may be added if somewhat better sensitivity is desired, but it should not be necessary if the object is simply to hear most of the signals on the band. The intermediate frequency chosen should be within the high-performance range of the available receiver, and the RMA approved value, 10.7 Mc., is a logical choice as a starting point.

Although designed for use with an HRO, which the author had available, the 6-meter converter to be described can be easily adapted for use with any communications receiver. To reduce initial expense and to make best use of available equipment, power for the unit is taken directly from the receiver itself. The additional filament- and plate-power requirements are small and should not overload the average receiver power supply.

*Engineer, National Company, Inc., Malden, Mass.

• It's neither difficult nor expensive to get a good receiving system working on the 50-54-Mc. band if you already have an ordinary communications receiver. Here's a converter design that takes advantage of some of the newer types of tubes that are particularly useful at v.h.f.

To secure maximum performance with minimum tube complement it was believed that the new miniature high-frequency tubes would be ideal. The 6AK5, a high-transconductance pentode, is used as the mixer, and a 6C4 works well as a tuned-plate grid-tickler oscillator.

As shown in the schematic diagram, Fig. 1, the oscillator voltage is injected at the screen grid of the mixer tube. The coupling condenser, C_9 , has sufficient capacitance to act as the 6AK5 screen by-pass condenser as well. The grid tank circuit, comprised of L_2 in parallel with C_1 , C_2 , and C_3 , resonates over the operating frequency range, 49.5 to 54.8 megacycles. C_3 is ganged with the oscillator tuning condenser, C_6 .

The oscillator operates over a range 10.5 Mc. higher than that of the mixer, and the mixer plate circuit is tuned to this intermediate fre-

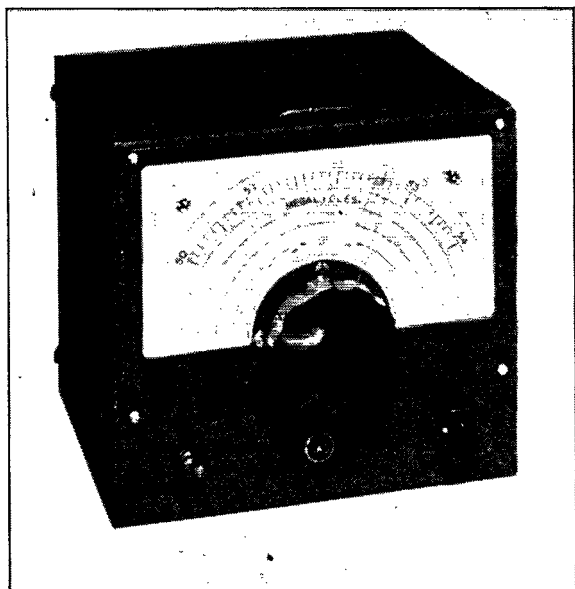

◆

This two-tube 50-Mc. converter incorporates new miniature tubes and obtains its power from the communications receiver with which it is used. The toggle switch at the left cuts the filament circuit when the unit is not in use. The control at the lower right transfers the antenna from the converter to the receiver for normal reception.

◆

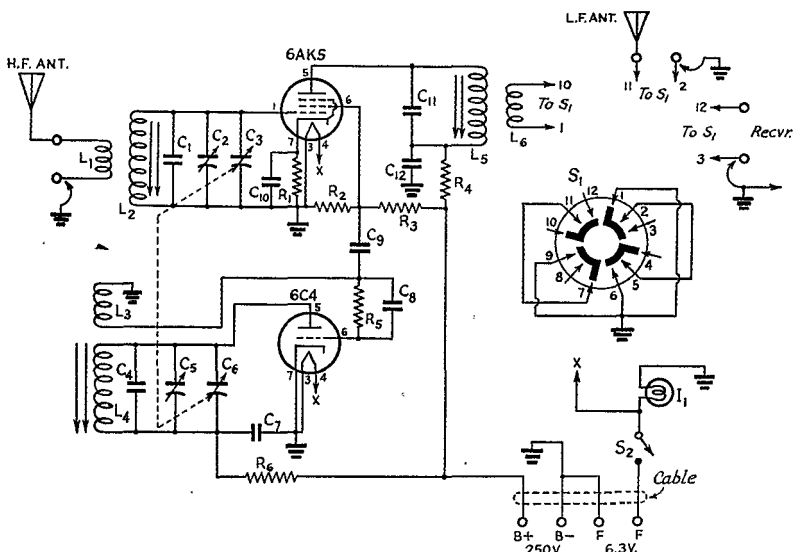

Fig. 1 — Circuit diagram of the 50-Mc. converter.

- C₁ — 15- μ fd. fixed, ceramic, zero temp.-coeff. (Eric NPOA).
- C₂, C₅ — 2-6- μ fd. ceramic trimmer (Centralab 820-A).
- C₃ — 11- μ fd. variable (National UMA-10 with 1 stator plate removed).
- C₄ — 12- μ fd. fixed, ceramic, zero temp.-coeff. (Eric NPOA).
- C₆ — 9- μ fd. variable (National UMA-10 with 1 stator and 1 rotor plate removed).
- C₇, C₈, C₉ — 100- μ fd. mica or ceramic.
- C₁₀, C₁₂ — 50- μ fd. mica or ceramic.

- C₁₁ — 35- μ fd. fixed, ceramic, zero temp.-coeff. (Eric NPOA).
- I₁ — 6.3-volt pilot lamp.
- L₁ to L₆, inc. — See Fig. 2.
- R₁ — 6800 ohms, $\frac{1}{2}$ watt.
- R₂ — 1.5 megohms, $\frac{1}{2}$ watt.
- R₃ — 0.47 megohm, $\frac{1}{2}$ watt.
- R₄ — 0.1 megohm, $\frac{1}{2}$ watt.
- R₅ — 25,000 ohms, $\frac{1}{2}$ watt.
- R₆ — 10,000 ohms, 1 watt.
- S₁ — 4-pole double-throw switch, preferably with ceramic wafers (Oak type HC).
- S₂ — S.p.s.t. toggle.

quency. It was found that the originally-chosen frequency of 10.7 Mc. put several undesirable beats in the region around 51 Mc. and changing to 10.5 Mc. moved them outside the low-frequency end of the band. These beats result from combinations of the converter and receiver local-oscillator harmonics. With the 10.5-Mc. i.f., the fifth harmonic of the receiver's local oscillator ($10.955 \times 5 = 54.775$ Mc.) appears just outside the high end of the tuning range, sufficiently far from the calibrated band so that it does not interfere with normal operation.

Tracking is easily accomplished over the frequency range under consideration because the percentage of frequency change is small. Starting with two identical tuning condensers (National type UMA-10), two plates are removed from the one used in the oscillator and one plate from the one in the mixer. Sufficient fixed padding capacitance, using a zero temperature-coefficient ceramic for low over-all temperature drift, is added to give the required range. The coil forms used are provided with adjustable cores of high-frequency powdered iron, providing an easily-accessible inductance adjustment.

Switch S_1 provides a means of channeling either the converter output or a low-frequency antenna into the antenna terminals of the re-

ceiver. When the converter is in use both low-frequency antenna terminals are switched to ground, thus minimizing direct receiver pick-up at the intermediate frequency. Single-wire or doublet antennas may be used at either high- or low-frequency inputs.

When operating the receiver over its normal frequency range, the converter filaments may be turned off by means of switch S_2 . This function also could be accomplished by means of an additional wafer on S_1 .

A four-prong-to-four-prong adapter, of the sort used for making tube substitutions, is used on the power cord to enable both it and the receiver cord to be plugged into the HRO power pack simultaneously. With receivers having integral power packs a different arrangement would be required, one possibility being to use a similar plug adapter under one of the power tubes in the receiver, picking up the "B" voltage at the screen-grid pin.

Mechanical Details

The tube-and-condenser assembly is mounted on a 3-inch-wide subchassis which is secured by four screws to the main chassis as shown in one of the photographs. Tabs bent up at each end of the bottom provide a mounting for the tuning

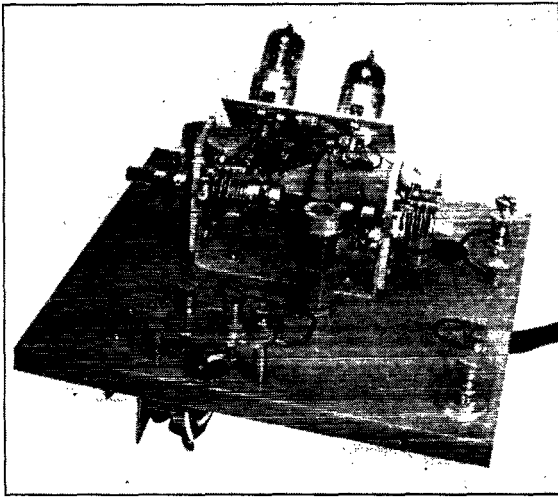

The r.f. construction is shown in this above-chassis view. The 6C4 oscillator is at the left and 6AK5 mixer at the right on the subchassis. The 10.5-Mc. i.f. output coil is in the foreground. Flexible ground leads are shown connected to their binding posts in the position normally used for grounded antenna systems.

condensers. Forty-five degree inclination of the tubes keeps them easily accessible should it be necessary to change them and at the same time brings the wiring within easy reach of a soldering iron — a feature frequently neglected in high-frequency equipment. The r.f. and oscillator coils are mounted on the main chassis as close as possible to their respective condensers and tubes. Tank leads are accordingly kept quite short and direct. The i.f. coil and condenser are likewise mounted on the chassis, in a position opposite the 6AK5 so that the plate lead crosses the condenser shaft at a right angle. All tuning slugs are accessible from the bottom of the unit.

Ceramic trimmer condensers are mounted on top of the tuning condensers, with the respective stator terminals soldered together. The trimmer and air-condenser rotors are connected together by a short piece of bus wire. The tuning condensers are ganged by means of three insulated shaft couplings and two short lengths of bakelite rod.

Both low- and high-frequency antenna terminals are located at the back of the chassis. Short pieces of flexible lead should be provided for grounding one terminal, if the use of a single-ended antenna is contemplated. The i.f. output terminal strip is mounted on $\frac{3}{4}$ -inch spacers in such a position that short leads may be used to connect to the HRO antenna terminals. A knurled nut should be used on one of the mounting screws so that the receiver ground bus may be permanently connected to the converter.

The antenna switch, S_1 , is mounted on a bracket under the main chassis in such a position that short lengths of twisted-pair may be used to connect to the i.f. link and output terminals. A coupling and short length of brass shaft may be used to control the switch from the front panel.

Construction of the coils is shown in Fig. 2.

The tickler winding of the oscillator coil may be secured by threading the ends through two $\frac{1}{32}$ -inch holes at the top of the form and running the leads directly to ground and grid leak respectively. The links on the r.f. and i.f. coils are held in place by twisting the leads tightly as they leave the form. They are then twisted loosely to form a short transmission line to their points of termination. A light coating of Duco cement may be used to hold all windings securely. Depending on the particular type of receiver used, it may be advantageous to vary the coupling between L_5 and L_6 for maximum signal transfer to the receiver.

Alignment Procedure

Test equipment useful in alignment includes an absorption-type wavemeter calibrated from 49 to 65 Mc., and a high-impedance d.c. volt-

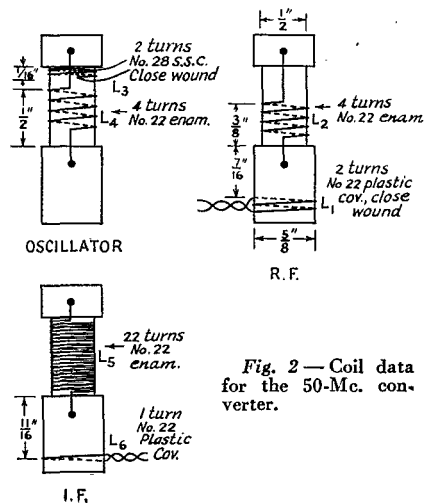

Fig. 2 — Coil data for the 50-Mc. converter.

meter such as the RCA Junior Volt-Ohmyst (a 0-100 microammeter with a 200,000-ohm series resistor may be used as an effective substitute).

As a rough preliminary adjustment, set trimmers C_2 and C_5 at approximately one-half full capacitance. The tuning slugs may be set as follows, assuming that the National type XR-50 coil forms and slugs with $1\frac{1}{2}$ -inch shafts are used:

Coil	Slug-Shaft Protrusion
L_2	7/16 inch
L_4	13/16 inch
L_5	3/8 inch

The step-by-step alignment procedure is then as follows:

(1) Set the dial near the high-capacitance end of the range and measure the oscillator frequency by adjusting the loosely-coupled wavemeter for a *dip* in grid voltage, as indicated by the high-impedance voltmeter connected between the chassis and Pin No. 6 on the 6C4. Adjust the slug in L_4 until this frequency is approximately 60.5 Mc.

(2) Set the dial near the low-capacitance end and adjust C_5 until the oscillator frequency is approximately 64.5 Mc.

(3) Repeat steps 1 and 2 until the proper range, 60.5 to 64.5 Mc., is covered over the desired number of dial divisions for good band-spread without requiring retuning at either end.

(4) Couple the converter to the antenna terminals of the receiver by means of a short twisted or coaxial transmission line. Set the receiver at approximately 10.5 Mc., leaving S_1 in its h.f. position. Adjust the slug in L_5 for *maximum* noise. If a noise peak cannot be observed readily, a man-made static generator such as a fluorescent lamp in the vicinity should help materially.

(5) Set the dial at the low-frequency end of the

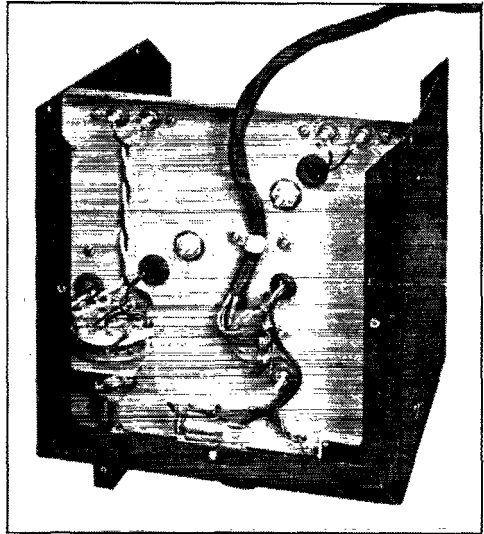

A bottom view of the converter. S_1 , the antenna-transfer switch, is at the lower left. Low-impedance antenna leads should be twisted loosely as shown. The three adjusting screws for the iron-core inductances protrude from the chassis on either side of the power cord.

band and adjust the slug in L_2 for a noise peak.

(6) Reset the dial at the high-frequency end and adjust C_2 for *maximum* noise.

(7) Repeat steps 5 and 6 until the noise level is fairly constant throughout the band. If necessary, the plates of C_2 and C_6 may be bent slightly to improve tracking.

The background noise should be *reduced* noticeably if either L_2 or L_4 is short-circuited.

The converter is now ready for operation, and in the case of the HRO should be directly coupled to the receiver by means of short lengths of bus wire. The slug in L_5 may be reset again for peak noise at 10.5 Mc. The dial may be directly calibrated against crystal-controlled signals on the band or against a one-megacycle crystal standard, if available.

For those interested in performance, the signal-to-noise ratio was measured with the converter connected to a standard HRO. A 10-db. change in audio output was observed between on-off, using 1000-cycle audio at 30 per cent modulation, with an input level considerably less than 1 microvolt. This is of the same order of magnitude as that to be expected of the receiver itself when operated at 10.5 Mc. One microvolt input, as specified above, delivered well over one watt of readable audio output. The image ratio of this receiving system speaks for itself when a comparison is made of r.f. and i.f. frequencies.

Last, but far from least, we come to the crucial point — the number of hard-earned dollars necessary. A rapid survey of current catalogs would seem to indicate that twenty dollars should cover everything from tubes to cabinet.

About the Author

• Richard W. Houghton carried on receiver and carrier-current experimental work for several years before succumbing to the urge to get into amateur radio. Licensed as WINKE early in 1941, his ham interests had just reached the point of mild saturation when the war came along. WERS, wired wireless and the construction of f.m. and television receivers were his war-time projects. After 3 years at Dartmouth College where he majored in physics, WINKE transferred into the Coöperative Course in Communications at MIT, receiving his B.S. in E.E. in 1944. Since graduation he has been associated with the Marine Transmitter Engineering Section of RCA, and more recently with the Receiver Division of the National Co. He is a member of the IRE and the Mass. Radio Society.

June 22nd-23rd—Tenth ARRL Field Day!

*Annual Dates Set for Testing Self-Powered Emergency Rigs Afield—
Emergency Corps, Club and Individual Participation Scheduled—
Separate Score Listing for Groups or Persons Using
Only V.H.F.—U.H.F.—S.H.F.*

EMERGENCY COÖRDINATORS and their groups, also radio clubs, are invited to arrange special Field Day activities. *Every amateur* is invited to take part, whether in group plans or individually. There is no activity to compare with an ARRL Field Day. Dedicated to advancement of emergency-readiness of the amateur service, it offers opportunity for testing equipment, perfecting operating techniques, and reviewing message procedure. Liberal dividends in radio result, and fun and fellowship are guaranteed, with the outings normally planned throughout the nation.

Testing of self-powered amateur stations in actual operation is the top aim of the FD. Join a group or get up a group to get maximum fun and profit from the occasion. Send a postal for the ARRL Emergency Corps membership application unless an ARRL Coördinator already knows your equipment and readiness to assist in emergencies or emergency radio tests.

No amateur station should be regarded as complete without *some* measure of self-powered equipment. *To be prepared for communications emergencies* requires advance readiness. The operator must have the equipment, know how to set up quickly for efficient operation, know how to handle messages (order of parts, check, receipting responsibility, record of handling data), know how to tune up workable ready-cut antennas in new locations, how to make the most of low power, and many other things. Operator experience is as essential as the equipment.

Operation: The aim for each field-portable is to work as many other amateur stations as possible (either home or afield) in the time allotted. Report your FD location and circumstances by radio message to ARRL. Advance

¹ To comply with FCC regulations for portable station operation, licensees must make advance notification of the location in which the portable will be operated, for work either above or below 25 Mc., to the Inspector-in-Charge of the district representing the original licensing area, and also a second notice to the Inspector-in-Charge of the one of the 23 U. S. FCC Districts (see ARRL *License Manual* list) in which the operation will take place. Then in "FD" operation it is necessary to use proper station identification (DN 1-2 etc.) after the "notified" identifying station call.

² 10 points will be deducted from the possible 25 for incorrect check, failure to show full handling data, improper order of sending preambles, or other defects or variance from standard ARRL procedure. Word count for correct checking is explained in the present and prewar copies of *Operating an Amateur Radio Station*, copies on request to ARRL members.

HOME STATIONS

• Home stations are invited to list all their contacts with FD stations in the above period, sending these in for a separate score listing—to show what they can do—and to encourage the cause of amateur preparedness even if they are personally unable to join a FD group as yet. Home-station scores will be **THE NUMBER OF FD PORTABLES WORKED plus POINTS FOR FD MSGS HANDLED** (1 ea. rec'd if copy mailed Hq.) (2 for relays; 1 when rec'd, 1 when sent forward). Stations claimed must be listed with the time worked, and message credits must be substantiated by copies of the messages, with full handling data.

entry is not required. All participating will use the call (c.w.) CQ FD or ('phone) CALLING ANY FIELD DAY STATION. Mobile work does not count. It is a test of portables. Manufactured contacts with any station or stations of members of the same field group in the contest do not count. Any or all amateur frequency bands may be used.

Portable stations operated in the field (away from "home" address) are eligible to submit field scores. Only portable setups may be listed with FD classification. Individuals or groups under *one call* must be "in the same locality," "in one group or building or field," constituting a single FCC-notified¹ location. To have points count, all station control points at a FD station must be within 500 horizontal feet of some given point.

The Operating Period: Operating time for the FD shown in logs must be between Saturday, June 22nd, 4 p.m., your LOCAL TIME and Sunday, June 23rd, 6 p.m., your local time.

FD Scoring: Each nonportable amateur station worked counts *one point* toward the score. Portable-to-portable contacts will count *two points*. The same station contacted again counts again *only* if the FD transmitter credit reported was on a different amateur frequency band, as for example, a contact when using 3.5-Mc. c.w., followed by one with the FD setup on 3.9-Mc. 'phone, on 7-Mc. c.w., etc. An extra credit of 25 points² before multiplier may be claimed for radio origination of not more than one message addressed to ARRL Hq., *provided only* message

copy is submitted with claimed score. FD Messages to Hq. all will include the following data: number of operators, location, conditions, power. One additional point (also before multiplier) may be claimed for radio handling of each FD message of another group if copy showing full handling data is submitted with station list and claimed score ($\frac{1}{2}$ point for receiving and $\frac{1}{2}$ point for radio relay transmission).

Multipliers: Score may be multiplied by 2 if either the receiver or transmitter is independent of mains or commercial power source, by 3 if both transmitter and receiver are supplied from an independent local source or sources. The following additional score multiplier is determined by the power input to the final stage (plate voltage times plate current):

(a) Up to and including 30 watts — multiply score by 3.

(b) Over 30, and up to 100 watts — multiply score by 2.

(c) Over 100 watts — multiply score by 1.

Entries for stations located in the Northwestern, Pacific, Rocky Mountain, Southwestern and West Gulf Divisions may have the score computed as above described multiplied by a final multiplier of 1.5 to assist in equalizing contact opportunity for Field Day setups in the less-populous areas.

V.H.F.—Only Score Listings: To give recognition to work accomplished using *only* v.h.f.-u.h.f.-s.h.f. bands, any such scores will be grouped under a special appropriate heading. If a reporting station uses equipment on bands above 50 Mc. and *likewise* reports points for work on lower frequencies, its scoring will be given in *QST* with similarly-reported AEC, Club and individual scores, *not* in this special listing. Contacts cannot count for both a v.h.f. and a v.h.f.-h.f. listing. This new score grouping is designed to lend point to the participation of v.h.f. Emergency Corps networks that may wish to arrange special activities or simulated tests on these dates.

Reporting: Score claims must be shown as the sum of points for each setup. A station-worked list for each band must show contact times for each contact. A statement covering on-off times for bands and transmitters is required. State the maximum number of transmitting units in simultaneous operation at any time. Attach copies of all messages for which any credit is expected, just as handled and with time and stations indicated. Note the source(s) of plate and filament power, along with the "watts input" for each rig. All reports to count must be mailed on or before July 11, 1946, to constitute an entry.

In the event of any doubtful points the interpretation and evaluation by the rules committee on the matter in question will be final. For the purpose of *QST* listings, groupings of participating stations will be based on the maximum number of *simultaneously-operated transmitters* used at any

time in the contest period by any entrant. All units or setups constituting a score group are placed under the call *and control* of one licensee who has made the required advance notification meeting FCC requirements and who is responsible for accuracy of all logs and records.

Design your station equipment, especially excitors and receivers, for portability, for connection to battery or emergency supply quickly if power fails and necessity arises. Don't deny yourself the ability and pleasure to set up in any location when radio links to agencies served by amateurs in the public interest may be needed. Surprisingly efficient and useful equipment may be operated from vibrator-type, genemotor and battery power supplies. Gas-electric emergency power units for 300 watts or more are not as expensive as they used to be.

The only purpose of the scoring system is to make it interesting to see how our work measures up with others who go afield. Group-planned Field Days are interesting, constructive, and good fun. If you cannot be with a group, aim to check in for a few contacts with an *individual* setup. Prove emergency readiness on these dates by participation! Here's luck, and we're looking for your report.

— F. E. H.

Silent Keys

IT is with deep regret that we record the passing of these amateurs:

W1AQA, Wm. J. Brown, jr., Boston, Mass.
W1EMH, Lt. Fred L. Lamb, USNR,
Waban, Mass.
W1LMN, Warren O. Richardson, Wal-
tham, Mass.
W2HFB, Wm. H. Zilliox, Hillside, New
Jersey.
Ex-4DO, 4SW, Dr. M. M. Burns, Pelham,
Ga.
W5DXG, Lt. Guy M. Brown, jr., USNR,
Vicksburg, Miss.
W5GB, Harry F. James, Gage, Okla.
W6SF, Carl Schneider, Stockton, Calif.
W8DES, Fred Bubbs, Palm Springs, Calif.
W9CTS, R. G. Carpenter, Alton, Ill.
W9RCA, Robert B. Angell, East Du-
buque, Ill.
KA1BB, Newland and Barry Baldwin,
Manila, P. I.

Looking Over the Postwar Receivers

The Hammarlund HQ-129-X

THE new HQ-129-X receiver might almost be the 1946 city cousin of the HQ-120-X, since a very strong family resemblance shows through the sophisticated styling of the 129. The controls are arranged in exactly the same way on the panel of the 129 as they were on the 120, but the knobs, panel and case of the 129 show the modern trend toward conservative streamlining. The circuit has been handled in much the same way — there is a strong family likeness, but the circuit of the 129 has been improved and modernized wherever practicable.

Front-panel controls on the receiver are Crystal Selectivity, Crystal Phasing, Send-Receive, Sensitivity (r.f. and i.f. gain), Main Tuning, Antenna Compensator (antenna-circuit trimmer), Band Switch, Bandspread Tuning, Audio Gain (and a.c. switch), Noise Limiter on-off switch, Manual-AVC-BFO switch, Beat Oscillator tuning, and headphone jack. A signal-strength meter is also included which, according to the instruction book, is calibrated in units from 1 to 9 in 6-db. steps. The production S-meter setting is 50-microvolts input for a reading of 9 on the meter, but this can be adjusted by the operator to suit his particular taste in meter calibration.

The R.F. Section

The "front end" of the HQ-129-X uses a 6SS7 r.f. amplifier and a 6K8 converter. The 6SS7 is a single-ended version of the 6S7, and has a low-drain heater and a slightly higher mutual conductance than the 6K7 and similar super-control r.f. pentodes. Both automatic and manual gain are applied to the r.f. stage but, in the interests of stability, the gain of the 6K8 is not varied. For further stabilization, the voltage to the oscillator portion of the 6K8 is fed from a VR-105 regulator tube.

• During the past five years you may have had a few idle moments to dream about the shiny chromium communications receivers of the promised brave new plastic world, and with this issue we inaugurate a series of descriptions of these receivers. We plan to point out the pertinent and new mechanical and electrical features of each receiver, as gleaned from a study of the sample, but we will avoid passing any opinion on the equipment because it is so much a matter of individual preference and demands.

The tuning range of the receiver, 0.54 to 31.0 Mc., is broken down into six bands, and the band switch has no limit stop on it, a convenience if one wants to take a short-cut from Jack Benny to the 10-meter band or vice versa. The bandspread dial, calibrated directly for the 3.5-, 7-, 14- and 28-Mc. amateur bands, is used by setting the main tuning dial to the high-frequency end of the bandspread range, under which condition the bandspread frequencies can be read directly. Both dials have their scales spread over 310 degrees, and eight revolutions of the tuning knobs are required for this rotation. The bandspread is the usual electrical type that uses a small bandspread condenser in parallel with the main tuning condenser, although it is made elaborate in this case by breaking down the bandspread condenser into three sections, so that various sections or combinations of them can be used on the different amateur bands. In this way the *L*-to-*C* ratio can be made closer to the optimum value for each band.

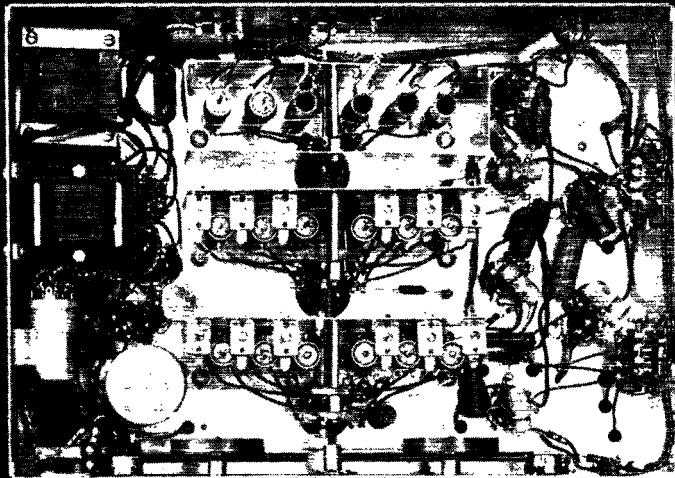

⋈
A bottom view of the receiver shows the band-changing switch and the r.f. coil assembly. Heavy wheels on the tuning-knob shafts are used for "smooth" tuning.

⋈
QST for

The I.F. Amplifier

The i.f. amplifier is unconventional when compared to those of most communications receivers in that it uses three i.f. stages instead of the usual two. The amplifier consists of three stages of 6SS7s, with the crystal filter between the first and second i.f.-amplifier tubes. The gain per stage is purposely made low, by tapping down the grids on the secondaries of the transformers and using degeneration, since three stages of high-gain amplification are not needed, but the additional tuned circuits give an over-all selectivity characteristic with steeper sides than is obtained with only two stages. An additional advantage of an amplifier of this type is that the detuning of the i.f. amplifier with changes in gain — by manual adjustment or a.v.c. — is negligible. This is not the case with an amplifier running with high gain per stage, since changes in the mutual conductance of the tubes, with changes in gain, reflect different input capacities across the secondaries of the transformers and consequently detune the circuits. This can become quite objectionable if the effect is marked and a signal is fading over a wide range, and the apparent effect is one of detuning with changes in signal strength. The crystal filter appears to be the same as that used in the HQ-120-X¹; a six-position switch gives six degrees of selectivity, ranging from good broadcast-quality bandwidth with the crystal switched out, through three crystal positions useful for 'phone reception to two positions for single-signal c.w. reception. Both automatic and manual gain are applied to the first and second i.f.-amplifier stages — the third stage operates at fixed gain. One section of a 6H6 is used for the second detector and a.v.c. source, and the other section is used in a noise-limiter circuit. The b.f.o., a 6SJ7 in the usual electron-coupled oscillator

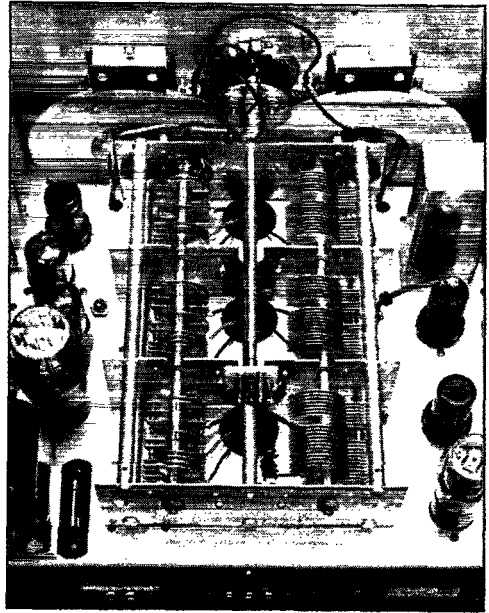

A top view of the HQ-129-X with the dust cover removed from the tuning-condenser assembly to show the main-tuning gang (right) and the bandspread condensers. The antenna trimmer condenser is in the center.

circuit, is capacity coupled from the plate of the oscillator to the second-detector plate.

The noise-limiter circuit, shown in Fig. 1, is a new variation of the series type of limiter, and it has the important feature that it automatically accommodates itself to the carrier level. A negative voltage proportional to the carrier level is applied to the cathode of the limiter diode through a filter network R_3 , C_2 and R_4 . Modulation changes will not affect this voltage because of the long time constant of R_3C_2 , but slow changes in carrier level caused by fading or tuning in another signal will be readily transmitted. Half of the voltage developed at C_2 is applied to the plate of the diode through the voltage divider R_1R_2 . Thus the anode is normally only half as negative (with respect to ground) as the cathode — in other words, it is positive — and the diode will conduct. Normal audio voltage developed across R_2 , which is part of the detector diode load, will cause a change in the current through the limiter diode and hence a change in the voltage across R_4 , and thus any normal modulation will be transmitted without appreciable distortion. However, if a pulse of noise comes along that rises above twice the normal carrier level, or even if the carrier is modulated over 100 per cent, the anode of the limiter will be negative with respect to the cathode, and the diode will not conduct as

(Concluded on page 108)

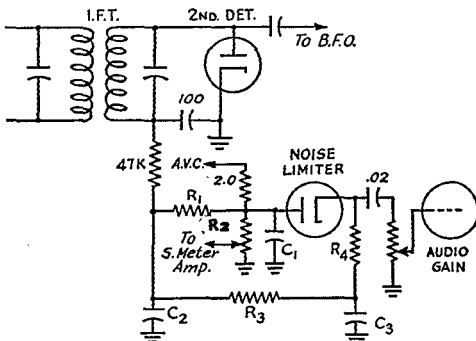

Fig. 1 — Noise-limiter circuit of the HQ-129-X.

C_1 , C_2 — 100 μ fd.
 C_3 — 0.05 μ fd.
 R_1 , R_2 — 0.27 megohm.
 R_3 — 1.0 megohm.
 R_4 — 0.82 megohm.

¹ Oram, "Full-Range Selectivity with 455-Kc. Crystal Filter," *QST*, Dec., 1938.

Happenings of the Month



RENEWAL APPLICATIONS NOT WANTED — STATION LICENSES AGAIN EXTENDED

We have been wondering what the schedule would be for filing renewal applications. And everybody was keenly cognizant that the six months' reinstatement of our station licenses was due to expire May 15th. FCC settled both matters for us on April 17th when it directed in its Order 130-F that amateur station licenses that were validated for six months by either of its November orders be extended for the duration of the term of the operator license held by the licensee of the station. Operator licenses themselves have been extended so that none expires before December 8th of this year. The new FCC order extends the term of the station license to coincide with the term of the operator license. It accomplishes that by amending the first ordering clause of Orders 130 and 130-A to read as follows:

(1) Each amateur radio station license which was valid at any time during the period December 7, 1941, to September 15, 1942, and which has not heretofore been revoked, is hereby validated for the term, as extended, of the amateur radio operator license held by the licensee of the station.

Now we have a schedule for the simultaneous expiration of both station and operator licenses. We need not apply for renewal of either (or modification of the station license; see item in this column on "New Portable-Status Rules") until the expiration date approaches. *Moreover, FCC does not want us to file renewal applications now.* This latest development therefore washes out the suggestion in our last issue that amateurs apply soon for renewal from those areas where calls are due to be changed upon renewing. FCC asks us who are already licensed to sit tight and let them devote their limited facilities to new applicants who do not yet possess licenses.

Let us now see when renewal applications should be filed. Your station license expires when your operator license does, so get out your operator ticket and look at its date of issuance. You can see your schedule from the following analysis which we have made of the effect of the various FCC orders in the 115 series extending operator licenses:

If your operator license was issued between Dec. 7, 1938, and Dec. 7, 1939, and was first due to expire between Dec. 8, 1941, and Dec. 7, 1942, it has been extended exactly 5 years.

If your operator license was issued between Dec. 7, 1939, and Dec. 7, 1940, and was first due

to expire between Dec. 8, 1942, and Dec. 7, 1943, it has been extended exactly 4 years.

If your operator license was issued between Dec. 7, 1940, and Dec. 7, 1941, and was first due to expire between Dec. 8, 1943, and Dec. 7, 1944, it has been extended exactly 3 years.

If your operator license was issued between Dec. 7, 1941, and Dec. 7, 1942, and was first due to expire between Dec. 8, 1944, and Dec. 7, 1945, it has been extended exactly 2 years.

If your operator license was issued between Dec. 7, 1942, and Dec. 7, 1943, and was first due to expire between Dec. 8, 1945, and Dec. 7, 1946, it has been extended exactly 1 year.

If your operator license was issued between Dec. 7, 1943, and Dec. 7, 1944, and was first due to expire between Dec. 8, 1946, and Dec. 7, 1947, it has *not* been extended.

Thus it will be seen that all operator licenses in the above categories are now going to expire on some date between Dec. 8, 1946, and Dec. 7, 1947; and, if you also have a station license issued before September 15, 1942, it is going to expire on that same date. That date is the anniversary of your date of issuance. Ascertain that date in your own case and write it down some place where you won't overlook it. It is the *last* date on which you may file a renewal application. Under the new FCC rules you may do so any time during the preceding 120 days. You get the amateur application form from your district inspector, attach your old license or licenses, and mail direct to FCC in Washington. It is not expected that any proof of use of licenses will be required in these first postwar renewal applications.

NEW PORTABLE-STATUS RULES

FCC on April 10th issued its Order 132, making important changes in the rules for both "fixed-portable" and truly portable operation.

Notice of portable operation (including "fixed-portable") has not heretofore been required above 25 Mc. Portable operation has caused some interference to other services that cannot be traced because of the lack of notices. Consequently FCC temporarily suspended the waiver of such notices, in § 12.92, and now all portable operation, both above and below 25 Mc., must be reported in advance to the inspector in whose district it will occur. Mobile operation above 25 Mc. is unaffected and still permitted without notice.

So many amateurs are now operating "fixed-

U. S. RADIO DISTRICTS

<i>District</i>	<i>Territory</i>	<i>Address, Radio Inspector-in-Charge</i>
No. 1	The States of Connecticut, Maine, Massachusetts, New Hampshire, Rhode Island and Vermont.	Customhouse, Boston, Mass.
No. 2	The counties of Albany, Bronx, Columbia, Delaware, Dutchess, Greene, Kings, Nassau, New York, Orange, Putnam, Queens, Rensselaer, Richmond, Rockland, Schenectady, Suffolk, Sullivan, Ulster and Westchester of the State of New York; and the counties of Bergen, Essex, Hudson, Hunterdon, Mercer, Middlesex, Monmouth, Morris, Passaic, Somerset, Sussex, Union and Warren of the State of New Jersey.	748 Federal Bldg., 641 Washington St., New York, N. Y.
No. 3	The counties of Adams, Berks, Bucks, Carbon, Chester, Cumberland, Dauphin, Delaware, Lancaster, Lebanon, Lehigh, Monroe, Montgomery, Northampton, Perry, Philadelphia, Schuylkill and York of the State of Pennsylvania; and the counties of Atlantic, Burlington, Camden, Cape May, Cumberland, Gloucester, Ocean and Salem of the State of New Jersey; and the county of Newcastle of the State of Delaware.	1200 Customhouse, Second and Chestnut Sts., Philadelphia, Pa.
No. 4	The State of Maryland; the District of Columbia; the counties of Arlington, Clark, Fairfax, Fauquier, Frederick, Loudoun, Page, Prince William, Rappahannock, Shenandoah and Warren of the State of Virginia; and the counties of Kent and Sussex of the State of Delaware.	508 Old Town Bank Bldg., Baltimore, Md.
No. 5	The State of Virginia except that part lying in District 4, and the State of North Carolina except that part lying in District 6.	402 New Post Office Bldg., Norfolk, Va.
No. 6	The States of Georgia, South Carolina, and Tennessee; and the counties of Ashe, Avery, Buncombe, Burke, Caldwell, Cherokee, Clay, Cleveland, Graham, Haywood, Henderson, Jackson, McDowell, Macon, Madison, Mitchell, Polk, Rutherford, Swain, Transylvania, Watauga and Yancey of the State of North Carolina; and the State of Alabama except that part lying in District 8.	411 Federal Annex, Atlanta, Ga.
No. 7	The State of Florida, except that part lying in District 8.	312 Federal Bldg., Miami, Fla.
No. 8	The States of Arkansas, Louisiana and Mississippi; and the city of Texarkana in the State of Texas; the county of Escambia in the State of Florida; the counties of Mobile and Baldwin in the State of Alabama.	400 Audubon Bldg., New Orleans, La.
No. 9	The counties of Aransas, Brazoria, Brooks, Calhoun, Cameron, Chambers, Fort Bend, Galveston, Goliad, Harris, Hidalgo, Jackson, Jefferson, Jim Wells, Kenedy, Kleberg, Matagorda, Nueces, Refugio, San Patricio, Victoria, Wharton and Willacy of the State of Texas.	404 Post Office Bldg., Galveston, Tex.
No. 10	The State of Texas except that part lying in District 9 and in the city of Texarkana; and the States of Oklahoma and New Mexico.	500 U. S. Terminal Annex Bldg., Dallas, Tex.
No. 11	The State of Arizona; the county of Clarke in the State of Nevada; and the counties of Imperial, Inyo, Kern, Los Angeles, Orange, Riverside, San Bernardino, San Diego, San Luis Obispo, Santa Barbara and Ventura of the State of California.	539 U. S. Post Office & Courthouse Bldg., Los Angeles, Calif.
No. 12	The State of California except that part lying in District 11; the State of Nevada except the county of Clarke.	328 Customhouse, San Francisco, Calif.
No. 13	The State of Oregon; and the State of Idaho except that part lying in District 14; and the counties of Wahkiakum, Cowlitz, Clark, Skamania and Klickitat of the State of Washington.	805 Terminal Sales Bldg., 1220 S. W. Morrison St., Portland, Ore.
No. 14	The State of Montana; the State of Washington except that part lying in District 13; and the counties of Benewah, Bonner, Boundary, Clearwater, Idaho, Kootenai, Latah, Lewis, Nez Perce and Shoshone of the State of Idaho.	808 Federal Office Building, Seattle, Wash.
No. 15	The States of Colorado, Utah and Wyoming.	504 Customhouse, Denver, Colo.
No. 16	The States of North Dakota, South Dakota and Minnesota; the counties of Alger, Baraga, Chippewa, Delta, Dickinson, Gogebic, Houghton, Iron, Keweenaw, Luce, Mackinac, Marquette, Menominee, Ontonagon and Schoolcraft of the State of Michigan; and the State of Wisconsin except that part lying in District 18.	208 Uptown P. O. & Federal Courts Bldg., St. Paul, Minn.
No. 17	The States of Nebraska, Kansas and Missouri; and the State of Iowa except that part lying in District 18.	809 U. S. Courthouse, Kansas City, Mo.
No. 18	The States of Indiana and Illinois; the counties of Allamakee, Buchanan, Cedar, Clayton, Clinton, Delaware, Des Moines, Dubuque, Fayette, Henry, Jackson, Johnson, Jones, Lee, Linn, Louisa, Muscatine, Scott, Washington and Winneshiek of the State of Iowa; the counties of Columbia, Crawford, Dane, Dodge, Grant, Green, Iowa, Jefferson, Kenosha, Lafayette, Milwaukee, Ozaukee, Racine, Richland, Rock, Sauk, Walworth, Washington and Waukesha of the State of Wisconsin.	246 U. S. Courthouse Bldg., Chicago, Ill.
No. 19	The State of Michigan except that part lying in District 16; the States of Ohio, Kentucky and West Virginia.	1029 New Federal Bldg., Detroit, Mich.
No. 20	The State of New York except that part lying in District 2; and the State of Pennsylvania except that part lying in District 3.	328 Federal Building, Buffalo, N. Y.
No. 21	The Territory of Hawaii, Guam, Wake, Midway, Am. Samoa.	609 Stangenwald Bldg., Honolulu, T.H.
No. 22	Puerto Rico and the Virgin Ids.	322 Federal Bldg., San Juan, P. R.
No. 23	The Territory of Alaska.	7 Shattuck Bldg., Juneau.

portable" after several changes of address that FCC mail to amateurs (including citations!) isn't being delivered, and consequently § 12.93(a) has been temporarily suspended and a new procedure substituted. Our old rule required notice every 30 days, with not over four such notices permitted unless modification was applied for. FCC wants to concentrate on the issuance of new licenses and is not yet in position to entertain applications for modification from amateurs who want to escape signing the portable indication. We have our licenses, and FCC has just extended their validity, while we meanwhile operate under simplified "fixed-portable" requirements: one notice (stating name, call, and station location) must be sent the inspector in charge of the district where the amateur was when licensed, and one notice to the inspector of the district where the amateur is now located (if that be a different inspection district). One such set of notices is good for all time, if one stays at that address. One may move again and send another set of notices for each such move. Modification applications are not wanted. The requirement applies to all frequency bands.

Amateurs still operating at the licensed address have nothing to file except when they engage in true portable operation.

When operating "fixed-portable" or portable or mobile, the portable indicator to be signed by c.w. or stated in words by voice must be in terms of the new call areas — which have been in effect since October 24th. The call itself, however, is that which FCC has assigned you, and it must be so signed — even though you have a new amateur next door signing the new call-area digit; he too is signing what FCC assigns him. Digits in calls will get changed only as FCC issues new or renewed licenses.

It is important to send your notices to the right inspectors. FCC inspection districts frequently split states into counties. The required notice for portable operation must be sent the inspector whose district includes the county in question. On page 27 we give you both the text of the new FCC order and an up-to-date listing of the FCC districts.

ORDER NO. 132

At a session of the Federal Communications Commission held at its offices in Washington, D. C. on the 10th day of April, 1946:

WHEREAS, the large number of new and renewal amateur station and operator license applications recently filed with the Commission has made their prompt processing difficult; and

WHEREAS, many amateur station licensees have changed their station locations since the issuance of their station licenses and now operate from new fixed locations, making it difficult for the Commission to communicate with them; and

WHEREAS, the provisions of § 12.92 of the Commission's Rules exempt all amateurs who operate portable stations on frequencies above 25 Mc. from the requirements of notice concerning their intended operations; and

WHEREAS, the provisions of § 12.93(a) of the Commission's Rules are not presently adequate to regulate the operation of non-portable amateur radio stations at permanent locations other than those specified in the station licenses;

IT IS ORDERED THAT

1. The provision in § 12.92 of the Commission's Rules exempting amateur radio station licensees who operate portable stations on frequencies above 25 Mc. from the requirements of prior notice to the district inspector where operation is intended is suspended until further order of the Commission. On and after the date of this order, the operation of portable stations on frequencies above 25 Mc. shall be subject to the same requirements of prior notice as are specified for the operation of portable stations on frequencies below 25 Mc. in § 12.92.

2. The provisions of § 12.93(a) of the Commission's Rules regarding the operation of non-portable stations which have been moved from one permanent location to another not specified in the station license, are suspended until further order of the Commission.

3. The licensee of an amateur radio station may, on and after the date of this order, commence operation at a permanent location other than that specified in the station license if advance written notice is given to the inspector in charge of the district for which the station license was issued, and to the inspector in charge of the district in which the operation (on frequencies below or above 25 Mc.) is intended of the following particulars: the station call, the name of the licensee, and the proposed station location.

4. The licensee of an amateur radio station who is now operating at a permanent location other than that specified in the station license may continue such operation if, within thirty days of the date of this Order, written notice is given to the inspector in charge of the district for which the station license was issued, and to the inspector in charge of the district in which the station is being operated (on frequencies below or above 25 Mc.) of the following particulars: the station call, the name of the licensee, and the station location.

5. The operator of an amateur station located at a permanent location other than that specified in the station license shall follow the calling procedure referred to in § 12.93(c).

This Order shall become effective immediately.

A.C.S. NEEDS HAMS

A lot of GIs separating from the Army and Navy these days, officers and enlisted men alike, are not finding civilian life as they thought it would be. Once the first thrill of being "free" wears off, and they have to settle down to this business of making a living, they find the going plenty rough — so much so that they're drifting back into the services, little by little.

It goes without saying that former ACS * men who reënlist are finding the way back to their old jobs, especially those who were hams, or who became hams as a result of their ACS connections. ACS is partial to hams. The big brass in ACS are mostly hams and you know what that means. In almost any outfit you will find hams all around you performing their interesting jobs in a way that reflects their ham careers. During free time they're busy building and operating their own rigs. They are encouraged to do this and helped in many ways. At many ACS installations, both here and overseas, there are group rigs on the air at which any ham in the outfit can pound brass for the asking.

ACS has been going to bat for the hams ever since it was organized. They're not going to stop now. They need men, skilled men, and they need them badly. They'll get them, all right, one way or another, but they want hams. They are especially interested in former ACS men and other ham discharges. So if you're getting disgusted

* ACS (Air Communications Service) was formerly AACS (Army Airways Communications System).

with conditions in civilian life, and find yourself occasionally longing for the days when everything was furnished by your Uncle Sam, give ACS some thought.

Here's the procedure. If you're a dischargee you have your choice of services when you reënlist. If you choose the Air Forces, and have previously served with the ACS, it's a cinch that your experience will put you back in the same outfit. If you weren't with ACS, drop a line to the ACS recruiting officer, Langley Field, Va., state your qualifications and experience, and say that you want in. Although ACS can't guarantee that you'll wind up there, they'll do their best to get you, and your chances are very good.

In any event, the ACS man will be glad to furnish you with all the facts and figures. What can you lose by dropping him a line?

WHAT BANDS AVAILABLE?

Below is a summary of the U. S. amateur bands on which operation is permitted as of May 15th. Future changes will be announced by W1AW broadcasts. Figures are megacycles. AØ means an unmodulated carrier, A1 means c.w. telegraphy, A2 is m.c.w., A3 is a.m. 'phone, A4 is facsimile, A5 is television; FM means frequency modulation, both 'phone and telegraphy.

3,500-	4.0	-- A1	
3,900-	4.0	-- A3, Class A only	
27,185-	27,455	-- AØ, A1, A2, A3, A4, FM	
28.0	- 29.7	-- A1	
28.1	- 29.7	-- A3	
29.0	- 29.7	-- FM	
50.0	- 54	-- A1, A2, A3, A4	
52.5	- 54	-- FM	[is only
144.0	- 148	-- A1, A2, A3, A4, FM; except band	
144.0	- 146.5	within 50 mi. of Washington, Seat-	
		tle and Honolulu.	
235	- 240	-- A1, A2, A3, A4, FM	
420 *	- 430 *	-- A1, A2, A3, A4, A5, FM	
1,215	- 1,295	} AØ, A1, A2, A3, A4, A5, FM, Pulse	
2,300	- 2,450		
5,250	- 5,650		
10,000	-10,500		
21,000	-22,000		
Above 30,000			

* Peak antenna power must not exceed 50 watts.

STAFF NOTES

New names in the *QST* masthead include that of Harold M. McKean, W1CEG, as assistant to the editor. Mac took up amateur radio in 1928 at a tender age and did notable work with a pair of push-pull '10s. He has been a newspaperman for many years, coming to us from the advertising department of the *New Britain Herald*. During the war he served as an RT1c in the Coast Guard, graduating at the top of his class as an advanced radio technician and later planning courses and acting as head radar-laboratory instructor at the USCG Radio Engineering & Maintenance School at Groton, Conn.

Another new face is that of Richard M. Smith, W2FTX/1, from Flushing, N. Y., now a technical assistant in our Technical Department.

ARE YOU LICENSED?

• When joining the League or renewing your membership, it is important that you show whether you have an amateur license, either station or operator. Please state your call and/or the class of operator license held, that we may verify your classification.

Graduated from Pennsylvania State College in 1937, he served during the war as senior instruction-book editor for Hazeltine Laboratories, builders of secret war-time electronic gear. He has been an active ham since 1933, working most bands on both 'phone and c.w., and is interested mainly in low-powered stations.

A. David Middleton, W2OEN/1, has been transferred from the Editorial Department to the Technical Department as a technical assistant and will devote his talents largely to the design and construction of apparatus for the *Handbook*.

John T. Rameika, W1JJR of Hartford, is the new senior operator at W1AW. Active for many years and possessed of a clean fist, John holds not only Class A but commercial first-class telephone and second-class telegraph licenses. If amateur radio weren't his first love, he would still be a mechanical-department foreman, his skill as a mechanic showing in the admirable construction of his home station.

The "reconversion" of the headquarters office establishment is now practically complete and we are set for lots of hard work. There are over fifty of us now. Come in and see us if you get down to New England this summer on your vacation!

FLASH!

ENTIRE 80-METER BAND OPENED!

• FCC Order 130-G on May 9th brought us the good news that the remainder of the 3500-4000 kc. band was opened to us at 11 A.M. E.S.T. that date. Again there was extraordinary collaboration by all interests involved, for which we are grateful. We now have the whole of good ol' 80; all of it is open to c.w., and 3900-4000 to Class A 'phone.

The same order authorized amateur experimentation nonexclusively on all frequencies above 30,000 Mc. (30 kMc.), and authorized the use of AØ and pulse emission on all our frequencies above 1215 Mc.

The outlook remains good for the early return of goodly portions of the 7- and 14-Mc. bands.



25 Years Ago

this month

It's a warm June, 1921, and anticipation of summer's QRN is not pleasant. But are we going to QRT for the season as in past years? No! We've got "high-pitched" c.w. now and the optimists in our ranks are prophesying year-round traffic handling for our nets. In announcing ARRL's summertime Static-Puncturing Contest, *QST* for the month says, "The main idea is to settle once and for all, the question whether or not c.w. will come through when the spark falls down."

Receivers for c.w. have been our problem; they have not, in fact, kept abreast of the development of our new c.w. transmitters. John L. Reinartz, 1QP, comes up with "A Receiving Tuner for C.W." in a timely lead technical article. His single-bulb receiver, with a range of 150 to 450 meters, oscillates nicely at any wavelength to which the grid circuit is tuned. The aerial circuit and coupling never need be adjusted. You just start the receiver oscillating, vary the secondary, and you will hear c.w. stations as you pass their waves. You can stop without effort on any of them, or switch almost instantly back and forth from one to the other, and find them always in the same spot on the dial, without any hand-capacity effect.

The Old Man lets off steam again! He complains of "Rotten Nerves." Says converting to c.w. has him worn all to a frazzle, and for all his effort he can't get over a lone amp in the antenna.

"Wonders never cease — in radio!" *QST* has learned of a newly-developed filamentless-type Amrad tube that oscillates, rectifies and amplifies. Reputedly, it is filled with either neon or helium, and has been successfully demonstrated. We can't wait for more dope! . . . H. E. Bussey, 4AI, authors "A Radiophone Employing A.C. and a Chemical Rectifier," a description of his new rig employing a pair of 50 watters with a.c. on the filaments and a 24-jar chemical rectifier for plate supply. He has worked 700 miles on c.w. and 350 miles with modulation. . . . "The Ideal Relay Spark Station," in two parts, by R. C. Denny, 6CS, wins second prize in *QST*'s contest for practical suggestions for spark sets.

Complete returns are in on the Washington's Birthday Relay. Over 7240 amateurs reported! First-prize winners are Leander L. Hoyt and S. D. Browning, Hayward, Calif. The relay message: "May the spirit of Washington be our guide in all our national aspirations and may the current year mark the return of tranquility, stability,

confidence and progress thruout entire world." Who is this J. DeWitt of Nashville, Tenn., 37th-place winner of a pair of Brownlie Phones? Every day sees new records set! 2BK has been heard by 6KA, who in turn has been heard by 8AGK. 8ZA has been copied by 6EJ. 3HJ has been heard 200 miles west of the Azores. Despite QRM and QRN, last month's traffic soared to 10,352 messages. 1HAA is first again with 457.

Outstanding stations described this month are Frank M. J. Murphy's 8ML, Cleveland, Lawrence Mott's 6XAD, Catalina Island, Calif., and John L. Reinartz's 1QP, South Manchester, Conn. Clifford J. Goette and S. Kruse are saluted in *QST*'s "Who's Who in Amateur Wireless" section.

Dr. J. H. Dellinger, Chief of the Radio Laboratory, Bureau of Standards, Department of Commerce, outlines his department's activities in the development and control of the radio art. He thanks amateurs for their coöperation and decries the limited budget upon which his forces must operate. Editorially, *QST* hits at budget pruners who would hinder the work of the Department. ARRL's Board of Directors will be asked to take up the matter at its next meeting.

The First ARRL National Convention and Radio Show is announced for Chicago in late summer. A bang-up five-day program is promised. There'll be plenty of hotel accommodations but make your reservation now, OM.

Perusing the ads, we just can't resist this new gear for our station: Radisco's Vario-Coupler at \$7.50, with every part accurate to .002 of an inch; Brandes Matched Tone Headsets that overcome the stress of weather and other conditions; an Acme 1½-Henry Choke for ironing out pulsations.

Strays

So it's always the other fellow's transmitter that drifts, and not your receiver, eh? Well, for an object lesson on drifting, put your receiver on WWV's 5000 kc. and watch WWV drift some!

— . . . —

W4ERI does not hold the record for a high bounce with his round-trip-to-the-moon radar signal. It appears that the world's record bounce (reported in *IRE Proceedings*, October, 1929, p. 1750) was made by European radio men who received authentic echoes of their signals 4-minutes-and-20-seconds after their transmission. That figures out about 22 million miles one way.

A Mobile Rig for 50 and 28 Mc.

Featuring Quick-Heating Filaments and Push-to-Talk Operation

BY EDWARD P. TILTON, * WIHDQ

• Spring is the mobile season, and mobile work on 6 and 10 meters is expected to reach an all-time high this year. Here is a neat little two-band rig which can be fitted into any car. Its quick-heating filament-type tubes reduce over-all battery drain, and operation is controlled entirely by the push-to-talk switch on the microphone.

WHEN HE decides to try mobile operation the enthusiast must choose between two techniques. If he has a small truck, a station wagon, or a jalopy, he may load it up with extra batteries, install a heavy-duty generator, or even take along a gas-engine-driven a.c. generator, in order to put a husky signal on the air. If, on the other hand, he is a one-car man with a family, it is usually a matter of designing his mobile rig so that it will run satisfactorily on the regular car battery, and be unobtrusive physically, so as not to interfere with the use of the car for its intended purpose, the transporting of family and friends.

In addition to economy of operation and neatness of appearance, we wanted our mobile job to include push-to-talk operation, for convenience and safety. It had to be of rugged construction, so that it would be ready to go at any time, and, since we once again are permitted mobile operation on 28 Mc., we wanted to be able to work on that band as well as 50 Mc., with a minimum of effort involved in changing from one band to the other.

Economy of operation, from the standpoint of

* V.H.F. Editor.

◆
The 6- and 10-meter mobile unit installed in the author's car. The small aluminum box mounted at the right of the unit houses the antenna change-over relay. Genemotor and starting relays are mounted under the hood.

◆

over-all drain from the car battery, is best obtained through the use of filament-type tubes which are lighted only during transmission periods. This has not been too practical for low-powered rigs in the past, as the only quick-heating filament tubes available were those designed for higher voltages than are normally obtained from small vibrator and genemotor supplies. Recently, however, a new low-power filament-type beam tetrode of the miniature variety was introduced by Hytron. This new tube, the 2E30, is admirably suited for use in the exciter and audio stages of an amateur mobile rig.

Five 2E30s are used in this job, serving as crystal oscillator, frequency multiplier, Class-A driver, and push-pull Class-AB modulators. The final stage uses a 2E25, also a filament-type beam tetrode, but of somewhat larger construction. Total filament drain is only 4.3 amperes, and there is no drain whatever when the rig is not actually on the air. Total drain from the plate supply, at 100 per cent modulation, is under 150 ma. with a 275-volt supply.

For neatness of appearance the rig is mounted in a grey crackle-finish cabinet of modern design (Par-Metal CA-202). The cabinet, which is 8 x 8 x 16 inches in size, is shock mounted on a shelf in back of the seat in the writer's coupe, but it lends itself to installation in the trunk compartment of sedan-type vehicles. All interconnecting cables are rubber covered, the antenna leads being RG-11-U coax with screw-on fittings.

Special attention was paid to ruggedness of construction. All leads to small components are made short and direct, and liberal use of terminal plates permits parts to be rigidly mounted at both ends. Tuning controls are equipped with dial locks (National ODL) to keep the rig in tune

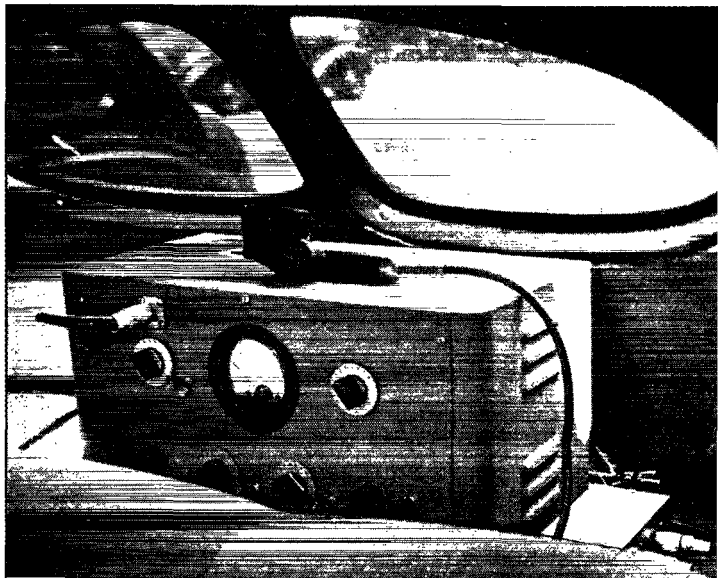

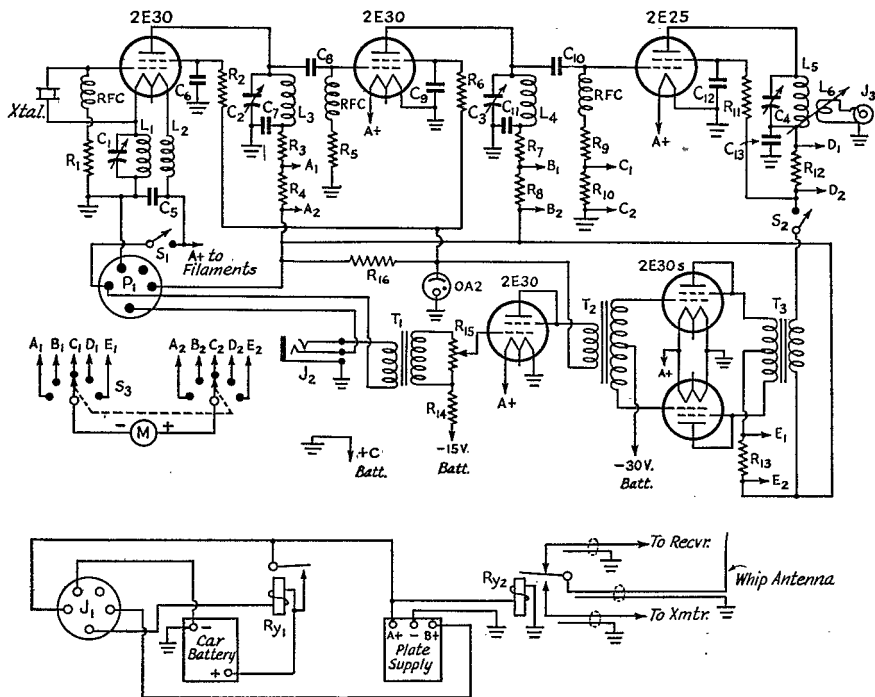

Fig. 1 — Wiring diagram of the mobile rig for 6 and 10 meters.

- C_1 — 100- μ fd. midget, screwdriver-adjustment type (Hammarlund APC-100).
 C_2, C_3 — 100- μ fd. midget, shaft type (Hammarlund HF-100).
 C_4 — 15- μ fd., double spaced (Hammarlund HFA-15-E).
 C_5 — 0.001- μ fd. mica.
 $C_6, C_7, C_9, C_{11}, C_{12}, C_{13}$ — 500- μ fd. midget, mica.
 C_8, C_{10} — 100- μ fd. midget, mica.
 R_1 — 82,000 ohms, 1 watt.
 R_2, R_6 — 1000 ohms, $\frac{1}{2}$ watt.
 R_3, R_7, R_{10} — 100 ohms, $\frac{1}{2}$ watt.
 R_4, R_8, R_{12}, R_{13} — Special shunts. (See text.)
 R_5 — 150,000 ohms, 1 watt.
 R_9 — 30,000 ohms, 1 watt.
 R_{11}, R_{16} — 5000 ohms, 10 watts.
 R_{14} — 10,000 ohms, $\frac{1}{2}$ watt.
 R_{15} — 0.5-megohm potentiometer.
RFC — 2.5-mh. r.f. choke, National R-100.
 J_1 — Socket on power cable, 5 prong.
 J_2 — Double-button microphone jack. If T-17-B microphone is used, a special jack designed for this

- microphone must be obtained.
 J_3 — Coaxial fitting (Amphenol 83-1R. Matching plug is 83-1SPN).
 P_1 — Power plug on transmitter chassis.
 S_1, S_2 — S.p.s.t. snap switch.
 S_3 — 2-section 5-position wafer-type switch.
 T_1 — Single-button microphone transformer.
 T_2 — Driver transformer (Stancor A-4752).
 T_3 — Modulation transformer (UTC S-18).
 L_1, L_2 — 7 turns each, No. 20 d.c.c., 9/16-inch long on 1-inch dia. form, windings interwound.
 L_3 — 10 turns No. 12 enam., closewound on 1-inch dia. form.
 L_4 — 6 turns No. 12 enam., $\frac{3}{4}$ -inch long, $\frac{1}{2}$ -inch inside dia., self-supporting.
 L_5 — 28 Mc.: 10 turns No. 12 enam., 1 $\frac{1}{2}$ -inch long, 1-inch inside dia., self-supporting.
 50 Mc.: 5 turns No. 12 enam., 1-inch long, 1-inch inside dia., self-supporting.
 L_6 — 3 turns on $\frac{1}{2}$ -inch polystyrene rod — See text and detail photo.

during the roughest going. The meter (a Marion 0-10 ma. sealed unit) is back-of-panel mounted, with a sheet of lucite serving as a protecting window. Mounting the meter back from the panel also provides an easy means of illuminating the meter face, dial lights being mounted at either side of the meter.

To facilitate quick band changing without cumbersome switching arrangements, the circuits are laid out so that it is merely necessary to change the crystal and the final plate coil, L_5 , and retune the plate condensers, C_2, C_3 , and C_4 , in going from one band to the other. The cathode tuning-condenser setting is uncritical, and may

be left near maximum capacity for both bands. The oscillator and multiplier plate-tuning condensers are large enough so that the circuits may be tuned to both bands with the one coil in each place.

With the use of two relays, complete push-to-talk operation is possible. The first relay starts the genemotor and applies the filament voltage, the second handling the switching of the antenna from receiver to transmitter. When filament and plate voltages are applied simultaneously as they are in this unit, a motor-generator power supply is preferable to the vibrator type, because the voltage builds up gradually with the former, not

reaching maximum until the filaments of the tubes are close to full operating temperature. With the filament-type tubes there is no necessity for preliminary switching. The operator simply grasps the microphone and thereby goes on the air — an important factor in keeping the driving of the car a moderately-safe proposition.

Circuit Considerations

The crystal oscillator is a Tri-tet, modified for filament-type tubes. In place of the usual tuned circuit in the cathode lead, interwound coils are inserted in the oscillator filament leads, one of the coils being tuned with a screwdriver-adjustment trimmer mounted on the chassis near the oscillator tube. The setting of this adjustment is not at all critical — it is set near maximum capacity and left at the same position for all crystals. The oscillator doubles in its plate circuit at all times, the crystals used for 50-Mc. operation being in the range between 8334 and 9000 kc., while 7-Mc. crystals are used for 28-Mc. output.

The stage following the oscillator is operated as a doubler for 28 Mc., and as a tripler for 50 Mc. At first this gives the impression of being a dubious approach, for it would appear that there would tend to be a lack of excitation for the higher frequency. Actually, it turns out that there is *more* excitation on 50 than on 28 Mc., because the tuned circuits are operated with quite high *C* at the lower frequency. The 2E30 is a very effective frequency multiplier, and there is adequate excitation on both bands, with both 2E30s running well below their rated input. Screen voltage to the exciter stages and plate voltage on the Class-A driver is maintained at 150 volts by means of a voltage regulator tube, in this case a new miniature OA2. It is similar in characteristics to the VR-150, and was selected in preference to the VR-150 merely because of its smaller size.

The manufacturer-rated maximum plate potential for the 2E30 is 250 volts. Most mobile power units deliver slightly more than this voltage under load, but by holding the screen voltage at a constant value lower than the rated maximum there seems to be no harm in running the plates at 300 volts, as long as the stages so operated are not modulated.

The final stage uses a 2E25, a filament-type beam tetrode of larger size and higher power capability than the 2E30. It is a well-shielded tube, with its plate lead coming out the top, permitting the mounting of the grid circuit below the chassis and the plate components above, which results in completely-stable operation without neutralization. A small shield, cut from an old-style tube shield, comes up to the bottom of the plate assembly of the 2E25, providing complete shielding of the leads in the base of the tube. The 2E25 plate coil, L_5 , is made plug-in, and only this coil and the crystal need be changed in going from one band to the other.

To permit variation in antenna coupling, the output coupling coil, L_6 , is mounted so that it may be moved in and out of the plate coil by means of a front-panel control. The coupling coil is wound on a piece of $\frac{1}{4}$ -inch diameter polystyrene rod, into which is inserted a $\frac{1}{4}$ -inch rod of the same material, which extends through the panel. A shaft-locking panel bushing (Bud PB-532 bushing, Millen 10061 shaft lock) allows the coupling to first be set at the proper point by the "push-pull" method, and then locked in place by tightening the nut on the shaft lock. This nut may be set "finger-tight," allowing the coupling to be adjusted, yet holding it with sufficient firmness to prevent its being jarred out of position.

The Audio System

Three 2E30s, one as a Class-A driver and a pair as Class-AB modulators, supply the audio for modulating the 2E25. It will be noted that all three tubes are triode connected, the plate and screen being tied together at the socket. Operation of the tubes as triodes resulted in appreciably-better quality than the pentode connection, though there was more than adequate audio supplied by either hook-up. Full modulation at normal speech levels is obtained with the gain control somewhat less than full on, and the voice quality is reported as considerably better than that normally expected of a carbon microphone. Tests with an oscilloscope and an audio oscillator indicate very satisfactory fidelity in the speech-frequency range.

Bias is obtained from a 30-volt hearing-aid battery, upon which an operation was performed to give it a tap at 15 volts. The cardboard case

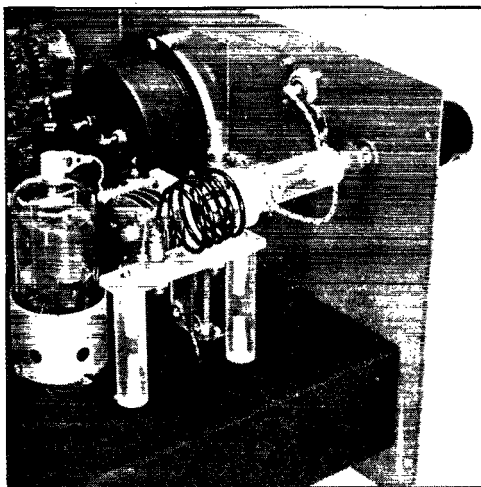

Detail photo of the 2E25 final stage, showing method of coupling to the antenna. The coupling coil, wound on a polystyrene rod, is adjustable from the front panel. The plate coil is mounted by means of G.R. plugs.

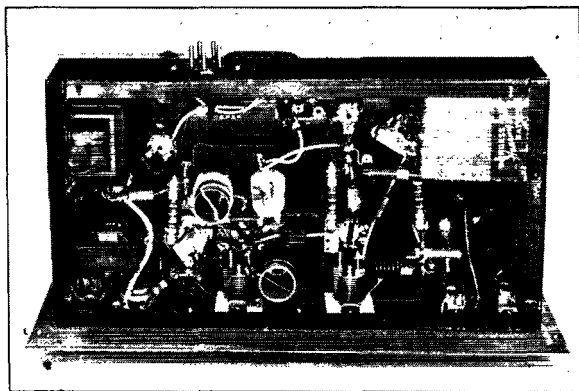

Bottom view of the mobile rig. At the left center are the interwound coil and tuning condenser which are part of the oscillator filament circuit. Audio components are at the left, with oscillator and multiplier plate circuits near the front panel.

was slit open with a sharp knife, and a tap soldered at the midpoint (this type of battery is made up of two 15-volt assemblies connected in series). A lead was then brought up to the unused terminal in the three-pin socket on top of the battery.

The microphone used is an Army T-17-B, now available on the surplus market. It has a button assembly similar to the newer telephone units, and is equipped with a convenient and rugged push-to-talk switch. Any similarly-equipped single-button microphone may, of course, be used.

Metering of the plate current in the oscillator, multiplier, final, and modulator stages, as well as the grid current in the final, is accomplished by means of a 10-ma. meter which is switched into the various circuits. Small 100-ohm resistors are connected across each set of switch points, and those in the plate circuits are wound with shunts to increase the meter range by a factor of ten. These shunts are scramble-wound of No. 30 enameled wire, using a piece approximately 7-foot long. The simplest way of making the shunts come out just right is to wind on an excess of wire, and then reduce the length until the multiplication of the meter scale is correct.

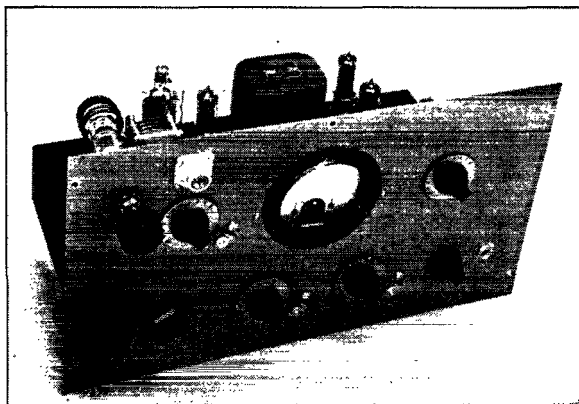

Front view of the mobile unit, showing arrangement of controls. At the upper right is the meter switch, and below it the gain control. The two dials below the meter are the oscillator tuning, right, and multiplier tuning, at the left. In the upper left are grouped the final tuning, coupling adjustment, and coaxial output jack. The two knobs at the lower left are the manual controls for the filament and final plate voltages. Note dial locks on tuning controls. Panel area is 8 x 14 inches.

Adjustment and Testing

Except for the speech stages, the rig may be tested using 6.3 volts a.c. on the filaments and an a.c. power supply. Modulation must be tested using a storage battery, as the polarity of the filament voltage affects the bias conditions, and a.c. on the audio-stage filaments produces a heavy hum. The power supply used should put out not more than about 200 volts, in order that no harm be done to any of the tubes during the initial testing.

Set S_1 to the "on" position, leaving S_2 "off." With the meter switch in position "A" apply plate voltage and note the meter reading, which is the oscillator plate current. This will be about 20 ma., dipping slightly at resonance as C_2 is adjusted. Switch S_3 to position "B" and adjust the multiplier tuning condenser C_3 . Plate current to this stage should be about the same as that to the oscillator. The dip at resonance may not be as pronounced, so the final-stage grid current (position "C," 10-ma. scale) is the best indication of proper tuning of the preceding stages. Final grid current should be about 4 ma., dropping to about 3 ma. when final-stage plate voltage is applied (by closing S_2), and a load coupled to the plate circuit. Final plate current, position "D," should

The plate circuit of the final stage is the only r.f. circuit above the chassis. The three tubes at the left are the driver and audio stages, with the oscillator and multiplier tubes directly in back of the meter. The tube to the right of the modulation transformer is the OA2 voltage regulator. Chassis size is 7 x 13 x 2 inches.

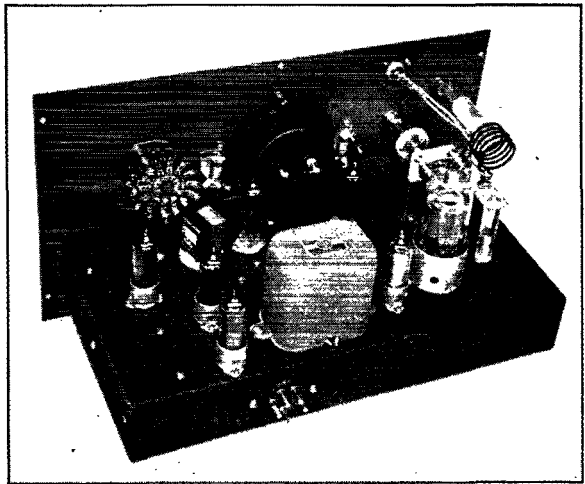

drop to 10 ma. or less when the plate circuit is resonated with no load. If all is well up to this point, higher voltage may be applied. The average mobile plate supply delivers around 275 volts at the load this unit puts on it, so we made our final tests at about this figure. With an antenna or dummy load, the final plate current should load up to 60 ma. or so, though this loading will not be obtained with a lamp connected across L_6 . In order to light a 25-watt bulb appreciably, five or six turns of pick-up coil will be needed, providing a fairly-bright indication.

Modulator plate current, position "E," will run around 20 ma. with no speech, swinging up to 40 ma. or so for full modulation. Much higher peaks, up to 80 ma. or higher, can be reached at full gain setting, but this will result in over-modulation. It is well to measure the Class-A driver plate current also, though no metering position is provided. This should be around 10 ma.

In putting the rig on the air there is little danger of ending up on a wrong frequency, since the final circuit will not tune to wrong harmonics if the constants given are followed closely. It is possible, however, to obtain grid current on out-of-band frequencies, so it is a good idea to check the frequency of each stage with an absorption-type wavemeter, when the stage is placed in operation. It is advisable to record the setting of the various controls at which best operation results; then in changing bands it is merely necessary to swap the crystals around, change the output coil, set the dials to the predetermined points and secure them in place with the small locks provided.

The octal socket used for the crystal provides a convenient storage place for the crystal not in use. To have the plate coil for the other band always ready for use, a stand-off insulator fitted with a G. R. socket was mounted on the rear wall of the cabinet. Other refinements we expect to add, on the basis of our brief operating experience

with the rig, include a calibration of all controls, mounted in permanent form on the underside of the cabinet cover, and also some means of clamping the cover down tightly in place. At present it gives forth an annoying rattle in rough going.

Performance on the two bands is similar, an input of about 18 watts being realized with a 300-volt plate supply. The rig has been used successfully with a plate voltage of around 225 and an input of 6 to 8 watts. Actually, in most mobile work, the lower power works out just about as well, and the saving in battery drain is considerable. If higher power is desired, an input of 30 watts or more can be run to the final, by supplying that stage from a separate power source capable of delivering 400 volts d.c. This sort of arrangement is rather rough on the battery, and something special in the way of battery and generator equipment is in order, if use of this amount of power is contemplated as the regular thing.

Installation in the Car

Suitable change-over relays for coaxial feeders are still on the list of things to come, so we had to do the next best thing and make our own. The net result is not a coaxial-line relay, by any means, but it serves the purpose, and the transfer of energy to the antenna seems to be about the same when the relay is used as when the feeder is connected directly to the transmitter. An ordinary 6-volt s.p.d.t. relay, having low-loss insulation and fairly-wide contact spacing, was installed in a handmade aluminum box, on the sides of which are three Amphenol coaxial fittings for the cables to the antenna, receiver, and transmitter. The relay case is grounded and only the inner conductors are switched.

A headlight relay is used to handle the job of starting the genemotor. These relays can be purchased at any auto-accessory store at low cost,

(Continued on page 110)

Long-Wire Antennas

A Physical Picture of Rhombics and Vs

BY WALTER VAN B. ROBERTS, * W3CHO

THE COMPLETE analysis of the operation of long-wire antennas usually involves rather complicated mathematics, so it is interesting that some of the main results of such an analysis can be obtained in a relatively easy and simple manner which has the incidental advantage of providing a physical picture of their operation.

The present treatment starts with a simple long wire terminated nonreflectively so that purely traveling waves slide along it. These are waves of current, but they travel at the same speed along the wire as do radio waves in space so that both kinds of waves can be represented in the same way on a diagram.

Fig. 1 shows a long wire in free space set at an angle θ with respect to the direction in which transmission is desired. The diagram is in the

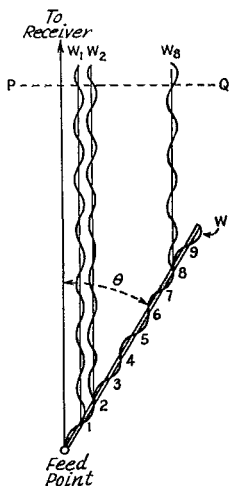

Fig. 1—How radiations from individual elements of a long wire add up along a given direction.

nature of an instantaneous photograph showing current waves W along the wire and three sample radio waves, W_1 , W_2 , and W_8 , which have been radiated from points 1, 2 and 8 on the wire and are on their way to the desired receiving point. All the various waves add up at the receiving location to produce a resultant field, but they must be added vectorially because they are not all in the same phase when they arrive. By drawing a line PQ across the waves it can be seen, for example, that W_2 is a little out of phase with W_1 .

*155 Hodge Road, Princeton, N. J.

¹ Exactly the same condition determines the best length of a microwave horn for a given flare angle; also the diameter of the first Fresnel zone in wave propagation studies.

Fig. 2 shows how to find the vector sum, S , of the nine waves emitted from the nine points marked 1 to 9 on the wire. First a vector marked W_1 is laid off to represent wave W_1 , then at the end of W_1 we draw a vector W_2 with just enough change of direction to correspond to the phase

Fig. 2—Vector diagram showing the addition of field components from different sections of the radiator at a point in space.

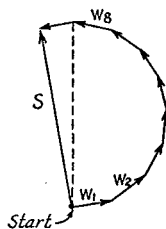

difference between W_1 and W_2 . This process is continued until all the waves have been represented. The sum of all the vectors is the line from the starting point to the head of the last vector and is marked S . (If we had divided the wire up into a great many points instead of just nine, Fig. 2 would have looked like part of a smooth circle.)

It will be seen from Fig. 2 that S would be slightly greater if we had left off the ninth little vector. In other words, the wire is too long to produce the maximum signal possible in the desired direction. On the other hand, if the wire had been cut off at, say point 7, the sum S would again be less than the maximum possible. But it will also be noticed that the wire can be considerably longer or shorter than the optimum length without very much reduction in S , which fact accounts for the wide frequency range of operation of rhombics, for example.

Fig. 2 shows that the maximum value of S occurs when the waves from the two ends of the wire are 180 degrees out of phase. This happens when the wire is a half-wave longer than its projection along the line to the receiver¹ so that

• There are a few simple trig formulas and vector diagrams here, but don't let them frighten you. Essentially, the article is an easily-followed exposition of the principles underlying long-wire antennas. It will help you to visualize and understand what goes on, and why, in rhombics and Vs.

we have the equation $L = \frac{\lambda}{2} + L \cos \theta$ to tell us

the optimum length of wire for a given value of θ . This equation may be rewritten thus

$$L = \frac{\lambda/2}{1 - \cos \theta} \quad (1)$$

We have now developed a formula giving the best length of wire to use for a given angle θ , but what is the best value of θ to use? A plausible argument to determine this is as follows: Let us suppose that the wire is always divided into the same large number of parts so that the radiation from each part is represented by the individual vectors of a diagram such as Fig. 2. Obviously, the longer each vector is the greater S will be, assuming that the total wire length is always made to satisfy Equation 1. Now the radiation from each part of the wire in the desired direction is proportional to the length of the part multiplied by the sine of θ . Hence the field at the receiver will depend on $L \sin \theta$. Putting in the value of L given by Equation 1, the field is therefore deter-

mined by the quantity $\frac{\sin \theta}{1 - \cos \theta}$. It turns out

that this quantity does not have a maximum value for any value of θ but continues getting bigger the smaller θ is made. Hence all we can say is that θ should be made as small as possible considering that L becomes very large as θ is made very small, which fact puts practical limits on the reduction of θ .

Ground Reflection

But in all the foregoing we have been talking about a wire in free space, which is not the usual condition. Usually the wire is stretched horizontally over ground. If the ground acts as a good reflector its action is to reinforce the radiation along a certain elevation angle which depends on the antenna height. This elevation angle will be figured later but for the present we will simply assume that there is such an angle and call it Δ . Referring to Fig. 1 again and considering it as a plan view of the antenna, we will now figure out all over again what is the best length of wire — but this time we want to know the best length for sending signals not directly toward the receiver but at an angle Δ above this line. Radiation is reinforced at this vertical angle in any case so we might as well design the antenna to work best in the same direction.

The recalculation happens to be very simple because Equation 1 tells us the optimum length in terms of the angle between the wire and the desired direction of transmission, so all we have to do is to consider the θ in Equation 1 as being

replaced by the angle between the wire and a line elevated by the angle Δ above the direction to the receiver. By reference to the formulas of spherical trigonometry it will be found that the cosine of this new angle is simply the product $\cos \theta \cos \Delta$, where θ has the same meaning as in the previous discussion; that is, it is the horizontal angle between the wire and the direct line to the receiver. Hence Equation 1 becomes

$$L = \frac{\lambda/2}{1 - \cos \theta \cos \Delta} \quad (2)$$

Again we have found how to make the length optimum for a given value of θ but do not know what is the best value of θ . To find out, we apply the same argument as before and this time find that the field at the elevation angle Δ is proportional to

$$\frac{\sin \theta}{1 - \cos \theta \cos \Delta}$$

This time there is a best value for θ , namely $\theta = \Delta$. (3)

Equations 2 and 3 give definite values to L and θ which result in radiating the maximum possible signal at elevation angle Δ . All we need now is to know how high the wire should be so that reflection from the ground will reinforce signals transmitted at the elevation angle Δ .

Each of the individual waves from the wire is reflected from ground exactly like the waves from an ordinary dipole, so that the angle of reinforcement of radiation from the long wire will be the familiar angle that applies to horizontal dipoles. For the sake of completeness the derivation of this angle is shown in Fig. 3. The object is to find the elevation angle at which the direct and

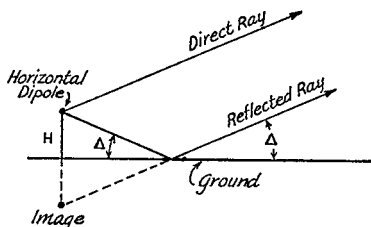

Fig. 3 — Reflection from ground.

reflected rays are in phase. One way to do this is to know that horizontally-polarized waves are reversed in phase by reflection and then find what angle makes the path of the reflected ray a half-wave longer than that of the direct ray. The other way is to replace the earth by the image of the dipole, which is of opposite polarity to the dipole, and find what angle makes the path from the image a half-wave longer than that from the dipole. Either method gives the result:

$$H = \frac{\lambda}{4 \sin \Delta} \quad (4)$$

This last equation supplies the finishing touch to the design of a long-wire antenna to give maximum signal at a given elevation angle. The equations may be rearranged in various ways by substituting values from one into another. For example, if we want to find best values of L , H and θ for transmission at a desired elevation angle Δ , the equations are more convenient thus:

$$H = \frac{\lambda}{4 \sin \Delta} \quad (5)$$

$$L = \frac{\lambda}{2 \sin^2 \Delta} \quad (6)$$

$$\theta = \Delta \quad (7)$$

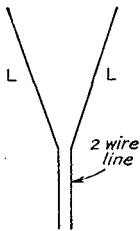

Fig. 4 — The V antenna.

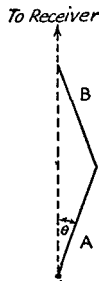

Fig. 5 — Combination of two long wires to form a half-rhombic antenna.

Vs and Rhombics

The wire has been shown slanting off to the right but it could just as well have been drawn off to the left except that the direction of the currents, or rather their crosswise components, would have appeared reversed as viewed from the receiving point. Thus if we use both right and left wires at once and drive them in push-pull their signals will add and we have a "V" antenna of optimum design, as shown in Fig. 4. Furthermore, Equations 5, 6 and 7 also give the optimum design of a rhombic whose sides are each of length L with an angle 2θ between sides at the feed point. That this is so will require a little more demonstration.

In Fig. 5 the wire A is chosen in accordance with Equations 5, 6 and 7 and hence radiations from its various parts add up to an exact semi-circle in the diagram of Fig. 2. Now if wire B were added to A without a change of direction, the vector diagram of the radiations from the parts of B would simply continue around the circle in Fig. 2 to come back to the starting point, making the resultant S shrink back to nothing. But actually wire B is reversed in slope with respect to the line of transmission so that all the little vectors representing its radiations are reversed. Following the procedure for vector addition this results in the diagram of Fig. 6, which

has the sum S twice as large as that from the single wire. If we now add two more wires, C and D , together with a two-wire line for feed and a terminating resistor R connecting the far ends of both sides, the result is the complete rhombic of Fig. 7.

There is one more thing we can deduce without much trouble, namely the power gain of the V and the rhombic as compared to the single wire of Fig. 1. When we add another wire to form a V the impedance presented to the source is doubled since the two wires are in effect fed in series, so that twice as much power is required to produce a given current in the two wires as in one alone. But the field at the receiving point also is doubled, and doubling the field is equivalent to quadrupling the power. Thus the V has a power gain of 2 over the single wire. Now adding elements B and C to the V to form a rhombic does not change the input impedance because there is no reflected wave, so the doubling of the receiver field that is thus produced is equivalent to quadrupling the power without any increase in actual input. Thus the rhombic has a power gain of 4 over the V. These results might be stated as follows: Each wire added to the single wire of Fig. 1 gives a power gain of 2.

Power Gain

Calculating the gain of a rhombic compared to a half-wave dipole is beyond the scope of the present qualitative sort of treatment, but an approximate value can be obtained from the known input resistance of the rhombic, which, when properly terminated and designed for maximum performance, is about 720 ohms. (Not that



Fig. 6 — Vector addition of field components from the antenna shown in Fig. 5.



Fig. 7 — The rhombic antenna.

the last two digits are significant, but 720 is just ten times the input resistance of a half-wave dipole, making it a convenient figure to use.) If then we assume that the impedance of the rhom-

bic is ten times that of a dipole, it will require ten times the power input to produce the same current in the rhombic as in a dipole. But the current in the rhombic is much more effective than the same current in a dipole. We can figure the relative fields set up in the desired direction by the same current in the two antennas by figuring their effective lengths, the term "effective length" being here defined as the length of wire that would be required to produce the observed signal at the receiver if the current were uniform and of the same phase throughout the wire, and the wire were crosswise to the line to the receiver. In the case of the half-wave dipole the current is in the same phase all along the wire but it is not of uniform strength, so that the effective length

is $\frac{\lambda}{\pi}$. In the long-wire traveling-wave antenna the

current is approximately uniform² but the varying phase of the waves received from different parts of the wire makes the resultant (see Fig. 2) only the diameter of a circle instead of the numerical sum of all the vectors, which is a semi-circumference. In other words, phase differences

reduce the effective length by the factor $\frac{2}{\pi}$. Also,

the long wire is not crosswise to the emitted beam so its effective length is further reduced by the factor $\sin A$ where A is the angle between the beam and the wire. Thus the effective length

is $\frac{2}{\pi} L \sin A$. But we can use Equations 5, 6 and 7

to get rid of L , whence effective length is

$$\frac{\lambda}{\pi} \cdot \frac{\sin A}{\sin^2 \Delta}$$

In the rhombic the effective length is four times this value because there are four wires "pulling together" so that the effective length of the rhombic is

$$4 \frac{\sin A}{\sin^2 \Delta}$$

times that of a half-wave dipole and hence the fields produced by the same current are in that proportion. The ratio of the powers, being the square of the ratio of the fields, is

$$16 \frac{\sin^2 A}{\sin^4 \Delta}$$

But remembering that it takes ten times as much power to get the same current into the rhombic as into the dipole, the actual power gain is

$$1.6 \frac{\sin^2 A}{\sin^4 \Delta}$$

The angle A can be eliminated from this expression since we found previously that

$$\cos A = \cos \theta \cos \Delta \text{ and by Equations 5, 6 and 7,}$$

this gives us

$$\cos A = \cos^2 \Delta \text{ or } \sin^2 A = 1 - \cos^4 \Delta \\ = (1 - \cos^2 \Delta)(1 + \cos^2 \Delta) = \sin^2 \Delta (2 - \sin^2 \Delta).$$

Thus, finally, the power gain is

$$\frac{3.2}{\sin^2 \Delta} - 1.6$$

To see how this checks up assume $\Delta = 14\frac{1}{2}^\circ$, which makes $\sin \Delta = \frac{1}{4}$. Then the gain is $(3.2 \times 16) - 1.6$ or about 50, which is about 17 db. This value checks very closely with the value given by A. E. Harper of the Bell Telephone Laboratories.³

The present discussion is not intended to be used as the basis for the design of actual antennas or even for the calculation of their performance, because it only treats the case of the design for maximum possible output. In practice the dimensions can be economized considerably with very little loss in performance. For instance, in a detailed treatment of the rhombic⁴ it is shown that there are even some advantages in reducing the lengths of the sides to 74% of the value given by equations 5, 6 and 7, the values of θ and H being unchanged from those given by the equations. The objective here is to give a physical picture of the operation of long wires and the relationship between different long-wire antennas so that more detailed treatments may be read with better understanding. The method employed may also be extended to determine the directions of other "lobes" of radiation from the long wire.

One final note: if the equations of this article are compared with equations in other treatments of rhombics a certain confusion may arise with respect to the angle θ . Other treatments usually deal with an angle which they call the "tilt angle" and which is 90 degrees minus θ . Of course it makes no difference which angle is used so long as we know what we are talking about, but the angle θ seemed the more natural one to use in the present derivations.

² The assumption has been made throughout this treatment that the current strength is uniform all along the wires. Obviously this cannot be true or else the entire input power would be delivered to the terminating resistor. However, the assumption appears close enough to the truth to permit reasoning to conclusions that are sufficiently accurate for the present purposes.

³ Equation 19, page 59, *Rhombic Antenna Design*, by A. E. Harper, published by D. Van Nostrand Co., New York.

⁴ Bruce, Beck and Lowry, "Horizontal Rhombic Antennas," *Proc. I.R.E.*, January, 1935.

A Field-Intensity Meter for V.H.F.

Construction of a Simple Instrument for Checking Antenna Adjustments

BY D. C. SUMMERFORD,* W9AYH

IT is much more difficult to adjust a v.h.f. transmitter and antenna system by conventional methods than a similar system on the lower amateur frequencies. For maximum performance, the system should be adjusted under actual radiating conditions. This may be done by having another ham make readings on the "S" meter of a communications receiver, or by using a field-intensity meter. In general, the use of the field-intensity meter is more satisfactory, especially when work is being done on directional antennas.

The simple, yet sensitive set shown in the photographs was built by the author for some experimental work. The circuit, shown in Fig. 1, makes use of a 955 acorn triode biased to near cut-off and operated at low plate voltage. A typical calibration curve made with a v.h.f. signal generator is shown in Fig. 2.

Construction

Physically, the meter is small. Exclusive of antenna and insulator, it is 4 inches wide by 4 inches deep by 8 inches high. The front panel was made from 1/4-inch aluminum for rigidity, while the case is made of sheet aluminum with the seams soldered. Steel flanges are riveted inside the case to take the filister-head panel screws. By removing the four front-panel screws, the instrument may be removed from the case for battery replacement and changing coils without breaking connections.

* Asst. Tech. Director, WHAS, Louisville 2, Ky.

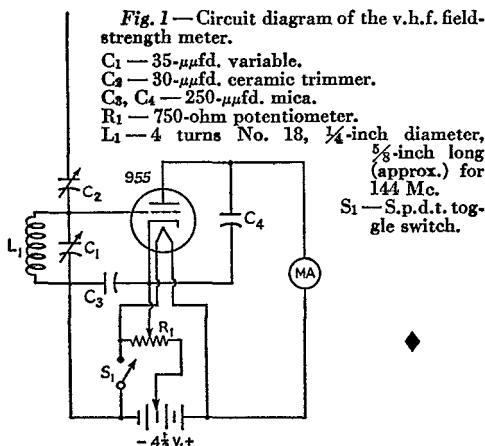

Front view of the v.h.f. field-strength meter. The meter deflection is adjusted initially to 10 per cent of full scale by means of the screwdriver control at the left of the dial knob. The battery switch is to the right.

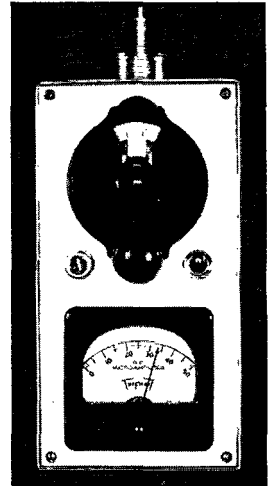

All parts are mounted on the panel, as shown in the photograph of the interior.

A small polystyrene subpanel, spaced from the front panel by means of brass pillars, serves as a mounting for the components which make up the r.f. circuit. The tuning condenser is a Hammarlund which is mounted on the subpanel in reverse position. The dial is attached to an extension shaft which is joined to the tail shaft of the condenser by an insulating flexible coupling. The tube socket is mounted on the rear side of the subpanel on metal spacers so that the tube will clear the front shaft of the condenser. The coil and antenna-coupling condenser are mounted above the socket and tuning condenser.

The adjusting potentiometer, the switch and

• Proper adjustment for maximum antenna and transmitter performance, not always an easy job at the lower frequencies, becomes increasingly difficult at the higher frequencies. Small changes in physical values cause relatively enormous changes in performance and the reliability of the more commonly-used methods of adjustment is reduced. At high frequencies, a field-strength meter of the type described in this article becomes almost indispensable.

the meter, of course, are mounted on the front panel. Behind these is another larger subpanel which serves as a support for the three flashlight cells which make up the $4\frac{1}{2}$ -volt battery. They are held in place by an aluminum clamping strip fastened to aluminum angle pieces by machine

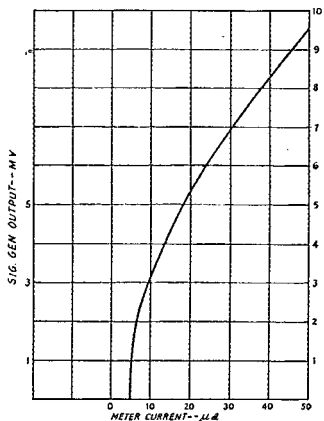

Fig. 2 — Response curve of the v.h.f. f.s. meter in terms of millivolts input and microamperes deflection.

screws and thumb nuts. The telescopic half-wave antenna plugs into a Johnson jack-top feed-through insulator as shown in Fig. 3. The assembly screw of the insulator, in turn, makes contact with the series coupling condenser through a spring contact. A socket was mounted in the bottom of the cabinet so that the unit could be used on a standard camera tripod.

Adjustment

As with most v.h.f. equipment, coil dimensions and frequency range are determined largely by the arrangement of parts. In this particular model, the top frequency is around 225 megacycles with practically no coil. The coil shown in the photograph (right) tunes to around 100 Mc. Approximate dimensions for the 144-Mc. band are given under Fig. 1.

After the unit has been finished, the potentiometer, R_1 , should be turned to the left as far as possible. This puts a $1\frac{1}{2}$ -volt bias on the tube. Then the off-on switch, S_1 , should be turned on. After waiting about 30 seconds, the potentiometer should be turned clockwise with a screwdriver until the meter reads 10 per cent of full scale (in this instrument, 5 microamperes). Then the exciter stages of the transmitter should be turned on and the f.s. meter tuned until a sharp rise in deflection is obtained. If necessary, the coil may be squeezed or expanded, or the number of turns may be altered to hit the desired frequency. When the coil has been trimmed properly the antenna length and the capacitance of the coupling condenser, C_3 , should be adjusted for maximum deflection. The coupling-condenser adjustment is not critical. Those adjustments should serve to increase the sensitivity. Making

the antenna less than one-half wavelength long may be advantageous when working close to the antenna or with high power. However, changing the antenna length will have some effect upon the tuning range.

This particular instrument has not been calibrated in absolute values of field intensity, i.e., in microvolts per meter, and in ordinary ham use such a calibration is not needed. However, to give an idea of the sensitivity, it was used with a relay broadcast transmitter having an output of about 100 watts on 156.75 megacycles. The transmitter is well shielded and uses a long coaxial line to the antenna. In the same room as the transmitter, the meter read from a low value to hard against the pin as it was passed through standing waves in the room. Outside, in the clear, it was possible to get full-scale deflection two blocks from the antenna.

Making Measurements

Normally, the meter is set up for vertical polarization. If the transmitting antenna is horizontal, a horizontal antenna should be used on the meter. This may be provided by bending the antenna rod just above the insulator, or by using a right-angle adapter coupling. Of course, perhaps the simplest thing to do is to tilt the meter until the antenna is horizontal.

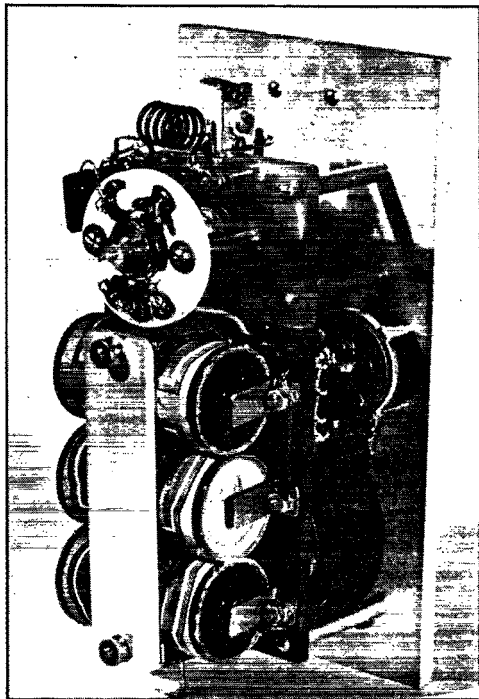

The r.f. circuit components are arranged in a compact group on the polystyrene subpanel at the top. The antenna makes contact with the terminal of the trimmer-type coupling condenser.

In making measurements, the instrument should be set up a few wavelengths from the antenna, as much as possible in the clear, on a rigid support. In adjusting an antenna and transmitter for maximum radiation, the instrument should be

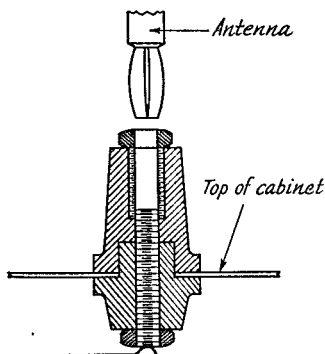

Fig. 3—Sketch of the antenna mounting. The assembly screw is cut off flush with the hex nut where the spring of the antenna-coupling condenser makes contact.

left fixed at one spot, since a movement of a foot or so when working at two meters will cause wide variations in readings. The effect of the observer's body and passing vehicles should be noted, since violent fluctuations in the meter reading may be caused by reflections from near-by objects.

The only expensive item is the microammeter. Any meter with a scale of from 10 microamperes to 1 milliampere may be used, but of course the sensitivity is dependent upon a low-current meter. The total cost of this instrument was \$25.00 and 25 hours work. Using standard components and cabinets, any amateur should be able to duplicate it in a much shorter time.

About the Author

• D. C. Summerford, W9AYH, learned the code at Alabama Polytechnic Institute and obtained W4FN after the DX bug hit him. Licensed W9AYH in '31, Summerford reported great enjoyment on 20-w-phone in the pre-Class-A days. W9AYH is a member of the RCC, holds a Code Proficiency Award for 35 w.p.m. and a WAC certificate. A member of the IRE, Summerford is on the RTPB panel studying broadcast facsimile and on the FCC Industry Committee working out f.m. propagation tests.

**SWITCH
TO SAFETY!**



ARRL QSL BUREAU

FOR THE convenience of American and Canadian amateurs, the League maintains a QSL-card distributing system which operates through volunteer "District QSL Managers" in each call area. To secure such foreign cards as may be received for you, send your district manager a standard No. 10 stamped, self-addressed envelope. If you have reason to expect a considerable number of cards, put on an extra stamp so that it has a total of six-cents postage. Your own name and address go in the customary place on the face, and your station call should be printed prominently in the upper left-hand corner. If you have held other calls in previous years, submit an envelope for each such call to the proper manager—there are many thousands of un-called-for cards in the files. All incoming cards are routed by Hq. to the home district of the call shown in the address. Therefore, cards for portable operation in other districts should be obtained from the home-district manager. Amateurs in the new WØ area should send envelopes to the W9 Manager until their calls are actually modified to carry the zero designator. VE6-7-8 amateurs should keep envelopes on file for their former calls.

(See the "Foreign Notes" section of May QST for the method of handling *outgoing* cards from W-K-VE amateurs to foreign countries.)

W1 — Jules T. Steiger, W1BGY, 231 Meadow St., Willimansett, Mass.

W2 — Henry W. Yahnel, W2SN, Lake Ave., Helmetta, N. J.

W3 — Maurice W. Downs, W3WU, 1311 Sheridan St., N. W., Washington 11, D. C.

W4 — Edward J. Collins, W4MS, 1215 North 12th Ave., Pensacola, Fla.

W5 — L. W. May, jr., W5AJG, 9428 Hobart St., Dallas 18, Texas.

W6 — Horace R. Greer, W6TI, 414 Fairmount Ave., Oakland, Calif.

W7 — Frank E. Pratt, W7DXZ, 5023 So. Ferry St., Tacoma, Wash.

W8 — Fred W. Allen, W8GER, 1959 Riverside Drive, Dayton 5, Ohio.

W9 — F. Claude Moore, W9HLF, 1024 Henrietta St., Pekin, Ill.

WØ (as established) — Alva A. Smith, W9DMA, 238 East Main St., Caledonia, Minn.

VE1 — VE1FQ will resume service soon.

VE2 — C. W. Skarstedt, VE2DR, 3821 Girouard Ave., Montreal 28, P. Q.

VE3 — W. Bert Knowles, VE3QB, Lanark, Ont.

VE4 — c/o ARRL.

VE5 — H. R. Hough, VE5HR, 1785 Emerson St., Victoria, B. C.

VE6 — W. R. Savage, VE6EO, 329 15th St. North, Lethbridge, Alta.

K7 — J. W. McKinley, K7GSC, Box 1533, Juneau, Alaska.

Getting Started on 420 Mc.

Transmitter and Receiver Technique for a New U.H.F. Band

BY W. F. HOISINGTON, * WILAS/2

• One sure-fire way of getting some activity on a new band is to build two complete stations and loan one of them out to your friends. These rigs demonstrate that the generating of a husky signal in the new 420-Mc. band need not be too complicated or expensive for the average u.h.f. enthusiast.

SOME PRELIMINARY thinking about the new 420-Mc. band, the first one-third of which was made available on March 1st, produced the following conclusions:

1) While the old reliable 955 acorn, in the more or less standard superregenerative circuit, would take care of our early receiving requirements, something with more power would have to be used for transmitting if satisfactory coverage was to result.

2) Two complete stations would have to be assembled, if two-way communication was to be carried on without delay.

3) At least one of the stations should be made portable, and capable of being operated from 6 volts d.c., as work from hilltops might be necessary to cover any appreciable distance at first.

4) The equipment should be as simple as possible, using available components and sure-fire circuits, in order to encourage others to come on the band.

5) If we don't use the band, someone else will!

The Transmitters

The transmitting oscillator being the most difficult part of a station for this band, it was tackled first. The ferreting out of surplus parts and tubes during the past two years now showed beneficial results, because two RCA 8012s were reposing in the "tube department" of the shack. These tubes are rated at 22-watts *output* on 500 Mc., so they should be OK on 420!

The *Handbook* was not much help here, since only receiving-tube circuits are shown. There are certain facts regarding u.h.f. oscillators that are not usually found in books. These have to do mainly with the amount of r.f. voltage to allow on the cathode circuit, its phasing (instantaneous potential with respect to the grid and plate), proper amount and phasing of grid excitation, and a not-too-great radiating configuration.

By using the 8012 in a half-wave line, as shown in Fig. 1, instead of a quarter-wave line, the hot end of the line (in this case the middle) is placed inside the tube itself. This procedure is possible, of course, only with tubes having two leads for both grid and plate. Such an arrangement leaves as much as two inches of tubing outside of the tube itself, at 425 Mc., provided that the grid is "unloaded" somewhat from the plate tank. This is done by using a variable trimmer for the grid condenser, the capacity of which may be as low as 10 or 15 $\mu\text{fd.}$ when the oscillator is running properly.

The d.c. connection to the grid is brought out through the inside of the grid rod, thus removing

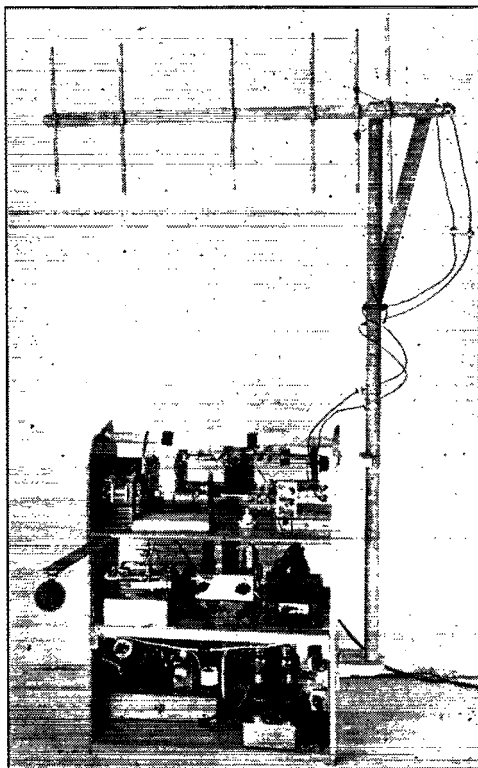

Both 420-Mc. stations are built in portable form. On the top shelf are the oscillator, wavemeter, and antenna-switching panel. The middle shelf houses the receiver, audio system, and send-receive controls. At the bottom are the power supplies and modulator. A single-button microphone is mounted on an arm which folds back under the shelf.

*U.H.F. Resonator Co., Guion Rd., Rye, N.Y.

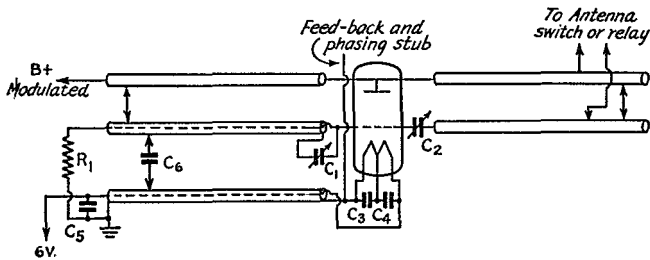

Fig. 1 — Schematic diagram of the 420-Mc. oscillator.

C_1, C_2 — 3-30- μ fd. mica trimmer.
 C_3, C_4, C_5, C_6 — 500- μ fd. midget, silver-mica.
 R_1 — 1000-ohm 2-watt carbon.

All lines are $\frac{1}{4}$ -inch copper tubing approximately 4-inches long. The oscillator tube is an 8012.

the necessity for an r.f. choke, and also unloading the grid resistor from the r.f. plate tank. The filament voltage is likewise brought through the center of the cathode line, in order to be able to treat the cathode circuit as a single rod.

The r.f. voltage on the cathode is taken care of in two ways; first, by a carefully-tuned cathode line, and second, by a phasing and feed-back stub. No filament chokes are needed with this arrangement. The cathode line is tuned by C_6 (Fig. 1), with clips between the grid and cathode lines. The phasing and feed-back stub, see schematic diagram and photo, is cut to length and positioned with respect to the plate for maximum excitation. Both an r.f. output indicator (a 15-watt lamp will do) and a grid-current meter should be used while making this adjustment, as maximum grid current does not necessarily mean maximum output.

Both rigs were tuned up using 6-element arrays similar to the one shown in the photograph of one of the complete stations. A flashlight bulb mounted in the center of a half-wave dipole at a distance of six to eight feet was used as an output indicator. This is a necessary check, as it is possible to lose most of the r.f. on the way up to the antenna. The antenna line originally used was the $1\frac{1}{2}$ -inch spaced feeder shown in the photograph, but this has since been replaced with 300-ohm Twin-Lead, for maximum convenience.

In order to make it a simple matter to make changes in any part of the two stations, they were made up of small units, interconnected with cables. In addition to the transmitter-oscillator these units include a modulator, two power supplies, receiver, receiver control panel and receiver audio system.

Modulation can be supplied in almost any way which provides a suitable amount of audio power. In the station which was designed for a.c. operation we used a pair of 6A3s in push-pull, with a high-gain speech amplifier. The rig for field work uses two 6L6s in parallel, with a 6C5 speech amplifier. The field rig is equipped with a.c. supplies, but the over-all drain is low enough so that it can be operated from a battery and a genemotor or Vibrapack if desired.

The Receivers

The receivers are the same in each station, using 955s as superregenerative detectors. This sounds simple, and, indeed, it is not difficult to get an acorn to receive on 420 Mc., but to get one to operate smoothly over the whole range from 400 to 500 Mc. without the use of filament chokes, took a little experimenting. The schematic for the receivers is shown in Fig. 2(A). Tuned circuits similar to those used in the transmitter, employing $\frac{1}{4}$ -inch copper tubing and a shorting bar driven by a hand-crank knob, are used for tuning the receivers, but the phasing and feed-back stub was not needed. By simply changing the 1-megohm grid resistor to 5000 ohms, the unit may be converted into a good local oscillator

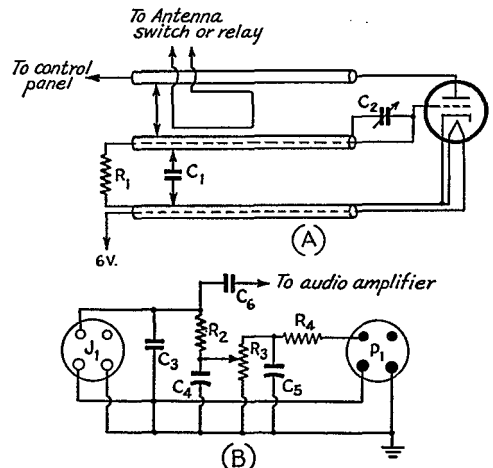

Fig. 2 — A shows the schematic diagram of the receiver proper. B is the superregenerative receiver control panel.

C_1 — 100- μ fd. midget, silver-mica.
 C_2 — 3-30- μ fd. mica trimmer.
 C_3 — 0.003- μ fd. mica.
 C_4 — 0.5- μ fd. paper.
 C_5 — 8- μ fd. electrolytic.
 C_6 — 0.01- μ fd. paper or mica.
 R_1 — 1-megohm or 5000-ohm, $\frac{1}{2}$ -watt, see text.
 R_2 — 25,000-ohm, $\frac{1}{2}$ -watt.
 R_3 — 100,000-ohm potentiometer.
 R_4 — 10,000-ohm, 1-watt.
 J_1 — Socket on control panel.
 P_1 — Power plug on cable.

Lines are similar to those used in the transmitter. Detector tube is a 955.

for use in a superhet. The unit may, in fact, be tuned up using the 5000-ohm resistor and about 100 volts on the plate, with a 2-volt 60-ma. pilot light for a load in place of the antenna. When the oscillator runs smoothly with little variation in output over the whole tuning range, satisfactory superregenerative operation is assured when the 1-megohm resistor is substituted. If a squeal is heard as the regeneration control is advanced, the value of the grid resistor or condenser should be reduced. Too low a value of grid condenser will result in loss of superregeneration, which will in turn require reduced antenna coupling.

The receiver unit has a three-wire cable and a four-prong plug, so that conversion to a local oscillator merely requires changing the resistor and plugging the cable into a suitable power supply, instead of plugging into the receiver control panel shown in Fig. 2(B). This panel arrangement is useful around a v.h.f. station, and is self-explanatory to anyone who has worked with superregenerative receivers. C_3 helps to control the quench frequency, C_4 by-passes the regeneration control, and R_4 is the dropping and filter resistor for the B+ lead. The power plug goes into any power supply in the shack or car, and the audio output to any of several audio amplifiers. Receiver audio systems in both stations use a 6C5 and a 6L6.

Another small panel serves as a send-receive control, switching the B+ to receiver and transmitter. Antenna switches are mounted on a polystyrene panel, pending the acquisition of suitable relays.

Antenna coupling to the receiver is critical, and must be quite loose. There is considerable difference between 420 and 144 Mc. in this respect, as the receiver oscillation is much weaker at the higher frequency, and coupling must be correspondingly loose. Another trouble which is magnified on the higher frequency is the instability of the receiver and transmitter resulting from movement of the feeder system in the wind when long outdoor feedlines are used. Both of these troubles indicate that much-improved per-

formance would be obtainable if a superhet were used for reception. As the detector can be changed to a local oscillator by merely changing the grid resistor, we may try the superhet idea.

Results to Date

The first on-the-air tests were made between WILAS/2 and W2LXV, both of Rye, N. Y., over a 1½-mile path. Signals were S9-plus at this distance, as they were later when tried over a similar distance between W1HDQ and ARRL Headquarters. Using the six-element arrays on both units, the beam patterns were quite sharp, the signal dropping to zero at 25 to 30 degrees either side of the maximum point. The rigs were also tried over the indirect 5-mile path between W1HDQ and W2OEN/1, but without success in the limited time available.

The best DX worked with the rigs to date is 17 miles, covered recently when one of the stations was taken to W8WCG/2 at Flushing, N. Y. The 6-element arrays were installed out-of-doors, the one at Rye being mounted on a 15-foot pole outside the window and the one at Flushing about 8 feet above the roof of a 4-story apartment house, both using the 300-ohm Twin-Lead as a feeder system.

Contact was established in a few minutes at the first try and reports were S7 in one direction and S9 in the other, one of the power supplies delivering only 250 volts compared to 350 from the other. Orientation of the arrays had to be substantially correct, as the beams were very sharp in both the horizontal and vertical plane.

Right now we are waiting for other recruits on the band, and wondering how things will be when we have hundreds of stations there as we now have on 144 Mc. The new band is much wider than either the 144- or 235-Mc. bands, and it is not completely beyond the range of carefully-designed equipment of the conventional sort. War-time experiments indicate that there are interesting propagation characteristics awaiting us there. All we need now is activity!



Detail view of the 8012 oscillator used in the 420-Mc. rigs. Note feedback stub mounted alongside the tube envelope.

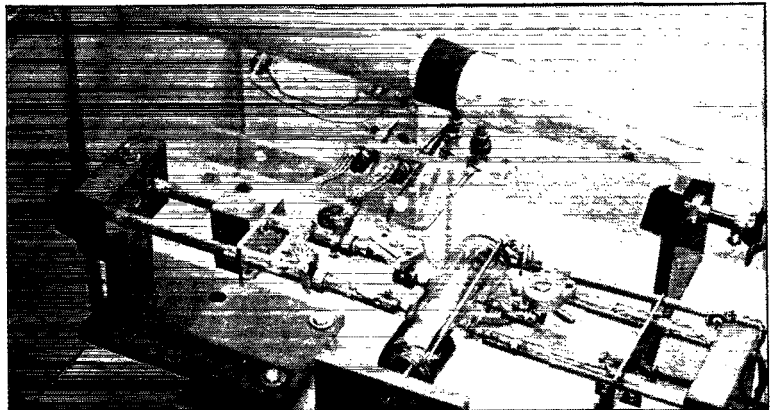

• Technical Topics —

Standardized Component Values

ALTHOUGH the use of preferred numbers for values of small components such as resistors and condensers was not a wartime development, the war did bring about standardization throughout the radio and electronics industry on those values. The system is based on the logical idea that the permissible tolerances in values are what count.

Starting with 1 (or 10, 100 or any decimal multiple) values increase logarithmically so that each higher value represents a constant percentage increase over the value immediately below it. In practice, the values are rounded off to two significant figures, this order of accuracy being enough to give a complete range of the smallest tolerance (5%) ordinarily required.

A summary of values from 10 to 100 is given in Table I. Larger values are found by multiplying by 10 or any multiple of 10, smaller values by dividing by 10 and its multiples.

Many of our old friends such as 25, 50 and other "even" values, do not appear in this table. However, such values in themselves usually have no particular significance; they are simply convenient numbers to remember. The advantages of the standard system are so obvious that we intend in the future to use it in *QST*. Where no tolerance is specified it is to be understood that the largest tolerance available in that value is to be used; where two or three tolerances are available and a small tolerance is required, it will be specified. For example, if a 47,000-ohm resistor is called for, the tolerance is understood to be 20% unless otherwise specified. On the other hand, the 36 value appears only in the 5% column, so it would be understood that a 3600-ohm unit would have 5% tolerance.

Values for the capacitances of small mica condensers follow a similar table, although in this case the values listed under 5% tolerance also can be obtained with 2% tolerance.

If circuit values specified in future *QST* diagrams look odd compared to past practice, remember that there is a logical basis for them. To most amateurs, however, they will simply represent the continuation of a system with which they became thoroughly familiar during the war.

— G. G.

20% Tolerance	10% Tolerance	5% Tolerance
10	10	10
		11
	12	12
		13
15	15	15
		16
	18	18
		20
22	22	22
		24
	27	27
		30
33	33	33
		36
	39	39
		43
47	47	47
		51
	56	56
		62
68	68	68
		75
	82	82
		91
100	100	100

Frequency-Shift Keying

JUST BEFORE the lid began to be lifted on wartime radio developments the grapevine had it that there was a new system of code transmission that made 100 watts equal to 10 kilowatts. It wasn't an idle rumor. The joker — there always has to be one! — is that the system is one peculiarly suited to commercial transmission and, as it looks to us, equally peculiarly unsuited to amateur work.

By now, if you've listened at all on 7 or 14 Mc., you've heard it on the air. On an ordinary receiver the signals don't sound a bit stronger than

they would with the same power and regular keying — the only difference is that there is a back-wave a kilocycle or two away, just as strong as the main wave. The listener has a hard job deciding which is which, in fact, because neither wave spells out regular code. These transmissions are used with radio printers, which have a special code of their own.

It's essentially a case of the now-familiar story of f.m. versus a.m. in signal-to-noise ratio. Above a certain level of carrier strength, f.m. suppresses noise to such an extent that a large improvement

in signal-to-noise ratio can be obtained. Under certain conditions, frequency-shift telegraphy will give an improvement in signal-to-noise ratio of as much as 20 db., which is where the 100-times-power comparison comes in. This is an important consideration in teleprinter operation, because noise will cause erratic operation. The same amount of it, though, would not bother an operator doing normal copying by ear. Insofar as amateur operation is concerned, it appears to be simply a matter of improving a signal-to-noise ratio that already is high enough to be quite satisfactory.

But that isn't the whole story by any means. Printer circuits, being automatic in operation, require a channel not only wide enough to take care of the keying modulation but also to allow for instability in both transmitter and receiver. In turn, this means that there is a definite lower limit to usable receiver selectivity. Those of us who make use of our crystal filters are accustomed to a very much higher order of selectivity than can be used in commercial circuits. And since high selectivity brings with it a reduction in noise, we already have at our disposal a means for getting at least the equivalent of the gain claimed for "f.s.k." Furthermore, it helps where we want it the most — when the signal is weak; in that case it will bring out the ones that get lost in receiver hiss with normal i.f. selectivity. It is well known that f.m. works in the opposite way; down to the "threshold" level it gives a better signal-to-noise ratio than a.m., but below the threshold a.m. is better.

Frequency-shift keying is like regular f.m. in that the improvement in signal-to-noise ratio arises wholly as a result of the *receiving* method used. F.s.k. transmitters by themselves are no more useful in reducing noise than f.m. transmitters alone. Consequently, the receiver must be capable of utilizing the system before any benefits are available. In the systems currently used, the process of translating the signal into usable code symbols is carried out in a "converter" unit which works out of an ordinary a.m. communications receiver. A representative block diagram is shown in Fig. 1. The incoming signal is detected in the communications receiver, using regular beat-note reception, with the beat-frequency oscillator adjusted to give different tones on the mark and space signals. In the Press Wireless system, for example, where the frequency shift is

600 cycles, the beat oscillator is set so that one tone comes out to be, say, 2250 cycles and the other 2850 cycles. The difference between these figures represents the total frequency swing, in f.m. terminology. The frequency deviation is therefore 300 cycles on either side of an assumed "carrier" frequency of 2550 cycles. The receiver output is fed through a band-pass filter to eliminate noise and interference components outside the limits of the frequency swing, and thence into a limiter, just as in regular f.m. practice. The amplitude-limited signal then goes to a discriminator which, in the block diagram of Fig. 1, consists of separate tone filters and rectifiers for each of the two tones with the detector outputs combined "back-to-back." This gives a keyed d.c. output which actuates a keyer unit, the latter then operating the printer or, with an auxiliary a.f. oscillator, a headset.

It is to be observed that this is an f.m. system in which the carrier is an audio frequency and the modulation is the keying envelope. It can only produce a keyed d.c. output. This is fine for automatic reception, but the only way to get aural signals is to key an audio tone, and since that tone is entirely independent of the frequency of the incoming signal, there is no way to get the aural selectivity that is so useful in amateur communication. The lack of aural selectivity might not be serious if every transmitter had a clear channel, but we can't visualize that condition as existing in any busy ham band! And, like regular f.m., the system is vulnerable to interference from other transmitters, including both a.m. and f.m., which may operate within the receiver pass-band, except in the special case of one operating on the same carrier frequency and weaker than the desired signal. In our c.w. work we don't usually worry much about interference that is weaker than the signal we want.

The proponents of f.s.k. for amateur work are usually intrigued by the fact that the transmitter is on continuously and, since the keying simply shifts the frequency back and forth, it should therefore be possible to key a high-power rig without key clicks. On the basis of the sidebands set up by equivalent keying waveforms in the two systems, this is a fallacious argument because sidebands in f.m. cover a larger frequency range than in a.m. Practically, there may be something to be said for frequency-shift keying in that it may be *easier* to shape the keying waveform so that the transients that produce clicks are eliminated. There is a real advantage to f.s.k. in another respect, too; where interference to b.c. reception is the result of rectification of the signal simply because the receiver is in a strong field, f.s.k. will be much less annoying than ordinary keying. In such cases am-

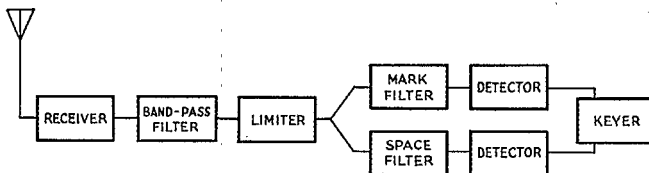

Fig. 1 — Block diagram of representative receiving system for frequency-shift keying.

plitude keying causes the received program level to "jump up and down" with keying, but with f.s.k. the level will change only when the transmitter is turned on and off.

During the war OWI used f.s.k. as a means of simultaneous transmission of Morse code and broadcasting on the same carrier, a stunt which is perfectly feasible with a small frequency shift (400 cycles was employed in the OWI transmitters). Whether or not this scheme has any possibilities in amateur work remains to be determined. At first thought it would seem to have little application in two-way communication except on those bands where the carrier can be left on continuously.

For whatever benefits f.s.k. may have to offer in ham communication, the price is pretty steep: twice as many signals per transmission as with ordinary keying. If we all used it, the effective width of our c.w. bands would be halved even if we could still use the receiver selectivity we now take as a matter of course. But that can't be done; the actual ratio, both circuit and aural selectivity considered, appears to be more like 5 to 1.

This conclusion is reached solely on the basis of what is already known about the two systems. Amateur experiment with f.s.k. is not precluded under the present regulations; the new 27-Mc.

assignment is open to f.s.k. along with the part of the 28-Mc. band above 28.95 Mc. and the part of the 50-Mc. band above 52.5 Mc. There is thus plenty of opportunity to try out the system, and if this preliminary diagnosis is wrong experiment should show it.

So far, it seems as though wartime developments in communication systems have effected improvements useful only for the special requirements of military and commercial communications — and only at the expense of ever-wider channels per transmitter. In the end, the wider channels may actually save spectrum space by speeding up traffic to a greater extent than they use up kilocycles; that is, the number of "kilo-cycle-hours" may be reduced by the new methods as compared to the old. Unfortunately, saving time in that sense is not an important factor in reducing congestion in the amateur bands; time saved in one QSO is simply time available for another, so the total interference is not affected appreciably. Our situation is such that any new system that effects an improvement by widening the frequency band occupied by a given type of emission wants to be approached with extreme caution. Developments in the other direction would be welcomed with open arms — but so far none have been disclosed.

— G. G.

"No Neutralization Required"

MANY AMATEURS have been disappointed in the performance of a new rig using one or more beam tetrodes because of oscillations that occur under certain tuning and operating conditions. The advertisements for the tubes lead one to believe that no neutralization will be needed, the amateur in the next block has a transmitter using the same type of tube without neutralization, but our rig persists in "taking off" when the fixed bias is decreased or the grid (or plate) circuit is detuned, and the first conclusion is that the new gear is the home of some malevolent jinni. Sometimes the trouble appears when the tetrode is used in an amplifier with the keyed stage ahead of it, and sometimes it shows up under modulation peaks. The troubles usually stem from a lack of understanding of the conditions under which the "no neutralization required" statement holds true.

Any experienced amateur knows the test of a stable triode amplifier. A neutralized triode amplifier can be completely unloaded in the grid and plate circuits, the fixed grid bias reduced until the plate power input is the normal dissipation rating of the tube — or tubes, in the case of a push-pull amplifier — and the grid and plate circuits can be tuned in any combination without any oscillation or even a flicker in the plate current. Such tests just aren't made with a tet-

rode amplifier, although a good one will pass the test if the bias is kept reasonably high and the grid circuit is loaded by the driver stage.

The sources of feed-back in an amplifier using a tetrode are the grid-plate capacity, inductive coupling between grid and plate coils, and inductance in the screen lead. Most rigs are designed with shielding adequate to eliminate the inductive (and external capacitative) coupling between grid and plate circuits, and a good mica screen by-pass condenser with short leads will usually bring the screen down to ground at normal communications frequencies, although in the v.h.f. range it is often necessary to series resonate the screen circuit.¹ However, the grid-plate capacity is built into the tube, and the set constructor must either neutralize this capacity if it is too large or operate the amplifier under conditions for which the capacity is not too large.

That the grid-plate capacity of a tetrode may be too large may come as a surprise to those who consider all multigrad tubes to have negligible grid-plate capacity. In any amplifier with tuned-grid and tuned-plate circuits, the expression for the maximum grid-plate capacity that can be tolerated without oscillation under any tuning

(Continued on page 118)

¹ Eitel-McCullough, Inc., "Application Notes on 4-125A."

Making the Most of It

Planning the Radio Shack for Appearance and Convenience

BY EUGENE A. HUBBELL,* W9ERU

NOT every ham has the chance to build his own shack (known as "home" to the wife and parasitics), but when he does he wants to make the most of the opportunity. Here are a few suggestions and experiences gained from doing such a job a short time ago.

The location of the prospective home will be the first consideration. For the most of us, this will be a compromise depending upon one's finances, work, transportation, friends, etc., with the ham angle being a very acute wedge of the pie. In my opinion, the newer subdivisions offer the best locations because of fewer neighbors, less interference (electrical equipment is newer, less automobile traffic), more chance for antenna experiments in the vacant lots, and the fact that one's amateur activities will be well established when newer homes are built. In other words, a BCL can only blame himself if he moves in alongside a kilowatt 'phone. Also, a subdivision is usually considered to increase in value as homes are regularly being built and the district becomes more settled. I have also noticed that, in general, the higher sections of the city are more desirable from a residence standpoint, and these high spots offer better antenna locations. Needless to say, highways and through streets carrying large amounts of traffic should be avoided. The dead-end street looks good to me.

Restrictions on the land govern the location of the house to some extent, and as the wife will usually register more than a little dismay at the antenna supports being placed in the front yard, the more back yard the better. In my case, the agreement was reached between my wife and me that the antenna must be confined to the rear of the house, but there I was free to put in what I wanted. Since power poles present a much better appearance than lattice towers, and require no

guy wires, negotiations were opened with a friend on the local power company staff, and a pair of discarded cedar poles about sixty feet long were obtained.

A ground system is essential to any properly installed radio station, so a little thought should be given this before work is actually started. In my case, a couple of hundred feet of one-inch wide copper ribbon was obtained, and one strap was put in lengthwise and two crosswise in the excavation, with the ends being brought up to the top of the foundation, and *outside* of the foundation. These ends provide places to tie on any additional ground network which may be put in later. Straps should be soldered on inside the foundation and brought up for connection in the radio room and to the work bench. A network of heavy copper wire could be used equally well, if no ribbon is available. After the house is built, all pipes and metal work can be bonded together and connected to the same ground strap.

Most small-home plans used today provide for a play room in the basement, but if no provision is made for one, it can easily be arranged for the contractor to build in one. Care should be taken to moisture-proof the walls as thoroughly as possible, and the inside of the room should be finished in whatever material will best resist dampness. If room is available on the floors above ground level, the dampness question will be more easily solved. In my case, the downstairs provided a room intended originally for a bedroom, and measuring about twelve feet square, with windows to the side and rear. In other cases an upstairs bedroom can be used — until one's family pushes the hamshack out. A sunparlor, if adequately protected against cold weather, makes a very good shack.

The interior of the radio room will present a much better appearance from the amateur viewpoint if the walls are finished in something besides rough plaster or ordinary wall paper. There is an exception to the wall paper angle, however, since there is available a wood-grain wall paper which can be used to simulate a paneled wood appearance. Celotex, wall board, and plywood paneling can also be used. I chose the latter, lightly stained and varnished. The Celotex offers the advantage of sound deadening, but has the disadvantage of rubbing off quite easily, unless painted — and does it soak up paint! The ceiling can very well be plastered and painted a light color for reflected lighting.

* 2511 Burrmont Road, Rockford, Ill.

PUT DOWN ON PAPER
EVERY POSSIBLE IMPROVEMENT
--- AND DISCUSS
THEM WITH YOUR
CONTRACTOR
BEFORE YOU
BUILD.

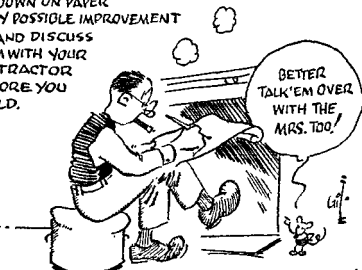

A small wood molding run around the upper wall surface to join the walls to the ceiling offers a good place to hide receiving antenna leads, control wires, speaker leads, etc., especially if a gap of a quarter inch is left between molding and ceiling. Even if the molding is tightly placed against the ceiling, small metal clips of the type used to hold extension cords on top of baseboards can be used to good advantage. Joints between panels, if plywood, Celotex, or wall board is used, must be covered with molding also, the back of which could be hollowed out to take wires, provided the molding were removable. Removable baseboards would also allow a place for running control wires, and another idea would be to have plugs made for insertion in the flooring, say the width of a floor board, and three inches long, planed smooth on all edges and screwed in place. With the screws recessed and plugged with plastic wood, the floor can be sanded smooth and finished so that the floor blocks will not show. They can be dug out, however, when necessary to connect leads, the leads passing over the basement ceiling. This idea *isn't* successful if the radio room is on the second floor.

Built-in shelves and cupboards would be very handy in a shack, and every effort should be made to provide room for *QST's*, catalogs, old logs and many other items which clutter up an operating desk. Large panels of Celotex can be screwed to the wall (assuming the room is not finished in Celotex) to take maps and *QSL* cards. An extra wide door served me very well when I discovered that my new operating desk had a minimum dimension of 30½ inches. Linoleum on the floor would give an opportunity for insertion of an ARRL diamond in the center, and commercial cut-outs of compass directions are available. Linoleum must be waxed and polished for wear and appearance, however, and shoes and furniture leave marks hard to polish out.

The electrical installation would probably give the amateur his best chance to improve the radio room, as compared to the average house wiring job. In my case, a Cutler-Hammer overload-breaker center provided circuit control for four 15-, one 24- and one 35-ampere circuits. The last two provided for three-wire services and, since I did not plan to use an electric stove, the 35-ampere circuit went to the ham shack, by way of three No. 8 wires. A pair of twist-lock receptacles

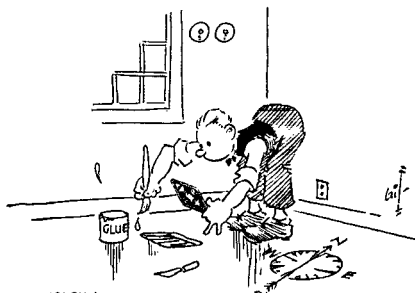

LINOLEUM ON THE FLOOR
WOULD GIVE AN OPPORTUNITY FOR
INSERTION OF AN ARRL DIAMOND

provide two 110-volt circuits, one on each side of the line, while 220 volts is available from the hot wires in each of these two circuits. The twist-lock receptacles have plugs which are inserted and then rotated a portion of a turn to prevent their working out with heavy cables attached — and perhaps interrupting a *QSO*. Ordinary home outlets provide connection for receiver supply, desk lamp, electric clock and other equipment requiring a small amount of current. A single extension cord comes from the nearest outlet to a five-gang outlet box located high up inside the knee hole of the desk, making it unnecessary to run a number of cords from desk to wall. A store-type indirect lighting fixture using a 200-watt bulb gives adequate light for everything except reading.

The ground strap mentioned earlier comes up through a wall slot just above the baseboard and across the floor to the base of the transmitter rack, and continues across the floor under the rug to the operating desk for a ground on the receiver and variable-frequency oscillator.

Receiving antennas for the broadcast receivers in the house can be installed in the walls when the house is being built, and come out at the special antenna outlet plates available. This will make it unnecessary to run any wires outside except the regular transmitting antenna. Connections to the transmitting antenna come through the wall by way of navy-type Pyrex bowls and heavy brass rods. The 1½-inch holes for the rods were bored through with an extension bit, and I hope you are luckier than I on was this — I hit a stud edge on, and had to bore through four extra inches of wood and plenty of nails.

Trimming for the radio room can include aluminum venetian blinds instead of curtains and, if your pocketbook can stand it, chrome-steel furniture. Strip carpeting can be used instead of a full-sized rug — probably you won't be shifting your furniture every few days as your wife does.

Put down on paper every possible improvement you can figure on before you ever start to build and discuss them with your contractor

(Concluded on page 116)

• Everyone of us dreams of an ideal location for ham radio — and hopes some day to find it and build a house on it. If the happy time ever comes, it's well to be prepared with plans for something more than the spots where the antenna masts are to be located. Here are some helpful pointers.



How's DX?



How:

Do you want to know how to work DX? Then take a tip from the fishermen. Did you ever stop to think how closely parallel the two sports of fishing and chasing DX are? The dawn and dusk periods usually pay off the best, good technique generally means more than fancy equipment, and the pretty gadgets in the stores always have great appeal — often more for the fisherman/DXer than for the fish/DX. The fisherman has his pet pool with a large fish in it that someday he's going to land, and the DXer has a prize DX station all spotted that some day he's going to land.

So what's the moral? Well, you know about the barefoot boy and his worms and bent pin — in DX there's always the little guy with the 807 who sneaks one away from you. And how do you work DX? Just like fishing — be there at the right time when he's biting and get him first!

What:

Now that we have two bands to scout, things are looking up. A few brave souls have ventured to 80 for fun and found it there. Conditions have been good, and stuff manages to get across the Pacific and down to South America. It's too bad that the ZLs aren't allowed to work us yet, because they're being heard in the Middle West — W9VFO logged ZL4GA, ZL4CK, ZL2HQ and ZL2MR one early yawning — and W6QZG listening down in Brazil heard W4HRO, W4TM, W6AM and W6ITH on 75 'phone. W6AM tells us that W6ITH was using four rhombics in push-pull parallel, a very nice array if one has the necessary two counties to put it in! — W8ROX worked KZ5AA (3860), and KZ5AB and XE1A were heard at W5YU. W3OP worked HH5PA with 10-watts input, and heard VO2KJ, and W1EH worked WINPC/VO (3790). — Another good one is VP3DA (3670) who is quite active and who heard all W except W7 very shortly after the band was opened. QSL him via W2MQB — K7s are fairly scarce on 10, but there seems to be plenty of them on 80, according to long lists sent in by W7RT, and 80 is also a good spot for some of those new VE7s and 8s.

The fancy band, 28 Mc., hasn't let down its faithful followers, if the juicy morsels some of them have come up with is any indication. Take, for example, the five continents worked in six hours by W1BPX: VU2AA (28,050), PK4DA (28,250), CN8BD (28,200), PY2KT and PA0MU. But no Ws! Other choice stuff, on other days, included VQ4AA (28,000), VQ6MI (28,070),

VQ2PL (28,180), KA1JM (28,085), W9ZIL/K7 (28,090) on Attu, and W6PUZ/Tinian (28,025) worked the long way 'round at 8 A.M., EST — — — — W2LRI/KB6 says CR9AG (28,100) on c.w. is looking for Ws. It goes without saying that they will be happy to look for him — — — — W2LMO worked W9YN/KB6 (28,650 f) and heard ZD4AC (28,700) — — — — W8BKP hasn't let any moss grow on his skywires, and adds the following frequencies for the wolves to patrol: XACP (28,080) in Sardinia, ZP2AC (28,400 f), XZ4AM (28,150), VS7CX (28,060), VU3LR (28,080), AC4YN (28,040 f and c.w.)!, VK7CW (28,000) and EQ3W (28,060 f) — — — — W6PBV came up with OA4AB (28,030), W9NWM/Majuro (28,030) in the Marshalls and KZ5AW (28,060). Bob had VESAJV/VP8 (28,050) all spotted, but recently the VE has been signing "/Marine" so it doesn't look too good for that VP8 contact — — — — W1HKK has been keeping his mike warm, and with good results, like EP1C (28,530), OQ5AE (28,400), VQ4ERR (28,320), TG9PB (28,840), W8QEN/CT2 (28,800) and K7GMN (28,390) — — — — W6OKK knocked off a flock of Europeans and VKs and KAs, and even snuck into the 11-meter band to grab W6RJG/J9 on Carlson Island in the Marshalls and W6SMF/K7 — — — — W1CH added VU7BR (28,160) and ZC6NX (28,100) to his long list of scalps — — — — VE1ME/5 — VE5, that is — worked W8WUE/KB6 (28,035), KA1AZ (28,055) and W9IIL/K7 (28,070), and W2FQS adds PY5AG (28,050), OA4R (28,150), HH5PA (28,110), CX1FY



(28,050), OQ5BQ (28,005), F3DI (28,060), F8WK (28,060) and ON4B (28,070). Cliff also worked HZ3FI (28,100), who says QSL via RSGB, but he's holding his breath and keeping his fingers crossed on that one W2KIK/5 knocked off W8SIR/VP9 (28,700), VK7CM (28,550), VP3LF (28,250), and heard VP9F (28,150), VP6RB (28,250) and W8RWW/J9 (28,800) on Kwajalein W6ITH, the guy with the push-pull parallel rhombics, has some nice stuff, including W4GFK/J9 (28,640) at famed Bikini Atoll, W8WSY/ZC3 (28,140) — he's on the VR3 Christmas Island and is signing the wrong call — W6QJW/KL7 (28,680) at Shemya, W8CJR/XU8 (28,720), KA1AN (28,330), ZL4BN (28,560), W1MUX/J9 (28,640) on Eniwetok, W9QMD/KJ6 (29,090) and TG9FG (28,160) W2MPA is beginning to find it hard to find new ones, but added XACR (28,100) and XABY (28,300) in Greece, W7GXR/KB6 (28,150), F3LG (28,100), PA0JM (28,250), VP6YB (28,100), CSZ (28,100) in Portugal, W3FWI/CT2 (28,500), HB9J (28,200), OZ7PH (28,200), and W9DCH/J (28,300). In the heard department: ZB1A (28,100), LI3AD (28,000 c.w.) in Libya, W7ELL/J (28,200) in Iwo and W2JE/J (28,100).

Where:

Good old Jeeves took pity on us after last month and got the address of PJ3X (28,000), now that it's being given out so freely: Box 81, Curacao, N.W.I. But we must rely on W4BYF for such as FM8AC (28,015), P.O. Box 260, Fort de France, Martinique; VQ6IM (28,050) via RSGB, and G8AB/I (28,060), Sig. Officer, RAF Stn., Elmas, CMF, Sardinia From W6ITH we get XE1KE (28,240), B. J. Kroger, Azteca Motion Picture Studios, Mexico City, a very familiar name to the 28-Mc. men of the middle '30s who knew him then as X1AY; and W1HKK gives us EP1C as Mr. Russell Houseworth, c/o TWA, Aberdan, Iran W3HAE/J requests QSL to his home address at 1433 Armistead Bridge Road, Norfolk, Va. W1BPX gives us VU7BR, S.T.J. Brown, c/o Anglo Persian Oil Co., Bahrein Island, Persian Gulf; VU2AA, c/o 166 Piccadilly, London, England, and KA1JM (28,050), Lt. Jim Moulton, 13th Air Force, APO 719, c/o Postmaster, San Francisco.

Who:

W7EYS is in a swell position to get in on the 28-Mc. schedule program for the BuStan, as outlined last month and elaborated this month elsewhere in *QST*, having jumped the gun with a traffic sked with W6QKB/KB6 from mid-February to April 20th, when QKB left for the States. Incidentally, QKB had worked 65 countries before he left Speaking of countries worked, a favorite pastime in DX circles since uIMO raised f8AB, W8BKP has 45 on

'phone and an additional 30 on c.w. for a total of 75, W1BPX is up to 69, W1CH had 56 in early April, and LU7AZ is somewhere over the half-century mark VS2AK will be back on in July, with a rhombic at the States, and will be glad to hear from any of the Ws he worked before he lost his home, gear, records and four years of freedom. You can reach him by addressing your letter to T. A. Dineen, c/o General Electric Co., Singapore W2NLW is back from Saipan, and his new *Call Book* is helping him to QSL to 500 contacts he made during his two months of operation on the island. His address is 3204 Kingsbridge Ave., New York 63, N. Y. W9VWL says that ON4PA in a letter sends greetings from ON to all Ws. One reason the ONs are a little slow getting back on is that most of them destroyed their transmitters rather than to let them fall into the hands of the Germans And W9VND passes along the story of YU7LX, who used to handle the QSLs in YU. LX was caught as a radio operator behind the Nazi lines, and as a result was shoved around in about ten different concentration camps. At the last camp, in Italy, he was in pretty dire straits, but he remembered an old buddy of his with connections in Italy, so he wrote to HB9CE in Zurich, told him of his plight, and could 9CE help him out? Franz — remember HB1CE? — got hold of a business mate in Italy close to the concentration camp, and between the two and a bit of skullduggery they managed to get food, clothing and money to YU7LX as well as news to and from home. That's ham spirit, of course, but wouldn't anyone do it? Perhaps, but possibly not if their living essentials were rationed as strictly as they were in Switzerland during the war! HB9AG did much the same thing, by answering a plea for help from an SWL in Holland and helping out with food, clothing and money via the Red Cross W5CXS doesn't even try to figure out the 10-meter band any more. He worked three VKs at midnight, including VK6RU, and the W6s were still coming through at 2 A.M. On a strictly daylight band! W6UUQ/3, ex-XU3OF, ex-KA1BZ, ex-W5JVQ, doesn't let his 35 watts give him an inferiority complex. Some new stuff there includes EI6G (28,020), HC1JW (28,050 f), SVIEC (28,100) and ZS2CB (28,220) G6QX says they renumbered the houses on his road during the blitz and he came up with No. 73. Personally, we think Bob and W1EH, who also grabbed off a "73" street number, should get together on a small pamphlet telling us dumb ones who for and how many drinks one buys for that kind of fortuity K6TZB is pretty much convinced that a lot of guys don't know about the QSL Manager system. Bob has QSled all of his contacts via the Managers, but says on repeat QSOs some of the guys squawk for cards, indicat-

(Concluded on page 118)

ARRL Code-Proficiency Program

*Qualifying Transmissions from WIAW—June 18th and July 19th
Tape Sending from WIAW to Aid Your Copying Ability*

BY F. E. HANDY,* WIBDI

SCORES of letters and cards have asked the resumption of ARRL's Code-Proficiency Program. Clearance of military use of WIAW frequencies was first necessary to permit more operation than three hours per night before we could expand schedules to give it to you. Such was the urgency of amateur requests that on getting the awaited FCC authorization we broke an item on Practice Schedules into Operating News of last QST. Here are the full details of the Code-Proficiency Program, speeds covered, objectives, awards, and the schedules of the first qualifying runs. Every amateur who hasn't already received a certification from ARRL at the top award-speed is cordially invited to participate.

We amateurs always have maintained an eager pride in our code ability. In the war years some of us permitted it to slip back from the top. A good many hams can follow the general idea of a contact "by ear" but when pressed to *write it down* as in real communications (record) work they muff the copy. The WIAW program invites every man to prove himself as a proficient operator, and sets up a progressive system of awards for step-by-step gains in **COPIING PROFICIENCY**.

Progress in proficiency in code reception is shown after the initial test and certificate award, by a separate dated and initialed Endorsement Certification to be added in a space provided. Silver Endorsement Stickers (a distinctive design for each speed) will be issued for progress from any lower speed to 20, 25, 30 or 35 w.p.m. All amateur operators may try for the progressive endorsements!



On May 1st we resumed the ARRL Code-Proficiency Program. This plan is designed to enable every radio amateur to check his code proficiency, to better that code proficiency, and to receive a certification of his receiving code speed, with a further award for every improvement that the certificate recipient can demonstrate up to a top of 35 w.p.m.!

This program is a whale of a lot of fun. The League will give a certificate to any licensed radio amateur who demonstrates that he can copy perfectly by ear for at least one minute, plain-language Continental code at 15, 20, 25, 30 or

* Communications Manager.

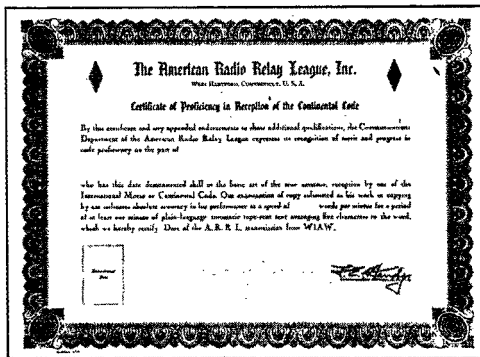

One of these Proficiency Certificates may be awarded to you. Try for it, by copying WIAW at 10:00 p.m. EDST (8:00 p.m. CST) June 18th or July 19th. If you can take 15 w.p.m. by ear and prove it, this handsome lithographed certificate is yours! If you can do 20, 25, 30 or 35 w.p.m. your certificate will so state! Every amateur operator licensee is eligible.

35 words per minute, all copy to be of special monthly transmissions to be scheduled from your ARRL station, WIAW.

There are two objectives: (1) To copy by ear, write down by pencil and paper, or better yet, write on a "mill" what is sent, to qualify for a certificate and rating on the best one can now do. (2) To put in a few minutes a day operating our station at the best speeds we can, also listening and copying PX and practice transmissions to train our powers of coordination, in order to win from the League the conspicuous endorsement that will be awarded to go on that first Proficiency Certificate whenever we can boost our speed honestly another 5-w.p.m.!

WIAW Practice Transmissions

WIAW will transmit practice material as follows: *Time:* 10:00 p.m. EDST, Monday through Friday. *Speeds:* 15, 20, 25, 30, and 35 w.p.m. consecutively, with approximately ten-minutes' practice at each speed.

Frequencies (Simultaneous):

3555—7145—14,280—29,150—52,000 kc.

The tape transmissions will be of plain-language material, accompanied by identification of the station, and the speed will be briefly indicated. The groups of practice material will be sent at constant speed, each group taking about ten minutes, including time to adjust the sending

device to the new speed. Look for the *QST* call on any of the frequencies indicated, Monday through Friday, at 10:00 P.M. EDST, (9:00 P.M. EST, 8:00 P.M. CST, 7:00 P.M. MST, 6:00 P.M. PST.) *Write down all you can copy* at any of the speeds used.

For practice we likewise recommend that interested amateurs copy the ARRL Official Bulletins, which are sent on all the above mentioned frequencies, on the following schedule, Monday through Friday:

Starting Times (P.M.)			Speeds (W.P.M.)	
EDST	CDST	MDST	PDST	Bulletins are sent at
8:00	7:00	6:00	5:00	25 w.p.m. and re-
11:30	10:30	9:30	8:30	peated at 15 w.p.m.

The midevening practice material is not read on voice since it is simply for practice and any recipient can tell how much he is getting just by looking at his paper. Practice texts on certain nights can be checked from *QST* as explained under "Sending Practice" in this article. The Official Bulletins are repeated on 'phone immediately after the conclusion of the radiotelegraph schedule and can be used for a check, if desired.

June 18th and July 19th — WIAW Proficiency-Certificate-Award Runs

At the usual practice time (10:00 P.M. EDST) on the above dates, WIAW will follow a five- to ten-minute explanatory "QST" message, by a special transmission, at consecutively-increasing speeds, through the usual ranges, for all interested amateurs to copy. This text, received successfully by ear at the highest speed you can copy, should be sent in to ARRL for checking. In all cases send your original copy. *Attach a statement to your copy certifying over your signature that the copy submitted is direct copy, made from reception of WIAW by ear, without any kind of assistance, personal or mechanical.* After time for checking papers has elapsed you may expect to receive acknowledgment, direct from the League, and if you qualified on a test date and transmission, also your certificate, or the appropriate endorsement sticker. Our limited personnel will be unable to do extensive checking and corresponding. No copies of the official texts will be given out, and no copies submitted will be returned. Decisions and awards will be final and must be accepted as such. There will always be another test period coming up, to redemonstrate higher code proficiency!

A word of caution: *Send in your original paper!* In the past, more individuals have failed because of attempting to recopy than the average amateur would suspect. To insure some measure of overcoming fading or QRM and QRN, we suggest that on the important dates, amateurs may use "split-headphone" reception (one 'phone on each of two receivers set on different WIAW frequencies) to minimize reception difficulties.

A complete record is kept at Headquarters

showing every certificate award and endorsement issued, and we know that every real ham will want to get his Code Proficiency Certificate just as soon as possible.

It is one thing to be able to hear some signals coming in and get the gist of the information conveyed. It is quite another to *write down AC-CURATELY* all that is sent! One cannot consider himself an operator in the truest sense until he can transcribe accurately. Sending well is an art that the writer considers even more difficult, especially if this hand transmission is to be maintained at an even tempo for any considerable period.

Sending Practice

Practice makes perfect. A few minutes each day in emulating tape sending (by hand) and in reception of code that is moving along *just a little above* the speed one can copy comfortably, with full accuracy, will pay big dividends in a very short time. Operating and more operating is recommended. Experience counts.

To permit direct comparison of one's fist and tape sending, *QST* will list in advance the text to be used for practice on two of the five weekly practice runs. The following tabulation indicates material to be used in the program. To get sending help hook up your own key and buzzer or audio oscillator, turn to the *QST* material, tune in WIAW, and attempt to send right in step with the tape signals. Adjust your spacing in the manner the received signal indicates necessary for improvement.

Date	Subject of Practice Text From April <i>QST</i>
May 29	The Postwar Naval Reserve, p. 54.
May 31	The World Above 50 Mc., p. 60.
June 4	The Circular Band Theorem, p. 65.
June 6	Technical Topics, p. 67.
June 10	Listening Post in the Philippines, p. 70.
June 12	Stabilizing the 144-Mc. Transmitter, p. 24.
June 18	Qualifying Run, 10:00 P.M. EDST.
June 21	A Self-Contained 60-Watt C.W. Transmitter, p. 13.
June 25	The NBS-ARRL Radio Observing Projects, p. 18.
June 27	Oscillators and Amplifiers at 1000 Mc., p. 34.

Amateur message handling and transcription is highly recommended as an aid to becoming a good operator. If you have at all neglected your c.w., start your code ability on the upgrade from where it is. Regardless of where we start, it is nothing to be ashamed of. Everybody will be doing it! The first ARRL certificate may be obtained at a 15-w.p.m. aural receiving ability. This is only a couple of w.p.m. above the skill required in initial license-qualification tests.

The new FCC regulations require that for renewal of operator license "proof of use" must be made by listing QSOs with three other amateur stations in the last six months of the license term and that these contacts must be by

(Concluded on page 118)

Long Leads Aren't Necessary

Concentrating Tank Elements to Balk Parasitics

BY GEORGE W. SHUART,* W2AMN

QUITE FREQUENTLY of late we have observed raw a.c. and r.a.c. signals on the 80-meter band, and an effort to copy some of them led to the discovery that many were back waves — that is, radiations when the key was open. Much of this trouble can be traced to the use of high-sensitivity tetrodes such as the 807, 813, TB-35 and similar types.

While these tubes are said to need no neutralizing, in the majority of cases that is true only when the tube and circuit shielding is practically perfect. When there is little shielding, and coupling can exist between the input and output circuits through the fields surrounding the plate and grid tanks, you're headed for trouble. If the amplifier uses fixed bias and the driver or a still earlier stage is keyed, you are likely to have not only a "key-up carrier" but gosh knows what else

when the key is down. If such an amplifier is modulated, you may have a series of "outlaws" that are likely to get you into trouble either with the neighbors or the local R.I. Although the amplifier may appear to behave normally, actually you may have other carriers on different frequencies during modulation, especially on modulation peaks when the plate voltage is doubled during the positive half of the audio cycle. To locate such an enemy you have to double the normal plate voltage and search the entire spectrum, but most of us have no facilities for such an investigation.

Parasitic v.h.f. and u.h.f. oscillations in a high-frequency amplifier not only are quite common but are very difficult to pin down. If we con-

sider the elements in the amplifier circuit we find that we have not just one but several possible resonant circuits all in one physical set-up. Many of us are beginning to find out that a great deal of b.c. interference, as well as spurious radiations and harmonics, can be eliminated if care is exercised in the design of our equipment. The first

rule, of course, is to make every effort to have all the inductance in one unit and all the capacitance in the other. In the ideal tank circuit there would be little danger of multiple resonance.

Suppose we have a "glitch" circuit resonating at 200 Mc. in the plate, and another of similar characteristics in the grid side of an amplifier employing high-gain tubes — particularly those which operate efficiently at frequencies as high as 200 Mc. That situation is perfect for putting out one carrier at 3.5 Mc. (or 28 Mc., if that's your band)

and another at 200 Mc. The RI's temperature goes up because you're "off frequency" and your neighbor blows his top because that 200-Mc. signal is splattering, over-modulated, frequency-

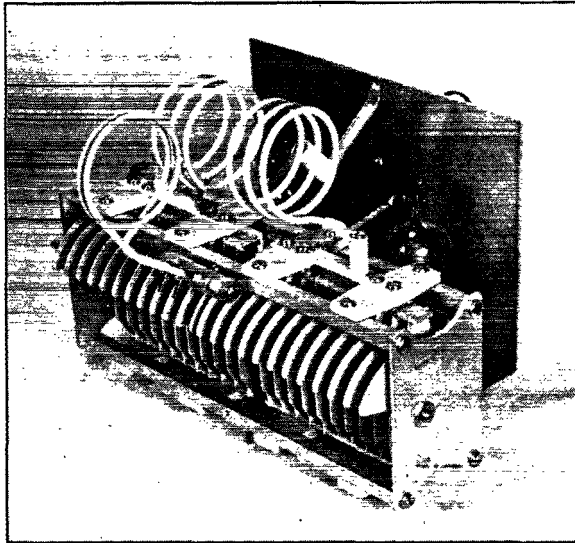

The swinging link is easily adjusted by means of a polystyrene-rod mounting, rotating on brackets fastened to the condenser tie-bar. The high-voltage "B" lead goes to the ceramic stand-off mounted on the strap which ties the top of the chassis shield to the condenser. The "porcelain" appearance of the coils and their supports results from lacquering over silver plating.

• While leads in themselves may do no particular harm at the operating frequency, when the latter is in the ordinary h.f. region, they may be the means of forming secondary resonant circuits that encourage parasitic oscillations. With some care in layout, plus a willingness to depart from conventional panel-chassis construction, the parasitic circuits can be broken up. Here are some suggestions.

*Hammarlund Manufacturing Co., Inc., New York City.

About the Author

• For many years, George W. Shuart devoted his time to writing radio articles for beginners, and as a result of his efforts many a present-day radio amateur was started off in America's No. 1 hobby. He has been signing W2AMN since 1928, through an amateur radio career that has embraced DXing, rag-chewing, experimenting, and v.h.f. and u.h.f. activity. When it comes to the serious business of making a living, you will find the author happily engaged, mixing vocation with avocation, as Advertising & Sales Promotion Mgr. of the Hammarlund Mfg. Co., Inc., N. Y. C.

modulated, and what not, and crashes right through his midget b.c. set — through the better ones, too, in many cases.

How do we eliminate the trouble? We wish we had a sure-fire answer to that question but there is none. The best rule to follow is: Use complete shielding; get all your *L* and *C* where they belong; and neutralize the amplifier if there is the slightest sign of reaction on the grid current when the unloaded plate circuit, with its B+ lead disconnected, is tuned through resonance.

The amplifier shown in the photographs, while not going to extremes, illustrates the points covered in this discussion. The plate tank coil mounts

right on the capacitor and at the same time makes contact to the stator sections through heavy but short connecting bars and pillars. A large bar or strap joins the two mounting points of each stator to reduce the inductance of the leads. The success of this method is proved by the fact that a large coil is necessary and the plates of the variable capacitor are meshed well over one inch on 28 Mc. — and the capacitor is plenty large for 80-meter operation. The result is an efficient circuit that is extremely easy to load. This permits loose coupling to the antenna circuit, which goes a long way toward reducing harmonic transfer and radiation. The output link coil is mounted on one of the horizontal tie-bars of the condenser for convenience and compactness, using a length of half-inch polystyrene rod as a rotatable support.

A piece of sheet aluminum 8 inches wide by 10 inches long was bent as shown in the photographs to form a mounting platform for the TB-35 tubes and at the same time to form a baffle shield between the plate and grid circuits. The baffle also serves to mount the grid tank with its variable link coupling. This arrangement, while not affording complete shielding, works out quite advantageously in that it provides for just about everything. Further shielding can be secured by using a larger piece of aluminum and making still another bend to form a top shield over the grid circuit. A rear side-plate can then be fitted to the main baffle and the front panel will serve to enclose the entire grid circuit. However, with the shield arrangement shown in the photographs there was every indication that the amplifier was performing perfectly when it was neutralized.

Neutralizing presented quite a problem. The intention, at first, was to build a small capacitor arrangement such as has been described in previous issues of *QST* (wires extending alongside the plates of the tubes) but finally the condensers were "manufactured" by using the capacitance between the

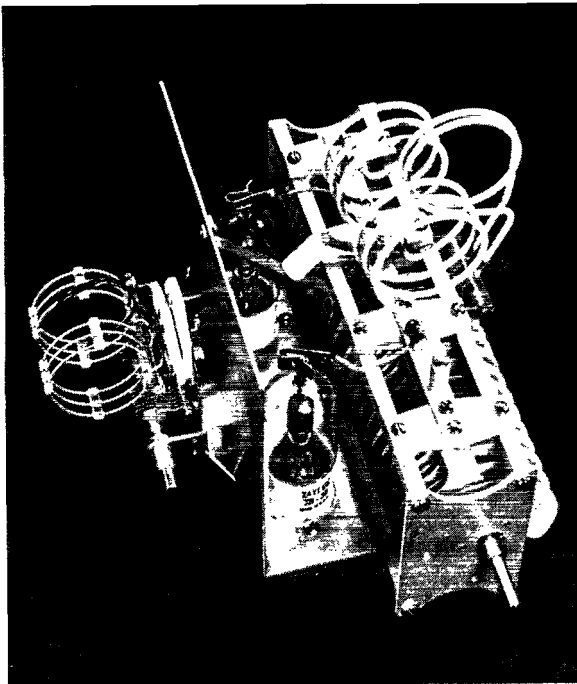

Using a pair of TB-35 tubes, this amplifier is mounted on and entirely supported by the plate tank condenser. The bent-aluminum "chassis," fastened rigidly to the tank-condenser tie-bars, provides a baffle shield between the grid and plate circuits as well as a mechanical mounting for the tubes and parts. The width is such that there is room for a compact exciter on the same relay-rack panel that supports the amplifier.

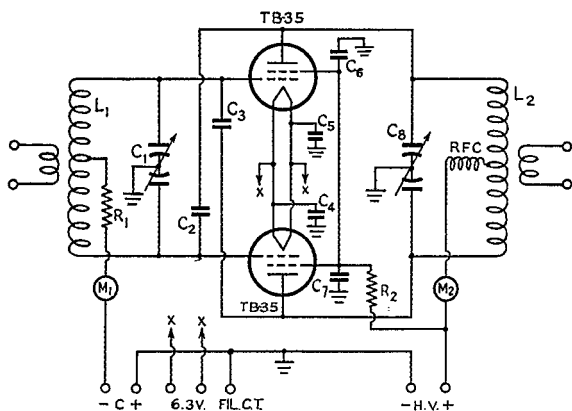
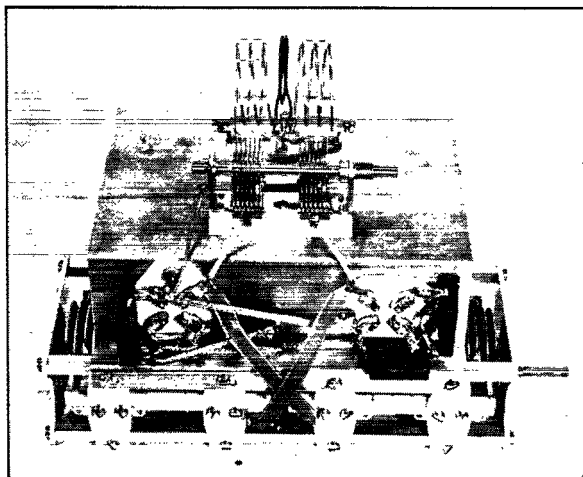

Fig. 1 — Circuit diagram of the amplifier.

wires of a short length of 300-ohm Twin-Lead. One wire connects to the grid of one tube and the other goes to the plate of the second. Simply by cutting "V" notches in the open end of one wire (starting near the very end) the amount of capacitance can be reduced in small steps until exact neutralization takes place. The usual procedure of observing the effect on the grid current when the plate circuit is tuned through resonance will prove entirely satisfactory, but don't forget to disconnect the B+ lead from the power supply.

How does the amplifier work? With 1250 volts on the plate and a plate current of 200 ma., it works smoothly with no serious harmonics and no spurious oscillations. The RI is happy and our neighbor is listening to his favorite programs. A total grid current of 10 ma. for the two tubes, through the 20,000-ohm grid leak specified in Fig. 1, provides ample drive for 'phone as well as c.w.; increasing the grid current causes no corresponding increase in either power output or efficiency. Although we have not given it a really good work-out below 30 Mc., it proved as equally efficient on the 3.5-Mc. band as on 28 Mc., and therefore should work well on 7, 14 and 21 Mc.

The Twin-Lead "neutralizing condensers" cross from grid terminals on the tube sockets to the tank-condenser stators, as shown in this bottom view. The neutralizing adjustment is simple — and permanent.



- C₁ — 100- μ fd.-per-section variable (Hammarlund MCD-100-S).
- C₂, C₃ — Neutralizing condensers; see text and photograph below.
- C₄, C₅ — 0.001- μ fd. mica.
- C₆, C₇ — 0.001- μ fd. mica, 2000-volt.
- C₈ — 110- μ fd.-per-section variable, 0.171-inch plate spacing (Hammarlund TCD-110-H).
- L₁ — Grid tank coils; approximate inductances: 3.5 Mc., 40 μ h.; 7 Mc., 12 μ h.; 14 Mc., 3 μ h.; 28 Mc., 1 μ h. (B & W or National).
- L₂ — 28 Mc., 6 turns 3/16-inch copper tubing, diameter 2 1/2 inches, wound as shown in photographs. For other bands, standard coils may be used by adapting the swinging-link type coils to the mounting shown.
- M₁ — 0-50 d.c. milliammeter.
- M₂ — 0-300 d.c. milliammeter.
- R₁ — 20,000-ohm 20-watt.
- R₂ — 20,000-ohm 75-watt, for operation at maximum tube ratings.
- RFC — 2.5-mh. 300-ma.

In view of the size of the tank coil used for 28 Mc., there is every possibility that it will also work satisfactorily in the 50-54-Mc. band. During our entire experience with it there has been no indication that the variable capacitor, large though it is, is not entirely satisfactory for operation on the 10-meter band, although with other methods of construction we have, in nearly every case, found that smaller and apparently more efficient h.f. variable capacitors were needed to get satisfactory 10-meter operation.

While no claim is made for the discovery of anything new, we believe that those who have the time and inclination can develop some very effective and very interesting apparatus, if enough attention is given to the constructional details. Before starting to hack away at a massive steel chassis when you build your next rig, first get all the parts together and see how they might be arranged for greater efficiency, by using some of the simple methods that we used in this amplifier.



The World Above 50mc.

CONDUCTED BY E. P. TILTON,* WHDQ

WE'RE OFF! For some time after the 50-Mc. band was released for amateur occupancy, some of us were wondering if there were any v.h.f. enthusiasts left in the United States. On the night of March 1st we seemed to get off to a good start, in New England at least, with quite a few stations in the Boston area and in the vicinity of Hartford giving the band a work-out. Within a few days, however, 6 became as quiet as 5 had been before it, and the opening of the 80-meter band on April 1st seemed to supply the finishing touch.

But the prospect of the month of May with its promise of skip-DX to come, this year on a new frequency, apparently did the trick, for in late April the number of signals on the band began to increase, and by the time the first DX opening rolled around there was enough activity to make things interesting for all concerned. What was probably the first two-way contact involving skip on the 50-Mc. band (and still the best DX reported, to date) was made on April 23rd at 10:43 p.m., between WILSN, Exeter, N. H., and W9DWU, Minneapolis, Minnesota. Other DX heard and worked on this first night has been reported as follows:

- WILSN, Exeter, N. H. heard W9s DZM, NFM.
- WILLL, Hartford, Conn., worked W9s DZM, QIN, DWU, NFM, ZHB; heard W8LZN.
- W1AEP, Springfield, Mass., worked W9s NFM, ZHB; heard W9DWU.
- W1HDQ, West Hartford, Conn., worked W9s DWU, ZHB; heard W9NFM.
- W8CLS/1, Waltham, Mass., worked W9s ZHB, DWU; heard W2JCR, W9s NFM, DZM, QIN.
- W1FJN, Scituate, Mass., worked W9s DWU, DZM.
- W2FID, Montrose, N. Y., worked W9QIN; heard W9s DZM, DWU.
- W9DWU, Minneapolis, Minn., worked W1s LSN, EKT, IN, FJN, KSA, LLL, HDQ, W2MEU, W8CLS/1; heard W1HXP.

The above represents reports received by mail or over the air. Actually, of course, it is only part of the story. It was a strange night, in several ways. Just about every sort of propagation known to v.h.f. veterans was in evidence in the course of the evening. Following the time-honored cus-

RECORDS

Two-way Work

- 50 Mc.: WILSN-W9DWU
1100 Miles — April 23, 1946
- 144 Mc.: W1LAS/2-W1IVA
145 miles — March 29, 1946
- 420 Mc.: W1LAS/2-W8WCG/2
17 miles — March 25, 1946
- 2300 Mc.: W6OJK/2-W9WHM/2
0.7 mile — April 29, 1946
- 5250 Mc.: W2LGF/2-W7FQF/2
31 miles — December 2, 1945

tom, W1s listening on 28 Mc. immediately upon arriving home from work, heard VO and VE1 signals roaring through on 10. This could mean only one thing: The aurora, due on the 28-day cycle (there had been a three-day auroral disturbance on March 23rd, 24th, and 25th) had arrived. There would almost certainly be things doing on 50 Mc. The evening meal was gulped down, in at least two W1 homes we know of, and another check of 28 and 50 showed the wavery auroral signals still strong on 10, and the characteristically high noise level on 6. Around 6:30, WILLL heard W8LZN, Detroit, Mich., coming through with very badly garbled voice, but he disappeared shortly and nothing more was heard until around 9:30, when W9s burst through with very erratic voice signals in the Boston area. No real QSOs resulted as sigs were weak and fading rapidly. Several very-weak fading signals were heard during this time in the Hartford area also, but it was not until after 10:30 that signals were workable at either point. From this time on several W9s were at meter-pinning strength around Boston. Later, at about 11:30 the same stations, W9s DZM, QIN and DWU, joined around midnight by NFM and ZHB, began ripping the receivers apart in the Hartford area. For us the opening lasted until nearly 1:00 A. M., with signals dropping out suddenly and completely on both 28 and 50 Mc. at almost exactly the same time.

Signals were unlike anything ever heard on 56 Mc. They were apparently of auroral origin, but they sounded more like ten-meter signals than like what we were trained to expect on 56 Mc. during aurora displays. Except for a period

* V.H.F. Editor.

from early evening until around 9 P.M., when the typical auroral distortion was noted on 'phone signals, the stations using voice were quite readable, though fading more rapidly than would be expected of sporadic-E signals. Almost no directivity was discernible on normally-sharp directive arrays, though a slight increase in signal strength was obtained by aiming the beam north. It seemed more as if the signals were raining down from overhead, and such they may well have been, for there was a mild display of aurora over the entire sky. Another way in which conditions varied from what is commonly expected of aurora was in the small area over which a signal could be heard at any one time. Normally in work by means of auroral reflection, signals are heard across most of the area between two communicating stations, with little or no skip zone involved, whereas these signals were coming through at high signal levels only in little patches at a time. An example of this was noted in a three-way QSO between W8CLS/1, Waltham, Mass., W9ZHB, Zearing, Ill., and your conductor at West Hartford. At first W9ZHB was pinning the meter at Waltham and was running only S1-S2 at West Hartford. Suddenly he plummeted almost to the noise level at W8CLS/1, rising at the same time to 20 db. over S9 at W1HDQ, remaining near that level for a half hour or more. At times his signal was stronger than any but the most powerful locals. Several reported W9ZHB and W9NFM as the strongest skip signals ever heard on any band above 14 Mc.

The strangeness of the band that night was complicated by the existence of a strong temperature inversion in W1. Signals from the Boston area were extremely strong in West Hartford, strong enough, in fact, to draw your conductor away from the six-meter band to work some 100-

mile DX on 144. Signals from all over Eastern New England were very strong on 144 Mc., and about 15 stations over 75 miles distant were worked in a period around 10:30. Hearing the third harmonic of W1LLL calling W9DWU brought us back to 50 Mc. in a hurry around midnight!

Characteristics of the skip signals seemed to indicate that propagation on 50 Mc. may be quite different from that experienced on the old five-meter band, seeming more like ten meters than five, though it may turn out that the difference is the result of our being near the peak of a sunspot cycle, rather than to any great difference in the propagation characteristics of the two bands. Men with long v.h.f. experience will recall that auroral DX on 56 Mc., with its distinguishing characteristic of being workable only on c.w., was a relatively new phenomenon. Back in 1935 and '36 voice contacts were made on 56 Mc. which we know now were the result of aurora. We didn't pay much attention to how the signals came through in those days — DX was DX and that was all that mattered. We worked it, and didn't care much how it all happened. Obviously, more observing and reporting is needed. Let us know what you hear and work, gang!

While we're chasing the DX on 50 Mc., we should bear in mind that the old assignment is still in use in many other countries. Canada and Australia are the only other countries thus far using the new band. Though most of the real advances in v.h.f. technique have come about in recent years, it is well to remember that 5-meter signals crossed the Atlantic in both directions on several occasions in the years before the European war eliminated the possibility of two-way work. With Canada, Australia, and the United States on 50 Mc., and Great Britain, the Union of South Africa, and other countries of the British Empire operating on 58.5-60 Mc., we have an unparalleled opportunity for transoceanic DX.

G6CL (of RSGB) reports that there is considerable interest in five-meter work in the British Isles. On April 11th there were several contacts made over distances in excess of 100 miles on 58.5 Mc. A number of Gs would like to keep skeds with interested Ws in the hope of effecting two-way contact across the Atlantic by means of v.h.f. In this connection, we suggest that the English operators watch the 28-Mc. band for evidence of short skip in the United States. At the height of such periods it is almost certain that 10-meter short skip would get across the Atlantic, and if it does then 50-Mc. signals might well do likewise. On our side, we should tune the 56-60-Mc. range, especially that portion above 58.5 Mc., whenever

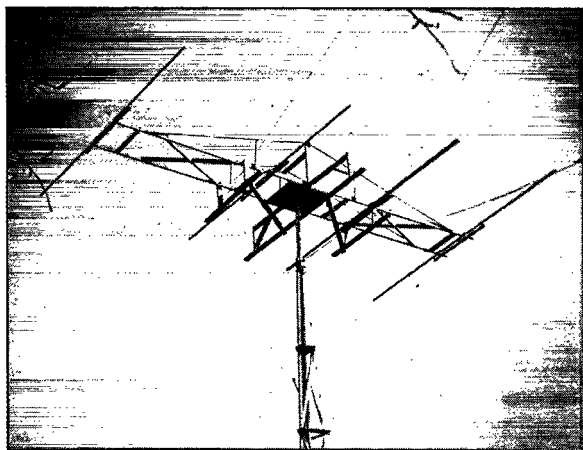

The 4-element rotary array for 50 Mc. installed atop its steel tower. The frame extending below the main framework serves as a rotating device. The array frame is mounted on a pipe flange, to which is fitted a length of pipe which serves as a vertical support.

things get really hot on 6. The new assignments make it possible for us to listen for transoceanic DX at both ends of the path, with no worries about local QRM blotting out a weak signal.

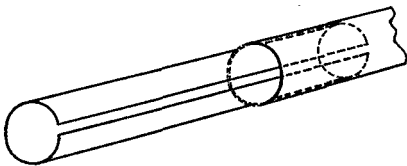

Fig. 1 — Detail of the ends of each of the parasitic elements, showing the slotted sleeve which provides a means of adjusting the length. Parasitic elements are of $\frac{3}{4}$ -inch tubing. The inserts are of the same material six-inches long, with a slot $\frac{3}{16}$ -inch wide sawed lengthwise to provide a spring fit.

There is some interest in several South American countries, too. Remember that most of them have the full 56–60 Mc. Watch the old five-meter band, gang — there may be a new v.h.f. DX record waiting for you! Right now is not too soon to be on the lookout, though June and July will provide the maximum probability of international DX.

A Four-Element Array for 50 Mc.

When the v.h.f. enthusiast decides to go in for directive arrays he plunges into a series of charts, graphs and tables which leave him completely confused. Most of the directive-antenna data is written in terms of low-frequency requirements, where the problems are quite different from those facing the 50-Mc. worker. The net result is that he decides on an array of 2, 3 or 4 elements, depending upon the space available and the leniency of his landlord. He cuts his elements by some magic formula, sets the spacing to some other figure, and hopes for the best. Even this procedure is usually productive of increased coverage, for almost anything in the way of a parasitic array is apt to be better than a simple dipole. But we all know that beam characteristics vary widely; we must select the type of array best suited to the sort of work we intend to do, if we are to achieve outstanding results.

If we were building an array for 14 Mc. we would place compactness and high front-to-back ratio at the top of our list of requirements. The fact that the close-spaced array which provides these also has a very limited frequency response would be unimportant. High front-to-back ratio may or may not be important on 28 Mc.; we might be willing to sacrifice it for high forward gain and broad response. Front-to-back ratio is almost completely unimportant; in fact, we want some pick-up off the back, in order to make the most of the somewhat limited occupancy of the band.

To facilitate checking the merits of various reflector and director spacings from 0.1 to 0.5 wavelength, a 14-foot frame was made up, with

provision for mounting the elements in any position with respect to one another. Parasitic elements were made adjustable in length as well as spacing, the method of adjustment being shown in Fig. 1. Elements are $\frac{3}{4}$ -inch duralumin tubing, with slotted extensions (see Fig. 1) of the same material in each end.

Length and spacing of the reflector were found to be relatively uncritical, any spacing between 0.15 and 0.25 wavelength giving approximately the same gain, if the reflector length was adjusted slightly as the spacing was changed. Reflector spacing was set at 0.2 wavelength and the length adjusted for maximum forward gain.

Next, one director was added, at the customary spacing of 0.1 wavelength, and its length adjusted for maximum forward gain. It was then moved out to 0.2 wavelength and the adjustment for gain repeated. At this point there was an increase of more than 10 per cent in field strength over the maximum obtained with close spacing. At 0.25 wavelength the same reading could be obtained by shortening the director slightly. Moving the director out to 0.3 wavelength resulted in a 3 per cent drop in reading, despite retuning, and there was a further drop of about the same amount when the spacing was increased to 0.4 wavelength. Even here, the gain was still somewhat more than that obtained with close spacing, and the element length was considerably less critical, indicating broader frequency response.

As maximum forward gain could be obtained at 0.2 wavelength, the first director was fastened in place at this spacing and a second adjustable director added. The same tuning process was followed through with this element, maximum gain resulting when it was spaced at 0.25 wavelength ahead of the first director. The length of the reflector and original director were readjusted for possible interlocking effects. The final element lengths turned out to be about 5 per cent longer than the driven element for the reflector, 5 per cent shorter for the first director, and 6 per cent shorter for the second director.

To recheck on the above spacing, which is at variance with much published data, the assembly was broken down and reassembled with conventional close spacing for a 4-element array. Feed-line impedance was changed so as to provide a good transfer of energy with both spacings, and the close-spaced system was tuned carefully for maximum forward gain. At no time was it possible to obtain as high a reading with the close-spaced system as resulted from the use of the 0.2–0.2–0.25-wavelength arrangement arrived at experimentally. The field-strength indication with four elements close spaced was, in fact, slightly less than that obtained with three elements using 0.2-wavelength spacing, which occupied the same space physically! Just why this is so we would not venture to say, but we do know that similar results have been obtained by a num-

ber of experimentally-inclined v.h.f. workers operating under similar conditions. Brown's data¹ shows that the pattern, in the plane of the elements, is sharpened when the spacing is increased; perhaps the apparent increase in field strength with wide spacing results from less energy loss in the vicinity of the antenna, due to lessened radiation toward the ground. For the moment, we were primarily concerned with getting a good 50-Mc. array up in time for the opening of the DX season — later on we hope to carry the project further and find the answers to the questions that are invariably asked whenever an array appears which utilizes other than the "standard" 0.1-wave spacing.

How Shall We Feed It?

The selection of the best method of feeding his parasitic array is also apt to confuse the prospective builder. We've always been a bit dubious of the delta system — that fanned-out area looks like a bad source of unwanted line radiation, and it is cumbersome mechanically. The parallel-pipe "Q" section is probably somewhat more efficient, but it is difficult to handle mechanically, and it is not too good for matching the low center imped-

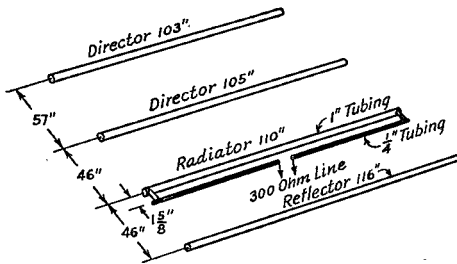

Fig. 2 — The spacing and length of the elements in the 50-Mc. array were arrived at experimentally. Dimensions given are for 50.5 Mc.

ances encountered in multi-element arrays. The concentric-line "Q" section, commonly used for parasitic arrays, may have high losses, its correct length is a question, and it may well result in unbalance.

The folded dipole looked like the best bet for this application, so we decided to try it, as it seemed to have several advantages over other methods. First, it is a broad-band device. It was for the purpose of covering the wide frequency ranges encountered in television service that the folded dipole was first employed.² Second, by matching the line directly at the radiator, it holds down line radiation (the weakness of the delta system) and eliminates the use of tuned stubs. Third, it is a flexible device which permits

the matching of the driven element in a parasitic array to a wide variety of line impedances.

By making the driven section of the folded dipole smaller than the parallel section, an additional impedance set-up may be obtained beyond the 4-to-1 ratio normally obtained with the folded dipole. We tried 3-to-1 and 4-to-1 conductor ratios, the latter, shown in Fig. 2, giving the lower standing-wave ratio with the 4-element system. A dipole having 3-to-1 ratio worked out nicely with a 3-element 0.2-wavelength spaced array, but the change to 4-to-1 ratio was necessary when the fourth element was added. The array was fed with a 300-ohm line. In the tests with close spacing, a 72-ohm feeder was substituted for the 300-ohm line, maintaining a low standing-wave ratio for both wide and close spacing.

Performance

With the array mounted atop a 32-foot steel tower, as shown in the accompanying photograph, tests have been run with numerous stations over distances up to 100 miles. As might be expected, from the method of tuning employed (concentrating on forward gain, with no reference to attenuation off the back) the front-to-back ratio is relatively low, being only about 10 db. Forward gain, in measurements involving reception of W8CLS/1, Waltham, Mass., nearly 100 miles distant, is in excess of 10 db. over a simple folded dipole of about the same height. Attenuation off the sides is high, a signal which is S8 on the meter of our NHU dropping completely out of audibility when the antenna is rotated 75 degrees either way from the maximum direction.

Frequency response is broad enough to permit operation over the active portion of the band, from 50 to 52 Mc., and it has even been used for f.m. work on 52.6, though directivity and gain drop off and standing-wave ratio increases above 51 Mc. The antenna was tuned up on 50.5 Mc., and the dimensions shown in Fig. 2 are for that frequency.

Since the opening of the 56-Mc. band on Nov. 15th, and on 50 Mc. since March 1st, we have maintained regular schedules with W8CLS/1 at Waltham, Mass. Prior to the erection of the new horizontal array, our contacts had been extremely rough going. Signal strengths, even on nights when there was appreciable inversion bending, were seldom above S5, and there were many nights when there simply was no signal at all. With the new array, and a 3-element horizontal at W8CLS/1, contacts have been made nightly on schedule for more than three weeks, and signals have run as high as 20 db. over S9 on peak at the Waltham end, and 10 db. over at West Hartford. Average signal on the poorest night to date was above S6, with only brief fades into the noise. Intelligibility of voice signals has been practically 100 per cent, whereas c.w. was neces-

(Continued on page 120)

¹ G. H. Brown, "Directional Antennas," *Proc. I.R.E.*, Jan., 1937.

² P. S. Carter, "Simple Television Antennas," *ECA Review*, Oct., 1939.

I.F. Amplifiers in Television Receivers

Practical Design of Wide-Band Coupling Circuits

BY MARVIN H. KRONENBERG,* W2IJU

FOR SATISFACTORY reproduction at the receiver of present-day television broadcast transmissions it is necessary to employ amplifying circuits capable of passing frequency bands of from 2.5 to 4 Mc. in width. Since the superheterodyne type of receiver has met with the greatest popularity in this field the problem of broad-band i.f. amplifier design becomes most important. As a result of bandwidth and certain other requirements, individual stage gain is low and circuits must be adjusted to a great degree of accuracy. In order to illustrate the problem more clearly, it is well to review briefly present-day practice in television receivers.

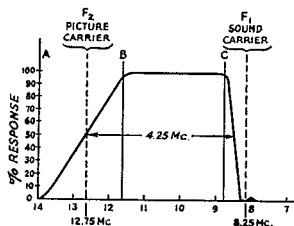

Fig. 1 — Selectivity curve of television i.f. amplifier.

In modern television superhets the picture-signal i.f. consists of a 4-Mc.-wide amplifier tuned so that it responds to frequencies extending from about 8.75 Mc. to 13 Mc. A separate i.f. amplifier tuned to 8.24 Mc. is used to select the sound transmission. Traps tuned to 8.25 Mc. are usually incorporated in the picture i.f. amplifier to eliminate sound interference with the picture. A factor affecting shape of the i.f. response curve is the method of transmission. In order to utilize the radio-frequency channels economically, a form of single-sideband transmission is used. One sideband is partially rejected at the transmitter, so that double-sideband transmission takes place only for the lower modulation-frequency components. As will be shown, the i.f. amplifier response curve must be designed so that all modulation frequencies will be restored to provide flat response over the entire band.

In Fig. 1, we have what might be considered an ideal selectivity curve of a television i.f. amplifier. Two important points on the curve should be noted. First, the response at the sound frequency

is very poor. In practice, the amplifier is designed so that its response at 8.25 Mc. is at least 40 db. below that at the mid-frequency level. Second, the picture frequency (12.75 Mc.) is located at the middle of the sloping portion of the curve (the point of 50 per cent response). This adjustment is very important so that the lower modulation frequencies will be restored in amplitude equal to that of higher-frequency components. The reason for this is that the receiver actually will respond to double-sideband transmission of modulation frequencies occurring only between points A and B, Fig. 1. The total response in this region is equal to the sum of the individual sidebands and, if the picture carrier is located at the point of 50-percent response, sideband components displaced symmetrically about the carrier in this region always will add up to the same amplitude as a single sideband located in the region B-C.

From this the importance of accurate adjustment of the shape of the amplifier-response curve can be seen. Also, in the case of the superheterodyne receiver, variation of the local oscillator will, in effect, shift the position of the i.f. curve in the r.f. spectrum. Therefore, the oscillator must be tuned correctly so that the picture and sound carrier will fall on the 12.75- and 8.25-Mc. points.

Another requirement of the circuit couplings not ordinarily met with in communication receivers is that of adequate phase response. It is well known that in an electrical circuit containing reactive components, phase shift is a function of frequency. This variation is complicated where many stages and coupled circuits are used. Unfortunately, poor phase response (that is, when the shift does not vary linearly with frequency) will cause distortion of the received picture. However, by using simple and symmetrical coupling between stages, proper amplitude response is usually accompanied by adequate phase shift characteristics. This is particularly important to the experimenter who is limited in test equipment.

• I.f. transformer design for television work differs considerably from that for ordinary receiver use since the bandwidth to be passed is many times greater. This article discusses the methods used to obtain wide-band response.

*84-12 126th St., Kew Gardens, New York.

Band-Pass Coupling

Many types of band-pass circuits are possible in the i.f. amplifier. The usual networks are based on either "coupled-circuit" or wave-filter theory. Since the conventional coupled circuits are quite simple to adjust and understand, they will be considered in this discussion.

In order to predict the action of a band-pass-coupled circuit, two important effects must be considered, first the bandwidth, and then the shape of the selectivity curve. It is well known that when two resonant circuits are coupled, the width of the response curve will increase as the coefficient of coupling is increased. The coefficient of coupling, K , is used to describe the degree of coupling used between the resonant circuits. Mathematically (in the case of inductive coupling) it is the ratio of the mutual-coupling inductance to the square root of the individual circuit inductances. As in the r.f. transformer, Fig. 2-A, this is expressed as:

$$K = \frac{L_m}{\sqrt{L_p L_s}} \quad (1)$$

where L_m = common coupling inductance

L_p = primary inductance

L_s = secondary inductance

The coefficient of coupling in the radio-frequency transformer depends upon the geometry of the transformer; that is the proximity of the coils to each other, coil diameters, coil lengths, etc. When a common coupling impedance, such as an inductance, is used to connect two resonant circuits, Fig. 2-B, then the expression for coefficient of coupling becomes:

$$K = \frac{L_m}{\sqrt{(L_p + L_m)(L_s + L_m)}} \quad (2)$$

Equation (2) differs from Equation (1) in that the coupling-coil L_m must be considered also as part of the primary and secondary resonant cir-

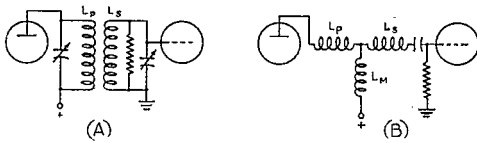

Fig. 2 — (A) Transformer coupling. (B) Common-impedance coupling.

cuits. Now remembering that the bandwidth is a function of the coefficient of coupling, it is useful to know just how these quantities are related. Fortunately in over-coupled (band-pass) circuits simplification of equations may be made to yield the approximate relation:

$$K = \frac{\Delta F}{F} \quad (3)$$

where ΔF = width of pass-band

F = mid-frequency of pass-band

With the bandwidth thus determined, the shape of the response curve can then be predicted by recalling an effect peculiar to closely-coupled resonant circuits. It is well known that as the degree of coupling is increased until the peak amplitude of the response curve ceases to become greater, the condition called "critical coupling" is obtained. At this point, the impedance coupled by one resonant circuit into the other becomes equal to the series impedance of the resonant circuit and the condition for maximum transfer of energy is reached. This condition, known as critical coupling, K_c , is important as a reference point in the determination of the shape factor, n , of the circuit. Increasing the coupling beyond this

Fig. 3 — Selectivity curves for three different degrees of coupling.

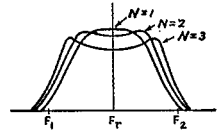

point eventually will cause a double-humped curve to appear, and so the shape factor, n , in an over-coupled circuit can be written as

$$n = \frac{K}{K_c} \quad (4)$$

or the ratio of the actual coefficient of coupling to the coefficient of critical coupling. Actually the coefficient of critical coupling for any set of coils is determined by the Q of each individual coil; that is,

$$K_c = \frac{1}{\sqrt{Q_p Q_s}} \quad (5)$$

In Fig. 3 a set of curves for various shape factors, n , is given. In practice, for wide band-pass circuits, it is found that a value of n of 1.5 or 2 is quite satisfactory.

In the design of a particular amplifier, adjustment for proper bandwidth is accomplished, therefore, by changing the degree of coupling, K , until the desired bandwidth is obtained. The relation easily is seen by referring to Fig. 3. Then, to obtain the desired shape factor, n , the value, K_c , coefficient of critical coupling, must be adjusted to obtain the desired ratio K/K_c . Since K_c is a function of the individual circuit Q s this value may be varied by the simple expedient of hanging damping resistors across the coils. In practice the damping usually is applied to the secondary coil. Fortunately, when heavy damping is used it is possible to predict the value of damping resistor by means of a very simple (but approximate) relation

$$R_d = \frac{1}{2\pi \Delta F C_s} \quad (6)$$

where C_s = capacity in shunt with secondary. This relation will be useful in design of the heav-

Fig. 4—Circuit for two-stage amplifier with 2.5-Mc. bandwidth.

C_1, C_2, C_3 —2-27 $\mu\text{f}.$
 L_1 —25 $\mu\text{h}.$
 L_2 —15 $\mu\text{h}.$
 L_3 —10 $\mu\text{h}.$

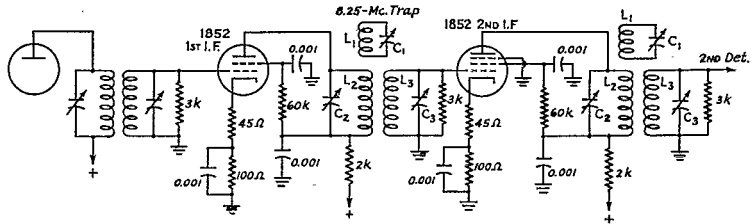

ily-damped over-coupled circuits such as described below. It is interesting to note that R_d in Eq. (6) is determined only by the bandwidth and the circuit tuning capacitance. Because the gain of the amplifier is limited by this resistor, it easily can be seen why amplification must be sacrificed for broad-band response, and also why it is important to minimize the tuning capacity in order to realize maximum available gain. (R_d varies inversely with C_s).

Practical Broad-Band Amplifiers

A simple i.f. system consisting of two stages of amplification with a bandwidth equal to 2.5 Mc. is shown in Fig. 4. Such an amplifier would be suitable in television receivers where low definition (equivalent to about 200 lines) is used. In this typical circuit the desired amount of coupling easily is obtained by mutually-coupled coils. Where greater degrees of coupling are necessary, as in an amplifier 4 Mc. wide, it is often difficult to obtain sufficient coupling in this manner. Also, capacitance coupling between the closely coupled coils often produces unexpected results. Fig. 5 shows the construction of a typical transformer.

Another method of inductive coupling, which is theoretically equivalent to the magnetically-coupled r.f. transformer, uses a common inductance as the coupling element. A broad-band amplifier (4.5 Mc.) using this system is shown in Fig. 6. The design of this amplifier was carried out with the aid of the formulas given above. In addition, calculation of the primary and secondary inductances should be carried out on the basis of resonating them with the tuning capacitance at a frequency higher than the mid-band frequency, say F_2 (Fig. 1), at the extreme high-frequency edge of the pass-band. This will compensate for the fact that the coupling inductance is in series with the primary or secondary coil, tending to reduce the resonant frequency. Therefore,

$$L_p = \frac{1}{4\pi^2 F_2^2 C_p} \quad L_s = \frac{1}{4\pi^2 F_2^2 C_s}$$

In order to realize the maximum possible gain, it is good practice in tuning to vary the coil inductance with iron-core slugs, and resonate with the inherent circuit capacitance (tube, wiring, etc.). This assures that the tuning capacitance is

kept at a minimum.

In addition to the components used to provide proper band-pass it is also necessary to provide for adequate rejection of the sound-carrier frequency. This is accomplished in the amplifiers described by use of parallel-resonant circuits tuned to the sound frequency (8.25 Mc.). In the case of the 2.5-Mc. amplifier these traps act to absorb energy from the coupling system. The traps in the 4.5-Mc. amplifier are placed in series with the cathodes to cause degeneration and loss in gain at the resonant frequency (8.25 Mc.). No particular advantage of one trap over the other is indicated and it is left up to the experimenter as to which is most convenient. However, it should be pointed out that degenerative traps lose their effectiveness in a.v.c. stages when a strong control voltage is applied to the grid.

Another important factor in the design of efficient broad-band amplifiers is the selection of suitable tubes. Broad-band amplification is ob-

Fig. 5—Details of windings for the circuit of Fig. 4. Coils are spaced $\frac{1}{8}$ inch.

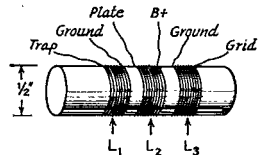

tained at the expense of gain, so it is important to select a tube of high amplification factor. Also, tube input and output capacitances must be low since this is a limiting factor on gain. A figure of merit relating these quantities is commonly used to describe the usefulness of tubes in wide-band amplifiers. The figure of merit, m , is expressed as the ratio of the tube g_m (pentodes) to the sum of its input and output capacitances. Tubes such as the 1852 and 1853, designed specifically for wide-band service, have a comparatively-high figure of merit, but there is no doubt that newer types, particularly in the miniature-tube categories, eventually will become popular.

Measurements

When using the coupling systems described, adjustment of the amplifier can be made with a few simple measurements. It is necessary first to determine as accurately as possible the shunting circuit capacitances, as a result of tube input and output capacitance, wiring, tube socket, etc.

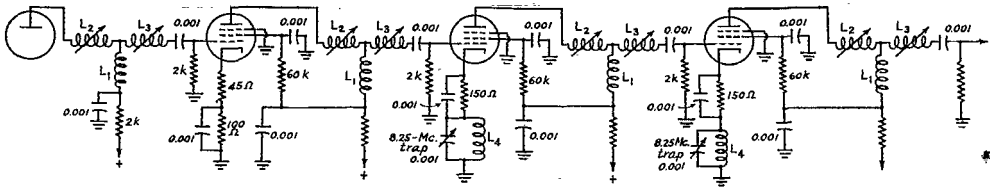

Fig. 6 — Circuit for an i.f. amplifier with a 4-Mc. bandwidth.

L_1 — 4 μ h.

L_2 — 12-15 μ h.

L_3 — 8-11 μ h.

L_4 — 0.37 μ h.

There are a few methods of doing this. One method found quite simple and satisfactory is to use the inherent shunting capacitances of the circuit to resonate with a coil of known inductance. This is done by setting up test equipment as shown in Fig. 7. As the signal generator is tuned, a sudden rise in output will occur at the frequency F , at which L , the known inductance, resonates with the unknown shunt capacitance. The capacitance then is found from the relation

$$C_t = \frac{1}{4\pi^2 F^2 L}$$

To find the capacitance of wiring and construction it then is only necessary to subtract from the total value, C_t , the rated tube capacities as listed in any tube handbook. Methods in measurement of other values, such as K , n , and gain, may be found in standard texts.

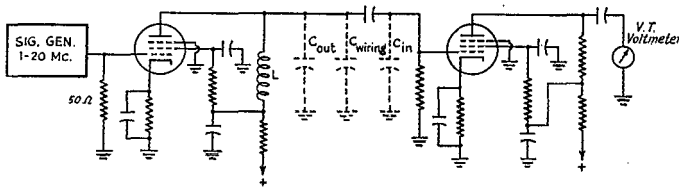

Fig. 7 — Test arrangement for determining inherent circuit capacity. Values such as cathode resistor, screen resistor, etc., are not critical; those suitable for resistance-coupled operation are in order. The total circuit capacitance, C_t is the sum of C_{out} , C_{in} and C_{wiring} . L is some known value of inductance; 50 μ h. is a good choice. Resonance with C_t should occur at a frequency, F , near

$$5 \text{ Mc. } C_t = \frac{1}{4\pi^2 F^2 L}$$

All too often the gain and response curves of the amplifier are quite different than expected. For example, the response curve may contain one or more extreme amplitude peaks located at various points in the band. This usually is an indication (assuming that circuits have been tuned properly) that there is a tendency toward regeneration in the amplifier. This condition is quite serious since it upsets the amplitude-response characteristic and leads to other effects which tend to impair the quality of the received picture. It can be ascertained whether or not there is any regeneration by recording the re-

sponse curve of individual stages of the amplifier and then drawing an over-all curve based on the fact that the over-all response is the product of the individual stage responses. This over-all curve should be similar in shape to that of the actual response over the complete amplifier. If regeneration is present it usually can be eliminated by resorting to the orthodox remedies, such as decoupling networks, filament chokes, short leads, correct by-passing, etc. Finally, the response curve may be affected by stray couplings such as excessive capacitance between two magnetically-coupled coils. This effect, caused by the complex nature of coupling (inductive and capacitive) may be minimized by proper connections to the transformer (note Fig. 5).

In the design and adjustment of amplifiers such as those described, it is desirable to have a well-calibrated (both for frequency and output) signal generator, a v.t. voltmeter capable of high-frequency operation, an impedance bridge and the usual d.c. voltmeters and milliammeters. Although this basic test equipment is considered a "must" for the experimenter in his work with broad-band radio-frequency amplifiers, it should be remembered that the i.f. amplifier is the "heart" of the television receiver and its adjustment has a great effect upon picture quality. Therefore, the more serious experimenters, particularly those who will be concerned with the servicing of television receivers, would do well to make use of more advanced equipment such as the oscilloscope, wide-band sweep oscillators, and the television-image (monoscope) and synchronizing signal generator.

Strays

W9WZH and W9Y CJ first QSOed in 1936. Nine years later they resumed their rag chew, this time in person, under operating conditions that would make 75-meter QRM seem tame. W9WZH, a dentist, was pulling W9Y CJ's teeth at Wakeman General Hospital, Camp Atterbury, Ind.



Hints and Kinks

For the Experimenters



DIRECT-COUPLED AUDIO AMPLIFIER

FIG. 1 shows a direct-coupled audio amplifier that I found simple to construct. It has a flat response from 30 to about 8000 cycles with about a 3- or 4-watt undistorted output. It is excellent for phonograph reproduction. However, with a 6SJ7 ahead of the 6F5, it will make a good microphone amplifier, with a performance exceeding that of many other low-power jobs I have seen. — *H. B. Ford, 343 Woodland Ave., Lexington, Ky.*

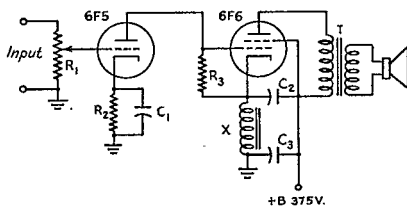

Fig. 1 — Direct-coupled amplifier requiring a minimum of parts.

- C₁, C₂, C₃ — 8 μ fd.
- R₁ — 0.5 megohm, variable.
- R₂ — 15,000 ohms.
- R₃ — 0.5 megohm.
- X — 2500-ohm speaker field, or 2500-ohm 10-watt resistor.
- T — Output transformer, plate to voice coil.

TWO KINKS FOR SEAGOING HAMS

SOME typewriters have the shift-key lock on the right side. This is sometimes unhandy when copying c.w. as one always has to keep unshifting. To cure this I hang a small weight from the lever handle over the side of the mill desk. The weight is just heavy enough to keep it from locking the shift.

Most all seagoing ops have the problem of mopping up the surplus battery solution which gathers on the tops of storage batteries after charging. A neat and handy method is to use a small medicine dropper. It will clear up all the solution quickly and easily, and is cheap, to boot. — *Jack C. Nelson, W8FU.*

IMPROVED CONDENSER CHECKER

I BUILT the condenser checker shown in Hints and Kinks in September, 1945. However, it was impossible to get the shadow to close properly if hooked up as shown in the diagram. By changing

the B-plus lead from the plate to the target, this checker worked properly.

Incidentally, using a 6U5 with about 320 volts on the plate, the value of R₁ necessary to close the shadow is approximately 30,000 ohms. — *J. H. Heuer, Chicago, Ill.*

THE TEN-DOLLAR WONDER

IT WAS GREAT to be back on the air again, but I with the choice of only a few prewar crystals I often felt the lack of a v.f.o.

But where was I going to scare up half-a-hundred bucks for a commercially-built unit? QRM grew worse so the time came to analyze the contents of the junk box. It revealed some midget variable condensers, tube bases — and best of all, a 70L7GT and a 6G6G. Some old aluminum-base 16-inch transcriptions supplied stock for the chassis. (All there is to cleaning them is to dip them in very hot water and then peel off the acetate coating with a knife, starting at the edge.)

It was thought that by using a transformerless power supply, fair regulation might be obtained without the use of voltage regulators. This proved true in spite of line voltage changes from 95 to 115. This arrangement also simplified the power-

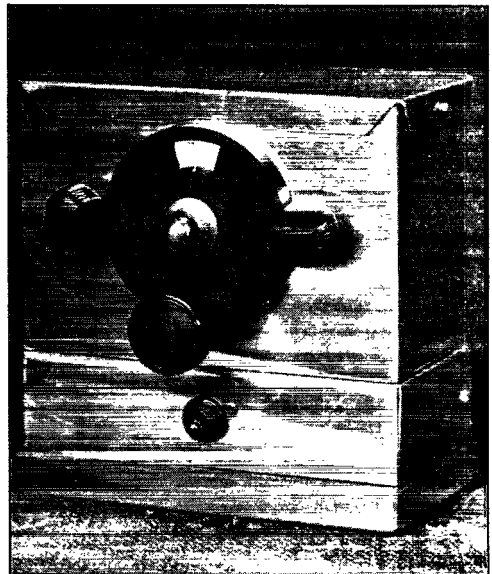

Front view of VE4ANQ's v.f.o.

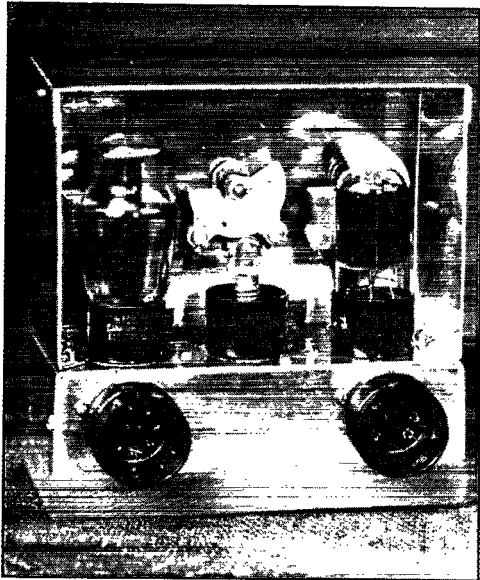

Rear view of the v.f.o. shows its compact arrangement. The coils are mounted on the rear of the chassis which must be kept clear of other units when in use.

supply problem from the standpoint of economy, stability and size. The whole unit measures 6 by 6 by 3 inches.

The 75-ohm resistor, R_5 , and the 150-ma. bulb were added to protect the rectifier section of the 70L7GT because high current is encountered in charging the filter. C_{10} is required to reduce hum and should not be omitted. (See Fig. 2.)

No screen-dropping resistors are required and no cathode bias resistor is used for the 70L7GT because it gets sufficient bias from the grid leak. The two coils are mounted at the back of the chassis so that there is no chance for them to be warmed by the tubes. The oscillator coil is un-

shielded. The unit sits on a wooden desk and no metal comes near the back of it.

With the condenser combination as shown it is just possible to cover the entire 160-meter band. The 6G6G is an excellent oscillator and runs cool. The 70L7GT doubles to 80 meters with over a watt output, sufficient to take the place of a crystal. I connected it to the grid of the regular 6L6 oscillator at terminal A, through " without even a ground return, and with an unshielded three-foot lead at that. The 6L6 stage then quadruples to "20" as if it were a Tri-tet.

We thought this design too good to keep to ourselves, after news of this compact and stable v.f.o. was received with unusual enthusiasm by others to whom we described its features. The cost of this unit was in the neighborhood of ten dollars. I like that neighborhood. — *Don Langbell, VE4ANQ.*

BIAS-SUPPLY TIME-DELAY CIRCUITS

REGARDING the 117Z6 trick in the April, 1946, "H & K" — I found that substituting a 5Z4 for a 5U4G in the bias supply of my transmitter (using bias interlock) gave me 30-seconds protective delay in case the regular time-delay relay failed.

The up-to-temperature time of heater-type rectifiers is increased by poor regulation of the heater supply but the tubes furnish the same emission when hot. Heaters have low resistance when cold and heat more slowly in a constant-current circuit.

A 25Z5, with its heater in series with a 350-ohm resistor, will take 40 seconds to reach 90 per cent emission. I use an 8- μ d.-condenser input and run 60 ma. through the relay. It'll work every time and the tube will last much longer than a 117-volt type. — *H. H. Cross, LSPH, Boston, Mass.*

Fig. 2 — Schematic diagram of the low-cost v.f.o. at VE4ANQ. The heavy line denotes the chassis. The unit is actually grounded only through the protective condenser, C_{12} . High-impedance output is taken from Terminal A. A low-impedance link may be connected to B and C.

- C_1 — 50- μ fd. variable.
- C_2 — 140- μ fd. variable.
- C_3 — 600- μ fd. mica.
- C_4, C_5, C_{11} — 100- μ fd. mica.
- C_6 — 0.01- μ fd. mica.
- C_7 — 40- μ fd. electrolytic.
- C_8 — 20- μ fd. electrolytic.
- C_9 — 100- μ fd. variable.
- C_{10}, C_{12} — 0.05- μ fd. paper.
- R_1 — 50,000-ohm $\frac{1}{2}$ -watt.
- R_2 — 100,000-ohm $\frac{1}{2}$ -watt 70L7GT grid leak.
- R_3 — 1000-ohm 10-watt, B + filter resistor.
- R_4 — 250-ohm line-cord resistor.
- R_5 — 75-ohm $\frac{1}{2}$ -watt.
- S — S.p.s.t. "on-off" switch for filaments.
- L_1 — 19 turns, tapped at 4 turns. (1.75 Mc.)
- L_2 — 25 turns. Link — 2 turns. (3.5 Mc.) Both L_1 and L_2 are wound on tube bases with No. 20 wire.

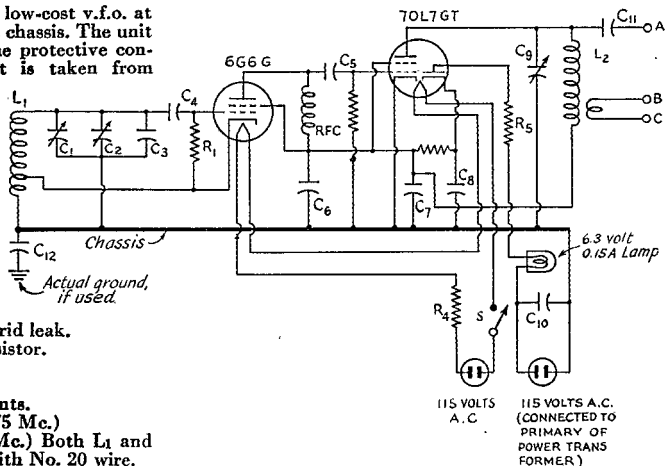

Foreign Notes

ARGENTINA

The *Radio Club Argentino* has completed a full year of its "school of telecommunications," promoting communications engineering knowledge. More than 800 persons applied for entrance, but accommodations were available for only 175 students. Approximately 96 per cent passed the course. We can expect the LU signals to be bigger, better and more frequent now!

BELGIUM

Probably the best news of the month is that the two Belgian amateur societies, one French- and the other Flemish-speaking, are merging into one group to be called the U.B.A. Full agreement has been reached, and there remains only the administrative and legal formalities of consolidation.

ON hams are, as most of you know, open on 28 and 56 Mc., and expect the early return of additional bands in line with the pattern set by Allied nations. Licenses will be restored to prewar holders.

CUBA

At recent elections, the *Radio Club de Cuba* formed the following governing board: James D. Bourne, CM2AZ, president; Gustave Rodriguez, CM2GR, vice-president; Eduardo Oliva Radelat, CO2WL, secretary; and Julio Rodriguez Forns, CO2DT, treasurer.

DENMARK

Another country has encountered difficulty in the use of the 80-meter band. Remember that Newfoundland withdrew the band from its amateurs because of interference to Allied military services? In Denmark, eager amateurs (or per-

haps some unlicensed persons) had been transmitting on 80 unlawfully, with the result that the P.T.T. issued a stern warning against continued operation on said channels. E.D.R. joined in the warning, pointing out that such activity could only prove harmful to good relations between itself and the government.

FRANCE

Amateurs who had been operating 'phone only in France, prewar, got a jolt with the publication of regulations governing a reopened amateur radio: only the licenses of radiotelegraphers were validated, and all future applicants must exhibit an official radiotelegrapher's certificate.

The new authorization is for 100 watts on 28-30 and 58.5-60 Mc., and 50 watts on 14-14.4 Mc.!

ITALY

After the liberation, A.R.I. was reorganized. While the administrative personnel continued headquarters in Milan, local sections were formed in the principal cities. Contact between such local sections and the society headquarters is maintained through delegates elected by the sections.

Application has been made to AMG for the official opening of amateur radio so that Italian hams will no longer be classified as "pirates." IIMB, the Rome-section delegate, points out that many Italian QSLs doubtless went astray during the war period, and amateurs who have not received confirmation of earlier contacts should apply once again via A.R.I. (see May *QST*).

VENEZUELA

For the 1946-47 term, the *Radio Club Venezolano* has elected the following officers: G. V. (Concluded on page 128)

◆
A new radio club of Czechoslovakian amateurs in Chomutov. The only persons identified are (seated: third from right) OK1KL, and (seated: third from left) OK1PB.
◆



How Much Inductance?

A Simple Method for Measuring Unknown Filter Chokes

BY GEORGE H. FLOYD,* W6OJK/2

BUILDING that new rig would be an easier job if we had remembered to mark all of our old parts before throwing them in the junk box. Not being blessed with such foresightedness, the writer found himself in such a fix — owning four large chokes but not knowing their inductances or current ratings. Being unwilling to trade them to the unsuspecting ham in the next block, he decided to measure the inductances of the chokes — and found it an easy job.

All that is required is an a.c. milliammeter and an a.c. voltmeter; or, if an a.c. milliammeter is not available, the shack volt-ohmmeter can do the job alone if it reads a.c. voltages. However, if the a.c. milliammeter is available, the measurement can be made more accurately than with the volt-ohmmeter.

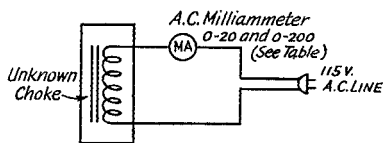

Fig. 1 — Using an a.c. milliammeter to measure current for determining inductance.

The test circuit using the milliammeter (Method I) is shown in Fig. 1. It will first be necessary to measure the d.c. resistance of the unknown choke, as the value of this resistance will be needed in the calculations. Then connect the choke as shown in Fig. 1. It will not be necessary to drop the line voltage to a low value unless you are uncertain as to what the unknown may be (perhaps a condenser?). As a matter of fact, it is desirable to use full line voltage so that the current will be high enough to give appreciable milliammeter deflection.

With the circuit connected as shown, read the current through the milliammeter and measure the line voltage. The table shows the current to be expected with chokes of various inductances,

Method I (Current in a.c. milliammeter—in ma.)	Method II (Voltage drop across 100-ohm resistor)	Inductance (henrys) (approximate)
5	0.5	60
20	2	15
80	8	3.75
160	16	1.875

* 1109 S. Country Club Drive, Schenectady 8, N. Y.

so that you can estimate the inductance and provide an a.c. milliammeter of suitable range. The inductance of the choke may then be computed from these two formulas:

If d.c. resistance of choke is less than 100 ohms:

$$\text{inductance of choke (in henrys)} = \frac{(\text{line voltage}) \times (1000)}{(377) \times (\text{current in milliamperes})}$$

(This formula assumes use of a 60-cycle line. If a 25-cycle line is used, substitute 157 for 377 in the formula.)

If d.c. resistance of choke is greater than 100 ohms:

First solve for X in this formula

$$X^2 = \frac{(1,000,000) \times (\text{line voltage})^2}{(\text{current in milliamperes})^2 - (\text{choke resistance in ohms})^2}$$

Then, using the value of X (not X²) just found,

$$\text{inductance of choke (in henrys)} = \frac{X}{377}$$

(Again use 157 instead of 377 if a 25-cycle a.c. line is used.)

If an a.c. milliammeter is not available but you are able to read a.c. voltage with a volt-ohmmeter, the circuit shown in Fig. 2 (Method II) may be used.

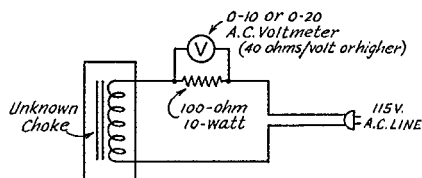

Fig. 2 — Indirect method of current measurement using a high-resistance a.c. voltmeter such as the copper-oxide rectifier type.

The trick in this case is to use an a.c. voltmeter to measure the voltage across the 100-ohm resistor and thus determine the a.c. current. Compute the inductance with these formulas:

If d.c. resistance of choke is less than 100 ohms:

$$\text{inductance of choke (in henrys)} = \frac{(\text{voltage across choke})}{(3.77) \times (\text{voltage across 100-ohm resistor})}$$

(Use 1.57 for 25-cycle line.)

(Concluded on page 132)



Correspondence From Members -

The Publishers of *QST* assume no responsibility for statements made herein by correspondents.

CIRCULAR BANDS

460 West 34th St., New York 1, N. Y.

Editor, *QST*:

I have just read the article on "circular bands" and I believe the only thing needed to make the program complete would be my theorem on vertical modulation, where the wave just presses forward and takes up no lateral area. Using this theory, we could modulate toward the center of the band rather than sideway toward the edges, and we could include ever so many more 'phone stations. What do you think?

— George W. Stuart, *W2AMN*

1140 W. Broadway, Columbia, Mo.

Editor, *QST*:

I wish to report on how I adapted my rig to use the new system (circular band theorem) and it is so simple one wonders how it was overlooked for such a long period. This applies to v.f.o.s only!

1. Modify the v.f.o. so as to get 100-per-cent bandspread.
2. Remove the stop-pin from the tuning condenser.
3. Purchase a good 360-degree dial.
4. Install the 360-degree dial.

Presto — a concentric or circular band!

— E. M. Sexton, *W0EKW*

LICENSE CREDITS

Avon Park, Florida

Editor, *QST*:

I have just finished reading a letter in April *QST* by *W2LXX*, and I cannot agree with his suggestion that credit toward the amateur license examination be granted certain persons. The present-day examination is not difficult if one will diligently apply himself to passing. He will pass if interested enough. If a person thinks he has enough technical knowledge or code speed to become an amateur radio operator let him prove it by passing the required examination. Let's keep ham radio on an equal basis.

— C. S. Bryant, *W4FQZ*

BOUQUET FOR OO_s

616 Greene St., Augusta, Ga.

Editor, *QST*:

This morning I received an ARRL Official Observer card from you stating that I had been reported from Davidson, N. C., as having a harmonic near 7.5 Mc. I immediately called *W4IEB*, a local ham, and had him give me a call on the air. I told him of the report and he checked my second harmonic. It was S9 at a distance of two miles! I signed with him and made a sked for one hour later.

Meanwhile, I took down the Zepp feeders to my long wire (end fed), drastically loosened the coupling to my final, changed my antenna tuning circuit and changed over to working against ground. After carefully tuning the old rig up, I held my breath and gave *IEB* the call on sked.

The results? My second harmonic is gone and the ol' sig is still up there putting the needle against the pin on *IEB*'s

SX-28-A receiver. Had it not been for ARRL's observer service I would never have known I had the second harmonic until I got a "pink slip." The second harmonic was eliminated within one hour after receiving your card. Thanks for saving me from a "cite," fellers.

— Frank Courtney, *W4FDX*

"A UNIQUE COUPLING"

Blue Bell P.O., Ambler, Pa.

Editor, *QST*:

Maybe I'm thick, but isn't there something missing from "A Unique Coupling," page 144, *QST* for April? A photograph is mentioned, which doesn't appear, and I can't dope out how the idea works at all.

— Jack Morgan, *W3QP*

[EDITOR'S NOTE: It confused us at first, too, OM — but it really works. Sorry we omitted the photograph; here it is.

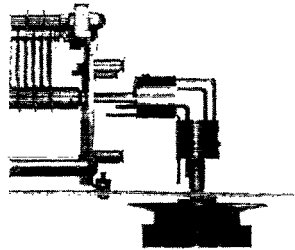

"JUMPING THE GUN"

Editor, *QST*:

Just want to register my feeling of disappointment and disgust with the flagrant disregard of the regulations exhibited by some amateurs prior to the official opening of the 75-80-meter band. It is almost incomprehensible that any of the boys and girls who have the intelligence necessary to become licensed amateurs would so flagrantly violate the honor of our fraternity. Surely these wanton violators were in the minority, and I have confidence that the great majority of our members did not participate. — *W0BPS*. . . . The "preview" opening of the band was shameful. Our fine record of the past years can be nullified by such actions. Let those who showed their stupidity by not using dummy antennas and fouled up the ether by signing silly names hang their heads in shame. — *W3FRC*. . . . It seems to us of the Elgin (Ill.) Amateur Radio Society that those who took part in the display might well commit to memory the "Amateur's Code," especially Part 1 entitled, "The Amateur is Gentlemanly." — *W0EVJ*, *W4FYF*, *W0MIZ*. . . . Damn the louses who beat the gun on 3.5 Mc. Sunday night! — *G2IS*. . . . I am not a ham, but as you make fun of us and call us SWLs I can say I feel proud to be an SWL, and would never think of doing a trick like that. I hope they catch every one and take their licenses away. — *E. G. Riggle*. . . . Suggest withholding the actual date and time of opening of additional bands until the hour is passed.

After all, what does one day more or less mean when we have so much time before us? Yes, and so much to lose by thoughtlessly becoming illegal operators. — *Chicago Area Radio Club Council*. . . . Perhaps it will beat us out of a number of new channels we might have got, or maybe it will help us get a number of new regulations I am sure every ham would love to have! The most heartening thing I can think of would be that FCC uses the information to revoke an untold number of licenses. No kidding, fellows — it is the dirtiest, rottenest thing that has ever happened. — *W6EYU*. . . . After listening to a heedless few break about every rule in the book, I want to say that deliberate out-of-band operation and signing of fraudulent calls is not funny and may interfere with other services; and the disregard for the rules of the game by a few is costly to the good standing of the vast majority of amateurs who stick by the rules. — *W9YDX*. . . . We do not think any of the old heads had anything to do with this sort of violation of FCC rules. We feel that the FCC should not consider this as the real amateur behavior but that it must be charged to a few beginners who may not be familiar with the amateur's code of ethics. — *Dade Radio Club*, (Miami). . . . I hope it doesn't get the ham fraternity as a whole into trouble. Some people have no patience. — *E. W. Strayer*. . . . For that very deliberate unsportsmanlike violation of the opening hour of 80, I would not object one bit if FCC put the lid on all of amateur radio for three months, or more. It certainly was disgraceful and needs some very plain, blunt and vitriolic treatment. If only the guilty ones could be banned from the air. — *W9UZ*. . . . I personally can't understand how a supposedly grown, mature individual could willfully commit all of those violations and knowingly jeopardize the standing of all American amateurs. Pour it on in *QST* and the tougher you get, the better; all of us are behind you. — *W6SYN*. . . . I was pretty disgusted. — *VE9AL*. . . . I express the sentiments of every ham in Minneapolis and St. Paul that I've talked to since the disgraceful demonstration. Can a single one of those pirates offer a single excuse for their actions? I'll say they can't! Sorry you can't print the language of contempt I would like you to. — *W9NFD*. . . . Nothing can harm our cause so much as illegal operating. It cannot be emphasized too strongly in what position they have placed our entire organization. — *W4HXM*. . . . One can hardly blame the gang for being extremely anxious, having been so exemplary in abiding with all the rules and regulations over such a long period. In the future would it not be good and sound policy to withhold the news of additional frequencies until they are actually available for use? — *VE2DR*. . . . Feel that it was one of the largest displays of thoughtless selfishness we've ever listened to. As hams, we resent it! — *W4MS*. . . . We protest bitterly, recommend strong editorial disapproval, and suggest that radio clubs revoke membership of all known violators. — *W9ECA*, *W9LIP*, *W9UIG*. . . . Coming from a group who are supposed to be the cream of the crop, it was disgraceful. Hope FCC goes to work on them. — *W2GNQ*. . . . A disgrace to our hobby. — *W3GKP*. . . . These irresponsible adolescents should be ostracized with the Wouff-Hong and Rettysnitch. — *W2EVI*. . . . There are times when even the hardest of us becomes ashamed of his kind. The demonstration on 75 'phone leaves me with a dark brown taste. We, who point with pride to our war record! Let's *think* before we permit our bands to disappear! — *W8HMJ/1*. . . . For the first time in more than twenty years of ham operation, I am ashamed to be an amateur. — *W7DTJ*. . . . Protest farce on 75. Do I have to work these bootleggers? — *W8SRD*. . . . Where's the old-time ham spirit? — *An Ole Tymer*. . . . After having been on the air twenty years, I never thought I would live to hear what I have listened to today and this evening. In an ill-considered moment these few have cast over the heads of the American ham the greatest stigma in the history of amateur radio. — *W1ACW*. . . . I cannot say I am proud to be a ham after the disgusting demonstration put on by the so-called "75-meter engineers." — *W2AYJ*. . . . In all my twenty-two years of being a ham, never have I witnessed a performance so disgusting and disappointing as the jumping of the gun on 80 meters. Every man who was on the band prior to the official lid-

raising is just as much a bootlegger as any unlicensed operator and just as much a threat to national security as any illicit war-time station. — *W1AY*. . . . Give 'em hell in *QST* for me. — *W9DIB*.

[*Editor's Note*: The above are excerpts from only a few of the host of letters, telegrams and telephone calls received at Hq., from loyal League members, to all of whom go our thanks.]

"ON THE BURMA ROAD"

Burma

Editor, *QST*:

Shortly after your receipt of this letter station "W4YA on the Burma Road" will cease operations due to the removal of all American personnel from this area. But not before it has made a name for itself, furthered American relations, and handled a vast amount of traffic to and from the GIs in this area. Many a homesick soldier has talked directly to his father, mother, brother or friend thousands of miles from the Burma jungles, and believe me, the Army has no form of morale uplift to compare with these direct contacts. I have seen soldiers enter "the shack" at a pre-arranged time, to talk to a brother or sister in Hawaii, Japan or the ITO, and upon hearing their voice cry for half an hour unable to talk to them. But believe me, that release of pent-up emotion is something to behold, and I am proud to say I was able to help, small as my part may have been. And the operation of this station does not in any way differ from hundreds of other American stations throughout the occupied areas. They are filling a gap no other Army activity can meet.

During the few closing weeks of this adventure it is impossible for me to contact all of our new-found friends and say goodbye to them, but I would appreciate it if *QST* would insert one line wishing them the best of luck and thanking them for all their help. My home address is 711 Forrest Ave. W., East Point, Ga.

— *Carlton H. Marsh, W4YA, ex-W9ASA*

HAM FREQUENCIES

15 Wilkinson St., Worcester, Mass

Editor, *QST*:

If *W7GRL* doesn't like the ultrahighs, that's his privilege. But we still have plenty of lads in these crowded eastern cities who couldn't be sold on anything lower than 144 Mc. Of course, you can't blame a fellow out there in the wide-open spaces for not liking the ultrahighs; one could probably call CQ until he was blue in the face without even a little automobile ignition as a come-back. I believe the trend he is referring to takes in most of the war years, when we were permitted limited activity on the ultrahigh frequencies and I think we were very fortunate in being allowed a variation of hamming even though it did come under the title of "WERS." Naturally, *QST* wasn't trying to plug the lower frequencies while they weren't available to us. However, as more of these old bands are released, I think we will begin to notice the old *QST* of four years back.

As for the slowness in getting back all of our old 20-, 40- and 80-meter bands, some of these guys have to be rapped on the noggin before they understand that the Army and Navy are using these bands — not the commercials. True, they are a little slow in coming back, but when you sit back and think that just one short year ago that same Army and Navy were in the thick of it, I wouldn't begrudge the slowness. Our bands are being used to facilitate occupation difficulties and I for one am patient enough to just keep waiting until a suitable arrangement might be reached by which we can get our bands back. I'd hate to think that my anxiety caused another complete shutdown of ham stations in twenty years or less. . . .

— *Al Kujampaa, W1KJO*

(Continued on page 154)



Operating News



F. E. HANDY, WIBDI, Communications Mgr.
E. L. BATTEY, WIUE, Asst. Comm. Mgr.

J. A. MOSKEY, WIJMY, Communications Asst.
LILLIAN M. SALTER, Communications Asst.

"Harmonic" Precautions Necessary. In March *QST* (page 80) we advised about possible spurious 14-Mc. radiation from 28-Mc. transmitters. One isn't safe from FCC citation for 14- or 21-Mc. out-of-band energy radiated from frequency-multiplying stages in error unless he has checked by all means and reduced or eliminated such spurious emissions in accordance with good engineering practice.

An additional note of warning is now required. On the Monday morning on which we write this copy we have two lists of amateurs logged strength 3-to-5, comprising received signals from all parts of the country, and all identified as second harmonics of 80-meter 3625-4000-ke. signals. Certain Airways stations also report fairly-strong 5602.5- and 5612.5-ke. interfering signals from several stations having what looks like the *third* harmonic of 1812.5- to 2000-ke. amateur crystals which double to "80." Signals strong enough to break up airline traffic at several hundred miles are a bad business!

The handwriting is clear. We *must* check our stuff before we switch to operation, and as soon as we are on the air we *must* ask several fellow amateurs to make a listening check of our signals to make sure we aren't alive with spurious radiations and improperly-strong harmonics. The latter complaint is common, to judge from the lists of off-frequency calls received. Reducing the plate voltage, cutting the bias, using suppressors (see page 19, July, 1937, *QST*) or absorbing circuits in the antenna, all the logical steps can be taken, once trouble is in sight.

It must be remembered that during World War II the Radio Intelligence Division of the FCC expanded tremendously, both in equipment and personnel. It is necessary in resuming our war-suspended amateur radio to assimilate some four years or so of progress in a short time. With the present efficient million-dollar monitoring facility actively on the job, it is a plain invitation to heavy citation-trouble to ignore making a close check of the transmitter before starting the band-warming! A word to the wise . . .

Calls Not Transferable. A station call for an amateur station practically becomes the owner's identity. As such it is a precious possession. The person to whom a call is assigned is responsible for compliance with FCC regulations. He must have a care for the ability and responsibility of

any amateur operator permitted to operate, even for a short period, while visiting his station. Since Sec. 12.27 of the regulations makes it possible for a person holding an amateur operator license to operate to the extent provided by the privileges for which his license is endorsed, the first duty of a station owner on receiving a request of a visitor to operate his station is to check the identification and license presented.

The holder of a station license cannot loan his call, and of course is most ardent to prosecute anyone who borrows it without the asking! Calls are *not* transferable. A case was recently brought to our attention where a lad with operator license but no station license attempted to "borrow" the call of another local amateur by asking if he might use it! It should be noted that it is *not* playing the game straight to attempt a temporary transfer of equipment, or other subversive means, to get hold of another man's identity to put an amateur station in operation. No responsible amateur should be party to such a deal. The FCC is now issuing amateur station licenses to LSPHs and there is no excuse for any illegitimate operation of any nature.

To V.F.O. Users. In the hands of skillful operators who observe the Golden Rule, the e.c.o. or "signal shifter" can be used for highly-efficient communication. Most important is (1) the intelligent timing of calls, and (2) transmission when the frequency is clear, things mentioned in our seven points for getting results, noted in this department for April.

Good v.f.o. operators use extreme care and patience. They tune up at the low-power frequency-control level, with the final OFF. They await that favorable moment when a contact has ended and it is legitimate to go after the distant amateur on his own frequency . . . after \overline{VA} , after his QRZ, after his CQ de — K, after he calls an amateur ending his call with \overline{AR} (showing contact has not yet been established)!

Operators of DX stations often answer v.f.o. calls of stations *near* but *not* exactly on their frequency, just to discourage improper use of v.f.o.s. After all, the best DX stations *can* usually choose which of a dozen calls will be answered. Local amateurs have been heard, after shifting exactly to a DX frequency, talking to each other and bemoaning the fact that they can't hook the station. Why shift to a station's frequency and

continue to call him *after* he is in communication with someone? Why, after working the rare station, continue on the same frequency? Why not give-someone else a break? Good results are obtained from *calls close to a station's frequency* which do not compete with QRM from competing calls. In traffic or DX work *after contact is established* with the v.f.o. it is efficient to work *exactly* on spot frequency. In that way two stations working together keep their channel reasonably clear and don't bother any one else. (It is when several pairs of stations on *different* frequencies do not work back and forth in exact unison that QRM pops up during QSOs. Of course we don't all have a v.f.o., and this is not to be construed as being for or against — we want to keep out of that argument.)

This discussion of v.f.o. operating characteristics is a call for FAIR PLAY resulting from a discussion that waxed hot in the Glendale Amateur Radio Club on the subject. It is believed that 75 per cent of the offending operators who are careless in tuning and thoughtless in calling or working with v.f.o.s do not realize the trouble they cause others, or how their calls are dragged in the dirt in club post-mortem discussions! The v.f.o. can pick those holes in the band without being obnoxious if it is handled correctly. It is probably here to stay. A suggestion to all and sundry v.f.o. users: Before calling ask yourself, "Is the frequency clear? Is the operator I want listening or sending now? Will my transmission interfere with a QSO in progress? Is my call timed right?" Amateur radio is a sporting game. *Play it fairly.*

The New ARRL Word List. For several years there has been a growing acceptance of the ARRL Word List, derived as a result of study in the OPS group before World War II. New FCC regulations effective April first were detailed in May QST. One of the sections of the regs invalidated our old ARRL List in part. *FCC now prohibits the use of names of countries, states or cities as phonetics* when an amateur exercises the option of using such words to insure full understanding, as in identifying his call. The FCC provisions required immediate consideration and restudy of the subject of phonetics as used in amateur radio.

As a service to all amateurs, the ARRL Phonetic Alphabet has been revised to eliminate large-city names. Each word has been considered for its contribution to intelligibility. The committee taking this subject under consideration examined words endorsed by independent communications organizations as suited to phonetic use. "Zero" was dropped in view of the new amateur licensing area of that digit. To insure that no amateur would be cited because at some remote spot on earth a city with one of the alphabet-names exists, we had FCC review the new ARRL standard list. The following Word

List is presented for your convenience and has been declared in compliance with the new amateur-service FCC regulations:

ADAM	JOHN	ROBERT
BAKER	KING	SUSAN
CHARLIE	LEWIS	THOMAS
DAVID	MARY *	UNION
EDWARD	NANCY	VICTOR
FRANK	OTTO	WILLIAM
GEORGE	PETER	X-RAY
HENRY	QUEEN	YOUNG
IDA		ZEBRA

The use of "original" phonetic equivalents is still possible for amateurs, insofar as their choices agree with the FCC rules. Unfortunately, the postal guide contains thousands of city names so one can hardly choose any old word without the possibility of conflict. Since letters to ARRL often refer to original choices as facetious and "childish," most good operators have turned to standard lists. In work on the above list attempt was made to avoid facetious words as well as to avoid change in words *not* in conflict with the new regulation. Where words have been retained it was with knowledge of the reluctance of some amateurs to change from satisfactory words in the old ARRL list.

Some amateurs were inclined to protest the FCC action as an infringement on freedom of speech. ARRL would certainly concur in an objection if the matter of use of a list was not left optional, on an if-and-as-required basis. However, FCC is *not* requiring us to use a list it prescribes. Some amateurs thought FCC intended the CCB list to be used, but there was no basis for that idea. Some names in that list are single syllables, low in intelligibility. Some may be cities. As we see the whole matter, the FCC is responsible for radio regulation in the public interest. It establishes uniform methods of giving calls and identifying stations to insure orderly operation and positive station identification by its monitoring stations and others. These things are as reasonable and necessary as traffic regulation for automobiles in our cities, sometimes minor nuisances to us individually but all in the public interest.

The use of one standard list within a service is a good thing since it aids quick general understanding. FCC is not promulgating a list, but ARRL, as a service to amateurs, has acted quickly to make an FCC-acceptable standard list available for any amateur purpose. The new ARRL standard phonetic list has been printed on small cards and distributed to all affiliated clubs. If you are a member of an affiliated group ask the secretary for one of these convenient cards, first in a series of Communications Department Operating Aids to be made available to such clubs — or ask us for one.

— F. E. H.

DXCC CERTIFICATE AWARDS

The ARRL DX Century Club Award, as originally conceived, provided the serious DX worker with the opportunity to obtain formal recognition of his efforts. A handsome certificate (our *handsomest*, some folks say!) was designed and offered to any individual who could prove, by irrefutable written evidence, that his station had been in two-way amateur radio contact with one hundred or more different countries. In line with standing Communications Department policy, our intention was to treat the DXCC Certificate Award like any other operating award, WAS for instance, and when an amateur obtained his certificate that would be his ultimate recognition. The DXCC certificate states only that much and does not credit DX worked above 100 countries. However, as in so many other phases of amateur endeavor, the competitive spirit crept in and a running contest developed among dyed-in-the-wool DX men. Countries worked totals were published from month to month to indicate total countries worked by holders of the CC award, and those aspirants to the award who had 75 or more countries confirmed. This listing became most popular. As might be expected, the majority of those amateurs credited with more than 100 countries were DX men of long standing and many years of experience in working rare and elusive countries.

Postwar plans for the DX Century Club were outlined broadly in December, 1945, *QST*, and discussed in subsequent issues by W1JPE in "How's DX?" The subject has been given much thought at Hq. and opinions from amateurs in the field carefully considered. The main concern, as we see it, in setting up the postwar CC is to allow each and every amateur with DX interests, particularly newcomers, to compete on an equal footing. To have continued the old DXCC listings would have limited competition to a relatively-few old-timers who would have remained at the head of the list. The fair-minded DX man agrees that all amateurs should start from scratch, to equalize opportunity. The plans in December *QST*, therefore, will be followed in general as outlined.

There are, of course, many amateurs who are not interested in the competitive aspects of DX

and who have striven for many years to work 100 countries only to obtain the coveted DXCC certificate award. For these individuals all previous announcements have been carefully re-studied. ARRL now announces a new more-liberal policy, in connection with the issuance of DXCC awards. This means in short that *no* amateur who at *any* time has worked DX is denied the opportunity to present it toward a DXCC certificate award at any time he wishes.

While the listings of DXCC prewar totals will no longer appear in *QST*, and while no postwar contacts will count toward increasing over-100 prewar totals, the basic award for 100 countries worked will still be available to all amateurs, whether contacts were made during the prewar or postwar periods. In the case of amateurs having fewer than 100 countries before the war, contacts with additional countries worked postwar may be counted towards a DXCC certificate, provided that such countries are included in the prewar ARRL Countries List, that geographical locations of stations worked correspond to countries in the prewar list, and that the prewar rules are followed.

The ARRL DX Century Club Award for confirmed contacts with 100 different countries is thus available as follows:

(1) To any radio amateur who worked 100 countries before the war, and who submits satisfactory confirmations to ARRL in accordance with prewar DXCC rules.

(2) To any radio amateur who worked fewer than 100 countries before the war, and who works sufficient additional countries after the war to bring his total to 100, and submits satisfactory confirmations to ARRL, provided that all postwar contacts must be based on the prewar DXCC rules, countries-list, and the same geographical locations as before the war.

(3) Under the postwar DXCC rules (yet to be announced), to any radio amateur who works 100 countries after the war, and who submits satisfactory confirmations to ARRL.

Under (1) and (2) above, confirmations should not be submitted until the applicant can provide proof of contact with a *total* of 100 countries.

Applications accompanied by fewer than the necessary 100 confirmations will not be processed or recorded, except in cases where the applicant already is credited on our prewar records with a total less than 100 and sends the remaining necessary confirmations. Please separate prewar cards, and indicate by a written list of countries during what period contacts were made, so your postwar work may be recorded in the event you wish to compete in the new listings at some later date.



INSTRUCTION IN RADIO CODE AND THEORY

Many ARRL-affiliated clubs conduct classes in radiotelegraph code and theory. In most cases instruction is designed to aid beginners and newly-licensed operators, as well as more advanced amateurs. The clubs listed below invite any interested individual to take advantage of their training programs. The listing indicates whether instruction is given in code, theory, or both. Full information regarding extent of the courses, meeting place, and dates and times, is available from the club secretaries. Correspondence from other affiliated clubs initiating such programs is invited for future listings.

City	Club	Instruction In		Club Secretary
		Code	Theory	
Akron, Ohio	Buckeye Short Wave Radio Club	X		W. O. Young, W8KMP, 1796 Tonawanda Avenue
Albany, New York	Albany Amateur Radio Association	X		Stephen J. Stanley, 24 Emmet Street
Billings, Montana	Southern Montana Amateur Radio Association	X	X	D. A. Detert, 801 Avenue B
Bloomfield, New Jersey	Bloomfield Radio Club	X		George W. Wright, W2HZY, 90 James Street
Bronx, New York	Bronx Radio Club	X		Nat Burnett, W2GKB, 1515 Grand Concourse
Burlington, Iowa	Iowa-Illinois Amateur Radio Club	X	X	R. A. Bischoff, W9QVA, 1309 N. 6th Street
Butte, Montana	Butte Amateur Radio Club	X		Leslie Blewett, 600 W. Broadway
Chicago, Illinois	Hamfesters Radio Club, Inc.	X		R. J. Walters, W9VVV, 8015 South Morgan
Chicago, Illinois	Lane Tech. Radio Club	X	X	Raymond Smith, 2501 W. Addison Street
Elizabeth, New Jersey	Union County Amateur Radio Association	X	X	Thomas Hunter, W2TH, 921 Edgewood Rd.
Enid, Oklahoma	Enid Amateur Radio Club	X	X	Owen Garriott, sr., 1301 West Elm
Framingham, Massachusetts	Framingham Radio Club	X	X	John DeCollibus, 115 Alexander Street
Garrett, Indiana	Northeastern Indiana Radio Club	X	X	W. J. Knisely, W9PIQ, 701 So. Lee Street
Hamilton, Ontario	The Hamilton Amateur Radio Club	X	X	Clarence Mogk, VE3AXV, 37 E. Twelfth Street
Joliet, Illinois	Joliet Amateur Radio Society	X		R. L. Whitmer, 1051 Mason Avenue
LaCrosse, Wisconsin	LaCrosse Radio Amateur Club, Inc.	X		M. T. Novotny, W9OGT, Box 423. Onalaska, Wisconsin
Milwaukee, Wisconsin	The Milwaukee Radio Amateurs' Club, Inc.	X		E. W. Kreis, W9HRM, 1632 N. 35th Street
Montgomery, Alabama	Montgomery Amateur Radio Club	X		W. P. Sides, W4AUP, Fleming Road
Moose Jaw, Sask.	Moose Jaw Amateur Radio Club	X		H. K. Bidwell, VE4ABI, 250 Ross Street, W.
New Haven, Connecticut	New Haven Amateur Radio Association	X	X	J. J. Morris, W1ATH, 74 Gorham Ave., Hamden, Conn.
Norfolk, Virginia	Norfolk Radio Club	X		R. S. Deacon, 118 E. Leicester Avenue
Pendleton, Oregon	Pendleton Amateur Radio Club	X	X	J. E. Roden, 519 N. W. Ninth
Quincy, Massachusetts	The South Shore Amateur Radio Club	X	X	Frank L. Baker, W1ALP, 91 Atlantic St., N. Quincy
Reading, Pennsylvania	Reading Radio Club	X	X	John Lenart, 633 S. 6th Street
St. Paul, Minnesota	St. Paul Radio Club	X	X	Wm. C. Ritt, New York Building
Savannah, Georgia	Amateur Radio Club of Savannah	X	X	B. M. Freeman, W4GMA, 1404 E. 33rd Street
Schenectady, New York	Schenectady Amateur Radio Association	X	X	Geo. H. Floyd, 1109 S. Country Club Drive
Sheridan, Wyoming	Sheridan Amateur Radio League	X	X	Frank Kedi, Box 122
South Ozone Park, L. I., N. Y.	Sunrise Radio Club	X	X	Thomas Knudsen, 114-14 202nd St., St. Albans, L. I., N. Y.
Waltham, Massachusetts	Waltham Amateur Radio Association	X	X	Mrs. D. B. Berry, 20 Riverview Avenue
West Lafayette, Indiana	Purdue Radio Club	X		T. C. MacCalla, jr., 468 Northwestern Avenue
Wichita, Kansas	Wichita Amateur Radio Club	X		Max D. Miller, W9DMF, 431 Edison Court
York, Pennsylvania	York Amateur Radio Club	X	X	Elmer Hauer, 49 Columbia Avenue

HAMMING IN NORTH CHINA

THE MARINES are the boys who represent Uncle Sam in North China. Through their signal officers they arranged with the Chinese Government to assign a block of calls (XUIYA to XUIYZ) to be used by "hams in the service" in the area. Calls have been issued on application to those who hold a valid U. S. license. The following calls are now in force: Tientsin — XUIYA YG YM YN YU YW YX YY YZ. Tsingtao — XUIYC YJ YO YQ. Peiping — XUIYK. Tangku — XUIYV.

The last-mentioned call, XUIYV, was assigned to me upon my special request, it being as near as I could get to W3QV. My experiences in getting on the air are probably representative of the rest of the gang out here. Around the first of February I started looking around for the nuts and bolts to make a ham rig. A BC610, which had been through the mill and was rather the worse for wear, rather than wear, looked like the best solution for a transmitter, and an RBG (HQ-120) receiver seemed best for my use.

Getting the transmitter on 28 Mc. was the problem. It was designed with an 8000-kc. ceiling and certain parts were either broken or missing. How to make the conversion with the least amount of labor and at the same time drive the 250TH reasonably well? It was found that one power transformer had a bad secondary, and filament windings were required in addition to those available. There were no spares, so two receiving-set power transformers (primaries in parallel, secondaries in series) made up the power for the exciter unit, 6J5-6V6-6V6-807. To get away from capacity effects in the BC610 driver stage, the plate circuit of the 807s was raised above the chassis. The grid circuit of the 807s is not tuned, but a piece of coax was made from some wire shield, the wire looped for two turns and soldered back on the shield, the other end wired directly (through .002 μ f.) to the grids, the shield being grounded close to the grids. A bracket for holding the adjustable coupling turns in place was necessary, as coupling was critical. A bit of antenna wire and a few condenser-plate spacers did the trick. A number of 7-Mc. crystals were available so no crystal grinding was necessary. At first the exciter was inside the BC610, but the problem of tuning, changing crystals, etc., made it necessary to mount it on the side of the transmitter.

The question of location for operating was next considered. If I was going to spend any time operating, it had to be close to my office. It is plenty cold up here, and the wind blows like I have never seen it blow before. One of the mobile communication vans (type MBL) seemed to be the ideal solution to both office space and ham shack. I now practically live in the van, and am right on the job, so it all works very well.

The antenna was another problem. In my anx-



Commander Brad Martin, USNR, XUIYV/W3QV, in the mobile communications van, which serves as his office and shack for XUIYV, Tangku, China. "Brad" made over 200 contacts on 28 Mc. from February 6th to April 6th, including W3, W4, W6, W7, W8, W9, VE4, VE5, VE7, KA, KB6, XU, J, K7, VK, G, LU, VQ3, VU2, VS5, VS6, SV, XE, ZL and ZS.

ety to get going, I hooked a pair of feeders onto an old Jap doublet. It was 110 feet in the air, and the flat top was about 150-foot long. The result of the first testing was a call from W8UIY/KA1, who said (and did my heart beat!), "UR RST 599-plus." And I continued to get excellent reports from all over the Pacific. However, I wasn't satisfied. I heard the boys working the States from Iwo Jima and Manila. I remembered how hard it was to work XU, VU, and such places from Eastern U. S. A. Again I started dreaming. I had made up my mind before leaving home that I was going to work back to the States, and more particularly to W3. A couple of 60-foot poles right near the van looked very nice, but there was not enough room in the right direction for a "Vee." Next day at noon I checked the true north. The poles used to support a broadside put it between ten and fifteen degrees from the North Pole. The distance between the poles indicated I could use a little more wire than a Lazy H. A six-element Sterba, fed off one corner, seemed like a good bet and eliminated a matching stub. So we put the thing up. That was February 15th. I hadn't heard even a W6 as yet.

Up early the next morning. This thing has got to work, I thought, because I'll have to send my wife a message on this, our twentieth wedding anniversary. Success! I worked two W6s and a W7. In the next few days I was working them all over the West Coast. The boys ganged up on me. I could hear five or six calling me at the same time. It was DX contests, RMNITE, Sweepstakes, WAC, etc., all wrapped up into one!

Well, one morning I was on at daylight. Suddenly the W6s went out like a light, and who was there all by himself, and calling me, but W3DGM, no QRM, no noise, no nothin'. Just like any other ole contest! "Gi' me a number just to make

it official," says he. (XU1YV had run into the ARRL Band-Warning Party. — Ed.) It was the biggest kick I had experienced in radio since I heard NAA's time-tick on a crystal detector in 1915! There is a big antenna-building program under way in North China. You are going to hear a lot more XU1 stations before long!

Commander Brad Martin, USNR,
W3QV/XU1YV
O-in-C, Naval Communications,
Tientsin Area.

WIAW OPERATING SCHEDULE

Official ARRL Bulletins containing latest FCC information relating to amateur operation and reactivation, and other bulletins on matters of general amateur interest are transmitted on regular schedules, as follows:

Frequencies: 3535, 7145, 14,280, 29,150, and 52,000 kc. (3950 'phone).
Times: 8:00 and 11:30 P.M. EDST, Monday through Friday. (0000 and 0330 GCT, Tuesday through Saturday.)

Starting at the times indicated, bulletins are transmitted by telegraph simultaneously on all frequencies. Bulletins are sent at 25 w.p.m. and repeated at 15 w.p.m. to facilitate code practice. Telegraph bulletins are followed by voice transmissions on each frequency in turn. Changes from this schedule will be announced by the operator.

Code-Proficiency Program: Practice transmissions at five speeds, 15 through 35 w.p.m., are made Monday through Friday, on the above listed frequencies, starting at 10:00 P.M. EDST (0200 GCT, Tuesday through Saturday). Approximately ten minutes practice is given at each speed. First certificate-qualification run is scheduled for Tuesday, June 18.

General Operation: WIAW engages in two-way work with amateurs as follows, Monday through Friday, all times EDST:

3:00-4:00 P.M. — 29,150 kc. (voice)
4:00-4:30 P.M. — 28,060 kc.
6:30-7:00 P.M. — 3950 kc. (voice)
7:00-8:00 P.M. — 3825 kc.

BRIEF

Diary of W8VWG, Saturday, February 2, 1946: (1) New antenna, erected just a week before, blew down. (2) Blew up tubes in transmitter trying to fire it up. (3) Smashed up car going to town to pick up new tube. (4) Power supply caught fire after getting rig and antenna back in shape, requiring a bucket of water. . . . To top all this off, after the transmitter was put back on the air, the first contact ended abruptly when the junior op fell down the basement stairs. — "The Listening Post," Queen City Emergency Net.

SIMULATED-EMERGENCY TEST

In connection with a Red Cross Disaster Preparedness Planning Group in York, Pennsylvania, a Simulated-Emergency Communications Test was held March 13th under the auspices of the York Amateur Radio Club and ARRL Emergency Coördinator Paul Stumpf, W3AQN. The test was witnessed by Mayor Snyder; city councilmen; Mrs. Minnie P. Hatton, Executive Director, York County Chapter, ARC; Mr. K. L. Cox, General Chairman, Disaster Committee, ARC; Mr. Charles Weaver, First Aid Committee, ARC; and Miss Abbie Whidden, Eastern Area, ARC. Miss Whidden stated, "I was very favorably impressed with this test and the fine work done by the local radio club. As a Field Representative in our Nursing Service, I was called to Kentucky a few months ago to help in the flooded area, and I know that much time could have been saved if we had had a similar setup operating at the scene of this disaster . . . this type of work would be very valuable in any community, should disaster strike."

Amateurs participating were W3AQN, W3BKB, W3BBV, W2ATX/3, W3IPE, W3KBA, W3IQF, W3EDO, W8CRJ/3, W3HWN, W3CDY, W3DEI, W3BTP, and W3HIE. The Control Station W3AQN was operated by EC Stumpf, and Robert Turkington, W3BIL, YARC president. With one exception, all operation was on the 144-Mc. band. The location of each station was indicated at the control point by a system of colored pins on a large map of the city. When stations moved to new locations, the pins were changed, blue pins indicating fixed stations, red designating portables. A stand-by 300-watt 110-volt a.c. gas-driven generator was kept in readiness in the event of power failure during the test.

The Lancaster (Pa.) Radio Club supported the demonstration by setting up a mobile unit at the Lancaster Red Cross Chapter, relaying to W3BKB, York, via W3DEI in Lancaster. W3BTP, Marietta, Pa., cooperated by furnishing reports on the river stages of the Susquehanna. W3CDY, Harrisburg, Pa., handled traffic for the Harrisburg Red Cross. W3HWN, Mechanicsburg, Pa., acted as relay between York and Harrisburg. W3BBV handled traffic to Harrisburg via 28 Mc. Two mobile units were used to cover an area of 22 square miles and aided greatly in relay and delivery of traffic.

Simulated disaster messages were handled for various Red Cross Committees: Survey, Transportation, Registration, Rescue, Shelter, and Volunteer Special Service. Each message was marked "test message" and messages for points in the local area requested a reply as to time of delivery. Handling time was good in practically every instance. Plans for the future call for more mobile units to speed up delivery.

OLD TIMERS CLUB — FORMERLY 20-YEAR CLUB

ARRL's 20-Year Club has a new name — the Old Timers Club. We want to hear from all members of the 20-Year Club who are still active. Old members need only to send a postal giving their present call, and date of first amateur license. We then will list them on the Old Timers Club roster, and send them one of the new membership certificates now being printed.

The Old Timers Club is open to anyone who holds an amateur call at the present time, and who held an amateur license (operator or station) 20-or-more years ago. This is the same requirement that applied to the 20-Year Club. An announcement in October, 1944, *QST* erroneously stated that an amateur license must have been held for at least twenty consecutive years. It is only necessary that you held an amateur ticket 20-or-more years ago, and are today the holder of an amateur call. Lapses in activity during the intervening years are permitted.

If you can qualify as an "Old Timer," send us a brief chronology of your ham career, being sure to indicate the date of your first amateur license, and your present call. If the evidence submitted proves you eligible for the "Old Timers Club," you will be added to the roster and will receive a membership certificate. Address all correspondence to the Communications Department.

GUAM RADIO AMATEURS LEAGUE

Charles E. Hunt, formerly of the 20th Air Force and now at Tuckahoe, N. Y., sends a list of GRAL members and information on the status of activities on the date he left Guam (Feb. 10, 1946). W9WUG/KB6 is the center of administration for all amateur activity. There were 20 active stations in operation in February, 14 using 100 to 500 watts, and 8 with 2- to 100-watts input, all on 28 Mc. Net control station was W6EKE/KB6, 29,200 kc. All stations are connected by a v.h.f. net using f.m. The GRAL roster includes:

W1MAQ NFB W2AYN IMJ JPQ KQT MFQ MVO NLU
W3AIM DLA EQL IMW JVR W4DNU FGL FKV GJA
W5ACP ENH GAB GBA GVR JMM JPC W6EKE FWJ
ICI MJC MLR OFZ PGM PKP KQB NFH SZC TQE
W7FXC HLA IAC IYO JCU W8DBT HDM MST OK
QCC QDD KTB TWX TXN UFH UMI WUV W9ARG
BAI BBQ DPZ EDS FZZ JBX JGO JPO JMG LEI LFI
LRK PDH QCJ QLO RMQ RTV RTZ RVU SKD WUG
WFW ZEO ZXH OZR W4DRK W6QKB W8WUE.

BRIEF

W9FLD, Sullivan, Missouri, and OA4AK, Lima, Peru, are keeping regular schedules on 28 Mc. They have had 34 contacts and have not missed a single schedule in over two-and-one-half months. OA4AK operates on 28,420 kc. with 40 to 50 watts input. W9FLD runs 250 watts. Both stations use four-element beams. The schedule is at 12:30 P.M. CST, three days per week. Chalk up another for 28-Mc. reliability.

DX ON 80!

On April 9th, Benton White, W4PL, Shepherd, Tennessee, took time out from some nice DX traffic work to write us the following:

"Not even Ripley is going to believe this one, but I am running a daily traffic schedule direct with Wake Island on 80 meters! A week ago today, about daylight, I was listening around and heard a station with a call a yard long trying for a W6. (K7HNG/KC6, and how would you like to have that one in an SS?) I thought it was one of those April Fool calls, but kept listening. He hooked his man (W6DDO), and said he was on Wake Island, and how about taking a little traffic from him?"

"Maybe you have heard the tale of the lad up for stealing some hams. . . . Claimed he took 'em for a joke. . . . How far from the smoke house was he when the officer caught him? . . . About a mile and a half. . . . 'That's carrying a joke too far,' sez his Honor, 'Thirty days.' So when this K7 ham began to give messages with instructions to send them WU night letter clear across to N. Y. C., I think if this is a joke, it's being carried pretty far.

"When he signed I called him, and it was just as simple as that. He is a Pan-Am Airways operator, and has special permission to work 80-meter traffic on account of very poor communication facilities at Wake Island. Of course it can't last, but while it does we are giving a message action; from two-thirds across the Pacific almost to the Atlantic Seaboard in one hop on 80 meters! From now on I believe in fairies, ghosts, and just lemme hear the fish tale I won't believe."

"OPERATING NEWS" INVITATION

The Communications Department is always interested in hearing about what you are doing in amateur operating. The Operating News columns are devoted to passing along to you items on every phase of operating interest. Send us information on operating events and activities, stories, briefs, oddities. All articles and items will be welcomed and will receive consideration for appropriate use. If something occurs in your operating that seems worthy of note, let us pass it along to the gang.

In addition to the general run of Operating News, the Communications Department conducts a continuing Article Contest. The author of each article used is awarded a \$10 prize, consisting of \$5 in Victory Stamps, and \$5 in ARRL supplies or publications (except *QST*). Contributions for this contest must be on a subject of interest to radio amateurs, and the length must be not over 500 words. Entries are judged on originality and value to the fraternity. Send as many contributions as you like. Write on any topic in the field of ham operating or organization. For contest consideration be sure to mark your article "for the CD Contest."

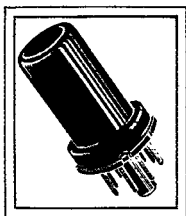

WE ARE often asked why we do not use "super duper" tubes like the 1852 in the input stages of National receivers. Amateurs tell us that they have substituted tubes of high mutual conductance for the tubes of your choice, and that it has resulted in increased sensitivity. This is undoubtedly true. The reason why we still stick to tubes like the 6SK7 for RF stages involves the whole subject of signal-to-noise ratio as well as sensitivity. We have discussed this before on this page but the subject is important enough to warrant taking another look at it.

Sensitivity is defined as the input signal required to produce an output of .05 watt at the speaker terminals when the carrier is modulated 30%. This definition does not say anything about noise, which makes it very misleading when applied to high gain communication receivers. A high gain receiver with a low-Q input circuit may generate enough noise to produce .05 watt at the speaker without any signal at all, so that by definition it has infinite sensitivity. Actually, the useful sensitivity of such a job would be pretty terrible, because only a strong signal could override all that noise. On the other hand, a really high quality receiver with a low noise level would have much less sensitivity, if sensitivity is based on gain only.

Signal-to-noise ratio is as important a factor as sensitivity. To be readable, the signal must be stronger than the noise. For easy copying, it should be a lot stronger. This requires that noise be kept down at the same time that the gain is raised. This really taxes the skill of the radio engineer.

An important factor in signal-to-noise ratio is the input circuit. A high-Q circuit here will produce less noise for a given signal. For instance, thermal agitation is a major source of noise, and the noise voltage from this cause is inversely proportional to the square root of the Q of the circuit. As regards amplifying the signal, we do not need to tell readers of this page why high-Q helps.

The Q of the input circuit depends on *everything* in the circuit and this means tubes as well as coils and condensers. At high frequencies, the grid circuit of a vacuum tube absorbs power even though the grid has a negative bias. With a Type 57 pentode, this is equivalent to a resistance of about 23,000 ohms when operating at 30 Mc. and is down to about 2100 ohms at 100 Mc. This resistance is inversely proportional to mutual conductance, other things being equal, so that good Q pretty much requires a low mutual conductance. (Incidentally, this input resistance explains why parallel operation of tubes does not improve RF stage gain.)

In addition to degrading signal-to-noise ratio, a low-Q input circuit has other objections. Images are worse, for instance.

National receivers have ample gain to work right down to the noise level. This is all the gain that can be used. If more were needed, there are better ways of getting it than by spoiling the input circuit.

JACK IVERS

Yes, we made a mistake here in April. Images are separated from the carrier frequency by twice the receiver IF frequency. Sorry.



MEET THE SCMs

One of our most energetic and efficient leaders is the featured SCM, Thomas M. Moss, W4HYW, who recently was elected to lead the Georgia Section following his release from the AAF after a four-years' tour of duty. Moss was a student of the Fixed Station Operator School, Signal Corps



School, Fort Monmouth, New Jersey, from February to July, 1942; chief operator of the War Department station attached to the Eleventh Air Force in the Aleutians from August, 1942, to March, 1944; operator of the Army Airways Communications System station (point-to-point net) until December, 1944; monitor of the 54th AACS group from March

to June, 1945; and "trick" chief of the AACS air-to-ground station at MacDill Field, Florida, until October, 1945.

In addition to his amateur license, which was issued on February 21, 1941, W4HYW also holds a restricted-radiotelephone operator permit. "Tom" has attained a receiving speed of 50 w.p.m. and is capable of copying 45 w.p.m. on a typewriter.

His station, which is located in the backyard, includes transmitting equipment consisting of 6F6G crystal, HY69 P.A. with 60-watts input, p.p. 6L6Gs Class AB, 6J5 Driver, 6SJ7 S.A., double-button carbon mike. Reception is provided by a Hallicrafters S-20R. His transmitting frequencies range from 80 to 6 meters, although he most often is found on 29,117/28,040 kc.

W4HYW is an associate member of the Institute of Radio Engineers, a member of the Veteran Wireless Operator's Association, and a member of the Atlanta Radio Club.

Photography ranks second to amateur radio as a hobby and "Tom" actively engages in bowling and tennis when time permits.

Among the appointments held by SCM Moss are those of Official Observer, Official Broadcasting Station, and Acting Emergency Coordinator. He is eager to make ARRL appointments and invites correspondence from qualified members under his jurisdiction. Moss is extremely interested in building a first-class organization in his Section and under his able direction Georgia should become one of the foremost Sections in the country.

BRIEF

Amateur D2 calls are being issued to Service personnel in British-occupied Germany. Members of the Royal Canadian Air Force's 8402 Air Disarmament Wing have formed the "8402 Wing Radio Club" with about ten members. The club's

station is set up in the attic of a house in Oldenburg. At 84 Group (RAF) Headquarters at Celle, Germany, two other Canadian amateurs are on the air signing D2PF and D2HH.

ELECTION NOTICE

To all ARRL Members residing in the Sections listed below:

You are hereby notified that an election for Section Communications Manager is about to be held in your respective Sections. This notice supersedes previous notices.

Nominating petitions are solicited. The signatures of five or more ARRL full members of the Section concerned, in good standing, are required on each petition. No member shall sign more than one petition.

Each candidate for Section Communications Manager must have been a licensed amateur for at least two years and similarly a full member of the League for at least one continuous year immediately prior to his nomination.

Petitions must be in West Hartford, Conn., on or before noon on the closing dates specified. In cases where no valid nominating petitions were received in response to previous notices, the closing dates are set ahead to the dates given herewith. The complete name, address, and station call of the candidate should be included with the petition.

The following nomination form is suggested:

Communications Manager, ARRL (Place and date)
38 La Salle Road, West Hartford, Conn.

We, the undersigned full members of the
..... ARRL Section of the
Division hereby nominate
as candidate for Section Communications Manager for this
Section for the next two-year term of office.

Elections will take place immediately after the closing dates specified for receipt of nominating petitions. The Ballots mailed from Headquarters to full members will list in alphabetical sequence the names of all eligible candidates.

You are urged to take the initiative and file nominating petitions immediately. This is your opportunity to put the man of your choice in office.

— F. E. Handy, Communications Manager

Section	Closing Date	Present SCM	Present Term of Office Ends
Nevada	June 3, 1946	N. Arthur Sowle	June 15, 1946
Maine	June 3, 1946	Grover C. Brown	June 15, 1946
Idaho	June 17, 1946	Don D. Oberbillig	Apr. 15, 1944
Tennessee	June 17, 1946	James B. Witt	Nov. 15, 1944
Mississippi	June 17, 1946	P. W. Clement	Apr. 1, 1945
Rhode Island	June 17, 1946	Clayton C. Gordon	Apr. 15, 1945
No. Minnesota	June 17, 1946	Armond D. Bratland	June 15, 1945
No. New Jersey	June 17, 1946	Winfield G. Beck	Sept. 23, 1945
San Diego	June 17, 1946	Ralph H. Culbertson	Apr. 15, 1946
West Indies	June 17, 1946	Mario de la Torre	Deceased
Illinois	Aug. 1, 1946	David E. Blake, II	Aug. 15, 1946
Oklahoma	Aug. 1, 1946	Ed D. Oldfield, jr.	Aug. 15, 1946
Western Mass.	Aug. 1, 1946	William J. Barrett	Aug. 17, 1946
Ohio	Aug. 1, 1946	Carl F. Wiehe	Aug. 17, 1946

ELECTION RESULTS

Valid petitions nominating a single candidate as Section Manager were filed in a number of Sections, as provided in our Constitution and By-Laws, electing the following officials, the term of office starting on the date given.

Alabama	Lawrence J. Smyth, W4GBV	Jan. 15, 1946
San Francisco	Samuel C. Van Liew, W8CVP	Feb. 15, 1946
Connecticut	Edmund R. Fraser, W1KQY	Feb. 15, 1946
Santa Clara Valley	Roy E. Pinkham, W6BPT	Feb. 15, 1946
New Hampshire	John H. Stoughton, W1AXL	Apr. 1, 1946
Sacramento Valley	John R. Kinney, W8MGC	Apr. 1, 1946
Arizona	Gladden C. Elliott, W8MLL	Apr. 1, 1946
Louisiana	W. J. Wilkinson, jr., W8DDW	Apr. 15, 1946
Indiana	Ted K. Clifton, W9SWH	Apr. 15, 1946
Vermont	Gerald Benedict, W1NDL	Apr. 15, 1946
Colorado	Glen Bond, W9QYT	Apr. 17, 1946
Missouri	Letha A. Dangerfield, W9OUD	Apr. 17, 1946

SUPER PRO

Series 400



Less QRM---Phone or CW

When the bands are active it only takes one minute to find that you need Hammarlund's patented variable crystal filter to have a successful QSO—either phone or CW.

Look to the future! When the number of Hams doubles or trebles you will need the crystal filter that weeds-out the QRM . . . If you can't hear 'em, you can't work 'em!

Price (SP-400-X)
\$342.00
Including Speaker



HAMMARLUND

THE HAMMARLUND MFG. CO., INC., 460 W. 34TH ST., NEW YORK 1, N. Y.
MANUFACTURERS OF PRECISION COMMUNICATIONS EQUIPMENT

Station Activities



REPORT YOUR ACTIVITIES

• All operating amateurs are invited to report to the SCM on the first of each month, covering station activities for the preceding month. Radio Club news is also desired by SCMs for inclusion in these columns. The addresses of all SCMs will be found on page 6.

ARRL members are invited by SCMs to make application for the following appointments: ORS, OES, OPS, OO, OBS. Leaders are needed in several Sections to handle important SEC and EC posts. The SCM would also like to hear of your interest in RM or PAM appointments. Send all inquiries and applications to the SCM for your ARRL Section.

ATLANTIC DIVISION

EASTERN PENNSYLVANIA — SCM, Jerry Mathis, W3BES — 3UA is reorganizing the Susquehanna Emergency net with the opening of the 3.9-Mc. 'phone band. He will make a survey of the area. 3AQN sends in a fine report of the York Amateur Radio Club's test with the Red Cross. They simulated incidents and handled the communication. Those listed as participating are 3BKB, BBV, IPE, KBA, IOF, EDO, HWN, CDY, DEL, BTP, HIE, AQN, 8CRJ, and 2ATX. Most of the operating was on 144 Mc. but 28 Mc. was used a bit. The test was observed by the mayor of York, committeemen, and officials of the Red Cross. ORS will be reinstated with the receipt of the second activities report. 8EU is all set to become a W3 and sends in his No. 1 report. 3UX hooks Zepp feeders to a tin roof and excites same. 3HRE, WERS radio aide of Easton, is moving back to Buffalo. We will miss him for his excellent emergency work. 3ITZ has a new 28-Mc. 8JK beam. There certainly must be some traffic handling going on. How about reporting it for QST. Just write to your SCM for reporting cards. Traffic: W3BES 2, 73, Jerry.

MARYLAND-DELAWARE-DISTRICT OF COLUMBIA — SCM, Hermann E. Hobbs, W3CIZ — GEB expects to be back on the air as soon as he gets his business arrangements in working order. Meanwhile, he keeps his radio knowledge in shape teaching in the Department of Education, Electronics Section, of the Baltimore City School System. ECP is back in civvies and has just finished a new e.c.o. for use in the 3600- to 3900-ke. band. He is interested in making traffic schedules and desires an OO appointment as soon as he gets some checking equipment finished. The Naval Academy Radio Club, which has twenty-one members, is ready with a Collins rig to go on all bands. The secretary-treasurer is Midshipman 2/c A. G. Opitz. The ticket holders of the club are 9CXT 1MCA, 9LCI, 9PIC, 1NWV, 4GZU, and 9PLO. They have been holding regular code and theory classes and the remaining members hope to get their tickets this summer. There is much interest in 144-Mc. work; also 28 Mc. has its adherents. The active members of the WRC held forth at the home of CDQ. Present were Lt. Oscar Sandoz, R.N., VE1QZ; Capt. Eric Illott, R.A.F., G2JK; EYX, 4GPW/3, HSW, CDQ, and KBE. Wayne Eller is on 28 Mc. with a Hallicrafters. The Wilmington Radio Club is keeping busy with its Emergency Coordinator in active control. If the new EC appointees in other districts of this section need pointers, give GL a call and he will fix you up. His address is 702 North Baneroff Pkwy., Wilmington 137, Delaware. The people of Delaware are communication conscious. Stories regarding radio communication applications get front-page notice in the local newspapers; also the local radio broadcasting stations are

most cooperative regarding publicity for Amateur Activities. They have the use of thirty-one walkie-talkies, civilian operated, in the 30-40-Mc. police band. PV, one of the newly-appointed Official Broadcasting Stations, recently received a nice report from a Texas listening station. He also has a message schedule with a station in Hawaii which has proven very satisfactory on 28 Mc. I need more reports. The Washington Radio Club is holding its spring hamfest on June 1st in the Broadmoor Hotel, Washington. Anyone interested may contact the secretary, Barbara A. Houston, at 4692 Nichols Ave. S.W., Apt. 3A or the vice-president, Gordon Walter, 1921 Kalorama Rd., N.W., North 3033, for further information. 73.

SOUTHERN NEW JERSEY — SCM, Ray Tomlinson, W3GCU — Section EC, BAQ; ECs, ABS and JNZ. ITR and GNM are on 3.5 Mc. The theory classes sponsored by the Hamilton Twp. Radio Club are progressing nicely under the tutelage of JLT. A committee consisting of GSP, CCC, and GCU, was appointed to get the code section started. HTJ and GQX were appointed to insure representation and participation of HTRC in our June Field Day. EC applications should be mailed to Section EC, Theodore T. Torretti, 1472 No. Olden Ave., Trenton. ASQ and AFH are new OBS. HTJ is using Selsyn motors for beam indication. CCC is using his new NC-100-ASD. Ed has an ACR-155 for sale. 1IRV/3 is active on 144 Mc. BEI, Class I OO, will be on 3.5 Mc. shortly with 300 watts to pair of 812s. Eric Leavens, of Red Bank, now signs W2OUS. 2ARP came on the air March 30th. ABS and ACC are operating on 144, 50, and 28 Mc. ACC is using three-element beam on 28 Mc. and ACC and 2ARP are using half-wave verticals on 28 and 50 Mc. and extended double Zepp on 144 Mc. ABS's new rig for 145 Mc. will be m.o.p.a. with Peterson Pot using HY75-832-829 with 60 watts. A new NC 2-40-C has been ordered for ABS's shack. The South Jersey Radio Association now meets in the Odd Fellows Hall, Haddonfield, the third Wednesday each month at 8 p.m. BMA's call now is 2BMA. FQ now has to sign 2OQH. Other W2 calls reported are OSC and OSS. The regular April meeting of the Trenton Radio Society was held April 5th in the Chamber of Commerce Room of the Stacy Trent Hotel. 73, Ray.

WESTERN NEW YORK — SCM, Charles I. Otero, W8UPH — The KBT Radio Club (Kenmore, Buffalo, Tonawanda) is active again. An organization dinner was held and the following temporary officers were elected: NNP, pres.; MQX, secy.; NVJ, treas. Among the members present at the dinner were MYW, VCI, UEP, UDD, SJV, RRL, DLK, VEX, UXH, PCN, NVO, LQC, IIE, CV, OWE, CIL, and PQC. The guest speaker for the evening was the Assistant Radio Inspector, Mr. I. A. Rockman. By the first of June MYW will join the University of Rochester. Immediately after the tidal wave disaster at Hawaii, RTX and NOL rendered special emergency service checking on the welfare of several persons in the Islands related to Rochester area residents. Their efforts were entirely successful. The Auction Meeting of the RARA was fun and a lot of dough came out of deep pockets. You never saw so much stuff — and good, too — sold out. DFN acted as auctioneer, assisted by NCM, and the boys were right on their toes all the time. A funny thing happened; a casual remark by the auctioneer that the part he was offering had a little defect immediately put the bidding in reverse in a hurry, but the thing was sold anyhow. VQM was a hard man to outbid. Well, 3.9 Mc. was opened at long last, and what a bang-up opening it had! They tell me that even at three o'clock in the morning the band is still congested. BAP and UPH are early birds among a great many others. Also operating regularly on 3.9 Mc. are PFR, RGA, and RJZ, from the Rochester area, and AFQ, from Brockport. The ECRA, of Syracuse, had an excellent quiz program at a recent meeting. Perhaps some of the section clubs would like to try that idea. 73, Charlie.

WESTERN PENNSYLVANIA — SCM, R. R. Rosenberg, W3NCJ — Section EC, AVY. New appointments: EC, TUA; OBS, BTQ. The Western Pennsylvania ORS net, with RM TOJ in charge, operates on 3750 kc. Monday through Friday at 6:30 p.m. BTQ is equipped with 50-watt emergency 3.9-Mc. 'phone transmitter with power supplied from 350-watt 120-volt generator driven by gasoline engine. FVA is increasing the power of his 3.9-Mc. 'phone transmitter. EYY has 100-watt 28-Mc. rig with 809 final, a 3.9-Mc. 'phone transmitter with 807 final modulated with pair of 6L6s and is constructing high-power job with p.p. 100ths in

(Continued on page 84)

For linear variation of light output with current

SYLVANIA GLOW MODULATOR TUBES

Sylvania's Glow Modulator Tube R1130B (1B59) is designed for practically any application requiring essentially linear relationship between current and light output.

In this crater-type tube, a high ionization density is obtained. In addition, discharge is viewed in depth. These two factors provide high actinic efficiency.

Electrical Ratings:

Operating Voltage	140 volts max.
Operating Current	5-35 ma.
Starting Voltage	225 volts max.
Modulating Frequency Range	15-15,000 c.p.s.
Useful Light Range	3500-6500 Angstroms
Filament Voltage	None: Cold Cathode

Applications

Sylvania Glow Modulator Tubes have found their chief use in facsimile recording. A photograph is placed on a revolving cylinder. A pinpoint of light is reflected back from photograph to a photoelectric cell, which generates current in accordance with light variations.

Current passes into a radio transmitter or telephone circuit. At receiving end, the Glow Modulator Tube emits light of an intensity that varies with the current. Light is focused on sensitized paper or negative on a revolving cylinder. As cylinder turns, original photo is reproduced.

Glow Modulator Tubes are also used in recording sound on film, and their characteristics suggest many other applications.

Correspondence is invited concerning projected uses of these tubes.



Sylvania Glow Modulator Tube R1130B (1B59)

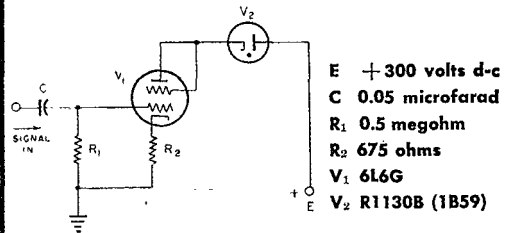
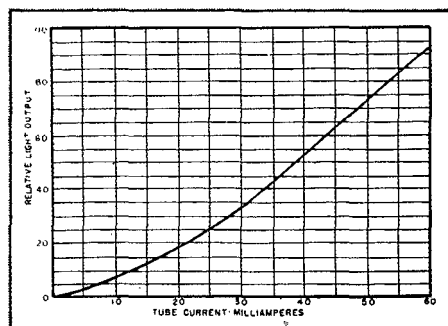

Fig. 1

E + 300 volts d-c
C 0.05 microfarad
R₁ 0.5 megohm
R₂ 675 ohms
V₁ 6L6G
V₂ R1130B (1B59)



Relationship between light output and current in the R1130B (1B59)

Fig. 2

SYLVANIA ELECTRIC

Electronics Division . . . 500 Fifth Avenue, New York 18, N. Y.

MAKERS OF ELECTRONIC DEVICES; RADIO TUBES; CATHODE RAY TUBES; FLUORESCENT LAMPS, FIXTURES, WIRING DEVICES; ELECTRIC LIGHT BULBS

(Continued from page 87)

final stage, OJL desires to hear from amateurs interested in the Coast Guard Auxiliary. NOR discussed arrangements for establishing 144-Mc. tie-in with CU and JNBW. The first W3 call believe issued in this section was W3KEW, of Meadville, formerly 9LEZ. The other active station in Meadville at present is MIE. New officers of the Mon-Yough Amateur Transmitting Assn. are: UST, pres.: NGD, vice-pres.; VYP, secy-treas. IZG's three-element beam is working out well on 28 Mc. OUM and CKO are active on 28 Mc. TST is completing new transmitter. AOE has worked fifteen countries on 28 Mc., ten of which were contacted on one Sunday. SFG worked Germany on 28-Mc. 'phone while running 30 watts input. OAJ and IYQ are working f.m. 'phone. CJB is the only kw. station in the county. GEG is active on 28-Mc. 'phone and has erected new 3.5-Mc. antenna using 300-ohm transmission line. CJF is on the air with 150-watt rig and has a new receiver. WDC has a "plumbers delight" working into three-element rotary beam. KCV is active on 3.5 Mc. CKO and KWA were logged on 3.5 Mc. the evening the band was opened up. AOE would like Pgh. area amateurs interested in traffic work and former AARS net members to contact him. JLH, EC for Lawrence County, wants to hear from v.h.f. amateurs desiring to become associated with their local AEC net. The Mercer County Radio Assn. has filed application for membership in the Pittsburgh Area Radio Clubs Council. The Pittsburgh Area Radio Clubs Council will hold a ham-fest on Aug. 4th at Spreading Oaks, South Park, Pittsburgh. Very 73. Ray.

CENTRAL DIVISION

INDIANA — SCM, Herbert S. Brier, W9EGQ — EBQ is assembling a modulator and speech amplifier for his 35Ts. RHL and DLI took one listen on 3.5 Mc. and thanked each other for being on 144 Mc. DLI and JZA have three-element beams and MVZ, RHL, and EGQ have four-element beams on 144 Mc. IU has forty-five countries; HKR has twenty-seven. ENH is on 3.5 Mc. with ten-year-old c.c.o. looking for traffic. QG has room for only a 40 Zepp, but works on 3.5 Mc. HUV has a "secret" DX antenna under construction. He schedules K6 on 28 Mc. FJI is new in Evansville. He is the first newly-licensed station to report. EGV kept his word and was on the air the minute it was legal on 3.9 Mc. ABB moved to Hobart and is using p.p. 35Ts. HDB has tried several beams, but his "J" outperforms them all on 144 Mc. PQL uses a folded doublet and p.p. 6J5s with 350 volts on the plates on 144 Mc. SNF got home from Kwajalein on a Friday, rebuilt a 112-Mc. transceiver, was on 144 Mc. Saturday, and was on 3.9-Mc. 'phone at 2:00 a.m. Monday. MJH bought a 400-volt, 150-mil. emergency power supply. OKR built two receivers; one covers up to 14 Mc., and the other covers 28 Mc. NNX has the honor or being the first OES in Indiana. MVZ, HUV, and CWO are now Official Observers. 73. Herb.

KENTUCKY — SCM, Joseph P. Colvin, W5IEZ/9 — BAZ was on 3.5 Mc. at 2 a.m. April first with "QRM a lil heavy." Where were other Kentucky stations? Also BAZ is the only station reporting to the SCM. How about more? Not all bootlegging in Kentucky is confined to mountain likker. Is AZY on 28 Mc.? Comdr. 9ALD is back after three years in Jap prison camps. OIC has f.m. transmitter on 28 Mc. 4IKO already is 4IKO/4. YQN still is QRX SS. The SCM is anxious to hear from former ORS and OPS appointees. Is a 50-Mc. net possible? BAZ has a supply of spot frequency crystals for emergency net. Write him. Sorry, boys, that Billie Martain is not teaching. It is a full class anyway, MRF reports. See me at ARTS meetings, Canary Cottage, second Saturday of each month, or write. 73. Joe.

MICHIGAN — SCM, Harold C. Bird, W8DPE — SONK reports the Motor City Radio Club now holds meetings the first and third Fridays of each month at its club rooms on Galley Road, between Warren and Ann Arbor Trail, Dearborn. 8SWF reports plenty of good luck on 28 Mc. A business meeting of the QMT 10-meter net on 28.3 Mc. will be held at his place in May. George is renewing his OBS and OPS appointments. 8PDJ says things are going OK with him and he will look for us on QMN. SWYT has just been issued a new call and wants the boys to watch for him on 3.5 Mc. 8RJG is going strong on 3.5 Mc. and says it's good to talk to the boys again. 8JUQ has purchased a 32-acre farm and will have his rig there. At present he is working 3.5 Mc. with emergency rig with nice signal. 9GJX is

going strong on both 28 and 3.5 Mc. and is holding schedules with 8SHI, formerly of East Lansing, now in Cuba. The Oakland County Radio Club held its second postwar meeting on April 1st. The newly-elected secretary and treasurer had to resign for business reasons and Richard Knight was elected to fill the vacancy. After the business meeting a buffet luncheon was served by the entertainment committee. Edward Gocha and Tennis Windingland should be complimented on a fine job. Now that the QMN net has opened again, fellows, let's have your traffic and activity reports on the first of each month. 73. Hal.

DAKOTA DIVISION

NORTH DAKOTA — SCM, Raymond V. Barnett, W9EVP — RBS is back in Bismarck, drafting for the Reclamation Department, and is having difficulty locating a permanent QTH. He is dickering for a War Surplus transmitter. ZRT got his new HT4B a few days ago, but so far the r.f. seems to prefer the audio equipment to the antenna. GJJ claims his house is wired with #24 wire. Line voltage drops plenty when he kicks the 100-watt rig on. SSW is sojourning on a farm near Linton until crops are in the ground. Your SCM is desirous of hearing from all of you ARRL members who have rigs on the air and are interested in OBS, OPS, or ORS appointment. Let's hear from you, either by letter or 3.9-Mc. 'phone or 3.5-Mc. c.w. and get both 'phone and c.w. nets going in North Dakota again. 73. Ray.

SOUTH DAKOTA — SCM, P. H. Schultz, W9QVY — UDI and USI are on the air from Brookings. A 315-Mc. c.w. net is shaping up with MZJ, ORE, and KQO as starters in the eastern part of the State. Let's expand to the west a little. 'Phone men on the same band are CJS, DB, and 5JXS/9. Additional stations expected soon are VT, HDO, 5KQ/9, and ILL. ADJ, activities manager of the reorganized Rapid City Club, informs me that ANW is president, YOB, vice-president, and TZJ, treasurer, with Ronning (W9?) as secretary, BLK and YOB are on 3.5-Mc. c.w. YKY and ADJ are building 28-Mc. beams. IWT is in the Army, GCW is at school, and OFS is in the Navy. The club is starting a code class with ZWL as instructor, and ADJ is handling a class preparing them for Class A exam. OXC and ADJ are being appointed OPS and will handle official broadcasts. All appointments are available. If interested, ask the SCM for information. Please send news the first of each month. 73. Phil.

SOUTHERN MINNESOTA — SCM, Vernon G. Pribyl, W9OMC — WQF rebuilt final using 807 for all bands. The St. Paul Radio Club entertained the Minneapolis Club at its April meeting. JSS has an FB radio and electric store. FAJ is busy raising pigs. JOY is out of the Army and studying E.E. at Colorado State. UYZ is working on 144-Mc. transceivers. GBZ reports that AIR, former Southern Minnesota SCM, is on the Mississippi with Federal Barge Lines and plans lots of activity. VET is our first OES. YXO worked thirty-six countries and WAC on 28 Mc.; also got S7 report from YV5 without antenna. He used a three-element beam. YDD has twenty-seven countries; NCS has sixteen. Most fellows are using folded doublets on 28 Mc. CVH and family are back and he is active again. QDE is going to Dunwoody. EOK is the first amateur in Minneapolis with new zero call and he got a real break by getting parts donated for a kw. rig! 5GFT is in our area and will be an asset to State net; he was SCM of Oklahoma. NCS worked twelve states and all Canadian districts on 28 Mc. during short skip period. The MSN is being reorganized with NCS as Net Control. Net meets every night at 7 p.m. on 3795 kc. Those active are ITQ, CGK, BBL, BHY, CVH, HEN, and CZO. Anyone who desires to join should write or radio NCS or the SCM. Traffic: W9NCS 5, OMC 3.

DELTA DIVISION

ARKANSAS — SCM, Ed Beck, W5GED — The report this month has been written by JIC. ICS has fired up the HY51A rig on 3.9-Mc. 'phone, but has decided to slide lower in frequency to pound brass and let the heterodynes have 3.9 Mc. for the time being. ARX has located new QTH and has just about got the old sky wire going again. GWT has the DX record of more stations and distance. We have lost 9V1P/5 to the J9s or KB8 group. DQV is waiting for new receiver. GTS is hopefully waiting for 7 Mc. and is

(Continued on page 88)

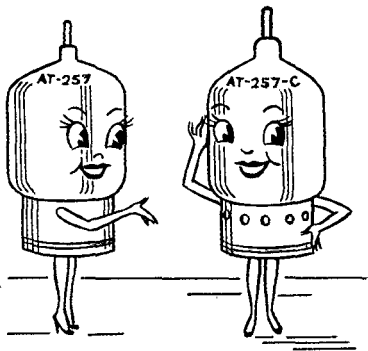

"Meet my Sister"

THE *New* LEWIS

AT257-C

BEAM POWER PENTODE

NOTE TO DESIGN ENGINEERS—With all the advantages of the Lewis AT-257 (4E27) — enormous power gain, great circuit flexibility—the new AT-257C has a "plus" factor you will be interested in. The addition of Zirconium coating to the anode has enabled Lewis Electronics to re-announce this versatile 75 watt beam pentode in the 125 watt class.

By nearly doubling the plate dissipation of the 4E27, the usefulness of this already popular tube is further extended. May we recommend that you consider the use of the Lewis AT-257C in fixed or mobile radio equipment you are now designing? A note to Lewis Electronics, Los Gatos, California, will bring further particulars.

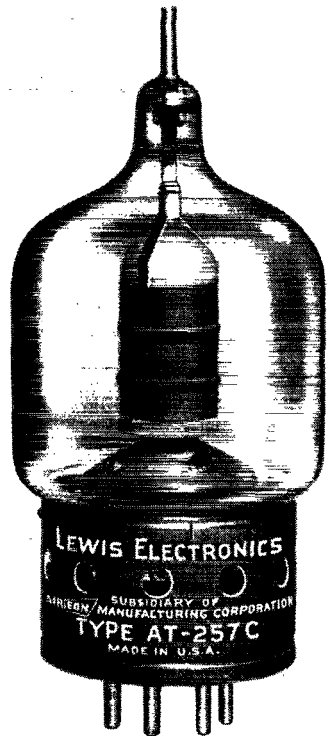

Lewis Electronics at Los Gatos, California, is prepared to build transmitting, rectifying, industrial or special purpose vacuum tubes to your specifications.

Filament Voltage 5 Volts

Plate Dissipation 125 Watts

Filament Current 7.5 Amps.

Jumbo 7-pin Metal Sleeve Bayonet

Lewis Electronics
 LOS GATOS • CALIFORNIA
 Subsidiary of **Aireon** MANUFACTURING CORPORATION

(Continued from page 84)

starting new rig. JDC's XYL is infected with the bug. We will be listening for her call in the near future. HTX has growing pains in the rig section. GWA is just about to blossom out with some kind of r.f. generator. IVY is constructing new e.c.o. and p.p. RK39 final with his eye on 3.5 and 7 Mc. JIC has new antenna for 28 Mc. with one going up soon on 3.5 Mc., 3886 kc. to be exact. HYS is in the middle of designing a mobile 815 rig for the old Ford. CFQ and his XYL, IZK, were here recently on a visit. Vivian was heard working K6 recently. DXJ has the 807 going in good shape on 28 Mc. JAP was up recently for a one-day visit and shopping trip. GQG is going to town in big way on 28 Mc.

LOUISIANA — SCM, Eugene H. Treadaway, W5DKR — GXO deserves the credit for writing this month's report. After licking some very bad BCI trouble IMT is now at ease on 28-Mc. 'phone. KSW is showing all of us how to go about grinding the one-buck crystals up to 7 Mc. His 28-Mc. rig is working out good. IAO was heard working 28 Mc. Pop Thomas is pounding brass on 3.5 Mc. UK has a new beam. EVR is using v.k.w. on 1280 kc. under call of WDSV. IDD has just acquired an HRO SR. The FB signal heard nightly on 28 Mc. v. Falstaff tang is QJ. Karl is new vice-president of Delta Radio Club. HOU and HHT are working DX on new 28-Mc. beams. KTB is doing OK with a T40 on 28-Mc. 'phone. Ex-8NAO is now 5KTG. BUK has 50 watts on 28 and 3.5 Mc. but is having antenna trouble. JPJ is recruiting operators for the Louisiana CAP net. GXO is anxious to hear from ex-radio students of Hattiesburg Vocational Schools and Mississippi State College Radio School. Present address is 6219 Vermillion Blvd., New Orleans. 3FPA is building an FB rig. HRD is weeping over the loss of "walking Charlie." (A portable antenna.) 4DTV/5 is really getting out on 28-Mc. 'phone and c.w. and has a nice 813 rig. HCJ is rebuilding speech amplifier. EDY works 28-Mc. 'phone with signal. IXL has gotten on 28 Mc. with a big bang. GHP and GWZ have been working a lot on 28-Mc. 'phone and are getting set for 3.5 Mc. KXU, thanks to HRD, has a nice rig on 28 Mc. GJO, ex-4IFE, has a brand-new receiver. FXX is sweating out 7 Mc. BI is on 3.5 Mc. and BN is rebuilding.

HUDSON DIVISION

NEW YORK CITY AND LONG ISLAND — SCM, Charles Ham, jr., W2KDC — Old reliable Brooklyn and Suffolk are right on the job. OHE reports over thirty stations now organized, regular meetings are held the 4th Friday of every month at the Willoughby House Settlement in downtown Brooklyn. Three nets, the Red, the White, and the Blue comprise the net, each striving for superiority in activity. Also the "Flatbush Floogies" with ten stations are competing with the well-organized Termitte League. DIO announces a new YL who cries in Morse. JSJ and OHE boast National 1-10 receivers and BPV and DUS are m.o.p.a. ADW had a difficult appendectomy. HQB is assistant EC covering Western Suffolk. IUX, in Southampton, and GGW, in Amagansett, are on 144 Mc. LUD, mobile, works out well and JFP, with a 7A4, works DX nicely. DOG is firmly settled in the cellar. FCH's DX-3 is doing nicely, as is LYH on 144 Mc. NMP, EBT, OQI, and GAH keep 28 Mc. warm. Traffic handling should show an increase as soon as 3.5 Mc. shows its stuff. The band was given a very handsome band-warming party and shows possibilities. KDC can't get used to fading on stations up to sixty miles after these many months on 28 Mc. KTW now discharged, is heard regularly on 144 Mc. from the Bronx. LKP's 'phone on 3.5 Mc. works nicely and MRL is soliciting traffic from the West on the same band, but on c.w. KIK, who was to report to Camp Crowder, Mo., writes from Camp Polk in Louisiana. He is on 28 Mc. and looking for his W2 pals. ECR boasts new antenna on his 65 mast and keeps 28.2 Mc. hot. NBJ was heard again from France with usual good signal. DXL is operating Peerless in Jamaica where LBK was seen recently, Joe still being at Sperry. KDB decided to make the Navy a career and has resumed rank of commander and is now in Washington longing for good old Long Island. BVE, also an ex-commander, left the Telco and joined a new airline. BOT practically lost his hearing from too much code and is planning to operate on 'phone exclusively, naturally. HPB still is in the Navy and has a new pair of twins. EAZ now is a chiroprapist after working for the R.I.D. and merchant marine. He uses his diathermy for a transmitter occasionally. JTQ is communications chief for Latin American Airways and will be set up in Ecuador

by this time. He is looking for contacts on 28 Mc. having shipped the rig to HC-Land by air. AST went from 144 to 3.5 Mc. and started the Snake Network, on 3993 kc. every night. BNW is at Niagara in New York City. MDB blew his modulation transformer and was promised immediate delivery, in sixty days. Standard Parts at Hempstead is quite a hang-out for Nassau hams these days. GTZ is back in New York from Mexico and Hollywood. IYX is at Raytheon in Brooklyn. The SCM would like to hear from the Hudson Radiophone Club. OG, JSV, KDC, and BYK had a good old hamfest recently. Traffic: W2MHB 4, EC 4, KDC 4.

MIDWEST DIVISION

IOWA — SCM, Leslie B. Vennard, W9FJR — JMB lost his antenna but is on 3.9 Mc. CS is set for 3.5-Mc. c.w. HAQ and YDX are earning OES certificates. Ex-TGJ, now 5KUY, wants Iowa contacts on 3.9 Mc. Give Bill a call, fellows. SEF has eight lined up for his 3.5-Mc. communications net. YBK has a pair of 8005s in his final on 3.5 Mc. and wants his ORS renewed. AHP and AEP renewed their QSO started 12/7/41 at 2:07 A.M. 4/1/46, AED, BAL, DIB, and CK are active on 28 Mc. AEP is spending his time getting set for 3.9 Mc. He wants the Iowa 3.9 Mc. Net to get going and is using p.p. 810s in final. AQJ, who writes a fine letter from Pittsburg, is getting ready for 28-Mc. portable. SWD, AEP, and AHP renew EC appointments. ZRC is new EC at Ames. We need more ECs, fellows. Won't you volunteer for appointment as EC if you don't have one in your city? 73. Les.

KANSAS — SCM, Alvin B. Unruh, W9AWP — Your attention is called to the new date for submitting reports. Mail them on the first of each month. MUN made application for AEC membership. Others are urged to do likewise. BYV has returned from the wars, and is rebuilding with kw rigs for 20 and 40 — "when." He reports five hams in Scott City, with interest in a 50-Mc. net. VWU is working for the State, and is temporarily holding down the mike at KAZZ until an operator vacancy can be filled. He is interested in OES, and plans to do some highly intensified 50-Mc. work in conjunction with the famous W8ZJB of Kansas City. W8TVU reports his station finally back on the air, working 3.9-Mc. 'phone. The Wichita Club is making plans to participate in the Field Day events. Let's hear from you, fellows. 73. Abie.

MISSOURI — SCM, Mrs. Letha A. Dangerfield, W9OUD — This first column after the change in reporting date covers just two weeks and finds us with more news on the hook than we expected. YHZ has been working 27 and 28 Mc. and experimenting with f.m. He tried 3.5 Mc. with 12 watts but with no QSOs so he is going back to 28 Mc. PXH is back on the air with a Sky Champ and HT-9 on 28-Mc. 'phone. TER has an 807 on the same band. EX-HIC, now 6UTU/J, has been working stations around the Orient on 28 Mc. and heard 9HCL/6 three days running on 28 Mc. ZJB has received the first and only OES certificate issued so far in this section. KEI is changing from low power on 28 Mc. to 600 to 800 watts on 3.5 Mc. and has sent in his ORS certificate for renewal. EFC was guest speaker at a meeting of the Central Missouri Amateur Radio Club. The club has nineteen members with AOP, pres.; and FRG, vice-pres. ØEKW, 9AOP, FRG, and 6SJI/9 are on 28 Mc. QXO is getting on 3.5 Mc. and NIP is rebuilding. TGN and QJP are on 3.5-Mc. 'phone and c.w. these days. BMS and OUD maneuvered a 3.5-Mc. antenna among the trees and get out fairly well with the Stancor 60-P when the wind blows the branches away. Remember, the new reporting date is the first of each month. Let's have lots of dope. 73.

NEBRASKA — SCM, Arthur R. Gaeth, W9FQB — RQK was appointed OBS and reports a Class A ticket with contemplated activity on 3.9-Mc. 'phone using 150 watts to a UH50. Several of the North Platte gang are active on 144 Mc., and a club is being organized. EWO has a 40-20-10-meter rig nearly completed, using a 6L6 crystal oscillator, 6L6 doubler, 6L6 doubler, and an 813 final, with about 400 watts input, and a band-switching arrangement. He also is building an 80-meter rig using a 6L6 crystal oscillator and an 803 final, 400 watts input. OKF is new OES appointee. He says the gang in Lincoln held a meeting to reorganize the South-East Radio Club. TQD is active on 3.5 Mc. and inquires about ORS appointment. He reports operating in Tokyo at TQD/J, and says DMY is waiting for new receiver. DI is back in Tobias, doing radio repair work. FJL

(Continued on page 88)

It's Collins!

It's new!

It's ready!

... the Collins 30K—a NEW transmitter for amateur radio—thoroughly engineered for the continuous exacting requirements of "ham" operation. Check this partial list of features against your desires:

5 band operation • 500 watts input on CW • 375 watts input on Phone • Push-to-talk • Clean, sharp keying • Speech clipper • Bandswitching • Fully metered break-in operation • Vfo controlled

The high efficiency of the 30K assures a strong signal. In addition, the speech clipper circuit assists in maintaining a high modulation level, with no danger of over-modulation. Speech clipping also improves intelligibility. Brass pounders will proudly note the clean keying at any speed.

The exciter unit, built into a receiver type cabinet, may be placed on the operating desk. A highly accurate and stable variable frequency oscillator, the product of years of research and manufacturing experience, is calibrated directly in frequency. The frequency can be varied considerably without retuning the final.

The attractive appearance of this up-to-the-minute transmitter will improve any "shack." Its smooth, easy operation will please you.

• Write today for complete details. Collins Radio Company, Cedar Rapids, Iowa; 11 West 42nd Street, New York 18, N. Y.

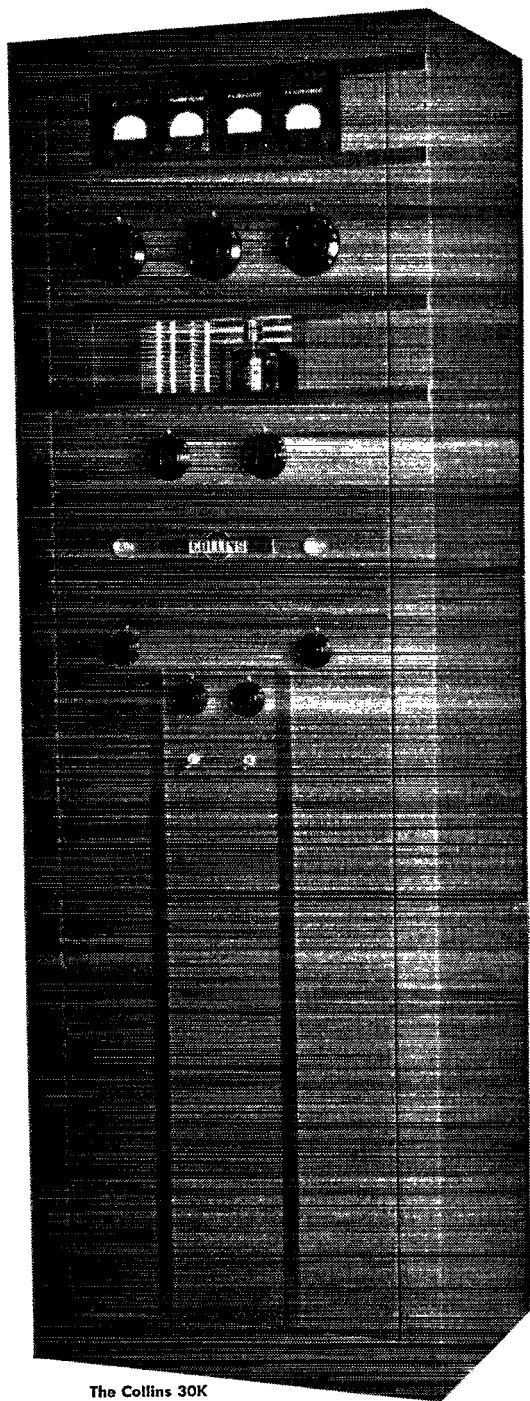

The Collins 30K



FOR RESULTS IN AMATEUR RADIO, GET . . .

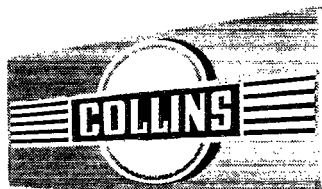

(Continued from page 86)

and HLX are working at monitoring station in Grand Island. KAL has a pair of T20s and 70 watts on 3.5 Mc. 8WJV/9 made application for W9 and will be located in Omaha. 6EEA/9 is W9FCQ and located in Omaha. 9FBK is on 28 Mc. with 20 watts to an 807 final. RQS put up a half-wave center-fed Zepp with tuned feeders, for lower frequencies. HTE is revising his BC610D and three-element beam. VHR had to take down six half-waves-in-phase for repair because of wind damage. FQB is waiting for HT-9 and is using Stancor 10-P on 3.5-Mc. c.w. The Ak-Sar-Ben Radio Club is making plans for Field Day activity. YUB is a new member. How about some traffic reports? Art.

NEW ENGLAND DIVISION

CONNECTICUT — SCM, Edmund R. Fraser, W1KQY — Norwalk ARA, NDS, has applied for ARRL affiliation and reports club membership has passed the twenty mark. Plans are completed for Field Day. 4HVH/1 now is NXB with new HQ-129-X to celebrate the occasion. ATH reports increase in NHARA, GB, membership and attendance. 8NJR/1 is new club member. JAK and EUG renewed membership. AMM reports satisfactory progress with his code and theory classes. Steve Tabor cut a set of code records for the club. FMV heads the Field Day committee. KAT worked Greece and Italy on 28 Mc. for his 33rd and 34th countries and keeps schedules with GIs in Germany and Azores having the GIs families at his QTH to talk with their beloved ones. JQK has resigned as EC due to pressure of business. JAK succeeds him. BIH and KYQ are new ECs for Torrington and Willimantic respectively. MVH is new OBS and Dunbar (LSPH) is OO 2nd class. General news: 2OEN/1 has a Sunday schedule with D4AFX on 28 Mc. MRC reports the OM, IM, has been nonpolarizing the rig since 3.5 Mc. opened up. BGT and IZG are using vertical ground plane antenna. DHS is using two-element beam. IYX worked a W5 station for first out-of-town QSO. MPW is using eight half-waves. IYH is rebuilding. AIY is experimenting on u.h.f. and v.h.f. KRC is using new folded vertical dipole fed with 300-ohm line. IYQ, using three-element self-designed folded beam, worked several K6s and Gs. BQQ worked IMMN/5 in Texas with latter's dad on 'phone line. JJR and JBJ are new men at AW. BDI worked K6 and G stations within a half hour of each other on 28 Mc. CTI opened up the Nutmeg Net April 1st with LOP, VB, UE, 2OCC (ex-KFN), BDI, JMY, 2OEN/1, HYF, and LUN. TD, KQY, and JQD could not get through QRM. Fred Burkle received the call OAS. UE reports bedlam on 3.5 Mc. at 3 a.m. April 1st with the following Headquarters' gang participating: BDI, JMY, EH, LOP, FWH, 2OEN, 9YMY, and UE. JMY contacted his XYL, MUW, on 3.5 Mc. KQY had enjoyable QSOs with EZ, HRC, 2OCC, and 3DGM on 3.65 Mc. Please help your SEC and EC by returning Emergency Corps forms. Make application for ORS and OPS appointment to your SCM. Traffic: W2OEN/1 6, KAT 6, MVH 6, HYF 2, 73. Ed.

MAINE — SCM, G. C. Brown, W1AQL — A nice letter was received from TO in which he states that the Emergency Corps is shaping up slowly in Augusta, the main trouble being to find an owner of a portable rig who has a car. Bob also adds that he, CMO, CPL, IOK, LYW, and NDC have been active on 28 Mc. ACW and LKP have received their OBS tickets. The first traffic report comes from GEX, who also reports a new ham, NXX, in West Scarborough. Forty-five of the gang from Bar Harbor, Ellsworth, Searsport, Belfast, Old Town, Hampden, Bangor, and Brewer gathered at the Knights of Pythias Hall in Brewer Feb. 29th for the first postwar hamfest of this vicinity. The SCM outlined the new set-up for ARRL appointments and UP, Section EC, gave a very interesting talk on the Emergency Corps. A club was organized with the following officers: BGG, Bangor, pres.; AWN, Lincoln; DAS, Ellsworth; BOK, Dexter; MPK, Belfast; AQL, Brewer; and CBU, Stockton Springs; as vice presidents; CBV, secy. and DLC; treas. FNL was appointed chairman of the program committee. Meetings will be held the second Friday of each month. A prize will be given to the member submitting the best name for the club at the next meeting. Don't forget the change in the reporting dates. All reports are to be mailed to your SCM not later than the first of each month. Traffic: W1GKJ, 73. "GC."

EASTERN MASSACHUSETTS — SCM, Frank L. Baker, jr., W1ALP — New ECs IBY, Wellesley; MF, Salem; JOJ, Ipswich; LRO, Provincetown. NXV, a new ham, expects to be on 28 Mc. LLW is out of the Army.

NXD, another new ham, is on 28 Mc. 311L, now 1KNZ, has an HRO receiver and will be on 28 Mc. soon. His kid brother's call is NXN. BHW is going to continue as OO. NKW is now on 3.5-Mc. c.w. 3BSY gave a talk at the last meeting of the Eastern Mass. Amateur Radio Assn. MNK is on 28 Mc. BBL will be on 3.5-Mc. c.w. and MBV on 28 Mc. Active Gloucester hams are: DKS, JIM, NPD, NCT, NRZ, GEM, and NWH. DKS has a three-element beam and has worked a VK and Cocos Island. NRZ, with 10 watts, has a confirmed contact with PY7. NCT has a pair of 813s and is running them a cool 100 watts. MNK handled a message for the local water superintendent to his son at Osaka, Japan, with delivery in less than two days. He gave it to NEI, on an LST 700 miles west of Portland, Ore. Please note the change in mailing date of your reports to the first of each month. The EMARA held an election of officers: FSK, pres.; HLX, vice-pres.; ILR, treas.; MPP, secy.; LIO and LMU directors. Don Ward's new call is NYH. Bill Byers' is NXM. BDT is waiting for 14 Mc. to open. 4IKQ, secy. of the M.I.T. Radio Society, MX, reports the club had an election of officers: 8WGF is pres. 3JTL, vice-pres.; J. S. Levin (LSPH), treas.; V. Mayer (LSPH), station mgr.; NDK, 4IDV and 2NKP, exec. comm. There are thirty-five members, one an Italian amateur, IILT, and they hold meetings on the 1st Tues. of each month at 5 p.m. in Room 10-267 at M.I.T. MXG writes from Casablanca that he has heard some W and K calls over there. IID is on 144 Mc., crystal, and building a 200-watt amplifier. NXN and NXY are on 144 Mc. HNN has worked so many Gs on 28 Mc, he now has an English accent. GF is in Nebraska. KB, EC for Haverhill, says the City is going to return the TRAs and then they will be on the air on 144 Mc. He has KUA, IWR, Henry Weber (LSPH), KQV, and CEF signed up for the Corps. CKW, chairman of the Brockton Amateur Radio Club Outing-Hamfest Committee, says the affair will be held on a Sunday in June at Romuva Park, Howard St., Brockton, Route 37. Registration \$2. Time 11 a.m. to 6 p.m. All clubs are welcome. 6MUY's XYL has applied for a ticket. 7HFY/1 is on 28 Mc. in Dorchester. JQV, from Raytheon, gave a talk on power tubes at the South Shore Amateur Radio Club meeting. AJA worked KB6QKB on Guam. GOU worked VK2AH and says he heard four ZLs coming in on 28 Mc. HUV, one of our OOs, reports that conditions on 50 Mc. are OK with a few 28-Mc. harmonics on 50 Mc. MME's father died. DBH and BB are on 3.5-Mc. c.w. BIO is on 28 Mc. FVD will be on 144 Mc. then 28 Mc. later. MNF is on 3.9-Mc. 'phone, as are MMU, FFD, KDK, BB, MKX, BPH, and MME. NID is on 28 and 144 and is now EC for Hull. NDJ, Acting SCM for Vermont, visited MMU in Quincy and we had the pleasure of meeting him. LZW had to call on KXN late one night; LZW is a fireman and KXN had a fire in his radio shack. Traffic: W1MNK 1, DBH 1.

WESTERN MASSACHUSETTS — SCM, William J. Barrett, W1JAH — Our Section EC, BSJ, reports the following EC appointments to date: GKY, Hampden County; IHL, Worcester County, NGH, Hampshire County; LUD, Pittsfield. If interested in AEC activities, just contact your EC, as listed above, or drop a line to BSJ direct. JLT put up new three-element rotary for 28 Mc. with fine results, first four contacts being ZS and ZL. Bob says he'll put a motor on it if it continues to perk like that. The Pittsfield 144-Mc. gang are continuing regular drills with 7EZT/1, KZS, HPA, KVN, IFE, IZN, JLT, and LUD. LUD is Pittsfield EC. JAH dusted off the ole ten-watter for the opening of 3.5 Mc. The band sounds like the busy hours of the old ORS Parties. Most noticeable was the preponderance of v.f.o.s and almost total lack of break-in operation. KJO reports from Worcester where he is at WORC. Al's English bride and new jr. operator are now with him. Al reports that 4HMS (ex-JXN) and LBR are back in Fitchburg after three years in the merchant marine. LAH was home but has gone back to sea, and is en route to his English YL. This report inaugurates the new reporting period, covering the calendar month. Please send in your news to reach here right after the first of each month. Hope to see all the gang on 3.5 Mc. one of these nights. 73. BHP.

NEW HAMPSHIRE — SCM, John H. Stoughton, W1AXL — Now that 3.5 and 3.9 Mc. have opened up again we should start planning our networks for emergencies and traffic. Please get in touch with us as soon as you are set up for c.w. or 'phone net operation. EAL is on 3.9 Mc. and reports that the gang in Derry are active again. APK took a day off for the opening of 3.9 Mc. ANS is back on 3.5-Mc. c.w. BFT and FTJ are back on 3.5 Mc. IDY is waiting for

(Continued on page 90)

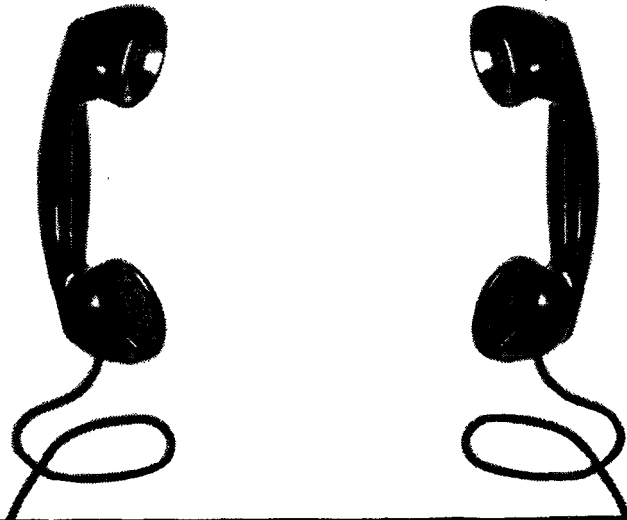

ALIKE AS TWO PINS?

Yes, or alike as two telephone handsets made by the same process. Yet, pins or handsets — no two could ever be made exactly alike. Dimensions, weight, performance — all vary every time due to variables in manufacture. How can these variables be controlled?

Back in 1924, Bell Laboratories' mathematicians and engineers teamed up to find out, forming the first group of quality-control specialists in history. They invented the now familiar Quality Control Chart, designed inspection tables for scientific sampling. They discovered that test data mathematically charted in the light of probability theory were talking a language that could be read for the benefit of all industry.

Western Electric, manufacturing branch of the Bell System, applied the new science to its large-scale production. In war, it was used by industrial and government agencies of the United Nations in establishing and maintaining standards for military matériel. A Quality Assurance Department, a novelty back in the nineteen-twenties, has come to be indispensable to almost every important manufacturer.

Scientific quality control is one of the many ideas of Bell Laboratories that have born fruit in the Bell System. The application of mathematics to production is helping good management all over the industrial world — and furthers the cause of good telephone service.



BELL TELEPHONE LABORATORIES

EXPLORING AND INVENTING, DEVISING AND PERFECTING FOR CONTINUED IMPROVEMENTS AND ECONOMIES IN TELEPHONE SERVICE.

We couldn't improve
the **VIBRATOR**
so we improved
the **CONTAINER**

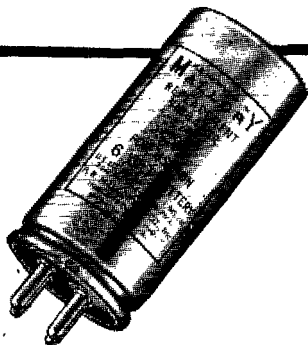

Long famous for dependability and long life, Mallory vibrators had been regarded for years as just about perfect for ordinary domestic and police service.

But military applications posed special problems. Under conditions of heat, or at high altitudes, the expanded internal air escaped. When cold, or under high atmospheric pressure, air re-entered the vibrator. As a result, corrosion and humidity sometimes damaged the vibrator mechanism—ionization breakdowns sometimes occurred.

The answer to this problem was—and is—the Mallory Hermetically Sealed Vibrator. Tested for leakage under 20 lbs. of applied air pressure, this Mallory vibrator is permanently air tight. The hermetic seal keeps in the natural air pressure, keeps out moisture and fumes. Yet this revolutionary improvement costs very little more.

For normal applications, the standard bakelite-based Mallory vibrator is available. But where the going is tough, hermetically sealed vibrators are definitely indicated.

For all regular replacement applications, follow the recommendations given in the Mallory Replacement Vibrator Guide. When special operating conditions are involved, do not hesitate to write direct to the factory for special help.

P. R. MALLORY & CO., Inc., INDIANAPOLIS 6, INDIANA

P. R. MALLORY & CO. Inc.
MALLORY

(Continued from page 88)

crystals and expects to be with us soon. LIQ is in Germany operating from D4AIA and is looking for New Hampshire contacts. MLW is back from the wars and living at 11 Amherst St. in Nashua. AVL expects to be on 28 Mc. soon with an 805 in the final. Ex-ATJ is waiting for his ticket and hopes to get his old call back. He has a new service shop at the local airport. BST is splitting his time 50-50 between ham radio and flying. NNX has been discharged from the services and is active on 28 Mc. Let's hear from the gang in the northern part of the State. Don't forget the new reporting date.

RHODE ISLAND — SCM, Clayton C. Gordon, WIHRC — The PRA had a club banquet with prizes on March 30th, at which NUA won the v. t. v. m. This club conducts code and theory classes each Tuesday at 7:30 p.m. Ex-GTN is responsible for the code group and Dr. Davenport for the theory group, which meets at 8:30 p.m. It is encouraging to see the old dyed-in-the-wool 'phone men who are taking up c.w. operating. I do not mean to imply that one should not enjoy 'phone operation, since I do not hold with the c.w. man who can see no good in 'phone, but rather to indicate that to get the most out of our hobby a fellow should diversify his activities, getting some of the fun out of all the different phases of it. It seems to me that unless you have the technical ability to become an independent inventor in some specialized field of radio research (and where is that rare bird who develops all his apparatus from the ground up?) you are just cheating yourself out of a lot of fun if you specialize your activities to the point where you become known as a member of the "phone gang," the "c.w. boys," an "ultra-high" bird, "traffic-hound," "DX-hound," or any of the other "exclusive" groups. Where are those monthly reports?

VERMONT — Acting SCM, Gerald W. Benedict, W1NDL — CUN, located in Newport and working for Power Co., has a new XYL. KTB is back in Lynden. IQG is in Orleans and has HRO. BLC is on 28 Mc. with eight-element beam. BJP is on 28 and 3.5 Mc. GXP, now teaching in Sherbrooke, was ordained into the priesthood last fall. AVP visited MLJ, NDB, and NDL. KJG visited MCQ, who is on 28 and 3.5 Mc. EKU, MLJ, and NDL have vertical coaxial antennas. EKU worked thirteen countries on one crystal in March. NDL and his XYL visited MMU at Wollaston, Mass. Montpeller and Barre hams have formed the Central Vermont Amateur Radio Club. Temporary officers are: NDL, pres.; FRT, secy. and treas. MLJ and L. S. Booth are on the committee to locate a club room. Traffic: W1EKU 5. 73. Jerry.

NORTHWESTERN DIVISION

ALASKA — SCM, August C. Hiebert, K7CBF — The Anchorage Radio Club is going strong, bolstered by members from other territorial areas and numerous newcomers. 3.5-Mc. activity there includes AWH, the 3-watt DXer, EYL, ARG, JHK, DIJ, HKA, and HZF. HYK and 51FC strung a 3.5-Mc. flat top instead of campaigning for HYK's city council position. (HYK won in a landslide anyway.) A new Intra-Alaskan club for break-in rag-chewing is the Arctic Amateur Icecube Chewers, with 8WXB, pres.; and VE4AHL, 6LMD, JDS, AWH, and EGN. They invite new candidates, but it's high speed hot air, fellows! AFG reports 28-Mc. DX activity from Tanacross, working twenty-three states and VK, XV, KA, KB, J, and VE1 in a month. AZV is working all over Alaska with 8 watts on 'phone. The new Barrow oil project has taken 6HFH and FUU for radio maintenance. 3JWS, of Fairbanks, is with CAA at Northway.

MONTANA — SCM, Rex Roberts, W7CPY — Section EC, BWH. The 3.9-Mc. 'phone band was 100 kc. of heterodyne here, too, on April 1st. CBY has r.f. troubles in the transmitter with everything in the vicinity "hot." The prewar International Before Breakfast Club opened up its daily chat on 3.9-Mc. 'phone the morning of April 1st with a number of the old-timers back on 3990 kc. BHB is getting one of the "Sherman Tank" transmitters. The Southern Montana Amateur Radio Association has reorganized and reaffiliated with the ARRL with twenty-eight members on the roll. CIZ is president; FIN, vice-president; and W. A. Detert, secretary. The club will meet every other Wednesday at the Commercial Club at Billings. ITG now is located in Portland, Ore. EMF will be the new EC at Butte. DON'T OVERLOOK the change of dates of reporting to the SCM — now the FIRST instead of the 16TH. 73. Rex.

(Continued on page 92)



Largest Producers of
CRYSTAL CARTRIDGES
for Phonograph Pickups

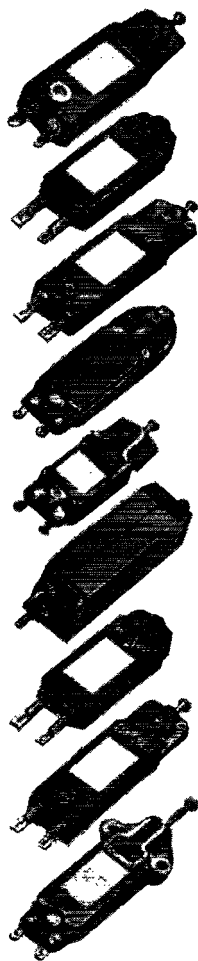

● That The Astatic Corporation is the world's largest producer of Crystal Phonograph Pickup Cartridges is, in itself, actual testimony of their outstanding service and high operating efficiency. That they are preferred and used by a majority of the leading manufacturers of electrical phonographs and automatic record changers, is convincing evidence of their expert engineering and construction. Astatic Crystal Cartridges are manufactured to meet today's exacting standards of performance and are individually tested and approved for output voltage and frequency response before being released for shipment. Astatic Cartridges are extensively used in an ever-growing field of new product applications, as well as for replacement purposes or the improvement of existing equipment.

*Astatic Crystal Devices manufactured
under Brush Development Co. patents*

THE
Astatic
ASTATIC CORPORATION
CONNEAUT, OHIO
IN CANADA: CANADIAN ASTATIC LTD., TORONTO, ONTARIO

VARIABLE CONDENSERS

FOR EVERY STAGE OF THE TRANSMITTER

For many years Johnson variable condensers have been the choice of hams who demand the highest quality and latest in condenser design. From oscillator through final amplifier Johnson condensers give outstanding performance and help put your rig "out front."

Shown here are but a few models of the popular line of Johnson condensers, incorporating the most recent advancements of Johnson engineering.

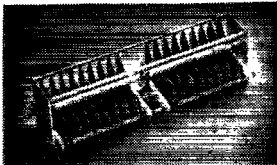

Type C . . . Single and dual models designed for high power applications. Plate spacing .125—.500

Type D . . . Single and dual models for high power, smaller than type C. Plate spacing .080—.250

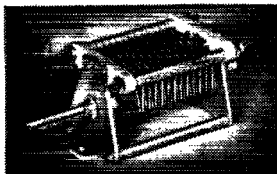
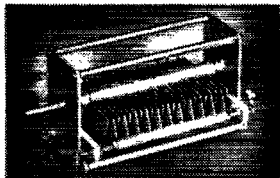

Type E . . . Single and dual models for medium and low power. Plate spacing .045—.125

Type H . . . Minimum of weight and size. Medium and low power. Single and dual models. Plate spacing .030—.080



Johnson condensers, inductors, insulators, plugs, jacks, "Q" antennas and ham hardware items are stocked by leading radio-electronic parts jobbers. Watch for new Johnson ham gear to be announced soon; it will be tops.

Write for catalog 968J.

JOHNSON

a famous name in Radio



E. F. Johnson Co. Waseca, Minn.

(Continued from page 90)

OREGON — Acting SCM, Cliff Tice, W7BEE — As far as reporting news is concerned the Pendleton Club seems to be the only club in the State carrying on activities. It is hoped that I may have reports from other hams on what they are doing. The Pendleton Club had a very enjoyable meeting with the Walla Walla Club the evening of March 18th and schedules were arranged for tests on 28 Mc. to see if it is possible to make reliable contacts from here. These are carried on every Tuesday evening and so far reports have been good, one hundred per cent readable and with good signal strength. Walla Walla is about forty miles distant and there are quite a few hills intervening. Meeting nights are the first Tuesday of each month and any visiting hams are more than welcome to attend. Please, remember that the mails are always running, and if you have pride in your accomplishments as an amateur, send in the dope for transmittal to QST. 73. *Cliff.*

WASHINGTON — SCM, O. J. Tatro, W7FWD — ECs are wanted in key spots. Would like to hear from Seattle, Bellingham, Aberdeen, and Hoquiam especially. Walla Walla: FPP reports that the WWRAC meets the first three Monday nights each month in the Pacific Power and Light Bldg. and visitors are welcome. FDN built a 28-Mc. superhet and is planning a 400-watt transmitter. GW with beam and 100 watts has contacted the East Coast, Alaska, Hawaii, Johnson Island, Tokyo, VKs and a portable-mobile Marine. EX completed a motor-driven rotary with push-button control and is having real DX on 28 Mc. EMP is employed by KIJ but a pair of new 520 bottles and 28 Mc. is working him overtime. DCV is on 28 and 3.5 Mc. GXA and GFU, from the Vets Hospital, are getting good results on 28 Mc. HYP, of KIJ, presented a handsome present of a 300-watt transmitter to the club. FAY is building toward 3.5 Mc. GVM soon will be on 3.5 Mc. His OM, CDS, is active around Dayton. IXR, a YL, is on 3.5 Mc. and looking for YL schedules. FPP helped unveil the 3.5-Mc. opening and his first QSO was with HAL; he then lowered the boom on FWD who had to regrid his crystal to bring his signal to T9. Yakima: YARC mourns the loss of FMN, who was killed in an airplane crash. ITR is attending WSC. CAM has another 144-Mc. super and likes his coaxial vertical dipole. CMX and IYB are getting their mobile radio with the State Patrol. ETX will be on 28 Mc. when his RME converter arrives. AWX has a rebuilt radar receiver on 144 Mc. and a rotary beam. FCZ is on 28 Mc. ALH is on 28 Mc. and flirting with 144 Mc. HCE finally got enough turns in the coil to get the light house tube up to 144 Mc. CAM, AWX, and HCE have 144-Mc. mobile, HCE has resigned as EC because he does not have the necessary time for organizational work. GMC, secy. of YARC, will be HCE's successor. Seattle: HGC/7 is on 3.5 Mc. and is anxious for net operation and v.h.f. CKJ is on 3.5 Mc. and HKA was on 3.5 Mc. the opening night. Mt. Vernon: JBH is trying to arrange to give code lessons via A2 emission. Olympia: ORC renews its ARRL membership. ANL reports IVC hearing FWR every morning from Tokyo on 28 Mc. Ex-VQ4KSL, now 9ATT/7, is building around an HT-6 as an exciter. 6SBV/7 is on 28 Mc. and modifying for 3.5 Mc. IJZ/1 is building around 812s modulated with 811s. Miscellaneous: 4LBR/7, IFV, GPP, FPP, HIQ, 6SBV/7, HPJ, 3GHI/7, GEK, GTA, IIH, 9IYH/7, HXJ, IHU, and AIU were worked on 3.5 Mc. at the beginning. 73. *Tate.*

PACIFIC DIVISION

SANTA CLARA VALLEY — SCM, Roy E. Pinkham. W6BPT — Asst. SCM, Jeff Almy, TBK, PAM, Ralph Herndon. HC and DZE are on 3.9 Mc. LFD has new 28-Mc. beam. TBK keeps schedules with K6MNV and 9YM/KG6 on Guam. Ex-OHC is now 20OP; he is on the air in New Jersey and can be heard around 29.15 Mc. JSB worked G6CU/ZC on Cocos Island and also keeps schedule with W6NDW/KA1. OBP, 7IKU/6, and 9YBX/6 are on 28 Mc. around Palo Alto. OQK has sold his rig and expects to rebuild. TAN is back on 28 Mc. 'phone. SYW, THV, and NVO keep schedules every night at 10:15. USO is proud papa of a baby boy. He also joined the San Jose Police as communications officer. JTQ is on 28-Mc. 'phone with a new rig. CFK, KG, and BPT have placed orders for new HQ-129-X receivers. NYR is working 28 Mc. portable-mobile 'phone. PVV is working good Pacific Island DX. IUZ is building 500-watt modulator. PBV has returned from the

(Continued on page 98)

MAKING TUBES IS EASY If YOU KNOW HOW!

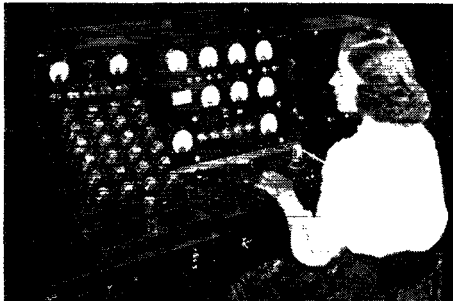

This standardized Hytron production tester is composed of three units: preheater, characteristics tester, noise tester. To permit a better view of the equipment, only one of three operators is shown.

HOW THE HYTRON 12SK7GT IS QUALITY CHECKED

Test	100% Production Test	Central Inspection Sampling	Quality Laboratory Sampling	100% Test at Packing
Shorts				
Base shell connection	x	x		x
Heater current	x	x		
Plate current	x	x		
Screen current	x	x	x	
Grid current	x	x	x	
Transconductance	x	x	x	
Suppressor action	x	x	x	
Emission	x	x	x	
Heater-cathode leakage	x	x	x	
R-f noise	x	x	x	
Transconductance cutoff	x	x	x	
Vibration		x	x	
Insulation resistance			x	
Input capacitance			x	
Output capacitance			x	
Grid-plate capacitance			x	
Grid emission			x	
Immersion (basing cement)			x	
Life			x	
Overall length			x	
Mechanical	x	x	x	

*Mechanical tests are covered by a multipage specification. Typical inspection is conducted visually and/or by gages for the following: pin solder, etching, getter flash, diameter, base-bulb alignment, bent base pins, glass defects, and rigidity of internal elements, bases, and base pins.

AGAIN HYTRON'S LONG EXPERIENCE

GIVES YOU THE BEST...

FOR your protection Hytron tubes are quadruple-checked. On the production floor, each tube is first tested for significant characteristics. In the central inspection department, a random sampling is next taken for statistical control of the production testing—to assure quality within acceptance limits. Failure at this point demands 100% retest.

Daily a smaller random sampling is subjected to a searching design check of characteristics such as inter-electrode capacitances, grid emission, and transconductance cutoff. These characteristics can be controlled by the smaller sampling, and their testing requires laboratory precision. Simultaneously production tests are again repeated for further statistical control. Again failure to meet acceptance limits demands 100% retest—even for design characteristics not production-tested.

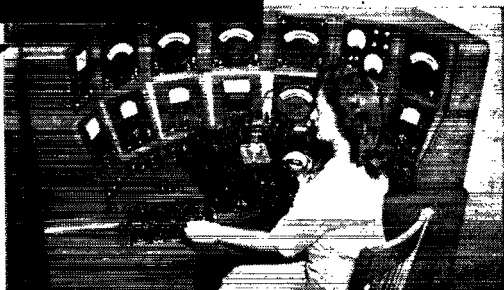

Extreme accuracy and flexibility of this Hytron master test station particularly fit it for quality control.

Finally each tube is once more short-tested and mechanically inspected just before packing.

This painstaking quadruple-checking ensures that specification failures of tubes actually shipped will be a practically irreducible minimum. When you buy a Hytron tube, you can be certain that every ounce of Hytron know-how on quality control—reinforced by wartime experience—has been in there punching to give you only the best.

OLDEST MANUFACTURER SPECIALIZING IN RADIO RECEIVING TUBES



HYTRON

RADIO AND ELECTRONICS CORP.



MAIN OFFICE: SALEM, MASSACHUSETTS



Important!

All products of the Thordarson and Meissner Divisions of Maguire Industries, Inc., and the Radiart Corporation are sold from a *single source* by a *single sales force*. Located strategically throughout the country, these men are trained to give competent sales-engineering advice and to render reliable, speedy service. For complete information, write to the address below . . . today.

THORDARSON

TRANSFORMERS
TRU-FIDELITY AMPLIFIERS

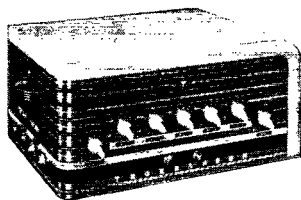

THORDARSON
TRU-FIDELITY AMPLIFIERS

Thordarson Transformers are precision-built for all requirements . . . replacement, communications, sound amplifier, industrial, experimental and amateur.

Thordarson Tru-Fidelity Amplifiers feature advanced tone compensation, conservative ratings, ample ventilation, low hum level, multiple input channels and maximum flexibility of controls.

**ELECTRONIC DISTRIBUTOR AND
INDUSTRIAL SALES DEPARTMENT**



MEISSNER

COMPONENTS
SERVICE INSTRUMENTS

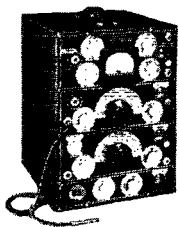

MEISSNER ANALYST

Meissner Components, all high quality, include antenna, R. F. and oscillator coils; standard, plastic and Ferro cart transformers; windings, coils, chokes and accessories. Meissner Service

Instruments include the famous

Meissner Analyst, a complete servicing instrument and the Meissner Signal Calibrator... a portable, self-contained unit for accurate and instant checking.

RADIART

VIBRATORS
VIBRATOR POWER PACKS
RUST-PROOF AERIALS

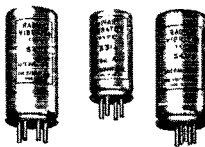

RADIART VIBRATORS

Radiart Vibrators are individually engineered, exact duplicate vibrators. Designed for long life, minimum R. F. interference, low noise level and proper starting.

Radiart Power Packs are designed to provide efficient,

economical and dependable plate power for operating all types of portable equipment where AC power is unavailable. Radiart Rust-Proof Aerials are newly designed to fit all cars; cowl, hood and under hood types. Made of finest materials with many exclusive features.

MAGUIRE INDUSTRIES, INC.

36 NORTH MICHIGAN AVENUE, CHICAGO 11, ILLINOIS



**"Post-War"
Is Now Here!**
You Must Act Fast
To Step Ahead of
Competition

CREI Technical Home Study Training Equips You to Step Ahead of Competition into a Better Radio Engineering Job!

THESE "tools" are the symbol of the trained engineer. Knowing how to use and apply them as a radio engineer is an important part of the training you enjoy as a CREI student . . . and an indication that you are equipped for a better-paying job, and secure future in the many branches of radio-electronics.

In our practical radio-electronics engineering course, you learn not only *how* . . . but *why*! Your ability to solve tough problems on paper, and then follow up with the necessary mechanical operation is a true indication that you have the *confidence* born of *knowledge* . . . confidence in your ability to get and hold the new, better radio jobs that are available to good, well-trained technical radiomen *today* . . . and offering secure careers and happiness for the future!

*"I have been helped by the course far beyond my expectation, and the lessons have been particularly timely for me."
—K. M. Hollingsworth, General Electric Co.
—42-9-5*

● WRITE FOR FREE BOOKLET

Tell Us About Yourself, so we can intelligently plan a course best suited for your needs. Write us now and let us prove to you we have something you need to qualify for a better radio job. To help us intelligently answer your inquiry—please state briefly your background of experience, education and present position.



CAPITOL RADIO ENGINEERING INSTITUTE

E. H. RIETZKE, President

Dept. Q-6, 16th and Park Road, Washington 10, D. C.

Branch Offices:

New York (7): 170 Broadway Chicago (2): 30 N. LaSalle Street
San Diego (1): 316 C Street San Francisco (2): 760 Market Street

Member: National Home Study Council, National Council of Technical Schools

(Continued from page 98)

Navy and is on the air using 250-TTs at 1 kw. input and has three-tube converter for 28, 50, and 144 Mc. GTI is using 250TTs at 1 kw. and worked WAC in ten hours. 1WV/6 is on 3.5-Mc. c.w. RX keeps traffic schedule with KA3CB. Traffic: W6RX 209, JSB 76, TBK 38, CFK 4, PVV 2, W1WV/6 1. 73. *Pinky.*

EAST BAY — SCM, Horace R. Greer, W6TI — Section EC, EE; RM, ZM; EC, QDE; EC v.h.f., FKQ; Asst. EC v.h.f., OJU; OO v.h.f., ZM; OO, ITH; OBS, TT, IDY, ZM, ITH. Please note new reporting dates. Effective at once you will make reports covering the first to the last day of each month inclusive. This means that you will have to mail your reports to me as soon after the first as possible, as my reports will have to be mailed by the seventh of each month to ARRL, so please get them to me not later than the fourth of each month in order to give me time to compile the information. IDY reports that his official broadcasts are being received with good reports all over. ITH is working all the DX that he hears and that is plenty. On March 29th, when the ZLs first went on the air, Reg worked six on 28-Mc. 'phone. Seemed like old times with the opening of the 3.5-Mc. band. Many of the local gang could be heard on both c.w. and 'phone really going to town. CAN reports that he is very active on the u.h.f.s in Napa and would like to make some 56-Mc. schedules and tests with some of the gang. His QRA is J. W. Clark, 70 Hoffman Ave. EE is building a new rig with a pair of Eimac 4-250As in final. GEA's new radio room looks FB. TI bought new Hallcrafters HT-4E all-band transmitter from TT and DUB. CDA is building all-band transmitter with 812s in final. EJA worked Wake Island the first night on 3.5-Mc. c.w. The SARO held a very successful Field Day on April 7th and a large gang turned out, some traveling many miles to make local contacts on all our bands. Even an airplane was pressed into service for u.h.f. contacts and some records may have been equalled or bettered. SEND IN THAT STAMPED SELF-ADDRESSED ENVELOPE WITH YOUR CALL IN UPPER RIGHT-HAND CORNER. YOU MAY HAVE SOME QSL CARDS HERE AT THE W6 QSL BUREAU. Traffic: W6ITH 70. 73. "TI."

SACRAMENTO VALLEY — SCM, John R. Kinney, W6MGC — The Sacramento Amateur Radio Club held its second meeting April 17th in the Clunie Memorial Club House in Sacramento. EWB and OJX had the honor of installing the new officers for the coming term. They are as follows: GZY, pres.; AK, vice-pres.; MGC, secy.; AP, treas.; and EJC, sergeant at arms. Sixty-nine members were present. The SARC now boasts a membership of 107 with more expected to come in. Meetings are held each third Wednesday. Contact MGC for further information. PIV still is in the hospital and will be on 3.5 Mc. when he gets out. MBY won a very fine Vibroplex at the last SARC meeting. OOR and DGL are doing experimenting work on the 1215- to 1295-Mc. band with good results. KME is building rig to use a pair of 35Ts in final on 3.5 Mc. AK and RMT, father and son, are using Abbott TR4s for ranch work and pleasure. GZY is revamping rig to use HK54s on 3.5 Mc. EJC, BVK, and AP are working Japan and Guam regularly on 28 Mc. MGC is rebuilding rig to use a 6L6 Tri-tet into an HK257B for 3.5 and 7 Mc. EWB is in the market for a new receiver and GAK is rebuilding for 3.5 Mc. CLV, BVK, KME, MBY, GAK, PNC, RKM, TJA, QKJ, and MGC are active on the 144-Mc. band with BVK being the headliner, working San Francisco with a 200-watt rig.

SAN JOAQUIN VALLEY — SCM, James F. Wakefield, W6PSQ — SRU worked 20AA/J8 in Korea with a 5-9 using an 807 into a half-wave vertical. LTA is on all bands with a new exciter using a 6C5 and four 6L6s which drives a 4-125A. Anybody interested in u.h.f. contact NJQ at 1260 Van Ness Ave., Fresno, for a schedule of Field Days for the Ultra High Club to be held this summer on the peaks surrounding Fresno. Here is a chance to crack the records. QFR has a pair of 4-250s running a cool kw. LTO is using a home-built super, fourteen tubes with miniature tubes in the r.f. end. UVM is on 144 Mc. with an HY-75. JCB also is on 144 Mc. with a new rig using a pair of 2C22s (7193) running 20 watts. QEU is stationed in the Singapore area and is on 14-Mc. c.w. HIP and JIN have opened a new jobbers store in Stockton. 5CHX/6 is on in Acampo. At Lodi SYR and CUL are on 28 Mc. DTY replaced his overworked TZ20 with a TZ40 which cools off his 150 watts. 56 Mc. shows a little activity with GWM, PDX, JPU, LFR, and PSQ on. GWM is using

(Continued on page 98)

LORAN BY SPERRY

03617*
TIME DIFFERENCE

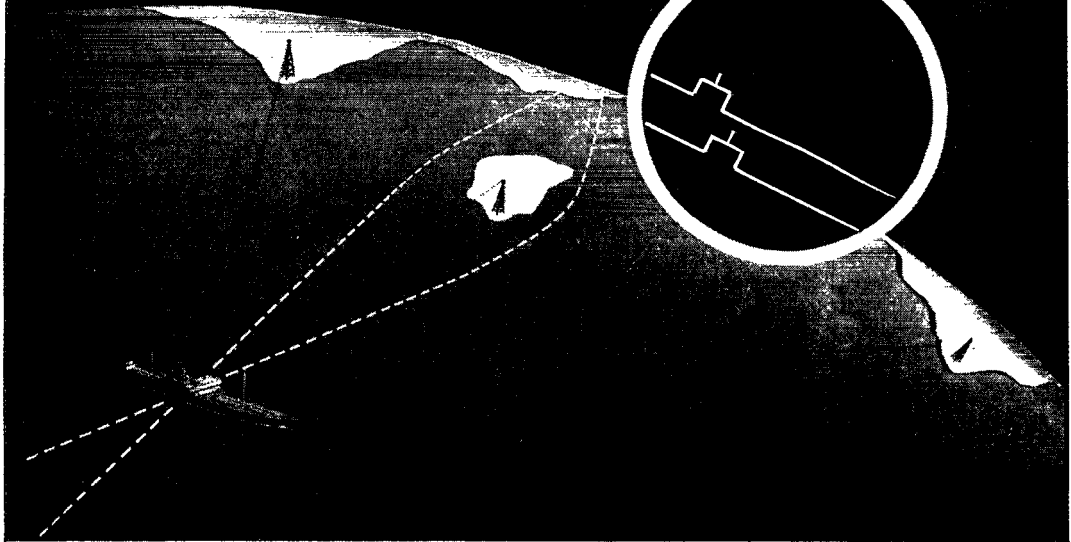

Accurate Long Range Navigation...anytime...in all weather

With Sperry Loran the navigator has at hand a quick and accurate means of determining a ship's position at any time, in all kinds of weather. This system involves the reception of accurately timed radio pulses from shore-based transmitting stations.

The *difference in time of arrival* of signals from a pair of transmitting stations is measured and the time difference is then used to determine, from special charts or tables, a line-of-position on the earth's surface. Fixes by crossing two lines of position are obtainable

at distances from shore stations up to 1400 miles at night, 700 miles in daytime.

A Time Difference Meter (see illustration above) greatly simplifies the operator's work and prevents errors in readings.

Sperry Loran is backed by a worldwide service organization and meets the usual high standards of test and performance of all Sperry products.

**The Time Difference Meter, giving position references directly, is a Sperry exclusive.*



Sperry Gyroscope Company, Inc.

EXECUTIVE OFFICES: GREAT NECK, NEW YORK • DIVISION OF THE SPERRY CORPORATION
LOS ANGELES • SAN FRANCISCO • NEW ORLEANS • HONOLULU • CLEVELAND • SEATTLE
GYROSCOPICS • ELECTRONICS • RADAR • AUTOMATIC COMPUTATION • SERVO-MECHANISMS

**The New 205 TS
HAR-CAM
VISUAL ALIGNMENT
SIGNAL GENERATOR**

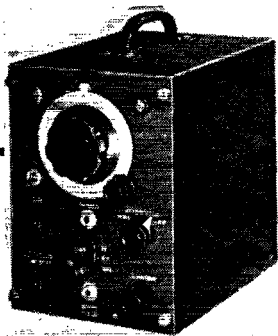

Essential for development, experimental and servicing work in connection with FM applications, IF amplifier alignment and in other uses where a sweep deviation is needed in the frequency range of 100 kc to 20 mc.

SPECIFICATIONS

1. Linear frequency sweep deviation adjustable from zero to 900 kc peak to peak.
2. Vernier frequency control of 100 kc allows zero beat calibration of main tuning dial or for vernier frequency deviations about main dial frequency setting.
3. Stable r-f gain control independent of frequency.
4. Five-step attenuator of r-f output giving overall voltage range of 1 microvolt to .1 volt when used in conjunction with the gain control.
5. Output impedance, 1 ohm to 2500 ohms.
6. Phone jack for aural monitoring of zero beat calibration of main tuning dial.
7. Panel jack to feed linear sweep voltage to x-axis amplifier of oscilloscope, thus synchronizing the frequency linear sweep of the generator with the spot trace on the scope screen.
8. Voltage regulated supply for internal oscillators. Careful oscillator design to minimize drift.
9. Size, 7" wide, 9½" high, 10½" deep. Weight, 18 pounds.

Write for free bulletin number H-40



**HARVEY RADIO
LABORATORIES, INC.**

451 Concord Ave., Cambridge 38, Mass.

(Continued from page 96)

a Utah rig; PDX, JPU, and LFR are using surplus Navy TBMs; PSQ is using 6C4s into p.p. 7C5s. Appointments are open so drop me your request. 73 and CUL. *Jimmie.*

ROANOKE DIVISION

WEST VIRGINIA — SCM, Donald B. Morris, W8JM —VKF/5 is working for the government in Louisiana and watching for the gang on 3.5-Mc. c.w. EZR runs a 6L6 to a tin roof antenna on 3.5 Mc. and gets out, too! Congrats to OXO, DFO, GBF, KWL, MIP, TDJ, UGH, UOW, and VZD for their excellent work in the NBS ARRL project. It is with regret we learn of the passing of BOW, of Wheeling. GEG/8, b.c. engineer, at Sharon, Pa., is working the WVA Net on 3770 kc. HUK, HSC, MIS, DMF, VPO, SNT, VAN, JM, VHG, and SPY were among the 'phone stations to get on 3.9 Mc. DSO, former WVA ham, is an R.I. in Atlanta, Ga., signing 3UO/4 on 3.5 Mc. RSR, TAP, UEK, VMK, TBQ, UEB, RFD, and JCB are active on 28 Mc. JCB has a new rig and beam and will operate on 50 Mc. Are you listening, Morgantown? PQQ received nice write-up in *Colliers* in an article about ham radio. MARA will be active in coming Field Day signing BOK/8. PZT has a German transmitter but can't read the directions that came along. AKQ, an old-timer, is active on 3770 kc. Remember, gang, 3770 kc. for handling your WVA traffic and get your rigs ready for the WACWV, worked all counties in W. Va., with prizes and certificates to those qualifying. 73. *Don.*

ROCKY MOUNTAIN DIVISION

UTAH-WYOMING — SCM, Victor Drabble, W6LLH —6SID, EC for Logan and Cache Valley, submits the following report from his area: 6MAV, 6SID, and 6TAR are active on 28 Mc. from their home stations. 6RIM is on at his QTH. More hams at the USAC are: 9FVO/6, Smithfield; 9YVE/6, 6ULV, and Grant Hoffman, operator license only. 6SID and 6MAV hold down the 144-Mc. band at Logan, Utah. They took their Class A exams on March 23rd. 6DTB is working a lot of DX with his 300-watt rig and a three-element beam. 6TMK, the radio club at the USAC, is on the 3.9-Mc. 'phone band with 375 watts. 6SID is on 28 Mc. with 40 watts into an 815 and a three-element beam. He made fifty-nine contacts on three continents in one day. 6FYR broke his foot and is getting around with a plaster cast. He is using the clothesline for an antenna. 4IHV/6 is having a time getting out with his little 40-watt 'phone rig. The "California" kilowatts blot him out on the 3.5-Mc. band. 6PFX is in civvies again and will be in Ogden until June. 6PGH got married April 5th. 6LLH gets on with a 10-watt portable c.w. rig and manages to make a few contacts regardless of the California kilowatts. 6DLR is EC for the Ogden area. Traffic: W7ILL 26, 6SID 7, 6DTB 3, 6TAR 2. 73. *Vic.*

SOUTHEASTERN DIVISION

ALABAMA — SCM, Lawrence J. Smyth, W4GBV — GVP reports for the Anniston boys and states that GYD and BHY are on 28-Mc. c.w. BCU is on 28 and 3.9 Mc. running around 500 watts. GVP is running 175 watts on 28 Mc. His Band Warming Contest came out well; he worked Argentina, Peru, and Hawaii. AUF installed a pair of 812s and is on 3.9 Mc. EW is making many DX contacts with his new beam installation. The Montgomery Radio Club is using moving pictures to teach theory to the boys going up for examination. The Mobile Club has started anew and we hope to hear from them soon. Would like to hear from anyone interested in OBS appointment. 73. *Larry.*

EASTERN FLORIDA — SCM, Robert B. Murphy, W4IP — Get yourselves lined up now for the Emergency Net. The Dade Radio Club is sponsoring a WAS contest starting May 1st and ending July 31st, is canvassing the membership for 100 per cent affiliation with the ARRL, and is promoting up-and-coming new members. CNZ, the old c.w. man, won a mike at the April meeting. FJC reports Jacksonville has organized a club which will be known as the "JARS" and will meet the first Tuesday of each month. FPC is pres.; 2IZT/4, vice-pres.; AKH, activities mgr.; HWA, secy.; FRP, treas.; FWZ, AWE, and 9LZI/4, executive committee. AKH will handle reports to the SCM.

(Continued on page 100)

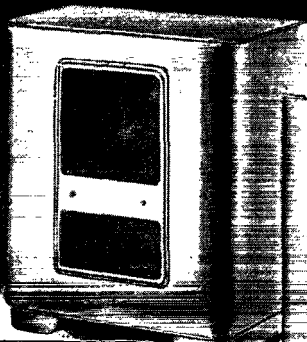

Model A-81 Cabinet

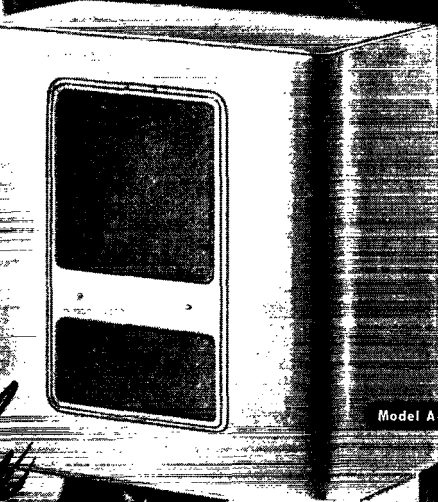

Model A-121 Cabinet

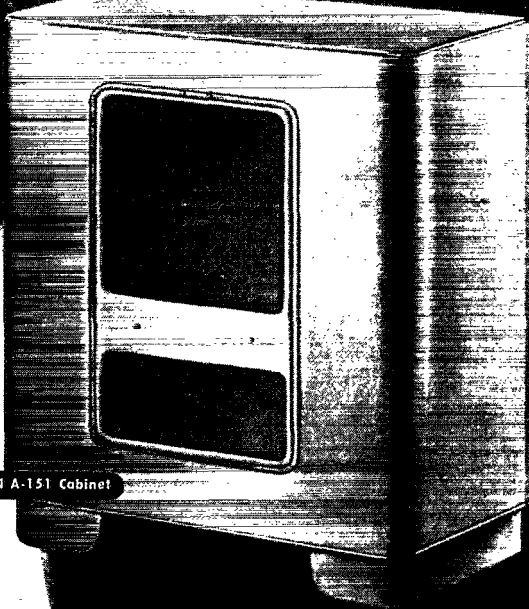

Model A-151 Cabinet

THE FAMOUS

* *Bass Reflex*

**REPRODUCERS IN NEW,
BETTER-THAN-EVER DESIGNS**

True high-fidelity reproducers with the famous and exclusive *Jensen Bass Reflex* principle of design are now available in improved postwar cabinets. *Jensen Bass Reflex* reproducers give crisp, extended range reproduction...no backside radiation...full bass with no boom.

Bass Reflex Reproducers are widely used in broadcast monitoring and in recording work. They are ideal for ham shack use and are in much demand for phonographs, FM reception, and general sound reinforcement applications.

Jensen Bass Reflex Reproducers are available in sizes for 8-inch, 12-inch and 15-inch loud speakers and are designed for floor or wall installation. The 15-inch cabinet is designed for both Type J and Type H *Jensen Coaxial Speakers* and for single-radiator 15-inch speakers.

Write for complete literature.

*Trade Mark Registered

The Jensen exhibit will be in Booth 68 at the 1946 Radio Parts Show in Chicago's Stevens Hotel, May 13th through 15th. Old and new friends alike are cordially invited to see the 1946 line of Jensen fine acoustic equipment.



Jensen
SPEAKERS
WITH
ALNICO 5

JENSEN RADIO MANUFACTURING COMPANY
6611 SOUTH LARAMIE AVENUE • CHICAGO 38, ILLINOIS
In Canada: Copper Wire Products, Ltd., 137 Oxford St., Guelph, Ontario

Specialists in Design and Manufacture of Fine Acoustic Equipment



PREFERRED
BY ENGINEERS

BURGESS BATTERIES

RECOGNIZED BY THEIR
STRIPES • REMEMBERED
BY THEIR SERVICE

(Continued from page 98)

How about an EC for that district? HUY has passed his Class A exam. EYI is having a lot of fun on 28 Mc. AFO has written in for emergency net set-up. VP5EM, at Kingston, writes he still is waiting for their impounded equipment to be released by the government. D. E. Yong at the PAA station in Piarco, ZQC, writes a very interesting account of the hams in the Caribbean. CNZ was in Piarco as code instructor for PAA training twenty-five English operators. EPZ is a mechanic at Piarco. KG is operator at Atchinson. FQZ is operator at St. Lucia. KG and FQZ are twin brothers and radio operators for PAA. "DY" at ZQC works HWO regularly on the circuits with WMDU. The operator in charge of ZQC is VP4TR, and "BG" is VP4TF. HXL is very active on 28 Mc. IE is trying to get some peanut power on 28 Mc. The first message-handling report was received from BYF with a nice report of 22 out as OBS and 7 received. GVC, our SEC, reports: BGL QSOs VKs on 25 watts 28 Mc. and QN worked St. Pete; IIX has twenty-seven "furriners" to his credit. HGO is a close second. 8QFN now is IJV. QN is lining up as OO. GIY is getting ready for OES. Let's have reports on the first of the month. 73. *Merf.*

WESTERN FLORIDA — SCM, Edward J. Collins, W4MS — BKQ schedules FA8NF so Syd can talk to his YL in Pensacola. 3IHC/4 is proud papa of a YL. DAO is the big DX man with his four-element beam. QK and VR are set for 3.7 Mc. EGN has been fighting bugs in the rig. HIZ has an FB four-element beam. EQR has a 250TH in the final. 4JV really pounds out FB with his 8JK beam. AXP is happy over the opening of 3.7 Mc. LT works into Pency on ground wave regularly. 3HNX/4 is welcoming 3.9 Mc. buck. UW sounds FB on 28-Mc. 'phone. 71QJ/4 has 15 watts on 3.9 Mc. ECT and FJR should be doing big things on 3.9 Mc. HJA is putting out a nice signal on 28-Mc. c.w. AXF is enjoying 28 Mc. MS needs Europe and Asia for a postwar WAC. FHQ is dusting rig off for 3.9 Mc. 2LQP/4 needs plate transformer to get on the air. KB says it will take a little time to rebuild his rig on 3.9 Mc. DXZ is having receiver trouble. 9MN/4 has his gear. 73.

GEORGIA — SCM, Thomas M. Moss, W4HYW — The Atlanta Radio Club adopted a new constitution and elected the following new officers: FKN, pres.; BOL, vice-pres.; IEO, secy.; HZG, treas.; HAH, activities mgr. Meetings are held the first Thursday of each month at 8 P.M. at 211 Decatur Street. Welcome back to civilian life and ham radio to: BVK and AJ (Valdosta); DXI and GTS (Atlanta); FCW (Cordele); HEC (Statesboro); BTB (Bremen); FGU (Athens); HPR (Marietta); GFF (Pitts); and CMA (Hapeville). Service men and women stationed in this section are cordially invited to participate in our activities. EV is a major in the Signal Corps. GJM is now a K4. GLB was a visitor at FID and says he and DIA are rebuilding at Albany. HWS acquired an OM and now housework and a job with the Navy is limiting her time for ham radio. The Amateur Radio Club of Savannah will hold its hamfest on July 21st. New OBS: EWY. FWD is continuing as OBS. More Official Observers are needed. New OO (Class I): EWY. Applications for ORS and OPS appointment are now being accepted. Would like to hear from prewar appointees. ORS renewals: MA. The Emergency Corps needs many Full and Supporting Member stations. County Coördinators also are needed. New ECs: BOL (Bleckley), BTB (Haralson), and FGU (Clarke). The post of Section Emergency Coördinator is open. Your EC inquiries are invited. Best of luck in the June Field Day and hope to see you at Savannah. 73. *Tom.*

WEST INDIES — Acting SCM, Everett Mayer, K4KD — K4LW, K4EJG, and W2OJV/K4 (ex-K4EMG) are active in Ponce on 28-Mc. 'phone. K4HHR is at Chanute Field, Ill., signing portable 9 on 28-Mc. c.w. K4HTU/W6 was heard in P.R. on 28-Mc. 'phone. K4HLP has applied for ORS. K4HEB's schedule with W3IMU is going along FB. W4BZA/K4 had rig on 3.9-Mc. 'phone. Bill worked EA and LU on 28-Mc. 'phone. W6PQE/K4, busy on v.f.o., worked LU on 28-Mc. 'phone. W3HUN/K4 worked HK on 28-Mc. 'phone. W4DYX is trying to work the old home town, Athens, Ga. W4GJM/K4's latest DX is PX1B. W9FKH/K4, W4AAO/K4, W4FAY/K4, and W5EVN/K4 are active on 28-Mc. 'phone. W5EVN/K4 has new three-element beam. W4DDY/K4 is on c.w. with QRP. W2OJV/K4 gave a picnic for the P.R. gang on March 17th. Contact SCM for details on CD appointments. Prewar ORS should forward reports and send in certificates for endorsement if continuance of appointment is desired. 73.

(Continued on page 102)

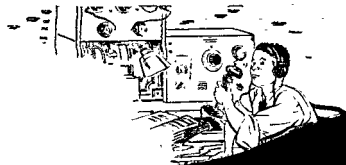

...Get back on the Air-

SAVE CONSTRUCTION HOURS BE SURE AS YOU BUILD

The Simpson Model 240 was introduced in 1939. In the two short years before "Hams" went off the air, this remarkable general service instrument built itself such a reputation that the demand for it has never ceased. During the war it was supplied to the Services in limited quantities. It has undergone steady improvement as the result of test and research. Now we can offer it to you again, a vastly better instrument than before—and it was always a sensational instrument.

Completely self-contained, needing no external multipliers, with a sensitivity of 1000 ohms per volt and a maximum voltage of 3000 volts A.C. or D.C., it has all the variety of useful ranges needed to do an all-around job for you.

The 3-inch meter has a scale over $\frac{1}{3}$ greater than before, offers greater accuracy in reading. The whole chassis is encased in heavy molded bakelite. All components and the sub-panel are mounted directly on the bakelite panel for easy servicing and greater sturdiness. All figures are engraved and filled with white enamel for greater legibility and wearing qualities.

Shock-proof, it has the famous Simpson movement with bridge-type construction and soft iron pole pieces, resistors in matched pairs to provide greatest possible accuracy for all ranges. It is furnished with test leads whose wire covering is capable of withstanding 3000 volts. Alligator clips have safety rubber guards.

Here is the instrument that will get you on the air and keep you there, helping you to build soundly and to trouble-shoot speedily and surely.

SIMPSON ELECTRIC CO.
5200-5218 W. Kinzie St., Chicago 44, Ill.

Simpson

INSTRUMENTS THAT STAY ACCURATE

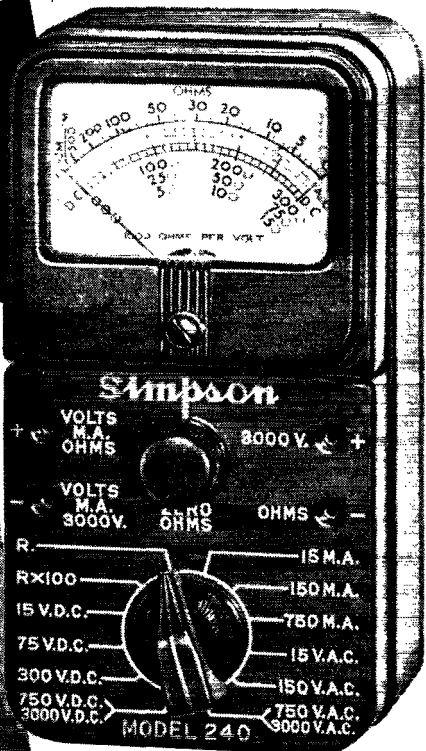

The New Simpson Model 240—
The "Hammer"—1946 version of the first self-contained pocket portable instrument built expressly to check high voltage and all component parts of transmitters and receivers.

RANGES

- VOLTS
- A. C.
- 0-15
- 0-150
- 0-750
- 0-3,000

- VOLTS
- D. C.
- 0-15
- 0-75
- 0-300
- 0-750
- 0-3,000

MILLIAMPERES

- D. C.
- 0-15
- 0-75
- 0-300
- 0-750

Ohms: 0-3,000 (center scale 30)
0-300,000 (center scale 3,000)

Price, complete with test leads. \$26.50

Ask Your Jobber

Did YOU get yours

P. L. 20,024

\$10.80

AMATEUR NET

?

Price includes 3 sets of
coils covering 144-148
M. C., 220 - 225 M. C.,
420 - 450 M. C. bands
—less 6F4 tube.

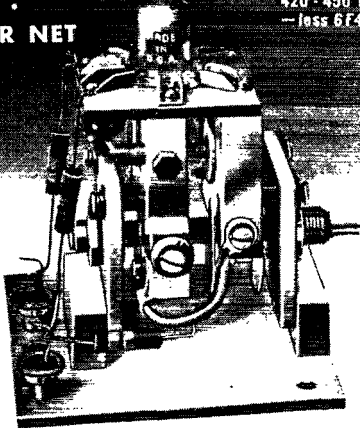

IT'S READY FOR YOU NOW THE NEW CARDWELL V.H.F. OSCILLATOR KIT

Here it is...precision engineered with a new technique...simple...effective...with revolutionary stability for 140-450 M.C. bands.

This is traditional Cardwell quality. Make no mistake about that. It is ideally suited as a local oscillator for super-heterodyne receivers, as a plate modulated oscillator for low power transmitter or transceiver, driver unit for amplifier tube in higher powered transmitter, V.H.F. signal generator, etc., etc.

It took a little time to catch up with the demand on this hot little V.H.F. Oscillator kit. Perhaps you were disappointed before. Now you can get one.

SEE YOUR DEALER TODAY

Cardwell Catalog No. 46, FREE, upon request



**THE ALLEN D. CARDWELL
MANUFACTURING CORP.**

MAIN OFFICE & FACTORY

97 WHITING STREET, PLAINVILLE, CONN.

(Continued from page 100)

SOUTHWESTERN DIVISION

LOS ANGELES — SCM, Ben Onstenk, W6QWZ — Section EC: UXN. The SEC, (ex-8WLC, has his new call, 6UXN. Other changes are 9NOP to 6UYI, 9SOT to 6UYE, 9NBX to 6UXF, and 2OIQ to 6UYG. REH uses a three-tube converter on 144 Mc. AEL and QWZ have their converters for 50 Mc. built. QWZ has a rig on 144, 50, 28, and 3.5 Mc. UXF and LBM are on 3.5-Mc. c.w. UYG reports from Riverside that TZF, SET, SEY, QI, LOY, and UZL are on 28 Mc. daily; also that UYG, RPH, SIW, GM, OZH, and NPX are active on 3.9 Mc. The Inglewood Amateur Radio Club has moved its meeting place; for information call QWZ or QIR. UXN, QD, KEY, and 9NPS/6 are making a speaking tour of the local clubs. QIL schedules K7HNG/KW6, on Wake, nightly. UXN handles traffic for QKB, on Guam. QPP will be on Wake on 28,245 Kc. SET has been appointed OES. RNN is back on 28 Mc. 9YAX/6 is using a Signal Shifter on 3.5 Mc. AEL is modulating a VT127 at 200 watts with two VT127s in Class A on 28 Mc. ELC and PNH are working for KGPL. KEI, MEP, PHG, and SRJ are responsible for starting the San Fernando Valley Radio Club. Clubs, please let me know your Field Day plans. Please note the new reporting date. Reports should be made to the SCM by the first of each month. CUL, 73. Ben.

ARIZONA — SCM, Gladden Elliott, W6MLL — The Verde Valley gang is going great guns on 144 and 28 Mc. and looking for u.h.f. parts. 2NPF/6 worked the gang there from Mormon Mountain. SNI has a pair of 812s on 28 Mc. and an MRT-3 on 144 Mc. RLC has 300 watts on 28 Mc. and a TR4 on 144 Mc. SQN has 200 watts on 28 Mc. and a pair of HK24s on 144 Mc. running about 100 watts. LJN has 125 watts on 28 Mc. and a TR4 on 144 Mc. PKZ is the first Phoenix ham to work a G. MAE bought TNJ's rig. NGD worked portable-mobile across the country on his way home to Phoenix. 7GYK/6 is working 28 Mc. portable-mobile with one-fourth watt input. UOG is back in Tucson. PDA is putting up a beam for 28 Mc. at Ajo. 9QEH/6 is the new president of the Tucson Short Wave Association. TXM won the 7-Mc. rock given as the door prize at the club's last meeting. GS got his first K6 on 28 Mc. with a vertical J and 20 watts. SLO, at Ingleside, Tex., is on 28 and 50 Mc. He reports his first 50-Mc. contact and worked SNI, SQN, and UPF on short skip on 28 Mc. OVK is on 28 Mc. The first new W7 call in Tucson is W7JFG. UPY has a new XYL. OZM modulates an 807 with a 6A6 and gets swell reports 5HMX/6 worked his first VK on 28 Mc. 73. GC.

SAN DIEGO — SCM, Ralph H. Culbertson, W6CHV -- Asst. SCM, Gordon W. Brown, W6APG. PDP has returned to Berkeley to finish his course in Electrical Engineering. JRM has his new 28-Mc. rotary beam up and is operating on 28-Mc. 'phone. SLH is located in St. Louis, Mo. QEZ and his XYL started to school on April 17th and are going to study for commercial tickets. DUP has new 28-Mc. rotary beam up and working very FB. DUP also has a new rig running about 500 watts on 3.9 Mc. Following is a list of stations operating on 3.9-Mc. 'phone. FMJ, LAM, OCJ, DUP, QAI, AD, EWU, CHV, 7HLV/6, 8VDZ/6, and 9GCE/6. EOP reports a schedule with 6NFL/J5 on Okinawa. He also is finishing rig for 50 Mc. BAM reports quite a bit of activity and a nice traffic total. The Palomar Radio Club's Birthday Party was a huge success with an attendance of about 115 from all of Southern California. LYF acted as M. C. Lt. (jg) Bert Fuller, formerly of KA1CM, gave an interesting and educational talk on amateur radio in the Philippine Islands. A comic skit by NDD and Bill Gilmore brought a lot of laughs. Mr. Munson, of Leucadia, won the men's door prize. The XYL of RPJ won the ladies' door prize. An FB raffle of about \$300 worth of radio parts completed the party and everyone attending reported an FB time. APG has finally received back his old call which has been held up in Washington for about five years. EZM finally got his rig to work on 28-Mc. 'phone and is running about 30 watts. He also reports FVQ is out of the Navy and expects to go back into commercial operating. FVQ is operating on 28 Mc. with about 50 watts to a pair of 6L6s. Gang, don't forget the new reporting date, the first of each month. Traffic: W6BAM 43, EOP 12. 73. Ralph.

(Continued on page 104)

Easiest-Low Cost Way for

1/2 KW to 1 KW

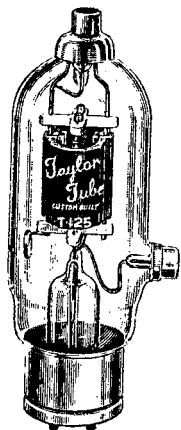

A single T-125 or T-200 operating at 2000 volts with only 15 watts drive gives you a fine performing, economical 500 watt phone or CW Rig. With 2000 volts, your associate equipment costs are lower—less space is required—and efficiency is high on all frequencies from 10 meters through 80 meters.

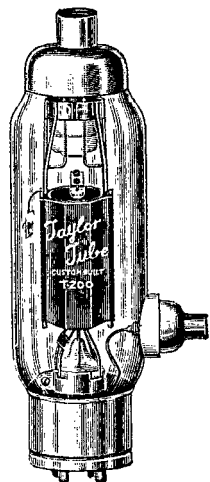

If you want a Power-house Kilowatt, use T-123's or T-200's in push-pull. They take the KW easily at 2000 volts with low drive and high efficiency. You'll save money, space and get better results.

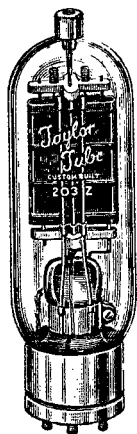

Modulate your high-power Rig with 203Z's or 805's. They are designed for Class B audio work and prove it by their fine operation.

Of course, you will use the famous Taylor 866A rectifiers in your power supplies.



For More Output at Lower Voltages Use TAYLOR TUBES

Remember
"MORE WATTS PER DOLLAR"

Taylor HEAVY **CUSTOM BUILT** DUTY **Tubes**

TAYLOR TUBES INC., 2312-18 WABANSIA AVE., CHICAGO 47, ILL.

OHMITE

Riteohm Precision RESISTORS

Non-Inductive • Pie-Wound • 1% Accurate



Available from Stock
... or Made to Order

OHMITE presents a *new line . . . a full line . . . of finer precision resistors!* Every type . . . every size . . . ready for every need! Each Riteohm is designed and built with all the specialized skill and experience that have made OHMITE units the standard in this field. However critical the application . . . consistent accuracy and reliability are assured. In these Riteohms, you get *time-proved protection against humidity, temperature and corrosion.*

AVAILABLE FROM STOCK in $\frac{1}{2}$ watt and 1 watt units in a wide range of values, in various types of mountings and terminals . . . or made to order. Complete line of 6 different series includes non-inductive pie-wound vacuum impregnated units . . . single-layer wound vitreous enameled units . . . and non-inductive pie-wound hermetically glass sealed units. Some units are in a range of 0.1 ohm to 2,000,000 ohms.

For complete data and listings, write now for Riteohm Bulletin No. 126.

OHMITE MANUFACTURING CO.
4864 West Flournoy Street
Chicago 44, Illinois, U.S.A.

Be Right with

OHMITE

RHEOSTATS • RESISTORS • TAP SWITCHES

104

(Continued from page 102)

WEST GULF DIVISION

NORTHERN TEXAS — SCM, Jack T. Moore, W5ALA — EZP reports that the only news from KRLD is that AJG has a new YL jr. operator. TW reports visits from NW and FPH while FPH was in Dallas taking Class A exam. BNQ had to take his beam down from the top of his house because his XYL was afraid that a high wind would come along and the house would take off like a helicopter. HCH sold his rig and is building a new one. Bob sends the following news on the Ft. Worth gang: SH has a new HT-9 transmitter and is looking for SU1MW; OJ is running low power on 28 Mc. AAE has his buffer working on 28 Mc. and will soon increase power; KVA is the latest call issued. BSY has been appointed EC for Denton. The Dallas Amateur Radio Club had a barbecue at HIP's ranch at Celina on April 6th. The SCM regrets to report the passing away of AJG's father. 73. Jack.

SOUTHERN TEXAS — SCM, James B. Rives, W5JC — HJY has a new 60-foot pole for the antenna on his half-kw. 3.9-Mc. 'phone rig. EHM joined the Caterpillar Club when he had to bail out of a C-45 over Tennessee. GGU has a new rig on 28 Mc. LQU is active on 3.5 Mc. at New Braunfels. JKC is rebuilding with a pair of 811s. TY and UH are busy installing a new 50-kw. broadcast station in San Antonio. KTL has moved to Texas from the second district and is active on 28 and 3.9 Mc. EVK is attending a communications equipment school at Scott Field, Ill. TM, DDJ, and 3IVT/5 are active on 3.5 Mc. in Galveston. ZG is constructing a new exciter unit. EPB and FNY are active on 3.9-Mc. 'phone in San Antonio. FNH is working some nice DX from Kerrville. 73. Jim.

NEW MEXICO — SCM, J. G. Hancock, W5HJF — DER, 9BEZ, and 9DER have the nicest signals heard so far on 3.9-Mc. 'phone. Not many c.w. men are heard from New Mexico yet. 3JSD (ex-5GGX), FAG, and a few others have been heard on 3.5 Mc. HJF is having difficulty getting out with the powerful little 28-watt DER loaned him while remodeling HJF's main rig, but he has a signal on 3.5-Mc. c.w. and 3.9- and 28-Mc. 'phone. ND is building flood controls at Orange, Tex., and plans to go on 3.5-Mc. c.w. as soon as he gets his new duplex apartments finished. 3IRM, former jr. operator at ND, is first lieutenant in the Air Corps but expects to be back at his old job in Washington shortly. You are reminded of the change in reporting dates to the SCM. Try to get that card in to me by the first of the month instead of the sixteenth as formerly. Hope to see all of you on 3.5 and 3.9 Mc. 73. Jake.

CANADA

MARITIME DIVISION

MARITIME — SCM, A. M. Crowell, VE1DQ — CW gives us some good dope from the P.E.I. gang. CO, on 28 Mc., is clipping off the DX with RK23 final, and has a pair of 812s ready. CW, also on 28 Mc., has 80 watts into an 807. BD will use a pair of T40s. EV, Moncton, has been heard in Summerside by CO. DB recently had a nice chat with VE6WG, formerly VE1CZ. Recently heard on the newly-opened 3.5-Mc. band: LZ, DW, IO, KU, FB, GP, IM, BC, and GC — all good signals. Say, gang, please help swell our reports by sending in YOUR doings on the FIRST of each month. Remember the new date. Club secretaries, please note. 73. Art.

QUEBEC DIVISION

QUEBEC — SCM, L. G. Morris, VE2CO — The MARC had a record of over 200 at its March meeting to hear Comdr. J. J. Kingan speak on "Wartime Radio Developments and Their Effect on Amateur Radio." The Club's membership is 140, including 114 licensed hams, the largest total since its inception. AR returned from overseas with the rank of major and is back in civilian life. W2KVE visited Montreal while on discharge leave and rag-chewed with KH and CO. IC has moved to Mont Laurier. DR has resumed his old position as QSL Manager. JJ and LV did some shopping in New York. FK has rebuilt and is running a half-kw. DU is living in Bordeaux. Additions to the gang on 28 Mc. are AI, AL, BR, HR, JL, WF, BV, PD, RD and SM.

(Continued on page 108)

HAM GEAR

at Newark Electric

Every day hams are stopping in at the three Newark stores — and are discovering that Newark is not only in a class all by itself as a source for radio gear, but is also a mighty friendly place to obtain information. You are bound to bump into fellow brethren of the air waves at Newark with interests similar to your own. If it's code you want to learn, for instance, we'll probably be able to find an o.m. to help you out.

And now a word to new hams. Confused about ticket requirements, which band to select, what equipment to buy? Our hams behind the counters have all faced the same problems themselves, and will be pleased to be at your service. Indeed they like to talk about the gear they sell, and will gladly discuss the story behind all the latest gear.

And now for a quick switch to S-meters — one of the most discussed features of communications receivers today. Some are "scotch" while others read S7 on "background noise." Although erroneous, some people judge a receiver's sensitivity by the deflection of the S-meter needle.

Recently, many amateurs have found that their S-meters read low on ten meters, but have a satisfactory reading on the other bands. That does indicate less signal getting into the I.F. amplifier either because of insufficient RF amplification or a poor antenna system. In most cases, however, just poor RF gain or low sensitivity on the higher frequencies is the main factor.

Because varying installations do affect overall readings of the S-meter, Hammarlund has provided a compensating adjustment on all of their communications receivers. For example, the S-meter is adjusted at the

factory to read S9 on a 50 microvolt signal at the antenna terminals. With a good set that is a Q5-S9 signal in any man's language!

If the operator feels that a lower reading should be obtained on a signal of given level because of gain in a directive antenna system, he can adjust the control to bring the reading down to the S number he feels is in line with the reports he has been accustomed to making. On the other hand, a poor antenna system may cause readings to be low. In that case, he can raise the readings by simply making proper adjustment.

The Hammarlund meter is calibrated in 9 steps of 6 DB each. An S8 signal, for example, is just twice as strong as an S7 signal. The sensitivity of the meter itself is relatively uniform up to S9, but at that point its sensitivity begins to fall off very rapidly.

If this were not an especially designed meter, signals much over S9 would hold the needle against the pin and no visual difference could be ascertained. By special design, Hammarlund engineers were able to obtain relatively high readings on moderately strong signals and still provide some indication of strength of signals in the order of several hundred microvolts, which ordinarily would provide full scale reading.

While no attempt was made to calibrate the area between S9 and full scale reading, the operator can easily determine differences in strength of signals, although they may be in the order of 500 to several thousand microvolts.

And that just about does it for this issue. We'll be back again at the same old stand, however, and don't forget our invitation to drop in at Newark with your problems.

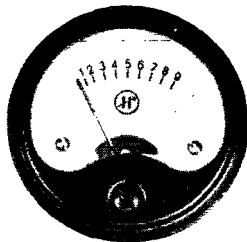

Chicago

Newark **ELECTRIC** Company New York

115-117 W 45th St.
NEW YORK 19
BRyant 9-4735
(ADOLPH GROSS)

212 Fulton St.
NEW YORK 7
BRyant 9-4735
(HY KAHN)

323 W. Madison St.
CHICAGO 6
DEArborn 0083
(SAM PONCHER)

Address N. Y. C. Mail to 45th St.

IF IT'S ON THE MARKET

RME-45



Features Cal-O-Matic two speed tuning, calibrated bandspread. Delivers peak performance from 550 Kc. to 33,000 Kc. Has DB signal level meter, five position Xtal filter, automatic noise suppression. Also stable, variable pitch beat oscillator, and many other features. A prime favorite with phone as well as CW operators.

\$186

YOUR COST

These are exciting days in amateur radio . . . and you can bet that Newark is right up on its toes in having all the latest HAM GEAR.

HAMMARLUND

Series 400
"Super-Pro"

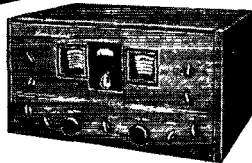

HAMMARLUND HQ-129-X

11 Tube Receiver

We are now delivering this sensational new set! Tuning range .54-31 mc. in 6 bands. Adjustable S-Meter, calibrated 1 to 9 in steps of approximately 6 DB. Variable selectivity crystal filter. Many exclusive patented features. Come in . . . see and hear this great receiver.

Complete with tubes and built-in power supply **\$129.50**

Designed for the man who prefers the best. Tuning range .54-30 mc. Has high image rejection, high sensitivity, low noise level. Complete shielding right up to the antenna terminals. Meets every need of the most critical professional or amateur operator.

★ **LIBERAL
TRADE-IN
ALLOWANCES**

NATIONAL NC-46

10 Tube Receiver

Fine performer at a moderate price. Excellent sensitivity throughout range of 550 Kc. to 30 mc. Circuit features amplified, delayed AVC, series valve noise limiter with automatic threshold control, CW oscillator. Also separate RF and AF gain controls. Push-pull output provides 3 watts, and AC/DC power supply is self-contained.

Just Released! NEW HALLICRAFTERS RECEIVER

MODEL S-38 • 6 TUBES

Announcing a low cost receiver with features every ham wants! Frequency range 540 Kc. to 32.4 mc. in 4 bands. Beat frequency oscillator, pitch adjustable from front panel. Maximum audio output—1.6 watts. 117 AC/DC operation. A smartly styled set. Complete with tubes, self-contained PM dynamic speaker.

YOU CAN GET IT AT *Newark*

Our motto, *You Can Get It At Newark*, means if it's on the market . . . we have it! Check Newark for all those hard-to-get items as well as easy-to-get equipment.

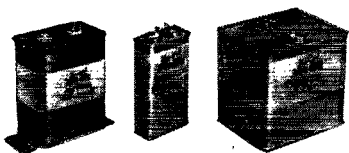

FILTER CONDENSERS

Fully guaranteed at rated voltages

CAP. MFD.	WORKING VOLTS D.C.	H	W	D	YOUR COST
1	1500	2-3/16	1 3/4	1"	\$.79
4	3000	3 3/4	1 3/4	3-5/16	3.75
8	2000	4 1/2	3 3/4	2 1/2	2.75
.15	4000	2 7/8	1 3/4	1	.89
.25	2000	3 3/4	1 3/4	1	.69
1.5	1000	2 7/8	1 3/4	1	.59
10	3000	4 7/8	3 3/4	3 1/4	4.75
13	1000	3 3/4	3 1/2	1 3/4	2.25
15	3000	4 3/4	4 5/8	3 3/8	5.25
8	3000	7 3/8	5 1/2	3 3/8	3.95
2+4	600	4 7/8	2 1/2	1 1/4	.80
5-5-15	1000	4 7/8	3 1/2	3 3/4	1.75

RME-84

Here's a recently announced receiver. Exceptional performance in the higher frequencies. Four tuning ranges, .54-44 mc., in 8 tube superheterodyne circuit. "Lock-in" tubes give high signal to noise ratio. Automatic noise limiter. Smooth vernier tuning control, and many other outstanding features. Compare for quality with anything in its price class.

YOUR COST **\$98.70**

★ **EASY TERMS**

SIGNAL CORPS HEAD SETS



Quality headset at a BARGAIN price! 8,000 ohms impedance. Rubber cushions. Adjustable headband. Built to Sig. Corps specs. 2,000 ohms D.C.

\$1.95 Your Cost, WHILE THEY LAST!

NATIONAL HRO'S
Are coming too!

★ Send name and address for monthly Bargain Sheets and big, new catalog.

Chicago New York

Newark ELECTRIC Company

115-117 W. 45 St. NEW YORK 19
Bryant 9-4735 (ADOLPH GROSS)

212 Fulton St. NEW YORK 7
Bryant 9-4735 (HY KAHN)

323 W. Madison St. CHICAGO 6
DEArborn 0083 (SAM PONCHER)

Address N. Y. C. Mail to 45th St.

XTALS • XTALS • XTALS

Mounted Low-Drift

3.5 M.C. and 7.0 M.C.

XTALS

± 5KC your specified frequency anywhere in 3.5 and 7.0 MC bands. Fits octal socket — has stainless steel electrodes — moisture resistant phenolic case and neoprene gasket seal.

Send cash or money order. No C.O.D. accepted.



Only

\$1.50

EACH

Postpaid in U. S. A.

COMMERCIAL EQUIPMENT CO.

1416-18 McGee St., Kansas City 6, Mo.



XTALS • XTALS • XTALS

(Continued from page 104)

VANALTA DIVISION

ALBERTA — SCM, C. S. Jamieson, VE4GE — 6EB, ex-4AEB, runs 40 watts to 807 final on 3.9 and 3.5 Mc. While in Edmonton 6YD worked several of the 28-Mc. gang from 6LQ's shack. 6WS, ex-4ABL, is running T40s in final with about 200 watts input. 6AE, ex-4AEA, keeps 28 Mc. hot. 6SZ is building a big rig. 6PP, ex-4AES, is heard on 3.9-Mc. 'phone. 60A has a 100-watt 'phone rig on 3.9 Mc. 6MJ, ex-5MJ, was one of the first 3.9-Mc. 'phones on, on April 1st. 6MO puts an FB 'phone signal into Edmonton. 6AL, ex-4ALO, will be heard on 3.9-Mc. 'phone. 6FK put out a nice signal with that 185-watt rig. 6AW built a new rig for 4AOZ. AW also built a rig for 6SW. 6EL, ex-4ANQ, 6XL, and 6SW have organized a radio club in Camrose. 6XE has cathode-modulated 807s on 28 Mc. 6AC gets out FB on 3.9 Mc. using bed-spring for antenna. Frank Gue's new call is 6FF. 6DR is back on 3.9 Mc. 'phone. 6OD built a new shack. 6SR, ex-4AEP, runs 250 watts to a pair of T40s. Ex-4APA now is 6MP, ex-4AHZ is 6HZ, ex-4BJ is 6DD, 4ACR is 4AC, ex-4AET is VE7GW. 6LA gets reports from Australia on 28 Mc. 6HM and 7FG, ex-5FG, have nightly schedule on 3.5 Mc. c.w. 6JP is back on. Ghost Pine Creek is represented by 6HB. 6EA recently completed a battery-operated rig and receiver for 6CE, ex-5CE, who is blind. 6BY, ex-4ADD, is working on new rig which will use 829 final. 73. VE61Q.

PRAIRIE DIVISION

MANITOBA — SCM, A. W. Morley, VE4AM — 3.5 Mc. opened with a bang. 'Phone stations active are QV, AC, ABV, IF, AP, and JM. C.w. has HD, IH, SO, NO, RO, DF, and AM. Twenty-six hours before the deadline someone was heard to remark, "Gosh, QRM already." AAI has his new rig ready to go but helping others seems to keep Alec off. With rearranging of call areas no one knows who's who. RB is active at Killarney. ADO is on at Deloraine with a pair of 6V6s. II is looking for a receiver. JN, at Waskada, has a new Hallicrafters. AM/JM spent a week getting R3-4 locally and finally quit blaming it on the sky-hook and started rebuilding. The XYL has the 'phone bug so it looks like the OM might forsake c.w. to keep peace in the family. How about your traffic reports? 73. Art.

Postwar Receivers

(Continued from page 25)

long as the condition exists. A switch not shown in the diagram short-circuits the limiter diode when not in use.

Audio Amplifier

The audio output from the second detector goes to a conventional audio gain control which controls the signal fed to the first audio stage. This audio stage is one section of a 6SN7 twin triode, and the other half of this tube is used as a d.c. amplifier for the S meter. A 6V6 audio output amplifier is used to give 3-watts output, and the headphone jack is connected across the 6-ohm output coil of the output transformer. Plugging in the headphones disconnects the speaker. A 5U4G is used in the power supply.

— B. G.

SWITCH TO SAFETY!



Overture

TO A NEW ERA IN SOUND

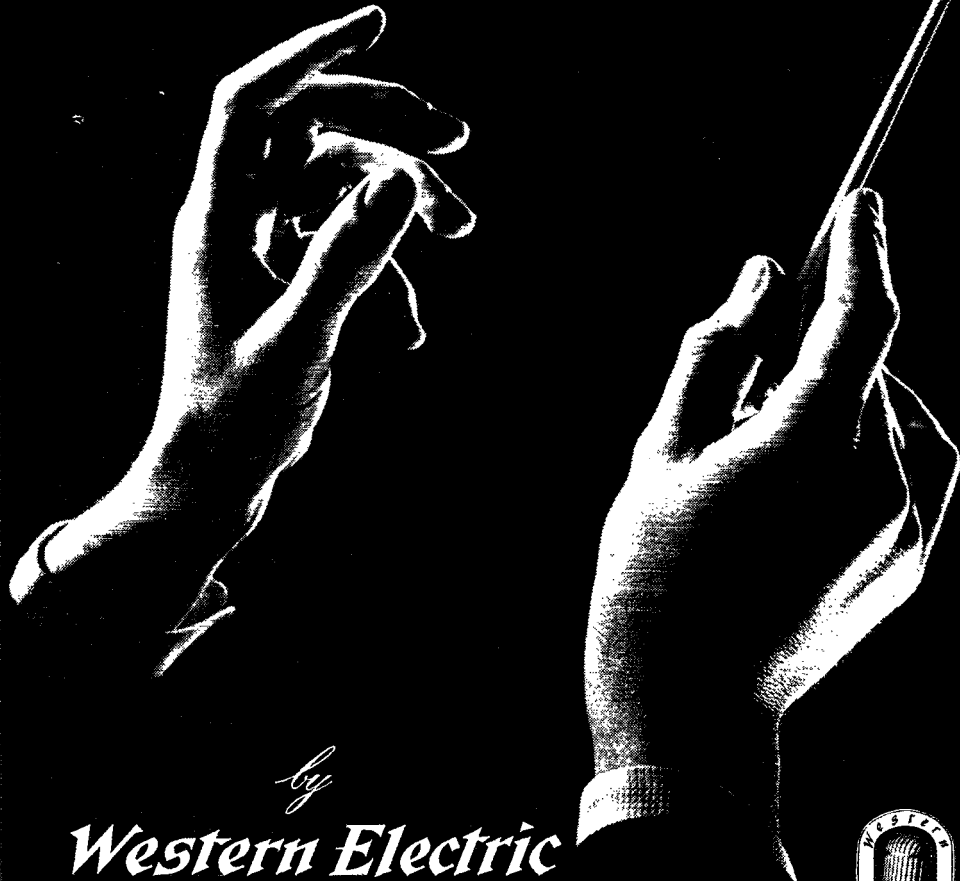

by
Western Electric



HAVE you ever heard a sound system with such natural tone, such emotional quality, such "presence" that you didn't know instantly that a sound system was in action? It's pretty safe to say you never have. But now you can!

Revolutionary advances born of wartime research have resulted in a new Western Electric

loudspeaker that reproduces speech and music with unsurpassed fidelity.

You'll find it hard to believe you are listening to *reproduced* sound rather than the original. That is why this new Western Electric loudspeaker is destined to open a new era in all fields of sound reproduction.

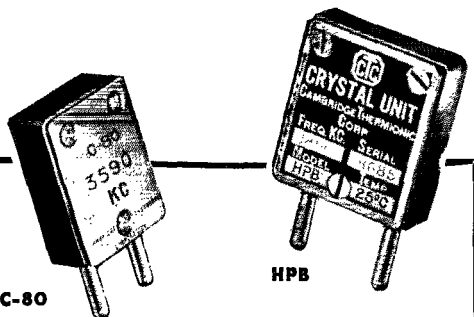

**FOR OUTSTANDING PERFORMANCE —
CHOOSE C.T.C.**

"Mathematically Dimensioned"
CRYSTALS

You get low drift and high activity in every C.T.C. Crystal—thanks to "mathematical dimensioning," the C.T.C. discovery for predetermining the crystal dimensions which consistently yield excellent performance. Yet this is but one of 21 vital checks and tests that go into the painstaking development of each and every C.T.C. Crystal to protect and insure its quality.

C.T.C. Crystals come in two types of holders—"C" to fit octal sockets and HPB to fit 5- or 6-prong sockets, for amateur frequencies in the 20, 40 and 80 meter band. Kilocycle spreads include — 20 meter band—14,000–14,750 kc; 40 meter band—7000–7300 kc; 80 meter band—3500–4000 kc.

*Write for
C.T.C. Crystal Bulletin today*



CAMBRIDGE THERMIONIC CORP.
451 CONCORD AVENUE
CAMBRIDGE 38, MASSACHUSETTS

Mobile Rig

(Continued from page 35)

and they are ideally suited to this application. Ours is a dual unit and we use the two sets of contacts connected in parallel. It comes mounted in a shielded assembly and equipped with two fuses; yet the price was only \$1.75! In the writer's car the battery is mounted under the hood, alongside the engine, so the genemotor and relay were mounted on the firewall. Power leads are in a 7-wire shielded rubber-covered cable, the shield acting as the negative lead. Two wires are connected in parallel to serve as the positive filament lead for minimum voltage drop. Battery leads are No. 10 rubber-covered wiring.

The antenna used thus far is the conventional quarter-wave whip with concentric feed at the bottom end, but provision is made for plugging in other antennas having coaxial feed. The whip is fine for mobile work, but we look forward to some mountain-top excursions during the coming summer, and we plan to have some sort of knocked-down array which can be assembled on the spot and hoisted into a tree or a fire tower, in order to improve our chances of working a little choice DX while we enjoy the New England scenery!

Mobile Coverage

At this writing the rig has been installed in the car only about a week, and as 50 Mc. is the writer's main interest in life, only that band has been tried under mobile conditions. The receiver in use at present is a simple two-tube superregen, formerly used on 112 and 144 Mc. Even with this unsatisfactory receiving arrangement some mighty nice contacts have been made. The reliability of the coverage we've obtained has been something of a surprise when we recall the difficulties we used to have with our first mobile rigs back in the early '30s, and our more recent experiences on 112 and 144 Mc. Almost everyone on 6 meters these days has a good antenna, a highly-sensitive receiver, and a fairly-powerful transmitter. The coverage of the average station is vastly improved over the old days when receiving-tube rigs and superregenerative receivers were standard practice for home-station use. The great improvement in fixed-station technique makes for much greater range with the mobile job, and we've found that contacts are quite solid up to distances of thirty miles or more, even in hilly New England.

Our last experience with 28-Mc. mobile was back in 1937, but even then we found it not too difficult to raise a W5 or W6 with our mobile rig on Ten. With the coming of the summer period, DX opportunities are fading on 10, but there is enough activity on that band to make things mighty interesting for the mobile enthusiast. The summer short-skip contacts should be made easily with this mobile job, and next fall we hope to knock off some real DX with the little rig. In the meantime, work with the locals will help to keep interest going on the band.



RME Owners Say!

156 South Second St.
Columbia, Penna.
March 1, 1946.

RADIO MFG. ENGINEERS, INC.
L. A. MORROW, Sales Manager
Peoria, 6, Illinois

Dear Sir:

Just a few lines to let you know how much I really appreciate the RME 45 I recently purchased. It was just a month ago yesterday that it arrived. I must say it is beyond my expectations. I have logged amateur stations on all continents, except Australia, during the times that I have been permitted to listen in. Only this evening I was able to pull in some real DX, namely, EPIC, Iran; HZ2YY, Hedjaz (Arabia); and TFLAM, Iceland; and, of course, South American stations. All these referred to were on 20 meters CW. And it really does a beautiful job on 10 meters, where some real DX has also been received.

Selectivity, sensitivity, stability, with a plus sign] after each, are all to be found in the RME 45. QRM has not presented much of a problem, due to the very efficient crystal filter. Boy, it really works, and how!

It is with much anticipation that I look forward to many happy hours twirling the dial of my RME. Truly, I can say with others, it is without comparison. I believe it can only be excelled by another RME.

Vy 73's,

Wilbur E. Righter, W3FSE

.....

P.O. Box 2127
Cristobal, Canal Zone
Jan. 8th, 1946

Radio Mfg. Engineers, Inc.
Peoria 6, Illinois, U.S.A.

Dear Sir:

I have an RME 69 now. The moisture got the rest in seven years or less in the same time I have had three other Commercial receivers and they went in about two years or less — so it is hats off to RME.

Hoping to place my order for the RME 45 after having the latest data from you, I remain,

Nicholas L. Poppelreiter, EX-K5AD



FINE COMMUNICATIONS EQUIPMENT
RADIO MFG. ENGINEERS, INC.
Peoria 6, Illinois U. S. A.

**AARON LIPPMAN HAS
IN STOCK at all Times**

**RADIO PARTS and
ELECTRONIC COMPONENTS**

produced by the leading manufacturer's in America today; namely

CARDWELL	NATIONAL
HAMMARLUND	PAR-METAL
I.R.C.	R.C.A.
KENYON	STANCOR
P.R. MALLORY	THORDARSON
MILLEN	U.T.C.

AND OTHERS

Quantities are still limited in many items but we will endeavor to fulfill as many orders as we receive, promptly.

Here are just a few values!

SIGNAL CORPS KEY.....J-38

3/8" Contact; shorting arm; beveled bakelite base; rugged construction. Special..... **\$1.95**

HIGH FREQUENCY COAXIAL CABLE

Reg. Price 19¢ NEW LOW PRICE **12¢** per ft.

TYPE RG8U—51 Ohms will handle 1.5 Kilowatts extremely low loss. 2.5 DB per 100 ft. @ 100 MCS.

RG22U at 95 Ohms 2 conductor balanced coaxial line—excellent for Television. **6¢ per ft.**

New Low Price **15¢** per ft. RG7U at 97.5 Ohms. Price **11¢** per ft.

Special Value in
OIL FILLED TRANSMITTING CONDENSER
Type TJL 6060—6MFDS. 600 Volts

Special Price **\$1.45**

We are Radio Parts Jobbers of all standard nationally known brands of merchandise especially adapted to "Hams" and Shortwave listeners. We welcome your mail order trade.

PUT YOUR NAME ON OUR MAILING LIST

Send your name and address on post card and receive all our announcements of special bargains and available new items from time to time.

AARON LIPPMAN
and COMPANY

246 Central Ave. Newark 4, N. J.
MITCHELL 2-3065-6-7

Technical Topics

(Continued from page 48)

conditions is given by ²

$$C'_{gp} = \frac{2(1 + \frac{R_p}{R_L})}{2\pi f \mu R_g} \quad (1)$$

where R_p = tube plate resistance
 R_L = shunt resistive component of plate circuit
 f = frequency
 μ = amplification factor of tube
 R_g = shunt resistive component of grid circuit

The equation shows, as one might expect, that increasing the voltage gain of the stage by increasing the load resistance, R_L , reduces the allowable grid-plate capacity or, stated another way, that increasing the load resistance — reducing the coupling to the load — increases the tendency for self-oscillation with any given value of grid-plate capacity. This is common in many tetrode amplifiers that are stable if loaded heavily enough but which oscillate when the load is removed.

Increasing any of the terms in the denominator will also reduce the allowable grid-plate capacity, which is another way of saying that, for any given grid-plate capacity, increasing any of the terms in the denominator will increase the probability of oscillation. Thus a higher operating frequency, lower fixed bias on the tetrode (resulting in higher μ) or lighter grid loading can bring about oscillations through grid-plate capacity.

Substituting some typical values in (1) will give a better idea of the magnitude of values under discussion. For example, taking $R_p = 0.1$ megohm, $R_L = 3000$ ohms, $\mu = 300$, $R_g = 5000$ ohms, and $C'_{gp} = 0.2 \mu\mu\text{fd.}$, and solving for the frequency f , we find that oscillations could occur at 35 Mc. Of course, these oscillations might not show up because of cathode-lead inductance introducing degeneration and consequently modifying the above result, but it does demonstrate that the 0.2- $\mu\mu\text{fd.}$ value of grid-plate capacity, a typical one for beam tetrodes, is far from negligible.

It takes very little work to show why normally the grid and plate circuits cannot be unloaded simultaneously. Unloading the plate circuit with the above conditions might send the plate load up to 50,000 ohms and, keeping the other values the same, would give a frequency of about 3.2 Mc. above which the amplifier could be unstable. Loading the plate circuit again with 3000 ohms, but unloading the grid circuit up to 50,000 ohms, would bring the frequency to 3.6 Mc. Reducing the loading in both grid and plate circuits simultaneously, to the 50,000-ohm value, would bring the frequency above which oscillation could take place to 0.32 Mc.!

(Continued on page 116)

² Mouromtseff, "Tuned-Grid Tuned-Plate Oscillator," Communications, August, 1940.

UNITED *Announces*

THE GREATEST DEVELOPMENT IN GRAPHITE ANODE TUBES!

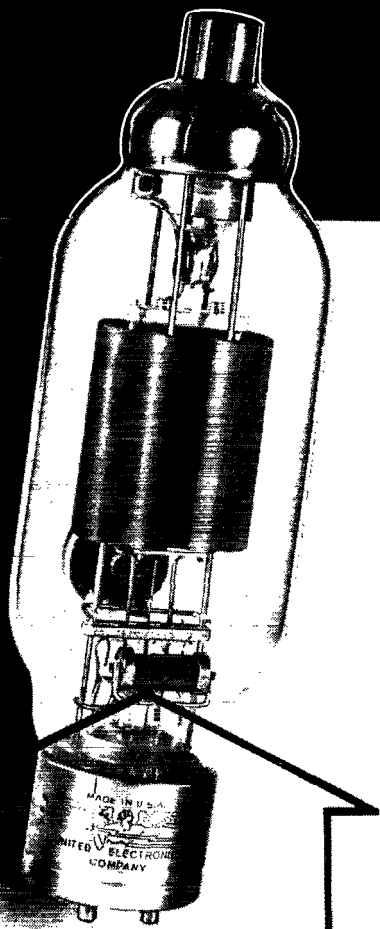

LOOK FOR THIS
"GETTER TRAP"
on all UNITED TUBES

Forecasting Higher Input and Efficiency Ratings

It is the consensus of opinion among electronic engineers, as a result of war experience, that graphite is superior to metal for internal anode tubes because of *unsurpassed thermal and non-warping properties.*

Heretofore, the enormous heat dissipating capacity of graphite anodes has been impeded by the use of free getters which deposited heavily on the bulb and tube elements.

The development of the *Isolated Getter Trap* by United has finally eliminated this long standing barrier to the full utilization of the superior features of graphite.

Gas content of these new United graphite anode tubes *average lower than that of any metal anode tubes of comparable size, and no gas can be liberated even on severe overloads.*

Available now with this new construction are types; HV-18, KU-23, 849, 838, 204A, 949A, 949H, V-70-D, 812H, and all of the diathermy types.

Order direct or from your Electronic Parts Jobber

UNITED ELECTRONICS CO.

NEWARK, 2  NEW JERSEY

Transmitting Tubes **EXCLUSIVELY** Since 1934

For Reliable Service call **RADIO SHACK** first

You don't need to let shortages keep you off the air . . . you can get all sorts of radio gear at the Radio Shack . . . our large stocks include plenty of regular items and lots of selected "surplus" bargains . . . we can't list 'em all, so no matter what you want, come in and see us . . . or check up by phone. Remember, it's Radio Shack for Reliable Service.

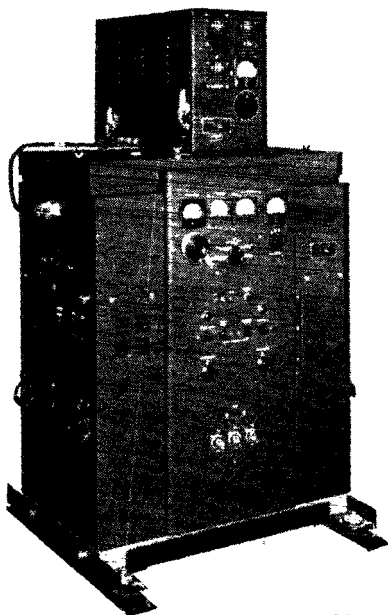

Ready to Use!

ON 10, 20, 40, & 80 METERS HALLICRAFTERS BC-610 XMTR

450 watts CW — 325 watts phone

No Modification No Conversion

ONLY \$535.00 COMPLETE
with speech amplifier, tubes, coils.
Factory-tested and ready to go.

ANTENNA TUNING UNIT AT-3
shown in place on transmitter; tunes
any single-wire antenna; continuously
adjustable. Net Price **\$74.50.**

TIME PAYMENTS

You can buy these units on these easy terms.

BC-610 Xmtr alone **\$178.50** down.

BC-610 Xmtr, with AT-3 Tuner
\$203.50 down; balance (including
small service fee) in equal monthly
payments over one year.

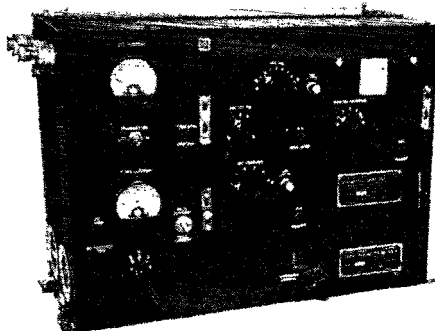

80 METER XMTR — 25 WATTS BC-223-A for phone, CW, or ICW

Here's a real bargain you can use either as a regular xmtr or as an exciter; 5-tubes include 801 osc, 801 PA, 46 speech amp, and two 46's class B mod; panel switch selects MOPA or any of four crystal frequencies; small enough for mobile or marine use; simple modification required for 80-meter operation; for use with external 500 volt dynamotor (not included); variometer tuning unit; plate and r-f meters. Net Price (complete with tubes) **\$37.50**

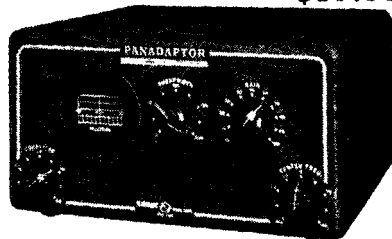

PANADAPTOR . . . lets you SEE where you're working! Panoramic reception — the modern operating technique — is yours with this PANADAPTOR added to your receiver; helps locate those "hard-to-find" signals; lets you watch a 200 kc section of the band wherever you choose; revolutionizes and simplifies your receiving and transmitting practises; furnished complete with ten tubes and full operating instructions. In stock for immediate delivery at only **\$99.75**

HIGH FREQUENCY SUPERHET

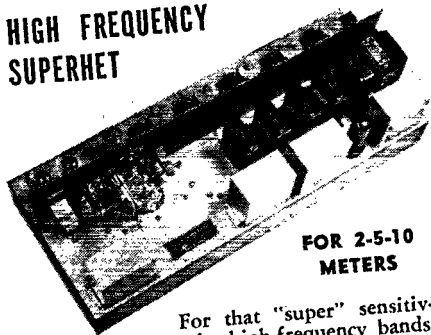

FOR 2-5-10 METERS

For that "super" sensitivity you want in the high-frequency bands, you'll want this 15-tube superhet. It's the famous radar-type BC-406 receiver easily adaptable to amateur use as described by Henry Geist, W3A0H, in February CQ. Designed for "super" service and using all super-quality components, this outfit lets you have the benefits of a superhet for high-frequency use at very low cost. Complete BC-406 superhet, including broad-band IF's, power-supply with 4-section filter, and 15 tubes including 5 acorns . . . net price \$27.50 plus \$1.50 packing charge.

And all these Standard Receivers! NATIONAL

- () NC-2-40-C\$225.00
 - () NC-46 ac/dc — to be announced
- More HRO's soon

HAMMARLUND

- () HQ-129-X complete\$139.50
- () Super-Pro — to be announced

R. M. E.

- () RME-45 complete\$186.00

HALLICRAFTERS

- () S-22R Sky rider Marine\$74.50
 - () S-36A VHF FM-AM with speaker 322.00
 - () S-38 39.50
 - () S-39 Sky Ranger 110.00
 - () S-40 Complete 79.50
 - () S-41G Complete 33.50
 - () SX-25 Super Defiant 109.50
 - () SX-28A Super Sky rider 238.00
- All prices net FOB Boston

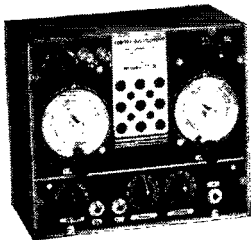

ABBOTT TR-4

The best-known rig for 2-meter use; immediate delivery from the Radio Shack.
Net price \$43.00
Kit of tubes \$8.30

108 PAGE CATALOG
FREE ON REQUEST

SPECIAL · SPECIAL · SPECIAL

General Electric RF Ammeter
Brand new, round, 2", 0-1 ampere
RF meter; black scale; luminous-tip pointer; \$4.45 ea. net.



STANCOR TRANSFORMERS AND CHOKES

- 1 Filter choke — 20 henry, 75 ma, 650 ohms \$1.60
- 2 Filter choke — 4 henry, 80 ma, 150 ohms 1.06
- 3 Input filter — 8.8 henry, 500 ma, 50 ohms (7500 volt test)..... 8.90
- 4 Audio input transformer 200 or 400 ohm line to 80,000 ohm (grid); hum-bucking type, with 'static shield..... 4.25
- 5 Audio output or modulator — for low-power modulation or transceiver use; matches single 6K6, 6G6, 6V6, or 6F6 to 6 ohm spkr or monitor load..... 2.95
- 6 Pwr trans — Pri 115 v 60 cycles 250 va; sec 550 v 450 ma; delivers 450 ma at 500 vdc with bridge rectifier 6.90
- 7 Fil & plate trans — pri 115 v 60 cycles; sec 600 v CT 70 ma; 13.1 v 5a; 5v 2a; 5v 3a; 5v 6a. 6.90
- 8 Audio modulation trans — for PP parallel 6L6 Class AB (3500 ohms) 100 ma into parallel 807 Class C at 210 ma r-f load (2000 ohms) 5.95

COAXIAL DIPOLE

Ideal for 144-148 mc work; matches 50-55 ohm lines; continuously adjustable; weather-resisting construction.

\$12.50 net

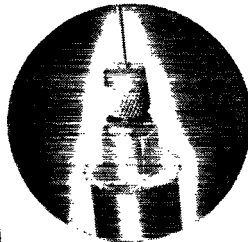

The RADIO SHACK

167 WASHINGTON ST.
BOSTON, MASS., U.S.A. ★

STATION TESTED*

*an added
proof of Quality!*



*Pres. W. A. Kuehl is shown at his amateur radio station W9EZN. With the war over, Walt is again pursuing his favorite hobby.

DRAKE RADIO SOLDERING IRONS

Yes, Drake irons are *right for radio*. And these sturdy irons have proved their dependability and worth in use on countless other jobs, too, for over 25 years. That's why we say — whatever your needs, you are certain to find a Drake iron that fills the bill exactly!



600-10—the Drake No. 600-10 is ideal for those all important connections when rewiring your rig. Get back on the air fast. Make good dependable connections with this 100 watt $\frac{3}{8}$ " tip.



400—the Drake No. 400 is the perfect iron for work in small places. Only 9 inches long, it is especially designed for tight corners and delicate connections. 60 watt, $\frac{1}{8}$ " tip.



Ask your nearest supplier or write for the name of the distributor nearest you . . . and give yourself the advantages of these superior irons.

DRAKE ELECTRIC WORKS, INC.

3656 LINCOLN AVE.

CHICAGO 13, ILL.

(Continued from page 118)

The value of R_g is the parallel sum of several resistances in the grid circuit. The coil losses and dielectric losses in the tube and circuit are present all of the time, but R_g will be high if the circuit and tube are good. When the tube is drawing grid current, the grid loads the circuit in the same way that a diode rectifier does, and the plate resistance of the driver stage also shunts the circuit. If the tetrode is not biased to cut-off — or to a point where the μ is very low — and there is no excitation, the grid circuit must be loaded in some manner if the value of R_g is to be kept low enough to avoid oscillation. A fixed resistor could be shunted across the grid circuit, but its value would have to be low and it would consume a large percentage of the power from the driver stage, reducing the economy of driving power that is one of the features of tetrodes. Consider, however, the choice of driver tube and its operation. In a c.w. transmitter keyed ahead of the driver stage and with the driver stage biased beyond cut-off, the driver stage introduces negligible resistance across its plate circuit (the tetrode's grid circuit) under key-up conditions, and hence the conditions are more favorable for oscillation. By reducing the bias on the driver stage or, better yet, by using a zero-bias triode, without excitation the driver tube will act as a low-resistance diode across the circuit and hold down the R_g to a very low value. With the key down, the plate of the driver stage and the grid current drawn by the tetrode combine to load the circuit. In a 'phone transmitter, with a modulated tetrode, the driver tube should be one that loads the grid circuit heavily, for the reasons given above.

The use of link coupling to the grid circuit of a tetrode has practically no advantages, except possibly in the case of a string of tetrode doubler stages where oscillation is no problem. For straight-through operation, however, heavy coupling is not always readily obtainable and consequently the grid-circuit loading with link coupling may not be heavy enough to prevent oscillation under all practical conditions.

— B. G.

Making the Most of It

(Continued from page 60)

before you build, or you may find that your ideas cost more money than you can afford. A few ideas built into the radio shack will probably improve convenience and comfort in operating, and efficiency as well, more than anything that can be added later, and they'll cost far less. For instance, my receiving antenna leads are nearly invisible, since they run along the ceiling molding. The power terminals provide ample capacity for any rig I will ever want to operate. The appearance is usually a source of favorable comment from visitors. The built-in shelves accommodate my QST's to perfection. And numerous other satisfactions occur from the fact that my ham radio room was built for the job.

S. WILLARD BRIDGES
293 SUMMER STREET
BOSTON 10, MASSACHUSETTS

April 9, 1946

Panoramic Radio Corp.
242 West 55th Street
New York 19, N.Y.

Attention: Mr. Bernard Schlessel

Gentlemen:-

It is seldom that I have purchased a piece of radio equipment and found it far superior to my expectations, but the Panadaptor that I purchased from the Radio Shack in Boston about two weeks ago has certainly out-performed anything I had hoped for.

I have used the Panadaptor primarily as a monitor for the 10 meter band in conjunction with an NC 200 Receiver, and I find it priceless for band coverage between transmissions. Today I discovered I was paying no attention whatsoever to the receiver dial but was controlling my receiver entirely from the scope screen where I could see the field both sides of the frequency to which I was tuned.

This is a fine unit and I know you will sell a great many of them.

Yours very truly,

S. Willard Bridges
S. Willard Bridges

swb:k

"PRICELESS"

FOR BAND COVERAGE . . .

CONTROLLING RECEIVER ENTIRELY . . .

Letters arrive daily . . . all enthusiastic

. . . all agree that PANADAPTOR

"out-performs anything hoped for."

To fully appreciate ALL that this amazing instrument offers, you must SEE

PANORAMIC RECEPTION

"Blind" operation is now a thing of the past . . . as outdated as the kerosene lamp for illuminating your home. Some radio amateurs may continue to "rough" it without a PANADAPTOR . . . but all modern shacks will have it.

PANADAPTOR Model PCA-2
Now Available at Leading Radio Parts Jobbers. Ask for demonstration. Amateur Net Price, complete with ten tubes and accessories for 115 V., 50-60 cycle operation.

\$99.75

ONE YEAR GUARANTEE
against defects in parts or workmanship (excluding tubes). Panoramic Handbook with full installation, operating, application and maintenance instructions furnished with each PANADAPTOR.

PANADAPTOR is the "EYE" of your rig. It lets you SEE holes in busy bands, SEE the signal characteristics of your own and other stations, SEE short calls. It shows you 200 kc of any band instantly, helps you locate your sked and avoid annoying QRM. PANADAPTOR makes radio more fun for you, by making operation of your station more efficient . . . smoother . . . easier. You owe it to yourself to see the PANADAPTOR — now on display at leading radio jobbers.

Exclusive Canadian Representative: CANADIAN MARCONI, Ltd.

PANADAPTOR, featuring PANORAMIC RECEPTION, is the exclusive and original design of PANORAMIC RADIO CORPORATION

PANORAMIC

CABLE ADDRESS
PANORAMIC, NEW YORK



RADIO CORPORATION

242 250 WEST 55TH ST New York 19, N.Y.

(Continued from page 58)

REGULATION

§12.136. LOGS. Each licensee of an amateur station shall keep an accurate log of station operation, including the following:

(a) The date and time of each transmission. (The date need only be entered once for each day's operation. The expression "time of each transmission" means the time of making a call and need not be repeated during the sequence of communication which immediately follows; however, an entry shall be made in the log when signing off so as to show the period during which communication was carried on.)

(b) The signature of each licensed operator who manipulates the key of a radiotelegraph transmitter or the signature of each licensed operator who operates a transmitter of any other type and the name of any person not holding an amateur operator license who transmits by voice over a radio-telephone transmitter. The signature of the operator need only be entered once in the log, in those cases when all transmissions are made by or under the supervision of the signatory operator, provided a statement to that effect also is entered. The signature of any other operator who operated the station shall be entered in the proper space for that operator's transmission.

(c) Call of the station called. (This entry need not be repeated for calls made to the same station during any sequence of communication, provided the time of signing off is given.)

(d) The input power to the oscillator, or to the final amplifier stage where an oscillator-amplifier transmitter is employed. (This need be entered only once, provided the input power is not changed.)

(e) The frequency band used. (This information need be entered only once in the log for all transmission until there is a change in frequency to another amateur band.)

(f) The type of emission used. (This need be entered only once until there is a change in the type of emission.)

(g) The location of the station (or the approximate geographical location of a mobile station) at the time of each transmission. (This need be entered only once provided the location of the station is not changed. However, suitable entry shall be made in the log upon changing the location. Where operating at other than a fixed location, the type and identity of the vehicle or other mobile unit in which the station is operated shall be shown.)

(h) The message traffic handled. (If record communications are handled in regular message form, a copy of each message sent and received shall be entered in the log or retained on file at the station for at least 1 year.)

Convenient ————— Complete

THE ARRL LOG BOOKS

Regular Log, 8½ x 11
35¢ each, 3 for \$1.00

Mini-Log, 4 x 6¼
25¢ each

American

RADIO RELAY LEAGUE
WEST HARTFORD, CONN., U.S.A.

ing that they don't have their self-addressed stamped envelopes in the right places. The smart lads have been getting good service, because no QSL Manager wants to keep the cards around, what with the housing shortage and all.

Predictions:

If you have a predilection for predictions, this paragraph is your personal palanquin to pertinent prophecy. But if you want to work a lot of DX on 10 in June, you can expect to dig for it and hard. The charts show that the East Coast can get down to South America with some consistency and the West Coast shouldn't have any trouble with ZLs and VKs, but the rest is going to be fairly spotty. There will be a lot of North-South work in Africa and the Pacific Islands.

Where no maximum usable frequency is shown it means the 28-Mc. band should be open during the period — a single time indicates when the corresponding m.u.f. is reached.

Path	Max. Usable Freq. (Mc.)	Time (GCT)
Washington — S. F.	26	0130
Washington — Rio		1630-2200
Washington — Paris	24	2130
Washington — Manila	22.6	0130
Washington — Sydney	27	0100
Washington — Johannesburg	24.5	1730
S. F. — Rio	27	2200
S. F. — Paris	21	2300
S. F. — Manila	26.5	0600
S. F. — Sydney		2030-0630
S. F. — San Juan, P. R.	27	0100
S. F. — Johannesburg	22	1800
N. Y. — San Juan, P. R.		2330

— WJPE

Code Proficiency

(Continued from page 54)

c.w. telegraphy. Even though this section is temporarily suspended, all amateurs want to keep at top proficiency and be ready for any test. This program is ideal for the purpose.

There's opportunity for you in the ARRL Code-Proiciency Program. The handsome certificate award has been designed to recognize your ability in this particular. Every amateur is invited to qualify for this certification in the basic art of the amateur. Start listening to the practice runs at any time, establish regular practice periods, operate all you can. Be ready for the first postwar *qualifying runs*, and send us your best copy of same for check so we can prepare your certificate award or endorsement!

**SWITCH
TO SAFETY!**





JOE MACJERK'S
STICKING HIS
FINGERS IN HOT
TELEVISION SETS
AGAIN!

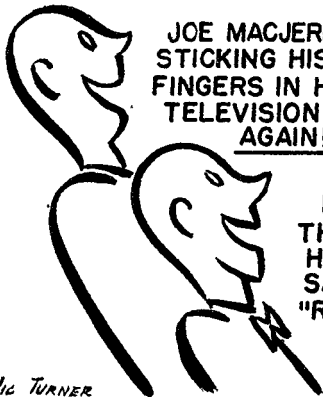

LAST TIME
THE BOSS SWORE
HE'D CUT JOE'S
SALARY AND BUY
"RADIO
MAINTENANCE"
FOR HIM!

Vic Turner

For
optimum
performance
in the
service
field
USE
Radio
Maintenance
Magazine.

*Special offer to
Radio Servicemen*

Articles monthly on:

- Television — AM — FM
- Public Address Systems
- Test Equipment — Tools — Service Kit
- Shop Layout — Service Bench
- Trouble Shooting
- Business News

Radio Maintenance

is not sold on
newsstands

RADIO MAINTENANCE MAGAZINE

460 BLOOMFIELD AVE., MONTCLAIR, N. J.

Please send me
RADIO MAINTENANCE

- For 1 year 2.00
- For 2 years 3.00

NAME _____

OCCUPATION _____

ADDRESS _____

CITY _____

ZONE _____ STATE _____

- CHECK ENCLOSED*
- BILL ME LATER

*NOTE: By enclosing payment,
thus eliminating billing expense

WE WILL ADD ONE ISSUE FREE!

TYPE--400 Antenna Relay

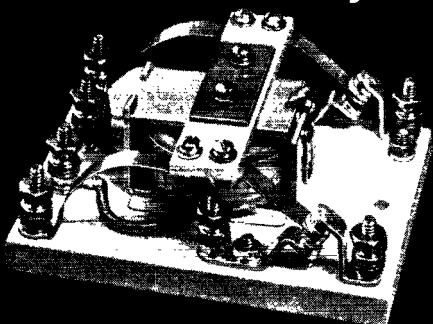

by **ADVANCE**

The advance type "400" relay is designed for switching any antenna open-wire transmission line, as well as for RF and high voltage switching applications. Ideal for multi-antenna installations where several transmission lines must be changed. The "400" is a double-pole double-throw relay. Contacts are 1/4" pure silver and rated at 10 amperes at 110 v.a.c. Base and crossarm are Steatite. Standard coil voltage is 110 v.a.c. but other voltage coils, both a.c. and d.c., are available.

Amateur Net Price \$5.40
(At Your Jobber)

Catalog of complete line of relays sent, free upon request.

Advance Relays



ADVANCE ELECTRIC & RELAY CO.

1260 West 2nd Street
Los Angeles 26, Calif., U. S. A.

Phone Michigan 9331

CODE SENDING SPEED RECEIVING

Have Skill, Accuracy

Be a "key" man. Learn how to send and receive messages in code by telegraph and radio. Commerce needs thousands of men. Expansion of air commerce and freight after war should create an even bigger peacetime demand for operators. The famous Candler System, maker of world's champions, teaches you the "knack" of sound sense and sound consciousness that is the secret of speedy sending and receiving. Good pay, adventure. Learn at home quickly.

FREE 52-PAGE BOOK explains extra course of training. Rush name for it today. It's absolutely free.

CANDLER SYSTEM CO.
Dept. 4-G, P. O. Box 928, Denver 1, Colo., U. S. A.
and at 121 Kingsway, London, W.C. 2, Eng.

50 Mc

(Continued from page 61)

sary on all but the very best nights heretofore. Readable signals have been exchanged under conditions when no signal at all could be heard when vertical dipoles were substituted at both ends of the circuit.

Our observer in the experimental phase of this antenna project was WIAEP, Springfield, Mass., who had horizontal polarization and is just about the right distance for reliable tests. After our tests he hauled down his 4-element close-spaced array and went through a similar test with a folded doublet and wider spacing. He duplicated our results, obtaining higher gain with three elements than he had formerly obtained with four in the same physical space.

Who's on 6 Meters?

We've received numerous requests for information on the activity on 6. Until recently, we've just not had anything to pass on, but things are looking up, and more fellows are coming on every day. Here are a few active stations and frequencies. How about adding yours?

WIAZ, Springfield, Mass., 50.1
WIAEP, Springfield, Mass., 50.09
WIAKD, Dorchester, Mass., 50.01
WICLS/1, Waltham, Mass., 50.04
WILLL, Hartford, Conn., 50.2
WIJLK, Tolland, Conn., 51.57
WIBJE/1 (mobile), 51.58
WICGY, Athol, Mass., 52.35
W9UNS, Marshall, Ind., 52.8
W8DDO, Detroit, Mich., 52.0
W8LZN, Detroit, Mich., 50.08
W9VWU, Topeka, Kansas, 50.4
W9ICV, Topeka, Kansas, 50.2
WIKJC, Wethersfield, Conn., 50.86
WINKZ, Glastonbury, Conn., 50.9
WIHDQ, West Hartford, Conn., 50.015
WIHDQ/1 (mobile) 50.54
W8SUL, Toledo, Ohio, 51.35
W8JLQ, Toledo, Ohio, 50.4
W6OVK, San Francisco, Calif., 50.2
W6QAP, Tucson, Ariz., 50.1
W8AZZ/8 (mobile) 52.8
W8NKJ, Detroit, Mich., 50.68
WIAW, Newington, Conn., 52.000
Minute-men (Boston area), 51.00

New 144-Mc. Records!

The opening of the 80-meter band April 1st made a big hole in the 2-meter activity for a while, but it is coming back gradually. Conditions during the month of April were not conducive to long-haul work, for the most part, and were something of a let-down for some of the gang, after the early-spring temperature inversions of March. On March 29th, one of the best nights to date on 144 Mc., many contacts beyond 100 miles were made along the Atlantic Seaboard, a number of them being over distances beyond the 120-mile record set on March 17th by W3HWN and W3GMY.

Best DX reported was a contact between WILAS/2, Rye N. Y., and WIIVA, Fall River, Mass., a distance of 145 miles; WIDP, also of

(Continued on page 184)

Crystalab

TRADE MARK REG. U. S. PAT. OFF.

Presents Crystal Kits without blanks...

Crystal kits #1 and #2 with blanks in 7MC Range were greeted enthusiastically. Some of you suggested kits without blanks, and Crystalab was quick to see the merit of this idea. Blanks are available, 5 to a card, for operation in any band from 2 to 80 meters, and any frequency from 3.5 MC to 8.22 MC.



\$5

NET PRICE

Buy your blanks
separately in the
frequency range
you want.



\$5

NET PRICE

CRYSTAL KIT #3

- 5 Holders CRL-16.
- 5 Complete sets: springs, electrodes, covers, gaskets, screws.
- 1 Lintless cloth for drying.
- 1 Package fine abrasive for finishing.
- 1 Package medium abrasive for rough lapping.
- 1 Lapping Button
- 1 Lapping Plate
- 1 Blueprint of Selector Switch.
- 1 Set Photographs of Selector Switch
- 1 Illustrated Instruction Book.

See your Local Radio Dealer

MAKE YOUR OWN SELECTOR SWITCH

With this Crystalab Kit, and easily obtainable standard parts, you can make a Selector Switch, like the one illustrated, which will accommodate 10 CRL-16 crystals, to give your rig the utmost flexibility for shifting frequency.



CRYSTAL RESEARCH LABORATORIES

INCORPORATED

LABORATORIES AND MAIN OFFICE: 29 ALLYN STREET, HARTFORD 3, CONN.

New York Office: 15 E. 26th Street, New York 10, N. Y. Phone MU 5-2352

More Exciting Facts About The **TEMCO 75 GA TRANSMITTER**

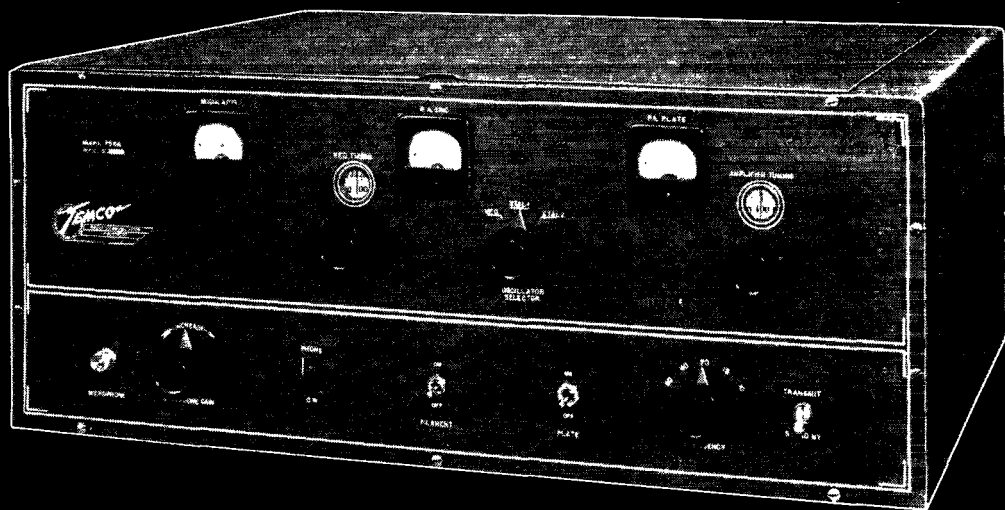

This new Temco 75/100 watt phone and cw transmitter with multi-frequency VFO and crystal control is causing a sensation, for here at last is the complete rig that puts everything at your fingertips.

It's a typical Temco masterpiece that leads the field in operational simplicity—maximum frequency flexibility and superlative craftsmanship. It covers all 5 amateur bands from 3.5 to 28 megacycles and doesn't require any external equipment to obtain the frequency flexibility needed as greater channel congestion occurs.

All tuning adjustments are at the front and within short reach. Band switching or changing from VFO to crystal control is accomplished with ease. When using crystal control (The 75 GA accommodates two crystal holders) the transmitter becomes a one-dial unit. For telegraph operation, break-in by the grid block method is employed to assure clear-cut, clickless keying. On phone a high impedance crystal or dynamic mike is used and a built-in relay transfers antenna from transmitter to receiver.

The 75 GA is compact yet every component is very accessible for easy servicing and it is as

excellent in its engineering design as it is handsome in appearance and construction. The only accessories needed to go on the air are mike, key and antenna.

A most striking feature of the 75 GA is the fact that it is also the exciter unit for a 500 watt output power amplifier. Never before has a complete transmitter been so engineered that it can be utilized in its entirety as an integral unit of an enlarged rig. This means that your initial investment in the 75 GA is good forever and represents a substantial saving when stepping up to higher power. Once and for all, Temco engineers have designed equipment that practically eliminates the factor of obsolescence.

In addition, amateurs who want to convert their present rigs to take in all bands up to 28 megacycles and enjoy the full advantages of frequency flexibility can obtain the VFO and frequency multiplier stages of the 75 GA as a separate unit—complete with its own power supply. This is the heart of the transmitter and is easily one of the best signal shifters ever built. Get the facts today from your dealer or write directly to Temco for full information.



**TRANSMITTER
EQUIPMENT
MANUFACTURING CO., INC.**

345 HUDSON STREET, NEW YORK 14, N. Y.

**READY
for you NOW**

ALLIED'S NEW 1946 CATALOG

of Radio Parts and Equipment

**Everything for the Veteran and the Beginner!
Includes Latest Communications Receivers**

Here's your latest, most complete Buying Guide for everything in radio! Includes newest receivers, Ham gear, code apparatus, parts, kits, tubes, tools, books, test instruments, public address and other equipment. Over 10,000 items available from the largest and most complete stocks under one roof. Nationally known makes. Finest values. Fast, efficient service from one reliable central source. Our experienced staff of licensed radio amateurs is glad to help you.

Free... Send for it today



Communications Equipment

Now from ALLIED Time-Payments • Trade-ins Accepted

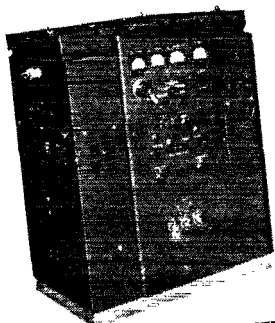

BC-610 (HT-4) TRANSMITTER

Available for immediate delivery from Allied stock. Net \$535
Including coils for 3 amateur bands

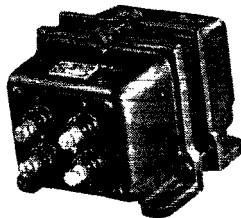

**350 WATT
MODULATION TRANSFORMER**
Brand new units as used in the BC-610 transmitter. Primary for class "B" 100-TH Modulators. Secondary 8300 ohm class "C" load at 250 ma. Special, Net..... **\$21.50**

Other Models	
Hallicrafters S-38	\$39.50
Hallicrafters S-40	79.50
SM-40 External "S"	
Meter	15.00
RME-84	98.70
RME DB-20	59.30
RME VHF-152 Converter	86.60
National NC-46	97.50
Speaker for NC-46	9.90
Hallicrafters SX-25	94.50
Hammarlund HQ-129X	129.00
	186.00
RME-45	197.70
National HRO	225.00
National NC-2-40C	223.00
Hallicrafters SX-23A	307.50
Hallicrafters S-36A	318.00
Hammarlund 400X	318.00
Hammarlund 400SX	591.75
Hallicrafters S-37	
Hallicrafters HT-9 Transmitter	250.00

Net, F.O.B. Chicago
Prices Subject to Possible Change

ALLIED RADIO

Everything in Radio & Electronics
833 W. Jackson Blvd., Chicago, Ill.

ALLIED RADIO CORP., D. L. Warner W91BC
833 W. Jackson Blvd., Dept. 27-FF-6
Chicago 7, Illinois

- Enter order for..... Model.....
 Enclosed \$..... Full Payment Part Payment
 (Balance C.O.D.)
 Send literature on Receivers and Time Payment Plan.
 Send FREE new 1946 Allied Catalog.
 Send special Amateur bulletins on Surplus Equipment.

Name.....

Address.....

City.....Zone.....State.....

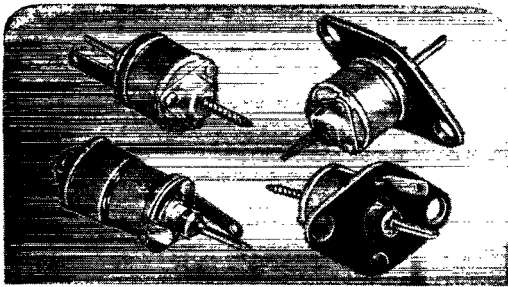

New ULTRA COMPACT HIGH-Q AIR CAPACITOR

Of unusually high-Q, extraordinary mechanical and electrical stability, easy of adjustment, small in size and useful to beyond 500 mcgcycles for trimming of tuning, a new air-dielectric capacitor is now available.

Produced at the famous Philips works in Holland, it is brought to American amateurs and experimenters through SILVER jobbers.

Less than one-half inch in diameter, less than 1 7/16" in length, SILVER Model 619 capacitor provides 3 to 30 mmfd. with air and high quality ceramic insulation. Rotor and stator are one piece, low inductance, multiple aluminum cups. Rotor meshing with stator gives a linear capacitance range of 27 mmfd. over three full rotations. Adjustment is permanent by virtue of retention spring; vibration does not effect capacitance since a long rotor bearing sleeve closely hugs a matching central ceramic insulator.

Model 619 capacitors have two solder terminals, are so light they may be mounted directly by connecting leads, though each is supplied with a low-loss phenolic mounting plate.

Price 30c. each, net at your favorite jobber.

OVER 35 YEARS OF RADIO ENGINEERING ACHIEVEMENT

McMurdo Silver Company

1240 MAIN ST., HARTFORD 3, CONNECTICUT

PRE-EXAM TESTS

For Commercial Radio Operator

FCC LICENSE EXAMINATIONS

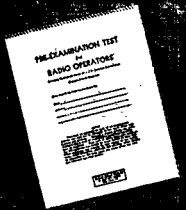

Don't Take A Chance!

Avoid Failure On FCC Commercial Radio Operator License Examinations!

Use NILSON'S COMPLETE PRE-EXAMINATION TESTS AND COACHING SERVICE

Enables You To

REHEARSE the FCC license examinations • **PRACTICE** the procedure • **PRACTICE** the multiple-choice examination methods used by FCC • **CHECK** your knowledge • **LOCATE** your weak points • **CORRECT** your weak points before taking the actual examination

Prepared by Arthur R. Nilson, Famous Co-Author of Nilson and Hornung's Radio Questions and Answers.

Use Coupon or write for Descriptive Folder
No obligation—no salesman

CLEVELAND INSTITUTE OF RADIO ELECTRONICS

Successors to Nilson Radio School, founded 1939
Smith Practical Radio Institute, founded 1934.

QT-6 TERMINAL TOWER CLEVELAND 13, OHIO

Approved for Veteran Training under G I Bill of Rights

CLEVELAND INSTITUTE OF RADIO ELECTRONICS
QT-6 Terminal Tower, Cleveland 13, Ohio

Gentlemen: Please send information about Pre-Exam Tests.

Name..... Address.....
City.....Zone.....State.....

(Continued from page 180)

Fall River, was worked later, and W1BJE/1 mobile in Fall River was heard. On this same day W2GGW/2 at Amagansett, near the eastern end of Long Island, heard W2MMY, Bronx, N. Y., working W2OJD/2 who was operating a walkie-talkie rig at Orchard Beach, also in the Bronx. Both ends of this QSO were heard at Amagansett, a distance of 95 miles. Not bad for flea power! W2GGW/2 worked W2IH, Astoria, N. Y., about the same distance, with 8 watts at one end and 25 at the other.

Another good night was March 22nd, when W2KNA, Farmingdale, Long Island, worked W1LPO, Newport, R. I., more than 135 miles, a new record for a week! That sort of thing is bound to happen often from here on. The temperature-inversion season has hardly more than started, and anyone who sets a new record can count on having it broken before it has stood long enough to get into QST's "records" box. The peak should come in August and September — we will be very much surprised if someone doesn't work 300 miles or more on 2 meters before next fall! Watch that band closely when DX comes through. We all have a weakness for working the loud ones, but we should dig down for the weak ones, too — there may be some choice DX lurking under those loud signals from 100 miles or so away!

On both coasts there is interest in a try for a real record. From San Francisco, W6OVK writes that he will be in a position to run some tests from Mt. Shasta during July and August, with W6OIN or other interested parties. Write him at 65 Market St., Rm. 909, marking the envelope "personal." W6TYP, also of San Francisco, has a neat little pack set with a 6-element Yagi antenna. He has used this rig with fine results on Copernicus Peak, Mt. Diablo, Mt. Tamalpais, and other high points. He will be operating from the summit of Mt. Shasta (14,191 feet) during July 27th and 28th and would like to line up some cooperation at various distant points.

At Mechanicsburg, Penna., W3HWN now has 300-watts input to a pair of HK-54s on 145 Mc. With this crystal-controlled rig, a hot superhet receiver, and a fine 16-element beam, Paul should be right up at the top whenever conditions break for long-haul work. He is interested in keeping schedules for DX work, as are numerous others in Southeastern Pennsylvania.

A number of fellows have arranged for the use of high elevations for more-or-less permanent stations. At North Castle, N. Y., W1LAS/2 has installed gear for 144 and 420 Mc. in a 30-foot tower atop an 820-foot elevation. He will be glad to keep schedules for work on either frequency.

Some of the gang around Washington are wondering why there is not more activity in the outlying districts around the Nation's Capitol. W2NVY/3 writes that while there is quite a bit doing in the district itself, nothing is heard from Annapolis and other localities which should be easy going from Washington. According to

(Continued on page 186)

A HARVEY SPECIAL!

LONG WAVE COMMUNICATIONS RECEIVER 15-600 KC IN SIX BANDS

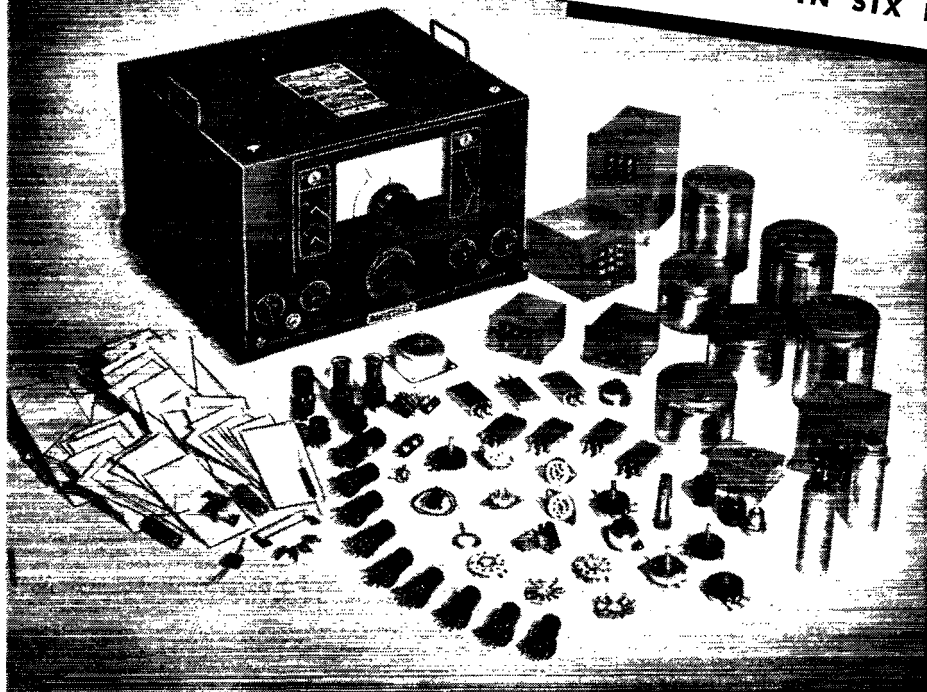

Navy Model RBL Receiver

Especially suitable for long wave c.w. or phone reception.
Ideal for 200-400 kc airport tower use.

- ★ Input plug for battery operation
- ★ Logging dial, reads 1 part in 1000
- ★ Two-stage r.f., impedance coupled
- ★ Two-stage audio, 600-ohm output
- ★ Lo-pass, Hi-pass filters in audio
- ★ Audio output limiter stage
- ★ 115 volt, 50/60 cycle power supply built in

SPARE PARTS INCLUDED — Parts are packed in steel chest with hasp, measuring 18" x 15½" x 12¼". 157 individually wrapped spares are included. Six 6SK7, two each 5Y3G, 6H6, 6K6GT, 6SG7 tubes plus full set in receiver. Replacement power and output transformers, choke, switches, resistors, capacitors, plugs, jacks, hardware, audio filters, r.f. transformers, fuses, dial lights, sockets, wrenches. (Spare parts chest, not illustrated, is included.)

**HARVEY'S
SPECIAL PRICE
\$59⁵⁰**

**HARVEY
RADIO COMPANY INC.**

103 West 43rd St., New York 18, N. Y.

Receiver and spare parts are packed in wooden case ready for shipment anywhere.

Telephone: LOnacre 3-1800



“Ward Leonard’s got ‘em”

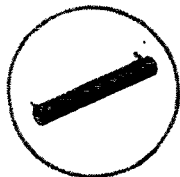

That's good news for the amateur. You have learned to depend upon Ward Leonard Resistors, Relays and Rheostats. Now that they are again available you naturally want to use them for new equipment and replacements. Send for Catalog.

WARD LEONARD

RELAYS • RESISTORS • RHEOSTATS

Electric Control Devices Since 1892

WARD LEONARD ELECTRIC COMPANY

Radio and Electronic Distributor Division

53B WEST JACKSON BLVD. CHICAGO, ILLINOIS

WAR SURPLUS!!!

R. F. TRANSMITTING CHOKES

6 mhy-500 ma

Excellent for multiband amateur operation. Same as pictured but less metal base. Ceramic insulator tapped for 6-32 screw.

• • •

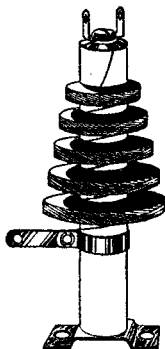

50¢ Each Postpaid in U. S. A.

Postage Extra, Elsewhere

JOBBERS: Write for Quantity Price

COTO-COIL COMPANY, INC.

65 Pavilion Ave., Providence 5, R. I.

(Continued from page 124)

W3HWN, his signals are being heard in Washington, a distance of more than 90 miles. Paul is working W4CDG/3 in Towson, Maryland, regularly, despite large hills along the path. W4CDG/3 is running 75-watts input to an 829, feeding a biconical antenna. The receiver is an S-27.

There seems to be more interest in 420 Mc. than we have ever had in connection with any frequency above 200 Mc. W3HJI/3 writes that he is working W3CUD/3 and W9UCQ/3 in Washington, and that others of the 2-meter gang are moving up to 420.

At the recent North Shore Hamfest at Queens Village, L. I., we heard that several fellows in that vicinity have 420-Mc. gear in the works or already going. W2WQ has two complete portables going.

From North Harwich, Cape Cod, W1BBM writes that though he has a vertical array of 15-db. gain and is active regularly, he is having little luck in keeping up interest on 425 Mc. He has run tests with several stations, but they soon go back to 144 Mc., where there is more activity.

Our DX record for 420-Mc. communication, to date, is 17 miles, the distance between Rye and Flushing, N. Y. Strong signals were exchanged between these two points when W1LAS/2 carted one of his portable rigs, described elsewhere in this issue, over to the home of W8WCG/2 and W3ILB/2 in Flushing. Has anyone done better?

First Amateur Work on 2300 Mc.!

• While most of us were battling the QRM on 80 or working DX on 10, two fellows were getting set for work on the new 2300-Mc. microwave band. On the morning of April 29th, at 10:44 A.M., W6QJK/2 and W9WHM/2 made what is believed to be the first two-way contact on this frequency, over a distance of 7/10 of a mile. Both rigs were transceivers using 2C40 “lighthouse” tubes, running at around five-watts input. Power output was of the order of 50 to 100 milliwatts. W6QJK, 2 used an electric heater as a reflector, while W9WHM/2 had a 65-inch copper-screen parabola. Signals were S7 in one direction, S9 in the other. Even the heater reflector was extremely sharp, movement in any direction of even an inch or so producing a noticeable change in the level of the received signal. The frequency used was 2410 Mc.

Strays

The most powerful electronic transmitting tube commercially available, a 200-kw. bottle used by the U. S. Government for overseas broadcasts, weighs 80 pounds as compared to the smallest, a 0.7-ounce hearing-aid tube, according to *Science News Letter*.



THE COUNTERSIGN OF DEPENDABILITY IN ANY ELECTRONIC EQUIPMENT

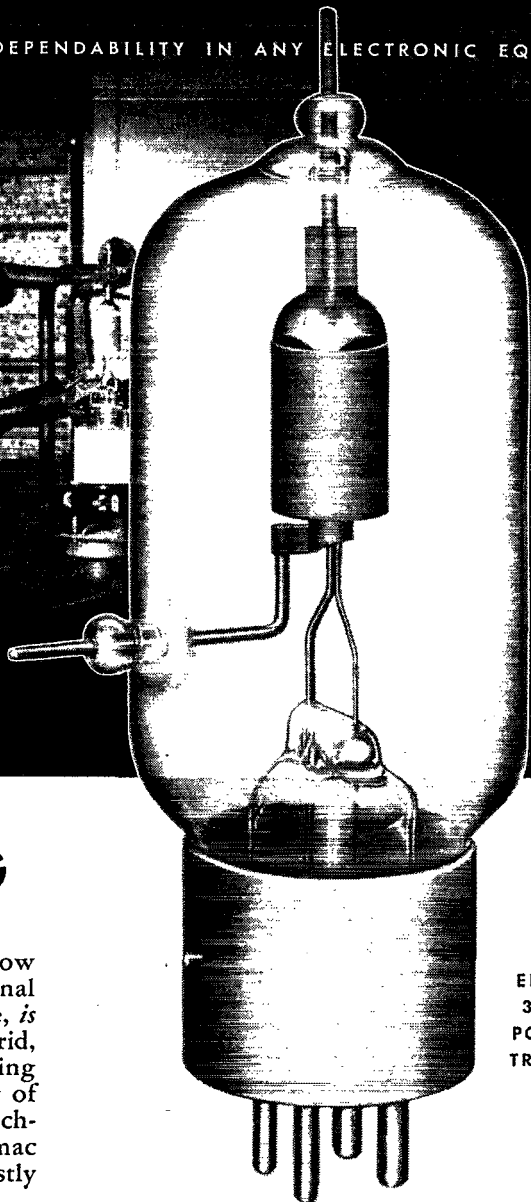
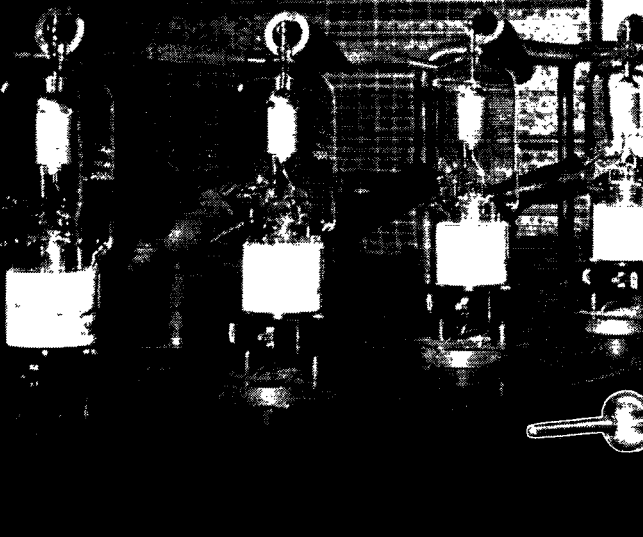

EIMAC
35TG
POWER
TRIODE

A BETTER 35TG

The famous Eimac 35TG VHF tube with its low inter-electrode capacitances, its logical terminal arrangement, its lack of internal hardware, *is further improved*. It now has a non-emitting grid, an improved filament, and a cooler operating plate. These improved elements, the result of wartime developments in manufacturing technique, are being incorporated in many Eimac tubes and are consistently resulting in vastly increased life.

The 35TG is a power triode of wide applicability. For instance, when used as a Class-C amplifier, it will give excellent performance due to its stability and low driving-power requirements. A pair of 35TG's, with 2000 volts on the plates, will handle 500 watts input with only 26 watts driving power.

Whatever rig you're planning, there are Eimac tubes for the job. It will pay you to keep informed about Eimac. See your dealer today, or write direct for full technical information.

ELECTRICAL CHARACTERISTICS

Filament: Thoriated tungsten	
Voltage	5.0 volts
Current	4.0 amperes
Amplification Factor (Average)	39
Direct Interelectrode Capacitances (Average)	
Grid-Plate	1.8 uuf
Grid-Filament	2.5 uuf
Plate-Filament	0.4 uuf
Transconductance ($i_b = 100$ ma., $E_b = 2000$ V., $E_c = -30$ V.)	2850 umhos
Frequency for Maximum Ratings	100 mc

Follow the leaders to



EITEL-McCULLOUGH, INC., 1230 San Mateo Ave., San Bruno, Calif.
Plant located at: San Bruno, California
Export Agents:
Frazar and Hansen, 301 Clay St., San Francisco 11, Calif., U. S. A.

Now! A Better Soldering Tool...

THE KWIKHEAT
VANATA

Has Built-in Thermostat Control!

THERMOSTATIC SOLDERING IRON



6 TIP STYLES

- #0—\$1.25
- #1—\$1.25
- #2—\$1.25
- #3—\$1.25
- #4—\$1.25
- #5—Melting Pot for Tinlino—\$1.25

HOT, READY FOR USE ONLY 90 SECONDS after plugging in! Kwikheat is the only soldering iron with a thermostat built into the tool itself—maintaining the proper level of heat for most efficient, economical operation. **SAFE!** ... Cannot overheat—**ECONOMICAL!** ... Lasts longer—saves tips and requires less retinning. **POWERFUL!**—225 watts—yet exceptionally light weight (14 oz.). Well-balanced with cool protecting plastic handle. Modern streamlined design. Six interchangeable tip styles adapt one Kwikheat Iron to all your soldering jobs. You will be proud to own America's finest and most versatile soldering tool... from tip to plug Kwikheat is in a class by itself. Ask your dealer to demonstrate the quick-heating feature now!

Kwikheat Iron complete with #1 tip... \$11.00
Set of 5 tips consists of #0, 2, 3, 4 and 5 \$ 5.50

6 TIP STYLES—QUICK HEATING ELEMENT—BUILT-IN THERMOSTAT—WELL-BALANCED—COOL, PROTECTING HANDLE—LIGHT WEIGHT

Dept. Q-6, Kwikheat Division of
SOUND EQUIPMENT CORP., 3903 San Fernando Rd., Glendale, 4 Calif.

ALUMINUM

ALL SIZES OF
TUBING for Beams
and Vertical Antennas

SHEETS and ANGLES
for **CHASSIS and PANELS**
BUILT—CUT—DRILLED

Send your requirements
for a quotation

● **TRIXE TOOL WORKS**
429 BROOME ST., N. Y. 13

**Complete
MACHINE
SHOP
Service
for HAMS**

A. L. MOSS • W2EVZ
Telephone
CAnal 6-1382

Carter

**THE PREFERRED
POWER SUPPLY**



Carter Dynamotors, Magmotors, DC to AC Converters and Genmotors provide the finest rotary power for your mobile rig. Widely used and preferred by leading State and City Police Mobile Networks. Wide range of receiver and transmitter models, filter and starting relays available. Send today for the latest free bulletin.

Carter Motor Co.
Chicago, Illinois

2645 N. MAPLEWOOD AVE.

CARTER... A well-known name in radio for over 20 years!

Foreign Notes

(Continued from page 68)

Mancera, president; M. R. Bolafios, YV5AE, vice-president; A. M. Crespo, YV5ABY, foreign secretary; and J. M. L. Garcia, treasurer.

While all bands are open at present, new regulations are under consideration which may affect the 80-meter amateur assignment. Government support is expected for the proposed amateur band at 21 Mc.

MISCELLANY

Netherlands amateurs receive a 100-kwh. ration every sixty days in addition to their normal allotment of electricity. . . . Like several other countries, South Africa is not yet in a position to grant transmitting licenses to *newcomers*. . . . New regulations in Colombia provide that only citizens may obtain licenses, whereas previously some foreigners were on the air by virtue of a license issued to one of their house servants! . . . If you hear any four-letter JE calls, they belong to members of the British forces in Germany. Most of them are using D2 calls, however. . . . We understand the Bahamas authorities are reopening amateur stations above 28 Mc.

Strays

ATTENTION—CPL. H. W. PROPSNER, USMC. The Victory Stamps awarded you for your Crystal Ball contribution are waiting at ARRL Hq. Please send us your correct mailing address.

A writer to ARRL's Technical Information Service asks if the Armed Forces have as yet released data on the secret circuits for "Contra-polar Frequencies" that were hinted in *QST* for March, 1944. This part of the spectrum is below 0 c.p.s., where frequencies are measured in "negacycles," resistors run frosty cold and electrons flow from positive to negative. Our correspondent has been patiently waiting all this time!

Wait 'til he hits the "circular band theorem!"

Spots before our eyes? . . . or maybe it was Saturday night's party that caused us to read, in our favorite Sunday morning paper, King Features Syndicate's science writer's so-simple proof that sunspots emit radio waves.

Here's his story (italics ours): "The emission of radio waves from sunspots has received striking confirmation through recent discoveries. During sunspot activity, when a radar set with a powerful aerial was turned toward the sun, a hissing noise was heard. *When the receiver was turned off, the hissing ceased.* Utilizing this knowledge, science can obtain by periodic tests early warning of radio fadeouts and magnetic storms."

HARRISON HAS IT!

★ HSS

Stromberg-Carlson DYNAMOTORS

Compact, well-constructed unit, excellent for mobile transmitters, amplifiers, etc. Ball bearings, good efficiency. Made for military use.

INPUT — Volts at A.M.P.S.	OUTPUT — Volts at M.A.
12 16.8	680 210
6 16.	300 210
6 21.5	265 300

3 1/4" dia. x 6 1/4" long. 6 lb, 12 oz., with mounting plate. Brand New. HSS SPECIAL. **\$8.95**

Beachmaster

POWER AMPLIFIER

250 Watts Class B 805's to 9 ohm load. Delivers 1500 Volts DC at 320 MA and 300 Volts DC at 150 MA; 10 and 6.3 Volts AC. On heavy chassis 12 3/4" x 19". Has blower fan to cool tubes. Excellent for P.A. booster, modulator, or power supply. Less tubes — **\$44.75**
HSS.

HSS TUBES

Raytheon RK-63. Regular price \$22.00. Special **\$9.85**.
RK-38 — **\$5.95**
RK-39 — **\$1.75**
Navy tested and accepted 805's — **\$6.90**.
Eimac 304-TL. Handle a KW cool! Slightly used in radar pulsing, tested and guaranteed O.K. Reg. net \$50.
HSS Special . . . **\$7.50**

HANDSETS

Latest, improved type, 200 ohm single button mike, high impedance phone. With push switch, cable, and plug. HSS. **\$4.45**

ROTARY COAXIAL COUPLING

Having trouble coupling to your rotary beam? Feed it efficiently through this constant impedance slip-ring coupling. Made for Signal Corps by Lapp Insulator Company, one of the best antenna system manufacturers. Surge impedance of 52 ohms will match most coaxial cable.

Head, 1 1/2" dia. finely machined from brass. Copper feed line 3/4" dia. is 51" long.

Outlets at top and bottom take standard AN coaxial plugs (or may be connected permanently). HSS. **\$7.75**

- A POSTCARD will put your name on our mailing list to receive new catalogs, bulletins, additional HSS bargains, and details of how you may obtain a copy of
- "ELECTRONIC PARTS AND EQUIPMENT," our new 800-page Buyers' Guide. Please send for it today!

Signal Corps RADIO TABLES

Just the thing for your shack. Used in the SCR-299 mobile radio trucks. Ruggedly made of heavy plywood, glued and screwed; linoleum top bound with metal edging; two lamps; two keys; power distribution and fuse boxes; shelf; drawer; speaker-phones; switching panel; wiring raceway with receptacles; shock mounts (easily unscrewed); type-writer panel; dark green finish. 24" wide. 7 1/2" long. 29 1/2" high. Good condition. **\$25.00**
Table — MC-269. **\$35.00**
MC-269-A (Same, but with 3" AC 0-150 line voltage meter and additional lamp)

For shipment, via Express — add \$2.50 for preparation.

FILTER

CHOKES

10 Henry; 260 Ma.

General Electric. Metal cased, potted, ceramic standoff insulators. 3 3/4" x 3 3/4" x 5" high. **\$3.23**
8 1/2 lbs.

HAND MIKES

High impedance dynamic microphones, used in the SCR-299 mobile transmitter. Excellent voice response. Push-to-talk button to close relay. Complete with 9 foot cable and Amphenol MC 3M plug. Tested and guaranteed. HSS. **\$9.75**

★ Harrison Select Surplus

Your assurance of good, usable, guaranteed, surplus material at sensationally low prices — top value all-ways! Come in and browse through our large, entirely separate HSS Department (Harrison Select Surplus).

HARRISON HAS IT!

ALL STANDARD LINES

NEW SKY CHAMPION

By special chartered cargo-plane, we obtained our initial stock of the new Hallcrafters S-40 Sky Champion receivers! They're going fast so rush in your order. Complete. **\$79.50**

We'll do everything possible to give you the very best service on all makes and models of receivers, transmitters, etc. — Keep sending in your orders.

TEST EQUIPMENT

Shipments are getting bigger and better! Send us your order now for quickest delivery.

- Dumont — GE — Hickok
- Precision — RCF
- RCA — Shallcross —
- Simpson — Supreme —
- Triplet — Weston.

TWIN RIBBON CABLE

Amphenol's sensational new transmission line. In stock in 75, 150 and 300 ohm surge impedance. Per foot. **3c**

PLASTIC PLIERS

New SPECOCO all plastic long nose pliers. Light, **89c** strong, very handy.

→ CQ—L. I. HAMS! ←

Our Jamaica Branch is the most handy place on the Island to get your Ham and Service material. Right at the bend in Hillside Ave. Complete stocks — plus direct lines to make our N. Y. store and warehouse stocks immediately available. Drop in — often!

BOAT OWNERS!

Immediate delivery of Islip Model MRT-10 Marine Radio Telephones. 10 Watt carrier output. 5 channel selector switch. Push-talk handset. For 6 or 12 Volt operation. 8 1/4" x 8 3/4" x 12", complete! Well engineered and constructed. With six crystals **\$195** for three channels
Coast Guard vertical rod antenna \$45. Real radiation efficiency!

RECORD CHANGERS

Garrard. **\$65.85**
Webster No. 56-1. **26.66**
Webster No. 50. **21.17**

STEEL ??

It's scarce, but we've just received shipments of several truckloads! Chassis — racks — panels — cabinets — boxes — brackets — etc., all sizes. Parmet — Bud — Middletown — ICA. Get yours now!

10X DIPOLE

Made by S.C. Labs. Lightweight, all aluminum adjustable elements and mounting pole. Machined center coupling insulator. Good value for little money! Complete, with instructions. **\$6.75**

PREMAX Antennae and elements in stock.

We are

FACTORY AUTHORIZED DISTRIBUTORS

for the top quality manufacturers and we now have in stock lots more new, latest improved production Ham gear! Visit our stores today, for everything you need. We promise you fresh, clean material — quicker — at the lowest current prices — and, above all, our sincere desire to be of friendly, helpful service.

MAIL ORDERS? — Certainly! Just list everything you want (items in this ad, or any ad, magazine or catalog) and include deposit.

73 de

Bill Harrison, W2AVA

HAM HEADQUARTERS
Since... 1925!



HARRISON RADIO CORPORATION

12 WEST BROADWAY • NEW YORK CITY 7

BARCLAY 7-9854

JAMAICA BRANCH — 172-31 Hillside Ave. — REPUBLIC 9-4102



Headphones Sharpen Dull Signals

Year after year MURDOCK Headphones maintain their leadership as the preferred listening ears for thousands of Hams all over the world.

Try MURDOCK Headphones—NOW. Prove to yourself how much better they are over your present phones. You'll like their light weight, exacting tolerances, strong, constant adjustments, and "hairline" sensitivity. Our war-sharpened manufacturing techniques have been translated into improved reception . . . clearer performance . . . lifetime service.

Signals are clearer, sharper, and steadier. The friendly exchange of messages with world-wide friends takes on new sparkle. You'll enjoy long listening hours in complete comfort!

No wonder men in radio put their confidence in MURDOCK Headphones . . . they keep you right on the "beam!"

JOBBERS

Get in touch with us by phone, wire, or letter for full details. Some territory still open.

If Your Dealer Cannot Supply You, Write to Us for Catalog

WM. J. MURDOCK CO.
215 Carter St., Chelsea 50, Mass.

at your service

THE EXTENSIVE FACILITIES
AND EXPERT PERSONNEL
OF NEW YORK'S MOST PROGRESSIVE

**RADIO SUPPLY HOUSE
TERMINAL HAS IT!**

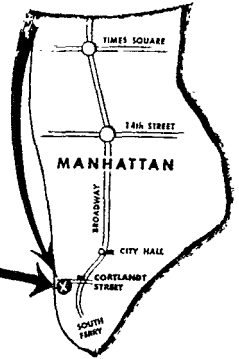

SHOP WITH CONFIDENCE

Terminal has kept its lead in New York by maintaining a complete stock of quality radio parts and equipment. Fair prices and friendly service assure you of the **BEST VALUES** at **TERMINAL!**



Visit our "SPECIALS" Department
Countless values of selected quality parts and equipment at unbelievably low prices!

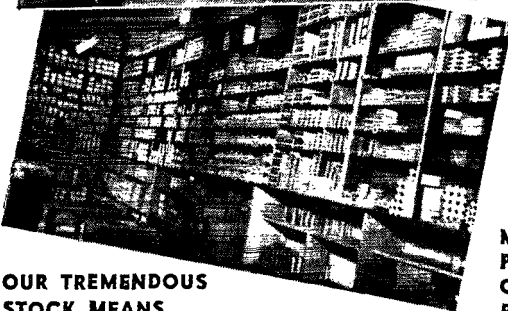

**OUR TREMENDOUS
STOCK MEANS
FASTER SERVICE**

**MAIL &
PHONE
ORDERS
PROMPTLY
FILLED**



TERMINAL RADIO CORP.

85 CORTLANDT STREET, NEW YORK 7, N. Y.

PHONE WORTH 2-4415

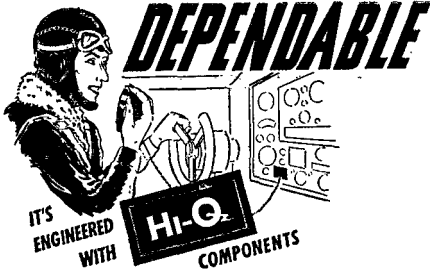

CERAMIC CAPACITORS



WIRE WOUND RESISTORS

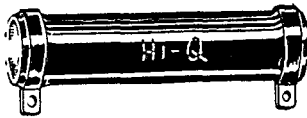

CHOKE COILS



ELECTRICAL REACTANCE CORPORATION
FRANKLINVILLE, N. Y.

Mr. Radioman—
What are your Qualifications?
EMPLOYERS ARE CHOOSEY!

You have the practical experience. Do you have the technical knowledge so necessary for professional employment in the new electronic developments of FM broadcasting, micro-wave relay systems, television, mobile communication systems for railroads, automobiles, busses and trucks? Employers want men who know the "Why" as well as the "How."

Let CIRE home study courses in radio—electronics—television help you. Competent instructors, progressively arranged lessons, remarkable workbooks of instructional aids combine to make study easy.

Send for new booklet, "THIS NEW WORLD OF ELECTRONICS HOLDS OPPORTUNITY FOR YOU."

CLEVELAND INSTITUTE OF RADIO ELECTRONICS
Successor to NILSON RADIO SCHOOL, Founded 1939
SMITH PRACTICAL RADIO INSTITUTE, Founded 1934
QT-6 Terminal Tower Cleveland 13, Ohio
Approved for Veteran Training under GI Bill of Rights

Cleveland Institute of Radio Electronics
QT-6, Terminal Tower, Cleveland 13, Ohio
Gentlemen: Please send information about your home study courses in Radio Electronics.

Name..... Address.....
City..... State.....

How Much Inductance?

(Continued from page 69)

If d.c. resistance of choke is greater than 100 ohms:

First solve for X in this formula

$$X^2 = \frac{(10,000) \times (\text{voltage across choke})^2}{(\text{voltage across 100-ohm resistor})^2 - (\text{resistance of choke in ohms})^2}$$

Then, using the value of X just found,

$$\text{inductance of choke (in henrys)} = \frac{X}{377}$$

(Use 157 for 25-cycle line.)

The table shows just what to expect with various values of inductance, assuming that the 115-volt a.c. line is used directly and that it is a 60-cycle line.

One word of caution about these measurements. The value of inductance of a smoothing choke, measured as explained, will be accurate within 10 per cent. However, if the unknown choke happens to be a swinging choke, the value of inductance measured will be the no-load inductance. In other words, a choke which has a rated inductance of 5 to 20 henrys, for example, may measure 25 henrys. The measured value of inductance should be reduced by about 20 per cent to get the actual maximum inductance rating (reducing 25 henrys by 20 per cent gives 20 henrys in the example above). The best way to determine if the choke in question is a swinging or smoothing type is to examine the core to determine if the choke has an air gap. If there is no air gap you may be sure that it is a swinging choke, but if there is an air gap, even if it is only the width of a few *QST* pages, you may be fairly sure that it is a smoothing choke.

Now that the resistance and inductance of the choke are known, the current rating may be approximately determined by weighing the choke and taking its measurements, and then comparing these to the weights and sizes of advertised chokes. For a given size, resistance and inductance, the current ratings should correspond by a fairly-close degree to those of other chokes made by various manufacturers.

At any rate, after deciding what the choke should handle, you can try it out. If it gets too hot to hold your hand on, it is carrying too much current, so perhaps you should try to trade it off to one of the low-power bugs!

Strays

The Peoria Amateur Radio Association is holding a hamfest Sunday, June 16th, at Pleasant Valley Park, near Dunlap, Ill. Prizes, 2-meter hidden-transmitter hunt, games, and equipment demonstrations highlight the program which begins at 10 A.M. Tickets, \$1.50, obtainable from Walter Shaff, W9OPD, 3026 Seventh Ave., Peoria, Ill.

Amateur-

HERE IT IS!

A crystal calibrated to .01% of marked frequency with dependable performance mounted in slender upright space saving holder either in 153 AC for regular 5 prong socket or 162 PM for octal socket. Frequency range 3500 to 4000 KC or 7000 to 8000 KC.

Our experienced engineers are designing more modern models for all bands. For information and prices on all types of crystals, contact your distributor or Crystal Products direct.

 **Crystal**
PRODUCTS COMPANY

MAIN OFFICE 1519 MCGEE STREET
 Phone: Victor 1686

KANSAS CITY 8, MISSOURI

The Answer to
 a Ham's Dream—
 Power—Accuracy
 Stability



\$2~~80~~
EACH

153-AC

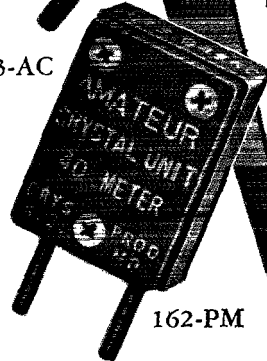

162-PM

The Amateur "Talkie Kit" is still available. Place your order now with your distributor or direct from the factory.

COMPLETE \$1 POSTPAID ONLY
 Cash with order within United States.

Canadian Distributors:
 MEASUREMENT ENGINEERING
 61 Duke Street
 Toronto 1, Canada

CAST ALUMINUM CALL LETTER PLATES

MADE TO ORDER—YOUR OWN LETTERS

Cast Aluminum, letters and borders raised and satin finished. Background, baked crackle enamel. Black is standard, —red, gray or blue 40c extra.



\$250

Add 20c For Packing and Postage

FOR YOUR CAR — Type A-18
Cast with brackets for auto mounting and two 6-32 x 3/8" threaded studs for panel mounting.

FOR PANEL MOUNTING — Type A-19—Same as above, but without auto brackets. Equipped with studs for panel mounting.

Dimensions 2 3/4" x 8 1/4"
Either Type

LAPEL BUTTONS — TYPE A-26

Letters are raised, sharp and clear, and are highly polished.



75c Add 10c for packing and postage

Standard RADIO & ELECTRONIC PRODUCTS COMPANY

135 E. SECOND STREET • DAYTON 2, OHIO

COMPLETE RADIO TRAINING!

Prepare now to accept a responsible position in Commercial Radio. New developments will demand technicians with thorough basic training, plus a knowledge of new techniques discovered during the war. Training open to high school graduates or those with high school equivalency. Courses 6 to 18 months' duration in RADIO AND ELECTRONICS. Approved Veteran training in Radio. Write for Particulars.

VALPARAISO TECHNICAL INSTITUTE
Dept. TN Valparaiso, Ind.



Founded in 1909

RADIO TELEPHONY
RADIO TELEGRAPHY

Courses ranging in length from 7 to 12 months. Dormitory accommodations on campus. Advanced students eligible for practical training at KPAC, 1 KW broadcast station owned and operated by Port Arthur College. New students accepted monthly. If interested in radio training necessary to pass F.C.C. examinations for first-class telephone and second-class telegraph licenses, write for details.

PORT ARTHUR COLLEGE PORT ARTHUR TEXAS

Approved for G.I. training

Correspondence from Members

(Continued from page 71)

576 Bellefontaine St., Pasadena 2, Calif.

Editor, *QST*:

I notice considerable correspondence with the general theme that *QST* is getting too highbrow — and who likes u.h.f. anyhow? This bothers me a bit, because to me it seems obvious that the only way that frequencies available to hams now, or those available before the war for that matter, can be stretched to accommodate all the hams in the game a few years hence will be by going to u.h.f. for short-haul work. As anyone who was in the radar program can testify, this does require a bit more theory than we got by with before the war.

I'd like to point out that the *Handbook* provides a plentiful source of information on the present state of the practical art of radio for all frequencies. Besides, one can still watch over someone-else's shoulder for a while to get started, just as so many of us did in the beginning. For the more-advanced ham who perhaps got a dose of theory during the war and would like to play along that line a bit there is another book which is useful. While I own no stock in the publishing firm of McGraw-Hill, I would very earnestly recommend Terman's *Radio Engineers' Handbook* to the ham who sometimes would like to dig a bit deeper in theory than the necessarily-limited thickness of the *Handbook* allows. For six bucks you can get in convenient form all the theory which normally one would have to sink twenty-five dollars for into half a dozen texts.

Keep up the articles on u.h.f. and advanced stuff — and who is going to be on 420 Mc. for me to work this summer? Let's see, my 6J6 puts out half a watt, but Terman's says on page 820 I can get 13 db. gain out of a corner reflector — 20 times the power. Why, that's 10 watts in the antenna to work DX and no transmission line for losses! Bet I can beat that 60-mile record with my \$1.75 worth of transmitter tube. See you in the middle of the band in July.

— Larry Haupt, W6NSX

WHO WAS FIRST?

4 Winfield Drive, East Bierley,
Bradford, Yorkshire, England.

Editor, *QST*:

Thank you for keeping our old friend *QST* coming over here so nicely during the hard years.

In reading *QST* for December, 1945, I note that "25 Years Ago This Month" treats the accomplishment of my old friend, George Benzie, and his amateur colleague, James M. Miller, with the same skepticism that prevailed in 1920, when they reported reception at Peterculter in Aberdeenshire, Scotland, of the radiophone signals of 2QR, Keyport, N. J.

I've long since lost track of George, but let's get together and put him in his honoured place . . . as the first amateur to hear another amateur . . . on 'phone, too . . . across the "ditch."

It was on Oct. 6, 1920, that Benzie, while listening on 200 metres with his two-valve receiver using loose coupling, perfectly and distinctly heard 2QR playing a record of Harry Lauder's "Roamin' in the Gloamin'!"

He and Miller couldn't believe it and they wrote to Hugh and Harold Robinson, operators of 2QR. They, too, were astounded and dared not tell the world until it had been confirmed on schedule. The performance was repeated on Nov. 16, 17 and 19, 1920. On this second attempt at reception here, little acknowledgment was obtained, but they did receive 3 phonograph records by radiophone on 200 metres, along with Robinson's calling them, saying he had tried 1000 metres that afternoon and arranging a schedule "for tomorrow and Saturday," on 200 metres. They also heard the call 2QR repeated again and again.

There can be no doubt about it; the tests were authentic and confirmed, and I still disagree with the findings of the special committee of the Radio Club of America. Never be the "first." It's too early.

— Percival Denison, G8OK (ex-G2KD, DHX)

[Editor's Note: Old-timers will recall the "Who was first?" issue revived by Mr. Denison's letter. For the infor-

(Continued on page 186)

HARVEY

presents...

A New System of Reception

THE PANADAPTOR

the **EYES** of your station...

PANADAPTOR Model PCA-2

Now Available.
Amateur Net Price,
complete with ten
tubes and accesso-
ries for 115 V., 50-60
cycle operation...

\$99.75

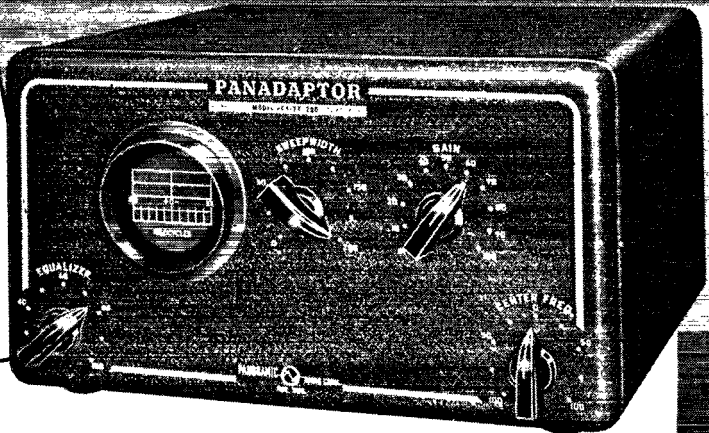

As the electronic art added sound to the movies, so Panadaptor adds sight to amateur radio—full vision of a band 200 kc wide, showing every signal within that range simultaneously. It eliminates "fishing"... it reveals short calls... holes in busy bands, you can also use it as a percentage modulation indicator or to study signal characteristics of your own and other stations. Used in conjunction with any good

communications receiver it opens a whole new method of operating to you. Until you have tried this new method you can't really appreciate what it will do for your station... no matter which phase of amateur radio is your speciality. So why don't you drop in to our store and try it... see how it pulls signals in through all the noise of a busy industrial district... even on 10 meters.

HARVEY HAS IT ALL!

Of course, Harvey has all the other things you need... receivers... exciter units... transmitting tubes... parts... and whether you can come in, or order by mail, you'll find the same friendly service, the same large stocks at your command. Couple this with Harvey's prices and rapid service and you'll agree, that for the radio amateur, the best place is...

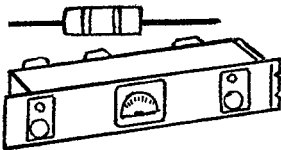

Telephone: **7-10rc** Longacre 3-1800

HARVEY

RADIO COMPANY INC.

103 West 43rd St., New York 18, N. Y.

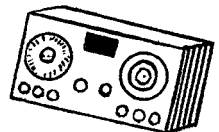

*Again at your SERVICE
For more and better DX*

CML SERVICE LABORATORY
devoted to the
ALIGNMENT & REPAIR of
COMMUNICATIONS RECEIVERS

Factory alignment and repair for Hallcrafters, National, RME, Howard. We check sensitivity, signal to noise ratio, and selectivity, with laboratory standard test equipment, to insure maximum performance. Prompt service on alignment and repairs.

Factory Service Division
**Communication Measurements
Laboratory**
120 Greenwich St. New York 6

RADIO

RADIO Technician and Radio Communications courses. Register now for new classes starting first Monday of each month. Day and Evening Classes.

AMERICAN RADIO INSTITUTE
101 West 63d St. New York 23, N. Y.

Approved under GI Bill of Rights

**AMATEUR
GEAR
HATRY & YOUNG**

*8 Connecticut and
Massachusetts Ham Stores*

Hartford	C	Stamford
New Haven	O	New London
Bridgeport	N.	Waterbury

BOSTON—MASS.—LAWRENCE

The ELECT in Electronics

(Continued from page 134)

mation of not-so-old-timers, a year-long investigation by a Radio Club of America committee, consisting of E. H. Armstrong, A. A. Hebert and L. G. Pacent, on Dec. 7, 1921, resulted in this decision: "We find that 2QR was not heard in Scotland as reported." Forty-two exhibits were offered in consideration of the evidence, along with a letter signed by Hugh and Harold Robinson of 2QR that stated "we are convinced that according to the evidence, Messrs. Miller and Benzie were in error in believing that they heard our signals." For the record, QST has always considered the Radio Club of America committee's decision as closing the matter.]

VFO TECHNIQUE

12 Prescott St., Wellesley Hills, Mass.

Editor, QST:

Fell out the wrong side of the bed this A.M.; hence the following verbal spanking to the few hams who unthinkingly cause a great deal of unnecessary QRM by zero-beating the v.f.o. to the frequency of a choice bit of DX calling CQ. I don't believe the results of this practice justify the annoyance caused to other hams trying to work the same station. This is particularly bad in a metropolitan area such as Boston where there are probably half a hundred hams within ground wave distance of each other, all trying to work DX on a Sunday when the 10-meter band is hot.

Last Sunday I was QRMed several times in this manner. After calling a DX station, using a reasonably short call, I would stand by only to find one of my brothers still calling him on his own frequency. Net result: even if I hooked him I'd have no way of finding it out with the channel all fouled up. If brother ham would take my advice he would get a few kc. one side or another of the operating frequency (preferably on a clear channel) if he is convinced that this is the best way of working DX. Incidentally, I use v.f.o. myself.

I am also of the opinion that only a minority of amateurs are seriously interested in cavity resonators, klystrons, microwave technique, etc. I do believe that these articles have a definite value, but should be mailed on request after an appropriate announcement in QST. When a sufficient number have been printed they could be bound into a booklet entitled "Microwaves," and offered for sale to cover costs, etc.

— Charles E. Nichols, jr., W1MRK

"PETER EASY ABLE"

c/o Postmaster, Seattle, Washington

Editor, QST:

Now that the war is over, perhaps something can be said concerning an unpublicized outfit in the Army Communications Service of the Signal Corps. Thousands of men and officers under the Plant Engineering Agency (PEA) have been quietly installing fixed station radio equipment in all four corners of the world under the most severe climatic conditions known. The primary job of PEA has been the engineering, installation and major maintenance of radio equipment for the Army Airways Communications System (AACS).

Incidentally, hams contributed much to the success of the organization in the field. Without the persistent efforts and skill of the men concerned, vital air communications would have been near impossible. These highly-skilled men, in the form of teams, performed an invaluable service. These were the men who dug pole holes in solid rock and ice in the frozen wastes of Alaska and Greenland; built antenna fields that had to withstand wind velocities over 100 m.p.h. in the blistery Aleutians; strung control cable lines over swamps in the South Pacific; improvised everywhere when no supplies were available; built radio ranges to guide the Air Forces to their destinations safely, etc. Hats off to another group of fellows who did so much with so little.

— H. A. Knapp, W1LOI
M. J. Krasnicar, W2MAX
J. E. Gider, W4GME

(Continued on page 140)

Announcing

NEW

PR

**SUPER
10-METER
CRYSTALS**



Available for the FIRST
Time at Your Jobber's

The new Z5 unit, when used in our simple circuit, is no more critical than an ordinary 40 or 80 meter crystal. High power output without damage to crystals is now possible with the new PR Super 10 meter crystal. PR Super 10 meter crystals, with a temperature coefficient less than 2 cycles per M. C. per degree centigrade, are now available at your favorite jobber's.

PR crystals can "take it" and really "put out." Every PR crystal is *unconditionally guaranteed*. See your jobber today — ask him for a copy of the descriptive booklet on PR 10 meter crystals.

PETERSEN RADIO COMPANY

2800 WEST BROADWAY — TELEPHONE 2760

COUNCIL BLUFFS, IOWA



HAM HEADQUARTERS FOR

Equipment and Information

SPECIALS

- Low loss Antenna Change Over Relay 6U.D.C. D.P.D.T. \$1.75
- 3C/24G Tubes \$1.90
- 3-3 MFD. 600V Oil Filled \$0.99
- 8 MFD-600V Oil Filled Round Can any Mounting, \$1.50
- 2 MFD-2000V CD \$3.50
- Ceramic Caps for 807-866 etc. Each \$0.19

MAIL ORDERS PROMPTLY FILLED

Amateurs to Serve You

(20% Must Accompany All C.O.D Orders)

Write to Dept. QST

W65CQ • W6UXN • W6NAT • W6SSU

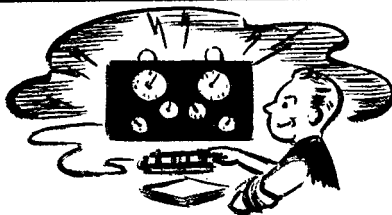

FOR YOUR NEW RIG

We Have a Good Stock
of All Standard Lines

SUPER BUY For 19 Meter F.M. Mobile Operator BC 1335 COMPLETE TRANSMITTER and RECEIVER from 27.5-38.9 MC READY TO GO with 3 Crystals for FM Portion of 10 Meters and Shure T17B Hand Set **\$53.00**

Radio Product Sales Company

238 WEST 15TH STREET
LOS ANGELES 15, CALIFORNIA Prospect 7471

for professional results with your rig
TURNER

99 and 999

Dynamic Microphones

These rugged Turner dynamics are built to deliver clear and crisp under the most difficult operating conditions. Withstand severe climate and temperature changes. Adjustable saddle fits any standard stand. Semi- or non-directional operation. Specified by leading manufacturers, widely used by broadcast studios and large city police departments. Gunmetal finish. Model 999 has same professional appearance as Model 99 with additional Balanced Line features for more critical applications. Both available in 30-50, 200, 500 ohms, or high impedance. Range 40-9,000 cycles. Level -52DB.

ASK YOUR DEALER
OR WRITE

Licensed under U. S. Patents of the American Telephone and Telegraph Company, and Western Electric Company, Incorporated

THE TURNER COMPANY
917 17th Street N.E.
CEDAR RAPIDS, IOWA

TURNER

Pioneers

in the communications field

Microphones

Crystals licensed under patents of the Brush Development Co.

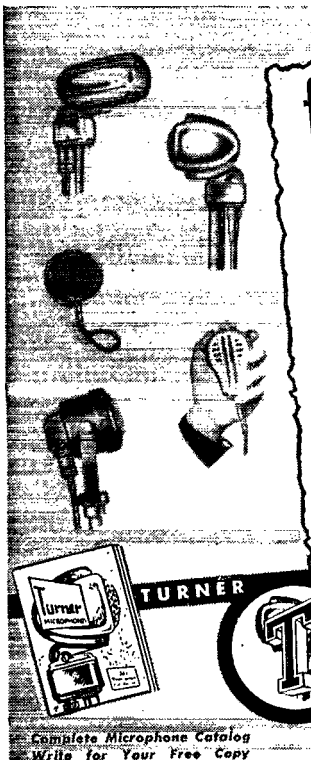

Complete Microphone Catalog
Write for Your Free Copy

The 1946 HANDBOOK

THE LATEST EDITION of The Radio Amateur's Handbook is postwar in content, containing 688 pages of the kind of material which has made The Handbook world famous ➤ With the suddenness of peace it meant much redoing of the Handbook but this was done ➤ Retained is the highly successful treatment of fundamentals which was an innovation of the 1942 edition ➤ Stripped to essentials, the theory and design sections cover every subject encountered in practical radio communication, sectionalized by topics with abundant cross-referencing and fully indexed ➤ An ideal reference work, this Edition also contains all the constructional information on tested and proved gear which has always been the outstanding feature of the HANDBOOK.

POSTPAID IN
CONTINENTAL U.S.A.

\$1

\$1.50 ELSEWHERE
BUCKRAM BOUND \$2

AMERICAN RADIO RELAY LEAGUE

» » » » » » »

**WEST HARTFORD 7
CONNECTICUT**

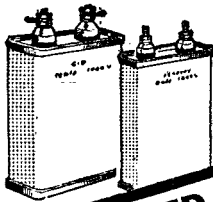

10 MFD.—1000 volts,
No. 17A268\$3.95
4 MFD.—1500 volts,
No. 18A227\$2.94
Plus 20c each postage
and pkg. charges.

OIL FILLED • HI-VOLTAGE CONDENSERS

EXTRA SPECIAL VALUE

Limited quantity of these fine condensers with ceramic insulated terminals. Place your order at once.

18 YEARS IN RADIO

Latest developments in radio and electronic parts and devices, newest "Ham" gear, gadgets to delight the heart of the experimenter, bargains in selected war surplus radio items. Some of the best values we have offered in our 18 years in business.

WRITE FOR CATALOG

Get on our mailing list and receive our bulletins and catalogs as issued.

BURSTEIN-APPLEBEE CO.
1012T McGee, Kansas City 6, Mo.

COMMERCIAL RADIO INSTITUTE

A RADIO TRAINING CENTER FOR 26 YEARS

Resident Courses Only • Broadcast, Service, Aeronautical, Television, and Marine telegraphy classes now forming for July 1st.
Literature upon request. Veteran training

Dept. B, 38 West Biddle Street, Baltimore 1, Maryland

Only Vibroplex Has It!

JEWEL
Movement

VIBROPLEX

Reg. Trade Mark: Vibroplex, Lightning Bug, Bug

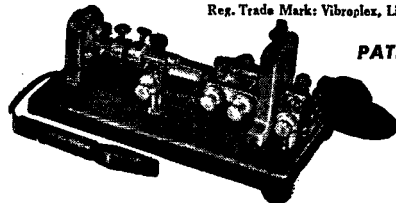

PATENTED!
EXCLUSIVE!

GENUINE
"ORIGINAL"
DELUXE
MODEL

\$19.50

America's finest radio key — the deluxe performer that sets new standards of sending excellence and operating ease. The jewels used in DeLuxe Vibroplex keys are the same as those placed in the finest made watches and precision instruments, providing watch-like precision, feather-touch action, lifetime service and ease of operation unapproachable by any other key. Chromium finished base. Bright machined parts. Colorful red switch knob, finger and thumb piece. DIE OUT contacts and mainspring. 3/16th contacts. Circuit closer, cord and wedge. DeLuxe finish also available in "Lightning Bug" and "Blue Racer" models. ORDER NOW! Money order or registered mail. FREE catalog.



The "BUG"
Trade Mark
Identifies the
Genuine
Vibroplex.
Accept No
Substitute

THE VIBROPLEX CO., Inc.

833 Broadway

New York, 3, N. Y.

(Continued from page 136)

ONE-SIXTY

Sudbury, Mass.

Editor, QST:

The published letter of Glen Dallas, W8RSR, in the March issue was to some and should be enlightening to all amateurs. Our 160-meter band seems to have been cast aside, and as Glen stated, the usual anti-160-meter-band propaganda has cropped up to take its place. In fact not so long ago you referred to 80 meters as the mother band. It would appear that the writer had not known or forgotten that back in the days of the loose coupler, spark coil, etc., we used to park anywhere that seemed convenient until a license became a must and then around 200 meters was the spot until the 160-meter band took over.

It is my conviction that some commercials are desirous of devouring the 160-meter band and are subtly working toward that end, and undoubtedly there are members of the ARRL who are not adverse to this loss. It is the time-worn tactics of those who desire to take something over or make a change, to divide and conquer. Take a little good advice, boys, and do not be divided. The 160-meter band is and was the true mother band and you may take my word for it that when a mother is lost the children suffer.

— Gordon Taylor, W1LAX

[Editor's Note: FCC proposes to assign the 160-meter band principally to government-operated radio navigation devices (loran), not to "commercials" in the usual sense of that term.]

GOOD 'PHONE OPERATING

61 West 56th Street, New York 19, N. Y.

Editor, QST:

Here are three cheers for W5EYV of Refugio, Texas! This very fine and gracious operator has been living up to the true spirit of ham radio by devoting many hours on Saturdays working "underprivileged" stations.

He apparently starts by listening at the low-frequency end of the 10-meter band, calling "CQ to those stations who have been unable to work out of their district." He comes back, in turn, to one after the other, giving them honest reports and always encouragement. The remarkable thing about this 'phone operator is that he never seems to repeat himself in subject matter and is able to be snappy without being brusque.

To stations in crowded areas who find it difficult to break through traffic, QRN and local QRM, W5EYV's friendly practice deserves commendation. To him and to other operators who may be using their excellent signals and locations in this way — "thanks a lot!"

— Lenore K. Conn, W2NAZ

HANDS ACROSS THE SEA

Marshallton, Delaware

Editor, QST:

I wonder if amateurs in this country fully realize the conditions endured by our foreign amateur friends? With necessities very scarce, life is a scramble for each day's existence; little things like soap, tinned meat, razor blades, tea, clothes, and the like are to them really luxuries of the first order. I suggest that each amateur get his DX cards out of the moth balls and write to his foreign friends. Many have lost their lives and homes so it is necessary to write before sending anything. A small parcel worth a buck-and-a-half looks like a mint to that old friend of yours.

This is really not charity. No one will deny that these people paid a much larger war price than any of us at home, so it is just a payment on our unbalanced war account. I know that we all give to the Red Cross, but these are our personal friends and deserve our personal interest. This is not only the spirit of amateur radio, but for each buck-and-a-half spent you will get better than three dollars' worth of satisfaction. Remember these people are not beggars, so use considerable tact in your correspondence.

— C. D. Justis, W1JVS

(Continued on page 148)

New! Exclusive! Ready Now!

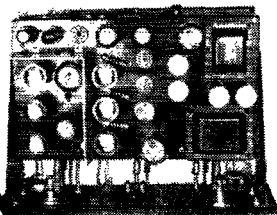
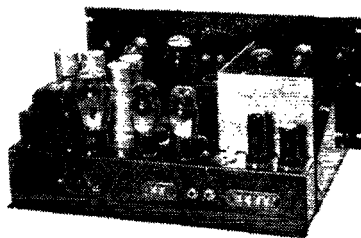
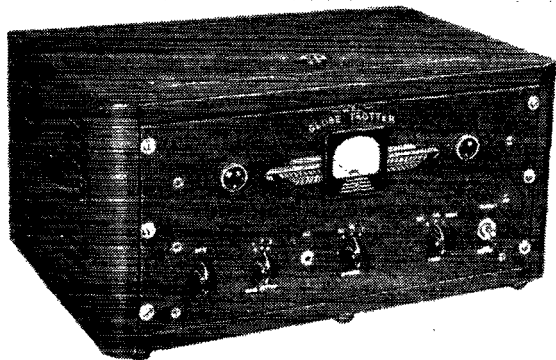

*The Sensation
of the Year!*

**WRL
Globe Trotter
40 WATTS INPUT CW
TRANSMITTER
KIT**

Transmitter kits are almost impossible to get, but Leo, W9GFQ, now offers amateurs the new WRL Globe-Trotter, destined to become one of the most popular kits on the market. The WRL Globe-Trotter is capable of 25 Watts input on phone on all bands from 3500 KC through 28 Megacycles. Incorporates the proven Tritet Oscillator using a 40 meter X-Tal and providing sufficient drive at 10 meters for the 807 final. Helixing choke modulation is incorporated with excellent results and good tonal quality. Look this over! It has everything! Three bands are all pretuned and available at the turn of a switch, 10, 20, and 80 meters. Metering is provided for both oscillator and final stages. The transmitter uses two power supplies, one furnishing power to the 807 final and modulator tubes, and the other supplying the speech, amplifier and oscillator stage. Tube Line Up: RF—6L6 OSC, 807 final amplifier; Audio—6SJ7, 6N7, 2-6V6S—Rectifiers, 2-5U4G.

**NEW
BC 348Q
RECEIVERS**

Original government price over \$200.

\$85.00

Including steel case, Speaker furnished at small added cost. Cat. No. 35-61.

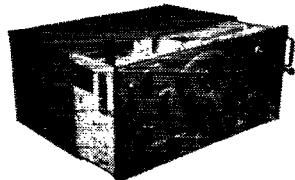

Here is one of the hottest war-surplus receivers that will be available, 9 tubes, 2 tuned RF stages, 3 stages of IF amplification. Frequency range, 200 to 500 Kilocycles; 1/2 to 18 MC in four bands. Tunes weather and aircraft bands, and all ham bands except 10 meters. Ask about our special converter for 10 meter operation.

BC-610 (Hallicrafters HT-4E) TRANSMITTERS

Counterpart of the famous SCR-299. 825 watts input on CW, 540 watts input on phone; 3 sets of coils. Range of 1/2 to 18 Meg. Completely reconditioned. Cat. No. R70-202, \$310.00—New Cat. No. 70-202, \$760.00. Reconditioned or new sets converted to 10 meters, \$25 extra.

Giant Radio Reference Map with time and amateur zones, standard and short wave stations, and other valuable information. Printed in colors. Size 3 3/4 x 4 1/2 feet. Only 15c

Write for our latest flyer of radio parts. FREE!

Complete kit including all parts, chassis, panel, streamlined cabinet less tubes, coils and meters. **\$59.95**

Cat. No. 70-300

Kit Same as above. Wired by our engineers

Cat. No. 70-312. \$75.00

ACCESSORIES

- Complete kit of 8 Tubes
- Cat. No. 70-314. \$5.95
- 3 in. Meter Cat. No. 70-318. 4.95
- Coils per set (any band)
- Cat. No. 70-316. 2.95
- Crystals-40-80 Meters Mts.
- Cat. No. 70-322. ea. 2.65
- Quality Crystal Mike and Stand
- Cat. No. 70-320. 9.45



Formerly Wholesale Radio Laboratories

Address Dept. Q-6, Council Bluffs, Iowa

NATIONAL HEADQUARTERS FOR HAM EQUIPMENT

Quality PRODUCTS
Since 1923

A complete line of
WIRES, CABLES, HOOK-UP WIRES,
RADIO HARDWARE, SHIELDED
MICROPHONE CABLE and S. J. CABLE
Complete Stock at Your Dealer

BIRNBACH

BIRNBACH RADIO CO., Inc.
143 HUDSON ST. NEW YORK 13, N. Y.

YOUNG ELECTRICAL ENGINEER ●

• Electrical engineer—young graduate wanted by a large manufacturer in electronics field. Manufacturing experience not necessary as applicant will be taught on the job. This is a permanent position in product design and test, with increasing responsibilities and pay. Reply by letter, giving background, to

BOX 149, QST, WEST HARTFORD, CONN.

**CONNECTICUT
HAM HEADQUARTERS**

Complete stocks of nationally known
amateur gear — radio electronic parts
— tubes — sets and equipment.

Wholesale Only

R. G. SCELİ & CO.

Pete De Pasquale, W1GUC Roger Amundson, W1HYF
George Loppo, W1LWV Roy Watson, W1MHH
Porter Noe, W1LWZ Ernie Johnson, W1FSY
Art Lundeen, W9PZI John Yacovelli, W1IKB

317 Asylum St.
Hartford 3, Conn.
Tel. 2-1144

84 Elm St.
Bridgeport, Conn.
Tel. 63-1811

ASK FOR OUR BARGAIN BULLETIN

(Continued from page 140)

CORRECTION

3540 Hertford Pl., N.W., Washington, D. C.

Editor, QST:

I have just finished reading a very interesting article on "QRM — The Electronic Life Saver," in the February issue of QST.

On page 31, last paragraph, and continued with names on page 32, there is a misleading statement. Lieutenants Van Orstrand and Picotte and CRE Callahan participated in the Amchitka work, but the Kuriles work was done after Picotte and Callahan had gone to the Central Pacific. Lieutenant Fay was in Adak (Aleutians) while the work was going on over in Amchitka, but he also went to the Central Pacific before the Kuriles' bombardments. These three officers were very active in RCM in the Central Pacific. Lieutenant Van Orstrand stayed in the North Pacific for slightly over a year and was engaged in RCM activities in the Kuriles during the first six months of Naval bombardment of those islands.

While the slight inaccuracy occurring in your story seems of little consequence, there are always a few people who feel that when names are given the publication should take the necessary precautions to give the proper credits and to avoid omissions.

— R. C. Sergeant, W6OBG, ex-K6OBG

TALE OF LX

Apartment 5, 206 Spruce, Coffeyville, Kansas

Editor, QST:

Rummaging through ex-W9MWM's file of QST, I found the following item (March, 1940, QST): "At the annual meeting of *Reseau Luxembourgois*, F. Scholtes, LX1OB, was elected president . . ."

Now you would think this only a minor item: but I was chief engineer of "Radio Luxembourg" (150 kw., 232 kc.) for PWD-SHAEF from the recapture of the station in September, 1944, until I left for the U. S. in January, 1945. Ferd Scholtes was my chief Luxembourg engineer! But in all the time I was at Radio Lux, running it and a 7 kw. short-wave rig, I never knew that Scholtes was a ham! I should have known something was up when, during the famed Battle of The Bulge, when I took Radio Lux off the air, my assistant (W9UYA) and I found a wonderful little ham transmitter, built of the best American parts, tucked lovingly in a corner of the transmitter building. We left the transmitter in its place, and after Radio Lux was once more on the air the little ham job disappeared, I suppose to Scholtes' home, where I hope someday he gets it back on the air.

Incidentally, Scholtes was imprisoned by the Germans because he refused to run Radio Luxembourg's transmitter for them. During most of the war he worked in an electrical shop, until we came and reinstalled him at the transmitter.

— Don V. R. Drenner, ex-W7FHZ

CALL CHANGES

5015 South Budlong, Los Angeles 37, Calif.

Editor, QST:

Due to the new licensing setup, many of us are losing old and cherished calls. May I suggest that as soon as we find our old call reassigned to another station, we write to the new operator and give him a brief history of ourselves and our activities prior to the war. In some cases where the old call is being dropped entirely, it may be wise to write both to the old call area and the new call area that supersedes the old call. Surely they will contact someone that will recognize the old call and may desire to get in touch with the former operator.

— Milton J. Malloy, W9GRH

A STAR PERFORMER.
PROVED BY THE YEARS
NOW BETTER THAN EVER
 ★ **INTEGRATED DESIGN**
 ★ **IMPROVED CIRCUIT**
 ★ **MOTOR TUNING**
 ★ **SHOWMANSHIP**



Broadcasting Stations Everywhere Applaud Its Stellar Dependability

The test was the crucial years just past when sheer dependability was paramount—when even normal maintenance and spare parts were in direct ratio to prevailing shortages. This Unit won the applause of Stations everywhere for dogged, trouble-free service, and we are proud to offer it now with added improvements that further distinguish its super performance and GATES superior engineering.

THE Gates 250-C TRANSMITTER — 250 WATTS

—gives your Station a new efficiency in broadcasting technique. Its proved design assures that. It is superior for its INTEGRATED DESIGN embodied in the new, structural layout rendering visibility and accessibility an easy procedure. Engineers will like this GATES achievement. The Front Panel is also designed to contribute a maximum effect to "showmanship"—another must for broadcasting stations.

Engineered to Meet Modern Demands

The Schematic Diagram at the right shows the fundamental circuits of this Unit — straightforward — properly applied — to obtain the best operation. Added is the distinguishing feature of MOTOR TUNING for the tuning adjustments of the final stage and loading to the antenna — another EXCLUSIVE for the GATES 250 C. Also, there are but TWO controls for the entire tuning procedure, for simplicity. These are only a few of its outstanding superiorities in engineering design.

WRITE FOR COMPLETE SPECIFICATIONS

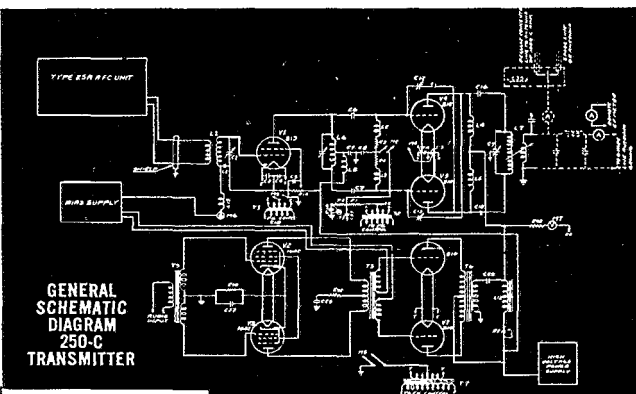

NEW YORK
OFFICE:
9th Floor • 40 Exchange Place

GATES
RADIO CO.
QUINCY, ILLINOIS

SOLD IN CANADA BY:
Canadian Marconi Co.,
Ltd., Montreal

EXCLUSIVE MANUFACTURERS OF RADIO TRANSMITTING EQUIPMENT... SINCE 1922



World's Largest DISTRIBUTOR OF SHORT WAVE RECEIVERS

Do business with the biggest and one of the best in the field. Enter your orders for the following:

Skyrider Jr. 541.....	\$33.50
Hallicrafters 538 complete.....	39.50
Hallicrafters SX-25.....	94.50
Hallicrafters SX-28A.....	223.00
Hallicrafters 536A.....	307.50
Hallicrafters 537.....	591.75
Hallicrafters 540.....	79.50
National N-2-40C.....	225.00
National One-Ten.....	56.10
National HRO Sr.....	197.70
RME-45.....	186.00
Hammarlund HQ129X.....	129.00
Hammarlund SP-400-SX Super Pro complete.....	318.00
Hammarlund SP-400-X Super Pro complete.....	342.00
Harvey 100 transmitter.....	583.00
Temco 75 100GA transmitter.....	495.00
HT-9 transmitter.....	250.00

Some models are available for immediate shipment. As more and more receivers become available Bob Henry will be able to serve you better and better. By dealing with the world's largest distributor of short wave receivers you are assured of the fastest delivery possible and the best of service.

Enter your reservation now. You can trade in your present receiver. You can order on our 6% terms. You can depend on Bob Henry also for a wide assortment and the best values in crystals, transmitting tubes, microphones, test equipment, etc. Your inquiries welcomed.

Bob Henry
W9ARA

BUTLER, MISSOURI

HENRY RADIO SHOPS

LOS ANGELES 25, CALIF.

"WORLD'S LARGEST DISTRIBUTOR OF SHORT WAVE RECEIVERS"

PLASTICON* CAPACITORS

*PLASTICONS — plastic film dielectric capacitors.

OBSOLETES

PAPER CONDENSERS!

Smaller, lighter, more economical. Specified by Signal Corps, Air Corps and Navy for more severe operating conditions than oil-paper capacitors. Closer tolerances, wider temperature range, greater safety factor, longer life.

Condenser Products Company 1375 NORTH BRANCH STREET
CHICAGO 22, ILLINOIS



**FOUR BANDS IN FOUR SECONDS!
TWO ADJACENT FREQUENCIES IN EACH BAND!**

Plus
**400 WATTS
ANTENNA POWER!**
with the
**WILCOX TYPE
99A TRANSMITTER**

A commercial equipment for the amateur who desires the ultimate in a four-band transmitter for use on any frequency between 2 Mc and 144 Mc.

Four fixed-frequency R. F. Units, each with a dual crystal plus a telephone-type dialing system, gives you your instantaneous choice of four bands, *with both phone and C. W. on each.*

Single 250TL final on medium frequency and Push Pull 4-125A's on VHF.

Complete remote control facilities are included, so that you may select any function, including channel selection, start and stop, etc., by an ordinary telephone dial.

Truly a deluxe transmitter for the discriminating amateur who wants the maximum in operating satisfaction from his hobby.

Complete engineering and installation service, including antenna systems, is available to you, to insure that you will realize the maximum benefit from this fine equipment.

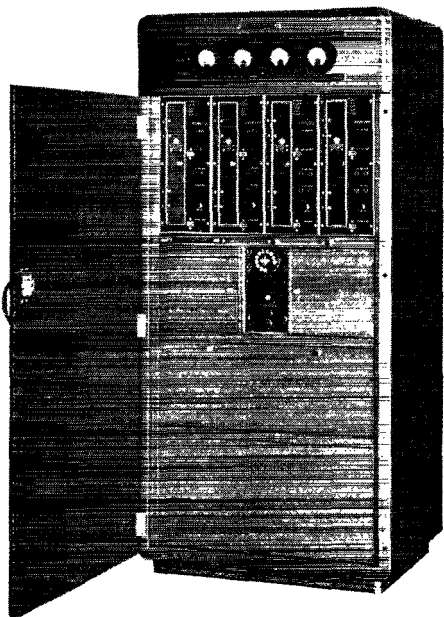

Wilcox 99A Transmitter with 4 R. F. Units.

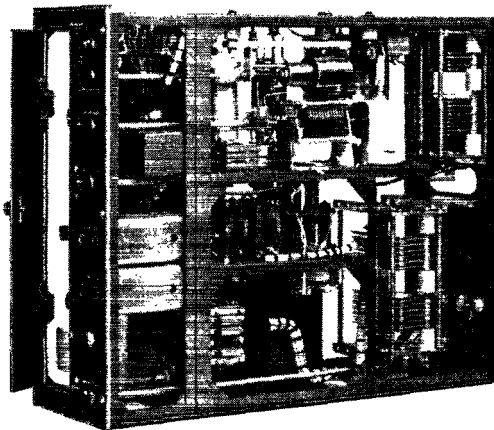

Interior View Removable R. F. Unit.

Price: *Approximately \$3900.00, depending upon frequencies chosen.*

Delivery: *30 days.*

Complete data available on request.

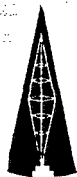

WILCOX ELECTRIC COMPANY, INC.

Manufacturers of Radio Equipment

Fourteenth and Chestnut

Kansas City, Mo.

2

MIGHTY BARGAINS FOR INSTANT DELIVERY!

Write for Our Bargain Flyer — Out Every Month

1 IT'S BRAND NEW! CRYSTAL SOCKET ADAPTER

Newest thing out! An adapter for using a new style crystal holder in a 5-prong socket, or old style crystal socket! Small! Will only raise crystal $\frac{3}{8}$ inch! Low loss material! Get your order in! **35¢**

2 AMERTRAN PLATE TRANSFORMERS

From one of the greatest makers! Rated at 2 KVA. **\$39.95**
Primary 105/110/115, 60 cycle. Secondary 6200 V ct. 11" x 14" x 10" high. This is a buy!

Freight Prepaid Anywhere in Continental U.S.A.

WHAT WE ADVERTISE—WE DELIVER!

WALTER ASHE RADIO CO.
1125 PINE STREET ST. LOUIS 1, MO



RCA INSTITUTES, INC.

Offer thorough training courses in all technical phases of

RADIO and TELEVISION

WEEKLY RATES DAYS — EVENINGS

VETERANS: RCA Institutes is approved under G. I. Bill of Rights

For Free Catalog write Dept. ST-45

RCA INSTITUTES, INC.

A Radio Corporation of America Service
75 Varick Street, New York 13, N. Y.

• *Ted McElroy*

World's Largest Manufacturer of
Wireless Telegraphic Apparatus

COMPLETE CENTRAL OFFICE EQUIPMENT

McElroy Manufacturing Corp.

82 Brookline Avenue • Boston, Massachusetts

High Forward Gain, Wide-Spaced, 4-Element,
All-Aluminum

10 METER BEAM

Weights only 13 lbs. Puts terrific sig. where you want it. No insulators, no adjustments of any kind! Just attach 2-inch line or twin 300 ohm line and use! Easily supported and rotated with a 1 1/2 inch round wood pole. Up to ten times power gain over 1/2 wave ant. Greatly reduces ignition and other QRM. Package has elements; hor. sup. member; delta or folded dipole term. panel; all hardware; complete instructions and clear print. Amateur net price \$50.

U.H.F. RESONATOR CO.

GUION ROAD, RYE, N. Y.

Telephone Rye 2030

BOOK REVIEWS

Principles of Radio for Operators, by Ralph Atherton; published by the MacMillan Company, N. Y. 344 pages, 5 1/2 x 8 1/4. Price, \$3.75.

From the preface we learn that "the material contained in this book has been used for some time in the training of Navy men and women as radio operators." The book shows considerable care in the arrangement and presentation of the sixteen chapters, particularly the early ones on the nature of electricity, batteries, circuits, magnetism and motors. Each chapter is headed by key statements outlining the chapter, many illustrations are included, and there is a review test at the end of each chapter. Each chapter also includes several "demonstrations," or experiments, to help in illustrating the principles introduced in the chapter. An unusual feature at the end of each chapter is the list of motion pictures and slide films covering the subject of the chapter. To further aid the student, many of the illustrations are photographs of actual components, so that the reader has a mental picture of the physical form of things like resistors, capacitors and inductors from the first time he reads about them. The beginner should be able to learn a great deal if he follows the text carefully.

As in many books of this type, there are things to criticize. A purist would take issue with the representations of radio waves in Fig. 183, because the sine waves start at maximum instead of zero and somewhere an amplitude-modulated carrier acquires modulation at twice the modulation frequency and also gathers itself considerable f.m. in the process. This may be the result of the author's habit of not neutralizing his triode amplifiers, since in Fig 370 and again in Fig. 383, a neutralizing condenser is shown incorrectly connected in the circuit, and it might prove rather confusing to the tyro. However, with someone to point out the few confusing points here and there, or in a corrected second edition, the beginner will find this a book that is easy to follow and understand.

Two-Way Radio, by Samuel Freedman; published by Ziff-Davis Publishing Co., Chicago. 506 pages, 6 1/2 x 9 1/2; illustrated. Price, \$5.00.

This book is apparently intended for private or public agencies contemplating the use of a two-way radio system. Its twenty chapters cover the entire useful radio spectrum from low-frequency induction systems to the use of micro-waves by railroads. Police, public transportation, personal and aeronautical applications are all discussed in more or less detail. Typical systems are described in each class, and in many cases initial cost and upkeep expense evaluations are made. Licensing and other legal requirements for station construction and operation are mentioned. The book is generously illustrated with photographs of various installations, and pictures and schematic diagrams of equipment. There doesn't seem to be too much of interest for the average amateur in this book, although the experimenter interested in commercial tube line-ups of mobile equipment will find a number of interesting circuit details of a.m. and f.m. transmitters and receivers, along with scattered design and constructional ideas.

Inside the Vacuum Tube, by John F. Rider; published by John F. Rider, N. Y. 407 pages, 6 x 8 1/2; illustrated. Price, \$4.50.

It is quite possible that there are people who could read Mr. Rider's latest book and then say they didn't have a very clear picture of how a vacuum tube works, but it hardly seems probable. Certainly such people have no business being interested in radio. The book does not pretend to be the last work in vacuum-tube theory, but one will find in its fifteen chapters an interesting physical picture of what goes on inside the various types of tubes. The accent is on a visualization of the workings of electrons

(Continued on page 160)



Burlington

★ PANEL INSTRUMENTS

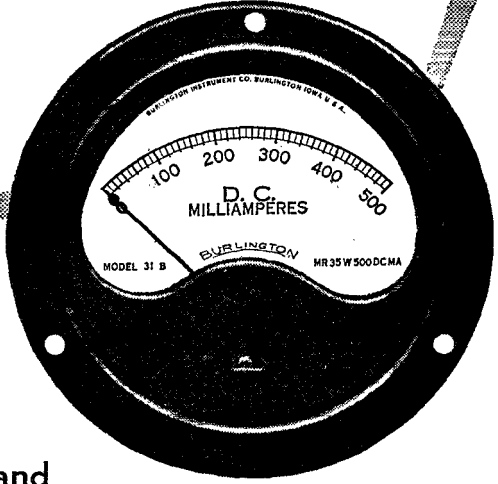

Guaranteed ACCURACY

Due to design characteristics and close control of manufacturing processes, Burlington instruments embody the following advantages:

PERMANENCE OF CALIBRATION ••• All DC instruments employ Alnico magnets which are known to be more highly resistant to shock, heat, vibration, and stray fields than any other magnetic material.

FREEDOM FROM STICKING ••• Clearances for all moving parts are such that the results of entrance of small particles as encountered in field service are reduced to a minimum.

STABILITY OF OPERATION ••• All instruments are "NORMALIZED" after assembly to eliminate "zero shift" and other calibration errors due to ageing.

Exceptionally high torque to weight ratio of control springs to moving element insures minimum error under conditions of shock, vibration, and other rough usage.

Alignment of jewels and magnet core piece is such that the center lines of these parts coincide within plus or minus .002". The design of the brass movement frame and components is such that mechanical tolerances are reduced to a minimum in assembly. As a result, jewel and pivot wear is uniform which reduces "frictional torque" of the moving coil.

All series resistors and coils are heat treated and impregnated after wrapping to insure stability and long life.

All ranges AC & DC are available in 2½", 3½" and 4½" sizes, both square and round, flush mounting.

*Engineering service furnished for specialized applications.
No obligation. • Write today for further information.*

BURLINGTON INSTRUMENT CO.
807 Fourth Street • Burlington, Iowa

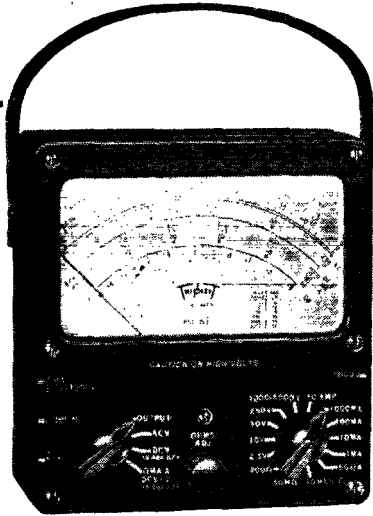

LONG SCALE, WIDE RANGE VOLT-OHM-MILLIAMMETER

**DOUBLE SENSITIVITY
D.C. VOLT RANGES**
0-1.25-5-25-125-500-2500 Volts,
at 20,000 ohms per volt for greater accuracy on Television and other high resistance D.C. circuits.

0-2.5-10-50-250-1000-5000 Volts,
at 10,000 ohms per volt.

A.C. VOLT RANGES
0-2.5-10-50-250-1000-5000 Volts,
at 10,000 ohms per volt.

OHM-MEGOHMS
0-400 ohms (60 ohms center scale)
0-50,000 ohms (300 ohms center scale)
0-10 megohms (60,000 ohms center scale)

**DIRECT READING OUTPUT LEVEL
DECIBEL RANGES**
-30 to +3, +15, +29, +43, +55, +69
DB

**TEMPERATURE COMPENSATED
CIRCUIT FOR ALL CURRENT
RANGES D.C. MICROAMPERES**
0-50 Microamperes, at 250 M.V.

D.C. MILLIAMPERES
0-1-10-100-1000 Milliamperes, at 250 M.V.

D.C. AMPERES
0-10 Amperes, at 250 M.V.

OUTPUT READINGS
Condenser in series with A.C. Volts for output readings.

ATTRACTIVE COMPACT CASE
Size: 2 1/2" x 5 1/4" x 6". A readily portable, completely insulated, black molded case with strap handle. A suitable black leather carrying case (No. 629) also available, with strap handle.

LONG 5" SCALE ARC
For greater reading accuracy on the Triplet RED • DOT Lifetime Guaranteed meter.

**SIMPLIFIED SWITCHING
CIRCUIT**
Greater ease in changing ranges.

Write for descriptive folder giving full technical details

Precision first . . . to last

Triplet

ELECTRICAL INSTRUMENT CO., BLUFFTON, OHIO

HERE'S THAT NEW
**TRIPLET
625-N**



A Buy-word for Excellence

40

YEARS

DEPENDABILITY

1906

BRACH

1946

Special-purpose transmitting antennas designed for volume production to your own specifications. Collapsible—sectional—direction finding—radar and coaxial type. All sizes, lengths and materials. Consult us on your needs.

PUR-A-TONE

Reg. Trade Mark

ANTENNAS

ALL TYPES FOR

**AUTOS
HOMES
MARINE**

A.M. — F.M. —

TELEVISION

L. S. BRACH MFG. CORP.

200 CENTRAL AVENUE NEWARK, N. J.



WORLD'S OLDEST AND LARGEST MANUFACTURERS OF RADIO ANTENNAS AND ACCESSORIES.

"IT'S ABOUT TIME I SPOKE FOR MYSELF!"

"I may be just a part of a shack, but I'm tired of repeating the words of some stranger a thousand miles away. Now I'm going to speak for myself.

"You've been letting us go to pot, O.M. Receiver out of alignment. Rig components need replacement. Switches shot. No meters. Brother, your rig is a mess, whether you know it or not.

"Look. Do us both a favor. Drop a card to Sun Radio. There must be *something* on Sun's half million feet of shelves to make us work better: parts, equipment, tools, accessories. Now that we're back on the air, let's really go to town. Call Sun Radio now, and get exactly what you need — the **FIRST** time."

"EYES FOR YOUR RECEIVER" WITH THE PANADAPTOR

Immediate delivery on this nationally advertised "ham's right arm". You can see up to 200 kc. of the band at once. Read Panoramic's full page ad in this issue and call Sun Radio. Comes ready to operate. One year guarantee. net \$99.75

EVERY HAM NEEDS A MILLEN 50 WATT EXCITER

Use it either as a low power xmtr or as an exciter for high power stages. Unless otherwise requested, comes less tubes but with coils for 10 meter operation and 40 meter crystal, to quadruple down to 10.

net \$37.50

HALLICRAFTERS S-40, FIRST IN PERFORMANCE, PRICE, STYLE

Permeability tuned "micro-set" type RF coils. 540 kc to 42 mc continuous in 4 bands. 3 position tone control. High signal to noise ratio. Inertia flywheel tuning. ANL. net \$79.50 (Approx.)

NEW CARDWELL UHF "BUTTERFLY" CONDENSERS

Pictured is type PL-6113. Range: 14-11 mmf. Perfect electrical symmetry and low distributed inductance. The only variable for use on the ultra highs. Type PL-6076 covers 6-2.5 mmf.

PL-6113 — \$2.40
net PL-6076 — \$1.62

Sun Radio has a complete stock of RCA batteries and B&W products.

Do you need record changers, playbacks, blanks, or PA equipment? Call Sun Radio.

Detailed Technical Data
For All Items
Sent On Request.

FREE OFFER

Condensed chart of Graphical Symbols for Electronic Diagrams as standardized by the RMA (includes those until recently kept secret). Just ask for it. Address Dept. ER-6.

In writing, please mention this ad.

Note our ONE and ONLY address.

SUN RADIO & ELECTRONICS CO., INC.

122-124 DUANE ST. NEW YORK 7, N. Y. Barclay 7-1840

**A 2 METER
COAXIAL VERTICAL
RADIATOR FOR
EITHER MOBILE OR
FIXED STATION USE
FOR \$11.75 NET
F.O.B. OAKLAND**



Both the 1/4 in. Radiator and Skirt are adjustable for frequencies from 144 to 148 mc. Fitted with an amphenol 83-1J connector, to take a 72 ohm line coaxial cable.

W. D. BRILL CO.
198 Tenth St. • Oakland 7, California
W6KLO W6SSN W6FJX

HAM SPECIALS

WHILE THEY LAST — REAL BARGAINS!!!

ALL STANDARD BRANDS

Fully Guaranteed at Rated Voltages

1 mfd. 3600 v. OIL Sq. Can Condensers.....	\$3.25
8 mfd. 1000 v. OIL Sq. Can Condensers.....	3.35
10 mfd. 2000 v. OIL Sq. Can Condensers.....	6.75
2 mfd. 1300 v. OIL Sq. Can Condensers.....	3.15
10 mfd. 600 v. OIL Sq. Can Condensers.....	3.05
10 h. 250 ma. 1500 v. Insulation Chokes.....	2.95

IN STOCK!! Hammarlund & National Receivers. Complete Line of RCA Power Tubes. MILLEN — RADI-ART — AEROVOX Parts. Write for our latest list of Specials.

CHIEF ELECTRONICS

"Mid-Hudson Valley's Only Distributor"

104 MAIN ST. W2APJ POUGHKEEPSIE, N. Y.



**ELECTRICITY
FOR RADIO AND ELECTRONIC
APPLICATIONS**

ONAN ELECTRIC GENERATING PLANTS supply electric service for electronic applications and general uses, mobile or stationary. Driven by Onan 4-cycle gasoline engines, they are of single-unit, compact design and sturdy construction.

65 basic models ranging in capacity from 350 to 35,000 watts. Standard A.C. models, 115-volt, 60-cycle, single-phase. Standard D.C. models, 32 to 115 volts. Special voltages to 660 A.C., and 6 to 4000 volts D.C. 5 KW to 35 KW units available in 3-phase. High frequencies to 800 cycles. Combination A.C.-D.C. types. Write for detailed literature or engineering assistance.

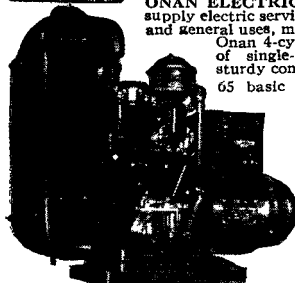

D. W. ONAN & SONS 2637 Royalston Ave. Minneapolis 5, Minn.

(Continued from page 146)

in the tube and in external circuits. The actual mathematics used is introduced so painlessly, that in many cases the reader who finds any math at all "too technical," will understand all that is taking place before he realizes that a slight touch of simple arithmetic has been added. The various graphs of tube characteristics are described, but the reader is led by the hand so carefully there is little chance for him to be frightened by the curves.

It would appear that Mr. Rider has done everything possible to make the book easy reading for the man interested in a lucid nontechnical description of vacuum-tube operation. In many cases illustrations are repeated on following pages so that the reader won't have to thumb back and look for the necessary pictures. The first four chapters, dealing with electrons, electrostatic fields, emission and ionization, are illustrated with cartoons that depict the electrons as friendly little guys either helping or punching each other, almost like everyday people. The rest of the book is profusely illustrated with line drawings that are never unnecessarily complicated. One is taken through elementary diode and triode theory to tetrodes, pentodes and cathode followers, and voltage and power amplification are both treated. There is a chapter on miscellaneous tubes that covers cathode-ray tubes, acorn tubes, gas-filled tubes and photoelectric cells, just to complete the picture. New radio amateurs, anxious to learn about transmitter operation, might be disappointed in the omission of a discussion of Class-B and Class-C amplifiers, but this hardly detracts from the value of the book, since the reader who has finished "Inside the Vacuum Tube" will be in an excellent position to go on to a more advanced book for further information.

One feature of the book, the "anaglyphs" that give a stereoscopic picture when viewed through spectacles that are included with the book, was quite unusual, but there are only three such illustrations and there could be many more. But this is hardly a shortcoming of a book that should be very educational and interesting to anyone who wants a physical picture of how a vacuum tube works.

— B. G.

Strays

Wanted: a "handle" exterminator. For our money, that's the most distasteful word in all the language of amateur radio.

Corporal Walter G. Egan, W2OKW, is an electroencephalographic technician in the Army Medical Corps and gives us some interesting information on their work in recording the electrical activity of the brain. This technique is mainly an additional diagnostic measure in epilepsy, brain lesions, tumors, etc. The amplitude of the brain wave at the scalp is of the order of 20 to 50 microvolts, and the frequencies vary between 1 and 40 c.p.s., normally lying in the range 8.5 to 12 c.p.s. Ten wires are fastened to the patient's head with collodion, eight on top and one on each ear. The patient is put in a shielded room and his wires are connected through a shielded cable with four independent amplifiers in a recording room, where oscillographic records on a moving strip of paper are made simultaneously from four areas of the brain. The amplifiers are 5-stage audio affairs with 4- μ f. coupling condensers between stages, ending in push-pull 6L6s.

In making the zero in the calls of WØ stations, FCC requires five dashes, will not permit the use of the single long dash.

Centralab

CRL

The Mark of QUALITY

THE initials "CRL" in the diamond represent the research-laboratory and technical manufacturing facilities of Centralab . . . a name outstanding for quality, precision and new developments in the field of radio and electronics.

Always Specify Centralab.

Send for Catalog No. 25.

CRL

Centralab

Division of GLOBE-UNION INC., Milwaukee

PRODUCERS OF



Ceramic Trimmers
Bulletin 695



Ceramic High Voltage Capacitors
Bulletin 814



Variable Resistors
Bulletin 697

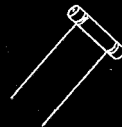

Tubular Ceramic
Capacitors
Bulletins 630 and 586

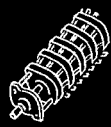

Selector Switches
Bulletin 722

T.A.C. ANNOUNCES THE NEW CODE PRACTICE OSCILLATOR WITH ADJUSTABLE RESONATOR



for Greater Volume

ADJUSTABLE
RESONATOR

Better Tone

MS-710, less resonator and less built-in key. Amateur net price, \$9.00

MS 710R, with resonator but less built-in key. Amateur net price, \$10.50

MS 710P, with built-in key but less resonator. Amateur net price, \$11.50

MS 710PR, DeLuxe Master Oscillator with resonator and built-in key. Amateur net price, \$13.00

Adjustable Resonator (optional) increases volume five times. Tone frequency variable from 600 to 1500 cycles. Volume control from 0 to FULL ON. "PM" DYNAMIC speaker may be disconnected during headphone operation. Up to 300 headphones may be used. Has phone jack for headphones. Optional built-in key. 110 V. AC or DC. Uses a 117N7GT tube. Gray crackle finish.

NOW IN STOCK AT ALL LEADING RADIO DISTRIBUTORS

TELEGRAPH Apparatus Co.

412 SOUTH GREEN ST.

CHICAGO 7, ILLINOIS

TRANSMITTING TUBES RECTIFIERS CATHODE RAY TUBES

We have been appointed a sales agent by Defense Supply Corporation of Government surplus tubes and rectifiers. All are first grade Government tested and inspected tubes—not rejects.

The following types are immediately available:

826 (HF Triode)	Cathode Ray Tubes
VT 127A (HF Triode)	5A1P1
304 TL	5BP4
872A M. V. Rectifier	3A1P1

Trade discounts to dealers on standard packages • Write for prices

LEWIS ELECTRONICS 16 Lyndon Avenue
Los Gatos, California

Here's a New POWER CUTTER KIT

with a cutting range of 5/8" to 2 1/2"



Only \$7.85 Complete

Two Bruno Adjustable Hole Cutters in one convenient kit. High speed steel blades cut clean, fast holes in metal, wood, plastics. Quickly adjustable and easily sharpened. Designed by tool engineers to operate efficiently in bench drill, drill press or portable drill. Ask your jobber, or write Dept.

MODEL	SHANK SIZE	EXPANSION	PRICE
100	1/4" st. shank	5/8" — 1 1/2"	\$3.00
101	3/8" st. shank	1" — 2 1/2"	\$5.00
790 KIT		5/8" — 2 1/2"	\$8.00*

*Fair Trade Minimum \$7.85

BRUNO

TOOLS

9330 Santa Monica Blvd.
Beverly Hills, Calif.

WWV Schedules

STANDARD-FREQUENCY transmissions are made available as a public service by the National Bureau of Standards over its standard-frequency station, WWV, on the following schedules and frequencies:

2.5 Mc. — 7:00 P.M. to 9:00 A.M. EST (0000 to 1400 GMT).

5.0 Mc. — Continuously, day and night.

10.0 Mc. — Continuously, day and night.

15.0 Mc. — Continuously, day and night.

The 10- and 15-Mc. radio frequencies are modulated simultaneously at accurate audio frequencies of 440 and 4000 cycles. 5 Mc. carries both audio frequencies during the daytime but only 440 cycles from 7:00 P.M. to 7:00 A.M., EST, while 2.5 Mc. carries only the 440-cycle modulation. A 0.005-second pulse may be heard as a faint tick every second, except the 59th second of each minute. These pulses may be used for accurate time signals, and their one-second spacing provides an accurate time interval for physical measurements.

The audio frequencies are interrupted precisely on the hour and each five minutes thereafter, resuming after an interval of precisely one minute. This one-minute interval is provided to give Eastern Standard Time in telegraphic code and to afford an interval for the checking of radio-frequency measurements free from the presence of the audio frequencies. Ionospheric disturbance warnings applicable to the North Atlantic path are given at 20 and 50 minutes past each hour. If a disturbance is in progress or is anticipated within 24 hours, the time announcement is followed by 6 Ws; if conditions are quiet or normal, the time announcement is followed by 8 Ns. The announcement of the station's services and of the station's call (WWV) is given by voice at the hour and half hour.

The accuracy of all the frequencies, radio and audio, as transmitted, is better than a part in 10,000,000. Transmission effects in the medium may result in slight fluctuations in the audio frequencies as received at a particular place; the average frequency received, however, is as accurate as that transmitted. The time interval marked by the pulse every second is accurate to 0.00001 second. The 1-minute, 4-minute and 5-minute intervals, synchronized with the second pulses and marked by the beginning and ending of the periods when the audio frequencies are off, are accurate to a part in 10,000,000. The beginnings of the periods when the audio frequencies are off are so synchronized with the basic time service of the U. S. Naval Observatory that they mark accurately the hour and the successive 5-minute periods.

Of the frequencies mentioned above, the lowest provides service to short distances and the highest to great distances. In general, reliable reception is possible at all times throughout the United States and the North Atlantic Ocean, and fair reception over most of the world.



R. C. (Dick) Hall
W5EIB

R. C. & L. F. HALL, INC.

"THE HAM SHACK"

1015-17 Caroline Street • Houston 2, Texas
Telephone C-9731

Our stock is at a new all time high although some items are still relatively scarce. We are delivering many communications receivers to those who have placed a \$5 deposit with us. Your attention is called particularly to the Hallicrafters S-38; the Robson-Burgess V-O-M at \$18.75 and the splendid value in the crystal control, 8 channel, Aircraft transmitter T-67-ARC/3, 100-156 mc, and our splendid stock of amateur components.



L. F. (Lillian) Hall
W5EUG

PANADAPTER	
Panadapter PCA-2 complete.....	\$99.75
HALLICRAFTERS	
S-38.....	\$ 39.50
S-40.....	79.50
S-41 Skyrider, Jr.....	35.50
S-22R Marine.....	94.50
SX-25 Super De Lant.....	94.50
SX-28A Super Skyrider.....	223.00
S-37 (130-210 MC) FMAM.....	591.75
S-36A (28-143 MC) FMAM.....	307.50
Speaker for SX-25, SX-28, S-36, S-37.....	15.00
HT-9 transmitter (less coils, crystals, mike).....	250.00
HAMMARLUND	
HQ-129X less speaker.....	\$168.00
Speaker.....	10.50
SUPER-PRO	
SPC-400-X (540 KC to 30 MC) cabinet model.....	\$334.05
SPC-400-SX (1250 KC to 40 MC) cabinet model.....	310.05
SPR-400-X (540 KC to 30 MC) rack model.....	344.55
SPR-400-SX (1250 KC to 40 MC) rack model.....	320.55
PS-CW-10 — 10-inch PM speaker.....	13.20

(OPA prices not determined at this time)

NATIONAL	
NC-2-40 Cless speaker.....	\$225.00
Speaker.....	15.00
NC-46, less speaker.....	95.50
Speaker.....	9.90
1-10 less tubes, speaker and power supply.....	56.10
5886 power supply for 1-10.....	19.50
Tubes for 1-10 (954, 955, 6C5, 6F6).....	8.57
HRO-5TA — 4 sets coils (less speaker, and power supply), table model.....	197.70
HRO-5RA — 4 sets coils (less speaker, and power supply), rack model.....	211.20
Speaker for HRO-5TA.....	10.95
Speaker for HRO-5RA.....	19.85
Power supply for HRO-5TA.....	17.70
Power supply for HRO-5RA.....	33.00
RME	
RME-45 with crystal, meter and speaker.....	\$186.00
RME-84 with self-contained speaker.....	98.70
DB-20 preselector.....	59.30
VHF-152 (2-, 5-, and 10-meter converter).....	

Wire, write or phone your order. We will ship C.O.D. with a \$5.00 deposit. We also offer easy terms and trade in allowances for used equipment. State tax not included in above figures.

BUD
Complete line of Bud products including: coils, hardware, transmitting condensers and coils, condensers, racks and panels, chassis and cabinets, etc.

PUBLICATIONS — NOW IN STOCK			
Amateur Radio Relay League Publications:			
Radio Amateur Handbook — 1946 Edition.....	\$1.00		
Hints & Kinks — 3rd Edition.....	.50		
How To Become a Radio Amateur.....	.25		
License Manual — Postwar Edition.....	.50		
Learning the Radiotelegraph Code.....	.25		
Log Books.....	.35		
Other Publications:			
Radio Amateur Call Book, Spring, 1946.....	1.25		
Radio Operating: Questions and Answers, by Nilson & Harnung.....	3.20		
Fundamentals of Radio — Compilation.....	5.00		
UHF Radio Simplified, by Milton S. Kiver.....	3.25		
TRANSMITTING TUBES			
The following lines of transmitting tubes are now in stock:			
Eimac.....	Gammatron.....	General Electric.....	Hytron.....
Lewis.....	Raytheon.....	RCA.....	Taylor.....

A complete line of Bud and Barker & Williamson coils.
"ACROSS THE OPERATING TABLE"
A postal card will place you on our mailing list to receive our amateur bulletin.

• • • • • A FEW OF THE MANUFACTURERS WHOSE PRODUCTS WE DISTRIBUTE • • • • •											
Aerovox	Clarostat	GE	Kaar	Meissner	Pioneer	Setchell-Carlson	Trimm				
Amphenol	Drake	Hallicrafters	Kainer	Millen	Precision	Silver	Triplet				
Astratic	Dumont	Hammarlund	Keilor	Mueller	Premax	Simpson	Turner				
B&W	Echophone	Hytron	Kwikheat	National	Radel	Speed-X	Vaco				
Belden	Eimac	Instructograph	Leach	Newcomb	Raytheon	Stancor	Vibroplex				
Bitley	Electronics Lab.	Insouline	Lectrohlm	Ohmite	RCA	Supreme	Walsco				
Buc	Eric	Jensen	Les Logan	Panoramic	Robson-Burgess	Taylor	Ward				
Centralab	Gammatron	JFD	Littelfuse	Peerless	RME	Thermador	Weller				
Cinadagraph	General Cement	Johnson	John Meck	Petersen	Sangamo	Thordarson	Weston				

TRANSFORMERS
The following lines of transformers are now in stock:
Peerless Stancor Ihermador Thordarson

SPECIALS
UHF-Aircraft transmitter, T-67-ARC/3, 8 channel, 15-Watt Output, crystal controlled, including modulator. Less crystals — 1J0-156 MC..... \$47.50

SUPREME PANEL METERS
Square Case — DC Milliammeters, DC Microammeters, DC Volt Meters

DC MILLIAMMETERS	
2", Range: 0-1.....	\$ 5.84
2", Range: 0-10, 0-25, 0-50, 0-75, 0-100, 0-200, 0-250, 0-300, 0-500, 0-700.....	5.68
3", Range: 0-1.....	6.17
3", Range: 0-10, 0-25, 0-50, 0-75, 0-100, 0-200, 0-250, 0-300, 0-500, 0-700.....	5.84
4", Range: 0-1.....	6.94
4", Range: 0-10, 0-25, 0-50, 0-75, 0-100, 0-200, 0-250, 0-300, 0-500, 0-700.....	6.60

DC MICROAMMETERS	
3", Range: 0-50.....	\$14.34
3", Range: 0-100.....	12.50
3", Range: 0-200.....	11.00
4", Range: 0-50.....	15.00
4", Range: 0-100.....	13.17
4", Range: 0-200.....	11.67

DC VOLTMETERS	
4", Range: 0-50.....	\$8.17

SIMPSON PANEL METERS
Square or Round Cases — DC Milliammeters, DC Volt Meters, AC Volt Meters

DC MILLIAMMETERS	
2", Ranges: 0-10, 0-50, 0-100, 0-150, 0-200, 0-250, 0-500, 0-700.....	\$4.30
3", Ranges: 0-10, 0-50, 0-100, 0-150, 0-200, 0-250, 0-500, 0-700.....	5.14

DC VOLTMETERS	
3", Ranges: 0-2000, 0-3000, 0-4000.....	\$11.00
3", Range: 0-5000.....	14.84

AC VOLTMETERS	
Model 57: Range 0-10.....	\$5.14
Model 57: Range 0-150.....	6.24

CRYSTALS — Bitley	
80 Meter.....	\$2.80
40 Meter.....	2.80

CRYSTALS — Petersen	
80 Meter.....	\$2.65
40 Meter.....	2.65
20 Meter.....	3.50

TEST EQUIPMENT IN STOCK
Silver "Vomax"..... \$59.85
Monitor "Crystalline" Signal Generator..... 57.50
Robson-Burgess V-O-M MT-100..... 18.75

Ask for other brands and models, since we carry practically all of them and are getting shipments from time to time.

COILS
A complete line of Bud and Barker & Williamson coils.
"ACROSS THE OPERATING TABLE"
A postal card will place you on our mailing list to receive our amateur bulletin.

COILS THAT CAN TAKE IT- AND DISH IT OUT!

FOR POWERS UP TO 500 WATTS

B & W Series 3400 Air Wound Inductor Coils are identical to those supplied by B & W to the Armed Forces for combat duty. They're plenty tough . . . and they'll give you the *utmost* in electrical dependability and flexibility.

Each coil has an individual internal rotary link, adjustable over 360°. This permits precise impedance matching up to 600 ohms, thus providing flexibility far in excess of any installation requirements.

In an actual test this B & W Series 3400 Inductor Coil was dropped on concrete from 3 floors up—and it still worked perfectly!



B&W

WRITE FOR THE NEW
B & W CATALOG

BARKER & WILLIAMSON

235 FAIRFIELD AVENUE • UPPER DARBY, PENNA.

RG-8/U FLEXIBLE COAXIAL CABLE *at a War-Surplus Price*

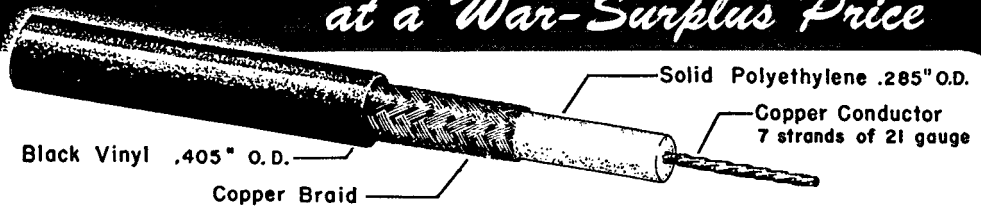

U. S. Signal Corps excess inventories of RG-8/U flexible coaxial cable have been released for civilian sale at a new low price. This is your opportunity to acquire a stock of coaxial cable at rock bottom cost.

RG-8/U is the most completely practical cable for feeding receiving and transmitting antennae for all frequencies up to 250 mc, and also can be used up to 3,000 mc and down to dc. Easily installed because of its flexibility, it is excellent for high-fidelity telephone transmission lines and unsurpassed for feeding PM speakers at long distances from the amplifier and at low impedance levels.

Its shielding, if used as a ground lead, prevents electrical noise pickup, and its low attenuation results in maximum power transmission. The Armed Forces used RG-8/U Coaxial Cable for all-weather outdoor and indoor transmission lines, test cables, and antenna phasing lines.

The solid polyethylene dielectric is absolutely impervious to moisture. Lines do not have to be

pressureized, as in the case of beaded-dielectric cables. The solid dielectric and absolute uniformity of construction eliminates reflections caused by discontinuity of dielectric, and enables engineers to figure on lumped constants.

Nominal impedance is 52 ohms. Nominal capacity per foot is 29 mmf. Maximum attenuation is .027 db per foot at 100 mc and .25 db at 3,000 mc. Maximum operating voltage is 4,000 volts rms. Average power rating is 480 watts at 200 mc and 90 watts at 3,000 mc.

Your local dealer has RG-8/U coaxial cable in stock or can get prompt delivery from

BELMONT RADIO CORPORATION

3633 S. RACINE AVE. • CHICAGO 9, ILLINOIS

AGENTS FOR THE WAR ASSETS ADMINISTRATION
UNDER CONTRACT SIA-3-5

SUN RADIO — The Home Of Nationally Known Radio Parts

WAR SURPLUS EQUIPMENT

At A Fraction of Their Original Government Cost!

• AEROVOX • AMPHENOL • A.R.R.L. • ASTATIC • B. & W.

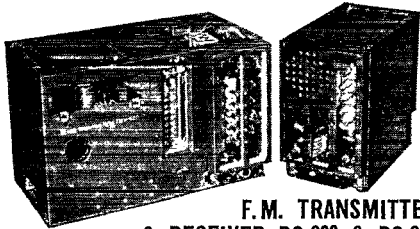

F.M. TRANSMITTER & RECEIVER BC-683 & BC-684

These units are only slightly used and are guaranteed in perfect condition. The BC-683 Receiver operates on less than 1 microvolt, complete with 9 tubes, 10 push buttons, squelch circuit. The BC-684 Transmitter provides 35-watt output, 10 channel push button crystal control employing NONLENIER MODULATING COIL, complete with 8 tubes. These units tune from 27 to 38.9 mc. These units come complete with tubes less power supplies and crystals. Excellent 10 meter band for "Ham" use.

YOUR COST..... **\$69.95***

RADAR RECEIVER BC-1068A

Original Gov't cost \$625

YOUR COST **\$39.95***

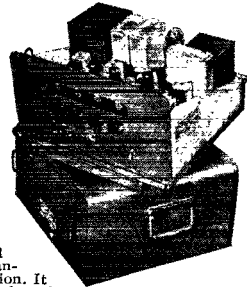

These units are all slightly used and guaranteed in excellent condition. It is a "Hot" receiver for the "Ham" and the short wave experimenter covering the 174 to 210 mc television band. Has individually slug tuned antenna, R.F., Detector and Oscillator circuits resulting in maximum sensitivity; contains 2 R.F. and 5 I.F. stages, detector and video amplifier. Complete with 110 volt AC power supply and tubes.

* Net F. O. B. Washington, D. C. — 25% Deposit Must Accompany All C. O. D. Orders

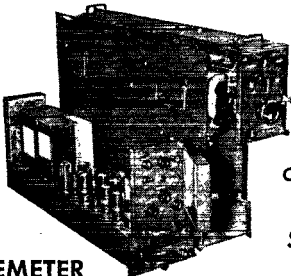

WAVEMETER INTERCONNECTION UNIT BC-1073A

These units are only slightly used and are guaranteed in good condition. They contain a high quality resonant cavity wavemeter, oscillator, heterodyne amplifier, electric tuning eye, complete with 19 tubes, 110 volt AC power supply. The unit tunes from 150 to 210 megacycles.

Original Gov't cost \$550
YOUR COST **\$24.95***

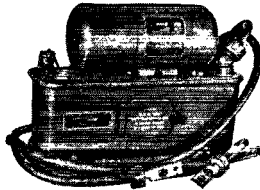

DYNAMOTOR POWER SUPPLY PE-103

Original Gov't cost \$300

YOUR COST **\$39.95***

These units are brand new in the original cartons, operate from either 6 volts or 12 volts and deliver 500 volts DC at 160 milliamps; mounted on box with circuit breakers, relays, interference filter and complete with cables.

Limited Quantities! First come, first served. Order Now!

OTHER SPECIALS

- Octal Molded Bakelite Sockets... Each \$1.10
- Crystal Microphone complete with Desk Stand..... 6.95
- Jackson 85 Watt Soldering Iron..... 2.95
- Bat-Handle Toggle Sockets..... .34
- S.P.S.T.....
- Replacement Antenna Switch..... .24
- Microphone Connector, Jones 101 Series, Male and Female Complete..... .48
- Fluted Pointer Knobs, General Radio 1 1/2"..... .25
- Double Edged Aligning Screwdrivers..... .25
- Metal Binding Post..... .24
-10

• J. F. RIDER • WALSCO • STANCORE • TRIPLETT • U.T.C. • VALPEY • VIBROPLEX • RADART • R.C.P.

• CLARASTAT • HALLICRAFTERS • HAMMARLUND • INSULINE • JENSEN • MEISSNER • R. C. A. • HYTRON

SUN RADIO
OF WASHINGTON, D. C.

938 F STREET, N. W. WASH. 4, D. C.

HAM-ADS

(1) Advertising shall pertain to radio and shall be of nature of interest to radio amateurs or experimenters in their pursuit of the art.

(2) No display of any character will be accepted, nor can any special typographical arrangement, such as all or part capital letters be used which would tend to make one advertisement stand out from the others.

(3) The Ham-Ad rate is 30c per word, except as noted in paragraph (6) below.

(4) Remittance in full must accompany copy. No cash or contract discount or agency commission will be allowed.

(5) Closing date for Ham-Ads is the 25th of the second month preceding publication date.

(6) A special rate of 7c per word will apply to advertising which, in our judgment, is obviously non-commercial in nature and is placed and signed by a member of the American Radio Relay League. Thus, advertising of bona fide surplus equipment owned, used and for sale by an individual or apparatus offered for exchange or advertising inquiring for special equipment, if by a member of the American Radio Relay League takes the 7c rate. An attempt to deal in apparatus in quantity for profit, even if by an individual, is commercial and all advertising by him takes the 30c rate. Provisions of paragraphs (1), (2), (4) and (5), apply to all advertising in this column regardless of which rate may apply.

(7) Because error is more easily avoided, it is requested signature and address be printed plainly.

Having made no investigation of the advertisers in the classified columns, the publisher of QST is unable to vouch for their integrity or for the grade or character of the products or services advertised.

QUARTZ — Direct importers from Brazil of best quality pure quartz suitable for making piezo-electric crystals.
Diamond Drill Carbon Co., 719 World Bldg., New York City.

AMATEUR radio licenses. Complete code or theory preparation for passing amateur radio examinations. Home study and resident courses. American Radio Institute, 101 West 63rd Street, New York City.

WRL Transmitting kits — 15, 35, 70, and 150-watt units — low priced. All makes of receivers, both new and reconditioned. Leo offers best trade-in deal, and easy time payment plan. One of the country's largest parts supply houses. Write today for free catalog, special radio map and tube-base calculator offer, and other items. Leo, at World Radio Labs, Dept. HA, Council Bluffs, Iowa.

RADIO tubes, parts, condensers, free bargain lists. Potter, 1314 McGee, Kansas City 6, Mo.

YOUR station call plate beautifully cast in aluminum, size 2" x 5 1/2". Two styles, Type P, with tapped bosses for panel mounting. Type D for desk use. Price either type, \$1.50. Duplicates at same type, 75c each. Print your call plainly. P & H Sales Co., 619 Jasper Street Kalamazoo 31, Mich.

HAM crystals: \$2.50 within 10 kc. of specified frequency; excellent oscillators guaranteed; 3500 kc. to 8000 kc.; Army type, FT 243 holders. L. Kipp, 277 Broadway, N. Y. C. 7.

CRYSTALS: Precision low drift x-ray oriented units manufactured by latest and most scientific methods. Optional holder mounting type 400 A for five-prong sockets or type 100A of which plug in single octal socket. Your specified frequency: 3500 Kc to 4000 Kc, \$2.30; 6250 Kc to 7425 Kc, \$2.60; 12,500 Kc to 14,850 Kc, \$3.30. Rex Bassett, Inc., Ft. Lauderdale, Fla.

CO-AXIAL cable available RG 8/U (new material) in 29' lengths, with end fittings, \$3. per length. C. F. Moretti, Boulevard, Peekskill, N. Y.

QSLs, samples. H. L. Carter, Jr., W8JOT, 749 S. Plymouth, Rochester 8, N. Y.

QSLs, Samples. Glenn Print, 1042 Pine Heights Ave., Baltimore 29, Md.

COMMERCIAL radio operators examination questions-and-answers. One dollar per element. G. C. Waller, W5ATV, 6540 E. Washington Blvd., Tulsa 15, Okla.

PERSONALIZED QSL cards. Your photo on your card, price: 500 cards, \$7.50; 1000 cards, \$10. Samples on request. Albraun Studio, 1742 N. Palmer St., Milwaukee 12, Wis.

QSLs, Samples free. Radio Headquarters, 1217 So. Calhoun Street, Fort Wayne 2, Indiana.

ALASKAN hams: Here is a source of supply closer to home. Stocking leading brands of ham gear, communication receivers, parts accessories, engine generators. Save time and money. Robbie's Radio Supply, Alaskan jobbers, P.O. Box 1835, Anchorage, Alaska.

NATURAL color bakelite tubing: 3' lengths, 3/4", 1/2" and heavy 1/4" OD. Impervious to moisture. Ideal for long insulators, spacers, coil forms and insulation. Any three lengths, 75c postpaid. Bud Slocum, W8JO, Roscommon, Mich.

CRYSTALS, 40-80 meters, 5 kc. of desired frequency, calibrated, holder fits 5-prong socket. \$2.85 postpaid. Immediate delivery. Borri Electric Co., Granville, Ill.

KAI1AF will QSL all his QSOs. Any station not receiving a QSL should notify KAI1AF by QSL or postal, giving call and QSL OTH. Thanks v'y 73a. Judy. Address: KAI1AF, Lt. Julius M. Hoffer, W8UHF, 3217 Leslie Avenue, Detroit 6, Michigan.

CO-AXIAL cable RG8/U, RG13/U and RG59/U available 50 feet to 1,000,000 feet at ridiculously low prices. See QST April F. 51 for detailed description. 5" oscilloscopes BC-412 complete, \$40; Thordarson T19C44 chokes; 12H, 400 ma. \$6.50; National HRO receivers complete with coils, \$110. Coaxial Cable Co., Box 19, Woodside, N. Y.

ROTOBEAMS. Bandsread RME-45a, New National and Hammarlund receivers. Conklin Radio, Bethesda 14, Md.

IN stock: HT4 BC-610 transmitters reconditioned and converted for 28 mc. operation by Hallcrafters with tubes, speech amplifier, coils for any three bands, \$535. Henry Radio, Butler, Mo., and Los Angeles, Calif.

QSLs? — SWLs? America's finest cards! Samples? (please send stamp). 1946 "Radio Handbook" (700 pages) \$2.00; mounted crystals, \$2.00. Sakkers, W8DED, Holland, Mich. (veteran).

CASH for 350 to 500-watt phone and cw xmt, 80, 40 and 20 meters. S. E. Bowers, W5EAY, Boyce, La.

WANTED: antique radio material, old radio books, magazines, for ham collection. Have some old duplicated items; will exchange for wanted items. Answer all letters. Write: Corpe, W6LM, Box 132, Wrightwood, Calif.

RECEIVERS, BC348Q in original boxes, 28 v.d.c. 500 to 500 kc. and continuous coverage 1.5 to 18 mc. in 5 bands. Beat oscillator, crystal filter, mechanical bandspread. Less speaker. Use on 32 V system with resistor. \$79.50. Converted 110 v.a.c., \$109.50 Electronic Services, 710 W. 74th St., Kansas City, Mo.

FOR SALE: used mica and variable transmitting cond., new and used transmitting, receiving and acorn tubes, high voltage antenna inductors and G-E dynamotor. Write for complete list and prices. R. Whitaker, 54 Road, Pittsburgh 21, Pa.

FOR SALE: 200 watt audio amplifier, 300 watts peak, built for Signal Corps, peak limiter, will modulate up to 500 watts. Rf. built-in power supply. Complete with tubes, \$150. White Sound Service, 151 West 63rd St., N. Y. C.

HALLCRAFTERS S-29 portable or S-31 tuner AM/FM wanted. Have almost new S-36A for sale. A. C. Brookes, RFD 2, Brown's Lane, Middletown (Newport), R. I.

SELL new HRO components, coils, 100 kc. 30 mc., \$10. xtal filters, S meters, L. F. and power trans., chokes, vibrapaks, vibrators, dials, condensers. Norton, 7200 Ridge Blvd., Brooklyn 9, N. Y.

FOR SALE: 2000 volt power supply, 300 Ma. All components new, never used. Complete with cabinet, tubes, \$45, or part payment on good receiver wanted; new out thereabouts \$20K. S. X-25 or what have you? Bill Valentine, care Station KGAE, Gallup, New Mexico.

QSTs: offer 60c each, October 1940, June, September, 1942, August, September 1945. Write EDC, 38 LaSalle Rd., W.Hfd. 7, Conn.

FOR SALE: 100 TS tubes, 100 watt plate dissipation, 200 mc., 5 volt, 60 and 180 amp 60 cycle transformers. Meters, Weston 301, 8 volts, a.c.; 476, 4, 150 v.a.c.; Westinghouse 150 v.a.c., 100 microamperes, d.c. 2 3/4"; Marion, 1-0-1 milliamperes, d.c. 2 3/4". H & H, 5 amps, circuit breakers; 5" oscilloscope, a couple 5B1 and 5B4 tubes. f.o.b. Gunning Bradford, W2HAF, 705 St. Marks Ave., Brooklyn 16, N. Y.

METERS repaired, rebuilt, and calibrated. Factory accuracies. Springfield Testing Laboratory, 2931 East Eros, Springfield, Ill.

EXCHANGE: transmitters, receivers, meters, transmitting tubes (no junk) Savage 303 rifle for screw-cutting bench lathe or cash. Herb Walleze, Drums, Penna.

OSCILLOSCOPES: 5" Army surplus, SCR268 Western Electric manufacture. Complete with all tubes. Special offer, \$44.95 plus crating and shipping charges. Variable condensers, four sections, 12 uufd min. to 200 uufd max. per section. Heavily silver plated rotors and stator counterbalanced rotor insulated flexible coupling on 1/4" shaft. Weight 3 1/2 lbs. Special, \$5.95 prepaid. All orders filled promptly. No c.o.d.s. Write for other surplus bargains. Kayline Distributing Co., 3523 Dolfield Ave., Dept. AR, Baltimore, Md.

NORTHWOODS hams! We have excellent surplus equipment. Sherman tank transmitter-receivers, B-29 Collins Autotune transmitters, BC-342s, BC-610s, similar to HT4E, frequency meters. Get our mailing list. Range Electric 224 Norfolk, Ironwood, Michigan.

ONE complete course radio, television and marine radio, plus technical books for sale, reasonable. Write Bensusan, 1849 West 8th St., Brooklyn, N. Y.

SELL: going to higher power so offer 61.6-807 ten meter xmt including all tubes and coils less power supply on steel chassis and 19 x 8 1/2" gray rack panel commercial appearance, \$35. Also Abbott TR-4 revamped for 144-148 Mc band with tubes, less power supply, \$40. A.c. power pack, \$12. All f.o.b. W3HGH. Money order only or will ship c.o.d. W3HGH.

HALF dollar (coin) brings pictures surplus amateur gear. WLNO, Curran, Route #3, Fulton, N. Y.

WANTED: 35 — 70 Mc. coil set for HRO. Can trade 1.7 — 4.0 Mc. J. M. Fraser, Bincarth, Manitoba, Canada.

QSLs-SWLs. Meade, 1507 Central Ave., Kansas City, Kansas.

SELL two unused surplus receivers, type TBs7, superhet 12-tubes, triple tuned 956 R.F., 3 stages, 5.3 Mc. intermediate noise silencer. Covers 60 to 80 Mc.; easily converted for higher frequency. Box 72, Campbell, Wenham, Mass.

CRYSTALS: low drift each finished to your exact frequency, 40 and 80 meters. The new FT 243 with socket, \$2.50, regular ham size to fit five prong socket, \$2.80, 24 hour service. Tedford Crystal Labs, Ted, W8AKW, 1626 Chase St., Cincinnati 23, Ohio.

8MM movie projector Eastman Model 60 a.c. only, trade for precision E200 signal generator and cash W2OHE, 1156 East 40th St., Brooklyn, N. Y.

CRYSTALS: sealed, low temperature coefficient units; 7 megacycle band, \$1.95, 14 megacycle band, \$2.95. J. J. Cress Co., P.O. Box 326, South Pasadena, Calif.

WANTED: Uhf converter. C. W. Brown, 1 River St., Oceanside, L. I., N. Y.

WANTED: Meissner signal shifter, W2BZB, Doersam, Palisades, N. J.

WANTED: Signal Corps frequency meter, SCR-211. State condition and price. Richard S. Baker, W8DRG, 513 No. Main St., Orrville, Ohio.

SELL rack-mounted HRO complete with six coil units, general coverage and bandspread, Price, \$180. Also sell RME-99 complete and in good shape, \$120. Want an NC-200, W9ERU, Huubelli, 2511 Burrmont Rd., Rockford, Ill.

SELL or trade NC80X, Corona portable, UTC heavy Universal output, Eray 114, Conley postcard camera. Want #20 or 1000 v pack, receiver, universal modulator transformer, parts. Woodsman, W9GI, 901 No. 11th, Manitowoc, Wis.

QNLs, the way you want them. Write Dossett, W9HUU, 857 Burlington, Frankfort, Ind.

SELL: latest type Millen exciter, with 10-meter and 80-meter coils. \$30. W2HFM, Belvid, Merrick, N. Y.

SELL QSTs, Vols. 1-8 bound; 9-16 loose. Pacific Radio News, 12-22, bound. Old books, Zenneck, Butler, Pierce, others. W. A. Masten, 1303 Lakeview Ave., Lorain, Ohio.

MEISSNER signal shifter coils 10-20-40 wanted. Will sell a.c. Instructograph with 14 tapes, SW3 plus power pack, 200-300 kc and broadcast through 13 meter coils included. J. Mitchell, 434 Edmund, St. Paul, Minn.

SENSITIVE relays, 2 Weston model 634 meter type and 2 Eby 10,000 ohm. \$13. G. Hausske, W9OLE, 1650 N. Long, Chicago, Ill.

TRANSMITTER, 500 watts 'phone and cw; TW-150 final, TZ-40 buffer, National exciter-speech amplifier, complete with Ham 10-meter coils, relay rack, panels, J. V. Ogle, W5JAK, Wink, Texas.

THORDARSON 19P60 transformer, 3750 vct. 300 Ma. dc. Stancor swinging and filter chokes, 300 Ma. \$45. E. Erickson, WINLM, Oakland Heights, Bethel, Conn.

WANTED: A National 200 communications receiver. Art Stockellburg, 68 River St., Arlington, Mass.

WANTED: High power 'phone transmitter or parts. Sell or trade complete, Kodak-Medalist outfit. Capt. S. C. Macy, Eupedon Farm, Clarksville, Tenn.

SALE: Bar-Metal broadcast Type C rack 66 1/2 x 17. \$25. J. E. Bright, 33-17 84th, Jackson Heights, L.I., N. Y.

WANTED: Meissner signal shifter, state condition coils and price. W. K. Gardner, 1821 Tchoussau St., St. Louis, Mo.

SELL: Vhf tubes, Abbott DK2. Write Marks, 97 South 8th, Brooklyn, N. Y.

ELEVEN megacycle intermediate frequency transformers. Permeability tuned. Heavy aluminum shields. \$1 postpaid. Worth \$5. Taylor, W9NAF, 9 3rd & Ewing, Seymour, Indiana.

DISBANDING station. Have new 100TH, 250TH, 211, 3AP1, 5AP1 tubes. Make offer for lot or individually. Walter Miller, Apt. 4C, 1507 Metropolitan Ave., New York 62.

80-METER transmitter, 25 watts output, modulator receiver. Small compact unit. Louis Bloch, 15705 So. Moreland, Cleveland, Ohio.

NAMEPLATES; professional touch to equipment, crackle or plastic. Any size, any lettering. Send for circular and sample. Olson Engraving Co., 985 Sonoma Ave., North Sacramento 15, Calif.

SELL SX-28 also RME-69, with speakers, excellent condition. Make offer. W. H. Goodell, 84 Wyatt Road, Garden City, N. Y. Phone GC-4336.

PERSONALIZED QSL cards. H. G. Turner W3AOT, Box 308, Petersburg, Va.

NAVY type MBF transmitter-receiver 60-80 Mc. USES 23 tubes 6AK5B, 6C4s, 6AQ6s, 28D7s, and 2526s. Complete less crystals. Trade for late test equipment. S. G. Church, 3874 35th, San Diego 4, Calif.

SELL: QSTs 1924 through 1930 complete. Also some issues 1922 and 1923. W5JWJ, MacDowell, 2113 Daisy Lane, Ft. Worth, Texas.

NATIONAL 101X, loudspeaker, excellent condition, \$75 f.o.b. E. Just, W2LCD, RD #3, Paterson, N. J.

IMMEDIATE shipment transmitting variable condensers. 3500 spacing. High grade ceramic insulation. Shaft length 1 1/2" x 3/4". Split stator 50 ufd per section, \$4.50. 70 ufd per section, \$4.75. Single section 25 ufd, \$1.75. We probably have the most complete ham stock in USA. Write for list and state needs. Prompt shipments. Kentucky Radio Supply Co., 519 Georgetown St., Lexington 24, Kentucky, Allender W9OZY.

SELL: DM36 converter. W5AJG, May, Jr., 9428 Hobart St., Dallas 18, Texas.

JK stabilized crystals in stock. Order from Fritz. QSLs-SWLS. Get 'em now! Fritz, 1213 Briargate, Joliet, Illinois.

RME-69 and DB-20, pre-selector. Sell both or separately. Best offer. Besancon, K6OLU/4, 810 10th St., Alexandria, Va.

SELL: factory-built portable transmitter, receiver, transceiver, rotary converter from 12 v.d.c., c.w. mcw, phone. 807 final. Best offer. E. Lynch, Labadie, Mo.

3500 vct. 450A power transformers, a.c. and d.c., Selsyns, other surplus bargains. Lectronic, 5832 Hegerman & Howell, Phila. 24, Penna.

WANTED: An old Utah 5-10-20 rig in any condition. W2LZW.

MID-WEST Hams: Gifford-Brown, Inc., of Cedar Rapids is making shipments of parts every day. We are distributors for all leading manufacturers. G. A. Wise, W9VCF, is now in charge of our Communication Equipment Department. Here are our bargains this month: 813 and modulation transformer, \$14.75; 12" x 18" chassis, \$75; BC-610 (HT4E) transmitter, speech amp., tubes, etc. — \$485; 25-watt CW xmtr in cabinet — \$37.50; Hallcrafters S-36A, \$307; xtal kit, \$1; Taylor, Eimac, and Hytron tubes in stock, also Peterson xtals. Your inquiries welcomed. 73s. Gifford-Brown, Inc. 106-108 First St., SW, Cedar Rapids, Iowa.

WANTED: National NSM modulator. Young, W5DLC, 4425 Bordeaux, Dallas, Texas.

SELL: several 829B tubes, unused, Hoeffle, W9JZU, Box 22, Parsons, Kansas.

WANTED: Cooke radio slide-rule. Bob Ingals, WINNJ, Valpo Tech Trailer Camp, Valparaiso, Indiana.

WANTED: NC-45 or similar receiver. Have Cine Model 25 camera (new) or some ham gear, or straight cash. State condition, your need, or cash price. W9TWW, 736 Buena Ave., Chicago 13, Ill.

CASH, pair 809s, unused. For 1000 volt transformer, Hawkins, Box 153, W5EHV, Sallisaw, Okla.

WANTED: loop kit, complete all bands for Howard pre-selector, Model 650. Rowe, W3BNC, Route #2, Hagerstown, Md.

HUNGRY for a good old-fashioned Starved Rock Radio Club Hamfest? Come to Camp Ki-Shau-Wau near Starved Rock State Park, Ill., June 9th. Follow signs South from junction of Illinois Routes 78 and 71. Keith, W9QLZ, Box 22A, Utica, Ill.

FOR SALE: 2-meter Abbott TR-4 with all tubes, exceptionally well filtered conservative power supply, carbon mike, all brand new. Cost \$30. First check for \$65 takes all. Farnsworth, Box 306, Fryeburg, Me.

FOR SALE: A large number of new Hallcrafters SX-28s, \$179.50, used SX-28s, less. No trade-ins accepted. All sets guaranteed. Send for list. Orman Wanamaker, 608 Buchanan, Topeka, Kansas.

SELL or trade: bound volumes QST 1939 through 1945. Make offer. Want bug. S. G. Tiller, 5330 Village Rd., Long Beach, Calif.

CONDENSERS: 250 G-E pyranol, 7000 volt, 1 ufd, price, \$36, 85% discount on 250, 75% discount on 100; 150 c-d two section 1/2 x 1/2 ufd, 9000 volt each section, price \$100, 90% discount on 1/4, 85% discount on 50. All new unused top quality inspected equipment. Write for details. John Walstrom, Nelson Road, Lexington, Mass.

FOR SALE or swap: BC-221 signal generator, BC-312-N receiver. RCA-813 tubes. All new. Wanted BC-779 or what have you? Reply W. Eng, 4435 N. Racine St., Chicago, Ill.

SELL: complete 350-watt radiotelephone transmitter. Dual r.f. sections operating 80-40-20 and 20-10-5. Coils for 80 and 10, 400 and 1250 volt power supply, modulated Class B T240. All stages metered. Steel cabinet, dolly, antenna tuning panel, relays remotely controlled. Complete with tubes, \$400. Also Stancor 515 speech amplifier, \$40. De Luxe Meissner Signal Shifter with coils for 20 meters, \$40. Browning, 5-10 converter, \$15. Contact Dr. Thos. J. Riley, Jr., WILPT, Box 308, Niantic, Conn.

WANTED: Mim's 10-20 meter signal squitter beam. Will pay top price for beam in good condition. W. N. Brown, 1137 Terrace Dr., Richmond Heights 17, Mo.

NEW W. E. BC-412 5" oscilloscope complete, \$65; IN21 crystal .35; CR1 crystal holders, 2 for 25¢; Lo-Drift cut active crystals 2-9 Mcs. mounted, \$1.49; mounted 1000 kc. standard, \$7; Cathode ray tubes, new government inspected, 5AP1, 5BP1, 5BP4, \$9.95; gov't. inspected, new \$72A, \$6.50; 866A, \$1.40; 807, \$1.95; 6J4, \$2.40; VT-127A, \$4.95. 304TL used guaranteed, \$1.95; G-B choke, 4-HV 1/2 A, \$2.95; vacuum tube voltmeter Signal Corps 1-107-F complete, \$29.70. Write for catalogue; specialists in guaranteed tested war surplus material. Let us know your requirements. Export inquiries invited. "Tab", Dept. Z, 6 Church St., New York 6, N. Y. Enclose postage, deposit with order.

FOR SALE: Transmitter, 6V6GT ECO, 6L6 BFR doubler, 6L6 driver, T240 final, with antenna tuner, 150-watt input on all bands, 2 power supplies in table rack. Best offer over \$75 takes it. Complete for 80-meter operation. O. Kolen, W2MRL, 1729 Mahan Ave., New York 61, New York.

THE RADIO AMATEUR'S

Library

● Many requests are received for the complete list of our publications. The list follows:

Title	Price
QST	\$2.50 per year*
List of Stations	Discontinued
Map of Member Stations	Discontinued
Operating an Amateur Radio Station Free to members; to others	10c
The Story of The A.R.R.L.	Discontinued
The Radio Amateur's Handbook	
a. Standard Edition	\$1.00**
b. Special Defense Edition	\$1.00
The Log	35c each; 3 for \$1.00
How to Become a Radio Amateur	25c
The Radio Amateur's License Manual	25c
Hints & Kinks for the Radio Amateur	50c
Lightning Calculators:	
a. Radio (Type A)	\$1.00
b. Ohm's Law (Type B)	\$1.00
Amateur Radio Map of the World	Out of print
Two Hundred Meters and Down:	
The Story of Amateur Radio	Out of print
Building an Amateur Radio-telephone Transmitter	Out of print
A.R.R.L. Antenna Book	50c
The Minilog	25c
Learning the Radiotelegraph Code	25c
A Course in Radio Fundamentals	50c
* In the United States and Possessions — other Countries	\$3.00 per year.

**Postpaid in Continental U.S.A.

— \$1.50, postpaid, elsewhere

(No stamps, please)

THE AMERICAN RADIO RELAY LEAGUE, INC.

West Hartford 7, Connecticut

RADIO COURSES

- RADIO OPERATING
- RADIO SERVICING
- CODE
- ELECTRONICS

REFRIGERATION SERVICING

Personal Counselling Services for Veterans Write for Latest Trade & Technical Catalog

Y. M. C. A. TRADE & TECHNICAL SCHOOLS
4 W. 64th Street
New York City

Designed for



Application

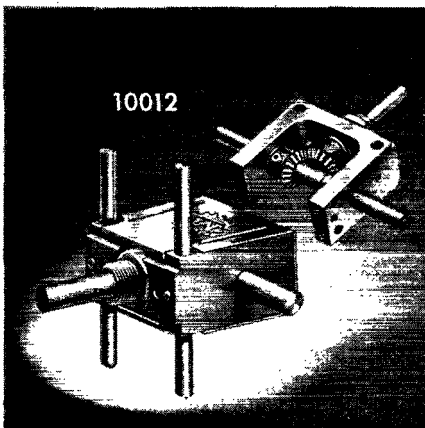

10012

**The No. 10012
RIGHT ANGLE DRIVE**

"Designed for Application." Extremely compact. Case size is only 1 1/2" x 1 1/2" x 3/4". Uses bevel gears. Mounts on adjustable "standoff rods," single hole panel bushing or tapped holes in frame. Ideal for operating switches, potentiometers, etc., that must be located, for short leads, in remote parts of chassis.

**JAMES MILLEN
MFG. CO., INC.**

MAIN OFFICE AND FACTORY
**MALDEN
MASSACHUSETTS**



Index to Advertisers

	Page
Advance Electric & Relay	120
Aireon Manufacturing Corp.	85
Allied Radio Corporation	123
American Phenolic Corporation	8
American Radio Institute	146
Ashe Radio Co., Walter	146
Astatic Corporation, The	91
Barker & Williamson	154
Bell Telephone Laboratories	89
Belmont Radio Corporation	154
Birnbach Radio Co.	142
Billie Electric Company	1
Brach Mfg. Co., L. S.	148
Brill Co., W. D.	150
Bruno Tools	152
Burgess Battery Co.	100
Burlington Instrument Co.	147
Burstein-Appleebee Co.	140
Cambridge Thermionic Co.	110
Candler System Co.	120
Capitol Radio Eng. Institute	96
Cardwell Mfg. Co., Allen D.	102
Carter Motor Company	128
Centralab	151
Chief Electronics	150
Cleveland Inst. of Radio Electronics	124, 132
Collins Radio Company	87
Commercial Equipment Co.	108
Commercial Radio Institute	140
Communication Measurements Laboratories	136
Condenser Products Company	144
Coto-Coil Co., Inc.	126
Crystal Products Co.	133
Crystal Research Laboratories	121
Drake Electric Company	116
Eitel-McCullough, Inc.	127
Electrical Reactance Corporation	132
Gates Radio Company	143
General Electric Company	9
Hall, R. C. & L. C.	153
Halicrafters Company, The	4, 5
Hammarlund Mfg. Co., Inc., The	81
Harrison Radio Company	129
Harvey Radio Company	125, 135
Harvey Radio Laboratories	98
Hatry & Young	136
Henry Radio Shop	144
Hytron Elec. & Radio Corporation	93
International Resistance Company	7
Jensen Radio Mfg. Co.	99
Johnson Co., E. F.	92
Ken-Rad	160
Kwikheat Soldering Irons	128
Lewis Electronics	152
Lippman & Co., Aaron	112
Maguire Industries	94, 95
Mallory & Co., P. R.	90
Marion Electrical Inst. Co.	2
McElroy Mfg. Co.	146
McMurdo Silver Co.	124
Millen Mfg. Co., James	158
Murdock Co., William J.	130
National Co., Inc.	79, Cov. III
Newark Electric Co.	105, 106, 107
New York YMCA Trade & Tech. School	157
Ohmite Mfg. Co.	104
Onan & Sons, D. W.	150
Panoramic Radio Corporation	117
Peterson Radio Co.	137
Port Arthur College	134
Radio Maintenance Magazine	119
Radio Mfg. Engineers	111, 159
Radio Product Sales	138
Radio Shack, The	114, 115
RCA Institutes, Inc.	146
RCA Tube Department	Cov. IV
Sceli & Co., R. G.	142
Simpson Electric Co.	101
Sperry Gyroscope Co.	134
Standard Radio & Elec. Products Co.	134
Sun Radio & Electronics Co.	149
Sun Radio Co. of Washington	155
Sylvania Elec. Products Inc.	83
Taylor Tubes Co.	103
Telegraph Apparatus Co.	152
Terminal Radio Co.	131
Transmitter Equip. Mfg. Co.	122
Triex Tool Works	128
Triplet Elec. Instrument Co.	148
Turner Co., The	138
UHF Resonator Co.	146
United Electronics	113
United Transformer Corp.	Cov. II
Valparaiso Tech. Institute	134
Vibroplex Co., The	140
Ward Leonard Electric Co.	126
Western Electric Co.	109
Wilcox Electric Co.	145
World Radio Laboratories	141

RME Announces CAL-O-MATIC

TWO SPEED TUNING
AND
CALIBRATED
BANDSPREAD



CONSTANTLY IMPROVED —
BUT NO YEARLY MODELS

In the RME 45 you will now find:

1 Two Speed Tuning. A dual drive mechanism is now provided, in line with the calibrated bandspread scale, which gives rapid tuning to cover the band, slow tuning to locate that station. Smooth, effortless, single dial control, calibration on five amateur bands, plenty of spread and real efficiency.

2 Voltage Regulation. Incorporated as an added feature, the RME 45 is now equipped with a VR-150 regulator tube to further reduce any drift to an absolute minimum and to stabilize the overall performance of an already fine instrument. You will like this addition.

3 Improved Noise Limiter. To make operation in a noisy location more enjoyable, a series noise limiter with an ON-OFF switch is being built into the RME 45. It works exceptionally well on all types of interference and goes after the spark-plug type with a vengeance.

Now more than ever, you MUST hear the RME 45 perform!

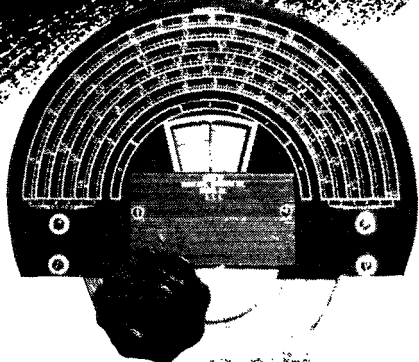

The two speed dial and calibrated bandspread scale provide the maximum in mechanical and electrical efficiency!

View of the translucent calibrated bandspread scale.

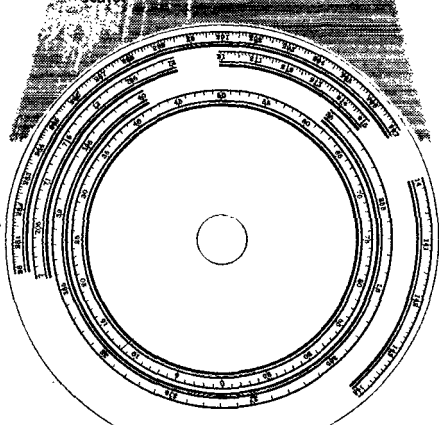

Specification Sheet
on Request



RME

FINE COMMUNICATIONS EQUIPMENT

RADIO MFG. ENGINEERS, INC.

Provia 6, Illinois U. S. A.

“Мы разсуждали об американском оборудовании”
“We’ve Been Discussing American Equipment”



K

KEN-RAD
TUBES

For more and clearer QSO's

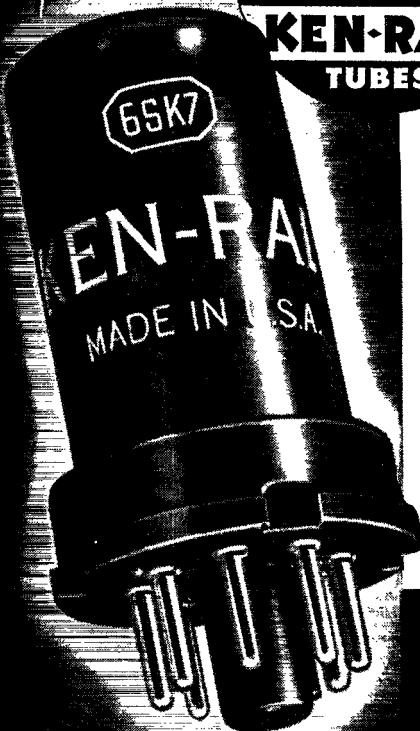

THE friend in Moscow you've never seen will query you on behalf of his group, "Are American receivers as efficient as we hear? How is DX on the various bands?" His signal, travelling thousands of miles, will be clearer because of the Ken-Rad all-metal tubes you're using. *War-tested*, the Ken-Rad features of compactness, short lead lengths, and self-shielding design now are available to improve your rig's performance. Type 6SK7—popular high-gain receiving tube—is one of many efficient, stable types about which your Ken-Rad distributor or dealer gladly will give you complete information.

Characteristics of Type 6SK7

Heater voltage	6.3 v	Max screen voltage	100 v
Heater current	0.3 amp	Amplification factor	1,600
Max plate voltage	250 v	Transconductance	2,000 mhos

178-EG-9850

KEN-RAD

DIVISION OF GENERAL ELECTRIC COMPANY

OWENSBORO, KENTUCKY

Type 6SK7
 \$1.00

Make the nearest Ken-Rad distributor or dealer your preferred source for amateur tubes

NEW IF TRANSFORMERS

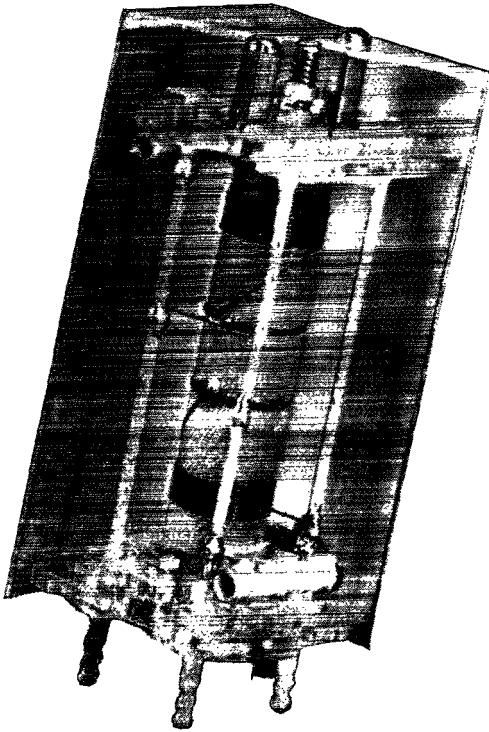

These new IF transformers are designed to meet the highest standards of performance in high frequency FM and AM. All operate at 10.7 Mc., making them ideal for the new FM band. Iron core tuning is employed and the tuning does not affect the bandwidth of 100 Kc. for the IFN or 150 Kc. for the IFM.

The discriminator output is linear over the full 150 Kc. output and remains symmetrical regardless of the position of the tuning cores.

Insulation is polystyrene for low losses. Mechanical construction is simple, compact and rugged. The transformer is $1\frac{1}{8}$ inches square and stands $3\frac{1}{8}$ inches above the chassis.



NATIONAL COMPANY, INC., MALDEN, MASS.

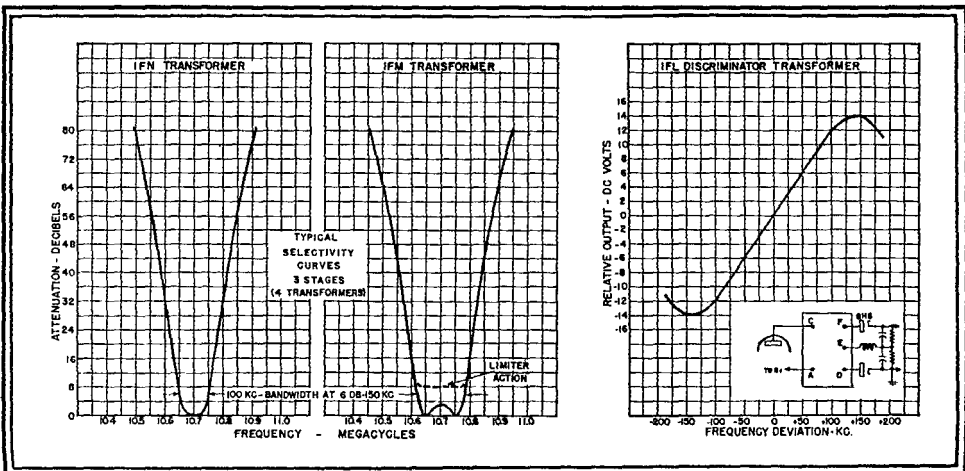

TWO OLD RELIABLES STEP OUT WITH NEW PERFORMANCE

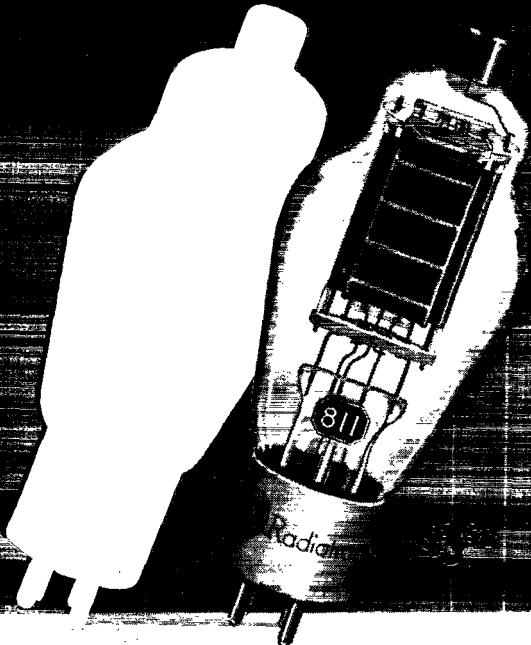

CLASS B MODULATION (Typical Operations with Two Tubes)

	ICAS*
D-C Plate Volts	700
D-C Grid Volts	0
Peak A-F Grid-to-Grid Volts	160
Zero-Signal D-C Plate Milliamperes	70
Max.-Signal D-C Plate Milliamperes	250
Plate-to-Plate Load Resistance, Ohms	6200
Max.-Signal Driving Power, Watts	3.4
Max.-Signal Power Output, Watts	120

*ICAS—Intermittent Commercial and Amateur Service

CLASS B MODULATION (Typical Operations with Two Tubes)

	ICAS*
D-C Plate Volts	1250
D-C Grid Volts	0
Peak A-F Grid-to-Grid Volts	150
Zero-Signal D-C Plate Milliamperes	48
Max.-Signal D-C Plate Milliamperes	240
Plate-to-Plate Load Resistance, Ohms	12,000
Max.-Signal Driving Power, Watts	3.4
Max.-Signal Power Output, Watts	210

*ICAS—Intermittent Commercial and Amateur Service

Now — Operate These Class B Modulators at Zero Bias and Get Greater Output With Low Driving Power

The new ICAS zero bias operating conditions for ratings given the RCA 809 and 811 transmitting triodes make them more than ever preferred types for Class B Modulator service. Under these new conditions, a pair of 809's will deliver 120 watts at a plate voltage of 700 with 3.4 watts grid drive — enough audio power to plate-modulate a quarter kilowatt. A pair of 811's will deliver 210 watts at a plate voltage of 1250 with 3.4 watts grid drive — enough audio power to plate-modulate a half kilowatt. Higher plate voltages together with battery bias will give even greater output.

The RCA 809 and 811 are also favorites in the amateur field as Class C amplifiers and frequency doublers. They can be operated at full ratings as high as 60 megacycles.

For further details on these triodes, see your local RCA Tube Distributor or write RCA, Commercial Engineering Department, Section A-21E, Harrison, N. J.

THE FOUNTAINHEAD OF MODERN
TUBE DEVELOPMENT IS RCA



TUBE DEPARTMENT

RADIO CORPORATION of AMERICA

HARRISON, N. J.