

QST

april, 1946

25 cents

35c In Canada

devoted entirely to

amateur radio



Compact 3-Band Transmitter
for C. W.

A New Idea: Band-Pass
28-Mc. Converter

A 144-Mc. M. O. P. A.

LS SERIES

The Ultimate in Quality

UTC Linear Standard Audio Transformers represent the closest approach to the ideal component from the standpoint of uniform frequency response, low wave form distortion, high efficiency, thorough shielding and utmost dependability. Wartime restrictions having been lifted, and UTC production running at full capacity, we now offer these transformers with immediate delivery.

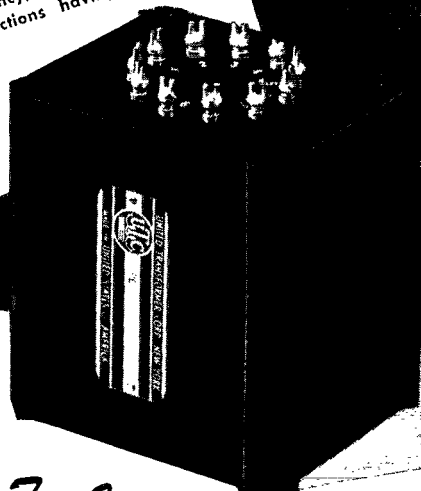

UTC Linear Standard Transformers feature...

- **True Hum Balancing Coil Structure** ... maximum neutralization of stray fields.
- **Balanced Variable Impedance Line** ... permits highest fidelity on every tap of a universal unit ... no line reflections or transverse couplings.
- **Reversible Mounting** ... permits above chassis or sub-chassis wiring.
- **Alloy Shields** ... maximum shielding from induction pickup.
- **Multiple Coil, Semi-Toroidal Coil Structure** ... minimum distributed capacity and leakage reactance.
- **Precision Winding** ... accuracy of winding .1%, perfect balance of inductance and capacity; exact impedance reflection.
- **Hiper-Alloy** ... a stable, high permeability nickel-iron core material.
- **High Fidelity** ... UTC Linear Standard Transformers are the only audio units with a guaranteed uniform response of ± 1.5 DB from 20-20,000 cycles.

For Immediate Delivery

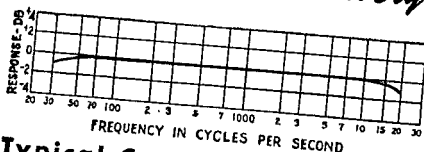

Typical Curve for LS Series

Type No.	Application	Primary Impedance	Secondary Impedance	Max. Level	Relative hum-pickup reduction	Max. unbalanced DC in primary	List Price
LS-10	Low impedance mike, pick-up, or multiple line to grid.	50, 125, 200, 250 333,500 ohms	60,000 ohms in two sections				
LS-10X	As above	As above	50,000 ohms	+15 DB	-74 DB	5 MA	\$20.90
LS-21	Single plate to push pull grids	8,000 to 15,000 ohms	135,000 ohms; turn ratio 1.5:1 each side.	+14 DB	-92 DB	5 MA	\$26.10
LS-30	Mixing, low impedance mike, pickup, or multiple line to multiple line	50, 125, 200, 250 333,500 ohms	50, 125, 200, 250, 333,500 ohms	+14 DB	-74 DB	0 MA	\$19.70
LS-30X	As above	As above	As above	+17 DB	-74 DB	5 MA	\$20.90
LS-50	Single plate to multiple line	As above	As above	+15 DB	-92 DB	3 MA	\$26.10
LS-55	Push pull 2A3's, 6ASG's, 300A's, 275A's, 6A3's	5,000 ohms plate to plate and 3,000 ohms plate to plate	50, 125, 200, 250, 333,500 ohms	+17 DB	-74 DB	1 MA	\$19.70
LS-57	Same as above	5,000 ohms plate to plate and 3,000 ohms plate to plate	500, 333, 250, 200, 125, 50, 30, 20, 15, 10, 7.5, 5, 2.5, 1.2 30, 20, 15, 10, 7.5, 5, 2.3, 1.2	+36 DB			\$23.20
				+36 DB			\$16.25

The above listing includes only a few of the many units of the LS Series. For complete listing — write for catalogue.



United Transformer Corp.

150 VARICK STREET

EXPORT DIVISION: 13 EAST 40th STREET, NEW YORK 16, N. Y.

NEW YORK 13, N. Y.

CABLES: "ARLAB"



Ends your search for a versatile
HARD AS DIAMOND CERAMIC

Conjured up in the crystal ball lies the answer to your radio frequency insulation and industrial ceramic problems. Consult with us on the possibilities of using STEATITE... the material of the future... TODAY.

Centralab

Division of GLOBE-UNION INC., Milwaukee

PRODUCERS OF



Ceramic Trimmers
Bulletin 695



Ceramic High Voltage Capacitors
Bulletin 814



Variable Resistors
Bulletin 697

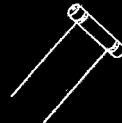

Tubular Ceramic Capacitors
Bulletins 630 and 586



Selector Switches
Bulletin 722

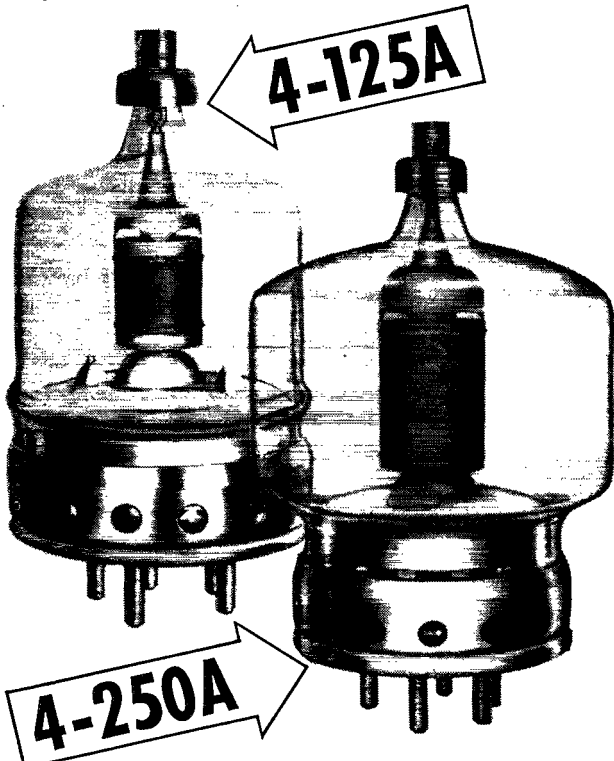

ONE KILOWATT PHONE	
THE CLASS-C AMPLIFIER	
A pair of Eimac 4-250A's	
D-C Plate Voltage	2500 volts
D-C Plate Current	400 ma.
D-C Screen Voltage	400 volts
D-C Screen Current	52 ma.
D-C Grid Voltage	-200 volts
D-C Grid Current	22 ma.
Plate Power Input	1000 watts
Plate Power Output	750 watts
Driving Power	5.5 watts
THE MODULATOR	
A pair of Eimac 4-250A's	
D-C Plate Voltage	2500 volts
Zero-Sig. D-C Plate Current	140 ma.
Max-Sig. D-C Plate Current	400 ma.
D-C Grid Voltage	-80 volts
D-C Screen Voltage *	500 volts
D-C Screen Current	-2 ma.
Peak A-F Grid Input Voltage (per grid)	74 volts
Load Impedance, Plate-to-Plate	11,300 ohms
Audio Power Output	500 watts
Driving Power	0
Total Harmonic Dist.	1.6 %

A Kilowatt Phone or CW Rig for Every Amateur

Wartime developments in vacuum tubes put "the kilowatt rig," whether phone or CW, within the reach of every amateur. These two Eimac tetrodes are outstanding examples.

A pair of Eimac 4-125A's will allow a full kilowatt CW input at 2500 volts at all amateur frequencies up to and including the 5-meter band. The two 4-125A's require a total driving power of only 7.2 watts. Neutralization is not necessary.

Amateurs who prefer a single tube in the CW output amplifier will find the Eimac 4-250A to their liking. This new tube will handle a kilowatt input at 3000 plate volts on all amateur bands up to and including the 5-meter band. At one kilowatt input the 4-250A

requires a driving power of only 5.8 watts.

For the one-kilowatt phone transmitter the combination of two 4-250A's in the Class-C stage and another pair of 4-250A's in the modulator offers the ultimate in economy of r-f and audio driving equipment. At 2500 plate volts the one-kilowatt Class-C amplifier requires a driving power of only 5.5 watts, while the Class-AB₁ modulator requires zero driving power. The modulator may be driven directly from a resistance-coupled speech amplifier; no "driver" stage is necessary.

Today (Post-War) you can depend upon Eimac for leadership just as you did yesterday (Pre-War). Keep in touch with Eimac—your inquiry incurs no obligation.

ONE KILOWATT CW		
	A pair of Eimac 4-125A's	One Eimac 4-250A
D-C Plate Voltage	2500 volts	3000 volts
D-C Plate Current	400 ma.	333 ma.
D-C Screen Voltage	350 volts	500 volts
D-C Screen Current	80 ma.	52 ma.
D-C Grid Voltage	150 volts	-200 volts
D-C Grid Current	24 ma.	23 ma.
Plate Power Input	1000 watts	1000 watts
Plate Power Output	750 watts	750 watts
Driving Power	7.2 watts	5.8 watts

FOLLOW THE LEADERS TO

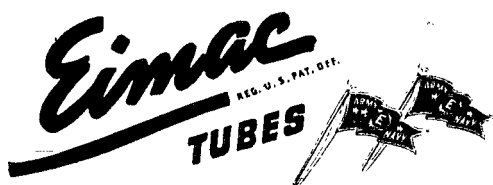

EITEL-McCULLOUGH, INC., 1152 San Mateo Ave., San Bruno, Calif.
 Plants located at: San Bruno, California and Salt Lake City, Utah
 Export Agents: Frazer & Hansen, 301 Clay St., San Francisco 11, Calif., U. S. A.

APRIL 1946

VOLUME XXX

NUMBER 4

★
STAFF

Editorial

KENNETH B. WARNER, W1EH
(Managing Secretary, ARRL)
Editor

GEORGE GRAMMER, W1DF
(Technical Director, ARRL)
Technical Editor

DONALD H. MIX, W1TS
BYRON GOODMAN, W1JPE
Assistant Technical Editors

A. DAVID MIDDLETON, W2OEN
Department Editor

EDWARD P. TILTON, W1HDQ
V.H.F. Editor

WALTER E. BRADLEY, W1FWH
Technical Information Service

Production

RALPH T. BEAUDIN, W1BAW
Superintendent

ELSIE C. HOCHMEISTER
Assistant

Advertising

F. CHEYNEY BEEKLEY, W1GS
Advertising Manager

Circulation

DAVID H. HOUGHTON
Circulation Manager

RALPH T. BEAUDIN, W1BAW
Assistant Circulation Manager

★

OFFICES

38 La Salle Road
West Hartford 7, Connecticut

Subscription rate in United States and Possessions, \$2.50 per year, post-paid; all other countries, \$3.00 per year, post-paid. Single copies, 25 cents. Foreign remittances should be by international postal or express money order or bank draft negotiable in the U. S. and for an equivalent amount in U. S. funds.

Entered as second-class matter May 29, 1919, at the post office at Hartford, Connecticut, under the Act of March 3, 1879. Acceptance for mailing at special rate of postage provided for in section 1103, Act of October 3, 1917, authorized September 9, 1922. Additional entry at Concord, N. H., authorized February 21, 1929, under the Act of February 28, 1925.

Copyright 1946 by the American Radio Relay League, Inc. Title registered at U. S. Patent Office.

QST

devoted entirely to

AMATEUR RADIO

PUBLISHED, MONTHLY, AS ITS OFFICIAL ORGAN, BY THE AMERICAN RADIO RELAY LEAGUE, INC., AT WEST HARTFORD, CONN., U. S. A.; OFFICIAL ORGAN OF THE INTERNATIONAL AMATEUR RADIO UNION



CONTENTS

It Seems to Us	11
New England Division Convention	12
Feedback	12
A Self-Contained 60-Watt C.W. Transmitter Donald Mix, W1TS	13
The NBS-ARRL Radio Observing Projects T. N. Gautier, jr.	18
Stabilizing the 141-Mc. Transmitter George Grammer, W1DF	24
Attention, OMs!	30
Good Operating Pays Off John Huntoon, W1LVQ	31
Oscillators and Amplifiers at 1000 Mc. Philip S. Rand, W1DBM	34
Happenings of the Month	41
In QST 25 Years Ago This Month	43
A Band-Pass 28-Mc. Converter Byron Goodman, W1JPE	44
Crystal Grinding Without Tears Francis R. Cowles, W1AOK	48
Flexible Coaxial Cable Ringland M. Krueger	51
The Postwar Naval Reserve Lt. Commander Stuart D. Cowan, jr., USNR, W2DQT	54
The "Tiny Tim" Handie-Talkie Charles T. Haist, jr. W6TWL	58
The World Above 50 Mc.	60
Silent Keys	62
How's DX?	63
The Circular Band Theorem Larson E. Rapp, W1OU	65
Foreign Notes	66
Technical Topics	
Those 14-Mc. Signals	67
Harmonics in the V.H.F. Range	68
Listening Post in the Philippines . F. Joseph Visintainer	70
Correspondence from Members	73
Hints and Kinks	
RMA Color Code for Multiwire Cables — An Electrostatic Key — Inexpensive Relay for Push-to-Talk Circuits — W2ASB Has a Real Send-Receive Switch — Ham-Made Solder Flux — Two Crystal Holder Sockets — A Simple Time Delay Circuit — Crystal Grinding Compound — Perforated Metal Sheeting — One-Tube V.H.F. Receiver — Master-Control Switch — A Unique Coupling — An Audio Oscillator in the Receiver — Feeding Parasitic Arrays with Coaxial	75
Operating News	77
Station Activities	82
Ham-Ads	156
QST's Index of Advertisers	158

hallicrafters

New design, new utility in a great new communications receiver . . .

Here is Hallicrafters new Model S-40. With this great communications receiver, handsomely designed, expertly engineered, Hallicrafters points the way to exciting new developments in amateur radio. Read those specifications . . . it's tailor-made for hams. Look at the sheer beauty of the S-40 . . . nothing like it to be seen in the communications field. Listen to the amazing performance . . . reveals anything in its price class. All around, up and down, through and through it's a true Hallicrafters-built ham job.

See your local distributor about when you can get an S-40—the up and coming leader in the popular price field.

INSIDE STUFF: Beneath the sleek exterior of the S-40 is a beautifully engineered chassis. One stage of tuned radio frequency amplification, the S-40 uses a type 6SA7 tube as converter-mixer for best signal to noise ratio. RF coils are of the permeability adjusted "micro-set" type identical with those used in the most expensive Hallicrafters receivers. The high frequency oscillator is temperature compensated for maximum stability.

From every angle the S-40 is an ideal receiver for all high frequency applications.

\$79⁵⁰

(APPROXIMATELY)

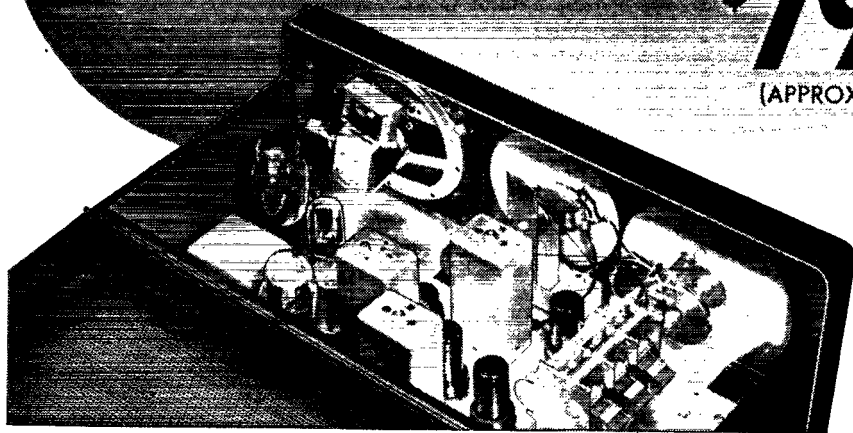

Interior completely accessible. Entire top turns back on piano hinge.

COPYRIGHT 1945
THE HALLICRAFTERS CO.

new Model S-40

Tuning range from
540 kc to 42 Mc
continuous in four
bands

Separate electrical
bandspread with
inertia flywheel
tuning

New beauty and
perfect ventilation
in the perforated
steel top

Self-contained,
shock mounted,
permanent magnet
dynamic speaker

Standby re-
ceive switch

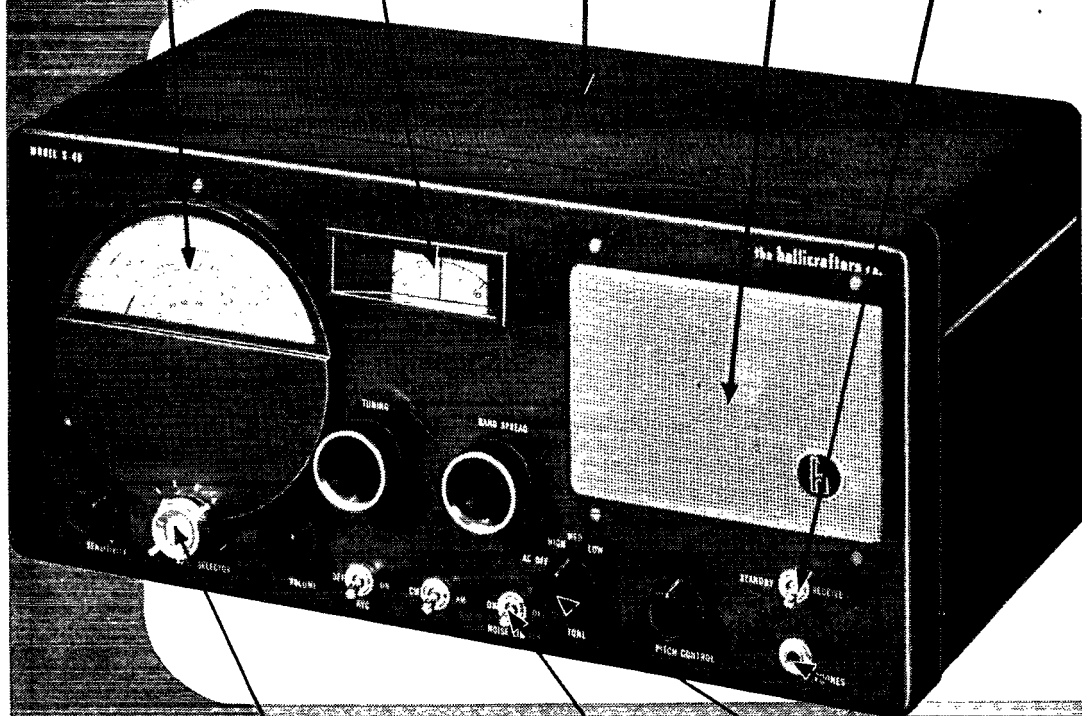

All controls logically grouped for easiest operation. Normal position for broadcast reception marked in red, making possible general use by whole family.

Automatic noise limiter

3-position tone control

Phone jack

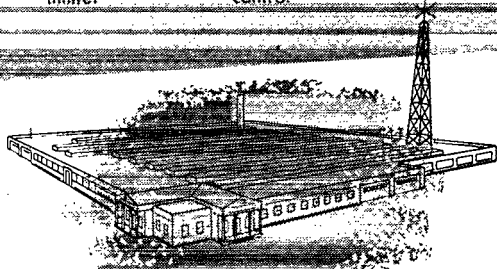

hallicrafters RADIO

THE HALLICRAFTERS CO., MANUFACTURERS OF RADIO AND ELECTRONIC EQUIPMENT, CHICAGO 16, U. S. A.

Sole Hallicrafters Representatives in Canada: Rogers Majestic Limited, Toronto-Montreal

Section Communications Managers of the A.R.R.L. Communications Department

Reports Invited. All amateurs, especially League members, are invited to report station activities on the first of each month (for preceding month) direct to the SCM, the administrative official of ARRL elected by members in each Section whose address is given below. Radio Club reports are also desired by SCMs for inclusion in QST. New ARRL Field Organization appointments, with the exception of SEC, OBS, EC, OBS, and OO are not at present being made. See Operating News.

ATLANTIC DIVISION			
Eastern Pennsylvania Maryland-Delaware-District of Columbia Southern New Jersey Western New York Western Pennsylvania	W3BES W3CIZ W3GCU W8UPH W8NCJ	Jerry Mathis Hermann E. Hobbs Ray Tomlinson Charles I. Otero R. R. Rosenberg	623 Crescent Ave. 9701 Monroe St. Silver Springs P. O. 623 E. Brown St. 4158 Ridge Road, West 927 East 23rd St.
CENTRAL DIVISION			
Illinois Indiana Kentucky Michigan Ohio Wisconsin	W9NUX W9EGQ W5IEZ* W8DPE W8MFP W9RH	David E. Blake, II Herbert S. Brier Joseph P. Colvin Harold C. Bird Carl F. Wiehe Emil Felber, Jr.	4501 N. Malden St. 385 Johnson St. 1653 Beechwood Ave. R.F.D. 2, Box 228 122 St. Albert St. 1625 N. 18th St.
DAKOTA DIVISION			
North Dakota South Dakota Northern Minnesota Southern Minnesota	W9EVP W9QVY W9FUZ W9OMC	Raymond V. Barnett P. H. Schultz Armond D. Brattland Vernon G. Pribyl	406-17th St. 118 N. Yankton Ave. 2802 S. Western 560 Brown St.
DELTA DIVISION			
Arkansas Louisiana Mississippi Tennessee	W5GED W5DKR W5HAV W4SF	Ed Beck Eugene H. Treadaway P. W. Clement James B. Witt	2503 Bishop St. P. O. Box 44 524 Santini St. R.F.D. 6, Shady Dell Trail
HUDSON DIVISION			
Eastern New York N. Y. C. & Long Island Northern New Jersey	W2HZL W2RDC W2CQD	Ernest E. George Charles Ham, Jr. Winfield G. Beck	2044 Lexington Parkway 151-06 84th Drive 617 Spruce St.
MIDWEST DIVISION			
Iowa Kansas Missouri Nebraska	W9PYR W9AWP W9OUD W9FQB	Leslie B. Vennard A. B. Urub Mrs. Letha A. Dangerfield Arthur R. Gaeth	2712 Washington St. 1617 S. Seneca St. 411 Moffett Ave. 6105 N. 37 St.
NEW ENGLAND DIVISION			
Connecticut Maine Eastern Massachusetts Western Massachusetts New Hampshire Rhode Island Vermont	W1KOY W1AOL W1ALP W1JAH W1ETJ W1HRC W1NLO	Edmund R. Fraser G. C. Brown Frank L. Baker, Jr. William J. Barrett Mrs. Dorothy W. Evans Clayton C. Gordon Burtis W. Dean	48 Willow St. 379 No. Main St. 91 Atlantic St. 239 Columbia St. P. O. Box 312 70 Columbia Ave., Gaspee P. O. Box 81
NORTHWESTERN DIVISION			
Alaska Idaho Montana Oregon Washington	K7CBF W7AVP W7CPY W7GNJ W7FWD	August G. Hiebert Don D. Oberbillig Rex Roberts Carl Austin O. U. Fistro	c/o KFAR P. O. Box 486 Box 1088 1137 Federal 513 N. Central
PACIFIC DIVISION			
Hawaii Nevada Santa Clara Valley East Bay San Francisco Sacramento Valley Philippines San Joaquin Valley	K6RLG W6CW W6IUZ W6TI W6RBO W6MDI KA1GR W6PSQ	Howard S. Simpson N. Arthur Sowie Earl F. Sanderson Horace R. Greer William A. Ladley Vincent N. Feldhausen George L. Rickard James F. Wakefield	2068 Wells St. Box 2025 600 Acacia Ave. 414 Fairmount Ave. 200 Naylor St. 113 South Quincy St. Box 849 1548 L St.
ROANOKE DIVISION			
North Carolina South Carolina Virginia West Virginia	W4CVB W4BQE/ANG W3AKN W8JM	W. J. Wortman Ted Ferguson Walter C. Walker Donald B. Morris	c/o Duke Power Co. 3422 Rosewood Drive 217-51 St. 303 Home St.
ROCKY MOUNTAIN DIVISION			
Colorado Utah-Wyoming	W9VGC W6LLH	H. F. Hekel Victor Drabble	2743 Julian St. 1024 Oak St.
SOUTHEASTERN DIVISION			
Alabama Eastern Florida Western Florida Georgia West Indies (Cuba) (Puerto Rico-Virgin Islands)*	W4GBV W41P W4MS W4HYW K4KD	Lawrence J. Smyth Robert B. Murphy Lt. Edward T. Collins Thomas M. Moss Everett Mayer	808 Winona Ave. 3302 S.W. Grapeland Blvd. 1215 N. 12th Ave. 570 Oak Drive P. O. Box 1061
SOUTHWESTERN DIVISION			
Los Angeles Arizona* San Diego	W6QWZ W6MLL W6CHV	Ben W. Onstenk Gladden Elliott Ralph H. Culbertson	9631 3rd Ave. P. O. Box 424 1712 Eads St.
WEST GULF DIVISION			
Northern Texas Oklahoma Southern Texas New Mexico	WSALA WSAYL W5JC WSHJF	Jack T. Moore Ed Oldfield James B. Rives J. C. Hancock	4529 Fairway Ave. 2141 N.W. 35th St. 1721 Kentucky Ave. 110 S. E. Nevada St.
MARITIME DIVISION			
Maritime	VE1DQ	A. M. Crowell	69 Dublin St.
ONTARIO DIVISION			
Ontario	VE3EF	Dr. Donald R. Gunn	1007 Lakeshore Road
QUEBEC DIVISION			
Quebec	VE2CO	Lieutenant L. G. Morris	4114 Hingston Ave.
VANALTA DIVISION			
Alberta British Columbia	VE4GE VE3DD	C. S. Jamieson C. O. I. Sawyer	581 W. Riverside Drive 2634 West 31st Ave.
PRAIRIE DIVISION			
Manitoba Saskatchewan	VE4AAW VE4SY	A. W. Morley Arthur Chesworth	26 Lennox St. 1084 Redland Ave.

*Officials appointed to act temporarily in the absence of a regular official.

MACHINED STEATITE FOR INTRICATE CERAMIC DESIGNS

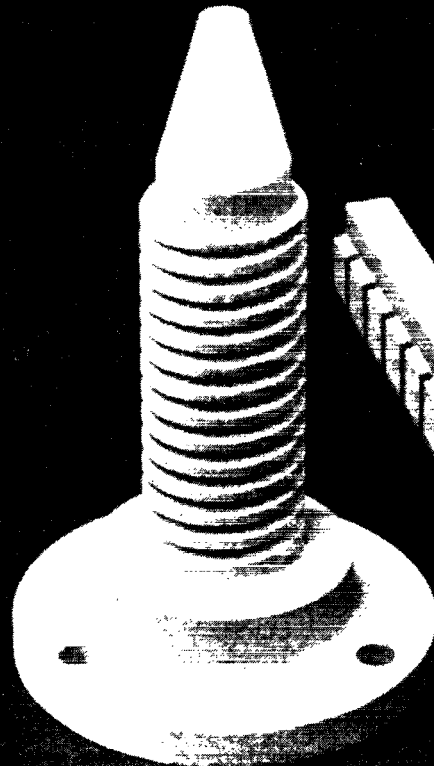
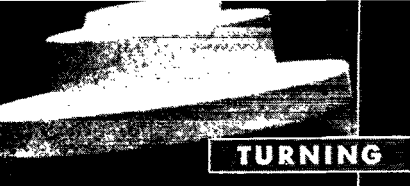

Original Award July 27, 1942
Second Award February 13, 1943
Third Award September 25, 1943
Fourth Award May 27, 1944
Fifth Award December 2, 1944



FOR equipment which requires intricate or unusual Ceramic designs, we can furnish machined ALSiMAG Steatite parts. Highly specialized equipment of our own design, as well as conventional machine tools, is used for turning, threading, drilling, slotting and other machine operations.

AMERICAN LAVA CORPORATION
CHATTANOOGA 5, TENNESSEE
43RD YEAR OF CERAMIC LEADERSHIP

CERAMICS

FOR ELECTRONIC AND ELECTRICAL USES

**Quality to Highest
Known Standards**

**Large Production
Facilities**

**Research and
Engineering
Collaboration**

NEW

... and Individually Marked



Resistance value and wattage are marked on every unit for quick identification.



Enlarged view

Meet Joint Army-Navy Specification JAN-R-11
AVAILABLE FROM STOCK IN STANDARD
RMA 10% TOLERANCE VALUES

TYPE	SIZE		RESISTANCE RANGE	MAXIMUM VOLTS	LIST PRICE
	LENGTH	DIAM.			
1/2 Watt	3/8"	3/4"	10 Ohms to 22 Meg.	500	13c
1 Watt	1/2"	7/32"	10 Ohms to 22 Meg.	1000	17c
2 Watt	1 1/16"	5/16"	10 Ohms to 22 Meg.	3500	25c

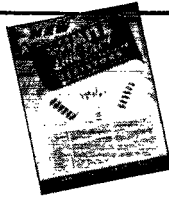

Send Now for
BULLETIN No. 127

Gives complete data and list of RMA values. Includes dimensional drawings and handy color code. Write for it today!

OHMITE Little Devil INSULATED COMPOSITION RESISTORS

1/2 Watt • 1 Watt • 2 Watt • ±10% Tolerance

NOW . . . OHMITE makes available to you three *Little Devils* of exceptional ruggedness and stability!

Millions of these tiny molded fixed composition resistors have been used in critical war equipment and in the nation's foremost laboratories. They meet Joint Army-Navy Specification JAN-R-11, including salt water immersion cycling and high humidity tests. They can be used at their full wattage ratings at 70°C (158°F) ambient temperature. They dissipate heat rapidly—have low noise level and low voltage coefficient.

Ratings for maximum continuous RMS voltage drop are high: 500 volts for the 1/2 watt unit—1000 volts for the 1 watt unit—3500 volts for the 2 watt unit. Units have high insulation breakdown voltage.

Little Devils are completely sealed and insulated by their molded plastic construction. Leads are soft copper wire, hardened immediately adjacent to resistor body—strongly anchored—and hot solder coated.

Light, compact, easy to install. All units color coded. Resistance value and wattage are marked on every unit for quick identification. Available from stock in Standard RMA values from 10 ohms to 22 megohms. Order them now!

Available Only Through OHMITE Distributors

OHMITE MANUFACTURING CO.

4863 FLOURNOY STREET, CHICAGO 44, U. S. A.

Be Right with

OHMITE

RHEOSTATS • RESISTORS • TAP SWITCHES • CHOKES • ATTENUATORS

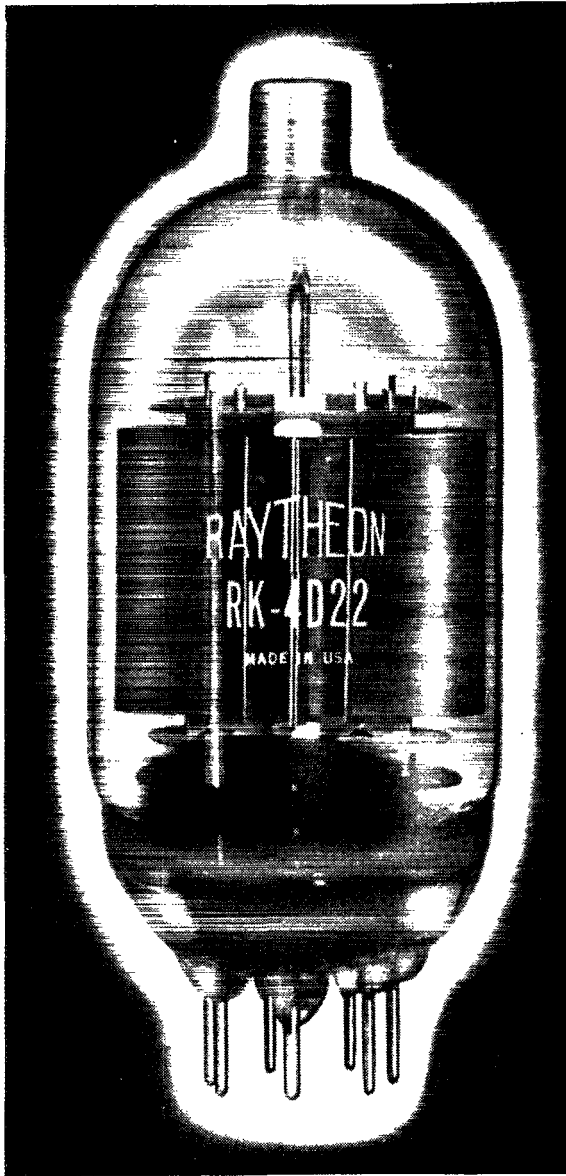

ACTUAL SIZE

RATINGS

FILAMENT RATINGS

RK-4D32	6.3 volts at 3.75 amps.
RK-4D22	25.2 volts at .8 amps. or 12.6 volts at 1.6 amps.

MAXIMUM RATINGS CLASS C TELEGRAPHY

D.C. Plate Voltage	750 volts
D.C. Grid Voltage	—200 volts
D.C. Screen Voltage	350 volts
Plate Dissipation	50 watts
Screen Dissipation	12 watts

New RAYTHEON BEAM AMPLIFIER

100 watts at 600 volts

Six Important Facts About RK-4D32 and RK-4D22

- ① Over 100 watt output at 600 plate volts.
- ② Low driving power requirements less than 1.25 watts required for full output.
- ③ High efficiency due to beam tetrode construction.
- ④ Full efficiency and no neutralization up to 60 megacycles.
- ⑤ Ruggedized construction for mobile and aircraft service.
- ⑥ 125 watts of undistorted audio output can readily be obtained from a pair.

Of special interest is Raytheon's newest cathode type beam amplifier. Capable of delivering 100 watts output with only 600 volts on the plate, this product of Raytheon research is of ruggedized construction designed particularly for ham use. It offers particular advantages for making a low powered, low cost, 100 watt band switch transmitter.

This new beam tetrode typifies Raytheon advanced engineering and precision manufacture. For any other tube application you may have, there is a Raytheon tube engineered to do that job, give you continuing satisfaction.



Excellence in Electronics

**POWER TUBE DIVISION
WALTHAM, MASSACHUSETTS**

THE AMERICAN RADIO RELAY LEAGUE, INC.,

is a noncommercial association of radio amateurs, bonded for the promotion of interest in amateur radio communication and experimentation, for the relaying of messages by radio, for the advancement of the radio art and of the public welfare, for the representation of the radio amateur in legislative matters, and for the maintenance of fraternalism and a high standard of conduct.

It is an incorporated association without capital stock, chartered under the laws of Connecticut. Its affairs are governed by a Board of Directors, elected every two years by the general membership. The officers are elected or appointed by the Directors. The League is noncommercial and no one commercially engaged in the manufacture, sale or rental of radio apparatus is eligible to membership on its board.

"Of, by and for the amateur," it numbers within its ranks practically every worth-while amateur in the nation and has a history of glorious achievement as the standard-bearer in amateur affairs.

Inquiries regarding membership are solicited. A bona fide interest in amateur radio is the only essential qualification; ownership of a transmitting station and knowledge of the code are not prerequisite, although full voting membership is granted only to licensed amateurs.

All general correspondence should be addressed to the Secretary at the administrative headquarters at West Hartford, Connecticut.



Past Presidents

HIRAM PERCY MAXIM, W1AW, 1914-1936
EUGENE C. WOODRUFF, W8CMP, 1936-1940

Officers

President GEORGE W. BAILEY, W1KH
Washington, D. C.

Vice-President

Secretary KENNETH B. WARNER, W1EH
West Hartford, Connecticut

Communications Manager F. E. HANDY, W1BDI
West Hartford, Connecticut

Treasurer DAVID H. HOUGHTON
West Hartford, Connecticut

General Counsel PAUL M. SEGAL
1026 Woodward Building, Washington 5, D. C.

Directors

President
GEORGE W. BAILEY, W1KH
1530 P St., N.W., Washington 25, D. C.

Vice-President

Canadian General Manager
ALEX REID, VE2BE
240 Logan Ave., St. Lambert, P. Q.
Alternate: Leonard W. Mitchell, VE3AZ
78 Raglan Ave., Toronto, Ont.

Atlantic Division
EDWARD G. RASER, W3ZI
315 Beechwood Ave., Trenton 8, N. J.
Alternate: J. Victor Brotherson, W8BHN
1743 Ottawa Drive, Erie, Pa.

Central Division
JOHN A. KIENER, W8AVH
3462 Edison Rd., Cleveland Heights,
Cleveland 21, Ohio
Alternate: Earl S. Nelson, W8DS
22551 Hadden Rd., Euclid 17, Ohio

Dakota Division
TOM E. DAVIS, W9VVA
915 W. Becker Ave., Willmar, Minn.
Alternate: Harold B. Love, W9ZRT
Box 426, Mandan, N. D.

Delta Division
GEORGE S. ACTON, W5BMM
Plain Dealing, La.
Alternate: Samuel H. Dowell, W5ERV
1057 Mildred St., Shreveport 15, La.

Hudson Division
ROBERT AKERIDGE KIRKMAN, W2DSY
Werah Pl., R.F.D. No. 1, Box 61, Long Branch, N. J.
Alternate: George Ruffa, Jr., W2CJY
38 Brookwood Drive, Manhasset, L. I., N. Y.

Midwest Division
FLOYD E. NORWINE, JR., W9EFC
7405 Hiawatha Ave., Richmond Heights 17, Mo.
Alternate: C. A. Colvin, W9VHR
% Omaha & Council Bluffs St. Railway Co.,
Omaha 2, Nebr.

New England Division
PERCY C. NOBLE, W1BVR
37 Broad St., Westfield, Mass.
Alternate: Clayton C. Gordon, W1HRC
70 Columba Ave., Warwick, R. I.

Northwestern Division
KARL W. WEINGARTEN, W7BG
3219 N. 24th St., Tacoma 7, Wash.
Alternate: R. Rex Roberts, W7CPY
110 W. Brennan St., Glendive, Mont.

Pacific Division
J. L. McCARGAR, W6EY
66 Hamilton Pl., Oakland 12, Calif.
Alternate: Elbert J. Amarantes, W6FBW
1675 Dale Ave., San Jose, Calif.

Roanoke Division
H. L. CAVENESS, W4DW
2607 Vanderbilt Ave., Raleigh, N. C.
Alternate: J. Frank Key, W3ZA
Box 707, Buena Vista, Va.

Rocky Mountain Division
Acting Director:
HOWARD R. MARKWELL, W9TFP
355 Monroe St., Denver 6, Colo.

Southeastern Division
WILLIAM C. SHELTON, W4ASR
527 Revilo Blvd., Daytona Beach, Fla.
Alternate: William P. Sides, W4AUP
Fleming Road, Montgomery, Ala.

Southwestern Division
JOHN E. BICKEL, W6BKY
1834 E. Whittier Blvd., Whittier, Calif.
Alternate: Eldridge E. Wyatt, Jr., W6ARW
P. O. Box 3597, Long Beach 3, Calif.

West Gulf Division
WAYLAND M. GROVES, W5NW
% Humble Pipe Line Co., Odessa, Texas
Alternate: Jennings R. Poston, W5AJ
P. O. Box 848, Curundu, Panama Canal Zone

"It Seems to Us..."

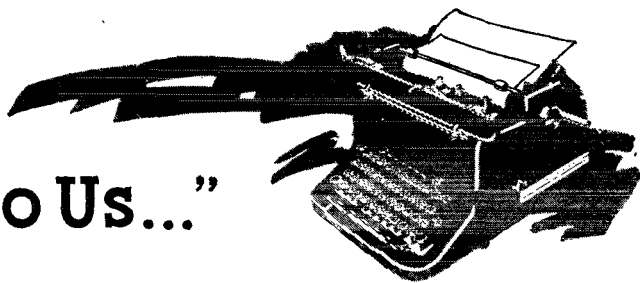

3700-4000!

AS WE START our monthly pecking for this page it is that alleged lull in between the two week-ends of the Band-Warming Party. What a warming the 10-meter band has been getting! Why, if anybody had ever told us that a band as generally punk as "10" could be a squirming mass of signals from one end to the other for a solid week-end —! And then we have just recently put out the good word that the shift to 50-54 Mc. becomes an actuality, so that we can settle down to a stable life in that band as well and give it a good warming, too. But the bandwarmingest and heartwarmingest news for any ham since V-J Day is the glad tidings that we're getting back the major portion of the 80-meter band. Dear old 80!

As probably every amateur in the United States now knows, the military services have agreed to relinquish the frequencies from 3700 to 4000 kc. in continental U.S.A. by March 31st, with certain nonexclusive exceptions not too important to us, and FCC is expected to put them at our disposal on April 1st. Canada is expected to establish the same arrangement. The whole 300 kc. will be open to c.w. work and, as already provided by our regulations, 3900-4000 kc. will also be available for Class A 'phone work. It is early March as we write, and all the details haven't been arranged, so we'll hope you have been listening to the W1AW bulletins for information on exact dates and rules.

As we endeavor to show you each month in *QST*, ARRL has been working ever since V-J Day on this problem of getting back our bands. It is a problem concerning the military. Some of you seem to think that we should be turning the heat on FCC to give us back our bands, but it isn't an FCC question, fellows. The Commission is more than willing, even eager, to see us restored. During the emergency (which still exists, as far as the law is concerned) the military services took over countless commercial channels as well as our amateur bands. They are only gradually releasing them back to FCC to reassign to their rightful holders. The

Commission administers the civilian radio services but can do nothing in such cases as ours until the military remove themselves and hand back the frequencies. For months we have been pointing out to the military people that the amateurs of most of the small countries of the world are back on the air on useful frequencies, while we, who think we won the war, have yet to taste the fruits of victory radio-wise. Finally, late in February, there was a conference at the Pentagon between ARRL officers and representatives of all the military services, under the aegis of the War Department and with FCC representatives also present. We want to tell you about it. You may be wondering how we can show jubilation over the return of a mere sixty per cent of only one of our three useful bands. It is because it is a beginning and we can now see the rest. At that conference both we and the military people got a good look at each others' position and problems. For our part, we explained our needs, how we use our bands, and our particular need to get going now on the 80 meter band, and to follow it up with the rest soon. For their part, they showed us what they had already done, what they had underway, and some of the particular problems that bedevil them. Unhappily, the military men who assign frequencies and who clear and release them are not the ones who determine what circuits shall be maintained; that's a matter of front-office policy. Circuit requirements are not coming down as fast as other demobilization is proceeding, and planning is handicapped by incomplete decisions on what bases will be kept permanently. In addition to returning amateur bands, the national interest requires that the military also vacate the commercial channels they have been occupying, a job scheduled for completion this early summer and temporarily making things tighter than ever. These are the things on the debit side. On the plus side, we find that the military have every appreciation of the value of amateur radio and are eager to return our bands as fast as their system will let them; that they have already sent directives to the field concerning the gradual clearance of our bands;

and that, working since late November, they had already practically cleared 200 kc. of our 80-meter band.

We then got down to a realistic discussion of what could be done about dates and bands. Here is the way it stacks up: As to the 7- and 14-Mc. bands, there are complexities of such extent as to make it unlikely, as seen at this date, that the bands can be returned to us in their entirety before late this year, but prospects are good for the release to us of a substantial portion of each band by midsummer. On 3.5, similarly, it must be later in the year before we get the whole band. But with 200 kc. of this band already cleared it was determined, through the quite special collaboration of the Army Air Forces, that with a little sharing it would be possible to squeeze out another adjoining 100 kc. in another month. And so it was agreed that 3700-4000 should come back to us the end of March or first of April — assuming FCC willing, as of course it will be — and that the services will do all they can to clear the rest of the band quickly.

The military frequency situation is still so tight that you will not be too surprised to know that there are some temporary strings attached to this return. The reopening at first will be confined to continental United States, since the services' uses increase enormously as soon as the territories and possessions are reached. Consultations are going on now looking to extending the arrangement and it is hoped that it will not be long before at least Hawaii is included. The AAF has about half a dozen channels in this range for which replacement frequencies are not yet available. They are willing to take a chance on our interference, without asking any restrictions on us, but the return to us is possible only on the understanding that they continue this shared use a short while. Most of their stations are outside the United States and all will be moved soon, probably before midsummer. Finally, on behalf of Army requirements for many low-powered stations, it was agreed that they may possess a secondary right to operate throughout these frequencies, until the whole band is returned, on the condition of no interference to amateurs.

So there it is: a beginning, but an important step, and with more coming. Meanwhile ARRL stays on the job, works every way it can to improve our position. We'll continue to report in *QST* but fast news on important developments is best got nightly from W1AW, and in particular you'll want to check on the official opening of the band to amateurs by FCC. It won't be open to us until FCC says it is.

Let us give a caution about the expected opening of 3900-4000 kc. for 'phone. This is a so-called Class A band; it is not open to every amateur except for c.w. It may be used for A3

voice emission only under the twin conditions that the station be licensed to a person whose operator license is endorsed for Class A privileges, and that it be operated and controlled by a person so licensed. A Class A holder may not magically endow a Class B (or C) man's station with the right to work 'phone in this band, just by the honor of his presence; nor may a Class B man operate 75-meter 'phone in a Class A man's station just because the latter is so licensed. The holder of a B or C ticket may speak over the mike, of course, but he has no more rights to control the station or sign it off than an unlicensed person has. Let's keep straight on this.

We look forward with particular keenness to the reestablishment of clean, fast, reliable telegraphic communication at moderate distances, accompanied by renewed ability to fulfill the requirements of community responsibility. With what "10" occasionally offers in the way of DX, we shall have a little of everything and a big improvement in our general position. It will be good to be on a real c.w. band again. The days of real sport are back. BCNU!

Edgar

Flash!

First Postwar
New England Division Convention
Dennison Memorial Hall
Framingham, Mass.
Saturday, May 4th

- Registration opens 1 p.m. Technical talks and gear demonstrations at 2 p.m. Hidden-transmitter hunt, 2-meter band, 3 p.m.; bring your own receiver. Banquet at 7 p.m., real Yankee cooking, long on feed and prizes, short on speeches. Prizes, yes — including several receivers. Big gang expected, with lots of displaced portable hams. Ticket for everything, \$4.75. If purchased by mail before April 21st from Chairman E. S. Parsons, W1BWJ, 29 Pitts St., Natick, Mass., ticket will carry an extra prize coupon over those sold at door.

BCNU!

FEEDBACK

In the circuit diagram of Fig. 1, page 14 of the March issue, one side of the heater circuit is connected to cathode. In each case, the heater connection should be made to the chassis instead. C_{13} should have a value of 500 μfd .

A Self-Contained 60-Watt C.W. Transmitter

3.5, 7 and 14 Mc. in Two Stages

BY DONALD MIX, * W1TS

• This article describes a compact two-tube low-power transmitter for 3.5, 7 and 14 Mc. The power supply and antenna tuner are included in the unit. The rig will deliver a power output of 30 to 45 watts on all bands.

COMPARED with a 1-kw. rig with all the latest gadgets, a simple two-tube transmitter isn't an exciting subject for discussion. After all, there just aren't enough parts (at least there shouldn't be) to permit the imagination to stray far from the conventional, particularly when it comes to tube line-up. Yet it is doubtless true that more hams who work the "bread-and-butter" bands — 20, 40 and 80 — are interested in gear of this class than in all other types put together.

Before the war the now venerable 6L6 figured prominently in the low-power transmitter field — not because it was the best tube for the purpose but for the reason that, being a mass-produced b.c. tube, it was cheap. However, in view of a series of reductions in the price of the 807 within the

past year or two, there seems to be no necessity for further use of the 6L6 in r.f. applications, even at low plate voltages, for the 807 is a well-screened tube designed for r.f. work, while the 6L6 is not. When higher plate voltages are available the 807 will handle considerably more power without sacrificing service life. While it is not particularly well suited to v.h.f. work, it is a "natural" in a low-power transmitter for the lower frequencies, such as the unit shown in the photographs.

The Circuit

The circuit diagram is shown in Fig. 1. A 6V6GT Tri-tet oscillator drives an 807 output stage directly with simple capacitive coupling. Crystal blanks are inexpensive these days and the new-type holders make it possible to mount several crystals in a very small space. In this instance any one of ten crystals may be selected from the front of the panel by the crystal switch, S_1 . Bands are changed by means of a system of plug-in coils.

The oscillator circuit operates with either 3.5- or 7-Mc. crystals. In either case, oscillator output may be obtained at the crystal fundamental frequency or its second harmonic. While the output stage may be used as a frequency doubler with fair efficiency, this sort of operation is not

* Assistant Technical Editor, *QST*.

◆
A two-stage low-power transmitter for three bands. To either side of the milliammeter are the oscillator and amplifier plate tuning controls. Along the bottom are the crystal switch, the plate-voltage switch, the meter switch, the key jack and the antenna-tuning control.
◆

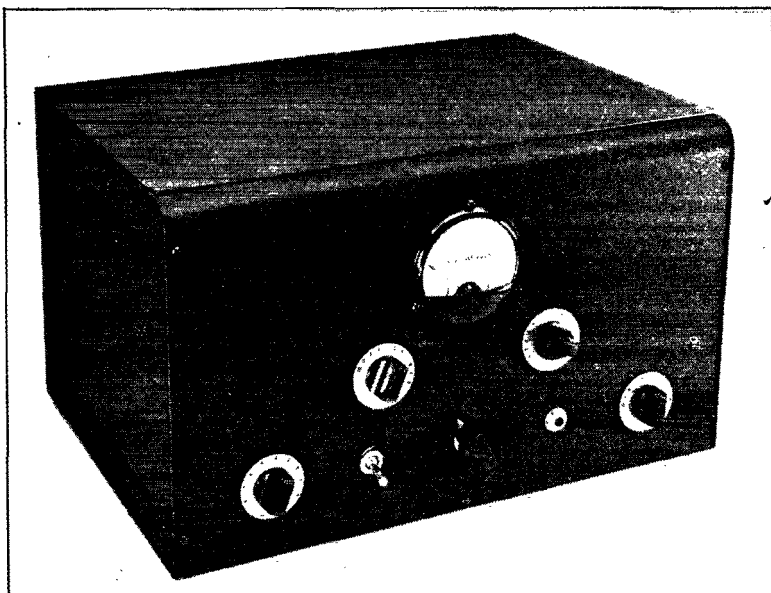

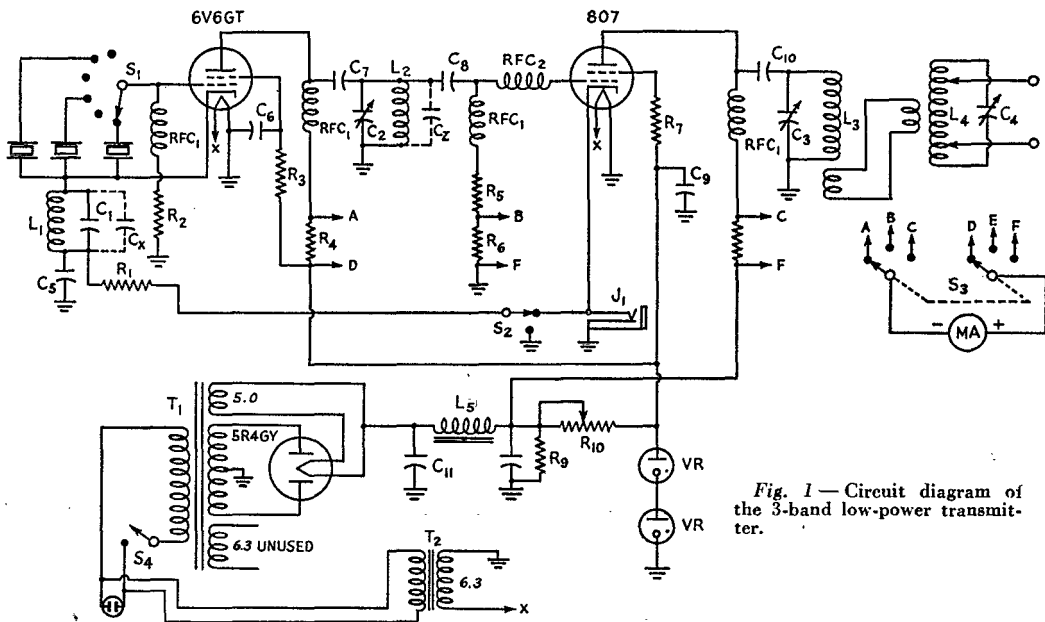

Fig. 1 — Circuit diagram of the 3-band low-power transmitter.

- C₁, C₈ — 100- μ fd. mica.
 C_x — 100- μ fd. mica (see text).
 C₂ — 50- μ fd. variable (National ST-50).
 C_x — 20- μ fd. mica (see text).
 C₃, C₄ — 150- μ fd. variable (National ST-150).
 C₅, C₆, C₉ — 0.01- μ fd. paper.
 C₇, C₁₀ — 0.001- μ fd. mica.
 C₁₁ — Filter output, 4- μ fd., 1000-volt paper.
 R₁ — 200 ohms, 1 watt.
 R₂ — 50,000 ohms, $\frac{1}{2}$ watt.
 R₃ — 40,000 ohms, 5 watts.
 R₄ — 100-ma. meter shunt (see text).
 R₅ — 15,000 ohms, 1 watt.
 R₆ — 50 ohms, $\frac{1}{2}$ watt.
 R₇ — 50 ohms, 1 watt.
 R₉ — 50,000 ohms, 25 watts.
 R₁₀ — 5,000 ohms, 25 watts.
 L₅ — 6-hy, 175 ma. filter choke.
 S₁ — Meter switch, 11-point tap switch, ceramic insulation.
 S₂ — S.p.d.t. toggle.
 S₃ — Double-gang, 3-position rotary switch.
 S₄ — S.p.s.t. toggle.
 RFC₁ — 2.5-mh. r.f. choke.
 RFC₂ — 11 turns No. 20, 5/16 inch diam., $\frac{1}{4}$ inch long.
 T₁ — 600 volts each side of center, 200 ma.; 5 volts, 3 amp. (UTC S-41).
 T₂ — 6.3 volts, 3 amp. (UTC S-55).

VR — Voltage-regulator tubes — VR150 and VR105 in series to give 255 volts.

- L₁ — Oscillator cathode
 1A (3.5-Mc. crystals) — 14 turns No. 22 d.c.c., 1-inch diam., $\frac{1}{8}$ inch long, 100- μ fd. mica, C_x, connected in parallel.
 1B (7-Mc. crystals) — 10 turns No. 22 d.c.c., 1-inch diam., $\frac{1}{8}$ inch long.
 L₂ — Oscillator plate
 2A (3.5 Mc.) — 80 turns No. 26 d.c.c., $\frac{1}{2}$ -inch diam., closewound, C₁ connected in parallel.
 2B (7 Mc.) — 40 turns No. 24 d.c.c., $\frac{1}{2}$ -inch diam., closewound.
 2C (14 Mc.) — 25 turns No. 18 d.c.c., $\frac{1}{2}$ -inch diam., 1 $\frac{1}{2}$ inches long.
 L₃ — Amplifier plate
 3A (3.5 Mc.) — 24 turns 1 $\frac{1}{2}$ inches diam., 1 $\frac{1}{2}$ inches long (B & W JEL-80 with 16 turns removed), 3-turn link.
 3B (7 Mc.) — 18 turns 1 $\frac{1}{2}$ inches diam., 1 $\frac{1}{4}$ inches long (B & W JEL-40 with 4 turns removed), 3-turn link.
 3C (14 Mc.) — 12 turns 1 $\frac{1}{2}$ inches diam., 2 inches long (B & W JEL-20), 2-turn link.
 L₄ — Antenna coil
 4A (3.5 Mc.) — 30 turns 1 $\frac{1}{4}$ inches diam., 2 inches long, 3-turn variable link at center (B & W JVL-80 with 5 turns removed from each end).
 4B (7 Mc.) — 24 turns 1 $\frac{1}{4}$ inches diam., 2 $\frac{1}{2}$ inches long, 3-turn link at center (B & W JVL-40).
 4C (14 Mc.) — 14 turns 1 $\frac{1}{4}$ inches diam., 2 $\frac{1}{4}$ inches long, 3-turn link at center (B & W JVL-20).

recommended unless the unit is to be used as an exciter for a following amplifier.

Parallel plate feed is used in both stages to permit mounting the tuning condensers, C₂ and C₃, directly on the metal chassis without insulation. The v.h.f. choke RFC₂ and the screen resistor, R₇, are necessary to suppress h.f. parasitic oscillations.

The s.p.d.t. toggle switch, S₂, makes it possible either to key both stages simultaneously for break-in work on the lower frequencies, or the

output stage alone at 14-Mc. frequencies where oscillator keying chirp may become noticeable. The unit includes a link-coupled antenna tuner, L₄C₄.

The self-contained power supply is built around an inexpensive multiwinding transformer, T₁. The separate filament transformer, T₂, makes it possible to cut off the plate voltage without turning off the heaters of the tubes. A condenser-input filter is used to boost the output voltage to 600 under load. Voltage for the plate of the oscil-

lator and the screen of the 807 is kept from soaring when the key is open by a pair of voltage-regulator tubes. This operating voltage of 250 is dropped to 150 volts for the screen of the 6V6GT by the series resistor, R_3 .

The milliammeter may be switched to read oscillator plate current and 807 grid or plate current by the double-gang switch, S_3 , which connects the meter across the shunting resistors, R_4 , R_6 and R_C . R_4 and R_F are adjusted to multiply the 10-ma. basic meter-scale reading by 10 and

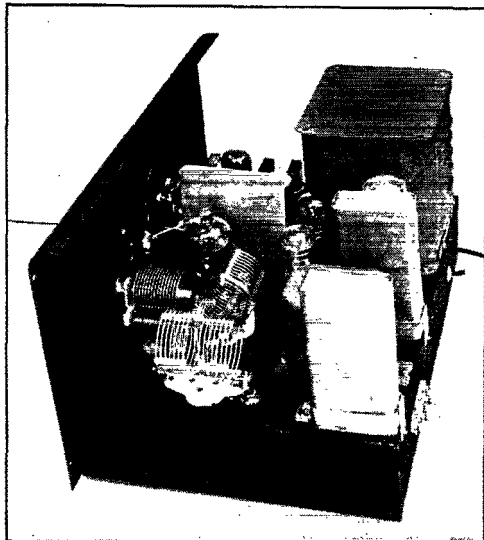

Looking into the amplifier end of the chassis. The 307 socket is spaced below the chassis to provide shielding between the input and output sections. The coil in the foreground is in the antenna tuner, while the one behind it is the amplifier plate tank coil.

20, making the full-scale reading 100 and 200 ma. respectively when checking plate currents, while the resistance of R_6 is sufficiently high to have negligible effect upon the meter reading when measuring the grid current of the amplifier.

Construction

The transmitter is built on a 10 by 14 by 3-inch chassis which fits a standard 9 by 15 by 10 $\frac{3}{4}$ -inch cabinet. The r.f. section occupies the front half of the chassis, while the power-supply components are lined up at the rear.

In a job of this sort, it will save time if all details of the layout plan are worked out in advance so that holes will not have to be drilled or cut after the assembly is started. All tube and coil sockets are submounted so that holes for these must be cut. There are nine of these in all. The cathode coil, L_1 , requires a 4-prong socket, octals are needed for the 6V6GT, the oscillator plate coil, L_2 , the rectifier and the two VR tubes, while L_3 and L_4 require 5-prong sockets. In

spotting the mounting holes for these, care should be taken to turn the sockets to the proper position to make shortest leads possible.

The oscillator and amplifier groups are separated by a small baffle shield cut from sheet aluminum. It is 4 inches high and 5 inches long and has a cutout in front for the meter. It is spaced 8 inches in from the right-hand end of the chassis. The line of ten Millen crystal sockets are placed as close to the left-hand edge of the chassis as possible. Each of these requires two clearance holes and a mounting-screw hole between.

Alongside the crystal row are the 6V6GT oscillator tube and its cathode coil, L_1 , followed by the plate coil, L_2 , and the oscillator tuning condenser, C_2 . The latter is mounted directly on the chassis 4 $\frac{5}{8}$ inches from the left-hand edge. The oscillator grid and plate chokes are mounted underneath.

On the other side of the baffle shield are the 807 with its plate-circuit choke and blocking condenser, C_{10} , the output tank condenser and coil, C_3 and L_3 , and the antenna-coupler coil, L_4 . The antenna tuning condenser, C_4 , is mounted under the chassis. The socket for the 807 is spaced as far below the chassis level as possible, without protruding from the bottom, by means of brackets cut from strip metal. The purpose of this is to provide a shield between the input and output sections of the tube. A 1 $\frac{7}{8}$ -inch hole is required to clear the tube envelope. C_3 is mounted directly on the chassis with its shaft 4 $\frac{5}{8}$ inches from the right-hand end of the chassis to balance the shaft of the oscillator plate tank condenser.

The antenna tuning condenser, C_4 , must be

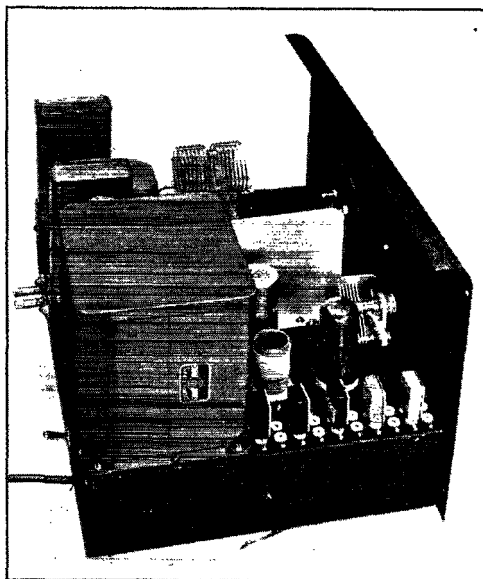

The oscillator section, showing the line of crystal sockets, the cathode coil, the shielded plate coil and the 6V6GT.

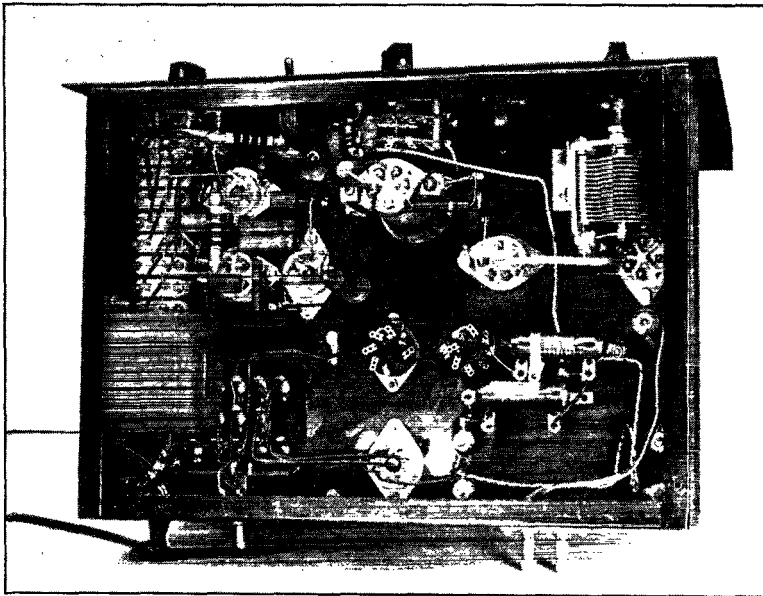

Bottom view of the low-power transmitter, showing the mounting of the 807 socket at the upper center and the location of by-pass condensers, resistors and r.f. chokes. The separate filament transformer is fastened to the left-hand edge of the chassis. The antenna tuning condenser is in the upper right-hand corner, supported on an aluminum angle bracket which is insulated from the chassis by polystyrene buttons.

insulated from the chassis. This is done by means of an aluminum angle bracket and a pair of polystyrene feed-through buttons. The condenser is placed so that its shaft comes $1\frac{1}{2}$ inches from the end of the chassis to balance the shaft of the crystal switch at the opposite end. The antenna coil is mounted at right angles to L_3 .

The meter switch, S_3 , is mounted at the center between the front edge of the chassis and the bottom part of the 807. The key jack and power switch, S_4 , are spaced equally to either side of the center of the front edge of the chassis.

The power-supply components are placed as close as possible to the rear edge of the chassis, with the transformer, T_1 , at the left followed by the rectifier and voltage-regulator tubes, the input condenser, C_{11} , the filter choke, L_5 , and the output condenser. A large cutout is required for the transformer terminals and if filter condensers of the type shown are used, holes for the terminals must be provided in addition to the mounting-screw holes. The leads to the filter choke are fed down through a grommet-lined hole next to the choke. The key switch, S_2 , and the antenna terminals are mounted in the rear edge of the chassis where the power cord also is brought in.

Underneath the chassis the power wiring is done first, keeping it bunched and close to the chassis wherever possible. The separate filament transformer, T_2 , is fastened to the left-hand end of the chassis. By-pass condensers and r.f. chokes should be placed close to the tube terminals to which they connect. The by-pass condensers should be grounded to the chassis at the nearest available point. The coupling and blocking condensers, C_7 , C_8 and C_{10} , should be well spaced

from the chassis. The same applies to all r.f. wiring, which should also be kept short and direct between points of connection. The length of leads to resistors is not important. In some cases it may be convenient to use fibre lug strips as anchorages or supports for small resistors and r.f. chokes.

The meter shunts, R_4 , R_6 and R_{C-F} , are mounted directly on the meter switch. R_4 , and R_{C-F} are made from No. 30 magnet wire. Approximately 7 feet will be required for R_{C-F} and 14 feet for R_4 . Before the meter is mounted in the panel, it should be connected in series with a 3-volt battery and a variable resistance of about 500 ohms. A resistor with a slider will serve the purpose if none other is available. The resistance should be adjusted until the meter reads full scale. When the shunting wire, cut to a length of two or three feet more than that required, is connected across the meter terminals, the reading will drop. The length of the wire should be adjusted, bit by bit, until the reading drops to 1 ma. for R_4 and to $\frac{1}{2}$ ma. for R_{C-F} . The wire then may be wound on a small form for compactness. A $\frac{1}{2}$ -watt resistor of 100 ohms or more makes a good form and its resistance does not affect the calibration of the shunt to any practical degree.

The link line between the output tank circuit and the antenna tuner and the connections between the latter and the antenna terminals at the rear should be made with rigid wire spaced well away from the chassis and surrounding components.

Coils

The output and antenna tank coils, L_3 and

L_4 , are of the B & W JEL and JVL series respectively.

Some of these require pruning, as indicated in the coil table, to provide the correct L/C ratio. The antenna-tuner coil, L_4 , requires an extra pair of contacts for the tap leads. Since a center tap is not required, it may be cut free from the base pin so that this pin may be used for one of the tap contacts. The other tap contact is provided by drilling out the tubular rivet at one of the ends of the base coil-supporting strip and substituting a banana plug. A jack for this plug then is mounted in the chassis close to the coil socket by drilling out a pair of polystyrene button-type feed-through insulators to fit the jack and setting them in the chassis.

The two cathode coils for L_1 are wound on Millen 4-prong 1-inch forms. The one to be used with 3.5-Mc. crystals requires a 100- μ fd. mica condenser, C_x , connected across it in addition to C_1 . This condenser is mounted inside the form so that it is connected in the circuit along with the coil when the latter is plugged in.

The oscillator plate coils are wound on Millen octal-base shielded plug-in forms. If the forms are of the type with iron-core slugs, these should be removed. The 3.5-Mc. coil requires an extra padding condenser, C_x , of 20 μ fd. This may be a mica condenser soldered across the winding as shown in the accompanying photograph.

COIL TABLE

X tal. f.	Output f.	L_1	L_2	L_3	L_4
3.5 Mc.	3.5 Mc.	1A	2A	3A	4A
3.5 Mc.	7 Mc.	1A	2B	3B	4B
7 Mc.	7 Mc.	1B	2B	3B	4B
7 Mc.	14 Mc.	1B	2C	3C	4C

Adjustment

Since the tuning of the cathode tank circuit is fixed, only three circuits, including the antenna circuit, need adjustment. The coil table shows which coils should be plugged in to obtain output depending upon the crystal frequency and the output frequency desired. For initial testing it is well to use a combination giving output in the 3.5- or 7-Mc. band. Before turning on the power supply, a key connected to a plug should be inserted in the key jack and the key switch, S_2 , should be thrown to the amplifier-keying side. This will permit the oscillator to operate alone. When the power plug is inserted, the heaters of the tubes should warm up. The VR tubes should glow as soon as the power switch, S_4 , is closed. If they do not, the resistance of R_{10} should be reduced until they do.

With the high voltage applied and the meter switched to the first position for oscillator plate current, the meter should read between 35 and 50 ma. As C_2 is adjusted, a point will be found where the plate current dips to a minimum (between 10 ma. and 30 ma. depending upon the

frequency) rising on either side. If L_2 has been made close to specifications, this resonance point should be found with about 60 per cent of maximum capacitance in use at C_2 for 3500 kc., 70 per cent for 7000 kc. and 30 per cent for 14,000 kc. If the plate circuit is tuned to a harmonic of the crystal frequency, the increase in current either side of the minimum should be smooth. However, if the plate circuit is tuned to the crystal frequency, the plate current may jump suddenly to a high value when it is tuned to the high-capacitance

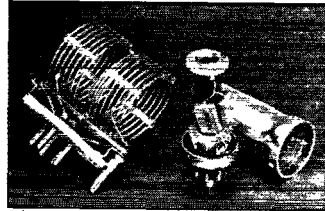

The antenna coil requires the addition of an extra contact which is provided by the banana plug. To the right is the 3.5-Mc. oscillator plate coil with the mica padding condenser connected across the winding.

side of the minimum plate-current point. This indicates that the circuit has stopped oscillating. C_2 should be set sufficiently to the low-capacitance side of the minimum to insure reliable starting of the oscillator when the power is switched on or when the amplifier is keyed.

The amplifier should be tuned up first with the antenna coil out of its socket. With the meter switched to the second position where it reads amplifier grid current, a reading of 3 to 9 ma. should be obtained when the key is closed. If no grid-current reading is obtained, it is probable that the oscillator stopped when the key was closed. In this case, the tuning of the oscillator should be readjusted. In this instance, at least, it has been found that best keying is obtained when the oscillator plate circuit is detuned to the low-capacity side of resonance to a point where the oscillator plate current remains constant with the key open and closed. This refers only to amplifier keying when the oscillator plate circuit is tuned to the crystal fundamental, of course. Readings of 5 to 10 ma. or more should be obtained in all cases. The key should not be held closed for periods longer than necessary to obtain the reading, until the amplifier plate circuit is tuned to resonance.

With the meter switch thrown to the last position, where it reads amplifier plate current, a reading of 100 ma. or more should be obtained. As C_3 is turned through its range the plate current should dip to a minimum of between 10 and 15 ma. With the L_3 coils altered as indicated in the coil table, resonance should occur at approximately 90 per cent for 3500 kc., 30 per cent for 7 Mc. and 15 per cent for 14 Mc.

(Concluded on page 114)

The NBS-ARRL Radio Observing Projects

And the WWV Observing Project

BY T. N. GAUTIER, JR. *

JUNE 30, 1945, was the last day of the third of a series of three radio observing projects in which the radio amateurs of the United States cooperated with the National Bureau of Standards in obtaining radio propagation data urgently needed in work which the Bureau was doing for the allied armed forces. The first two projects, called the NBS-ARRL Projects I and II, were organized under the joint auspices of the National Bureau of Standards and the American Radio Relay League, and most of the participating observers were ARRL members. The third project, the WWV Observing Project, was organized independently of the NBS-ARRL Project, but a number of participants in the NBS-ARRL Project became observers in the WWV Project after the termination of the NBS-ARRL Project.

Heretofore, the projects were kept confidential because of their military significance; now, however, the story may be told and tribute paid to the radio amateurs of America and their organization, the American Radio Relay League. They contributed to the war effort urgently-needed data on radio propagation that could not have been obtained in any other way.

Prewar readers of *QST* will recall the National Bureau of Standards' predictions of radio distance ranges and skip distances which appeared quarterly in this magazine until January, 1942. These predictions were based principally on long-distance radio reception observations and vertical-incidence ionosphere measurements made at Washington, D. C. In applications to actual radio transmission problems, therefore, these predictions were, in general, accurate only for transmission paths passing near Washington, D. C. A much greater range and variety of data were needed for accurate predictions of world-wide radio propagation conditions. When this country began national defense preparations and accurate world-wide predictions became a vital necessity, the National Bureau of Standards undertook to gather the required basic data.

In particular, accurate data were needed on the distance ranges for reliable c.w. and radiotelephone communications on frequencies between 1500 and 30,000 kc. For this purpose a large number of observations on radio stations at various distances was required. Since experienced radio amateurs had just the type of training necessary for making such observations, toward

* National Bureau of Standards, Washington, D. C.

• There are lots of undramatic but nonetheless important tasks connected with winning a war. Here's the story of one that was made to order for the amateur; one that it would have been difficult, if not impossible, to organize expeditiously and quietly without amateur radio and ARRL.

the end of 1940 the American Radio Relay League was called on for assistance. The response was immediate and wholehearted. The entire facilities of the ARRL organization, insofar as they were available, were placed at the Bureau's disposal.

The simplest way to get volunteer observers for such an observing project would have been to run a suitable announcement in *QST*, but because of the confidential nature of the project it was necessary to avoid all publicity and to recruit participants privately by letter and personal interview. In spite of this inconvenience, however, a workable plan for enlisting the required observers and a suitable program of observations were developed, with valuable assistance from the ARRL Headquarters staff.

The plan for enlisting observers was as follows: seventeen ARRL members, mostly Section Communication Managers located in different parts of the United States, were selected by the ARRL Headquarters staff and invited to act as "regional coordinators." Each coordinator then organized an observing group of 20 or more amateurs in his vicinity who were willing to put in two 2-hour observing periods each week, one in the daytime around noon, and one after dark.

The program of observations was as follows: for convenience, the frequency spectrum between 1.5 and 30 Mc. was divided into five bands, 1.5 to 4.5, 4.5 to 8.0, 8.0 to 14.5, 14.5 to 23.0, and 23.0 to 30.0 Mc. In each observing period each observer took a single band, in accordance with a schedule arranged by the coordinator, and tuned through the band, identifying as many stations as possible and recording the frequency, the call sign, location, and ratings of the carrier intensity and readability on 1 to 5 scales similar to the standard QSA and QRK scales. Readabilities of 'phone and c.w. stations were recorded separately. The background noise intensity was also rated and recorded. Afterward the distance and direction of each station, as determined from

maps and charts furnished by the Bureau, were also recorded. The band assignments were rotated every week so that each observer covered all five bands every five weeks.

Besides arranging observing schedules, other duties of the coördinator were to secure replacements from time to time of observers who were unable to report regularly; to distribute instructions, report forms, and other material furnished by the National Bureau of Standards, and to collect and forward the observers' reports to the Bureau.

Each observer was supplied with instructions on observing and reporting the desired data, maps, station lists, and information about the ionosphere. Periodically, bulletins describing the progress of the work and suggesting ways for improving the observations were issued by the Bureau to all observers.

The NBS-ARRL Project I was officially begun on July 1, 1941, with the following regional coördinators:

Mrs. A. H. Dangerfield (Letha Allendorf),
W9OUD Joplin, Mo.
Carl Austin, W7GNJ Bend, Oregon
Frank L. Baker, jr., W1ALP
North Quincy, Mass.
M. L. Bender, W9YNQ Spring Valley, Minn.
Horace E. Biddy, W5MN San Antonio, Texas
Harold C. Bird, W8DPE Pontiac, Mich.
Oscar Cedarstrom, W4AXP
DeFuniak Springs, Fla.
Fred Chichester, W8PLA Sonyea, N. Y.
Ralph Click, W7MQM Los Angeles, Calif.
Carl C. Drumeller, W9EHC Pueblo, Colo.
W. A. Ladley, W6RBQ San Francisco, Calif.
Jerry Mathis, W3BES Philadelphia, Pa.
W. D. Tabler, W8OXO Elkins, W. Va.
H. S. Walling, W6PPO Fresno, Calif.
W. J. Wilkinson, W5DWW Shreveport, La.
Louis A. Wollaeger, W9ANA Wauwatosa, Wis.
W. J. Wortman, W4CYB Morganton, N. C.

Later on, some of the above were obliged to resign as coördinators. In October, 1941, Richard E. Lake, W6BV, Fresno, Calif., succeeded H. S. Walling. In November, 1941, C. H. Haas, W6EAH, Glendale, Calif., succeeded Ralph Click, and Orval Cunningham, W9KHQ, Towner, Colo., succeeded Carl Drumeller. In February, 1943, Henry Gassman, W6SUM, Fresno, Calif., succeeded Richard Lake, and C. J. Nelson, W9KRB, Cheyenne Wells, Colo., succeeded Orval Cunningham.

After our country went to war, following the Japanese attack on Pearl Harbor, the need for radio propagation data became even more urgent than before. Realizing this, and in spite of the fact that many amateurs, including NBS-ARRL observers, joined the Services or took other jobs that prevented participation in the project, the remaining observers redoubled their efforts and

actually reported more observations per month than before. Particular credit is due to these amateurs in view of the fact that amateur transmitters were no longer available for observation, that the Armed Forces bought up many amateurs' receiving sets, that replacement parts became scarce, and that everybody's spare time was cut to a minimum.

To keep their observing schedules, many observers had to do without sleep and use precious hours on Sundays and days off, but they did it gladly as a patriotic service without thought of pay or recognition.

At the end of the second year, the NBS-ARRL Project I was brought to a close and the coördinators and observers were invited to participate in another project, the NBS-ARRL Project II. In the second project, instead of working in only one of the five bands at each observing period, each observer took the entire spectrum up to 30,000 kc. but recorded only the highest frequencies heard from stations located at distances greater than 2500 miles. These observations were used to check predictions of the maximum usable frequency for communication over long distances.

In November, 1943, the observations were further limited to the highest frequencies received from stations in each of four zones, namely: (1) Northwestern Europe, (2) Eastern South America, (3) Japan, and (4) Australia and New Zealand. Also, observations on stations in each zone were confined to periods of the day when frequencies above the maximum usable frequency for the path to the observer were expected to be in use in that zone, i.e., periods when the maximum usable frequency was low for the path to the observer but high for transmission paths in other directions from the zone. Such periods could have occurred on east-west transmission paths approximately between the times of sunrise at the two ends of the path, if the observer was at the western end, or approximately between the times of sunset at the two ends of the path, if the observer was at the eastern end.

By June 30, 1944, sufficient data had been accumulated to give the necessary checks with predictions, and the second project was terminated. At that time observers located at distances greater than 500 miles from Washington, D. C., were invited to participate in the WWV Observing Project which was then in operation.

The calls and names of all participants in the NBS-ARRL Projects from July 1, 1941, to June 30, 1944, and the number of data sheets contributed by each are listed below. On each data sheet there were spaces for 25 observations, and not all observers filled out every sheet, but in general the number of sheets can be considered a fair measure of the observer's contribution.

Of those listed, 33 contributed 100 or more data sheets. Four contributed more than 600 data

Fig. 1 — Comparison of predicted and observed frequencies, February, 1942. Each dot represents an observed station. Lengths of great-circle transmission paths are between 2500 and 2800 miles. Midpoints lie between 35° and 50° N. latitude (96% between 35° and 45°). The predicted maximum usable frequency (MUF) is for 2500-mile paths with midpoints at Washington, D. C. (39° N.). The predicted lowest useful high-frequency (LUHF) is an average of the LUHF for both directions of transmission over east-west paths lying between 30° and 50° N., predicted for the period November, 1941, through February, 1942.

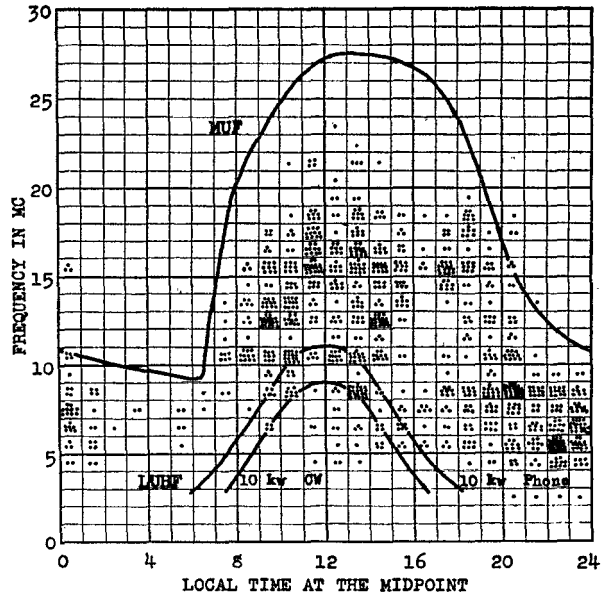

sheets each! The leading contributor was Horace E. Bidly, W5MN, coordinator of the Texas group, with the splendid total of 2030 data sheets! The others were: S. B. Young, W9HCC, 939 sheets; Paul N. Brown, W8KWL, 749 sheets; and K. M. Blaney, W6PIV, 634 sheets. Mr. Young made most of his contributions as an independent observer. Mr. Bidly and Mr. Blaney also participated in the WWV Observing Project.

Of the various groups, the Massachusetts group under Coördinator Frank L. Baker, jr., W1ALP, turned in the best performance. They contributed a total of 3303 data sheets. Other groups that performed outstandingly were the Texas group under Coördinator Horace Bidly, W5MN, the Oregon group under Coördinator Carl Austin, W7GNJ, the West Virginia group under Coördinator W. D. Tabler, W8OXO, the Pennsylvania group under Coördinator Jerry Mathis, W3BES, and the California group under Coördinator W. A. Ladley, W6RBQ.

As an example of the results of the projects, a comparison of observed and predicted data for February, 1942, is presented in Fig. 1. Each dot represents a station observed at a distance of between 2500 and 2800 miles over great-circle paths having midpoints between 35° and 50° north latitude (96 per cent were between 35° and 45°). Most of the paths were between stations and observers on the East and West coasts of the United States. The frequency of the station observed is plotted against the local time at the midpoint of the path.

The curve marked "MUF" represents the predicted maximum usable frequency. The curves marked "LUHF" represent the predicted lowest

useful high frequency for radiated powers of 10 kilowatts 'phone and 10 kilowatts c.w., respectively. Most of the stations observed were commercial c.w. stations operating with about 10 kilowatts power.

Only 7 stations in all were observed at frequencies definitely above the predicted MUF, and very few at frequencies below the predicted LUHF for 10 kilowatts c.w. The scarcity of observations above 19 Mc. in the middle of the day, although the predicted MUF is above 25 Mc. from 1000 to 1730, is attributable to the fact that very few stations operated at frequencies above 19 Mc. Similarly, the small number of observations below 4 Mc. during the night hours is due to the fact that relatively few identifiable stations operated at frequencies between 1.5 and 4.0 Mc. For frequencies between 4 and 19 Mc., however, the predictions are in excellent agreement with the observations.

The WWV Observing Project

In December, 1943, a project involving observation of the National Bureau of Standards' standard-frequency broadcast station WWV was organized among a group of persons who had requested the Bureau's letter circular, "Methods of Using Standard Frequencies Broadcast by Radio," and had expressed an interest in the WWV broadcasts.

WWV has several advantages over most stations for regular observations of radio propagation conditions. It is easily identified, and operates on four frequencies, 2.5, 5, 10 and 15 Mc., either continuously or on fixed daily schedules. It also maintains a constant radiated power on

each frequency and uses omnidirectional antennas. For these reasons observations on this station are in many respects easier to interpret in terms of radio propagation conditions than are observations on miscellaneous stations.

Observers in this project were requested to tune in on each of the four WWV frequencies as often as possible at approximately one-hour intervals and to record ratings of the carrier intensity, the background noise intensity, the readability of each of the various modulations, and the rapidity and depth of the fading. The observers were not organized into groups as in the NBS-ARRL Project; each observer received supplies directly from and reported directly to the National Bureau of Standards.

The names of participants in the WWV Observing Project and the number of data sheets contributed by each are listed below. Asterisks on the left indicate those who were also observers in the NBS-ARRL Project.

R. B. Murphy was the leading contributor with 527 data sheets. Others contributing more than 100 sheets were: Lt. Comdr. and Mrs. N. C. DeWolfe who jointly contributed 252 sheets; Wm. K. McKay, 170 sheets; Mrs. A. H. Dangerfield, 114 sheets; and Fred L. Schirk, 103 sheets. Mrs. Dangerfield and Lt. Comdr. DeWolfe had also participated in the NBS-ARRL Project.

An example of the results of the WWV Project is given in Fig. 2. The predicted maximum usable frequency (MUF) and lowest useful high frequency (LUHF) for 10-kw. c.w. transmission via the regular ionosphere layers (i.e., the F_2 , F_1 and E layers) are compared with average intensities

(QSA) of WWV on 5, 10, and 15 Mc. received at midday in April, 1944, at distances of 900, 1500, and 2400 miles. The height of the blackened area in each square is proportional to the average QSA intensity rating; for example, the average intensity was 4.1 on 15 Mc. at 900 miles, 3.3 on 10 Mc. at 1500 miles, and zero on 5 Mc. at 2400 miles.

If 2.0 be considered to correspond to the lowest useful average intensity, the correspondence between the observed data and predictions is good with the exception of the data on reception of 15 Mc. at 900 miles. According to the MUF prediction, which is below 15 Mc. at 900 miles, 15 Mc. should have skipped on more than one-half of the days at this distance, bringing the average intensity down below 2.5. Consideration of irregular propagation effects, such as those due to sporadic- E layer reflections about which comparatively little is known at present, would improve the agreement somewhat.

In conclusion, it is desired to thank all participants for their contribution toward the success of these projects. They may feel justly proud that their services were in direct support of our successful war effort and helped to hasten the day of victory for us and our allies. In addition, their contribution has gone far to improve our general scientific knowledge of radio wave propagation and communication, from which we will all benefit in the days to come.

Special acknowledgment and appreciation are due to the ARRL Headquarters staff for their thoughtful consideration and actions in behalf of the program.

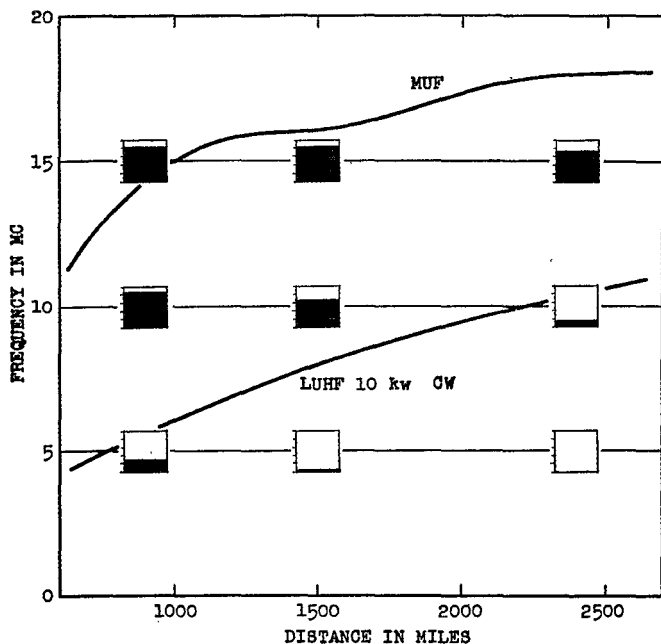

Fig. 2 -- Comparison of the predicted maximum usable frequency (MUF) and lowest useful high frequency (LUHF) with average received intensities (QSA) of station WWV at midday in April, 1944. Irregular propagation effects, such as those due to sporadic- E layer reflections, were not considered in the predictions. The height of the blackened area in each square is proportional to the average QSA intensity rating.

**Participants in the NBS-ARRL Projects and Number of Data Sheets
Contributed by Each**

W1ACM, J. A. Mulligan, Lawrence, Mass.	15	W5DBN, M. J. Chelkowski, San Antonio, Texas	46	(Coördinator)	
W1AKS, H. C. Shirley, Salem, Mass.	28	W5DWW, W. J. Wilkinson, Shreveport, La. (Coördinator)	104	W6PRQ, Calvin Maehl, N. Hollywood, Calif.	39
W1ALP, Frank L. Baker, Jr., N. Quincy, Mass. (Coördinator)	4	W5EPB, R. P. Thomas, M.D., San Antonio, Texas	6	W6PTF, C. M. Sheets, Fresno, Calif.	2
W1AR, L. C. Runey, Belmont, Mass.	36	W5FFD, S. M. Clark, Austin, Texas	29	W6QMF, E. L. Sutherland, Redding, Calif.	8
W1BB, S. S. Perry, Winthrop, Mass.	15	W5FGR, Boyd Sinclair, Hempstead, Texas	2	W6RAF, W. R. Hopson, Burlingame, Calif.	3
W1BCF, V. R. Brien, Attleboro, Mass.	5	W5FNA, Bill Case, San Antonio, Texas	25	W6RBQ, W. A. Ladley, San Francisco, Calif.	2
W1BDU, B. H. Chace, Winthrop, Mass.	223	W5FNH, C. R. Toler, Kerrville, Texas	38	W6RHR, W. B. Overstreet, San Francisco, Calif.	11
W1FWS, P. C. MacDonald, jr., E. Milton, Mass.	2	W5FXY, R. R. Culmer, San Antonio, Texas	8	W6RYJ, Pearle Stout, Sacramento, Calif.	15
W1HCL, G. E. Sprague, Quincy, Mass.	62	W5FYN, R. L. Hasbrook, San Antonio, Texas	28	W6SYM, Henry Gassman, Fresno, Calif.	33
W1HWE, A. D. Conant, Danvers, Mass.	363	W5GLS, G. N. Sharp, Houston, Texas	15	W6SWJ, B. L. Wood, Glendale, Calif.	13
W1IBF, R. G. Ling, Danvers, Mass.	8	W5GUW, John Bowden, Kingsville, Texas	37	W6TDO, J. Gilliam, Taft, Calif.	35
W1JFH, Earl Martin, Lynn, Mass.	16	W5GYP, Otto Uhrbrook, Edinburg, Texas	7	W6TZK, T. H. Gotisar, E. Orange, N. J.	10
W1JLK, H. M. French, N. Easton, Mass.	2	W5HHV, Howard Leveque, Lake Charles, La.	3	W6ZFR, R. G. Martin, Burlingame, Calif.	3
W1KTG, Beatrice S. Wertheimer, Cambridge, Mass.	273	W5HLK, C. A. Perkins, Del Rio, Texas	4	W7AIE, R. W. Haynes, Portland, Oregon	18
W1KWD, I. L. Shaw, Weymouth, Mass.	60	W5HSY, C. H. Darnell, Laredo, Texas	4	W7ERA, W. J. Manning, Milwaukee, Oregon	9
W1LNE, H. F. Gardner, Hull, Mass.	16	W5HUB, Mrs. W. B. Luckie, Corpus Christi, Texas	5	W7FHD, P. N. Young, Portland, Oregon	5
W1LTP, S. H. Bradish, Marblehead, Mass.	30	W5HZN, R. M. Hornsby, George West, Texas	13	W7FNS, Virgil Cowen, Portland, Oregon	28
W1LTT, W. A. Barry, Lawrence, Mass.	230	W5IFW, S. R. Middleton, Corpus Christi, Texas	25	W7GAE, C. M. Weagan, Portland, Oregon	2
W1LVZ, A. T. Heyworth, Beverly, Mass.	236	W5IGQ, James McKenzie, Fort, La.	30	W7GLE, Joy Ustick, Klamath Falls, Oregon	6
W1LWH, W. H. Daehler, Beverly, Mass.	109	W5IKU, Billy Coates, Homer, Texas	3	W7GNJ, Carl Austin, Bend, Oregon	3
W1LZW, Wm. H. Pitts, N. Quincy, Mass.	26	W5IOP, D. S. Brobst, Shreveport, La.	3	W7GUP, W. L. Dudley, Medford, Oregon	12
W1MAL, H. W. Taylor, Cochituate, Mass.	2	W5JGM, G. W. Boynton, Kingsville, Texas	3	W7HDN, E. C. Wiedmaier, Portland, Oregon	5
W1MAN, R. L. Biggs, Marblehead, Mass.	152	W5JKU, Floyd Roland, San Antonio, Texas	12	W7HIA, H. Gilbaugh, Portland, Oregon	51
W1MQQ, I. E. Sweet, Stowe, Vt.	2	W5JPC, Norman Wehrli, Kilgore, Texas	19	W7HKL, A. H. Gould, Portland, Oregon	341
W1MDD, Louise F. Bruya, Waltham, Mass.	43	W5KEE, F. A. Rotramel, Kilgore, Texas	7	W7HLY, B. Penners, Portland, Oregon	4
W1MJE, Alice G. Morrison, Danvers, Mass.	302	W5MNH, H. E. Biddy, San Antonio, Texas (Coördinator)	2030	W7HMW, R. D. Pruess, St. Helens, Oregon	3
W1MME, B. H. Rudderham, Hull, Mass.	13	W5WN, H. A. Keys, Kinder, La.	2	W7HVX, Larry Williams, Bend, Oregon	59
W1MMM, G. W. Bartlett, New Bedford, Mass.	1	W6ADH, E. L. Robberson, San Francisco, Calif.	3	W7IDJ, Larry Quinn, Klamath Falls, Oregon	5
W1MPP, Eunice Randall, Watertown, Mass.	20	W6ATY, E. S. Graham, San Francisco, Calif.	13	W7IJK, Robert Sappington, Bend, Oregon	11
W1MPT, Ed. Doherty, W. Quincy, Mass.	8	W6AYR, C. F. Yates, Altadena, Calif.	7	W7JN, Clarence Bischoff, Portland, Oregon	143
W1MQT, J. E. Cabral, jr., New Bedford, Mass.	3	W6BGY, C. G. Cady, Oakland, Calif.	2	W7SD, P. B. Tompkins, Portland, Oregon	16
W1MUB, Wm. F. Lynch, Lawrence, Mass.	1	W6BKY, J. E. Bickel, Whittier, Calif.	2	W7WH, O. R. Anderson, Portland, Oregon	322
W1MXJ, E. W. Sullivan, W. Lynn, Mass.	11	W6BV, R. E. Lake, Fresno, Calif. (Coördinator)	85	W8BCL, A. S. Waterbury, Perry, N. Y.	123
W1NKW, Harold Ryall, Lynn, Mass.	87	W6CBX, N. C. DeWolfe, San Carlos, Calif.	16	W8DFC, O. A. Hutcheson, Princeton, W. Va.	3
W1ZR, Edith E. Rotch, Nonquitt, Mass.	372	W6CJA, C. Frunk, Tracy, Calif.	7	W8DOD, E. J. Grabb, Rochester, N. Y.	15
W2NOC, H. S. Schecht, Catskill, N. Y.	368	W6CVP, S. C. Van Liew, Daly City, Calif.	5	W8DPE, H. C. Bird, Pontiac, Mich. (Coördinator)	7
W3AGV, R. C. Weise, Philadelphia, Pa.	54	W6DSP, R. M. Ambrosch, Glendale, Calif.	1	W8EBR, C. W. Floring, Dewitt, N. Y.	17
W3BES, Jerry Mathis, Philadelphia, Pa. (Coördinator)	42	W6DWE, C. L. Kirkpatrick, Selma, Calif.	22	W8GBF, M. A. Morgan, Fairmont, W. Va.	137
W3DGM, M. E. Wardell, Chester, Pa.	15	W6EAH, C. H. Haas, Glendale, Calif.	19	W8KWL, P. N. Brown, Morgantown, W. Va.	749
W3DPU, H. R. Pemberton, Philadelphia, Pa.	31	W6EIM, H. L. Messier, Glendale, Calif.	49	W8MCW, W. F. Bellor, Canandaigua, N. Y.	12
W3FED, W. C. Ellsworth, Flourtown, Pa.	186	W6ETI, L. H. Nelgen, Burbank, Calif.	9	W8MGB, Elwood Bryan, Detroit, Mich.	40
W3FZA, D. R. Ripani, Philadelphia, Pa.	6	W6FT, C. D. Roe, Glendale, Calif.	28	W8MPF, W. L. Williams, Clarksburgh, W. Va.	117
W3GGC, F. S. Crosland, Philadelphia, Pa.	196	W6GM, George Ewing, San Bernardino, Calif.	8	W8OXO, W. D. Tabler, Elkins, W. Va. (Coördinator)	12
W3HFE, B. C. Algoz, jr., Orland, Pa.	15	W6HGM, J. R. Mitchell, Oakland, Calif.	17	W8PK, E. Seiler, E. Bloomfield, N. Y.	12
W3HWO, R. A. Wo-ley, Trenton, N. J.	6	W6HHJ, W. G. Tuers, N. Hollywood, Calif.	5	W8PLA, J. F. Chichester, Sonyea, N. Y. (Coördinator)	9
W3LXN, F. H. McEmanen, Narberth, Pa.	284	W6IAH, S. E. Hyde, Los Angeles, Calif.	268	W8RGA, Dr. G. T. Smith, Rochester, N. Y.	57
W3JB, Wm. N. Wilson, Media, Pa.	92	W6KQQ, G. W. Thunen, Oakland, Calif.	19	W8RKM, W. L. Pettet, McGraw, N. Y.	9
W4AAK, Martin E. Mann, Fayetteville, N. C.	6	W6LYL, A. T. Adams, Merced, Calif.	4	W8RMR, C. Shurtleff, Mt. Morris, N. Y.	204
W4ABN, J. E. Brightwell, Asheville, N. C.	8	W6LNN, I. F. Gardner, Fresno, Calif.	34	W8SBV, J. P. Ryan, Elmira, N. Y.	64
W4AJT, C. W. Fields, Greensboro, N. C. (see also W4HVZ)	6	W6MMX, R. F. Oppelt, Van Nuys, Calif.	13	W8TDJ, C. B. Seibert, Morgantown, W. Va.	111
W4AXP, Oscar Cedarstrom, DeFuniak Springs, Fla. (Coördinator)	6	W6MQM, Ralph Click, Los Angeles, Calif. (Coördinator)	3	W8TEX, O. F. Bauer, Rochester, N. Y.	8
W4CYB, W. J. Wortman, Morgantown, N. C. (Coördinator)	66	W6MRB, H. Hansen, Acampo, Calif.	3	W8TWM, George Olsen, Rochester, N. Y.	1
W4DGU, N. B. Lee, Lattimore, N. C.	66	W6MRF, H. E. Pedersen, Cutler, Calif.	101	W8UGH, C. J. Crabill, Martinsburg, W. Va.	33
W4DNG, C. S. Oldham, Durham, N. C.	7	W6MYT, J. V. Hartshorn, Hollydale, Calif.	9	W8UOW, P. E. Hilliard, Bluefield, W. Va.	32
W4DLX, J. C. Geuslen, Charlotte, N. C.	2	W6OGJ, P. R. Randolph, Forest Glen, Calif.	20	W8UQK, Kenneth Glass, Detroit, Mich.	33
W4FRQ, Hewitt Penton, Panama City, Fla.	1	W6OZC, Lt H. O. Douglass, Sausalito, Calif.	5	W8USX, E. R. McAuslan, Scio, N. Y.	30
W4HVZ, Mrs. C. W. Fields, Greensboro, N. C. (contributed with W4AJT)	6	W6PIV, K. M. Blaney, Sacramento, Calif.	634	W8UXT, W. B. Derrick, Eggertsville, N. Y.	176
W4KB, J. T. Long, Nicville, Fla.	4	W6PPO, H. S. Walling, Fresno, Calif.		W8VZD, O. J. Jones, jr., Fairmont, W. Va.	146
W4NP, W. M. Speed, Durham, N. C.	27				
W4OC, Felix Whitaker, Durham, N. C.	136				
W4QK, Vernon Colley, Pensacola, Fla.	12				
W5BHO, D. H. Calk, Houston, Texas	1				
W5CEW, A. F. Wingate, Shreveport, La.	10				

W9AGO, R. H. Hoffman, Hokah, Minn..	15	W9KRB, C. J. Nelson, Cheyenne Wells, Colo. (Coördinator).....	70	W9YNQ, M. L. Bender, Spring Valley, Minn. (Coördinator).....	61
W9ANA, L. A. Wollaefer, Wauwatosa, Wis. (Coördinator).....		W9ZWG, John Sterle, Duluth, Minn.....	1	W9YPN, Willard Nelson, Minneapolis, Minn.....	26
W9BHY, A. E. Swanberg, St. Paul, Minn.	10	W9NRX, Joseph Kircher, Milwaukee, Wis.....	16	W9ZNN, F. K. Matejka, Estes Park, Colo.....	2
W9BVV, H. C. Morrison, Hatfield, Mo..	1	W9NSU, Wayne Duncan, Mountain View, Mo.....	133	W9ZWG, John Sterle, Duluth, Minn....	1
W9CDP, H. A. Miller, Sterling, Colo....	30	W9OMN, C. F. Williams, Eckley, Colo..	11		
W9CWI, George Collier, Anoka, Minn....	61	W9OSX, H. G. Larson, Anoka, Minn....	17		
W9DEI, F. C. Kramer, St. Charles, Minn.	10	W9OUD, Mrs. A. H. Dangerfield, Butler, Mo.....	315		
W9DWI, G. C. Bowen, Milwaukee, Wis.	12	W9OWU, Leonard Hofstad, Minneapolis, Minn.....	13		
W9EHC, C. C. Drumeller, Pueblo, Colo. (Coördinator).....		W9PJM, John Grigsby, Greeley, Colo..	6		
W9FUZ, A. D. Brattland, Bemidji, Minn.	13	W9QMD, Robert Morwood, Springfield, Mo.....	69		
W9GBJ, C. L. Arundale, Springfield, Mo.	2	W9QYL, A. P. Smith, Paoli, Colo.....	1		
W9GLE, William Hornseth, Rochester, Minn.....	2	W9REH, E. R. Felber, Milwaukee, Wis..	3		
W9GLG, R. S. Burton, Rifle, Colo.....	55	W9RHM, John Fugal, Walsenburg, Colo.	7		
W9GQO, E. J. Irving, Milwaukee, Wis..	1	W9RLL, M. B. Millet, St. Cloud, Minn.	44		
W9HCC, S. B. Young, Wayzata, Minn....	939	W9SBG, R. G. Neiheisel, Boulder, Colo..	25		
W9HFF, H. T. Hanley, jr., Oak Knoll, Minn.....	77	W9VDY, E. C. Schmidt, Milwaukee, Wis.	1		
W9ITQ, Adolphus Emerson, Minneapolis, Minn.....	33	W9VIB, H. W. Koch, Milwaukee, Wis..	5		
W9ITW, J. V. Cloud, Springfield, Mo....	8	W9WPK, W. C. Cowherd, Monett, Mo....	5		
W9JPS, Roman Hudzinski, Chicago, Ill..	20	W9WIS, J. E. Lovan, Buffalo, Mo.....	87		
W9KHQ, Orval Cunningham, Tower, Colo. (Coördinator).....	97				

Observers Without Calls

Charles M. Buxton, Arlington, Mass.....	113
Bob Coker, Hollywood, Calif.....	2
Dr. Earl Dawson, Los Angeles, Calif....	1
W. R. Faries, Bala-Cynwyd, Pa.....	51
Edgar Foster, Los Angeles, Calif.....	6
Calvin R. Graf, San Antonio, Texas....	40
W. T. Langan, Lynn, Mass.....	9
C. S. Martell, Arcadia, Calif.....	7
Scott Merwin, Bend, Oregon.....	206
Harold Ohanian, Los Angeles, Calif....	10
Roger A. Pollock, Salem, Mass.....	6
Wm. M. Potts, Boron, Calif.....	21
Irving Shapiro, E. Lynn, Mass.....	14
Bill Ward, Los Angeles, Calif.....	22
Marshall Weisel, Los Angeles, Calif....	3
J. V. Wood, Santa Barbara, Calif.....	137

Participants in the WWV Observing Project and Number of Data Sheets Contributed By Each

*Anderson, O. R., W7WH, Portland, Oregon.....	48	*Gould, A. H., W7HKI, Ocean Park, Wash.....	94	Nichols, J. J., W7AMG, Seattle, Wash....	3
Bellber, Julio, San Juan, Puerto Rico...	71	Hall, W. H., Norman, Okla.....	9	Phillips, Don, Ashdown, Ark.....	15
Bergman, W. F., W9NNQ, Chicago, Ill....	56	Hardison, Jerry A., W4HQM, Humboldt, Tenn.....	14	Reider, L., W9IES, Sterling, Colo.....	11
*Biddy, H. E., W5MN, San Antonio, Texas.....	39	Horne, G. D., Seattle, Wash.....	19	Rottering, Rev. A. F., W9IWS, Atchison, Kansas.....	83
*Blaney, K. M., W6PIV, Sacramento, Calif.....	65	Humphrey, H. K., Winnetka, Ill.....	3	Ryan, Albert H., Seattle, Wash.....	24
Connally, J. R., Seattle, Wash.....	3	Hudson, Jack, Kansas City, Mo.....	84	Schirk, Fred L., Denver, Colo.....	103
*Dangerfield, Mrs. A. H., W9OUD, Butler, Mo.....	114	Kaiser, Glenn, Minneapolis, Minn.....	11	Severson, Myron, Minneapolis, Minn....	60
*DeWolfe, Lt. Comdr. N. C., W6CBX, San Carlos, Calif.....	172	Kullberg, John E., Laramie, Wyo.....	4	Stearns, Gordon, Chester Depot, Vt....	40
DeWolfe, Mrs. N. C., San Carlos, Calif..	80	Laper, Charles A., Greenville, Mich....	2	Sutton, Edwin, Juneau, Alaska.....	27
Engstrom, Warren C., Minneapolis, Minn.	3	Mathews, L. E., Denver, Colo.....	6	Updegraff, Vern L., W7IJS, Portland, Oregon.....	6
Flottman, Richard, Chanute, Kansas....	3	McKay, Wm. K., W6CMZ, Alameda, Calif.....	170	Williams, G. T., W7EPT, Bremerton, Wash.....	79
		*Merwin, Scott, Bend, Oregon.....	56	Williams, S. B., Flint, Mich.....	14
		*Murphy, R. B., W4IP, Miami, Fla.....	527	Wilson, Charles L., Kansas City, Mo....	59

(Asterisks on the left indicate those who also participated in the NBS-ARRL Project.)



E. M. Tingley, of Oak Park, Illinois (father of W9QFZ), contributes these excerpts from his article in *School Science and Mathematics* on correcting watch time by vibrations:

"A good watch may be made to run faster or slower by balancing it, face horizontal, on a bit of rubber about 1/32-inch thick cut from a live elastic rubber band.

"A button of rubber 1/8-inch round or square will cause the watch to gain ten to twenty seconds overnight or in about ten hours. It may require several attempts to balance the watch horizontally on such a small button. The guard or chain must be removed. The oscillations or shimmy of the whole watch due to the reactions of its balance wheel should be plainly visible.

"A similar rubber support about 3/16-inch square will cause the watch to lose about six seconds in ten hours.

"It is interesting to view very small oscillations with a microscope using a magnification of 30 to 60 diameters. Place the watch with its rubber support on a glass slide for convenience in centering it on the microscope stage and use the fine

scratches on the pendant as targets. Also watch oscillations may be projected greatly magnified on a screen with the familiar laboratory mirror and lamp.

"Using the cut-and-try method with rubber supports, a good watch may be maintained within ten seconds of correct time indefinitely by repeating the correcting operations occasionally as required, without opening the case.

"All the above applies to a 16-size lever set watch of railway quality. It is probable that like performances may be obtained with 12- or 18-size watches by trial, but probably not with very small watches.

"It is best to regulate a watch to run fast then slow it by vibrations as required. Artgum cut capstan-shape and half an inch high is a good vibrator and is not so easily lost as a bit of rubber band."

Mr. Tingley stated in his letter that his watch, regulated by vibrations, had not been opened, regulated or adjusted in the past year and during this period it had seldom been more than ten seconds from WWV time.

Stabilizing the 144-Mc. Transmitter

Simple M.O.P.A. Combinations to Reduce Unwanted Frequency Modulation

BY GEORGE GRAMMER,* W1DF

WHEN THE amateur population in a band becomes too dense for comfort there is only one way to make more room, and that is to narrow down the bandwidth occupied by the transmitter and to increase receiver selectivity accordingly. When occupancy is relatively light it is possible to tolerate such things as unnecessarily-broad signals simply because there are too few stations to cause much interference, but this care-free condition is only temporary; eventually there comes pressure for the increased transmitter stability that makes the use of receiver selectivity possible. This pressure is now beginning to be felt, in many parts of the country, on the 144-Mc. band.

At its root, of course, is the need for the "greatest good for the greatest number." But there is another side to frequency stabilization that too often is overlooked. Besides helping the other fellow, any steps taken to increase frequency stability are decidedly in the direction of enlightened self-interest. The reason is that the transmitter becomes a much more effective piece of equipment when it is stabilized. And it is not too hard to make out a good case for it from the very practical dollars-and-cents angle.

Any amateur who lives in a region where there is appreciable 144-Mc. activity eventually is go-

* Technical Editor.

ing to do something about improving receiver selectivity if he intends to continue operating in the band. A simple superregen receiver is pretty vulnerable when the fellow a few blocks away opens up, so a better receiver is built — with the immediate result that many of the signals that before were perfectly receivable now become difficult, if not impossible, to copy. The reason is simple — the badly-wobblated signals are swinging over so wide a frequency range that they cannot be accommodated by the receiver pass-band.

The trouble is not just that the receiver utilizes only a fraction of the energy picked up by the antenna, although that is an important factor in reducing the signal strength. An even more pronounced difficulty results from the fact that the average frequency under modulation is not the same as the frequency of the unmodulated carrier. On a simple superhet of the type using a superregenerative second detector, for example, the modulation will be found on a different spot on the dial from that at which the unmodulated carrier is tuned in. We have frequently observed signals that had sufficient carrier strength to produce adequate quieting of the superregen hiss for good communication — yet the modulated signal would be practically unreadable because it was necessary to tune well off into the hiss to find the voice. Under such conditions a stable signal will

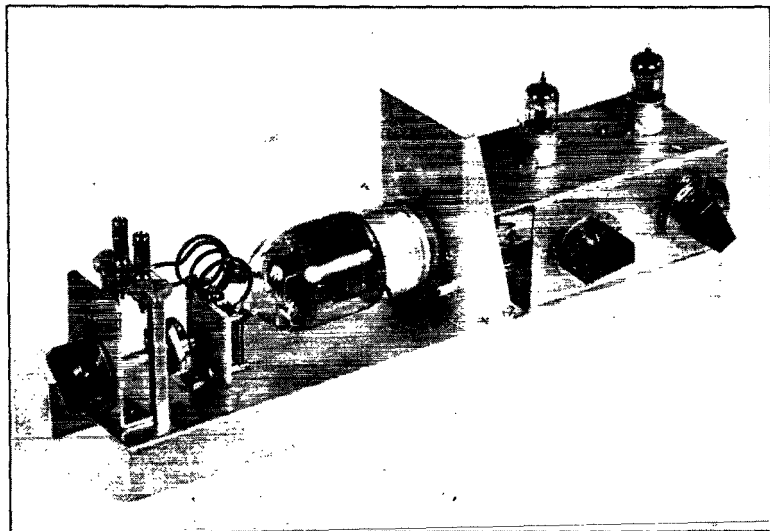

This three-stage 144-Mc. transmitter, using a 6C4 oscillator, 6C1 buffer and 815 final amplifier, develops about 40 watts of r.f. output and is sufficiently free from frequency-modulation effects to be easily readable on a receiver having a 456-kc. i.f. with normal communications-receiver selectivity. The oscillator and buffer are built as a unit on the folded aluminum chassis at the right.

get through when a wobblated one having many times the power will not. Scattering energy all over the band doesn't pay off in QSOs.

The superregenerative superhet does not represent a very high order of selectivity, despite the fact that it is too high for many of the badly-wobblated signals. The situation becomes worse with straight supers, even those with broad i.f.'s. When the frequency of the signal wobbles into and out of the receiver pass-band the quality of the signal depreciates along with its strength — frequently to the point where it cannot be understood at all. Increasing power is no cure under such conditions; the only thing that helps is to stabilize the transmitter.

Oscillators vs. Amplifiers

All this is well known to anyone who has used a 144-Mc. receiver having any pretense at selectivity. A point that has received less attention has to do with transmitter economics. To illustrate the case, let us assume that the tube used has a plate dissipation rating of 20 watts. If it is used as an oscillator, even with a circuit adjusted for the most output and without regard to frequency stability, the chances are that the efficiency will not exceed 40 percent — most of those we have seen do not reach that figure. If the tube ratings are to be given any consideration this means that 20 watts represents 60 percent of the power going into the plate, so the input will be 33 watts and the output about 13 watts. If the same oscillator is stabilized by the use of a high-*C* tank circuit the overall efficiency will drop to perhaps 20 percent, bringing the input down to 25 watts and the output to 5 watts. Nevertheless, the benefits of stabilization will more than overcome the 4-db. drop in carrier strength because the *effective* power at the receiver will be greater in terms of readability and signal-to-noise ratio.

On the other hand if the same 20-watt tube is used as an amplifier, it is not too difficult to obtain a plate efficiency of the order of 60 percent, which permits us to use an input of 50 watts to obtain a carrier power of 30 watts. This is an increase of nearly 4 db. over the frequently-useless wobblated oscillator and almost 8 db. over the stabilized oscillator — with still greater stability, incidentally. Or, to put it another way, the separately-driven amplifier gives the same power output as a wobblated oscillator using a tube having a plate rating of almost 50 watts and running at an input of nearly 80 watts, and also the same as a stabilized oscillator using a 120-watt tube operating with 150 watts input. When the modulator requirements for the various cases are considered it begins to look as though a modulated oscillator is a pretty expensive item, on the basis of watts output per dollar of investment.

There is still another point — minor, perhaps, and certainly no factor in the planning of the average oscillator transmitter. An oscillator

cannot be modulated 100 percent without considerable distortion, for the simple reason that it does not continue to oscillate all the way down to zero plate voltage. Depending upon the particular set-up, the tube usually quits when the plate voltage gets into the 50- to 100-volt region. This may represent anywhere from 10 to 20 percent of the plate voltage, and even though the modulation percentage is reduced correspondingly the modulation is not likely to be linear. Common practice seems to be to swing it as much as possible and let the overmodulation sidebands fall where they may. It must be admitted that these sidebands do not matter very much in view of the frequency modulation, which usually masks other effects completely. Nevertheless, it is a point to keep in mind against the time when the denizens of 144 Mc. become quality conscious — which will happen just as quickly as the superregen receiver passes out of the picture.

M.O.P.A. Considerations

The ideal answer to the question of stabilization is the use of crystal control. It has the disadvantage, however, that 144 Mc. is a long way from the nearest practicable crystal frequency and is entering a region where frequency multiplication with ordinary small tubes is not too efficient; in terms of number of stages vs. power output, crystal control works out best in higher-power transmitters. While it is by no means ruled out for low-power sets, it seems worth while to look into the possibility of securing a satisfactory degree of stabilization by simpler methods. The obvious approach is an m.o.p.a. of some sort.

In considering the question of possible tube combinations, the choice of a double beam tetrode, as typified by the 815 or the various forms of the 829, seems most logical in view of the low driving-power requirements. The 815, at least, is not an expensive tube; the 829, while higher in price, seems to be pretty widely distributed among amateurs as a result of its extensive use during the war and, too, it is appearing in surplus-disposal stocks at prices that often are attractive. Either type of tube can be driven with less than a watt of r.f., according to published ratings — which, even with the usual allowances for unpredictable losses plus provision for a reasonable reserve of power, means that only a small amount of driving power is needed.

In the preliminary experimental attempts at getting an m.o.p.a. into operation it was hoped that a high-*C* oscillator using a garden-variety receiving tube could be adapted to the purpose, since low cost was part of the objective. These hopes were not entirely realized. The 6V6GT, which had proved to be a pretty fair performer at 112 Mc.,¹ failed to give the hoped-for output at 144 Mc.; evidently its frequency limit was being

¹ Grammer, "A 112-Mc. Emergency Transmitter," *QST*, December, 1941.

◆
A rear view of the
m.o.p.a. transmitter,
showing the circuit
construction.
◆

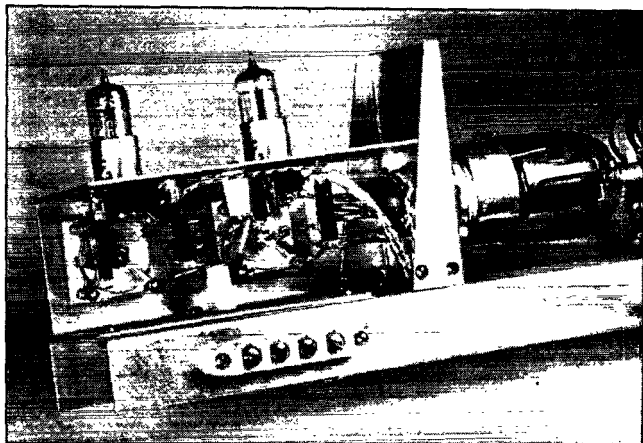

approached. Other small tubes such as the 6J5 and the 7C5 proved to be equally disappointing, none being capable of delivering enough excitation for an 815 running at rated input. The 6C4 did prove to be capable of doing the job, but just about; the trouble was that it was necessary to couple so tightly between the oscillator and the amplifier grid circuit that modulating the amplifier caused considerable reaction on the oscillator frequency. Compared with the ordinary low- C modulated oscillator the stability was considerably improved, but did not differ greatly from that which could be obtained by using a high- C modulated oscillator. The amplifier efficiency, of course, was much higher than would have been obtainable with the same tube operated as an oscillator, so on the whole the combination was not too unattractive. However, it is possible to do better.

There are two methods of approach to the question of reducing reaction on the oscillator. One is to use an oscillator having several times the necessary power output and thereby make it possible to use loose coupling between the oscillator and amplifier. The other is to use a buffer stage between the oscillator and amplifier. From our experience, the first requires an oscillator using something larger than a receiving tube if the hoped-for improvement in stability is to be realized; a small v.h.f. transmitting tube — the HY75 is an example — seems to be indicated. With the second method it is possible to use the inexpensive 6C4 and not only drive an 815 adequately but also to attain a degree of stabilization demonstrably superior to that possible with the simple two-stage m.o.p.a. The buffer stage is actually not as much of a complication as might be thought.

The three-stage transmitter shown in the photographs represents a design arrived at after trials of a number of component arrangements. Among other things, a linear tank circuit was tried for the amplifier plate and proved to have no advantages over the more conveniently-tuned

coil-condenser combination. The oscillator tank circuit, while containing a reasonable amount of capacity, is by no means as high- C as it is possible to make it. It is, however, sufficient for the purpose because the 6C4 takes relatively low plate current and thus can be stabilized with a tank L/C ratio which might seem high for a tube taking two or three times the plate current at the same plate voltage. In addition, there is the fact that the sort of stability we want in an m.o.p.a. is not necessarily influenced by the same factors that operate in the case of a modulated oscillator. It is not really necessary, for example, to stabilize the oscillator against changes in plate voltage, because the plate voltage is expected to be constant whether or not the amplifier is modulated. On the other hand, the oscillator *should* be made to be as independent as possible of changes in loading, and should not have serious frequency drift.

The frequency stability obtainable with this transmitter, although not as good as would be expected with crystal control, is more than adequate for present-day operation on 144 Mc. The total frequency change is about 30 kilocycles when the amplifier plate (and screen) voltage is varied from zero to 800 volts, twice the plate voltage under unmodulated conditions. Most of this change occurs in the region below 400 volts, the frequency being practically unaffected when the voltage is increased above 400. A plate-voltage test of this sort is frequently not too representative of actual operation under modulation, since the test is necessarily made at a very slow rate and heating effects not typical of modulated operation have a chance to show up.

It is perhaps more indicative of the actual performance of the transmitter to say that the signal is easily receivable on a regular communications receiver having a 456-kc. i.f., when used with a 144-Mc. converter. Some distortion is obviously present with the receiver i.f. in the "sharp" position (bandwidth about 10 kc. at 10 times down)

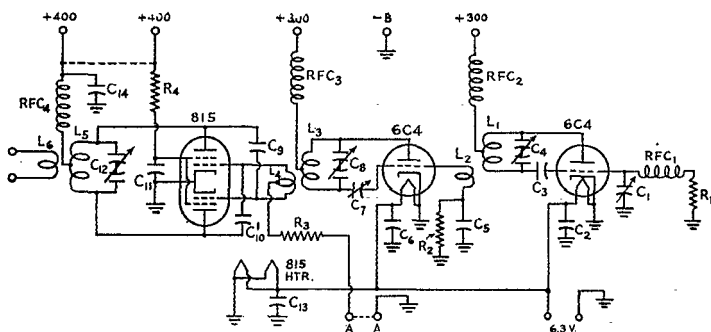

Fig. 1 — Circuit diagram of the three-stage 144-Mc. m.o.p.a. transmitter.

- C₁ — 3-30- μ fd. trimmer.
- C₂, C₆, C₁₁, C₁₃ — 500- μ fd. midget mica.
- C₃, C₅ — 50- μ fd. midget mica.
- C₄ — Oscillator tuning; see text (Cardwell ER-14-BF/SL).
- C₇ — Buffer neutralizing; see text.
- C₈, C₁₂ — Buffer and amplifier tuning; see text (Cardwell ER-6-BF/S).
- C₉, C₁₀ — Amplifier neutralizing (see text).
- C₁₄ — 100- μ fd., 2500 volts.

- L₁ — 2 turns No. 12; inside diameter $\frac{3}{16}$ inch, length 1 inch; plate-supply tap at center.
- L₂ — 2 turns No. 14; inside diameter $\frac{1}{2}$ inch; turns spaced wire diameter.
- L₃ — 4 turns No. 14; inside diameter $\frac{1}{2}$ inch, length 1 inch; plate-supply tap at center.
- L₄ — 2 turns No. 14; inside diameter $\frac{1}{2}$ inch; turns spaced diameter of wire; tapped at center.

- L₅ — 2 turns No. 12; inside diameter 1 inch, length 1 inch; plate-supply tap at center.
- L₆ — 2 turns No. 12; inside diameter $\frac{3}{4}$ inch.
- R₁ — 20,000 ohms, $\frac{1}{2}$ watt.
- R₂ — 25,000 ohms, $\frac{1}{2}$ watt.
- R₃ — 15,000 ohms, 1 watt.
- R₄ — 15,000 ohms, 10 watts.
- RFC₁, RFC₂, RFC₃, RFC₄ — 1-inch winding of No. 24 d.s.c. or s.c.c. on $\frac{1}{4}$ -inch diameter polystyrene diam.

but not enough to affect intelligibility. This distortion is entirely absent with the receiver i.f. in the "broad" position (bandwidth 20 kc. at 10 times down), indicating that practically all of the sidebands are contained within a 20-kc. channel. On v.h.f. superhets using intermediate frequencies of 5 Mc. or more there is of course not the slightest difficulty in accepting the entire signal. The average-frequency shift under modulation that is so apparent with modulated oscillators is noticeable by its absence.

On the watts-per-dollar side of the ledger, the power output appears to be approximately 40 watts as judged by the fact that a 40-watt lamp can be lighted to about normal brilliancy. This is with the rated plate input of 150 ma. at 400 volts, with the recommended 3 ma. of grid current through a 15,000-ohm grid leak. The amplifier plate current is quite steady under modulation, showing that the driving power is adequate; as a matter of fact, the power output does not drop off appreciably even with less than 3 ma. of grid current, while increasing it beyond the rated value seems to have no effect whatever on the output.

Construction Details

As shown in the circuit diagram, Fig. 1, the tube line-up consists of a 6C4 oscillator, 6C4 buffer, and 815 final amplifier. The oscillator is the familiar ultraudion with an excitation control, C₁; this control is essential for securing optimum output. The tank condenser, C₄, is a specially-made "butterfly" or 90-degree type having a fixed loading section. This construction was adopted in an effort to provide a condenser

having a minimum of inductance and one in which it would not be necessary to have r.f. current flow through friction contacts. Its construction is shown in Fig. 2, the frame and plates (with the exception of the circular plates) having been adapted from a Cardwell ER-type double condenser.²

The oscillator and buffer are built as a unit on a U-shaped piece of aluminum $6\frac{1}{2}$ inches long on top, $2\frac{3}{8}$ inches high, and $2\frac{1}{8}$ inches deep on the top. The 815 amplifier is mounted on a vertical aluminum piece measuring $4\frac{1}{4}$ inches high and 3 inches wide, reinforced by bending side lips as shown in the photographs. The two sections are assembled on an aluminum channel.

Lead lengths in the circuit are reduced to a minimum by the construction shown in the rear-view photograph. The oscillator tuning condenser, at the left in this view, is mounted so that the two sets of stator plates are at top and bottom, using the screws and spacers provided with the condenser. The hole for the shaft is made amply large so that the condenser rotor is not grounded.

The oscillator tube socket is mounted so that the plate lead can drop in as straight a line as possible to the terminal at the right on the upper stator plates of C₄. The grid condenser, C₃, is supported at one end by the grid prong on the tube socket and at the other by the left-hand terminal on the lower stator plates. The excitation control, C₁, has its movable-plate tab bent at

² Similar condensers are now being manufactured by Cardwell, the type numbers being shown in the caption for Fig. 1.

a right angle so it can be bolted to the vertical support, and the stationary-plate tab is soldered directly to the grid prong on the tube socket. The grid choke, grid leak, and plate choke are supported as shown in the photograph. The condenser along the rear edge of the assembly is the heater by-pass condenser, C_9 .

The buffer tuning condenser consists of a rotor having three butterfly plates and two stators each having two 90-degree plates. The grid circuit of the buffer is self-resonant, the tuning being adjusted by squeezing the turns of the grid coil, L_2 , together or prying them apart. The buffer neutralizing condenser, C_7 , mounted directly between the grid of the 6C4 and the lower set of stator plates of C_8 , is a 3-30- μ fd. trimmer with the movable plate removed and a washer soldered under the head of the adjusting screw. The washer, by replacing the movable plate, reduces the capacity of the condenser to a value suitable for neutralizing the 6C4.

The grid coil of the final amplifier is resonant with the input capacity of the 815. For best operation, the 815 requires neutralization at this frequency. The neutralizing "condensers," C_9 and C_{10} in the circuit diagram, are simply pieces of No. 14 wire extending from the grid of one section of the 815 to the vicinity of the plate of the other section. The wires are crossed at the bottom of the tube socket and go through tubular feed-through insulators in the metal partition. The screen and filament by-pass condensers are mounted so that the leads between the socket prongs and the nearest ground point are as short as possible.

The amplifier plate tank circuit uses a condenser of the same construction as that used in the buffer tank. It is mounted as closely as possible to the plate caps on the 815, and to preserve circuit symmetry the condenser is tuned from the left-hand edge of the chassis.

The output terminals, a standard binding-post assembly on polystyrene, are mounted on metal posts to bring the coupling coil in proper relation to the amplifier plate tank coil, L_5 . Coupling is adjusted by bending L_5 toward or away from L_6 . The plate by-pass condenser and screen dropping resistor are mounted underneath the chassis.

In putting the transmitter into operation, the first step is to adjust the frequency range of the oscillator. The tank condenser construction provides just enough capacity variation to cover the 144-148-Mc. band adequately. It may be necessary to vary the inductance of L_1 slightly to center the band in the tuning range; this can be done by squeezing the turns together or pulling them apart. The frequency can be checked with Lecher wires or a calibrated absorption wavemeter. Final adjustment to L_1 should be made after C_1 has been adjusted for optimum output from the oscillator, since the setting of this condenser has some effect on the frequency of oscillation. The

proper setting for C_1 can be found by coupling a flashlight lamp and loop to L_1 and adjusting for maximum lamp glow. The 6C4 buffer should be out of its socket when making this test.

To tune the buffer stage, first use loose coupling between the buffer grid coil, L_2 , and the oscillator tank coil, L_1 (the coupling may be adjusted by bending L_2 away from L_1 on its mounting lugs) and adjust L_2 by changing the turn spacing until the grid circuit is resonant. Resonance can be checked by measuring the voltage across the buffer grid leak, R_2 , with a high-resistance voltmeter. The maximum voltmeter reading indicates resonance. The coupling between L_1 and L_2 can then be tightened until the voltmeter reads about 40 volts. Following this, the buffer should be neutralized by varying the capacity of C_7 until there is no change in the voltage across R_2 when the buffer tank condenser, C_8 , is tuned through resonance.

After the buffer is neutralized, plate voltage may be applied and C_3 adjusted to resonance, as indicated by minimum plate current. If the coupling to the final amplifier is quite loose, the

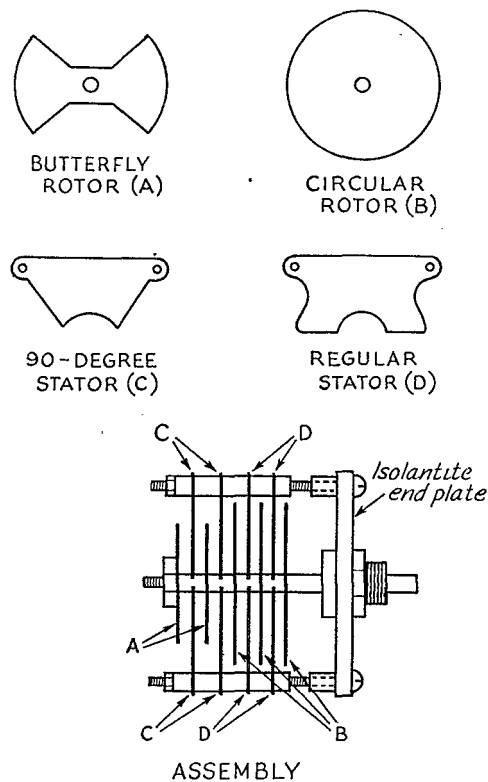
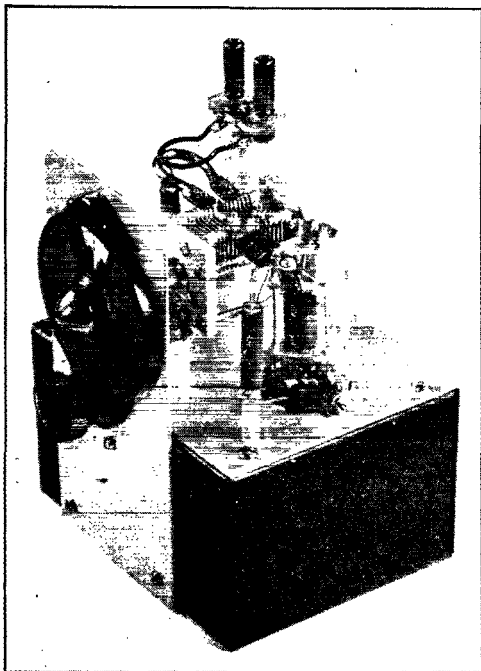

Fig. 2 — Construction of the condenser used in the oscillator tank circuit. The buffer and amplifier tuning condensers use butterfly rotors and 90-degree stators, but do not have the fixed-capacity section.

minimum plate current should be approximately 17 ma. The amplifier grid coil may next be resonated and the coupling increased until the maximum grid current is secured. The grid current should be 4 milliamperes or more and the buffer plate current should rise to about 28 ma.

Neutralization of the 815 is the next step. If the grid current changes when the plate condenser, C_{12} , is tuned through resonance, the neutralizing wires should be moved closer to or farther away from the tube plates until tuning C_{12} has no effect on the grid current. When this condition is reached the amplifier is neutralized and plate and screen voltage may be applied. With no antenna load on the amplifier the plate current should dip to approximately 65 ma. at resonance. Loading the amplifier to a plate current of 150 ma. should not cause the grid current to drop below about 3.5 ma. A 40-watt lamp used as a dummy load should light to practically normal brightness at this input, using a plate-supply voltage of 400.

For maximum stability, the coupling between the oscillator and buffer should be as loose as possible. It is better to obtain the rated 815 grid current of 3 milliamperes by using tight coupling between the buffer and amplifier and loose coupling between the oscillator and buffer than vice versa. The oscillator plate current should be approximately 25 ma. and the buffer plate current 28 ma., using a plate voltage of 300.



A high-C oscillator using the HY75. Capable of an output of about 4 watts, it is well suited to driving an 829 amplifier such as the one shown in March QST.

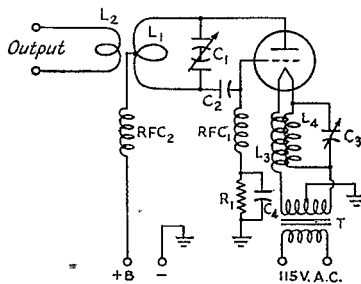

Fig. 3 — Circuit diagram of the high-C 144-Mc. oscillator using an HY75.

- C_1 — Split-stator condenser, 31.5 μ fd. total (Hammarlund VU-30).
- C_2 — 50- μ fd. midget mica.
- C_3 — 3-30- μ fd. ceramic trimmer.
- C_4 — 100- μ fd. midget mica.
- L_1 — 1 turn of $\frac{5}{32}$ -inch copper tubing, approximately horseshoe shape; overall length from mounting holes, $1\frac{3}{4}$ inches; outside diameter at widest point, $1\frac{3}{16}$ inch; plate tap at center.
- L_2 — 1 turn No. 14 enameled; diameter $\frac{3}{4}$ inch.
- L_3, L_4 — 6 turns No. 18 d.c.c. on $\frac{1}{2}$ -inch form; L_3 interwound with L_4 , no spacing between turns.
- R_1 — 5000 ohms, 1 watt.
- RFC_1, RFC_2 — 1-inch winding of No. 24 d.s.c. or s.c.c. on $\frac{1}{4}$ -inch diameter polystyrene rod.
- T — 6.3-volt filament transformer.

It is worth-while to regulate the voltage applied to the oscillator and buffer and thereby eliminate one possible cause of frequency variation. Since the plate currents of these tubes have no occasion to vary in normal operation, the regulation can easily be obtained by using two VR-150s in series in the power supply. It is readily possible to operate the whole transmitter from a single 400-volt supply in such a case, provided the supply is capable of furnishing about 250 milliamperes.

Other Combinations

For driving an amplifier such as an 829 directly, the high-C oscillator shown in one of the photographs has proved to be quite satisfactory. Its circuit diagram is given in Fig. 3. The tank condenser is a v.h.f. job made by Hammarlund and has a maximum capacity of slightly over 30 μ fd., practically all of it being used when the tank inductance is properly pruned. The circuit is essentially the same as that used with the 6C4 oscillator in Fig. 1 except for the method of controlling feed-back, which in this case is secured by using a tuned cathode circuit consisting of L_3, L_4 and C_3 . L_3 and L_4 are tightly coupled by being wound together on the same form so that both filament leads in effect go through the same inductance. The setting of C_3 is not critical, but a tuned circuit is definitely required and is much more easily adjusted than the more common self-resonant "chokes." Although the cathode tuning has almost no effect on frequency, it has a marked control over the power output.

In itself, the oscillator can be used as a low-

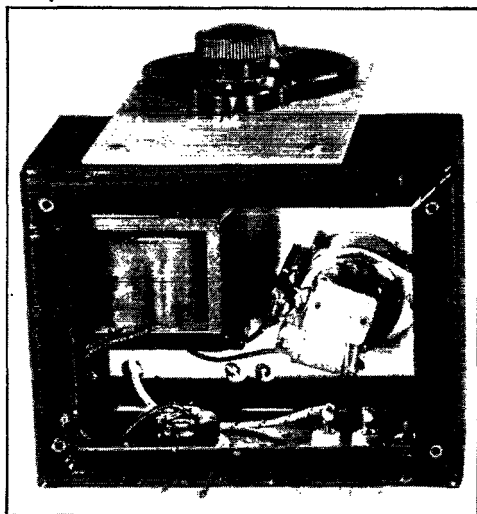

Below-chassis view of the high-C 144-Mc. oscillator. The filament transformer and filament tuned circuit are mounted inside the 3-by-1-by-5 box.

power transmitter by modulating it in the usual fashion. Operated at a plate input of 65 ma: at 325 volts, the power output is in the neighborhood of 4 watts. The frequency stability, while not comparable to that obtainable with an m.o.p.a., is materially better than that of the usual low-C oscillator. However, the overall stability of this oscillator in combination with an 829 amplifier is much better than that of the oscillator alone.

The amplifier used with it was described in *QST* last month.³ The two units are link-coupled, using Amphenol 300-ohm Twin-Lead as the coupling link. The oscillator is easily capable of furnishing the 12 ma. or so of grid current required to drive the 829 to normal ratings. Operating with a plate input of slightly under 200 ma. at 400 volts, the 829 delivers a power output of about 50 watts. Although this two-stage transmitter is not quite as good, from the standpoint of frequency stability under modulation, as the three-stage outfit it represents a decided improvement over a modulated oscillator of similar power. Plate-voltage variation tests showed a total frequency change of about 80 kc. over the range from zero to 800 volts. With voice modulation the signal is easily readable on the communications receiver with the i.f. in the "broad" position, but the selectivity in the "sharp" position is too great for good readability. The shift in average carrier is about 5 kc. between no modulation and full modulation.

On the whole, the results secured with these two set-ups show that an m.o.p.a., even one having only two stages, is far superior to a modulated oscillator. When a buffer stage is added, the performance is more than adequate for present needs

³ "A V.H.F. Amplifier Using the 829," *QST*, March, 1946.

and will continue to be so even in the rather unlikely event that receivers having communications-receiver selectivity come into general use on the 144-Mc. band. Best of all, the improved performance can be obtained at little, if any, additional cost when the thing is looked at realistically in the light of watts-per-dollar.

ATTENTION, OMs!

There are thousands of foreign QSL cards, many from hard-to-get DX stations of pre-war days, on hand in the district manager offices of the League's QSL forwarding system. The W6 manager alone has 20,000. If you've ever worked any DX, some of them may be for you. If you've never submitted an envelope, do so now! The managers must clear their files of pre-war cards and make ready to handle future ones according to revised call areas. This may be your last chance. Send your district manager, address given below, a standard No. 10 (9½ by 4¼) stamped envelope, carefully addressed to yourself, and with your own call printed prominently in the upper left-hand corner. Additional postage should be attached if you have reason to expect any volume. If you have held other calls in previous years, submit envelopes to the appropriate manager for each call. Cards for portable operation outside the home district should be obtained from the home district manager; e.g., W9KJY/KB6 would send envelope to the W9 Manager.

W1 — Jules T. Steiger, W1BGY, 231 Meadow St., Willimansett, Mass.

W2 — Henry W. Yahnel, W2SN, Lake Ave., Helmetta, N. J.

W3 — Maurice W. Downs, W3WU, 1311 Sheridan St., N. W., Washington 11, D. C.

W4 — Edward J. Collins, W4MS, 1215 North 12th Ave., Pensacola, Fla.

W5 — L. W. May, jr., W5AJG, 9428 Hobart St., Dallas 18, Texas.

W6 — Horace R. Greer, W6TI, 414 Fairmount Ave., Oakland, Calif.

W7 — Frank E. Pratt, W7DXZ, 5023 So. Ferry St., Tacoma, Wash.

W8 — Fred W. Allen, W8GER, 1959 Riverside Drive, Dayton 5, Ohio.

W9 — F. Claude Moore, W9HLF, 1024 Henrietta St., Pekin, Ill.

WØ (when established) — Alva A. Smith, W9DMA, 238 East Main St., Caledonia, Minn.

VE1 —

VE2 — C. W. Skarstedt, VE2DR, 3821 Girouard Ave., Montreal 28, P. Q.

VE3 — W. Bert Knowles, VE3QB, Lanark, Ont.

VE4 —

VE5 — H. R. Hough, VE5HR, 1785 Emerson St., Victoria, B. C.

K7 — J. W. McKinley, K7GSC, Box 1533, Juneau, Alaska.

Good Operating Pays Off

Hints for Beginner and Old Timer Alike

BY JOHN HUNTOON* WILVQ

MOST OF us have had the unhappy experience, when firing up the rig after four years of idleness, of finding a bleeder that opened, a by-pass that let go, or a strange new parasitic in the final. A few minutes with the *Handbook*, a screwdriver and the junkbox usually fixes the trouble.

Many of us have likewise found our operating has suffered wartime casualties — Are we putting enough dahs in the numeral “1” or are we sending WJLVQ? . . . Is the portable designator “BT” or the fraction bar? . . . Are we making long enough calls? And the like.

We get straightened out somehow. But most of us find our answers haphazardly, such as imitating the procedure used by another operator — who may or may not know what he is doing. After we have been back on a while our operating again becomes more or less automatic — fine if the habits are good ones, deplorable if they are not. This business of imitating the other fellow is the way most of us acquire our operating habits, which are formed early and last long. For less interference, for better relations with fellow operators, for more accomplishment with one's station — in short, for a better enjoyment of amateur radio — these habits must be good. We often tear down our rigs, on paper at least, to examine the possibility of rebuilding a more effective unit. Isn't the same procedure applicable to our operating habits? And isn't right now an ideal time to review them?

About now we can hear some gent switching off his rig and pleading, “Aw, let us alone — after all, it's only ham radio.” Sure it is. You can also hack around 18 holes of a golf course, driving into the foursome ahead, forgetting to replace divots, defacing the green with practice swings that go astray — if you want to have that kind of fun.

* Assistant Secretary, ARRL.

Sure, it's only golf. But the golf club and its members won't want you, and neither does ham radio need or want the sloppy and inconsiderate operator. Some fellows with the snappiest-looking stations and strongest signals would be surprised to know what brother hams actually think of their operating habits.

So, when you sit down at the rig tonight, whether you are a bearded old-timer with thousands of QSOs behind you or an LSPH with a brand-new station license ready for your first contact, give some thought to this business of operating.

The most important fundamental is that a good amateur operator spends much more time listening than transmitting; otherwise he becomes a pseudo “broadcaster.” The good op knows he gets more results by thorough listening. He has the “feel” of the band; he knows what is going on. He thereby avoids useless calls and QRM to others — and incidentally saves on the electric bill. You won't hear him rabidly calling CQ DX while some choice foreign stuff is trying to work through on his own frequency — a fault of which many of us have been guilty. Let's leave the key or mike alone, then, until we find out — by listening — what's going on in the band we choose for the evening's work.

There are two ways we can attempt contact: call another station or send the general CQ. The smart amateur, if he wants a really pleasant contact, first searches the general territory surrounding his chosen transmitter frequency, since on the major ham bands it is accepted practice to work only such a portion of the band; he selects a station with a clean signal and, if on c.w., a good “fist” and a code speed about like his own.

How long to call? For an accurate answer you must be familiar with practices in the particular band, but some generalizations may be made: If operating near (for c.w., within about 75 kc. of) the edge of the band, and calling a station in the same tuning area, you should call the approximate length of time necessary for the CQer to tune from the edge to your frequency, as in Fig. 1A. You may approximate this time by several “test” receiver runs of your own, tuning between the band edge and your transmitter frequency. It is obvious that in a crowded band a slightly longer call will be necessary, as more time will be required for the

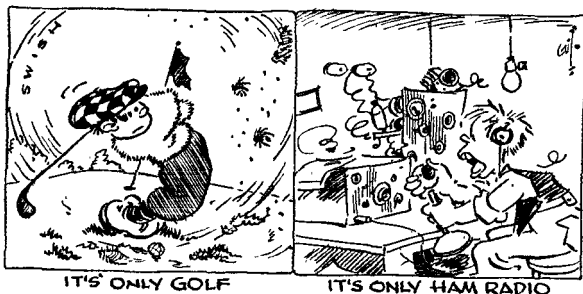

searching party to examine the additional signals as he tunes through them towards you. It is also obvious that if your station is right near the band edge, you may need to call only four or five times before signing. This sounds like a neat operating convenience, but in practice a tendency to crowd the edges of the bands results in a higher QRM level and less chance of being heard when one calls.

When operating away from band ends, a CQer will usually listen for answers in the general vicinity of his own transmitter frequency, plus or minus 50 or 100 kc. The calling time is more difficult to estimate here, since it is usually not known whether the CQer will first tune towards your frequency, or away from it and return later, as in Fig. 1B. Actually it is logical to plan two calls here: a fairly short one with a quick (but clean) sign-off, assuming the CQer is tuning toward you — and, if no answer comes, a second short call on the assumption the CQer tuned the other way first and, having reversed his dial motion, is now tuning toward you.

Actually, the ultimate in calling convenience and efficiency is the use of "break-in." At the very least a well-designed station has a control scheme which will allow rapid changeover between receiving and sending status. For 'phone work the most common arrangement is "push-to-talk," where one push-button control cuts off the receiver and turns on the transmitter, as well as

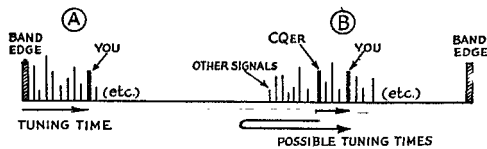

Fig. 1 — Customary tuning practices, depending on location in the amateur band.

operating an antenna switching relay if that is necessary. Such an arrangement permits the calling station to interrupt his transmission momentarily and check on the called station. He may, by saying "break" as he cuts his carrier, invite the called station to respond immediately; by a several-second check of the channel he may determine whether (1) the called station has answered some one else, in which case of course he ceases further calling; (2) there is no indication that the called station has returned, in which case he continues his call; or, as he hopes, (3) the called station answers him.

In c.w. work this may be carried one step further, if a separate receiving antenna is used and the transmitter oscillator stage is keyed. The receiver may be left on while calling (with headphones not clamped too tightly over the ears!) and thus the operator may have a constant check on the channel of the called

CALLING PRACTICES

• After a CQ, a transmission should end with K, thus:

*CQ CQ CQ (etc.) . . .
de W1LVQ W1LVQ K*

After a call (contact not yet established) the transmission should end with AR, thus:

*W1AW W1AW (etc.) . . .
de W1LVQ W1LVQ AR*

At the end of each transmission during a QSO use K, thus:

. . . RHOMBIC HW W1AW de W1LVQ K

At the conclusion of a QSO use SK, thus:

. . . TNX OM 73 SK W1AW de W1LVQ

(If the operator is closing down, he adds CL.)

station by what he hears during the minute periods the key is up between words and even between characters. Not so much as a dit need be wasted with such a system. It is helpful, also, as a constant check on communication during a QSO, particularly in message-handling work.

Regarding calling procedure for c.w., present recommendations are something like five calls and two signatures, the whole repeated several times. Actually there is no point to signing in the middle of a call; if the CQer happens to tune through your signal at the moment you are signing, he'll never know you're calling him. If not using break-in, then, before signing make calls a sufficient length to ensure the CQer a chance to reach your frequency during his tuning process; then sign clearly. Remember that while your call letters are quite familiar to you, they're probably new to the other guy — so watch your enunciation and phonetics, or "fist" if on c.w., when signing your call.

If you want to take "pot luck" and talk to anyone, a CQ is the thing. If interested in a particular direction or locality, possibly for purposes of message relay, so indicate in your call; e.g., "CQ WEST," "CQ W8," or "CQ OHIO." When sending a CQ make its length sufficient to accomplish the result of attracting one or more operators, yet short enough not to cause the listening op to tire of waiting for you to finish. Much will depend on the amount of activity in the band; a crowded band indicates many more operators are tuning for CQs so but a short transmission is needed. It is well to point out here that there is

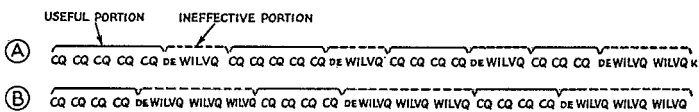

Fig. 2 — Excessive signing during a CQ decreases its effectiveness, as shown in B

little use in signing at length during portions of a CQ. Compare A and B of Fig. 2. The brackets show the effective portions of the transmission — an operator's attention will not be attracted if he tunes through your signal while you are signing (except in an otherwise empty band — if such a thing exists). While the B transmission is somewhat longer, A is actually more effective. Care should be taken not to send too many CQs without an intervening signature, however; 8 or 10 is the maximum. While our examples have been mostly in c.w. terms, the principles apply also to 'phone work.



We're talking about operating now, and it is assumed your transmitter is properly adjusted to put out a clean signal free from chirps or keying transients or, in 'phone work, with no splatter nor appreciable distortion. These factors are particularly important in CQs. If you can operate from Nyasaland and sign a ZD6 prefix you'll get answers no matter what kind of r.f. your rig emits; but so long as you sign a common prefix such as W or VE, brother, your replies will be generally in proportion to the quality of your signal.

After establishing contact, what? Well, that's pretty much up to you as an individual. For goodness' sake, be one! Don't fall into the dull routine of a stereotyped contact just because many others do. Our preachments so far have related to the business of *establishing* communication on an orderly basis; we must all practise a common calling procedure to facilitate contacts. But once in a QSO, it's up to you to forget your secondary status as a bug-pusher or mike-holder and become an individual.

The gent you work will want a signal report — if it is honest — and your location. Those are probably the only two standard items of useful conversation. If the weather isn't unusual, why bore him with it? A routine description of a routine rig is dull. But if you're using a new antenna feed system or a modulator that cuts off the "highs," that's something new! Talk about the same things you might if the fellow were right in your shack. In fact, if you want the greatest return from your operating time it is smart policy to make occasional schedules, especially when you find a good operator; thus you can make friends and get away from stereotyped contacts which exchange routine information of little interest to either participant. We c.w. operators, generally

speaking, observe much better calling and working procedures than our 'phone brothers, but are apt to be a bit routine in the body of our QSOs — yet the conversation is the object in making contact! We 'phone gents, conversely, are often sloppy about communications procedures but, except in instances where we overdo the business of being an individual, usually have more personalized QSOs. Each group can learn much from the other.

The smart 'phone amateur steers clear of inane conversation, for he knows he is "the voice of amateur radio in the loudspeakers of the world." He has no silly phonetic identification such as, "Double-you One Little Vicious QRMer," for he knows the boys will laugh at him, not with him. He does not believe in the false modesty of an editorial "we" if his is a one-operator station. Neither does he use the trite, "The handle here is Joe"; if his name is Joe, he says so. He does not chide his wife for listening to the morning radio serials or "soap operas" and then give the same sort of performance during his ham contacts. Yes, we previously said, "Be an individual." There's a difference between being an individual and being a screwball. The point is in *how* we conduct our contacts.

The thoughtful amateur must today give particular consideration to the beginner. There are thousands of LSPH-newcomers, the accumulation from four years of amateur shutdown; and there are thousands more to come, many from the ranks of returning veterans. Today's beginners are tomorrow's regulars, and if we want capable operators for our future brothers we must get them started right by lending a helping hand on the air. Keep an ear open for signals with unsteady sending, particularly if they sign calls well down the alphabet. A poor operator you hear may be only a beginner who needs guidance; a poor operator is a lid only when he refuses to try to improve his habits.

The smart amateur is interested in improving his operating ability, because he knows it will add to his operating fun and accomplishments. When he is scored on a bad habit he does not whine, "Heck, it's only ham radio," and then, ostrich-like, stick his head in the sand. Sure, it's only ham radio. Whistling at a sweet young thing is only wolfing, too — but there are good and bad methods, and the good ones pay off!

Bibliography

- "How to Operate Well," *QST*, Nov., 1939.
- "Personality Over the Air," *QST*, Jan., 1940.
- "Say It With Words," *QST*, June, 1940.
- "Self-Training Hints for Voice Operators," *QST*, Feb., 1941.
- "This Business of Code," *QST*, Feb., 1941.
- "The Secrets of Good Sending," *QST*, Sept.-Oct., 1941.
- "We're Off" (Editorial), *QST*, Dec., 1945.
- Operating an Amateur Radio Station*, free on request to ARRL members.
- See also "Operating Practices" tabulation in pre-arr yearly *QST* index (December issue).

Oscillators and Amplifiers at 1000 Mc.

Using Lighthouse Tubes and Cavity Resonators in the U.H.F. Region

BY PHILIP S. RAND,* W1DBM

OF THE secret wartime developments so far made public, the number which has any direct application to amateur radio has been disappointingly small. The purpose of this article is to describe a wartime development job, engineered by amateurs, that produced a communications-type transmitter in the 1000-Mc. region and to give some pointers based on much cut-and-try experience. While the actual piece of gear is of more advanced design, both electrically and mechanically, than will be required for amateur communication at this stage of the game, it is of interest because it is illustrative of the types of circuits and construction that probably will have to be used to obtain really successful operation in the 1215-Mc. band.

The transmitter shown in the accompanying photographs was developed for the U. S. Navy under the cognizance of Commander Thornton W. Chew, USNR, ex-W6COK. It was designed to have a carrier power output of 25 watts, video modulated with construction meeting size and weight specifications for airborne operation.

*Electronic Division, Remington Rand Inc., Middletown, Conn.

Under the direction of J. J. Lamb, W1AL, Division Chief Engineer, and general supervision of J. A. Brustman, Circuit Section Chief Engineer, Remington-Rand Electronic Division, the development work on the r.f. circuits was carried out by Harry B. Whittemore, W1BR, and Joseph H. Marchese, together with the writer.

The description which follows is given primarily to illustrate the type of tuned circuit necessary for the 1215-1295-Mc. amateur band, and to show how these circuits can be adapted to use with both oscillators and amplifiers. The actual transmitter has three stages — oscillator, buffer and modulated amplifier — because of frequency-stability and modulation-linearity requirements. While for the present, at least, a multistage job is hardly a necessity for amateur work, the differences between oscillator and amplifier operation nevertheless should be of interest. The tubes used are lighthouses, with 2C43s as oscillator and buffer and the higher-power 2C39 as the final amplifier.

The resonant circuits are of the cavity type, a form of circuit which it might be said represents the ultimate and logical conclusion of tuned-

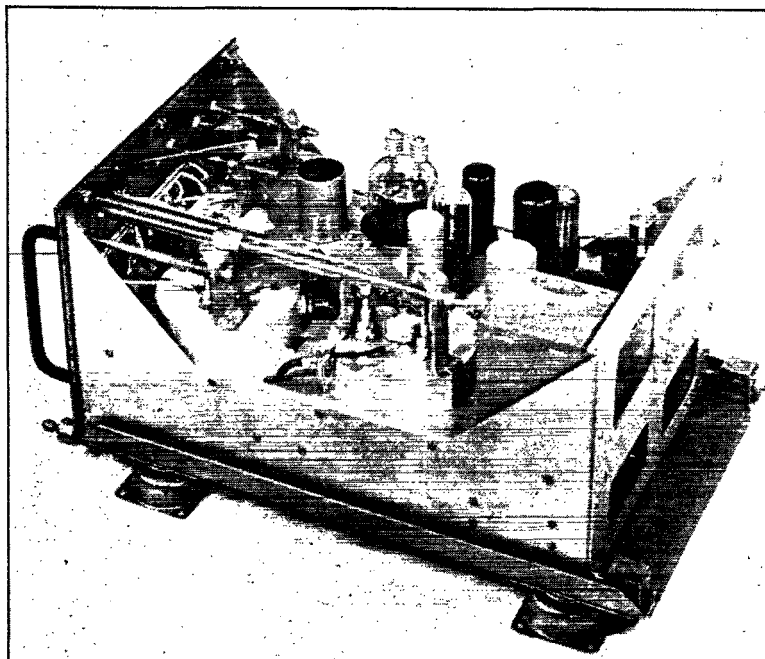

Built for airborne use, this transmitter has three r.f. stages, oscillator, buffer, and final amplifier, using lighthouse tubes. The assortment of tubes at the right rear in this photograph comprise the modulation circuits.

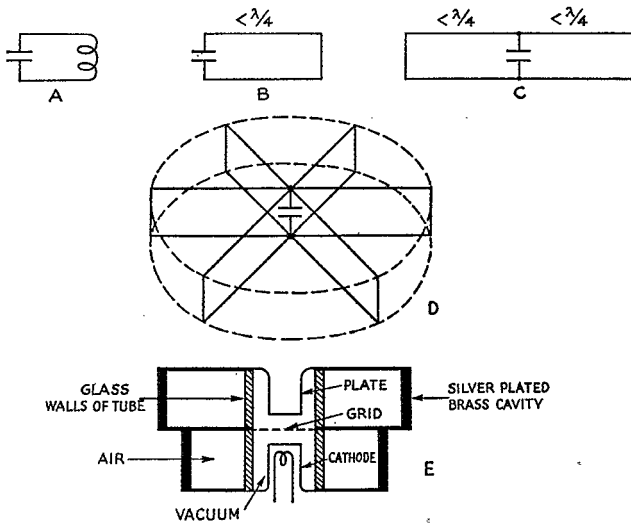

Fig. 1 — Development of the radial type of cylindrical cavity resonator from an LC circuit. The condenser shown in the linear circuits at B, C and D represents the tube capacity and accounts for the fact that the line lengths are indicated as less than the theoretical quarter wavelength. A simplified representation of a lighthouse tube with plate and cathode cavities is shown at E.

circuit design since, when reduced to its simplest mechanical construction, the cavity consists essentially of nothing but space enclosed within conducting material, the dimensions being chosen so that a radio wave of the desired frequency can exist within the boundaries. In actual use the cavity resonator may take many different shapes and the r.f. fields may be distributed within it in a variety of ways or "modes." For this reason a cavity, like an antenna, can resonate at a number of different frequencies, although unlike the antenna the relationship between the various frequencies is not necessarily harmonic.

Two types of cavities have been generally used in the 1000-Mc. region, both of circular cross section. One, the "coaxial" cavity, is nothing more than the familiar resonant section of coaxial transmission line, the resonant frequency being determined by the length of the line and being independent of the other dimensions. The other is the "radial" cavity, essentially a section of a hollow cylinder, where the primary frequency-determining dimension is the diameter of the cylinder. For the mode of oscillation desired in this case the resonant frequency is independent of the length of the cylinder; however, this is not true of several other modes that can be supported by the cavity. The cavities used in this transmitter are mostly of the radial type. More will be said about their design and dimensions later.

Development of An Oscillator

The design work on this transmitter was begun in the midst of wartime secrecy, when no one let his right hand know what his left was doing. Consequently, none of the parallel development work being carried on by other groups was known to us. Our experience up to this time had been with relatively low-frequency transmitters working in

the range from 100 to 300 Mc. At these frequencies, of course, ordinary coil-condenser and linear circuits could be used. However, when we were given the problem of making triodes work at frequencies in the vicinity of 1000 Mc. these circuits were no longer usable and other types had to be developed. While it was generally known that cavity resonators had to be used in the centimeter-wave region, it was thought that at 1000 Mc. circuits of this type might prove to be too cumbersome to meet the space limitations set up for the equipment.

The first circuits tried were of the coaxial type, using quarter-wave lines in both the cathode and plate circuits. Physically, these were arranged so that they extended in opposite directions from the grid plane, since this type of construction best fitted the lighthouse tube. The unit was large, heavy, and required a large number of precision-machined parts, together with sliding contacts that gave considerable trouble even though they were silver-plated. Lead inductance in the cathode circuit also was a source of difficulty, making it necessary, with some tubes, to resort to the use of a three-quarter wave cathode line. This made

• With the exception of the jamming equipment described in recent issues of *QST*, most war-developed u.h.f. gear has been built for pulse transmission of various sorts. The transmitter described in this article, although designed for operation at 900 Mc., uses circuit techniques that undoubtedly will be adapted to amateur use in the new band from 1215 to 1295 Mc., and was built to be modulated by familiar methods. Suggestions for 1215-Mc. construction are included.

the circuits even more cumbersome, although in later models the over-all length was reduced by folding the plate line back over the cathode line.

We had already done some work at 400 Mc. using parallel-line tank circuits and had found it possible to reduce the shortening effect of the tube capacities on line length by using two or more lines in parallel. It was reasoned, therefore, that by continuing to add circuits in parallel like spokes in a wheel we would eventually arrive at a cavity somewhat in the shape of a tunafish can. This simple method of developing a cavity is shown in Fig. 1. An ordinary resonant circuit is shown at A, with its linear equivalent at B. Two such linear circuits are connected in parallel at C, while in D the number of parallel circuits has been increased until we are approaching a cavity. This rather simple development is not a really accurate representation of cavity operation, because in the cavity the field is entirely inside while with the parallel-conductor lines it extends all around, but it gives a picture which is an aid to understanding how the cavity can be resonant. The cavity in Fig. 1-E with the tube mounted in the center is electrically a half wavelength in diameter, consequently the voltage is high at the center and the current is large at the rim. The actual diameter is somewhat less than a half wavelength because of the loading effect of the tube capacity, which shortens the radius in much the same way that it would shorten a quarter-wave line similarly connected.

One advantage of this radial cavity is that the lighthouse tube structure becomes part of the cavity wall, with the result that all the r.f. is contained inside the cavity and none is lost by radiation. Another advantage is that r.f. chokes and by-pass condensers may be dispensed with in many cases because the outside walls are "cold," hence power-supply leads may be attached to the outer surfaces without the necessity for r.f.

chokes and by-pass condensers. The filament leads, for example, are cold because the heater is inside the cathode cylinder and therefore is shielded from the r.f. field.

Translated into an electrical equivalent using the familiar low-frequency circuit symbols, the

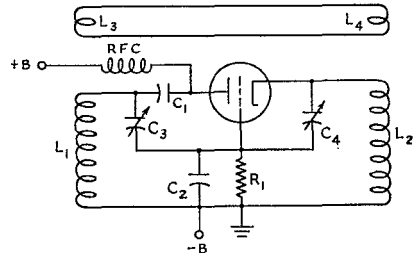
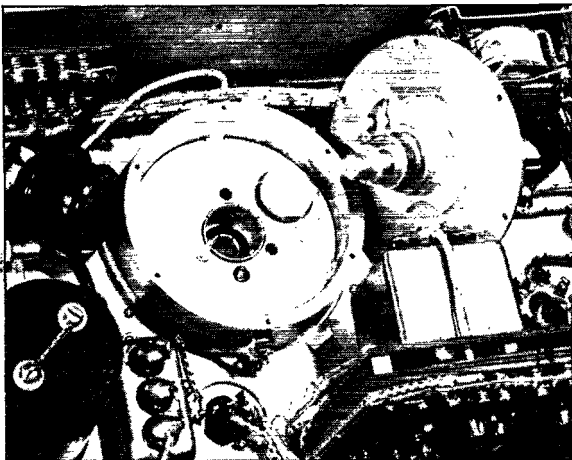

Fig. 2 — Low-frequency equivalent circuit of the cavity resonator oscillator or amplifier. L_1C_3 — Plate cavity; L_2C_4 — cathode cavity; R_1 — grid leak; C_2 — grid condenser; C_1 — plate blocking condenser; L_3, L_4 — feed-back coupling.

circuit of either an oscillator or amplifier is shown in Fig. 2. In this circuit L_1C_3 represents the plate resonator and L_2C_4 the cathode resonator, with C_2 a low-reactance condenser which has no effect on the r.f. operation other than to by-pass the grid leak, R_1 . L_3 and L_4 are coupling loops to provide feed-back, positive in the case of an oscillator, negative (for neutralizing) in the case of an amplifier. The amplifier circuit is of the "inverted" type — that is, cathode-driven with the grid grounded — because this is the most practicable type of amplifier circuit for these frequencies as well as one particularly suited to the lighthouse tube construction. Coupling between stages is through coaxial lines terminating in small loops or probes, the former giving inductive coupling and corresponding to ordinary link coupling, the latter giving capacitive coupling.



The oscillator cathode cavity with the bottom plate removed. The baffle plate with its supporting tabs is flush with the top of the grid socket. This resonator mounts underneath the chassis, with the plate cavity directly above it on top. Filament connections to the tube are made through the octal cable socket at the left.

In the photograph of the complete transmitter the cavity resonators appear as "pillboxes" mounted on the chassis. They are connected by ducts through which air is forced for cooling the tubes, and are tuned from the front panel by means of the gear arrangements shown. The rear cavity (toward the rear of the chassis) is for the oscillator; to its left is the buffer stage, and in the far corner, concealed by the ductwork and gearing, is the final amplifier. Each stage has a plate cavity and a cathode cavity, with the chassis acting as a dividing plane between them, and in each stage the plate cavity is above the chassis and the cathode cavity below, with the grids by-passed to the chassis.

Cavity Details

A view of the oscillator cathode cavity with the bottom plate taken off is given in another photograph. In this view, the large slotted ring in the center is the socket for the grid of the tube; the plate socket is visible through it. The resonant frequency of the cavity is adjusted by means of a variable condenser, the stator plate of which is to the right of the grid socket inside the cavity. The movable plate, mounted on the bottom plate of the cavity, is just above the plate cap of the lighthouse tube in the photograph. The r.f. cathode connection of the tube fits into a spring-finger socket mounted on the cavity bottom plate.

A necessary part of the oscillator cavity is a baffle plate or shield for the purpose of suppressing oscillations in undesired modes. This is a disc having a diameter almost equal to the inside diameter of the cavity and having clearance holes for the socket, condenser, and other parts mounted inside the cavity. Its function is to short-circuit the electric field of the undesired oscillation mode without disturbing the field of the desired mode. The shield is suspended in the center of the cavity

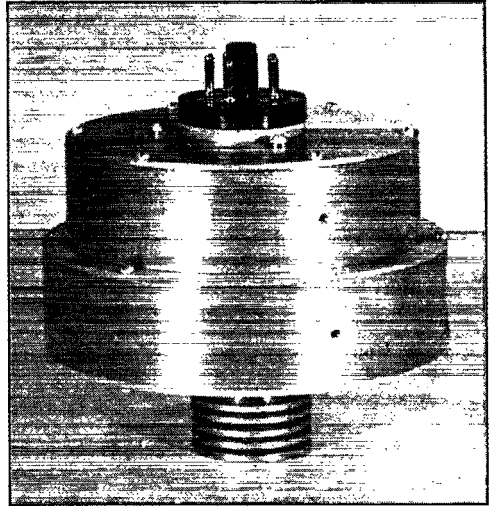

A complete oscillator or amplifier assembly for the 2C43. Construction is identical for either type of operation, the difference being in the phase of the feed-back. Note the heat radiator at the bottom of the assembly.

by three tabs, two of which are visible in the photograph, fastened to the circular wall. Without it, there is a tendency to jump to a higher frequency with certain tuning adjustments. The oscillator plate cavity uses the same general type of construction, but with different dimensions.

The complete double-cavity assembly of the oscillator removed from the chassis is shown in another photograph. This gives some idea of the relative sizes of the cathode and plate cavities, the differences in diameter being necessary because the grid-plate and grid-cathode capacitances and lead inductances are not equal. The lengths of the cylinders are determined by the

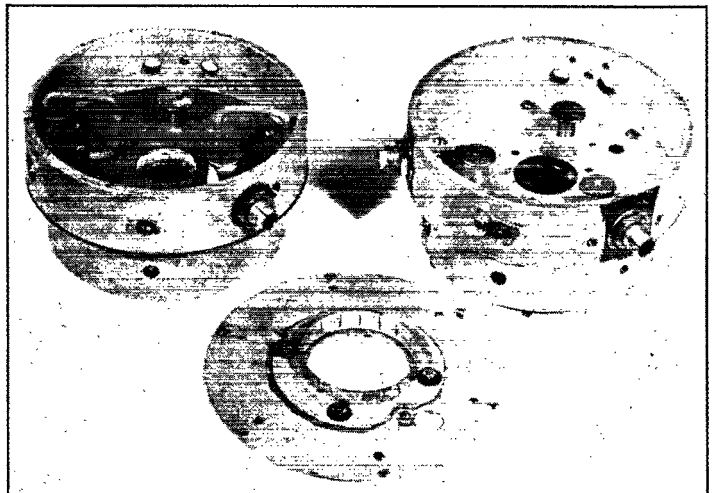

Cavities in the process of assembly. The one at the left uses inductive feedback, that at the right capacitive feedback. The inductive loops are insulated from the cavity proper. The disc at the bottom is the separation plate between the cathode and plate cavities.

spacing necessary between the cathode, grid and plate sockets, and in practice worked out to be one inch. A cathode cavity having an inside diameter of $3\frac{1}{8}$ inches tunes from 780 to about 900 megacycles with the type of tuning condenser shown; for the corresponding tuning range in the plate circuit the cavity diameter is $3\frac{3}{4}$ inches.

Cavities designed for the 2C43 are shown in various stages of assembly in one of the photographs. The one at the left uses inductive feed-back, in the form of a square loop projecting into the plate cavity and connected to a similar loop projecting into the cathode cavity immediately below. The same type of feed-back may be used for neutralization simply by twisting one of the loops 180 degrees in relation to its counterpart in the other cavity. More than one pair of such loops may be necessary to provide sufficient feed-back. A similar loop may be connected to a coaxial cable connector, or simply brought out through the side of the cavity and connected to an antenna.

The cavity at the right in the same photograph shows a different method of obtaining feed-back. In this case the small disc at the left, mounted on a polystyrene pillar, is attached to the center conductor of the coaxial cable connector, and the electrical length of a coaxial line between the plate and cathode cavities is adjusted by means of a condenser formed by this disc and a similar one mounted on the cover plate in the fashion of disc-type neutralizing condensers. This is a somewhat nicer control, mechanically, than moving the inductive loops to change the coupling. The disc at the right, also mounted on polystyrene, is one plate of a similar condenser which forms the antenna-coupling control.

The separation plate that goes between the cathode and plate cavities is shown at the bottom of the photograph. The grid socket, mounted at the center, is insulated from the plate by a thin

mica washer. The two metal pieces and mica insulator also form a built-in condenser to by-pass the grid leak. The grid socket must be insulated from the separation plate to avoid short-circuiting the grid bias to the plate, which is at d.c. ground potential.

Adapting to 1215 Mc.

A suggested form of oscillator construction for amateur use is shown in cross-section in Fig. 3. The dimensions given should bring the frequency approximately to the 1215-Mc. band, based on our experience with cavities in the 900-Mc. range. Coupling loops L_3 and L_4 are included to provide some extra feed-back for good oscillation, and a similar loop can be installed in the plate cavity for antenna coupling. Leads from such a loop could come through the top or the circumference, whichever is most convenient. The simple type of tuning condenser shown in this drawing consists of two pieces of phosphor bronze approximately $\frac{1}{4}$ inch wide and $\frac{3}{4}$ inch long, with a $\frac{1}{4}$ -inch tab bent on one end of each. One strip is soldered on the grid socket and the other on the plate socket (or cathode socket, in the cathode cavity) as shown. A strip of mica should be cemented to the fixed strip to prevent short-circuiting the condenser when the movable plate comes close to the fixed plate and also to add to the maximum capacity of the condenser and thereby extend its tuning range. The capacity is varied by pressure on the movable plate through a polystyrene rod mounted in a bushing; the rod and bushing may be threaded, if desired, or a plain rod and locking-type shaft bushing may be used to maintain the condenser setting.

In making up an oscillator of this type it is recommended that it be constructed from sheet copper and soldered as indicated in Fig. 3. Then, after the operating frequency has been deter-

Fig. 3 — Suggested construction for an oscillator for the 1215-Mc. band. Connection to the grid socket may be made by an insulated wire running out through the cavity wall. Actual dimensions may be found to vary slightly from those shown, to bring the frequency inside the band.

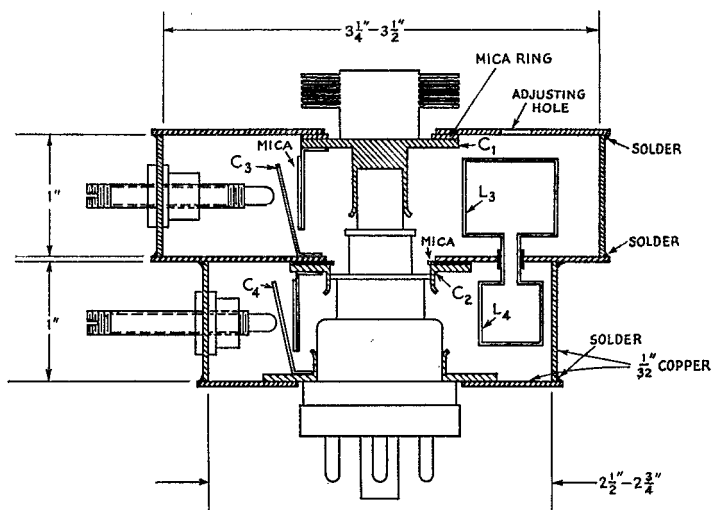

mined, any necessary changes in the dimensions to bring the frequency within the band can be made without much difficulty. Once satisfactory operation has been obtained a more rugged job can be done, if desired, by making a duplicate from thick-walled brass tubing of the proper inside diameter as determined from the experimental model. The covers likewise can be made of heavier material, such as 3/32-inch sheet brass, and the parts can be silver plated to lower the resistance.

The grid and cathode sockets may be purchased from Millen or may be made up from sheet copper as suggested in Fig. 4. The plate and grid sockets should be insulated from the cavities by mica washers (forming by-pass condensers of about 75 $\mu\text{mf.}$) but the cathode socket should be grounded directly to the bottom plate. This keeps the outside of the oscillator cold so far as d.c. is concerned and reduces the possibility of accidental shock. Some type of heat-radiating fin must either be purchased or fabricated (a stack of metal washers, alternately small and large, can be used) and attached to the plate socket. A small electric fan or blower should be provided for cooling.

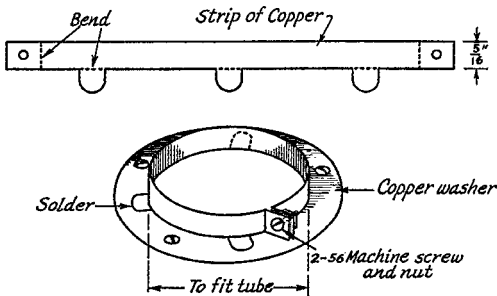

Fig. 4 — A simple method of constructing lighthouse-tube sockets. Dimensions should be adjusted to fit the contacts of the type of tube used, and should not put any strain on the plate and grid seals.

In testing the operation of the oscillator the use of a grid milliammeter, as well as a plate meter, will be a convenience. After allowing a few minutes for the tube cathode to come to temperature (the lighthouse tubes are slow-heating), oscillation will be indicated by the presence of grid current, or by a dip in plate current as the tuning condenser of either cavity is tuned through resonance with the other. If there is no oscillation, one loop of the feed-back link should be reversed by twisting it through 180 degrees.

The problem of r.f. output indication is somewhat difficult at these frequencies. A flashlight lamp coupled to the antenna pick-up loop will give a rough check, or better still, one of Sylvania's v.h.f. dummy loads may be used. However, coupling difficulties and circuit losses, as well as the u.h.f. characteristics of dummy loads of this

type, make the accuracy of any power measurements based on them rather questionable. As an illustration, in one instance power measurements based on lamp loads indicated an output of about 6 watts whereas a "lossy-line" u.h.f. power meter, Bird Electronic Corp. Model 532-B, showed that the actual output was in excess of 25 watts.

For determining whether or not the oscillator is inside the band, a crude check can be made by means of Lecher wires. They are not too accurate because it is difficult to make a set of parallel wires that does not radiate at these frequencies. If used, they should be constructed of 1/4-inch brass rod with quite close spacing, and should be mounted to be as mechanically rigid as possible. A better frequency-measuring device would be a length of coaxial line a wavelength or more long, using brass tubing for both the inner and outer conductors, and provided with a movable short-circuiting plunger. The open end of such a line should be loosely coupled to the transmitter, and as the plunger is moved along the line the resonance points will be indicated by kicks in the oscillator plate current. The distance between two such kicks indicates the half wavelength more accurately than is possible with Lecher wires since the line will not radiate and is free from body-capacity effects.

As an indication of what might be expected from such an oscillator, a similar circuit operating at 900 Mc. gave a power output of 6 watts, using a plate voltage of 400 and a plate current of 40 ma. With a 3000-ohm grid leak the grid current was 10 ma.

The same circuit could be used as a super-regenerative detector if a high-resistance grid leak is switched in in place of the transmitting leak. Another possibility is to use a u.h.f. crystal detector coupled to a resonant cavity of the same general type, the cavity being tuned by a single-disc condenser mounted at the center and giving capacity variation by the distance between the disc and the opposite flat wall. Antenna input could be through a loop near the rim, and audio output would be taken from the crystal circuit.

To use the assembly as an amplifier it is only necessary to reverse one of the loops so that the feed-back will be in the right phase for neutralization rather than to sustain oscillation. Using an oscillator set-up to drive it, the two should be coupled through a section of coaxial line and the coupling adjusted for maximum grid current. Neutralization is adjusted by rotating the amplifier feed-back loops until the effect of plate-capacity tuning on grid current is minimized, the plate voltage being off the amplifier when the adjustment is made. Either a grid leak or a combination of grid leak and cathode resistor may be used to bias the amplifier.

A simple type of construction suited to the 2C39 lighthouse is shown in one of the photographs. The plate tank is a radial cavity, while

the cathode tank is of the coaxial type. The plate cavity was made from two discs of copper cut out with tin shears and soldered to a rim made by

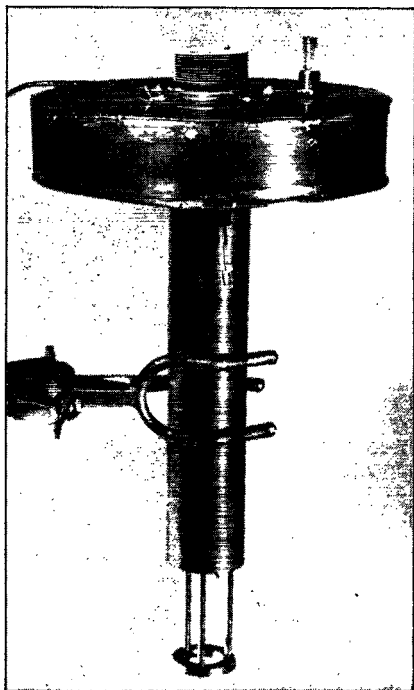

An experimental lighthouse oscillator with a radial-cavity plate circuit made from sheet metal. This oscillator, using the 2C39, has a three-quarter wave coaxial line as the cathode resonator.

rolling a 1-inch strip of copper into a circle. The plate socket, manufactured by Millen, is insulated from the cavity by a mica washer, the assembly acting as a plate by-pass condenser and making it possible to apply plate voltage without the necessity for an r.f. choke and without making the whole cavity hot with d.c. The grid socket, of similar construction, is also insulated from the cavity by mica; the grid leak is connected from the socket to the outside of the cathode line. This particular oscillator uses a three-quarter wavelength cathode line, tuned by pushing or pulling the plunger projecting from the bottom. The plate cavity is tuned by the small polystyrene rod extending through the panel bearing just to the right of the heat radiator. The tuning condenser is a small disc-type neutralizing condenser mounted as close as possible to the plate and grid sockets so that it will have the maximum tuning effect.

In conclusion, a word of caution is in order for those who build cavities from thin sheet metal. The oscillation frequency is determined by the physical dimensions of the inside of the cavity,

so the frequency stability of the oscillator is a function of the rigidity of the material of which the cavity is constructed. If the oscillator is simply for experimental purposes thin material may be used. However, if good stability is required the outer ring should be made of thick-walled tubing and the cavity top, bottom and separation plates should be made of 3/32-inch thick brass. It should also be remembered that the physical dimensions of the cavity will change with the expansion of the material from heating; consequently, for best stability the air blast should be directed so that it keeps the cavity as well as the tube radiator cooled.

BIBLIOGRAPHY

The following references will be of interest to those seeking additional information on operation in the vicinity of 1000 Mc.:

- Reference Data for Radio Engineers*, Federal Telephone & Radio Corp., New York; page 84, "U.H.F. Tubes," and page 118, "Wave Guides and Resonators."
Microwave Transmission Design Data, Sperry Gyroscope Co., Inc., Garden City, N. Y.: Chapter X, "Cavity Resonators."
 Terman, *Radio Engineers' Handbook*, McGraw-Hill Book Co., New York; pages 264 to 273 "Cavity Resonators," and pages 516 to 518 "U.H.F. Oscillators."
Practical Analysis of Ultrahigh Frequency Transmission Lines, RCA Service Co., Camden, N. J.; page 18, "Cavity Resonators," and page 20, "Use of Slotted Lines."
 Jones, William J., "Types and Applications of Microwave Frequency Meters," *Radio*, January, 1946. McQuay, Jordan, "A Resonant Cavity Wavemeter," *Radio News*, February, 1946.
 Cornelius, E. C., "Germanium Crystal Diodes," *Electronics*, February, 1946.
 McArthur, E. D., "Disc Seal Tubes," *Electronics*, February, 1945.
 Cutler, Stanley, "V.H.F. Dummy Antenna," *Electronics*, May, 1945.

Strays

A device, called the Handi-Glow, indicates whether any electric outlet, socket or power cord is on or off. A thin adapter fits over the prongs of the plug and a tiny neon bulb (protected by a metal covering), located over the head of the plug, glows when the outlet is turned on. The Handi-Glow should remove any doubt as to whether your soldering iron or other powered tool is on or off, and would probably find many other uses around the ham shack.

— . . . —

Two W9s had a 10-meter QSO. Nothing unusual about that, you say. No? Well, lissen OM — both transmitters had 807s with Class AB 6L6s, both receivers were the same make, both frequencies were in the high end of the band, and both signals were the same strength, and W9GZR is an engineer at WASV in Savannah, while W9GZD is an engineer at KIL0 in Grand Forks, N. Dak.

Happenings of the Month

LICENSING MATTERS

Colonel Carl H. Hatch, Arlington, Va., on February 8th was the recipient of FCC's first postwar license for a new amateur station, with the call W4IIT.

It is perhaps significant that the first postwar license is in an area involving a change of call numeral — a W4 in Virginia. W4IIT lives in the midst of a group of W3 stations whose calls will not change to W4 until they come up for renewal. If he operates portable or mobile in Virginia, he of course will be signing W4IIT/4, while the amateurs from all districts who are temporarily living near him and operating "fixed-portable" are still signing /3. This situation is causing considerable confusion. Of course an amateur still living at his registered address and possessing a valid license must sign the call that is stated thereon; but aside from that it seems to us that it would be more logical for the areas to be referred to in terms of their new delineation — which went into effect October 24th. We understand that FCC has a new order coming up soon which will clarify this matter.

Although the issuance of new licenses began on February 8th, it has proceeded with an unhappy slowness. Last month we told you how FCC's amendment of its Order 75 was making clerical people available for this task. It seems that not quite so many will be released as had been hoped and there is a big backlog of Order-75 work which must be finished up before many are available. There are many thousands of amateur applications waiting at FCC and it will take some months to catch up with the requests for new licenses. The situation will improve, and everything that can be thought of is being done to help it along, so there is nothing to do but be patient.

One result of this slow speed is that FCC will not be able to act with promptness in the months of March and April on the renewal applications which we last month suggested be sent in. At this writing we estimate that this work will run behind by from one to two months, correspondingly slowing down the whole great job of renewing all of the rest of us. We shall expect to make a fur-

80 METERS COMING!

- For information on the opening of 3700-4000 kc. in April, read this month's "It Seems to Us . . ." And watch W1AW for current details as the time approaches.

ther report on this situation in our next issue. If you have not yet sent in your renewal application, we suggest that you await further word in next *QST* or via W1AW.

V.W.O.A. HONORS AMATEURS

At its twenty-first annual "dinner-cruise" at the Hotel Astor in New York on February 16th, the Veteran Wireless Operators Association presented its Marconi Memorial Service Award to ARRL on behalf of the nation's amateurs. The

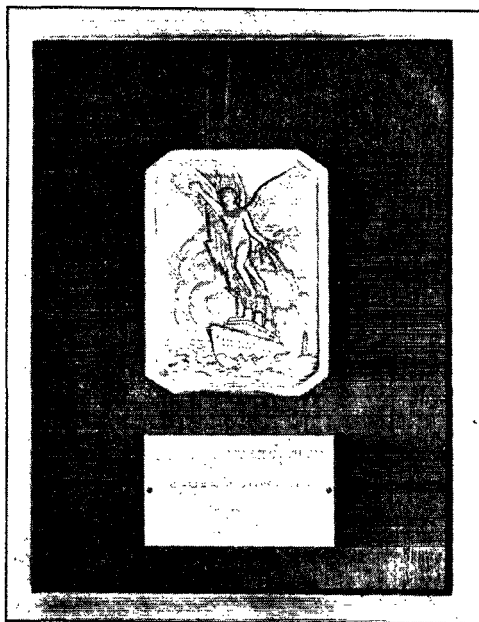

plaque was presented by VWOA President William J. McGonigle, W2ASN, and accepted by ARRL President George W. Bailey, W1KH, the proceedings being broadcast over an NBC coast-to-coast hook-up. A similar award was made to the Institute of Radio Engineers on behalf of the outstanding contributions during the war of American radio engineers.

Our handsome plaque, now hanging in the Headquarters, carries an inscription stating that it is "awarded to The Radio Amateurs of America, in recognition of their outstanding contributions to the successful prosecution of World War II. Presented to The American Radio Relay League, George W. Bailey, President, February 16, 1946."

VWOA numbers most of the leading figures in the radio and communications industry in its membership, and its dinner was attended by high-ranking officers of the armed forces. Marconi Memorial Medals of Service were presented to Maj. Gen. Harold M. McClelland, Air Communications Officer of the AAF; Rear Admiral Joseph R. Redman, retiring wartime Chief of Naval Communications; Commodore E. M. Webster, Chief of Communications of the Coast Guard; and J. R. Poppele on behalf of Television Broadcasters Association. The Medal of Valor went to Technical Sergeant Forrest Vosler, AAF radio operator, major enlisted hero of World War II; while Sergeant Irving Strobing, SC, the operator who sent the last message from Corregidor, received the Marconi Commemorative Medal. A Medal of Achievement went to Dr. Allen B. DuMont, a Medal of History to Orrin E. Dunlap, jr., while President McGonigle himself received the association's Medal of Merit.

5-METER BAND BECOMES 6 METERS

The expected shift in television channels contemplated by the FCC allocation report for frequencies above 25 Mc. is now occurring and, as a result, FCC made the long-expected shift in our old 56-60 Mc. band to 50-54 Mc. effective on March 1st.

Because this impending change has hung heavily over our heads, postwar activity on the old 56-60 frequencies has been nothing like what it should, the gang holding back to avoid two rebuilding jobs. Now we can go ahead! This is a splendid band that is going to show some startling DX, in addition to which it ought to be carrying a great deal more of our local talk than it does. Ho for 6 meters!

Because the Commission order which shifted this band summarized all our authorizations to date, we give you its text in its entirety.

ORDER NO. 130-C

At a session of the Federal Communications Commission held at its offices in Washington, D. C., on the 20th day of February, 1946:

WHEREAS, by Order No. 130-A, dated November 14, 1945, as amended by Order No. 130-B, dated January 16, 1946, the Commission made available for amateur station operation certain frequency bands; and

WHEREAS, the frequency band 56.0 to 60.0 Mc. was assigned to the Amateur Radio Service by Order No. 130-A, as amended by Order No. 130-B, until March 1, 1946; and

WHEREAS, the frequency band 50.0 to 54.0 Mc. hitherto allocated to the Amateur Radio Service by Commission action in Docket No. 6651, has now become available for amateur station operation;

It is ordered that the second ordering clause of Order No. 130-A, as amended by Order No. 130-B, be and it is hereby further amended to read as follows:

2. (a) The following frequency bands are available for use for amateur station operation, subject to the limitations and restrictions set forth herein:

- (1) 28.0 to 29.7 Mc. using type A1 emission.
- (2) 28.1 to 29.5 Mc. using type A3 emission.

(3) 28.95 to 29.7 Mc. using special emission for frequency modulation (telephony).

(4) 50.0 to 54.0 Mc. using types A1, A2, A3 and A4 emissions and, on frequencies 52.5 to 54.0 Mc., special emission for frequency modulation (telephony).

(5) 144 to 148 Mc., using A1, A2, A3 and A4 emissions and special emissions for frequency modulation (telephony and telegraphy). The portion of this band between 146.5 and 148 Mc. shall not be used, however, by any amateur station located within 50 miles of Washington, D. C., Seattle, Washington, or Honolulu, T. H.

(6) 420 to 430 Mc., 1215 to 1295 Mc., 2300 to 2450 Mc., 5250 to 5650 Mc., 10,000 to 10,500 Mc., and 21,000 to 22,000 Mc., using on these six bands, A1, A2, A3, A4 and A5 emissions and special emissions for frequency modulation (telephony and telegraphy). Peak antenna power on the band 420 to 430 Mc. shall not exceed 50 watts.

(b) Upon the effective date of this order, no frequencies other than those assigned in this order shall be used for amateur operation.

This order shall become effective on the 1st day of March, 1946 (3:00 A.M., Eastern Standard Time).

BY THE COMMISSION:

T. J. SLOWIE
Secretary

WHAT BANDS AVAILABLE?

Below is a summary of the U. S. amateur bands on which operation is permitted as of March 1st. Future changes will be announced by WIAW broadcasts. Figures are megacycles. A1 means c.w. telegraphy, A2 is m.c.w., A3 is a.m. 'phone, A4 is facsimile, A5 is television; FM means frequency modulation.

28.00-	29.7	A1	
28.10-	29.5	A3	
28.95-	29.7	FM 'phone	
50.0 -	54	A1, A2, A3, A4	
52.5 -	54	FM 'phone	[only
144.0 -	148	A1, A2, A3, A4, FM; except band is	
146.5 -	148	within 50 mi. of Washington, Seattle, Honolulu	
420* -	430*	A1, A2, A3, A4, A5, FM 'phone, FM telegraphy	
1,215	- 1,295		
2,300	- 2,450		
5,250	- 5,650		
10,000	-10,500		
21,000	-22,000		

* Peak antenna power must not exceed 50 watts.

Up to this writing, our band in the 200-Mc. range has not come through, but it is expected momentarily. However, it is going to be slightly altered in location from what we expected. It will be remembered that the opening of this band was held up pending the work of an international technical committee studying the requirements for a radar distance-indicator in this region of the spectrum. It has been decided that it must be accommodated there for some years to come, thereafter to be moved much higher. As a result of these considerations, the amateur band is going to be established at 235-240 Mc. at least until January 1, 1949 — a date which might possibly be extended. When the distance-indicator is moved, the amateur band is to become 220-225

Mc. as originally planned. The opening of the band to us is now in process and its availability will be announced via W1AW.

NONCONTINENTAL PREFIXES

Since the prefix K is to be available on the mainland for use with three-letter calls after the W series is exhausted, it becomes necessary to have some changes in the calls of the outlying territories and possessions so that they may still be instantly identified. Indeed, it is part of the new call plan that such areas shall possess calls consisting of two prefix letters, a numeral and two suffix letters. We now learn at FCC that they propose to use the following two-letter prefixes for new licenses issued in these areas:

KB6 — Baker, Howland, American Phoenix Ids.
 KG6 — Guam
 KH6 — Hawaii
 KJ6 — Johnston
 KL7 — Alaska
 KM6 — Midway
 KP4 — Puerto Rico
 KP6 — Palmyra Group, Jarvis
 KS6 — American Samoa
 KV4 — Virgin Islands
 KW6 — Wake Group

The Canal Zone will use KZ5, although these calls are issued by the War Department, not by FCC. FCC will probably hold K16 in reserve for further growth in Hawaii. We also observe that it is only a question of time until many Pacific Islands which came into our possession during the war will have amateur applicants, particularly among GIs, and consequently we expect that there will soon be additions to this list.

As in the case of stations on the mainland, the existing calls of already-licensed stations are not expected to be changed until the licenses come up for renewal. There thus promises to be a brief period of confusion, particularly in the case of KB6 vs. KG6.

ARE YOU LICENSED?

• When joining the League or renewing your membership, it is important that you show whether you have an amateur license, either station or operator. Please state your call and/or the class of operator license held, that we may verify your classification.

**SWITCH
TO SAFETY!**



THE LEADING article in our April, 1921, issue is an announcement of the winners in *QST*'s Spark Station Contest: first prize, R. H. G. Mathews, 9ZN; second, R. C. Denny, 6CS, and third, Sumner B. Young, 1AE. 9ZN's article, "The Ideal Relay Spark Transmitter," appears in this issue. The contest judges report that "the majority of the contestants agree on a vertical aerial, a buried radial ground system, a glass-plate oil-immersed condenser of adjustable capacity, a high-voltage high-leakage transformer, synchronous 60-cycle gap, pancake oscillation transformer with very heavy ribbon; and they pay considerable attention to the adjustment of the closed circuit for best power factor. For receiving a separate single wire is advocated, running at right angles to the transmitting aerial, making break-in operation possible; and the receiving equipment in favor is a variometer regenerator with two stages of a.f. amplification."

Director F. F. Hamilton, 9ZJ, describes how to make squirrel-cage induction motors run synchronously by rewinding or milling slots in the rotor. . . . Julius G. Aceves, writing in a paper prepared for the Radio Club of America, explains the theory behind "The Determination of Resistance, Inductance and Capacity by the Wheatstone Bridge Method."

Simple but effective c.w. sets at 1XX, 8ZG and 7AD are described in an article relating the phenomenal performance of these stations. . . . Transcontinental relaying without nation-wide stand-by cooperation has been accomplished by the Amrad "Quenched Gap Limited." One transcon message made it in 28 minutes! . . . J. F. Scholtes, 9AR, explains the "Chicago Plan" for control of QRM in metropolitan areas. . . . The fourth and final series of Bustans-ARRL Fading Tests is scheduled for Tuesdays and Thursdays throughout April. . . . Transcontinental reception of signals is becoming almost commonplace. . . . A grand total of 9793 messages is reported last month, with 8IK leading the field with a reported 302.

The Radio Club of Mansfield, Ohio, has an elaborate station, 8ZR, the details of which are given in a station description. Transcontinental reception has been reported many times and 1000-mile QSOs are frequent occurrences. One of the features is the "Round's round ground, consisting of copper plates buried endwise in a circular trench six feet deep and 130 feet in circumference. The station is located in the center of this system and leads of 2-inch copper ribbon supported on insulators on short posts run radially to

(Continued on page 116)

A Band Pass 28-Mc. Converter

Simplified Construction with Fixed-Tune R.F. Stages

BY BYRON GOODMAN,* WIJPE

ON THE low-frequency bands receiver sensitivity is usually limited by "site" noise — static and such — but often the performance at 28 Mc. is handicapped by the tube noise in the first stage of the receiver, given a location reasonably free from man-made noise. An ideal receiver would have no noise in the output when the grid of the first tube was shorted to ground, and when the short was removed all of the noise would come from the resistance of the input circuit ahead of the grid. This theoretical ideal has never been reached, but with a high-gain tube in the first stage it can be approached fairly well. Of course the noise coming through the receiver is also dependent on the band width of the receiver, but the band width can be restricted almost anywhere in the receiver. Generally it is done in the i.f. amplifier and audio circuits. If anyone has any doubts about improving the signal to noise ratio of a receiver by decreasing the bandwidth, let him take a page from the book of the moon-radar experiments, where the receiver bandwidth was 50 cycles! Compare this with the 150-cycle bandwidth of a good crystal filter. However, the usual communications receiver has a crystal filter that restricts the band-

* Assistant Technical Editor.

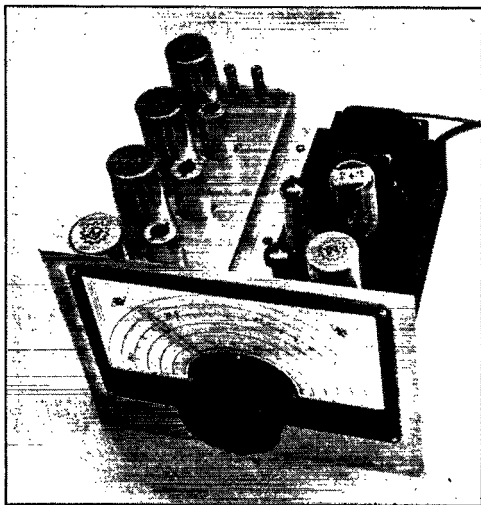

A 28-Mc. converter that uses fixed-tune r.f. stages and thus eliminates the ganging problem. The performance is excellent because of the use of 6AK5 miniature tubes.

• Here is a 28-Mc. converter that eliminates the tracking problem the easy way — by removing the tuning condensers from the r.f. stages. A simple band-pass amplifier is substituted for the r.f. channel, and the noise figure is kept low by using the hottest tube in the field, the 6AK5. The unit is a very useful adjunct to those surplus receivers that won't reach 28 Mc., and it will pep up the 10-meter performance of any pre-war receiver.

width well enough for most amateur communication purposes.

A Simple Pre-Amplifier

The concept of this converter came after a single broad-banded 6AC7 had been put ahead of an old Comet Pro receiver. The 6AC7 stage, with a tightly-coupled input circuit and with a plate circuit loaded with a 5000-ohm resistor, was broad enough to require no tuning over the 28-Mc. band, but when put ahead of the old receiver it brought in weak ground-wave voice signals that previously had manifested themselves only as weak carriers when the b.f.o. was turned on and the selectivity cranked up. This was possible because of the relatively poor signal to noise ratio in the Pro. The resultant enthusiasm prompted the more ambitious undertaking of a converter with no r.f. tuning, since it was felt that the elimination of tracking problems more than compensated for the additional complexity of a 4-tube converter plus power supply. However, for those who feel that the converter is too great an undertaking we suggest a little experimenting with broad-band 6AC7 or 6AK5 pre-amplifiers for their present receivers. One advantage of the converter, however, is that the operator requiring additional bandwidth for c.w. work has only to replace the oscillator coil — with appropriately larger padding condenser — and he is all set. Try to do something like that simply with a gang-tuned affair!

The Circuit

Ideally, the r.f. portion of this converter would be a band-pass filter centered on 29 Mc., exactly flat for plus or minus 1.25 Mc. and with very rapid attenuation beyond. Such a filter can only be achieved with many tuned circuits and is

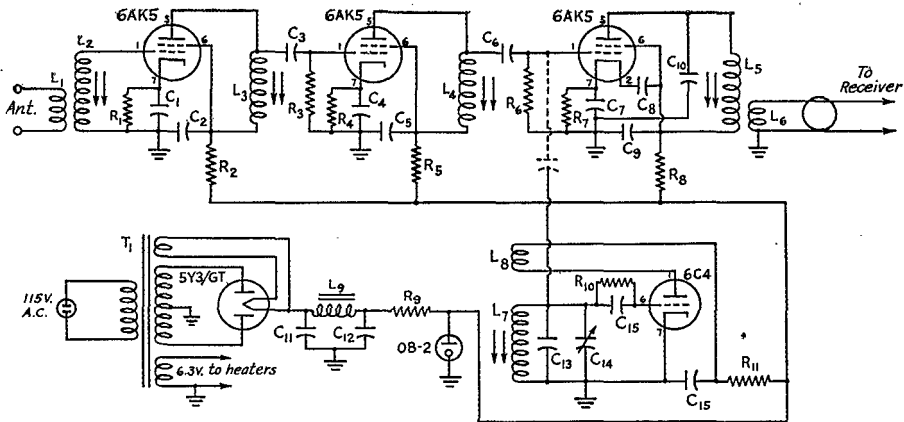

Fig. 1 — The circuit diagram of the high-performance converter.

- $C_1, C_2, C_4, C_5, C_7, C_8$ — 0.001- μ fd. postage stamp mica.
 C_3, C_6 — 100- μ fd., postage stamp mica.
 C_9 — 0.01- μ fd. mica.
 C_{10}, C_{13}, C_{15} — 51- μ fd. ceramic (Erie N150).
 C_{11}, C_{12} — 16- μ fd. 450-volt electrolytic.
 C_{14} — 11- μ fd. midget variable (Hammarlund HF-15 with one stator plate removed).
 L_1 — 7 turns No. 26 d.s.c. close-wound over ground end of L_2 .
 L_2 — 14 turns No. 24 enam., close-wound.
 L_3, L_4 — $8\frac{1}{2}$ turns No. 24 enam., close-wound.
 L_5 — 37 turns No. 26 enam., close-wound.
 L_6 — 9 turns No. 26 enam., close-wound and separated from L_5 by single washer thickness.
 L_7 — 7 turns No. 20 enam., close-wound.
 L_8 — 3 turns No. 26 d.s.c., separated from L_8 by single washer thickness.
 L_9 — 8-henry, 50-ma. filter choke (Stanco C-1279).
 R_1, R_4 — 180 ohms.
 $R_2, R_5, R_7, R_8, R_{11}$ — 270 ohms.
 R_3, R_6 — 6800 ohms.
 R_9 — 5000 ohms, 10-watts, wire-wound.
 R_{10} — 51,000 ohms, 1-watt.
 All resistors $\frac{1}{2}$ -watt unless otherwise indicated.
 T_1 — 300-0-300 volt, 50-ma. power transformer (UTC R-6).

hardly practical for the amateur — or most commercial production! — and so something more straightforward must be found. The next best would be double-tuned transformers, slightly overcoupled, but here again is something outside the scope of most home construction, and so we must resort to single-tuned circuits. However, the broad-banding is obtained by loading the circuits with resistors to decrease the Q, using a minimum of capacity for the same reason, and then “staggering” the circuits; i.e., tuning them to slightly different frequencies so that the resultant pass band is broad and nearly flat within the required range. The input circuit, from the antenna, must be broad, and this can only be obtained by heavy coupling to the antenna. However, this condition coincides with the condition for best signal transfer and is to our advantage. It is the antenna input circuit that is the big bugaboo in this work, and if one is working from an odd length of wire, or from any system that requires antenna tuning during transmission, it is necessary to tune the antenna for receiving. If one works from an untuned line — a so-called “flat” line — it will be easier to get the proper loading on the input circuit. This doesn’t mean that this converter is complicated and not worth the trouble — it means that your antenna coupling isn’t too adequate as it stands, and the only thing that saves it is the fact that the input stage is tuned, by the ganged condenser.

As can be seen from the wiring diagram in Fig. 1, the only tuning controls in the r.f. stages are the powdered-iron slugs of the coils. These are used to resonate the coils with the circuit capacities to the signal frequency. The loading resistors, R_3 and R_6 , also serve as grid returns for their respective tubes. The plate and screen voltage is the same on each tube, to reduce the number of bypass condensers, and filter resistors are used to prevent overall feedback through the common power lead. Another possible source of overall feedback is the heater circuit, and in this converter the “hot” heater lead to the input stage was run in shield braid to reduce the possibility of feedback. The only unconventional circuit element in the r.f. portion is C_8 , a 0.001- μ fd condenser found necessary to eliminate regeneration in the amplifier. As will be found when working on broad-band r.f. amplifiers, they have a tendency to be regenerative in many different ways, and often the only solution is to find a spot where an extra bypass condenser will cool down the system.

The oscillator is a straight plate-tickler type using a 6C4, and it is coupled to the mixer through a capacity shown as dotted lines in the diagram. Actually the coupling capacitor consists of a short length of wire near the grid of the mixer tube.

The output frequency is 7.3 Mc. approximately, and this is the frequency to which

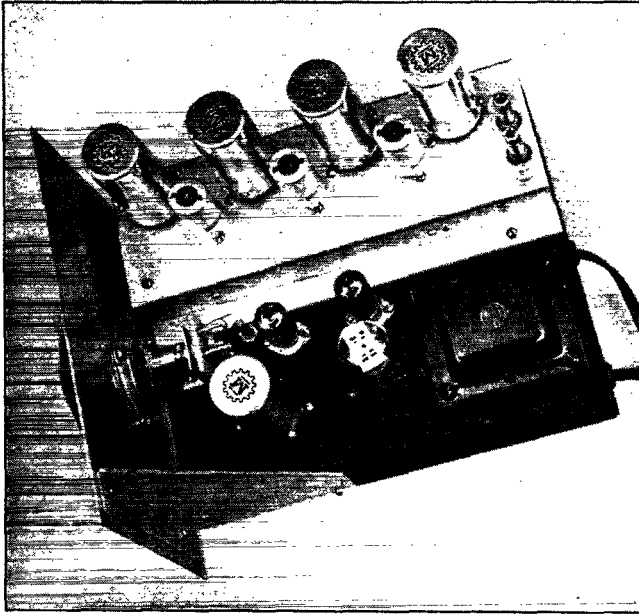

Another view of the converter showing the r.f. sub-chassis. Note the bracket on the tuning condenser, used to avoid backlash.

$C_{10}L_5$ is tuned. If a frequency slightly below 7.0 Mc. is used, there is a possibility that the fourth harmonic of the receiver high-frequency oscillator will find its way into the converter, resulting in a constant signal that has only nuisance value. A low-impedance shielded line feeds the 7.3-Mc. output into the communications receiver. The communications receiver furnishes the necessary selectivity.

The power supply is regulated, using the miniature equivalent of the VR-105, and the stabilized 105 volts is fed to all stages.

Construction

The r.f. stages and mixer are built as a separate unit on a strip of aluminum, as can be seen in the photographs. This wasn't done to be fancy, but rather to furnish a chassis in which the grounds were more certain than they would be on a black-crackled steel chassis, and it also gave a well-shielded amplifier when mounted on the steel chassis. The steel chassis is a standard 7-by 11-by 2-inch affair. A panel is used to support the National ACN dial, and to reduce metal

work on the steel chassis the panel is supported away from the chassis by an aluminum bracket on one side and by two of the screws that fasten the dial to the panel. Holes in the chassis allow access to the tuning slugs of the r.f. coils.

As first assembled, the tuning condenser was mounted on the chassis by the single hole in its bracket, but this inadequate support allowed too much backlash and so a small aluminum bracket was added that was fastened to the chassis by two screws and to the condenser by the shaft bushing. This resulted in a rigid mount that contributes considerably to the mechanical stability of the oscillator.

The construction of the aluminum channel is apparent from the photographs. It is 3 inches wide and $1\frac{1}{4}$ inches high, and is bolted to the side of the steel chassis and to the top. The arrangement of the components can be seen in the photograph of the strip. A small strip of bakelite, supported away from the side by screws and small spacers, is used to support the power-supply end of the filter resistors R_2 , R_5 and R_8 . The ends of the resistors are fed through small

The straightforward arrangement of the r.f. components is shown in this view of the sub-chassis. The straight side is screwed to the side of the chassis.

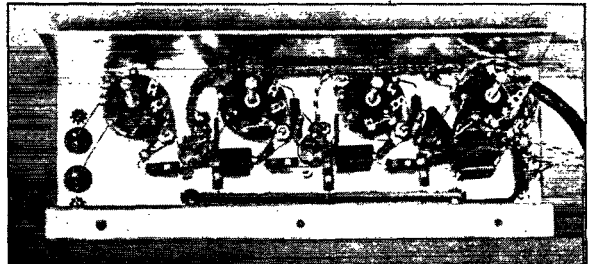

holes in the bakelite and then wrapped around the insulating strip before being soldered together.

In the heater circuits of the miniature tubes, pin 4 is grounded to a lug under the nut fastening the socket, and pin 3 is the "hot" heater lead. In the case of the input 6AK5, the hot heater lead was led back in shield braid, and the braid was grounded at the lug grounding pin 4, and to lugs at two other points along the way. These latter lugs are under the nuts fastening the sockets for L_3 and the output coil, L_5L_6 .

The cathode and screen/plate bypass condensers are grounded to lugs under nuts holding the sockets of their respective plate coils. Since it doesn't matter where the cathode resistors are grounded, they are returned to lugs under the coil sockets ahead of them. Pins 1 and 2 of the coil sockets are grounded to the lugs just mentioned, the No. 3 pins of the coil sockets for L_3 , L_4 and L_5 go to the plates of their respective tubes, and the No. 4 pins of the same sockets are connected to the screen pins on the tube sockets. The grid condensers, C_3 and C_6 , are tied from pin 7 on the coil sockets to the grid pins on the tube sockets.

The oscillator and power-supply wiring on the steel chassis is conventional, with the exception of the oscillator coupling condenser. A small National TPB bushing is mounted on the chassis where it will be parallel to the lead on the grid side of R_4 . This bushing is connected to the stator of C_{14} and the "hot" side of L_7 by a heavy wire, and coupling is obtained by the capacity between this bushing and the grid lead of the mixer stage. The output cable from L_6 is a length of RG-59/U 70-ohm cable. If one of the free points on the OB-2 voltage regulator tube socket is used as a tie point for C_{12} and L_9 , as was done in this case, be sure to clip off the pin on the tube. If this isn't done, a discharge will be obtained inside the tube, since the free pin projects inside the tube envelope and acts as an anode.

The coils for the converter are wound on the new Millen 74001 tuned plug-in coil form. The coils are started on the form about $\frac{1}{8}$ inch above the lower limit of travel of the iron slug. In the case of L_2 and L_4 , one end of the winding is connected to pin 4 and the other to pin 7. A jumper is then run from pin 7 to pin 3. This jumper has the effect of tapping down the plate on the coil, since the jumper has some reactance at these frequencies. In the case of the oscillator coil, the padding condenser, C_{13} , is mounted inside the coil, although it could be mounted on the coil socket. The tickler, L_8 , is wound on the form away from the slug end. The mixer output capacitor, C_{10} , is mounted on the socket. All coils are securely fastened with coil dope, and this is particularly important in the case of the oscillator coil assembly, to insure long-time stability.

Alignment

After the wiring has been completed and checked, the oscillator should be tested. This will require a receiver capable of tuning around 21 Mc. or an absorption wavemeter in the same range. Lacking either of these, put a voltmeter across R_{11} and see if the voltage increases slightly when you touch the grid of the oscillator tube. If it does, it shows that the circuit is oscillating, and you can tune to frequency with the iron slug.

Couple the output of the converter to your communications receiver on 7.3 Mc. and tune the slug of L_5 for maximum noise in the receiver, with power to the converter. You will now need some kind of 28-Mc. signal with which to establish your oscillator frequency accurately, and this

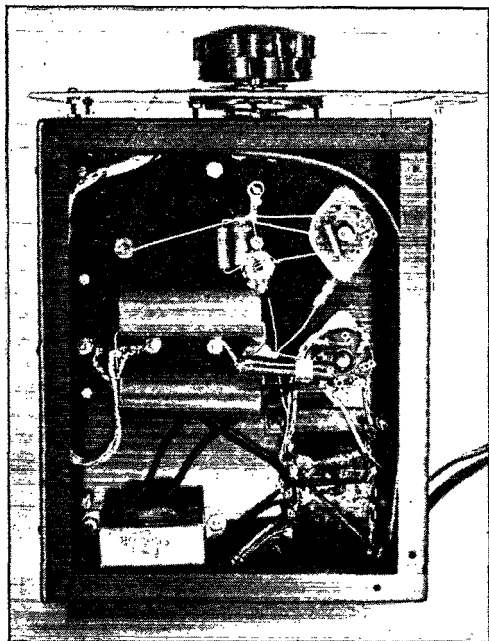

A view underneath the chassis shows the polystyrene bushing used to couple from the oscillator to the mixer. The panel is mounted away from the chassis to simplify mounting of the dial. The tuning screws of the r.f. coil can be seen projecting through holes in the chassis.

signal can be a harmonic from your transmitter or a test generator you borrow. Assuming a signal source of, say, 28.5 Mc., set the tuning dial to about 35 and adjust the slug on the oscillator coil until the signal is heard. Short the input of the receiver with a carbon resistor equal in value to the impedance of your antenna line while doing this — if you use a tuned line a value of 300 ohms is a fair compromise value. Having established your tuning range — and checked it at other points if available — peak L_2 , L_3 and L_4 on noise. You will find L_2 is very broad. Now tuning

(Continued on page 116)

Crystal Grinding Without Tears

Helpful Hints on Bringing Blanks to Frequency

BY FRANCIS R. COWLES,* WIAOK

BEFORE making crystals professionally, the author's feelings about crystals were probably the same as those of most hams. Eventually daring to open some of my commercial crystals, I decided to grind one of them to a higher frequency. After a terrific struggle the frequency was finally raised — so high that the crystal was never used again!

In the past three years I have learned enough about grinding crystals to know that it is possible to get into lots of trouble grinding your own. The only way to be a crystal maker is to work at it. However, it is hoped that the following information will help the average ham to grind his own crystals, although it does not guarantee to show you how to get all your blanks on frequency with good activity. If anyone reading this does know how to do this I would like to hear from him.

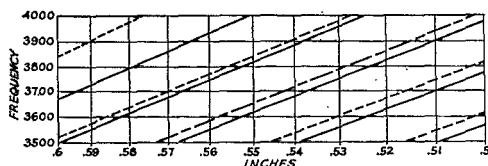

Fig. 1 — A crystal dimensional chart, showing frequencies at which harmonics of low-frequency vibration modes occur as a function of the dimensions of the crystal blank. X and Z harmonics are shown by solid and dashed lines, respectively. The crystal dimensions should be chosen so that the length and width do not fall on one of the lines at the desired frequency, because coupling between the various modes causes erratic operation with temperature changes and is accompanied by a drop in activity. This chart is given for illustrative purposes only, since the dimensions at which couplings occur will be modified by slight variations in the angle of cut, parallelism of faces, whether or not the edges are beveled, etc. (Adapted from a chart prepared by the Franklin Engineering Co.)

Page 58 of the 1945 *Handbook* gives an elementary idea about what crystals are and how they work. Most ham crystals are now either AT or BT cuts, and *Handbook* Fig. 262-A shows just how these two cuts oscillate. However, there are other vibration modes which can couple to the shear mode and cause interferences which prevent oscillation. The dimensional chart, Fig. 1, shows how these interfering modes can be avoided by using proper dimensions. Since these charts are based on computations it is usually necessary to check them by dimensioning and temperature-testing a few crystals to determine the extent to

• Whether or not you acquire some government surplus crystals, there usually comes a time when you want to move a crystal to what seems to be a greener spot in the band. You'll get there with fewer tribulations if you have some idea of what crystal grinding is all about. Here is some good dope from a ham who is associated with a well-known crystal producer.

which practice deviates from theory. The regions on the chart which are shown to be clear of interfering modes are usually explored before cutting blanks because in mass production the only way to get a practical percentage through the temperature test is to pre-dimension all crystals. For practical purposes, however, usable activity at room temperature is all that is required in an amateur transmitter because temperature changes are of small magnitude.

A good crystal-grinding layout for hams should have several components. The first necessity, of course, is a flat piece of plate glass, usually about four inches square. In order to keep the crystal flat a "button," also of plate glass, is necessary; it may be either round or square and should be slightly larger than the crystal blank, as shown in the photograph. Both plate and button can be obtained at the local glass store. Two grades of abrasive, No. 303 emery for surface grinding and No. 600 carborundum for edge grinding and beveling, are ideal. These can usually be obtained at a hardware store or at an opticians' supply house. A small paint brush is handy for moistening the abrasive and spreading it around the lapping plate. For those hams who have a micrometer and like to use it, the formula on Page 58 of the 1945 *Handbook* tells how to find the frequency when the thickness and constant are known. (The constant for BT quartz is 101.5.) A micrometer isn't really a "must" in grinding crystals; if you know the approximate frequency of your blank, all you need is your crystal oscillator and a receiver. The receiver, of course, should cover the frequency at which you will be working.

Because frequent checking of activity and frequency are necessary while grinding the crystal, it is wise to provide a test holder and clip to make this process as rapid and easy as possible. A simple one made from an FT243 holder is

* c/o Crystal Research Laboratories, Hartford, Conn.

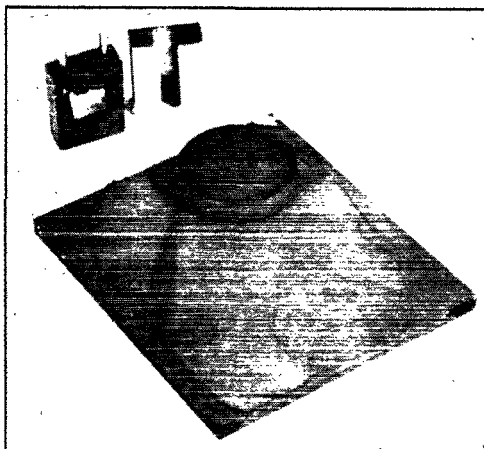

The equipment necessary for grinding a crystal blank to frequency. A piece of plate glass and a "button" of the same material are essential. The "quick-change" adaptation for the crystal holder is a convenience. Not shown, but also convenient, are a small paint brush for spreading abrasive and a toothbrush for scrubbing.

shown in the photographs; it is made by substituting a sliding cover for the screw-on cover plate. The sliding cover is nothing more than a rectangular piece of sheet copper or brass bent to fit around the holder as shown. Crystals can be interchanged, with this cover, in a matter of a few seconds. For other type holders similar clips can be easily made from an old piece of aluminum or sheet tin.

Soap and warm water and a tooth brush are used to clean and rinse the crystal. In crystal shops clean compressed air is used to dry the crystal and electrodes, but for home grinding lintless cloth from an optician's, or at least a clean towel, can be used.

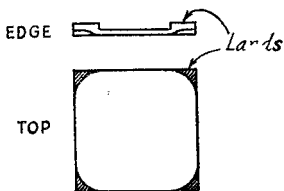

Fig. 2 — The $\frac{1}{2}$ by $\frac{1}{2}$ inch electrodes used in modern crystal holders, showing the lands at the corners between which the crystal is firmly held.

Present-day electrodes have raised lands on each corner, as shown in Fig. 2, and the crystal should lie at least half-way across these lands and should not be larger than the electrode. The electrodes should be cleaned as carefully as the crystal. Before final assembly both crystal and electrodes should be handled carefully by the corners or edges after their last good scrubbing.

How to Grind

The actual grinding is done as follows: Spread the 303 abrasive over an area about a half inch

square on your lapping plate, wet the brush, mix water into the spot and spread the abrasive over the lapping plate. Always keep the abrasive moist. Take the button and put a drop of water at its center, and press a dry blank over the drop of water. There should be just enough water in the drop so that it squeezes out under the edges of the blank, where it is wiped away. Place the button, blank down, on the emery and put the index finger in the center of the button. Use just enough pressure to move the button in a figure-8 pattern. This motion is used because it seems to balance the hand directly over the button and helps keep the blank flat.

After grinding through ten or fifteen "8s" the blank should be rechecked for frequency and activity. The blank's activity is a term used in crystal making to describe how strongly a crystal will oscillate. In ham gear this might be indicated by the magnitude of the dip in the plate current, grid current to the next stage, or rectified grid current in the crystal oscillator. It is nearly impossible to tell how much change in frequency will occur during the grinding of a crystal, because pressure on the button, the amount of abrasive, and the area of the "8" all will vary the frequency. The frequency change probably will be between 200 and 1000 cycles per "8," using a 7-Mc. crystal. The crystal can be moved along faster as the operator becomes more familiar with the technique, but for the beginner frequent checks of activity are in order so that any drop can be corrected.

To grind a crystal successfully the activity must be good when the crystal is brought to the desired frequency. There are several ways to raise the activity. Assuming that, with careful grinding on a flat plate with a flat button, the two faces of the crystal are parallel, the major cause of low activity will be dirt or moisture on the crystal or electrodes. Before checking activity the crystal should be scrubbed carefully with the tooth brush, using warm water and soap. Wipe the crystal clean and be sure that the electrodes are clean and dry. If the activity is still down the next thing is to bevel all eight edges of the crystal, as shown in Fig. 3. The beveling can be done with either fine or coarse abrasive, but is usually more effective with the coarse. Beveling, incidentally, will also raise the frequency because of the quartz ground off during the process.

Although beveling will usually improve the

Another view of the crystal holder, showing the assembly.

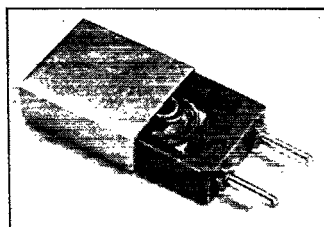

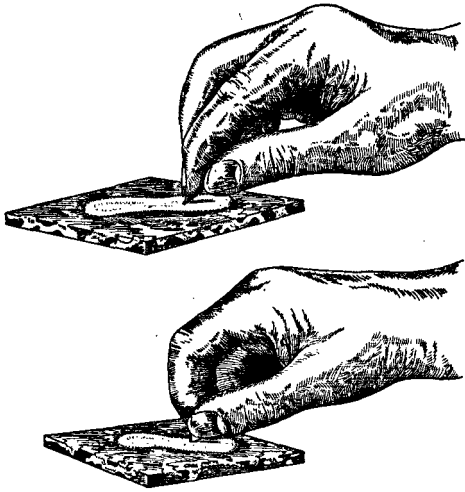

Fig. 3 — Beveling and edge grinding.

activity, another method — and probably the simplest — is to change electrodes. The land heights on the electrodes have a critical effect on activity. This is attributable to two things: the capacity across the electrodes, and the reflection of supersonic waves which are given off by the crystal and reflected by the central portion of the electrode. These supersonic waves are caused by the flexure or rise and fall of the center of the crystal as it vibrates in the shear mode. If the center of the crystal becomes too high and the lands are so low that the center of the crystal touches the center of the electrodes, the crystal will stop oscillating.

The last step and the most drastic method of raising activity is to edge-grind adjacent edges, as in Fig. 3. This grinding is best done with coarse abrasive and should be followed by a slight bevel to remove any chips which may remain. The author uses the figure-8 motion for both beveling and edge grinding to keep the bevel even on all sides and to keep the sides parallel. By checking the crystal frequently, a drop in activity can be corrected by the above methods. If the crystal is ground too far and goes completely dead, the frequency may be too high when the crystal is again active.

Since the author is a ham, the gear in which the crystals were checked was also taken from the 1945 *Handbook*. Two crystal oscillators were built as recommended, one a 6L6 pentode oscillator and the other a 6L6 Tri-tet. The circuits used are given on pages 97 and 98, the only difference being that in the author's gear the plate voltage was 450. These two oscillators were arranged so that either one could be used to drive an 807 final which was also built as per ye old *Handbook*. Thus, with no trick circuits or special gear the crystals were ground just as any ham

probably would go about it. With a 150-ma. pilot bulb to protect the crystal the rig was put on the air. Allowing for a rusty fist the signal was clean-cut and all that could be asked of a crystal. Seven-Mc. crystals were used. With the pentode oscillator on 7 Mc. and the 807 on 14 Mc. the rig worked fine — with a dummy load. In the Tri-tet oscillator the 7-Mc. frequency was quadrupled and the 807 worked as an amplifier on the 28-Mc. band. Many contacts were made and reports indicated that the signal was still keying well and according to the best ham technique. Standard 14-Mc. crystals were used in the pentode oscillator with the 807 doubling to 28 Mc. and still putting out a good signal. For the average amateur, 14-Mc. crystals are rather difficult to grind as they are touchy things to handle, but it is not difficult for any ham to grind his own 3.5- and 7-Mc. crystals. When a crystal was on frequency it was tried in the rig. In all cases each crystal was made to work by the recommended methods for improving activity and obtaining the necessary drive.

Finally, there should be a word of warning about out-of-band operation. The mounted crystal should be tested for stability of mechanical assembly before the transmitter is put on the air. This can be done by rapping the holder several times on the edge of the table. Another method is to drop the crystal from a height of about a foot on to a hardwood surface. If any change in frequency can be observed the holder should be taken apart and reassembled. In modern holders the spring may cause instability if it is not seated properly. If good frequency-measuring equipment is not available, do not try to crowd the edges of the band. Changes in frequency in the order of 500 cycles can occur between various oscillators, and smaller changes are possible in tuning. If you must crowd the band edge, get another ham who has accurate measuring gear to check your frequency. Grinding your own crystals can be lots of fun, and you can have the freedom of a v.f.o. without the danger of a pink ticket.

Strays

W. Offutt, LSPH, sent us the following list of ham calls found scratched on a pillar in the Chambers Street (NYC) subway station — W2NGF, W2NGV, W2AGB, W2MXQ, W2AJJ, W2OMU, W2JCD, W2ONX, W2MCA and W2KEY.

What? No DX!

— . . . —

Lt. Col. J. H. DeWitt, W4ERI, appears to have set a new DX record for 2½ meters when he bounced those radar signals off the moon on January 10th. *QST* expects to present soon the complete story on this historic event, written by one of the amateurs who participated in Project Diana at Camp Evans.

Flexible Coaxial Cable

New Developments in Solid-Dielectric Lines

BY RINGLAND M. KRUEGER*

MANY electrical components were improved considerably during the accelerated development and production programs of the war, and modern semi-flexible solid-dielectric coaxial cable is an outstanding example. Expedited by the close joint coöperation of the various manufacturers and the armed forces, under the leadership of the Army-Navy R.F. Cable Coördinating Committee, a number of types were developed and produced in large quantities, to the close mechanical and electrical tolerances necessary for full interchangeability of sections of like type designation. These cables had to withstand the extreme cold encountered at high altitudes, the terrific heat in mobile equipment stationed on a desert or on a South Pacific island, the bending experienced in the turret of a tank or the scanning radar antenna in a bomber, and the terrific shock when mounted on a battleship firing a full salvo.

The first flexible coaxial cable was made with bead spacers, but there was always the definite danger of moisture collecting within the cable and seriously reducing the breakdown voltage. For example, when a fighter plane or bomber climbs rapidly from near sea level to a high altitude, the temperature of the plane may drop as much as 100 degrees F. in a matter of minutes, and this sudden reduction in temperature causes condensation of any water vapor present in the air within the cable. It was, therefore, imperative that a solid-dielectric coaxial cable be developed, to eliminate all air spaces between the center conductor and shield. The first solid-dielectric semi-flexible cable, meeting the electrical and mechanical requirements of the Services prior to Pearl Harbor, used a dielectric called "copolene." Early in the war, through the joint coöperation already mentioned, "polyethylene" was developed and adopted as the dielectric material.

Polyethylene has a host of desirable characteristics as a dielectric for solid coaxial cables. It is very flexible under extreme cold and readily passes a cold bending test at temperatures as low as -40 degrees C. It has a high softening point and will withstand temperatures as high as 185 degrees F. Of paramount importance, however, is its excellent low power factor of 0.0003 to 0.00045 and its dielectric constant of 2.29, the combination of which produces a desirable low loss factor. Polyethylene is not affected by acids, alkalis, aviation gasoline, oil, hydraulic brake fluid or sea water. There is no known solvent for

• Many a ham was impressed during the war with the wonderful advances that were made in flexible coaxial cable, and many a ham now has an eye on some for his new or revamped rig. Here is a story for the fellows who didn't have a chance to become acquainted with it during the past few years.

polyethylene at ordinary temperatures. From an electrical standpoint, polyethylene is almost comparable to polystyrene and it has the advantage of flexibility. Solid polyethylene coaxial line has more constant impedance than washer-spaced lines, because the dielectric material is homogeneous and of constant diameter over the entire length of the cable.

The center conductor of solid coaxial cable is made of either solid or stranded copper wire, and in some lossy applications a nichrome-wire inner conductor is used. A polyethylene sheath is extruded over the inner conductor, and several inspections are made to insure constant diameter and permissible eccentricity. The eccentricity is tested by X-ray methods and is held below 10 per cent. For the smaller cables, this is only 0.0055 inches!

The outer conductor is then woven over the core. This conductor is usually one or two layers of bare copper braid, but for some special applications the braid is made of tinned-copper or of a silver-coated braid covered with a plain copper braid. The braid in turn is covered with a vinylite jacket. Vinylite — or "vinyl" — is a plastic material that is unaffected by oils, gasoline, hydraulic brake fluid, water or sunlight, and its weatherproof qualities have proved themselves many times in the past few years. Some cables for military applications are made with an additional steel-braid armor jacket over the vinyl, but these are of limited interest to amateurs.

One great advantage of solid coaxial cables like those described above is that they are very easy to install, and can even be buried in the ground without additional treatment. Extended tests on cables buried underground for fifteen months, in a naturally low spot where water or frost was a constant threat, showed no ill effects on the cable either mechanically or electrically. Actually, no change in the electrical characteristics could be detected with very precise measuring equipment.

* American Phenolic Company, Chicago, Ill.

TABLE I — LIST OF STANDARD COAXIAL CABLES

Class of Cables		Army Navy Type Number	Inner Conductor	Nominal Diameter of Dielectric (Inches)	Nominal Overall Diameter (Inches)	Weight Pounds Foot	Nominal Imped- ance Ohms	Nominal Capaci- tance $\mu\text{F.}/\text{Ft.}$	Attenuation in db. per 100 ft.		Max. Operating Voltage Rms	Remarks
									50 Mc.	100 Mc.		
50-55 ohms	Single Braid	RG-58/U ¹	20 A.W.G. Copper	0.116	0.195	0.025	53.5	28.5	2.0	4.1	1900	General purpose small size flex- ible cable
		RG-8/U	7/21 A.W.G. Copper	0.285	0.405	0.106	52.0	29.5	1.0	2.1	4000	General purpose medium size flexible cable
		RG-17/U	0.188 Copper	0.680	0.870	0.460	52.0	27.5	0.37	0.85	11,000	Large high power low attenu- ation transmission cable
		RG-19/U	0.250 Copper	0.910	1.120	0.740	52.0	29.5	0.31	0.70	14,000	Very large high power low at- tenuation transmission cable
	Double Braid	RG-55/U ²	20 A.W.G. Copper	0.116	Max. 0.206	0.034	53.5	28.5	2.0	4.1	1900	Small size flexible cable
		RG-5/U RG-14/U	16 A.W.G. Copper 10 A.W.G. Copper	0.185 0.370	0.332 0.545	0.087 0.216	53.5 52.0	28.5 29.5	1.4 0.66	2.7 1.4	2000 5500	Small microwave cable General purpose semi-flexible power transmission cable
70-80 ohms	Single Braid	RG-59/U	22 A.W.G. Copperweld	0.146	0.242	0.032	73.0	21.0	1.9	.7	2300	General purpose small size video cable
		RG-11/U	7/26 A.W.G. Tinned Copper	0.285	0.405	0.096	75.0	20.5	0.93	1.9	4000	Medium size, flexible video and communication cable
	Double Braid	RG-6/U ³	21 A.W.G. Copperweld	0.185	0.332	0.082	76.0	20.0	1.4	2.7	2700	Small size video and i.f. cable
		RG-13/U	7/26 A.W.G. Tinned Copper	0.280	0.420	0.126	74.0	20.5	0.93	1.9	4000	I.F. cable
Low Capacitance	Single Braid	RG-62/U	22 A.W.G. Copperweld	0.146	0.242	0.0382	93.0	13.5 Max. 14.5	1.6	3.0	750	Small size low capacitance air- spaced cable
		RG-63/U	22 A.W.G. Copperweld	0.285	0.405	0.0832	125	10.0 Max. 11.0	1.1	2.0	1000	Medium size low capacitance air- spaced cable
	Double Braid	RG-71/U ⁴	22 A.W.G. Copperweld	0.146	Max. 0.250	0.0457	93.0	13.5 Max. 14.5	1.6	3.0	750	Small size low capacitance air- spaced cable for i.f. purposes
Twisting Application	Single Braid	RG-41/U ⁵	16/30 A.W.G. Tinned Copper	0.250	0.425	0.150	67.5	27.0	4.6	10.0	3000	Special twist cable

All cables use copper braid and vinyl protective covering unless otherwise noted.

¹ Tinned copper shielding braid.

² Tinned copper shielding braid and polyethylene protective covering.

³ Shielding braid: inner — silver coated copper; outer — copper.

⁴ Shielding braid: inner — plain copper; outer — tinned copper. Polyethylene protective covering.

⁵ Tinned copper shielding braid and neoprene protective covering.

Velocity factor is a term used to describe the decrease in velocity of transmission in a coaxial cable and is expressed as a percentage of the velocity in free air. In other words, if r.f. energy has a wavelength of 100 cm. in air and only 66 cm. in coaxial cable, the velocity factor is 0.66. A method of determining this factor is to select a piece of cable and connect a small half loop between the inner and outer conductors at one end of the cable, leaving the other end of the cable open. The half loop is then coupled to a grid-dip meter and the lowest frequency is found that will dip the meter. The cable is an electrical quarter wavelength at this frequency, and the velocity factor can be computed from

$$F = \frac{f \times L}{246}$$

where F = velocity factor
 f = frequency in Mc.
 L = length in feet

If the far end is short-circuited, the length becomes a half wave and the above formula requires a constant of 492 instead of 246. The coupling loop must be made as small as possible consistent with sufficient coupling to the grid-dip meter, or else a small error will be introduced. Incidentally, this grid-dip meter method is an excellent one for checking the electrical length of a quarter-wave piece of coaxial line used as a matching transformer between the radiator in a close-spaced array and a higher-impedance transmission line.

Coaxial cables suitable for feeding antennas are available in impedances of 50 and 70 ohms. Wide variations in physical size and power capabilities are available, as can be seen from Table I, a compilation of the standard cables now available and most likely to be used by amateurs. The proper selection of cable types depends upon the requirements, such as the operating frequency, desired impedance, power level and the length of the cable run (attenuation).

A low-capacity line is available. It has a novel type of construction that uses a small thread of polyethylene spiralled around the center conductor to act as a supporting medium in a tube of polyethylene. The conventional shield braid is placed over this, along with the normal jacket. This particular type of line is used where low capacity and not constant impedance is the important factor.

"Twin Lead" Parallel Line

A new development of great interest to the amateurs who have tested it is Amphenol's polyethylene insulated "twin-lead" line, which is manufactured in impedance values of 300, 150 and 75 ohms. The 300-ohm line was brought out under recommendations of the R.M.A. as a standard impedance for use with television and fac-

simile receivers. Amateurs, always quick to adopt new ideas, have utilized "twin-lead" for feeder applications in the bands now open.¹ This line was not brought out with the thought in mind of supplying the amateurs with a transmission line, but reports have been received indicating successful performance of the 300-ohm line with 500 watts of power at 30 Mc., where the standing wave ratio was less than 2 to 1. The attenuation of the 300-ohm line is 0.88 db. per 100 feet at 30 Mc., and its velocity factor is 0.82. This line is excellent in dry weather, but being an open type of line some change in impedance is to be expected when frost, condensation, or rain collects on the line, or when it is run closer than several inches to metallic objects.

It is therefore recommended that, for the best all-around operation in any type of weather, a coaxial line be used in place of any parallel-wire type of line. However, many amateurs may feel that the lower-priced "twin-lead" line will be satisfactory for his operations, and this is quite true provided he is familiar with its limitations.

Coaxial cables have been used very extensively throughout the entire war period and have been most satisfactory under all possible conditions. It is felt that the amateur will use more coaxial cable for links between the various stages of his transmitter and for his antenna feed. He will find that he has not only an excellent antenna set-up, but that regardless of weather conditions he will not be bothered by flash-over of his feed line while "on the air."

Strays

Having heard and read much about the famous "doorknob" for v.h.f., we decided to try it. We removed the knob from our door and substituted it for the HY75 in our pet oscillator. Vast improvements were immediately noted, among which were:

- 1) Remarkable lack of spurious radiations such as sidebands, parasitics, and harmonics.
- 2) Stability under modulation.
- 3) Constant power output and stability over the entire tuning range.
- 4) No overheating of the doorknob even under heavy load.
- 5) Circuit constants not critical for normal operation — therefore likely to give same results even for beginners.

Before you try it, however, make sure your power supply can take it, as the power consumption is rather excessive. The theory of operation is beyond the scope of this paper. Suffice it to say that by judicious use of relativity theory, calculus of variations, and advanced bugging we became convinced that this apparatus was the most sensible way of going insane since the invention of the regenerative receiver.

— Victor Mayer, jr.
 — Fred Kann

¹ Mix, "A Low-Power 28-Mc. 'Phone-C.W. Transmitter," QST, March, 1946.

The Postwar Naval Reserve

Organization of the Communication and Electronic Components

BY LT. COMMANDER STUART D. COWAN, JR., USNR, W2DQT *

TOP-RANKING naval officers are cognizant of the vital role played by radio amateurs in World War II and are counting on the hams for know-how, enthusiasm and leadership in the communication and electronic components of the postwar Naval Reserve. The Navy intends to do its part by providing training ships, buildings, modern equipment, funds, publications, training plans and active supervision of reserve activities through a new, streamlined organization.

The veterans of World War II will form the backbone of the Naval Reserve during the next few years, after which they will be replaced gradually by younger men. Officers are automatically members of the reserve after separation; enlisted men must enroll in class V-6, USNR, for inactive duty. WAVES are included in the reserve program — particularly in communications!

A progressive program for promotion and advancement of personnel is planned and time in the reserve counts toward longevity benefits in higher pay. All members are eligible for a two-week active duty period, cruise or equivalent, with pay, on a quota basis. Weekend cruises aboard combatant ships will be available at coastal ports.

Basic Organization

The organization of the new Naval Reserve bears little resemblance to that of the prewar reserve. A rear admiral, USN, in the Bureau of Naval Personnel, Washington, is the Director of Naval Reserve; Rear Admiral John E. Gingrich, USN, has been appointed the first DNR and has on his staff personnel versed in communications and electronics, including radio amateurs. Reserve training will take place in all naval districts except the 10th (Caribbean), 15th (Canal Zone), 16th (Philippines), and 17th (Alaska). In each district, except those listed, a captain, USN, assigned as District Director of Naval Reserve, will supervise reserve activity.

The Naval Reserve is divided into two prin-

* c/o Cowan & Dengler, Inc., 527 Fifth Ave., New York.

cipal groups — the Ready Reserve and the Standby Reserve, both of which include air, surface and specialist components and constitute one unit in the over-all U. S. Naval Reserve.

The Ready Reserve, to be maintained in a high state of training, will consist of 175,000 men and 25,000 officers and be available for immediate mobilization in time of emergency. This group will drill one night a week for a two-hour period and take a two-week cruise or training duty each year. *Members may be ordered to active duty only with their consent in time of peace.* Communication and electronic personnel in the Ready Reserve will be trained in Ready Reserve armories.

The basic unit in the Ready Reserve is the division. It is to be made up of 13 officers and 200 enlisted men.

The Standby Reserve is not limited in size and will be composed of officers and men unable to devote as much time to the reserve as members of the Ready Reserve. They will be encouraged to attend instruction periods and take part in Ready Reserve activities on a voluntary basis; members of this group will have an opportunity to transfer to the Ready Reserve. Through the establishment of communication companies



Rear Admiral John E. Gingrich
Director of the Naval Reserve

• Here is your first look at the tentative plans for the new Naval Reserve. Congressional action is necessary before any plan becomes a reality. The author participated in Navy Department planning for the establishment of the communication and electronic components of the postwar Naval Reserve, and this article states his understanding of present plans. It must be pointed out that changes in elements of the described plans may be made prior to final approval. Accordingly, we shall have a further article describing final plans as soon as known. *QST* will welcome comment on this article.

and communication platoons, provision has been made for large-scale participation in communication drills by the Standby Reserve; communication equipment for these units is in storage awaiting distribution.

The Ready Reserve will receive one day's base pay per drill; members of the Standby Reserve will receive the same pay for drills they attend.

In order to maintain the Ready Reserve within age brackets which insure physical fitness for arduous sea duty in time of emergency, plans call for a turnover of personnel between reserve units.

Various branches of the Navy Department interested in maintaining direct, active liaison with their specialist personnel are being encouraged by the DNR to work out plans for its accomplishment.

Other divisions of the reserve are the Merchant Marine Reserve, Fleet Reserve, NROTC units and Honorary Reserve.

The Ready Reserve is to be organized in 758 divisions, each composed of 13 officers and 200 men. Each group of not more than four divisions which utilizes the facilities of one armory will be grouped in a battalion under the command of a reserve commander or captain.

Ready Reserve armories will be equipped with engineering, bridge and CIC mock-ups, classrooms, guns, radars, electronic maintenance facilities and complete radio installations. Also under consideration are: use of fleet training centers and other regular Navy facilities; use of vessels of the Reserve and Inactive fleets; location of ships in cities on inland waterways to be used as armories. If a unit is located on navigable waters a vessel will be provided for underway training.

It is planned to distribute a magazine containing reserve news and articles of general interest to members of the reserve.

Communication Organization

The Naval Reserve Communication System includes a comprehensive chain of radio stations linking naval districts with Radio Washington, and district stations with armory, company and platoon stations within the district. The NRCS will handle reserve traffic, drill messages, and will tie in with amateur emergency nets and serve as an alternate to the Naval Communication Service in the event of a major casualty.

Twelve district radio stations control reserve communications in as many districts. No instruction of reserve personnel will take place at district stations — they are operating stations only.

It is planned to operate fourteen alternate district stations, one in each district except the 9th (Middle West) and 12th (West Coast) — which require two each because of their size. Alternate district stations assist district stations and assume control in the event of a material breakdown.

Each of the two hundred and fifty Ready Reserve armories will maintain a large, well-equipped radio station operating in the armory net under the control of a district station. The armory station controls communication company and platoon stations netted with it. Armory station equipment is to be used for extensive formal instruction in operation and maintenance.

Nine hundred communication companies and five thousand communication platoons allow for large volunteer participation in communication

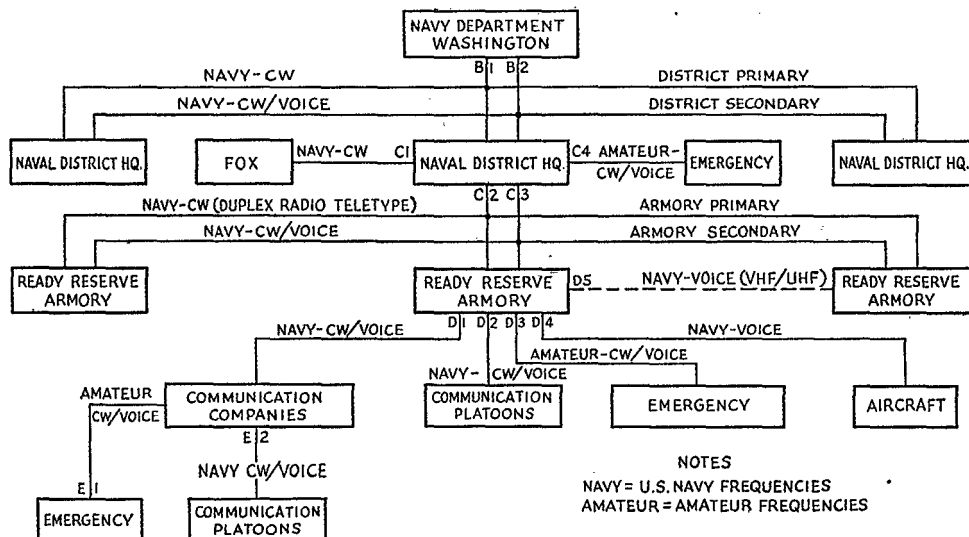

NOTES
 NAVY = U.S. NAVY FREQUENCIES
 AMATEUR = AMATEUR FREQUENCIES

TENTATIVE COMMUNICATION CIRCUITS FOR POSTWAR U.S. NAVAL RESERVE

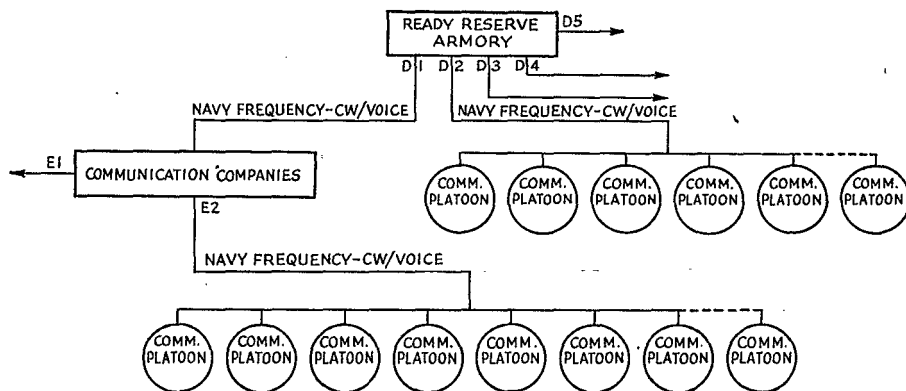

PROPOSED RELATIONSHIP OF COMMUNICATION PLATOONS TO READY RESERVE ARMORIES AND COMMUNICATION COMPANIES

activities by the Standby Reserve. These organizations are linked for purposes of drills and administration to Ready Reserve units and are an integrated part of the reserve program. They will be organized from Standby Reserve personnel: (1) on the waiting list for the Ready Reserve; (2) who wish to remain in the Standby Reserve; (3) in outlying areas without access to armory facilities. The complement of a communication company will be approximately 3 officers and 15 men. The communication platoon will be approximately 1 officer and 5 men. The formation of each unit will be determined on the merits of the case. It is expected that hams will be represented prominently in these units. Women's Reserve personnel will be encouraged to form companies and platoons.

Company stations will be controlled by armory stations and in turn will control platoon stations netted with them. Platoon stations operate under either a company or an armory station. These units are to be located in suitable places which can be locked up when not in use.

Communication Circuits

The function of most of the projected circuits is clear from the diagram but a few remarks are in order. Circuit C1 is an automatic Fox broadcast to reserve activities in each district; C2 is a duplex radioteletype circuit from District Directors to battalion commanders; C3 is an armory secondary to be used on voice in conjunction with CIC problems. C4, D3 and E1 are emergency circuits. D4 is an h.f. or v.h.f. voice circuit to aircraft used in CIC problems; D5 provides inter-armory communications for exchange of CIC problem information in cities which have more than one armory.

It is planned to hold communication drills between fleet units at sea and reserve radio stations. Navy frequencies are to be used throughout except for emergency circuits. Navy call signs

starting with "N" will be used on c.w. circuits except when reserve stations enter amateur bands for emergency communications, when amateur calls are to be used. At a future date, amateurs may obtain copies of the District Reserve Call Sign Book by writing to the District DNR. Extensive voice radio drills, using special voice calls, will be conducted.

Equipment Allowances

Electronic equipment allowances for the reserve have been approved and most of the material is already stored pending distribution. Allowances are generous and include frequency meters, test equipment, repair kits, tools, crystals and typewriters in addition to transmitters and receivers. Transmitter and receiver allowances are as follows:

District and alternate district stations:

- 2 H.f. transmitters, 400/500 watts, A1, A3
- 2 H.f. transmitters, 100/500 watts, A1, A3
- 1 L.f. transmitter, 100/500 watts, A1
- 1 H.f. transmitter and receiver unit in a truck for emergency communications (Army SCR 399 or Navy equivalent)
- 4 H.f. receivers, 2-20 Mc.
- 2 H.f. receivers, 4-20 Mc.
- 2 H.f. receivers, 2-4 Mc.
- 1 L.f. receiver
- 1 Radioteletype assembly, complete
- 1 Automatic tape transmitting assembly

Armory stations:

- 1 H.f. transmitter, 400/500 watts, A1, A3
- 2 H.f. transmitters, 100/500 watts, A1, A3
- 1 L.f. transmitter, 100/500 watts, A1
- 1 H.f. transmitter and receiver, semi-portable, Model TCS
- 1 L.f.-h.f. transmitter and receiver unit, portable, Model MM (TBW-RBM)
- 2 H.f. transmitter and receiver units, portable, Model TBX
- 5 V.h.f. transmitter-receiver units, portable, Model TBY
- 1 V.h.f. transmitter, Model TDQ
- 3 H.f. receivers, 2-20 Mc.
- 1 H.f. receiver, 4-20 Mc.
- 1 H.f. receiver, 2-4 Mc.
- 1 L.f. receiver

- 1 V.h.f. receiver, Model RCK
- 1 Radioteletype assembly, complete

Communication company stations:

- 1 H.f. transmitter, 100/500 watts, A1, A3
- 1 H.f. transmitter and receiver, semi-portable, Model TCS
- 1 H.f. transmitter and receiver unit, portable, Model TBX
- 2 H.f. receivers, 2-20 Mc.
- 1 L.f. receiver

Communication platoon stations:

- 1 H.f. transmitter and receiver, semi-portable, Model TCS
- 1 H.f. receiver, 2-20 Mc.

Model letters indicate the type of equipment requested but the Bureau of Ships, in certain cases, has substituted similar equipment. Power ratings, where given, refer to output.

Naval Reserve Air Stations have been allotted an ample supply of all types of aviation communication and electronic equipment — enough to make a ham's mouth water and fill two pages in *QST!* Electronic workshops to train Electronic Technician's Mates (ETMs) in material maintenance will be furnished vast quantities of modern equipment — surface, air and fire-control radars, loran, sonar, fathometers, transmitters, receivers, teletypes, frequency meters, panoramic adaptors, oscilloscopes, signal generators, tube testers, VT voltmeters, repair kits, wavemeters, receiver construction kits, etc. The Navy considers it essential that the reserve be supplied with a continuous flow of modern equipment and intends to implement this policy. Flag hoist, flashing light and semaphore instruction is to be given at armories and communication companies — masts, flag bags, flag sets, signal searchlights, semaphore flags and ship models to illustrate tactical maneuvers have been requested.

Training

Reserve training will be standardized and curricula issued from the Director of Naval Reserve. The weekly two-hour drill period is to be divided between classroom instruction and practical work on equipment. Publications, including drill cryptographic aids and tactical publications, are being set aside by the Bureau of Naval Personnel and the Chief of Naval Operations. Instructors will be selected from qualified reserve officer and enlisted personnel and maximum use made of training films, strip films, slides, mock-ups, charts, etc.

Current plans call for field days using portable equipment, and inspection trips to military and commercial activities. Close liaison with the Army, Marine Corps and Coast Guard will be maintained and joint communication drills held. Officers and men will be eligible for courses at Navy electronic schools and the Navy has under consideration plans to distribute electronic equipment without cost to selected high schools, col-

leges and universities to encourage the study of electronics.

Aviation communication and electronic personnel will train at NRASs with reserve squadrons.

Active and continuing liaison between reserve and fleet personnel is to be maintained; training plans are being written from "the fleet point of view" and will be reviewed by fleet operational training commands.

National Advisory Council

Plans call for the formation of a National Advisory Council composed of outstanding regular and reserve naval officers and civilians of national reputation to advise the DNR on reserve matters. Naval Reserve officers on inactive duty are eligible for membership. A few civilian outstanding leaders in communications and electronics industries may be invited to sit in on this council.



Connecting-wires in radio receivers are eliminated by a method announced recently. Bare metal sprayed into channels in a plastic chassis is the basis for the method which, it is said, speeds production, reduces operating costs, permits lower prices and improves performance of radio receivers. The process has been used in other countries, particularly Germany, where in wartime the spray method was used in the fabrication of radio coils.

REQUIEM

How sweetly sleep the Silent Keys!
How proudly wear the Golden Star,
Who gave their lives beyond the seas
In the red hell of war.

They heard the challenge to the right
By which all free men seek to live;
They knew the cost to win the fight,
The price that they should give.

Yet went they forth from hill and plain,
From friendly cities of their birth,
To bring goodwill and peace again
To all the ravished earth.

And now they sleep in foreign fields
Beneath the crosses and the stars;
With memory's tears alone the yields,
And Silent Keys and Stars.

Envoi

O soldiers, sailors, home again,
Prevent these endless wars
Where right survives by blood and pain,
By Silent Keys and Stars.

— Lt. Comdr. Robert D. Bass, W4CQG-W3JSI

The "Tiny Tim" Handie-Talkie

A Midget Portable Station for the 144-Mc. Band

BY CHARLES T. HAIST, JR.,* W6TWL

THE ARTICLE on the "handie-talkie" in June, 1944, *QST*¹ brought comments and inquiries from all over the United States, Canada and South America. But the prize came from quite close to home — from a friend who, on seeing the article, observed "Why didn't you build a *small* one?" A challenge like that couldn't be ignored, naturally, and the result of it all is the new version shown in the photographs.

This "Tiny Tim" handie-talkie has been in operation for almost a year, first in WERS work, then on the 112-Mc. band after the reopening, and still later on the 144-Mc. band. It is 7½ inches high, 2½ inches wide, and 1½ inches thick, and weighs only 1½ pounds complete with batteries. Since it is small enough and light enough to slip into a coat pocket it can be carried and used on a second's notice. Good reports have been received at distances up to two miles, although its primary purpose is for communication with mobile or fixed stations which ordinarily would be within a few city blocks of the portable unit.

Two tubes are used in a transceiver circuit, a 957 as the detector and oscillator and a second 957 as the audio amplifier and modulator. If somewhat more power is desired it would be possible to substitute 958s for the 957s. The battery power supply, contained in the same case, consists of a single No. 1 flashlight cell and one midget 45-volt "B" battery (Burgess XX30). The drain on the flashlight cell is 100 milliamperes and the "B" current is only 3 milliamperes.

As shown in the circuit diagram, Fig. 1, a three-pole two-position switch, *S*₁, is used to change over from send to receive. One switch

section connects or disconnects the microphone, the second section connects the proper grid leak, and the third section shifts the oscillator plate circuit from the primary of the transceiver transformer, *T*₁, to which it is connected for receiving, to the plate of the audio amplifier-modulator for transmitting. The headphone is made to do double duty by serving as a modulation choke during transmission.

The case is made from two pieces of aluminum. One, on which the parts are mounted, is in the form of a U-shaped channel as shown in the inside view. The other is bent at the top and bottom to complete the enclosure. The microphone is a single-button unit (Universal Type W) mounted on a circular block cut at an angle so that it is properly tilted for voice pick-up when the headphone is held against the ear. The headphone is one unit of a 2000-ohm set mounted to the case by two screws.

The tubes are mounted by soldering the two negative filament pins (Nos. 4 and 5) to small brass angles which in turn are mounted on opposite sides of the case as shown in the inside view. The screws that hold the angles to the case also are used to mount the two switches, *S*₁ and *S*₂. *S*₁ is mounted underneath the tuning knob while *S*₂ is on the opposite side.

The tuning condenser is a revamped 3—30-μfd. trimmer. The adjusting screw was removed and its head was cut off, then the screw was threaded tightly into a ¾-inch length of ¼-inch diameter

*743 Warfield Avenue, Oakland 10, Calif.

¹Haist, "A Self-Contained Handy-Talkie," *QST*, June, 1944.

Fig. 1—Circuit diagram of the 144-Mc. handie-talkie.

- C*₁ — 3—30-μfd. ceramic trimmer (see text).
- C*₂ — 50-μfd. ceramic fixed.
- C*₃ — 0.002-μfd. 200-volt midget paper.
- L*₁ — 5 turns No. 16, ⅜ inch inside diameter, length ⅜ inch.
- L*₂ — 1 turn No. 16, ⅜ inch inside diameter.
- L*₃, *L*₄ — 50 turns No. 36 d.s.c. on 10-megohm, ½-watt resistor.
- R*₁ — 25,000 ohms, ¼-watt.
- R*₂ — 10 megohms, ¼-watt.
- R*₃ — 400 ohms, ¼-watt.
- S*₁ — Triple-pole double-throw slide switch.
- S*₂ — Single-pole single-throw slide switch.
- T*₁ — Transceiver transformer (Inca I-45)

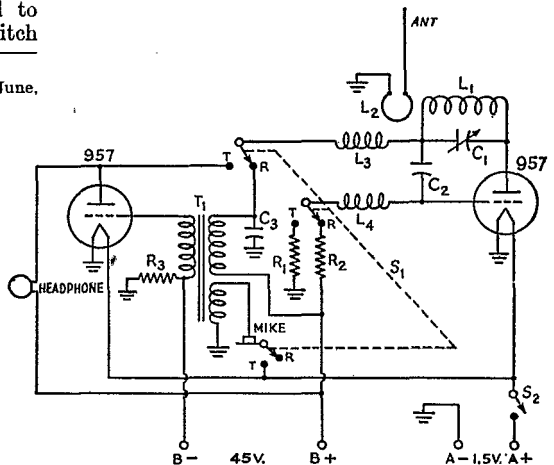

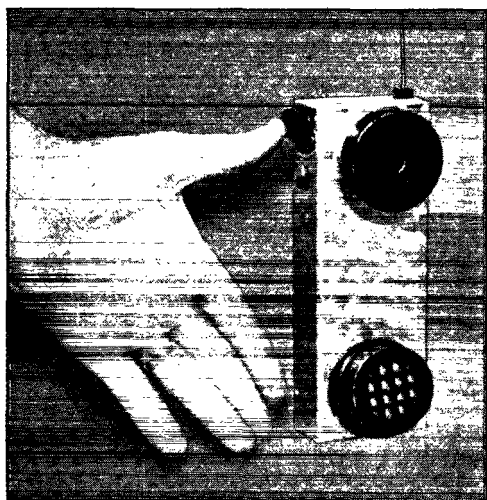

A handie-talkie that is really handy — its approximate dimensions are 7 by 2½ by 1 inches. Completely self-contained and small enough to be slipped into a pocket, it has a range of a mile or more in reasonably open terrain.

round polystyrene rod. The assembly was then rethreaded into the condenser so that the end of the poly rod pressed against the movable plate, thereby providing a miniature tuning condenser with the shaft extending outside the case for ready adjustment. The tuning knob is equipped with stops so that it can be rotated just sufficiently to cover the 144—148-Mc. band. The condenser and tank coil, L_1 , are supported by their leads, one end of the tank circuit being soldered to the plate lead of the tube.

A single layer of No. 36 d.s.c. wire wound on a 10-megohm ½-watt resistor makes a good r.f. choke. The wire is held in place with coil dope and the ends of the coil are wrapped around the resistor leads before soldering.

The antenna plugs into a pin jack mounted on an aluminum angle which is bolted to the case

at the top. Steel or brass rod ¼-inch in diameter may be used for the antenna; a length of approximately 18 inches is required for a quarter wavelength. The length may be pruned to the optimum figure by starting with the rod a little long and cutting off a bit at a time until the antenna shows the maximum tendency to throw the super-regenerative detector out of oscillation when set in the 144-Mc. band.

The "spare parts" box shown in the photograph is purely a gag — it's the only unused spot in the case!

◆
Inside the handie-talkie. Over half the case is occupied by the battery power supply. To save space no tube sockets are used, the connections being soldered directly to the tube pins.

◆

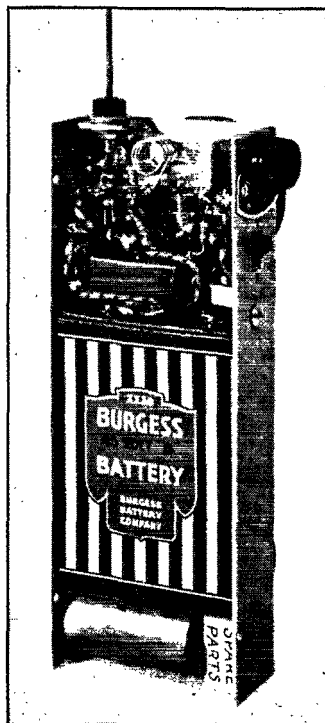

Strays

W5DE, W5EQH and W5HXY of KTSM, El Paso, have found a new and excellent way in which to assist hospitalized veterans.

Learning that a large proportion of the radios, used by the patients at William Beaumont Hospital, were out of order and that long delays in servicing were unavoidable, this trio of hams offered to repair these radios "for free."

Through the cooperation of W5EQH, manager of KTSM, they secured repair parts and set to work on their tremendous servicing job to be done

in their then idle ham shacks on their own time.

After the initial rush was over, these enterprising amateurs solicited inoperative radios from local KTSM listeners. Most of the sets donated were repairable and after being serviced were turned over to the Red Cross for distribution in the hospital. Local jobbers and service men cooperated in a fine manner in locating vitally-needed parts.

The overwhelming expressions of gratitude from the GIs have amply repaid the efforts of these hard-working hams of El Paso.



The World Above 50mc.



CONDUCTED BY E. P. TILTON,* WIHQD

HOW ARE WE doing on 144 Mc.? When we converted from 112 to 144 Mc. on November 15th results were discouraging at first. It seemed that the range on the new band was going to be considerably shorter than on the old. Where we had been working up to 100 miles or so fairly frequently we now seemed to stop rather close to the horizon, and the maximum distance covered by the better stations was seldom in excess of 25 miles.

There were several reasons for this. Most operators were using simple low-powered rigs the efficiency of which dropped considerably when they were altered for the new frequency. Many were none too good on 112, and the jump to 144 was more than most of them could stand. Even this seemingly small difference in frequency made quite a difference in the operation of conventional antennas, line losses increasing and efficiency dropping. Most important of all, we hit the new frequency at just the time of year when the best temperature inversion bending had passed. The conditions which made possible the record-breaking DX on 112 Mc. in September were gone but not forgotten by November.

Those of us who were interested to find out what we could do with the new band stuck with it through the long winter months, working nightly to improve the efficiency of our gear and trying countless antennas to see which types would best serve the purpose of extending our reliable coverage beyond the horizon. We can look back on that period now and feel that it was time well spent. We have things pretty well in hand, and with the coming of spring we're going to reap the benefits when signals begin to bend around the hills and spread out along the sea-coasts.

Just how far will they go? Plenty far, if propagation data gathered by various scientific war agencies, notably M.I.T.'s Radiation Laboratory, mean anything. We have already cited a few instances of phenomenal v.h.f. reception. At the Winter Technical Meeting of I.R.E. more was heard of this sort of thing — 200 Mc. covering 1700 miles, microwave radar picking up targets 700 miles distant, strong signals in the microwave region at 300 miles, and so on down the list.

We hope to present more information along

* V.H.F. Editor.

RECORDS

Two-way Work

56 Mc.: W1EYM-W6DNS
2500 miles — July 22, 1938

112 Mc.: W1BJE-W3FYB
355 miles — September 6, 1945

144 Mc.: W6OIN/6-W6UID
100 miles — January 10, 1946

224 Mc.: W6IOJ/6-W6LFN/6
135 miles — August 18, 1940

400 Mc.: W6IOJ/6-W6MYJ/6
60 miles — September 14, 1941

5250 Mc.: W2LGF/2-W7FQF/2
31 miles — December 2, 1945

this line at a later date, but for the present it will suffice to say that under certain conditions, most commonly occurring in warm climates or in temperate zones during the summer months, a double temperature discontinuity may be set up in the atmosphere. By the method of refraction well known to most v.h.f. workers, the wave may become "trapped" in such an "atmospheric duct" and may be propagated for considerable distances by multiple reflections from the upper and lower boundaries of the duct, in a manner similar to propagation inside a wave guide.

An important fact about the duct theory is that propagation by this medium is possible at frequencies far above those normally considered to have DX possibilities. Many of us, this writer included, have thought of the frequencies above the 5-meter band as principally a line-of-sight proposition, with some variations possible under fortunate weather conditions. Actually, it appears that we have a whole new field awaiting us in the region above 144 Mc. Surely the coming summer should see some impressive records set up in our 2-meter band, and in other new bands on up through the microwaves, if amateur activity can be developed in these ranges.

Equally intriguing, for a different reason, are our prospects in the new 6-meter band. Here, again, we are due for a new line of thinking. We used to think of DX conditions on our h.f. and v.h.f. bands as something of a hit-or-miss affair controlled by a kindly or capricious fate. A war-time need for reliable data months in advance on

the right frequency to use at a given time over a given path led to the development of a reasonably accurate system for predicting ionospheric conditions and their effects on high-frequency communication. Information from the Bureau of Standards indicated correctly the current aspects of the 10-meter band months ago, so when their figures for maximum usable frequency begin to run up near 50 Mc. it is time for v.h.f. enthusiasts to sit up and take notice.

Along North-South paths especially, between Southern U. S. (below 30 degrees latitude) and Brazil, Argentina, and Chile, 50 Mc. is almost certain to be open for short periods around 2:00 p.m. local time frequently in the next few months. Stations in Florida, Louisiana, and Texas have an excellent chance for intercontinental DX, if they can persuade some PYs, LUs, or CEs to work with them. We suggest that v.h.f. men who work South Americans on 28 Mc. make every effort to promote interest in this sort of thing on the part of workers in the various South American countries. For the time being such work will have to be cross-band in nature, as most other countries will be retaining the old 56-60 assignment for the present.

In other sections of the country there is more than just a possibility of transoceanic and transcontinental work on 50 Mc. at times. The maximum usable frequency data issued by the Bureau of Standards is conservative in the extreme. For example, predictions for February showed the maximum frequency for trans-Atlantic work to be well below 28 Mc., yet that band was open to Europe almost every day. Predictions for May run high enough so that the 50-Mc. band will bear watching for F_2 signals almost anywhere.

There is little doubt that it will be watched, as interest in this band is at a high pitch throughout the country. Sporadic-E skip, already running ahead of prewar schedules on 28 Mc., should be providing us with skip DX contacts on 50 Mc. by Mid-April. The spring DX season of 1946 may well be the most interesting in the history of v.h.f. skip work.

Another possibility for international v.h.f. DX work looms as the result of interest in the Union of South Africa. V.h.f. work is nothing new to ZS1T and XS1AX, who kept many schedules with W stations in the years before the war. ZS1T has a good v.h.f. superhet, which he will have rigged for 50-Mc. reception by the time this appears in print, and he will be glad to listen for W signals when conditions for such work become propitious. The assignment in this frequency range will not be changed over there for the time being, ZS stations being limited to 25 watts in the 58.5 to 60-Mc. band. Their position is not as good as that of the South American stations, as their path where the maximum usable frequency reaches the highest figure runs north, to a part of the world where the possibility of v.h.f. activity is

very remote. Their country is big enough to present the possibility of sporadic E skip DX between the various ZS districts, and such work is already being done on 28 Mc.

— . . . —
The radar contact with the moon, made by the Signal Corps in January, resulted in a flood of letters saying, in substance, "Why don't we do it on v.h.f.? Is this not a means of working DX on the frequencies normally considered to be good for line-of-sight work only?" V.h.f. reflections from the moon are probably not beyond the realm of possibility, but before we get too excited about it we should take into account the nature of the gear used in the Signal Corps experiment. Transmitter power, antenna gain, and receiver sensitivity were all far beyond the scope of amateur radio, yet the returned signal was still very weak. It would appear that lunar-reflected DX is not apt to revolutionize our v.h.f. bands in the immediate future. Propagation by means of atmospheric ducts, first unwrapped at the same time as the moon experiment but in a much quieter way, is much more likely to provide us with DX thrills in the v.h.f., u.h.f. and microwave ranges.

— . . . —
Some real progress is being made in developing activity and increasing the effective working range on 144 Mc. in several sections of the country. In Baltimore, for instance, there are more than 20 stations active, with W3's CRB, CGF, FT, GIO, FAM, JMA, IBP, HDZ, FIM, IFW, GKA, GYS, IQP, W9JQQ/3 and W8NWA/3 setting the pace. There is also considerable activity in and around Washington, D. C., according to W3CRB of Baltimore, who is able to work W3's GKP, JDQ, JHT, W9GBA/3, and W1HJT/3 there regularly, the distance ranging from 30 to 45 miles. There is considerable interest in improved gear, and several of the above are using crystal control.

From Mechanicsburg, Penna., W3HWN reports that there are about 25 stations using crystal controlled or m.o.p.a. rigs in Cumberland, York, and Lancaster Counties. In Lancaster, 40 miles away, W3LN, W3DEI, W4HXA/3, and W2KAR/3 are all using 829 m.o.p.a. rigs, and putting S9 signals into Mechanicsburg. W3HVL, Reading, bridges the 60-mile gap to Mechanicsburg with only 20 watts. Other stations active in this region include W2IET of Lancaster, W4AIH/3 and W8IVO/3 in Harrisburg, W3CXE of Lebanon, W3's BKB, NP, IPE, EDO, and W8TTM/3, all of York, and W3GEJ of Lemoyne.

The rig at W3HWN is crystal controlled, with an 829 in the final feeding a 16-element array. A superhet receiver, employing a 954-954-955 front end, gives excellent results in weak-signal reception of stabilized signals. All the boys in this area are interested in the possibility of working into Philadelphia and up toward the New York area. How about some DX skeds with stations

having stable rigs and hot receivers, to give these boys something to get their teeth into?

Ray Jacobs, W6OIN, writes that the trend in the San Diego area is also toward improved equipment. The rig at W6OIN is crystal controlled, with a pair of 826s in the final running 200 watts or more. The receiver is a "butterfly" converter using a 6J6 "push-push mixer" and 955 oscillator, feeding into an SX-25 at 10 Mc. The antenna is a 4-element horizontal array 70 feet in the air. W6EDJ has a 25-watt crystal-controlled mobile rig. At the home station he and a partner have rigged up a parabolic reflector which can be rotated, tilted, and used horizontal or vertical! W6KCO has an m.o.p.a. rig using a 6J6 oscillator driving an 832 final.

There is interest in a try for a real world's record for 144 Mc., and W6OIN will arrange to take his high-powered rig and a portable array to Mt. Frazier, south of Bakersfield, for schedules with Mt. Diablo, a 250-mile shot, or better still, with Mt. Shasta, in Northern California some 500 miles distant. Any takers?

In the Cincinnati area, W8QHW/9 finds little to do on 144 Mc. He has a low-powered rig, an acorn receiver, and a set of Lecher wires, and will be glad to assist anyone in finding the band and getting started on 2 meters. His address: 202 Kenton St., Ludlow Station, Bromfield, Kentucky; phone Colonial 1239.

144-Mc. Beam-of-the-Month

Parasitic arrays are often difficult to feed properly, and this matter of getting a good match becomes increasingly important as we go higher in frequency. Unless the feedline is designed for minimum standing-wave ratio, a parasitic array will be little better than a good dipole at 144 Mc. The array shown in Fig. 1 is fed at its center (always a good idea in v.h.f. arrays) with a line of 300 to 500 ohms impedance, without the use of matching stubs or "Q" sections other than

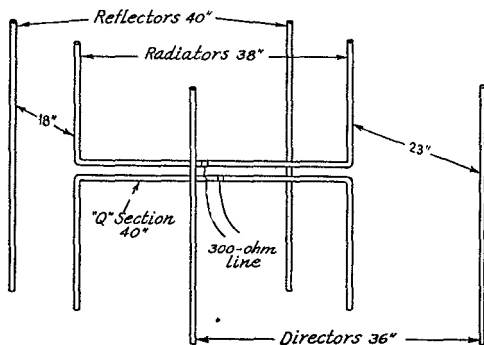

Fig. 1 — A double-Q array for 144 Mc. The horizontal portion of the half-wave H acts as a Q section, matching the antenna impedance to the 300-ohm line attached at the center of the array.

those basic elements of the system itself.

The experimental model at W1HDQ is made of 1/4-inch copper tubing, the driven elements being formed of two pieces bent into U-shaped sections, the horizontal portion of which acts as a double "Q" section, matching the impedance of the line to that of the centers of the radiators. Reflectors are spaced about 18 inches in back of the radiators, and the directors are 23 inches in front. The position of the reflectors is not particularly critical, except as it affects the impedance of the system, and this spacing can be changed to take care of different line impedances, closer spacing being usable if desired. The spacing of the horizontal section may also be adjusted to provide a proper match, though a spacing of approximately one inch between centers worked out nicely for the parasitic element spacing shown, when a 300-ohm line (Amphenol-21-056 Twinlead) was used. An open wire line of 500 ohms impedance may be used with a slight variation in Q-section spacing.

This array has been in use for about two months at W1HDQ and has given a very satisfactory account of itself in comparisons with single-section arrays containing up to five elements. It has been used with good results in both horizontal and vertical positions.

For those who may be having trouble with broadcast interference it is interesting to note that reduction of radiation from the transmission line may be an important factor in curing this difficulty. The array described above, and several others having low standing-wave ratios and well-balanced feedlines, have reduced interference which was extremely bad when arrays having tuned feeders or poorly-matched lines were used.

Silent Keys

It is with deep regret that we record the passing of these amateurs:

- W1PD, S/Sgt. Darrah M. Pomeroy, Livermore Falls, Me.
- W5DUS, Harold R. Pahlmann, Little Rock, Ark.
- W5ERV, Samuel H. Dowell, Shreveport, La.
- W6AEX, David L. Bigley, Oakland, Calif.
- W6BAW, M. Albertson, Sr., Los Angeles, Calif.
- W6RWW, Douglas Aitken, Prescott, Ariz.
- W6SFT, Lloyd C. Litton, Oakland, Calif.
- W6UCY, Blas Marich, Globe, Ariz.
- W9FVM, Frank M. Davis, Cedar Rapids, Ia.
- W9MRZ, Wm. E. Craycraft, Lexington, Ky.

How's DX?

How:

Last month there wasn't much in the way of DX news, so this page was filled with tears and weeping. But by the time our favorite magazine got around to Mr. Constant Reader the 10-meter band was pretty hot and our lachrymose lament found no sympathetic souls. This month there is a 180-degree phase shift and things look pretty peachy, but our enthusiasm will be tempered by a crossed-fingers attitude because the fickle finger of F2 may step in between now and reading time.

But first we have a gripe to get off. Early in



February 'we heard W6VX working W7FJU/K6. Dave had a message for K6 which FJU tried to take but had a very tough time indeed because there were too many eager-beaver DX men calling the K6 on VX's frequency throughout the message. This stuff is bad enough during ordinary contacts, but when someone is trying to handle traffic . . . Jeeves, open a window! (Don't mind him, folks. He's just sore because he couldn't raise the K6 either. — *Jeeves.*)

What:

One little plum that has turned up is G6CU/ZC2 (28,060 f) at Cocos Island, worked by W2MPA and W6ITH. He uses 100 watts and a 3-element beam, and made WAC in a couple of days after putting up the antenna. The sad part is that he was slated to return to England in March Another fat one is W4YA/XZ (28,160 f), worked

by G6CL. The QTH given is "portable on Burma Road." For the c.w. boys, W1BPX reports the following gems: W9QMD /KE6 (28,110), YR5C (28,125), ZC4C (28,255), SU2GV (28,225), PX1B (28,000), VQ3TOM (28,035), OQ5AQ (28,000), HH1NCU (28,140) and LX1B (28,120). Those really look like old home week, but some might be in the eager-and-anxious category The VKs are getting through to the East coast. W2MPA heard VK2MH (28,200), VK4JP (28,000), VK2GU (28,300) and VK4AHP (28,000) on 'phone, K6UUT/3, ex-W2BMX, now in Washington, heard VK2KK (28,030) and VK4UL (28,100), and W5GNV/1 heard VK2AHT (28,030 f). Out West, W5JOO reports VK2RA, VK3CP and VK3RX on 28,000 c.w. W6ITH adds VK2AO (28,300 f) The ZS gang is on full blast, with ZS1AX (28,080 f), ZS6DW (28,110 f) and ZS1T (28,060 f) getting out consistently. K6MVV worked ZS6DW and ZS6P Another terrific signal from Africa is FA8JD (28,630 f), who is W9NTV and seems to concentrate on working W9s, just like a well-known W6, now too old and decrepit to pound brass, used to do More from the dark continent: OQ5AE (28,030) on 'phone and c.w., worked by W9JWJ W2OEN/1 worked W6MBA /KB6 (28,040) on Tinian, and W1DLC grabbed off W9TQD/J (28,050).

Where:

Take a deep breath and we'll pitch in to some more DX. We weren't kidding when we said there were things and stuff this month. For example, W2MPA has, in the worked column: X4AF (28,490 f) in Naples, SU1MW (28,500 f), LX1SI (28,000 f), HB9CX (28,190 f), ON4F (29,150 f), and EK1IND (28,500 f), ex-W2IND in Tangier. W9WVG /KB6 (28,500 f), XABZ (28,300 f), and W5HHO /J were heard W5GNV/1 crawled into the speaker and came up, in the heard column, with LA8AM (28,250 f), CX2CO (28,100 f), CE3FG (28,010 f) and old reliable VP2AT (28,050 f) W7EYS has a new antenna, two "lazy H" jobs one above the other, that accounted for W6NFH /KB6 (28,200 f), W8RHU /KAZ (28,070) on Leyte, W2NLW /Saipan (28,140 f), W2KQT /KB6 (28,030), W2JE /J5 (28,190) on Okinawa, and W5DBT /Tinian (28,150 f) W6PBV has to content himself with listening so far, but heard XE1HA (28,720 f), XE2FC (28,190 f), KAIRO (28,500 f), and W6EKE /KB6 (28,700 f), on an SW-3 In Ohio, W8TOB heard W9KXN /CT2 (28,060), VO1Y (28,300 f) and TI2DX (28,265) Among the HQ gang,

WILOP worked TG9JBM (28,300 f); W1UE heard TG9FG (28,090 T5), KZ5AA (28,040) in Canal Zone, and F8CHA (28,100) And leave us not omit W2OAA/J8 in Seoul, Korea, who operates on 'phone anywhere from 28,100 to 28,300, worked by W6ITH.

Who:

If those D2 calls you hear are confusing and sound like phoneys, ponder no more. They are used by British hams in the British Occupation Zone, and are licensed for 50 watts, on 28 to 29 and 58.5 to 60 Mc. This W6MBA/KB6 doesn't fool around. He's using 150 watts strained out through 16 — count 'em, 16 — half waves in phase, and has worked 53 countries since Nov. 15th That makes the efforts of some of the mainland gang look weak by comparison, but W1DLC, W1BPX and W1CH have nothing to be ashamed of with 32, 34 and 40 countries, respectively Speaking of DX, G6CL made WAC and WBE nine days after the Gs got back on. His contacts were SV1EC, ZS2X, VO2KJ, PY2QC, W4YA/XZ and G6CU/ZC2 W9ILF, well-known in TWA (Tibet Workers of America) circles and newly-appointed W9 QSL Manager, says AC4YN is on 28,240 these days. No, Claude didn't grab him off again — HLF is rebuilding in a new location "picked strictly for DX," as if his old location did him dirt!



Well-known old timer OK1AW, holding a QRP TNT transmitter in his right hand and an "underground" receiver in his left. The receiver used a single 30 tube with 18 volts on the plate.

Speaking of QSL Managers (You do a lot of speaking, don't you? — *Jeeves*), don't forget to have an envelope or two on file with them. They have thousands of prewar and some postwar cards that they would like to get rid of, without benefit of arson. On the other hand, many of the foreign QSL Bureaus are slow getting started again, as can be appreciated, so your best bet is to send your foreign cards direct unless you want to chance a considerable delay through the old Bureau system. Foreign stations requesting QSL via ARRL can do themselves some good by furnishing us with instructions direct XU3SJA now has an official call, XU1YQ (28,040) and is being worked by Ws VQ2AM is very much a phoney, according to VQ2PL, ex-CR7IA, ex-CR7AX and ex-ZE1JD. While the licensed VQ2s are impatiently waiting to get the go-ahead sign from the government, this VQ2AM has been active *through the war*, which doesn't help the cause of ham radio very much, and won't help him at all when they catch up with him! OK1AW would appreciate getting the cards owed him by W9ARL, W7BYW, W5DNV and XE1AA, which he needs for WAS and WAZ. He writes that the OK gang hopes to get 56- and 112-Mc. privileges this summer, which after seven mighty tough years will seem awfully good to them. They do their share of listening on the other ham bands, though.

Predictions:

In the first race, there's a filly called . . . no, those are some other predictions that have little to do with DX, although this filly is best over the longer distances. But the 28-Mc. conditions, predicted by the IRPL charts, look good for April. The month should see VKs coming through on the East coast, South Africans getting through to W6, and excellent signals from South America. From the charts, Europeans aren't slated to get through to W at all, but there is always the chance, of course.

Where no maximum usable frequency is shown it means the 28-Mc. band should be open during the period shown — a single time indicates when the corresponding m.u.f. is reached.

Path	Max. Usable Freq. (Mc.)	Time
Washington — S. F.	27.5	1930-0000
Washington — Rio		1430-2330
Washington — Paris	23.0	1830
Washington — Manila	21.0	2250
Washington — Sydney		1930-0100
Washington — Johannesburg		1430-1830
S. F. — Rio		1730-0200
S. F. — Paris	21.5	2000
S. F. — Manila	26.0	2100-0430
S. F. — Sydney		1930-0430
S. F. — San Juan, P. R.		1800-0100
S. F. — Johannesburg		1800-1830
N. Y. — San Juan, P. R.		1530-0000

— W1JPE

The Circular Band Theorem

Operational Advantages of Concentric Frequency Allocations

BY LARSON E. RAPP, W1OU

THE ENTIRE history of amateur radio has been the story of steady advances in a field which was at first a technical art and has now become an accepted science.¹ In the design, construction and operation of every type of equipment — transmitters, receivers, antennas, vacuum tubes — amateur radio can point with pride to its many contributions. In recent years some of the larger radio companies have established laboratories of their own and to some extent have become serious competition for amateurs in this field which they once monopolized. Undaunted, amateurs have turned to a territory which is exclusively theirs and have developed it to a fine art. This unique field, which no commercial interest would dare invade, is the peculiar world of "amateur-band operating."

Amateur-band operating, or "ABO" for short, is a distinct art which is responsible for such ingenious devices as the stabilized transmitter, the single-signal superheterodyne, rotatable antenna arrays, "resonant" filters, wide-range key clicks, dynamic prognostication,² and the v.f.o. These brilliant contributions can be traced directly to the crowded bands and intense competition encountered in ABO, and amateur radio can be proud of the way in which it recognized the problems and accepted the challenge.

Band Edge Technique

Starting around the year 1925 or 1935, a new type of operating slowly came into being and subsequent popularity. Realizing that after operators called "CQ" they had to start listening somewhere and that this somewhere was usually the edge of the band, a few hardy pioneers established themselves on frequencies close to the limits of the amateur portions of the radio spectrum. Their original thinking was rewarded by a high percentage of successful calls, and other stations followed suit. This practice became known as the "band-edge technique," and reached a minor peak during the 1937 DX Contest, when for 23 consecutive minutes 32 per cent of the active amateurs in the world were operating on six band edges ± 2.5 kc. It was subsequently discovered that many operators started listening on their own frequencies for replies to CQs, and this

• Here is a proposal of such importance that it will be very easy to predict its effect on the future of amateur frequency assignments. It is "must" reading for any operator familiar with prewar conditions in our bands, and it holds out some kind of hope for beginners troubled with finding new frequency assignments.

led to the custom of calling a station on its own frequency if you were at all serious about a contact and not just engaging in code practice. This type of operating reached a peak in the 1939 DX Contest, when 32.1 per cent of the active amateurs in the world simultaneously called two stations *exactly* on their own frequencies, with the result that "dead spots" were burned in at these two wavelengths and they have been useless for communication ever since. Fortunately, both frequencies happened to be just outside the high-frequency edge of the 20-meter band, so the loss to Ws isn't too great.

This brings up the point that a suitable dial has yet to be devised for v.f.o.s. used for band-edge operation. All available dials seem to have considerable inertia which may carry them *past* a band-edge station's frequency and out into never-never land, particularly when one tunes on to the station in a hurry.

It is possible that continued band-edge operation may lead to the burning of more dead spots, even within our bands, and in the interests of frequency conservation the author took it upon himself to find a solution. The addition of two more band edges in the 14-Mc. band, where the c.w. and 'phone assignments meet, was a partial answer but not entirely adequate. Seven years of research have resulted in what appears to be the only possible reply to the situation in which amateur radio finds itself.

The Circular Band Theorem

A careful study of the method of allocating amateur frequencies showed that, without exception, our wavelengths are assigned in "bands" or finite linear sections of the spectrum. For example, the 40-meter band extends from 7.0 to 7.3 Mc. Obviously this has two band edges, and thus is a vulnerable target for the highly-developed "band-edge technique" and the consequent dan-

(Continued on page 180)

¹ Webster's Collegiate Dictionary says "art is knowledge made efficient by skill, science is systematized knowledge." This is undoubtedly what Mr. Rapp had in mind. — Ep.

² Rapp, "Putting Dynamic Prognostication to Work," QST, April, 1941.

Foreign Notes

AUSTRALIA

VKs are open on 28-29 Mc., as well as 50-54, 166-170 and 1345-1425, with power input of 50 watts. As in other larger allied nations, return of the lower-frequency bands is expected late in the year. Silent for six years, the Australian ham has much "catching up" to do on theory and technique, and this reconversion process is somewhat handicapped by lack of material. The *Wireless Institute of Australia* predicts a total of 8000 hams by 1950, compared to roughly 2000 pre-war.

FRANCE

Via the press association we hear that French hams have received official assurance from the Ministry of Posts, Telegraphs and Telephones that they will be returned to the air soon. We understand that the Ministry is accepting applications for licenses from all operators who hold government certificates as "radio telegraphists."

NEWFOUNDLAND

Due to interference with some of the armed forces communications channels, the use of amateur low-frequency bands was withdrawn from VO hams, who are now restricted to 28 Mc. and above.

N.A.R.A. at its recent annual meeting effected certain changes in its constitution as concerns administrative affairs. In the future, the Council will be composed of two members from the first amateur district, one each from all others,

elections by mail ballot. Provisions are made for associate membership, open to persons not yet having government licenses.

NEW ZEALAND

N.Z.A.R.T. recently conducted a poll of members on ideas for post-war operating regulations. A sizeable majority favored 'phone operation throughout all bands, but were also willing to agree to 'phone-c.w. allocations generally similar to American hams. The ZLs confirmed past policy of 100 watts final input, prohibition of duplex except on v.h.f., and testing only with dummy aerial. They rejected the idea of compulsory crystal control, but thought 'phone transmitters should cut off all modulation frequencies above 3000 cycles.

GLEANINGS

The Chinese Amateur Radio League has moved its headquarters to 50 May Yuan Villa, Kuo-Fu Road East, Nanking (instead of Chungking). . . . On February 16th, British hams were given the remainder of the 10-meter band and may now use the entire portion 28-30 Mc. . . . Denmark and Norway are reported back on 28 Mc. and above, with very low power, although actual regulations are unknown. . . . We have good news from Belgium to the effect that, as in Netherlands, the two amateur societies will band together to form one new large association. . . . Welcome to *Oesterreichischer Versuchssenderverband*, now active again with W. Blaschek, OE3WB, as secretary.

Strays

This thrilling account of a message relay was clipped from the *Miami Herald* and sent in by W4NE:

"A tenuous 2300-mile long thread of emergency communications Saturday night carried Richmond Naval Air Base's frantic plea for fire-fighters through a howling hurricane to Miami, just 20 miles away.

"The first SOS from the blazing blimp base was picked up at San Juan, Puerto Rico, by Pan American Airways and the Civil Aeronautics Authority station WRW.

"Beamed to Miami, it was in turn picked up by WBR, the Overseas Foreign Airways Communications station in the Everglades.

"Here the thread came close to snapping.

Badly battered by the hurricane, WBR was cut off from the outside world except for a direct telegraphic hookup with a Pan American flight watch seven miles from Miami.

"The watch, on duty at a field without electricity or telephone, resorted to an auxiliary power plant to transmit the SOS to Western Union via a teletype circuit.

"A few minutes later, emergency units had the message:

"Send all fire-fighting equipment to Richmond Air Base. All hangars are burning."

"Back around the 2300-mile route went the reply:

"Assistance being sent from Miami Naval Air Station and Fort Lauderdale."

● Technical Topics —

Those 14-Mc. Signals

THE GREEN QSLs — those unwelcome harbingers of something done that shouldn't have been — are flying again, but the main complaint now is one strange to prewar days. True, it has to do with out-of-band operation — but not because the frequency has slid over the edge or because the transmitter is generating harmonics; most of the citations are for putting out signals on the still-closed 14-Mc. band. So far as we know, none of the stations picked up actually was jumping the gun by getting in a few early licks on twenty. The condition arises as a result of legitimate operation on the 28-Mc. band.

Somewhere in the transmitter, of course, there is a 14-Mc. stage that's responsible. When conditions are right on 14 Mc. a little bit of energy can travel a long way — especially, as now, when even the weakest signal on that band sticks out like a sore thumb instead of being buried under layers of QRM. Except for one thing, we might brush off this particular brand of green ticket as representing a temporary condition which, while requiring action, eventually would solve itself in that such more or less puny radiations would be absorbed completely when we get back to normal operation on our lower-frequency bands. The new factor is this — our bands above 28 Mc. are no longer in harmonic relationship, so the fellows who use crystal control and frequency multiplication for v.h.f. work are likely to have the problem with them continually. The potentialities for causing interference locally to other services are worth keeping in mind.

In the meantime the 14-Mc. question needs immediate attention. If you're operating on ten and haven't yet received a notice, it would be wise to find out whether it's because your transmitter actually has a clean bill of health or whether it's just because you've been lucky. Get a local amateur to listen for you on 14 Mc. when you're transmitting on 28; if he can't hear you — provided he's within a couple of miles — you're no doubt in the clear. But if you do have a 14-Mc. signal it would be well to do something about it.

Keeping the Signal Out of the Antenna

No data are available as to the types of transmitter line-ups that are most at fault — if, indeed, any general conclusions of that sort could be drawn. However, a few things seem fairly obvious. Any 14-Mc. energy getting into the antenna system can be radiated, but the radiation does not have to take place from the

antenna or feeders. The point can easily be checked by having the other fellow listen and report the change in signal strength when the feeders are completely disconnected from the transmitter — preferably not just by holding the change-over relay open, however, because the capacity between contacts might cause some erroneous conclusions to be drawn. If disconnecting the feeders causes the signal to disappear the problem is clear enough but the solution may not be so simple.

Perhaps the first thing to try is a pair of 14-Mc. wavetraps, one in each feeder. To avoid upsetting the operation on 28 Mc. these should be fairly high-*C* — say about 100 $\mu\text{fd.}$ of capacity in use. This will call for a coil of about 7 turns of No. 14 spaced out to occupy $1\frac{1}{2}$ inches on a $1\frac{1}{2}$ -inch diameter form. The traps should be installed far enough from the transmitter so they do not pick up energy from any of the tank circuits. A distance of a few feet should be enough. For maximum suppression they have to be accurately tuned; the cooperating station can help in determining the right condenser settings, but it is faster and more convenient to use a sensitive absorption wavemeter such as the crystal-detector and milliammeter outfit described in the *Handbook*,¹ placing it so that it indicates only what is in the feeders on the far side of the traps.

The traps probably offer better promise of results than other schemes, because almost any antenna system will accept some 14-Mc. energy if it can be coupled into it — and it usually can. With a balanced feeder a Faraday screen will not be of much help unless the actual coupling between the final tank and the antenna pick-up coil is through stray capacity and the feeders work in parallel at 14 Mc., the whole antenna system then working against ground through the stray coupling capacity. A trial of the screen is necessary to check the point. If it works, the screen has the advantage that it is effective at all frequencies, whereas the traps require retuning when the transmitter is shifted to another spot on the band.

Transmitter Layouts

Whether or not the antenna does the radiating, the radiation will be least when the 14-Mc. power in the transmitter is small. Less trouble is to be expected from an outfit in which all the frequency multiplication is done in stages operating at power levels of only a few watts, with the

¹ See chapter on "Measurements and Measuring Equipment," *ARRL Handbook*.

power amplification all taking place at the final operating frequency. For example, an exciter using small receiving tubes to get from the crystal to 28 Mc., and followed by a beam tetrode or similar high-sensitivity buffer stage before the final amplifier, is not likely to have much 14-Mc. output under any circumstances; the power is small in the first place, and the last frequency multiplier is followed by several selective circuits that do much to eliminate the undesired frequency.

Probably the worst type of transmitter in this respect is one using a triode doubler as the final stage. Such a stage requires a lot of 14-Mc. excitation and is likely to be run with a pretty high L/C ratio in the tank — meaning that the tank circuit selectivity is so poor that there is a great deal of fundamental in the output. The obvious remedy in such a case is to install another stage and drive the final as a straight amplifier. As further insurance, use a doubler that doesn't require as much power for driving as you expect to get from the plate circuit. In fact, it is probably the fundamental rule of eliminating off-band radiation that the r.f. power generated in any frequency-multiplying stage should be just as small as possible. This is under ready control in the transmitter design. If frequency multiplication is confined to very low-power stages it is also readily possible to shield the tank circuits of such stages and thus practically eliminate any direct radiation. Also, the greater the number of tuned circuits between the last doubler stage and the antenna the better; link coupling somewhere along the line is fine in this respect. Incidentally, the elimination of the 14-Mc. component from the grid drive to a 28-Mc. amplifier means that the amplifier efficiency will be greater because the plate current won't have a frequency component for which there is little or no impedance in the plate tank.

Measures like these taken in the transmitter

itself will show results whether or not tests indicate that the radiation is taking place from the antenna. If disconnecting the feeders does not cause appreciable reduction in the radiated signal, other conductors in the vicinity should be investigated — here is where the sensitive absorption wavemeter earns its keep again. Probably the most likely suspect is the power wiring running to the transmitter; if it isn't cold, some by-passing and choking is called for. Any improvement achieved is bound to be reflected in better over-all transmitter performance, too, because r.f. eliminated from places where it shouldn't be is r.f. saved for its intended purpose. Beyond pointing out the possibility that radiation can take place from conductors in the vicinity there isn't much that can be done in the way of making specific recommendations; no two installations are alike and the only thing to do is to root out the cause and try the cures, such as traps, filters and detuning, that have worked in similar cases in the past.

Finally, there is always the possibility of direct radiation from a 14-Mc. tank circuit. The only real check on this is to shield the tank and see what happens to the signal. Naturally, if the shielding works it should be left in place.

Whether or not this low-frequency radiation question is going to dog us in the future, it behooves us to pay some attention to it for at least two reasons. Our regulations require that spurious emissions — and such radiations unquestionably are spurious — be reduced to the extent that the state of the art permits. Second, even though the radiation is not strong it can cause wholly unnecessary interference at times — if not at a distance, then at least to other fellows who may be operating within a few city blocks. These signals are unnecessary, they're easy to eliminate by proper transmitter design, and we ought to do away with them.

— G. G.

Harmonics in the V.H.F. Range

THE RADIATION of strong harmonics in the 5-meter band has been like bad weather — everyone talks about it but nobody does anything to correct it. In the past it did not present too serious a problem, except to the minority of the amateur body represented by v.h.f. enthusiasts, who have complained bitterly about this source of QRM in their pet territory. And here, the harmonic from 28 Mc. was occasionally a blessing in disguise, for it served to show the isolated 56-Mc. worker when the band was open for DX work, when the condition might otherwise have gone unnoticed. In any event, the spurious radiation was in an amateur band, and therefore did not constitute the sort of transgression that would be likely to cause much trouble.

Now the picture is quite different. On March

1st we dropped our harmonic relationship with 28 Mc., vacating the 56-Mc. band in favor of the new allocation at 50-54 Mc. Our ten-meter harmonics now fall in a television band — where they may well cause us no end of trouble. Interference to television may seem remote to ten-meter men in rural areas, but to those situated in or near several of our larger cities it bids fair to become a very real problem in the near future.

Observation in the Hartford area shows more than thirty signals in the range between 56 and 59 Mc. which come from local ten-meter stations. About half of these are strong enough to cause serious interference to television reception, and several can be heard at S9 level or higher for a distance of 20 miles. In some cases the local field on 56 Mc. is practically the same

strength as that radiated on the fundamental.

In searching for a cure for this trouble all the familiar suggestions have been tried with only partial success. It is not necessarily true, for instance, that the use of push-pull design will result in the cancellation of even-harmonic radiation. The worst offenders in this area are the medium- and high-powered stations using push-pull amplifiers. Complete even-harmonic cancellation in push-pull r.f. stages is confined to the center of the tank coil, and use of the proper coupling methods at this point will hold down the amount of second harmonic transferred to the antenna by a 28-Mc. push-pull amplifier. Even harmonic voltages do exist, however, between ground and the two extreme ends of the tank circuit², and in the case of high-powered amplifiers of open construction, the amount of second harmonic radiated locally, independently of the antenna, may be considerable.

Commonly-accepted procedures for the elimination of harmonic radiation include the use of tuned antenna systems, which resonate at one frequency only, and the employment of tuned networks and link coupling to the final stage. These points, effective with low-frequency equipment, have been tried on 28 Mc. and found wanting. Several locals having strong second harmonics are using carefully-tuned parasitic arrays. Tuned trap circuits and filters of several kinds have been inserted in the feeders, resulting in only a slight reduction in the local field strength of the second harmonic, as they eliminate only that portion which is radiated by the antenna — usually less than 10 per cent of the total second harmonic power. Even the most effective harmonic reduction scheme which can be applied to the antenna system will thus effect only a very minor reduction in the interference potentialities in such cases.

It is obvious from the above that shielded construction is required if second harmonic radiation by high-powered transmitters is to be held to a level which will not cause interference within a radius of several miles. By enclosing the r.f. portion of the transmitter in a metal cabinet, or by encasing the high-power stages within a copper screen, stray radiation from the tubes and tank circuits can be held to a minimum. Then, if harmonics are still in evidence, suitable traps, filters, or matching networks can be installed to keep the unwanted frequencies from being radiated by the antenna. There is no better time than the present, with so many postwar rigs still in the planning stage, to give careful consideration to the reduction of harmonic radiation in the construction of a new station.

— E. P. T.

WWV Schedules

STANDARD-FREQUENCY transmissions are made available as a public service by the National Bureau of Standards over its standard-frequency station, WWV, on the following schedules and frequencies:

2.5 Mc. — 7:00 P.M. to 9:00 A.M. EST (0000 to 1400 GMT).

5.0 Mc. — Continuously, day and night.

10.0 Mc. — Continuously, day and night.

15.0 Mc. — Continuously, day and night.

The 10- and 15-Mc. radio frequencies are modulated simultaneously at accurate audio frequencies of 440 and 4000 cycles. 5 Mc. carries both audio frequencies during the daytime but only 440 cycles from 7:00 P.M. to 7:00 A.M., EST, while 2.5 Mc. carries only the 440-cycle modulation. A 0.005-second pulse may be heard as a faint tick every second, except the 59th second of each minute. These pulses may be used for accurate time signals, and their one-second spacing provides an accurate time interval for physical measurements.

The audio frequencies are interrupted precisely on the hour and each five minutes thereafter, resuming after an interval of precisely one minute. This one-minute interval is provided to give Eastern Standard Time in telegraphic code and to afford an interval for the checking of radio-frequency measurements free from the presence of the audio frequencies. The announcement of the station's services and of the station's call (WWV) is given by voice at the hour and half hour.

The accuracy of all the frequencies, radio and audio, as transmitted, is better than a part in 10,000,000. Transmission effects in the medium may result in slight fluctuations in the audio frequencies as received at a particular place; the average frequency received, however, is as accurate as that transmitted. The time interval marked by the pulse every second is accurate to 0.00001 second. The 1-minute, 4-minute and 5-minute intervals, synchronized with the second pulses and marked by the beginning and ending of the periods when the audio frequencies are off, are accurate to a part in 10,000,000. The beginnings of the periods when the audio frequencies are off are so synchronized with the basic time service of the U. S. Naval Observatory that they mark accurately the hour and the successive 5-minute periods.

Of the frequencies mentioned above, the lowest provides service to short distances and the highest to great distances. In general, reliable reception is possible at all times throughout the United States and the North Atlantic Ocean, and fair reception over most of the world.

² Terman, *Radio Engineer's Handbook*, page 633.

Listening Post in the Philippines

The Story of an Italian Priest's Struggle to Maintain Underground Reception During the Japanese Occupation

BY F. JOSEPH VISINTAINER *

ARE you interested in knowing all that the Filipinos did to keep in touch with the world outside during the Japanese occupation? The Japs did everything in their power to shut us off from every avenue by which we could know what was happening in the world. That they did not succeed was certainly not their fault.

One of their first acts was to banish all sort of antennas. Then all radios had to be reconditioned, that is, all those parts that served for the reception of short waves were to be taken out, so that only long waves could be picked up. Of course, with all the receivers in the Islands working only on long waves, and all antennas banned, only locals could be heard, and no outside broadcasts reach the Filipinos.

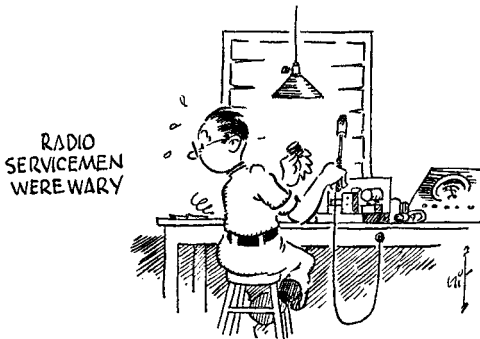

Some of the sets, after being reconditioned by the Japs, were repaired again, but to do it was a risky enterprise and radio servicemen were wary. Life, under the Japanese rule, counted very little, still the average serviceman did not relish the prospect of losing his. With all parts necessary for short-wave reception missing, the reconversion was not a quick and easy job. Besides, we were kept under close vigilance and knew that spies were at large. Sometimes we knew beforehand of the approaching military police, but never knew how to distinguish between a common citizen and a Japanese spy. Building converters and adapters was easier if we were able to secure the needed materials. Converters are very small things and easy to hide. Many of them were built and used. But when some of the short-wave listeners got caught, and had to pay very dearly, some even with their lives, many grew afraid and gave up.

* Cuenca Batangas, Philippine Islands.

We admit that this is not a story of radio amateurs or of their activity during the war. However, F. Joseph Visintainer demonstrated the outstanding qualities of a true amateur. His loyalty, persistence and ingenuity qualify his story for these pages, and the success of his ventures should be an inspiration to us all.

We present the following excerpts from a letter accompanying his article:

"This is the account of something we did here in the Philippines in order to hear the truth of what was going on. Of course, what I am telling is only my story but I think that, more or less, it was the same throughout these Islands, and my story may be the story of many others who were lucky enough to come out with their lives. Alas! That many more had to succumb — the story of their trials and martyrdom will never be related. As I am a Catholic priest, radio is only my hobby, but during this war it served me well."

Many others, however, went into the mountains and to places far away from towns and other localities where the Japs and their spies used to prowl.

There was no electricity in such out-of-the way places. Storage batteries could be used, it is true, but only for sets built or adapted to the purpose.

The trouble was that batteries needed recharging, and there was no fuel to charge them. Some tried to distill their own fuel — alcohol obtained from sugar cane or, more commonly, from coconut wine. But it was a long and not easy procedure, because of the lack of proper apparatus. They made stills out of tin cans and copper tubing taken out of old cars. In such crude retorts, instead of having alcohol distilling and water left behind, nine times out of ten you had the water distilling and the alcohol going out the wrong way.

Others, in order to charge their batteries by hand, made crude contraptions with cartwheels and auto generators. They worked, but it was too tiresome a task. Then waterwheels were tried. The wheels were installed in some deep gorge of very difficult accessibility. Batteries were carried to the charging place by men walking up or down the bed of the river from the nearest ford, in order

not to leave tell-tale tracks. But here in the rainy season rivers grow so suddenly that there was no time to remove the wheel. At the first downpour upstream, many a wheel went merrily sailing down the river and was seen no more. Some were found again, but so disfigured, that it would have baffled anyone who had had the wish to know what they were used for.

Then we thought of charcoal. Crude gas producers were built and proved satisfactory. We had only to be cautious and use a good exhaust silencer, otherwise the military police would have been there before long. A windmill would have answered the need nicely, but as it had to be installed in the clear and quite above ground, it would have had the noses of the military stuck into it in no time.

At last the Japanese got so frantic about news coming in and circulating everywhere despite all their efforts, that they began to look for radios in every nook. Spies were busy and with the soldiery and the police scouring the country, of course some got into trouble. Sets were seized and owners brought to military prisons from which one seldom, if ever, came back alive.

It was on one of these raids that one of the sets I had made was discovered. In the fright of the moment the owner told where the set had been made. It was his salvation. They dropped everything, forgot even to arrest him, and came straight to Ibaan where I was then residing. They were so excited and so angry that there was ground for fears that my last hour was at hand. In fact, I thought that the least they were about to do was to shoot me. Luckily, it never came to that. I led them into my workshop where I opened all the drawers and showed them everything. I tried to behave courteously, gave them all the explanations they asked for, and led them in their search throughout the house from the cellar to the attic. They searched, rummaged, threw everything into disorder, but could not find what they hoped for. True, they found many things, but nothing incriminating — no short-wave radios or antennas. There were five old long-wave sets, all of them duly registered, some test instruments, many spare parts, about fifty new tubes, and yes . . . a storage battery, but as I explained that the storage battery belonged to the church, and was used for the processions, which was true, and I being a priest, and living in the rectory, that was not incriminating.

"Had I not built many short-wave sets?" . . . "Yes, I did build some short-wave sets, but it was long ago, before the prohibition." "Did I not belong to the guerrillas?" . . . "No! I did not, I was a priest, and priests are forbidden to take part in political issues. And besides, I was an Italian citizen."

While the search was going on I ordered my boy to prepare some coffee. Japs, as a rule, like coffee very much and, little by little, they cooled

down. When they had had their coffee they became almost courteous. Then they began to carry out all my things. They were about to carry away one of the boxes full of junk. I told them to take them all if they wished, but that I was so sorry that there was nothing but junk in them. So they let it down and inspected the contents, saw that I had told the truth and left the boxes there. Before going they told me that I was pardoned for that first time. I thanked them. But, they continued, they would be coming back again, and then if I would be found tinkering with radios . . . it would be only too bad. . . . Did I understand? I did. "So," they finished, "beware! Let us not find you tinkering with radios again if you prize your life." I did prize my life, and, of course, if I could only help it, I was not to let them find me again at work on radios.

When they departed, they took all my things including the storage battery belonging to the church. Left alone, I came to life again but now I was shut off from the world. One of the sets they had taken had a secret contrivance built in, by the use of which I was able to listen to the San

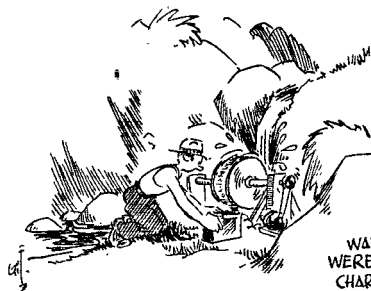

WATER WHEELS
WERE CONTRIVED TO
CHARGE BATTERIES

Francisco broadcasts. I must build myself another set, but where were the necessary materials? To buy them was not wise. . . . I began rummaging into the junk. There were many things there that with a little patience and some skill could be fixed up. There I found a tube I had discarded only because it was gassy. As a detector it might work. There were resistors, condensers with nothing wrong but broken pigtailed. There was an old dial plate, knobs, sockets, volume controls, tubes, a little of everything, even headphones. The only trouble was that every item had been discarded because it was not in working order. The following day I had enough parts repaired to make a little one-tube set. It worked wonderfully. The tube was a 35A5. Our light plant was a 32-volt Delcolight, so with 32 volts on the plate, and without a shadow of an antenna, I could hear San Francisco, Sidney and many other places very clearly on the phones.

So I was not shut off from the world after all. People continued to come in for news as before, and the military police never found out. After some months, that is, in June 1943, I was re-

moved to San José. As there was also a 32-volt plant operating for the church, I brought my radio along. There were Japanese soldiers in San José, a lot of them. They had occupied all the principal buildings of the town and most of the rectory, and they had a lookout on the roof of the church. That complicated things considerably. Nevertheless, when at home I always listened regularly to the San Francisco news. Indeed, it was very exciting to be in the midst of those who sought by every means to hinder you of doing something and had the power for it, and yet to be able in spite of all, to do this thing. But, it was also sufficiently dangerous, because they entered our rooms without knocking. Being in danger of being discovered at any moment was not a very

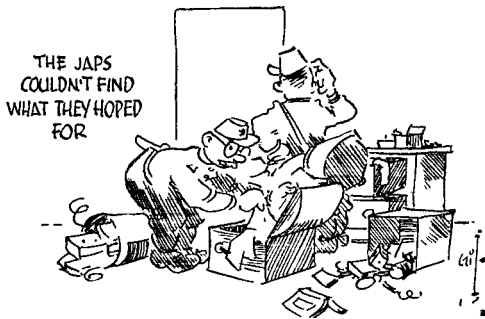

pleasant thing to bear. But the people had to have their news. And news was becoming more and more interesting every day.

Spies there were, the Japs were ever on the alert, but in spite of it all, news was brought out and kept circulating. The Japs knew it, what they did not know was — what to do next? All means had been tried but in vain. All? No! They still had another trick in their bag. They seized all the small electric plants. All the farm lights went out, and ours in San José were not excepted. I was in the dark again and all the radios for miles around were silenced. The nearest receiver still operating was situated about thirty miles away. In my situation only dry batteries or primary cells could be taken into consideration, all of the other means having been rendered impossible. Dry batteries were out of the question. From the time the Japanese boots had begun to tread our shores, dry batteries had literally disappeared, and that was a long time ago. (About three years, to be sure, but they seemed more than thirty.) Primary cells? I began to collect what was necessary. I found plenty of zinc. It was not pure, and I had not a single drop of mercury to amalgamate it, but it had to do. I found plenty of old flashlight cells, from which I took the carbon element. Next came the electrolyte. Ammonium chloride was nowhere to be found. If I could only prepare it myself! Ammonium sulfate I found, and lime and manganese ore. I had common salt and some very

diluted sulphuric acid. I got plenty of calcium hypochlorite for the latrines from the Japanese.

But I am not a chemist. I hoped to obtain ammonium chloride by mixing the hypochlorite with the sulfate. The result, I hoped, was to be insoluble calcium sulfate and soluble ammonium chloride, to be separated later by washing. The result — a loud explosion. An embarrassing and very loud explosion that rocked the rectory and filled the room with poisonous fumes. A hailstorm of Japanese soldiers poured down on me. When they tried to enter the room to see what was going on inside, they were hurled back by the gas streaming out. Angry words were heard. They would not believe that I was only trying an innocent experiment to get some plaster of Paris in a hurry, and that I had got a detonation instead. Maybe they thought that I was manufacturing explosives. In order to convince them, I had to repeat the experiment. The first detonation had left the jar intact. In it I again introduced the two ingredients, and put the jar outside in the open. The explosion did not keep us waiting. It was like a cannonade. When we went to look for the jar, it was not there, but we saw bits of it everywhere. The soldiers withdrew satisfied — almost. After that, I do not know how many experiments I tried but all to no avail. Finally, I began to saturate water with ammonia and then introduce chlorine into the solution. Then, by evaporating the mixture I got my sal ammoniac. It was a long process. I had to make my own tools with old bottles and rubber hose and tin cans, and I never knew when the solution was neutral. At last, I had to look for the pots. They were made of bamboo. The stems of bamboo are hollow inside, very hard outside, and their joints are very thick. Every joint was cut to the desired length and impregnated with tar from old dry batteries. I put together a battery of thirty cells. The voltage was somewhat low. That I ascribed to the impurities in the zinc. It could be remedied by adding more cells.

And now to look for a battery-operated tube. I knew where to borrow a 3Q5 and got it. The few necessary changes in the wiring of the set were made and when the hour came I was so thrilled to hear San Francisco again that I felt well repaid for all my work and all the risks connected with it. The day was the 26th of December, 1944. It had taken me 35 days to get going again. The Americans had made big gains meanwhile. Liberation was nearing.

After the landing of the Americans in Lingayen, the garrison of San José was sent north and I was left alone. But on the 27th of February, 1945, I was arrested and placed, for the space of more than three hours, before a machine-gun. I feared that my hour had come at last. It did not. After an interminable time of waiting to be shot, I was released once more. They had nothing on me so

(Concluded on page 136)



Correspondence From Members -

The Publishers of *QST* assume no responsibility for statements made herein by correspondents.

V.H.F. STABILITY

c/o Colonial Airlines, Municipal Airport,
Burlington, Vt.

Editor, *QST*:

I'd like to take issue with Wes Bell's letter in February *QST* re "Let's not see any more modulated oscillators and rush boxes for 144-148 Mc." I was on 56 Mc. back in '38 when the gang on that band were forced to go "stable" with e.c.c. or crystal control and I, personally, dropped out of the band because I had no filthy lucre or the wherewithall to buy any more gear than my pair of 45s modulated.

I have a little more gear now and a lot more experience on v.h.f. (up to 3 cm) but I'm still sticking to my modulated osc. until my pocketbook can be xtal controlled and my bank book can afford a superhet for 144-148 Mc.

Don't forget, Mr. Bell: the club is not an exclusive one. We modulated oscillator and "rush box" users were bounced out the back door of club 56 about seven years ago. We'd like to stay until the party's over in club 144.

— Don Getchell, W1GKA

HANDBOOK ADVERTISING

USS Colahan, c/o Fleet Post Office,
San Francisco, Calif.

Editor, *QST*:

... I wish you would request your advertisers to give useful information about their products in their (Handbook) advertisements, such as does the National Co. on pages 4-21 and the Millen Co. on page 66. The public is fed too much baloney these days about "our product is the best on the market" whereas I would prefer information such as the Continental-Diamond gives about their product on page 118. When a company advertises a receiver I want to know the sensitivity, selectivity, image rejection ratio, tube lineup and freq. range. I want facts and statistics, not baloney! ...

— James E. King, RT9c

INCREASED LEAGUE FRATERNITY

3914 Agua Vista St., Oakland 1, Calif.

Editor, *QST*:

Much closer coordination between League Hq. and the hundreds of ham activities all over the country could be easily facilitated by the setting up of lodges or groups of ARRL. A set-up of this sort, I feel, would increase the already fine show of fraternity in our organization. This great country of ours didn't achieve its full measure of greatness and strength until after a complete and cooperative unity was realized among the states. The same could be said, to a certain degree, for our ARRL. Why not have the various sections worked out onto a large scale and with meetings weekly or bi-monthly? The SCM could remain as the presiding head with the necessary addition of treasurer, secretary and any other officers deemed necessary.

Instead, then, of several hundred independent clubs working more or less within themselves and in many cases with little or no contact with other clubs have these various sections all over the country working under a general setup decided by League Hq. and with allowance made for these groups who may have activities peculiar to their specific locality. Would like to hear what other ops have to say on this idea. How about printing a few letters from members who might agree with my idea?

— E. H. Nickell, W6FCF

"DRIVEL"

507 Haverford Ave., Narberth, Pa.

Editor, *QST*:

I'm a c.w. man. Not a "dyed in the wool" edition as I'm still an embryo, having got my ticket just about a year and a half before Pearl Harbor. But in that time I feel that I learned the technique of c.w. operating — i.e., meaty QSOs, brief and to the point, but not lacking the human friendly touch that many think cannot be associated with a bug.

Came WERS and my first contact with a microphone. Not bad. We conscientiously refrained from hamming and therefore everything went along in a clean, business-like manner. Then the 2½ band was opened up for amateurs, and were my eyes (and ears) opened! Listening in, I heard ever so many fellows reestablishing acquaintance with stations they had worked on 10 and 20 before the war. Plenty nostalgic. And then came the rude awakening of what goes on in the phone band.

Could this be amateur radio? Such drivels I could scarcely imagine! Apparently some birds have an inferiority complex that they shed as soon as they sit in front of a modulator, and their inhibitions are gone with the wind as they run off at the mouth and drool along by the hour with stations not a stone's throw away. And to be sure of a solid QSO they turn on their California kw. and monopolize a goodly hunk of the ether night after night having a round-robin with guys around the corner.

I put myself in the shoes of BCLs and wonder what impression they have of hams. With c.w. mighty few outsiders can eavesdrop, but the drooling phonesters certainly can't conceal their asinine conversation from the local community. After all, there are plenty of topics to discuss, and there is no need to drag YLs and XYLs into the shack to entertain them with dialogues that might be impressive to the participants but plenty on the revolting side to everyone else.

So here's hoping for a renaissance among those phone men who abuse the privileges given them by FCC. True, they are in the minority but it takes only one fly to spoil the dessert.

As soon as I can get a driver transformer, I, too, will be on phone. But may my grids denaturalize if I yield to the temptation of behaving like the lids referred to above.

— Frank McEnanem, W3IXN

"DRIBBLE"

Route 2, Box 32, Canby, Oregon

Editor, *QST*:

Having been a member of the fascinating game of amateur radio and an ardent supporter of the ARRL and all of its activities for a good many years, I feel it necessary to uncork a haymaker for the benefit of a few of our fellow amateurs that need a little blistering for cluttering up the good pages of *QST* with stuff about some of us fellows cluttering up the airways with our so-called "dribble." Boy, I'm mad!

I am referring to remarks made by a few of our dear brethren regarding the conduct and conversations carried on by some of our fellow members on the air, both by c.w. and mostly by phone, such as Aunt Minnie discussing the merits of her apple pies with Cousin Matilda, or maybe my own little YL talking to my friend's little YL in a not too distant city, etc., namely about her dolls, or what did she get for Christmas.

If my memory doesn't fail me, the ARRL *Handbook* itself expounds the fact amateur radio is for, by and of amateur radio operators who are interested in the game strictly from a social, technical and educational standpoint, for no remunerative purposes whatever, etc.

Now, let's analyze that statement a little. When you attempt to crowd a group of fellows into a groove, to think, eat and sleep alike, you are toying with the possibility of regimentation — well, not exactly toying, brother, you have it! This is America; we just about eat, sleep and think the way we darned well please; that's the democratic way. Let's keep amateur radio a democratic organization, else it shall die through the efforts of a few to dominate the many by pressuring others into doing and thinking as they would have us do and think.

We have fellows in amateur radio that derive their pleasures of the art from designing, others from contacting other stations, others from permitting the use of their stations by outsiders for conversations with relatives and friends (that's me), others from offering their services, equipment and knowledge for all classes of emergency. No two guys are alike, no two fellows build or think alike (my rig's better than yours because . . . your rig's better than mine . . . etc.). Out of this conglomeration of thoughts, ambitions and pleasures, comes the spirit of amateur radio, with gradual improvement of the game and equipment from ideas, designs built by our own amateurs and these ideas are gradually refined and passed on to the general public and organizations who benefit from the efforts of the amateurs in their zeal to attain enjoyment from their hobby, surely a just reward for our efforts.

Now to my poor, downtrodden fellow members of the amateur profession, I only have one thing to add regarding QRM. If my QRM gets you, that's tough; maybe you could use your bean and figure out a scheme to eliminate it. If your QRM gets me, that's just tough for me, too. But if my Aunt Minnie wants to talk about her apple pies and if my little YL wants to talk to another little YL about a lot of kid stuff — brother, duck your head; because as long as the FCC will permit me to disturb the airways I shall be in your hair. One more thought before I leave: don't overlook the fact that the fellow who spends his time cluttering up the airways, as you so diplomatically put it, is quite as capable of thinking and of using his brains as you are. I have yet to see the ham shack that didn't have a good workshop to carry out ideas. Yes, the fellow that enjoys just a good gabfest with a lot of "dribble" is also a builder of the amateur game. Let 'em alone.

— E. L. McCauley, W7GYA

OK IS OK

Czechoslovakia

Editor, *QST*:

It is a great pleasure and satisfaction to me that, after seven long sad years, I can express to all hams the world over our sincere wishes for a Merry Christmas and a really Happy New Year, with restored licenses and renewed contacts. In my wishes I am heartily joined by all our compatriots.

— Otakar Halas, OK2RR,
Secretary of C.A.V.
Rosemount, Minn.

Editor, *QST*:

Hoping that you may have a few minutes to read a letter from an old ex-ham who started in the game in 1916 and, with the exception of a couple years, was in the amateur game until 1931. Have been off the air since the latter date but am getting a strong urge to again clutter up the air with a vibroplex.

I have got the last three issues of *QST* from the newsstands and, having been out of the game for a number of years, I find these issues distinctly disturbing. If I may be permitted to "growl through my whiskers" for a moment, I would like to say that I think the mag has gone highbrow! Opening and looking through these issues, I received the impression that I was looking at a textbook on mathematics written by Steinmetz. In the old days *QST* devoted its pages to telling the amateur what he wanted to know, not what the editors thought he ought to know! As an example, in the December issue, I think that pages 57-60 could well be devoted to something useful as this information can be obtained in any math book.

Now that I have this gripe off my chest, I would like to suggest that *QST* devote some space for the old ex-ham and the new beginner who are bewildered and don't know where to start. I would like to get back on the air but am thoroughly confused. I personally don't know the difference between a Lecher wire and a leash on a cocker spaniel; neither do I know the relative merits of a single or double button or ribbon mike. I have personally talked to many of former hams who feel as I do and who would like to get back on the air but are at a loss as to how to start.

What we want to know is what receiver to buy, what transmitter circuit is the most simple and reliable for the various wave bands, what antennas can we use and which are the most reliable. Give us some transmitter circuits for the old reliable rag-chewing bands and DX bands. I would like to see a simple but reliable transmitter circuit that could be used on the 5, 10, and 20-meter bands, crystal controlled with 250 watts output. Some of the other things that some of us present day greenhorns would like to know is what kind of power supply is the best and what the multitude of present tubes are used for.

I realize that the foregoing is a large order but I think that *QST* will be willing to rescue some of us old timers from the limbo of inactivity and give us a fighting chance to get back in action once more. We would all appreciate your devoting a section of our mag to the beginners and the virtually helpless old timers who would like to get into the swim again.

I am among the countless number of old amateurs who started back in the days of the spark coil and crystal detector, then after the first world war came on the air with a 1 kw. spark and an audiotron detector, graduating — or rather allowing ourselves to be talked into — the new-fangled c.w. in the 20s. I finally wound up my amateur career temporarily on 20 meters with an old 204-A (250-watt) self-excited job in a t.p. & g. circuit, with which I managed to roll up a quite imposing DX score under the call of W8CLP, located at Toledo, Ohio.

I expect to go up for a license as soon as possible to replace the commercial first I carried for many years and operated under on the Great Lakes, and by the time I do get my ticket I hope that *QST* will have succeeded in bringing the light to the old timers so that we can get back in the game on an intelligent basis.

— Charles F. Parcells, ex-8AHT, W8CLP

WX WORK

Hq. 288 F.A. Obsn. Bn.,
APO 403, c/o PM, N. Y.

Editor, *QST*:

. . . At present I am stationed in Grafenwohr, Germany, and am chief of section of a metro crew of 10 men. We are making daily "flights" to take weather data for the artillery testing grounds. With the radio direction-finder, we get our wind data. In a van, mounted on a 2½-ton truck, is our radiosonde receptor, from which we get temperature and humidity at all levels up to 80,000 feet. Our highest flight to date has been 126,000 feet! We also transfer our dope to the 21st weather squadron of the Air Corps. The radio direction finder is a honey of a piece of radio equipment. I watched its development while going to school in New Jersey, learning the maintenance of it and the radiosonde. . . .

— M/Sgt. Thomas F. Cann, W9HOD

VENUS IN THE SIDE POCKET

Saltair, Utah

Editor, *QST*:

This radar contact with the moon looks like a break for us hams. Now, that we know we can penetrate the earth's atmosphere and the ionosphere, all we need to do for DX on our new h.f. bands is to squirt a sig at the moon, a star, or even the sun and bounce it back where we want it. However, this is going to give the crack pool and billiard players an unfair advantage in figuring the complicated bank shots and the proper English. Imagine a shot, Mars to Venus to the antipodes, hi!

— Leonard F. Zimmerman, W6EYS
(Continued on page 130)



Hints and Kinks

For the Experimenter



RMA COLOR CODE FOR MULTIWIRE CABLES

WE USED to keep elaborate records of the colors of wires and the terminals used in a multi-conductor cable hookup. I hit on the idea of using the well-known RMA color code for this purpose and have found it works exceedingly well. Fig. 1 shows the basic idea. It will be noted that the terminals are numbered from top to bottom (or left to right), with No. 1 at top or left. The colors start — brown, red, orange, etc. Wire No. 11 would be brown with a brown and white tracer. Wire No. 12 would be brown with a red tracer. This system proved useful in connecting up 127 thermocouple vacuum gauges in a recent job. I

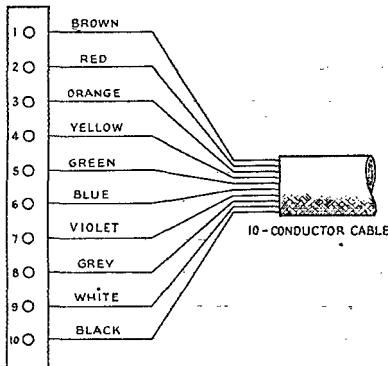

10-LUG TERMINAL STRIP

Fig. 1.

believe it offers more possibilities than the Bell System plan which only goes to 33 and in which the colors are not in a well-known sequence. — *Dwight Stebbins, W9WLK.*

— . . . —

AN ELECTROSTATIC KEY

THIS electrostatic key is extremely simple in construction and does not use any tubes. It keys uniformly and accurately at speeds up to thirty-five or forty words per minute.

This key has the advantage of simplicity and compactness found lacking in many previous models. All of the parts can easily be mounted on the base of a regular bug reconstructed for this purpose.

The circuit shown in Fig. 2 requires two relays; one for making the dots and dashes, the other for

making the spaces. When S_1 is closed and the key is pressed to either side, Ry_1 is connected in parallel with either C_1 or C_2 and the 45-volt bat-

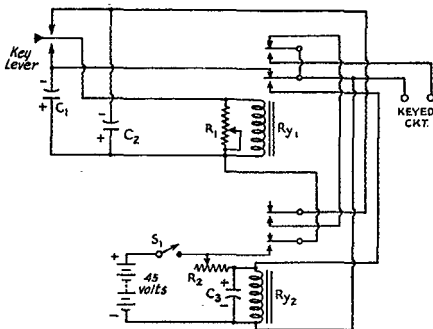

Fig. 2 — An electrostatic key.

- C_1, C_3 — 4- μ fd. 150-volt electrolytic.
- C_2 — 12- μ fd. 150-volt electrolytic.
- R_1 — 10,000-ohm potentiometer (linear).
- R_2 — 25,000-ohm potentiometer (linear).
- S — S.p.s.t. toggle switch.
- Ry_1, Ry_2 — 10,000-ohm d.p.d.t. relay (Leach 1037).

tery. This immediately pulls in the relay Ry_1 and disconnects the battery from the circuit. The relay is held down until the voltage across either C_1 or C_2 has reached practically zero. This length of time is partially controlled by the potentiometer (this is the speed control) connected across the relay.

Also, when Ry_1 closes, it shorts out C_3 , connected in parallel with Ry_2 , which has slowly charged through R_2 . After Ry_1 opens, it is necessary for a length of time equal to a space to elapse before C_3 can again be charged enough to close Ry_2 and recharge C_1 and C_2 . This process will continue as long as the key lever is held to one side or the other. C_2 is three times as big as C_1 so as to form a proper relationship between the dots and dashes. — *Harris Adams, P. O. Box 1407, Merced, Calif.*

— . . . —

INEXPENSIVE RELAY FOR PUSH-TO-TALK CIRCUITS

A USEFUL adaptation of an automobile part to a ham radio is the use of a double headlight relay in a push-to-talk system. I bought my relay from one of the automotive chain stores for \$1.19 and it works swell! — *M. E. "Bud" Dahl, 4710 Meridian St., Phila. 36, Pa.*

W2ASB HAS A REAL SEND-RECEIVE SWITCH

TOM GARRETSON, W2ASB, told us that he changed his s.p.s.t. toggle switch in his receiver to a d.p.d.t. and connected the new elements of the switch in series with an outlet from which he obtained his 115-volt supply for his transmitter. Now when he throws the switch from *Receive* to *Send* — he does!

.....

HAM-MADE SOLDER FLUX

AN EXCELLENT non-corrosive soldering flux can be made by crushing rosin into a fine powder, then mixing it with methyl hydrate or rubbing alcohol until a syrup about the consistency of molasses is secured. This mixture should be kept corked when not in use. However, I have found that the alcohol does not evaporate rapidly when mixed with rosin. A 1-oz. bottle of this flux will last a long time, so it is very inexpensive. — *Austin A. Smith, 6164 Jeanne Mance St., Montreal 8, Que.*

.....

TWO CRYSTAL HOLDER SOCKETS

THE INCREASED use of FT243 crystal holders brought forth these two sockets. In Fig. 3-A I used clips taken from a Millen crystal socket to

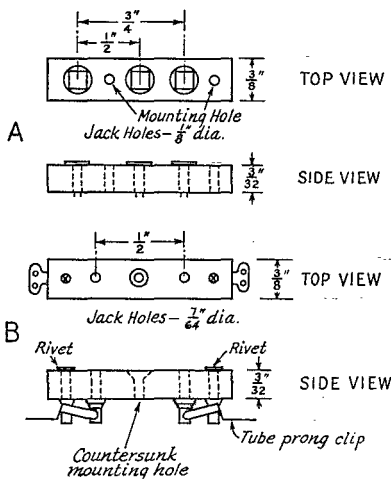

Fig. 3 — Two crystal holder sockets fabricated by WILIG. In A, clips from a Millen crystal socket are spaced for both amateur standard and FT243 holders. Another style, for FT243 holders only, is shown in B and utilizes clips from a tube socket riveted in place.

make up a socket that will accept both amateur standard and FT243 holders. Fig. 3-B takes only the FT243 holder and is made from two tube-prong clips riveted in place. — *Dr. J. E. Greenbaum, W1LIG.*

A SIMPLE TIME DELAY CIRCUIT

THE TIME-DELAY arrangement shown in Fig. 4 depends, for its operation, on the time required for a heater-type rectifier tube to reach operating temperature. A 117Z6 is shown, but a 50L6, with grids and plate tied together, also worked satisfactorily.

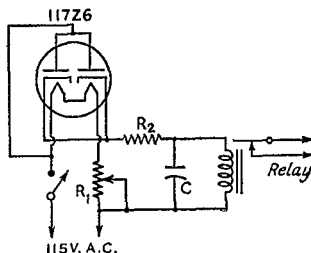

Fig. 4 — A simple variable time-delay system

A 400-ohm 10-watt potentiometer, R_1 , is connected in series with the rectifier heater, to control the time delay, which is variable between 15 seconds and about one minute. R_2 is used to limit the current through the relay to the rated value. I found that 10,000 ohms was right for the relay I had on hand, as it allowed 8 ma. to flow through the relay at full operating temperature. The relay closed at 6 ma. The relay should have a d.c. resistance of from 1000 to 2000 ohms. The condenser is a 30- μ fd. filter, used to prevent relay chatter. — *James D. Matthews, Gainesville, Ga.*

.....

CRYSTAL GRINDING COMPOUND

ANYONE interested in a good fast-cutting and easy-to-obtain crystal grinding abrasive should try ordinary automobile valve grinding compound.

The writer has been using it very successfully to grind 160-meter crystals to the 80-meter band. The grinding operation takes about twenty minutes. — *Louis D. Breetz, W8QLP.*

.....

PERFORATED METAL SHEETING

THE perforated metal used in some types of acoustic ceilings is readily adapted to other uses around the ham shack. It can be used as a speaker grill, as protection over ventilation openings, as shields over high voltage bleeders, rectifier tubes or filter components.

The metal sheet is easily cut to the desired size with tin snips and can also be bent to the required shape without difficulty.

Scrap pieces can usually be obtained from contractors engaged in acoustical treatment of buildings. — *William G. Walker, W8NUG.*

(Continued on page 140)



Operating News



F. E. HANDY, WIBDI, Communications Mgr.
E. L. BATTEY, WIUE, Asst. Comm. Mgr.

J. A. MOSKEY, WIJMY, Communications Asst.
LILLIAN M. SALTER, Communications Asst.

On Getting Results. Listen on the air and you will hear all kinds of operating. Good operating is much to be desired. There's more to getting results than hooking a transmitter to an antenna though.

Anyone can be a good operator, and improve his results. This is a matter of putting some applied common sense principles to work. Steer clear of calling at the wrong time, or on a frequency being used by a high power station. Avoid stupid long calls when short ones will do the job. Use intelligent businesslike procedure for voice or c.w.t. operating. Even if your voice isn't as melodious or your fist as smooth as the ultimate, you will improve your results. Here are some simple pointers that may help:

- 1) Listen much (DX and other signals are often missed by rapid tuning, passing over weak signals).
- 2) Make short calls. With frequent breaks to listen, short calls are most effective.
- 3) Time your calls intelligently; call a station when it is free and invites answers, not while it is still sending.
- 4) Transmit when your frequency is clear.
- 5) Speak or send clearly at all times. ("Say it with connected phrases" not by disconnected words. A moderate transmission speed is usually best. The speed-operator, c.w.t., who makes repeats necessary is way slower than the careful steady chap.)
- 6) Reserve local rag chews on DX frequencies for times when the bands are dead to DX.
- 7) Send "single" unless and until your correspondent asks for repeats (QSZ).

Make Your Call Come Last. There is the FCC regulatory requirement that all amateur stations identify themselves at the beginning and end of each transmission by transmitting "the call let-

ters of the station called or being worked and the call letters assigned the station which he is operating." Note that the order in which these calls appear is indicated in the FCC regulations and examples. It is a matter of good etiquette as well as a practical necessity for identification that your call come last whenever you send a sequence of calls on the air. It is confusing in voice when the call of the station worked is sometimes given at the very end of the transmission. The proper order of calls is just as necessary on the air as the proper placing of the address at the beginning and the signature at the end of a letter. "To" and "from" follow in natural sequence: WIAW from WIBDI.

The last call heard in ending a QSO thus always identifies the station transmitting. If we disturb this traditional order we risk missing some "heard" reports. Also we risk conflict with the stated FCC regulations for identification of stations. Here is another point from the ARRL operating booklet. "VA (end of work) shall be used by each c.w.t. station when signing off, this followed by your own call sent once for identification purposes." Thus at the termination of our correspondence with WIAW, to show that we are through with this station and will listen for whomever wishes to call we will send: ". . . VA WIAW de WIBDI." Note that the SK or VA doesn't come at the end of the transmission but at the end of the message or discussion, and our identifying call comes at the very end, in compliance with the FCC regulation.

This group of amateurs stationed in and near Frankfurt, Germany, got together on January 10, 1946, to form the Frankfurt Amateur Radio Club. Those pictured are, left to right, Seated: D4ACY/Lt. R. E. Kramer; D4AAA/W9SWY; D4ACE/W7HQC; D4ABK/W7IOX; D4ACD/W9UXQ; D4ACR/W6PLK; W3-FMR. Standing: W9ZHN; D4ABL/W8ECZ; D4ADX/W8PHZ; D4AAH/W9MTR; D4AAG/W8RRX; D4AAX/W9QGT; D4ABB/W8JTW; D4ACM/W9HDD; D4ACX/Sgt. W. J. Madison; D4AAI/W4GOX; D4ADN/W6PFO; D4ADV/Tech. Sgt. Ed Ames; W6MEV. W9UXQ writes, "Keep an ear open for us between 29 and 30 Mc., 'phone and c.w. daily." Col. W. A. Beasley, W9-FRC/D4AFC, advises that over 150 D licenses have been issued.



New Reporting Dates. Effective April 1st reports of operating activity to SCMs will be due for the calendar month just preceding. It will be easier for appointees and active operators to remember. Reports will cover periods like March 1-31, April 1-30, May 1-31, etc. If you reported activity March 16th, make your April 1 report for just a half-month. Otherwise send Station Activities for full months April 1, May 1, June 1, etc. SCMs welcome news from all active amateur stations for QST.

Applications for Appointments Invited. ARRL has available new application forms for Official Experimental Station and Official Observer appointments. Full detailed announcement of the Official Experimental Station v.h.f.-u.h.f.-s.h.f. appointment for stations above 50 Mc. appears on page 66, March QST, with an abbreviated description of each type of ARRL-SCM appointment. Also see "ARRL Appointments," page 80, March QST. ARRL will welcome inquiries concerning any of the ARRL appointments. Detailed information and appropriate forms where necessary will be supplied on request of members expressing interest in any one appointment. Application forms for OES, ORS,¹ OPS,¹ OO, or OBS can be sent you. When transmitted to SCMs (see page 6) with the data on your amateur station or equipment and statement of your intention to pursue and report regular activity along stated lines, maintaining high standards of work, your SCM will advise, and if possible make the appointment.

Official Observers have assisted many hams currently by mailing them cooperative notices to call attention to spurious radiations, improperly strong harmonics, bad notes or other difficulties that invite FCC trouble for the individual or the fraternity. Depending on equipment, experience and certification of frequency measuring test results OOs engage in the following classes of work: I. Precise frequency checking. II. General frequency checks (± 5 kc. at 14 Mc.). III. Radiotelephone checks of modulation, stability, quality. IV. Radiotelegraph checks: Notes, clicks, chirps, stability. More OOs are needed. Ask for the OO-application form on which to indicate your receiving-checking equipment and willingness to help in this mutual benefit ARRL program.

ARRL Emergency Corps Progress. AEC application forms have been sent to all clubs that requested them, and Emergency Coördinators (or ARRL) will send more on request. Local emergency organization meetings are now the vogue, to prepare for possible spring flood conditions.

¹ SCMs cannot make new ORS and OPS appointments until ARRL announces reactivation of these groups. However, SCMs welcome applications, backed up by monthly reports demonstrating your station activity, which is prerequisite to appointment. Qualified applicants who have filed in advance and reported activities will be among the first to be certified when official ORS-OPS activity is resumed.

Such meetings help build a sound foundation for interesting radio test activities and a good Emergency Corps group in every city and town.

The month's appointments of new SECs include:

Gordon E. Woodruff, W4GVC, E. Fla.
Roy Brady, W8WLG/6, Los Angeles.
J. B. Wathen, III, W9BAZ, Kentucky.
Arthur Brennan, WINDQ, R. I.

A hearty welcome to these new Section officials who will promote and extend Emergency Corps coverage. These men, the SECs mentioned in these columns in previous months, and SCMs, want recommendations of live-wire member-amateur candidates for the ARRL appointment of Emergency Coördinator in certain towns and cities in every ARRL Section. There's opportunity for leadership and community prestige too, in the job. The places where ECs have not yet been appointed, where general amateur meetings have not yet been held, where opportunity has not been extended publicly to every amateur to join the Emergency Corps, where plans for this regular, interesting, supervised, amateur radio operating activity have not been completed, need the leadership an Emergency Coördinator can give.

Send such recommendations — and your request for a Form 7 Emergency Corps application blank to a Section or other ARRL official without delay. Don't let your town go without this interesting public service branch of amateur activity.

— F. E. H.

FAMILY REUNITED BY AMATEUR RADIO

On the morning of February 16th, W1IAR, Farmington, Conn., worked D4AEY (William Sexton) in Weinheim, Germany, on 28-Mc. 'phone. After a few transmissions each way, they discovered that they had known each other as youngsters. W1IAR called D4AEY's mother on the telephone. With the telephone held up to the loud speaker "Bill" talked to her for several minutes, readability 5. The process was then reversed by holding the telephone receiver up to the microphone and his mother then talked to him, readability 4. A schedule was arranged for the next morning, when D4AEY's wife, father, mother, and sister, came over to W1IAR. Contact was made on the first call. For fifty minutes the family was reunited, readability 5 both ways during the entire contact. D4AEY was running 25 watts to a beam antenna and the S meter at W1IAR registered S9 at times. "Bill" was never interested in radio until he was put in the Signal Corps. He expects to get a W call when he gets back to the states. We are confident he will never have to sell his family on amateur radio!

— . . . —
We overheard one ham mention that he was operating from his wife's pantry. Hi! In these days of housing shortages there must be many other unusual station locations. How about yours?

PRIZE ARTICLE CONTEST

• The article by Mr. W. L. Hall wins the CD Article Contest prize this month.

Each month we print the best article received for contest consideration up to time of publication. The author of each article used is awarded a \$10 prize, consisting of \$5 in Victory Stamps and \$5 in ARRL supplies or publications (except QST). Contributions may be on any subject of interest to amateur radio operators. Articles are selected on originality and value to the fraternity.

Give this contest a try. You may wish to write on Emergency Corps planning work and drills; 'phone or c.w. operating procedures; work on radio club committees; organizing or running a club; the most interesting band for you; code proficiency techniques; DX activities; traffic work; getting the most out of ham radio; or some subject we haven't mentioned. You are not limited; make your contribution on any topic of interest to radio amateurs. Please mark your contribution "for the CD Contest."

500 KC.

By W. L. Hall*

Many hams have indicated interest in what goes on at 500 kc. This OM, long active on this frequency winning the daily bread, with but little to show for it but a shining bald pate and a slightly stiff right wrist, is about to take off. Got me tuned in, fellows? Let's go — 500 kc. is the International Distress and Calling Frequency. Here is where you may hear those SOS calls, XXX urgent messages, "DH" (Deadhead-no charge) medicos, and traffic relating to ship movements and messages of a personal nature. If the West and Gulf Coast boys will pocket their pride for the moment, let's use the Atlantic Coast for our explanations.

Ships leaving Europe heading for some East Coast port in the good old U.S.A., loaded with seasick GIs, matches from Sweden, sardines from Norway, and "Ye Olde Scotch" from Britain, report their arrival time while several days distant so that their steamship agents may take action in preparing for their unloading, loading, and next voyage. Along the Atlantic Coast several radio companies have erected permanent powerful coastal stations all tied in to domestic services by Western Union teletype. These stations send traffic lists every few hours on their working frequencies, first calling "CQ" on 500 kc. and then shifting instantly. With from 5 kw. to 15 kw. in the antenna, using i.c.w., traffic lists for ships are sent

* Ex-W1BMS, Friendship, Maine.

in alphabetical order of call signs as internationally assigned. At the end of the list the coast station listens on frequencies assigned to ships for replies. These frequencies are 500, 462, 468, 454, 425, and 400 kc.

In between lists the coast station monitors 500 kc. and calls individual ships from time to time since not all lists are copied.

The normal maximum daylight range is about 1150 miles without skip effects. At night some skip is noticed between 200-400 miles and the maximum range increases greatly, it being common to work 2500 miles and even up to 4500 under ideal conditions.

With shipping very active, QRM is severe. "40" meters never could compare with this unholy din. Therefore, in order that a vessel in distress may be heard, two International Silent Periods are observed. Beginning at 15 to 18 and 45 to 48 minutes past each hour it is forbidden to transmit on 500 kc. except in relation to a vessel or plane in distress. This gives opportunity for hearing weak signals. Naturally, a ship in distress sends an SOS at any time, but the Silent Periods bring order out of chaos and also give a fellow a chance to light his pipe.

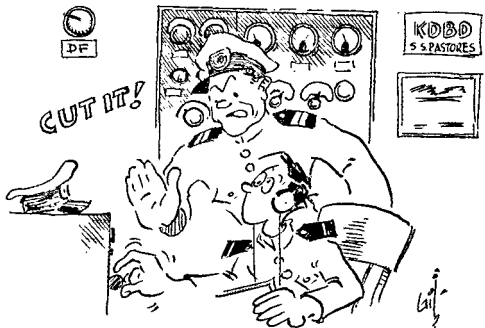

THERE'S NO PLACE ON 500 KC FOR A WEIGHTLESS BUG

When an SOS occurs, a coastal station takes over control of it, if not in midocean, so that assistance may be rendered rapidly. Coastal operators are almost 100 per cent ex-merchant marine operators and with their powerful transmitters and general "savvy" get results in short order. "XXX" is the urgent signal, and means that the message to follow is of extreme importance and no interference should be caused to it. "DH" medico messages relate to an injured or ill passenger or seaman and free advice is furnished from a nearby ship or from a U. S. Marine Hospital.

When 500 kc. is clear of all distress traffic, ordinary paid messages are always in progress between ships and between ships and shore. Rates start at 21 cents per word and increase as the distance over the landlines increases beyond the shore station. Traffic is handled at speeds be-

tween 18 and 25 w.p.m. There is no place on 500 kc. for a weightless bug. (And no other place, we might add.—Editor.) Slow and sure is the standard.

Signal strength reports are seldom given and only if requested. Since communications are the important factor rather than transmitter performance a signal is either easily readable and single transmissions are used, or received with difficulty and "QSZ" ("Send each word or group twice") is requested. Repetitions are asked for if needed to fill parts of the message missed. The form of a message is adequately described in the ARRL *Handbook*. Berne Lists, which are books containing call letters, QRAs (QTHs to you!), Rates, and other facts relative to marine operation are at hand on all ships and at coast stations and with these Berne Lists a newly-licensed merchant marine operator can intelligently perform his tasks from the start of his first voyage.

The U. S. Navy has a few stations in operation on this frequency but the Coast Guard has many. While these installations are less powerful than those of commercial radio companies their operation adds greatly to the "Safety of Life at Sea." Either directly or through excellent cooperation between coastal stations and the Coast Guard, ships and lives have been saved that might otherwise have been lost. 500 kc. gives us all this. There are many hams among the 500 kc. operators. Take a listen "down there" some time.

W1AW OPERATING SCHEDULE

Official ARRL Bulletins containing latest FCC information relating to amateur operation and reactivation, and other bulletins on matters of general amateur interest are transmitted on regular schedules, as follows:

Frequencies: 3555, 7145, 14,280, 29,150, and 52,000 kc.

Time: 8:00, 9:00, and 10:00 p.m. EST, Monday through Friday. (0100, 0200, and 0300 GCT, Tuesday through Saturday.)

Starting on the hour, bulletins are transmitted by telegraph simultaneously on all frequencies. Speeds used are 15 and 25 w.p.m. Bulletins are sent at 25 w.p.m. and repeated at 15 w.p.m. to facilitate code practice. Telegraph bulletins are followed by voice transmissions on each frequency in turn. Changes from this schedule will be announced by the operator. Extension of schedule to a later hour for W1AW special frequencies has been requested. Service clearance pending.

ELECTION RESULTS

Valid petitions nominating a single candidate as Section Manager were filed in a number of Sections, as provided in our Constitution and By-Laws, electing the following officials, the term of office starting on the date given.

Alaska	August G. Hiebert, K7CBF	Jan. 15, 1946
South Dakota	P. H. Schults, W9QVY	Jan. 15, 1946
Southern Minnesota	Vernon G. Pribyl, W9OMC	Jan. 15, 1946
West Virginia	Donald B. Morris, W8JM	Feb. 15, 1946

ELECTION NOTICE

To all ARRL Members residing in the Sections listed below:

You are hereby notified that an election for Section Communications Manager is about to be held in your respective Sections. This notice supersedes previous notices.

Nominating petitions are solicited. The signatures of five or more ARRL full members in good standing, residing in the Section concerned, are required on each petition. No member shall sign more than one petition.

Each candidate for Section Communications Manager must have been a licensed amateur for at least two years and similarly a full member of the League for at least one continuous year immediately prior to his nomination.

Petitions must be in West Hartford, Conn. on or before noon on the closing dates specified. In cases where no valid nominating petitions were received in response to previous notices, the closing dates are set ahead to the dates given herewith. The complete name, address, and station call of the candidate should be included with the petition.

The following nomination form is suggested:

Communications Manager, ARRL (Place and date)
38 La Salle Road, West Hartford, Conn.

We, the undersigned full members of the ARRL residing in the Section of the Division hereby nominate as candidate for Section Communications Manager for this Section for the next two-year term of office.

Elections will take place immediately after the closing dates specified for receipt of nominating petitions. The Ballots mailed from Headquarters to full members will list in alphabetical sequence the names of all eligible candidates.

You are urged to take the initiative and file nominating petitions immediately. This is your opportunity to put the man of your choice in office.

— F. E. Handy, Communications Manager

Section	Closing Date	Present SCM	Present Term of Office Ends
Sacramento Valley	Apr. 1, 1946	Vincent N. Feldhausen	June 15, 1941
New Hampshire	Apr. 1, 1946	Mrs. D. W. Evans	Sept. 1, 1942
Idaho	Apr. 1, 1946	Don D. Oberbillig	Apr. 15, 1944
Arkansas	Apr. 1, 1946	Edgar Beck	Aug. 17, 1944
Virginia	Apr. 1, 1946	Walter G. Walker	Oct. 15, 1944
Tennessee	Apr. 1, 1946	James B. Witt	Nov. 15, 1944
Mississippi	Apr. 1, 1946	P. W. Clement	Apr. 1, 1945
Rhode Island	Apr. 1, 1946	Clayton C. Gordon	Apr. 15, 1945
North Carolina	Apr. 1, 1946	W. J. Wortman	May 2, 1945
No. Minnesota	Apr. 1, 1946	Armond D. Brattland	June 15, 1945
No. New Jersey	Apr. 1, 1946	Winfield G. Beck	Sept. 23, 1945
San Diego	Apr. 1, 1946	Ralph H. Culbertson	Apr. 15, 1946
Missouri	Apr. 1, 1946	Letha A. Dangerfield	Apr. 17, 1946
West Indies	Apr. 1, 1946	Mario de la Torre	Deceased
Arizona	Apr. 1, 1946	Douglas Aitken	Deceased
Md.-Del.-D. C.	Apr. 15, 1946	Hermann E. Hobbs	Dec. 1, 1945
Louisiana	Apr. 15, 1946	Eugene H. Treadaway	Feb. 25, 1946
Indiana	Apr. 15, 1946	Herbert S. Brier	Resigned
Vermont	Apr. 15, 1946	Burtis W. Dean	Resigned
Philippines	May 1, 1946	George L. Rickard	Oct. 15, 1938
Alberta *	May 1, 1946	C. S. Jamieson
British Columbia *	May 1, 1946	C. O. I. Sawyer
Manitoba *	May 1, 1946	A. W. Morley
Maritime *	May 1, 1946	Arthur M. Crowell
Ontario *	May 1, 1946	D. R. Gunn
Quebec *	May 1, 1946	Lindsay G. Morris
Saskatchewan *	May 1, 1946	Arthur Chesworth
Montana	May 15, 1946	R. Rex Roberts	June 1, 1946
Eastern Fla.	May 15, 1946	Robert B. Murphy	June 1, 1946
Nevada	June 3, 1946	N. Arthur Bowie	June 15, 1946
Maine	June 3, 1946	Grover C. Brown	June 15, 1946

* In Canadian sections nominating petitions for Section Managers must be addressed to Canadian General Manager, Alex Reid, 169 Logan Ave., St. Lambert, Quebec. To be valid such petitions must be filed with him on or before the closing dates named.

THE RAG CHEWERS' CLUB

Applications for RCC membership are again coming in. Now we're sure the war is over! We want to bring our records up to date. Members of the RCC who are still active on the air are requested to send a card to Headquarters with this information so that they may be included on the active roster.

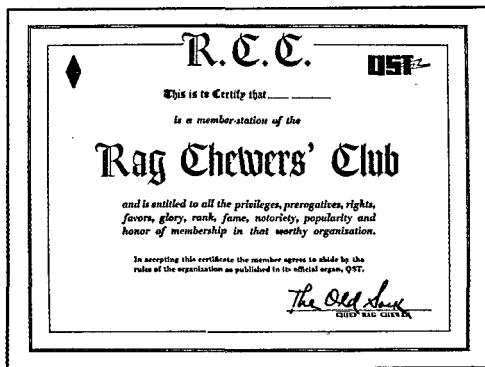

If you like to use your amateur radio station to make and maintain real friendships, if you are a disbeliever in the "Hello-Goodbye" brand of contacts, you will want to get into the Rag Chewers' Club. Here's how:

How to get in:

- 1) "Chew the rag" *with a member of the club* for at least a solid half-hour. This doesn't mean a half-hour spent in trying to get a message over through bad QRM or QRN, but a solid half-hour of conversation or message handling.
- 2) Report the conversation by card to the Rag Chewers' Club, ARRL, West Hartford, Conn., and ask the member station you talked to do the same. Indicate time contact started and ended. When *both* reports are received you will be sent a membership certificate entitling you to all the privileges of a Rag Chewer.

How to stay in:

- 1) Be a conversationalist on the air instead of one of these tongue-tied infants who don't know any words except "ouagn" or "cul," or "QRU" or "nil." *Talk to the fellows you work and get to know them.*
- 2) Operate your station in accordance with the government regulations and ARRL practice.
- 3) Observe rules of courtesy on the air.
- 4) Sign "RCC" after each call so that others may know you can talk as well as call.

How to get out:

- 1) Call a fellow at random and then say something like, "W1 nil hr Om cul 73 VA."
- 2) Call anybody if you are so dumb that you can't make some conversation.
- 3) Fail to QSP promptly a single message — either by radio or by mail.
- 4) Call CQ more than five times without signing, or call lengthy CQs without listening for answers.

The classy certificate here pictured is yours when you qualify. In working towards membership remember these two important points: (1) It is necessary that the ragchew (of at least thirty minutes duration) be *with an amateur who is already a member of the club.* (2) It is necessary for

both the applicant and the club member worked to submit confirmations of the "chew."

Present club members will be heard signing "RCC" after their calls so that those wishing to join may identify them and take steps to get "initiated." It's a quite painless initiation by the way, and will hold nothing but pleasure for you if you are the type worthy of RCC.

NEW YORK HAMFEST, APRIL 26TH

The North Shore Radio Club of Long Island will sponsor the second annual postwar Hamfest to be held in Greater New York on Friday evening, April 26, at the Commercial Hotel, 96-43 Springfield Boulevard, Queens Village, L. I., N. Y. The program includes prominent speakers from both the amateur and professional communications fields, over 100 door prizes, and entertainment. Anyone interested in amateur radio is welcome. Tickets (\$1.00) are available at Greater New York radio stores dealing in ham equipment, from North Shore Radio Club members, and at the door.

Those who remember the North Shore Radio Club's 1945 Hamfest won't want to miss the 1946 affair. Possibly the first postwar hamfest, last year's get-together was held August 24th, three days after the postwar reopening.

BRIEFS

W1SS writes, "W9UMP/1 and I have developed a system whereby a c.w. operator can make it known that he is trying to contact a 'phone station. If W9UMP/1 using c.w. wants to raise me, he runs off nine dots after his call. If he calls CQ, he runs in the nine dots. It has worked out fine." The present generally used practice of c.w. stations desiring 'phone QSOs is to call "CQ fone." For brevity "CQ F" might be used. ARRL will welcome comments on W1SS' idea, or on the general subject of 'phone-c.w. contacts.

Have you joined the ARRL Emergency Corps? Application blanks are available from your local Emergency Coördinator, any ARRL-affiliated club, the SCM (address, page 6), or League Headquarters. Line up today for participation in the Emergency Corps' interesting activities.

HAMS ENTERTAIN SCOUTS

As a feature of National Boy Scout Week, amateurs of Metuchen, N. J., and nearby cities held a Boy Scout Night on February 15th. W2EQQ originated the idea, which proved a great success. The following amateurs opened their stations to the Scouts and acted as hosts to groups of boys for the evening: W2IGN, KZG, OJJ, ASB, HIY, MDV, MGF, KTX, NLH, LHN, and W3HOH. Demonstrations of ham radio were conducted, with W2MXX acting as master control for the evening's operations.

Station Activities



IMPORTANT!

CHANGE IN REPORTING DATE

• Effective immediately, reports to SCMs should be mailed on the *first day of each month*, covering activity for the preceding month. Your *April 1st* report will cover the period March 16-31, if you made a mid-month report on the old schedule. All later reports should include activities for all of the month preceding and should be mailed May 1, June 1, etc. All active amateurs, especially ARRL members, are invited to report station activities on the first of each month direct to the SCM (address on page 6). Radio Club reports are also desired by SCMs for inclusion in these columns.

ATLANTIC DIVISION

EASTERN PENNSYLVANIA — SCM, Jerry Mathis. W3BES — 3GUE has returned from the wars. 3QV is on from XUIYV and has worked the West Coast, sending a message through 6ANN. 3GHM is doing some high-powered listening over in Ledo and hopes to get something on the air from there. 3EXA has a new 8JK beam which works out well. 3LXN is on 28-Mc. phone with a pair of 812s. The York Road Radio Club is preparing for Field Day. The Reading Radio Club is still alive and very active. It has its net control station on with the call of W3 Call District Station, operating on 144 Mc. The new calls are coming through, 3KBB being the first heard here on 28 Mc. 3HRD is trying to win the BW Contest on 144 Mc. 3AGV is working 28-Mc. DX with his new vertical antenna. 3BXE will be on with a pair of 807s soon. 3GQW is not doing so well with his antenna in the cellar so he is putting up an end-fed vertical. 3JBC is showing his mettle working DX on 28 Mc. 3DGM is doing it the hard way, working the 'phone stations with c.w. 3ENX has his new exciter on and has added an HQ-120 and a beam to his station. 3GHD has a swell-sounding e.c.o. on 28 Mc. 3ILK is back on 28-Mc. c.w. 3KD says a new UHF Radio Club is being formed, largely among the former WERS gang. 3KT is working the "G" stations on mass production. 3EER has a new daughter. The press of business forced 3JAY to resign as Section EC. 8GV has a new QTH with plenty of antenna room and is working out well on 28 Mc. 73. *Jerry.*

MARYLAND-DELAWARE-DISTRICT OF COLUMBIA — SCM, Hermann E. Hobbs, W3CIZ — 1IIN/3 has been appointed OBS and will send official bulletins on 146 Mc. at 10:30 p.m. Tues., Thurs., Sat., and Sunday. Recently-appointed ECs are: 1IIN/3, Baltimore; EIS, Alexandria and Washington; CRB, Baltimore; and AQV, Cumberland PV sent in the first traffic report, indicating a regular schedule with K4ENT weekly, some traffic moving on the 28-Mc. band and regular contacts with the West Coast and European stations. With an attendance of about seventy-five at their meeting on Jan. 26th at the CREI Laboratories, the Washington Radio Club enjoyed a lecture and demonstration of a complete modern television system. Many 28-Mc. stations reported bad QRM from trucks and buses. 8LSS, of U. S. BuShips, gave the club an interesting talk on "Loran." DQJ sent the following: "DQJ and FRV were forced down in a snowstorm Jan. 20th while on a return flight from Cumberland with parts to rebuild FRV's new

transmitter. Both were former pilots in the CAP." EYX has a schedule with 5JYZ, Albuquerque, N. Mex., who is ex-HJQ and ex-HS of 100-meter fame. HQG is thrilled with his 28-Mc. rig. HDZ reports as follows: The Baltimore Amateur Radio Assn. is being reorganized and invites new members. There are about twenty active stations on 144 Mc. in Baltimore. CRB works into Washington nightly. CRB and CGF heard JVL/4 mobile operating in Lake Worth, Fla., with 20 watts input on 144 Mc. Traffic: W3PV 31.

SOUTHERN NEW JERSEY — SCM, Ray Tomlinson, W3GCU — Section EC, BAQ; ECs, ABS, JNZ. HKO/20AI has been presented with the Bronze Star. EED, at Okinawa, has pulled in WSL, ASQ, HTJ, GQX, and JOL are proud owners of a Meissner Signal Shifter. HTJ uses an 813 into an HK354 capable of about 650 watts. GQX is lining up an 813 buffer-doubler. ASQ finishes up with a T40. EDP is running 400 watts on 28 Mc. ITS has a pair of 814s in his final on 28 Mc. EEQ puts out a nice "squirt" on 28 Mc. HW is on the air with f.m. 'phone, the first in Trenton. 9RIY/3 and 6TFE/3 are operating 28 Mc. GHK has an 89 e.c.o. available for all-band work. ASQ is getting swell reports on his signal from that four-element rotary; recent actual tests revealed a front-to-back gain of 34 db. AFH hiked his beam up on a new pole. CCO ironed out receiving difficulties and found correct match to the BD-20/SX-28 line-up, and with ITU worked K6ROJ. 2MAX/K7 is running 300 watts on 28,680 kc. to a "V" beam. AXU is using a vertical double-extended Zepp on 28 Mc. EFF has his squirter going on 28 Mc. AFA is on with a nice signal. The Trenton Radio Society held a reorganization meeting on Feb. 1st. ABS reports progress on the 144-Mc. emergency set-up in Somerville. GQX reports that a message originated in Alaska, relayed to him through a W9, thence to Philadelphia, was delivered in 10 minutes. DCQ, with TWA, originated a message to his XYL from Newfoundland, via 3HTJ, time 20 minutes. Traffic: W3CCO 3, HTJ 3, GQX 2, JXJ 1, AFA 1.

WESTERN NEW YORK — Charles I. Otero, W8UPH — Big hamfest coming up, fellows. The Rochester Amateur Radio Association has set Saturday, May 4th, as the date for the big event. Turkey dinner, prizes, exhibits, entertainment, and speakers, including one from Headquarters, all for three bucks per ticket. Write Ray Kohl, NBI, RARA secretary, 37 Miles Ave., Fairport, N. Y., for further details. SJV is doing an FB job helping with AEC organization. Wish a lot of you guys would do the same thing. Drop me a card and I'll send you an application blank. VCI and GGY are back in Tonawanda. GGY made an XYL out of a WAVE while in the services and both are back. NOR is on 144 Mc. nightly, also using f.m. on 144 Mc. Active are: BSM, SOK, 2EEE/3, EBF, QZN, IRU, OSN, WOH, VJJ, IKV, IGI, PCZ, UJR, MKB, OEOW, ODQ, VSN; but NOR, BSM, and SJV still are showing that 144 Mc. is a good band for local rag chews. CYT and AXW are out of the Army and back on the job at WPEA. NOR has been running tests on f.m. with a rotary beam pointed towards Toronto, hoping to contact VE3ADO. WWQ was home on leave. He used a rig consisting of a 958 and 184 as transceiver and has worked as portable K5, KB5, W6, W2, and W8. John Earshen and R. Lamy, ex-operators of WQWT, WERS station, soon will be getting their station calls. Some of the crew of WQWT and WKNL got together at the home of QZN through the initiative of EBF. RDX gave an interesting talk at the RARA meeting on impedance matching transformers. Quite a number of fellows worked out Dean's formulas and made the gadget. OQC is having so much trouble that he is re-building *again*. He wants the best, or nothing. CWV is on after so many years; putting out an FB signal, too. BCP is not content with one solitary 100th and a long wire. TEX is back on with the usual good quality signal. ETJ is also back on after so many years and putting out a whale of a signal. TXB has left the employ of Stromberg-Carlson Co. and is employed as a full-time engineer at WHEC. He has moved from Elmira and the new QTH is 239 Eastman Ave., Rochester 13. Keep May 4th open for the RARA hamfest. There is a lot of fun coming. Don't forget to drop me a card for AEC application blanks. 73. *Charlie.*

WESTERN PENNSYLVANIA — SCM, R. R. Rosenberg, W8NCJ — Section EC, AVY. ECs have been selected for the following counties: Erie, QJ; Warren, TOJ; McKean.

(Continued on page 84)



★ ★ ★

BEGINNING in *QST* for April, 1941, we ran a series of three articles on selecting a new receiver. These described a number of simple tests that any amateur can make, using a minimum of equipment, little time and no specialized training. Nevertheless, they give a lot of information about receiver performance. Everything we said on those pages still applies today, and we recommend that you read them if you are interested in buying a receiver.

On the other hand, there are two tests *not* to make, because they are very misleading.

Many amateurs feel that a good way to test sensitivity is to try the receiver with the antenna disconnected, on the theory that a very sensitive set will pull in signals "without an antenna." This is not true. It tests shielding, not sensitivity. No one to our knowledge has ever accused the HRO of not having extreme sensitivity, yet it is almost dead when the antenna is disconnected because the shielding is almost perfect. On the other hand, a very poor AC-DC receiver of the \$19.95 variety will turn out a strong signal with no antenna because it picks up plenty of signal (and noise) from the power lines. It is useful to test the receiver without an antenna, but remember the receiver should be praised for silence under such treatment.

Often a good AVC system causes a receiver to be condemned by inexperienced amateurs. If the AVC is really good and the set is sensitive, there are often very noticeable images. A little reflection will show why this is true. The receiver may suppress images 30 db below the signal level, but if the AVC raises the gain 30 db when the images are tuned in, then the images will be as strong (at the speaker) as the signal. After all, the whole purpose of an AVC is to raise the level of weak signals.

If you have any doubts about the ability of a receiver to suppress images, turn off the AVC while you test. A word of caution: Do not confuse harmonics from the transmitter with images. It is easy to tell them apart. Transmitter harmonics are multiples of the transmitter frequency, while images are separated by the receiver IF frequency.

These and other points are described in detail on this page back in April, May and June of 1941. They are worth study if you are considering the purchase of a receiver.

JACK IVERS



(Continued from page 38)

AXD; Elk and Cameron, NDE; Mercer, AOE; Lawrence, J.L.H. Active amateurs are invited to write the SEC for details regarding EC appointment for localities not yet covered. New OO, BWP, AAQ, of Erie, reports that VTK, of Oil City, has returned home from the Pacific area. UVD hears regularly from UHO, on occupational duty in Germany. AOE submits usual fine report: TVA, now in Pittsburgh, finally got around to mailing QSLs confirming pre-war contacts with UVD and AOE. AOJ and IQY are experimenting with f.m. on 28 Mc. running about 175 watts input. SFG gets out well on 28-Mc. f. m. with only 1½ watts input. OIY has four-element beam antenna strung up in attic of his home and contacts West Coast consistently. Other amateurs in Mercer area active on 28 Mc. are: KY, WDC, IQY, CJB, SFG, AOE, and 1KIU/8. VUR has more time to operate 28-Mc. 'phone. QCN is experimenting with new oscillator. 1KIU/8 is having his 85-ft. mast and rotary antenna shipped down from Massachusetts. CBJ is making final adjustments to his kw. c.w. transmitter. The Mercer County Radio Assn. now has thirty-five members. At a recent meeting SFG gave an enlightening talk on reactance modulation, and demonstrated f.m. possibilities. UUG and MPO are reported to be working nice DX on 28-Mc. 'phone. KWA reports considerable radio activity in Pittsburgh area. CUG and JMP are working on 28-Mc. band. The ATA, with UUG as president, is going strong with over seventy in attendance at recent meeting. TOJ, EC for Warren County, has 28-Mc. transmitter in operation. BOZ is completing portable-mobile job, and one additional 28-Mc. transmitter is under construction. The Radio Assn. of Erie conducts code classes from 7 to 8 p.m. preceding regular bimonthly meetings. The Pittsburgh Area Radio Club Council now assembles on the second Saturday of each month. Delegates from following member clubs were present at the Jan. 19th meeting: Fort Necessity Radio Club, South Hills Brass Pounders and Modulators, Steel City Radio Club, and the Amateur Transmitters Assn. of W. Penna. 73. Ray.

CENTRAL DIVISION

INDIANA — SCM, Herbert S. Brier, W9EGQ — III, in the Aleutians, has a "V" aimed at Indiana. DGA has a TZ40 on 28 Mc. and gets out well. TIY is on 28 Mc. in Texas — if all the boxes containing his rig arrived. HBD, SUT, EEO, DLI, RHL, DEJ, PQL, MVZ, JZA, and EGQ are on 144 Mc. PBS worked VO and KB6. MVZ worked K6 and VO. WJU and AHS, about two blocks apart, each bought a pair of 4-125As! New officers of Indianapolis Radio Club are: AOG, pres.; JFX, vice-pres.; YOT, secy.; DSC, treas.; VPN, chief operator; OYQ and NNX, directors. They are resuming publication of the *Ama-chewer*. FDS is in Paris, Ill., temporarily. EGV is trying to get up courage to cut up his aluminum tubing for a three-element beam. AB is on 28 Mc. It took him over a year to find out how to wire his 815 filaments, but he used it on 112 Mc. anyway. WDV and LMX are on 56 Mc. BXD was host to Mishawaka gang recently. KBQ is using PP TZ40s cathode modulated. MBM likes his vertical better than a low horizontal. PUB spends his daylight hours on his roof. DHK uses a vertical 8JK antenna on 28 Mc. NVA is not on the air, but hears Chicago f.m. stations consistently in Richmond. KLI is "giving up" radio, but keeps buying new equipment. 6KTI visited EGQ to tell him what a loud signal he had in K4. (It wasn't EGQ's rig; just borrowed.) CWO is building a kw. rig. WKN claims he needs only a filament transformer for his kw. DUT is building a 250-watt rig with two finals. Have you chosen the man you want for SCM yet? 73. Herb.

KENTUCKY — SCM, Joseph P. Colvin, W5IEZ/9 — Bob Cooper, ARTS, was hooked by the Navy Feb. 4th. Welcome to Geo. Whackey from the Signal Corps. Billie Martain, 1410 Olive St., is teaching theory and code to large classes two nights each week in MRF's basement. ARTS meetings feature talks on topics near and dear to the average ham's heart. ALR has finally shown up at ARTS. YQN is QRX for the sweepstakes. Greetings from the new SCM, address 1653 Beechwood, Louisville. How about some dope from out in the State? The following are known to be active: BOF, Winchester; DXO/8, Ft. Knox; FZG, Bowling Green; ZUZ, Lafayette; AWN, Ludlow; NRA, Bellevue.

HZL is spending time in Florida. BAZ, MRF, NQQ, ATN, 5IEZ/9, JEI, GOM, and others are working DX, including Indiana. BCL trouble has MLI QRX. BAZ, our EC, is getting ready for emergencies. Traffic: W9BAZ 5. 73. Joe.

MICHIGAN — SCM, Harold C. Bird, W8DPE — SAHV worked 8NF, in Algiers, Africa, on 28,700 kc. His DX schedule is Tuesday, Wednesday, and Thursday a.m. He worked D4ADK, Frankfurt, Germany. 8IXJ returned from the South Pacific and is out of the Army. 8ONK/8 would like to start a net on 28 Mc. until other frequencies open up. 8TNO worked D4AAG, in Germany, and handled message to his folks in Detroit. He also works West Coast and Pacific Islands. 8WIK does a nice job on 28 Mc. and works lots of W6 points. 88JH pointed his beam toward Mexico and worked an XE station. 8UGR is working 28 Mc. and has push-push 807s final. Paul also is out for Assistant Coördinator appointment. 8BQA is with conservation department as regional radio engineer and needs three radio men with at least second-class licenses. 8GP announces the birth of an eight-and-one-half-lb. jr. operator, Spencer George Wycoff. 9GQF tells us that the Hiawatha Radio Assn. held an informal meeting at the home of 9CSI. Bill is Assistant Scout Master and is teaching his troop the code. 9YKI has gone to Chicago to attend radio school. 8WUD/9 is out of the services and back with Western Electric. 9EVI is working 28 Mc., 'phone and c.w. 9VJJ is working 28 Mc. from Ishpeming. 9GJX has a 450-watt transmitter on 28 Mc, working into a three-element beam about fifty feet in the air. Helen wants ORS and RM appointments. 9ADY/8 has a forty-foot pole in back of the house with rotary beam atop. He is looking for contacts with the Upper Peninsula gang on 28 Mc. 8BIU has started working up his emergency network. Ray is president of the DARA, and also SEC for Michigan. Your SCM solicits your monthly reports. Now that most of you are active on 28 Mc. you most certainly should have activity to report. Please send a card telling about your activity. 73. Hal.

OHIO — SCM, Carl F. Wiehe, W8MFP — The Toledo Radio Club reports that a new membership drive has been inaugurated. At the January meeting Lt. Don Scott gave a talk on his experiences in Alaska and painted a very attractive picture of the country. QUO took on double harness on Jan. 12th. OXK's new "V" beam is bringing in some very FB DX. PCP's and NIH's new rotaries are doing similarly. VSB and VDV have gone into the radio service business together. RRU has been seen in town. PCS is reported on his way home from the Hawaiian Islands. Emergency Corps work under TKS is progressing. WRN reports from Columbus that there is considerable activity, both DX and local, on the 28-Mc. band, with some on 144 Mc. The Cuyahoga Radio Association reports the annual election of officers under way. Lt. EFW gave an interesting account of his experiences in the Army at Okinawa. FFK, another old-timer, recently discharged from the Army, was present. SDQ, of Hamilton, writes from aboard the SS *Phineas Banning* that after sailing on a C-2 cargo ship in the Atlantic as radio operator he signed up as second operator on this ship along with RUS, of Pittsburgh, who is chief operator. He met many hams in the Pacific area and is at present in Okinawa. The Greater Cincinnati Amateur Radio Association held its first meeting since Pearl Harbor on Feb. 13th. Approximately 115 persons attended and many signed for membership. Refreshments were enjoyed by all. The club organ, *The Mike and Key*, will resume monthly publication with the March issue. Meetings will be held at the Brotherhood of Railway Clerks Bldg. on the 2nd Wednesday of each month at 8:30 p.m. WHE celebrated the arrival of a brand-new daughter by attending the first meeting of the GCARA. The Cincinnati QCEN 71st consecutive meeting, held in February, was well attended. The newly-elected officers are: TQS, pres.; VAV, vice-pres.; 9NRA, secy.; MEU, treas. It was announced that tests were being scheduled for both the 144- and the 50-Mc. bands to determine which is better for the local emergency network. It was reported that the memorial station dedicated to Dudley M. Outcalt, located in the Hamilton County headquarters of the American Red Cross, was complete and nearly ready for operation. The equipment of 9BQK, the first casualty from this area in

(Continued on page 86)

SERIES 400

"SUPER-PRO"

TUNING RANGE .54-30 mc.

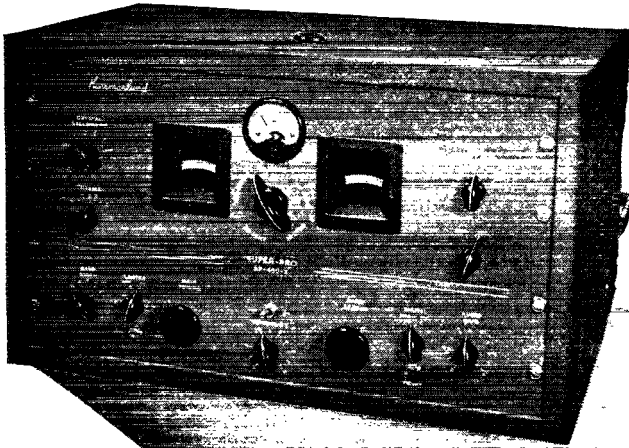

The "400" has high image rejection, high sensitivity, low noise level. It is designed for weak signal reception — puts new life in your 10-meter activity.

ASK THE MEN IN THE AACs WHO USE THEM . . .

The Series 400 postwar "Super-Pro" stands by itself, a leader in the field of communications. The reason of course is continual improvement in design through years of service under a wide variety of operating conditions. The people who know most about receivers choose "Super-Pros."

SEND FOR TECHNICAL DATA



ESTABLISHED 1910

HAMMARLUND

THE HAMMARLUND MFG. CO., INC., 460 W. 34TH ST., NEW YORK 1, N.Y.
MANUFACTURERS OF PRECISION COMMUNICATIONS EQUIPMENT

(Continued from page 84)

World War II, is to be installed in the Campbell County Chapter House of the American Red Cross as a memorial station. Both stations are being sponsored by the QCEN and are to be used primarily for emergency work but will be available for general ham use. RN expects delivery of new HT-9 transmitter soon. His DX contacts include HC, PY, TI, K7, VE4, VE5, VO1, K5, W6, W7. Traffic: W8RN 20. 73. Carl.

DAKOTA DIVISION

NORTH DAKOTA — SCM, Raymond V. Barnett, W9EVP — DAK has returned to Jamestown for a few months' operation on 28 Mc. before attending University. RGT is cathode-modulating a pair of HK254s while waiting for new plate modulation transformer. He boasts a new RME-45. ILT was married recently. GZD is working on 28 Mc. and heard BBD, formerly of Fargo, working 144-Mc. portable from Eatonville, N. J. IBW is on the air with almost everything but the tubes home-constructed — he built all transformers and most of his variable condensers. SSW is *all* ham — played sick from the job one day and had twenty-five QSOs with his 15 watts. GJJ finally got a new 60-watt modulation transformer. He is building a mobile power supply which probably will be used with EVP's mobile rig until GJJ can get his mobile rig finished. How about applications for EC appointment? Could also use more activity items. 73. Ray.

SOUTH DAKOTA — SCM, P. H. Schultz, W9QVY — DKJ is in Washington and has been promoted to lt. comdr. in the Navy. EOJ is on the air with 400 watts on 56 and 28 Mc. YMB, in the Army near Nuremberg, Germany, is looking for South Dakota contacts on 28 Mc. Watch around 8:00 a.m. for those signals. EKT, secretary of Sioux Falls Club, reports technical items are the present order of business for the club. OLB, ex-7FMW, is railroad station agent at Glenham and is on 28 Mc. with 50 watts to an 807. SGI is moving to Langley Park, Ill. ZBU reports that WZH is located at Glasgow, Ky. KQO reports that recent snowstorm raised the very dickens with antennas, etc., at his QTH. Been working everywhere, long and shortskip. Sgt. TXK is home from O'Reilly General Hospital and has been working 144 and 28 Mc. INT is back at Wessington Springs looking for contacts. Thanks to all for reflecting me SCM. How about requests from clubs for appointments? 73. Phil.

NORTHERN MINNESOTA — SCM, Armond D. Brattland, W9FUZ — ZMQ is on with a nice signal. YPN is a newcomer. TOZ has completed his mobile f.m. job. QIN, ITQ, YDD, and WKS are a few of the Minneapolis hams who have helped others get on the air. BQY is going strong. MTH is building a dandy converter for 28 and 56 Mc. IBD has returned to the air. The Minneapolis Club has elected the following officers: YDD, pres.; CUD, vice-pres.; GDL, secy.-treas. OPA continues to work DX. IXR uses an indoor folded doublet, puts out a nice local signal, and also gets DX. TLE was host to RPT and BHY at a midnight turnout. Gary is going strong with the new radio club at Fairmont. OBM, HEX, and others in the Mill City have the club going again. ZWW gave a very interesting talk on low frequency antennas at a recent St. Paul Club meeting. YCR continues to improve his rig. GVO plans on a new "V" at Snobs Knob. ORA completed his new rotary. HRB built a converter for 28 Mc. NCS and NBW keep the c.w. activity on 28 Mc. alive with clean-out, snappy operating. Plans are being made for a better-than-ever Minnesota emergency organization. Portable and mobile equipment will be required both on the long haul bands and the high-frequency bands. 73. Army.

SOUTHERN MINNESOTA — SCM, Vernon G. Pribyl, W9OMC — Burton S. Waldron, W9ZT, is pinch-hitting for the SCM this month. The word hasn't gotten around as yet that the Southern Minnesota section is back in circulation, but next month we ought to have lots of news if the gang will pass on all the dope. For the information of Twin City hams and visitors, the Minneapolis Radio Club has resumed meetings every third Monday at DeLaSalle School with OBM as president. At the last meeting BHY gave some interesting dope on how the WERS functioned during the war. The radio club in St. Paul has been reactivated with JIE

as president, and meets the first Friday of each month at the Ryan Hotel. There is a lot of activity on 28 Mc. with QRM so heavy that when the band is open the contacts are pretty much limited to local affairs. We hear OTE is very active on 28 Mc. We need lots of personal items for this column. 73. Burt.

HUDSON DIVISION

EASTERN NEW YORK — SCM, Ernest E. George, W2-HZL — Activity in the Tri-City area booms once again with the QRM getting thicker day by day. The Schenectady Amateur Radio Association has started monthly meetings again. New officers elected at the December meeting were: NHY, pres.; IMPU, vice-pres.; 60JK, secy.; CAZ, treas.; MB, GFH, and BKW, directors. BLU reports he is trying to organize an emergency net in the Maybrook area and that the boys there are warming up their old bottles again.

NEW YORK CITY AND LONG ISLAND — Charles Ham, jr., W2KDC — With the appointment of OFD, Staten Island, all counties now have an EC. Nothing has been heard from ECs in Queens, Bronx, and Manhattan for two months. Get those reports in, gang. Brooklyn EC, OHE, reports twenty-four stations active and more being added. A simulated disaster is scheduled for the near future. DIO received cheers for the RCA manuals he distributed recently. NQQ enjoys 144 Mc. and also heads the Termites League; he is never too far away from those he QSOs. NKW's jr. operator is all set to take over the rig; he contributes background at present. IMIG/2 is returning to Boston, but since BPV worked Greenwich, a net to that city is possible. KAN is active. DIO's antenna problem is being ironed out. AES worked OHE with antenna only 20 ft. above sea level (at low tide). DOG still is seeking Red Cross acknowledgment. (Note to BGO, Section EC: Remember those promises at the meeting ending the WERS?) HDQ is working in nicely from the North Shore. JWO is county control by virtue of coverage due to 1/2-kw. rig. All Suffolk stations on 144 Mc. are urged to contact DOG for AEC membership. FCH is welcomed by the East End gang. EBT uses folded doublet on 28 Mc. and is boosting power on 144 Mc. ADW is building a new receiver. DOG's shack is being moved from attic to cellar, by request. Nassau EC, CET, reports the old reliables and the following newcomers on 144 Mc.: CMU, NDC, ODB, IER, LRJ, HTG, BGF, BJR, IRY, and OBE. JWO, LPA, and OBW, in Suffolk, report direct. On Feb. 11th, FI originated a message to Hartford which started via NBZ, RZ, LPA, and JWO (on a high hill) to INGV. MHW has an understanding landlady who allows antennas. A personal get-together between Nassau and Suffolk took place at Patchogue at JWO's with KNA-CET and OBW-LPA. Contact en route was made by KNA's mobile. OBW is quite a cowboy impersonator. GET has long wire on 28 Mc. and worked K6. MHD is on 28.04-Mc. c.w. using electronic bug. HBO reports the Tu-Boro Radio Club again functioning with BVE, pres.; DGD, vice-pres.; HBO, secy.-treas. Club meetings are scheduled the 2nd and 4th Fridays of each month. KGN fooled the SCM by changing his name. Stan is married, is at San Francisco, and is readying an HT-9 and SX-28 for 28 Mc. BNX is heard on 144 Mc. IAG has new beam on roof. BMT and MWB are 28-Mc. neighbors in Woodhaven. NDQ, now commander, is on SS *General Hugh L. Scott*. Seml, of WERS, is at Somar, P. I., where he hunts souvenirs and dreams of the QRN of Queens Boulevard in Kew Gardens. KDC proposes a campaign to educate auto manufacturers to eliminate this curse. JZX is rebuilding, but listens to 28 Mc. occasionally; son, LJJ, is home after twenty-five months in the Pacific area, and hubby, JDG, awaits return to the air. Ex-HH4AS, now 5JSZ/2, told MYE that transmitters are taxed 40¢ per watt in Haiti. NVD has 5 watts on 28 Mc. KYV and NBH just report a party on New Year's Eve. Gary built a new 28-Mc. superhet. OMM, a good friend of 3HOH, well known on 112 Mc., is heard on 28 Mc. The Sunrise Radio Club had a dinner-dance on Feb. 15th in Belle-rose, attended by forty members and friends. FDY boasts a two-element on 28 Mc. OMM says his two-element on 28 Mc. with 50 watts equals 500 watts on old Q antenna. OOL and LOO are sporting HT-9s, delivered by OMM,

(Continued on page 88)

When you build or REBUILD



**THE TANK CAPACITOR SHOULD
HAVE THESE FEATURES ...**

- ✓ Rigid construction.
- ✓ Staked aluminum for light weight.
- ✓ Symmetrical design for high-efficiency at high frequencies.
- ✓ No through-frame contacts.
- ✓ Provisions for mounting other components right on capacitor.
- ✓ Hand fitted bearings for smooth operation.

✓ Write for latest Capacitor Catalog.



HAMMARLUND

THE HAMMARLUND MFG. CO., INC., 460 W. 34TH ST., NEW YORK 1, N. Y.
MANUFACTURERS OF PRECISION COMMUNICATIONS EQUIPMENT

(Continued from page 86)

DWG has a kw. and BCL. ECR put up a Q on his 65-footer in the rain. JSJ awaits HRO to get on the air. 3HOH spends lots of time in Brooklyn. NBJ/F8 was heard from Paris on 28.3-Mc. c.w. with 50 watts. 1AA/2's voice was recognized by a broadcast operator while visiting WHOM recently. M/Sgt. Brosnan is at Arlington. Traffic: W2MHD 1.

NORTHERN NEW JERSEY — SCM, Winfield G. Beck, W2CQD — The Union County Amateur Radio Association meets every Thursday night at the "Y" in Elizabeth. IIN, president, invites all the local gang to attend these bang-up hamfests. Lt. Mil Krasnican writes that he is on 28 Mc. working quite a number of Pacific rocks as W2MAX/EK7, and has even worked a W6 portable J4 in Japan on 28-Mc. 'phone. Mil's address is: Lt. M. J. Krasnican, 3369th Sig. Svc. Bn. — Als. Comm. Sys. NWPEA, APO 986, o/o Postmaster, Seattle, Wash. Pfc. Jack Fern, P. O. Box 246, Camp Pinedale, Fresno, Calif., writes that there are some twenty hams at the base, among them 1M2T, 8STJ, and 2MQJ, the latter two active on 28 Mc. Jack recently heard MQJ on 28 Mc. working KQT, who is on Guam, on c.w. MRG has six crystals on 144 Mc. and can QSY in less than a minute by stop watch. JN has three crystals in use. Some of the active stations on 28 Mc. are: NLJ, OLV, MWZ, LQL, HMA, LSY, GFZ, DZR, DO, LXV, GJC, KQB, OKE, OKI, LSH, MJC, GPG, 8VGL/2. On 144 Mc.: BCN, BGH, BMO, BMY, DAR, DZA, EJA, EWA, EPR, ECP, FXE, FBL, FQX, FMT, FKI, HIK, IGX, IPE, JN, JWH, JUJ, JZN, KRK, KUL, KUJ, KBQ, LBY, LKN, LXD, NLI, NML, MRG, NPJ, OBA, OCH, OJA, EPI, EDR, LRG, GBW, MWZ, OLV, NPJ, CQD, 1ASQ/2, 9JBL/2, 9DBZ/2, 9GVZ/2, 8TXM/2, 3DYZ/2, 3GQU/2, 3DMY/2. Organization of AEC is under way in Bloomfield. MO was heard in Washington, D. C., on 2 1/2 meters. LSX writes that he has listened on 28 Mc. and heard Stateside signals as far east as Indiana at about 8:30 A.M. On Jan. 31st the Monmouth County Amateur Radio Association held its second hamfest at Eatontown. Almost 300 amateurs, YLs, and XYLs attended. Those attending the recent hamfest included: 2OEN, from ARRL; Maj. VK2AJZ, of Australia; Maj. Wilson, of Scotland, and various commercial representatives. Among the amateurs present were: IBLX, FZX, HUZ, NP, 2AIZ, BDS, BYK, COK, DME, DOL, DWK, EQD, EYW, FWK, FR, FZS, GUM, IID, IIN, LGX, LJR, OCC, OEN, ZC, 8AC, BAQ, CZY, JFV, OGY, 4FV, 5BAT, DEN, 6AXD, K8O, QGG, 7FAZ, FMI, 8ABI, CTP, DLU, EKG, ETG, HLM, SBU, TO, TWQ, WJY, 9BBB, DBW, FWY, WYU, and NYT. Correspondence concerning the activities of this rapidly expanding organization should be addressed to Sidney Berg, pres., IID, 74 Barker Avenue, Eatontown. Bill Wegge reports that the JSARA will have a complete operating station in the Cavalcade of Progress Business Men's Show at Asbury Park Convention Hall the week of April 1st. GUM is in charge of the committee. The following members of the JSARA are active on 28-Mc. 'phone: CQB, FC, GUM, FQK, OFM, NZC, DSY, KZW, LMB, NIE, CYS, IRP, BYK, GMR, MWW, CGY, AEX, LIR. FC is top man on DX and is working everything he can hear with a two-element rotary beam mounted on a 55-foot triangular tower; power input is only 30 watts to an 807. BYK and FQK are using vertical dipole antennas. KZW is rebuilding his 28-Mc. 'phone rig and hopes to put Ocean Grove on the DX map. Most active ham there is NZC. MWW is on 28-Mc. 'phone. CYS is working plenty of DX on 28 Mc. OFM is building a 28-Mc. rotary beam. IRP has increased power. CGY, of Neptune, has been laid up. 73. "Win."

MIDWEST DIVISION

IOWA — SCM, Leslie B. Vennard, W9PJR — ONG is home from the Air Forces and is on 28 Mc. SEF wants to hear from the Iowa gang operating on 3.5-Mc. c.w. So do I, but not until the bands open. SDA says there has been no activity report from Shenandoah since '33. He says AWI, CJD, IYB, GDR, and SDA all work at KMA. NLY is the sixth ham there. DKQ has real emergency rig for use on

28 Mc. JMB is building 146-Mc. rig for local rag chews and hopes to get others interested. YBV just got back from overseas and expects to get going soon on c.w. and/or 'phone. Here are the new Iowa ECs since last report: JMB, TGK, QAQ, PHA, and WHC. Let's have more of them so we can be ready for any emergency. 73. Les.

KANSAS — SCM, A. B. Unruh, W9AWP — YZB, formerly of Emporia, is operating portable in Pratt on 28-Mc. c.w. with 600 watts and reports contacts with Gium and Marianas. BZL and NOH are on 28-Mc. 'phone there also. 5KSF is trying to get his old 9AJD call back in Kansas City, Kans. He keeps in touch with the gang by operating at FRI. He says the boys at KNBO (Braniff) are getting ready to do some serious brass pounding on the lower frequency bands since their teletype was installed. UUV was looking for a break in the weather to put up a 28-Mc. antenna. Likewise EQD at Parsons. 5GUE, ex-IEL, is home, with hopes of getting old call back. JZU is building 28-Mc. rig using 829s. The Wichita Club held a banquet meeting for members and YFs and YLs Feb. 21st. Attendance has grown steadily since reactivation. Fifty were present at the Feb. 7th meeting, at which time a lecture and movies on Loran were presented by DMF, Boeing-Wichita engineer. About twenty-five Wichita 'phones have been heard on 28 Mc. Newest are QEF and KUU with Hallicrafters HT-9s, and OZN with a flea-power job. DJL and PGL had recent long-winded Sunday three-way with 1HCH/K6, all using three-element rotaries. GUO has new three-element beam ready to go up. AWP worked KE6 and flock of K6s using new "V" beam with two and one-half waves per leg. JYZ has new rig with 813 final. IGJ has T65s final and is building new low-power rig. JTN has new Meissner Signal Shifter and SX-25. Traffic: W9DJL 2, PGL 1, AWP 2. 73. Abbe.

MISSOURI — SCM, Mrs. Letha A. Dangerfield, W9OUD — FIR/FOR is back from the Maritime Service, and GHD is home from the service in the Aleutians. He has an HT-6 transmitter which is being adjusted for ham work after its military stretch. 5K5J and MOT are living on a farm near Sheldon and would like to contact some hams in the vicinity. PXH has Sky Champ and HT-9 on 28-Mc. 'phone. TER is building a modulator while using an 807 final on 28 Mc. WFK requests OBS appointment — first request for that department. AOP has a new SX-25 and is on 28 Mc. WXO has resigned as secretary of the CMARC because of work. VMI, WFK, and KEF have agreed to continue as EC for their districts. There is little interest so far in the AEC. We need more EC appointments and some suggestions for SEC. Also more news, as you can see. Let's have some letters. Good luck and 73.

NEBRASKA — SCM, Arthur R. Gaeth, W9FQB — EWO has accurate VFO and frequency standard. RQK is working with DNW for A.T. & T. at North Platte on K carrier. EKP has 55-foot sticks for antenna. DNW has a pair of 807s. OEU is using 6L6-807 on 28 Mc. OKI has six code and theory students. ZNI visited the SCM and volunteered for AEC. K6TXV/9, ex-MUK, asks the whereabouts of K6TYB, ex-FOW. "Cellophane" (LSPH) reports punching the mill for Ag. experimental station in Connecticut. LTL, now located in Maywood, Calif., reports that LPA is with KHJ in Los Angeles. Ex-ZNA is out of the Navy and active on 28 Mc. at South Gate, Calif. 8ALP/9, Fort Omaha, has 807 rig and half-wave doublet on 28 Mc. 5EEA/9 has a new three-wire folded doublet. PHW now is a civilian and located in Omaha. NYU reported as a civilian via a personal visit. BQP/9 is working for WRL in Bluffs and is active with 6L6 final, pair 6L6s as modulators, 20 watts to a half-wave antenna. QUA has a pair of 807s and a Johnson Q. HTE purchased HT4E and an SX-28A receiver. HGV put new elements on beam using B29 conduit. VHR and FQB helped them tune them up. SHH is putting up a three-element beam. VIG received a pair of 813s as a gift. Ex-KVZ, after eleven years of inactivity, is putting an 813 on 28 Mc. EXX has a new three-element beam for 28 Mc. GTC has an HT-9 on the air with two half-waves in phase. RQS has an HT-9 and a lazy H. UFD has Triplet modulation meter. FQB is using full-wave vertical. Apply for AEC membership. Art.

(Continued on page 90)

A MICRO-THIN METAL FILM

**MEANS
SUPERIOR
CRYSTAL
PERFORMANCE**

First for amateur frequencies...

BLILEY TYPE AX2 PLATED CRYSTALS

We are justly proud of the technical accomplishments represented in the AX2 *plated* crystal. Its advanced development and pace-setting design again demonstrate Bliley's leadership in the manufacture of crystals for amateur frequencies.

Primary electrodes in the AX2 *plated* crystal unit consist of a micro-thin metal film which is deposited directly on the major surfaces of the quartz crystal by evaporation under high vacuum. This film exhibits extremely high adhesion to the crystal and can almost be considered as a chemical bond to the quartz. Since the crystal is chemically cleaned before plating the film provides a coating which protects the crystal surface against contamination.

Secondary electrodes, under spring pressure, are used to clamp the crystal in posi-

tion and to provide a medium for thermal dissipation.

Under rigid comparative tests with unplated crystals, AX2 *plated* crystals show—

- better grid current stability over a wide temperature range.
- improved frequency stability under high drive conditions.
- substantial improvement in keying characteristics.

Type AX2 *plated* crystals, for the 40-meter band, are available now from your Bliley distributor—frequency selection from stock at \$2.80 each. Prices and information on type AX2 *plated* crystals for the 20-meter band will be released shortly. Keep in touch with your Bliley distributor for latest information.

**Bliley
CRYSTALS**

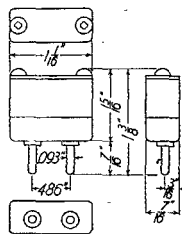
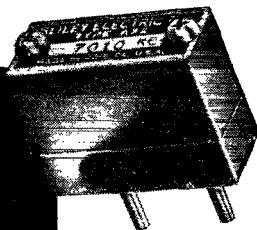

(Continued from page 38)

NEW ENGLAND DIVISION

CONNECTICUT — SCM, Edmund R. Fraser, W1KQY — Club news: Manchester Radio Club: FSH reports that twenty members met at his QTH to discuss future plans for the club. Officers are: LMK, pres.; BEQ, vice-pres.; FSH, secy.; DJC, treas. Meetings will be held every other Tuesday. Among those present at the meeting were: KOY, DJC, and CBG. Norwalk Amateur Radio Assn.: 1946 committees are: Membership, A. Ciarletto; Refreshment, F. Ferenzi; Public Relations, Martin Lee; House, H. Gregory; Program, C. Ciarletto. Special committees: Research, F. Blore; Field Day Planning, W. Vornkahl; Anniversary Celebration, C. Ciarletto and LRT. New Haven Amateur Radio Assn.: JQK, in the absence of KQY, reports that FMV, LTZ, LTB, JAK, JQK, MEF, EUG, J. Harper, Limoncelli, Murdock, and Cohen attended the Norwich hamfest. DET was the host of the evening, ably assisted by QV. Ed Bates has the distinction of receiving the first new call in New Haven, having been issued NWC. AMM and ILG fixed the club receiver. MEF and EUG built signal tracers for receiver trouble shooting. FMV has a new Millen 6L6-807 exciter to drive his HK54s. Reeves has a new RME. KAT, BIC, and MVH have new SX-28As and KQY has new HRO-5TA. JAK reports his HalliCrafter HT-9 working very nicely. BIC is now on 28 Mc. using a new exciter and some new concentric cable for feed line. 2FUO/1 is permanently located in West Haven and is getting his rig in operation. JZJ is operating D4ABC on 29.1 Mc. and looking forward to New Haven contacts where he can QSO with XYL. LXX is out of the services and back with WELI. MVH received his commercial radiotelegraph 1st-class license. JHN has been assigned to radio work for S.N.E.T. Co. KQY QSOed 2NU over A.T. & T. Morse circuit. General news: BPU, formerly of Middletown, was heard working MMN, of Waterbury, on 28-Mc. c.w. EAO, Section EC, reports CTI was only EC to return Form 8A. IED is Danielson EC. EAO and ON have been very active in OO work. QV reports a coming DX roundup in New London. BDI, on 28 Mc., is using portable 6L6 rig and old 66' flat top. Please obtain AEC forms from your local EC and get them in so we can build up our emergency organization to full strength. 73. Ed.

MAINE — SCM, G. C. Brown, W1AQL — BPX and DLC are sure going to town on the 28-Mc. band; both have worked all continents. DLC has worked amateurs in thirty-one countries, including 9TQD portable J in Tokyo. BPX has worked thirty-three countries. EJS sends in the following items: FZW is on 28 Mc. FZD and KTT are rebuilding. GGF is on 28 Mc. JJN was on 28 Mc. but part of his rig went west and he is off for repairs. CBV has a fine 28-Mc. beam on his garage. IKE, of Connecticut, is at Bates College and will have a 250-watt rig ready to go on 3.5, 7, and 14 Mc. when the bands open up; he also has a 10-watt rig ready to go on 56 Mc. BZS is back at WGAN after twenty-eight months active duty with the Coast Guard. Many thanks to EJS, IKE, and BZS for the fine letters this month. These letters go a long way toward a fine write-up for the Pine Tree State, so keep up the good work. 73. "G. G."

EASTERN MASSACHUSETTS — SCM, Frank L. Baker, jr., W1ALP — BHD, in Everett, is now an OBS. He says he is very busy with police radio work. DDO has a new jr. operator, his second child. We also hear that ZK and his XYL have a jr. operator. LOU is living in Milton. CGU is living in Quincy. GEQ is now a civilian. 8MDP is stationed in Boston for a few months. 6EFC/1 is on 28 Mc. in Boston. NKW is all enthused with a new HRO. 3AIM writes that he worked at M.I.T. in '41-'42; he is now a lt. col. in the Air Corps and hopes to be a civilian in April. Capt. JOT, stationed in Boston and living in Brookline, is getting a rig ready for 28 Mc. The Merrimack Valley Amateur Radio Club of Lawrence started up again and new officers are: MWG, pres.; NON, vice-pres.; JDU, secy.; IQH, treas. Meetings will be held the second and fourth Wednesdays of each month at the YMCA until the club gets its own quarters. The second meeting was held at CBY's house with the following present: MQN, MWG, KBO, FCR, JDK, JDU, JTP, NON, IQH, MQE, JED, LGG, IFB, CBY, LEA,

KNU, ICU, HXE, H. Spitz, A. Theberge, H. Lunn. HXE says he is still working at the So. Boston Navy Yard and will be on 28 Mc. later; he is living in Stoneham. EKQ has returned to Quincy after working for the W.E. Co. on the West Coast. MGP is living in Somerville. LQ is back at his old job with an insurance company in Boston. BVL is working in Boston with Sylvania. The Brockton Amateur Radio Club held its annual banquet in Brockton with a supper, entertainment and prizes. The South Shore Amateur Radio Club is going strong with two meetings a month. An auction was held recently with AKY as the auctioneer, a talk on "Butterfly circuits" was given by Bill Byers and DDO from General Radio, and at the last meeting IYU gave a talk on radio theory. Attendance at meetings has been around fifty. Visitors are welcome. Lt. 7BOG is still at M.I.T. but hopes to be a "civvie" soon, and then is going back to Oregon. HUV writes that the 56 Mc. Minute Mea had their first organization meeting and most of them are back on the old 56-Mc. band. The Eastern Massachusetts Club is getting together and will start regular meetings soon. HUV is an Official Observer and reports fine cooperation from those that have had harmonics on other bands when they were on 28 Mc. Get in touch with him for any checks you want to make. MIH in Hyannis says he has Skydrizer 5-10 and will be on 28 Mc. Traffic: W1BNS 3.

WESTERN MASSACHUSETTS — SCM, William J. Barrett, W1JAH — CH reports twenty-seven countries on 28 Mc. since reopening, including W9TQD/J in Tokyo. SULO/1 reports from Springfield, where he is locating after five-years Signal Corps service. Section EC, BSJ, reports progress in developing section emergency organization. GKY, EC for Hampden County, has picked the following local ECs as his assistants: BVR, Westfield; EUZ, Holyoke; CJK, Springfield; FOI, Wilbraham; KK, Chicopee; and NH, Feeding Hills and Agawam. Still to be heard from at this writing are Worcester, Northampton, and Pittsfield. Please drop a note to BSJ if you are willing to take part in the section emergency organization. COI reports first traffic since reopening of bands, delivering a message from Okinawa and starting reply on its way west. LUD and KVN furnished radio communication between foot and summit of Thunderbolt ski trail on Mt. Greylock for recent Massachusetts downhill championship races. How about some news for the report, fellows? 73. Bill.

RHODE ISLAND — SCM, Clayton C. Gordon, W1HRC — NDQ, 1001 Atwells Ave., Providence, is your new Section EC and will take full charge of Emergency Corps organization and supervision for the State of Rhode Island. He is anxious to get a good organization of ECs for the various sections of the State. Please give him your enthusiastic support in this work. At this time, it is fitting to remember with thanks the fine work which JEZ did for us in this capacity prior to and during the war. His exceptionally hard and faithful work was greatly appreciated. NUA is having fine results with his new 28-Mc. beam. LCH has erected one like it and is working into Massachusetts with very good results. HJB has worked some ZSs and Cs on 28 Mc. and is all smiles. JMT has a new Harvey transmitter. JND was laid up for a couple of weeks because of a bad fall, but has recovered and is engineering a new 28-Mc. beam, with some of his salvaged Mims Signal Squirter entering into it. 3JJW/1 reports fine results from regrading one of those "Dollar Crystal Kits." BUZ was heard calling a VK4 on 28 Mc. recently. HRC put up a new Delta Match 28-Mc. antenna and completed a control panel with monitoring audio oscillator built in that is a real help for c.w. break-in.

VERMONT — Acting SCM, G. W. Benedict, WINDL — MCQ is on 28 Mc. with PP 807s and Signal Shifter; he has a rotary antenna nearly completed. IDW and AD are experimenting with 144 and 56 Mc.; both are building four-element 56-Mc. beams. IDW is working on new transmitter for the lower frequencies. AD is dusting off the old rig and getting ready for the lower bands. MMV hopes to get on 28 Mc. as soon as he gets home from the hospital. NDB has oiled up his flat and has his XYL and L. S. Booth as code students. Hal has a Signal Shifter on the way. EKU is on his farm in Chelsea and hopes to get on 28 Mc. with PP T4Os. CGV, EKU and FSV are out of the services. KXP

(Continued on page 38)



MR. RADIOMAN: CREI Training Can Equip You To Step Ahead of Competition and Gain the Confidence Born of Knowledge . . .

Will YOU Be Ready?

**CREI Can Prepare You Now for
a Better Job and a Secure career
in RADIO-ELECTRONICS**



CREI Technical Home Study Training Prepares You for the Secure radio jobs that pay good money for ability.

You can be ready to enjoy the security of an important engineering position and take advantage of new career opportunities . . . if you prepare yourself now.

Join the ambitious radiomen who are assuring themselves of secure good-paying jobs with a planned program of advancement made possible by CREI home study training in Practical Radio-Electronics Engineering.

You can study at home — in your spare time — develop your technical ability — increase your knowledge to keep pace with important developments now taking place in the industry.

CREI home study courses are constantly being revised and kept up-to-date with the rapid developments in the industry.

By adding CREI training to your present radio experience you can safeguard your future and keep pace with such new developments as U.H.F. Circuits, Cavity Resonators, Pulse Generators, Wave Guides, Klystrons, Magnetrons and other tubes. Are you equipped to handle them? CREI

is equipped to help you, by providing the know-how and ability that is required.

In our proved method of instruction, you learn not only how but why! Easy-to-read-and-understand lessons are provided well in advance, and each student has the benefit of personal guidance and supervision from a trained instructor. This is the basis of the CREI method of training for which many thousands of professional radiomen have enrolled since 1927.

Act Now. Get underway today! It costs nothing but a moment's time to send for our booklet and complete details — without obligation.

WRITE FOR FREE 36-PAGE BOOKLET

If you have had professional or amateur radio experience and want to make more money—let us prove to you we have something you need to qualify for a better radio job. To help us intelligently answer your inquiry—please state briefly your background of experience, education and present position.



CAPITOL RADIO ENGINEERING INSTITUTE

HOME-STUDY COURSES IN PRACTICAL RADIO-ELECTRONICS
ENGINEERING FOR PROFESSIONAL SELF-IMPROVEMENT

Dept. Q-4, 3224 — 16th Street, N. W., Washington 10, D. C.

*Contractors to U. S. Navy—U. S. Coast Guard—Canadian Broadcasting Corp.
Producers of Well-trained Technical Radiomen for Industry*

MEMBER: NATIONAL COUNCIL OF TECHNICAL SCHOOLS

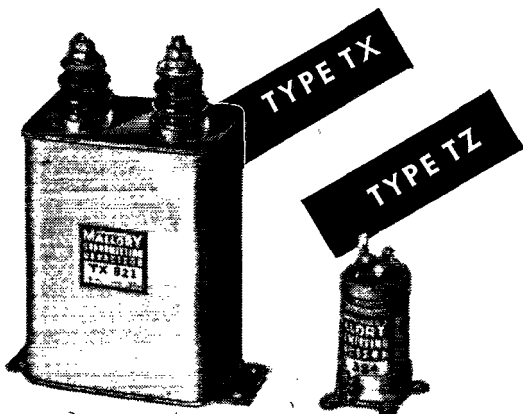

Transmitting and Television Capacitors

Mallory Transmitting Capacitors are compact—but their compactness is the result of skilled engineering, not the result of the elimination of needed material. Their generous internal construction provides the extra margin of safety that insures long life and dependability. Adequate sealing bans deterioration from moisture.

There are suitable types of Mallory Transmitting Capacitors for every purpose. Rectangular Type TX Capacitors are available in numerous stock sizes with working voltages from 600 to 6000. For operations where cost is a factor, Mallory offers the economical Type TZ Round Can Capacitors in 8 sizes, with working voltages from 600 to 1500.

Like other cataloged items in the Mallory line, transmitting capacitors are available from your Mallory distributor.

P. R. MALLORY & CO., Inc.
INDIANAPOLIS 6 INDIANA

P. R. MALLORY & CO. Inc.
MALLORY

(Continued from page 90)

is on 28 Mc. c.w. EZ is working out on 28 Mc. with vertical 8JK antenna. BNS is on 28 Mc. from Medford, Mass. NDL is on 28 Mc. phone and c.w. KXP, LWN, and NLO are on 144.6 Mc. in Burlington with FB results. NLO resigned as SCM and Acting SEC, effective Feb. 1st. 73. Jerry.

NORTHWESTERN DIVISION

MONTANA—SCM, Rex Roberts, WCPY—9HKF/7, HFZ, and BWH have written the SCM asking to be included in the Montana Section Emergency Net. Expect to announce appointment of Section EC next month. CT, of Billings, is new OO; DXQ, of Baker, is OBS; and CPY is PAM. These are renewals of prewar appointments. HOU, of Desmet, Idaho, is located at Conrad. 73. Rex.

WASHINGTON—SCM, O. U. Tatro, W7FWD—Olympia; ORC is reactivated with DDY, pres.; HMJ, vice-pres.; GIX, secy-treas.; FWD, trustee. Meeting held at 513 N. Central, Olympia, the second Tuesday and fourth Thursday of each month. Preparation for emergency communication will be stressed. AIU is building e.c.o. and exciter. GKY is building e.c.o. HMJ is building 144-Mc. transmitter-receiver. ERU acquired a new TR-4. HPJ works Tokyo, Manila, Guam, etc., with 50 watts. FWD is building a beam. Yakima: CAM, on 28 and 56 Mc., is trying to QSO HEA over Antanum Ridge in Toppenish with an 807. HEA has a Harvey transmitter. EDR is having fair luck on 28 Mc. and ALH is digging holes for his masts. HCE, EC, is winding transformers and constructing components; his transceiver quit supering on 144 Mc. Spokane: The SROC has nominated EEN as EC and appointment will be made as soon as we hear from him. The club is taking steps to affiliate with ARRL. GBU held a 100 per cent QSO with GNN/K7 at Homer, Alaska, in which CWT, who is in Alaska, communicated with his XYL in Spokane. HDV, HZE, 6TIR/7, and GHD sport new rotary beams. FLQ, GTA, and HWG have been contacting the Far Pacific. ELN and 6EKU/7 have been granted experimental licenses for F30 service; calls are 7XHO and 7XHN. IOR has returned from the Navy and is on 28 Mc. FBY/7 has been listening in vain for his home town gang. Seattle: RT, ex-SCM, is out of the Signal Corps after four years in the Army and two years overseas and is working c.w. on 28 Mc. NU, GEJ, HOL, IGM, EKA, ACF (Issaquah), EUI (Bellevue), HS, BDW, FIM, KO, RY, CE, JAO, ANZ, VY, BAC, DMN (Woodinville), PU, HLU, AW, IMF, MB, GGF, IAB, GUI, IVA, CJU, HTA, and BTZ are all reported on 28 Mc. Overseas: IVC writes from Tokyo that he is stationed on the USAT *Spindle Eye*, a new communication ship, and hears a lot of W7s on 28 Mc. He has met quite a few Japanese hams and is anxious to get back at hamming. ANN is a warrant officer on the USS *Mona Island* and Lt. Comdr. GEV is now at Shanghai worrying about the status of his license. New in the shack here is a Signal Corps frequency meter BC-221-N and a new beam of dural elements is being constructed. 73. Tate.

PACIFIC DIVISION

HAWAII—SCM, Howard S. Simpson, K6RLG—W9QMD/KE6, Johnston Island, using a kilowatt, puts out a consistent signal into the mainland. CGK has the Kauai High rig going full blast on 28 Mc. 2LFE/K6, Oahu, schedules ROJ, Hawaii, on 28 Mc. from 7 to 9 p.m. LKN became a granddaddy in January. TTT is making arrangements to take unto himself an XYL. Hard luck hit QLG recently. In the midst of a QSO his transmitter refused to perk and a few minutes later his receiver also went west. EDH, Hawaii, is having licensing trouble. SZE, Molokai will be on 28 Mc. shortly. NPE, Hawaii, is now manager of Hawaii Radio Supply, Hilo. BJJ is accumulating equipment for a kilowatt. FAZ and PHD, Maui, have just returned from Molokai, where they worked on police radio. The Maui gang is busy converting 112-Mc. rigs so that a local net can be formed on 144 Mc. 73 and Aloha. Howard.

SANTA CLARA VALLEY—SCM, Earl F. Sanderson, W6IUZ—The Santa Clara County Amateur Radio Association has just reorganized and elected the following new officers: 9FAU/6, pres.; LCF, vice-pres.; JTE, secy.; NRG, treas. HC, CFK, QLP, IXJ, and UFG are members of the executive board. QLP and USO are sporting new HRO. 9FAZ/6 has new rig on the air. KG, CFK, UGF, NRG, LFD, KDX, JWT, EI, 7IXQ/6, RAH, and BPT,

(Continued on page 94)

"HET IS HIER VROEG IN DE MORGEN."
 "It's early morning here."

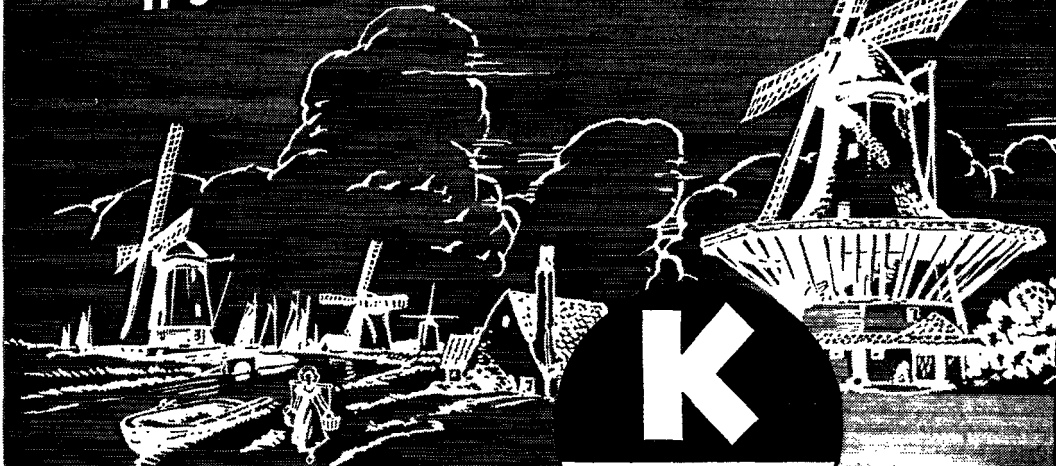

For more and clearer QSO's...



HOLLAND'S signal will be clear and steady in your earphones while you drink your midnight coffee. Before *he* bicycles off to work and *you* go to bed, there'll be a friendly exchange—spanning the Atlantic—of topics of mutual interest. *Ken-Rad tubes, war-tested and proved, will play a leading part...* Type 6N7, versatile twin triode, is typically Ken-Rad, sturdy, and modern in its compact all-metal, self-shielding design with short lead lengths. Your Ken-Rad distributor or dealer will be glad to give you complete facts about this and other types.

Characteristics of Type 6N7

Heater voltage	6.3 v	Max plate current, per plate	... 125 ma
Heater current	0.8 amp	Max avg plate dissipation, per plate	... 5.6 w
Max plate voltage	300 v		

178-K4-8850



Type 6N7
\$1.60

KEN-RAD

DIVISION OF GENERAL ELECTRIC COMPANY
 OWENSBORO, KENTUCKY

Make the nearest Ken-Rad distributor or dealer your preferred source for amateur tubes

CARDWELL

ANNOUNCES

A NEW ADVANCED

HIGH FIDELITY AUDIO AMPLIFIER



MODEL CE-25

- 25 watts undistorted output.
- Three High Impedance Inputs—Two for microphone and one for phonograph.
- Individual bass and treble boosting controls.
- Dynamic audio compensation circuit on phonograph channel.
- Ultra-modern cabinet styling with recessed control panel edge lighted.
- Quick release cover for instant accessibility.
- All aluminum construction combines durability with light weight.
- New vane type construction assures good ventilation and low operating temperature.
- Concealed hand holds for easy portability.

SPECIFICATIONS

POWER OUTPUT: 25 watts undistorted.

GAIN: Microphone 135 db. Phonograph 86 db.

FREQUENCY RESPONSE: Response at 50 cycles controllable from -15 to +17 db. Response at 10,000 cycles controllable from -15 to +22 db. In addition, Audio Compensation is used on the phonographic input which boosts bass as the volume level is reduced. This compensation is effective over a 40 db range in volume level and results in exceptional tone balance.

POWER REQUIRED: 115 watts at 105-125 volts 60 cycles AC.

DIMENSIONS: Length 15½ in., Depth 10¼ in., Height 8¾ in.

CONTROLS: Two microphone volume controls and one phonograph volume control. One bass boost and one treble boost control.

TUBES: (2)—6SJ7, (3)—6SL7GT, (2)—6L6G, (1)—5U4G.

OUTPUT IMPEDANCES: 2, 4, 8, 16, 250, and 500 ohms.

INPUT IMPEDANCES: Microphone channels—10 meg-ohms. Phonograph channel—500,000 ohms.

WEIGHT: 26 lbs. All aluminum case.

**WATCH FOR THE
NEW CARDWELL COMMUNICATIONS
RECEIVER TO BE ANNOUNCED SOON**

Introducing new and unusual mechanical and electrical features.



**THE ALLEN D. CARDWELL
MANUFACTURING CORP.**

MAIN OFFICE: 81 PROSPECT ST., BROOKLYN 1, N.Y.
 FACTORIES: PLAINVILLE, CONN.—BROOKLYN, N.Y.

(Continued from page 98)

who sent in this FB report, are back on the air. SYW keeps a schedule with JSB Monday through Friday. HJP has an XYL and will be in the W9 area. 1WV/6, on the air Jan. 25th, has contacted twenty-four states toward another WAS, and four countries toward WAC, and reports hearing much FB DX. FKK, formerly located in Modesto, is engineer for KHUB, Watsonville. ISW is active on 28 Mc. DLA, formerly of Carlin, Nev., now is located in Lomita Park. MOV is a civilian again after several years in the South Pacific. Your SCM has resigned so this may be his last report. Success to the new SCM. Traffic: W1WV/6 2. 73. Sandy.

EAST BAY—SCM, Horace R. Greer, W6TI—Section EC, EE; EC, QDE; EC v.h.f., FKQ; Asst. EC v.h.f., OJU; OO v.h.f., ZM; OBS, TT, IDY, ZM. It is with deep regret that we report the death on Jan. 21st of AEX, who was president of the SARO all during the war. It was his efforts that kept that amateur organization together during the war period, and he was just finishing his last term when death came. We welcome 1NCY, from Hartford, who now will be W6. LMZ reports no traffic for this period. The following new officers of the Richmond Radio Club have been elected: AAT, pres.; HZK, vice-pres.; QDE, secy. and treas.; LMZ, sgt. at arms. The club meets the first and third Fridays of each month in the Richmond City Hall and, according to reports, has doubled in size in the last several months. The Oakland Radio Club meets the first and third Thursdays of each month at the Lincoln Club House, 11th and Alice Sts., Oakland, and is increasing in size with each meeting. TT likes his 28-Mc. Johnson Q antenna. GEA has found someone to dig out his basement for his new radio room and workshop at last. ZM is trying out vertical antenna on 28 Mc. NPP is waiting for his new call letters. PB got new 28-Mc. rotary up. IKQ is building new 28-Mc. rotary which sure is a honey, and will have it in operation by March 15th. I suggest you take a run over to Phil's and take a "look-see." As I am writing this report, we are in the middle of the first ARRL contest since before the war. It is most encouraging to note that many of the boys who are not really in the contest are offering a helping hand to those that are by exchanging numbers and reports when asked to. That's what I call real ham spirit. Remember that the W6 QSL Bureau is now open for business. Please drop me a penny postal card with news anytime. 73. "TI."

SAN FRANCISCO—Acting SCM, Sam C. Van Liew. W6CVP—Phone RA. 6457. ECs; DOT, KZP; OO, NJW; OBS, FVK, KNH; Asst. SCM, GPB. NGB is back on 28-Mc. 'phone. BIP is rebuilding on 28 Mc. PFK returned to civilian life after three years in the Air Corps in India and China. LMD, now stationed at Juneau, Alaska, operates K7JBZ. Ex-NQB, Bob 3JJD, Washington, D. C. send regards to both San Francisco and Marin Radio Club members. The San Francisco Radio held its first club meeting on Feb. 15th with a fine attendance. Clay Bane and Fran Wells each gave interesting talks on antenna feed systems. Club meetings will continue monthly at the American Legion Hall, 1641 Taraval St., San Francisco. All amateurs and those interested in the art of radio are welcome. SLD, LES, RBQ, 4TQ, KZP, NJW, DWJ, and others, are on 144 Mc. regularly. WB and RBQ are busy working DX on c.w. DOT, WN, MZ, KNZ, and NPT are on 28 Mc. and doing well. NPT won the HK-354 at San Francisco Club meeting. RBQ built a new concentric-fed doublet. CIS is building new transmitter and is active on 28 Mc. with pair 807s. NYQ has new three-element beam. JYN expects to be back on the air soon with new rig. CVP is building new antenna and rig for 28 Mc. Will appreciate more reports. Traffic: W6OZC 76, KNH 117, RBQ 78. 73. Sam.

SAN JOAQUIN VALLEY—SCM, James Wakefield, W6PSQ—The SJVRC was reactivated last December with KUT, pres.; LTO, vice-pres.; and NJQ, secy.-treas. Board of Directors: LOS, PDX, PSQ, KPW, FPW, and MYP. Meetings the second Friday of month in Fresno. The VHF Club, formed for emergency work, drills every Tuesday and Thursday evenings at 1900 on 144 Mc., with PDX as chairman and JCB, NJQ, SGH, QK, GCF, PSQ, FTA, and MGN as subordinates. RSD was reported heard in France by SWL Q5R6 but QRM from East Coast stopped chance for two way. FPW was called back to active duty with the Navy after three months in civvies. RMC is on the high end of 28 Mc. with four watts to a 6V6 with envious results for the high-power boys. 8STJ, 1MZT, and 9SCM, all portable six at Camp Pinedale near Fresno, are on with an HT-4 and Super-Pro. Activity on 56 Mc. is increasing, with KUT.

(Continued on page 98)

ARRL'S Amateur BAND-WARMING PARTY

*Ushers in a New Era of Activity
for Hams on the Air Waves*

AND Astatic's complete line of dependable products will again be available to thousands of amateurs through authorized Astatic Radio Parts Jobbers. Astatic Microphones, Phonograph Pickups, Cartridges and Recording Heads are held in high esteem by the ham fraternity, faithfully served by Astatic over many years.

THE *Astatic*
ASTATIC CORPORATION
CONNEAUT, OHIO
IN CANADA, CANADIAN ASTATIC LTD., TORONTO, ONTARIO

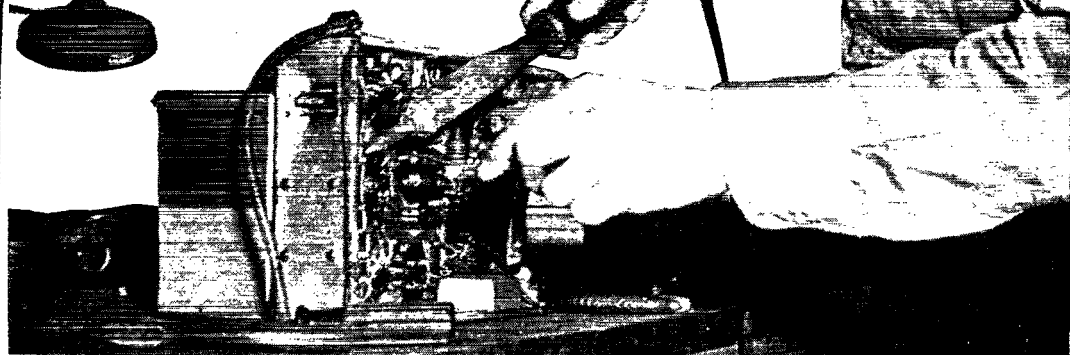
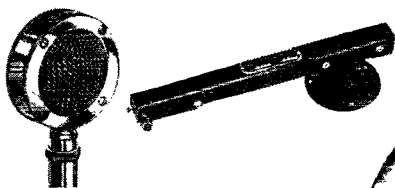

REMEMBER FOR PRECISION-BUILT

MEISSNER
THORDARSON
RADIART

Look!

FASTER • BETTER • MORE
COMPLETE SERVICE BECAUSE ALL 3
ARE NOW SOLD FROM A SINGLE SOURCE

**ELECTRONIC DISTRIBUTOR AND
INDUSTRIAL SALES DEPARTMENT**

THESE 3 NAMES ELECTRONIC PRODUCTS

**- MEMO -
REMEMBER . . .
MEISSNER**

FOR

✓ Service Instruments, including the famous Meissner Analyst and Meissner Signal Calibrator.

✓ Components . . . R.F. and Oscillator Coils; Standard, Plastic and Ferracart Transformers; Windings, Chokes, Coils, Etc.

**- MEMO -
REMEMBER . . .
THORDARSON**

FOR

✓ Quality-built Transformers for all requirements.

✓ True-Fidelity Amplifiers in new, modern designs and containing many exclusive features and improvements.

**- MEMO -
REMEMBER . . .
RADIART**

FOR

✓ Correct Replacement Vibrators . . . individually-engineered to meet exactly the physical as well as the electrical requirements.

✓ Rust-Proof Aerials . . . newly designed to fit all cars . . . cowl, hood and under-hood types.

IMPORTANT! The Electronic Distributor and Industrial Sales Department of Maguire Industries, Incorporated, was formed primarily to offer better, faster service . . . to assume all merchandising, sales and customer relation duties and responsibilities essential in marketing the combined, precision-built products of the Thordarson Division, Meissner Division and Radiart Corporation . . . For complete information, write to the address below . . . today.

MAGUIRE INDUSTRIES, INC.

236 NORTH MICHIGAN AVENUE, CHICAGO 11, ILLINOIS

STATION TESTED*

*... an added
proof of Quality!*



*Pres. W. A. Kuehl is shown at his amateur radio station W9EZN. With the war over, Walt is again pursuing his favorite hobby.

DRAKE RADIO SOLDERING IRONS

Yes, Drake irons are *right for radio*. And these sturdy irons have proved their dependability and worth in use on countless other jobs, too, for over 25 years. That's why we say — whatever your needs, you are certain to find a Drake iron that fills the bill exactly!



600-10—the Drake No. 600-10 is ideal for those all important connections when rewiring your rig. Get back on the air fast. Make good dependable connections with this 100 watt $\frac{3}{4}$ " tip.



400—the Drake No. 400 is the perfect iron for work in small places. Only 9 inches long, it is especially designed for tight corners and delicate connections. 60 watt, $\frac{1}{4}$ " tip.



Ask your nearest supplier or write for the name of the distributor nearest you . . . and give yourself the advantages of these superior irons.

DRAKE ELECTRIC WORKS, INC.
3656 LINCOLN AVE. CHICAGO 13, ILL.

(Continued from page 84)

LPY, and JPU on with surplus Navy equipment. Any of you fellows interested in appointments of any kind contact me for the necessary forms. Also reports must be in early to get information to headquarters. Need reports from Stockton, Turlock, Bakersfield, Taft, and Visalia to make a comprehensive report for the section. Traffic: W6SUV 1, QOP 12, PSQ 1. 73. *Jimmie*.

ROANOKE DIVISION

SOUTH CAROLINA — SCM, Ted Ferguson, W4BQE/ANG — CMR reports from Calcutta that he has run up a nice bunch of DX. CQU has moved to Florida. CKW has a new jr. operator. FNC hopes to be out of the services soon and has already started his postwar rig. 9JNC/4 has been transferred to New York. HEV has his "duck" and will be on the air soon. EXJ is in business at Whiteville, N. C. FMZ soon will hit the air with a nice signal. VL is rebuilding. AZT is getting the bugs out of his prewar rig. HMG says DX is good on 28 Mc.; he is building c.e. for 144-Mc. operation. ERB says 28 Mc. sounds like old times. HWZ is back and has taken a church at Greenville. EHF is at Fort Bragg. FHE is building new kw. rig. GKD, better known as "Short Circuit Price," says he is blooming out with high power. DIP has a nice signal on 28 Mc. You should hear BPD's ground-wave signal here on 28 Mc. AW is dishing out the parts at Dixie. HVG keeps plugging away at the university and is on 28 Mc. DNR reports from Tokyo that he soon will have a rig on the air and will be looking for South Carolina contacts. The secretary of the Greenville Amateur Club says the club has reorganized, elected new officers, and has forty-four members. Please report, gang. 73. *Ted*.

VIRGINIA — SCM, Walter G. Walker, W3AKN — The following military personnel have returned to Virginia from overseas duties: HZU from Tokyo to new station at Langley Field; NT from Manila to the Norfolk Navy Yard. HBH is out of the Army and is on 28 Mc. with an HK-24 running 50 watts. GGI is out of the Army and back in Newport News; he has a newly-acquired NC-101X and is getting a transmitter ready for 28 Mc. IIF has returned to Virginia and is getting a 28-Mc. rig lined up. The following stations have made DX contacts in the new sweepstakes for the Century Club: FQP and PK, 17 countries; MT, 4 countries; BEK, 2 countries; AKN, HBH, and AJA, 1 country. Received the following news via JHC at Buckroe Beach: JNH, Richmond, is out of the Navy. The following are active on 144 Mc.: AJA, JHC, IINN/3, INVQ/3, JAZ, GHI, FQP, BEK, IQY, 4FKY/3, 6QIL/3, 9ZUJ/3. NE writes that he still is radio operator on the SS *J. W. Van Dyke* now in Atlantic service. JGS expects to be mustered out of the Army at Scott Field and will return to Bristol, where he will fire up the 28 Mc. rig. WS reports from Richmond that the RSWC is putting on code and theory classes and had over 100 turn out for the January meeting. GWQ has applied for renewal of his OPS appointment; he is active on 28 Mc. and has a new NC-240C receiver. IVN is out of the Army and back in Bristol. He reports he is active on 28 Mc. HNX is a Navy lieutenant and is stationed at Foley, Ala. AIM reports from Alexandria that he expects to be on the 28-Mc. and 144-Mc. bands as soon as he can set up his apparatus. He recently returned from Guam, and was with the 20th Air Force. ATY called on the telephone to report he now is stationed at Langley Field. A group station is active at Langley and the following amateurs are active there: INJM/3, 2NNM/3, K6TUL/3. The commanding general at Langley Field is an active amateur. 73. *Walt*.

WEST VIRGINIA — SCM, Donald B. Morris, W8JM — KWL and SPY are active on 28 Mc. in Morgantown, with KWL DXing with 200 watts' phone and beam. WNO is working in Fairmont and has new 9-lb. jr. operator. EHA built stage of preselection for his 28-Mc. receiver and then QSOed Scotland with 25 watts. KWI and RCN have returned from the wars and are active on the air. VAB, with 750 watts and rotary beam, works the world on 28 Mc. The MARA is quite active and meets the first Friday in month at WMMN studios in Fairmont. A nice clubroom has been fixed up through the courtesy of the station and ESQ, chief engineer. GQE, formerly of Uniontown, Pa., is on 28 Mc. with 15 watts to 807 and is building 100-watt amplifier. WSL is building a beautiful rack and panel 1 kw. transmitter to work with a four-element rotary. West Coast stations have been heard working Charleston stations but to date none have been heard in Fairmont on short skip. As your new SCM, I would like to hear from all active

(Continued on page 100)

HAM GEAR

at Newark Electric

Comes Spring, and with it that old restless urge to do things, go places, enjoy the great out-of-doors.

To you dyed-in-the-wool amateurs who are deterred by the necessity of leaving behind your ham gear, we have a suggestion to make. Take it along! And what, you ask, shall we use for power?

That question brings us neatly to the subject matter of this month's "Ham Gear" column — P. R. Mallory & Company's splendid line of Vibrapacks. Stowed in the trunk compartment of the old buggy along with your transmitter and receiver, a Vibrapack will provide vibrator power from a low voltage storage battery. Vibrapacks come in a variety of types and sizes including nominal input of 6, 12 and 32 volts D.C.; nominal output voltages from 125 to 400.

Some have a tube rectifier while others are self-rectifying. Weights vary from 4¾ to 12¾ pounds.

There are four factors to be considered in selecting the correct Vibrapack type:

1. Input voltage — the low voltage D.C. source.
2. Output voltage — allowance should be made for voltage drop in external filter chokes, if required.
3. Output current — maximum and minimum. The load current should not exceed the rated output of the Vibrapack. For example, if an amplifier requires 125 milliamperes, a dual Vibrapack should be selected, rather than attempting to operate a single unit beyond its rated capacity.

4. Self-rectifying or tube rectifying type? If "B—" is to be connected to the ground or one of the storage battery leads, a self-rectifying Vibrapack may be used. When the "B—" circuit incorporates resistors, chokes, or the speaker field, so that the voltage drop may be used for bias, a tube rectifier type Vibrapack *must* be used.

A tube rectifier type Vibrapack can be used with "B—" grounded, if desired. Where circuit conditions permit, self-rectifying units are recommended.

Nearly all Vibrapacks are designed to mount directly on the chassis of a



receiver, transmitter or amplifier without transmission of hum or "hash." Mounting is accomplished by drilling four ½" holes (six holes for dual Vibrapacks) which line up with spade bolts attached to the chassis of the Vibrapack. Rubber grommets and cup washers

are provided to insulate the Vibrapack from the chassis electrically and mechanically.

Grounding the Vibrapack chassis is best accomplished by soldering a heavy strip of stranded braid on the chassis and grounding the other end to the Vibrapack chassis at the screw located directly under the terminal board, or between the terminal boards on the dual units. The length of this lead must be kept at a minimum for best results.

Low voltage leads from the battery to the set and the Vibrapack must be as short and as large in cross section as possible, as the output secured is directly affected by the voltage drop in these connecting leads. Input wiring losses can be kept to a minimum by observing three conditions:

1. Keeping the battery leads as short as possible.
2. Making certain that the switch or relay used to control the circuit has low resistance.
3. Using wire of sufficient size to carry the current properly.

If control is required from any location that is not in the direct line of wiring between battery and Vibrapack, do not run long leads to the switch. Insert a relay in the circuit. The coil of the relay can be energized through leads of any reasonable length.

In all heavy-duty automotive installations it is recommended that the "A Ground" circuit be carried by copper wire, rather than by the frame of the vehicle.

But here we go again running out of space on this page. P. R. Mallory & Co., Inc., has published a booklet crammed full of engineering data on the Vibrapack. Why not drop in for your copy, or mail us a postcard? We'd also like to hear how you like this "HAM GEAR" column, and what you'd like us to publish in future issues.

CHICAGO

Newark *ELECTRIC* Company

NEW YORK

"Service is the Foundation of our Business"

115-117 W 45th St.
NEW YORK 19
BRyant 9-4735
(ADOLPH GROSS)

323 W. Madison St.
CHICAGO 6
DEArborn 0083
(SAM PONCHER)

Where Will You be
in **ELECTRONICS**
IN
1947?

**Study NOW for a
Better Job Then!**

THIS NEW WORLD OF ELECTRONICS is moving at a rapid pace. War born developments equivalent to twenty years of research are here. Still newer techniques are coming out with surprising speed. Have you the basic technical knowledge to keep pace with these developments?

MORE THAN EVER BEFORE, a sound basic knowledge of up-to-date, fundamental engineering of radio-electronics is an essential to a better job—promotion—increase in pay.

THESE NEW TECHNIQUES MEAN BRAND NEW JOBS in brand new fields; but they demand men who have knowledge and training—men who know the WHY as well as the HOW. Regardless of your past practical experience, the future demands that you must acquire a solid foundation of theory if you expect to forge ahead in this new world of electronics.

IT COSTS YOU NOTHING TO INVESTIGATE—The coupon on a postcard will bring full information of the CIRE plan of personalized aids and coaching service, with qualified competent instructors, and systematic, progressively arranged study assignments in recognized, approved texts—these are only a few of the many superior advantages of CIRE's plan of spare-time home study training for professional self-improvement.

CIRE HOME STUDY COURSES COVER THE FIELD OF RADIO-ELECTRONICS—TELEVISION, ULTRA-HIGH FREQUENCY TECHNIQUES, AM AND FM BROADCASTING, COMMUNICATIONS ENGINEERING—from simple treatment of fundamentals, through preparation for FCC commercial radio operators' license examinations, up to and including complete high level quantitative treatment of advanced radio-electronics and communications engineering. Choose the course best suited to your needs, and start with the section you are qualified to enter. You pay for only the section or sections you need. Use the "Pay-as-you-go plan" patterned after ethical, educational practice. These features are unique with Cleveland Institute, and represent the best in the modern, post-war concept of home study training.



Many CIRE students of advanced engineering courses today are broadcast chief engineers. Graduates of CIRE courses are eligible for the top jobs in radio-electronics.

Write today for free, descriptive booklet—**"THIS NEW WORLD OF ELECTRONICS HOLDS OPPORTUNITY FOR YOU."** No obligation—no salesman.

CLEVELAND INSTITUTE OF RADIO ELECTRONICS

Contractors to the Canadian Broadcasting Corporation

Successors to

NILSON RADIO SCHOOL, Founded 1939

SMITH PRACTICAL RADIO INSTITUTE, Founded 1934

QT-4, Terminal Tower

Cleveland 13, Ohio

(Continued from page 88)

amateurs and ask that you give consideration to the various appointments. Please let me have your comments and recommendations. With the gang returning and getting on the air, there should be a lot of news. 73. Don

ROCKY MOUNTAIN DIVISION

COLORADO—SCM, H. F. Hekel W9VGC—EHC/5 is back in civvies and located at 4608 Parrish Rd., Ft. Worth, Tex. and is on the staff of the CAA. He has two ambitions in life—to get back on the air and get an SX-28A. New DX records are being made and broken every day on 28 Mc. Here is one I heard all by myself: 2NT/9 got an S6-7 report from OQ5AE in the Belgian Congo 11:48 A.M. Jan. 31, 1946, IQZ, with 64 watts and a vertical half-wave antenna, worked KA2LNL, on Leyte, P. I.; 6MBA, on Tinian; and TG9WPB, Guatemala. EYN and 5GIB/9 hook all the Ks and all points west. They claim their DX is to within a few hundred yards of the China Coast. AZT, formerly of Scotts Bluff, Nebr., now in Denver, has been keeping his antenna indoors but will put it out in the sun again as soon as the weather gets warmer. A check of the "Q-Boys" in Denver is incomplete but these are still with us: QYT, YQW, QXJ, IQZ, HQI, BQO. QEC is in Tennessee, where the high-powered grenades are made, and BFQ was in Alaska the last time he wrote. QCX was seen running around the streets of Denver the other day. Will someone please find the others? Here is the list: VQZ, QYU, PRQ, GBQ, EKQ, DQM, NBQ, QDC, JUQ, and QKW. VQY is on the western slope and has a good job over there. I want to take this opportunity to thank those who jumped in and helped make the SCM task a little easier for me. I hope you will help your new SCM all you can. When the other bands are opened his job will be much easier with your assistance. 73. *By Heck.*

UTAH-WYOMING—SCM, Victor Drabble, W6LLH—6NMK would like to hear from the gang. His address is: R. R. Larsen, ETM1c, USN Hospital, Ward 473, Corona, Calif. 6IWY finished his rotary-beam antenna and is getting out with 18 watts. 6SID is getting the Cache Valley gang on the 144-Mc. emergency net and reports 6MAV and 6SID first on, followed by 7IYP/6, 6CKI, and 6RIM. 6SID worked 6MBA/KB6, Tinian, and has logged twenty-one countries to date. 9ZCB is on 28 Mc. 6SYD remodeled his Abbott transceiver to 144 Mc. 9NFX is building a modulator. 6FYR has rebuilt his het-beat variable frequency oscillator. 6UOM has gotten the bugs out of his rig and likes the skip on 28 Mc. 6MQL/6 is waiting for his receiver to get on 28 Mc. 6STB claims the postman is going to be kept busy delivering QSL cards to the active gang in Provo. 6RWY has an FB three-element rotary beam antenna. 6TCC gets on the air with a high-power rig, rotary beam antenna and an FB Sky Champion receiver. 6MSY is president of the newly-formed Central Utah Amateur Radio Club in Provo, while 6DPJ is vice-pres. and 6STB is secy-treas. 6DTB is raising the height of his rotary antenna another seventeen feet. 7COV now is a civilian. 7IAP and 7CRP are remodeling for 28 Mc. 73. *Vic.*

SOUTHEASTERN DIVISION

ALABAMA—SCM, Lawrence J. Smyth, W4GBV—Asst. SCM, Col. Fred J. Elser, W6ANM/4. The section extends its sympathy to SCM GBV in the loss of his mother. The Montgomery Club now has forty-two members answering roll call. Meetings are held each Wednesday night in Power Company auditorium with code practice each Friday night. DVJ is home again after four years in the Signal Corps. DPQ, ECF, and EIB show renewed activity on 28 Mc. Birmingham vicinity regulars include ELY, FBI, FSU, and FUJ, on 28 Mc. 6ANM/4 bought a new SX-28A and has applied for 4th district call. ECF is a civilian after 3½ years with AACCS. 5JNY/4 is getting on 28 Mc. at Maxwell Field. Ex-6TNK, Maxwell Field, has applied for a license. EFD is rebuilding to 28 Mc. EPA is on terminal leave after 3½ years with the Navy. DPX is on terminal leave after 3½ years with AACCS. Montgomery's original "ham," Bob Carrie, AP, was seen at club meeting after long period of silence. GOX, after four years in the Signal Corps, is awaiting transportation home from Germany. FYC is out of the Navy after four years' service. AEZ is a civilian again after 3½ years with AACCS. Let's hear from the Birmingham and Mobile gangs. 73. *Fred.*

(Continued on page 108)



another **NEWARK** store

CONVENIENT NEW OUTLET IN DOWNTOWN NEW YORK

Located at 212 Fulton St., New York 7, N. Y., another big Newark Electric Company store has been opened to serve the needs of amateur operators. All specials listed on following pages are available at *all three* Newark Electric stores, plus many more models of big-name receiving sets, meters, batteries, condensers, tubes, transformers, etc. Make Newark Electric the headquarters for all your HAM GEAR requirements.

FAMOUS NEWARK SERVICE

Stop in at the downtown New York store when planning your new rig, and you will find the same competent understanding personnel that has made buying at Newark a pleasure. Hy Kahn, branch manager, or one of his capable assistants, will gladly assist you in any problems that you have.

NEW YORK NEWARK ELECTRIC Company		
115-117 W. 45th St. NEW YORK 19 BRyant 9-4735 (ADOLPH GROSS)	CHICAGO 212 FULTON ST. NEW YORK 7 BRyant 9-4735	323 W. Madison St. CHICAGO 6 DEArborn 0083 (SAM PONCHER)



From Design to Delivery PEERLESS

Does it Better!

A complete transformer service—from engineering design to correctly cased unit. Peerless transformers, windings, reactors, and fluorescent ballasts are available or can be produced in sizes and capacities to meet *your* needs. Write for new catalog.

**Prompt Delivery
If You Order Now!**

Choice territories open
for qualified
representatives

PEERLESS

ELECTRICAL PRODUCTS CO.

6920 McKinley Avenue
Los Angeles 1, California

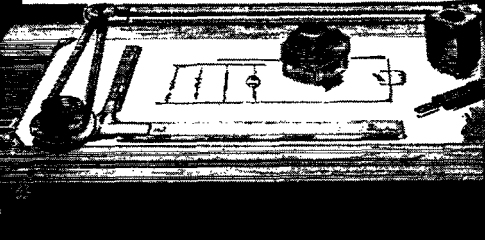

(Continued from page 100)

EASTERN FLORIDA — SCM, Robert B. Murphy, W4IP — GVC has been appointed Section EC. Write him and get lined up for our emergency hurricane net. GVC's recommendations for the various appointments will be given preference. ES is back from Washington. VP5EM, Kingston, is listening to Merrie Ole England but is unable to transmit due to impounded equipment. IP, jr., was a visitor there and the contact was enjoyed by all concerned. NB and a couple of the locals on 28-Mc. c.w. want to get the local QRA "ZAZ" right to all hands. NB is doing some nice work with one-half kw. EYI reports the following: FPC is active on 28, 56 and 144 Mc. IGQ is out of Navy and has gone to California. EPW is QSO Africa, Italy, and Germany. ANH is becoming an aviator. FJC, in Jax, says ham activity is on the up and up with a real club in the making. He reports the following on 28 Mc.: AWE, FRP, FJC, GXX, K6RUA/4, FBL, FWZ, HWA, UJ, GUJ, AKH, 9JEX, DAA and PI. The following were present at the first club meeting since the war: BSJ, HWA, DAA, 8VCC, DLL, DQV, GXX, AKH, K6RUA, ATM, EBE, FJU, GUJ, PI, AIJ, JU, FJC, FBL, GZJ, FWZ, QB and 9JFX. Key West came to the front with a letter from K6IRS/4. 9AQW, 9OCN, and IRS are active. IFF, EFH, 2LPD, and 8AAK are doing their best to get WAC from kw. IE, in Sarasota, was paid a visit by 6ANM, who will be remembered as PIIZA and KA3AA. 1FAN is with Raytheon at Waltham, Mass. QN, of Orlando, has applied for OO appointment. I hope others will request this appointment so we may establish a net of four or five OOs when 40 and 80 open. They can establish a net frequency where they may compare notes, something like the old FCC monitoring systems. We are honored to have FUM as a member of our section; he was the only W4 to WAS and WAC on 28-Mc. 'phone before the war. DKA worked all continents, plus a few more, in two weeks. 73. *Merf.*

WESTERN FLORIDA — SCM, Lt. Edward J. Collins, W4MS — EQR has an FB two-element rotary going with 300 watts. DAO has three of his four elements going on his beam. AXP has a nice antenna up. 3IHC/4 had a shack-warming. 6OHN/4 hears and works lots of DX. Ex-CTZ was worked from K6-land, as was EPT/K6. 9WEF is getting on in Milton. HIZ and BKQ are on again. ECT and FJR are on c.w. with an FB signal. MS has a "plumber's delight" going FB. AXF is waiting for 14 Mc. to open. LT is heard in Pensa on short skip. DXZ has an FB new HRO. ASV is getting back on. 7IQJ/4 wants antenna location. UW promises activity. JV has been missed on his c.w. VR is waiting for 7 Mc. 5FUM was a visitor to the section. 9MN/4 is waiting for his transmitter to arrive. EZT is attending the U. of Fla. DXQ is looking at 28 Mc. QK is working hard on his new rig. COG is getting married. We would appreciate more reports. 73.

GEORGIA — SCM, Thomas M. Moss, W4HYW — First of all, thanks for the SCM appointment. I shall do my best. The section is in immediate need of a Section EC and County ECs. How about some applications for both, and also some nominations for SECT? All amateurs in the section are urged to apply for Emergency Corps membership. League membership is not required for membership in the Corps. ERT is EC for Bibb County. HYW is Acting EC for Fulton. Applications for OBS are now being accepted. EEE is OBS. HYW is maintaining irregular OBS schedules. With most of us quadrupling to get on 28 Mc., Official Observers (all classes) are needed. RM, ORS, PAM, and OPS appointments will be made as bands are returned. Clubs and members are urged to send reports of activities for publication. The Emergency Corps program is important at this writing, and your help will be appreciated. 73. *Tom.*

WEST INDIES — Acting SCM, E. W. Mayer, K4KD — K4FYD has been heard on 28 Mc. K4DDH is on with 803 in final. W8VRD/K4 built modulator and is going FB on 'phone. W3HUN is in P. R. with U.S.C. & G.S. and expects to get on. K4HEB/K4 was on for his first 28-Mc. operation; he and K4KD worked TG9WFPB on c.w. K4BNH, Mayaguez, and K4DUZ, Junco, are active. W4BZA returned to P.R. and is on 'phone. He has a brand new jr. operator, born Dec. 4th. W4IEN/K4 is building a new transmitter. Ex-W5EVN has new Class A ticket and is applying for K4 license. W4DYX and W6PQE, both in P.R., still are in process of construction. W3JLH is in P.R. with CAA. W9KFB returned to P.R. and plans to get on soon. W8VRD/K4 schedules W9FFB on 28-Mc. 'phone daily. All the above dope was obtained by grapevine and eaves-

(Continued on page 104)

NEWARK DOES IT AGAIN!

National NC-100-ASD Receiver

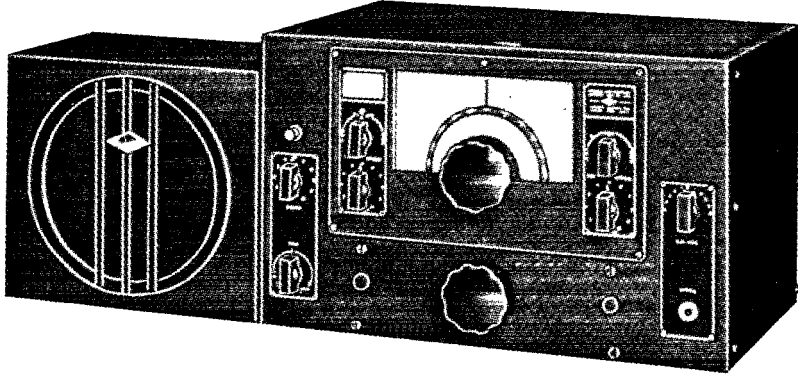

At the *sensationally low price of* **\$115.00** *(complete with speaker in cabinet)*

OUR SUPPLY of this excellent National ham receiver is limited, so hurry! A ten-tube, table-mounting super-heterodyne, the NC-100-ASD covers a continuous frequency range of from 200-400 kc. and 1,300 to 30,000 kc. in five working bands as follows:

- 200 to 400 kc.
- 1,300 to 2,800 kc.
- 2,800 to 6,400 kc.
- 6,400 to 14,000 kc.
- 14,000 to 30,000 kc.

Spare Parts Kit consisting of controls, resistors, condensers, etc., for this receiver..... **\$4.95**

BIG HEADSET OPPORTUNITY!

You've wanted them—here they are; SIGNAL CORPS lightweight, high impedance Headsets with sponge cushions. **\$1.95** For only.....

Newark NEW YORK **ELECTRIC** CHICAGO **Company**

115-117 W. 45th St.
NEW YORK 19
BRyant 9-4735
(ADOLPH GROSS)

212 FULTON ST.
NEW YORK 7
BRyant 9-4735

323 W. Madison St.
CHICAGO 6
DEArborn 0083
(SAM PONCHER)

QST

YEARLY BINDERS



Are We Right?

You should have at least two of them—one for your complete 1945 file of copies, and one for each 1946 issue as published.

With each Binder is furnished a sheet of gold and black gummed labels for years 1927 through 1947. The proper one can be cut from the sheet and pasted in the space provided for it on the back of the binder.

Price **\$1.50** postpaid

Available only in United States and Possessions

THE AMERICAN RADIO RELAY LEAGUE
West Hartford, Conn.

104

(Continued from page 108)

dropping. What say, gang, how about dropping me a line and giving me news for these reports. 73. *Ev.*

SOUTHWESTERN DIVISION

LOS ANGELES — SCM, Ben W. Onstenk, W6QWZ — Will all you fellows and gals who have or would like appointments as OBS, ORS, OPS, OO, PAM, RM, or EC, please contact me. My address is 9631-3rd Ave., Inglewood, Calif. The clubs in this section are expanding more and more each meeting. A partial list follows: Inglewood Amateur Radio Club meets on the first and third Fridays in the Veterans Memorial Bldg., Warren Lane and Centinella, at 8 p.m. The Long Beach Club meets on the second Tuesday in the Bowling Green Club House, Recreation Park, at 8 p.m. The Mike and Key Club of Santa Monica meets every other Wednesday at the home of NSC, 1011 Pine St., Santa Monica, at 8 p.m.; next meeting April 3. The Foothill Radio Club meets on the second Thursday at the YMCA Bldg., 134 W. Badillo St., Covina, at 8 p.m. The United Radio Amateurs Club meets on the second Friday; for more dope call ANN or MDX. The Amateur Radio Researchers meets on the second and fourth Thursdays at the home of QQR, 8416 San Carlos St., South Gate. The Glendale Club meets on the first and third Thursdays in the Spar Heights Community Center, 3311 Downing St., Glendale. Will the secretary of any club not listed above please send me the dope on meeting place and dates. The Foothill Club elected the following officers: FFN, pres.; DTS, vice-pres.; ON, secy.; CQG, treas. The Glendale Club elected UP, pres.; EQM, vice-pres.; DXR, secy.; RKS, treas.; TUT, activities mgr. The Mike and Key Club elected NSC, pres.; TSN, vice-pres.-treas.; RIU, secy.; PTR, activities mgr. The following are OBS: OGM, GZZ, EKM, ON, ANN, KEI, and K4HTU/W6. ECs are: MSO, MVZ, RO. Section EC is Roy Brady, 8WLG/6. For frequency checks GZZ, as OO, is well equipped. Active AEC members are MVZ, Firestone district; MSO, Centinella Valley; RO, Long Beach. The Glendale Club has plans well under way for a district convention to be held in the fall. Traffic: K4HTU 10. 73. *Ben.*

The Arizona section suffered a severe blow when its SCM, Douglas Aitken, W6RWW, passed away on January 16th. Doug was born in Prescott, Ariz. on Nov. 20, 1893. He served with the 63rd Infantry in World War I and was employed as an engineer on government projects until his illness. He is survived by his wife, Kitty, W6SGD. Between trips to the hospital Doug built a 350-watt rig that would be an accomplishment for any ham. He was Arizona SCM during the entire period of World War II and never missed an activities write-up. He was a member of AARS and secured reorganization of Arizona into the Ninth Service Command. He got his first ticket in August, 1939, and his Class A ticket in 1941. He held A-1 Operator, WAAC No. 1 (worked all Arizona counties), WACC No. 6 (worked all California counties), and WAS certificates, and handled considerable traffic to several nets. During the war he helped a number of men to learn the code before they entered the services. He began the movement to start a State radio organization in Arizona. We in Arizona will miss Doug, a grand fellow, a real leader, and an inspiration to every ham.

ARIZONA — Acting SCM, Gladden Elliott, W6MLL — QLLZ, KJJ, and LKK are trying out u.h.f. LSF and QJL are on 28 Mc. PEKZ is rated as the outstanding ham on 28 Mc. in Phoenix. LPV does better with his 5 watts on 28 Mc. than many with high power. MAE is Phoenix QSL Manager. PDA is on 28 Mc. at AJO. New officers of the Tucson Short Wave Club are: TFM, pres.; GS, vice-pres.; and OWG, secy.-treas. Meetings are held twice a month at the Safford Jr. High School. Code and theory classes will be conducted. OWX is the new 25 Club president and SGP is the secy.-treas. QAP is building a portable station in a jeep. LJJN, RLC, SNI, and SQN are experimenting with a 144-Mc. linear tank 200-watt rig and want the 144-Mc. gang to keep a lookout for them. All the gang around Jerome-Clarkdale

(Continued on page 108)

HAMS ... now three big Newark stores to serve you, well stocked with the latest and best in radio. Order from the one nearest you.

THIS MONTH'S FEATURES

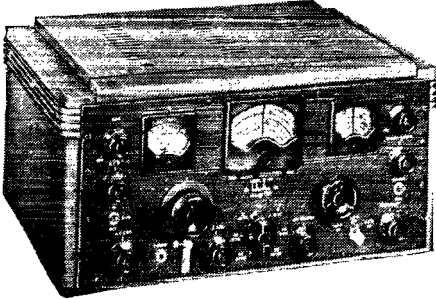

HALLICRAFTERS

SX-28A	Super Skyrider with crystal, less speaker.	\$223.00
S-40	Brand new model; has built-in speaker...	79.50
S-41	Skyrider, Jr.	33.50
S-22R	Skyrider Marine with built-in speaker...	74.50
SX-25	Super Defiant with crystal, less speaker...	94.50
S-39	Sky Ranger portable, AC/DC and battery	110.00
SX-36	FM/AM receiver.....	415.00
S-37	V.H.F. FM/AM receiver.....	591.75
PM-23	10" PM speaker in cabinet for use with SX-25, SX-28A.....	15.00

HAMMARLUND

HQ-129X (with tubes)..... **\$168.00**
 SP-400-X Super Pro 5A-30MC..... *Price not yet established*

NATIONAL

NC-2-40C and speaker..... **\$240.00**
 NC-46 AC-DC self-contained power supply..... *Price not yet established*

RME

RME-45 and speaker..... **\$186.00**

TUBE BARGAINS • Many famous makes, popular types at ridiculously low prices! Write for list! Kit of tubes for Abbott TR-4 transmitter-receiver **\$8.30**

NEWARK TRANSFORMER BARGAINS

45556 778 V.C.T. at 200 M.A. 115 V. 60 Cycle 6.3 V.C.T. at 5A. 5 V. at 30 amp. 9 lbs..... **\$3.95**

CLOSE OUT ON METERS. \$4.95 EACH

Western Electric Micro-ammeter. Bakelite case fits 3 3/4" hole. Radium dial 150-0-150. Can be used with 0-200 micro and amp scale costing 15¢ additional. Excellent as a 5,000 ohm-per-volt meter or null, sound level and galvanometer indicator. Instruction included. No priority required.

NEWARK GUARANTEE

All merchandise advertised carries the usual Newark Electric guarantee of complete satisfaction!

McELROY KEY

The Deluxe — Model CP 810 **\$9.75**

G.E. METERS

0-500 D.C. MA. 2" round Bakelite case..... **\$3.50**

0-8 RF ammeter; 2" round Bakelite case..... **\$4.00**

ABBOTT TR-4

Compact, efficient 2 1/2 meter transmitter-receiver less tubes and power supply **\$43.00**

The famous Newark bargain oil-filled, oil-impregnated

FILTER CONDENSERS

Fully guaranteed at rated voltages

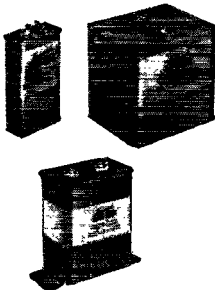

Capacity	Working Voltage	Height	Width	Depth	Wt.	Price
1 mfd.	1500 V. D.C.	2 3/8"	1 3/4"	1 1/2"	4 oz.	\$.79
4 mfd.	1000 V. D.C.	3 1/4"	2 1/2"	1 1/4"	12 oz.	1.50
4 mfd.	3000 V. D.C.	3 3/4"	1 3/4"	3 3/8"	1 1/4 lbs.	3.75
.15 mfd.	4000 V. D.C.	2 1/2"	1 3/4"	1"	8 oz.	.89
.25 mfd.*	2000 V. D.C.	3 3/4"	1 3/4"	1"	6 oz.	.69
<i>*Specia. Porcelain Insulators</i>						
1.5 mfd.	1000 V. D.C.	2 1/2"	1 3/4"	1"	8 oz.	.59
10 mfd.	3000 V. D.C.	4 1/2"	3 3/4"	3 1/4"	3 lbs. 8 oz.	4.75
13 mfd.	1000 V. D.C.	3 3/4"	3 1/2"	1 3/4"	1 3/4 lbs.	2.25
15 mfd.	3000 V. D.C.	4 3/4"	4 3/4"	3 3/4"	5 lbs.	5.25
8 mfd.	3000 V. D.C.	7 3/4"	6 1/2"	3 3/4"	7 lbs. 4 oz.	3.95
2 mfd. and 4 mfd.	600 V. in metal can	4 1/2"	2 1/2"	1 1/4"	14 oz.	.80
5-5-15 mfd.	1000 V. in metal can	4 1/2"	3 1/2"	3 3/4"	4 1/4 lbs.	1.75

Get Your Name on Our Mailing List

Be first to get announcements of merchandise available, special bargains, etc. Send name and address on post card. State whether amateur, engineer, school, industrial or service man. Address orders and inquiries to Dept. Q, at NEWARK store nearest you.

NEW YORK
Newark ELECTRIC Company
 CHICAGO

115-117 W. 45th St.
 NEW YORK 19
 BRYANT 9-4735
 (Adolph Gross)

Now also at:
 212 West Fulton St.
 New York City
 (Hy Kahn)

323 W. Madison St.
 CHICAGO 6
 DEARBORN 0083
 (Sam Poncher)

ALL PRICES SUBJECT TO CHANGE WITHOUT NOTICE

Another

Lewis First 4C36

Big Brother to the 3C28

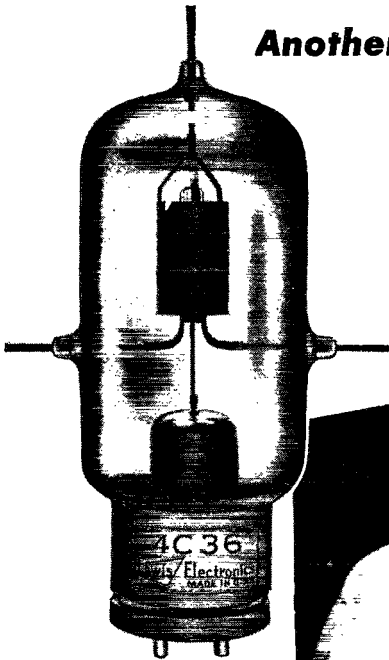

A **Lewis**

at Los Gatos

DUAL GRID LEAD TRANSMITTING TUBE

in the 125 watt class.
At Your Dealers Everywhere
List Price \$14.00

Filament	5.0 volts	7.5 amps
Amplification Factor	. . . 29	
Max. Plate Dissipation	125 watts	
Max. Plate Voltage	. 4000 volts	
Max. Frequency	. . . 60 mcs.	
R-F Power Output	. 480 watts	
A-F Power Output	. 500 watts	
	(2 tubes class B)	
Base	. . . Standard 50 watt	

The 4C36 is a new and versatile triode in the 125 watt dissipation group. Separate grid terminals for neutralization and excitation, by removing common inductance, materially reduce driving power at the 4C36 upper frequency limit of 60 mcs., also affording better symmetry in push-pull amplifier design.

Ample emission from the 37.5 watt filament, absence of internal insulators, ability to operate at plate voltages up to 4000 volts and the amplification factor of 29 make the 4C36 truly a general purpose triode.

Lewis

Subsidiary of **Aireon**
MANUFACTURING CORPORATION

ELECTRONICS

LOS GATOS • CALIFORNIA

An example of Cinaudagraph Speaker Engineering—the fifteen-inch electrodynamic speaker of Aireon's Electronic Phonograph, most perfect of commercial music machines.

There's a better

Aireon

Cinaudagraph Speaker

for every
electroacoustical application

Aireon Cinaudagraph Speakers, Inc., has the facilities, experience and engineering ability to design and produce better speakers for any purpose. Whether it is a two-inch unit for portable radios, or a fifteen-inch for commercial phonographs, the same research, precision construction and superior materials are employed. Cinaudagraph PM Speakers use Alnico 5, the "miracle metal" which gives you four times the performance without size or weight increase.



← Aireon Cinaudagraph Speaker for small radios—remarkable fidelity reproductions within a two-inch cone.



In Aireon's scientific laboratories individual and special problems of electroacoustical reproduction are under constant study, so that the finest and truest tonal reproduction may be combined with unusual stamina and long service life.

As a result, electronic perfection never before achieved has been incorporated in Cinaudagraph Speakers—for public address systems, radios, commercial phonographs and many special purposes.

Cinaudagraph Speakers, Inc.

Subsidiary of **Aireon** Manufacturing Corporation

3911 SOUTH MICHIGAN AVENUE, CHICAGO



EVERYTHING FOR THE HAM

WRITE

Leo, W9GFQ

For Fast Delivery!



Get Leo's own personal, sudden-service on your radio needs. Leo will help you get back on the air quickly with first delivery on anything in radio.

HAM NEEDS

Transmitting tubes, condensers, mikes . . . everything for the Ham. One of the country's largest stocks of Ham equipment. Write Leo, W9GFQ, today, and be first with the latest. We invite inquiries for special equipment of all kinds.

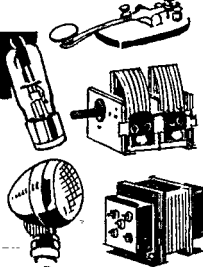

TRANSMITTERS

For peak performance and more dollar for dollar value, get a WRL Transmitter Kit . . . designed in Leo's own laboratories . . . tested and proven. Available in 15, 35, 70, and 150 watt kits as well as kits custom built to your own specs. Write Leo today for complete details, prices and terms.

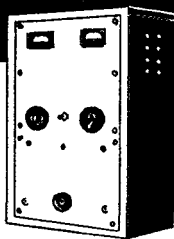

RECEIVERS

Here are just a few of the many well-known receivers offered by Leo:

- Hallicrafters SX-25 \$ 94.50
- Hallicrafters S-20R \$ 60.00
- Hallicrafters SX-28A \$223.00
- Echophone EC-1A \$ 29.50
- Hammarlund HQ-129X \$129.00
- National NC-2-40C \$225.00

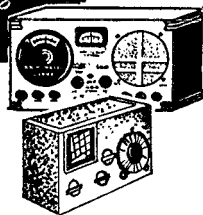

FREE! NEW 52 PAGE FLYER

52 pages packed with real buys in radio, electronic, and general merchandise. Write for details of our trade-in plan and easy terms.

- Giant Radio Reference Map (size 3 1/2" x 4 1/2") 15c
- Handy Tube-Base Calculator 25c



Formerly Wholesale Radio Laboratories

(Continued from page 104)

and Clemenceau belong to AEC and conduct regular drills. The Live Wires at N. Phoenix High are starting code classes. Some of the old gang back from the services are: UFF, UPY, UPH, IZY, TFM, ROD, KMM, TUW, UAL, MNH, SCF, SNT, and John Curtis, operator license. New calls about the State are 5HMx, 9UV, 5GEK, 6MwK, 7GYK, 9WJS, 9QEH, 9DAD, 8RMJ, 9OVR, 9MIJ, 7JBU, 8PQX, and 5JDL. Jerry Johnson, on the USS *Bosque*, says 28 Mc. s almost dead in the Pacific. 73. GC.

SAN DIEGO — SCM, Ralph H. Culbertson, W6CHV — Asst. SCM, Gordon W. Brown, W6APG. OUQ has just completed a new rig 28 Mc. and will be on the air as soon as antenna can be put up. 4GGX, operating fixed portable near La Jolla, is putting out an FB signal in the South Pacific with his new rig. EOP is handling traffic for 2NFL, operating portable on Okinawa. QEZ and his XYL have departed for New York City where he expects to go to school. NDD is recuperating from a major operation. RPJ has opened a new radio shop in San Diego. The February meeting of the Palomar Radio Club was held at Oceanside with an attendance of about fifty. Plans were completed for the 11th Birthday Party of the club, which will be held at the Beach Hotel in Oceanside on March 23rd. Committees appointed were: SSF and OFT, hosts; LYF and APG raffle; MHL, tickets; and BKZ, entertainment. The meeting closed with an FB raffle. ACW took first prize, an FB mike. JRQ has returned home after some time in the Army. LRU had a very busy afternoon on Feb. 9th working Saipan, Okinawa, Tinian, Guam, Japan, and Argentina. APG, MHL, and CHV were visitors at the open meeting of the Helix Club on Feb. 15th. OIN reports quite a lot of activity on the new 144 Mc. band. OFT has completed a new FB rotary beam and by reports from stations in the South Pacific it sure must be tuned right on the nose. PAX, home from college for a short vacation, worked his 8JK antenna over and is rebuilding his buffer stage. RGY has recovered from his recent operation and is back on the job. LKC worked VK2GU and his first ZS. EWU has just completed a new FB four-element rotary beam made out of wire, and what a masterpiece! LKC and OUQ have been appointed OPS. LYF has renewed his ORS appointment. 73. Ralph.

WEST GULF DIVISION

NORTHERN TEXAS — SCM, Jack T. Moore, W5ALA — CHJ is an electrical inspector for the City of Dallas. JQH has moved to Dallas. SN is home from India. HZB is attending Texas A. & M. IZU reports reorganization of the Tyler Radio Club with the following new officers elected: W. W. Tutt, pres.; KJO, vice-pres.; J. B. Sheppard, technical adviser; W. R. Kelly, secy-treas.; Bob Wileman, publicity chairman; IZU, program chairman; Bill Whitman, entertainment chairman. The Club has a membership of thirty-two and is seeking affiliation with the ARRL. ISD, out of the Army, sends the following news: GXU is out of the Navy and back at his old job as police operator. FZN also is out of the Navy. HMO is out of the AACs. HAF is very active. AWT is working on the railroad. ZZF set up his rig in his radio shop. AW is trying to get on the air. ISS and HRA are in the Navy. BTU is in Seminole. HYA is located in Coahoma. FCV is out of the Army and is a teletype technician in Paris, France. Everett would like to hear from the boys back home. JAC soon will have a K4 call. IMF used his Navy experience to study how radar could be used by hams and reports that he had some success in modulating it. The following are new officers of the Dallas Amateur Radio Club: ALA, pres.; GZH, vice-pres.; HKK, secy-treas.; JQY, sgt. at arms. Directors: BNQ, program; DAS, entertainment; TW, vigilance; III, finance; ATM, technical. 73. Jack.

OKLAHOMA — SCM, Ed Oldfield, W5AYL — Tulsa reports! The TARC has been reactivated and meetings are held the first and third Wednesday of each month. Newly-elected officers are: FWZ, pres.; WI, vice-pres. and secy.; HUI, treas. Thirty Tulsa amateurs are working 28 Mc. and TARC boasts a five-year high in paid-up memberships, including forty licensed and seven unlicensed. FWZ moved the rig to the basement. HUI is adding to the garage for ample space to house the rig — lacking a basement. FFW finished his attic for a location. Not only a shortage of housing exists but the amateur fraternity seems to have caused a building boom. Beam antennas apparently are going to be popular in Tulsa; all the aluminum tubing is disappearing from the junk yards. GZK is operating on 28 Mc. IOW, also on 28 Mc., visited Oklahoma City recently and gave us the word

(Continued on page 110)

MARION "HERMETICS" ARE HERE TO STAY *because...*

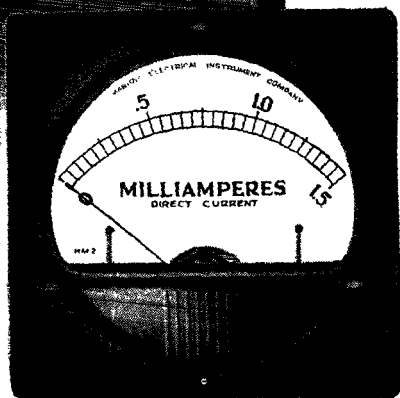

...they're **dustproof and moisture-proof** — foreign matter which oxidizes pivots and attacks bearings and thus shortens the life of an instrument cannot enter.

...**sustained performance** over a longer period of time is assured and rejects of complete equipment due to instrument failure are minimized, if not eliminated.

...**the magnetic and electrostatic shielding** obviates the need for special calibration for different types of panels or separate shielding of instruments in order to prevent RF leakage through the case.

...**interchangeable colored flanges**, in both round and square shapes, are available at no extra charge; finer in performance, Marion "hermetics" are also smarter in appearance.

...**they are 100% guaranteed** for six months — after that, regardless of condition and provided the seal has not been broken, we will replace any 2½" or 3½" instrument from 200 microamperes upward for \$1.50; any 2½" and 3½" type with sensitivity greater than 200 microamperes for \$2.50.

Marion Glass-to-Metal Truly Hermetically Sealed 2½" and 3½" Electrical Indicating Instruments

Note: Marion "hermetics" cost no more than most standard unsealed instruments — and they are positively interchangeable. Write for 12-page brochure.



CANADA: THE ASTRAL ELECTRIC COMPANY, SCARBORO BLUFFS, ONTARIO

THE RADIO AMATEUR'S LIBRARY

• Many requests are received for the complete list of our publications. The list follows:

<i>Title</i>	<i>Price</i>
<i>QST</i>	\$2.50 per year*
List of Stations.....	Discontinued
Map of Member Stations	Discontinued
Operating an Amateur Radio Station Free to members; to others 10¢	
The Story of The A.R.R.L.	Discontinued
The Radio Amateur's Handbook	
a. Standard Edition.....	\$1.00**
b. Special Defense Edition..	\$1.00
The Log.....	.35¢ each; 3 for \$1.00
How to Become a Radio Amateur	25¢
The Radio Amateur's License Manual.....	25¢
Hints & Kinks for the Radio Amateur.....	50¢
Lightning Calculators:	
a. Radio (Type A).....	\$1.00
b. Ohm's Law (Type B).....	\$1.00
Amateur Radio Map of the World.....	Out of print
Two Hundred Meters and Down: The Story of Amateur Radio	Out of print
Building an Amateur Radio- telephone Transmitter	Out of print
A.R.R.L. Antenna Book.....	50¢
The Minilog.....	25¢
Learning the Radiotelegraph Code.....	25¢
A Course in Radio Fundamentals	50¢

*In the United States and Posses-
sions — other Countries \$3.00 per
year.

**Postpaid in Continental
U.S.A. — \$1.50, postpaid,
elsewhere.

(No stamps, please.)

THE AMERICAN RADIO RELAY LEAGUE, Inc.

West Hartford 7, Connecticut

(Continued from page 108)

from Ada. Two new hams invaded Ada but have no calls as yet. The MARC held election of officers in December and elected BGR, pres.; GZN, vice-pres.; Anderson, secy. and treas. The club station is in operation and new engine for 500-watt generator is needed. Carrier-current rigs are being used by Ru, 9PIW/W5, and Anderson; MARC hopes to have 100 per cent ARRL membership soon. DQB, who worked for FCC, is with the Army in Japan. HUM has been working in Panama Canal Zone. JFY will attend A. & M., after serving in the Marine Corps since 1942. Regards, Ed.

SOUTHERN TEXAS — SCM, James B. Rives, W5JC — Col. VV has returned to Austin after five years with the Army Airways Communication System and is active on 28 and 144 Mc. Wilmer is an outstanding example of the important part played by the hams in winning the war. JC attended a meeting of the Houston Club and obtained information about the activity there. LI is the EC and doing a nice job. Stations active on 144 Mc. are: KFY, GLS, ON, 6VOR/5, FQQ, JPU, HMN, and IGS. Those on 28 Mc. are: JMI, IGS, GLS, with 350 watts; HGG, ADZ, HAQ, HFO, 200 watts 'phone; HYZ with four "V" beams; IOO, JTZ, KLG, GRA, IOF, EEX, HPB, KFY, and FWC, with a new three-element beam. AMJ is now a civilian and in the radio service business in Houston. The following are active on 28-Mc. 'phone in Galveston: APP, BVF, AUX, ZG, and 3IVT/5. JEZ and DDJ are on c.w. ZG is very enthusiastic about the new resonant line of his own design he is using. 2KGI/5 is active at Camp Wallace. The San Antonio Radio Club meetings are well attended on the first and third Fridays of each month. There are a large number of LSPHs eager and ready to go on the air upon receipt of station licenses. EPB, 3ESP/5, EHM, HBQ, 2LNY/5, 9PEC/5, JLY, and FNY are active on 28 Mc. BUV is busy with AEC organization. 73. Jim.

CANADA

MARITIME DIVISION

MARITIME — SCM, A. M. Crowell, VE1DQ — The HARC has overhauled its by-laws and brought 'em up to date. At a recent meeting the large turnout was entertained by some interesting and instructive films showing vacuum tube theory and operation of electronic relays. New HARC station call will be FO. The local gang is battling away on 28 Mc. for the most part and wondering when 14 Mc. will be opened. JH is interested in new RCAF network. KS is our first OBS under the new set-up. More applications are wanted. FQ will soon return from England. The RCNC fellows, of Halifax, have nice plans for the boys who are future hams and plans for their own station when they "get out." Interested Naval personnel get in touch with CPO Tel. Shepherd at the Signal School Dockyard. Remember, the HARC meets the 3rd Friday of each month at Moir's Recreation Hall. Drop in and see if you are eligible for enrollment. Come on, fellows, send in reports until we can get a "report by ham radio" net going. Will the MARC and St. John Club please recommend appointees for EC appointment for their areas. 73. Art.

VANALTA DIVISION

ALBERTA — SCM, C. S. Jamieson, VE4GE — This month's report was written by LQ. 4AC is rebuilding frequency-meter. AJO runs a 300-watt rig in Cow-Town and tells us that the CARA is conducting classes in code, procedure, technical dope, etc. AJO has started a radio club at No. 10 Repair Depot (RCAF). AEV had an FB signal on 21 Mc. caused by chipped crystal. AAD heard LQ in Calgary recently. LX is on 28-Mc. 'phone with 160 watts input. ALU and PJ are on 28 Mc. AEV worked three W9s in a round-table QSO recently. Our sincere sympathy goes out to JP in the loss of his father. ALO worked into VK a few days ago. LG is back with CJCA. SZ, of CJCA, showed up at the last NARC meeting, as did DC, of Wetskiwin. HC is the new president of NARC. YX is back at the service bench. US is studying for 1st-class steam engineer's ticket. WH attended the annual meeting of the Alberta Association of Architects held in Edmonton and talked over old days with LQ. BJ is on the air with an 807. HM has modulator finished and has checked it on the air. ADD, honeymooning in Florida, worked RO from W4FLH's shack. XB is latest 28-Mc. 'phone in Edmonton, and QE is on the band with c.w. rig. AOZ has his rig at AW's place being revamped for 28 Mc.

(Continued on page 114)

Adaptability

... JOHNSON
COMPONENTS PICKED
FOR USE IN AIRLINE
TRANSMITTER!

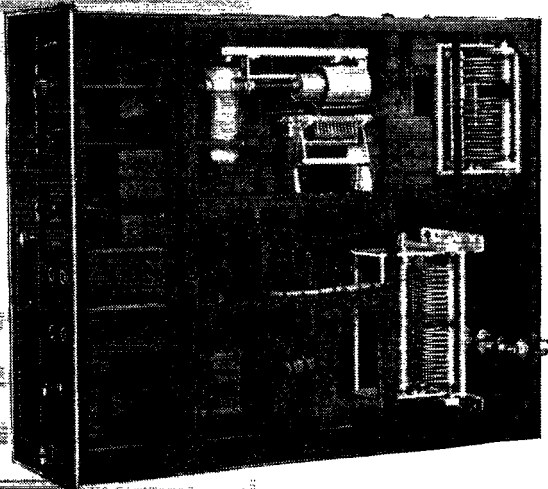

The new Wilcox 99A, medium power transmitter designed primarily for airline fixed communication service, is provided with features including four removable radio frequency channels in the low, high and very high frequency ranges.

Shown above is one of the r.f. channels with Johnson components highlighted... Type D dual condensers in the antenna tuning and final amplifier stages, Type F condenser in the r.f. amplifier, Type N neutralizing condenser, "Hi-Q" plug in inductor, shaft coupling, cone insulators and thru-panel insulators with jack connections. Not visible in the photograph are Johnson 211 and 237 tube sockets, lead-in bushings and panel bearings.

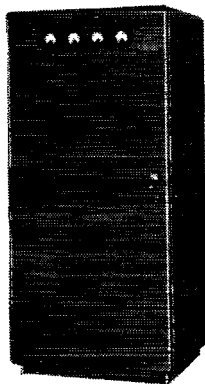

WILCOX 99A
TRANSMITTER

The use of Johnson components in the Wilcox 99A is further proof of

the reliability of Johnson products. In a transmitter of this type, designed for flexible and trouble-free service, components must meet the highest standards of quality and adaptability.

The adaptability of Johnson products results in great savings to Johnson customers by minimizing the need for specially designed components. For example, the Type D dual condensers used in the assembly shown above are standard models reduced in overall size and supplied with special mounting brackets to meet chassis design. The standard Type D used in the final amplifier has been furnished with dual sections of different capacitances, thus eliminating the need for a special condenser.

Whether you are working on a "ham rig," electronic heating equipment, commercial transmitter or any other radio electronic device, you will be sure of top performance with components by Johnson. Send us your special problems and we will first try to adapt our standard products to meet your special requirements.

R. F. CAPACITORS AND INDUCTORS • TUBE SOCKETS • INSULATORS
CONNECTORS • PILOT LIGHTS • HARDWARE ITEMS

WRITE FOR SPECIFIC INFORMATION
OR GENERAL PRODUCTS CATALOG 968J

JOHNSON

a famous name in Radio



E. F. JOHNSON COMPANY • WASECA • MINNESOTA

NEW h-f power triode



GL-592

400 watts (phone) input
on the 6-meter band
with a single tube!

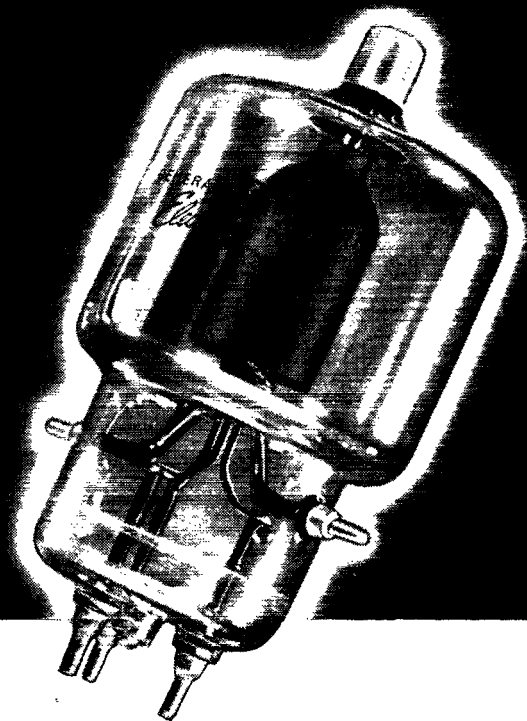

Ultra-modern in design, Type GL-592 operates at frequencies (for max ratings) up to 110 megacycles. CW input of 600 watts with dissipation of 200 watts gives this small, compact tube plenty of wallop combined with topnotch efficiency.

Two grid leads to separate side terminals, plus the center-tapped filament, help reduce lead inductance, as well as make circuit layout much easier for the ham designer.

Elimination of a base cuts dielectric losses. Fernico glass-to-metal seals make possible not only this feature, but also non-soldered plate and grid terminals which withstand high temperatures successfully. All terminal contacts are silver-plated for greater efficiency.

Rating	Class C telegraphy	Class C telephony (plate-modulated)
Filament voltage	10 v	10 v
Filament current	5 amp	5 amp
Max plate voltage	3500 v	2,000 v
Max plate input	600 w	400 w
Max plate dissip.	200 w	130 w

An ordinary 8" household fan or a small furnace-type or other blower will cool a pair of GL-592's, as only a small amount of forced-air cooling is required. See your G-E tube distributor for price and other information, or write direct to *Electronics Department, General Electric Company, Schenectady 5, New York.*

ELECTRONIC TUBES OF ALL TYPES FOR THE RADIO AMATEUR

GENERAL  **ELECTRIC**

161-60-8880

HALLICRAFTERS BC-610 Xmtr
 450 WATTS C.W.
 325 WATTS PHONE
 now available to the amateur!

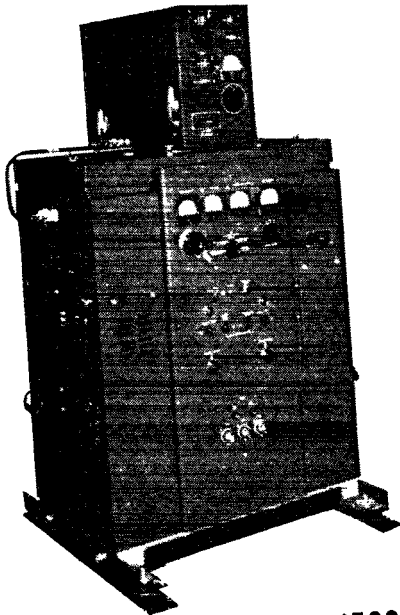

NET PRICE complete.....\$500.00

This high-power transmitter, famed for its performance in the SCR-299 mobile radio station, is ready now for YOU. Includes all regular features of the familiar HT-4E . . . plus battle-tested improvements that make it better than ever. Furnished complete with speech amplifier, tubes, 3 sets of coils (1.5 to 18 mc.), and simple modification instructions for operation on 10 meters. Like new — used only slightly. Fully guaranteed.

Antenna Tuning Unit - AT-3

Tunes any single-wire antenna, from 15 foot whip to long wire; continuously adjustable from 1.5 to 18 mc.; ceramic insulated.

Net Price \$74.50

**SEND FOR OUR FREE
 108-PAGE CATALOG**

And here's a HOT RECEIVER Buy!
NATIONAL HRO-W

Complete with tubes, crystal, PM speaker, power supply, and 4 sets of military type general-coverage coils.

\$217.35 net

Coil sets available for 50 to 2050 kc.
IMMEDIATE SHIPMENT on receiver
 and all coil sets.

THESE FAMOUS RECEIVERS, too!
NATIONAL

() N-2-40Cabout \$225.00

HAMMARLUND

() HQ-129X\$129.00

() Super-Proto be announced

R.M.E.

() RME-45\$186.00

HALLICRAFTERS

() S-22R Skyrider Marine ..\$ 74.50

() S-36A VHF FM/AM 430.00

() S-39 Sky Ranger 110.00

() S-40 540 kc to 42 mc
 approx. 79.50

() SX-25 Super Defiant 109.50

() SX-28A Super Skyrider 238.00

All prices are for complete receivers
 and are net F.O.B. Boston.

MILLEN 90800 EXCITER

Gets you on 10 meters in a hurry.
 Order today, giving xtal frequency,
 and we'll ship at once. Net price, less
 tubes, with one set coils.....**\$37.50**

U.H.F. ACORN TUBES Types 954-955-956

Six tubes same type or assorted. **\$2.95**

Isolantite sockets for acorn
 tubes **48c each**

**The RADIO
 SHACK**

★ **167 WASHINGTON ST.** ★
BOSTON, MASS., U.S.A.

... just about everything
radio you need... Here at
HARVEY
now!

Harvey's shelves are loaded with thousands of items, components and complete units. We have tubes, coils, mikes, transformers, chassis, racks, receivers, recorders, P.A. systems, testers—in fact, just about "everything radio" you can use. Send Harvey your orders now! If we can fill from stock, we'll ship immediately. The service is fast... prices are reasonable... satisfaction is guaranteed!

HARVEY recommends this month:



**A SPECIAL BUY! WESTERN ELECTRIC
6AK5 H. F. PENTODE**
The Miniature tube everyone is talking about, used so successfully in World War II. Harvey has them in limited quantities. Order now! \$2.00



Low loss mica socket and shield for 6AK5 and all other miniature tubes including the 9000 series. Complete, with spring in shield to prevent tube wobbling in socket.....39c

WESTERN ELECTRIC METERS



3" microammeter; center pivot; range: 0-200. Scale covers approximately 140°; excellent damping; cased for mounting in steel panel. A real buy! \$5.95

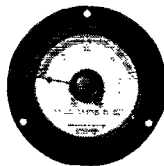

3" milliammeter; center pivot; range: 0-20. Matches microammeter listed. \$3.95

All items listed are subject to prior sale.

Telephone: **Longacre 3-1800**

HARVEY
RADIO COMPANY

103 West 43rd St., New York 18, N. Y.

(Continued from page 110)

PRAIRIE DIVISION

MANITOBA—SCM, A. W. Morley, VE4AAW—56 Mc. is the latest in Winnipeg with ACG, AHR, AHW, XH, BM, XG, ARY, and ACE all active. ACG is using an RK49 with about 12 watts. There is talk of 56-Mc. work around Miami and the Winnipeg boys are requested to look for AHE and KN. There are still more stations on 28 Mc., the latest being ASU, LH, TJ, BR, FU, EA, and NO. NO is busy cleaning up BCL trouble after rebuilding to a pair of 807s. JN and AMX were in Winnipeg during the Bonapier. ADX and FU have new receivers. EK is busy burning out 28-Mc. crystals. TJ has new cabinet. AAI is drying out equipment left in basement for three years. SR found his trouble—dud T40. AFE finds washing and ham radio don't mix. 3AL was in Winnipeg in connection with AFARS. 73. Art.

Low Power Transmitter

(Continued from page 17)

The antenna should now be connected to the antenna terminals and the antenna coil plugged in. The adjustable link of the antenna coupler should be swung about half-way out and the taps should be placed on the outside turns of L_4 . With the key closed, C_4 should be swung through its range. At some point the amplifier plate current should increase to a maximum, decreasing on either side. Leaving C_4 at the point where maximum plate current is obtained, C_3 should be readjusted for a minimum point which, of course, will be higher than the unloaded minimum obtained before. The adjustments of C_3 and C_4 should be juggled around until a point is reached where any change in C_3 will cause an increase in plate current, while any adjustment of C_4 will cause a decrease in plate current. If the plate current at this point is less than the maximum rated plate current for the tube, the link coupling should be closed up. If it is greater than 100 ma., the coupling should be reduced. If it is found that the link adjustment is insufficient to bring the plate current to the desired value, the taps should be moved in a turn at a time, keeping them always equidistant from the ends of the coil. It should be remembered that the tap adjustments as well as any change in the position of the link may affect the tuning of the amplifier plate circuit so that it should be retuned to obtain minimum plate current as a final adjustment. This minimum should, of course, be the rated plate current of 100 ma. when the amplifier is fully loaded. The dip in plate current at resonance naturally will be very slight when the amplifier is operating under full load.

**SWITCH
TO SAFETY!**





RME Owners Say!

Radio Mfg. Engineers, Inc.
Peoria, Illinois.

Seattle 22, Wash.
Nov. 30th, 1945

Dear Sirs:

As per "QST" page 127 for Nov. 1945, please send me data on your RME45 receiver, VHF152 Converter and your DB Preselector, including the price of this complete unit and at what dealer can same be obtained?

My thirty six years experience in radio has taught me to pick the best regardless of price when it comes to making contacts with other Hams. You can use my name any time as a 100% booster, and have picked your receivers over all others for good receiving satisfaction.

Very truly yours

Arthur C. Dailey W7BL
On the air since 1909

Radio Mfg. Engineers,
Peoria 6, Illinois

734 West Scott Street
Springfield, Missouri
November 30th, 1945

You will notice from the attached registration card that I have become the owner of one of your new RME-45 receivers. I wish to state that I have put it through all the paces only a ham would think of trying. And I have come to the conclusion that it is "One ham's ideal receiver." Please refer to page 53 of Nov. 1945 "QST." This RME-45 has all this, and More. I would like to correct the heading on this article, to read, "All ham's ideal receiver."

I am sure that I will always be as well satisfied with this receiver, regardless of the future models.

I have witnessed the operation of the RME-69, although I was not fortunate enough to own one. I did always want one, but I honestly believe that the RME-45 has it out-dated by five years.

I again wish to thank you for "Get the most out of your receiver,"* and your interest in my RME-45.

Scott Keeton W9HDM

*Write for your copy.



FINE COMMUNICATIONS EQUIPMENT

RADIO MFG. ENGINEERS, INC.

Peoria 6, Illinois U. S. A.



PREFERRED
BY ENGINEERS

BURGESS BATTERIES

RECOGNIZED BY THEIR
STRIPES - REMEMBERED
BY THEIR SERVICE

**CODE SENDING
RECEIVING SPEED**

Have Skill, Accuracy

Be a "key" man. Learn how to send and receive messages in code by telegraph and radio. Commerce needs thousands of men. Expansion of air commerce and freight after war should create an even bigger peacetime demand for operators. The famous Candler System, maker of world's champions, teaches you the "knack" of sound sense and sound consciousness that is the secret of speedy sending and receiving. Good pay, adventure. Learn at home quickly.

FREE 52-PAGE BOOK explains extra course of training. Rush name for it today. It's absolutely free.

CANDLER SYSTEM CO.
Dept. 4-D, P. O. Box 928, Denver 1, Colo., U. S. A.
and at 121 Kingsway, London, W.C. 2, Eng.

25 Years Ago This Month

(Continued from page 45)

the buried plates." The antenna is a vertical fan of eight wires, 110 feet high.

The convention at Philadelphia brought over 400 amateurs together at Turngemeinde Hall. ARRL's Traffic Manager Schnell was presented with a genuine Rettysnitch by the Washington Radio Club. It is explained that "while the Wouff-Hong acts by leverage, the application of the Rettysnitch is rotary." . . . A group of 300 New England amateurs gathered at M.I.T.'s Walker Memorial Hall in Cambridge for the annual banquet of the ARRL affiliated clubs in the Boston area.

RCA recommends alternating current for heating the filaments of power tubes, instead of d.c., as we all now use, since "a.c. gives a better distribution of electron emission and potential gradient." The RCA engineers further state that "the voltage across the tubes should be kept constant rather than the current through the filaments."

The Correspondence column includes a vigorous discussion of M. B. West's recent speculative article on "Whys and Wherefores, particularly by Ellery W. Stone, general manager of Pacific Radio Supplies Co. Thus the background is being set for the great battle on power factor at our next national convention.

A Band-Pass 28-Mc. Converter

(Continued from page 47)

across the band, the output noise should peak near the center of the range and fall off slightly at either end. By increasing the inductance of L_4 — running the slug in — and decreasing the inductance of L_3 , it will be possible to get practically uniform noise output over the entire range.

If any queer burbles or sudden peaks of noise are encountered, it indicates regeneration in the r.f. stages. If this is encountered, the r.f. stages can be worked on while removed from the chassis, since there will be enough stray oscillator output to the mixer to receive signals, and the various plate and heater supply leads can be investigated with a 0.001- μ fd. mica condenser until the source of feedback is found. Poor grounds can also give trouble. (Don't let the foregoing discussion lead you to the conclusion that all these troubles were found in this particular unit! The only irregularity was in C_3 mentioned previously — the suggestions come from experience with other broad-band amplifiers in the same frequency range.)

Under normal conditions, the gain of the communications receiver following the converter will have to be reduced considerably, since the gain of the converter runs around 60 db. It will be found to require very little antenna for normal pick-up, but in order to give it every break it should be used with the best antenna available. As mentioned previously, some experiment with

(Concluded on page 180)

HARRISON HAS IT!

HARRISON HAS IT!

ALL STANDARD LINES

HSS—HARRISON SELECT SURPLUS



HALLICRAFTERS SIGNAL CORPS TRANSMITTERS!

450 WATT CW
325 WATT PHONE
CONTINUOUS
DUTY OUTPUT

Used in the SCR-299 mobile station (the famous "Voice of Victory") these transmitters are outstanding for their dependable, efficient service. This war-improved version of the HT-4 ruggedly constructed for continuous duty, in modern black console cabinet is suitable for the finest commercial or amateur stations.

Among the outstanding features

Band switching of oscillator and buffer stages—crystal or VFO (Variable Frequency Oscillator) operation—all stages metered—remote Speech Amplifier for control desk—control and protective relays and interlock switches—modulation limiter—all steel cabinet 33" x 22" x 40" high—link output to transmission cable.



We are having the Hallcrafters factory remove these transmitters from the SCR-299 trucks, and carefully retest and crate them for shipment. A few may have been slightly used for demonstration but all are fully guaranteed to be in perfect condition.

We make them available for only a fraction of the original cost!

Complete BC-610 transmitter with BC-614 speech amplifier and connecting cable, all tubes, operating manual, and coil sets for 20, 40, and 80 meter bands (or one set of coils for any other frequency between 2 and 18 Mc.), for 115 Volt, 50/60 cycle..... \$590

ACCESSORIES

Crystals: Amateur bands \$4.80, commercial \$19.50.
Microphone: with desk stand, cable, and plug \$28.50.
Additional sets of coils for commercial frequencies \$40.00.

10-METER OPERATION

Hallcrafters is furnishing us conversion kits containing coils, parts and complete instructions for simple changes to permit efficient operation on 28-30 Mc..... \$25.00

LOCALHAMS!

Come in and get the SCR-299 operating tables. Heavy plywood, linoleum top, with lamps, cable channel, etc. P.B. value!
Also select all your requirements from our large stock of all standard lines and many more HSS bargains.

— RECEIVERS —

And here are the SCR-299 receivers at a sensational price! One of the finest, most modern communications receivers—sturdy, dependable, compact—excellent for all services.

Two RF stages—high sensitivity with exceptionally low noise level—crystal filter—two IF stages—precision dial—4500 division vernier bandspread—ten tubes—9 1/2" x 18" panel with 8" deep metal cabinet—beam power output—phones or speaker—1.5 to 18 Mc. (Use with 2, 5, & 10 meter converter for top efficiency on all bands!)

Complete receiver with tubes, speaker in metal cabinet, and instruction manual—ready to operate. Model BC-342, 115 volt 50/60 cycle, \$92.50.

For mobile, marine, etc., or emergency service—Model BC-312, operates on 12 volt battery, \$95.00.

LIMITED QUANTITY!

Wire or Special Delivery your order. Don't wait or they may be all sold. Immediate shipment from New York. 50% with order, balance C.O.D.

A POST CARD will put your name on our mailing list to receive new catalogs, bulletins, additional HSS bargains, and details of how you may obtain, without cost, a copy of "Electronic Parts and Equipment," our new 800-page Buyers' Guide.

PLEASE SEND IT TODAY!

IF YOU WANT to be among the very first to have any new, or not immediately available equipment, get on our "Preferred List."

The factories owe us plenty—and as it comes in we rush it right out!

You can make sure of getting yours quicker by telling us now what you want. (Naturally, orders with deposit come first.) If you change your mind you can cancel without obligation.

HAM HEADQUARTERS
Since... 1925!



HARRISON RADIO CORPORATION

12 WEST BROADWAY • NEW YORK CITY 7

BARCLAY 7-9854

JAMAICA BRANCH — 172-31 Hillside Ave. — REPUBLIC 9-4102

Home of Wilcox
Electric Company

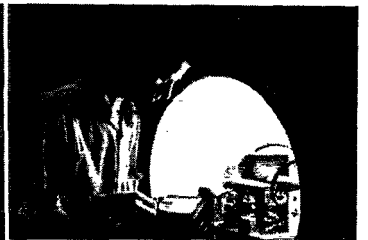
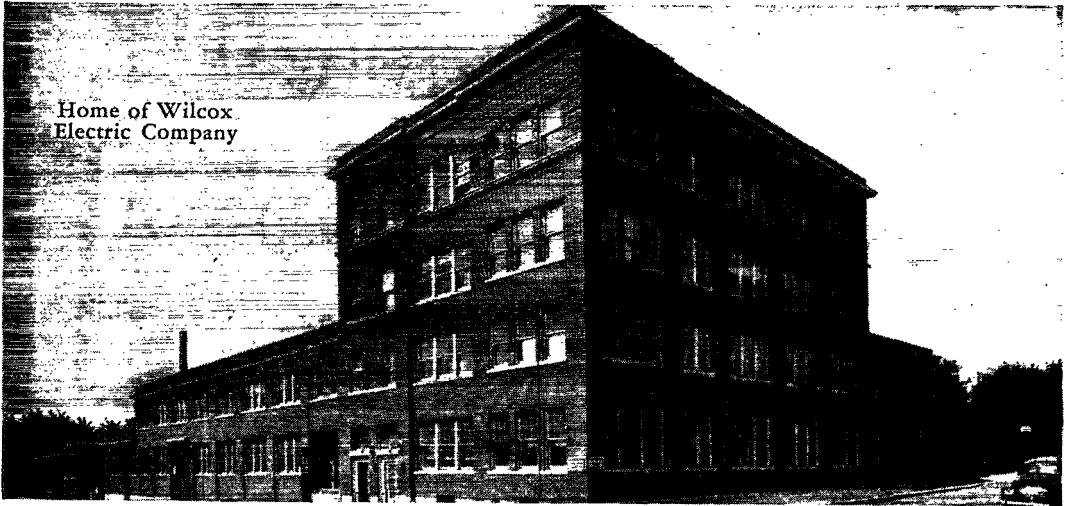

Metal Shop where work begins. Assembly line of equipment. Final test and pressure chamber.

NOW-COMING TO YOU

*W9CUN
W9UFB
W9GHS
W9CZW
W9BGW
W9BLU
W9SKP
W8TMX
W9FTI
W9ZFX
W9AQE
W9SON

PLANT AND
SUPERVISION:

W9MKZ
W9EJU
W9ARP
W9AYR
W9LRU
W9MRM
W9RGP
W9BAU
W9ZGL
W9KZT

Devoted for the past 12 years to the development and production of high quality communication equipment, The Wilcox Electric Company, Inc., is pleased to announce the organization of its Amateur Division.

Under "Vince" Dawson, W9ZJB/3JSL, is a staff of qualified amateurs*, developing amateur equipment with the same high standards that have characterized the products of this company in the past.

Watch for these developments from this modern communications equipment plant, equipped with the finest research and production tools and staffed with the men who know and understand the amateur field and its problems.

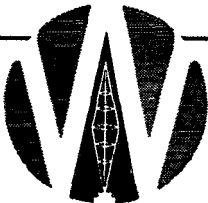

Amateur Division of
WILCOX ELECTRIC COMPANY, INC.

Manufacturers of Radio Equipment

Fourteenth and Chestnut

Kansas City, Mo.



Perfect Parallel Line Lead-in Wire

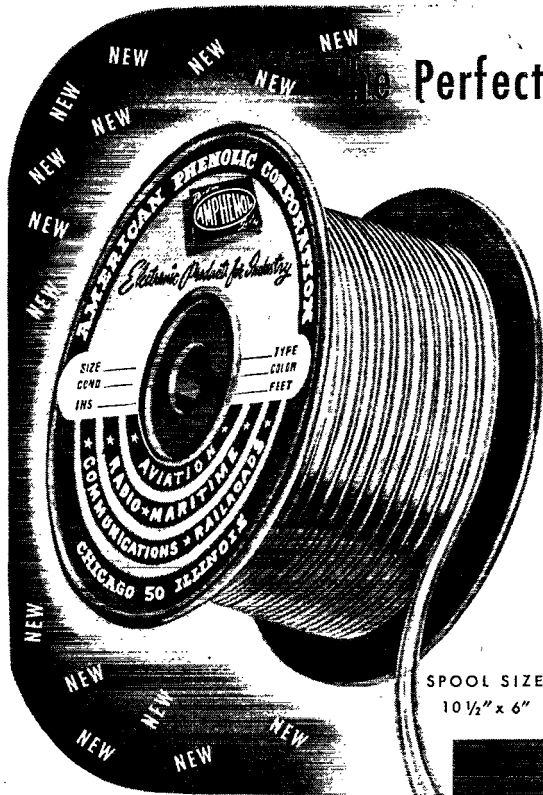

Amphenol Twin-Lead is a new type of radio frequency transmission line which combines the low cost of an open line with the excellent dielectric qualities of Polyethylene as a continuous spacer and insulator for the line. It is light and flexible—it can be tacked to a wall and is easy to lead in under a window sash. Its resistance to moisture, cold and heat is far superior to the usual rubber insulated, woven-braid-covered twisted pair used for antennas prior to the war.

Twin-Lead is made in three impedances that serve numerous applications. Selection of type is a simple matter. The 300 ohm line is the most universal in use, particularly for FM and Television reception. Amateurs are using this line for both antenna and lead-in. The 150 ohm type is excellent for antennas used mostly for short-wave broadcast reception, and is useful as a link between stages of a transmitter. The 75 ohm line, originally designed for amateurs who operate in narrow bands of frequency, is also many times better for broadcast reception than the conventional rubber covered or cotton covered wire generally used.

It is to be emphasized that Amphenol Twin-Lead should not be thought of as exclusively for use at ultra-high frequencies. It is THE antenna lead-in for all frequencies.

AMERICAN PHENOLIC CORPORATION
CHICAGO 50, ILLINOIS
In Canada • Amphenol Limited • Toronto

SPOOL SIZE
10 1/2" x 6"

ELECTRICAL DATA

Amphenol "Twin-Lead" Transmission Line is available in 300-ohm impedance value. RMA standardized on 300-ohm lead-in line for Television as the most efficient over broadband operation.

Amphenol also supplies 150-ohm twin-lead to those interested in particular applications and experimental work.

Designed especially for amateurs who operate in very narrow bands of frequency or one particular frequency. Ideal for dipoles with a nominal impedance of 72 ohms at the frequency for which they are cut. This line is also excellent for broadcast reception.

Dielectric constant of Polyethylene—2.29
Capacities (mmf per ft.): "300"—5.8; "150"—10; "75"—19.

Velocity of propagation (approximately): "300"—82%; "150"—77%; "75"—69%.

Power factor of Polyethylene—up to 1000 Mc—.0003 to .00045.

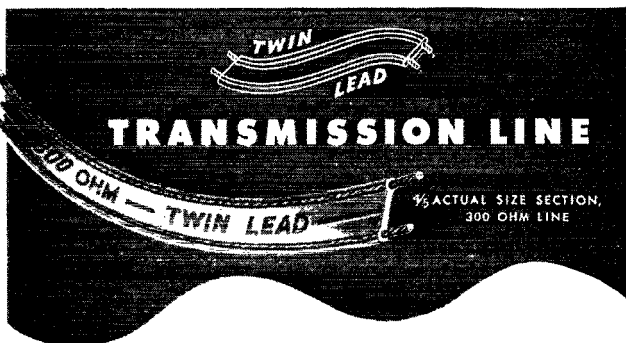

ATTENUATION - FM AND TELEVISION BAND

Megacycles	300-ohm DB per 100 Ft.	150-ohm DB per 100 Ft.	75-ohm DB per 100 Ft.
25	0.77	0.9	1.7
30	0.88	1.03	2.0
40	1.1	1.3	2.5
60	1.45	1.8	3.4
80	1.8	2.25	4.3
100	2.1	2.7	5.0
200	3.6	4.7	8.3



COAXIAL CABLES AND CONNECTORS • INDUSTRIAL CONNECTORS, FITTINGS AND CONDUIT • ANTENNAS RADIO COMPONENTS • PLASTICS FOR ELECTRONICS

Long, Satisfying Service

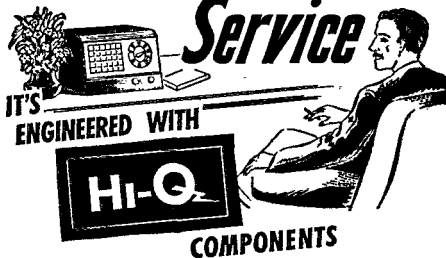

CERAMIC CAPACITORS



WIRE WOUND RESISTORS

CHOKER COILS



ELECTRICAL REACTANCE CORPORATION
FRANKLINVILLE, N. Y.

Now—a really high-powered



RADIO ENGINEERING LIBRARY

- especially selected by radio specialists of McGraw-Hill publications
- to give most complete, dependable coverage of facts needed by all whose fields are grounded on radio fundamentals
- available at a special price and terms

THESE books cover circuit phenomena, tube theory, networks, measurements, and other subjects—give specialized treatments of all fields of practical design and application. They are books of recognized position in the literature—books you will refer to and be referred to often. If you are a practical designer, researcher or engineer in any field based on radio, you want these books for the help they give in hundreds of problems throughout the whole field of radio engineering.

Free Examination • Special Low Price • Easy Terms

McGraw-Hill Book Co., 330 W. 42nd St., New York 18
Send me Radio Engineering Library, 5 vols., for 10 days' examination on approval. In 10 days I will send \$3.00, plus few cents postage, and \$3.00 monthly till \$24.00 is paid, or return books postpaid. (We pay postage on orders accompanied by remittance of first installment.)

Name.....
Address..... Company.....
City and State..... Position..... QST 4-46

5 VOLS.
3319 PAGES,
2289 ILLUSTRATIONS

1. Eastman's Fundamentals of Vacuum Tubes.
2. Terman's Radio Engineering.
3. Everitt's Communication Engineering.
4. Hund's High Frequency Measurements
5. Henney's Radio Engineering Handbook.

(Continued from page 116)

the input coupling will be necessary if a tuned antenna is used, but this might be only a tuned circuit with a link line running to the converter input.

The image ratio, which might be thought to be low with broad circuits like this, is saved by the use of the high output frequency. It measured 1000 to 1, which compares with an image ratio of about 350 to 1 at 14 Mc. in the best available communications receiver using two stages of pre-selection. The comparison is made at 14 Mc. because any images in the converter will be in this vicinity.

As nearly as could be measured without a screen room to eliminate all stray pick-up, the noise figure is about 6 db. better than a good pre-war communications receiver.

Circular Theorem

(Continued from page 66)

ger of out-of-band operation. Suppose, however, that we were assigned 300 kc. at 40 meters with no band edges! This would mean that an operator would tune from 7.299 through 7.300 to 7.001 Mc., and tuning in the opposite direction he would go from 7.001 through 7.000 to 7.299 Mc. Note that at no time would he be out of the band, and hurried or careless setting of his v.f.o. would never result in a pink ticket. With no band edges to crowd, we would get a more even distribution of stations in the bands, to our eternal credit. Some of the old die-hards may object to this and spend the first hundred years—the hard ones—searching in vain for the good old band edge, but the true merit of the system will be immediately apparent to the large majority and they will set-

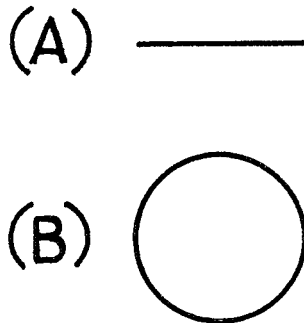

Fig. 1—Graphical representation of the conventional FCC bands (A) and the proposed circular bands (B).

tle down to make the most of it. Another way of looking at it is that, no matter what his separation is in kc. from another station—a maximum of 150 kc. in the 7-Mc. band—everyone can consider himself to be on the band edge, and so is the other fellow 150 kc. away. The advantage, of course, is that one does not have to set his frequency accurately, since no matter where he lands he is on a band edge. If this is a little hard to visualize, and we must confess it is at first, draw a

(Concluded on page 122)

COLLINS

FM

Collins FM research, begun long before the war, went into high gear immediately following VJ Day. An intensive engineering program is developing a series of FM transmitters to cover the power range of 250 watts to 50,000 watts.

These transmitters will be available, beginning with the 250 watt type 731A in midyear, 1946, and the 1000 watt type 732A soon thereafter. 3, 10, 25, and 50 kw transmitters are scheduled to follow in rapid succession.

With typical Collins thoroughness, these FM transmitters are designed to specifications well within FCC and RMA requirements and recommendations.

Notable achievements in circuit design assure efficient and dependable operation. Power output can be increased as desired, with a minimum of changes. The styling is attractively modern, and will blend well with up-to-date station layout.

Collins is prepared to supply your FM transmitter and all accessories. Our engineering staff is available at all times for consultation, and will assist you in effecting early installation and operation. Write today.

Collins Radio Company

Cedar Rapids, Iowa

11 West 42nd Street, New York 18, N.Y.

FOR BROADCAST QUALITY, IT'S . . .

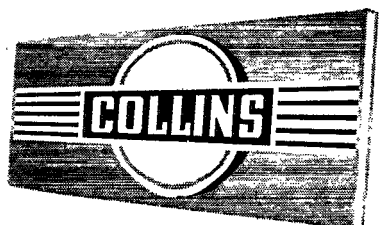

NOW IN STOCK AT ALL LEADING RADIO DISTRIBUTORS
CODE PRACTICE

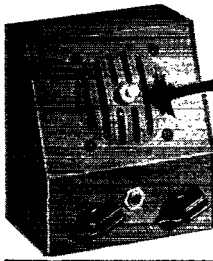

OSCILLATONES

WITH
**ADJUSTABLE
RESONATOR**

For Greater **VOLUME**
and Better **TONE!**

Adjustable Resonator (optional) increases volume five times. Tone frequency variable from 600 to 1500 cycles. Volume control from 0 to FULL ON. "PM" DYNAMIC speaker may be disconnected during headphone operation. Up to 300 headphones may be used. Has phone jack for headphones. Optional built-in key. 110 V. AC or DC. Uses a 117N7GT tube. Gray crackle finish.

MS 710FR • DeLuxe Master Oscillatone with resonator and built-in key. Amateur net price...\$13.00

MS 710P • With built-in key but less resonator. Amateur net price...\$11.50

MS 710R • With resonator but less built-in key. Amateur net price...\$10.50

MS 710 • Less resonator and less built-in key. Amateur net price...\$9.00

Designed by
THE WORLD'S
CHAMPION
RADIO
TELEGRAPHER

TELEGRAPH

Apparatus Co.

412 SOUTH GREEN ST

CHICAGO 7, ILLINOIS

Pre-Exam Tests for FCC Commercial Radio Operator Examinations

Determines your weak points—enables you to brush-up before taking the FCC Exam. Prepared by A. E. Nilson, famous co-author Nilson & Hornung's RADIO OPERATING QUESTIONS AND ANSWERS.

CLEVELAND INSTITUTE OF RADIO ELECTRONICS

QT-4 Terminal Tower

Cleveland 13, Ohio

ASK FOR OUR BARGAIN BULLETIN

Phone, Wire or Write

WHOLESALE

**Radio-Electronic Parts
Tubes, Sets and
Equipment**

R. G. SCALI & CO.

317 Asylum St. Hartford, Conn.

Telephone 2-1144

BRANCH: 84 ELM ST., BRIDGEPORT, CONN.

(Continued on page 180)

straight line and a circle, as in Fig. 1. Follow along the straight line with a pencil point, and you will note that there are two ends, or "band edges." Now transfer the pencil point to the circle and note that by following the line you can't tell where the circle was joined together—the old-fashioned band edges—and neither can any of your friends. Thus, after running around in circles for several days you will settle down at some arbitrary point and say, "This is the band edge," and will be quite content. However, your friends are likely to end up at some other points where they will be equally satisfied.

Since the need for precision frequency-measuring equipment is eliminated, the money saved can go into additional transmitter power. An estimate after an informal survey of the W6 district indicates that the additional power resulting from this move would raise the average power in that district 0.032 db! With out-of-band worries eliminated, the FCC could reduce the monitoring of amateur bands and both parties concerned could live freer and happier lives.

Fig. 2—With circular amateur bands a reality, the beginners would be started in the "inner circle," to avoid any feeling of inferiority they might otherwise develop.

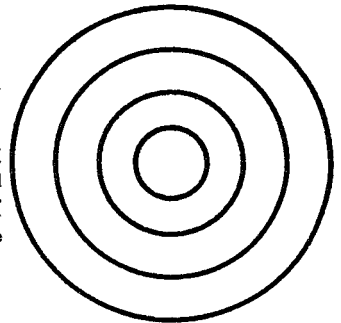

The bands should be assigned in *concentric* circles, as in Fig. 2, and the beginners should be encouraged to start in the smallest circle. Thus, even if one managed to get out of the band—we don't see how he could, but someone would find a way!—he would still be inside the next circle and amateur radio would have no black mark against it for out-of-band operation. Further, the fact that a beginner was encouraged to start in the *inner circle* would make him feel like he was one of the boys right off, being allowed into the inner circle!

With our thesis fully developed—the assignment of amateur frequencies in concentric circles instead of bands and the consequent elimination of out-of-band operation and band-edge crowding—we have no hesitation in encouraging experimenters in developing our technique to the point where it will be possible to work someone 40 or 50 kc. removed from one's frequency, as old-timers claim they used to do back before 1925 or 1935. All we have to do is write to our directors and congressmen and *insist* that the FCC assign us circular instead of linear bands!

McELROY "400" SERIES

COMPLETE AUTOMATIC RADIO AND TELEGRAPH TRANSMITTING AND RECEIVING EQUIPMENT

New designs, new features, new low prices. Immediate delivery, in any quantity. Illustrated catalog and technical manuals available in all commonly used languages.



McELROY TAPE PULLING HEAD

TPH-400

Admits tape from any angle from the right; prevents breakage; permits tape to come from any level on receiving table. \$45.00

McELROY WHEATSTONE CODE TAPE PERFORATOR

PFR-400

Designed to modernize small stations, at sea, ashore or on the air. For 110-120 volts, AC or DC. \$95.00

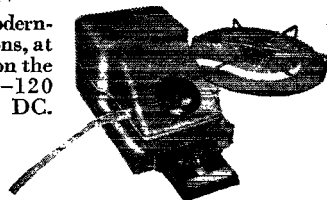

McELROY KEYING HEAD

HED-400

Complete with built-in polarized relay. Made without a Star Wheel opening in contact case; this assures clean contacts. \$240.00

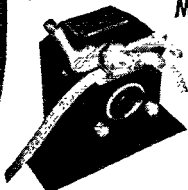

McELROY UNIVERSAL DRIVE

MSD-400

Permits rapid interchangeability of keying head and tape pulling head. Save money on maintenance and spares. \$195.00

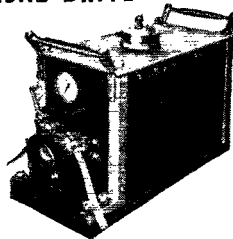

McELROY INK RECORDER

REC-400

Capable of speeds up to 700 words per minute. Tape holder, which is part of equipment, may be attached to right or back of case. \$195.00



McELROY RECORDER AMPLIFIER

MRD-400

Designed to drive the Ink Recorder at speeds to 300 words per minute. Cabinet or rack mounting. \$195.00



McELROY PHOTOTUBE KEYS

PTK-400

Delivers a tone code signal to from 1 to 50 headphones for operator training, and runs at low or extremely high speeds. \$45.00

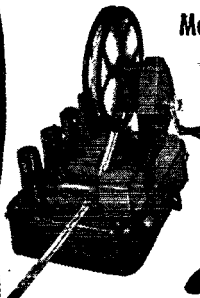

McElroy engineers never copy, never imitate. We create, design, build . . . we are never satisfied with mediocrity.



McElroy MANUFACTURING CORPORATION

82 BROOKLINE AVENUE

BOSTON, MASSACHUSETTS

LIFE-EXTENSION BY THE GRAM

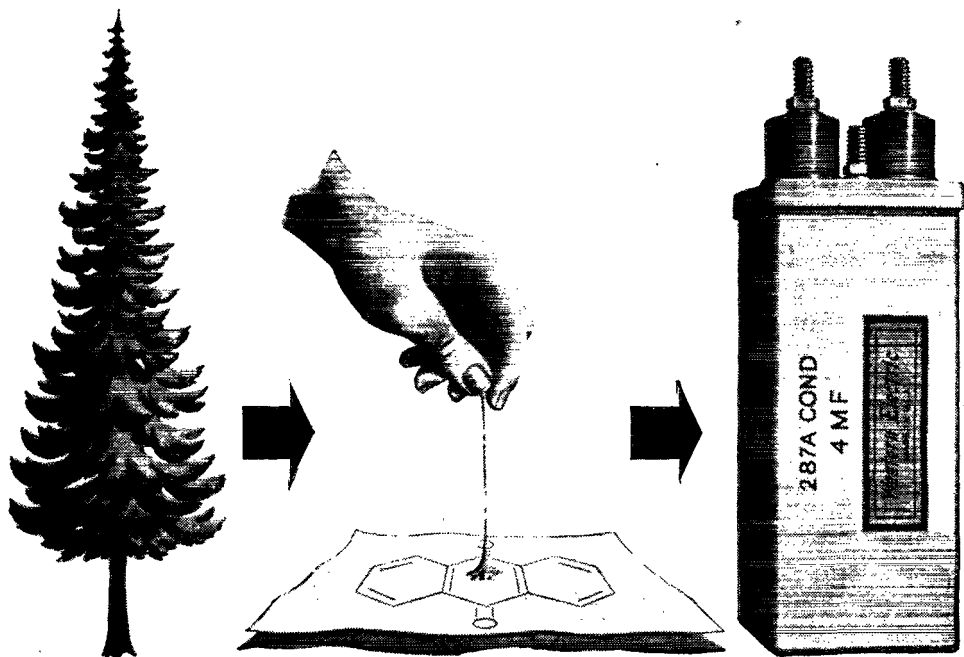

CRUCIAL links in every wire and radio system are paper capacitors—rolls of impregnated paper and metal foil. At least one is in every telephone—and more than 100 million are in the Bell System. A single failure can sever a telephone call, put a costly line out of service. So finding out how to make capacitors stand up longer is one of the big jobs of Bell Laboratories.

All-linen paper was once the preeminent material. Then wood pulp was tried—and found to last longer under heat and direct voltage. But why? Something in the wood was helping to preserve life. What was it?

Ultra-violet light, delicate micro-chemical analysis and hundreds of electrical tests gave a clue. Researchers followed it up—

found the answer by treating the impregnated paper with anthraquinone—a dye intermediate. A mere pinch of the stuff prolongs capacitor life by many years.

When war came, great quantities of capacitors were needed for military equipment, where failures could cost lives, lose battles. The Western Electric Company, manufacturing for the Bell System, disclosed the life-preserving treatment to other manufacturers. Today in communication capacitors, the new “life-extension” helps to give more dependable telephone service.

Day by day, resources of this great industrial laboratory are being applied to perfect the thousands of components which make up the Bell System.



BELL TELEPHONE LABORATORIES *Exploring and inventing, devising and perfecting for continued improvements and economies in telephone service*

Already a Big Success!

TAYLOR TB-35
 BEAM TETRODE
The Wizard Tube!



ACTUAL SIZE
\$10.00

**FOR SALE AT ALL
 LEADING RADIO
 PARTS DISTRIBUTORS**

- ▶ 35 Watts Plate Dissipation
- ▶ Tantalum Plate and Grids
- ▶ No Neutralization
- ▶ Easy Drive
- ▶ Nonex Glass

FREQUENCY LIMITS

Full Input..... 250 MC
 Half Power..... 400 MC

GENERAL CHARACTERISTICS

Fil. 6.3 Volts (Thoriated Tungsten)..... 2.75 Amps.
 Amplification Factor..... 65
 Mutual Conductance..... 2750
 Grid to Plate Capacity..... .2 MMF
 Input Capacity..... 6.5 MMF
 Output Capacity..... 1.8 MMF
 4 Prong UX Base — Plate Lead at Top
 Size: 4⁷/₈" by 1⁵/₈" Maximum

TYPICAL OPERATION

D.C. Plate Volts..... 1500
 D.C. Plate Current..... 110 MA
 D.C. Control Grid Volts..... -300
 D.C. Control Grid Current..... 15 MA
 D.C. Screen Grid Volts..... 375
 D.C. Screen Grid Current..... 22 MA
 Driving Power..... 4.5 Watts
 Power Output..... 130 Watts

Write for Complete Technical Data Bulletin

Taylor HEAVY **CUSTOM BUILT** DUTY **Tubes**

TAYLOR TUBES INC., 2312-18 WABANSIA AVE., CHICAGO 47, ILL.

Quality PRODUCTS
Since 1923

A complete line of
WIRES, CABLES, HOOK-UP WIRES,
RADIO HARDWARE, SHIELDED
MICROPHONE CABLE and S. J. CABLE
Complete Stock at Your Dealer

BIRNBACH

BIRNBACH RADIO CO., Inc.
145 HUDSON ST. NEW YORK 13, N. Y.

COMMERCIAL RADIO INSTITUTE

A RADIO TRAINING CENTER FOR 26 YEARS

Resident Courses Only • Broadcast, Service, Aeronautical, Television, and Marine telegraphy classes now forming for July 1st.
Literature upon request. Veteran training

Dept. B, 38 West Biddle Street, Baltimore 1, Maryland

AMATEUR GEAR HATRY & YOUNG

8 Connecticut and
Massachusetts Ham Stores

Hartford	C	Stamford
New Haven	O	New London
Bridgeport	N	Waterbury
	N.	

BOSTON—MASS.—LAWRENCE

The **ELECT** in Electronics

Listening Post

(Continued from page 78)

far. Radio and batteries were well concealed. To find them it was necessary to rip up the floor of my room, and they did not do it just then, and of course I had no mind to tip them off. By now the Americans were nearing Manila. Two days later I was again arrested while in the country. This time I managed to escape from their very hands by jumping into a very deep gorge, the almost perpendicular edges of which were covered by thick thorny bushes. When I came out, I had become perhaps a fit model to pose for the painting of an *Ecce Homo*, but I was still alive.

On the evening of the 13th of February, 1945, while yet under the Japanese oppression, I listened for the last time to the news from San Francisco. Not because the Americans entered San José the following day, but because the Japanese military police had encircled the rectory and I was barely able to jump out and escape in my pajamas and without shoes. It was then that they discovered the batteries. They looked for me everywhere. Doors were smashed, cupboards and wardrobes broken into. But they did not find the radio, and what's more, its owner!

After that, I deemed it best to go away. It was too hot for me in San José, and besides I knew the liberation was but a matter of days. I went into the hills and on March 14th I was happy to meet the first Americans, and on the 30th of the same month I was able to return to the now liberated San José. There I found my radio where I had left it.

It is a wonderful little set and it draws so little current that any rundown battery can work it. I am using an antenna now, and with it have sometimes to cut down the volume because it is too loud to be comfortable to the ear, in spite of the fact that San Francisco lies seven thousand miles away and I am hard of hearing.

Strays

A new dielectric heating system under development is, in effect, an electronic blowtorch. The heating unit projects ultra-high frequency radio waves at the work to be heated, thus making it possible to focus heat on restricted areas and irregularly shaped objects without scorching or burning the work. — *Ohmite News*.

RCA has announced plans to resume the publication of the *RCA Review*, a technical journal of radio and electronics research and engineering. The *Review*, to be published quarterly, will be similar in scope to those prepared prior to 1942 and will contain many items of interest and value to radio amateurs.

Look what you gain
with this basically new idea
in **fm** circuits

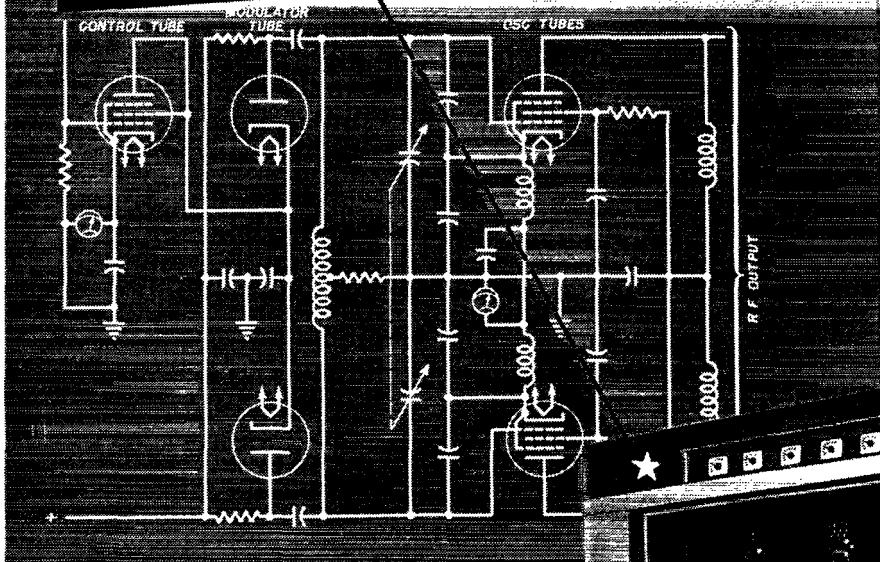

These new ideas in FM circuits designed by Westinghouse bring you important advantages never before available in FM transmitters.

Modulation, for example, is a simple, straight-forward diode type... noncritical, non-microphonic, no-trick tubes (see drawing above). The effective resistance of the tubes is a function of plate current in the modulator-control tube.

Thus, the master oscillator tank circuit is frequency-modulated due to *resistance variation* in response to audio signals applied to modulator-control input circuit. And the frequency-modulated master oscillator operates at only 1/9th the F.C.C. assigned center-frequency.

There are other important benefits in the new Westinghouse design. Frequency is held without using critically-tuned elements or moving parts and nowhere does frequency stability depend upon a tuned circuit.

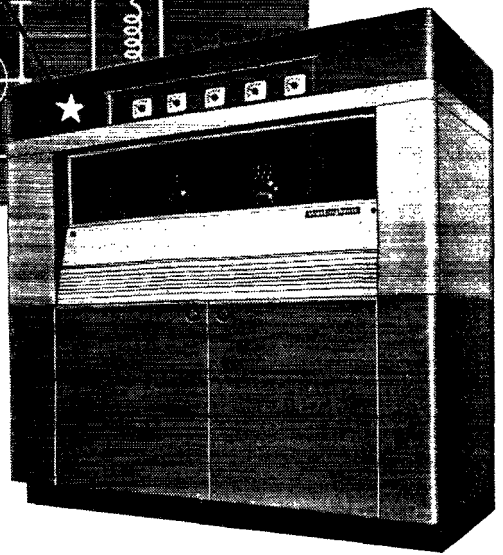

These new improvements are born of intensive wartime radar experience and actual operation of five FM stations... a background unmatched by any other transmitter manufacturer. Ask your nearest Westinghouse office today to give you all the facts, and look at Westinghouse before you buy! Westinghouse Electric Corporation, P. O. Box 868, Pittsburgh 30, Pa.

J-08158-A



Westinghouse
PLANTS IN 25 CITIES . . . OFFICES EVERYWHERE

Electronics at Work

FOR
Easy
LISTENING



CHANGE TO
**MURDOCK
RADIO PHONES**

EVERYBODY in Radio knows MURDOCK. MURDOCK Radio Phones are built by sound manufacturing methods to give service — traditionally out-lasting ordinary radio phones by years of service.

Since 1904 "precisioneering" has made MURDOCK Head Phones famous for super-sensitivity, clear reception, trouble-free performance, and durable, shock-proof construction. Naturally, then, you get keen *hear-ability* under all operating conditions.

No other listening experience is like hearing through the "Ears-of-a-Nation" — produced by MURDOCK engineers

and craftsmen. Thousands are now listening without strain or discomfort, thanks to MURDOCK'S research through the years. They get the message right . . . the first time . . . all the time.

MURDOCK Radio Phones have been a FIRST for over 40 years with unusual features that mean effective, EASY listening. Be sure to consult with us for sturdy, solid-built Head Phones.

JOBBERS

Our Radio Phones are now available to you in greater quantities. Write us for full details today.

Get the Full Story of What These Radio Phones Can Do for YOU. Write for Catalog!

WM. J. MURDOCK CO.
213 Carter St., Chelsea 50, Mass.

**PRECISION
MOVEMENTS**

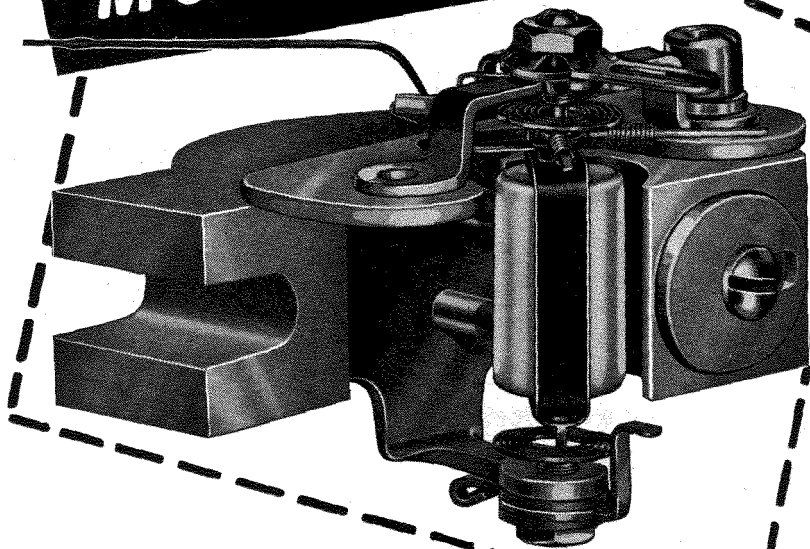

Burlington

PANEL INSTRUMENTS

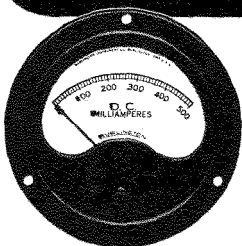

The heart of every Burlington Instrument — and the reason for its high degree of dependability — is the Burlington Precision Movement.

Design, material, and manufacturing processes are selected in such a manner that Burlington gives you a rugged instrument — which may be subjected to rough usage — and still retain its original calibration characteristics. All DC instruments employ Alnico magnets which are known to be more highly resistant to shock, heat, vibration, and stray fields than any other magnetic material. All ranges AC and DC are available in 2½", 3½" and 4½" sizes, both square and round, flush mounting.

*Engineering Service Furnished for Specialized Applications. No Obligation
Write Today for Further Information*

BURLINGTON INSTRUMENT COMPANY • 805 Fourth Street, Burlington, Iowa

Crystalab CALIBRATION SERVICE FOR HAMS

A
Special
Service
60¢
per crystal

Have your crystals checked for exact frequency at room temperature. Crystals are calibrated on representative "ham" equipment to ± 5 KC. Calibrating circuits are featured in Figures 403, 404, 406, 407, and 408 of the 1945 ARRL Radio Amateur Handbook.

Further tests may be made to meet your special requirements. Upon inquiry, please state exact desired temperature. For further tests, prices will be quoted.

Mailing charges back to you are included.

Pack shipments carefully and insure . . . C. R. L. not responsible for damage in transit to us.

I am enclosing.....Crystals for
Calibration at room temperature.
Please Calibrate in circuit Figure No.....
Name.....
Address.....
CITY.....STATE.....

Send money order or check — please do not send cash.



**CRYSTAL RESEARCH
LABORATORIES INC.**

29 ALLEN ST. HARTFORD, 3, CONN. PHONE 7-3215

RADIO

RADIO Technician and Radio Communications courses. Register now or new classes starting first Monday of each month. Day and Evening Classes.

AMERICAN RADIO INSTITUTE
101 West 63d St. New York 23, N. Y.

Approved under GI Bill of Rights

TELEVISION TECH CORRESPONDENCE COURSE

WANTED: Qualified radiomen to take a specialized television course. Instructions begin and end with television. Course has been written for the experienced radioman (amateur, serviceman, operator, or technician) who wishes to prepare for this new field. Course covers reception and transmission in detail. A knowledge of basic radio is assumed.

PREPARATION: Authors of a large portion of this course are Edward M. Noll and O. J. Jimerson. Mr. Noll is a former member of the television department of a major radio corporation and author of the practical math series in QST and television series in Radio News; Mr. Jimerson, a former senior radar inspector and member of same television staff.

TELEVISION TECH ENTERPRISES

Box 94 Dept. C HATBORO, PA.

Correspondence

(Continued from page 74)

ANTI-V.H.F.

669 No. 10th, Laramie, Wyoming

Editor, QST:

I have been observing with much disgust for the past four years the trend toward the very high and the ultra high frequencies. Apparently you are trying to convince us that we want these frequencies when the opposite is actually the case. Which side are you on — on the commercials or ours? In the first place if we want to talk to somebody across town we can use the telephone. Most of us have them. In the second place we want our 20, 40, 80 and 160 meter bands back and we don't want to wait until England or anybody else wants to give them back. We feel that we are entitled to them and see no reason for waiting any longer. It looks like Loran fixed one of our old bands for good. I can't understand it. But giving us higher frequencies is not what we want. Every ham I have talked to out here wants the old bands back. Let the commercials have the high frequencies. I am in favor of a slush fund. Everybody donate. I am willing to give quite a bit and then maybe we can buy somebody off and get some action. This is the first time in over 20 years that I have ever written you but I don't like high frequencies, and from the conversation on the 10-meter band nobody else does either, so quit trying to ram it down our throats.

— B. F. Monteith, W7GRL

BOOTLEGGING

Fort Monmouth, N. J.

Editor, QST:

To start with, I've been very careful to operate within the band limits and such whenever I was on the air. But today I received a notice from Grand Island that I was operating on about 14,025 kc.

Now this is just fine and dandy, as all of my equipment is locked up and I'm about 3,000 miles away from it! I'm spending my time in the Army at Fort Monmouth just like a lot of other guys waiting to get back on the air. But it looks like some lunk-head with more money than brains and probably 4-F just couldn't find time to study and get his own call. For him it must be fun to sit and work other stations all over the country, while I have to write and explain just why he can't keep his rig where it belongs.

I think it is time for everyone to start a campaign against these darn bootleggers before too many guys have to start answering for them. So if in the future any of our readers work or hear W6PYM on the air it isn't the real McCoy as I won't be back 'till 1947. Until then, 73.

— Charles W. Abern, W6PYM

NEWCOMERS

83 College Ave., Poughkeepsie, N. Y.

Editor, QST:

Your September editorial has had me figuring on the problem of the newcomer for several weeks now. In the hope that results of all this celebration may be of use to you, I make the following suggestions:

I think that servicemen and women whose duties require adequate knowledge of radio matters should be granted exemption from the corresponding parts of the amateur license examination and that those so qualified be able to receive a small pamphlet on amateur law and regulations in lieu of the regulations portion of the exam — all this is to be handled as an extension of the Class C examination system. I believe that this practice will not cause any lowering of the quality of amateur licensees because a service-trained man who has forgotten much of what he was taught still has more radio "savvy" than many of us whose sole preparation was a sketchy boning-up for the elementary amateur exam. It seems likely that much real support for this program could be obtained from the several veteran's organizations, they being very anxious to be on the affirmative side of any proposition even vaguely resembling a "bonus" for prospective members. You would know better than I, of course, how much weight they could swing with the FCC, but it

(Continued on page 136)



WHEREVER THE CIRCUIT SAYS Ω

IRC Catalog 50 lists a resistance unit for every ham-rig requirement. Your local IRC Distributor has a copy waiting for you! . . . and he now can give you prompt service on IRC products. Drop in, look around—you'll find his store headquarters for the *best* in electronic parts and equipment of all kinds.

INTERNATIONAL RESISTANCE CO.

401 N. BROAD ST., PHILA. 8, PA.

In Canada: International Resistance Co., Ltd.
11 King St., W., Toronto

IRC MAKES MORE TYPES OF RESISTANCE UNITS, IN MORE SHAPES, FOR MORE APPLICATIONS THAN ANY OTHER MANUFACTURER IN THE WORLD.



IT'S RIGHT...



for
MODERN
BROADCASTING
TECHNIQUE

for
DEPENDABILITY

for
VERSATILITY

for
EASY
OPERATION AND
SHOWMANSHIP

The GATES 1-KILOWATT TRANSMITTER

It has everything you want in performance—modern broadcasting technique from circuit developments, now incorporated, which are the result of proved laboratory tests. It is versatile to meet all demands. Yes, and it is dependable under all circumstances. In addition to these mechanical perfections which Gates engineers assure, the BC-1E Transmitter combines easy operation and beauty in appearance to make your Station outstanding in showmanship. It is RIGHT for the 1-Kilowatt Station. Investigate it!

CONDENSED SPECIFICATIONS

FREQUENCY RANGE: 530 to 1600 K. C.
FREQUENCY STABILITY: Plus or minus 10 cycles maximum.
POWER OUTPUT: 1000 Watts. May be operated as 500 Watt Transmitter. Power reduction for night operation may be incorporated to suit requirements.
POWER SUPPLY: 230 Volts, 60 Cycles, single phase, regulation not to exceed plus or minus 5%.
FREQUENCY RESPONSE: Within 1½ Db. from 30 to 10,000 cycles.
DISTORTION: Less than 3% from 50 to 7500 cycles. 0-95% modulation.
NOISE LEVEL: 60 Db. below 100% modulation.

WRITE FOR COMPLETE SPECIFICATIONS

NEW YORK OFFICE:
9TH FLOOR, 40
EXCHANGE PLACE



RADIO CO.
QUINCY, ILL.

SOLD IN CANADA BY:
CANADIAN MARCONI CO., LTD.
MONTREAL

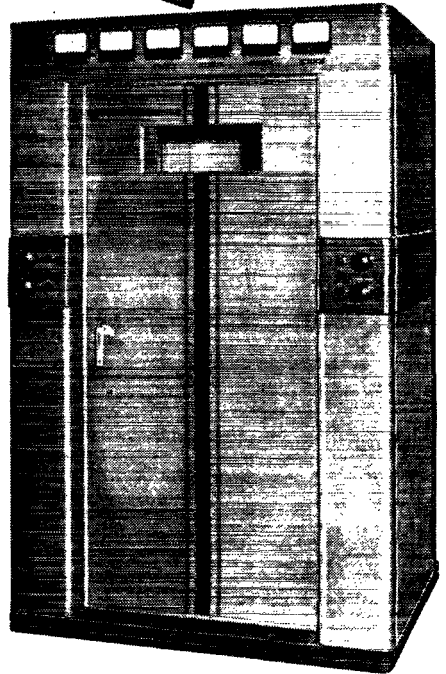

EXCLUSIVE MANUFACTURERS OF TRANSMITTING EQUIPMENT... SINCE 1922

READY
for you NOW

ALLIED'S NEW 1946 CATALOG

of Radio Parts and Equipment



Everything for the Veteran and the Beginner! Includes Latest Communications Receivers

Here's your latest, most complete Buying Guide for everything in radio! Includes newest receivers, Ham gear, code apparatus, parts, kits, tubes, tools, books, test instruments, public address and other equipment. Over 10,000 items available from the largest and most complete stocks under one roof. Nationally known makes. Finest values. Fast, efficient service from one reliable central source. Our experienced staff of licensed radio amateurs is glad to help you.

Free... Send for it today

FOR EARLIEST DELIVERY... ORDER YOUR Communications Receiver

Now from **ALLIED**

Time-Payments • Trade-ins Accepted

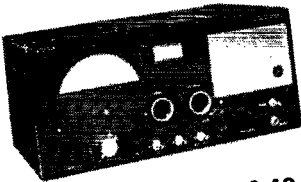

NEW HALLICRAFTERS S-40

Simple to operate. Frequency range 550Kc. to 44Mc. in 4 bands. Wide vision main tuning dial accurately calibrated. Separate electrical bandspread dial, inertia flywheel tuning. Beat frequency oscillator. Automatic noise limiter. Separate RF and AF gain controls. Three position tone control. "Micro-set" permeability adjusted coils in RF section. Internal dynamic speaker. Net, **\$79.50**
Model SM-40 External "S" Meter, \$15



NEW PRECISION RME 45

Delivers peak reception on *all* frequencies—500 to 33,000 Kc. Full vision calibrated dial using one control for two-speed tuning. Five Amateur bands with ample band spread. DB calibrated signal level meter. 5 step variable crystal filter. Automatic Noise Suppression. Stable, variable pitch beat oscillator. Net, with Speaker **\$186**

Other Models

Hallicrafters SX-25	\$94.50
RME DB-20	59.30
RME VHF-152 Converter	59.30
Hammarlund HQ-129X	129.00
National NC-2-40C	225.00
National HRO	197.70
Hallicrafters SX-28A	223.00
Hallicrafters S-36A	415.00
Hammarlund 400X	318.00
Hammarlund 400SX	318.00
Hallicrafters S-37	591.75
Hallicrafters HT-6	110.00
Hallicrafters HT-9	225.00

Net F.O.B. Chicago
Prices Subject to
Possible Change

ALLIED RADIO

Everything in Radio & Electronics
833 W. Jackson Blvd., Chicago, Ill.

ALLIED RADIO CORP., D. I. Warner W9IBC
833 W. Jackson Blvd., Dept. 27-DD-6
Chicago 7, Illinois.

Date

- Enter order for Model
- Enclosed \$ Full Payment Part Payment
(Balance C.O.D.)
- Send literature on Receivers and Time Payment Plan.
- Send FREE new 1946 Allied Catalog

Name

Address

City Zone State

"POWER FAILURE AT 24 NORTH BROAD"

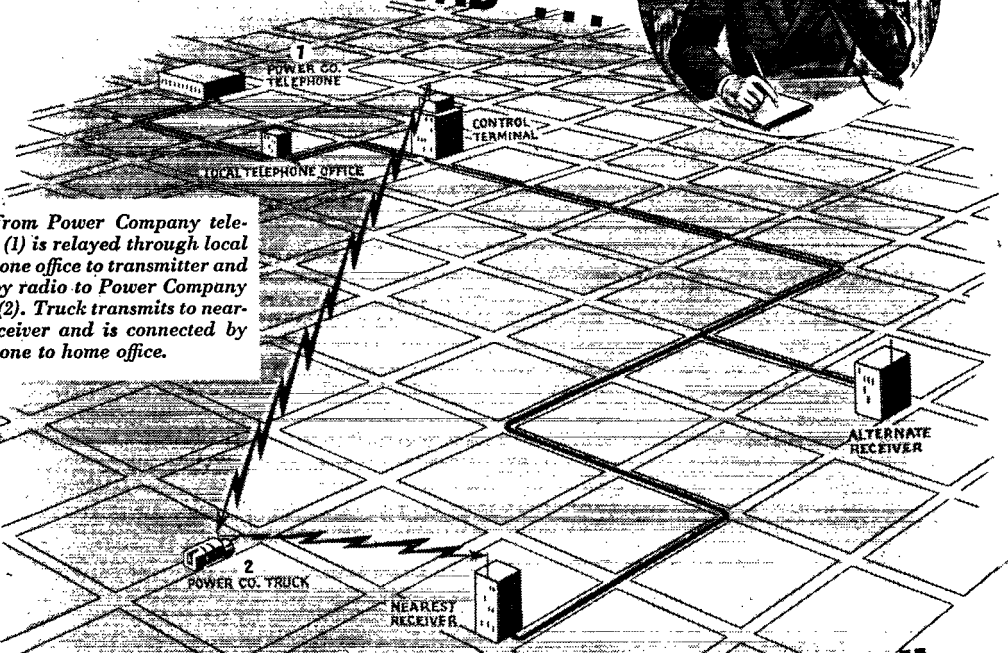

Call from Power Company telephone (1) is relayed through local telephone office to transmitter and then by radio to Power Company truck (2). Truck transmits to nearest receiver and is connected by telephone to home office.

"WE'LL BE THERE IN 3 MINUTES!"



The operating companies of the Bell Telephone System have plans under way for extensive trials of general two-way mobile radiotelephone service in many large cities throughout the country — and plans are being made to extend these service trials to highways between cities.

Electric companies will be among the first to realize the advantages of direct voice contact with drivers of mobile equipment — routine repair and inspection work can be expedited, and appropriate vehicles can be made available in case of emergency.

Source of supply for the Bell System since 1882, Western Electric pioneered in mobile radio in 1917 — and Western Electric equipment has led the way ever since. It is natural that Western should play a major part in extending telephone service to the streets and highways of America.



Western Electric

PIONEERS IN MOBILE RADIO

*you get your
money's worth plus!*

CORNELL-DUBILIER CAPACITORS

When you're thinking of quality in capacitors — you're thinking of us. C-D's *deliver* the fine performance you expect, because they represent internationally-recognized capacitor engineering talent, applied over 36 years' of concentration on designing and building nothing else but capacitors. C-D "firsts" in capacitor designs have become the standard in the industry.

THE "PLUS" YOU GET WITH C-D's

Add to C-D's designs, other features *exclusively* C-D's — such as C-D's finer materials, developed through years of patient research — **PLUS** carefully controlled production and exacting inspection. These give you your money's worth in quality and performance . . . and they cost no more than capacitors that only *look* like C-D's. If you haven't already been convinced of C-D's quality over the years, by using them — as nearly every "ham" has — prove it to yourself — next time, try Cornell-Dubilier. See how much better they are and how much longer they last!

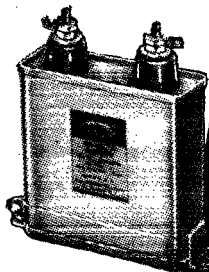

CORNELL-DUBILIER

WORLD'S LARGEST MANUFACTURER OF

CAPACITORS



**SAFEGUARD YOUR "HAM" STANDING
SEND FOR CATALOG 195**

and pick your C-D capacitor types from the most complete line in radio capacitor history. A C-D jobber is nearby — call on him! Cornell-Dubilier Electric Corp. So. Plainfield, New Jersey



MICA • DYKANOL • ELECTROLYTIC • PAPER

RESISTORS CAN BE

A JOY...



... OR A HEADACHE

When you install WARD LEONARD resistors, you know they will continue to function indefinitely... and not blank you out right in the middle of an interesting contact. It pays to spend a few more pennies for dependable resistors. Send for catalog.

WARD LEONARD

RELAYS RESISTORS RHEOSTATS

Electric Control Devices since 1892

WARD LEONARD ELECTRIC COMPANY

Radio and Electronic Distributor Division

83B WEST JACKSON BLVD. CHICAGO, ILLINOIS



ELECTRICITY FOR RADIO AND ELECTRONIC APPLICATIONS

ONAN ELECTRIC GENERATING PLANTS supply electric service for electronics applications and general uses, mobile or stationary. Driven by Onan 4-cycle gasoline engines, they are of single-unit, compact design and sturdy construction.

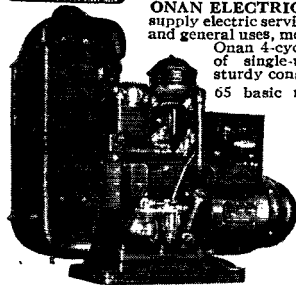

65 basic models ranging in capacity from 350 to 35,000 watts. Standard A.C. models, 115-volt, 60-cycle, single-phase. Standard D.C. models, 32 to 115 volts. Special voltages to 660 A.C., and 6 to 4000 volts D.C. 5 KW to 35 KW units available in 3-phase. High frequencies to 800 cycles. Combination A.C.-D.C. types. Write for detailed literature or engineering assistance.

D. W. ONAN & SONS 2634 Royalston Ave. Minneapolis 5, Minn.

CUT Any SIZE* HOLE TO Any DEPTH IN WOOD

Something new in wood-boring tools! Bruno Expansive Bit works like a lathe... requires less pressure... actually pulls itself through. Positive lock with patented triangle blade. Diamond grind on lead screw prevents splitting. Wide throat for chip clearance. Easy-to-read scale. All cutting surfaces of high grade tool steel. Replaceable blades.

*Wide Cutting Range!

No. 200-B cuts $\frac{1}{8}$ " to $1\frac{1}{4}$ " Diameter \$2.95
No. 201-B cuts $1\frac{1}{2}$ " to $3\frac{1}{2}$ " Diameter \$4.95
Each comes with 1 long, 1 short cutter.

Ask your jobber, or write Bruno Tools, Beverly Hills, California, Dept. QST-4

NO. 200-B
\$2.95
COMPLETE

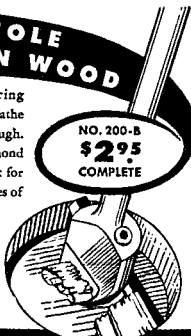

BRUNO TOOLS

Beverly Hills
California

(Continued from page 130)

may be that some of the Commissioners are good Legion or VFW men. Could be?

Second, I should like to agree emphatically with your ideas on the importance of the local work necessary if the veterans are to be reached. Here, again, it is noteworthy that there are active veteran's organizations in a position to reach qualified radiomen in places where amateur organizations just cannot bring off that first introduction between ham and non-ham that has traditionally been the open door to our ranks. Considerations of special veteran treatment aside, we here are going to try our darndest to have our local Legion and VFW pass the good word around. We shall also beat the big drum on our own hook. And with regard to the suggestion you made concerning attractive literature on amateur radio: we are going to let the neophytes draw up a chair before an operating transmitter and receiver and watch the wheels go 'round; that should do it!

An active League is the *sine qua non* of any program aimed at expansion of the amateur fraternity. At the risk of mouthing a cliché, I add, "keep up the good work."

—Gurdon R. Abell, Jr., W2IXK

6000 S. Tripp, Chicago 29, Ill.

Editor, QST:

The members of this organization have read with great interest and mingled feelings the editorial in the September issue of QST and the proposed idea of doing everything possible to make more people interested in being amateur radio operators.

No doubt the idea behind this is to make the League and the hobby of greater strength through greater numbers. While this may be worthwhile and desirable, we cannot help but feel that it may also lead to chaos because of the limited space for use by amateurs.

If we were to receive a greater part of the radio spectrum for our use we would say — yes, do advertise and build up the organization. But in view of the fact that we are not certain of even maintaining our present number of frequencies, and that we don't know how many would be satisfied to stay parked in the new ultra-high bands, we are against advertising for people to hurry up and get a license and get on the air and join us in this great American hobby. We think the increase in numbers will come of itself and that it will need no advertising to bring in those who have the ordinary desire to do so.

We feel that our League and its officers are doing a good job, and will continue to do so, but we do not think much good will come of promoting our hobby as if it were something to be sold to people. The selling we need to do is to sell ourselves on good operating, emergency preparedness, etc.

This is our view on this subject and we trust it will be received as such. The League and amateur radio will continue on without the help of synthetic hams! Keep up the good work, and get ready for all those fellows and gals who will want to be on the air and who are already waiting!

—P. E. Haller, W9HPG, Secretary,
Chicago Radio Traffic Association

NEWS

21 Sibley Court, Cambridge 38, Mass.

Editor, QST:

Thanks for your letter containing news of the 44 to 108 Mc. allocations and the ARRL testimony. I have recently talked with over a dozen hams, and none of them have seen any of the recent FCC amateur frequency allocations in ordinary newspapers. All agreed with my observation formed since receiving your letter that only through technical magazines such as QST can one authoritatively find out what is going on down there in Washington.

Therefore please keep up the good work of giving us the news that affects the hams. Keep it up even if it may seem "old stuff," by the time it appears in QST, to you who are working directly on this matter of such vital interest to all hams.

—Willard Miller, W1NVI, ex-W9ULR
(Continued on page 140)

REPAIR ANY KIND OF RADIO EQUIPMENT

PREPARE NOW FOR A BETTER JOB AT HIGHER PAY IN THE RADIO-ELECTRONIC FIELD.

Complete Basic Radio-Electronic Training for Beginners...FOR ONLY \$5

EASILY WORTH \$50 IF YOU BOUGHT IT AS A COURSE

No sir! Radio-Electronic Training doesn't have to be expensive to be good. Actually, A. A. Ghirardi's famous 972-page RADIO PHYSICS COURSE book gives you just the training you need—ALL YOU NEED—easier, better, faster—AT A TOTAL COST OF ONLY \$5 (\$5.50 foreign). No previous training is necessary. RADIO PHYSICS COURSE book carries you rapidly

through Basic Electricity (over 300 pages) to the latest Radio-Electronic developments. Nothing is omitted or condensed. Each step is made crystal clear by thorough explanations and by more than 500 illustrations. Each section contains Self-Testing Review Questions so you can check your progress every step of the way. There are no lessons to wait for—no monthly payments to make.

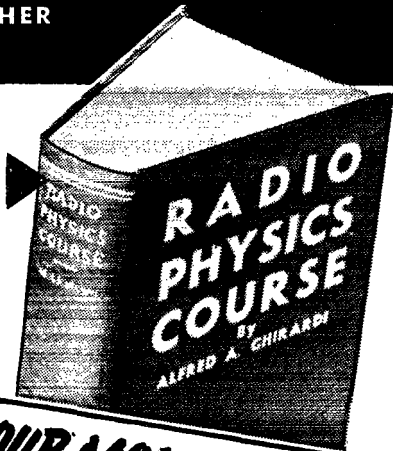

★ **More universally used for home study, by more Signal Corps, Navy and civilian schools and colleges than any other book of its kind!**

All you need is a little spare reading time plus a desire to get started NOW to make more money in the rapidly expanding fields of broadcasting, aviation radio, F-M, Television, radio servicing, electronic manufacturing—or any other of Radio-Electronic's fast-growing branches. RADIO PHYSICS COURSE is famous for making it easy for beginners to learn Radio-Electronic fundamentals—at home without an instructor.

You can understand every word without previous training. You'll be pleasantly surprised how easily you'll master the subjects that other books and courses make seem very complicated. Our 5-Day Money-Back guarantee enables you to examine this great book for five full days—and get every cent of your money back if you're not more than satisfied. Send coupon today!

YOUR MONEY BACK
in 5 Days if Ghirardi's RADIO PHYSICS COURSE doesn't teach you EASIER, FASTER, and AT LESS COST than any other Radio-Electronic book or course!

HERE'S HOW TO LEARN MODERN SERVICE WORK *without an instructor!*

Ghirardi's MODERN RADIO SERVICING (see below) is the only single, inexpensive book giving a complete course in modern radio repair work. Written so you can understand it without an instructor! Read from the beginning, it takes you step by step through all phases of the work. Used as a reference book, it serves as a beautifully cross-indexed work for "brushing up" on any job that puzzles you. Explains ALL test in-

struments, how they should be used and why (it even gives all data for constructing your own test equipment); Troubleshooting Procedure and Circuit Analysis; Testing and Repair of Components; Installations; Adjustments, etc., etc.—ALSO How to Start a Successful Radio-Electronic Service Business. 1300 pages; 720 Review Questions; 706 Illus. Only \$5 (\$5.50 foreign). 5-Day Money-Back Guarantee!

HERE'S HOW TO REPAIR RADIOS THE EASY WAY

Ghirardi's big 744-page manual size RADIO TROUBLESHOOTER'S HANDBOOK (below at right) isn't a "study," book. You simply turn to it whenever you want to fix a particular trouble in a particular model and make of radio. Its 404-page Case History Section gives full details on common trouble symptoms, their causes and remedies for practically every Radio in use—over 4000 of them! It describes the trouble exactly—tells you exactly how to fix it—without any elaborate testing whatever!

If you like to tinker with radios the HANDBOOK is your "Open, Sesame!" to fast, efficient work. If you are already a radio man it will help you fix two sets in the time normally required for one—repair cheap sets profitably—train new helpers—substitute parts properly, etc. Also, hundreds of pages devoted to I-F alignment peaks; transformer troubles, tube substitutions and dozens of charts, graphs, helpful hints, etc.—all indexed so you can find them fast. Only \$5 complete (\$5.50 foreign) on our 5-Day Money-Back Guarantee



JUST LOOK UP *the model radio you want to fix. The Handbook tells exactly what to do — exactly how to do it!*

MONEY-SAVING OFFER

See coupon for special combination offer on MODERN RADIO SERVICING and TROUBLESHOOTER'S HANDBOOK—over 2040 pages representing a complete service library for only \$9.50! (\$10.50 foreign)

RADIO & TECHNICAL DIVISION

Murray Hill Books, Inc.,
Dept. Q-46, 232 Madison Ave., New York 16, N. Y.

Enclosed find \$_____ for books checked; or send C.O.D. (U.S.A. only) plus postage. If not fully satisfied, I may return books within 5 days and receive my money back.

RADIO PHYSICS COURSE \$5 (\$5.50 foreign) MODERN RADIO SERVICING \$5 (\$5.50 foreign)

RADIO TROUBLESHOOTER'S HANDBOOK \$5 (\$5.50 foreign) **MONEY-SAVING OFFER:** Modern Radio Servicing AND Troubleshooter's Handbook \$9.50 for the two (\$10.50 foreign)

Name _____

Address _____

City & Dist. No. _____ State _____

PUR-A-TONE
Reg. Trade Mark

ANTENNAS



Masterpieces of

**DESIGN AND
CONSTRUCTION**

A.M. — F.M. — TELEVISION



for

- **AUTOS**
- **HOMES**
- **MARINE**

Brach Pur-a-tone Antennas have long been recognized as the standard by which all others are judged. They're a byword for Quality and a buy-word for Satisfaction. Please your customers and increase your profits—ask your distributor for BRACH ANTENNAS.

Special-purpose transmitting antennas designed for volume production to your specifications. Collapsible—sectional—direction-finding—radar—and coaxial type. All sizes, lengths and materials. Consult us on your needs.

L. S. BRACH MFG. CORP.

200 CENTRAL AVENUE NEWARK, N. J.



WORLD'S OLDEST AND LARGEST MANUFACTURERS OF RADIO ANTENNAS AND ACCESSORIES.

PRACTICE MAKES PERFECT

... and if you plan to increase your code speed ... easily ... rapidly,—write today for information on the famous electronically keyed code practice machine that will do the job right. This complete code practice outfit is again available. ... Deliveries can be made at once.

Ayers Automatic Code Mach. Co.
711 Boylston Street • Boston 16, Mass.

TRANSMITTING TUBES RECTIFIERS CATHODE RAY TUBES

We have been appointed a sales agent by Defense Supply Corporation of Government surplus tubes and rectifiers. All are first grade Government tested and inspected tubes — not rejects.

The following types are immediately available:

826 (HF Triode)	Cathode Ray Tubes
VT 127A (HF Triode)	8AP1
304 TL	8BP4
872A M. V. Rectifier	3AP1

Trade discounts to dealers on standard packages • Write for prices

LEWIS ELECTRONICS 16 Lyndon Avenue
Los Gatos, California

ADVANCE

WITH VALPEY

Since 1931 Valpey has aimed its production at the wants of the AMATEUR FIELD OF COMMUNICATIONS—Quartz Crystals perfected and precision-cut.

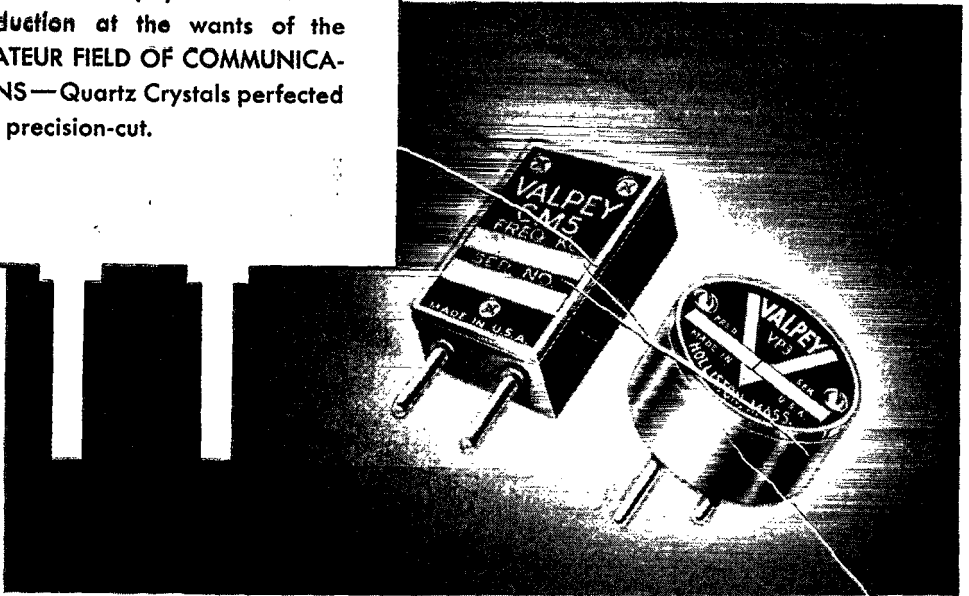

The veteran, as well as the amateur, just entering this field should bear in mind Valpey's worldwide wartime achievements. Hardly a communication system was developed without the tiny, all-important Valpey Crystals.

Whatever your requirement in amateur experiment and development — turn to advanced Valpey units.

ADVANCE WITH VALPEY

VALPEY CRYSTAL CORP.

HOLLISTON, MASS.

Craftsmanship in Crystals Since 1931

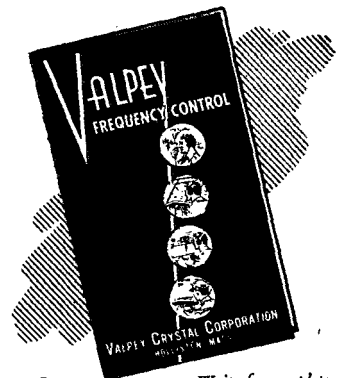

Write for complete information and data sheets.

Valpey
CRYSTALS

2 OF THE MOST FAMOUS NAMES IN TRANSFORMERS FOR IMMEDIATE DELIVERY!

The scoop of the year! Highest quality transformers from two of the greatest names in the field! Bargain prices! Here are four of the typical "buys" — write for others!

PLATE TRANSFORMERS

Rated at 2 KVA. Secondary 6200 V ct. Primary 105/110/115, 60 cycle, 11" x 14" x 10" high. **\$39.95**

Freight Prepaid Anywhere in Continental U.S.A.

PLATE TRANSFORMERS

Secondary 725-670-615-560-0-560-615-670-725 at 550 Mills. Primary 115 volts. **\$6.75** FOB St. Louis

CHOKE

4 hy @ 550 mills, 35 ohms. Here is your chance to pick up a real special! **\$3.75** FOB St. Louis

MODULATION TRANSFORMER

Primary Imped. 5000 ohms, secondary 2000 ohms, 250 ma. D.C. current. **\$2.00** FOB St. Louis

WHAT WE ADVERTISE—WE DELIVER

WALTER ASHE RADIO CO.
1125 PINE STREET ST. LOUIS 1, MO

HIGH FORWARD GAIN 5-ELEMENT BEAM

FOR 144 — 148 MEGACYCLES
Radiator, Reflector, 3 Directors, Features

1. Light weight, 1/2-inch seamless aluminum tubing allowing high installations on light poles.
2. No adjustments of any kind! Just attach two inch open wire line and use.
3. High directivity, great reduction in your QRM as well as others.
4. Puts TERRIFIC signal where you want it!
5. The result of years of use. (On 112 and 144 Mc.)

The "Package," 5 elements cut exactly to length. . . . \$5.50
The "Standard," 5 elements and 1 x 2 red cedar supporting member all drilled, all hardware. . . . \$8.50
The "UH F ARROW," all aluminum, "A Thing of Beauty" as well as high power. . . . \$14.50
VERY COMPLETE INSTRUCTIONS and clear print in every box.

The U.H.F. RESONATOR CO.

Guion Road, Rye, N. Y. • Telephone Rye 2030

Carter THE PREFERRED POWER SUPPLY

Carter Dynamotors, Magmotors, DC to AC Converters and Genmotors provide the finest rotary power for your mobile rig. Widely used and preferred by leading State and City Police Mobile Networks. Wide range of receiver and transmitter models, filter and starting relays available. Send today for the latest free bulletin.



CARTER . . . A well-known name in radio for over 20 years!

(Continued from page 136)

BCL INTERFERENCE

8057 Fontaine St., Oakland 3, Calif.

Editor, QST:

We understand and enjoy our great hobby because we are interested in radio. The great percentage of the population are only interested insofar as receiving their favorite broadcast program clearly and without interference. This means electric shavers, vacuum cleaners, power leaks and radio amateurs.

While we are all in a hurry to get back on the air, let's not overlook any opportunity in our new designs to cut down BCL interference. And if it's still there, through no fault of our own, let's cooperate to eliminate this interference. Remember, the average BCL doesn't understand radio: consequently, to him you are a public nuisance. By clearing up his trouble you can sell another customer on amateur radio; if you don't you've made a hundred enemies for your hobby, as he'll tell all his friends.

The FCC office in this area is already in receipt of many complaints, and, of course, the low-frequency bands are still closed.

— Floyd R. Penning, W6FOF, ex-KD6FOF

Hints and Kinks

(Continued from page 76)

ONE-TUBE V.H.F. RECEIVER

HERE is a one-tube v.h.f. receiver that worked very well for me, and I thought some of the boys might like to make up a simple job that has lots of sock, even though it has but one tube. Fig. 5 shows the details of the circuit. For 112 Mc

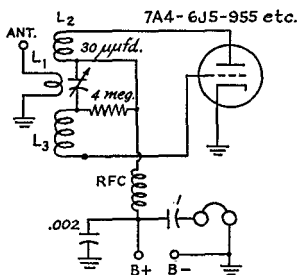

Fig. 5 — A one-tube v.h.f. receiver. The values of the components are shown in the diagram, except for L_1 , L_2 and L_3 , for which the suggested values are 2, 4 and 4 turns respectively, for the 144-Mc. band. The usual "cut-and-try" method should result in maximum performance on this receiver.

VE3ACW's coupling device installed with shaft aligned 90-degrees from the front panel.

the coils were 6 turns each side of the 2-turn antenna pickup coil. For 144 Mc. I suggest four turns 1/2 inch in diameter, No. 14 wire, for the plate and the grid coils. Experiments will show the exact number of turns and spacing required to cover the band in a particular receiver. — John J. Kaiscr, USNRA, Bainbridge Island, Port Blakely, Wash.

MASTER CONTROL SWITCH

THE SYSTEM of operating control installed here may interest others contemplating the use of low power transmitters with a common transmit-receive antenna. A bat-handled s.p.s.t. toggle

(Continued on page 144)

Motorola

RADAR RESEARCH

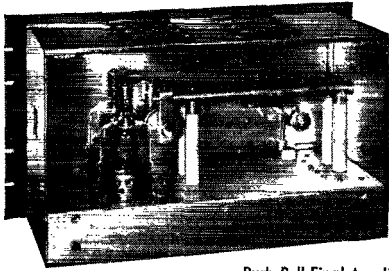

Push-Pull Final Amplifier

Leads the way in 152-162 MC 2-Way Radiotelephone Equipment

Motorola's extensive RADAR development and productive activity is reflected in the new line of 152-162 mc. equipment. The use of cavities, lines and microwave techniques provide exceptional performance and trouble-free service in the new bands.

The new 152-162 mc. equipment has been field-tested and proved before being released. Recently, field tests were conducted at the Motorola factory before a group of APCO members. The tests included comparison of 250-watts 162 mc. and 30-40 mc. equipment using a 150-ft. tower for antenna support. The Central Station power was reduced to 15 watts. Two cars using 15-watt transmitters were cruised over a radius of 20 miles including areas like the loop, lower level of Wacker Drive and Lake Shore Drive with tall buildings between the cars and Central Station, in addition to the normal territory encountered in a large city. Solid 2-way coverage with marvelous fidelity and very high signal-to-noise ratio was reported. Comparison with 30-40 mc. over the same area showed marked superiority of 162 mc.

Motorola proudly announces its 152-162 mc. equipment with the Model FSTRU-250-BR 250-watt Central Station Transmitter-Receiver unit.

WRITE TODAY for full details showing how Motorola Radiotelephone will solve your communications problem

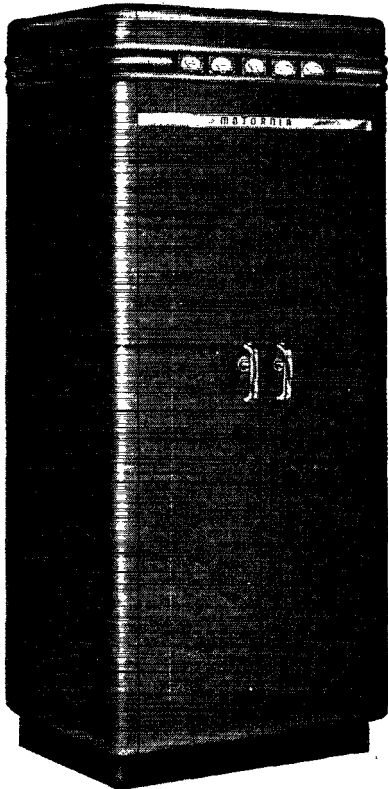

GALVIN MFG. CORPORATION • CHICAGO 51
COMMUNICATIONS AND ELECTRONICS DIVISION
F-M & A-M HOME RADIO • AUTO RADIO • TELEVISION • "HANDIE TALKIES" • POLICE RADIO • AIRCRAFT RADIO



World's Largest DISTRIBUTOR OF SHORT WAVE RECEIVERS

Do business with the biggest and one of the best in the field. Enter your reservations for the following:

Skyrider Jr. S41.....	\$33.50
Hallcrafters S22R.....	74.50
Hallcrafters S39.....	110.00
Hallcrafters SX-25.....	94.50
Hallcrafters SX-28A.....	223.00
Hallcrafters S36A.....	415.00
Hallcrafters S37.....	591.75
Hallcrafters S40.....	79.50
National N-2-40C.....	225.00
National One-Ten.....	56.10
National HRO Sr.....	197.70
RME-45.....	166.00
Hammarlund HQ129X.....	129.00
Hammarlund Super Pro.....	318.00
HT-9 transmitter.....	225.00
HT-6 transmitter.....	110.00
HT4E BC-610 transmitter.....	695.00

Some models are available for immediate shipment. As more and more receivers become available Bob Henry will be able to serve you better and better. By dealing with the world's largest distributor of short wave receivers you are assured of the fastest delivery possible and the best of service.

Enter your reservation now. You can trade in your present receiver. You can order on our 6% terms. You can depend on Bob Henry also for a wide assortment and the best values in crystals, transmitting tubes, microphones, test equipment, etc. Your inquiries welcomed.

Bob Henry
W9ARA

BUTLER, MISSOURI

HENRY RADIO SHOPS

LOS ANGELES 25, CALIF.

"WORLD'S LARGEST DISTRIBUTOR OF SHORT WAVE RECEIVERS"

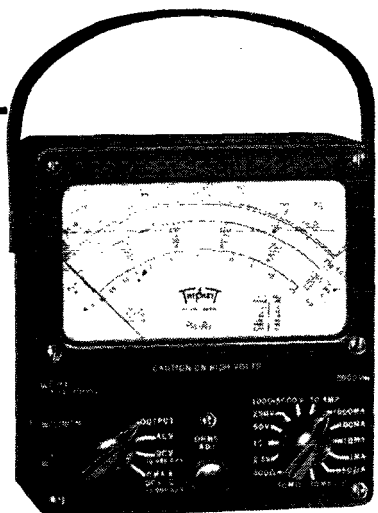

LONG SCALE, WIDE RANGE VOLT-OHM-MILLIAMMETER

DOUBLE SENSITIVITY

D.C. VOLT RANGES
0-1.25-5-25-125-500-2500 Volts.
at 20,000 ohms per volt for greater accuracy on Television and other high resistance D.C. circuits.
0-2.5-10-50-250-1000-5000 Volts,
at 10,000 ohms per volt.

A.C. VOLT RANGES
0-2.5-10-50-250-1000-5000 Volts,
at 10,000 ohms per volt.

OHM-MEGOHMS
0-400 ohms (60 ohms center scale)
0-50,000 ohms (300 ohms center scale)
0-10 megohms (60,000 ohms center scale)

**DIRECT READING OUTPUT LEVEL
DECIBEL RANGES**
-30 to +3, +15, +29, +43, +55, +69
DB

**TEMPERATURE COMPENSATED
CIRCUIT FOR ALL CURRENT
RANGES D.C. MICROAMPERES**
0-50 Microamperes, at 250 M.V.

D.C. MILLIAMPERES

0-1-10-100-1000 Milliamperes, at 250 M.V.

D.C. AMPERES

0-10 Amperes, at 250 M.V.

OUTPUT READINGS

Condenser in series with A.C. Volts for output readings

ATTRACTIVE COMPACT CASE

Size: 2 3/4" x 5 3/4" x 6". A readily portable, completely insulated, black molded case, with strap handle. A suitable black, leather carrying case (No. 629) also available, with strap handle.

LONG 5" SCALE ARC

For greater reading accuracy on the Triplet RED DOT Lifetime Guaranteed meter.

SIMPLIFIED SWITCHING CIRCUIT

Greater ease in changing ranges.

Write for descriptive folder giving full technical details

Precision first . . . to last

HERE'S THAT NEW
**TRIPLETT
625-N**

Triplet

ELECTRICAL INSTRUMENT CO. BLUFFTON, OHIO



MAKING TUBES IS EASY *If YOU KNOW HOW!*



HERE'S ANOTHER EXAMPLE OF

UNMATCHED **HYTRON** KNOW-HOW



A GAIN a painstaking, tough job is made easy. This Hytron electronically-controlled cathode-spray machine minimizes the element of human error always present with hand spraying. Evenly applied emissive coating of exactly the right weight and density is obtained hour after hour. Number and speed of coating passes, distance from spray guns to cathode sleeves, and intensity of the spray are precisely controlled.

An endless belt, with 8 racks each containing 40-100 bare cathode sleeves, travels before the two spray guns at 37-112 racks per minute. These guns are fired electronically only while racks appear before their nozzles. Each gun can be aimed through an arc of 0-45° to accommodate flat, oval, or round sleeves. Distance between gun and rack is finely adjustable. Number of passes is electronically controlled between 2 and 32.

An ingenious device automatically reverses—at each revolution of the endless belt—the side of a given rack exposed to the guns. A bank of infra-red lamps

dries each layer of coating immediately after its application.

Intensity and width of spray are regulated by pressure and nozzle adjustments. A continuously circulating system (instead of suction or gravity feed) maintains the coating fluid in the necessary state of suspension, and prevents clogging by coagulation.

Cathode coatings are held to such close tolerances that they must be measured by weight—on balances capable of reading .1 milligram. Yet this machine can apply accurately over 100,000 of such fine coatings daily. Another example of Hytron's mass production with precision—the Hytron know-how which gives you better tubes.



OLDEST MANUFACTURER SPECIALIZING IN RADIO RECEIVING TUBES

HYTRON

RADIO AND ELECTRONICS CORP.

MAIN OFFICE: SALEM, MASSACHUSETTS



Shur ANTENNA MOUNT

Perfect for
AMATEURS

Fits Anywhere

ANY ROOF TOP

ANY SLOPING SIDE

ANY HOUSE SIDE

SIMPLE STURDY
VERSATILE

Fits 1 1/4" Uprights

* Pats. Pending

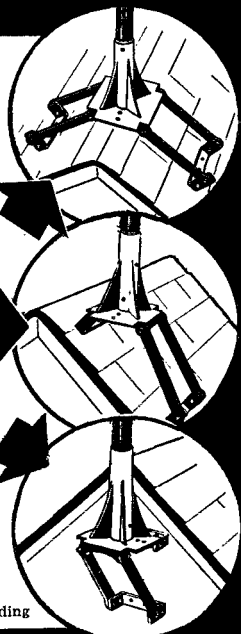

SHUR-ANTENNA-MOUNT INC.

Eastern Division:
SEA CLIFF, N. Y.

Western Division:
PORTER BLDG., KANSAS CITY, MO.

COMPLETE RADIO TRAINING!

Prepare now to accept a responsible position in Commercial Radio. New developments will demand technicians with thorough basic training, plus a knowledge of new techniques discovered during the war. Training open to high school graduates or those with high school equivalency. Courses 6 to 18 months' duration in RADIO AND ELECTRONICS. Approved Veteran training in Radio. Write for Particulars.

VALPARAISO TECHNICAL INSTITUTE
Dept. TN Valparaiso, Ind.

IN A CLASS BY ITSELF! . . .

GENUINE
EASY-WORKING
"ORIGINAL"

VIBROPLEX

Reg. Trade Mark: Vibroplex, Lightning Bug, Bug

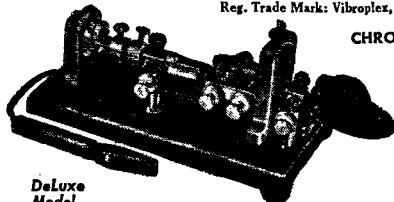

Deluxe
Model

America's finest radio key — the deluxe performer that sets new standards of sending excellence and operating ease. The jewels used in DeLuxe Vibroplex keys are the same as those placed in the finest made watches and precision instruments, providing watch-like precision, feather-touch action, lifetime service and ease of operation unapproachable by any other key. Chromium finished base. Bright machined parts. Colorful red switch knob, finger and thumb piece. DIE CUT contacts and main spring. 3/16th contacts. Circuit closer, cord and wedge. DeLuxe finish also available in "Lightning Bug" and "Blue Racer" models. Order NOW! Money order or registered mail. FREE catalog.



The "BUG" Trade Mark identifies the Genuine Vibroplex. Accept No Substitute

THE VIBROPLEX CO., Inc.

833 Broadway

New York 3, N. Y.

CHROMIUM
FINISHED
BASE

PATENTED
JEWEL
MOVEMENT
\$19.50

(Continued from page 140)

switch located in a convenient position (near transmitting key or where the left hand can manipulate it easily) does the trick.

This master toggle switch controls three relays, either 6- or 110-volt types as follows:

- Relay No. 1 — d.p.d.t. (antenna changeover).
- Relay No. 2 — s.p.s.t. normally closed (receiver B-plus switch).
- Relay No. 3 — d.p.d.t. (headphones).

Connect so that in transmit position,

- Relay No. 1 — connects antenna to transmitter.
- Relay No. 2 — opens B-plus to receiver.
- Relay No. 3 — connects headphones to monitor.

Then, in receive position,

- Relay No. 1 — connects antenna to receiver.
- Relay No. 2 — closes B-plus to receiver.
- Relay No. 3 — connects headphones to receiver.

This affords a quick and efficient changeover, little short of break-in operating. — Harold W. Ryall, W1NKW.

— . . . —

A UNIQUE COUPLING

THIS DEVICE permits placement of the shaft of a variable condenser parallel with the panel and yet allows it to be turned by a front-panel dial in the usual manner.

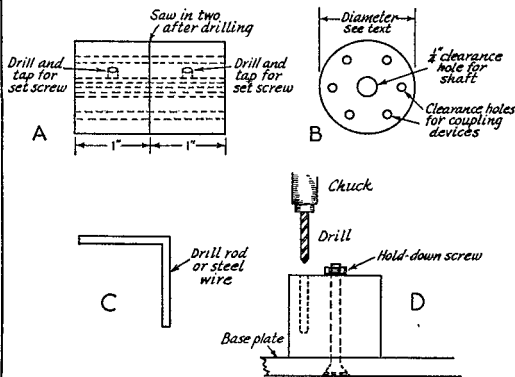
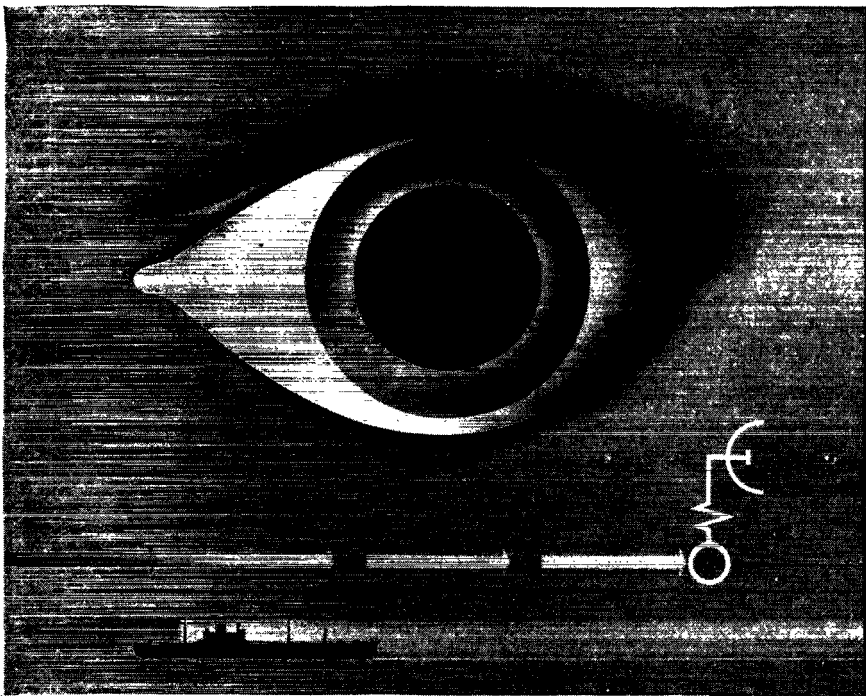

Fig. 6 — A, the barrel of the shaft coupling before sawing. Drill the holes lengthwise, as shown in A and B, by placing the piece on a mounting base as shown in D, and drilling the holes vertically. Setscrews fasten the barrel on to the condenser and the dial shaft. Steel drill rod or wire is bent accurately to the angle desired as shown in C. All connecting rods must have the same angle for smooth operation of the coupling. A drop of oil should be placed in each hole when assembled.

The drawings in Fig. 6 and the photograph depict a 90-degree coupling. However, any angle up to 90 degrees can be provided for, if the steel rods are bent accurately to the desired angle.

The coupling may be made from brass or steel and if insulation is desired, from bakelite. However, in the latter case a coupling of sufficient size

(Continued on page 148)



Look ahead ^{to} with Radar by Sperry

• This year, Sperry Gyroscope Company introduces its new *Radar* equipment for marine use.

Sperry *Radar* has been conceived to function better in this fundamental service: To enable ships to operate on schedule regardless of visibility...through thick fog, heavy rain, dense smoke, darkness.

As an aid to navigation it picks up channel markers and buoys; assists in making landfalls with assurance; spots icebergs, floating derelicts and other hazards projecting above surface. It also permits vessels to enter harbors and proceed with

all due safety and caution through fog. Another important feature: Sperry *Radar* provides a Cyro-Compass-controlled image and can be operated by bridge personnel without extensive technical background.

In design and construction, Sperry *Radar* reflects this company's many years of experience in precision manufacture of marine equipment—as well as its outstanding achievements in the field of electronics. In simplicity and dependability, this new *Radar* exemplifies again Sperry's ability to build superior products for merchant ship service.

Sperry Radar Features:

- Designed to meet all Class A specifications of the U. S. Coast Guard.
- Maximum range 30 miles—minimum, 100 yards.
- 10-inch picture on a 12-inch screen.
- Images presented in true or relative relationship at option of operator.
- Gives accurate ranges read from indicator instead of estimated from scope.
- Backed by world-wide service.

SPERRY GYROSCOPE COMPANY, INC. GREAT NECK, N. Y.



Division of the Sperry Corporation

LOS ANGELES • SAN FRANCISCO • SEATTLE • NEW ORLEANS
CLEVELAND • BROOKLYN • HONOLULU

GYROSCOPICS • ELECTRONICS • RADAR • AUTOMATIC COMPUTATION • SERVO-MECHANISMS



TOP PERFORMANCE FOR INPUTS UP TO 75 WATTS

- Three Junior Inductor types—end linked, center linked and variable link.
- May be used in capacity-coupled circuits by omitting connection to the links.
- 10-15-20-40 and 80 meter types.
- Conservatively rated.
- Perfect air-spacing and high Q as result of B & W Air Wound construction.
- Small, rugged, low in price.
- Featured by leading jobbers.

WRITE FOR THE NEW B & W CATALOG

Inductors, Turrets, Rotary Coils,
Accessories for All Amateur Uses.

BARKER & WILLIAMSON

Dept. Q-46, 235 Fairfield Ave., Upper Darby, Pa.

INDUCTOR HEADQUARTERS

HAM HEADQUARTERS FOR Equipment and Information

EXTRA SPECIALS

- 24 G Tubes. Limited Supply.. \$1.90 net
- 3-3 MFD. 600 W. V. Oil Filled Condenser.....99¢ net
- Leach Relay. Low Loss D.P.D.T. 6V. D.C. Coil. \$1.75 net
- SHURE T 17 B Mike with Relay Switch. \$3.10 net

Mail Orders Promptly Filled

Amateurs To Serve You

Write Dept. QST

W6SCQ • W8WLG/6 • W6NAT • W6SSU

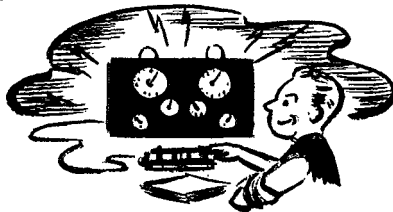

FOR YOUR NEW RIG

Monitor Crystals. 7 MC. Band. Type 43B.....\$2.80 net

Also Complete Line of:

National Johnson Ohmite Taylor	Eimac Jones Amprex Advance	Barker- Williamson Hallicrafters
--------------------------------------	-------------------------------------	--

Radio Product Sales Company

238 WEST 15TH STREET

LOS ANGELES 15, CALIFORNIA

PRospect 7471

HAMS! You're on the air at amazingly Low Cost with New V.H.F. and U.H.F.—



Mail Coupon Below for

NEW CONCORD CATALOG—FREE

Order **PARTS**
EQUIPMENT—SUPPLIES
at TREMENDOUS SAVINGS from
CONCORD

America salutes the radio ham, and gives thanks for amateur pre-war experimenting. This constant search and striving for new and better methods, equipment and results paved the way for phenomenal war-time radio and radar progress in the V. H. F. and U. H. F. bands. Now these war-born developments are available from Concord for you to build ultra-modern V. H. F. and U. H. F. rigs at a fraction of the cost of pre-war high frequency equipment. Concord stocks

are huge and complete—and Concord's buying of termination inventories released by war-equipment contractors permits us to list the finest standard, nationally-known radio and electronic equipment, all built to high and rigid government standards, at amazingly low prices. Mail the coupon now for your FREE copy of CONCORD'S new RADIO PARTS Bargain Book.

Typical Catalog Values—A Few of Hundreds



Decibel Meter—
 Calibrated—10 to +6 db. 2 11/16" flange mounting. 5B4120. Each... **\$4.95**

High Voltage R. F. Switch—
 8 positions, 1/4" contacts made of special alloy. Mycalex and isolantite insulation. C14518. Each... **\$6.95**

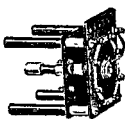

.01 mfd., 5000 Volt Capacitor—Pyraloid treated and filled. Overall size: 6" x 1 1/4". 5B3160. Each... **\$2.25**

- 160-Watt, 250-Ohm Adjustable Resistor—**
 Vitreous enamel coating. 8 1/2" x 1 1/2" dia. With slider. C4443. Ea. **98c**
- Output Meter—**0-10 output units. 7.8 ohms, 10.5 m.v. movement. 2 1/2" flange mount. 5B4073. Ea. **\$4.95**
- 110-Volt A. C. Relay—**D.P.S.T. 1/4" silver contacts. 5B3995. Ea. **\$1.39**
- Headset and Chest Plate Mike—**Phone 300 ohm impedance. Mike 200 ohm carbon type. 5B7059. Ea. **\$5.95**
- Power Transformer—**117/120 Volt Pri. 800 Volt, 200 M. A. center tapped sec. 5B5116. Ea. **\$3.95**
- Tube Puller—**Safeguard against burnt fingers. 5B6967. Ea. **59c**
- Walden Midget Socket Wrench Set—**3/16" to 7/16" sockets. Standard Set. C15574. Ea. **\$5.00**
- Crystal Holder Socket—**Made of low loss steatite. 1/2" spacing for .095 pins. 5B6912. Ea. **14c**
- Interstage Transformer—**10,000 ohm pri., 100,000 ohm sec. Overall size: 2" x 1 1/2". 5B5110. Ea. **\$1.99**

 ★ **Ready Soon!**
 ★ CONCORD'S great new postwar COMPLETE Catalog—128 thrilling pages of nationally-known ham equipment parts, kits, supplies, replacement parts. Also new Concord Radios and sensational line of Amplifiers. Mail coupon below for FREE copy.



CONCORD

RADIO CORPORATION

LAFAYETTE RADIO CORPORATION

CHICAGO 7

ATLANTA 3

901 W. Jackson Blvd.

265 Peachtree Street

CONCORD RADIO CORP.

901 W. Jackson Blvd., Dept. ST-46
 Chicago 7, Ill.

Please send me FREE a copy of your latest Catalog of Radio Parts, Accessories, and Equipment.

Name.....

Address.....

City..... State.....

**Now! A Better Soldering Tool...
THE KWIKHEAT**
THERMOSTATIC SOLDERING IRON

Has Built-in Thermostat Control!



6 TIP STYLES

- #0—\$1.25
- #1—\$1.25
- #2—\$1.25
- #3—\$1.25
- #4—\$1.25
- #5—Holding Pot for tinning—\$1.25

HOT, READY FOR USE ONLY 90 SECONDS after plugging in! Kwikheat is the only soldering iron with a thermostat built into the tool itself—maintaining the proper level of heat for most efficient, economical operation. **SAFE!**... Cannot overheat—**ECONOMICAL!**... Lasts longer—saves tips and requires less retinning. **POWERFUL!**—225 watts—yet exceptionally light weight (14 oz.). Well-balanced with cool protecting plastic handle. Modern streamlined design. Six interchangeable tip styles adapt one Kwikheat Iron to all your soldering jobs. You will be proud to own America's finest and most versatile soldering tool... from tip to plug Kwikheat is in a class by itself. Ask your dealer to demonstrate the quick-heating feature now! **patented*

Kwikheat Iron with choice of any one tip . . . \$11.00
Set of 5 tips, consisting of #0, #2, #3, #4, and #5 . \$5.00

Dept. Q-4, Kwikheat Division of
SOUND EQUIPMENT CORP., 3903 San Fernando Rd., Glendale, 4 Calif.

Adson
RADIO CO.
Dept. Q—221 FULTON ST. N. Y. 7, N. Y.
EVERYTHING FOR AMATEURS AND SERVICEMEN
COMPLETE LINE OF ELECTRONIC EQUIPMENT



Founded in 1909

**RADIO TELEPHONY
RADIO TELEGRAPHY**

Courses ranging in length from 7 to 12 months. Dormitory accommodations on campus. Advanced students eligible for practical training at KPAC, 1 KW broadcast station owned and operated by Port Arthur College. New students accepted monthly. If interested in radio training necessary to pass F.C.C. examinations for first-class telephone and second-class telegraph licenses, write for details.

PORT ARTHUR COLLEGE PORT ARTHUR TEXAS

(Continued from page 144)

should be used to allow for adequate separation between connecting rods.

The coupling may be any size desired, and the length should be about one inch, for convenience in drilling. — Isaac L. Newton, VE3ACW.

— * —

**AN AUDIO OSCILLATOR
IN THE RECEIVER**

HERE'S what I believe to be the simplest solution to the problem of setting up an audio oscillator to keep that fist in shape. Here's the deal. Take any radio receiver, add a condenser (about 0.01- μ fd.) and a key in series between the second

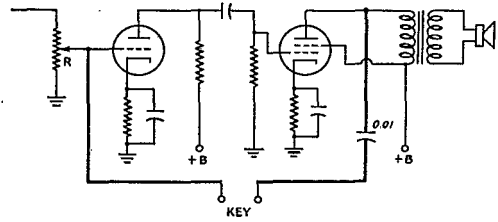

Fig. 7 — Converting the audio amplifier of a receiver to an audio oscillator. The volume control, R, becomes the pitch control when the coupling condenser and key are wired in as shown by the heavy line.

a.f. plate and the first a.f. grid as shown in Fig. 7. The volume control, R, becomes a pitch control as it affects the feedback. When the key is open, the receiver functions normally. There are no batteries, power supplies, or gadgets kicking around in the way, nothing but the receiver that was there in the first place. — T/5 James E. Shea.

— * —

**FEEDING PARASITIC ARRAYS WITH
COAXIAL LINE**

NOW THAT the RG-series coaxial cable, developed during the war, is becoming available at moderate cost, more fellows will be looking for ways to use it as transmission line for feeding 3- and 4-element arrays. The method shown in Fig. 2 gives good efficiency and is stable mechanically as well.

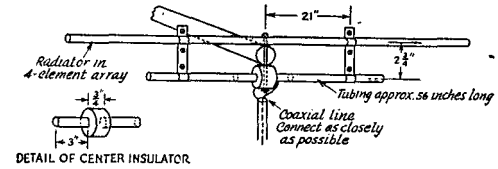

Fig. 2 — Matching system for RG-series coaxial cable.

The driven element is a single piece of tubing cut to the proper length, as determined by formula, or adjusted to resonance. The matching arrangement is a mechanically-solid version of the familiar delta. Dimensions given are for a

(Continued on page 152)

HELPS FOR HAMS



★ ★ ★

Hints & Kinks

Amateurs are noted for their ingenuity in overcoming by clever means the minor and major obstacles they meet in their pursuit of their chosen hobby. An amateur must be resourceful and a good tinkerer. He must be able to make a small amount of money do a great deal for him. He must frequently be able to utilize the contents of the junk box rather than buy new equipment. Hints and Kinks is a compilation of hundreds of good ideas which amateurs have found helpful. It will return its cost many times in money savings — and it will save hours of time. Newly revised. *Price 50 cents*

The Radio Amateur's License Manual

To obtain an amateur operator's license you must pass a government examination. The License Manual tells how to do that — tells what you must do and how to do it. It makes a simple and comparatively easy task of what otherwise might seem difficult. In addition to a large amount of general information, it contains questions and answers such as are asked in the government examinations. If you know the answers to the questions in this book, you can pass the examination without trouble. *Price 25 cents*

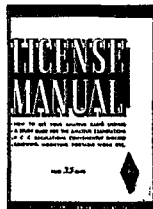

How to Become a Radio Amateur



Universally recognized as the standard elementary guide for the prospective amateur. Features equipment which, although simple in construction, conforms in every detail to present practices. The apparatus is of a thoroughly practical type capable of giving long and satisfactory service — while at the same time it can be built at a minimum of expense. The design is such that a high degree of flexibility is secured, making the various units fit into the more elaborate station layouts which inevitably result as the amateur progresses. Complete operating instructions and references to sources of detailed information on licensing procedure are given. *Price 25 cents*

Lightning Calculators

RADIO, Type A — This calculator is useful for the problems involving frequency, wavelength, inductance, capacity, etc. It has two scales for physical dimensions of coils from one-half inch to five and one-half inches in diameter and from one-quarter to ten inches in length; a frequency scale from 400 kilocycles through 150 megacycles; a wavelength scale from two to 600 meters; a capacity scale from 3 to 1,000 micro-microfarads; two inductance scales with a range of from one microhenry through 1,500; a turns-per-inch scale to cover enameled or singlet silk covered wire from 12 to 35 gauge, double silk or cotton covered from 0 to 36 and double cotton covered from 2 to 36. Using these scales in the simple manner outlined in the instructions on the back of the calculator, it is possible to solve problems involving frequency in kilocycles, wavelength in meters, inductance in microhenrys and capacity in microfarads. Gives the direct reading answers for these problems with accuracy well within the tolerances of practical construction. \$1.00

OHM'S LAW, Type B — With this concentrated collection of scales, calculations may be made involving voltage, current, and resistance, and can be made with a single setting of a dial. The power or voltage of current or resistance in any circuit can be found easily if any two are known. This is a newly-designed Type B Calculator which is more accurate and simpler to use than the justly-famous original model. It will be found useful for many calculations which must be made frequently but which are often confusing if done by ordinary methods. All answers will be accurate within the tolerances of commercial equipment. \$1.00

ABOVE PRICES ARE POSTPAID • PLEASE DO NOT REMIT IN STAMPS

AMERICAN RADIO RELAY LEAGUE, INC., West Hartford, Connecticut

TERMINAL IS YOUR BEST BET FOR BETTER BUYS!

**HEADQUARTERS
FOR AMATEUR
EQUIPMENT**



New Stock!

**20 and 40 METER
MOUNTED CRYSTALS**

A "best seller" at TERMINAL! Wide selection of frequencies. Plug into octal socket or standard crystal socket. Accurately calibrated, low drift over wide temperature range. Mtg. spacess than 1/2 x 3/4 inch.

Type Z-3. 14001 to 14399 kc.....\$3.50 net
Type Z-2. 7001 to 7399 kc..... 2.65 net

Comes Spring, A Ham's Fancy Turns To . . . Antennas

Ground plane for both 144-148 Mc. and 220-225 Mc. bands. Compact, low angle radiation, broad band response and non-directional. Use with 50 to 72 ohm coaxial cable. Supplied complete with coaxial coupler, detailed instructions and response curves. . . . \$12.25 net

5 element beam for 144-148 Mc. High forward gain really boosts your signal strength! Extreme light weight allows high

installation on light poles. No adjustment necessary — attach 2" open wire line and use. Complete with instructions. Kit of elements. . . . \$5.50 net

Complete kit, including elements, wood frame and stand-off insulators. . . . \$8.50 net

Johnson O Antenna, 10 meter band. Model 10QS, complete. . . . \$5.09

Feeder Spreaders — Best quality, glazed porcelain. 2" — 9c ea., 4" — 12c ea., 6" — 15c ea.

Johnson Antenna Insulators — 7" long, No. 107 — 42c ea., 12" long, No. 112 — 54c ea.

Antenna Wire — Solid enameled copper wire. Prices per 100 ft. No. 14 — 66c, No. 12 — 96c, No. 10 — \$1.50.

Copperweld Enameled Antenna Wire. High tensile strength, will not stretch. Prices per 100 ft. No. 14 — 75c, No. 12 — \$1.14, No. 10 — \$1.65.

300 Ohm Amphphenol Twin-lead Cable, Polystyrene insulation. Per foot — 3c.

Relay Specials
6 and 12 volts D.C., 10 amp. contacts, DPDT. . . . \$1.49

110 volts A.C., ceramic insulation, DPDT antenna change-over, 10 amp. contacts. . . . \$1.89

6 volt D.C. antenna relay, ceramic insulation, 3PDT 10 amp. contacts. . . . \$2.49

Sensitive relay, 10,000 ohms. DPDT. . . . \$1.95

Time delay relay, 30 second pre-heating high voltage rectifiers, 20 amp. contacts, 100 volt AC. . . . \$4.65

Advance 400, Antenna change-over, DPDT 110 volt AC. \$5.29

Visit our Communication RECEIVER DEPT. All sets on demonstration. Prompt Deliveries!

TERMINAL Radio Corporation

85 CORTLANDT STREET • NEW YORK 7, N. Y. • WOrth 2-4415

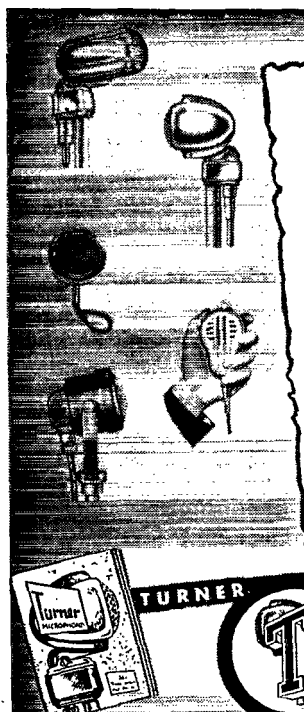

**The New Turner
211 Dynamic**

STUDIO PERFORMANCE FOR YOUR RIG

Precision engineered for outstanding performance, this new Turner 211 Dynamic utilizes a new type magnet structure and acoustic network. The high frequency range is extended and the extreme lows raised 2 to 4 decibels. Its unique diaphragm structure results in extremely low harmonic and phase distortion without sacrifice of high output level. A sensitive unit, yet ruggedly Turner-built for dependable use indoors or out under the most difficult operating conditions. Modernly styled case finished in rich brushed chrome. Level — 54DB. Range 30-10,000 cycles. Equipped with tilting head, balanced line output connection, and 20-ft. heavy duty removable cable set.

Ask Your Dealer or Write

Licensed under U. S. Patents of the American Telephone and Telegraph Company, and Western Electric Company, Incorporated

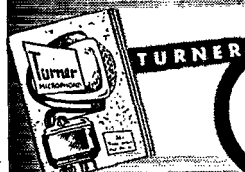
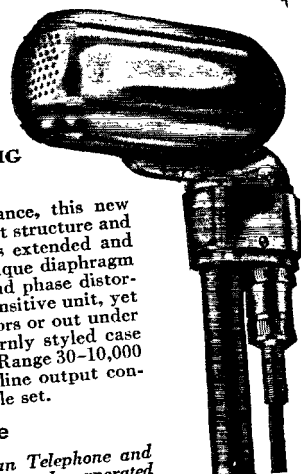

TURNER

pioneers

in the communications field

Microphones

THE TURNER COMPANY
917 17th Street N. E.
CEDAR RAPIDS, IOWA

Complete Microphone Catalog
Write for Your Free Copy

Crystals licensed under patents of the Brush Development Co.

Announcing

NEW

PR

**SUPER
10-METER
CRYSTALS**



Available for the FIRST
Time at Your Jobber's

The new Z5 unit, when used in our simple circuit, is no more critical than an ordinary 40 or 80 meter crystal. High power output without damage to crystals is now possible with the new P R Super 10 meter crystal. P R Super 10 meter crystals, with a temperature coefficient less than 2 cycles per M. C. per degree centigrade, are now available at your favorite jobber's.

P R crystals can "take it" and really "put out." Every P R crystal is *unconditionally guaranteed*. See your jobber today — ask him for a copy of the descriptive booklet on P R 10 meter crystals.

PETERSEN RADIO COMPANY

2800 WEST BROADWAY — TELEPHONE 2760

COUNCIL BLUFFS, IOWA



Buy Direct from Indiana's Most Exclusive
"HAM-GEAR" Supply House

New Models Now at Lowest Prices

● National
● Hammarlund
● Hallicrafters

• RME • RCA • HK • B & W • Aerovox • Astatic •
Biley • Presto • Stancor • Taylor • Triplett • Temco
• Vibroplex

and 100 other top lines to choose from. Rush us your
order now with a \$5.00 deposit for quickest possible
delivery.

We're making deliveries NOW!

W9KJF, W9LVI, W9MMJ, W9OEK, W9VEK, W9TE

VAN SICKLE
RADIO SUPPLY CO.

34 W. OHIO ST. • INDIANAPOLIS 6, IND.



RCA INSTITUTES, INC.

Offer thorough training courses
in all technical phases of

RADIO and TELEVISION

WEEKLY RATES

DAYS — EVENINGS

VETERANS: RCA Institutes is approved
under G. I. Bill of Rights

For Free Catalog write Dept. ST-46
RCA INSTITUTES, INC.

A Radio Corporation of America Service
75 Varick Street, New York 13, N. Y.

(Continued from page 148)

50-ohm cable feeding a 28-Mc. array having four elements and close spacing, but a good match can be obtained with other cable sizes and numbers of elements by sliding the clamps along the driven element and matching section until maximum loading and minimum standing-wave ratio are obtained.

The center insulator for the matching section was made from a section of one-inch diameter insulating material $6\frac{3}{4}$ inches long. This was turned down to the proper diameter to fit inside the tubing for a length of three inches at each end. This center insulator should be bolted to lateral member in the case of a "plumbers' special" shown in the sketch, or otherwise fastened in place to keep the matching section in alignment with the driven element. The coaxial line should be connected to the two sides of the matching section with as little slack as possible, and the line should be fastened in place, to the lateral member or to the mast, by means of a hose clamp.

— L. L. Pafford, W6OWX

**SWITCH
TO SAFETY!**



GLAUB XTALS!

Amateurs...

DO YOU know where you are in the Radio Spectrum? With a Glaub Xtal you can be sure. Our Xtals are ground to within .03% of specified frequency and guaranteed, with a temperature coefficient of less 3 cycles per megacycle per degree centigrade. They can't be beat! Attractive, convenient holders to fit any set. A custom built Xtal to your specifications at a standard price.

DELIVERED 48 HOURS AFTER RECEIPT OF ORDER

LET US PUT YOU IN YOUR PLACE ON THE AIR!

PIONEER ELECTRIC COMPANY

Western Distributors of Glaub Crystals

3700 East Olympic Boulevard • Los Angeles 23, California

152

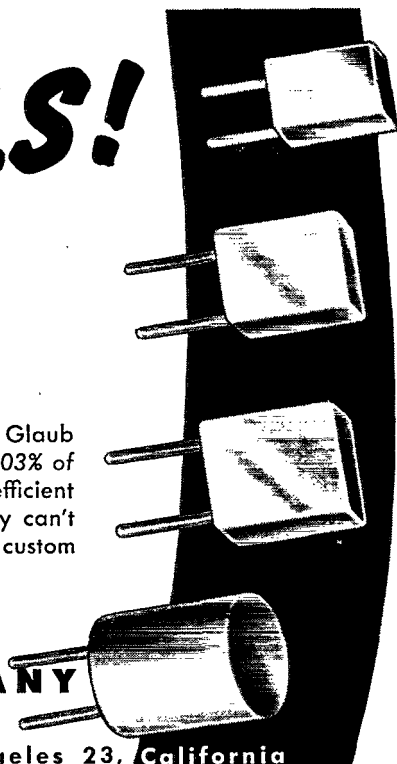

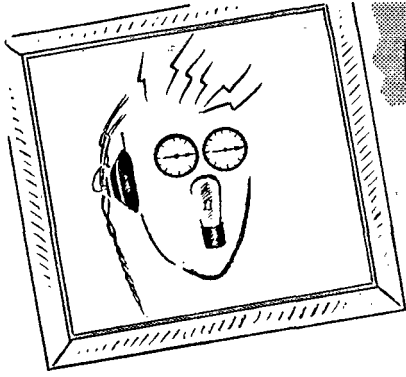

Portrait of *The Ham*

He has likes, dislikes and strong habits. His pet hate is wasting money and time getting the parts and equipment he urgently needs, so he develops the habit of ordering from SUN RADIO (and he likes it.)

Because so many of his fellow hams have the same idea, Sun has had to move into larger quarters. We now occupy the ENTIRE 3rd floor at 122-124 Duane St., New York City. Naturally we're in better shape than ever to supply the ham with exactly what he wants — in a hurry.

And another thing about him. He's not bashful about writing Sun for information on anything his heart desires.

FREE OFFER

Condensed chart of Graphical Symbols for Electronic Diagrams as standardized by the RMA (includes those until recently kept secret). Just ask for it Address Dept. ER.

HAMMERLUND HQ-129-X Amateur Communications Receiver



Tuning Range — .54-31 mc. in six bands
Calibrated band spread on ham frequencies
11 Tubes
Approx. 3 watts undistorted audio, 6 ohms impedance
S-meter, calibrated 1 to 9 in steps of approximately 6 dB; Xtal filter, for single signal CW; AVC; ANL..... Approx. **\$129.00**



FOR IMMEDIATE DELIVERY

DUMONT 164E OSCILLOSCOPE

For your shack,
lab or shop

INPUT IMPEDANCE: Vertical, 1,000,000 ohms; Horizontal, 800,000 ohms; Maximum potential, 400 volts d-c.

FREQUENCY RANGE: Vertical and horizontal amplifiers both uniform within ± 3 db. from 5 to 100,000 cycles.

DEFLECTION SENSITIVITY: Maximum vertical, 0.70 rms volt/in.; maximum horizontal, 0.55 rms volt/in.; Direct sensitivity of cathode-ray tube is 30 rms volt/in.

SWEEP CIRCUIT: Variable over range from 15 to 30,000 cps. Return trace elimination. Synchronization from vertical amplifier

or external signal. **\$105.00**

SUN RADIO & ELECTRONICS CO., Inc.

122-124 Duane St.

NEW YORK 7, N. Y.

BARCLAY 7-1840

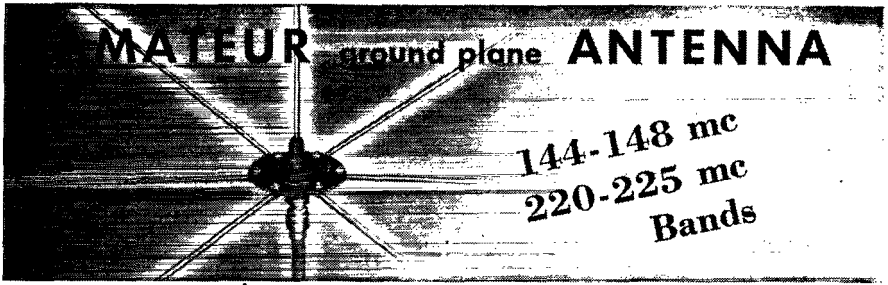

144-148 mc
220-225 mc
Bands

Now available to amateurs, this brilliantly performing antenna was originally designed for the Air Corps to operate at a much higher frequency. Skillful redesign has resulted in a remarkable antenna for these two new amateur bands. Merely screwing on an extra tip to each radial and the dipole converts it from the 220 mc to the 144 mc band. The graphs show the small loss encountered with 72 ohm coaxial cable, such as RG-10/U, and the even smaller loss with 50 ohm coaxial cables such as RG-8/U, 9/U or 10/U. The antenna is supplied ready for assembly with type "N" UG-21/U weatherproof connector for use with any of the above-mentioned cables.

FOR IMMEDIATE DELIVERY at your local dealer's, neatly packaged, complete with instruction leaflet. If he is unable to supply you, send us his address. Net List Price \$12.00.

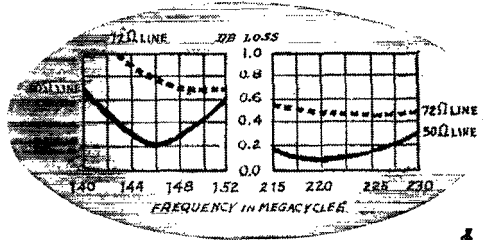

The WORKSHOP ASSOCIATES

Specialists in High-Frequency Antennas

66 NEEDHAM STREET, NEWTON HIGHLANDS 61, MASSACHUSETTS



PLASTICON*

CAPACITORS

*PLASTICONS — plastic film dielectric capacitors.

OBSOLETES

PAPER CONDENSERS!

Smaller, lighter, more economical. Specified by Signal Corps, Air Corps and Navy for more severe operating conditions than oil-paper capacitors. Closer tolerances, wider temperature range, greater safety factor, longer life.

Condenser Products Company

1375 NORTH BRANCH STREET
CHICAGO 22, ILLINOIS

MAKE YOUR OWN...

Xtals
AT HOME



ANY FREQUENCY
ACCURATE • RELIABLE

Designed for the Amateur... this kit provides all necessary instructions and supplies to process a semi-finished oscillating blank to any desired frequency in the Amateur Band.

Complete Kit

• Includes 4 Crystal Blanks and All Equipment you need.

Only **\$8.75**

F. O. B. KANSAS CITY

DEALER'S FRANCHISES OPEN

IT'S FUN! Process YOUR OWN CRYSTALS

Take extra pride in a rig operating with a crystal of your own processing. Why use expensive factory calibrated and mounted crystals, when you can enjoy making your own and develop a new skill in the process? *The difference in cost will permit you to own more crystals!*

This kit contains four oscillating blanks prepared to rigid professional specifications involving type of cut and other important factors to insure a high standard of performance. Just follow the simple instructions and you can grind and etch your crystals to spot frequency.

GENERAL ELECTRONICS CO.
116 WEST 5th STREET
KANSAS CITY 6, MO.

Please send the name and address of the nearest dealer who can supply me with your Frequency and Activity Control Kit.

Name _____

Address _____

City _____ State _____

GENERAL ELECTRONICS COMPANY
116 West 5th Street
Kansas City 6, Missouri

HAM-ADS

(1) Advertising shall pertain to radio and shall be of nature of interest to radio amateurs or experimenters in their pursuit of the art.

(2) No display of any character will be accepted, nor can any special typographical arrangement, such as all or part capital letters be used which would tend to make one advertisement stand out from the others.

(3) The Ham-Ad rate is 30c per word, except as noted in paragraph (6) below.

(4) Remittance in full must accompany copy. No cash or contract discount or agency commission will be allowed.

(5) Closing date for Ham-Ads is the 25th of the second month preceding publication date.

(6) A special rate of 7c per word will apply to advertising which, in our judgment, is obviously non-commercial in nature and is placed and signed by a member of the American Radio Relay League. Thus, advertising of bona fide surplus equipment owned, used and for sale by an individual or apparatus offered for exchange or advertising inquiring for special equipment, if by a member of the American Radio Relay League takes the 7c rate. An attempt to deal in apparatus in quantity for profit, even if by an individual, is commercial and all advertising by him takes the 30c rate. Provisions of paragraphs (1), (2), (4) and (5), apply to all advertising in this column regardless of which rate may apply.

(7) Because error is more easily avoided, it is requested signature and address be printed plainly.

Having made no investigation of the advertisers in the classified columns, the publishers of QST are unable to vouch for their integrity or for the grade or character of the products or services advertised

QUARTZ—Direct importers from Brazil of best quality pure quartz suitable for making piezo-electric crystals.
Diamond Drill Carbon Co., 719 World Bldg., New York City.

AMATEUR radio licenses. Complete code or theory preparation for passing amateur radio examinations. Home study and resident courses. American Radio Institute, 101 West 63rd Street, New York City.

WRL Transmitting kits—15, 35, 70, and 150-watt units—low priced. All makes of receivers, both new and reconditioned. Leo offers best trade-in deal, and easy time payment plan. One of the country's largest parts supply houses. Write today for free catalog, special radio map offer, tube-base calculator offer, and other items. Leo, at World Radio Labs, Dept. HA, Council Bluffs, Iowa.

CRYSTALS: Complete units mounted in holders $\frac{3}{4}$ " pin spacing to fit 5-prong socket. 3.5 mc. 14 mc. bands within 5 kc. your selected frequency. \$3.30 ea. Blanks large $\frac{3}{4}$ " by $\frac{7}{8}$ " oscillating blanks, 3.5 mc. and 7 mc. bands, \$1.00 each. Immediate shipment. No priority required. Rex Bassett, Inc., Ft. Lauderdale, Fla.

HAM crystals: \$2.50 within 10 kc. of specified frequency; excellent oscillators guaranteed; 3500 kc. to 8000 kc.; Army type. FT 243 holders. L. Kipp, 277 Broadway, N.Y.C., 7.

CRYSTALS: Ham and commercial. Low TC. Fast service on 80 and 40 = 1 mc., \$2.65; 20 meter = 2 kc., \$3.50; 100 kc. standard crystal, \$12.50; 1000 kc. standard crystal, \$6.50; 465 & 456 filter crystals at \$4.50. Filters, 80, 40, & 20 ft octal sockets. Standards fit 5-prong socket. Write me your crystal problems. Al, Scientific Radio Products Co., 738 1/2 W. Broadway, Council Bluffs, Iowa.

QST, 1925-1938, 146 copies, also August, 1923. Make offer. Cash or trade for ham equipment. WICTC, Doolittle, 51 Pond St., Milford, Conn.

FOR SALE: National HRO complete, like new, \$140. Dual diversity DD-1 Hallicrafters, practically new, \$350. Want good recorder, also 16 mm. sound on film projector. Write Joe Taber, 20420 Riopelle, Detroit, Mich.

ALL new: 814, 3AP1, 10-watt modulator, 300 m.a. Simpson meter; 25-watt c.w. transmitter. Sell, swap for SX-25, 1250 .300 Ma. plate transformer and filter components. John A. Masters, 1305 Trinity, Austin, Texas.

WANTED: Mellson signal shifter (de luxe). In good condition. Archie Foster, Colton, N. Y.

WANTED: One set each A, B and C coils for National AG-5 receiver. McCasland, WINFE, WHOL, Woods Hole, Mass.

FOR SALE: Abbott DK-3, \$15. Excellent condition. Cooke, 21 St. Paul's Court, Brooklyn 26, N. Y.

SELL Westinghouse 5" oscilloscope, containing six 6L6s, two 6X7s, one 6A7, one 5Y4, one 6Y7, one 6H6, one 5B4, all Thordarson, stancor, chokes, filters. Weight 120 lbs. Offer? Altunian, 304 2nd St., S.W., Chisholm, Minn.

WANTED: HRO Senior 20 and 40-meter bandsread. Coils, Green, W3BEN, Box 161, Hagerstown, Md.

WANTED: Thordarson T-11M77 modulation transformer. State condition and price. Karl Pearson, W9HXE, 453 S. Harvard Ave., Villa Park, Ill.

NATIONAL HRO, loudspeaker, power supply, ten coils (four bandsread), excellent condition, \$220.00 f.o.b., Whettemore, W2CUZ, 36 Masterton Rd., Bronxville, N. Y.

MACHINE shop service for amateurs. Send sketch or drawings. Let us make it. Brown Brothers Machine Co., E. Brown, W9BMM, 5370 Southwest Ave., St. Louis, Mo.

WANTED: Television iconoscope tube 1847. Captain Osborne, A.C., Box 1723, March Field, California.

COAXIAL cable, 15 ft. lengths, with two connectors, 49c. Mail orders, 75c. Many 25-cycle and 220 v. filament and plate transformers. Open 1-9 PM. Schuh's Radio Parts, 1253 Loyola Ave., Chicago 26, Ill.

K4KD, K4HEB mail address, Box 1061, San Juan 5, P.R.

SURPLUS: New 805s, \$6.50 ea. Sepassy, 39 9th St., No. Arlington, N. J.

SELSYN motors, large size. Write or illustrations, description, etc. J. A. Weber, 150 Maple Ave., Hershey, Penna.

125-watt c.w. transmitter, 20-40-80. Professional construction. Relay keyed and controlled. Easily adaptable to phone. \$130. Less than parts cost. John Moses, 15 Smith Street, Weylesley, Mass.

WANTED: Commercially-built transmitter. Collins, Hallicrafters preferred, phone. Also receiver. Cash. Above must be in perfect condition. What have you? Arnold Badt, W8VBW, 169 Britain Ave., Benton Harbor, Michigan.

800-watt transmitter, c.w. and phone, commercially built, 2 m.c. to 24 m.c., E.C.O. Extra set of tubes. Speech amp. SX-28A and speaker, audio osc. Instructograph bought in 1946, never on air. Also Thordarson, Kenyon and Chicago transformers, chokes, 2 Elm k.w. tubes, meters, Variac, resistors, etc. \$1250.00 f.o.b. Earle Davis, 4306 W. 60th St., Los Angeles, Calif.

QSLs-SWLs, Fritz, 1213 Briargate, Joliet, Illinois

RECEIVERS: RME, Hammarlund, National, Conklin Radio, Bethesda, Md.

COAXIAL cable available. RG 8/U (new material) in 29' lengths, with end fittings, \$3 per length. C.F. Moretti, Blvd., Peekskill, N.Y.

QSLs. Samples. Carter, W8JQT, 749 So. Plymouth, Rochester 8, N.Y.

RADIO tubes, parts, condensers, here bargain lists. Potter, 1314 McGee, Kansas City 6, Mo.

YOUR station call plate beautifully cast in aluminum, size 2" x $\frac{5}{8}$ ". Two styles, Type P, with tapped bosses for panel mounting. Type D for desk use. Price either type, \$1.50. Duplicates of same type, 75c each. Print your call plainly. P & H Sales Co., 619 Jasper Street, Kalamazoo 31, Mich.

SACRIFICE new and used radio-electronic equipment. New in original cartons. Write for list. F. Corgiat, W90LJ, 322 West B'way, Centralia, Ill.

RADIO parts and equipment, new and used, for sale at tremendous discounts. Write for free list, Stephen Duma, W2HLD, 128 Tallman St., Staten Island 9, New York.

QSLs? QSLs? SWLs? Samples? Biley Crystals? RME-45a, Callbooks? Sakkers, W8DED, Holland, Mich. (Veteran).

TUBES: 803, \$8; 8025, \$6.60; 807, \$1.60. U.S.A. only. Send remittance for prepaid shipment. Free list. Offer expires 30 days. Senesec, W9CNO, 7335 W. Balmoral, Chicago 31, Ill.

SELL several 829B tubes, unused. Hoeft, W9JZU, P.O. Box 22, Parsons, Kans.

WANTED: Collins 30J transmitter. V. D. Strang, W9RFT, 919 West Ninth St., Waterloo, Iowa.

TRADE: German aircraft transmitter-receiver (42-48 Mc.) unit, Dynamator mounted separately. Diagram-data in German. For good communications receiver. H. Schützmann, 1605 Vyse Ave., New York City.

SELL Hallicrafters HT-1 transmitter complete with tubes, crystal 40, 20, 10 meters. Hallicrafters SX-10 receiver complete with speaker. Make offer. Mrs. Gertrude Raub, Main, Nantucket, Mass.

WANTED: SW3 complete with coils and power supply or Howard 435A. Gantz, W8QMN, 3107 Midgard, Columbus, Ohio.

WILL pay top price for Mims beam complete in good condition. Also need two plate power transformers 1500 to 2000 each side center 500 milliamps. Driver transformer, 500 ohms to grids, Class B. L. A. Benson, 3601 Lindell Blvd., St. Louis 8, Mo.

WANTED: Signal shifter Deluxe, prefer inclosed dial 1941 gray. Utah 5-10-20. Thordarson 100W or Universal, Harvey, Stancor, Thordarson; compression speech amplifier, 19 series, chokes, any 19P57 to 19P67, 19D04, 11M77, 19M17, 13R15, -16, 19F94, 92F20; TW75, 813, 811 tubes. Excellent or new bargains. Lawson, W9BQZ, 1382 Park Ave., Plainfield, N.J.

FOR SALE: QST's: 1924 to 1946, complete. Excellent condition. Make offer or trade plus cash for Winchester Model 70, Winchester Model 52 or Remington Model 37 rifle. W. G. Ballard, 1905 Juniata Rd., Norristown, Pa.

SELL or swap: pair 203As, HV filter condensers, few BC fundamental stals, featherweight car-inset phones, throat mike, other ham gear. Write for details. Radio, 309 Beechwood Ave., Norfolk 8, Va.

PRACTICALLY new Hallicrafters SX-36 high frequency receiver, audio frequency amplitude modulation. Kato Engineering, Mankato, Minn.

IN STOCK: Hallicrafters Signal Corps HT4E transmitters, complete with coils, for 10-20-40-80 meters, at big savings. Available on 6% terms. Trade-ins accepted. Write for details. Henry Radio, Butler, Mo., and Los Angeles 25, Calif.

FOR SALE: Abbott TR-4 and power supply, also Abbott DK-3, portable transceiver, one Stancor 10P transmitter, ready to use, 10 to 80 meters, send for list. P.O. Box 361, Williamsport, Penna.

COMPLETE 450-watt phone transmitter, 6L6 oscillator, TZ-40 doubler, TZ-40 buffer, push-pull T-55 final, Class B 203A modulator. Includes 30-watt speech amplifier, Turner 22X mike. All stages metered. Relay controlled. Operation from 75 to 10 meters. Make offer. W. J. Nolan, W9TQL, 3442 Clarence Ave., Berwyn, Ill.

WANTED: Prescaler DB20, new or slightly used. Walter Camp, Jr., 236 Emerson St., Washington 11, D.C.

NAMEPLATES: Professional touch to equipment. Crackle or plastic. Any size and lettering. Send for circular and sample. Berns Olson, 985 Sonoma Ave., No. Sacramento 15, Calif.

SOUVENIR Jap quartz crystals with original holders and boxes in 80 or 40 meter bands; \$10 each. High quality quartz crystals in 80 or 40 meter bands without holders. Guaranteed, \$2.00 each. Medlock, 732 No. Spruce, Colorado Springs, Colo.

CRYSTALS: amateur license-holders only: 7000 to 7425 Kc.; 4th harmonic for 10 meter band; 9000 to 9250 Kc. 16th harmonic for 144-148 Mcs. band. $\frac{1}{2}$ " square blanks, BT cut, peak activity, stable at 23° C. Blank only (in band), \$1.50; blank only (your choice of frequency within 10 Kc.), \$2; blank and electrodes (your choice, within 10 Kc.), \$2.25; complete etched crystal unit (your choice, within 200 Kc.), \$4. Beaumont Electric Supply Co., 1319 So. Mich. Ave., Chicago 5, Ill.

QSLs, SWLs, free new style samples, guaranteed printing. Richard Franzen, W3DEE, Maple Shade, New Jersey.

Eyes for your receiver

Panoramic Reception with the PANADAPTOR

a "must" for
modern radio show



With the PANADAPTOR connected to your receiver...

... keep track of many more
stations than ever before!

... watch 40, or more, signals
while listening to one!

... locate those hard-to-find signals, since
they can now be previewed 40, or more,
times longer than they are usually heard
while tuning the receiver!

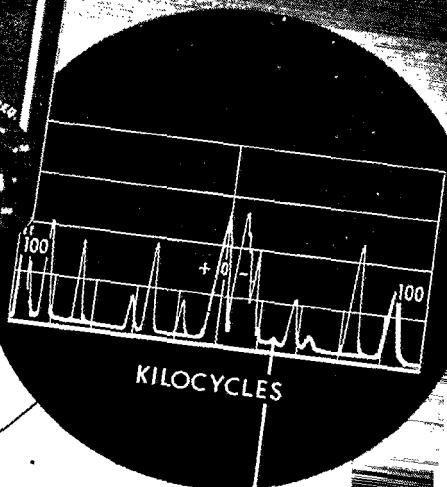

The PANADAPTOR provides Panoramic Reception. That is—all stations within any selected 200 kc. portion of a band produce on the Panoramic screen corresponding deflections indicating station characteristics. And for more

detailed examination, a single signal can be magnified to occupy the entire screen. This flexibility makes the PANADAPTOR ideal for all sorts of amateur applications for listening and transmitting.

You must see the PANADAPTOR in operation to realize how it is revolutionizing and simplifying amateur technique.

ONE YEAR GUARANTEE against defects in parts or workmanship (excluding tubes). Handbook with full installation, operating, application and maintenance instructions furnished with each PANADAPTOR.

PANADAPTOR Model PCA-2 Now
available at Leading Radio Parts Jobs.
Ask for demonstration. Amateur
price, complete with ten tubes and
batteries for 115 V.,
cycle operation..... **\$99.75**

Write to us for a free descriptive booklet.

PANORAMIC

CABLE ADDRESS
PANORAMIC, NEW YORK



RADIO CORPORATION

Designed for



Application

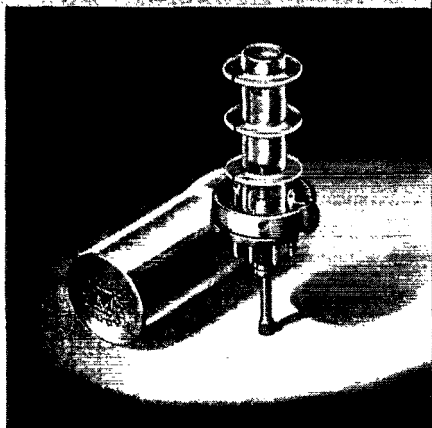

**The No. 74001
Tunable Coil Form**

Another new Millen "Designed for Application" product is the No. 74001 permeability tuned, shielded plug-in coil form. Standard octal base of low loss mica-filled Bakelite, polystyrene 1/2" diameter coil form, heavy aluminum shield, iron tuning slug of high frequency type, suitable for use up to 35 mc. Adjusting screw protrudes through center hole of standard octal socket. Special extension terminals facilitate connection to base pins.

**JAMES MILLEN
MFG. CO., INC.**

MAIN OFFICE AND FACTORY
**MALDEN
MASSACHUSETTS**



Index of Advertisers

	<i>Page</i>
Adson Radio Company	148
Aireon Manufacturing Corp. (Lewis Electronics)	106, 107
Allied Radio Corp.	133
American Lava Corp.	7
American Phenolic Corp.	119
American Radio Institute	130
Ashe, Walter	140
Astatic Corp., The	95
Ayers Automatic Code Machines	138
Barker & Williamson	146
Bell Telephone Laboratories	124
Birnback Radio Co.	126
Bliley Electric Co.	89
Brach Mfg. Co.	138
Bruno Tools	136
Burgess Battery Co.	116
Burlington Instrument Co.	129
Candler System Co.	116
Capitol Radio Engineering Inst.	91
Cardwell Mfg. Co., Allen D.	94
Carter Motor Co.	140
Centralab	1
Cleveland Inst. of Radio Electronics	100, 127
Collins Radio Co.	121
Commercial Radio Institute	126
Concord Radio Corp.	147
Condenser Products Co.	154
Cornell-Dubilier Elec. Corp.	135
Crystal Research Laboratories	130
Drake Electric Co.	98
Eitel-McCullough, Inc.	2
Electrical Reactance Corp.	120
Galvin Mfg. Co.	141
Gates Radio Co.	132
General Electric Co.	112
General Electronics Co.	155
Hallcrafters Co., The	4, 5
Hammarlund Mfg. Co.	85, 17
Harrison Radio Co.	117
Harvey Radio Co.	114
Hatry & Young	126
Henry Radio Shop	142
Hytron Electric & Radio Corp.	143
International Resistance Co.	131
Johnson Co., E. F.	111
Ken-Rad	93
Kwikheat Soldering Irons	148
Lewis Electronics	106, 107, 138
Maguire Industries	96, 97
Mallory & Co., F. R.	92
Marion Elec. Instrument Co.	109
McElroy Mfg. Co.	123
McGraw-Hill Book Co.	120
Millen Mfg. Co., James	158
Murdock Co., Wm. J.	128
Murray Hill Book Co.	137
National Co., Inc.	83, Cov. III
Newark Electric Co.	99, 101, 103, 105
Ohmite Mfg. Co.	8
Onan & Sons, D. W.	136
Panoramic Radio Corp.	157
Peerless Elec., Prod. Co.	102
Peterson Radio Co.	151
Pioneer Electric Co.	152
Port Arthur College	148
Radio Mfg. Engineers	115, 159
Radio Products Sales Co.	146
Radio Shack Corp.	113
Raytheon Mfg. Corp.	9
RCA Institutes, Inc.	152
RCA Mfg. Co.	Cov. IV
Seell & Co., R. G.	122
Shur-Antenna Mount, Inc.	144
Sperry Gyroscope Co.	145
Sun Radio & Elec. Co.	153
Sylvania Elec. Products Co.	160
Taylor Tubes Co.	125
Telegraph Apparatus Co.	122
Television Tech. Enterprises	130
Terminal Radio Co.	130
Triplet Elec. Inst. Co.	142
Turner Co., The	150
U H F Resonator Co.	140
United Transformer Co.	Cov. II
Valparaiso Tech. Institute	144
Valpey Crystal Co.	139
Van Sickle Radio Supply Co.	152
Vibronex Co.	144
Ward Leonard Elec. Co.	136
Western Electric Co.	134
Westinghouse Elec. Corp.	127
Wilcox Electric Co.	118
Workshop Associates, The	154
World Radio Laboratories	108

RME Announces CAL-O-MATIC

TWO SPEED TUNING
AND
CALIBRATED
BANDSPREAD



The RME 45 is now available with two outstanding improvements—Cal-O-Matic two speed tuning and calibrated bandsread.

Two speed tuning: "Tunes fast to cover the band. Tunes slowly to find the station." This is accomplished by a dual drive control mechanism which provides approximately five revolutions of a smaller knob to one revolution of the larger knob. Phone as well as CW operators will like the effortless way in which the small knob gives them the peak of a signal with the crystal filter in. Cal-O-Matic tuning, that's what RME engineers have termed this system. It enables automatic tuning and calibrated bandsread to go hand in hand. That also means better calibration of the entire frequency range of the receiver without any further adjustments—once the receiver comes out of the test room!

You'll like the new bandsread scale on the RME 45. Not only are the 3.5 mc., 7 mc., 14 mc., 21 mc. and 28 mc. amateur bands calibrated—but the scale also carries arbitrary divisions from 0-100. These make logging on any frequency both easy and accurate.

Spread? There's plenty! The 20 meter band, for example, takes up three inches on the dial. The large knob turns $2\frac{3}{4}$ times and the small one turns nearly 14 times when tuning from 14,000 to 14,400 KC. You'll find that Cal-O-Matic tuning provides the maximum in mechanical and electrical efficiency!

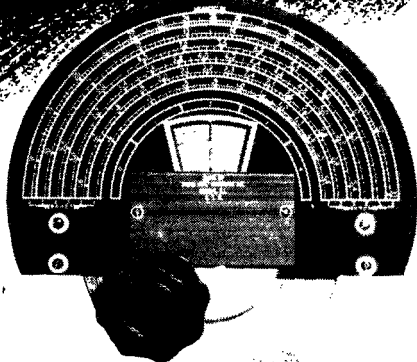

The two speed dial and calibrated bandsread scale provide the maximum in mechanical and electrical efficiency!

View of the translucent calibrated bandsread scale.

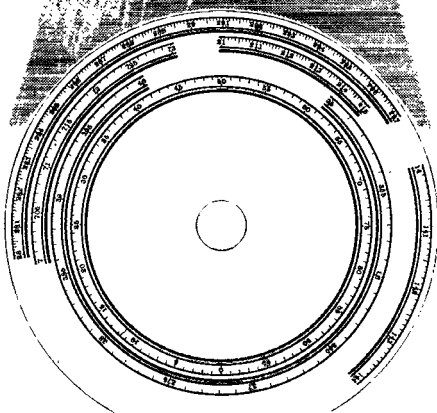

Specification Sheet
on Request



RME

FINE COMMUNICATIONS EQUIPMENT

RADIO MFG. ENGINEERS, INC.
Peoria 6, Illinois U. S. A.

GAS SWITCHING TUBES RADAR - TR's and ATR's



Sylvania Electric's line of Gas Switching Tubes includes both TR and Anti-TR types. These tubes have found their most extensive use in radar applications. The combination of an Anti-TR and a TR tube directs the high-power SHF transmitter pulse of the magnetron to the antenna, and directs the echo into the receiver... accomplishing the switching automatically.

Sylvania Gas Switching Tubes have potential applications in many fields outside of radar. Your inquiries are invited.

SYLVANIA ELECTRIC

Electronics Division, 500 Fifth Ave., New York 18, N. Y.

MAKERS OF ELECTRONIC DEVICES; RADIO TUBES; CATHODE RAY TUBES; FLUORESCENT LAMPS, FIXTURES, WIRING DEVICES; ELECTRIC LIGHT BULBS

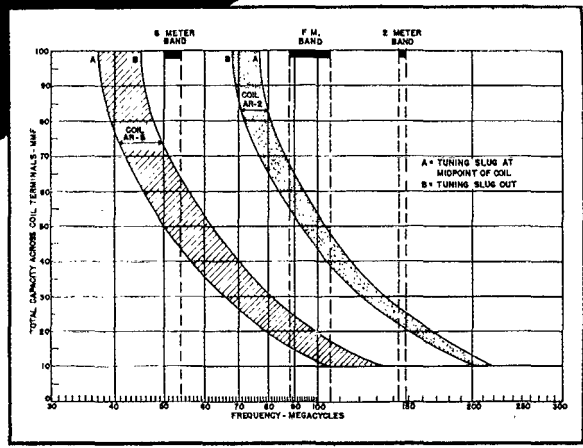
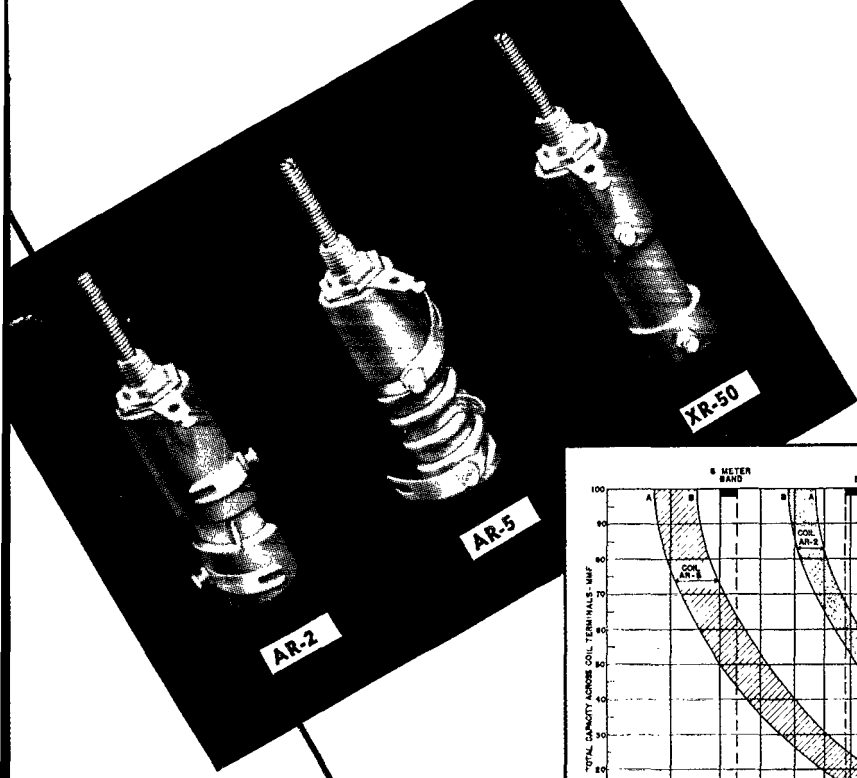

Here are the postwar high frequency coils amateurs will need for work with the micro-waves. Originally designed to meet Navy requirements, these new high-Q units have adjustable inductance and give fine performance as high frequency oscillators, RF stages or frequency multipliers. Two coils are available covering the range from 37 to 220 Mc. A blank form, Type XR-50, may be wound as desired. All three are small and compact, and all are designed for convenient single-hole mounting.



NATIONAL COMPANY, INC., MALDEN, MASS. U.S.A.

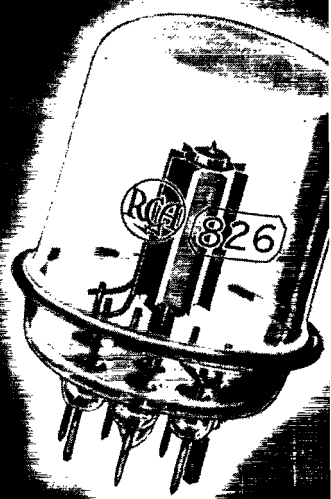
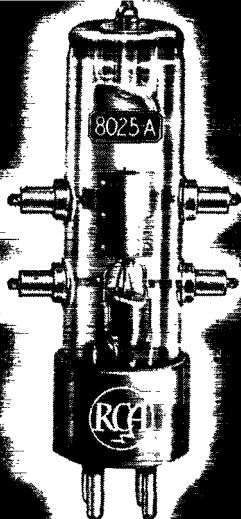

3 RCA Transmitting Triodes for Amateur UHF Bands

Designed for operation at 224, 420, and 1250 Mc., or lower bands at maximum ratings.

THE RCA-2C43, 8025-A, and 826 Transmitting Triodes offer the amateur unusual opportunities for experimental work in the comparatively unexplored frequency bands above 144 Mc.—or for general service at lower frequencies.

The RCA-2C43 "Lighthouse" Triode may be operated at maximum ratings as high as 3000 Mc.—either as a keyed or modulated oscillator in conjunction with concentric-line circuits. An outstanding feature of the RCA-2C43 is its low-frequency drift with variations in heater and plate voltage.

The RCA-8025-A may be operated at maximum ratings as high as 500 Mc. It makes an excellent oscillator, r-f power amplifier, or frequency multiplier. The RCA-8025-A has a double-helical, center-tapped filament to minimize the effect of filament-lead inductance. Its double grid and plate connections can be paralleled to re-

duce lead inductance.

The RCA-826 may be used as an oscillator, r-f power amplifier or frequency multiplier at maximum ratings up to 250 Mc. It also has a double-helical, center-tapped filament, and double plate and grid connections to reduce internal lead inductance.

For further details on these triodes, see your local RCA Tube Distributor or write RCA Commercial Engineering Department, Section A-21D, Harrison, N. J.

COMPARATIVE TECHNICAL DATA

Tube Type No.	Fil. Volts	Plate Input Watts	Max. Rating Freq Mc	Drive Power at Tube	Plate Volts
2C43*	6.3	CCS 16	3000	—	450
8025-A†	6.3	ICAS 33	500	1.4w	800
826†	7.5	CCS 75	250	6.2w	800

*As self-excited c-w oscillator

†As plate-modulated class C amplifier

The Fountainhead of Modern Tube Development is RCA



TUBE DIVISION

RADIO CORPORATION of AMERICA

HARRISON, N. J.