

QST

February, 1946

25 cents

35c In Canada

devoted entirely to

amateur radio

In This Issue:

High-Efficiency Linear
Amplifier for Phone

UHF Tuned-Circuit Design

28 Mc. Converter/Receiver



Published by the Radio Society of America, Inc., 1800 K Street, N.W., Washington, D.C.

... ONLY NEW . . . FOR THE AMATEUR

PANADAPTOR



**NOW AVAILABLE AT LEADING
RADIO PARTS JOBBERS**

Model PCA-2, Amateur
net price, complete with
tubes and accessories,
for 115 V. 60 ν . operation.

\$997

**One year guarantee against
defects in parts or workmanship
(excluding tubes). Full operating
instructions and maintenance man-
ual furnished with each PAN-
ADAPTOR.**

PANORAMIC RECEPTION enables **SIMULTANEOUS VISUAL** reception of many radio signals, continuously selectable from a broad band of frequencies down to a single frequency.

NOW FOR THE FIRST TIME . . . with the **PANADAPTOR** connected to your receiver you can see up to 200kc of the band at once.

The PANADAPTOR will . . .

- Select QRM-free spots for sending and listening.
- Provide automatic visual and aural monitoring over a band of frequencies up to 200 kc.
- Locate stations whose exact frequencies are not known.
- Enable observation of other fellow's frequencies in three-way or round robin QSO's—acts as an additional tunable receiver.
- Spot replies to your CQ's.
- Provide instantaneous signal strength ("S") meter for CW and PHONE.
- Simplify frequency setting and station monitoring.
- Facilitate netting operations.
- Assist in making adjustments of transmitters and antennas.
- Enable identification and interpretation of transmitter signal characteristics (your own and others)
 - CW . . . key clicks, noise, frequency shift.
 - PHONE . . . modulation percent, distortion, carrier shift and splatter, spurious supersonic and R.F. parasites.
 - FM . . . frequency deviation, AM on FM, modulation monitoring.

Partial List of PANADAPTOR Features . . .

- Easy, simple connection to all receivers with any IF from 450kc to 470kc.
- Covers up to 200kc of continuous radio spectrum at once.
- Sensitivity equal to, or better than, receiver.
- Modes of operation: *Panoramic*—visual, aural, visual-aural (Automatic Monitor). *Tunable Unisignal*—visual (modulation, signal check, etc.), aural (additional receiver), visual-aural.
- A signal output jack.
- Four simple operating controls.
- Does not affect normal operation of receiver.
- Clear, sharp Panoramic picture in normally lighted room.
- Non-walking rubber feet.
- Sturdy steel cabinet and chassis plus high quality components and workmanship assure long life and trouble-free operation.
- Panel and cabinet finished in standard black or grey satin wrinkle to harmonize with the rest of your rig.
- Overall dimensions: 11" wide, 9-3/8" deep, 6-3/16" high.

Write your dealer
for free demon-
stration or write
for descrip-
tion booklet.



NEW EIMAC EXTERNAL ANODE TRIODE 3X2500A3

Rugged mechanical construction Outstanding electrical efficiency

In the new 3X2500A3, Eimac engineers have developed a highly efficient external anode triode which, in Class C service, delivers up to 5 KW output at a plate voltage of only 3,500 volts. The mechanical design is radically simple, incorporating a "clean construction" which gives short, low inductance heavy current connections that become an integral part of the external circuits at the higher frequencies.

The external anode, conservatively rated at 2500 watts dissipation, has enclosed fins so as to facilitate the required forced air cooling.

Non-emitting vertical bar grid does not cause anode shadows ordinarily created by heavy supports in the grid structure.

Thoriated tungsten filament. Note unusually large filament area, and close spacing.

Filament alignment is maintained throughout life of the tube by special Eimac tensioning method.

New glass-to-metal seals do not have the RF resistance common to iron alloy seals, nor the mechanical weaknesses of the feather-edged types.

Grid ring terminal mounts a cone grid support which acts as a shield between plate and filament.

A coaxial filament stem structure forms the base of the tube. This makes possible proper connections to the filament lines.

Grid and filament terminal arrangements make it possible to install or remove the 3X2500A3 without the aid of tools.

The new mechanical and electrical features of the Eimac 3X2500A3 external anode triode make it valuable for use on the VHF as well as low frequencies. More complete data and information yours for the asking.

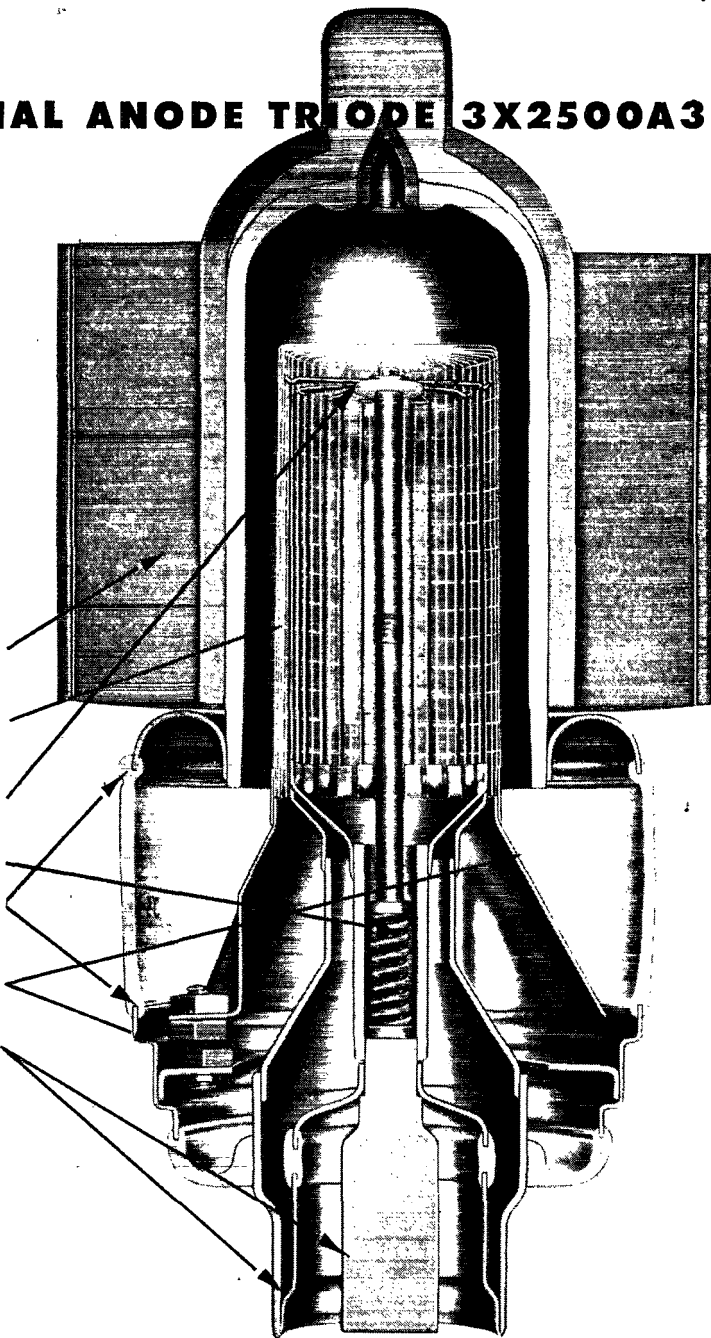

FOLLOW THE LEADERS TO



EITEL-McCULLOUGH, INC., 1123 San Mateo Ave., San Bruno, Calif.

Plants located at: San Bruno, Calif.



and Salt Lake City, Utah

Export Agents: Frozar and Hansen, 301 Clay St., San Francisco 11, Calif., U.S.A

TYPE 3X2500A3 — MEDIUM MU TRIODE ELECTRICAL CHARACTERISTICS

Filament: Thoriated Tungsten	
Voltage	7.5 volts
Current	48 amperes
Amplification Factor (Average) 20	
Direct Interelectrode Capacitances (Average)	
Grid Plate	20 μ fd.
Grid Filament	48 μ fd.
Plate Filament	1.2 μ fd.
Transconductance ($i_b=830$ ma., $E_b=3000$ v.)	20,000 μ mhos



Looms Large on the **CERAMIC** Firmament

Your search for a "hard-as-diamond" versatile material ends when you discover the myriad possibilities of Steatite.

Let us tell you more about STEATITE . . . a material that may solve your production problems.

Centralab

Division of GLOBE-UNION INC., Milwaukee

PRODUCERS OF



Ceramic Trimmers
Bulletin 695



Ceramic High Voltage Capacitors
Bulletin 814



Variable Resistors
Bulletin 697

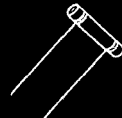

Tubular Ceramic
Capacitors
Bulletins 630 and 586

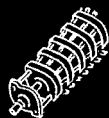

Selector Switches
Bulletin 722

FEBRUARY 1946

VOLUME XXX

NUMBER 2



STAFF

Editorial

KENNETH B. WARNER, W1EH
(Managing Secretary, ARRL)
Editor

GEORGE GRAMMER, W1DF
(Technical Director, ARRL)
Technical Editor

DONALD H. MIX, W1TH
BYRON GOODMAN, W1JPE
Assistant Technical Editors

A. DAVID MIDDLETON, W2OEN
Department Editor

EDWARD P. TILTON, W1HDQ
V.H.F. Editor

WALTER F. BRADLEY, W1FWH
Technical Information Service

Production

RALPH T. BEAUDIN, W1BAW
Superintendent

ELSIE C. HOCHMEISTER
Assistant

Advertising

F. CHEYNEY BEEKLEY, W1GS
Advertising Manager

Circulation

DAVID H. HOUGHTON
Circulation Manager

RALPH T. BEAUDIN, W1BAW
Assistant Circulation Manager



OFFICES

38 La Salle Road
West Hartford 7, Connecticut

Subscription rate in United States and Possessions, \$2.50 per year, postpaid; all other countries, \$3.00 per year, postpaid. Single copies, 25 cents. Foreign remittances should be by international postal or express money order or bank draft negotiable in the U. S. and for an equivalent amount in U. S. funds.

Entered as second-class matter May 29, 1919, at the post office at Hartford, Connecticut, under the Act of March 3, 1879. Acceptance for mailing at special rate of postage provided for in section 1103, Act of October 3, 1917, authorized September 9, 1922. Additional entry at Concord, N. H., authorized February 21, 1929, under the Act of February 25, 1925.

Copyright 1946 by the American Radio Relay League, Inc. Title registered at U. S. Patent Office.

QST

devoted entirely to

AMATEUR RADIO

PUBLISHED, MONTHLY, AS ITS OFFICIAL ORGAN, BY THE AMERICAN RADIO RELAY LEAGUE, INC., AT WEST HARTFORD, CONN., U. S. A.; OFFICIAL ORGAN OF THE INTERNATIONAL AMATEUR RADIO UNION



CONTENTS

It Seems to Us	11
Tuned Circuit Design for U.H.F. <i>Maurice Apstein, W2QI and Moe Joffe, W2BNY</i>	13
A 28-Mc. Receiver/Converter	Byron Goodman, W1JPE 17
A New Linear Amplifier Circuit	Sidney T. Fisher 21
Dixie Jones' Owl Juice	26
QRM — The Electronic Life Saver — Part II <i>Paul Robbiano, W6PKM</i>	27
New Apparatus — Tuned Plug-In Coil Form	35
Forecasting Long-Distance Transmission <i>William R. Foley, K4FEC</i>	36
WWV	41
Happenings of the Month	42
Silent Keys	45
Feedback	45
Premodulation Speech Clipping and Filtering <i>W. W. Smith, W6BCX</i>	46
How's DX?	51
A Non-Radiating Superregenerative Receiver for Two Meters	E. P. Tilton, W1HDQ 53
ARRL Band-Warming Party	57
In QST 25 Years Ago This Month	58
Hints and Kinks <i>Making out Color Code on Old Mica Condensers — Automatic High-Low Range Meter Switching — A Simple Method of Coupling Between V.F.O. and Amplifier — Two Soldering Hints</i>	59
The World Above 50 Mc.	60
Loran — the Latest in Navigation Aids — Part III <i>Alexander A. McKenzie, W1BPI</i>	62
The Crystal Ball	66
Correspondence from Members	69
Foreign Notes	71
Operating News	72
Station Activities	76
Book Review	120
Ham-Ads	140
QST's Index of Advertisers	142

hallicrafters

New design, new utility in a great new communications receiver . . .

Here is Hallicrafters new Model S-40. With this great communications receiver, handsomely designed, expertly engineered, Hallicrafters points the way to exciting new developments in amateur radio. Read those specifications . . . it's tailor-made for hams. Look at the sheer beauty of the S-40 . . . nothing like it to be seen in the communications field. Listen to the amazing performance . . . excels anything in its price class. All around, up and down, through and through it's a true Hallicrafters-built ham job.

Ask your local distributor about when you can get an S-40—the up and coming leader in the popular price field.

INSIDE STUFF: Beneath the sleek exterior of the S-40 is a beautifully engineered chassis. One stage of tuned radio frequency amplification, the S-40 uses a type 6SA7 tube as converter-mixer for best signal to noise ratio. RF coils are of the permeability adjusted "micro-set" type identical with those used in the most expensive Hallicrafters receivers. The high frequency oscillator is temperature compensated for maximum stability.

From every angle the S-40 is an ideal receiver for all high frequency applications.

~~\$~~ **79⁵⁰**
(APPROXIMATELY)

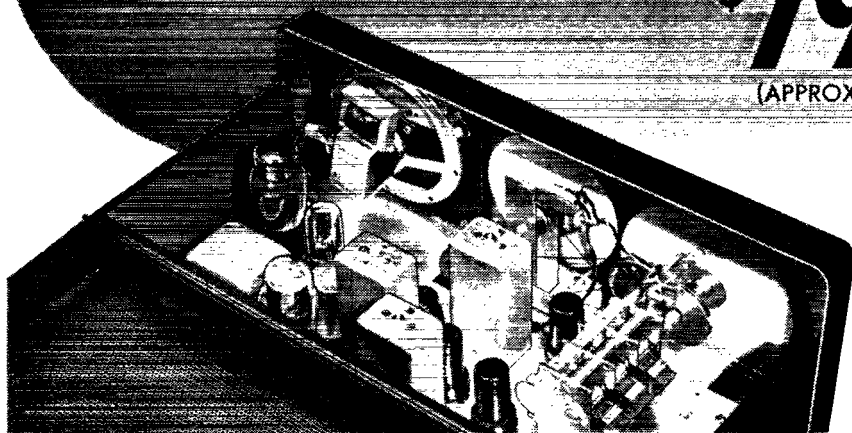

Interior completely accessible. Entire top turns back on piano hinge.

COPYRIGHT 1945
THE HALLICRAFTERS CO.

new Model S-40

Tuning range from 540 kc to 4.2 Mc continuous in four bands

Separate electrical bandspread with inertia flywheel tuning

New beauty and perfect ventilation in the perforated steel top

Self-contained, shock mounted, permanent magnet dynamic speaker

Standby receive switch

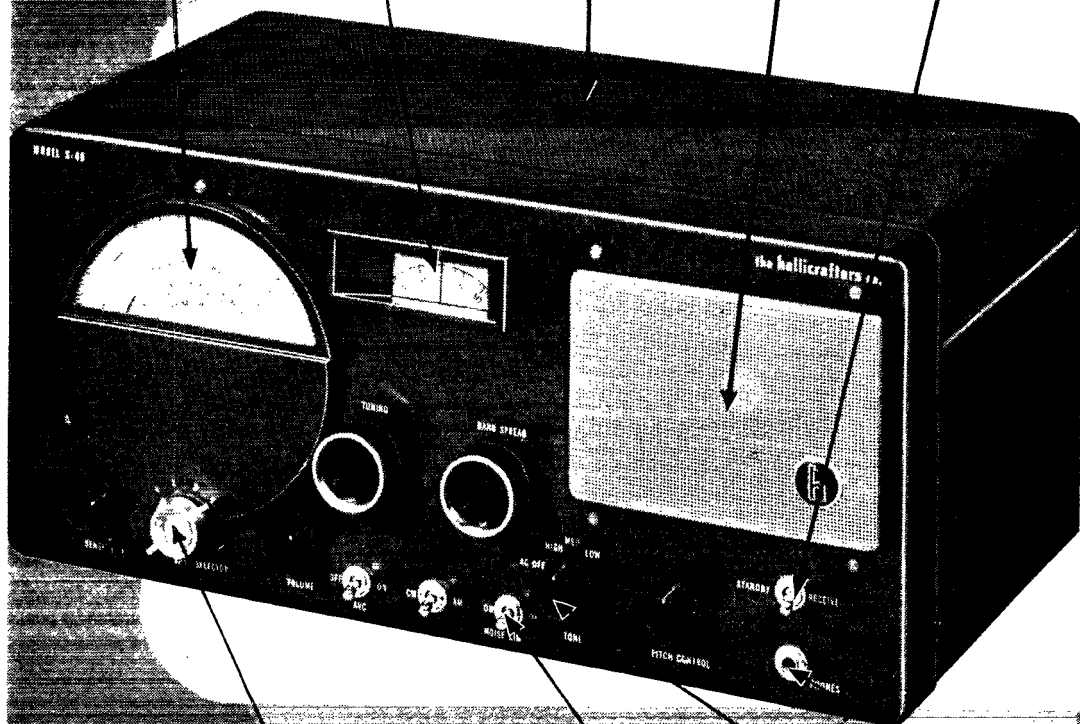

All controls logically grouped for easiest operation. Normal position for broadcast reception marked in red, making possible general use by whole family.

Automatic noise limiter

3-position tone control

Phone jack

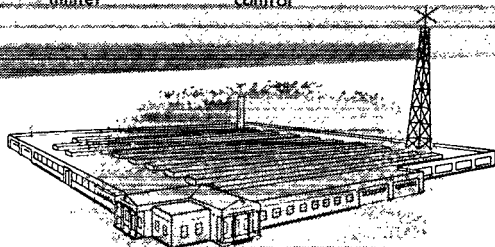

hallicrafters RADIO

THE HALLICRAFTERS CO., MANUFACTURERS OF RADIO AND ELECTRONIC EQUIPMENT, CHICAGO 16, U. S. A.

Sole Hallicrafters Representatives in Canada: Rogers Majestic Limited, Toronto-Montreal

Section Communications Managers of the A.R.R.L. Communications Department

Reports Invited. All amateurs, especially League members, are invited to report station activities each mid-month (16th of the month for the last 30 days) direct to the SCM, the administrative official of ARRL elected by members in each Section whose address is given below. Radio Club reports are also desired by SCMs for inclusion in QST. New ARRL Field Organization appointments, with the exception of SEC, EC, OBS, and OO are not at present being made. See Operating News.

ATLANTIC DIVISION			
Eastern Pennsylvania	W3BES	Jerry Mathis	623 Crescent Ave. 9701 Monroe St.
Maryland-Delaware-District of Columbia	W3CIZ	Hermann E. Hobbs	Silver Springs P. O.
Southern New Jersey	W3GCU	Ray Tomlinson	623 E. Brown St.
Western New York	W8UPH	Charles I. Otero	4158 Ridge Road, West
Western Pennsylvania	W8NCJ	R. R. Rosenberg	927 East 23rd St.
CENTRAL DIVISION			
Illinois	W9NUX	David E. Blake, II	4501 N. Malden St.
Indiana	W9EGQ	Herbert S. Brier	385 Johnson St.
Kentucky	W9ARU	Darrell A. Downard	2077 Sherwood Ave.
Michigan	W8DFE	Harold C. Bird	R.F.D. 2, Box 228
Ohio	W8MFP	Carl F. Wiehe	122 St. Albert St.
Wisconsin	W9RH	Emil Felber, Jr.	1625 N. 18th St.
DAKOTA DIVISION			
North Dakota	W9EVP	Raymond V. Barnett	406-17th St.
South Dakota	W9OVY	P. H. Schultz	118 N. Yankton Ave.
Northern Minnesota	W9FUZ	Armond D. Brattland	2802 S. Western
Southern Minnesota	W9YNQ	Millard L. Bender	608 N. Huron Ave.
DELTA DIVISION			
Arkansas	W5GDD	Ed Beck	2503 Bishop St.
Louisiana	W5DKR	Engene H. Treadaway	P. O. Box 44
Mississippi	W5HAV	P. W. Clement	524 Santini St.
Tennessee	W4SP	James B. Witt	R.F.D. 6, Shady Dell Trail
HUDSON DIVISION			
Eastern New York	W2HZL	Ernest E. George	2044 Lexington Parkway
N. Y. C. & Long Island	W2KDC	Charles Ham, Jr.	151-06 84th Drive
Northern New Jersey	W2CQD	Winfield G. Beck	617 Spruce St.
MIDWEST DIVISION			
Iowa	W9PJR	Leslie B. Vennard	2712 Washington St.
Kansas	W9AWP	A. B. Unruh	1617 S. Seneca St.
Missouri	W90UD	Mrs. Letha A. Dangerfield	41 Moffett St.
Nebraska	W9FQB	Arthur E. Gaeth	6105 N. 37 St.
NEW ENGLAND DIVISION			
Connecticut	W1KOY	Edmund R. Fraser	48 Willow St.
Maine	W1AOL	G. C. Brown	379 No. Main St.
Eastern Massachusetts	W1ALP	Frank L. Baker, Jr.	91 Atlantic St.
Western Massachusetts	W1JAH	William J. Barrett	239 Columbia St.
New Hampshire	W1EJF	Mrs. Dorothy W. Evans	P. O. Box 312
Rhode Island	W1HRC	Clayton C. Gordon	70 Columbia Ave., Gaspee
Vermont	W1NLO	Burtis W. Dean	P. O. Box 81
NORTHWESTERN DIVISION			
Alaska	K7GNN	James G. Sherry	
Idaho	W7AVP	Don D. Oberbillig	P. O. Box 486
Montana	W7CPY	Rex Roberts	Box 1088
Oregon	W7GNJ	Carl Austin	1137 Federal
Washington	W7FWD	O. U. Tatro	513 N. Central
PACIFIC DIVISION			
Hawaii	K6RLG	Howard S. Simpson	2088 Wells St.
Nevada	W6CW	N. Arthur Sowle	Box 2025
Santa Clara Valley	W6IUZ	Earl F. Sanderson	600 Acacia Ave.
East Bay	W6TI	Horace R. Greer	414 Fairmount Ave.
San Francisco	W6RBQ	William A. Ladley	200 Naylor St.
Sacramento Valley	W6MDI	Vincent N. Feldhausen	113 South Quincy St.
Philippines	KA1GR	George L. Rickard	Box 849
San Joaquin Valley*	W6BXB	Edward H. Noack	811 West Magnolia St.
ROANOKE DIVISION			
North Carolina	W4CVB	W. J. Norton	c/o Duke Power Co.
South Carolina	W4BQE/ANG	Ted Ferguson	3422 Rosewood Drive
Virginia	W3AKN	Walker G. Walker	217-51 St.
West Virginia	W8JRL	Kenneth M. Zinn	P. O. Box 132
ROCKY MOUNTAIN DIVISION			
Colorado	W9VGC	H. F. Hekel	2743 Julian St.
Utah-Wyoming	W6LLH	Victor Drabble	1024 Oak St.
SOUTHEASTERN DIVISION			
Alabama	W4GBV	Lawrence J. Smyth	808 Winona Ave.
Eastern Florida	W41P	Robert B. Murphy	3302 S.W. Grapeland Blvd.
Western Florida	W4MS	Lt. Edward J. Collins	1409 N. 10th Ave.
Georgia	W4FDJ	Ernest L. Morgan	R.F.D. 2
West Indies (Cuba) (Puerto Rico-Virgin Islands)*	K4KD	Everett Mayer	P. O. Box 1061
SOUTHWESTERN DIVISION			
Los Angeles	W6QVV	H. F. Wood	429 So. Fairview
Arizona	W6RWW	Douglas Aitken	341 S. Mt. Vernon Ave.
San Diego	W6CHV	Ralph H. Culbertson	7172 Eads St.
WEST GULF DIVISION			
Northern Texas	W5ALA	Jack T. Moore	4529 Fairway Ave.
Oklahoma	W5AYL	Ed Oldfield	2141 N.W. 35th St.
Southern Texas	W5JC	James B. Rives	1721 Kentucky Ave.
New Mexico	W5HJF	J. G. Hancock	110 S. E. Nevada St.
MARITIME DIVISION			
Maritime	VE1DQ	A. M. Crowell	69 Dublin St.
ONTARIO DIVISION			
Ontario	VE3EF	Wing Commander Donald R. Gunn	c/o Canadian Bank of Commerce
QUEBEC DIVISION			
Quebec	VE2CO	Lieutenant L. G. Morris	4114 Hingston Ave.
VANALTA DIVISION			
Alberta	VE4GE	C. S. Jamieson	581 W. Riverside Drive
British Columbia	VE5DD	C. O. I. Sawyer	2634 West 31st Ave.
PRAIRIE DIVISION			
Manitoba	VE4AAW	A. W. Morley	26 Lennox St.
Saskatchewan	VE4SY	Arthur Chesworth	1084 Redland Ave.
			Glenside Gardens
			Linden, Maryland
			Trenton 10
			Spencerport
			Erie
			Chicago 40
			Chicago 15
			Louisville 5
			Lafayette 2
			St. Bernard 17
			Milwaukee 5
			Bismarck
			Pierre
			Los Angeles, Calif.
			Spring Valley
			Little Rock
			LaPlace
			Biloxi
			Knoxville
			Schenectady 8
			Jamaica, L. I., 2
			Roselle
			Burlington
			Wichita 12
			Joplin
			Omaha 11
			West Haven 16
			Brewer
			North Quincy 71
			Adams
			Concord
			Plateau, Providence 5
			Burlington
			Homer
			Boise
			Glendive
			Bend
			Olympia
			Wailuku, Maui
			Reno
			San Bruno
			Oakland 11
			San Francisco 12
			McCloud
			Manila
			Stockton
			Charlotte 1
			Columbia 25
			Newport News
			Clarksburg
			San Juan 5, P. R.
			Burbank
			Prescott
			La Jolla
			Dallas 4
			Oklahoma City 6
			San Antonio 1
			Portales
			Halifax, N. S.
			New Toronto, Ont.
			Montreal 28, Que.
			Drumheller, Alta.
			Vancouver
			St. Vital
			Moose Jaw

*Officials appointed to act temporarily in the absence of a regular official.

..... Superior Engineering ... basis of Collins quality leadership



Above all, the Collins Radio Company is an engineering outfit. An unusually large percentage of its personnel are graduate engineers.

They came to Collins because the Collins progressiveness and quality standards are their own ideals. They are the nucleus of the organization, from management on through.

These men determine and uphold the character of Collins radio communication equipment from inception, through all stages of research, design, production, quality control, field test and field service. Many of these engineers and their lab assistants are active hams.

W9TTK heads a group working on new ham transmitter developments, and another team under W9GJY is shaping up a receiver incorporating highly desirable innovations. Both are under the general supervision of W9FVM. Look for a significant Collins announcement soon!

COLLINS RADIO COMPANY
Cedar Rapids, Iowa
11 W. 42nd Street, New York 18, N.Y.

IN RADIO COMMUNICATIONS, IT'S

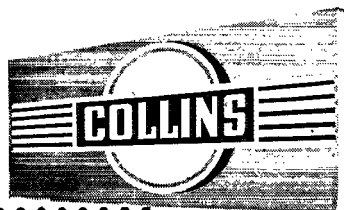

Finer in Performance AND NOW – Smarter in Appearance with
INTERCHANGEABLE COLORED FLANGES

ROUND OR SQUARE... AT NO EXTRA CHARGE



***Marion Glass-to-Metal Truly Hermetically Sealed
2½" and 3½" Electrical Indicating Instruments***

Smart styling, sleek lines, more color are invading the radio and electronic industry... bulky packaging and drab blacks and grays are no longer in step with the times... appearance now takes equal rank with performance in consumer demand.

Sensing this important trend, we here at Marion present a "beauty treatment" for radio and electronic equipment in our new and attractive interchangeable colored flanges. There are 12 different iridescent shades, including blue, red, green, silver, gold and others—in both round and square shapes.

Manufacturers who specify Marion hermetically sealed instruments will find that the eye-appeal of these new flanges will give added sales value to their products. Amateur radio operators and experimenters will especially welcome the idea because the interchangeability feature will help reduce instrument costs by permitting universal application of Marion "hermetics" when building or modernizing their equipment.

Marion "hermetics" sell for no more than most competitive unsealed instruments... and they're being delivered in ever-increasing quantities. Write for our 12-page brochure.



MARION ELECTRICAL INSTRUMENT CO.

MANCHESTER, NEW HAMPSHIRE

EXPORT DIVISION 458 BROADWAY · NEW YORK 13 N. Y. U. S. A.
CABLE ADDRESS MORHANTX



PROTECT THE CONTINUITY
of electrical currents

with
AMPHENOL
CONNECTORS

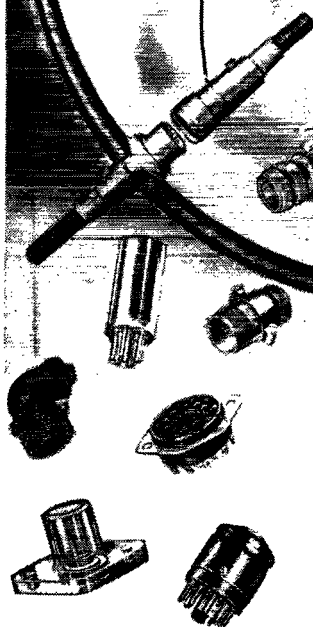

As the aviation industry again swings into peacetime production, Amphenol is ready to offer practical aid in many forms. Amphenol components helped to fight a winning war . . . and now Amphenol engineers with their "know-how" — deepened and strengthened by wartime experience — are cooperating in creating peacetime applications for aviation communications, electrical circuits and electronic controls. Amphenol connectors, cable assemblies and other parts provide positive electrical contacts within all types of equipment. For detailed technical data on Amphenol products — send for Condensed Catalog No. 72.



AMERICAN PHENOLIC CORPORATION
CHICAGO 50, ILLINOIS

In Canada • Amphenol Limited • Toronto

U.H.F. Cables and

Connectors • (A-N, U.H.F., British) • Conduit • Cable Assemblies • Radio Parts • Plastics for Industry

THE AMERICAN RADIO RELAY LEAGUE, INC.,

is a noncommercial association of radio amateurs, bonded for the promotion of interest in amateur radio communication and experimentation, for the relaying of messages by radio, for the advancement of the radio art and of the public welfare, for the representation of the radio amateur in legislative matters, and for the maintenance of fraternalism and a high standard of conduct.

It is an incorporated association without capital stock, chartered under the laws of Connecticut. Its affairs are governed by a Board of Directors, elected every two years by the general membership. The officers are elected or appointed by the Directors. The League is noncommercial and no one commercially engaged in the manufacture, sale or rental of radio apparatus is eligible to membership on its board.

"Of, by and for the amateur," it numbers within its ranks practically every worth-while amateur in the nation and has a history of glorious achievement as the standard-bearer in amateur affairs.

Inquiries regarding membership are solicited. A bona fide interest in amateur radio is the only essential qualification; ownership of a transmitting station and knowledge of the code are not prerequisite, although full voting membership is granted only to licensed amateurs.

All general correspondence should be addressed to the Secretary at the administrative headquarters at West Hartford, Connecticut.



Past Presidents

HIRAM PERCY MAXIM, W1AW, 1914-1936
EUGENE C. WOODRUFF, W8CMP, 1936-1940

Officers

President.....GEORGE W. BAILEY, W1KH
Washington, D. C.

Vice-President

Secretary.....KENNETH B. WARNER, W1EH
West Hartford, Connecticut

Communications Manager.....F. E. HANDY, W1BDI
West Hartford, Connecticut

Treasurer.....DAVID H. HOUGHTON
West Hartford, Connecticut

General Counsel.....PAUL M. SEGAL
1026 Woodward Building, Washington 5, D. C.

Directors

President
GEORGE W. BAILEY.....W1KH
1530 P St., N.W., Washington 25, D. C.

Vice-President

Canadian General Manager
ALEX REID.....VE2BE
240 Logan Ave., St. Lambert, P. Q.
Alternate: Leonard W. Mitchell.....VE3AZ
75 Raglan Ave., Toronto, Ont.

Atlantic Division

EDWARD G. RASER.....W3ZI
315 Beechwood Ave., Trenton 8, N. J.
Alternate: J. Victor Brotherson.....W8BHN
1743 Ottawa Drive, Erie, Pa.

Central Division

JOHN A. KIENER.....W8AVH
3462 Edison Rd., Cleveland Heights,
Cleveland 21, Ohio
Alternate: Earl S. Nelson.....W8DS
22551 Hadden Rd., Euclid 17, Ohio

Dakota Division

TOM E. DAVIS.....W9VVA
915 W. Becker Ave., Willmar, Minn.
Alternate: Harold B. Love.....W9ZRT
Box 426, Mandan, N. D.

Delta Division

GEORGE S. ACTON.....W5BMM
Plain Dealing, La.
Alternate: Samuel H. Dowell.....W5ERV
1057 Mildred St., Shreveport 15, La.

Hudson Division

ROBERT AKERIDGE KIRKMAN.....W2DSY
Werah Pl., R.F.D. No. 1, Box 61, Long Branch, N. J.
Alternate: George Ruffin, Jr.....W2CJY
38 Brookwood Drive, Manhasset, L. I., N. Y.

Midwest Division

FLOYD E. NORWINE, JR.....W9EFC
7405 Hiawatha Ave., Richmond Heights 17, Mo.
Alternate: C. A. Colvin.....W9VHR
% Omaha & Council Bluffs St. Railway Co.,
Omaha 2, Nebr.

New England Division

PERCY C. NOBLE.....W1BVR
37 Broad St., Westfield, Mass.
Alternate: Clayton C. Gordon.....W1HRC
70 Columbia Ave., Warwick, R. I.

Northwestern Division

KARL W. WEINGARTEN.....W7BG
3219 N. 24th St., Tacoma 7, Wash.
Alternate: R. Rex Roberts.....W7CFY
110 W. Brennan St., Glendive, Mont.

Pacific Division

J. L. McCARGAR.....W6EY
66 Hamilton Pl., Oakland 12, Calif.
Alternate: Elbert J. Amarantes.....W6FBW
1675 Dale Ave., San Jose, Calif.

Roanoke Division

H. L. CAVENESS.....W4DW
2607 Vanderbilt Ave., Raleigh, N. C.
Alternate: J. Frank Key.....W3ZA
Box 707, Buena Vista, Va.

Rocky Mountain Division

Acting Director:
HOWARD R. MARKWELL.....W9TFP
355 Monroe St., Denver 6, Colo.

Southeastern Division

WILLIAM C. SHELTON.....W4ASR
527 Revilo Blvd., Daytona Beach, Fla.
Alternate: William P. Sides.....W4AUP
Fleming Road, Montgomery, Ala.

Southwestern Division

JOHN E. BICKEL.....W6BKY
1834 E. Whittier Blvd., Whittier, Calif.
Alternate: Eldridge E. Wyatt, Jr.....W6ARW
P. O. Box 3597, Long Beach 3, Calif.

West Gulf Division

WAYLAND M. GROVES.....W5NW
c/o Humble Pipe Line Co., Odessa, Texas
Alternate: Jennings R. Poston.....W5AJ
P. O. Box 843, Curundu, Panama Canal Zone

"IT SEEMS TO US—"



THESE BANDS

For an institution that as yet has regained only a small part of its normal facilities, it seems to us that amateur radio operating has been proving pretty interesting. Certainly we've been having all kinds of conditions.

Except on the 5-meter band, that is. Maybe we have there, too, but there doesn't seem to be enough of us on 5 to know much about it. What that band chiefly needs is more population. Too many of us seem to be QRX for the shift to 6 meters, and meanwhile we're missing a lot. The other evening there was gorgeous E_s skip and in the whole blamed country there seem to have been just two amateurs on to enjoy it. There have been some nights with tropospheric DX extending out several hundred miles, and the maximum number of distant stations that anybody has heard on such nights is seven. Just think of it: Hundreds of stations could be working hundreds of miles and only half a dozen can be heard within one's reception range! Let's get in there and do some work, fellows. For one thing, how about transferring to 5 some of the local conversations that now disfigure the 10-meter band during DX hours? Everybody, we think, ought to be equipped to do local work on a local band, or else lay off during the hours that DX is hot. And if we get on 5, we'll be there when that band "makes open."

Have you ever thought of our bands as having personalities? We have; maybe we're nutty but we can't escape it. Sometimes the characteristics change but generally we go around thinking of the hambands as if they were people. To us there is something fundamental about the 3500-4000 band and we generally think of her as a serene and broad-bosomed mother-band who looks after and nourishes all of us. Then 7 and 14 Mc. are her strapping sons, hard bronzed warriors ever ready for distant battle. The v.h.f. of course are the young sprouts, and the super-highs are probably gremlins, although we haven't doped that out thoroughly as yet. We're a little uncertain, too, about 28 Mc. Sometimes he

seems to be a friendly gnome in a cave and sometimes we think that he's just an eccentric nephew of Mother 3500. We do know that he's young and just slightly potty and very inventive, and that he spends all his time at his workbench fashioning new developments for the boys. And has that guy ever been busy since November 15th! What a bunch of stuff he has turned out! It's as though he knew that for the moment he was our only distance band, and that therefore most of us were depending on him for everything during this brief interlude until the rest of our bands come back to us. What an amazing variety of performances he has been handing us! Here's a band that ought to be more or less uniformly uninteresting and bless us if it hasn't been one of varied miracles ever since we moved in on the Potty One. He's still not so good on reliability but we've had super-DX, continental DX, Sporadic-E short skip, aurora reflections, tropospheric extensions, local groundwave stuff — everything from one mile to seven thousand. It has been of such variety as to fascinate the most case-hardened ham. Pretty good, Potty, and we thank you; keep it up!

A handwritten signature in cursive script, likely the author's name, located at the end of the 'THESE BANDS' section.

WAR SURPLUS

One of the subjects creeping into our correspondence at Hq. these days is the disposition of electronic gear which has been or will be declared surplus by Army and Navy. We think it is time to sound off. We don't intend to propose a solution for this problem — and truly it is a mammoth problem — because it so greatly transcends the single field of amateur radio, but we do want to get across a few facts and correct certain false impressions which seem to exist.

There was, for example, the wild story that billions of dollars worth of radio and electronic gear was being dumped into open fields near the Air Forces electronics depot at Dayton with terrific loss because of exposure to weather. Actually, the equipment had been

crated, either waterproofed, fungus-proofed or tropicalized, and made ready for or just returned from overseas, so that a little local weather would do it no harm. But, hearing the story, local hams propositioned the Army to buy some of the gear; when turned down they raised quite a hubbub, one of the reasons being a lack of understanding of complexities in the disposal system. In point of fact the equipment was no longer under Army jurisdiction and the commanding officer couldn't have sold or given away a nickel's worth of it if he'd wanted to.

Let us first roughly outline steps in the disposal process. All surplus — from WAC bobby pins to railroad locomotives — is handled under the direction of the Reconstruction Finance Corporation. To assist in this vast job, RFC appoints certain companies as their agents. First of all, items must be cleared for sale — that is, declared surplus by the military. The original manufacturer then has first opportunity to buy it back. If he doesn't want it — and many do not — there are then certain preferences for veterans, if they can use the stuff in their businesses. Then it is offered for public sale in large lots. It is through this last channel, via distributors, that an increasing amount of gear is reaching the ham market.

Now some of our members are suggesting we should arrange for the sale of single items direct to individual purchasers. Unfortunately there is a firm policy — provided in the basic law set up by Congress — not to sell single units to individuals. Remember that this is not solely a radio-equipment matter but a policy governing disposal of all surplus commodities. For the most part, therefore, such gear will have to reach us via normal distribution channels through jobbers and dealers.

It has occurred to some of our gang to suggest that the League act as RFC agent for amateurs, buying surplus gear in wholesale quantities and retailing the stuff at cost. It sounds swell. But think a minute, OM. Let's go as far as to make the Utopian assumption that there would be sizeable quantities of desirable equipment available at a reasonable price. Remember ARRL has members not only in the continental United States but also in our territories and possessions and in most foreign countries as well. We'd need a physical plant with hundreds of thousands of feet of floor space and several hundred employees. We'd have to set up departments for personnel, purchasing, orders, shipping, accounting, claims, technical, laboratory testing. We'd be continually engaged in squabbles over a priority system, claims and damages, customs difficulties. No, thank you. It's a huge job, and your local dealer is well entitled to the few

bucks he tacks on that receiver's cost as his fee. We'd have to build from scratch an organization far more vast than any radio distributing corporation now in business and then completely disband it when the gear had been processed — perhaps within a year. It just doesn't add up to common sense. And this is all aside from the fact that ARRL is a membership society and does not belong in the radio distributing business.

While we're talking about it, let's get out of our heads the idea that all such communications equipment is ideally suited for ham operation. It isn't. In fact, with the exception of certain models of receivers and some types of measuring apparatus, most of it is particularly *unsuited* to our needs even with extensive alterations. The limited application of special military gear, now that the shooting has stopped, is one reason why the original manufacturer doesn't want the stuff back.

For example, there's a certain Army receiver manufactured during wartime in large quantities, the surplus of which is currently reaching amateur distribution channels. Selling for perhaps 15 or 20 per cent of original cost, it might sound like a good buy. But is it? The sensitivity is considerably less than that of the better manufactured ham receivers; background noise is quite a lot higher than we're used to; 18 Mc. is its top limit; it has no amateur bandspread; the common model is dynamotor-supplied from storage batteries. General sentiment around here: at a ridiculously low price such a receiver might be a good standby or "second" receiver, but hams would be wiser to invest only a few more dollars and get one designed for amateur communications work. Remember that the original price to the Government was abnormally high because of tough mechanical specifications and that even a small per cent of this cost can run into the price range of good ham receivers.

Then there's a transmitter we've seen, not yet declared surplus, but which soon will be. It cost Uncle perhaps \$4,000 and might hit our market at \$400. A good buy, it seems. But is it? It is 8 feet tall, 4 wide, 3 deep; its weight is enormous; the power supply is a motor-generator set; the tuning system and controls doubtless were suitable in the application for which it was designed but the conglomeration of dials, knobs and meters would, frankly, drive us nuts! Even if we had an oversized shack (with concrete foundation) in which to house it, at \$400 it's no go — we'd even think twice before accepting one for free. Components, did you say? We can do a lot better with \$400 elsewhere.

Of course, not all gear is like this. Certain

(Concluded on page 102)

Tuned Circuit Design for U.H.F.

Conventional Tanks in Unconventional Form at 140 to 450 Mc.

BY MAURICE APSTEIN,* W2QI, and MOE JOFFE,* W2BNY

• Coil-condenser tank circuits can be used at frequencies as high as 500 megacycles. In v.h.f. and u.h.f. oscillators the "old-fashioned" tank circuit may even — believe it or not — be better than a linear circuit. The trick is to keep the inductance and capacitance where they belong.

AFTER Pearl Harbor, security regulations prevented the disclosure of many developments taking place in communications. At the same time, the tremendous demand for v.h.f. and radar equipment resulted in considerable acceleration of the research in these fields. During the last year we have had many hints of the new and wondrous developments that would soon be disclosed. To those of us who have had some small knowledge of the equipment in use by the armed forces, there have emerged two distinct types which are worthy of amateur attention. One, concerned with that part of the frequency spectrum above 1000 Mc., has been used almost exclusively for radar work. The tubes are either velocity-modulated types or magnetrons, and the tuned circuits almost exclusively cavity resonators or "plumbing." Most of the material released of late has concerned this microwave region.

Concurrent with the microwave research, but for different purposes, there was carried forward

* Engineering Department, Allen D. Cardwell Mfg. Corp., Brooklyn, N. Y.

extensive development of practical communications equipment for the region between 100 and 1000 megacycles. It is with the work done in this region that amateurs will be most concerned, at least for the present, because equipment for these frequencies is more readily available and because the techniques involved are a logical extension of the principles pioneered by the v.h.f. gang. Then, too, hams after all are primarily interested in communication, and with equipment now available this region lends itself more readily to communication than the microwave bands.

Heretofore, v.h.f. oscillator design has largely been based on the use of tank-circuit elements made of large-diameter tubing. The stability of such oscillators was generally attributed to the high Q of the resonant lines. But investigation has shown that rigid mechanical construction frequently was a more important factor than the high Q , primarily because the high reactance and low Q of the tube leads nullified the good electrical properties of the line. At 300 megacycles the tube leads have almost as much inductance as the line, with the result that the overall Q of the circuit is considerably reduced. A nonrigid line oscillator performs as poorly as a nonrigid coil-condenser combination.

Specifications for portable military equipment require that a minimum amount of space be used. To meet this requirement, compact, high- Q circuits have been developed which equal the stability of large lines. Tests have proved that compact v.h.f. oscillators can be built to embody stable operation equal to that of large line oscil-

◆
Using an LC tank circuit, this oscillator generates about $1\frac{1}{2}$ watts of r.f. in the frequency range from 140 to 450 megacycles. Exceptionally solid construction results in excellent frequency stability. The tube is a 6F4 acorn triode.
◆

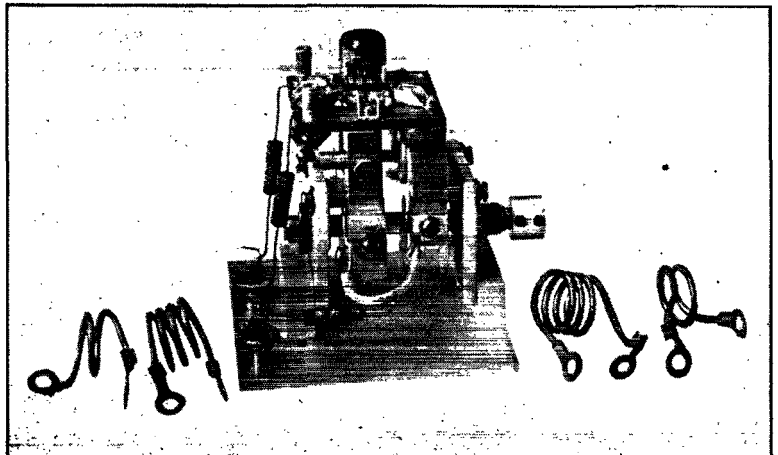

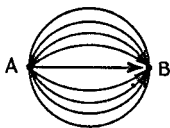

FIG. 1

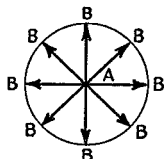

FIG. 2

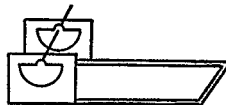

FIG. 3



FIG. 4

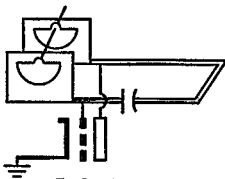

FIG. 5

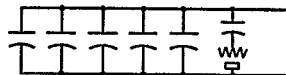

FIG. 6

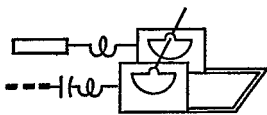

FIG. 7

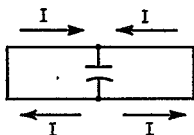

FIG. 8

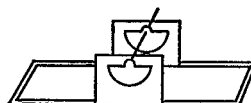

FIG. 9

lators if strict attention is paid to mechanical and electrical details—even though lumped parameters are used.

The oscillator described in this article should be of interest to all hams expecting to operate in the v.h.f. region because it embodies several novel concepts in circuit design and mechanical construction, all contributing to its efficiency, stability, and general smoothness of operation.

Inductance Where You Want It

To analyze the circuit used, let us start with the basic concept of inductance. By definition, inductance is the ratio of the voltage induced to the rate of change of the current responsible for the induced voltage. A coil has a great deal of inductance because the current in every turn induces a voltage in every other turn; thus the inductance of a solenoid is proportional to the square of the number of turns, other things being equal. The inductance of a straight wire is very small, and at low frequencies the voltage induced in such a wire is entirely negligible. But at very high frequencies, where the rate of change of current is extremely large, current in each part of the wire induces an appreciable voltage in the rest of the wire, and the reactance (and therefore the inductance) of even a short length of wire becomes a considerable factor. Increasing the diameter of the wire has the same effect as connecting a large number of conductors in parallel; in other words, the effective inductance is decreased. From this may be inferred the basic principle that the inductance of a particular conductor depends not

only upon its length or dimensions, but also upon the paths which the currents take in flowing along it.

A simple flat disc is an example which illustrates the importance of current path in determining the effective inductance of a given conductor. If the current flows from A to B, as in Fig. 1, we simply have a large number of essentially parallel paths. Although the inductance is small, at high frequencies it is appreciable.

In Fig. 2 the same disc has the current entering at the center and flowing radially out toward the edge. Here we have several things occurring, all tending to decrease the effective inductance: (1) the current paths are shorter; (2) the currents in radial elements of the surface are equal; (3) for every current path there is a corresponding path in the opposite direction. Item (3) is most important because it means that all voltages of self-induction will be almost completely cancelled out. It is for this reason that the end plate of a coaxial cavity (short-circuited concentric line) can be considered to have negligible inductance even though its dimensions are comparable to the length of the inner conductor.

Let us examine this principle as related to a simple quarter-wave line tuned by a variable capacity at the open end, as indicated in Fig. 3. The circuit we want looks like Fig. 4, schematically, but when we set it up physically, it looks like Fig. 5. We find that it works fairly well up to about 250 or 300 Mc., but if we try to go higher the line becomes so short that the tube is practically at the shorting bar. Even if oscillations

can be obtained we have practically no inductance to which to couple.

What has happened is shown in Fig. 6. The dimensions of the condenser plates are sufficiently large to represent a considerable length of the line, and the tube, instead of being actually at the end of the line, is tapped too far down to have a reasonable value of load impedance. The result is that there is no oscillation.

Let us then try to use the plates of the condenser as part of the line by connecting the tube at the other end, as in Fig. 7. The tube leads represent considerable inductance added to the end of the line, so we have to move the shorting bar still closer to the condenser. And here we have a peculiar condition. If we rotate the condenser clockwise, we begin to mesh the plates halfway down the line, with the result that we get little tuning effect unless we use a large capacity. But if we use a large capacity we soon get to the point where the capacity short-circuits the line and parasitic oscillations start, because the oscillatory currents flow directly across the condenser and back into the tube and ignore the line completely. On the other hand, when the condenser is rotated counter-clockwise, we at first get a very great frequency change because we are loading the line at its hot end, but as we turn it further into the

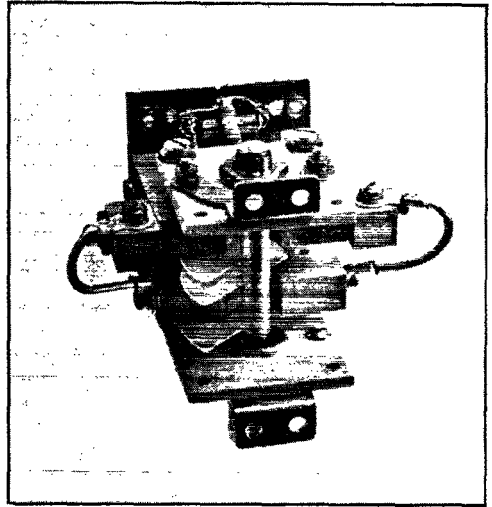

A view from underneath the assembly, with the mounting plate taken off. This shows the construction of the tuning condenser rotor and the two grid condensers.

mesh the effect of the capacity introduced decreases because the rotor is traveling farther down the line and approaching the shorted end. Soon we get to the shorted condition outlined above.

By applying the principle of reducing inductance by symmetrical current flow, these effects can be minimized and the over-all circuit efficiency increased. Consider the circuit of Fig. 8. Here we have two quarter-wave lines in parallel, symmetrically arranged about the tuning condenser. Alternatively, it may be looked upon as a half-wave line shorted at both ends. At any given instant, current is flowing either toward the center from both ends, or away from the center toward both ends. Around the center region, therefore, there will be almost complete cancellation of self-induction, and the conductors will contribute very little to the overall inductance of the circuit. When we make this center region of our tuned circuit the stator plates of a split-stator condenser, we find that to reach a given frequency we need much more inductance than usual, external to the condenser — which is where we want it. Such an arrangement would look like Fig. 9.

A Wide-Range Oscillator

The design of the oscillator shown in the accompanying photographs was based upon these principles. The circuit diagram is shown in Fig. 10, and the photographs show the details of construction. Basically, the assembly consists of two very heavy brass plates which do double duty, acting as tube mounting supports and as the stator plates of the tuning condenser. The tube is a 6F4, which in itself has symmetrically arranged grid and plate leads and thus carries out

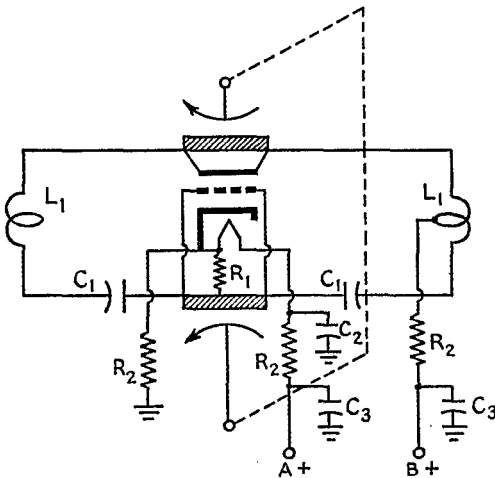

Fig. 10 — Circuit diagram of the 140-450 Mc. oscillator. The oscillator tube is a 6F4, drawn here in unconventional fashion to show how the tube elements are tied in with circuit construction.

- C₁ — 30- μ fd. mica, constructed as described in the text.
- C₂ — 100- μ fd. midget mica.
- C₃ — 500 μ fd. (Erie Ceramicon)
- R₁ — 0.22 megohms, $\frac{1}{2}$ -watt.
- R₂ — 0.5 ohm, $\frac{1}{2}$ -watt.
- L₁ — 144 Mc.: $3\frac{1}{2}$ turns No. 12 silvered wire, $\frac{1}{2}$ inch inside diameter, $\frac{1}{2}$ inch long.
- 220 Mc.: $1\frac{1}{2}$ turns No. 12 silvered wire, $\frac{1}{2}$ inch inside diameter, $\frac{1}{2}$ inch long.
- 420 Mc.: $\frac{1}{2}$ turn No. 12 silvered wire, $\frac{1}{2}$ inch inside diameter.

Dimensions of the tuning condenser are given in Fig. 11.

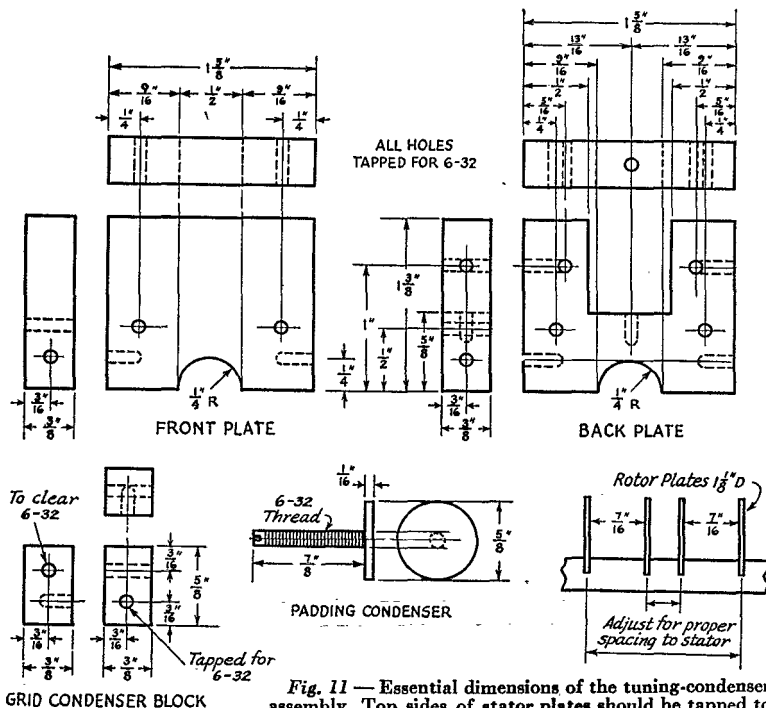

Fig. 11 — Essential dimensions of the tuning-condenser assembly. Top sides of stator plates should be tapped to fit socket contacts.

still further the principle of inductance cancellation. In addition, the method of connecting the tube to the line is such that the lead wires to the tube are shunted by low-inductance silver-plated brass plates, causing lead length to have very little loading effect on the line.

On each end of the stator plates is mounted a small coil which represents most of the inductance in the circuit. By making the coils self-supporting and of heavy gauge silver-plated wire, losses are kept to a minimum. Three amateur bands are covered by the three sets of coils shown, the one-turn set tuning from 417 to 456 Mc., the 2-turn set from 215.6 to 230.8 Mc., and the 4-turn set from 141.2 to 151.9 Mc. Thus the same oscillator assembly can be made to do duty on three of the most interesting of the v.h.f. bands available to amateurs. The coils are mounted to the stator blocks by means of 6-32 screws and soldering lugs so that they may be readily removed. On either side of the grid stator plate is a small brass block spaced off from the main assembly by a mica sheet. These act as low-inductance grid condensers.

In addition, in order to permit band setting for proper bandspread, two small disc-type trimmers are mounted between the stator blocks directly underneath the tube. When these are adjusted it is advisable to keep the airgaps approximately equal and thus avoid unbalancing the circuit.

To ascertain the upper frequency limit of the assembly, two flat bars were used instead of the coils and the grid condenser blocks were removed. A piece of mica was placed under one side of each bar to form the grid condenser. The frequency at which the circuit oscillated was 796 megacycles. The tuning range, however, was very small because the rotor plates meshed too far down on the line, demonstrating the principle discussed earlier. By using the two trimmer discs as tuning condensers a considerably greater frequency range was obtained, again confirming the earlier statements.

The frequency stability of the oscillator

is excellent because of its rigid construction. A sharp blow on the table causes the frequency to shift only several hundred cycles at 400 megacycles. The warm-up period is very short and is mostly due to the effect of the heater in warming up the other tube elements. Once the tube reaches operating temperature, frequency drift is negligible.

When using a high-order harmonic from a crystal to beat against the oscillator output the note is almost pure, having none of the characteristics of the general run of variable oscillators operating at 400 megacycles. With a plate voltage of 250 volts the 6F4 will deliver approximately 1.5 watts, which is much more power than can be obtained from the usual transceiver oscillator, and is ample for low power work at these frequencies.

The oscillator may be used to drive a "light-house" tube as the power amplifier of a transmitter. It can also serve as the high-frequency oscillator in a superheterodyne receiver. For maximum stability the 200,000-ohm grid leak should be used. By increasing the value of the grid leak the unit may be used as a superregenerative receiver. Higher plate voltages, up to 300 volts, may be applied provided the rated plate dissipation of 2 watts and the maximum plate current of 20 ma. for the 6F4 are not exceeded. An important point to remember is that the tun-

(Concluded on page 106)

A 28-Mc. Receiver/Converter

A Combination Unit for Getting Started on Ten Meters

BY BYRON GOODMAN, * WIJPE

• Here is a simple superheterodyne with good c.w. performance that can be used with any broadcast receiver to furnish excellent 'phone reception. When used as a converter ahead of a b.c. receiver, the second detector is used as a b.f.o. for code reception and as a regenerative "peaker" for voice.

ASK THE average amateur what his idea is of a "simple" receiver, and he will probably reply "A regenerative detector and one stage of audio." Ask him if he recommends it for ten-meter operation and — if he has ever used one on that band — he will probably answer "No." That, unfortunately, is the fundamental fact that we must face — the old reliable detector-and-one-audio which so many operators cut their eye teeth on just isn't the receiver for 28 Mc. Not that it can't be used — it can and has — but one has to have considerable patience and savvy to handle it properly. The next best "simple" approach is, of course, a converter — the front end of a superheterodyne feeding into a low-frequency receiver instead of a conventional i.f. amplifier — but if one works a converter into a broadcast receiver the reception of c.w. signals is difficult because of the absence of a beat-frequency oscillator. It was decided that a "simple" receiver for 28 Mc. would be a converter for

* Assistant Technical Editor.

working into a b.c. receiver, with the b.f.o. built into the converter so that c.w. reception could be obtained. However, when this has been done we have a pretty fair c.w. receiver by adding a stage of audio amplification to the converter, and the end result is a converter that is also a superheterodyne receiver in itself. By plugging headphones into the unit, excellent c.w. reception is obtained, and by working the converter into a b.c. receiver one can receive 'phone signals very acceptably. Of course, one can receive 'phone signals via the headphones and c.w. signals through the b.c. receiver, but we feel that the most satisfactory reception is obtained with headphones for c.w. and b.c. receiver for 'phone. By actual trial there isn't quite enough gain for weak 'phone signals without feeding into a b.c. receiver, although c.w. signals can be heard right down into the noise.

There is a little bonus with this arrangement that works out nicely when the converter is fed into a b.c. receiver of slightly low gain, such as some of the smaller midget receivers. By setting the b.f.o. just below the oscillation point, so that it is in a highly regenerative condition, an additional boost is obtained on weak 'phone signals.

The simplest converter for working into a b.c. receiver would be a single 6SA7 or similar oscillator-mixer tube, but unless one gangs the oscillator and mixer tuning circuits he will notice that the oscillator frequency is shifted as the mixer input circuit is tuned through resonance. This is objectionable enough with 'phone signals,

◆

A combination converter and superheterodyne receiver for 28 Mc. The large tuning knob is the main tuning control — the center knob is mixer tuning and the right-hand one is the regeneration control. The tubes, from left to right, are VR, oscillator, detector/b.f.o. and audio.

◆

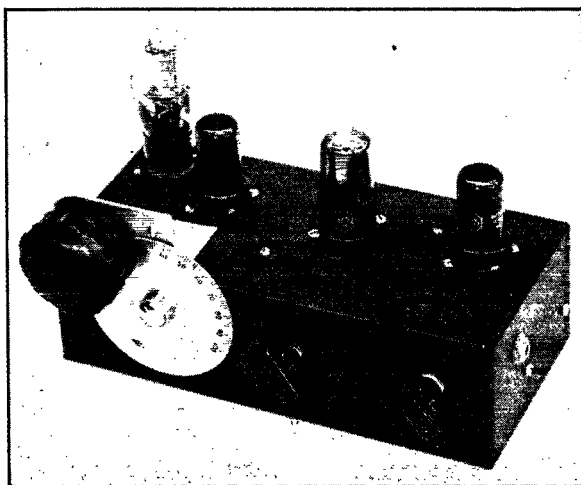

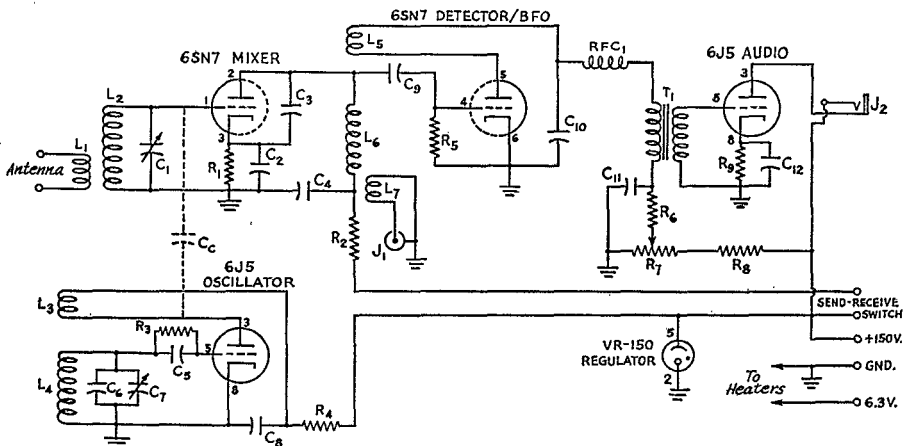

Fig. 1 — Wiring diagram of the 28-Mc. receiver/converter.

C_1, C_7 — 15- μ fd. variable (Hammarlund HF-15).

C_2, C_4 — 0.01- μ fd. postage-stamp mica.

C_3 — 250- μ fd. silver mica, 5% tolerance.

C_5, C_9 — 100- μ fd. mica.

C_8 — 55 μ fd. silver mica (50 and 5 μ fd. in parallel).

C_9 — 250- μ fd. mica.

C_{10} — 0.001- μ fd. mica.

C_{11} — 0.1- μ fd. 200-volt paper.

C_{12} — 25- μ fd., 25-volt electrolytic.

C_s — See text.

R_1 — 20,000 ohms.

R_2, R_4 — 500 ohms.

R_3 — 50,000 ohms, 1-watt.

R_5 — 1.0 megohm.

R_6 — 15,000 ohms.

R_7 — 50,000-ohm potentiometer, wirewound.

R_8 — 20,000 ohms, 1-watt.

R_9 — 1000 ohms.

Resistors $\frac{1}{2}$ -watt composition unless otherwise mentioned.

RFC_1 — 10 mh. iron-core r.f. choke (Meissner 19-6840).

J_1 — Cable connector (Jones S-201).

J_2 — Midget open circuit telephone jack.

T_1 — Small 3 to 1 audio transformer (Thordarson T-13A34).

but it is intolerable with c.w. signals under QRM conditions. As one peaks the mixer the oscillator frequency is "pulled," and it is definitely a two-handed job to tune in a signal. If the circuits are ganged, the pulling will still be present but it is not noticeable because of the single control. However, ganging and tracking is a chore the home receiver constructor likes to avoid. In an attempt to escape this objectionable pulling in a two-control converter, rather loose coupling was used between oscillator and mixer — actually just stray coupling — and the result was quite satisfactory. Although the signals will all be somewhat louder with greater oscillator injection, no weaker signals can be heard, and the lack in gain can be made up elsewhere. The reduction in pulling is a tremendous convenience, and the less than one-kc. shift that can be observed in this converter is considerably less than that obtained with any other simple combination that has been described.

The Circuit

The wiring diagram is shown in Fig. 1. The oscillator, a conventional tuned-grid plate-tickler type using a 6J5, is loosely coupled through stray fields to a triode mixer. This coupling can be represented by C_c , as in the diagram, but no conventional capacitor is used. The triode mixer is one section of a 6SN7 dual triode, and the other half of this tube is the detector/b.f.o., for want of

a better name. This detector/b.f.o. is the conventional regenerative detector, and its tuned grid circuit also furnishes the plate load impedance for the mixer. The mixer input circuit, L_2C_1 , is tuned to the frequency of the incoming signal, say 28.1 Mc. Since the converter is designed to work into an intermediate frequency in the broadcast range, say 1550 kc., the oscillator circuit, $L_4C_6C_7$, will have to be tuned 1550 kc. higher or lower to give the proper beat. The oscillator is tuned on the low side in this set, so for the 28.1-Mc. signal the oscillator would be set at 26.550 Mc. The 1.55-Mc. beat develops in the plate circuit, L_6C_3 , of the mixer, which is tuned to this frequency. For headphone reception, the signal is detected in the detector/b.f.o. and amplified in the 6J5 audio amplifier. The headphones are connected in the plate circuit of the 6J5 through J_2 , and if crystal headphones are used it will be necessary to use a resistor across them to complete the d.c. path to the tube. When working into a b.c. receiver, the 1.55-Mc. beat is coupled out through L_7 and J_1 to the antenna and ground connections of the b.c. receiver.¹ For c.w. reception, the regeneration control, R_6 , is advanced

¹ No difficulty was encountered with this low-impedance winding in coupling into the rather high-impedance input of a typical midget b.c. receiver. However, for maximum signal transfer it might be advantageous to connect to a low-impedance winding on a circuit tuned to 1550 kc., connecting the tuned circuit directly across the antenna terminals of the b.c. receiver.

until the detector/b.f.o. is oscillating. For 'phone signals, the control is retarded until the detector/b.f.o. is regenerative but not oscillating.

The resistor R_6 , in series with the regeneration-control arm, is insurance against a noisy potentiometer at R_7 . The time constant of R_6 and C_{11} is sufficient to iron out the small discontinuities of voltage encountered in noisy wirewound potentiometers.

A VR-150 regulator tube is included to stabilize the voltage throughout the set, and the voltage to the converter must be fed through a dropping resistor from a higher voltage than 180, to insure firing of the VR tube. Provision is included for removing the mixer plate voltage during transmission periods, and this feature allows one's transmissions to be monitored without complete blocking of the receiver. With no plate voltage, the mixer acts as a half-baked diode and allows strong signals, as from one's transmitter, to be heard by tuning the oscillator to the proper frequency. It also allows one to spot himself in the band with respect to other signals, since the tuning dial calibration does not change when the mixer plate voltage is removed.

Construction

A first glance at the converter in the photographs might identify it as a transmitter or v.f.o., since it must be confessed that it doesn't have a panel in the usual sense of the word. However, the design was arrived at in an effort to simplify construction, and none of the essential parts of a receiver are missing. The main tuning knob, the one that gets the working-over during long operating periods, is mounted on the left-hand side for left-hand tuning — to leave the right hand free for copying and for log-book entries — and it is high enough so that one's hand doesn't become cramped. The knob and dial, National

HRK and K-ODD, are inexpensive but very smooth in operation. The knob is mounted on an aluminum bracket which represents the only metal work necessary outside of the chassis itself.

The chassis is the popular 5 by 10 by 3-inch size, and the tuning condensers C_1 and C_7 are mounted by their shaft bushings. In addition, the oscillator condenser, C_7 , is tied down to the top of the chassis by a screw through the chassis and the tapped hole in the condenser bracket. The headphone jack, J_2 , is mounted on the side of the chassis and must be insulated from the chassis by two fiber washers, to avoid shorting of the plate voltage. The antenna terminals, a National FWG assembly, the converter output jack, J_1 , and an Amphenol 5-prong male plug for the power leads, are mounted along the rear of the chassis.

Although some of the components may appear crowded in the photograph, wiring the unit is a simple matter if a little thought and care are exercised. After the variable condensers, Amphenol MIP tube sockets, power plug and antenna posts are mounted, the heater leads should be laid in place. Pin No. 8 on the 6SN7 socket is grounded to a lug under the nut of a mounting screw for the socket, pins 1 and 2 on the 6J5 audio socket are grounded to a similar lug at that socket, pins 1 and 7 are grounded to a lug at the oscillator socket, and pin No. 2 on the VR-150 socket can be grounded over on pin 1 of the oscillator socket. The "hot" heater leads, pin 7 on the 6SN7 and pins 2 and 7 on the oscillator and audio sockets respectively, are then tied together and a lead carried to the power plug.

It is convenient to wire the audio stage first, since the socket is not very accessible with the audio transformer in place. The 'phone jack must also be wired before the audio transformer is in position. Pin 4 on the 6J5 socket is used as a tie

◆
The location of the components under the chassis and along the rear is shown in this view. The detector/b.f.o. coil is mounted on the rear of the chassis, between the antenna posts and the power plug.
◆

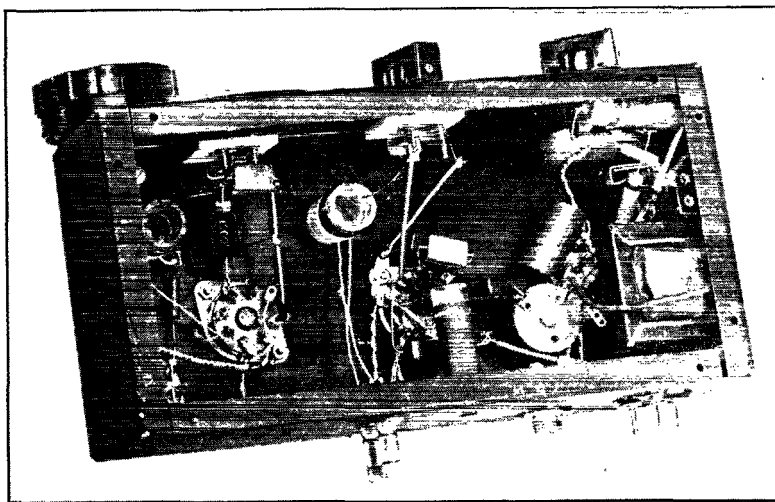

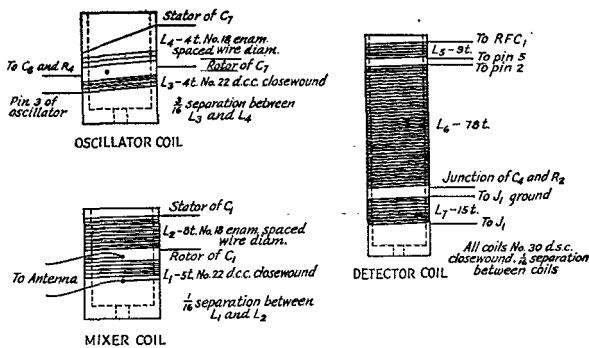

Fig. 2 — Construction of the coils. The mixer and oscillator coils are wound on National PRF-2 forms — the detector form is a National PRE-3. All coils are wound in the same direction.

point for R_8 , which is supported between this pin and the potentiometer, R_7 . The plate voltage to J_2 is also picked up at this pin, and hence a lead must be run back from pin 4 on the 6J5 socket to pin 5 on the VR-150 socket. The grid and ground leads of T_1 must be connected to the proper points before installing the audio transformer.

At the mixer socket, C_8 , C_9 and R_5 are mounted across the socket. C_2 and R_1 ground to a lug under the same nut that holds the heater ground lug, and a heavy lead from the rotor of C_1 is also run to this point, to insure a good r.f. ground for the tuning condenser. C_4 grounds to pin 8 of this socket — its other end is anchored to a tie point which also serves as the junction for the leads from L_6 and R_2 . This tie point is mounted under the other nut on the socket, and another soldering lug at this point grounds C_{10} . A heavy wire lead is run from the stator of the tuning condenser, C_1 , to the mixer grid.

The coils for the mixer and detector/b.f.o. can now be installed. Only the ends of the coils were fastened with Duco cement at the time of winding, just in case some adjustments had to be made, and this procedure is recommended unless you are willing to force your luck! Fig. 2 gives full data on the winding of the coils.

At the oscillator socket, R_3 and C_5 are hung between the tuning condenser rotor and the socket. Pin 8 grounds through a heavy lead to the rotor of C_7 , rather than to a lug and hence back through the chassis to the tuning condenser, and C_8 grounds to the center of this wire. This heavy lead and the others mentioned previously are of No. 14 wire, and are used where it is necessary to minimize inductance and for mechanical stability. The other lead of C_8 is stuck in a small hole in the L_3L_4 coil form, thus serving as a tie point for R_4 and one end of L_3 . The oscillator padding capacitor, C_6 , is hung directly across C_7 .

Adjustment

To test the receiver, connect a power supply and adjust the VR-150 dropping resistor men-

tioned above until the VR tube draws 12 or 15 ma., with all of the tubes operating. A convenient point to measure this current is in the ground lead of the VR-150. The receiver will draw about 28 mc., including the VR current, in case you know your power supply voltage and wish to calculate the dropping resistor beforehand.

With the tubes drawing current — and nothing smoking! — connect the converter output from J_1 to a b.c. receiver through a twisted or shielded pair, advance the regeneration control and look around 1550 kc. for a loud unmodulated carrier. If the detector is oscillating, you will find the carrier easily, and if you are lucky its frequency will be around 1550 kc. Its exact frequency doesn't matter at all, just so long as it isn't beating with a strong local b.c. station that might creep through. When the regeneration control is backed off, the carrier in the b.c. set should get weaker and finally disappear. If no oscillation is obtained at any setting of the regeneration control, check the direction of winding on L_5 and L_6 and the values of the components in the circuit. If it is found that the frequency is a poor one because of a local b.c. station, the frequency can be shifted by removing turns from L_6 or, more easily, by adding a small capacity — 10 or 20 μfd . — across C_3 . When operating properly, the detector should go into oscillation with the regeneration control advanced about halfway.

The only difficult job is to check the oscillator frequency, but a transmitter harmonic can be used for first spotting, or a strong local signal can be tuned in to give one an idea of where the band is. With the constants given, the band will occupy about 70 of the 100 dial divisions. If the high-frequency portion of the band is missing, push the turns of L_4 together just a bit, and pull them apart slightly if the low-frequency end of the band can't be tuned. If the oscillator doesn't work at all, check direction of turns and, of course, all wiring connections.

If 70 divisions is not enough bandsread, more can be obtained by increasing the padding condenser C_6 and spreading the turns on L_4 . We went whole hog and removed a stator plate from C_7 , and this spread the band out to 90 divisions. However, the adjustment of L_4 then becomes rather critical, and the procedure is not recommended until one is thoroughly familiar with the receiver and his marker signals.

If a milliammeter is connected in the send-receive switch line, it will read mixer current. This will be about 0.2 ma. with the mixer and oscillator circuits tuned to the proper frequencies, and will increase to about 1.0 ma. as the mixer is tuned closer to the oscillator frequency. With the

(Concluded on page 108)

A New Linear Amplifier Circuit

Divided-Wave Amplification for High Efficiency

BY SIDNEY T. FISHER *

Here is a novel idea for increasing the efficiency of linear power amplifiers. Because there are no hard-to-adjust and hard-to-maintain phasing arrangements, the circuit offers better possibilities for multifrequency operation than high-efficiency linear circuits previously proposed.

POWER amplifiers for either unmodulated or frequency-modulated service operate with such high efficiency, of the order of 75 per cent, that no considerable improvement is necessary. But a power amplifier for a carrier wave modulated in amplitude by a speech wave still presents an outstanding problem, and it is the purpose of this article to describe a new line of attack.

Several solutions have previously been offered. The most wide-spread arrangement in use today is the Class-C radio amplifier modulated at high level by a Class-B audio amplifier. Other more complex arrangements in less common use are the Chireix "out-phasing modulation" method, and the Doherty high-efficiency circuit. Neither of these is readily adaptable to transmitters which must operate on a number of frequencies or be tunable over a band of frequencies.

Linear Amplifiers

When a wave containing amplitude modulation is to be amplified, the amplification must be linear. Linear amplification is conventionally obtained with a Class-B amplifier, the efficiency of which is about proportional to the r.m.s. value of the radio-frequency wave being transmitted by it. When operated continuously at its maximum capacity, such an amplifier will have a peak efficiency of the order of 66 per cent. Maximum capacity represents 100 per cent modulation, at which point the peak power output is four times the carrier power and the value of the applied r.f. voltage is twice the carrier voltage. Half of this four-times increase in power is secured as a result of the fact that the peak efficiency is twice the carrier-only efficiency because the applied

r.f. voltage is doubled, and half because the instantaneous d.c. power input to the amplifier also is twice the carrier input. The net result is that a Class-B linear amplifier must have a maximum power capacity twice that necessary for the carrier alone.

Since over any considerable period of time the modulation in a voice-modulated wave has a very low average value, we are not far wrong in considering the efficiency of the circuit for the carrier wave alone as its actual performance. Thus we have, in conventional linear amplifiers intended for transmitting a carrier wave amplitude-modulated by a speech wave, and where the modulation may reach 100 per cent, an average efficiency of only about 33 per cent. This means that for every watt delivered to the antenna, about two watts of power is dissipated as heat at the anodes of the output tubes.

Two disadvantages are immediately apparent: first, the cost and difficulty of providing this relatively large amount of direct-current power at high voltage are considerable, and second, unduly large power-amplifier tubes must be employed in order that this amount of heat may safely be dissipated.

In the Doherty high-efficiency circuit, linear

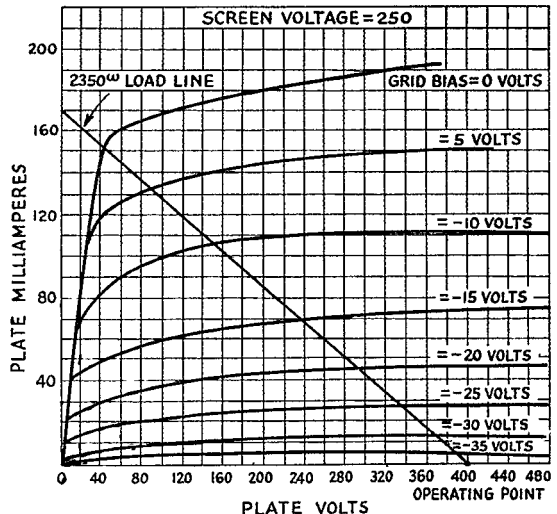

Fig. 1 — Plate voltage — plate current curves of a small transmitting tube used to illustrate the points brought out in the text. The load line is drawn for Class-B operation.

*F. T. Fisher's Sons, Ltd., Toronto, Ontario, Canada.

amplification is obtained at an efficiency of around 60 per cent, which is very nearly twice the efficiency of the ordinary Class-B linear amplifier. This is the same order of efficiency as is achieved in a plate-modulated Class-C amplifier, and the choice between the two systems lies in the practical details of components, ease of adjustment, and first cost. For any individual applications these may be quite different for the two approaches to the problem.

A New Method of Linear Amplification

If a linear amplifier can be made to operate at an efficiency equal to that of a plate-modulated stage, there is an excellent opportunity for saving of weight, size, and power requirements — serious considerations in radio equipment for aircraft and other mobile uses. It is believed that the proposal which follows is a basically-correct approach to the problem.

The plate dissipation in a vacuum tube goes to a low value when either the plate current is reduced to a low value without exceeding the allowable plate voltage, or the plate voltage is reduced to a low value without exceeding the maximum plate current. It will be obvious that an applied r.f. wave form which causes both these conditions will be transmitted with maximum efficiency. The ideal form is a square-topped wave, because in such a wave the energy is contained completely in rectangular pulses which rise instantaneously from zero to the maximum

value, and drop to zero from this maximum value instantaneously. The energy therefore can be transmitted wholly during the time when the maximum allowable plate current is being drawn, and under this condition the ratio of voltage drop across the load to voltage drop across the tube is a maximum. The Class-C amplifier, as ordinarily operated, approximates this condition, since the high bias and large r.f. grid voltage cause the plate current to flow in pulses essentially rectangular in shape. In such amplifiers it is possible to obtain an efficiency of the order of 90 per cent, using conventional tubes.

Fig. 1 illustrates the point in a qualitative way. This figure shows the plate characteristic of a typical small transmitting tube. When the tube is operated as a Class-B amplifier into the rated load impedance, the plate current rises with excitation along the load line from the plate-current cut-off point to a maximum value which is determined by the allowable plate heating and the allowable cathode current. For the tube whose characteristics are given in Fig. 1, this maximum value occurs at zero grid voltage. When the grid is driven to zero voltage, 10 per cent of the plate voltage appears across the tube and 90 per cent across the load. Thus at this point the tube is delivering power at an instantaneous efficiency of 90 per cent. However, with sine-wave excitation only a small part of the energy is developed at or near this high-efficiency point, and most of the energy content of the output wave is delivered

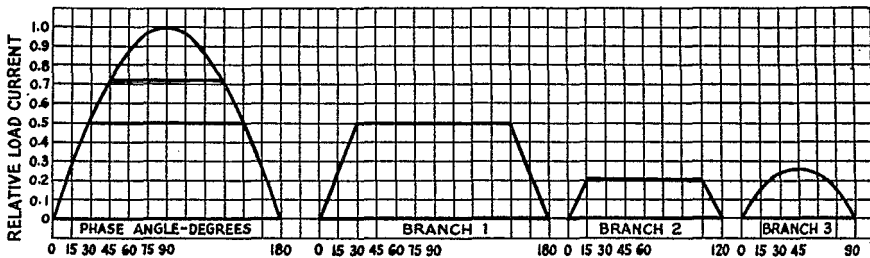

(A)

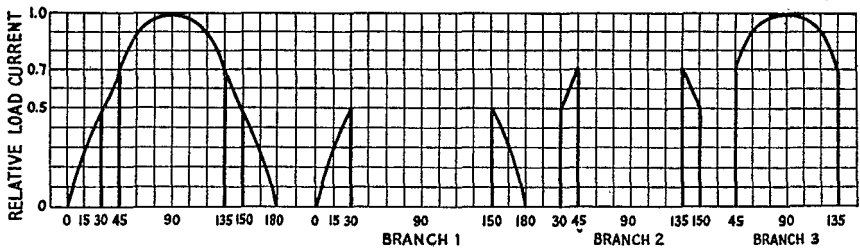

(B)

Fig. 2.—Two waves in which a sine-wave voltage can be split into sections approaching the shape of rectangular pulses. Above — “horizontal” division, or separation on an amplitude basis; below — “vertical” division, or separation on a time basis.

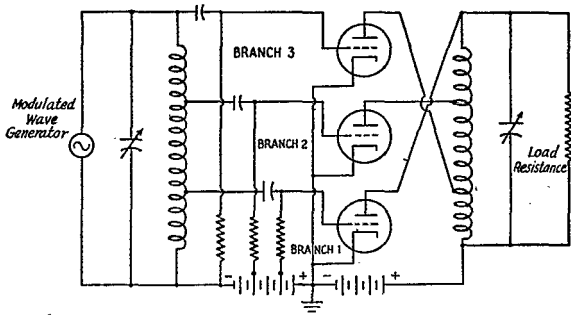

Fig. 3 — Schematic of a 3-branch amplifier of the type described in the text. This circuit separates the sine wave into a series of pulses and recombines them in the output circuit.

at much lower efficiencies. A sine wave will be amplified with about 60 per cent efficiency and, for the reasons previously given, this will be reduced to a carrier efficiency of about 30 per cent when 100-per-cent modulation is provided for. On the other hand, the tube would amplify a square-topped wave with an efficiency of 90 per cent, so that for a given plate dissipation the tube would have a power output for the square-topped wave about four times greater than for the sine wave, and about six and one-half times greater than for the carrier wave 100-per-cent modulated by a signal.

Insofar as linear amplification is concerned, the solution to the problem resolves itself into changing the actual r.f. signal wave into the form in which it can be amplified with the highest efficiency; that is, having it approach a square-topped wave as nearly as possible. Fig. 2 shows two ways in which this can be done. The wave can be divided into a number of sections, horizontally or vertically — that is, on either an amplitude basis or a time basis. The method to be proposed consists therefore of the following steps:

- 1) Sub-division of the r.f. wave into components which approximate the optimum rectangular waveform.
- 2) Amplification of these components in separate amplifiers.

3) Recombination of the separately-amplified components in the output circuit so that the original waveform is reproduced.

In other words, high-efficiency amplification is achieved by dividing the wave into several sections (in practical cases, about three), transmitting each of the sections through a power amplifier whose peak allowable current is that of the section being transmitted, and then combining the three sections at the output by connecting the three amplifier branches to a common load.

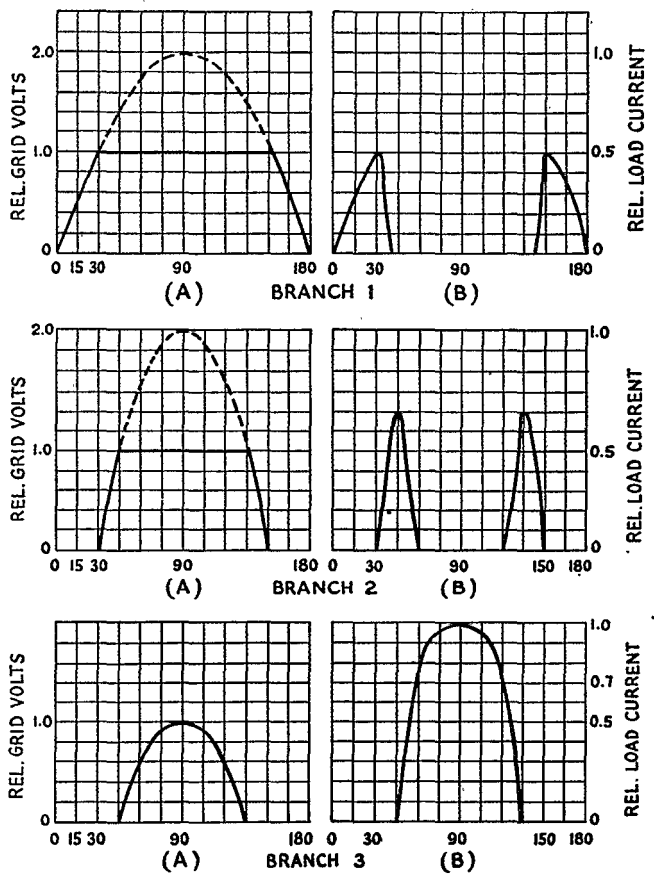

Fig. 4 — Operation of the circuit shown in Fig. 3. The left-hand column shows instantaneous grid voltage applied to the three branches, while the right-hand column shows the corresponding instantaneous plate currents.

circuit so that the original waveform again is obtained. This arrangement involves some circuit complexity, but it increases the plate-circuit efficiency of the amplifier by a large factor. Also

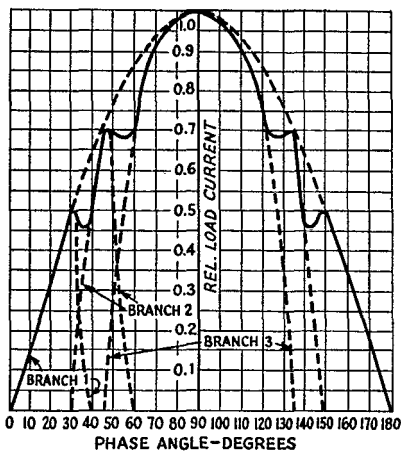

Fig. 5—Shape of recombined wave in the output circuit. The distortion is at radio frequencies and is easily filtered out by the tuned plate tank circuit.

it reduces the required tube power capacity, since the increase in efficiency chiefly manifests itself as a reduction in the amount of power dissipated in the plates of the power amplifiers.

It may be helpful to think of this system as a series of Class-C amplifiers, each driven by different sections of the wave, the sections being selected by a combination of grid bias and grid drive in an arrangement which might be termed an "amplitude filter." Each branch then amplifies its section of the wave at higher efficiency and higher output than would be possible if it had to handle the whole wave, and the sections then are combined in the output circuit so that an over-all linear relationship between input and output is obtained.

In practice this rather round-about method has been found to work out with surprising ease. Fig. 3 shows an outline circuit of a 3-branch modulated-wave linear amplifier. Each of the three branches has its grid drive and grid bias individually adjusted so that the branches transmit current in sequence and not simultaneously. Branch 1 is biased to cut-off so that it operates as a conventional Class-B amplifier. It receives the lowest grid drive. Branch 2 is biased beyond cut-off, and it has a greater grid drive. Branch 3 is biased to about twice cut-off, and it has the highest grid drive. These three branches are connected to the load through a common plate coil, and their load impedances are adjusted in about inverse proportion to the grid drive. Branch 1 has the highest load impedance, Branch 2 an intermediate load impedance, and Branch 3 a load impedance about one-half that of Branch 1.

Referring to Fig. 4, when the wave commences Branch 1 immediately starts to draw plate current, since it is biased for Class-B operation. As the wave advances it reaches a point, shown as a relative grid voltage of 1.0 and a relative load current of 0.5, where the peak allowable current of the Branch 1 tube is reached. At this point the grid starts to draw current and is biased more negatively because of the d.c. voltage set up across the grid leak. At the same time the plate current of Branch 1 decreases abruptly, because at this point in the wave Branch 2 has started to draw plate current and is delivering power to the load from a higher-impedance source than does Branch 1. Similarly, as the wave advances, Branch 3 draws plate current and Branch 2 at this point has its plate current abruptly reduced. The same process takes place in reverse order when the wave has passed its maximum value and decreases again to zero. Each tube operates linearly over the range of amplitude for which it alone delivers power, and non-linearly outside this range. The three groups of pulses are delivered in sequence to the load resistance, and the way in which they combine is shown in Fig. 5. It might be mentioned that the figures shown are copies of oscillograms in an experimental amplifier.

The recombined wave has, for a 3-branch arrangement, appreciable harmonic content, principally at the ninth harmonic. In any radio-frequency application it is, of course, rather easy to reduce the ninth and higher harmonics by any factor desired. If the circuit is used for audio frequencies the harmonic content can be reduced by the application of negative feed-back.

Plate-Circuit Efficiency

It will be apparent that the efficiency of this circuit is high, even when the r.f. grid voltage is small, because the instantaneous efficiency rises to about 90 per cent when the maximum current in each branch is reached. This is shown in Fig. 6, which is a plot of per cent instantaneous efficiency against per cent peak load current for the amplification of a sine wave. For the conventional Class-B amplifier the efficiency is assumed to be proportional to the peak load current, rising to a value of about 90 per cent at 100 per cent of the allowable current. The plot shows how this efficiency curve varies as circuits of varying numbers of branches are used. In each case for which the data are given, the power ratio from one branch to the next is 2 to 1; that is, a 3-db. separation.

For example, in the 3-branch circuit illustrated by the previous waveform curves, the instantaneous efficiency rises to 90 per cent at 50 per cent of the maximum load current, and the efficiency does not depart far from this value right up to the maximum power output from the over-all circuit. For waves of low amplitude the efficiency of this circuit therefore is quite good and, in fact, it is

the same for waves of half the maximum amplitude as the efficiency of a conventional Class-B amplifier for waves of maximum amplitude. In other words, the carrier efficiency is twice that obtainable in ordinary Class-B linear amplification.

If as many as ten branches are used, then the efficiency of the circuit for waves of 4.4 per cent of the maximum amplitude is the same as the efficiency of the conventional circuit for waves of maximum amplitude, and for waves of amplitude higher than 4.4 per cent the efficiency steadily improves to a value in excess of 90 per cent for waves of maximum amplitude.

Fig. 6, which was obtained experimentally, is further explained by Fig. 7, which shows the efficiency obtained in amplifiers having different numbers of branches with 3-db. separation between each. The efficiencies are shown both for a sine wave of constant amplitude, and for a signal-modulated carrier wave with 100 per cent modulation, and were derived experimentally using the tube whose characteristics are shown in Fig. 1. For normal applications involving speech modulation an arrangement of about three or four branches gives a practical compromise between efficiency and circuit complexity.

Controlled-Carrier Systems

The linear amplifier system described, whose efficiency remains relatively high for low amplitudes of the transmitted wave, has some advantages to offer as a power amplifier for a system in which the carrier is either controlled so as to keep the percentage modulation substantially constant and high, or in which the carrier is suppressed. Since suppressed-carrier systems are of a rather special nature and require special receivers, consideration of a controlled-carrier system is of more interest in the present application.

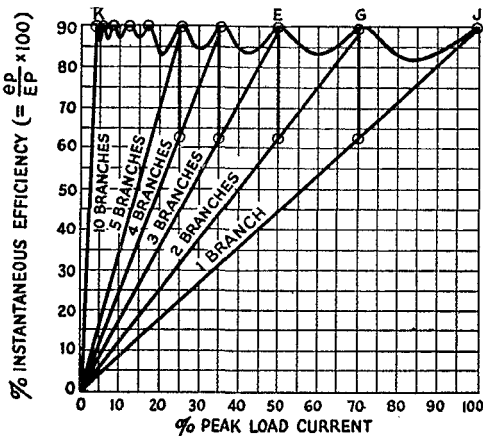

Fig. 6—Instantaneous efficiency as a function of output load current for circuits having from 1 to 10 branches.

In a controlled-carrier system, in general it is not necessary to use special receivers, and the transmission is essentially no different from constant-carrier systems.

The usual controlled-carrier system operates in such a way that when no speech current exists the carrier is transmitted at a very low level, say 5 per cent of the maximum capacity of the system.

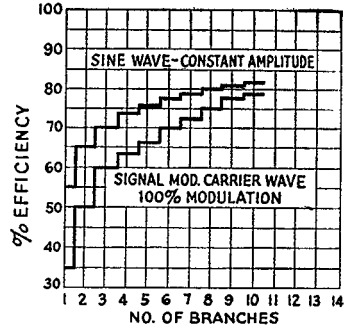

Fig. 7—Efficiency as a function of number of branches, for unmodulated and 100-per-cent modulated signals.

When speech modulation is applied, the carrier is increased proportionately to the modulation so that the output consists of a voice-modulated carrier whose modulation is substantially complete for all modulation amplitudes. Since average voice modulation is only about 20 per cent, the range of amplitudes of the output wave will vary in a ratio of about 10 to 1, with the average amplitude about one-tenth of the peak amplitude. This factor is responsible for the low efficiency of conventional linear amplifiers in controlled-carrier systems, and the ability of the circuit outlined in the previous paragraphs to sustain its efficiency at low amplitude will be of value in this type of transmission. For example, to consider again a transmitter with an unmodulated output of 100 watts, if this carrier is controlled so that it drops to, say, 5 watts in the absence of modulation, it will rise to a total value of 150 watts, averaged over an audio-frequency cycle, for 100 per cent modulation. Considering average modulation as 20 per cent, the average power content of the carrier plus the sidebands would be approximately 6 watts if the carrier were completely suppressed during silent periods, but the constant-carrier output of 5 watts combined with the modulation gives an average carrier plus sideband output of about 10 watts. This output power will be generated in a 3-branch amplifier with an efficiency of around 30 per cent. That is to say, the direct-current input to this output stage will be about 33 watts for speech. This compares with the case of the conventional Class-B amplifier operating on a controlled-carrier system where, under similar conditions, the direct-current input

is of the order of 90 watts, or of the Class-C carrier amplifier modulated by the Class-B audio amplifier using a constant carrier where the total d.c. input is between 250 and 300 watts.

Practical Variations

A large number of variations of this basic idea obviously are possible. Only the "vertical" division of the wave has been considered. "Horizontal" division in which all branches may transmit current simultaneously also is possible; this would involve a bridge or hybrid-coil arrangement in the output, so that the branches could supply current simultaneously to the load, without mutual coupling. Both series and shunt plate supply arrangements should be considered. In place of the "signal-shaping" arrangement employing adjustments of grid drive and grid bias to set up the sections of the wave, the plate current of one branch can be utilized to "trigger" the grid bias of the succeeding branch. By using a divided d.c. power supply, the branches can be arranged in parallel or in series to deliver power to a single load impedance, instead of the divided load described. The adaptation of this circuit to a modulated amplifier and to an oscillator are straightforward.

Special tubes having a higher ratio of plate current to plate dissipation than those currently used will have particular value in this circuit. New forms of tubes, employing multiple grids or multiple anodes, with heat interchange between the anodes, appear to have useful possibilities.

In conclusion, this arrangement appears to have an advantage of at least 5 to 1 on the basis of d.c. power input over circuits now in use, and in some cases this improvement might be 10 to 1. It is possible that these advantages will not be obtained in all cases in practical apparatus because of the greater circuit complexity, but substantially the improvement to be expected should be obtained.

A further point is that with this circuit the total power dissipation of the output stage is considerably reduced. For instance, with a 100-watt carrier and 100-per-cent sine-wave modulation, the power to be dissipated by the plates of the power-amplifier tubes as indicated by Fig. 7 is about 66 watts. The maximum power to be dissipated by the anodes of the power amplifier in a controlled-carrier system using a conventional Class-B power stage is about 150 watts, and without controlled carrier is about 200 watts, while in an output stage in which a Class-C amplifier is plate modulated by a Class-B audio amplifier the total plate dissipation is about the same. The plate dissipation in the system described, therefore, is only about one-third of that obtained in conventional systems, if the small amount of power required for low-level modulation is neglected, and the tube complement employed is a correspondingly smaller capacity.



DIXIE JONES' OWL JUICE

I SWARE, I go through me a war and I come out a stinking captain and I think I am doing swell and even brag about it a little off and on sense 1919 up to lately, and then here comes along another war and of all the dum bunny hams that git into it none of them ever comes out less'n a major. Is my face red. Old Goat Saxon, W4AAY, was a bloomin' lieutenant commander, which is sump'n similar to a major, when the Navy tied him up, and old Leland Smith, W4AGI, is a major, and old Teddy Winstead, W4ALT, is a major, and old Willis Hudgins, W9BNT, is a major, and old Leroy Thompson, W4BRF, is a major, and old Roy Gale, W1BD, is a major, and old Jim Spratlin, W4KV, is a dad blame full colonel, whoooooce, and I ain't such a much dummer'n they are, and even one of them good-for-nothing Three Wise Monkeys from Arkansas — the one in the middle — Logan, W5IQ-W4FPD —, blew into my shack last week to be deprocessed at Fort McPherson and you can shoot me for a commy if he ain't another bloomin' major. It ain't right. Don't any hams ever miss it just one little notch and wind up nothing but captains? I ask you.

— W4IR

Strays

Some really small capacitors were made during the war using Lectrofilm, a synthetic dielectric material developed during the war and used in applications for which only mica was previously considered suitable. These capacitors became known as "matchsticks" and will have many postwar applications in lightweight or compact equipment.

Sheldon H. Dike, W3DPE, is the first radio amateur to report his active participation in the development of both the A-bomb and the radio proximity fuze, our No. 1 and No. 2 "secret weapons."

Among the nine radio communications employees of Press Wireless now serving in the Philippines who have been awarded by the Philippine Army the Philippine Liberation Ribbon, is Forrest B. Bartlett, W6OWP.

QRM—The Electronic Life Saver

How Enemy Radar Was Foiled by Jamming In Two Parts—Part II*

BY PAUL ROBBIANO,* W6PKM

In this concluding part of the radar countermeasures story the receiving equipment and antennas are described and some of the tactical uses of the equipment are discussed. The transmitting equipment was described in Part I, which appeared in QST for January, 1946.

CONCURRENT with the development of radar transmitting gear was an equally intensive program for the development of radar receivers covering frequencies from 30 Mc. up to approximately 10,000 Mc. These receivers were to provide continuous coverage of the above spectrum with the emphasis placed upon achieving as wide a tuning range as possible for a given unit, such as a two- or three-to-one ratio of high- to low-frequency limits. Primarily such receivers were to be designed for the purpose of reception of radar transmissions, which are characterized generally by pulse modulation in which peak powers are present for relatively short intervals. Because the duty cycle is low, the average power in the signal is likewise low. This situation calls for special considerations in the receiver. For instance, an a.v.c. circuit designed for normal operation on amplitude-modulated signals, in which considerable carrier power is present, will not function on radar signals of even large amplitude. Also, if the receiver is to reproduce

*Radio Research Laboratory, 18 Divinity St., Cambridge, Mass.

the modulation with reasonable fidelity, with pulses of duration of one microsecond or less, it must be able to handle sidebands and video-modulation components extending into the megacycles. Such requirements led to the development of high-frequency i.f. amplifiers operating at frequencies of 30 Mc. and above. Careful design and proper choice of tubes enabled construction of i.f. amplifiers with bandpass in terms of megacycles without sacrifice of much of the high overall gain necessary in the more refined types of radar search receivers.

Generally speaking, two types of receivers evolved from the research work done at the Radio Research Laboratory. The first and simplest of these was the "direct detection" type. This type of receiver used a simple detector, such as a diode or crystal, followed by a pulse or video amplifier feeding a pulse-distorting diode; this in turn was followed by an audio amplifier. Such a receiver is neither as sensitive nor as selective as a superheterodyne, but its simplicity has made its use desirable in some cases. Direct detection was used in an early receiver designed to warn the pilot of a combat aircraft of the dangerous proximity of airborne radar systems carried in enemy night-interceptor aircraft. Accordingly, when an enemy night interceptor was within range of the warning system, the pilot was given immediate warning of imminent interception and was able to take suitable evasive action.

More recently, two other direct-detection type receivers have been developed at this laboratory.

◆
A "direct-detection" receiver, consisting simply of a tuned circuit feeding a rectifier, followed by sufficient video and audio amplification to bring the received signal up to a suitable level. The model illustrated tunes from 1000 to 3500 megacycles, using an adjustable plunger in a concentric cavity.
◆

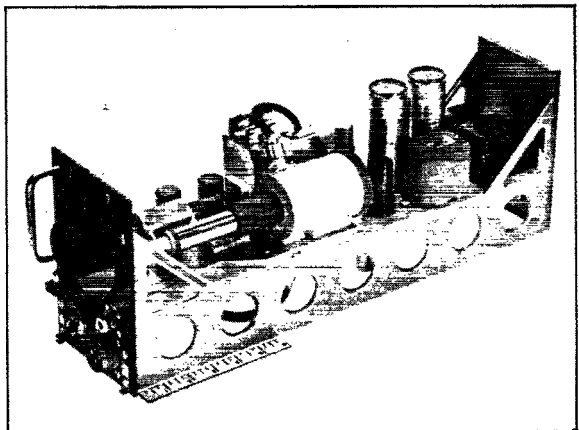

Both the low-frequency model, tuning from 1000 to 3500 Mc., and the higher-frequency version, covering from 2500 to 5000 Mc., were put to good use for radar search work in the Pacific war theaters. True enough, they lacked some of the selectivity and sensitivity of superheterodyne receivers operating in the same range; however, their compactness and simplicity of operation made them very attractive.

Much of the receiver research at Radio Research Laboratory has been directed toward the development of a series of high-performance superheterodyne receivers providing continuous frequency coverage from approximately 50 Mc. on up to very high frequencies. Work was begun on such a receiver at the General Radio Company even before the Radio Research Laboratory was operating. Later the U. S. Navy awarded a contract to this concern to manufacture a number of these early radar receivers. However, early in 1942 the receiver project was moved to Radio Research Laboratory where many improvements were made on the General Radio model, the greatest one probably being the successful ganging of the oscillator and mixer tuning controls.

The layout and construction of the set in its final form was of necessity neat and systematic; it was also compact since it was for airborne use. The receiver was constructed in two sections, main chassis and r.f. head. On the main chassis were

the power supply, designed for 115 volts, 60 to 2400 cycles, the 30-Mc. i.f. amplifier, second detector and video output amplifier, feeding into earphone jacks. The r.f. head contained the local oscillator and crystal mixer with a single tuning control. This whole r.f. head was completely shielded and plugged as a unit into the main chassis assembly.

Once the main chassis had been developed, most of the additional work was directed toward the development of higher-frequency plug-in r.f. heads. Eventually, four r.f. heads were developed providing continuous coverage over a frequency range from 40 to 3400 Mc. These were also used in a newer receiver which incorporated some improvements over the earlier model, such as a two-step variable i.f. bandwidth control and separate i.f. and a.f. gain controls. Other receivers, tuning to considerably higher frequencies, were also developed but were never used to as great an extent as the original series. In addition, special receivers were devised which incorporated automatic tape-recording systems for use in radar search applications.

Antennas and Direction Finding Equipment

The same reasons which made it necessary for the receivers and transmitters to cover large frequency ranges applied in the case of antennas.

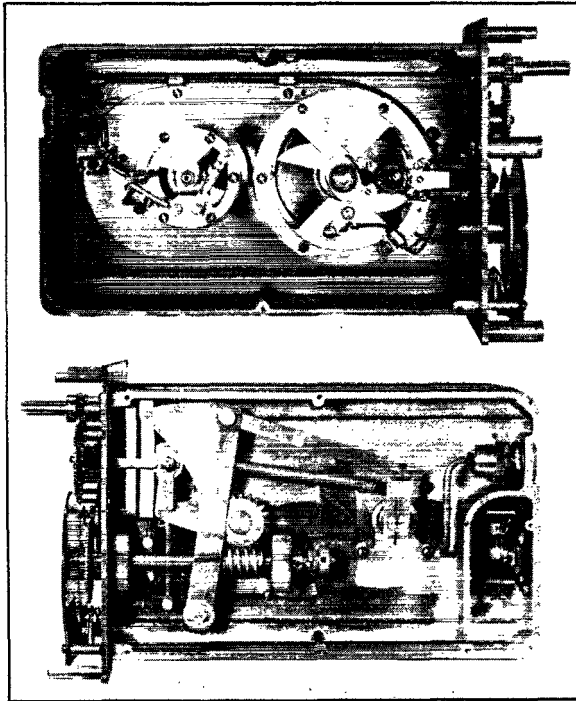

◆

The "butterfly"-tuned converter unit for a 300-1000 Mc. receiver constructed on the vertical central partition of an aluminum casting. In the upper view, the larger "butterfly" at the right, incorporating a 955 acorn, makes up the high-frequency oscillator (the second harmonic of the oscillator is used to cover the frequency range). The mixer circuit, at the left, uses a small "butterfly" and a crystal detector.

The mechanical tracing arrangement, on the other side of the partition, is shown in the lower photograph. The nine screws at the upper left permit adjustment of tracking at the same number of points throughout the tuning range.

◆

◆

Wide-band cone antenna for the frequency range 300-3000 megacycles. The inverted cone is mechanically supported above the ground plane by the insulating cone-shaped skirt. The end of the antenna cone terminates in the coaxial fitting at the bottom.

◆

In aircraft installations it was essential to keep the number of antennas to a minimum, since each antenna added weight and drag. On ship installations a minimum number of antennas was just as important because the number of clear locations in the superstructure of a ship is limited, and never sufficient for all the antennas needed for radars, communication and IFF as well as for the countermeasures equipment.

The wideband characteristic required of the antennas was not the only unusual feature. Frequently, the directional properties and the polarization required of the radiated signal were equally unconventional. An additional problem was imposed by aircraft antennas. As the speed of the aircraft increased, it became essential to reduce as much as possible the aerodynamic drag caused by aircraft antennas. This was done by applying streamlining techniques to the design of the antennas or else by recessing them in the wings or fuselage of the plane.

In the course of this program several different types of antennas were designed. Early in the work of the Radio Research Laboratory it was found possible to design a cone antenna so that it matched well into a transmission line over a tremendous frequency range. One of these antennas worked from 300 to over 3000 megacycles. The trick consisted not only of choosing the right angle for the cone (about 60 degrees if 50-ohm feed line is used) but of supporting it in such a way that a smooth transition was made from the feed line to the cone. This cone was fine so far as matching a line was concerned, but its radiation pattern and polarization were suitable only in certain special cases. It wasn't of much use against the Germans' Wurzburg radar, since the Wurzburg had a spinning dipole. This meant that if the jamming were being transmitted by a vertically-polarized antenna, the Germans would not be jammed at the time that their dipole was horizontal (and this occurred 1500 times a minute). In fact, once the Wurzburg antenna characteristic became known it was recognized that the jamming antenna must radiate a signal at every angle of polarization. In other words, circular polarization was needed.

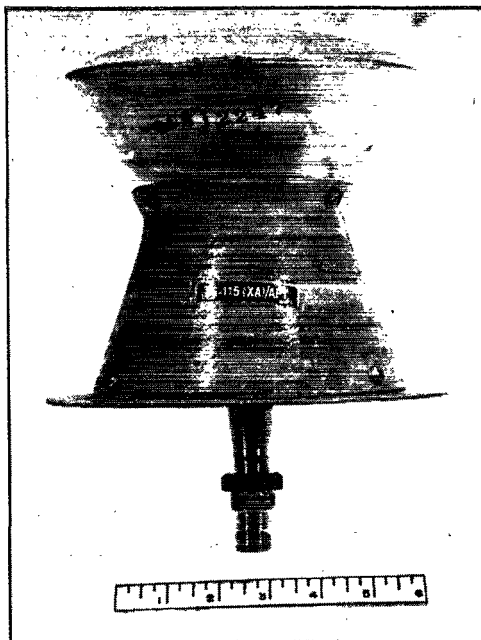

An antenna nicknamed the "Fishhook" was designed to supply this. It consists of two dipoles crossed at an angle of 90 degrees and bent toward the ground plane. The radiating elements are fed 90 degrees out of phase through a balancing and phasing unit built into the antenna base and dipole supports. The elements are bent toward the ground plane to increase the vertical component of the radiated field at angles near the horizontal. This antenna is normally mounted on the under side of the wing or on the belly of an aircraft and produces a circularly-polarized field in a single-lobed pattern which is cosinusoidal in shape in all planes through the antenna axis. Flight tests using the "Fishhook" antenna and a noise-modulated transmitter to jam a simulated German Wurzburg radar showed that the radiation patterns of the "Fishhook" were satisfactory. Later this antenna became a standard installation on all aircraft of the 8th and 15th Air Forces.

As the speed of our aircraft increased with the advent of more efficient engines and jet propulsion, it became necessary to consider more seriously the problem of aerodynamic drag in the design of antennas. This problem was solved completely in the higher-frequency ranges by the design of a series of "slot" antennas, consisting of a shallow box-like cavity energized by a loaded stub in the form of a "T", the aperture of the box being covered by a thin sheet of fiber-glass. In terms of wavelength, at the minimum frequency at which the slots are suitable for transmitting purposes, the dimensions of the cavity are approximately 0.6λ long, 0.2λ wide,

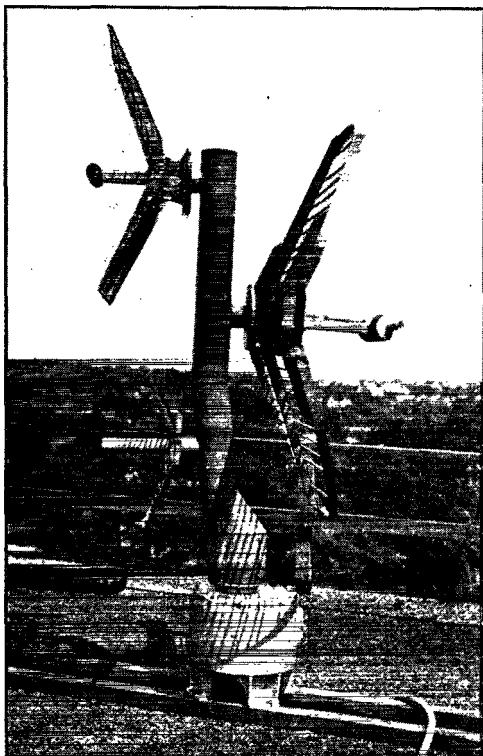

◆
 An example of shipboard antenna design. The three corner-reflector antennas shown cover the frequency range 145-800 megacycles. The base structure contains the electric drive mechanism used to rotate the system.
 ◆

teries in the Normandy invasion and against Japanese airborne radars in torpedo planes in the Pacific Theater of Operations.

Once the initial requirements for broadband antennas for the early jamming transmitters had been met, it became expedient to design directional antennas and combine them with already-developed receivers to build up direction-finding systems.

The need for direction-finding equipment to locate enemy radar stations was emphasized as a result of a Technical Observer mission to North Africa early in 1943. Since most enemy radars were on frequencies of 100 to 600 Mc., the initial emphasis was on direction finders for this frequency range. On these and also higher frequencies, the polarization of the signal radiated from a radar antenna may remain the same out to the limit of the radar's range. Since some radar transmitters use vertical polarization and some horizontal, it was necessary to develop direction-finder antennas which operated on either vertical or horizontal polarization. In fact, the ability of the direction finder to distinguish the polarization of the enemy radar signal is of advantage since this same polarization will be most effective for the jamming signal.

One direction finder was developed for the frequency range 100 to 600 Mc. The antenna consists of a horizontal dipole for horizontal polarization and two vertical out-of-phase dipoles, or Adcock, for vertical polarization. Both antennas are mounted as a unit on a single support and are rotated manually for a minimum signal as observed with a receiver.

Another type of direction finder was also developed to give an automatic indication of the bearing of the received signal. In this type a unidirectional receiving antenna rotates at speeds of several hundred revolutions per minute. The rotating antenna or "spinner" actually consists of two antennas, one responsive to vertically-polarized and one to horizontally-polarized signals. Either can be selected in order to match the polarization of the received signal. The antenna output enters a receiver such as described elsewhere in this article, is amplified and applied to the magnetic deflection coils of a cathode-ray tube. The deflection coils are rotated

and 0.2λ deep. The antennas operate over about a 2-to-1 frequency range and radiate energy polarized parallel to the narrow side of the aperture in a single broad lobe. Since a slot antenna is installed with its aperture in the plane of the skin of an aircraft, and the aperture is covered with a fiberglass window, it causes no drag.

Antennas having the necessary structural strength to withstand heavy vibration and gun blast as well as the necessary broadband electrical properties for RCM applications were needed for use in ship-borne systems. A series of dipoles with corner reflectors was developed to meet these requirements. The dipoles were of the sleeve type, consisting of the conventional balanced, center-fed dipole with a hollow tube, insulated from the fed elements and coaxial with them, extending half-way from the feed point to each end of the radiator. By properly choosing the characteristic impedance of the transmission line formed by the dipole elements and the sleeve, this type of antenna can be made quite broadband and it has the additional advantage of simplifying the mechanical problems involved in providing structural strength.

A series of antennas of this type was designed to cover the frequency range of 85 to 1400 megacycles, and they were widely used in the Fleet for countermeasures against German coastal bat-

synchronously with the antenna so that angular deflection corresponds to antenna position and radial deflection to signal strength. Thus a pattern similar to the shape of the direction-finder antenna pattern is drawn on the face of the cathode-ray tube. The direction in which the pattern points corresponds to the direction of the received signal.

With this type direction finder a bearing could be obtained even though the enemy signal was of very short duration. This was an advantage in the case of enemy radars with highly-directional rotating antennas. The antennas for this type direction finder are of the broadband type. The first model operated in the frequency range of 300 to 1000 Mc., but this range was subsequently extended to both higher and lower frequencies with antennas developed later. One operates over a frequency range of more than 10 to 1. Later developments also included indicators using electrostatic-deflection cathode-ray tubes.

From the outset the direction finders found wide application in investigational aircraft operating near and over enemy territory. With the aid of the direction finders the location of numerous enemy radars was "pin-pointed," and this information played an important part in later tactical operations. Production models of direction finders developed at RRL were installed in numerous aircraft and also aboard many ships.

Tactical Use of RCM Equipment

In the preceding pages, emphasis has been placed on research and development taking place at Radio Research Laboratory, while little has been said concerning the tactical use of such equipment in the different war theaters. The entire tactical story is far beyond the scope of this article; however, a brief revelation of the important part that radar countermeasures played during the war certainly seems justified.

Radio amateurs played an important part in the operational use of radar countermeasures equipment as well. For example, according to Captain Hugh Winter, W9HID, who was supervisor of countermeasures training at the Army Air Forces Training Command Station at Boca Raton, Florida, from 1942 to 1943, over 25 per cent of the officers and 10 per cent of the enlisted

men who were selected in that period to take the Army Air Forces' special countermeasures training course were radio amateurs. That the RCM officers had a remarkably thorough training before being given countermeasures work will be understood from the fact that they were required to pass regular courses in the field of communications, radar and IFF work, before being allowed to study RCM. Countermeasures officers and enlisted men were accordingly among the most highly trained electronics experts in the AAF!

The first use of U. S. radar countermeasures equipment against the enemy took place in the early spring of 1943 when the Army Air Forces sent a specially-equipped B-24 radar search plane (carrying RRL-developed equipment) to the Alaskan theater in order to scout suspected Japanese radar on the island of Kiska. This plane, the first of a long line of such aircraft (known as Ferrets) did indeed locate two potentially dangerous Japanese radars on that island. Operating the search equipment were AAF countermeasures officers, Lt. William Praun, W6MEV, and Lt. Edward Tietz, W9QDL.

The Navy, too, was active in the Alaskan area. It assisted in a Signal Corps jamming expedition to Amchitka, from which point the Kiska radars were to be blinded during the invasion of that island. (The Japs, however, blew up their radars when they abandoned Kiska two days before our invasion.) Navy countermeasures-equipped PBV search planes flew missions westward over the Kuriles, and ship-board RCM teams were on the job during the bombardments of those islands. Among the hams

◆

A "Fishhook" antenna designed to give a circularly-polarized radiation pattern over the frequency range 530-580 megacycles. The balancing and phasing unit is in the base.

◆



active in this work were Lt. W. P. Van Ordstrand, W6FDE; Lt. L. C. Fay, W8HEO; Lt. G. L. Picotte, K7IAF; and CRE C. Q. Callahan, W9MBK.

The Radio Research Laboratory's earliest direct contact with operational problems occurred in April, 1943, when an engineer from the Laboratory flew to North Africa as an AAF civilian technical observer in the first of a series of Ferret planes sent to that theater. The early planes, containing what was then the latest gear for intercepting and finding the direction of enemy radar stations, were manned by AAF countermeasures officers, many of whom were hams. Among them were Lieutenants Norman Wood, W9JKW, Matthew Slavin, W6BWE, and John K. Pheley, W6JHM, of Fresno, California. Pheley was later lost during a radar scouting flight from Tunis to Southern France.

The equipment carried by these first Ferrets was some of the very earliest DF'ing gear developed at RRL and now seems quite crude compared with the more elaborate sets more recently devised. The Ferrets were started at the request of the theater commands of the Allied Forces in North Africa. At that time it was known that the Germans possessed many radar stations of all types along the coasts of Sicily and Sardinia, but their exact location was not known. It was imperative that as many of these stations as possible be located and destroyed before the contemplated invasion of Sicily. If this was not done it would mean that the Germans would have available methods of tracking approaching Allied naval craft, thus removing virtually all of the element of strategic surprise which the Allies were counting on. On top of this, the Germans were also capable of following the movement of planes and directing anti-aircraft fire at them. The firing of the coastal defense guns on the coast of Sicily was similarly controlled. In order to eliminate this serious threat, radar intelligence work had already been started by a special group of RAF planes equipped with investigational gear. Their data, plus that collected by flights of the U. S. Ferret plane, proved to be extremely valuable in "pin-pointing" the

location of many of the potentially dangerous German radar sets. Once the location had been determined, Allied fighter-bombers were sent in to bomb and strafe these installations. This early work contributed considerably to the success of the Allied landings on Sicily which occurred in July of 1943. Investigational work of this sort was carried on until the end of the war, and later done on a greatly expanded scale and with far superior equipment.

The landings themselves were protected by radar countermeasures which were the responsibility of specially trained Navy teams assigned to each particular operation. Used during the invasion at Salerno, for example, were a number of RRL-developed 400 Mc. jammers installed and operated by these teams. The jammers took the German coast-watching radars out of action and prevented the accurate direction of gunfire against our assault forces. Amateur members of Navy RCM teams which participated both in these Mediterranean operations as well as in the Normandy invasion itself included Lt. Cdr. Colbert, W6ADG; Lt. R. H. Haas, W8HWE; and Lt. W. A. Leonard, W3JYG.

During the later stages of the war in Europe, the U. S. 8th Air Force in England, for instance, was sending several planes equipped with interception gear on nearly every bombing mission over Germany. Included in this equipment were radar receivers incorporating automatic recording machines. Operators kept a record of all the German radar signals intercepted, always on constant lookout for new German radar frequencies which might mean new types of German radar; however, the majority of German radar signals intercepted turned out to be in the 450- to 600-Mc. region, and were largely signals from enemy radar sets used to control the fire of anti-aircraft guns. Such advance information on the frequency distribution of German radar stations proved to be of vital importance in the successful large scale radar jamming activities that were begun in the whole 8th Air Force in the fall of 1944.

When the U. S. 8th Air Force first started its strategic bombing of Germany early in 1943, the German Air Force

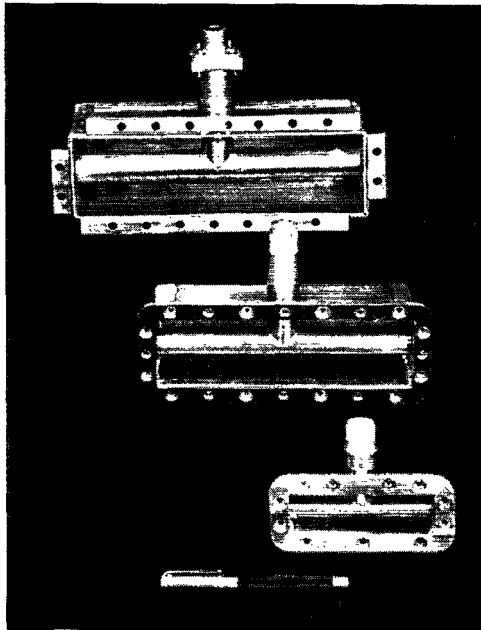

Three sizes of "slot" antennas, designed to mount flush with the skin of a plane and avoid drag.

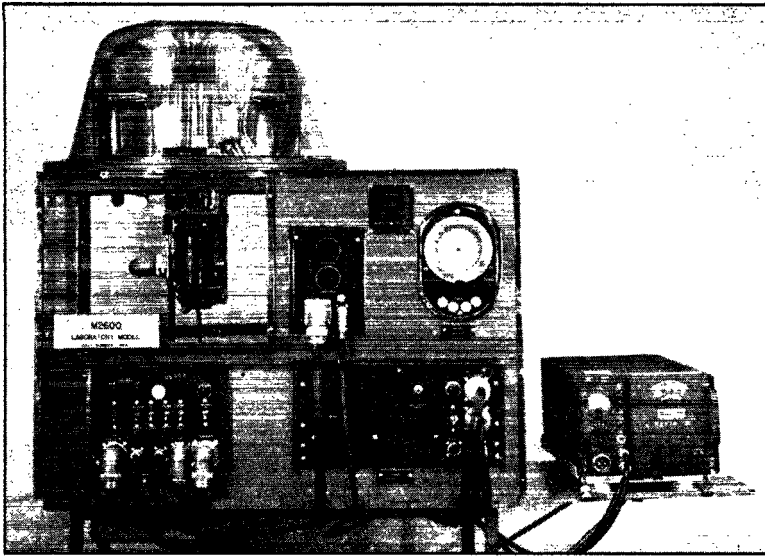

Laboratory model of the automatic-indication direction-finding system. The rotating antenna is covered by the transparent dome at the upper left. As the antenna rotates, the variations in strength of the received signal cause the antenna directional pattern to be plotted on the screen of the cathode-ray tube at the right. The receiver used with the system is at the far right.

was still well supplied with first-line fighter planes which were attacking American bombers constantly during their missions over Germany, and inflicting heavy losses. Later on, after the 8th Air Force began sending larger and larger numbers of escorting fighter planes, the problem of German fighter opposition eventually diminished to the point where American escort fighters had to hunt for enemy fighters in order to find something to shoot at. However, while the destruction of the German Air Force was slowly but surely taking place, German radar-controlled flak batteries were multiplying at an alarming pace. As a result, it seemed that every time a bombing mission was flown over German territory new flak batteries would appear; moreover, the fire from these radar-controlled batteries was accurate, and the losses that the 8th Air Force was forced to sustain to German flak were beginning to compare to those suffered formerly to German fighter planes. The introduction of blind-bombing techniques in the 8th Air Force, while greatly increasing the effectiveness of our strategic bombing, did not help this situation very much since clouds did not impair the accuracy of German radar-controlled flak, and heavy losses to flak continued.

Meanwhile, in the United States attempts were made to get large scale production of radar countermeasures equipment under way. By October, 1943, two bomb groups of the 8th Air Force had been equipped with Carpet jamming transmitters which were flown on each mission. This sudden

development in the radar war took the Germans completely by surprise, resulting in about half as many bomber losses to flak in these two Carpet-equipped groups as were being experienced by non-equipped groups. Later the Germans were able partly to overcome this handicap by changing and spreading the frequencies of their fire-control radars to escape much of the jamming. Shortly after, the 8th Air Force introduced "Window." To the Germans, Window presented a new headache since on the radar scope it was pretty hard to tell the difference between a cloud of Window and a bomber plane. Ironically enough, the Germans had also thought of Window, but they had never made use of it for fear the Allies would use it against them. Actually the RAF made the first use of "Window" in one of their night bombing raids on Hamburg. The design of the British "Window" was improved by personnel at Radio Research Laboratory, and machinery was devised here to put the newer and much lighter Window into mass production. Once in mass production, it was used in ever-increasing quantities until the end of the war.

The success of RCM as experienced by the original two Carpet-equipped bomb groups led to the equipping of the entire 8th AF with electronic jammers, a task involving the field installation of over 6000 equipments! The installation of the RCM equipment in bombers of the 8th AF was greatly expedited by American engineers from the American-British Laboratory.

This was a civilian laboratory established by the Radio Research Laboratory in Great Britain to assist U. S. Services in the European theater with their RCM activities. Most of the time this consisted of directing installation of RCM gear or giving instructions to RCM mechanics on maintenance of such gear.

The efforts of the American-British Laboratory personnel and the radar men in the 8th AF began to pay off by October, 1944. Losses to flak, while relatively light, were hard to interpret, and it wasn't until radar intelligence men, civilians from ABL as well as Army officers, went into Germany and interviewed German radar officers and crews that the true extent of the German helplessness in the face of concentrated American jamming became known. The simultaneous use of Window and Carpet jamming had reduced the effectiveness of German radar-controlled flak to 25 per cent or less of its effectiveness before jamming was introduced! German officers admitted that under unfavorable jamming conditions 3000 rounds of heavy ack-ack were fired for every American bomber shot down, as against an average of 800 rounds or less required per kill under conditions of little or no jamming. In many cases this waste of shells was so alarming that the flak batteries involved were ordered to shut down. After this was done, all the Germans could do was to "sit and take it."

Certainly, the story of RCM in the 8th AF is only a very small part of the complete picture of the role played by RCM during the course of the war with the Axis, but it is a good example inasmuch as the 8th AF was the biggest user of radar countermeasures equipment. A similarly intense program was carried on by the slightly smaller 15th AF in Italy. The Air Forces in the Pacific Theater also used RCM equipment, though on a smaller scale. Radar countermeasures also had an important place in all of the large-scale naval landing operations, the most notable of these

being the invasion of France. In this operation, several hundred radar jamming transmitters were carried in vessels of all classes for the purpose of jamming German coast-watching radars and radar used to control the fire of German coastal defense guns. Large amounts of Window were also used. Evaluation of the part played by RCM in this operation would not be reliable because of the many complications involved; however, British intelligence reports showed that shortly after the invasion was in full swing, only one German radar station was in operation in the invasion area. Of the many German stations in operation before the invasion, quite a few were knocked out by low-level bombing, while the rest were believed to have shut down because effective Allied jamming made operation of the enemy radars impossible.

Perhaps not so widely known is the fact that the Germans had not expected the main Allied landings to occur on the beaches of Normandy. Instead, landings had been expected farther North. Capitalizing on any possible German errors in judgment, the Allies staged several fake invasion maneuvers. One fleet of small ships was sent toward Calais with a number of jamming transmitters aboard and with airplanes circling overhead, dropping great quantities of Window. To the German radar operators, this unprecedented jamming seemed convincing

enough evidence that a large-scale landing was to be expected in that vicinity; their confusion was no help to the High Command.

In the Pacific theaters, the airborne RCM program never became so wide-spread as in Europe. The main reason for this was that Japanese radar was generally inferior and less abundant than that used by the Germans, and hence never proved as serious an obstacle to the offensive operations of our air forces. The U. S. Navy, the bulk of which was in the Pacific waters, was equipped with radar intercept and jamming equipment, however, and made very effective use of it to jam Jap airborne



Top view of the 250-1000 Mc. antenna used with the automatic direction finder. This assembly rotates at speeds up to several hundred r.p.m. The two horizontal tapered cylindrical elements form the DF'ing antenna responding to horizontally-polarized signals, while the single vertical element on the opposite side of the curved reflector-shield is used for vertically-polarized waves.

radar, as well as Japanese shipborne radar. U. S. submarines, in particular, employed RCM to great advantage.

Conclusion

With V-E Day and V-J Day has come the termination of activities at Radio Research Laboratory. The ending of the war has also brought home several hundred laboratory people who went overseas as civilians to help both American and British Services with their RCM problems. Some 120 laboratory personnel were sent over to England to the American-British Laboratory, many of these later going to continental Europe. Others were sent to the Mediterranean area and to all of the Pacific war zones, including Alaska. Through the efforts of these advanced observers, the operational use of laboratory-developed equipment was greatly expedited. They were also responsible for numerous up-to-date reports on enemy radar activity, which made it possible for their fellow engineers at Radio Research Laboratory always to keep several jumps ahead of the enemy in the fast-changing radar war. While most of the overseas personnel were active in field engineering and radar intelligence work, a number had a direct hand in the planning of new tactics made possible by the advent of RCM equipment, since they were assigned to Operational Analysis Sections of the American Air Forces.

Taken in total, the RCM program carried out at Radio Research Laboratory represented a rather large investment; however, on a dollar-for-dollar basis, this investment paid for itself many times over in the number of ships and planes saved directly by the protection afforded by RCM equipment. More important, countless Air Force and Navy men have come back home safe only because an enemy radar operator had his radar range 'scope jammed at the crucial moment. This saving of men and machines has more than justified the existence of Radio Research Laboratory, a heretofore secret war activity in which the amateur was again found in the forefront.

Strays

One day in '41, John Alton Fitch, W8DT, and I went ashore on the northwest coast of Greenland. There we chanced upon the now deserted camp of the Hobbs-Greenland Expedition. While rummaging around the site Fitch found a copy of a 1928 *QST* among the debris.

A few days later our Naval party was joined by Capt. Donald B. McMillan and his stout ship, the *Bowdoin*.

These two incidents recalled historic events in amateur radio.

— *Ens. Harold Quinn, W3GAD*

New Apparatus Tuned Plug-In Coil Form

ONE of the greatest deterrents to home communications-receiver construction is the tedious process of trimming the coils for proper coverage, particularly in a gang-tuned affair with one or more r.f. stages. It is felt that many more receivers would be home-built if there were some way to avoid the lengthy cut-and-dry process of adjusting each coil to the correct inductance. Further, it should be possible to plug in the coils for band changing, since band-switch receivers are not normally an amateur project.

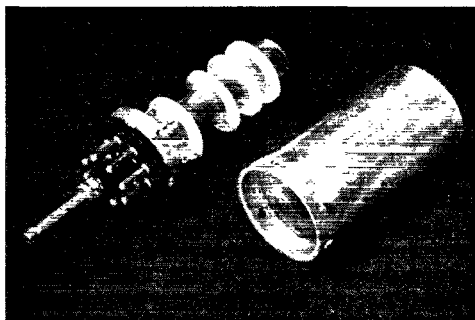

A coil form that goes a long way toward simplifying receiver construction is the new Millen No. 74001 Permeability-Tuned Coil Form. Built on an octal-tube base, the coil form is of 1/2-inch o.d. polystyrene tubing. Four split collars of polystyrene are supplied with each form, allowing the experimenter to place them on the form to suit his needs and then cement them in place. These collars serve to hold the ends of the windings and to separate two or more windings from one another. A powdered-iron plug inside the form is used to adjust the inductance, the adjustment screw coming out through the normal octal-base key pin. A friction lock holds the adjusting screw in place, and bringing the adjustment out through the bottom permits easy adjustment through the keyhole of the socket. A heavy aluminum shield can is part of the assembly, and it grounds through one of the pins of the base. The heavy shield not only allows the forms to be used close to one another but also serves as a grip for removal of the coil from the receiver.

Using No. 32 enamelled wire, a coil of 68 μ h. can be wound on the form. With the iron slug full in, the inductance is 100 μ h. and thus the form is large enough for any amateur operation that might be contemplated. The powdered-iron slug is a type that is suitable for use up to 35 Mc. without loss, and its use results in a coil of somewhat higher Q than would normally be obtained for the same diameter.

B. G.

Forecasting Long-Distance Transmission

Using Predicted-MUF Charts for Determining DX Frequencies and Times

BY WILLIAM R. FOLEY, K4FEC*

BEFORE the war the literature on high-frequency propagation consisted mainly of highly scientific — and very dull — articles on the ionosphere confirming what we'd already learned by experience — that transmission sometimes is possible over great distances, and sometimes it isn't. During the war the military needed propagation information and needed it badly. More than that, they needed it four months in advance, and written so the average radio operator could understand it and use it. The result was a tremendous advance in the practical application of propagation information. With the removal of security restrictions, this information will soon be available to the amateur fraternity.

Ionospheric Propagation

As we all remember, long-distance transmission at high frequencies is made possible by reflections from the ionized layers that exist from about 70 to 250 miles above the surface of the earth. Unfortunately there is not just one layer, but four with which we are concerned. The general situation, in daylight, is shown by Fig. 1. Energy leaving the transmitting antenna at a low angle passes through the *D*, *E*, and *F*₁ layers, is reflected by the *F*₂ layer, returns through the *F*₁, *E* and *D* layers, and finally reaches the distant receiving antenna. At night, the *E* and *F*₁ layers usually disappear.

There are two basic facts in this picture. If the frequency used is *too high* the wave will not be reflected by the *F*₂ layer. Instead it will pass right through and be lost in outer space, and the desired communication will not be possible. If the frequency used is *too low* the absorption in passing through the lower layers will be so great that the

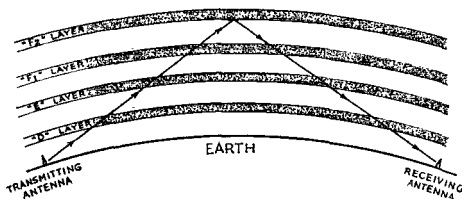

Fig. 1 — In long-distance transmission signals penetrate the lower ionospheric layers and are reflected by the *F*₂ layer.

*3103 Pliers Mill Road, Kensington, Md.

• Working DX need no longer be a matter of instinct or long hours of listening; with the proper charts, it's now possible to determine with good accuracy, well in advance, the best frequencies and best hours of the day for any given transmission path. The method is relatively simple, as this article shows. (But it's still an art to raise 'em!)

desired communication will not be possible. Thus there is always an upper and a lower limit to the frequency that can be used between given points at a given time. "Propagation analysis" is the prediction of these limits.

Distance and Maximum Usable Frequency

Fig. 2 shows the paths taken by signals in going various distances. As the distance changes, so does the angle *a* at which the signals strike the reflecting layer. It has been found that the maximum frequency that can be reflected is affected by this angle. For example, at a time when frequencies only up to 7 Mc. can be reflected over a very short distance path (when the angle *a* is 90 degrees), it may be found that 21 Mc. can be reflected if the distance is 2500 miles (when the angle *a* is about 30 degrees).

Although measurements of the ionosphere are regularly made at zero distance (that is, with transmitter and receiver at the same location, and an angle *a* of 90 degrees) it is more convenient to base all computations on the frequencies that could be reflected for a transmission distance of 2500 miles. This figure is chosen because it is the greatest distance that can be covered with a single reflection. Table I can then be used to find the *F*₂ frequency limit for any shorter distance.

When the distance exceeds 2500 miles, transmission can take place in two or more "hops" as shown by Fig. 3. Now here is a point where theory and practice don't quite agree. If we consider a distance of 3000 miles, which is a little too great to be made in one hop, to be made up of two hops of 1500 miles each, it would seem logical that the upper frequency limit should be based on 1500 miles. From Table I the maximum usable frequency would be seen to be *less* than for a

TABLE I
Factors by Which 2500-mile F_2 Frequencies
Must Be Reduced for Shorter Distances

Distance	Factor
0 miles	0.35
250 miles	0.36
500 miles	0.42
750 miles	0.53
1000 miles	0.63
1250 miles	0.73
1500 miles	0.82
1750 miles	0.90
2000 miles	0.94
2500 miles	1.00

transmission distance of 2500 miles. But experience shows that this is not the case; the frequency limit for a transmission of 3000 miles is just as great as it would be for 2500 miles. The best results are obtained if we consider the two points 1250 miles from each end of the path as being "control points." Any frequency which can be reflected at both of these points seems to find its way over the entire path! This is true of all paths which are longer than 2500 miles. The locations of the control points along the path are indicated in Fig. 4.

Effect of Longitude

In the early days of the war the F_2 layer charts were found to be quite good for transmission in the United States and for the North Atlantic, but the values seemed to be too low for the Pacific

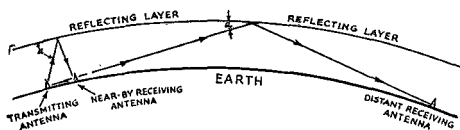

Fig. 2 — The angle "a" at which signals strike the reflecting layer varies with the distance from the transmitter. It is nearly 90 degrees at short distances and drops to less than 30 degrees at a distance of 2500 miles.

ocean areas. The addition of data from new ionospheric measuring stations confirmed this fact. To take account of this variation, the world is divided into three "zones," and separate F_2 layer charts are published for each zone. The proper chart to use is determined by the zone in which each control point is located. The zones are shown in Fig. 5.

Determination of Maximum Usable Frequency (MUF)

Keeping the previous explanation in mind, we can now proceed to determine the upper frequency limit for a particular example. Let us take the case of Hartford, Connecticut, to Rio de Janeiro, Brazil, a distance of approximately 4900 miles, for the month of February 1946.

Using your kid brother's geography book, mark the locations of both Hartford and Rio on the

outline map, Fig. 5. Next take a sheet of transparent paper¹ and draw a horizontal line in the center to represent the equator; also draw a vertical line in the middle to represent local time at Hartford. Place this sheet over Fig. 5 with your equator line on the equator, and with your Hartford time line on Hartford. Mark the locations of both Hartford and Rio on the transparent sheet.

The next step is to draw the great-circle path between Hartford and Rio, since that is the path that the radio signals must take for efficient propagation. This can be done with the aid of Fig. 6, which is a great-circle chart. Slide the transparent sheet along Fig. 6, keeping the equator line on the equator of Fig. 6, until both Hartford and Rio appear on the same solid line. Trace the solid line from Hartford to Rio; this is the great-circle path. Before removing the transparent sheet, measure 2000 kilometers (1250

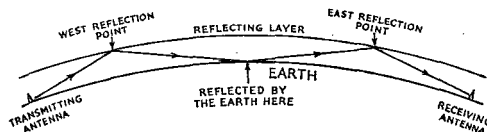

Fig. 3 — When the distance is too great to be covered by one reflection, the signals can take two or more "hops."

miles) from each end of the path to locate the control points. This can be done by eye because the dotted lines in Fig. 6 are spaced every 1000 kilometers.

Now return the transparent sheet to Fig. 5 very briefly to determine the zone in which each of the control points is located. In this example both control points are in the "W" zone, so we use the "W" zone frequency chart to read the values for both control points. At this point it will be convenient to rule up a working sheet to tabulate the figures. Four columns will be needed, headed (1) Local time at Hartford, (2) MUF at west control point, (3) MUF at east control point, and (4) MUF for path. Twenty-four lines will be needed to accommodate entries for each hour of the day.

Now take the transparent sheet and place it

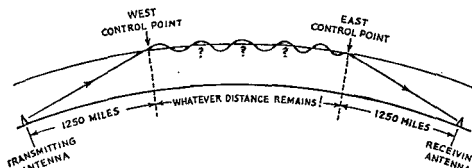

Fig. 4 — When the distance exceeds 2500 miles it is assumed that the signal is reflected at two points 1250 miles from each end. How the signals travel between these two "control points" is anybody's guess, but this method of prediction gives results that agree with experience.

¹ There is a roughened celluloid which is excellent for this purpose. It can be marked easily with a pencil, and can be erased and used over again.

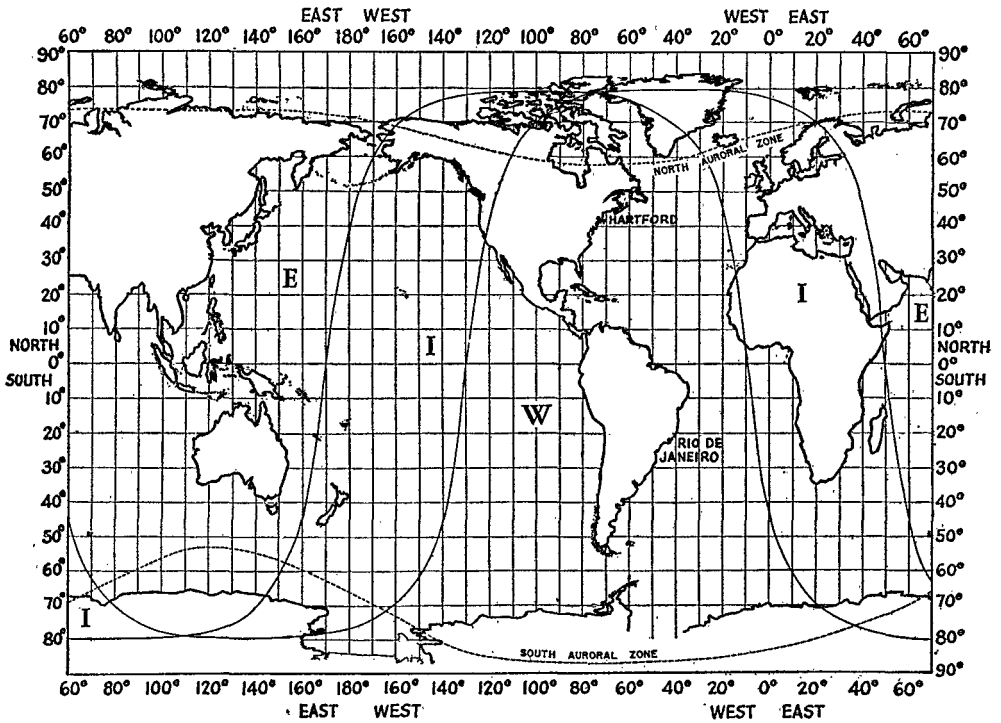

Fig. 5 — Modified cylindrical projection map of the world showing the three F_2 layer zones.

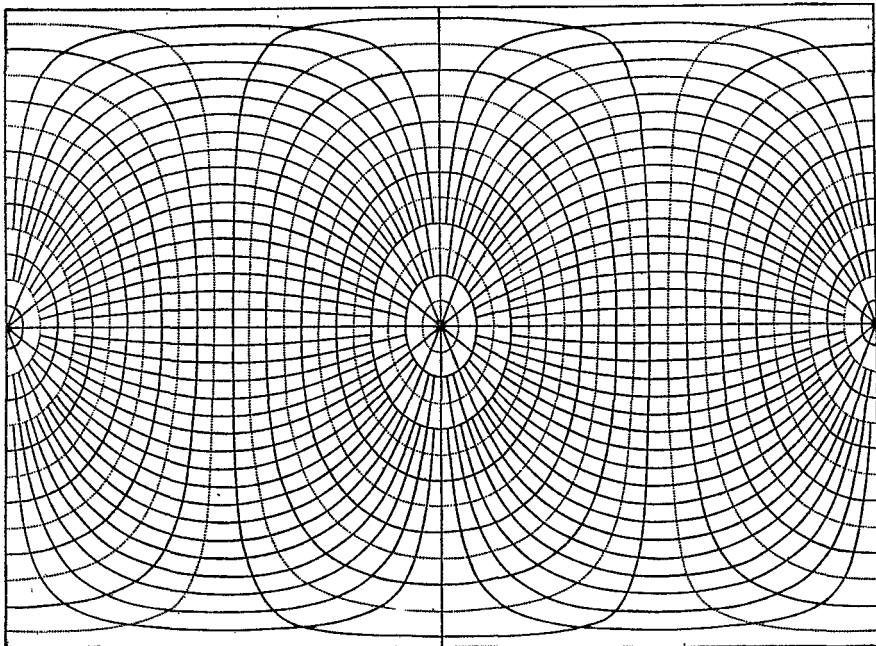

Fig. 6 — Great-circle paths for the map of Fig. 5. The spacing between dotted lines is equal to 1000 kilometers.

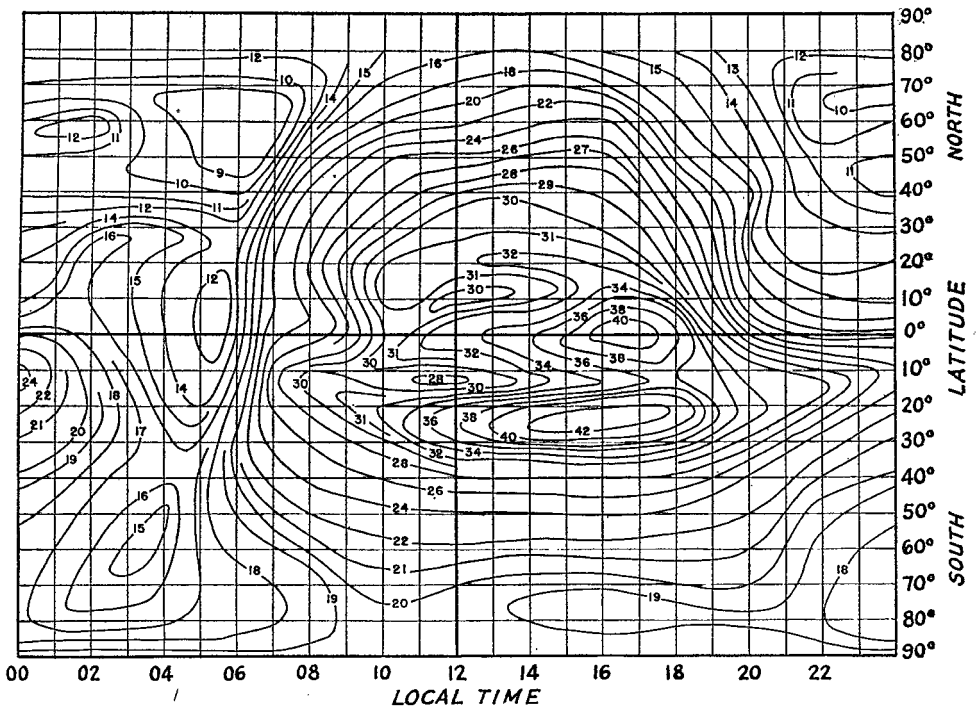

Fig. 7 — Chart of 2500-mile F_2 layer maximum usable frequencies, "W" zone, for February, 1946.

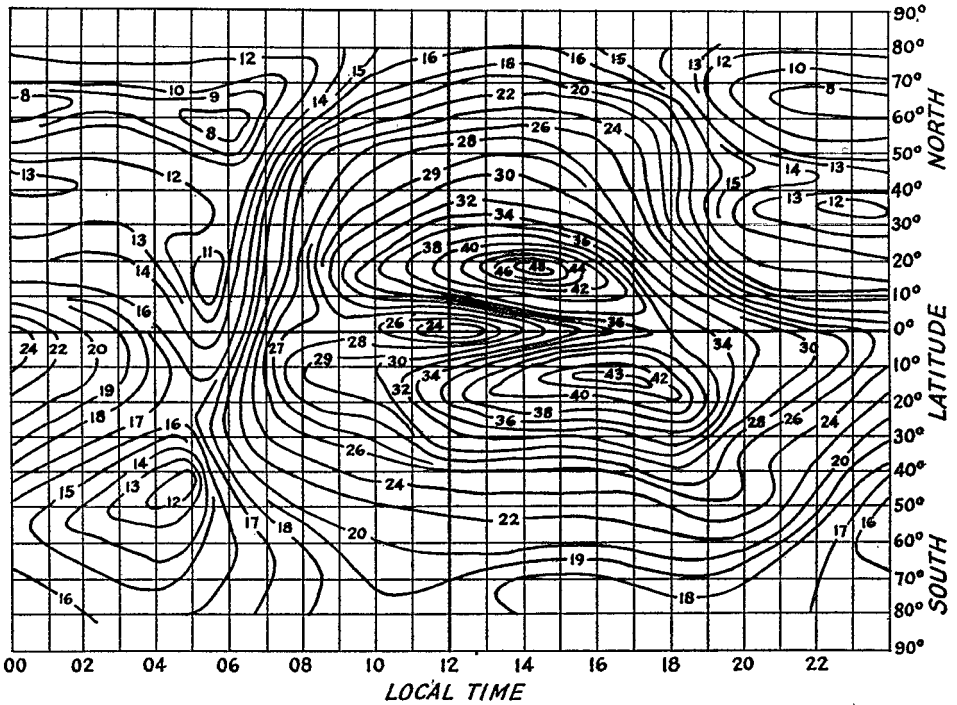

Fig. 9 — Chart of 2500-mile F_2 layer maximum usable frequencies, "I" zone, for February, 1946.

TABLE II • WORK SHEET
Maximum Usable Frequencies, Hartford to Rio,
February 1946

Local Time at Hartford	MUF at West Control Point	MUF at East Control Point	MUF for Path
00	13.5	20	13.5
01	15	17	15
02	16	15	15
03	15.5	13	13
04	14.5	14	14
05	13	20	13
06	18	27	18
07	24	28	24
08	27	29	27
09	28.5	31	28.5
10	30	31.5	30
11	31	31	31
12	31	33	31
13	31.5	35	31.5
14	31	37	31
15	31	38	31
16	30	38	30
17	28.5	36	28.5
18	24	31	24
19	17	28	17
20	14	26	14
21	13.5	24	13.5
22	13	23	13
23	13	22	13

on Fig. 7, which is the 2500-mile F_2 chart² for February, 1946, for the "W" zone. Keep the equators lined up, and slide the sheet along until the Hartford line is at 00 hours. Mark down on the work sheet the frequency values which appear under each control point. Move the Hartford line to 01 hours, and read them again. Repeat this, hour by hour, until you have the values at each control point throughout the 24 hours of the day. At 23 hours you will find that the east control point is off the right-hand edge of the chart. When this happens, you have to shift your transparent paper 24 hours to the left to read the value, which will then be just inside the left-hand edge of the chart. Someday when paper is cheap they'll make these charts double so this won't happen.

It may happen that on some problems the control points will be on an exact north and south line so that it is impossible to call one the "west" and the other the "east." In such a case simply label your columns "north control point" and "south control point."

Now go down your working sheet and for each hour fill in Column 4, using the *lower* of the two figures in Columns 2 and 3 for the same hour. Column 4 is the predicted upper-frequency limit (MUF) for communication between Hartford and Rio during the month of February, 1946.

² These charts, prepared by the Interservice Radio Propagation Laboratory at the National Bureau of Standards, are not available for general distribution at this time. As soon as they can be obtained, an announcement will be made in QST.

Optimum Working Frequency (OWF)

Since the absorption in passing through the lower layers is reduced as the frequency increases, the strongest signals will be received when the frequency is as high as possible. However, the figures shown on the F_2 layer charts are the *average* values expected, and if operation is attempted using these exact frequencies it will be found that on about half the days the frequency will be too high. If we want reliable transmission day after day, the maximum usable frequencies should be reduced by about 15 per cent. The resulting value is defined as the Optimum Working Frequency (OWF).

Commercial services needing interruption-free point-to-point service naturally would be guided by the OWF in their choice of operating frequency. However, amateurs as a rule are less interested in consistent communication than in DX possibilities; besides, the nature of amateur frequency assignments is such that comparatively little choice can be exercised. Both these considerations — in addition to the fact that the MUF predictions are on the conservative side — indicate that for amateur work the band to use should be selected on the basis of the MUF rather than the OWF.

Selection of Best Frequency Band

The data from the working sheet have been plotted as Fig. 8, and from it we can determine the best frequency band for working between Hartford and Rio in February, 1946. The guiding principle is to use the frequency band as close as possible to the MUF line, but always *below* it. This has been drawn in as a dotted line. Starting at 00 hours (midnight Hartford time) we find

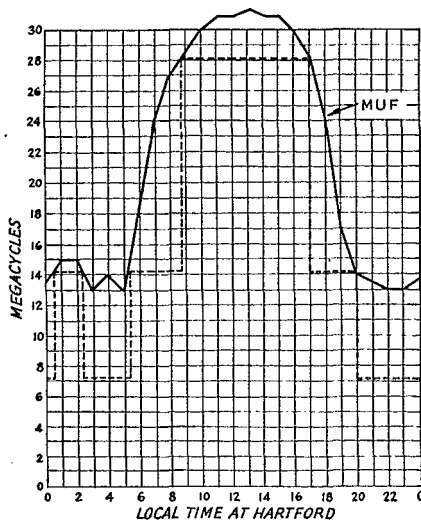

Fig. 8 — Maximum usable frequency, Hartford to Rio de Janeiro, February, 1946.

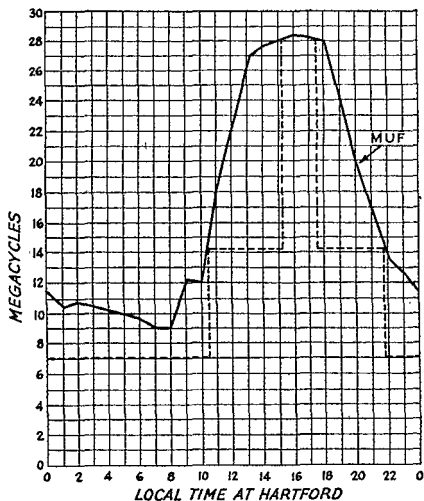

Fig. 10 — Maximum usable frequency, Hartford to Honolulu, February, 1946.

the 7-Mc. band to be the best. Between 12:30 and 2:30 A.M. the 14-Mc. band may come through, but after that 7 Mc. will be required again until just after 5:00 A.M. At that time 14 Mc. will be the best band until 8:30 A.M. when the lower edge

of the 28-Mc. band should come through. It appears that 28 will be the best band all day until 5:00 P.M. After that time 14 will be best until 8:00 P.M., when the shift to 7 Mc. will be made. The remainder of the evening will find 7 Mc. the best band.

When the control points are located in different zones the method of working out the maximum usable frequencies is the same, using the appropriate zone prediction chart for each control point. The path between Hartford and Honolulu, for example, involves two zones: the "W" zone for Hartford and the "I" zone for Honolulu. After the great-circle path has been traced and the control points located, the MUFs for the Hartford control point are determined from the "W" zone prediction chart, Fig. 7, and the MUFs for the Honolulu control point at corresponding times are found from the "I" zone chart, Fig. 9. The two sets of MUFs are tabulated and the lowest selected at each hour, just as in the example above. For February, 1946, this procedure leads to the graph of Fig. 10.

At distances of less than 2500 miles the problem is complicated by distance factors and by the fact that the reflection may take place in either the E layer, the F_1 layer or the F_2 layer. The procedures will be described in a subsequent article.

WWV Schedules

STANDARD-FREQUENCY transmissions are made available as a public service by the National Bureau of Standards over its standard-frequency station, WWV, on the following schedules and frequencies:

2.5 Mc. — 7.00 P.M. to 9.00 A.M. EST (0000 to 1400 GMT).

5.0 Mc. — Continuously, day and night.

10.0 Mc. — Continuously, day and night.

15.0 Mc. — Continuously, day and night.

The 10- and 15-Mc. radio frequencies are modulated simultaneously at accurate audio frequencies of 440 and 4000 cycles. 5 Mc. carries both audio frequencies during the daytime but only 440 cycles from 7:00 P.M. to 7:00 A.M., EST, while 2.5 Mc. carries only the 440-cycle modulation. A 0.005-second pulse may be heard as a faint tick every second, except the 59th second of each minute. These pulses may be used for accurate time signals, and their one-second spacing provides an accurate time interval for physical measurements.

The audio frequencies are interrupted precisely on the hour and each five minutes thereafter, resuming after an interval of precisely one minute. This one-minute interval is provided to give Eastern Standard Time in telegraphic code and

to afford an interval for the checking of radio-frequency measurements free from the presence of the audio frequencies. The announcement of the station's services and of the station's call (WWV) is given by voice at the hour and half hour.

The accuracy of all the frequencies, radio and audio, as transmitted, is better than a part in 10,000,000. Transmission effects in the medium may result in slight fluctuations in the audio frequencies as received at a particular place; the average frequency received, however, is as accurate as that transmitted. The time interval marked by the pulse every second is accurate to 0.00001 second. The 1-minute, 4-minute and 5-minute intervals, synchronized with the second pulses and marked by the beginning and ending of the periods when the audio frequencies are off, are accurate to a part in 10,000,000. The beginnings of the periods when the audio frequencies are off are so synchronized with the basic time service of the U. S. Naval Observatory that they mark accurately the hour and the successive 5-minute periods.

Of the frequencies mentioned above, the lowest provides service to short distances and the highest to great distances. In general, reliable reception is possible at all times throughout the United States and the North Atlantic Ocean, and fair reception over most of the world.

HAPPENINGS OF THE MONTH



Charles E. Blalack

Charles E. Blalack, W6GG, the genial and well-loved vice-president of the League, died suddenly at his home in Yuma on the evening of December 7th. He was 57 years old.

Engaged with his brother in the Blalack Feed & Seed Company, he was a dealer in tractors and harvesters and much interested in agricultural machinery, having recently invented a greatly-improved mowing machine. He had previously been in business in El Centro, although Pasadena was really home to him. In earlier years he had been in business in San Francisco.



Charlie was an old-timer, having entered ham radio in 1913, and always had a transmitter on the air. Before becoming W6GG he was 6JE, 6ZAK and W6XBR. He was active both on c.w. and on 14- and 4-Mc. 'phone.

When the Southwestern Division of the League was created, Charlie became its first

director, taking office at the beginning of 1936. He continued in that duty until his election as vice-president at the May, 1940, meeting when George Bailey was elevated to the presidency, holding that post in successive two-year terms until his death. He was chairman of the Board's Planning Committee since its inception, making several transcon trips to its meetings; and he was also chairman of the Board's Regulations Committee, of which he had called a January meeting in West Hartford just two days before his passing.

We shall miss W6GG, his counsel, his charm. As President Bailey said in a letter to directors, "Charlie's genial personality, his capacity for hard work, his loyalty to ARRL and his unswerving devotion to amateur radio made him an outstanding figure. His memory will linger long in the hearts of his friends, who are legion."

THE OUTLOOK

There are some indications that there has been a consultation between the United Kingdom and the United States on the question of simultaneous joint action in reopening the remaining amateur bands, with the resultant decision that it will not be possible to return our 7- and 14-Mc. bands to us before March 1st, at which time the subject is to be reexamined. Military needs for these frequencies have continued, both in the Pacific theater and in the rehabilitation of Europe. The matter of our 3.5 band is believed to be somewhat easier, training activity having been substantially cleaned out; but some hot circuits remain for which substitute frequencies have not yet been found.

The United States-British Commonwealth Telecommunications Conference at Bermuda concluded in early December, with substantial delegations from this country and from most of the Empire. The conference officially dealt only with economic matters, chiefly rates on commercial traffic.

We understand that, pursuant to some discussions at Bermuda, it is now tentatively planned to have a meeting in Washington of the five great powers about the beginning of Spring. This meeting would be preliminary to a world telecommunications conference, in much the same manner that Dumbarton Oaks preceded the San Francisco UNO conference. At that time the place and date for the world conference will be decided — some time between the coming autumn and the following spring.

The opening of our band 220-225 Mc. is now in prospect by February. It was held up pending the ironing out of some divergent views of U.S.A. and the Empire, particularly Canada, concerning certain aids to aerial navigation. This matter has probably also been the cause of the hold-up in the 420-450 band. And it would seem that only the load of paperwork has delayed the opening of our 1215-1295 band, so it is expected soon.

FCC's problems of personnel and finances are easing slowly, and early action in the resumption of amateur station licensing is expected. Also in prospect for the near future is a general review of the amateur regulations, with numerous minor amendments to clarify or improve administration but without fundamental change.

NORWINE HEADS COMMITTEES

President Bailey has named Director Floyd E. Norwine, jr., W9EFC, of the Midwest Division, to succeed our late vice-president, Charles E.

Blalack, as chairman of two committees of the ARRL Board of Directors, the Planning Committee and the newly-formed Regulations Committee. The latter committee, studying for the Board the matter of proposed changes in amateur regulations, is having a meeting in West Hartford in mid-January.

ELECTION RESULTS

In the second solicitation of nominations for alternate director of the Delta and Midwest Divisions, the Delta Division again failed to make any nominations and is again being solicited hereunder. In the Midwest Division the only nominee was the incumbent, C. A. Colvin, W9VHR, of Omaha, and the Executive Committee accordingly declared him reelected as alternate director for the 1946-1947 term without the need for membership balloting.

ELECTION NOTICE

To all Full Members of the American Radio Relay League residing in the Delta Division:

You are hereby advised that no eligible candidates for alternate director of your division were nominated under the recent second call. By-Law 21 provides that if no eligible nominee be named, the procedure of soliciting and nominating is to be repeated. Pursuant to that by-law, you are again solicited to name Full Members of your division as candidates for alternate director thereof. See the original solicitation published on page 23 of August *QST*, page 21 of September *QST*, which remains in full effect except as to dates mentioned therein: Nominating petitions must now be filed at the headquarters office of the League in West Hartford, Conn., by noon EST of the 20th day of February, 1946. Voting will take place between March 1st and April 20, 1946, on ballots to be mailed from the headquarters office the first week of March. The new alternate will take office as quickly as the result of the election can be determined after April 20, 1946, and will serve for the remainder of the 1946-1947 term. You are urged to take the initiative and file nominating petitions.

For the Board of Directors:

K. B. WARNER,
Secretary

January 1, 1946

IF YOUR QST IS LATE . . .

ARRL Hq. is the busiest in its history. Despite a large increase in personnel and facilities, we have been unable to keep up with the winter load. Membership has been growing rapidly and our Circulation Department in particular has been overloaded. Both people and equipment are still hard to get and we haven't enough of either, so that during the winter peak we have been running about three weeks behind in the handling

of both new memberships and renewals. We have been doing our level best and we hope that we shall be out of the woods by the time these lines are in print. But if your first copy of *QST* on either your renewal or a new membership is later than you hope, don't worry — it will be along — and try to be patient with us in the knowledge that we're doing all we can to serve you.

EXAMINATION SCHEDULE

The Field Division of FCC, under George S. Turner as its chief, announces its schedule of amateur examinations for 1946, and with it a considerable improvement in the facilities offered us for examinations.

Eight new semi-annual examination points are established, at Amarillo, Texas; Bakersfield, Calif.; El Paso, Texas; Klamath Falls, Ore.; Las Vegas, Nev.; Salisbury, Md.; Tucson, Ariz.; and Wilmington, N. C. Incidentally, examinations at Grand Island, Neb., are now by appointment only.

Of more importance to us is the establishment of Tulsa, Okla., as a new quarterly examining point and a change of four cities from the semi-annual to the quarterly basis: Corpus Christi, Memphis, Omaha and Williamsport, Pa. The establishment of these examinations quarterly means that Class C tickets are no longer available within 125 miles air line of any of these cities and that henceforth applicants from those areas must appear in person and be examined for Class B.

FCC announces that it will give amateur examinations during 1946 on the following schedule. Remember this list when you need to know when and where examinations will occur. Where exact dates or places are not shown below, information may be obtained, as the date approaches, from the Inspector-In-Charge of the district. An asterisk (*) indicates that the examination dates shown are subject to change and should be verified from the inspector as the date approaches. No examinations are normally given on national or state holidays. All examinations begin promptly at 9:00 A.M., local time, except as noted below:

Albuquerque: Mar. 19, Sept. 12.
Allegan, Mich. (P. O. Box 89): By appointment.
Amarillo, Tex.: Mar. 14, Sept. 10.
Atlanta, 411 Federal Annex: Tuesday and Friday at 8:30 A.M.
Bakersfield, Calif.: Some time in February and August.
Baltimore, 508 Old Town Bank Bldg.: Wednesday, Friday and by appointment.
Bangor, Me.: Apr. 18*, Oct. 17*.
Beaumont, Tex., 329 P. O. Bldg.: Thursday and by appointment.
Birmingham: Jan. 19, Apr. 20, July 20, Oct. 19.
Billings, Mont.: Apr. 29*, Oct. 1*.
Bismarck, N. D.: Some time in April and October.
Boise: Some time in April and October.
Boston, 7th floor Customhouse: Monday through Friday.
Buffalo, 328 Federal Bldg.: First and third Thursdays of each month.

Butte, Mont.: Apr. 24*, Oct. 4*.
 Charleston, W. Va.: Some time in March, June, September and December.
 Chicago, 246 U. S. Courthouse: Friday.
 Cincinnati: Some time in February, May, August and November.
 Cleveland, 541 Old P. O. Bldg.: First and third Fridays each month, also by appointment.
 Columbus, Ohio: Some time in January, April, July and October.
 Corpus Christi: Mar. 14, June 13, Sept. 12, Dec. 11.
 Cumberland, Md.: Apr. 17, Oct. 17.
 Dallas, 500 U. S. Terminal Annex: Monday through Friday.
 Davenport, Ia.: Some time in January, April, July and October.
 Denver, 504 Customhouse: First and second Thursdays of each month.
 Des Moines: Jan. 10, Apr. 5, July 11, Oct. 11.
 Detroit, 1029 New Federal Bldg.: Friday and by appointment.
 El Paso: Mar. 23, Sept. 14.
 Fort Wayne: Some time in February, May, August and November.
 Fresno: Mar. 20*, June 19*, Sept. 18*, Dec. 18*.
 Galveston, 404 P. O. Bldg.: Tuesday and Friday.
 Grand Island, Nebr. (P. O. Box 788): Monday through Friday but only by appointment.
 Grand Rapids: Some time in January, April, July and October.
 Hartford, Conn.: Mar. 19*, Sept. 17*.
 Hilo, T. H.: Apr. 8, Oct. 21.
 Honolulu, 609 Stangenwald Bldg.: Monday at 8:30 A.M.
 Indianapolis: Some time in February, May, August and November.
 Jacksonville: May 4, Nov. 2.
 Juneau, Alaska, 7 Shattuck Bldg.: Monday through Friday and by appointment.
 Kansas City, 809 U. S. Courthouse: Friday and by appointment.
 Kaunakakai, T. H.: Oct. 14.
 Kingsville, Tex. (P. O. Box 632): Monday through Friday but only by appointment.
 Klamath Falls, Ore.: Some time in May and November.
 Lanai City, T. H.: Oct. 9.
 Las Vegas, Nev.: Some time in April and October.
 Lihue, T. H.: Apr. 29, Oct. 30.
 Little Rock: Jan. 16, Apr. 10, July 17, Oct. 9.
 Los Angeles, 539 U. S. P. O. & Courthouse Bldg.: Wednesday at 9:00 A.M. and 1:00 P.M.
 Memphis: Feb. 20, May 22, Aug. 21, Nov. 20.
 Miami, 312 Federal Bldg.: Monday and Friday.
 Milwaukee: Some time in January, April, July and October.
 Mobile: May 15, Nov. 6.
 Nashville: Feb. 15, May 17, Aug. 16, Nov. 15.
 New Orleans, 400 Audubon Bldg.: Monday at 8:30 A.M. and by appointment.
 New York, 748 Federal Bldg., 641 Washington St.: Monday through Friday.
 Norfolk, 402 New P. O. Bldg.: Friday.
 Oklahoma City: Jan. 22-23, Apr. 23-24, July 23-24, Oct. 22-23.
 Omaha: Jan. 17, Apr. 12, July 18, Oct. 18.
 Philadelphia, 1200 Customhouse: Requiring code test, 9-9:30 A.M. and 1-1:30 P.M. Wednesday. Not requiring code test, 9 A.M. to 1:30 P.M. Monday through Friday.
 Phoenix, Ariz.: Some time in April and October.
 Pittsburgh: Feb. 13*, May 10*, Aug. 8*, Nov. 7*.
 Portland, Me.: Apr. 16*, Oct. 15*.
 Portland, Ore., 805 Terminal Sales Bldg.: Friday at 8:30 A.M.
 Reno: Apr. 17*, Oct. 16*.
 Roanoke: Apr. 6, Oct. 5.
 St. Louis: Feb. 7, May 17, Aug. 8, Nov. 15.
 St. Paul, 208 Uptown P. O. & Federal Courts Bldg.: First and third Fridays of each month.
 Salisbury, Md.: Mar. 7, Sept. 12.
 Salt Lake City: Mar. 23*, June 22*, Sept. 21*, Dec. 21*.
 San Antonio: Feb. 27-28, May 23-24, Aug. 21-22, Nov. 13-14.
 San Diego, 307 U. S. Courthouse: By appointment.

ARE YOU LICENSED?

• When joining the League or renewing your membership, it is important that you show whether you have an amateur license, either station or operator. Please state your call and/or the class of operator license held, that we may verify your classification.

San Francisco, 328 Customhouse: Monday.
 San Juan, P. R., 322 Federal Bldg.: By appointment.
 Savannah, 214 P. O. Bldg.: By appointment.
 Schenectady: Mar. 13-14, June 12-13, Sept. 11-12, Dec. 11-12.
 Seattle, 808 Federal Office Bldg.: Friday.
 Sioux Falls, S. D.: Some time in March, June, September and December.
 Spokane: Apr. 18*, Oct. 10*.
 Syracuse, N. Y.: Jan. 9*, Apr. 9*, July 9*, Oct. 8*.
 Tampa, 409 P. O. Bldg.: By appointment.
 Tucson, Ariz.: Some time in April and October.
 Tulsa: Jan. 25, Apr. 26, July 26, Oct. 25.
 Wailuku, T. H.: Oct. 12.
 Washington, D. C., 410 International Bldg., 1319 F St. N.W.: Monday through Friday.
 Wichita: Mar. 8, Sept. 13.
 Williamsport, Pa.: Mar. 12*, June 4*, Sept. 10*, Dec. 3*.
 Wilmington, N. C.: Some time in June and December.
 Winston-Salem: Feb. 2, May 4, Aug. 3, Nov. 2.

CANADIAN REGULATIONS

In our November issue we reported the frequency bands made available to Canadian amateurs; now we have some additional information on the conditions to be observed by Canadian amateurs.

Amateur stations must be so operated as not to interfere with other services or with broadcast reception. Each licensee may operate one portable station at a temporary location or in his own passenger automobile. Such stations shall sign their assigned calls followed by the word "portable."

We have previously reported that the Canadian bands are the same as in the U.S.A. Amplitude-modulated 'phone may be employed throughout the 28-29.7 band under the following conditions: The station must have a reliable frequency meter and visual means of indicating overmodulation; the transmitter must be either crystal-controlled or of comparable stability and constancy; the modulation system must insure intelligible speech, must not exceed 100% modulation, and must not disturb the frequency stability of the transmitter. There are no restrictions on a.m. 'phone operation in the bands above 56 Mc. Unlike the U.S. regulations, no frequency-modulated transmission, either telegraph or 'phone, is permitted in the 28-29.7 band. However, as in the U.S., f.m. may be used on all the frequencies above 58.5 Mc.

NAVAL-BASES STATIONS

The following quotation from a letter originating in the office of the Chief of Naval Operations states the Navy policy on the authorization of amateur stations at naval activities ashore, in regions within the jurisdiction of FCC, i.e., within the territory in which the Communications Act authorizes FCC to issue amateur station licenses. (We have no information yet on the policy toward amateur installations in areas outside FCC licensing jurisdiction.)

... The following policy, governing the installation of amateur radio stations within the boundaries of naval activities ashore, supersedes the policy as set forth in previous references:

a) An amateur radio station will not be permitted in the same compartment with naval transmitting and receiving equipment at any naval shore radio station. This restriction does not preclude the installation of an amateur station in a building in which living quarters and regular Navy radio equipment are located in the same building.

b) The Department will interpose no objection to the granting of an amateur radio station license by the Federal Communications Commission to personnel at a navy yard, naval station or reservation (except as noted in paragraph (a)), provided, after due consideration as to hazards and its probable interference with naval radio activities, the Commandant approves such installations.

Each district commandant will keep a record of all amateur radio stations installed within the limits of each navy yard, naval station or naval reservation.

The Department will not approve an application for an amateur radio station license made by an individual residing outside the limits of a navy yard, naval station, or naval reservation, when such amateur radio station is to be installed within the limits of a navy yard, naval station, or naval reservation, unless such station is to be used in connection with training the Naval Reserve.

Radio stations used exclusively for training the Naval Reserve, which operate only on government frequencies assigned for such use by the Navy, and with Navy or Naval Reserve call signs, do not require any license from the Federal Communications Commission. The only stations which require FCC amateur station licenses are those which are operated in the amateur frequency bands.

The normal procedure for the licensing of an amateur radio station, to be installed on a naval reservation, is for the individual to prepare the usual application form in accordance with the regulations of the Federal Communications Commission. This application is to be forwarded by official correspondence to the district commandant having purview of the reservation in question. The commandant will either return this application to the individual concerned by disapproval endorsement, or forward it to the office of the Federal Communications Commission having cognizance of licensing in the area concerned, with an appropriate approval endorsement and furnish a copy thereof to the applicant.

The Federal Communications Commission regulations require that the application shall be prepared in the name of an individual without relation to rank, rating, title or any other connection with the military service, that the applicant shall have absolute control of the radio transmitter for use in amateur service, and shall use the transmitter only with a personal aim and without pecuniary interest.

While the amateur licensee is legally responsible for each and every transmission made from a transmitter under his control, the Commandant may regulate the hours and dates during which transmissions may be made from any such transmitter licensed to operate on a naval station or naval reservation under his command. The Commandant may also revoke authority for such operation entirely, at his discretion.

Silent Keys

It is with deep regret that we record the passing of these amateurs:

- W1ARM, F. Newton Williams, Laconia, N. H.
- W1SL, Col. Davis S. Boyden, Lunenburg, Mass.
- W2LVE, Lt. Wm. H. Birney, jr., Brooklyn, N. Y.
- W5BKC, Jack C. Ford (R/O RAF), Vicksburg, Miss.
- W6GG, Charles E. Blalack, Yuma, Ariz.
- W7ELV, Donal B. Lowe, Grace, Idaho
- W8AQD, RM1/c Clarence O. Reed, Kalamazoo, Mich.
- W8ATG, John Datko, jr., Youngstown, Ohio
- W8DMX, John H. Borden, Youngstown, Ohio
- W8NOU, CRT Oliver A. Goodwin, Towanda, Pa.
- W8QAO, RT1/c Richard A. Morrison, Williamson, N. Y.
- W9CAA, C. Raymond Stedman, Denver, Colo.
- W9OND, Chester Garriott, New Castle, Ind.
- W9PVC, Ens. Eric J. Kleven, USMS, Capa, S. Dak.
- VE4VJ, W. K. Angus, Edmonton, Alberta
- VE4XF, Sgt. H. F. P. Sullivan, Edmonton, Alberta
- I1KW, Renzo Albanello, Leghorn, Italy

A Correction

Lt. (jg) Charles Wesley Woodin, KA1CW, whose name appeared in the Gold Stars list in October *QST*, is reported alive and well after being a prisoner of war for three years. Although regretting the error, we are very happy to be able to make this correction.

Feedback

ON PAGE 57 of the December issue, in the tabulation at the end of the second column, the exponents in the second through the sixth lines should be reduced by 1. On page 58, first column, second tabulation, the last four lines should read 543.2×10 , 5432×1 , $54,320 \times 10^{-1}$, $543,200 \times 10^{-2}$, and in the last line of the third tabulation the number should be 56 instead of 0.56.

Premodulation Speech Clipping and Filtering

Increased Sideband Power without Overmodulation

BY W. W. SMITH,* W6BCX

MOST OF the consonant speech sounds or "lip" sounds are from 20 to 30 db. weaker in intensity than the loudest vowel sounds. Nevertheless they are the major contributors towards "connected-speech" intelligibility. When a signal is barely above the noise level and individually articulated strong vowel sounds can just be recognized, connected-speech or "discrete-sentence" intelligibility is poor because the weaker "lip" sounds — the really important sounds — are lost in the background noise. The connected-speech intelligibility can be greatly enhanced under these conditions by increasing the a.f. gain until the weak consonant sounds provide heavy modulation of the carrier, at the cost of rather severe distortion that occurs on the loudest vowel sounds as a result of amplitude limiting or "clipping."

It is the purpose of this article to emphasize the advantages to be gained by incorporation of amplitude clipping and low-pass filtering in the speech systems of amplitude-modulated amateur transmitters. It is felt that the dividends that accrue from peak clipping have not been sufficiently emphasized and that premodulation clipping and filtering does not enjoy the wide popularity among amateurs it deserves, even though first advocated for amateur use some six years ago.^{1, 2, 3}

* 215 West Cook St., Santa Maria, Calif.

¹ Grammer, "Lop-Sided Speech and Modulation," *QST*, Feb., 1940.

² Smith, "An Effective Splatter Suppressor," *Radio*, Oct., 1940.

³ Smith, "A Simple A.F. Peak Limiter (Chopper) for the Phone Transmitter," *Radio*, June, 1941.

• By incorporating peak clipping and a.f. filtering in an a.m. 'phone transmitter it is possible to realize an effective power gain of nearly 100 times so far as working DX is concerned — without splatter and without increasing heterodyne interference. The intelligibility of weak signals is greatly increased at a slight sacrifice in quality. The author suggests "Clipper" as a one-word label for the clipper-filter system.

Peak Clipping and Splatter

In a conventional transmitter which is "voice-modulated 100 per cent," the gain ordinarily is set at such a point that on normal speech the peak amplitude seldom exceeds 100 per cent, and then only for a very short period which may be described as a "burst." The burst represents overmodulation, with its inevitable generation of high-order distortion components and resultant adjacent-channel splash-over or "splatter." If the gain is gradually increased above this level, the bursts will become more and more frequent during conversational speech, until finally almost every syllable produces splatter. The pertinent and interesting fact is that if the distortion of the system is low at levels below 100 per cent, it is possible to run up the gain at least 10 db. above the level representing "100 per cent voice modulation" with only a negligible reduction in the connected-speech intelligibility. If, instead of relying upon transmitter overload, a clipper designed for the express purpose of chopping high-amplitude peaks is incorporated, the gain may be run up at least 20 db. It is true that the quality or "naturalness" will suffer slightly, but the speech is still highly understandable.

This is not an advocacy of heavy overmodulation, but rather an explanation of why it does exist in the amateur bands. When the equivalent power gain obtained is considered, it is easy to see why the temptation exists to crank up the gain and hope the FCC does not happen to be lending an ear. But regardless of the FCC, the practice is grossly inconsiderate and anti-social — and conducive to a verdict of "justifiable homicide."

Premodulation Clipping

What most amateurs have failed to appreciate is that heavy modulation, with consequent peak clipping, need not mean overmodulation and splatter provided the chopping is done in the *audio* system and that the high-order harmonics thus generated are filtered out before reaching the modulated r.f. stage. In fact, it is interesting to note that even if the question of splatter is ignored, confining the clipping to a chopper designed for the specific purpose makes it possible to realize a greater effective power gain than is

obtained by simple overmodulation and incidental clipping.

The effect of two degrees of speech clipping in a well-designed chopper is illustrated in Fig. 1. Curve A represents no clipping, and is representative of broadcast stations and a few amateur stations. Curve B represents 10 db. clipping, which produces negligible deterioration of the discrete-word articulation at high carrier levels and a considerable improvement at signal levels below 10 microvolts. Curve C, representing 25 db. clipping, provides a worthwhile improvement in intelligibility at signal levels around 3 microvolts, but deteriorates the intelligibility very slightly when the signal strength is good. Obviously, as much as 25 db. clipping would be advantageous only when working DX and the carrier is barely above the background noise. The average amateur transmitter is overmodulated on peaks of loud syllables and could be represented by a curve about midway between A and B.

The curves assume a typical communications receiver, negligible selective fading, no heterodyne interference, 100 per cent peak modulation, low distortion below the clipping level, and full-wave clipping (both negative and positive peaks limited to 100 per cent). They also assume that the peak noise limiter in the receiver is adjusted for optimum threshold level under each condition, or else is inoperative altogether. Many peak noise limiters (actually they are choppers or clippers) in communications receivers begin to limit on positive peaks at around 30 or 40 per cent. This is fine when the transmitted signal has little or no clipping, but is not so good when a high degree of clipping is employed at the transmitter.

The curves are representative, but will vary somewhat with receiver fidelity, transmitter fidelity, etc. More or less receiver sensitivity will simply displace all three curves to the right or left without affecting their relationship. If the distortion in either the receiver or the transmitter is high when no premodulation clipping is employed, then the equivalent power gain or gain in intelligibility under poor receiving conditions will not be so pronounced when a high degree of premodulation clipping is utilized. With regard to Fig. 1, it should be kept in mind that the discrete-monosyllabic-word articulation percentage determines the discrete-sentence intelligibility, but that the latter runs much higher.

With very bad selective fading, such as occasionally is encountered in the 4-Mc. band, a high degree of premodulation clipping will actually degrade the intelligibility, even when the signal

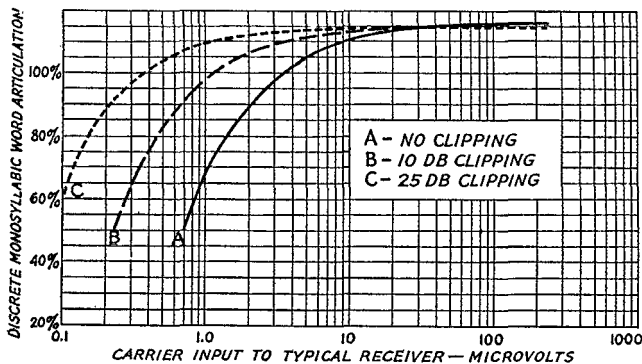

Fig. 1 — Illustrating the effect of peak clipping on weak signal readability. 100 per cent peak modulation and negligible selective fading are assumed in all three cases. If 80 per cent discrete-word articulation is arbitrarily taken as the minimum acceptable for DX communication, note that with 25 db. clipping it is possible to carry on communication with approximately 1/10th the carrier field strength, or 1/100th the received carrier power, required for unclipped speech. It should be kept in mind that the discrete-sentence intelligibility is considerably higher than the discrete-monosyllabic-word intelligibility, because of the aid of context. The ratio depends upon the syllabic articulation percentage and is not significantly affected by the degree of clipping.

is weak. However, this is an unusual case and should detract little from the overall attractiveness of premodulation clipping because communication is none too satisfactory under such circumstances anyhow, regardless of the received signal strength, unless diversity reception is employed.

Nomenclature

Because it is logical to assume that anything offering so much and costing so little will eventually become widely popular among the amateur fraternity, the question arises as to a short, descriptive title which is appropriate. Under the Bell System classification of "range controllers"⁴ the clipper or chopper portion of the system qualifies as a "limited range, instantaneous compressor," called a "peak chopper" for short.

This takes care of the clipper or chopper, but ignores the associated filter. Also, it would apply equally to incorporation in any speech equipment, whether it be transmitter, receiver, or public-address system. Perhaps "premodulation speech clipping and filtering" is the most appropriate from a descriptive standpoint, but it is quite a mouthful and could stand a little clipping itself. Some of our most noteworthy wartime electronic developments have been dubbed with nicknames for convenience; therefore it need not be considered facetious to coin a short title for the overall system. The author offers "Clipper," feeling that one name is about as good as another so long as the amateur fraternity all standardize on the same title.

⁴ Wright, "Amplitude Range Control," *The Bell System Technical Journal*, Oct., 1938.

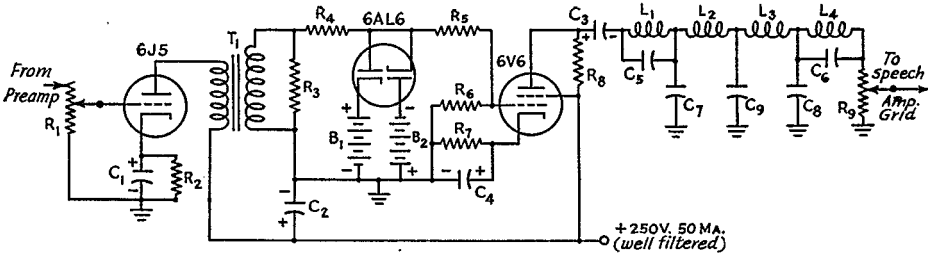

Fig. 2—Low-level, full-wave clipper system. The gain control R_9 is not required if one of the preceding stages has a gain control.

- B_1, B_2 — $7\frac{1}{2}$ -volt "C" battery
- C_1 —10- μ fd., 25-volt electrolytic
- C_2, C_3 —8- μ fd., 450-volt electrolytic
- C_4 —25- μ fd., 25-volt electrolytic
- C_5, C_6 —0.025 μ fd., $\pm 5\%$
- C_7, C_8 —0.07 μ fd., $\pm 5\%$
- C_9 —0.08 μ fd., $\pm 5\%$
- L_1 —30-mh. iron-core choke
- L_2, L_3 —80-mh. iron-core choke
- L_4 —30-mh. iron-core choke

- R_1 —0.5-meg. pot., a.f. taper
- R_2 —1000 ohms, 1-watt
- R_3 —0.15 megohm, 1-watt
- R_4 —0.25 megohm, 1-watt
- R_5 —0.5 megohm, 1-watt
- R_6 —0.25 megohm, 1-watt
- R_7 —400 ohms, 2-watt
- R_8 —1000 ohms, $\pm 10\%$, 5-watt
- R_9 —1000-ohm pot., a.f. taper, $\pm 10\%$ (check with accurate ohmmeter)

Practical Circuits

Illustrated in Fig. 2 is a "clipper" suitable for use on the 4-, 14- and 28-Mc. bands. The clipper circuit shown is but one of many that may be employed satisfactorily. It happens to be a shunt type, but a series type is equally suitable and may be preferred by some. The clipping level is nominally $7\frac{1}{2}$ volts, determined by the bias voltage supplied by each of the "C" batteries B_1 and B_2 . Because of contact potential effects, it is not advisable to attempt to run the clipper diode with much less bias.

To provide 25 db. of clipping requires about 6 volts peak input at the grid of the 6J5. The maximum output available at potentiometer R_9 is approximately 4 volts peak for all degrees of clipping, which means that the complete clipper illustrated has a voltage gain of slightly less than 1 when 25 db. of clipping is employed (figured on the basis of peak values). Usually this will permit the clipper as illustrated to be spliced into an existing speech amplifier at a suitable level without need for additional amplification.

Under conditions of maximum clipping, the peak voltage across the secondary of T_1 will reach about 200 volts. A husky interstage transformer with a well-clamped core is necessary in order to avoid acoustical lamination chatter.

The shunt diode clipper shown does a clean job of clipping, having negligible time constant and holding the peak output voltage to a negligible rise as clipping is increased from threshold to 25 db. No provision is made for clipping much more than 25 db., as the intelligibility deteriorates rapidly beyond this point.

It is important that leads between R_4, R_5, R_6 , the 6AL6, and the control grid of the 6V6 be kept short and not cabled with other leads or run against the chassis, in order to minimize the time constant of the chopper circuit.

The low-pass filter illustrated has a cut-off frequency of approximately 4000 cycles, and is 60 db. down at about 6500 cycles and above. Besides having good attenuation characteristics, its phase-shift characteristics are good (approximately proportional to frequency within the pass-band). The latter characteristic is important, because we want the filter to round off the sharp edges, as it were, without canting or otherwise disturbing the level tops of the clipped cycles of the wave. For the same reason it is important that the phase shift throughout the audio system following the filter be minimized, or the full benefits of peak clipping and filtering cannot be realized. The problem will be made somewhat easier if all frequencies below 400 cycles or so are attenuated ahead of the chopper, because inexpensive modulation transformers (particularly those designed to carry the Class-C plate current) have considerable phase shift and poor response down around 100 to 150 cycles, which takes in the fundamental frequency of most male voices. As the advantages of bass suppression for communications work are well known, it is only a matter of pointing out the necessity for placing the suppression circuits ahead of the chopper.

The filter need not be so elaborate for the v.h.f. 'phone bands, because receivers are not so sharp and it is permissible for the sidebands to extend out a little. In fact, fairly good attenuation at 15 kc. and above with negligible attenuation at 4000 cycles may be obtained by shunting both the primaries and secondaries of two or more transformers following the chopper with capacitors of optimum value, to be determined by cut and try. The leakage inductance of each transformer in conjunction with the shunt capacitors forms a π -section filter having attenuation characteristics adequate for v.h.f. use.

On the 420-Mc. band and above, no filter will be required except for the incidental filtering

which results from the limited high-frequency response of conventional audio components. However, because capacitors are cheap, it is advisable to shunt the transformers in every case to lower the cut-off frequency.

The filter illustrated was designed to use standard values of commercially-available chokes, such as Meissner. The filter capacitance values can best be obtained by checking with an accurate capacitance meter or bridge, paralleling two or more capacitors to get the desired value when necessary. Tubular paper capacitors have sufficiently high Q for the purpose, and the better grades will be found to run within 5 per cent of their marked values.

Adjustment

In order to take full advantage of the clipping feature, the transmitter must be capable of 100 per cent *sine-wave* modulation with low distortion. Lots of good-sounding amateur transmitters do not meet this requirement, and should be revamped before any attempt is made to set the world on fire with a clipper.

An oscilloscope is a great help in making initial adjustments and checking for correct operation, but is not absolutely necessary. Assuming that it has been determined that the transmitter is capable of 100 per cent sine-wave modulation without more than about 10 per cent distortion,⁵ turn the gain control (R_1 or other preamplifier control) full on and the clipping level control, R_2 , full off. Then, using ordinary speech, advance R_2 until the transmitter shows signs of being modulated at a low level. Listening on a 'phone monitor or the station receiver, adjust R_1 to the highest setting that gives good intelligibility.

Now advance R_2 to a position just below the point where splatter is heard when the station receiver (assuming it is a superhet with antenna terminals shorted to ground) is tuned just off the signal. Have another station, preferably nearby, check for splatter just to be sure. Potentiometer R_2 then need not be touched unless the adjustments to the modulated r.f. stage, particularly loading, are altered appreciably. In fact, it is advisable to make the control on R_2 not too accessible; otherwise, it may get twisted accidentally sometime.

If an oscilloscope is available it may be used to check the waveform out of the modulator to ascertain whether the tops of the clipped waves are flat. It may also be used to check the modulation envelope of the r.f. carrier and determine whether the negative peaks are being clipped *in the Class-C stage* (negative modulation in excess of 100 per cent). The latter condition is the worst

⁵ It is especially important from an interference standpoint that distortion caused by nonlinearity of the modulated r.f. amplifier be held to the lowest possible value. Distortion in the modulator is much more tolerable, but should not exceed 10 per cent for maximum exploitation of the clipper.

offender so far as splatter is concerned, particularly in a plate modulated rig. If the condition exists, it will be necessary to back off on R_2 until it is corrected.

When making over-the-air comparisons of adjacent channel splash-over between a rig using a high degree of peak clipping and one using no clipper system, the clipper-equipped transmitter should be compared with a conventional rig having much greater carrier power. Otherwise the greater sideband power obtained with a clipper system will give the illusion of more adjacent-channel interference. Because no receiver has a rectangular i.f. selectivity curve, greater sideband power in itself will give the effect of a slightly broader signal, the effect being exaggerated when a.v.c. action is employed and the ratio of sideband power to carrier power is high. However, increased sideband power, when confined to speech frequencies, produces a different quality of QRM than does splatter, and the difference can readily be recognized by anyone familiar with the ragged sound of overmodulation splatter.

A conventional kilowatt rig, not overmodulated, naturally cuts a wider swath on the tuning dial of a receiver than does a 100-watt rig operated under the same conditions. For the same reason, and also because of the receiver's a.v.c. action, the use of a clipper results in a signal which takes a slightly greater slice of kilocycles than does a signal from a conventional transmitter of the same carrier power. Instead of reasoning that the clipper-equipped rig is broader and produces more QRM, one should consider that for a given amount of *intelligence-carrying sideband power* the QRM actually is less with a clipper-equipped rig, because of the greatly-reduced heterodyne interference.

The first thing that the owner of a newly-installed clipper will observe is the much greater activity of the antenna-current meter under speech modulation. It is very gratifying to watch the antenna ammeter needle jump around in a lively manner and know that the fellow just up the street is copying a weak signal 20 to 30 kc. off your frequency with no trouble whatsoever. A word of warning is in order, however; it behooves the user of a clipper to make sure that at all times it is working correctly, because faulty operation can cause terrific QRM.

It is not necessary to make provision for more than two degrees of clipping. The first can be that which just causes perceptible distortion. This will correspond to about 10 db. clipping and can be used at all times except when working extreme DX.

The second degree of clipping corresponds to that at which the intelligibility begins to suffer when the signal is received under ideal conditions (no background noise). This corresponds to about 25 db. clipping, which need be used only when difficulty is experienced in "getting through."

It is possible to provide an indicator on the clipper circuit to show continuously the amount of clipping in effect. However, this is a luxury, if not an unnecessary refinement, and hence is not shown. A negative-peak clipping indicator on the Class-C stage, to ensure correct adjustment of R_p at all times, is of greater use. However, if you

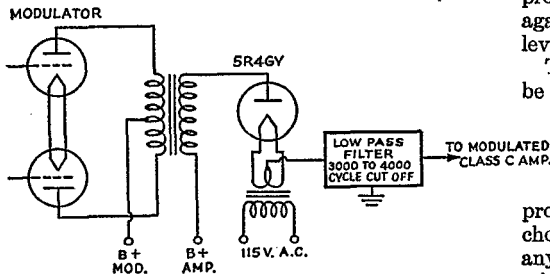

Fig. 3 — Half-wave, high-level clipper suitable for d.c. inputs up to 3000 volts and 500 ma. The rectifier filament transformer must be insulated for at least four times the d.c. plate voltage.

insist on something to indicate the amount of chopping, simply stick a 0-1 ma. d.c. meter (not over 40 ohms d.c. resistance) in series with one of the $7\frac{1}{2}$ -volt "C" batteries and ground. Then establish the correlation between meter readings and db. clipping.

An incidental advantage of the clipper illustrated in Fig. 2 is the protection it affords certain expensive components from breakdown, flash-over, or accelerated deterioration as a result of unexpected peaks from door slams, sneezes, etc. Included are the Class-B modulation transformer and the plate tank and neutralizing condensers.

Half-Wave, High-Level Clipper

Fig. 3 is a modified clipper system which has both advantages and disadvantages compared with the low-level, full-wave clipper system of Fig. 2. In the Fig. 3 system only the negative peaks are clipped; positive peaks are limited to a value within the upward modulation capability of the modulated amplifier by proper choice of modulator tubes, modulator plate voltage, and plate-to-plate load. By running the modulated tubes somewhat under full rating (both plate voltage and plate current), by providing plenty of excitation to the modulated stage, and by using wider than normal spacing on final amplifier tank and neutralizing condensers for the d.c. plate voltage used, the upward modulation capability can be made about 200 per cent. If sufficient audio power is available, it is possible to be modulating in the neighborhood of 200 per cent on positive peaks and slightly less than 100 per cent on negative peaks — without splatter. This would seem to violate the letter of the FCC amateur regulations limiting modulation percentage, but not the spirit or intent.¹

On the credit side are the automatically self-adjusting clipping-level feature, and the avoidance of difficulties because of phase shift in the Class-B modulation transformer.

On the debit side are the facts that the clipper and filter components must work at high power and are considerably more expensive. Also, no protection is afforded the modulation transformer against sudden surges as is the case with the low-level, full-wave clipper.

The filter portion of the Fig. 3 clipper should be designed to work into a load resistance equal to the d.c. plate voltage on the modulated stage divided by the d.c. plate current. One or more Thordarson "splatter chokes" may be used as inductances, these chokes being provided with taps to permit a considerable choice of inductance value. A suitable filter for any particular load impedance may be determined by referring to almost any text treating wave filters.

When this clipper circuit first was tried,² a delay bias resistor was connected between plus "B" and the input of the filter, with the idea of preventing filter hangover from causing the plate voltage on the modulated stage to go negative at any time. However, the resistor was found to be unnecessary, probably because all energy in the stop band of the filter shows up as d.c. input, giving a very slight controlled-carrier effect which is sufficient to prevent filter hangover from swinging the modulating voltage below zero. Good splatter suppression with a high degree of clipping was obtained from a simple, single-section π filter, but two or more sections are recommended when operating on the lower-frequency 'phone bands — assuming they will be at least as crowded as they were in 1941.

With the half-wave clipper the splatter may be slightly less with the speech poled one way than with it poled the other. However, the difference will be very slight, particularly if bass suppression is employed.¹

Use on F.M.

It is quite probable that some reduction in adjacent channel interference can be realized on f.m. by the use of a clipper, but no attempt has been made by the author to evaluate the possible improvement and advantages when used on f.m.

Stays

In radio, it is sometimes necessary to measure the power involved in cross talk between carrier channels. This power may be less than a hundredth of a millionth of a microwatt. Converted to heat energy, this is approximately equal to that from a 60-watt lamp falling on an area one foot square at a distance of 4000 miles. — *The Ohmite News*



How's DX?

How:

We had no sooner turned in last month's copy for this column than it became very apparent that the dope would be hopelessly ancient by the time it got into the various hamshacks. This is partially due to the lead time required by our production schedule, but it is mainly caused by the rapidly changing picture on the ten-meter band. Stations keep popping up all over the world and then move or unpop so fast that even a daily newspaper would have trouble keeping up with them. So if you find that some of the stations mentioned on this page during the next few months are old hat to you or that they are no longer active, bear in mind that these are trying times.

One thing we can be sure of, however, and that is that there has been enough of the stuff kicking around to make anybody happy. True, it isn't all too easy to raise, but it's there for the guys with the right combination, and after a number of starvation years it tastes mighty good, once you latch on to some of it.

Where:

Apparently those Gs reported last month were all kidding us. We know that G5DX was in France, and G3WP writes to say that the Gs have not yet been allowed back on, although action is expected shortly We trust this won't insult the intelligence of those in the know, but apparently a few of our foreign friends have been wondering about the fraction bar and numeral tacked on to the end of many a W call. For their information, that is the "portable" designation used in this country, to indicate a station not operated at the home address. For example, W1UE/1 means W1UE portable in the W1 district, W8KAY/KB6 means W8KAY portable in the KB6 area, and W9LOG/VP4 is W9LOG portable in Trinidad. Incidentally, the W calls you hear signing "portable J" and "portable PY" and so on are not phonies but generally GIs who have obtained permission from their officers to operate ham radio from some U. S. military post in that area. This is no kind of undercover operation, since it is being done with the full knowledge and sanction of the authorities. It's a swell break for our GIs stranded in some foreign port for a while We have received a number of lists of "Calls Heard," but space limitations prevent their publication. However, we would like to thank the donors for their trouble and suggest that some of the fellows they copied would appreciate a "heard" card. The lists came from W5KKN and W1BGJ in Nassau, G3BW in Eng-

land, W1GSB in French Morocco, W1NUR and W2KJT in Japan, W1JSV and W8NNF in Algiers, W8NWF on a ship in the English Channel, W5CUB in Egypt, W1QG and W1NIN in Germany, W2JZK near Guam, W6QAP in Ecuador, W8JIN in France, and W8KAY en route Leyte to Wake Island. If you do get a card from these fellows, or any others, don't forget that ham radio means plenty to them right now, and your acknowledgment and a note on ham radio would do much to bring them closer to home We have the addresses of G5DX and PIX, and will forward your cards if you worked them. G5DX was in France and PIX was undercover in Holland.

When:

W1DSB, at Limatambo, Peru, for Panagra, reports that OA4D is active on 10 'phone down there, and that a number of ex-Ws expect to get OA tickets very soon Looking over the good ones, W1LOU/8 reports HC1CZ (28,000) and T1ZDX (28,255) on c.w. HC1CZ was W6QAP using a one-tube regenerative receiver — he is now in a hospital in Canal Zone and will be back in W6 land shortly W7EYS worked W6NSL/J and W9TQD/J on 28,050 c.w., and K7CBF and K7HMS on 28,500 'phone. Heard on 'phone were W5KIO/Iwo Jima (28,400), KA1JB (28,600) and YV1AQ (28,130) W6HG heard XU3SJA (28,050) and says the way to

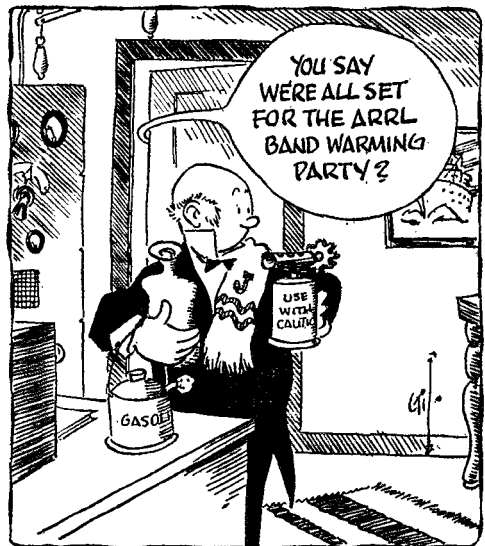

check on Asian conditions is to listen for EOA3 (28,000), a commercial in Tokyo W5KC, W1HDQ and a lot of others have been knocking off WSBOR/PY (28,480 'phone), who has been rocking in W6DTB reports W5ILM/Tinian, without benefit of frequency FA8NF has switched from c.w. to 'phone and is so loud that many stations pass him up. He's louder than EA1D was! W5ADZ heard a nice handful of c.w. on 28,000: W6PUZ/Tinian and W6HQJ/J W1UE/1, a traffic man gone ten-happy, reports hearing K6CGK, TI2RC, HC1JW, LU3DD, VP2AT and XE1AM, while the c.w. heard at W9NCS/3 includes F8RP (28,900), G3C (28,420), W7EGN/K7 (28,025), W2ILE/K6 (28,100), W3JAV/K6 (28,090) and W2AVO/K6 (28,400) Speaking of the gang operating in K6, which includes representatives from practically all W districts, W1NSS/K6 says that some have been using the higher portions of the band and don't seem to get many replies. Take a listen there around K6 time and do yourself some good Mouth-waterer of the month is reported by W8JIN, listening in France, who heard ZC6NX (28,300) on both 'phone and c.w. Yipes! VO2KJ (28,250) and VO2M (28,220) are on 'phone, as is W4HVT/PY (28,570) W9ZHB of 56-Mc. fame reports through W1HDQ that he has heard CX1FB, HK3AD, OA4M, W9LOG/VP4, W9WUG/KB6, W1KSF/Tinian, TG9RV, and a K6 calling VK2DY. We have had no official word on the VKs and so rather suspect that last one.

Who:

LU7AZ (28,150) very active on c.w. and sometimes 'phone, puts in a rocking signal up here from his new location at Nicasio Orono Nr. 75, Buenos Aires. He also has a station at the home of his parents, a "perfect amateur QTH out of the noise," and signs LU7EZ from that location. The address is Avellaneda 446, Ramos Mejia, Buenos Aires Colin Grattan, another outstanding station down Argentine way, writes to say that his call is no longer LU9BV but LU9EV. The new address is Rivera Indarte 271, San Isidro, F.C.C.A., Argentina Remember W8OSL of beer-can vertical and other fame? He used to get into Asia pretty well from the 8th district, but we find that he was one of a group of seven men who were officially the first into Japan, on Z-day minus two! His AACs career has carried him to Newfoundland, Australia, New Guinea and the Philippines W4ZZ was on a ship to Leyte and back and did a little listening — on the broadcast band. Best station was KSL, Salt Lake, which rode through out past Guam. Of the 5-kw. stations, KDYL, another Salt Lake station, held up best, and Herrick is convinced the salt lake and soil have something to do with it. When last heard from he was pricing salt in carload lots!

W4TZ writes that on his way through Hawaii he finally located KF6JEG, and that if any of the gang want confirmation on Howland, Jarvis or Canton Islands with JEG, he can be reached at Overseas-Foreign Aeronautical Comm. Station KVM, M Road, Damon Tract, Honolulu Please keep an ear out for old VR6AY. Pitcairn was one of AP's pets, and they would like to hear how the island fared during the war. It is good publicity for amateur radio, so if you hear anything from there, let us or the Associated Press know in a hurry W1NVO, ex-W2ESO, is pretty sharp. He says that the XYL, W1NVP/1, was D4USB's first 'phone contact and hence shares credit for the first 'phone QSO between Germany and U. S. One's first reaction is, of course, "Nuts!", until sharp Gene points out that Ds were never allowed on 'phone! And, so, another "first" is chalked up So you're all through with DX, because there's nothing new under the sun? Then you won't want to hear about AC3SS, Mr. H. G. Baker, The Residency, Gangtok P. O., Sikkim, via Calcutta, India. Located about 200 miles from AC4YN, he is hemmed in by British India, Nepal, Bhutan and Tibet. He will be active on 14 Mc The South Africans have just been allowed back on, on 28 and 56 Mc. ZS6DW was the first to get on ten, and on his first day was probably called by every active W 'phone, all at once! The rest of the gang will be on just as fast as licenses can be issued.

Predictions:

Now that you have had a chance to check on the 28-Mc. predictions published last month, and have lost all faith in us because you worked Manila when we said you couldn't, or you got on when we said you could work Rio and didn't even hear them, you can appreciate what we're up against. However, we repeat that these predictions represent trends only and we think you'll find that, in general, they work out pretty well. The conditions for February appear to be better than for January, so gather 'round and give a look. Where no maximum usable frequency is shown, it means the 28-Mc. band is open during the period shown — a single time indicates when the corresponding m.u.f. is reached.

Path	Max. Usable	
	Freq. (Mc.)	Time (GCT)
Washington — S. F.		1800-2300
Washington — Rio		1300-2200
Washington — Paris	27.3	1800
Washington — Manila	22	2300
Washington — Sydney	27	2400
S. F. — Rio		1630-0030
S. F. — Paris	22	1800
S. F. — Manila		2330-0130
S. F. — Sydney		2400-0230
S. F. — San Juan, P. R.		1700-2330
N. Y. — San Juan, P. R.	26.7	1800

— W1JPE

A Non-Radiating Superregenerative Receiver for Two Meters

Improved 144-Mc. Receiver Performance with New Miniature Tubes

BY E. P. TILTON, * WHDQ

THOUGH THE trend in v.h.f. receiver design is toward the superheterodyne principle the simple superregen still has much to recommend it. Its high sensitivity and noise rejection characteristics, its simplicity and low cost, and its adaptability to portable and mobile operation make it a "natural" for amateur v.h.f. work. The superregen still is the easiest receiver to build, and only the best of superhets have anything on it when it comes to weak-signal reception.

The outstanding fault of the superregenerative receiver is radiation, and this feature has long been the limiting factor in v.h.f. work in localities where there is any concentration of activity. Many "cures" have been offered from time to time — special circuits for which low radiation is claimed have been devised, and receivers with r.f. stages have appeared without number — but still the radiation persists. What, then, does it take to make a *non-radiating* receiver?

First, it takes more than a detector which will superregenerate at low plate voltage, although this is certainly a good start. Second, the mere fact that a receiver has an r.f. stage is no guarantee that it will not radiate. This was proven recently when a 112-Mc. superregen having an r.f. stage was tested for radiation in the Headquarters lab. An S-27 receiver having an S-meter was used to check the radiation. With no antenna on the t.r.f. receiver its radiation could be heard, but not with sufficient strength to give an S-meter indication on the superhet. With an antenna coupled to the detector, the meter read S-7. Connecting the antenna to the coupling coil on the r.f. stage dropped the meter reading to S-3 — still enough radiation to kick up quite a rumpus. From this, it appeared that not only must the detector be completely shielded, but it must be isolated from the antenna circuit, as well.

Design objectives for the receiver about to be described included not only elimination of troublesome radiation, but good sensitivity, ease of tuning, simplicity and low cost, as well as compactness and low current consumption, to permit the receiver to be used for portable or mobile work.¹ This four-tube receiver meets all these requirements. None of our near neighbors (there are several 144-Mc. stations within a

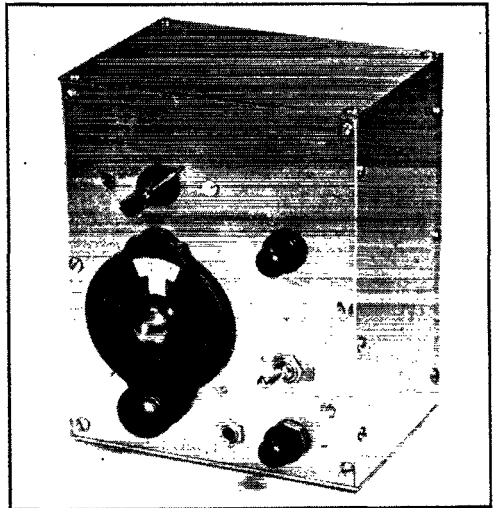

Front view of the 144-Mc. t.r.f. receiver. The pointer knob above the vernier dial tunes the r.f. stage. The small round knobs are for audio volume (lower right) and detector plate voltage variation. Outside dimensions of the handmade case are $7 \times 5\frac{1}{2} \times 4$ inches.

half mile of WHDQ) have been able to hear it, reception of weak signals from points well beyond the horizon is considerably improved, the receiver is essentially single-dial control (important in mobile work), and its low-cost miniature tubes permit compact assembly and low current consumption. Heater current is 625 ma., and the total drain from 135 volts of "B" battery is less than 10 ma.

The circuit is conventional throughout. Only the new-type miniature tubes and the mechanical arrangement employed represent departures from well established practice. The new 6AK5 pentode is used in a tuned r.f. stage, followed by a superregenerative detector employing a 6C4 triode. Two audio stages, using a second 6C4 and a new audio pentode, the 6AK6, supply ample volume for speaker operation at low plate voltages. To make for compactness, the smallest commercially-available components are used. Some shopping around for special parts (there were some splendid miniature components developed during the war) would make possible a somewhat smaller unit than the $7 \times 5\frac{1}{2} \times 4$ -inch design we em-

* V.H.F. Editor.

¹ Credit for most of the novel ideas in mechanical design should go to A. David Middleton, W2OEN, who worked closely with the author in the development of this receiver.

ployed. The chassis is $4 \times 5\frac{1}{4}$ inches in size, with a folded back support which is $1\frac{1}{4}$ inches high. Midget audio components could reduce this area materially, if small size is important.

Taming the 6AK5

The 6AK5 miniature r.f. pentode is rightfully called "the tube of the year." In it we have, for the first time at low cost, a tube which will give a good account of itself in r.f. stages operating at 144 Mc. and higher. But, like all tubes having high-gain capabilities, both the tube and its associated circuits must be well shielded if oscillation is to be avoided. The first r.f. stage in which we used a 6AK5 oscillated violently, despite shielding which had been adequate for a 9001.

To eliminate r.f. oscillation and detector radiation, completely separate compartments were used for the r.f. and detector stages. Identical

boxes $1\frac{1}{8}$ inches square and 3 inches long were made from scrap aluminum and $\frac{1}{4}$ -inch square brass rod. The tube sockets were mounted on the end plates, and all the connections to the socket prongs were made before the boxes were assembled. This made wiring a simple matter, despite the compact assembly.

The only part of either circuit which is not entirely shielded is the lead which runs from the r.f. stage coupling condenser, C_5 , to the detector coil, L_3 , through two small Isolantite feed-through bushings in the walls of the two shield compartments, a total of about one-half inch of unshielded wiring. This connection, the only interconnecting lead except for the power circuits, was made by running separate leads from the condenser and coil through the bushings, and then soldering the two ends together after the units were mounted on the front panel. Inductive

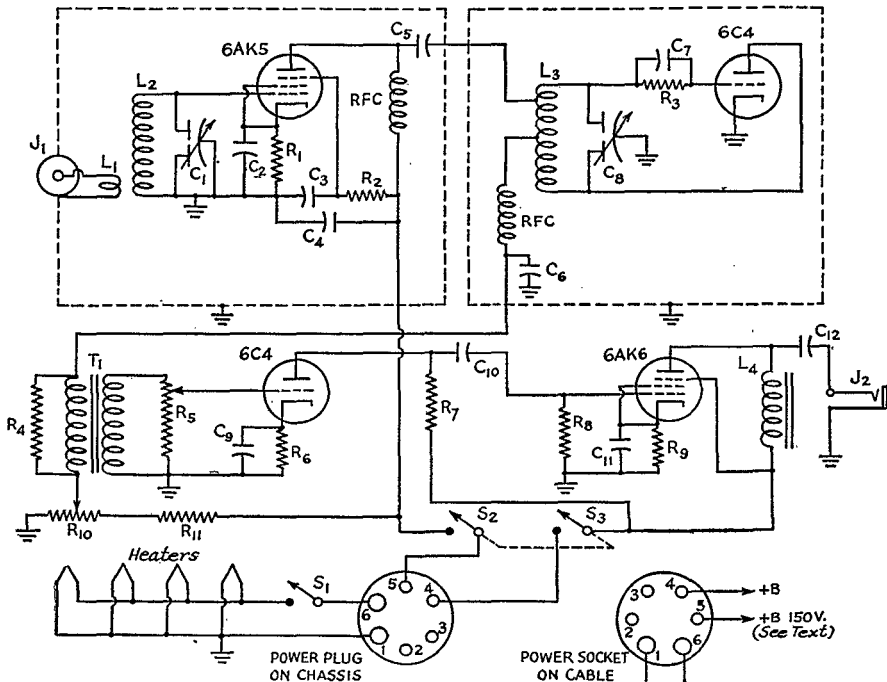

Fig. 1 — Wiring diagram of the four-tube t.r.f. superregenerative receiver. Boundaries of shield compartments housing r.f. and detector stages are shown in dotted lines.

C_1, C_8 — Split-stator condenser (Cardwell Trim-aire).

See text.

C_2, C_3, C_4 — 500- μ fd. midget mica.

C_5, C_7 — 50- μ fd. midget mica.

C_6 — 0.002 μ fd.-midget mica.

C_9, C_{11} — 10- μ fd. 25-volt midget electrolytic.

C_{10}, C_{12} — 0.1- μ fd. paper.

R_1 — 1500 ohms, $\frac{1}{2}$ -watt.

R_2, R_7, R_8 — 100,000 ohms, $\frac{1}{2}$ -watt.

R_3 — 3.3 megohms, $\frac{1}{2}$ -watt.

R_4 — 40,000 ohms, $\frac{1}{2}$ watt. See text.

R_5 — 500,000-ohm potentiometer.

R_6 — 2000 ohms, $\frac{1}{2}$ watt.

R_9 — 600 ohms, $\frac{1}{2}$ watt.

R_{10} — 50,000-ohm potentiometer.

R_{11} — 25,000 ohm, 1 watt.

S_1 — S.p.s.t. switch on R_{10} .

S_2, S_3 — D.p.s.t. toggle switch.

J_1 — Coaxial socket (Jones-S-201). Matching plug for antenna is P-101 or P-201.

J_2 — Headphone or speaker jack.

L_1 — 2 t. $\frac{3}{8}$ -inch i.d. No. 18 enam. inserted between turns of L_2 , at cold end.

L_2 — 4 t. $\frac{3}{8}$ -inch i.d. $\frac{1}{4}$ -inch long, No. 18 tinned.

L_3 — 5 t., center tapped, $\frac{1}{2}$ -inch long, No. 18 tinned.

R.f. coupling tap, 1 t., from grid end.

L_4 — Midget audio or filter choke (Inca D-92).

T_1 — Midget audio transformer.

coupling was considered, but was abandoned because of the mechanical complications involved.

Our original model had the two tuning condensers ganged, but this had several disadvantages. The optimum L/C ratio for each stage could not be used without tracking difficulties, and ganging complicated the shielding and isolation problems. Actually, the setting of the r.f. tuning condenser is not critical, and it may be left near the midpoint of the tuning range for all except the weakest signals. Operation of this receiver is actually much closer to being "single control" than that of the average superregen having an antenna trimmer.

We wanted the highest usable L/C ratio for the r.f. circuit, so the familiar Trim-aire, with its one stator plate cut in half, is used and the coil connected to the two stator terminals. The rotor, also a single plate, is grounded. This type of condenser has the distinct advantage that no moving contact is included in the circuit carrying r.f. Conventional condensers having one stator and one rotor plate were tried, but had to be discarded because of noisy operation.

"Superregenerative Detectors are All Alike!"

Almost everyone has his pet circuit, usually because he happened to hit upon the right combination for that particular hookup. Actually, once the various components are adjusted for maximum performance, one circuit has little to recommend it over another. While this is true, tubes, chokes, and other components vary widely, and variations in parts and their placement can cause surprising variations in performance. The builder of this or any other superregenerative receiver will do well to experiment with different values for the grid leak, R_3 , the quench by-pass, C_6 , the r.f. chokes, and the transformer-loading resistor, R_4 , if optimum performance is to be attained.

The detector tube, a 6C4 miniature triode, was chosen for its ruggedness and low cost, and also because its audio output is considerably higher than could be obtained with a 955 or 9002. It should be pointed out here that the first audio stage could be dispensed with for home use, the two stages having been employed to assure sufficient volume to override car noise in mobile work.

Some trouble was experienced with howling when the detector was operated near the point where it went out of oscillation, but this was cured by using a loading resistor, R_4 , across the audio transformer primary. This resistor may not be needed with some tubes, but when used it should be the *largest* value which will prevent howling. This value varied between 25,000 and 50,000 ohms for several 6C4s tried, and will depend on the characteristics of the audio transformer used.

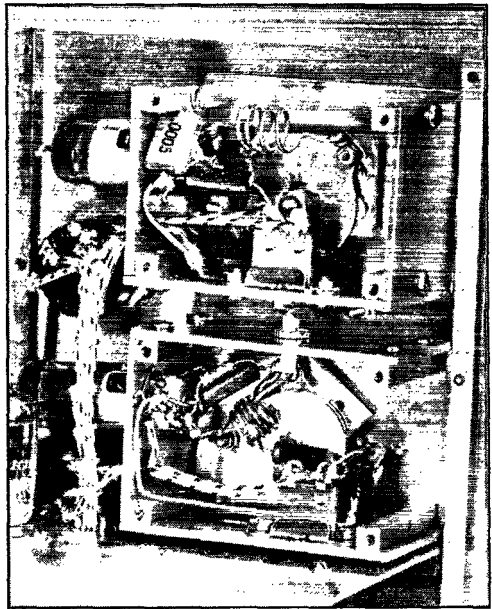

Close-up view of the r.f. and superregenerative detector compartments, with back plates removed to show details. Top, back, and right side may be removed from either assembly, providing accessibility despite compact design.

It is customary to strive for maximum L/C ratio in detector circuits also, but we found that this can cause some trouble with the 6C4. The 9002 and 955 seem to perform smoothly with low-C circuits, but some increase in capacity was necessary to get the 6C4 to tune across the band without variation in degree of superregeneration. The Trim-aire used for detector tuning has one split-stator plate and two normal rotor plates. In addition, a circular rotor plate was used to increase the minimum capacity and bandsread. With this arrangement (see the close-up view of the detector compartment) the 6C4 tunes across more than twice the width of the 144-Mc. band without readjustment of the regeneration control.

Bandsread is a point on which opinions vary. We feel that the twenty divisions (on the usual 100-division vernier dial) obtained with the condenser described above is all that is needed to provide easy tuning of weak signals, and that a relatively narrow spread is desirable for mobile operation. If the builder is of the other school of thought and feels that a dial should be cranked round and round to cover the band, then the spread may be increased by using only one normal rotor plate and the circular disc plate, or it may be increased still more by reducing the spacing between the circular rotor plate and the split stator plate, or by increasing the spacing between the stator and the normal rotor plate. None of these variations will have any effect on

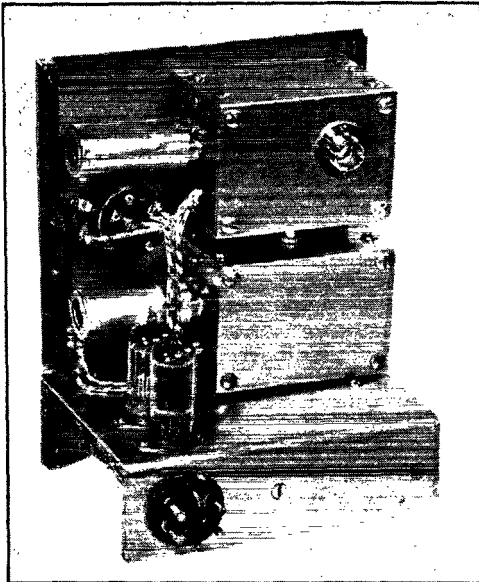

Rear view of the complete receiver. Note that the r.f. stage and superregenerative detector circuit components are in separate completely-enclosed compartments, for elimination of radiation. Miniature tubes are used throughout, for compactness and low current consumption.

the operation of the detector, other than to increase the spread of the band on the dial.

Several commercially-available r.f. chokes were tried and rejected in favor of the handmade variety, which provided smoother operation and were much smaller and more convenient to use. These were wound on IRC 1-watt resistors (the insulated type which is $\frac{1}{4}$ -inch in diameter and $2\frac{1}{32}$ -inch long). The ends were notched with a fine saw, to keep the No. 30 d.s.c. wire from slipping off, and then the wire was close-wound to a length of $1\frac{1}{32}$ of an inch. It is recommended that no lacquer be used to anchor the winding, as this will decrease the effectiveness of the choke by increasing the distributed capacity.

Power Supply is Important

Power supply filtering and regulation are important factors in attaining smooth and efficient performance with superregenerative detectors. The power plug mounted on the back of the chassis (see Fig. 1 and rear-view photograph) provides a separate connection (pin 5)

Bottom view, showing audio component arrangement.

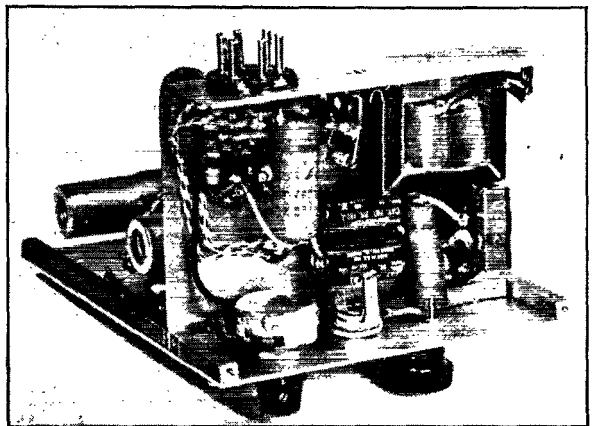

for the detector and r.f. B +, in order that this may be drawn from a regulated source, such as a VR-150. The other pin marked "B +" (pin 4) supplies the audio tubes, and the voltage used here need not be regulated. If "B" batteries are used — and they are highly recommended for mobile operation — pins 4 and 5 may be connected together in the power socket on the cable. The use of "B" batteries in mobile work will result in better sensitivity and more quiet operation than will be available with any sort of mobile power supply, vibrator or dynamotor, and the drain from the car battery will be negligible during receiving periods. A set of medium-size "B" batteries (135 volts is sufficient for good speaker volume) will last through a year or more of normal operation. When batteries are used, the on-off switch, S_2 - S_3 , should be thrown to the "off" position when the receiver is not in use, otherwise there will be a small continuous drain on the batteries through the R_{10} - R_{11} bleeder.

Operation

When the receiver is completely wired the first move should be to check detector operation. With the 6AK5 in its socket, but with no plate or screen voltage applied to it, apply the plate voltage to the detector and check for the customary hiss. Try the regeneration control, R_{10} , to determine whether the detector goes in and out of superregeneration smoothly. Some variation in values of R_3 and R_4 may be necessary to attain this end, and some 6C4s work better than others in this respect.

Next, the tuning range should be checked by means of Lecher wires or an absorption-type wavemeter. With the values given, 144 Mc. should fall at about 80 on the dial, with 148 Mc. at around 60. The position of the r.f. coupling tap on L_3 will have considerable effect on the resonant frequency of the combination. Its position is not critical, except for its effect on the tuning

(Concluded on page 103)

ARRL Band-Warming Party

First Postwar World-wide QSO Contest

February 22-25; March 1-4

REMEMBER the Sweepstakes? . . . and the DX Contest? Could you forget them?! Here is a postwar warm-up party to help you get back into the swing and prepare for things to come. It is a reunion session for all amateurs. Renew your old friendships. Make some new ones.

This Band-Warming Party is just what the name implies. You will note some features taken from the Sweepstakes, some from the DX Contest. It is a free-for-all. Amateurs all over the world are invited to participate. Use voice, or telegraphy, or both, as you choose. Note the extra credit for contacts between 'phone and c.w. All bands open to W and VE amateurs may be used. The opportunity to add states towards WAS awards is one of the attractive aspects.

The contest will be open for 118 hours over two week ends. Get in on the fun during any fifty of the available hours. The first week end includes February 22nd, a holiday for many. Join the gang for the postwar band-warming. See you there. CQ BW DE WIAW.

Contest Dates

Contacts for credit may be made during the following periods. *Total* operating time for both week ends must not exceed *fifty hours*.

FEBRUARY 22-25

Starting: Friday, Feb. 22
7:00 A.M. PST; 8:00 A.M. MST;
9:00 A.M. CST; 10:00 A.M. EST (1500 GCT)
Ending: Sunday, Feb. 24
11:00 P.M. PST; Midnight MST;
1:00 A.M. CST (Feb. 25);
2:00 A.M. EST (Feb. 25)
(0700 GCT Feb. 25)

MARCH 1-4

Starting: Friday, Mar. 1
5:00 P.M. PST; 6:00 P.M. MST;
7:00 P.M. CST; 8:00 P.M. EST.
(0100 GCT Mar. 2)
Ending: Sunday, Mar. 3
11:00 P.M. PST; Midnight MST;
1:00 A.M. CST (Mar. 4);
2:00 A.M. EST (Mar. 4).
(0700 GCT Mar. 4)

How it Works

Any and all frequency bands open to amateurs in the United States and Canada on the contest dates may be used. Contacts may be either 'phone or c.w., and between all amateur stations anywhere in the world.

WHO IS ELIGIBLE: All radio amateurs.

COMPETITION: It is an operator competition.

The highest one-operator score should be submitted in the case of stations having more than one operator.

Results will be reported in *QST*, with leaders in each ARRL Section and each Country indicated.

GENERAL CALL: On c.w. — CQ BW.

On 'phone — Calling any Contest Station.

EXCHANGE OF INFORMATION: Contacts should be numbered consecutively as established. Each station will send the contact number, signal report, and name of ARRL Section in which located. Outside stations shall use the name of country instead of section. Example of information to be exchanged: Nr 73 RST 459 Indiana.

CONTACT CREDITS: Each contact counts two points if the specified information is exchanged and receipted for both ways, or one point if information is receipted for one way only. Double credit is given for contacts *between* 'phone and

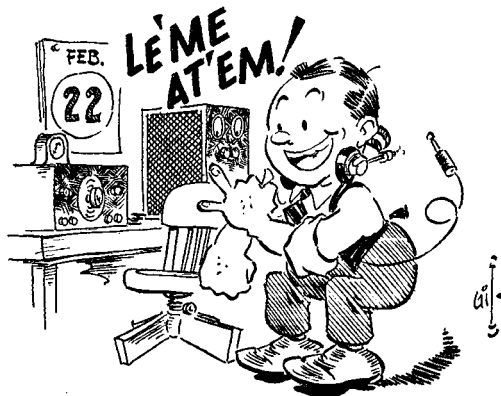

c.w. stations. However, such credit will be given only if contacts are *initially* established while each station is using a different mode of communication.

IF TWO-WAY EXCHANGE OF INFORMATION IS MADE —

Each 'phone to 'phone, or c.w. to c.w. QSO
2 pts.

Each 'phone to c.w., or c.w. to 'phone QSO
4 pts.

IF INFORMATION IS SENT ONE-WAY ONLY —

Each 'phone to 'phone, or c.w. to c.w. QSO
1 pt.

(Concluded on page 112)



25 YEARS AGO THIS MONTH

HEARTS and flowers and cupids and a gal make a Valentine cover for *QST* for February, 1921. There's a radio set too, of course — a CRL regenerator which an ad says is henceforth to be called a "Z-Nith."

Although Lester Spangenberg describes the tube transmitter at 2ZM using four 5-watters with an m.g. supply, the editor in this issue reiterates our belief that the d.c. generator will be outgrown in amateur c.w. work. In the lead article, "I.C.W. from Sixty-Cycle Current," LeRoy Clausing from NRL describes a motor-driven high-voltage reverser that will permit attaining any desired tone frequency. Most of us have progressed from the use of raw a.c. on one tube to the use of two tubes, back-to-back, self-rectifying. Hollis Hoffman and the editor go around and around on this subject in "Communications," the latter showing that a full-wave self-rectifying circuit gives an output much better suited for heterodyne reception than for a non-oscillating detector. The supply modulation is far from 100% and we understand that at Aldene the RCA has reduced modulation to about 30% simply by utilizing the reactive properties of large chokes. However, most of us don't consider such supplies satisfactory for 'phone use. In our first article on "An Electrolytic Rectifier for C.W.," P. J. Furlong, 1FF, our Boston city manager, describes his four-jar arrangement of lead and aluminum strips in a borax solution; "the darned thing works like a charm." The trend to c.w. is sustained by a report of the constants of various "Amplifying Bulbs," particularly the foreign ones, by A. E. Harper.

The spark contingent is upheld by M. B. West, old 8AEZ, with a provocative article on "Some Whys, and Speculations as to Some Possible Wherefores" — an article destined to start the classic furor in amateur circles over the power factor of an oscillating circuit. The world distance records are still held by a spark station: 2RK, Brooklyn, which leads off the station descriptions, has been copied in London, Gibraltar and off Pernambuco, the latter 3600 miles. 2RK has a 4-wire flat top on 75-foot masts, with a United Wireless 30,000-volt coffin, a Grebe synchronous rotary, 4 Navy Leyden-jar condensers and a heavy pancake O.T. 9ZJ, Indianapolis, has been heard over two-thirds of the country using a 24,000-volt transformer with 200-cycle supply,

feeding a 115-foot hexagonal cage antenna supported by two trussed pipe masts 88 feet high. Antennas for spark sets continue to hold the limelight, Boyd Phelps' recent letter on fans having caused a flurry of "Communications" dealing chiefly with the current distribution in the various wires.

Flash! A new transcontinental relaying record of 6½ minutes has been established, Hartford to Los Angeles and return — details next issue. . . . *Everyday Engineering Magazine*, which has been arranging trans-Atlantic sending tests for early February, has unfortunately been obliged to suspend publication. At the request of its radio department editor, M. B. Sleeper, the ARRL Operating Department is taking over the tests and will see them through. We are not particularly optimistic, as "British amateurs have not had the practical experience in shortwave reception that we have benefited by over the past 10 years." . . . Radio Inspector Kolster calls attention to the constant violation of the regulation requiring stations whose transmissions might interfere with the reception of time signals to remain silent during their transmission. . . . *QST* continues its campaign to get amateurs down to the legal maximum wavelength of 200 meters, the editor saying that if a Republican Congress wasn't unwilling to give a Democratic administration enough money to enforce the law, 90% of our stations would find themselves shut down. . . . An unusual receiving hook-up is suggested from Mexico by Julio Prieto, he who is destined to become the president of *LMRE*. Particularly sensitive to continuous waves, it employs an extra lead to the grid from the far end of the antenna, where the potential is highest. . . . Montgomery-Ward break a record with the largest *QST* advertisement yet published — six pages of standard components.

The highly-successful Midwest Division convention at St. Louis in late December is reported by none other than our unknown contributor, The Old Man, in "Rotten S.O.L.," the title meaning that he was sorry for those who couldn't be there. He was. Some fun! During that convention our ARRL Board of Direction had a meeting, "where for the first time our directors from the West and South actually sat in with those from the East and North, and we feel that the better understanding all of us gained by that meeting will do lots in strengthening our organization."



HINTS AND KINKS FOR THE EXPERIMENTER

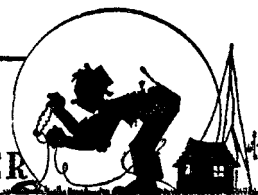

MAKING OUT COLOR CODE ON OLD MICA CONDENSERS

OLD mica condensers on which the color code is faded, scorched, or just plain dirty, will show their original identifying colors if a drop of water is placed on each spot of paint. — *Thomas E. G. Abbott, W5DTJ.*



AUTOMATIC HIGH-LOW RANGE METER SWITCHING

IT is often desirable to cut an amplifier's plate power input to a fraction of its original value. Such may be the case with a 1-kw. rig operating in a local net, in which it is desired to run less than 100 watts. The plate meter, usually 1000 ma. in such a rig, is difficult to read below 100 ma. One could more easily tune to resonance, with no load on the amplifier, using a 100 ma. scale, were it not for the danger of damaging the meter by accidental overloads.

An automatic meter switch can be provided with the addition of a relay and a pair of resistors to the usual 1-ma. meter circuit. The relay, one of a type that operates when 200 or 250 ma. flows through its winding, automatically shifts the meter shunt from high to low as the current increases. The circuit is shown in Fig. 3.

This type of switching does not rely on the

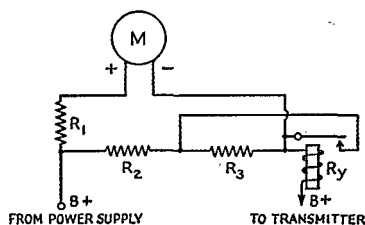

Fig. 1 — Automatic meter switching to read high or low currents. Ry operates when 200 to 250 ma. is drawn through its winding, thus shorting out R₂ and changing the full scale reading from 100 to 1000 ma. when the resistances are used as shown below. The relay winding must pass 1000 ma. maximum current.

- M — 1-milliampere meter.
- R₁ — 1000 ohms, minus the meter resistance.
- R₂ — 1 ohm, 2 watt.
- R₃ — 3 ohm, 5 watt.
- Ry — D.c. relay, designed to operate at 200-250 ma.

human element, and will provide protection for the meter and greatest ease in adjustment of the circuit. Through the use of different values of resistors, other current ratings may be obtained. — *Kenneth M. Miller, W9NQJ.*



A SIMPLE METHOD OF COUPLING BETWEEN V.F.O. AND AMPLIFIER

I HAVE found that the output of my e.c.o. (A Signal Shifter) is sufficient to drive an 807 buffer or doubler without employing a tuned circuit in the grid of the 807 stage, although the e.c.o. unit is on the operating table several feet

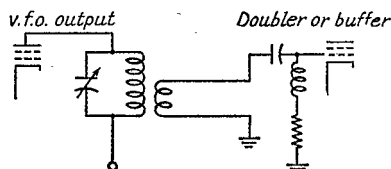

Fig. 2 — Remote coupling method for v.f.o. or exciter.

from the transmitter. The method of connection shown in Fig. 2 is, admittedly, an inefficient way to transfer power; but maximum efficiency is unimportant, so long as the stage receives sufficient drive. The ease with which this 807 is driven indicates that a higher-powered stage, employing an 813 or similar tube, could be operated by the same method. — *John P. Isaacs, W6PZV.*



TWO SOLDERING HINTS

A NEAT gadget for cleaning your soldering iron may be made as follows. Take an old phonograph needle cup, drill two small holes and screw it to the work bench. Pack it rather tightly with steel wool. A twist of the iron in the cup — presto, a nice clean iron. This idea is not original, but it's good. — *Jim Lydon, 165 Church St., Milton, Mass.*



ON THOSE hard-to-solder jobs, where the iron is too small for the job at hand, try pre-heating the metal parts to be soldered with an electric hot plate, toaster, or other source of heat. The iron will not then have to lose so much heat, and the operation can be performed successfully. — *J. C. Nelson, W8FU.*



THE WORLD ABOVE 50 Mc.

CONDUCTED BY E. P. TILTON,* WHHDQ

THE QUESTION is often asked these days "What is to become of the beginners and Class-B licensees who want to work on voice, now that 160 is no more?" Before a thousand voices shout "What's wrong with 10 meters?" in reply, let's look over the characteristics which are desirable in a 'phone band.

First of all, we want reliable local contacts. DX is fine, but the beginner makes progress and the oldtimer keeps his friendships by working locally. We should have a frequency where 'phone may be used with simple equipment, preferably of low cost, so that the small-pocket-book boys will not be too severely handicapped, and a small investment will bring a reasonable return. Our Class-B band should be relatively free from QRM; it should afford at least occasional opportunities for working DX; and it should be in a portion of the spectrum where the use of c.w. pays off sufficiently to encourage the newcomer in at least occasional use of other than voice operation. It should afford a chance to work on voice without causing the operator to become embroiled with his neighbors for miles around. Last, but certainly not least, the ideal Class-B band should be in a frequency range where experimental work is possible, to afford a maximum of incentive to the beginner to build and learn, rather than to encourage the purchase of readymade kilowatt rigs and commercial receivers.

Both 28 and 56 Mc. fill all these requirements, with the possible exception of that referring to local range, at least as well as 160 ever did, and the qualities of the 5-meter band for local work are such that many old hands at v.h.f. work will contend, with some justification, that things can be done on 5 that are impossible on 160.

How Far Can You Work on 5?

We have always felt that the men who regard 56 Mc. as primarily a DX band, and work other frequencies except when 5 is open for sporadic-E skip, are missing a large part of the pleasure and satisfaction which can be derived from working on the band. Many still think of 56 Mc. as a cross-town proposition, and feel that some lower frequency must be used to work beyond the horizon, except when 5 is open. That this is untrue has been proved repeatedly by consistent work over distances beyond 100 miles, in several instances

* V.H.F. Editor.

U.H.F. RECORDS

Two-way Work

- 56 Mc.: W1EYM-W6DNS, July 22, 1933 — 2500 miles.
- 112 Mc.: W1BJE/W3FYB, September 6, 1945 — 355 miles.
- 224 Mc.: W6IOJ/6-W6LFN/6, August 18, 1940 — 135 miles.
- 400 Mc.: W6IOJ/6-W6MYJ/6, September 14, 1941 — 60 miles.
- 5250 Mc.: W2LGF/2-W7FQF/2, December 2, 1945 — 31 miles.

over difficult terrain. The fellow who is situated in flat country should have no trouble in maintaining reliable contacts over a radius of 100 miles in all directions, and work up to 300 miles, and more, is possible more frequently than most people realize. If a definite effort is made to develop interest in local and extended-local work, enthusiasts in any populous area should have no trouble in keeping busy. The writer has been active on 56 Mc. since 1933, and finds it interesting all the time, whether it is the "DX season" or not. The new 50-Mc. band should be even better.

While it is certainly true that reasonably high power and complex gear pay dividends in improved coverage, there is probably no band where the beginner can do as well with a small investment as on 5 or 6 meters. A 100-watt rig for 50 or 56 Mc. need cost no more than the same power on 160, and the receiver problem can be handled with a simple two-tube converter, which, used with even the simplest communications receiver, will give a fine account of itself. Both the present and future bands are 4 megacycles wide, assuring that QRM need never become a limiting factor, causing operators to go to ever higher power in order to override one another.

Of all the bands ever assigned to amateurs, only 10 and 5 have exhibited, at one time or another, every form of wave propagation in the catalog. Five is more responsive to atmospheric conditions than is Ten, and its reaction to sporadic-E has been such as to indicate that a WAS on 6 meters is at least an intriguing possibility. The effect of the aurora borealis on 5-meter signals is like nothing else in all of amateur radio, and other lesser-known phenomena, such as reflections from meteors, are at hand to keep us guessing.

In the experimental field, v.h.f. work holds

vastly more possibilities than all low-frequency bands combined. On 160, when the worker had attained the ideal of a 1-kilowatt rig and a half-wave antenna, he was through, except to go on with the endless battle against QRM. The v.h.f. man seldom reaches the high-power stage; practically all the outstanding work in the history of the 5-meter band was done with less than 400 watts. He is working in a field where his results depend more on his ability and ambition than on the size of his pocketbook.

Why all this propaganda? Well, in a short time we're going to be changing to 6 meters. The new band will have all the desirable characteristics of the old, plus the entrancing possibility of F2-layer DX. Transcontinental and transoceanic contacts are almost certain to be made before we pass the peak of the current sunspot cycle. By next fall, the maximum frequency for F2 work is almost sure to have gone above 50 Mc.; but it won't do anyone any good unless hundreds of amateurs get going on the band in all sections of the country.

Just listening on the band, when conditions look good on 10, will not be enough. Since November 15th, 56 Mc. has been open for both sporadic-E and aurora DX on numerous occasions; yet almost no contacts have been made. Why? Because too many fellows were listening and waiting for someone to break through, before taking the trouble to get on themselves. The fact that sporadic-E skip has been appearing on 10 at the rate of one night in three since November 15th indicates that we are in the midst of the best winter season in the history of modern 5-meter work. Certainly the spring DX season will hit a new high — but there will have to be stations on the band before anyone will know it!

Right now is none too soon to get gear going. Transmitters, receivers, and antennas constructed now for use on 56 Mc. can be converted to 50 Mc. when the change comes, with a minimum of effort. Polishing that equipment off in consistent nightly work over local and extended-local paths will guarantee that its performance will be top-notch when the spring DX season begins to break, sometime in April. Let's get going!

—♦♦♦—

November 28th afforded the first strong short skip on 28 Mc. Signals were heard throughout the East from stations as close as 400 miles, ordinarily an indication that 56 Mc. was open, but to date no 56-Mc. DX has been reported for that night. W4FBH, Decatur, Georgia reports that short skip was heard from all call areas that night, and makes some interesting observations which illustrate the unusually widespread condition. He lists the call areas heard, with the call area each station was working. His list follows: 5-5, 6-5, 7-K7, 9-9, 9-5, 6-4, K6-VE4, 9-6, 6-9, 5-6, 1-8, 1-4, 4-2, 4-3, 2-9, 8-9, VE2-W4, 2-8, 8-3, 8-4, 3-4, 8-8, 4-VE4, VE3-3. All of these stations

were working skip, not working locally. There was a mixture of short and long skip (the "long" was probably multi-hop short skip) until about 10 p.m., with only short skip thereafter. This was still going on when Roy gave up at 1:00 a.m. the following morning. It would seem that, with all this sporadic-E, extending even to K6 and K7, surely 56 Mc. must have been open somewhere, but, alas, no contacts have been reported. Your conductor heard just about every man who has ever worked 5 in the Middle West working on 10 that night, and inquiries brought the information that practically none of them was in a position to get on 5 at that moment. Short skip appeared on 10 for four nights in a row during the last week in November.

Strong short skip appeared again on Dec. 12th and 13th, with a good aurora opening on 56 Mc. on the 13th. The typical aurora flutter was noted on 10 early that evening, and aurora-reflected 56-Mc. sigs, with their characteristic buzz-saw notes, began to come through on 5 at around 7 p.m. Your conductor's nightly 7-p.m. schedule with W8CLS/1 at Waltham, Mass., was completed by the use of a c.w., following which both of us worked W3HDJ, Delanco, N. J., on c.w. Numerous c.w. CQs by all parties concerned netted no other DX contacts, as far as is known; yet here was a condition which would have brought in everything from Maine to North Carolina — if there had been any activity in the right places!

On December 15th, W9ZHB, Zearing, Ill., heard numerous harmonics of 10-meter W4s and W5s on 56 Mc., but was unsuccessful in raising anyone, until he finally talked W5HHT, New Orleans, La., into doubling in his final, and a 56-Mc. QSO resulted. On the night of December 18th, short skip broke out with extreme strength on 28 Mc. almost immediately after the band went dead for normal skip. Signals from as close as Virginia and Western Pennsylvania were pounding into West Hartford, giving convincing evidence that 56 Mc., too, must be open. Numerous calls on 5 netted no results until 8:05, when W9ZHB broke through with a 5-meter signal over S-9 for more than a half hour. Surely this was as good a chance for 5-meter DX as the average May opening, yet 5 was practically unoccupied, and that one QSO was all we were able to do!

New Record for 112 Mc.

Because of the haywire nature of our early work on 112 Mc., we felt that there might have been some choice DX worked during September and October which never came to our attention. This suspicion was well founded, for word has been received, belatedly, that a new world's record for 112 Mc. was set on September 6th, when W1BJE, Westport Harbor, Mass., worked W3FYB, Greenbelt, Maryland, at 1:25 a.m. The exact distance involved has not been determined accurately at

Loran—the Latest in Navigational Aids

Part III—Navigators' Equipment and Summary

BY ALEXANDER A. MCKENZIE,* WIBPI

THE FIRST two parts of the article have summed up the elements of a Loran system and described the ground station (timing and transmitting) equipment as a series of black boxes connected in proper fashion. The navigator's receiver-indicator is a sort of miniature timer, and has, indeed, been so used in certain special applications of Loran. Although it is electronically complex it can be operated easily by the navigator after a few hours' practice. Tables or charts which interpret Loran information as received on the indicator in terms of latitude and longitude or in relation to terrain are the only additional equipment necessary. In future years, we may even expect Loran coordinates to supplement latitude and longitude in the identification of position.

Two general types of receiver-indicator equipment have been used during the war. The ship-borne type weighs over a hundred pounds and operates on 115 volts, 60 cycles, consuming about 300 watts. The air-borne equipment is divided into two units: the receiver and power supply, which can be mounted in an out-of-the-way corner with only its front panel showing, and the indicator unit, which must be more accessible to the navigator. The total weight usually runs to about 75 pounds. Aircraft equipments usually may be operated on either 80 or 115 volts from 400 to 2400 cycles at a power consumption of about 250 watts.

The presentation of the Loran information on the indicator scope is somewhat similar to that in the timer (see Part II) except that the navigator has no manual control over the time interval between the arrival of pairs of signals. That time interval tells his position. These are pulsed sig-

nals, arriving so fast and being so accurately spaced that they recur as pips, vertical lines, standing still or moving at uniform rates across the traces of the cathode ray 'scope.

Fig. 14 illustrates a sequence of 'scope presentations which would enable a navigator to ascertain a line of position. The first (a) shows a single pair of signals. The pair has first been selected by means of a numbered rate switch which in one of its positions makes them stand still. Any slight drift is stopped by correcting the indicator crystal oscillator. The Master signal has been set upon the upper pedestal in accordance with a simple operating rule. The Slave signal sits where

it will on the lower trace. Their amplitudes have been adjusted by the receiver gain control to a convenient value for the weaker signal and a discriminating amplitude-balance control has attenuated the stronger signal until it matches the weaker. The manual delay controls move the lower pedestal underneath the Slave signal, as indicated by the dotted lines in Fig. 14(A) so

that the pip stands in the same relation to the pedestal as the Master signal does to its pedestal. This gives a first approximation of the delay between the Master and Slave signals. As the sweep speed is increased in two steps, the pips widen out into pulses. This constitutes an electronic magnification of the left side of the pedestals. Fig. 14(C) shows the traces collapsed by means of the trace

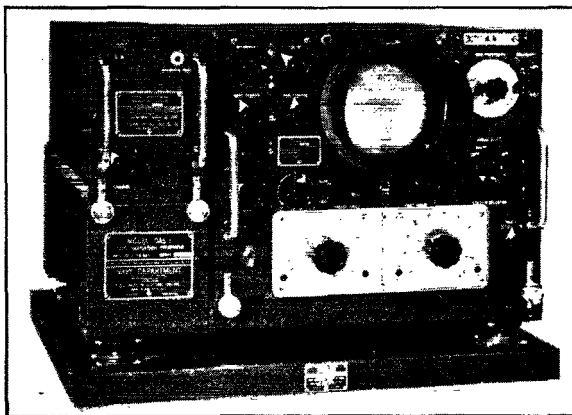

Shipboard-type Loran Receiver-Indicator

• In this concluding part of the description of Loran, the author discusses the receiving equipment and describes the method by which measurements are made. Part I, covering the system generally, appeared in December, 1945, *QST*, and Part II, describing the transmitting equipment, in *QST* for January, 1946.

*Radiation Laboratory, Massachusetts Institute of Technology, Cambridge, Mass. This paper is based on work done for the Office of Scientific Research and Development under contract OEMsr-262.

separation circuit to a single line and the pulses nearly coincident. Their shape depends principally upon the proper adjustment of the transmitters, but size and leading edge must be matched exactly by the navigator to insure greatest accuracy. The matching is accomplished by manipulation of gain and amplitude balance as well as the same delay controls which moved the lower pedestal under the Slave signal.

Measuring Delay

Let us switch back to the slowest sweep and determine the delay. We will use Figs. 14(A), (B), and (D) to demonstrate how the delay between arrival of Master and Slave signals may be measured to a microsecond. Ordinarily, at this point, the navigator cuts off the receiver lead to the 'scope so as to avoid distraction. Only the 500-microsecond markers are clearly visible on the traces, pointing downward, each fifth one somewhat shortened to aid in the identification. Usually the Master pedestal has been adjusted so that its left edge occurs at the second visible 500-microsecond marker. Counting markers to the right we find that we have moved the lower pedestal so that there is an approximate reading of $4000 \pm$ microseconds delay between the Master and Slave signals.

A medium-fast sweep is now switched on. Fig. 14(B) shows the 50-microsecond markers as the predominant ones, pointing down. The 10s are pointing up. (The 500s are displaced slightly to the right of the 50s.) Starting with a convenient 500-microsecond marker on the lower trace, we count off to the right by 50s until we reach the intersection of the first upper trace 500-microsecond marker with the lower line. In the illustration, this seems to be close to 150 microseconds. Adding this second approximation to the first we come out with a total of $4150 \pm$ microseconds delay between the Master and Slave signals.

The last step is to switch on the fastest sweep which makes the 10-microsecond markers apparent as bumps above the trace line, as in Fig. 14(D).

Using the same counting technique, we determine the delay in 10s between a pair of adjacent 50s (from left to right). In the example the delay is a little less than ten microseconds which we estimate as 9, making a total delay of 4159 microseconds. With a little practice it is easy to interpolate accurately. That the identification and matching of signals in actual navigation is not quite so simple will be apparent from a glance at the photograph, Fig. 15. It shows a typical night presentation at a point nearly equidistant from a pair of stations. The signals from left to right, on both traces, show ground wave, nighttime *E* reflection and second-hop nighttime *E* at about 700 nautical miles over water.

The Receiver-Indicator System

Besides describing the Loran receiver-indicator from the navigator's point of view, the information above should help in understanding why the equipment is required to function in the manner illustrated by the block diagram, Fig. 16.

As in the timer, a quartz crystal serves as the primary frequency-determining device. In the indicator, however, it is not necessary for the crystal to hold exact frequency for more than a fraction of a minute. A crystal phasing control can be adjusted from minute to minute so that the pulses stand reasonably still until the proper delays are set, after which the pulses are turned off anyway.

The output of the squaring amplifier is approximately a square wave at the crystal frequency of 100,000 cycles per second. The period of the square wave is exactly 10 microseconds.

The output of the first counter is so arranged that one output pulse is obtained for each group of five input cycles. The counter has an output frequency of 20,000 pulses per second and the time separation between output pulses is therefore 50 microseconds.

Output frequency of the second counter, without feedback, is a tenth of its input frequency, or 2000 pulses per second; time spacing, 500 microseconds.

Loran receiver-indicator equipment for airborne use is in two units. The unit at the left contains the receiver and power supply and may be installed in any convenient spot. The indicator at the right is installed at the navigator's position.

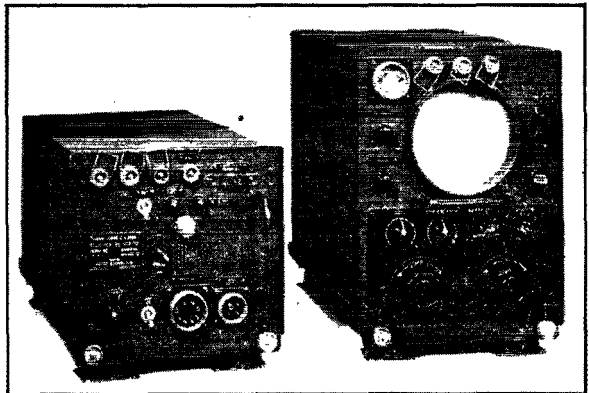

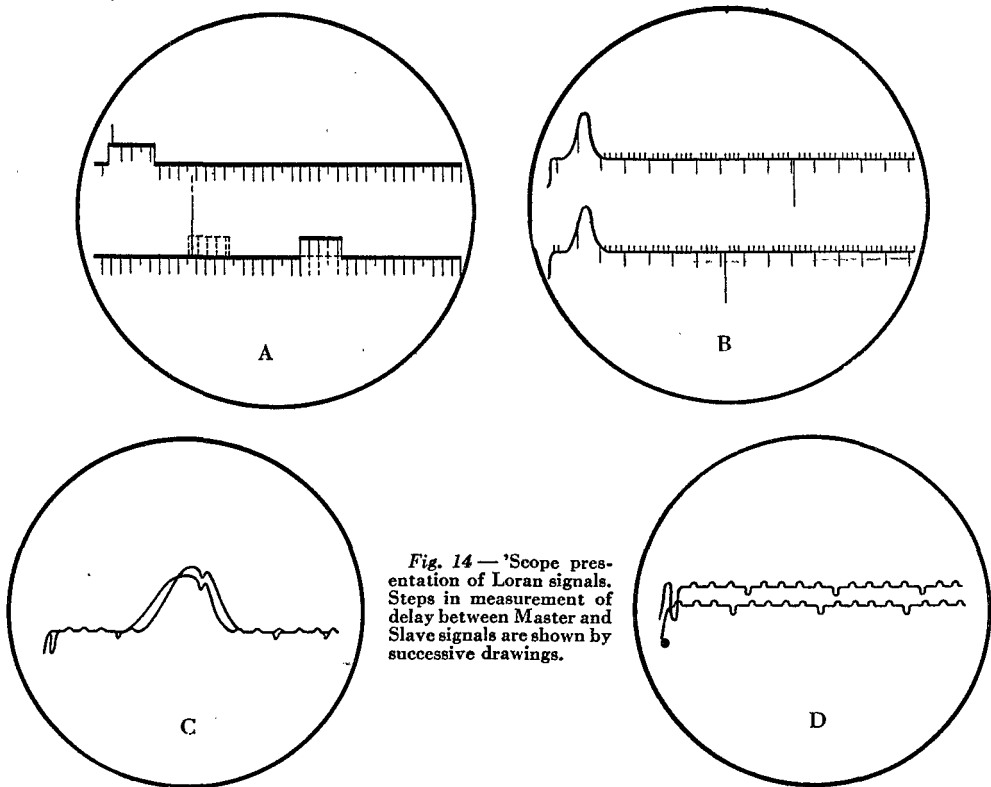

Fig. 14—'Scope presentation of Loran signals. Steps in measurement of delay between Master and Slave signals are shown by successive drawings.

The third and fourth counters, dividing by five and eight, have output pulses with time separations of 2500 and 20,000 microseconds, respectively.

It will be observed that one output pulse from the counter chain requires 400 output pulses from Counter No. 1. The feedback circuit provides a method by which the number of output pulses from Counter No. 1 required to produce one output pulse from the No. 4 counter is reduced in seven steps from 400 to 393. This corresponds to approximate pulse rates of 25 to $25 \frac{7}{8}$ pulses per second at the indicator scope, owing to the dividing action of the square-wave generator.

The slow-sweep generator provides a sawtooth voltage which is synchronous with the received pulses.

Output from the fourth counter trips an Eccles-Jordan circuit which provides a symmetrical square-wave output at a frequency one half that of the counter. When applied to the vertical plates of the oscilloscope this output appears as two horizontal lines, one exactly above the other and each of the same length.

The positions of the pedestals which are superimposed upon each of the horizontal lines are determined by delay circuits called "A" and "B" Delay Multivibrators. Both of these circuits are

actuated by input pulses from the square-wave generator. The A and B1 pedestals move in jumps, the delay circuits being locked at 500-microsecond markers. The B2 delay circuit differs from the B1 in that it is equipped with a continuously-variable control.

The intensifier circuit insures a strong 'scope signal only at the moment of interest and acts to discriminate against noise and other interference.

The paraphrase amplifier allows more effective presentation of signals on the horizontal plates of the 'scope.

The amplitude-balance control, which gives in-

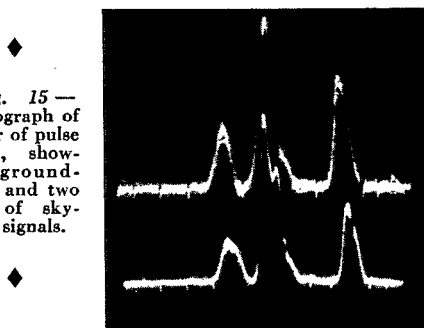

Fig. 15—Photograph of a pair of pulse trains, showing ground-wave and two sets of sky-wave signals.

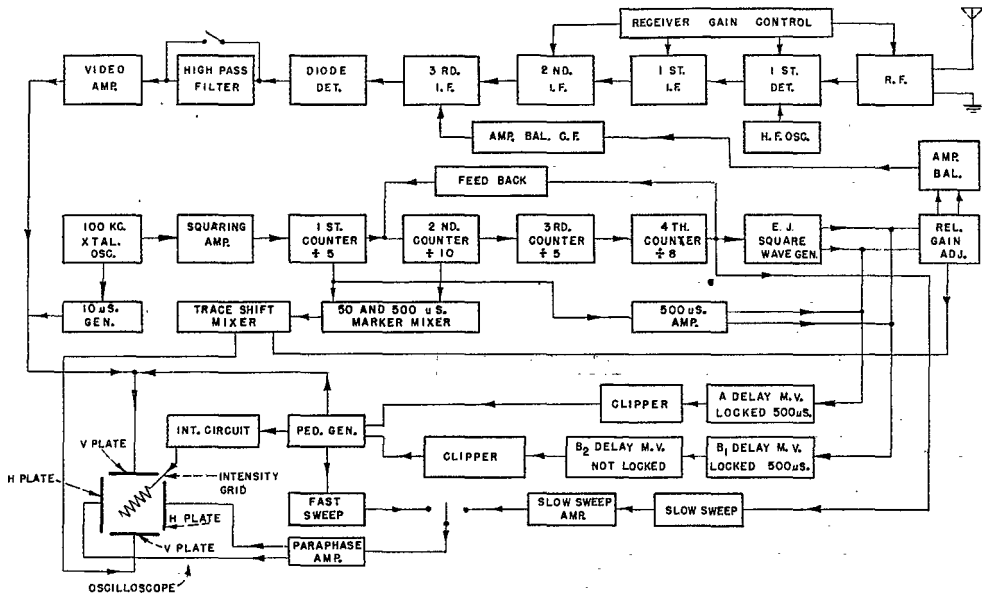

Fig. 16 — Block diagram of the Loran receiver and indicator

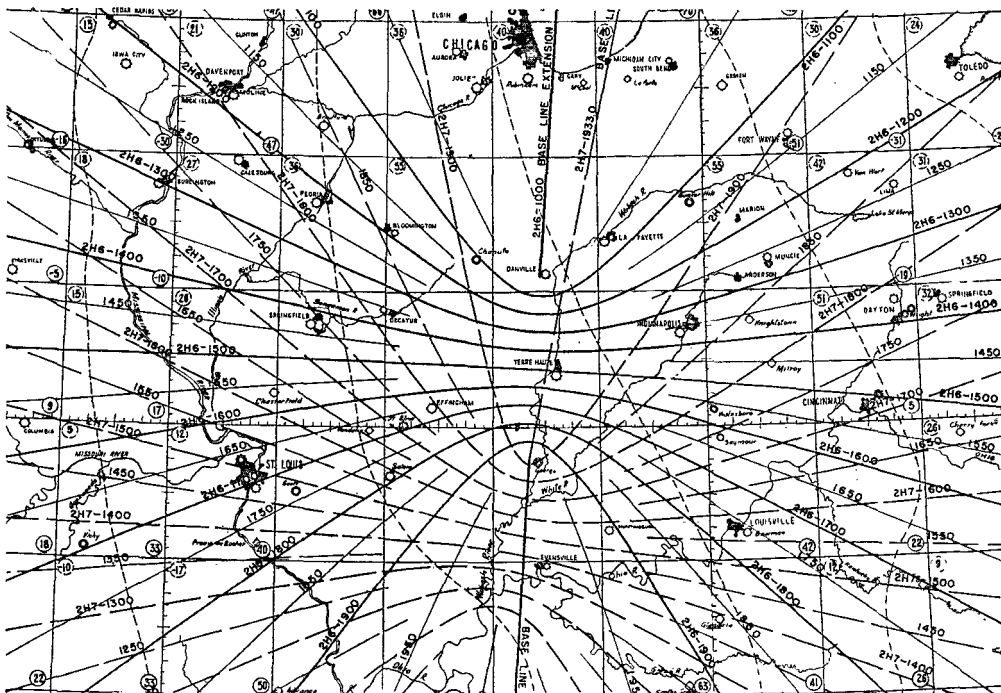
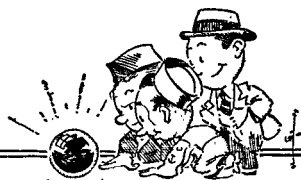

Fig. 17—Typical navigators' chart. The Loran coordinates, determined from the receiver-indicator, are used in much the same fashion as geographical latitude and longitude lines.

(Continued on page 134)

THE CRYSTAL BALL



CONDUCTED BY A. DAVID MIDDLETON,* W2OEN

SEVERAL winning entries in the Crystal Ball were contributed by LSPHs, OPLOs and some by "would-be" amateurs. Realizing that there will be a large number of newly-hatched amateurs as soon as licensing is resumed, we feel that it is high time this Department lent a hand in the design and construction-planning of their first, and maybe their most important, gear and station.

We therefore suggest that some of you expert crystal ball gazers dream up the "ideal beginner's rig" based on your own past experience, the availability and cost of parts, the ease of construction (by a beginner) and the overall usage by a new amateur. Here's your chance, OT, to help the new feller get started on the right track. Will you lend a hand?

ON OR OFF?

FROM the articles printed in the Crystal Ball it is evident that most of the brethren have their mental machinery running at prewar speeds. Don't they realize that we have entered upon a new era of rockets, A-bombs, robots, and fungicides? Why hack around with these pitiful pseudo-modern ideas for the new Ham Station? Here is a plan for a rig combining simplicity and ease of operation.

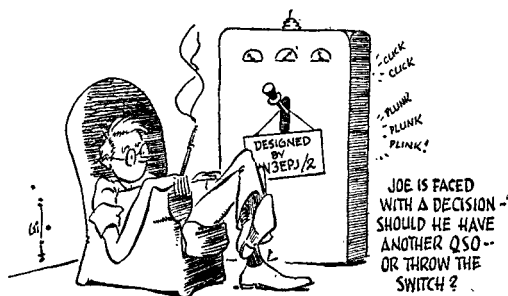

First, let us examine the fundamental requirements of an ideal amateur station. The primary question confronting the average ham is: does he want his station *on*, or does he want it *off*? Reference to the literature will confirm that an "on-off" switch is the most practical solution to this problem. Having established this component as a prerequisite, let us delve into the less-interesting sub-assemblies to be tied into the

*Department Editor.

on-off switch. The best way to cover this is to describe the sequence of operations occurring when this switch is thrown from the "off" to the "on" positions.

Joe Blow strolls into his shack, turns on the aforementioned switch, lights a cigarette, and starts reading the latest copy of *Esquire*. Rotating beam antennas on all amateur bands start scanning the horizon, feeding in signals to appropriate receivers, which are scanning the bands in frequency, looking for a CQ. Let us suppose that the receiver system on band A finds a CQ first. The audio signal, having passed through the CQ-pass filters, operates relays which de-energize the other receivers, switch off the scanning function of antenna A, and automatically points the beam at the originating transmitter by means of an appropriate servo system. Simultaneously, Joe's own transmitter is automatically tuned to the frequency of the incoming signal, and held in readiness to transmit. As soon as the received signal stops, the transmitter sends out a call automatically prepared on a magnetic wire recorder from the call sent by the other station and including Joe's call.

Whenever the other station breaks in, Joe's transmitter stands by and his receiving system comes into its own. Basically, the signal is fed into three channels, the Log Channel, the QSL Channel, and the Miscellaneous Channel. The Log Channel uses information contained in the signal relating to the signal strength and the time the QSO started, and prints it on the Log Sheet. The QSL Channel, in a similar manner, prints part of the QSL card. The Miscellaneous Channel accumulates the non-essential information passed out by the other station and feeds it into the waste basket. It also performs the very essential function of taking the signal report given, running it through a computer coordinating distance, number of previous QSO's, and blood pressure of Brother Joe in calculating a weighting formula to be applied to the otherwise accurate RST report to be given back to the distant station.

When the victim stands by, Joe's station automatically goes to the transmit position, sends out "Good Morning," "Good Evening," or "Good Afternoon," as determined by a suitably-connected clock, transmits the other fellow's RST report complete with fudge factor, gives the weather as measured by a barometer and thermometer on the roof, states the QTH (not

a variable, making this part simpler), adds 73 and signs.

After the other station signs, the Log and QSL machines finish printing their respective cards. When this is complete and the QSL card has been automatically shot out to the nearest mail box, the second-hand air raid siren is energized to distract OM Blow from his *Esquire*. He is then faced with a decision. Should he let things take their course and have another QSO, or should he throw the switch to "off" and delve further into the printed pulchritude?

— Carl C. Stotz, W3EPJ/2

PUSH-BUTTON COMMUNICATIONS RECEIVERS

THIS rag-chewer will wait just about so long for the manufacturers to dream up a push-button communications receiver; then he is going to invent one himself and collect the royalties.

Here's how it should work: the op holds down a button while tuning in a station; thereafter, pushing the same button will instantly swing the bandspread back to the selected spot. I'd want to be able to change that setting instantly. No soldering irons, pliers or screwdrivers, please. I'd like three or four push buttons for those three-way rag-chews, with an extra one for our own frequency for monitoring purposes.

— Elliott R. Weyer, W2LLZ, ex-W8ALW

SAFETY IN THE HAM SHACK

MANY OF the postwar hams will have had little or no experience in handling high voltages. Unless they are safety-minded, there will be frequent cases of injuries and deaths due to electrical shock from either high or low voltages.

It's only 115 volts!

Most of us consider the common 115-volt, 60-cycle line harmless. However, under certain conditions it is *lethal!* For example; let's take the case of C. Q. Long. His station is down in the cellar and the floor is concrete and sometimes quite damp. C.Q. has just been out in a rainstorm so his shoes are wet. He has a sked, throws the main switch but "no soap." He decides to check his fuses. He touches his thumb and index finger

of one hand across one of the fuses to see if it's open. No shock felt so he touches the other side of the line fuse. The concrete floor is wet. C.Q. receives a hunk of juice and slumps to the floor. Nobody is around to give him first aid — so that's the end of C. Q. Long.

Moral — For ham shacks in cellars, build an insulated wooden platform to keep your feet off the floor. And buy a fuse tester!

Aw! What's a little cut?

Most of us get cuts or scratches while drilling, filing or sawing on panels or chassis. Many times we let these small injuries go untended and continue with our work. Who wants to take time out to clean and bandage a minor cut? Nine out of ten times we get away with it! But, any one of us might be the exception and lose a finger, hand, or even an arm, due to infection!

Moral — Keep a small first aid kit right at the work bench.

Tools

Most modern radio plants insist on having tools in good condition. Dull tools and tools with sharp unprotected edges are invitations to injury. Make sure that hammer head won't fly off the handle! Dress up that rounded screw driver blade. Anchor that chassis when drilling with an electric drill; it's liable to turn if the drill sticks.

Moral — Good tools deserve good care and a little care saves accidents.

Use your legs, not your back!

There are quite a few heavy units in a medium or high-powered ham shack. Be careful about lifting power packs or transmitters. Ruptures are expensive and crippling. Avoid them by learning how to lift (using strong leg muscles) and by getting help in lifting or moving those extra heavy units around. Be especially careful when lifting components off a bench or table. Lift it up off the surface first, don't slide it off the edge. The sudden load may get the best of you and it'll fall on your toes, causing painful and costly broken bones.

Moral — Don't be afraid to ask assistance in lifting a heavy chassis or component. It's better to get aid than to suffer from a rupture or a badly sprained back.

FEBRUARY PRIZE WINNERS

• Contributors to the Crystal Ball Department are awarded monthly prizes consisting of a \$25 Victory Bond as first prize, \$10 in Victory Stamps as second prize, and \$5 in Victory Stamps as third prize. One dollar in Victory Stamps is awarded the writer of each additional published letter not receiving a major prize.

The most interesting letters are selected by two members of the Headquarters staff, the conductor of this department and a "guest judge." This month's winners, chosen by E. P. Tilton, WIHQ, (V. H. F. Editor) and W2OEN are: Carl C. Stotz, W3EPJ/2, first prize; Pfc. Stanley W. Jeffcoat, W5KPY, second prize; C. D. Justis, WIJVS, third prize; Elliott R. Weyer, W2LLZ; T/Sgt. Glen W. Smith, W3JOP; and Jack C. Nelson, W8FU.

Don't mix drinks and high voltage!

Sure, it's fun to go out with the gang, but don't fool around the high voltage when you feel woozy from those ten beers or that hard liquor! That's one time when you need your wits about you! Some say that a drunk never gets hurt in a car smash, for he is always relaxed. Well, high voltage doesn't know that! Relaxed or tense, the shock may kill you just as dead!

Moral — When you've had a bit too much, keep away from the ham shack.

Hot stuff, radio!

Keep drapes and curtains away from the rig. A wire might get too hot (unless you fuse properly) and burst into flames. Rubber insulation burns very easily and the drapes or curtains near the rig might catch fire, and burn down your shack.

Use ceramic sockets for rectifiers with more than 400 volts per plate.

Use wiring heavy enough to handle the full current you expect to use. Some 115-volt line cords get too hot to touch. If necessary use two cords in parallel.

Use an approved line switch and fuse box (with the correct size fuses) in the 115-volt line that feeds all of your ham equipment. When you leave the shack remember to turn it off. Then, if the children get into the shack while you are away, they will not be able to get mixed up in any juice.

The Safety A B C (Always Be Careful)

You can have just as much fun hamming with safety as any other way, and you will live longer — and happier! Switch to safety!

— Jack C. Nelson, W8FU/WMEA

REMOTE CONTROL UTILIZING THE V.H.F.

MY POSTWAR station will incorporate v.h.f. mobile control of my high-power, medium-frequency fixed station transmitter.

Such an arrangement is relatively simple and will be an incentive to v.h.f. experimentation in rural areas and small towns where the lack of other stations often places a handicap on the v.h.f. man. With v.h.f. control I can carry on QSOs on 7 or 14 Mc. from a moving car, any time and any place within range of the control transmitter.

The fixed transmitter in my shack will be controlled and modulated through a low-powered f.m. v.h.f. transmitter in the car. Control functions are accomplished by the use of one-tube R-C audio oscillators at the v.h.f. transmitter and band-pass filters (tuned to these different audio tones) at the station end. The outputs of these filters then operate vacuum-tube relays which in turn operate the filament "on-off" switch and apply the proper voltages to the

MOBILE INSTALLATION

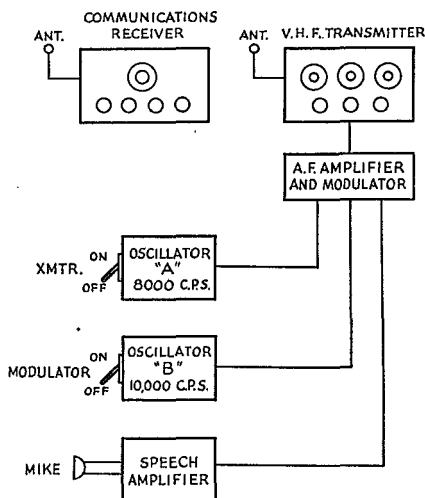

FIXED INSTALLATION

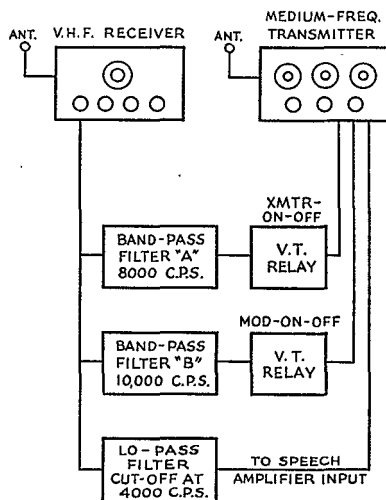

Fig. 1 — Block diagram of W5KPY's proposed v.h.f. remote control of his fixed station equipment from his automobile.

transmitter and modulator. Voice modulation is fed through a low-pass filter which cuts off above 4000 c.p.s.

Two-way operation on the medium frequencies is carried on in the car using a mobile-type communications receiver. C.w. operation could be available with slightly more complication but only voice will be used at first.

Control systems embodying such arrangements

(Continued on page 188)



CORRESPONDENCE FROM MEMBERS

The Publishers of *QST* assume no responsibility for statements made herein by correspondents.

STABILITY ON 2 METERS

3030 W. Garland Ave., Spokane, Wash.

Editor, *QST*:

Have just received my November issue of *QST* and the v.h.f. editorial policy makes me boil — pushing “rush boxes” and modulated oscillators! At least that’s the first postwar v.h.f. construction subject. The “rush box” may be dolled up as a superhet, but it belongs with the model T Ford.

I still work for the AAF and can’t tell the war story of v.h.f., but you can. You and I both know how it practically won the battle of Britain in the fighter-control systems, how our bombers and fighters were brought back to bases in all parts of the world by v.h.f. direction finding. Homing over 300 miles was a regular thing. The important point is, the equipment was simple but stable.

A 144–148 Mc. xmttr with xtal control is no more complicated than a 28 Mc. xtal rig; take the r.f. section of the SCR 522 for example (less rapid frequency change). A 144–148 Mc. receiver with 2 microvolt sensitivity is no more complicated than a Sky Buddy; for example, the BC-639. For gosh sakes, get your v.h.f. policy out of the horse and buggy age!

I personally am equipped to do some 144–148 and higher work, but I can’t do it alone. I must have someone to work. The gang around Spokane have all given up v.h.f. because of the limitations of transceivers, etc. I blame a lot of this on *QST*. Let’s not see any more modulated oscillators and rush boxes for 144–148.

— Wes Bell, W9FEG/7, ex-W7QB

C.I.S.T.

3523 Fincastle Rd., Louisville, Ky.

Editor, *QST*:

In catching up on back copies of *QST* after returning from Europe, I found a short article in the July, 1944, issue (page 62) dealing with a signal school operated in cooperation with the French army. “Now it can be told,” and having been connected with this school, I thought you might be interested in the rest of the story.

This school was called “C.I.S.T.,” *Centre d’Instruction des Specialistes des Transmissions*, and was intended to train French personnel to become instructors in maintenance of American signal equipment, radio, teletype, and field telephones. All except two of the staff were hams, including myself, W5FJQ, CN8MF, FA3XA, and FA8JK.

Originally divided between the barracks of a French signal company and space provided in the factory of the *Companie General de Radio*, after a short time the school moved to a remodeled stable previously used by a unit of Algerian cavalry, and where really excellent facilities had been built. Altogether this school was operated under American supervision for about four months, after which CN8MF took over the direction of the school from me.

— R. E. Jeffrey, W9ZDH, ex-W8GDC

NOTES FROM VK

P. O. Box 60, Toowoomba, Queensland

Editor, *QST*:

... Have been making a few reccos in the 21-Mc. spectrum of late and was elated to hear a G and LD commercial in that vicinity a few evenings ago around the time we used to work the Europeans on ten when that band was open about 1938 — so —!

Other interesting observations I have noticed are that we here in VK are to have gear comparable with the Ws after this — plenty of meters (which were always hard to get) and oodles of toobs in the medium-power category (807s, etc.) — also high-power resistors (they were a most difficult item prewar, practically unobtainable). Radio gear (except b.c. sets) are all released from control; we can now buy tubes, resistors, condensers fixed and variable and other gadgets which have made our mouths water for the last six years — and that’s a long time!

Best of all good wishes to all the fine gang at ARRL who have held the fort and fought and fought. By the way, I’ve just run across a copy of “Course in Radio Fundamentals” — it’s fine and VK4LZ and I are intending to work through the course thoroughly as we believe there are things in it we have been missing for a long time. The various experiments, we believe, will brush us up on things we’ve forgotten (or maybe never learned). Heck, it takes a bit of keeping up to, this radio game — especially where our livelihood more or less depends on what we know — or how much more we know than the other guy. LZ and I have been motion picture projectionists together for 10 years and before that he had 9 years of projection and I was engineer at the local b.c. station (4GR) holding both commercial and ham tickets since 1925. There’s more money in projection — especially if you can get the job as manager (thatsa me) — but there’s still more fun in ham radio than any other pastime.

— Cliff H. Gold, VK4CG

REPORT FROM SV

(EDITOR’S NOTE: The following excerpts from a letter to W3ASG are reprinted with his permission.)

17a Bucharest St., Athens, Greece

Dear OM:

It was quite an unexpected and pleasant thrill to hear from you today after all these years of grim silence. Thank you ever so much for remembering me. In fact yours is the first letter that I have received from a W ham, but then you are more than that to me. . . .

I just about managed to navigate through all these years of turmoil. The period of the Albanian war found me very busy building a 1 kw. broadcast rig for our Government. It certainly was a very interesting job while it lasted. . . . However, after six months we were invaded by the “master-race” and all activities in this direction came abruptly to an end. I was privileged to be visited by members of that famous band of cut-throats by the name of Gestapo both at home and at my business premises searching in vain for hidden transmitters and similar equipment and parts. Their efforts, however, were wasted as any equipment or parts of an incriminating nature were well away from both places. Unfortunately, several days later another party of organized looters came along and confiscated my HRO. You can well imagine how I felt at the time and more so now.

Then followed the period of starvation and systematic humiliation. I shall spare you the details because although it looks to me now as a bad nightmare, when I think of the incidents it makes me shudder even now. What you must have read in your newspapers was certainly not exaggerated. I wish I could be with you to relate all the miseries (to put it mildly) of German occupation.

After we were liberated we had a very unfortunate revolution during which many Greeks were killed or put to death by starvation or torture by communists apparently instigated by Bulgaria and Germany. A lot of houses and other buildings were intentionally destroyed by demolition,

blowing-up, fire, etc. My wife and I twice escaped death by miracle from mortar-shells. . . .

Business is very slack at the moment. Generally speaking our country, just like any other liberated nation, is going through a transitory period which is certainly the hardest one. Everything is wrong and everything must be put right, and it all takes time, patience and above all a cool head. Ordinarily mail takes about 1½ months to reach us from U.S.A. and I presume it takes the same time in the opposite direction. I have already written to some fifty American firms but have received a reply only from a few. I guess I shall be hearing from the others sooner or later. They are all very eager to cooperate but the financial conditions prevailing in our country for the time being do not allow direct business transactions with the U.S.A. . . .

One thing we are definitely short of here are radio magazines and books. I am just wondering if you have any old copies that you could spare of *QST*, *Radio*, *Electronics*, *Radio News*, etc. If so and if it is not going to put you into too big an expense perhaps you could send from time to time an old copy. I would have never thought of bothering you if it weren't for the fact that we have been cut off from the civilized world for such a long time, and moreover I know you won't think the worse of me for my asking. . . .

Best regards and good wishes.

— Bill Tavanotis, SV1KE

THE NAVY ISSUE

Office of the Chief of Naval Operations,
Washington, D. C.

Editor, *QST*:

. . . I was very interested in seeing the Navy article in the October issue. It certainly covered a lot of territory.

— Commodore J. V. Murphy, W3FN

U. S. Navy Underwater Sound Laboratory,
Fort Trumbull, New London, Conn.

Editor, *QST*:

I would like to forward to you my personal congratulations on your October issue of *QST*. It is an issue of which both the League and the Navy should be justly proud.

— Comdr. J. B. Knight, jr., W2JJ

Electronics Office, Navy Yard, Boston

Editor, *QST*:

Congratulations on the superb story of Navy Electronics organization. . . . During the critical anti-submarine warfare days in 1941-1943 when communications and electronics repair bases were being established and fitted out with whatever equipment one could requisition, beg, borrow or otherwise acquire, the most effective technicians and electronics officers of all rates and ranks were amateurs. . . .

— Comdr. W. D. Hudgins, W6CIW

USS *Sibley* APA 206, Div. N, c/o F.P.O.
San Francisco

Editor, *QST*:

. . . Probably by now you have heard from a couple hundred RTs about it (Editor's note: we have!), but in case some of the boys were too busy getting back on the air to write, maybe I'm in time to make a few corrections. Here goes:

The rig pictured on page 22 is not a TBK, but a TBL. On page 24 the rig in the background of the lower picture is not a 500-watt multichannel job, but a 125-watt TDE (also shown at the top of the page). The second paragraph of page 25 claims the TAJ-S to be a light-weight, compact rig; one of those babies weighs around a half ton, and is not very compact; the frequency range, incidentally, is 125 to 600 kc. The last paragraph on the same page identifies the RBK as an S-27D; the RBK we have aboard is a Hallcrafters S-36 v.h.f. receiver which really pulls them in, no strain. In the same paragraph you have the RAS as the old ham standby NC-100. I think you will find this to be an RAO.

And on page 26 the bottom picture is a TBS labeled

TBX. You have the correct dope on the TBX, but it most certainly does not look like the TBS pictured. The TBS is a v.h.f. (60 to 80 Mc.) rig, with a rated output of 50 watts from an 808 on the final, voice or A-2. This little job has been my especial headache for the past year or so, and I really sweat when it goes out, because it's the skipper's pet. The TBX, incidentally, is powered by a hand cranked generator for transmitting, although some beach parties were lucky enough to get a gas-driven job. The receiver is battery powered and works fairly well over considerable distances with a short antenna. I picked up Honolulu "Fox" broadcasts at Saipan with an eight foot sky wire while tuning up for the Iwo Jima show.

Well, Ed, those are the major mistakes I found, but all in all you did a damned good job on that issue. And speaking of damned good jobs, the one ARRL did getting us back on the air tops them all. . . . Thanks for the wonderful job of reinstating the hams.

— C. M. Dunlap, jr., W8W0E

Sleepy Eye, Minn.

Editor, *QST*:

Have just received my discharge from the naval service after serving on active duty beginning December 12, 1940, and *QST's* are stacked up here since then. In reviewing them I started at the top and the October edition featuring the Naval Communications System and the radio amateur moves me to express my approval and appreciation of these articles.

I am glad to see these articles for the record. They will be referred to often for this purpose, I am sure. And also I value them as a summary of my own experiences during these past five years. The pictures of service personalities in these activities alone are priceless to me — so many are friends that I knew and worked with. It would take much individual effort on my part to gather even a few of these treasured mementos.

I was fortunate enough to survive the many experiences of the past five years with a whole hide — something to be thankful for. My interest in maintaining the amateur status nationally and internationally was very low in this time but I am greatly pleased at the job done by ARRL during that time. I'm already gathering parts to put on the air at the earliest time that it can be made to perk, and especially do I want to try out a few v.h.f. tricks learned from naval gear. And I expect to meet many wartime and prewar friends under whatever calls they may have now, now that amateurs are again riding the air waves.

— Herman Radloff, W9AIR

Navy Department, Bureau of Ships,
Washington 25, D. C.

Editor, *QST*:

Congratulations on the Navy issue of *QST*! The consensus around the Electronics Division of BuShips is unanimous that you have done a swell job. I am in perhaps a better position than most people to know how good it is because I realize the fragmentary nature of your source material and the fact that it was not as well ordered as it might have been. However, the story is cohesive, interesting, and as one of our officers commented in a surprised tone of voice, ". . . you know, it makes sense!" The Navy's "hams" will carefully preserve their copies as a souvenir history of amateur radio's contribution to the winning of World War II.

— Comdr. Howard J. Waters

PORTABLE HANDBOOK

1862 E. 14 St., Brooklyn, N. Y.

Editor, *QST*:

The time has come when the *Handbook* is now one of the most important pieces of apparatus in the shack. All of us must now consult it more than ever before.

Due to the long layoff many of us are rusty on this point or that — perhaps we want to rebuild and must look up all

(Continued on page 134)



FOREIGN NOTES



ARGENTINA

The magic date in LU-land was November 21, 1945, when all bands from 1.7 to 224 Mc. were released to the amateur service, as a result of official negotiations by the *Radio Club Argentino*. Throughout the period of war, special activities and contests were permitted in the 56- and 112-Mc. bands and individual authorization was granted LU4AA, the society's headquarters station, for skeleton activity on all bands. As a result, v.h.f. technique has progressed more rapidly than normal and many new amateurs have been licensed after acquiring an interest in those channels. R.C.A. hopes for the early resumption of the Spanish *Handbook* edition, a prime means of bringing the latest technical data to Argentine hams.

BRAZIL

In reporting this month on the activities of our sister-society in Brazil, we can do no better than to quote portions of a letter from her president, Col. Riograndino KrueI, PY1AR:

"By decree-law issued in 1943, the L.A.B.R.E. was appointed as the 'official government body' controlling and directing the activities of all radio amateurs in Brazil, besides constituting a means for the formation of military reserves of radio-operators for the army and air force. L.A.B.R.E. is considered by the government as a public utility association and enjoys postal and telegraph exemption. Of the leading radio-amateur associations in the Americas, the L.A.B.R.E. was the only one who had an official representative at the Conference which took place in Rio in September, 1945. This representation was the result of a spontaneous invitation from the government to our League to nominate one of our members to the conference, and our choice fell on Mr. João Victorio Pareto Neto, PY1AX.

"We are at present negotiating with the government the donation of a plot of land in Rio where we intend building the League's headquarters, since we are at present located in the Ministry of Transport's building. The solemn sessions of the League are nearly always presided over by the Post Master General and, occasionally, by the Minister of Transport himself and higher authorities.

"Brazilian amateurs are classified under three different categories, viz:

"Class C — This is the lowest 'rank'. All amateurs (excepting those holding certificates issued

by a government body qualifying them as radio operators) when entering the League are automatically placed under this category or classification where they can operate Morse signals only on the frequencies 1,715 to 2,000 kcs., 3,500 to 4,000 kcs., and 7,000 to 7,300 kcs., and, in addition, phone on the 80-meter band only. This gives them a chance of practicing c.w. and becoming familiar with the wonders of radio and, of course, with its idiosyncrasies also. The permanence in this class, however, is of a temporary nature and the amateur must in the meantime prepare himself to undergo official examinations which give him access to the next higher rank, i.e. Class B.

"Class B — This is the next step up. Candidates to this class are entitled to operate on the following frequencies: Morse signals only on the bands as mentioned above plus phone in the sub-bands of 80 and 40 meters. After operating for a time as Class C, as stated above, amateurs undergo an examination, and if they pass this examination they then become Class B amateurs. This examination consists of the following: Copying of Morse signals at the speed of 15 w.p.m. from a minimum transmission of 50 words in plain language or 20 words in code at the rate of 10 w.p.m.; transmission of Morse signals at the same speeds as above; technical and regulatory matters. . . .

"Class A — This is the final classification which is the goal of every amateur as it entitles him to operate Morse and phone on the respective frequencies of all bands and, in addition, television. Access to this class is not compulsory but, needless to say, every amateur strives to be admitted into it, as it offers a greater field of activity. The requisites for admission into this class are the same as for Class B, with the difference, however, that code transmission and copying are at higher speeds and more technicality is involved in the examination."

FINLAND

The first word in four years from *Suomen Radioamatooriliitto* brings the news that the Finnish government's prohibition of September 16, 1939, is still valid. The society has not yet applied officially for reactivation, preferring to wait until United States amateurs are back on all bands. S.R.A.L. continued meetings during the war, and present enthusiasm among OH amateurs is rapidly mounting. In April, 1946, the society is celebrating its 25th anniversary, thereby being one of the oldest amateur organizations in Europe.

(Concluded on page 120)

OPERATING NEWS

F. E. HANDY, W1BDI, Communications Mgr.
E. L. BATTEY, W1UE, Asst. Comms. Mgr.

J. A. MOSKEY, W1JMY, Communications Asst.
LILLIAN M. SALTER, Communications Asst.

CQ BW. This is the general call you will hear a lot of in the Band Warming Party. The BWP is open to all radio amateurs, address immaterial. Scoring? It's been kept simple. See the announcement elsewhere in this issue. For a check on the performance of newly hooked-up gear you can hardly better this operating opportunity. This activity creates a chance to renew some wartime and prewar acquaintances in amateur radio, too. It may be too much to hope that all our h.f. bands are opened for us by February 22nd, but at any rate we're going to "warm" all the bands FCC has made available by that date, the starting date of the activity. All set? If not, you have until February 22nd to get going. One could squeeze a lot of operating hours into the second week end of the test in a pinch. Even one good hour of operating in the BWP will be fun. You're an amateur? You're invited.

Station Safety Measures. In the process of getting the old heap perking don't forget to *give a thought to safety*. Better a little delay than a fatal accident! Before the war we told you about safety precautions at W1AW: Totally enclosed transmitters, disconnects on cabinet doors, illuminated danger HV signs, plug-and-jack antenna grounding, and lattice fencing-in of hot antenna leads. That sounds like the ultimate, but in our new W1AW-planning even further schemes are under study. Relay switching all "hot" leads in place of manual switching of even interlock-protected circuits, paralleling h.v. pilot lights

with conspicuous warning lamps at "live" cabinet doors, use of a buzzer or squawker warning to the operator, if anyone opens a cabinet containing high voltage circuits are additional precautions under consideration. A master switch to kill *all* power circuits for servicing or tune-up changes may be a worldwhilè idea for you. A pair of lineman's rubber gloves, the posted rule to wear them, and the old caution about standing on insulation and keeping one hand in the pocket are good to remember, cheap safety where one *must* tinker. But permanent safeguards are best. All the above we think timely to mention since it is a station rebuilding and rehabilitation time for everybody. Set up your own SAFETY FIRST program. Pass the suggestion along. Switch to safety!

SCMs Wanted. Attention is invited to the notice in this *QST* soliciting SCM nominations. ARRL Members with good operating knowledge and broad experience are required. Above all the position is one of operating leadership, requiring exercise of administrative judgment, and care in selection of qualified appointees. The provision for nominations is contingent on alert action by individual members so that no office is allowed to become vacant and to see that the men best fitted for such leadership are put in office. In another month even more Sections will require SCM elections due to the unsettled conditions brought about by the war. Next to being a Director, there are few posts in amateur radio or ARRL that are



One of the first postwar hamfests was held in Oakland, Calif., in the Woodminister Bowl on October 14, 1945. This photo (by W6CBF) shows the General Committee absorbed in examination of a new bug key. Seated, left to right: W6SSN; W6EE, general chairman; W6AD. Standing: W6QDE; P. Cogshall; W6AEX; W6MFZ; W6ZM; W6PB. Over 300 hams, XYLs, YLs, Harmonics, and friends enjoyed the affair, which included speakers, dancing, antique exhibit, prizes, free coffee, and a 112-Mc. transmitter hunt. W6SQ found the hidden rig in 17 minutes, winning first prize. Second prize went to W6KGF, third prize to W6NTU. The fine assortment of prizes was made possible by the cooperation of all the ham equipment dealers in the Bay Area. Amateurs were present from all W districts.

WIAW OPERATING SCHEDULE

Official ARRL Bulletins containing latest FCC information relating to amateur operation and reactivation, and other bulletins on matters of general amateur interest are transmitted on regular schedules, as follows:

FREQUENCIES: 3555, 7145, 14,280, 28,245 and 56,968 kc.

TIMES: 8:00, 9:00 and 10:00 P.M. EST, Monday through Friday. (0100, 0200 and 0300 GCT, Tuesday through Saturday.)

Starting on the hour, simultaneous c.w. transmissions are made at 15 w.p.m. Each telegraph transmission is followed by voice transmission on each of the above frequencies, except that 28,245-kc. transmissions are made only when band conditions are satisfactory.

The station is not operated on legal national holidays.

of equal importance. Choose with care, please.

SEC Appointments. As this is written December *QST* with the announcement of the new ARRL Emergency Corps is just reaching you. Already appointments to the important post of Section Emergency Coördinator are being made. The first SEC appointments received name Burtis W. Dean, W1NLO, Vermont; Philip L. Sprague, W1UP, Maine; Lloyd A. Shellabarger, W6EE, East Bay; Dwight Johnson, W7CMX, Washington; R. M. Francis, W8AVY, Western Penna.; John S. Glass, W9SSW, North Dakota; and C. E. McGuigan, W9TMY, Iowa. Reliable leaders are needed in many Sections to promote community planning, implement and supervise Section-AEC programs. SCMs want to hear from amateurs desiring to help prepare amateur radio for effective emergency communications.

The ARRL Emergency Corps Program. Emergency Coördinators in many localities are calling reorganization meetings of amateurs, after having assessed community needs by contact with the appropriate local officials. ECs have a full supply of Application Form 7A and Membership Cards for certifying membership in the ARRL Emergency Corps. That is the current EC job — to build up units of the new Corps from scratch. All amateurs are invited to ask their local EC about the Emergency Corps. Get an application, and aim to join, whether there is a local AEC meeting coming up or not.

There's nothing difficult about adjusting existing gear to the new 144-148 Mc. band (See page 72, Oct. '45 *QST*) or determining the frequencies there accurately (Pages 15 and 38, Nov. '45 *QST*). By the time you get this issue of *QST* there should be little equipment tuned to the now discontinued amateur frequency range around our ham stations. The opening of additional amateur bands

on November 15th probably slowed down general amateur change-over to 144 Mc. at the time. However, preparedness for storms, floods, fires or other regional disasters, as well as the normal desire to get the most out of every ham band, should see our equipment on *each* band, ready for any communicating requirement.

The seven-point program of Emergency Coördinators in most communities consists of the following:

(1) Organization meetings of all available amateurs and emergency workers.

(2) Designation of assistants for an emergency planning committee.

(3) Committee meetings and appointments to handle particular responsibilities.

(4) Initiation of code class programs for those working for new amateur licenses, particularly ex-WERS.

(5) Liaison and general planning for assumed community emergency contingencies.

(6) Establishment of regular drill periods, simulated emergency tests of equipment.

(7) Monthly assessment of progress and reports for ARRL-*QST*.

Get in touch with your Emergency Coördinator to get information on any of the above points. Where there is a local club he will appreciate the assistance and coöperation of the club organization in furthering the aims of the Emergency Corps. If your area was organized under the WERS, the new plans ought to be taking shape under an EC by now. If your community was *not* so organized why not look into the possibilities and see if the amateur facilities are not enough to support this interesting and useful activity. The SCM and SEC will welcome your inquiry and recommendations for new Emergency Coördinators.

— F. E. H.

HAMS AT HEADQUARTERS

WIAW, ARRL Headquarters Station

WIINF, Headquarters Operators Club

The following calls and personal sines belong to members of the Headquarters gang:

W1BAW	R. T. Beaudin, "rb"
W1BDI	F. E. Handy, "fh"
W1DF	George Grammer, "gg"
W1EH	K. B. Warner, "ken"
W1FWH	W. F. Bradley, "wb"
W1GS	F. C. Beekley, "beek"
W1HDQ	E. P. Tilton, "ed"
W1JFN	A. L. Budlong, "bud"
W1JMY	J. A. Moskey, "jm"
W1JPE	Byron Goodman, "by"
W1LOP	Julius Galin, "jg"
W1LVQ	John Huntoon, "jh"
W1MFA	H. K. Isham, "hk"
W1TS	D. H. Mix, "don"
W1UE	E. L. Battey, "ev"
W2OEN/1	A. David Middleton, "mid"
W9YMV/1	L. T. Waggoner, "roy"

Transmitter maintenance at WIAW by H. A. Bubb, W1JTD, "hal."

MEET THE SCMs

RAYMOND R. ROSENBERG, W8NCJ, Western Pennsylvania's SCM, has been interested in radio since the spark coil days following World War I. Acquiring his amateur license in January, 1935, he has since taken a very active interest in all phases of amateur radio, including traffic work, experimenting, DX, and a very generous



measure of plain old-fashioned rag chewing. Attesting to W8NCJ's varied interests is the fact that he has received ORS, RM, RCC, WAS, WAC, and A-1 Operators Club certificates; a 35 w.p.m. Code Proficiency Award; and four Navy Day letters. He was several times winner for Western Pennsylvania in SS Contests and ARRL Mem-

bers QSO Parties, and his DX covers fifty countries worked from which confirmations have been received. In addition to his amateur Class A license, W8NCJ holds radiotelephone first and radiotelegraph second licenses. Ray was born in Erie, Pennsylvania on August 31, 1908. After completing high school in 1926 he graduated from a two-year special electrical course and later completed a three-year course in Electrical Engineering sponsored by Pennsylvania State College, Extension Branch, at Erie. Having previously been employed by an electric public utility as a meter testing foreman, he recently joined an engineering group of a prominent radio manufacturing concern. He now is a member of the newly-reorganized Radio Association of Erie. Other than amateur radio his principle hobby is swimming. Much credit is due Ray for his efficient work in conducting the affairs of the SCM office.

GI STATION IN JAPAN

American occupation troops in the Western Pacific are looking forward to resuming contacts with ham stations at home as soon as 7 and 14 Mc. open up. Up on the northern tip of the main Japanese island of Honshu, communication forces of the 323rd Infantry decided to do something about the matter shortly after taking over the area as part of the 81st Division last September.

Lieutenants Jesse Goodman, regimental communications officer, and Albert W. Speyers, III, communications officer of the first battalion and former junior operator at W6RUE, originated the idea after inspecting some captured

radio gear at the Hachinohe air station. Much of it was perfectly usable, and they suggested to the regimental commander that a ham station be set up. Approval was granted and the boys got busy.

With the help of several GIs and a copy of the ARRL *Handbook*, the problem of a suitable antenna was tackled. There was plenty of room for a "V" beam, and after much scurrying around for a globe or chart, the proper azimuth angle to hit the U. S. right down the middle was determined. Three 90-foot poles at the air station were earmarked to support the sky wires. Those poles had been put in to stay, but with the aid of a working crew and trucks they were duly dug up and hauled to the new locations near regimental Hq. Northern Japan winters include gales of hurricane force so it was necessary to anchor the sticks with half-inch steel guy cable every thirty feet, run to six heavy dead-men buried around each pole. A ton or two of 90-foot stick is something to reckon with! However, after a full week of hard work by all hands, the job was completed without accidents. The "V" was designed to run four wavelengths per leg on 7 Mc. or eight on 14 Mc. with a compromise included-angle to permit good coverage on both hands. Getting it up, with one leg crossing a 3000-volt power line, was a ticklish job.

For the shack a large room in the provost marshal's office was assigned and a new concrete floor put in to support the gear. The big rig is a Japanese all-wave 'phone and c.w. transmitter rated at about 3 kw. with its own 220-volt motor-generator power source. A 200-watt Japanese transmitter running off the 110-volt lines has also been installed for stand-by purposes. Receiving equipment includes an Army BC 312 and a Japanese receiver with a range of 140 to 20,000 kc. using banks of plug-in coils on the principle of an HRO.

The rig will cover 28 Mc. for experimental contacts, but regular message handling and 'phone conversations with relatives in the States will probably wait until 7 and 14 Mc. are opened.

W1LOP, Hartford, Conn., on November 27, 1945, made contact on 28 Mc. 'phone with W2LYE, portable at Bellows Field, Oahu, Hawaii. Operator at the Hawaiian end was Leonard McFarlane (operator's ticket only). W1LOP maintained schedule with W2LYE at 3:00 P.M. EST for several days. On November 28th the K6 operator's mother was at W1LOP's shack and a successful conversation ensued between mother and son.

ARTICLE CONTEST

See Operating News, January *QST*, for announcement of our new Article Contest. This is a continuing contest. The best articles, one each month, will be used in *QST*, and prizes awarded.

Subjects were suggested in the January announcement, but you may write on any topic of interest to radio amateurs. By the time you read this you may already have put your thoughts on paper. If not, give it a whirl. The ham world is waiting.

ELECTION NOTICE

To all ARRL Members residing in the Sections listed below:

You are hereby notified that an election for Section Communications Manager is about to be held in your respective Sections. This notice supersedes previous notices.

Nominating petitions are solicited. The signatures of five or more ARRL full members in good standing, residing in the Section concerned, are required on each petition. No member shall sign more than one petition.

Each candidate for Section Communications Manager must have been a licensed amateur for at least two years and similarly a full member of the League for at least one continuous year immediately prior to his nomination.

Petitions must be in West Hartford, Conn. on or before noon on the closing dates specified. In cases where no valid nominating petitions were received in response to previous notices, the closing dates are set ahead to the dates given herewith. The complete name, address, and station call of the candidate should be included with the petition.

The following nomination form is suggested:

Communications Manager, ARRL (Place and date)
 38 La Salle Road, West Hartford, Conn.

We, the undersigned full members of the ARRL residing in the..... Section of the..... Division hereby nominate..... as candidate for Section Communications Manager for this Section for the next two-year term of office.

Elections will take place immediately after the closing dates specified for receipt of nominating petitions. The Ballots mailed from Headquarters to full members will list in alphabetical sequence the names of all eligible candidates.

You are urged to take the initiative and file nominating petitions immediately. This is your opportunity to put the man of your choice in office.

— F. E. Handy, Communications Manager

Section	Closing Date	Present SCM	Present Term of Office Ends
West Virginia	Feb. 1, 1946	Kenneth M. Zinn	Feb. 15, 1946
Santa Clara			
Valley	Feb. 15, 1946	Earl F. Sanderson	Oct. 15, 1944
Md.-Del.-D. C.	Feb. 15, 1946	Hermann E. Hobbs	Dec. 1, 1945
Connecticut	Feb. 15, 1946	Edmund R. Fraser	Dec. 13, 1945
San Francisco	Feb. 15, 1946	William A. Ladley	Dec. 13, 1945
Louisiana	Feb. 15, 1946	Eugene H. Treadaway	Feb. 25, 1946
Eastern Mass.	Mar. 15, 1946	Frank L. Baker, jr.	Apr. 2, 1946
San Diego	Apr. 1, 1946	Ralph H. Culbertson	Apr. 15, 1946
Missouri	Apr. 1, 1946	Letha A. Dangerfield	Apr. 17, 1946
Colorado	Apr. 1, 1946	H. F. Hekel	Apr. 17, 1946
Philippines	May 1, 1946	George L. Rickard	Oct. 15, 1938

EMERGENCY NET ON 28 MC.

With 144 Mc. work at a temporary standstill due to rigs being rebuilt, W7HLLF, Acting Emergency Coördinator, Medford, Oregon, has lined up this 28-Mc. 'phone group for Monday night, operation: W7FMQ, W7FRO, W7DBZ, W7HWH, W7FSP, W7FUN. This is one way to maintain activity while licking the 144-Mc. problems.



Brasspounders who handled traffic in the ARRL Michigan Net and the AARS will remember this YL, Cpl. Helen H. Cloutier, CAP, W9GJX. Helen made her contribution to the war effort in the Civil Air Patrol, and also in teaching pre-flight radio. She is planning a bigger and better W9GJX. We'll soon be hearing that snappy fist again.

BRIEFS

The following interesting item was sent in by Kenneth T. Harvey, G5KT, of Bristol, England: "W1JFG was wandering around in the Somerset town of Wellington on one occasion and was disappointed to find that it was early closing day. Looking in a radio shop window, Willard found a dozen QSL cards displayed, accompanied by a printed memo to the effect that Cecil H. Andrews, G2HF, would appreciate a call in person if any of the senders of the cards were ever in the town. The first card displayed was W1JFG's!"

Have you noticed the scarcity of stations in the h.f. end of the 28 Mc. band? When the band is open we observe a concentration of 'phone signals around the middle portion, with decreasing occupancy either side. On the l.f. end, the c.w. gang holds forth. But only occasionally is anyone, 'phone or c.w., heard in the no-man's land on high end. It will take a comparatively few hardy souls to start the ball rolling. For most effective utilization of the band and most efficient operating we should spread out through the entire band. Come on, you fellows with the pioneer spirit, let's do something about it.

E. S. Holden, VO1H, Bank of Nova Scotia Bldg., St. John's, Newfoundland, sends this hospitable note: "We will be glad to meet any visiting Ws or VEs." VO1H is secretary of the Newfoundland Amateur Radio Association.

Station Activities



ATLANTIC DIVISION

EASTERN PENNSYLVANIA — SCM, Jerry Mathis, W3BES — 3GJY is working for the B&O in Baltimore; he says there will be less competition there in the contests. New officers of the West Phila. Radio Assn.: 3IBB, pres.; 3ITZ, vice-pres.; 3IUD, secy.; and Harmon DeWitt (LSPH). Likewise the Frankford Radio Club has new officers: 3BES, pres.; 3DVC, vice-pres.; 3IXN, secy.-treas.; 3KT, activities mgr. This club is returning to its prewar meeting schedule. 3EHK, 3ISV, and 3GRF are back from the wars. 3DOU lost his mast in a recent blow. 3GPM is plagued with a bad case of BCI. 3HRE is preparing to move to Rochester. New OBS: 3AOC, AOJ, AQN, FMF, IOU, IU, and 8AFV. 3ENX has a gang-tuned, band-switching, self-powered exciter with electronic keyer built in. 3BES worked OQ5AE on 28 Mc. c.w. 3EXA added a new country by working VP2AT. 3BYF expects to be on from KA soon. They have a radio club there and he reports that 3GHH is close by. 3DMQ is back in the States. Plans for the Emergency Corps are proceeding apace. In Philadelphia, 3KD is taking the EC job temporarily and the exact set-up will be announced later. Commander Mizel, of the USCG, announces a new Coast Guard Auxiliary communications system for amateurs. For information contact your SCM. Traffic: W3BES-2.

MARYLAND-DELAWARE-DISTRICT OF COLUMBIA — SCM, Hermann E. Hobbs, W3CIZ — Most of the Baltimore gang gave the new 144-Mc. band a whirl when it opened up, but did not enjoy as good results as had been had on 2½. There is very little occupancy on the band at the present time. Most of the boys are on either 5 or 10 meters. Albert E. Hayes, jr., has been rebuilding the ten-meter rig. FBB is now a member of the Patent Department at Bendix, working under 4AET, chief patent counsel, and 1IIN/3, chief patent engineer. JMO, who served as communication and radar officer of the *USS Fullam*, in the Pacific, is a civilian again and almost ready to get back on the air. The Argument Radio Club, Delaware, soon will be reactivated.

SOUTHERN NEW JERSEY — SCM, Ray Tomlinson, W3GCU — Regional EC for So. N. J., ASQ; EC for Somerset and all Somerset County in So. N. J., ABS; EC for Mt. Holly, Medford, Hainesport & Pemberton, JNZ. Your SCM is looking for qualified So. N. J. amateurs, ARRL members, to accept EC appointment. The Hamilton Twp. WERS Operators' Association is in the progress of reorganization. Classes in theory have been started under the expert tutelage of 3ARN, just returned from the Navy. IDY, CCO, AXU, BRJ, UK, and ABS are on 28 Mc. ITS is building for 28 Mc. GQX just slung up his beam, and ASQ is readying for his beam. ABS reports that the chief forest warden for Central N. J. has requested assistance of our emergency organization as soon as Stan has his district set-up going. Friday nights have been set for Stan's new "ham" school teaching code and theory. IDY and ASQ are only ones set for 144 Mc. AXU lost his 40-foot tower in a recent hurricane. GCU is building a receiver for operation on 10 meters and below. EED is in Naha. JAG just returned from a long jaunt with the merchant marine. BMN and EQF are back in civilian life. Rumors say HAZ soon will be discharged from the Army. HKO recently returned from Japan. GNM is back among us civilians. Upon completion of fixed station technician training, ISY will take a job with the foreign service division of RCAC. The second meeting of the IRE at the Science Bldg., Princeton U., welcome the following of our boys: HW, GFQ, CFB, ZI, AXU, BBO, and BAY. 73. Ray.

WESTERN NEW YORK — SCM, Charles I. Otero, W8UPH — The Rochester Amateur Radio Association cleared the decks for action. The first call to battle stations put on the move exactly 73, from the city and nearby towns. Gay eyes, big smiles, and a mighty-glad-to-see-you-again attitude greeted us everywhere at this meeting, a clear signal that the heart of amateur radio is pounding again. Even the

number attending meant good things ahead. But the most important question on the lips of those we saw was, "when do we get the other bands." The following members were elected to handle the business of RARA for the duration of the fiscal year: NCM, pres., who had been vice-pres.; OQC, vice-pres., back in civvies after a four-year absence; NBI, treas., reelected, who can do to duces what a magnet does to needles; KFU, secy., a newcomer from Buffalo who knows plenty; he is a lawyer. The new executive committee is composed of RDX, ex-6MUA, KAU, and UPH, the latter reelected. Seems like the trend is toward more power, but some of the essential stuff is as scarce as the proverbial hen's molar. Since the reopening of "ten" you can hear again the familiar voices of well-known prewar amateurs back on the air. These boys were quick to catch up with the old, natural way of carrying on a conversation. Apparently they did not lose any part of the old finesse either. And their signals still carry that desirable stamp of good-quality-audio. It is suggested that newcomers spend some little time listening to the masters' voices. The 28-Mc. band is attracting addicts, even among the die-hard "20s," despite its crazy inconsistencies. But not all the signals are as good as some of the reports would like them to be, which is probably due to the long-time-no-see, so-let-us-be-nice-to-him belief. Frankly, a more careful application of audio power would certainly do us a lot of good. And now that we are going back on the air, it is the best time to do a fellow a favor by telling him the truth about his signal. Much equipment is bad or goes bad shortly after resuming operation with the consequent lowering of the signal quality, and if a fellow can detect the trouble or the trouble is reported to him, he will surely save himself a lot of trouble and expense. If there is anybody who would like to swap looks, RQX is ready with his television. 73. Charlie.

WESTERN PENNSYLVANIA — SCM, R. R. Rosenberg, W8NCJ — New appointments: AVY as SEC; BHN and TST as OBS. Ex-SCM 9LEZ, off the air since leaving for Panama in 1940, is permanently located at Meadville. TWI, reporting from Oak Ridge, Tenn., is brushing up on c.w. and preparing to take examinations for amateur Class A and commercial tickets. TVA, traveling in the Midwest, visited TTD at Neosho, Mo., and spent a few days with members of the Chicago Hamfesters Club. He worked 28-Mc. 'phone and c.w. from 9EZF and 9UIG. NUH complains of ignition QRN from cars passing on the highway in front of his home. RMIc RCQ writes from USCG training station, Atlantic City, N. J., that he is active on 28 Mc. with exciter unit employing 6L6 oscillator into 807 final. TST reports the following news from McKeesport and vicinity: NGD, BSC, CKO, and MGZ are active on 28 Mc. OBS OTY has moved to West Virginia, and RNO is now located at Munnhall. Ex-NWB has taken amateur examination and awaits the good news from FCC. Local conditions on 2½ were good with the following stations being logged: NGD, UST, CKO, RUM, PGV, VYP, MGZ, RWQ, OUM, SHK, and OMY. TTD reports TTN is on the way to Manila starting the long trek home to Jeannette. "Don" Holler (LSPH), of Export, has been discharged from the Navy. UVD copies W1AW nightly and heard nice DX on 28 Mc. including XE1AG and K7CBF. VNE took examination for Class A ticket at Washington, D. C. AVY, secy. Pittsburgh Area Radio Club Council, reports activity from Pittsburgh. The Amateur Transmitters Association of Western Pennsylvania elected temporary officers. Attendance at South Hills Brass Pounders and Modulators and the Steel City Amateur Radio Club meetings has been gratifying. Lt. KWA has been discharged from the Navy and is back home. OW is reported to be back in town after spending the last few years in Naval Research Lab. OLI, who served as pilot with AAF, is on terminal leave and plans to reside at Erie. The Radio Assn. of Erie is continuing to hold bi-monthly meetings. Congratulations are extended to BHN, of Erie, on his election as alternate director of the Atlantic Division. 73. Ray.

CENTRAL DIVISION

INDIANA — SCM, Herbert S. Brier, W9EGQ — KMY, DGA, EHT, EUJ, NLS, KLI, WDV, SYJ, and UZW are home and out of the services. UZW moved to California,

and ZYJ to Texas. EGV has two antennas and has worked three stations. CQ is the name of the new Gary radio club. WVG is pres.; MVZ secy.-treas. The club has over thirty members. DUT, JZA, and PQL are working to get on 144 Mc. DHJ, DLI, and RHL are on 144 Mc. EBB/3 is looking for Indiana stations from Washington, D. C. MBM runs from 200 to 800 watts to a vertical on 28 Mc. MVZ runs 100 watts to a vertical. KYQ has a 60-foot steel tower. FDS and PUB bought new receivers. OJM expects to be home by February. AB put up an antenna. ZYK has a receiver big enough to use as a transmitter. GOE has a three-element beam. OOG is recruiting for the Signal Corps. NWN has 400 watts and a three-element beam. CFI, JNT, and WEU are building new rigs. ILL, on Attu, and SNF, on Kwajalein, are ready with rigs, waiting for 14 Mc. to be opened. 73. *Herb.*

KENTUCKY — SCM, Darrell A. Downard, W9ARU — The Amateur Radio Transmitting Society held its first election of officers since 1941, the newly-elected officers being: Glenn Cook, pres.; Jim Jackson, vice-pres.; Giles Allen, sgt.-at-arms, and yours truly, secy.-treas. J. B. Wathen, president for the past four years, was given a vote of thanks for the swell job he did during that period. Sgt. Baldauf got tired of writing the SCM from Frankfurt, Germany, so he made a recording and mailed that. BAZ has again been appointed EC for the Louisville area. Those of you who can participate in the Emergency Corps, please contact BAZ direct. CDA says that the extent of his radio work in the Army consisted of saying "Car 51 in (or out) of service." CNE can't get used to the long skip on 28 Mc. after working 115 Mc. for four years. Ed Weedman is back from the Army. Paul Sprowls is on terminal leave and looking for civvies.

MICHIGAN — SCM, Harold C. Bird, W8DPE — 5JKS, of Tulsa, Okla., wants to resume his schedule. 8NCB is pounding brass for WPEB. 8UEO writes from Subic Bay, Luzon, P. I., that he enjoys the bulletin and is looking forward to returning home. 8KHK has equipment standing by for medium frequencies to open up. 8MBM has renewed his subscription to *QST* and the bulletin. 8UGR is listening on 28 Mc. with a regenerative receiver, and is building a tri-tet crystal oscillator 616G doubler with push-pull 807s for this band. 8NVH sends in money for the *DARA Bull.* 8DED is back home and working 10 meters. 9GJX sends in *QST* membership. She hopes to have 350 and 400 watts 'phone and c.w. when medium frequencies are opened up. 9GQF appreciates everything ARRL has done. 9CGR, home on a visit, explained his work with the 8th Air Force. He paid a visit to 9PDE and 9EVL. 9CSI is working ten meters from Marquette. 9VJJ bagged a buck, his fifth in five years. 9YLS, returned from the Army, is running Radio Service. 9BZH is building a Class B speech amplifier. 8NDL is living at 1114 Wellington Court, Ann Arbor, since returning from service with the Navy and is attending school. 8PLC is with the Army in Texas. The *DARA* held its monthly meeting Dec. 13th and discussed several topics, one being the appointment of an SEC for Michigan. A card to your SCM telling of your activities will be appreciated. 73. *Hal.*

WISCONSIN — SCM, Emil Felber, jr., W9RH — NJT, of Watertown, has received his discharge from the Navy. NJV, his sister, is dropping her station call and will operate with NJT. NJU should be hearing wedding bells soon. JWV and IZG are operating police rigs. QHR is doing radio service work. ANM is all set for 80 meters c.w. with a T40 final. The Watertown hams are getting ready for the 50-54 Mc. band and will be looking for Milwaukee signals. MRU is stationed on the USS *Massachusetts* in the Pacific. NRP is in France. UFX sold his home in Madison and hopes to locate in a business nearby. 6FLC was picked up thumbing a ride, by UFX on the way to Chicago. HMG and FVX should be on the air by now. JLM is home from the Army. HZS is married. OME and LNM are working at Gisholt Plant. AVM is working for the State, painting. MFR is installing hearing aids. Lt. MRY, USN, has been discharged. JDA is churning butter. UFX would like to hear from WCW and WXD. VVZ reports that a well-known Wisconsin ham, S. B. Mateske, FJ, passed away in October. He helped many La Crosse hams to get started by sending code practice by the hour. T/Sgt. OEB, Sgt. Gil Rink, and Capt.

ZBP should be in civvies by now. The MRAC Club Bulletin sent to the boys in the services was discontinued with the December issue. IZO and DYO are proud fathers of a baby girl each. The following stations are operating on 28 Mc.: YMG, MZZ, TPO, DYO, QUN, GPI, NSC, GQO, ESO, EWW, VLA, IZQ, SPE, FPV, GIL, RH, RFN, CRX, LJU, HRM, and SQK. On 144 Mc.: HIF, GSP, ITJ, and JPK. 73. *Emil.*

DAKOTA DIVISION

NORTH DAKOTA — SCM, Raymond V. Barnett, W9EVP — SSW has been appointed SEC. GJJ is new OBS. Central Dakota Radio Club completed organization and is applying for ARRL affiliation. GZD, GJJ, CYN, MKB, SSW, ABQ, and EVP are active on 28 Mc. ZRT is dickering for new commercially-built half-kilowatt rig. NAW is back in Grand Forks. Kit Bush (LSPH) attending University, makes use of GZD's rig. ZZK, BMR, and UNU report from Wahpeton that VJH is depot agent at Browns Valley, Minn. NMV is at Page. IHS and DHW are working in St. Paul. RPM, brother of PDN, is flight radio operator with ATC. FDZ is with Engineers in P.I. EOJ, of Aberdeen, So. Dak., paid brief visit to Bismarck. RBS bought a ranch near Bozeman, Mont.; has plenty of room to put up antenna arrays now. GZD reports arrival of a new YL on Nov. 24th. EVP is trying to unscramble the signals put out by new jr. operator, who arrived Nov. 27th. 73. *Ray.*

SOUTH DAKOTA — SCM, P. H. Schultz, W9QVY — CJS, of Bryant, and 5JXS, ex-BJV, of Watertown, are maintaining their daily 5-meter schedules. About ten hams at Watertown are ready to go. USI, of Brookings, is a Signal Corps major and is at home on TD. NLR, of Brookings, passed away in early December. The SCM just learned that KMH, of Watertown, was shot down in a fight over Germany about a year and a half ago. Twenty members of the Sioux Falls Amateur Radio Club met on Dec. 7th and reactivated the club. ZRA is pres. and EKT is secy. EKT has a code class of twelve students. SOB, of Platte, who was Lt. comdr. in the Navy, has resumed his former position with Eastern Air Lines. PRZ is active on 28 Mc. from Bremerton, Wash. He is radio inspector in Bremerton Naval Base. How about some news from clubs and individuals? 73. *Phil.*

NORTHERN MINNESOTA — SCM, Armond D. Brattland, W9FUZ — OMC is located at Hutchinson. JNC writes from Columbia, S. C., that he will have a rig on 28 Mc., c.w. and 'phone and that NCS will be on from New Jersey. YCR is back at Lew Bonna. OOO is back behind the counter at Halls. We are all happy that IBD is recovering from his operation. BBN was heard by the SCM putting a nice signal into L.A. BCT and his XYL are back in the cities. BMX was host at the first postwar advisory board meeting at which time future long-range club activities in St. Paul were outlined. A pre-organization meeting was held in Minneapolis and the gang is looking forward to the first official Minneapolis Radio Club session. BVM is in the legal division of the FCC in Washington. FEW, at White Bear, is banging out a signal on 28 Mc. to the West Coast. TOZ is running almost a kw. ECU, the f.m. expert, is back in St. Paul. JIE has almost completed his new den. JRI is attending the U. of M. JHF also will attend the U., taking up E.E. IPR purchased a resort near Brainerd. HRB is building a super-duper receiver for 28 Mc. QIN put up a folded doublet three-element beam. KXA is back in Homestead, Fla., as air inspector AAF. SBO is a junior at the U. ITQ is on 28 Mc. CUD is in Tokyo with the Signal Corps. TYN is back home in St. Paul. VXH has been drafted into the Navy. PKO continues with the building of his new home. BIY and YTL are back home. UCA has a nice sounding rig on 28 Mc. TLE gave an interesting talk on multiband/vertical antennas at St. Paul Radio Club meeting. GVO and OPA are on 28 Mc. at White Bear. IXR hopes to be on 28 Mc. shortly from Minneapolis. FUZ is on a big troop ship, *TES Uruguay*. BHY will welcome a line from those who wish to become a part of the new Emergency Organization or MSN net members. Please inform FUZ, 2802 S. Western, Los Angeles, Calif., of your activity.

(Continued on page 73)

(Continued from page 76)

DELTA DIVISION

TENNESSEE—SCM, James B. Witt, W4SF—The following report was written up by GQL. BXG has been with a Chicago war plant and will be very unhappy over the loss of 160 meters. You may recall he was assistant net control of the 160-meter 'phone net called "The Knot Hole Net." FCJ, FET, and CHI worked in the same department of a war plant at Alcoa, Tenn. FCJ has a 28-Mc. 'phone rig but has no place for an antenna. FRM has been working at the atomic bomb plant at Oak Ridge. GQI has been with American Airlines at both the Memphis and Knoxville terminals. DHI, formerly of Maryville, has worked for Glenn L. Martin since early in the war. He, too, will be sorry to see 160 meters go. FUW was working as a serviceman when last heard of in Maryville. GQL has been in the Navy since Sept. 1944, first as an aviation cadet and at present in the radio technician training program.

HUDSON DIVISION

NEW YORK CITY AND LONG ISLAND—SCM, Charles Ham, jr., W2KDC—The Long Island Emergency Net activities have been considerably slowed by difficulties in changing from 112 to 144 Mc. Reports are very consistent and phrases like—"not enough drive," "no efficiency," "receiver won't super"—etc., etc., ad nauseum. However, the regulars continue and the ECs will welcome new or old members. In Nassau, FI, AES, RZ, and CET have acted as control in past month. Also active there are KNA, NBQ, IDJ, BJR, CMU, 3AIE/2, and 3AIX/2. AMT, OBW, JWO, BRV, and GLC are active in western Suffolk County. On Dec. 17, the Queens and Nassau controls successfully interchanged complete lists of stations. Drills every Monday at 9:00 p.m. The Sunrise Radio Club is becoming firmly settled in new QTH and plans code classes Tuesday p.m. They meet regularly every Friday. RZ is having trouble with R-C super. Feedback from his call? AES and GLC bought crystal-controlled frequency meters and are very satisfied. Helps find 144, they report. GLC and MHH are negotiating for Super Pro. Lucky boys. Farmingdale has a 28-Mc. QRM problem (they say) with ASW, KNA, MHH, and RZ on. They should live in N. Y. C. IJXT has super de luxe mobile on 144. Only trouble it drains the battery in no time. Automatic rag chew limiter? CET worked 1CLH at Bridgeport for first reported across L. I. Sound contact. The Farmingdale gang continues meetings, which incidentally were not even halted during war. KTTU, tired of 28 Mc. (already?), is going to 144. BVE on terminal leave, lives in Ridgewood and shares time with 28 Mc. and his twins. HVD is at Lido Beach separation center. However, Cliff only works there, he's not out yet. LC and JWE operate Broadcast Station WPAT. Bill was in merchant marine on tanker and spent time on West Coast. Pete is married and has a girl. BSL is rumored to be returning to business and adding a local ham as partner. HPB, radio op. on *California* at P.H., is now married J3V's rig was libelled by guests as a "safe" and then "a filing cabinet." Chas. Judge, who also visits Tom, drives Admirals around Brooklyn Navy Yard. BOT sells surplus supplies. Hams in Navy Yard kept 112-Mc. gear in their lockers and rigged it up evenings to bedsprings (no hammocks?) for QSO. JIH promises 90 watts on 144. He was heard working a J with beam headed west on 28 Mc. HNC, after four years in Army, returned and found "stored gear" in good shape. He swears by an SW3 on 28 Mc. Stan wonders where BAA is; he was a 28-Mc. enthusiast. In Suffolk ADW found 144 first (and only one). EBT, GAH, and KDA are on 28. DOG's receiver OK on 144 but no signals on. GIJ is out after five years in Navy. Bert is a civilian working for Navy at 90 Church Street now, and wants to let the gang know he's back. He received a commendation from Admiral Halsey. Ted Jerome (LSPH), of Sunrise RC, is going to Vermont permanently. Federation of L.I.R.C. to meet soon, will propose March hamfest and early Hudson Division convention in N. Y. C. KDB back from lt. comdr. to 144 Mc. Also JRB from Panama. Vin Kenney, BGO, is to be SEC; he did yeoman work as N. Y. C. radio aide for WERS and will continue.

NORTHERN NEW JERSEY—SCM, Winfield G. Beck, W2CQD—Yours truly is operating the Ham Shack at 1280 No. Broad St., Hillside, Elizabeth, N. J., where you can buy your nice fresh filter condensers, etc. NEL recently welcomed his second jr. operator, a boy. Everybody is doing nicely. The Bloomfield gang was reported to be on the broadcast band!—via WAAT and the Coffee Club. BCN, CVS, and OLV were guests on the program and really gave the boys and girls the dope on ham radio. Sounds like an awfully good idea too, fellers. If you get the opportunity to do any of this missionary work, hop to it. It's good dope and lots of fun, too. The Monday Nite Club, which usually met at CQD's and comprised such regulars as LI, AZL, IZC, CSL, HMB, HFP, and EUI, now meets at the Ham Shack in Hillside. The Ham Shack is open every evening 6 p.m. to 10 p.m. and Saturdays from 9 a.m. to 10 p.m. Drop in any evening or Saturday and bat the fat with the gang. 73. "W4n."

MIDWEST DIVISION

KANSAS—SCM, A. B. Unruh, W9AWP—We report with sorrow the passing of Frank Baughman, W9ZQP. His license was secured while a patient in a TB sanatorium. Pronounced cured, he worked for a time at KFBL. His death, ironically, was from another ailment. Fellow members of WARC assisted at the funeral; a final tribute to a stout heart. The December meeting of Wichita ARC was addressed by IGJ, returned after four years in the Navy's Air Force. Bob gave a play-by-play account of his personal adventures, ranging from teaching radio-radar school to hand-to-hand encounters on Jap-infested islands. YZX, YYW, and QEF are also home from the Navy. KQJ keeps the broadcast station and police radio working at Great Bend. QQI is in the Army at Sheppard Field, Texas. KKV claims a record—23 years with the same call and QTH. Also on 28 Mc. at Dodge City are VEL and SAM. KCS, active on the Kansas prewar traffic nets, is at Naval Hospital, Portsmouth, Va. He was on the first aircraft carrier attack on Tokyo; also active at Iwo Jima, Okinawa and Yokohama and others. Three fingers on left hand were casualties. OZN and AWP are operating c.w. at KGPZ. PGL and DJL have three-element rotary beams, with moderate input to final and excellent results. BEZ/W5, formerly of Wichita, enjoyed Albuquerque-Wichita "home town" QSOs with DJL, QQT, and AWP. If you are on the air, any band, send in a report. 73. *Abie*.

MISSOURI—SCM, Mrs. Letha A. Dangerfield, W9OUD—Actual operating news is still very much on the scant side around here, but we have several letters from the gang. First request for AEC membership comes from YHZ. KPM spent Christmas in China—his last was spent in Guam—and says he and the other hams in his outfit are working fine DX on ten. EYG, former Mo. SCM, let his ticket lapse but still is a League member and will be back on the air. ZXX received a medical discharge from the Navy and has been on ten but the results were not very satisfactory. BRN is competing with his 75 watts against ARA's kw. and having fun. MFN has set up his law practice again after leaving the merchant marine and has looked the old rig over. He says SPY is intermittently on ten, the rig itself being intermittent, and they have enlisted the help of CZY of Sikeston in case of emergencies. NSU and his brother looked over the transmitter and had it going for a few minutes before a condenser blew. QXO says the Central Missouri Amateur Radio Club has reorganized to meet alternate Thursdays with NIP, pres.; AOP, vice-pres.; QXO, secy. The club call is ZJK. PUV, after thirty-six months in England, France, and Germany, had the 144-Mc. rig on. TBU, released from the merchant marine, is working for Meissner. JWJ and GYZ have a rig on ten—ZVM invited them over to open the band. QZV, out of uniform, is working at a radio store. BMS and OUD think it might as well be spring! Good luck to you all and CU soon.

NEBRASKA—SCM, Arthur R. Gaeth, W9FQB—DNW, out of the Navy, is on 28-Mc. 'phone with a 50-watt 6F6 e.c.o.-807 final, NC 200 and a 7-Mc. $\frac{1}{2}$ -wave antenna. 5EEA/9, located in Omaha, is using an 802 final, suppressor grid modulated. RQK has an 807 final, a pair of 2A3s as

(Continued on page 80)



MILITARY model HRO Receivers are now available for sale to amateurs. Perhaps your dealer has already shown them to you. These "Military Model" receivers are not identical to the receivers you bought before the war, nor are they like the HRO-5A receivers that are just beginning to come down our production line in very limited quantities. Since we have never described the military receivers, we think it would be well to say a few words about them for the benefit of prospective customers. First of all, by "military models" we mean

a series of receivers differing in details, but alike in their high standards of construction to pass rigid performance specifications. We built several models. The RCE, the HRO-M and the HRO-MX were the first military models produced by us. Inasmuch as these were for military service, no amateur bandspread was provided. These three models had glass tubes.

In 1944 the HRO-5 and the HRO-W were furnished. These receivers had metal tubes and were built to JAN (Joint Army and Navy) AWS (American War Standards) specifications. Again, no bandspread was included.

In addition to the above, three other models were made — the RBJ, the RAS and the RAW. These receivers were made strictly to Navy requirements, although they were similar in appearance to the HRO. All had glass tubes. The crystal filter, signal strength meter and amateur bandspread were omitted. The RBJ and RAW had a standard 455 KC IF amplifier, while the RAS used 175 KC.

As stated above, none of these military receivers were built with amateur bandspread ranges. Furthermore, bandspread coils made for receivers of the standard HRO series can not be adjusted to give good performance in them. We are preparing bandspread coils for use in these receivers. A set of four coils covering frequencies from 1.7 to 30 MC and taking in the 10, 20, 40 and 80 meter amateur bands will cost about \$60.00 net to the amateur. This price includes alignment and adjustment to the receiver, but does not include repairs or transportation charges. To obtain good results, the receiver must be returned to the factory. We expect that the coils will be ready about next May.

Before the War, many HRO-Junior receivers were sold without bandspread coils to amateurs who found the general coverage coils entirely satisfactory for ham use. The PW Dial on the HRO has an effective scale length of over twelve feet, with the actual tuning done through a precision, preloaded worm drive. Such an arrangement provides more actual bandspread than is found in many bandspread receivers, and is very satisfactory even under adverse conditions.

The bandspread coils for the HRO are certainly a great convenience. The fact that each amateur band, regardless of width, begins and ends at 50 and 450 on the dial is worth the price of admission in the opinion of most amateurs. The point we wish to make, however, is that the HRO-W series of receivers are thoroughly competent for amateur work, just as they stand, with or without bandspread. Also, the HRO-W is a bargain for any man's money.

S. W. BATEMAN



(Continued from page 75)

modulators, a Howard 430 receiver, and a long wire antenna. IJF has 175 watts to a pair of 812s, TZ 20s Class B, SX24 receiver, 3/4-wave doublet. QQN put his T40s on 28 Mc. VKT has a 6L6-812 cathode-modulated rig. VIG is running 250 watts to a pair of 808s. UFD is using 6L6-807-812 exciter rig. SHF has a little Guthman on 28 Mc. SHH, after four years in Coast Guard, is getting his Stancor 20P rejuvenated. RUH purchased a little 7C5-7C5 rig from UFD and has worked both coasts. EKK works nothing but K6s and local stations with his 45 watts and half-wave doublet a full wave above ground. YZK was visited by HSA, who is now with the Nebraska State Highway Patrol. NFD is field representative for Westinghouse working out of Minneapolis. FUV has a 6L6 to a pair of 6L6s, cathode modulated. YBS is using 6L6-6L6-pair of 6L6s, S22R receiver, 40 watts. IPL has 6L6 pair 6L6s, SX24, and half-wave Q antenna. UEV is working K6s with 6L6-807 rig, 24 watts input, three-element beam. FQB is using a long wire antenna and a 6L6-807 rig. YMU reports that the Northeast Nebraska Radio Club in November held its first get-together since the war. The Ak-Sar-Ben Radio Club elected the following officers for 1946: UFD, pres., UEV, vice-pres., FQB, secy., VHS, treas. 73. Art.

NEW ENGLAND DIVISION

MAINE — SCM, G. C. Brown, WIAQL — In accordance with the plan of the ARRL Emergency Corps your SCM has appointed UP, 53 Grant St., Bangor, as SEC. Phil is well known over the Section, served as radio aide in the CD unit, and has been active in CAP Communications. ECs will do well to write the SEC and give him an outline on the activities in their areas. Speaking of ECs, there are too few in the Maine Section. Why not get together on this and let's have a real Emergency Corps? JTH is in the Navy. QH is working in the Bangor Post Office. A nice letter from FBJ with the following items: MUD is doing FB on 28-Mc. 'phone using 120 watts and a 3-element rotary beam. MXG is using a pair of 812s on 28-Mc. 'phone. MCW is on 28-Mc. 'phone at Cape Elizabeth. LNI, FXA, and FBJ were the first Portland hams to make contact on 144 Mc. GXY is using 15 watts on 28-Mc. 'phone. ISJ is using a vertical ant. on 28. ECM is operating fixed portable. DEO is heard on 28. MUD, IYP, and FBJ worked BST on 28-Mc. 'phone via a rebroadcast through XR on Mt. Washington. LNI has 260 watts to a pair of 812s on 28. GKJ is building a 28-Mc. rig.

EASTERN MASSACHUSETTS — SCM, Frank L. Baker, jr., W1ALP — We are sorry to have to report the death of a well-known ham from this section, SL GYZ is a lt. comdr. and is living in Takoma Park, Md.; he now has four children. IPZ and DDC are working for Watson Lab. in Cambridge. LZV is working for the A.D.T. in N. Y. and is moving to Verona, N. J. LID is in the Dutch East Indies. QW, out of the Navy, has moved to Newburyport and is working in Lawrence. MQX writes a letter aboard ship at Jacksonville, Fla. and hopes to be discharged soon. He says that NIC has been out for a few weeks. EHT is now working for National Co. in Malden. NVI, 9ULR, writes from Tulsa, Okla., and says he will be a W5 some day. He is working in the research department lab of the Stanoline Oil & Gas Co. DBH is in Atlanta, Ga., and has been on 28 Mc. using the call of 5JOV. He will be out of the Army in a few months. NEZ is working for Western Union in N. Y. and has been out of the Navy about a month. He will be a W2, and says he has a nice little XYL and an 11-months-old YL. The South Shore Amateur Radio Club held its meeting with the following present: LMG, IHA, EUW, HXM, KJD, CPD, CPB, MMU, GYZ, FVD, CT, DDO, LFD, GOU, BDM, MME, AJA, MD, AKY, KXN, JOB, CCL, ALP, JXU, EHT, API, WK, 5JED, Jack Burfitt, Bob Inglis, Hoxie, Mugford twins, and Byers. EHT gave a talk on the rig described in Dec. QST. API is working for Columbia U. in New York City. DNL is working for State College in Pa. B. L. Toy (LSPH) is a sophomore at Harvard and is waiting for a call to go on the 2-meter band. 2MWX is working for Polaroid in Cambridge. 3BSY is an engineer at C.C.R. in Cambridge. NNK is in the Navy. More hams on 2 meters

are: NFK, PE, FVR, JZ, QD, FH, NAV, JQA, HM, KSA, NFX, MCR, JSM, MQM, JTF, FVL, NQA, LAT, KWD, 3BSY, and ILL. ALP is working on a rig for 2 meters and hopes to be on soon. I want to thank all you hams for the many Christmas cards and hope you had a nice Christmas. ALP and EHT had a nice visit at ARRL. If any of you are in that vicinity, I suggest that you drop in and see what keeps QST going. KH says he spends a few days in New York City and a few in Washington, D. C. MPT is home again and says he hopes to be a civilian soon. IXD is a civilian and is back at his old job in Boston and living in Water-town. He was with the M.P.s and traveled all over the country.

WESTERN MASSACHUSETTS — SCM, William J. Barrett, W1JAH — The Worcester Emergency Radio System is in the midst of reconversion, with more experimenting than operating. CH has worked all districts except W2, including K4, K6, K7, and EA1D, FASCC, LU7AZ, and LU9EV. FNY reports the arrival of a jr. operator. Culver is still stationed at New London. BVR has resigned as Section Emergency Coördinator, with the suggestion that BSJ be named to the job. Effective at once West Massachusetts emergency activities will be under the direction of Ike Creaser, BSJ, 76 Cortland St., Springfield 9. Nominations for EC for each of the former warning districts should be sent to BSJ. How about dusting off the pen or the mill and sending in some dope for the report? 73. Bill.

NEW HAMPSHIRE — SCM, Mrs. Dorothy W. Evans, W1FTJ — HJI reports he is active on 2 meters in Washington and is having a swell time. KKQ is studying photography. JKH has taken unto himself a YF. Congratulations, Sully, MIP is home on leave from the Navy. BAC is located atop Mount Washington and may be QSOed on 10-meter 'phone. Seems good to hear signals on 10 meters from the different parts of our Section. Many different calls have been logged here in our shack. Your SCM would very much appreciate it if you fellows would send in nominations for a new SCM. Have tried to keep things rolling during the war years, but now that the boys are coming home it seems only right that someone else should get a chance at it, so please cooperate with me and with ARRL by sending in nominations. 73. Dot.

RHODE ISLAND — SCM, Clayton C. Gordon, W1HRC — JXA sold his receiver. LGH is on 28 Mc. 3JJW/1 is on 28 Mc. and has been very helpful in testing with HRC, who has his e.c.o. rebuilt. It was discovered that leaving the loudspeaker on for break-in while transmitting caused e.c.o. to go microphonic from speaker thumps. The goal of the Crystal Ball article is still to be attained. DQ is on 28-Mc. 'phone. HJB has been heard on 28-Mc. 'phone also. NES, stationed at Cape May, was home for Christmas furlough. BEB is working everything in sight with his "lazy-H" on 28 Mc. JEZ has moved to Wickford. Had several nice cards from the gang at Christmas time, one from LWA/6.

VERMONT — SCM, Burtis W. Dean, W1NLO — JEN is stationed with USCG at Easthampton, L. I. ELJ is with medical detachment at Camp Lee, Va. ILD is Army captain in the Philippines. FSV is with the Navy in the Caroline Islands. MZO is S2c in the Navy. AAJ has returned to Rutland. JXS is with GE's general engineering and consulting labs in Schenectady, N. Y. QQ is living at Central Falls, R. I. AD and IDW have been working on 2 1/2 meters with FB results. BJP and CUN have been experimenting on 112 Mc. Sixty-five attended the hamfest at Waterman Bldg. 2DC gave a demonstration of 2400 Mc. oscillator and GE wire recorder. Don Wheatley (LSPH) won code contest, with GKA runner up. AD, AVP, IDW, KXP, LWN, and NLO have converted to 144 Mc. On Nov. 19th KXP went up on Mt. Wauchussets, near Worcester, Mass., and worked three states on 144.6 Mc., with 60 miles maximum DX. MCQ is changing his 160-meter rig to 10 meters. AVP and KNC are on 28 Mc.

NORTHWESTERN DIVISION

MONTANA — SCM, Rex Roberts, W7CPY — AST, T/S in Alaskan Communications, is back in Forayth, making the move to Anchorage, Alaska, permanent. AYG (Continued on page 82)

POST WAR SERIES-400

"Super-Pro"

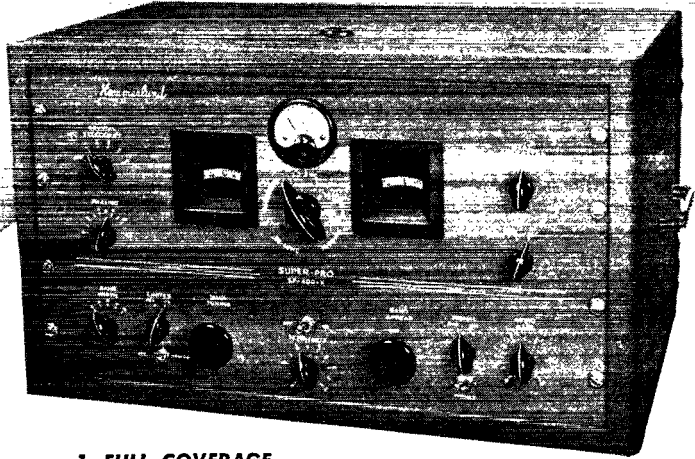

**FULL COVERAGE
.54-30 MC.**

1-FULL COVERAGE

2-VARIABLE CRYSTAL SELECTIVITY

3-VARIABLE I.F. SELECTIVITY

4-FULL BAND SPREAD

5-IMPROVED NOISE LIMITER 6-ADJUSTABLE S METER

Greatly Improved Performance

This is the greatest "Super-Pro" ever offered to the professional or amateur operator. Your new 400 Series "Super-Pro" covers the broadcast band as well as the 10 meter amateur band and its performance is greatly stepped-up through war-time developments.



HAMMARLUND

THE HAMMARLUND MFG. CO., INC., 460 W. 34TH ST., NEW YORK 1, N. Y.
MANUFACTURERS OF PRECISION COMMUNICATIONS EQUIPMENT

SMOOTH and SILENT

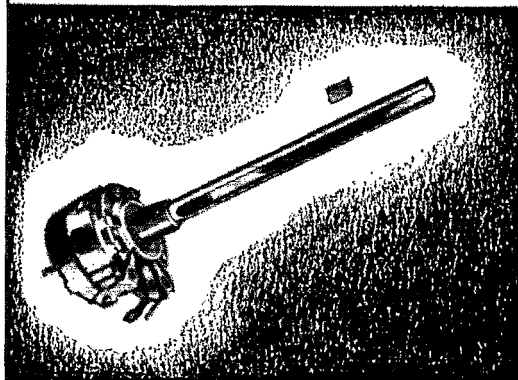

Mallory Volume Controls are precision-built like a watch—are quiet in operation. A new type resistance element defies wear, gives longer service. Accurately controlled tapers insure uniform control of volume. A simple A-C switch snaps on and *stays* on. That's why it pays to use Mallory controls on all radio equipment.

The Mallory control line is complete. There is a correct control for every application, including standard and midget sizes, wire-wound units for higher power dissipation, and T and L Pad types.

For replacement recommendations, consult the Mallory Radio Service Encyclopedia—or see your authorized Mallory Distributor.

P. R. MALLORY & CO., Inc.
INDIANAPOLIS 6 INDIANA

P. R. MALLORY & CO. Inc.
MALLORY

(Continued from page 80)

is looking for new receiver and transmitter to get back on the air. The Butte ARS held a meeting with the Anaconda gang at Opportunity. Anaconda formed its own club with the following officers: EQP, pres. Cliff Herberg, vice-pres.; Marguerite Jones, secy-treas.; Cunningham and Haverman, trustees; Bill Jones, scribe; and CME, examiner. EMF, EQM, CJN, HEM, FTO, FYN, BOZ, EWR, HIZ, BXL, and DSS are reported on ten meters. BMX is out of NCR and will enter U. of W. soon. CNP is one of the research engineers with Bendix Radio at Baltimore. GU, of Boise, Idaho, was a Butte visitor recently. FL is at home on terminal leave. CT is reported home from the Navy. Harry Baker, a BARC member, has been discharged from the Navy. IAY is reported discharged. CPY and DXQ are trying to work ten meters sixty miles over the hills. Thanks, gang, for the FB reports this month. 73. Rex.

OREGON—SCM, Carl Austin, W7GNJ—EBQ, of Astoria, says he will be on 28 Mc. as soon as his new exciter is finished. The old rig wouldn't respond to this high frequency. He mentions that AYW, who spent the duration as a "guest" of the Japs, is back on furlough. AYW was on 28 Mc. as a KA before the war. K6CIB, of Salem, has received his new SX-28A and likes it fine. AUH, now in Tanana, Alaska, heard the following W7 stations on 28 Mc. during a three-hour period of listening: EYS, DMN, IGI, AGU, AXS, HKA, HRV, FMT, EDK, FNK, ILR, EHQ, IGM, and HWZ. Bary reports temperature at about -30, with three feet of snow. HVX will be on 28 Mc. as soon as he gets his rig out of storage at Bend. ARZ mentions that during the eclipse of the moon, after 5:30 p.m. he heard stations in Guam, Okinawa, Tinian, etc., as well as 6s and K6s. He uses an 8JK antenna. Too busy to build, HJI bought the 28-Mc. rig of FZK. HJX is out and back at KBND as operator-announcer. MQ, of Pendleton, reports high interest in ham radio in that vicinity, and that GKM is back after forty-six months in the Navy, got himself married, and is on 28 Mc. MQ and GPO, his XYL, are on 28 Mc. with a peanut whistle but doing OK. 73. Carl.

WASHINGTON—SCM, O. U. Tatro, W7FWD—Since there was no amateur radio activity during the war this space was given over to news of the whereabouts of the various amateurs of the section. We now want to know of your activity and what you accomplish. Please contact your EC or send information direct to this SCM and let the gang know about your successes or your problems. The organization of communication chains or networks is of particular interest and we would like to hear about it. Let this column reflect the activity of this section. Yakima: HCE, EC, after pruning coils and adding filament chokes, is wiring a 2-meter transmitter-receiver and reports FCZ, YARC president, is bearing down on the housing committee for a club home besides making chassis and shield boxes out of 3/32" aluminum; US is loaning the pilots' relay-room of his flying school, where the annual Christmas party was held, for temporary quarters. ARF has offered to loan the club his transmitter and seven unlicensed members are about ready to make the trip to Seattle for examination. EDR was the only local on 28 Mc. Dec. 5th. Seven of the gang have signified their interest in emergency communications. CAM and AWX, on 2 meters, are trying to find out what areas of Yakima County can be covered directly on 2 meters and which populated areas out of reach can be covered with one relay station. Bremerton: EPT reports good results on two meters with 9SSQ/7, EYE/7, 6RST/7, and 8ISE/7 active. Bellingham: HDG is building around a pair of HK54s after blowing up the power supply of his 70-watter and reports the gang want to organize a club and affiliate with ARRL. ILR is on 28 Mc. with 240 watts. FOR was about ready to go on the air when a new baby girl halted operations temporarily. BBP and FXD are on 28 Mc. GNR is building from scratch and his boss (Jerry's Service Shop) has invited any ham to come in and use a bench in back of shop and any test equipment. Overseas: HUK reports from Italy that he will be on soon with an X call by permission of a commanding officer. And from EKW, Teingtao, China, comes this: "Too muchee long time no home see, Old friends across the sea, One little chit me sendee you, Talkey Melly Klisimas, and New Year too." 73. Tata.

PACIFIC DIVISION

EAST BAY—SCM, Horace R. Greer, W6TI—SEC, EE; EC, QDE; EC v.h.f., FKQ; Asst. EC v.h.f., OJU;

(Continued on page 84)

AVAILABLE NOW!

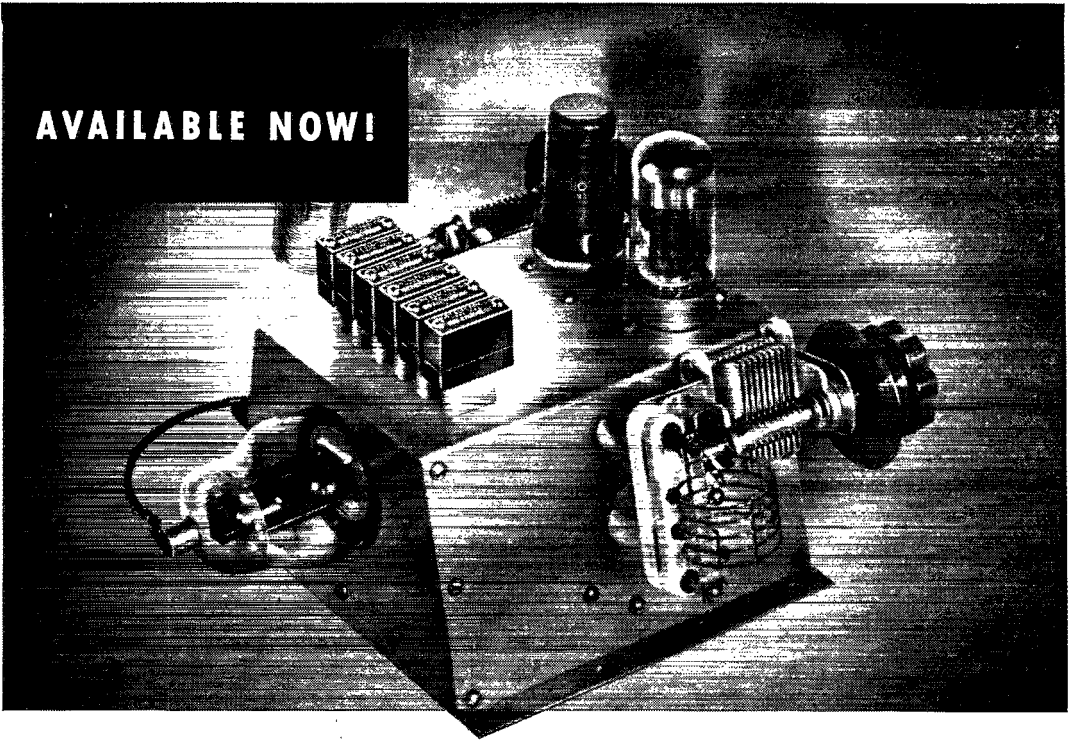

TYPE AX2, THE NEW BLILEY CRYSTAL FOR AMATEUR FREQUENCIES

Just one look at the many features that make up this new type AX2 and you'll understand why we say it's a worthy successor to a long, famous line of Bliley Crystals for amateur frequencies:

- 1 To prevent "aging" it is acid etched to frequency by Bliley's patented process.
- 2 Nameplate calibration accurate to $\pm .002\%$ at 25°C . in factory oscillator.
- 3 Temperature stability better than $\pm .02\%$ between -10°C . and $+60^{\circ}\text{C}$.
- 4 Activity level tested between -10°C . and $+60^{\circ}\text{C}$.
- 5 Stainless steel, coined electrodes, contact plates and spring.
- 6 Solid, stainless steel pins.
- 7 Welded contact between pins and contact plates.
- 8 Neoprene gasket seal.
- 9 Moisture resistant, molded phenolic case and cover.
- 10 Small, compact size permits easy stacking. Two units may be mounted back to back in standard octal socket.

Not a thing has been overlooked to insure top performance under any conditions encountered in amateur equipment. All our wartime experience is reflected in this new model, engineered specifically for amateur frequencies.

Frequency selection from your Bliley distributor's stock

TYPE AX2

3500-4000kc . . . \$2.80 ea.

7000-8222kc . . . 2.80 ea.

Prices on 20-meter and special order crystals to be announced shortly. Keep in touch with your Bliley distributor for latest information.

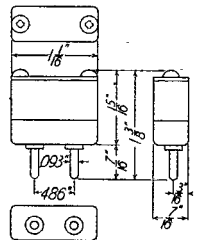

Bliley

CRYSTALS

CARDWELL'S 4 IN 1 TRIM-AIR

The PL-6293 Trim-Air, illustrated and described below, is a typical Cardwell value—four capacitors in one with a multitude of possible uses. It is an example, too, why Trim-Airs are a prime favorite of engineers and experimenters. A study of its features will convince you that it can be a valuable and versatile part of your rig.

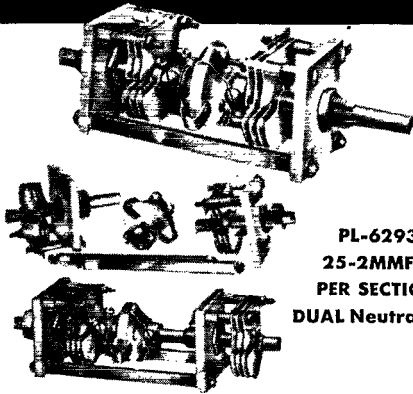

PL-6293
25-2MMFD.
PER SECTION
DUAL Neutralizer

10 Features and Uses of PL-6293

- Single Control Dual Neutralizer type construction.
- Rotor sections insulated from each other.
- Drive shaft at either end.
- Rotor lock on shaft bushing for permanent set or tension regulation.
- Each section can be set independent of the other.
- Rotor coupling removable; condenser becomes "B and-Spread" type.
- Two complete individual and separate condensers, by removing coupling and tie rods.
- Fits all standard Trim-Air brackets, mounting posts, etc.
- Original CARDWELL Trim-Air beryllium tension washer and front bearing at each end.
- Sliding rear bearing eliminated. Airgap constant.

Watch for announcements of startling new communications equipment incorporating many wartime advancements.

CARDWELL CAPACITORS



THE ALLEN D. CARDWELL
MANUFACTURING CORP.

Main Office: 81 Prospect St., Brooklyn 1, N. Y.
Factories: Plainville, Conn. — Brooklyn, N. Y.

(Continued from page 88)

OO v.h.f., ZM. EE has been appointed by your SCM to the new post of Section Emergency Coördinator. His duties will be the SCM assistant in charge of promotion or organization for amateur radio emergency work for all section communities. He will coördinate and implement a section program for this purpose. All those interested in emergency work and all who were signed up in WERS please contact Lloyd and get signed up for this all-important work. On Dec. 20th the following officers were elected to the Oakland Radio Club, Inc., for 1946: pres., BF; vice-pres., EE; secy., ZM; treas., OLL; chief opr., OZA; sgt.-at-arms, AKB; director-at-large, PTD. They meet the first and third Thursday evening at 8 p.m. at their new location in the Lincoln Club House, 11th and Alice Street, Oakland. Everyone is welcome. On Dec. 21st our Director, EY, took over the Master Chair in his lodge. The following are on 28-Mc. 'phone; the figures following calls show input to the final stage: QBL 700, QBR 300, RPY 150, PTD 35, OBJ 33, MRM 500, SUZ 75, OZA 350, KRM 25, LMZ 150, OJU 50, NJX 30, EJA 175, RMM 300; also TNM, MNG, AHG, UFD, AKB, KEK, and IUF. NPP works everything he hears on 28 Mc. with his rotary beam. IKQ's XYL has taken to radio like a duck takes to water and can be heard on 28 Mc. 'phone every night. The 144-Mc. band is plenty active of late around here. OCZ has new 350-watt rig, also TT and DUB. They were built for the Army during the war. SQ has a swell mobile rig on 28 Mc. and works plenty of DX on 'phone and c.w. Every day finds new stations on 28 Mc. Don't forget to send me what you are doing so I may include it in *QST* each month. 73. "TI."

SAN FRANCISCO — SCM, William A. Ladley, W6RBQ — Phone RA. 8340. Asst. SCM, GPB, ECs, DOT, KZP, OO, NJW; OBS, FVK, NJW, KNH. The Marin Radio Club held its annual Christmas dinner at the Bluerock Hotel on Dec. 15th at Larkspur and the following attended: HVX, DIX, SG, IBZ, TIJ, TSQ, ZM, OZC, RAK, MUF, FVK, MRZ, EY, RBQ, QGN, RM1a G. A. Nielsen, MAX, JKN, LHH, ONP, DNY, WB, SVRM, and Lt. Comdr. Pinky Delassaux. Many YLs of the above also attended. RAK did an admirable job as master of ceremonies. A grab box was passed around to both the ladies and the men present which added to the fun of the evening. CRM Thomas C. Nelson, 6QGN, who was reported lost early in the war and later turned up in Japan as a war prisoner, gave the guests some idea of the hardships these men suffered at the hands of the Japs. Tom has been a member of the Marin Club for many years. His wife attended the dinner with him. Director McCargar gave a short talk on League affairs. The San Francisco Radio Club expects to hold its first meeting within a few weeks. This has been held in abeyance because of lack of meeting quarters. RAH is back on the air on 28-Mc. c.w. WN is rebuilding with a new Eimac 4-125A in final. RBQ is building three-element beam, LES is back on ten meters, as are most of the other locals. Two meters, which was deserted when ten meters opened, is picking up again. RBQ has a new 100-watt 'phone and i.c.w. rig on 2 meters. WB is planning a new antenna on 28 Mc. DOT is working South Americans on c.w. CVP also shows up on ten-meter c.w. DJI is with Associated Radio. CIS soon will move to a new location near South City in San Mateo County. Another loss to the San Francisco gang. PGF, on 28 Mc. 'phone for the first time, lives next door to MZ. The code class continues at the California Guard under CVP. This unit may be mustered out early in 1946. So long, gang, and thanks for the support. 73. Bill.

RYANOKE DIVISION

NORTH CAROLINA — SCM, W. J. Wortman, W4CYB — Considerable activity has been noted since the opening of 28 Mc. Some of the fellows are back on the air in Asheville, Gastonia, Greensboro, Winston Salem, High Point, and Charlotte. The Charlotte Amateur Radio Club has been reorganized with the following members: W4CAY, NX, FXV, HJY, BX, HKD, DLX, FUU, HUI, HGC, HEB, EIV, EYF, CQ, CYB, W3IUA/4, W2OAZ/4, M. J. Minor, R. C. Miscally, and C. S. Marsh. The only letters or cards received in the past year have come from BHR and FXU. Please note change in QTH of the SCM and report any activity, or news that comes your way.

VIRGINIA — SCM, Walter G. Walker, W3AKN — The following are active on 28 Mc.: Norfolk: BEK, PK,

(Continued on page 88)

ENJOY THYRATRON CONTROL

for

- Chirpless, sparkless, clickless keying
- Stepless control of phone or CW output

with

UNITED

TYPE 967

December 1945 issue of QST says:

4) Don't have just one power setting, your maximum. Be able to reduce power and to trim it to the minimum needed to sustain satisfactory communication. That will vary with conditions and the distance. FCC regulations require it. We should be ashamed to cause interference at a thousand miles when talking to another station only five hundred miles away.

5) Give honest signal reports.

UNITED type 967 grid controlled rectifier tube offers new pleasures for amateur radio operators—both phone and CW enthusiasts.

A pair of these tubes in your power supply will give you modern and superior performance, and will eliminate the need for regular half-wave rectifier tubes.

Ask your local distributor for a copy of the special UNITED pamphlet giving all details, including schematic and parts list.



UNITED TYPE 967

FILAMENT

2.5v 3.0 amp.

FULL WAVE CIRCUIT

MAX. P.I.V. 7500v

MAX. IP (per tube) .250ma

IONIZATION TIME

10 microseconds

\$6.00

UNITED ELECTRONICS COMPANY

NEWARK 2



NEW JERSEY

Transmitting Tubes EXCLUSIVELY since 1934

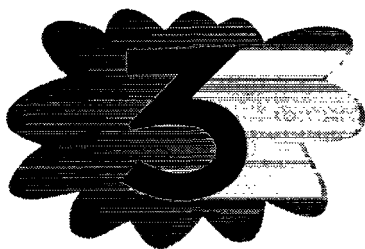

STAR NOW TEAMED

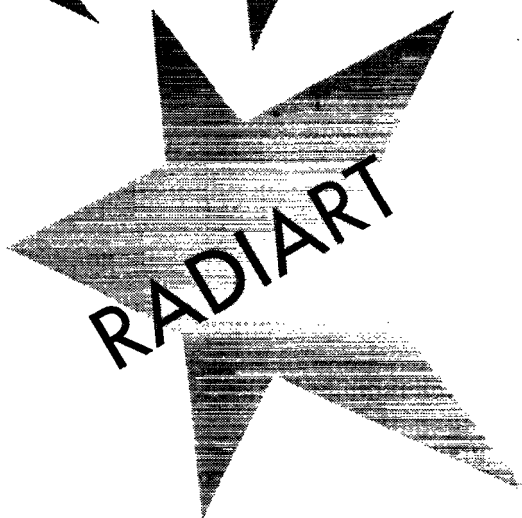

IMPORTANT!

For Faster, Better and More Complete
Service to All Customers,

Maguire Industries, Inc.,

formed its new

Electronic Distributor
and

Industrial Sales Department

This New Department Will Assume All
Merchandising, Sales & Customer Relation

Duties and Responsibilities Essential in
Marketing the Combined Products of the
Thordarson, Meissner & Radiart Divisions



**ELECTRONIC DISTRIBUTOR AND
INDUSTRIAL SALES DEPARTMENT**

PERFORMERS... TOGETHER!

ONE SALES SOURCE... ONE MARKETING RESPONSIBILITY
YOUR GUARANTEE OF BETTER SERVICE!



MEISSNER

COMPONENTS AND KITS

Meissner precision built components include Antenna, R.F. and Oscillator Coils; plastic, standard and Ferrocart Transformers; Cartwheel and replacement Windings; Coils, Chokes and Accessories.

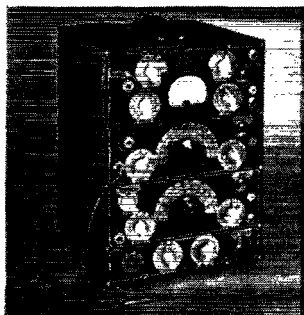

MEISSNER ANALYST

SERVICE INSTRUMENTS

Meissner Analyst operates by the "signal tracing" method, fastest and most reliable. Furnished complete, ready to go to work. Portable Signal Calibrator designed for accurate checking and adjusting of radio equipment.



RADIART

RUST-PROOF AERIALS

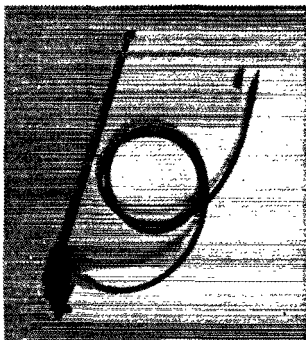

RADIART RUST-PROOF AERIAL

A complete line of newly designed aerials to fit all cars; cowl, fender and under hood types. Featuring water-proofed leads, "static muffler" magic ring and permanent all metal anti-rattler.



VIBRATORS

Radiart Correct Replacement Vibrators are individually engineered to meet exactly the physical as well as the electrical requirements of each application.



THORDARSON

TRANSFORMERS

Quality built and precision-engineered for all requirements; replacement, communications, sound amplifier, industrial, experimental and amateur. Tropex-impregnated for protection against moisture, salt air and humidity.



THORDARSON TRU-FIDELITY AMPLIFIER

TRU-FIDELITY AMPLIFIERS

True-Fidelity Amplifiers, in new modern designs, feature advanced tone compensation, conservative ratings, ample ventilation for continuous operation, low hum level, multiple input channels, and maximum flexibility of controls.

MAGUIRE INDUSTRIES, INC.

936 NORTH MICHIGAN AVENUE, CHICAGO 11, ILLINOIS

Get back on the AIR with . . . SHURE STRATOLINER MICROPHONE

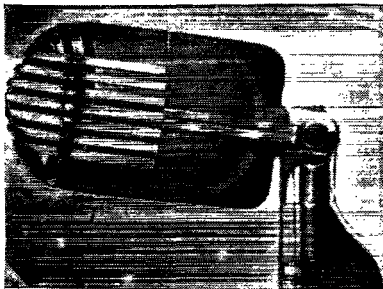

This expensive-looking, low-cost Microphone reproduces your voice clearly and fully. High output level with sharp speech response. Designed especially for Communications, Recording and Public Address. Has all the features of more expensive Microphones such as swivel-head, built-in cable connector. Genuine Bimorph Crystal. Model 708A.

List Price \$21.35

SHURE 707A CRYSTAL MICROPHONE

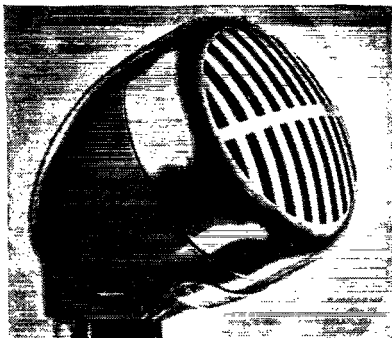

A quality Microphone at low-cost—has long been a favorite among HAMS for dependable service and clear speech reproduction. High output. Attractive modern die-cast case in Iridescent Gray finish with highly-polished plating on front grille. Model 707A.

List Price \$13.50

Available at Shure Distributors
everywhere

Licensed under the Patents of the
Brush Development Company.



SHURE BROTHERS

Designers and Manufacturers of Microphones and
Acoustic Devices

225 W. Huron St., Chicago 10, Illinois
Cable Address: SHUREMICRO

(Continued from page 84)

FQP, IQY, HWT, DHZ, 8PGL. Portsmouth: EAI, BAW, 4IIE. Newport News: MT, GGP, IAG, AJA at Hampton is back on 28 Mc. with pair of TZ20s in the final. AKN is building new v.f.o. for all-band operation. ICZ moved to Yorktown, Va. 9QAF has gone home to St. Louis. Reports from WS say the Richmond gang is reorganizing the Richmond Radio Club. First meeting was held Nov. 11th. Visitors included 4DW and ex-3AGH. Club plans for 1946 include classes in theory and code, and two types of membership. The Norfolk Radio Club has been reorganized and held its first meeting during early Dec. The Peninsula Amateur Radio Club is beginning to show signs of reviving. Brig. Gen. Ed Lynch is now commanding general, Hqtrs. Eleventh Air Force, APO 980, Seattle, Wash. Ed reports that several of the officers who hold amateur licenses are getting ready to put up ham stations at Adak, Alaska, the Hqtrs. of the Eleventh Air Force. Navy Lt. P. B. Schroeder, 3IEX, is back from the So. Pacific and may be reached at 2907 Delaware Ave., Santa Monica, Calif. Karl Wikstrom, 3IIF, and family have returned to Virginia and are temporarily located at Langley Field. MT has a new 28-Mc. beam that works nice and puts out a fine signal. Let's have more news from those parts of Virginia so far unheard from. 73. Walt.

ROCKY MOUNTAIN DIVISION

COLORADO — SCM, H. F. Heikel, W9VGC — Mrs. Martha A. Stedman, the wife of our late director, C. Raymond Stedman, W9CAA, his family, his father, Mr. C. R. Stedman, W9CAB, and Ray's aunt, Miss M. W. Raymond, wish to express their sincere thanks to all the amateurs in the Rocky Mountain Division for the flowers and many expressions of sympathy; they were deeply appreciated. The amateurs of the Rocky Mountain Division wish to thank the acting director, Howard Markwell, TFP, who acted in our behalf in sending a beautiful floral piece as an expression of our sympathy. 28 Mc. activity has been on the increase. Many new rigs are doing big things and old ones developing bugs. 3HPL, on his way home in Catasauqua, Pa. from the Pacific, had a short layover in Denver. 8KHT expects to spend the rest of 1946 around Denver. EHC is taking up new job with CAA. He expects to have a rig on the air as a W5 at Ft. Worth, Tex. and schedule his brother, FXQ, in Denver. DZB starts his school days again in March at C.U. in Boulder. YFJ took over the job at the Denver Airport when LYJ moved out to his new job with NBC. FAN is on his way back to duty with the AAF. FKK got back from the Pacific and expected to go to work for Western Electric. ZEF and family are located in that jack rabbit country just west of Denver where his XYL and little YL are waiting for "Junior" some time early in the summer. As soon as the spring cleaning is done the radio widows are heading for another of their picnics in the mountains. 73. By Heck.

UTAH-WYOMING — SCM, Victor Drabble, W6LLH — The following report was submitted by 7HDS of the Wyoming gang. 7BAH was the first in Cheyenne on 10 meters when the band opened and was followed by 7EUZ, 7HDS, 7ICZ, and 9OWZ/7. 7EHV transported two forty-foot poles from Fox Park for his new antenna system. 7BCL has been selected as EC for Cheyenne. 7EHV is building a new 10-meter rig for use at Ft. Warren. 7GDB enjoyed a furlough in Cheyenne from the Navy. 7HRM is home after 15 months in South America. 7IIB returned after serving in India. 6TVN, a new-comer to Wyoming, is welcomed by the Cheyenne gang. 7IMJ services the transmitter at KOA. The officers of the Shy-Wy Club are 9TGU, pres.; and Elmer Snow, secy. F. Keel, from Sheridan, Wyo., reports the gang there is busy remodeling its rigs for the 10-meter band. The following hams are home after serving with Uncle Sam: 7CSE from the Navy, 7IAD from the Seabees, and Eli Daniels from Alaskan service. 6IWIY bought a nice new SX-28 receiver. 6OUM finally got on 10 meters. 73. Vic.

SOUTHEASTERN DIVISION

ALABAMA — SCM, Lawrence J. Smyth, W4GBV — The Montgomery Radio Club had its first postwar get-together this month and nearly all the hams in town, including the following, showed up: GKZ, EW, GVO, APJ, EFD, GSO, AHO, DVJ, GBV, ECF, ANT, 6ANM/4, HEG, AUP, EIB, AEZ, ATF, GGC, GDU, EAY, and HKG. A fish supper was furnished by McInnis and Nolen, and a big time was had by all. The following hams in Mont-

(Continued on page 80)



ALCO has been awarded for the fifth time the Army-Navy "E" Award for continued excellence in quantity and quality of essential war production.

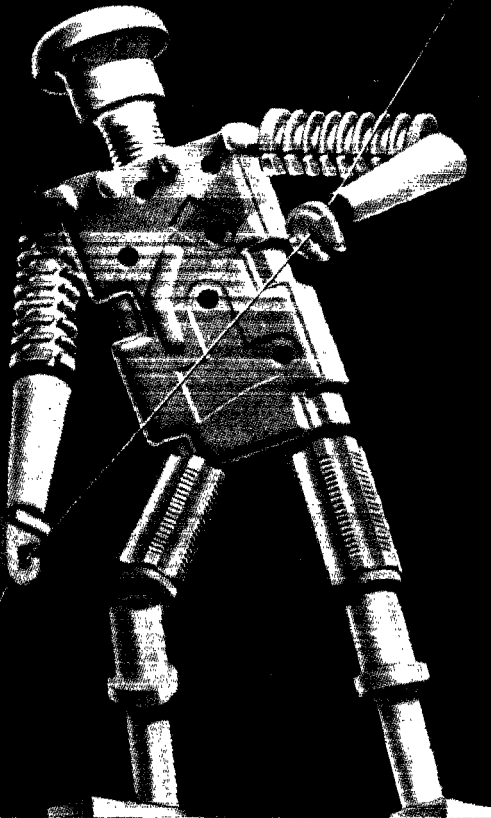

MASTER OF POWER AND HEAT

MANY of the brilliant advances in electronics made during the war, including extensive use of ALSIMAG Steatite Ceramics in radio, radar, communications, controls and high frequency heating, will be carried forward into peace-time products of *quality*.

Of prime importance to the efficiency and stability of high frequency circuits is insulation whose composition and strength is master of both power and heat.

Permanent in their hardness, strength and rigidity, ALSIMAG Steatite Ceramic Insulators are not subject to distortion, warping or shrinking.

Exceptionally Low Loss Factor, High Dielectric Strength and High Resistivity.

Let us prove that ALSIMAG will meet your requirements.

AMERICAN LAVA CORPORATION

Chattanooga 5, Tennessee

43RD YEAR OF CERAMIC LEADERSHIP

**Quality to Highest
Known Standards
Large Production
Facilities
Research and
Engineering
Collaboration**



CERAMICS

Better Look Into The ...

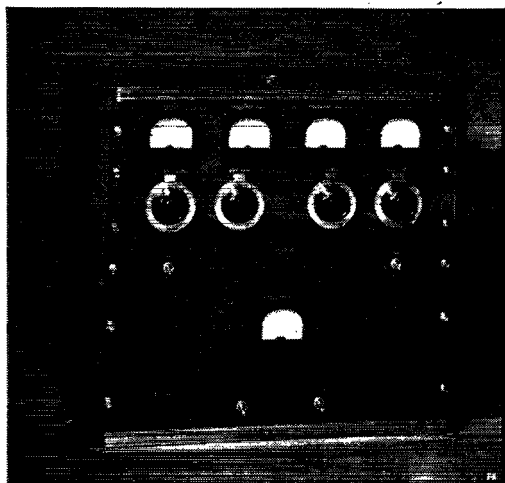

HARVEY MODEL 100-T TRANSMITTER

The HARVEY 100-T Transmitter is a plate modulated unit of moderate power that provides real "air" performance. It has everything a "ham" wants—appearance, 5-band operation, quick frequency shift, ease of tuning and low cost.

A pre-war favorite of amateurs, the HARVEY 100-T is still built to the same high standards of quality and endurance that qualified it for Admiral Byrd's Antarctic expedition and countless other important missions throughout the world during the war.

For complete information on the 100-T and other HARVEY Transmitters write for free Transmitter Bulletin.



HARVEY RADIO LABORATORIES, INC.

451 CONCORD AVENUE
CAMBRIDGE 38, MASSACHUSETTS

(Continued from page 88)

gomery are very active on 10 meters: AUP, EW, HEG, FVS, GGC, 6ANM/4, GBV, with AUP calling the roll on the round table after the band folds up. 6ANM/4, acting as OBS, gives us the latest dope from W1AW. Birmingham hams also are having their round table and the writer would like to hear from them and any others active on 10 meters. 73. *Larry.*

EASTERN FLORIDA — SCM, Robert B. Murphy, W4IP — Your SCM is down in San Juan, P. R., on a temporary assignment with PAA, but will endeavor to give you a report. A letter from GVC shows the postwar activity that is about to come up. A ham club is being organized in Orlando. All are interested in 28-Mc. activity and the following are on the air: QN, GIY, and 8BRL/4. Three more of the gang, DWI, ASE, and GBZ, are working hard to get on. We'll be looking for you guys out here at the listening post. Have not run in to K4KD, the local SCM, as yet, but have some cards out looking for him. Puerto Rico has some very good 28-Mc. 'phones on. Most of the fellows are working back to their own home towns. One fellow here is working into Chicago and talking to his wife. AAO, who will be remembered as one of Pop Jones' aides at IR during the prewar days, is here. I am staying with him and we expect to get something on the air for 28-Mc. operation. The nearest I have come to hearing Miami was High Point, N. C., but the skip may catch it just right one of these days. My next report will be from Miami. I am looking for members who will be interested in Section Emergency Coordinator and Official Observer appointments. Other appointments will be made as they are released. The line forms on the right, fellows, so let's get into this thing with a gang. We do need a good hurricane net in the State. Let us all get on the old ham band wagon and set up our 'phone and c.w. nets, then when the bands open we will be already to go. Let me see a stack of mail on my desk when I get back to Miami. 73. *Merf.*

WESTERN FLORIDA — SCM, Lt. Edward J. Collins, W4MS — DAO is on 28 Mc. and going strong. BKQ was first on 28 Mc. from Pensy. EQR is increasing power on 28 Mc. EZT is planning better antennas on 28 Mc. MS is planning plumber's delight for 28 Mc. 8MJX is moving back to New York. 9MEI has applied for his Ø. UW is busy at WCOA. QK is busy rebuilding. JV has started building. ECT plans 28 Mc. c.w. ACB was host to MS Thanksgiving. EAD is a civilian and becoming a Ø. DXZ is cleaning up beam. VR is waiting for 7 Mc. FHQ likewise. AXP is building in a rack. HJA wants a receiver. FJR likes 28 Mc. c.w. AXF is happy over 28-Mc. activity. DXQ is awaiting 7 Mc. opening. 73 de MS.

WEST INDIES — Acting SCM, E. W. Mayer, K4KD — The FCC returned our gear Sept. 19th. Nov. 15th found several of the gang ready to go. W4DAN/K4, W4IEN/K4, W8UAK/NDU/K4, W9MDQ/K4, K4HLLP, and K4KD were on Nov. 15th. K4JA, W4BZA, W4DYX, and W6PQE expect to be on 28 Mc. shortly. W4AAO/K4, with PAWA at WMDU, plans to get on. K4FAB is overhauling preparatory to resuming W9FFB skeds. W8UAK/K4 put W9FFB in contact with his folks in P.R. K4HEB is the proud daddy of a boy born Nov. 28th, making a granddaddy of K4KD. HEB expects to be on the air soon. The SCM's mail address is Box 1061, San Juan 5, P. R., so drop him a card with dope for these reports. Thanks and 73. *Ev.*

SOUTHWESTERN DIVISION

ARIZONA — SCM, Douglas Aitken, W6RWW — QWG was discharged from the merchant marine and will attend U. of A. in the spring. IIG writes that he now is a captain and communications inspector with HQ. AAL, TYD, JHV, and MDD are out of service. BRI is secretary of the Arizona Radio Club, which recently held its first postwar meeting. DZW, wounded and in the hospital, reports hams there had 2½ meters going. NRI is in Williams in the Forest Service. QNC was heard on 28 Mc. in Florida on Nov. 18th. Wonder who was first in Arizona to go on? GS is putting up a rotary beam. The Tucson Short Wave Association is staging a big hamfest in March. There will be eats, drinks, ball, and real prizes. Hope everybody can attend. Among the out-of-town boys on ten meters are 5J1U, 9GQ, TNJ, PKZ, and FDW. MDD is back again. PDA is at Ajo. QJL is back at Mesa. 73. *Doug.*

SAN DIEGO — SCM, Ralph H. Culbertson, W6CEV — Asst. SCM, Gordon W. Brown, W6APG. Activity around

(Continued on page 94)

A New Jensen Coaxial

TYPE H

WITH *Compression-type* HIGH-FREQUENCY SPEAKER

The first of a new series of JENSEN Coaxial Speakers, combining in one coaxial assembly a horn-type high-frequency speaker with a cone-type low-frequency unit. By unique design, the cone of the low-frequency unit forms a part of the high-frequency horn, thereby dispensing with a separate horn. An integral two-channel network gives the desired crossover characteristics. Thus this new Coaxial Speaker provides the quality of reproduction so essential and desirable for radio receivers and phonographs for home entertainment, particularly for FM reception and high quality phonograph recordings.

The distribution characteristics of the Type H Coaxial are excellent and, when installed in a suitable enclosure such as a Bass Reflex cabinet, its performance covers the entire frequency range useful in home reproduction.*

Type H Coaxial, illustrated here with field coil low-frequency speaker and *ALNICO 5* high-frequency unit, is designed for manufacturers. Other models for more general use, incorporating *ALNICO 5* design in both high-frequency and low-frequency units, will shortly be announced.

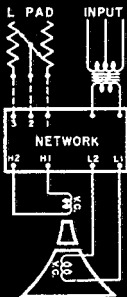

Low Frequency Motor

High Frequency Driver

High Frequency Horn - Low Frequency Cone and Continuation of High Frequency Horn

Low Frequency Speaker

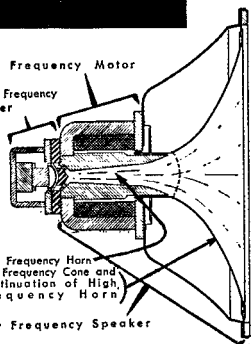

TYPE H SPECIFICATIONS

Power rating 25 watts maximum, in speech and music systems. Input impedance 16 ohms. Field 14-20 watts. List price approximately \$100.00.

*See No. 3 JENSEN Monograph: "Frequency Range in Music Reproduction," for discussion of useful frequency ranges.

Other Coaxials Now Available!



These Type J Coaxials, improved over prewar design, offer low-cost Coaxial performance in home radio receiver and phonograph entertainment.

JAP-60 (15-inch) with HF Control Switch. List price . . . \$79.45

JHP-52 (15-inch) with HF Control Switch. List price . . . \$56.15

JCP-40 (12-inch) HF Level Control extra. List price . . . \$33.45

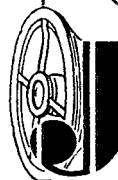

Jensen

SPEAKERS WITH
ALNICO 5

JENSEN RADIO MANUFACTURING COMPANY
6611 S. LARAMIE AVE. • CHICAGO 38, ILLINOIS

IN CANADA—COPPER WIRE PRODUCTS, LTD. • 137 OXFORD STREET, GUELPH, ONTARIO

Specialists in Design and Manufacture of Fine Acoustic Equipment

Actual
Size

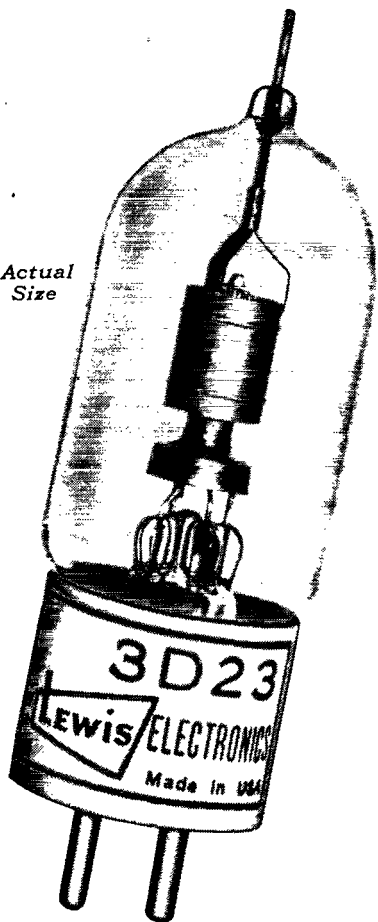

Licensed under R. C. A. Patents
Tantalum Plate
Medium 4-Pin Ceramic Base
Filament voltage 6.3 volts
A.C. or D.C.
Filament current 3.0 amperes
Maximum Power Input
175 watts at 250 MCS
Plate Dissipation 35 watts
List Price \$10.00

New

HIGH FREQUENCY BEAM TETRODE

BEAM POWER AMPLIFIER

130 Watts Output at 250 MCS

FREQUENCY MULTIPLIER

35 Watts Output Tripling

MODULATED AMPLIFIER

60 Watts Output at 250 MCS

A "LEWIS at Los Gatos" Transmitting Tube

The 3D23 will fill a long vacant gap in the field of high frequency communication. It is a very excellent beam power amplifier at 250 mcs. and can be used at half power input as high as 450 mcs. No neutralization is necessary at frequencies as high as 150 mcs., if adequate shielding is provided. Above this region a small inductance inserted in the screen lead will prevent self oscillation. As a frequency multiplier the 3D23 can furnish a power gain of 7 while doubling and 6 while tripling—this even in the neighborhood of 200 mcs.

Available at your dealer now

Lewis

Subsidiary of **Aireon**
MANUFACTURING CORPORATION

ELECTRONICS
LOS GATOS • CALIFORNIA

Aireon

Cinaudagraph Speaker

Engineered for High Fidelity

True High Fidelity, long-lasting and trouble-free, is built into the design, construction and materials of every Aireon Cinaudagraph Speaker. The result of exacting research and precision workmanship, the Aireon Cinaudagraph Speaker incorporates many electronic and acoustical developments for stamina and tone. The design of the special polyfibrous cones . . . the Acim voice-coil form, impervious to moisture or temperature variations . . . the use of Alnico 5 "the miracle metal" in the magnet structures . . . ribbon wire voice coils . . . are only a few of the plus factors which give Aireon Cinaudagraph Speakers the more efficient performance you require.

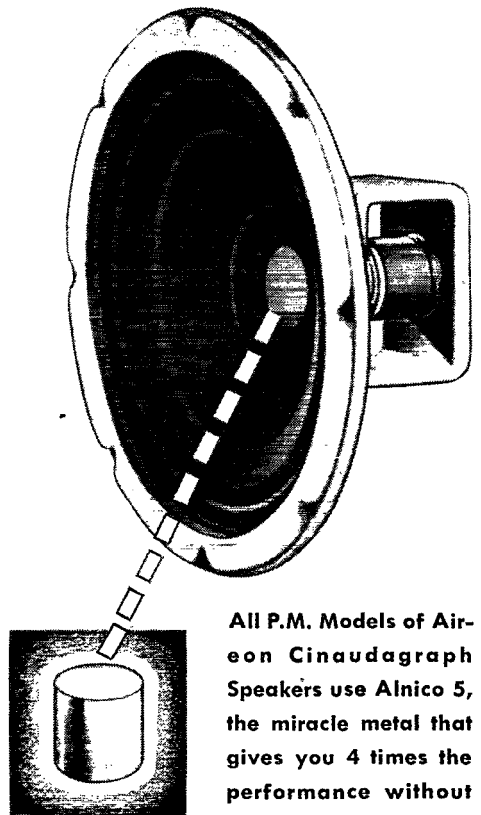

Alnico 5

All P.M. Models of Aireon Cinaudagraph Speakers use Alnico 5, the miracle metal that gives you 4 times the performance without size or weight increase.

Cinaudagraph Speakers, Inc.

Subsidiary of **Aireon** Manufacturing Corporation

3911 SOUTH MICHIGAN AVENUE, CHICAGO



PEERLESS POWER TRANSFORMERS

Constructed from the best in silicon core steels, enameled copper wire, and high quality insulating materials to provide a product capable of continued long life under the most difficult conditions of heat and humidity. Several attractive types of mountings available. Other transformers, windings, reactors and fluorescent ballasts in sizes and capacities to meet *your* needs. Prompt delivery if you order now. Write for new catalog.

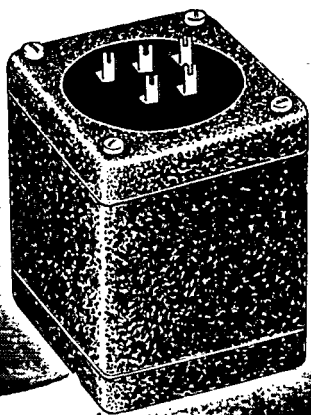

Choice Territories Open for Qualified Representatives

Cool Running Long-Lived



PEERLESS

ELECTRICAL PRODUCTS CO.

6920 McKinley Avenue
Los Angeles 1, California

(Continued from page 90)

San Diego has started out with a bang with the following stations noted operating on 28-Mc. 'phone: AD, AIX, CHV, EOP, EOW, LRU, LKC, OCJ, OFT, OJZ, OXQ, OZH, PAX, QEZ, QKI, RFX, RFJ, SIG, SYH, UNU, 3IKF, 5IVI, 7HAW, 7HFG, 8OCT, 8TCL, 9ITS, and 9YST. PAX, home on Thanksgiving vacation, had a chance to try out his new rig and worked FB all over U.S.A., K6 and K7. EOP reports the Helix Radio Club has resumed bi-monthly meetings. LKC has been keeping schedule with W1KFS/KB6 on Guam. OCJ has new rig on 28 Mc. running about 300 watts, and new three-element rotary beam with FB reports including several KB6. BKZ reports hearing EA1 on an SW3. OZH increased power to 500 watts and is handling lots of traffic from K6 and KB6; he reports schedule with a J4 on 28 Mc. LRU has an FB sounding rig on 28 Mc. running about 150 watts to a pair of 809s, cathode modulating with pair of 2A3s. The Palomar Radio Club had its second regular meeting at Escondido at the home of BOS. A fine turnout was witnessed with about thirty members present. New officers were elected for the coming year: APG, pres.; MHL, vice-pres.; NDD, secy.; LKC, treas.; DUP, bleeder (tongue twister). An FB raffle was put on with QEX walking away with the main prize. Refreshments were served by the XYL of the host. EWU put up a two-section 8JK for 28 Mc. QEZ rebuilt the 28-Mc. mobile rig for the car running about 10 watts with a vertical antenna coax feed. KW is reported working at Western Radio for RGY, who will go to the hospital for a major operation. (All the gang wishes you a speedy recovery, Fred.) 73. Ralph.

WEST GULF DIVISION

NORTHERN TEXAS — SCM, Jack T. Moore, W5ALA — JFF is located at Camp Swift. ISD recently completed a course in long distance telephone communication in Paris, France. Haynes says he is going to do some f.m. work on the high frequencies when he gets home as he has had some experience with it in the Army and it looks good to him. KRL was home from the Navy recently on a 30-day furlough. LY is showing signs of interest again by renewing his subscription to QST. GSS was commissioned a navigator in the Air Corps but the old radio bug wouldn't let him stay away from the squadron radio shack where he often assisted the communications officer. Manning is back at Texas A. & M. resuming work toward an E.E. degree. FMZ is plugging away at his job of rural mail carrier. FCV is stationed in Northern France at a large Signal Depot and is waiting for 20 meters to be released as he has plenty of radio equipment with which to work. HMO is going to Oklahoma U. HZB is going to Texas A. & M. to get an E.E. degree and sends the following news: FRE transferred to the Dallas office of American Tel. & Tel. the first of the year; FAJ is working for the same company at Dallas; HYE has received his discharge from the Signal Corps; JIE has worked India and Egypt on 10 meters. The Dallas Amateur Radio Club held a reorganization meeting in December with an attendance of 81. Please note that the SCM has a new QTH: 4529 Fairway Ave., Dallas 4, 73. Jack.

Oklahoma — SCM, Ed Oldfield, W5AYL — The Muskogee Amateur Radio Club became reactivated as of Nov. 21st and is off with a "bang!" Present at that historic meeting were BFZ, KON, GZN, JIQ, HFV, RU, and BGR. Elected for the balance of 1945 were BGR, pres.; GZN, vice-pres.; BJE, secy.-treas. New unlicensed members, as well as XYLs of GZN, HFV, RU, and BGR, attended. The XYL's auxiliary is reactivating. BJE starts up with a new 5X-25 receiver. HFV has decided to change his address to Tulsa. GLD, a new man at Muskogee and chief engineer of KBIX, is on 28-Mc. 'phone. BGR says that the *Blooper*, MARC's monthly amateur paper, will be printed again. FAB says push-pull is fine stuff after trying to neutralize a couple of HY40s in parallel on 28 Mc. KBA got out the other day with 14 watts and an antenna strung up in the room. W1AW puts in a fine signal on 7145 kc. and 3555 kc. at Oklahoma City, and with the up-to-date information OCARC voted two new directors to replace the two who have left the O.C. area. Door prizes are to be featured at club meetings to help stimulate attendance. HXX is assistant air inspector at Hendrix Field, Sebring, Fla., and has charge of the communications equipment with lots of work to do. Regards. Ed.

(Continued on page 98)

✓✓
**ONLY HAMMARLUND RECEIVERS
 HAVE THIS FEATURE...**

UNITED STATES PATENT OFFICE 2,222,043

SELECTIVE WAVE TRANSMISSION
 2,222,043
 Donald E. Oram, Forest Hills, N. Y., assignor to
 The Hammarlund Manufacturing Company, Inc.,
 incorporated, New York, N. Y., a corporation of
 New York

This invention pertains to electrical apparatus
 and circuits of the type known as filters and
 more especially to such apparatus and circuits
 of the type referred to as band pass filter.
 One object of my in-

Application June 28, 1939, Serial No. 281,612
 8 Claims. (Cl. 178-44)

incorporated in such receiver to such a degree as
 may be found necessary, and to make such re-
 duction quickly and to a predetermined degree.
 Another purpose is greatly to attenuate

HQ-129-X

The variable crystal filter
 used in the "HQ-129-X"
 and the "Super-Pro" is an
 exclusive Hammarlund
 patent. It provides wide
 band crystal selectivity for
 use in crowded amateur
 phone bands and single
 signal code reception.

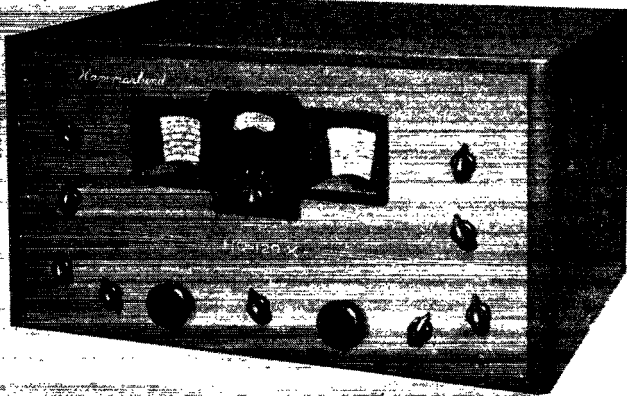

HAMMARLUND

THE HAMMARLUND MFG. CO., INC., 460 W. 34TH ST., NEW YORK 1, N. Y.
 MANUFACTURERS OF PRECISION COMMUNICATIONS EQUIPMENT

HUDSON AMERICAN

High Quality

TRANSFORMERS



Our many years of experience in manufacturing and our intimate knowledge of Transformer requirements in the field, is your assurance that Hudson American Transformers and Reactors will give you the utmost in reliability and economy of operation.

Write for catalog 1045

HUDSON AMERICAN CORPORATION
A subsidiary of Reeves-Ely Laboratories, Inc.
25 W. 43rd STREET, NEW YORK 18, N. Y.



Now—a really high-powered



RADIO ENGINEERING LIBRARY

- especially selected by radio specialists of McGraw-Hill publications
- to give most complete, dependable coverage of facts needed by all whose fields are grounded on radio fundamentals
- available at a special price and terms

THESE books cover circuit phenomena, tube theory, networks, measurements, and other subjects—give specialized treatments of all fields of practical design and application. They are books of recognized position in the literature—books you will refer to and be referred to often. If you are a practical designer, researcher or engineer in any field based on radio, you want these books for the help they give in hundreds of problems throughout the whole field of radio engineering.

5 VOLS.
3319 PAGES,
2289
ILLUSTRATIONS

1. Eastman's Fundamentals of Vacuum Tubes
2. Terman's Radio Engineering
3. Everitt's Communication Engineering
4. Hund's High Frequency Measurements.
5. Henney's Radio Engineering Handbook

Free Examination • Special Low Price • Easy Terms

McGraw-Hill Book Co., 330 W. 42nd St., New York 18
Send me Radio Engineering Library, 5 vols., for 10 days' examination on approval. In 10 days I will send \$3.00, plus few cents postage, and \$3.00 monthly till \$24.00 is paid, or return books postpaid. (We pay postage on orders accompanied by remittance of first installment.)

Name.....
Address..... Company.....
City and State..... Position..... QST 2-46

(Continued from page 94)

NEW MEXICO—SCM, J. G. Hancock, W5HJF—JLJ reports the Albuquerque gang really hot on 28 Mc. HAG was in Albuquerque in Nov. 9UVA/5 is on 28 from Roswell and wants to resume his ORS/OPS activities from there. Stations known to be on 28 Mc.: ZA, HPZ, DER, ISN, 9BEZ, 9UVA, and HJF. Plenty more have been heard being called. DER, KCW, and Howard Williamson came over from Clovis to help HJF get his gear to work on 28 Mc. Other visitors to the SCM: JLJ, David Erwin (LSPH), discharged from the Navy, and 9IRC, also discharged from the Navy. ENI discovered, the hard way, you can't bounce even an RME-69 off a steam radiator. 73. *Jack.*

CANADA

QUEBEC DIVISION

QUEBEC—SCM, L. G. Morris, VE2CO—Newly-elected officers of the South Shore Amateur Radio Club are: EP, pres.; BI, secy.; GL, treas. Members are BC, BE, BG, BI, BX, CA, CQ, DH, DI, ER, EP, GL, KR, LP, KY, PB, and PL. Meetings are held every second Monday, 8:30 P.M., at the club house in the Toc H Building, 628 Mercille Ave., St. Lambert. DE has transferred from the RCNVR to the RCN with the rank of Lt. Comdr. (E). BE, AX, and CO represented the ARRL Canadian Section at the first annual meeting of the Canadian Radio Technical Planning Board held in Montreal, Dec. 6th. Maj. 2AM is located at Canadian Military Hq., London, England. LC has been demobbed from the Navy; BU likewise from the Army and is back with the Bell Telephone Co. Also out is 2DO, who served as a flying officer with the RAF Transport Command in charge of radio installations for No. 45 Group. JJ, BG, BE, EV, and FS are active on 28 Mc. IE and HF are building exciters. Gang, over six years have elapsed since the last official list of Canadian ham stations was published. Your SCM is trying to compile an up-to-date one for Quebec. If your QRA has changed since 1939 please drop me a post card giving your new address.

VANALTA DIVISION

ALBERTA—SCM, C. S. Jamieson, VE4GE—BW and LQ had a race to get on 28 Mc. first. BW got tuned up on 5 meters accidentally so LQ was the first 10-meter 'phone on in Edmonton. The NARC mourns the loss of two past-presidents. XF and VJ passed away within a week of each other. XF was NARC president in 1939, while VJ held that office during the war years, relinquishing his post early in 1945 to LQ, vice-pres., on account of poor health. ALO makes his QTH in Edmonton. He has set up a rotary beam for 28 Mc. and is really going to town. He works K6s well after dark! AEV has set up a rig in Calgary and has nice reports on 28-Mc. 'phone. EY has his rig just about ready for 28-Mc. 'phone but needs one 809 to complete line-up. EA is busy working on "inhaler" at present! HJ recently was spotted leaving BW's joint with mike and modulation equipment. HF has a commercial ticket and is in charge of D.O.T.'s fan-marker station 20 or 30 miles from Whitehorse, Y. T. ABL found his 866s had gone soft on him. HM rebuilt the frequency-meter. He has finally got his exciter down on 28-Mc. c.w. and is working furiously to get 'phone equipment lined up. AH is sizing up the situation before going down to ten meters. AW reconditioned AEV's rig for him and is using it on 28 Mc. AJO is back there after getting around the country more than a little during the war. 5MJ, who works for Dominion Income Tax Branch, makes QTH in Edmonton and has the rig just about ready for 28 Mc. ATI is brakeman on N.A.R. passenger train to McLennan. BW softened up a pair of 807s in final on 28 Mc. He has come to the conclusion that 300 ma. at 500 volts is hitting one tube too hard! ADD is back from O/S and looking for discharge. Art is fit. lt., RCAF, and in charge of special radar equipment. XE is busy assembling a rig to get on 28 Mc. He already has "popped" four crystals trying to use regenerative oscillator. ACQ is impatient to get on the air again. US showed up at the last NARC meeting. IZ, who served with the New Zealand troops on New Guinea during the war, is in New Guinea and is expected back within the next few months. AAS showed up at the December meeting of NARC. Ray Wallace, holder of a commercial ticket, wishes to join the club. Wally Beaumont, ex-CU, also put in an appearance at the meeting and indicated genuine interest. EA heard RO on 13 meters the other day. Probably RO left too many turns on that tank coil

(Concluded on page 100)

McELROY "400" SERIES

COMPLETE AUTOMATIC RADIO AND TELEGRAPH TRANSMITTING AND RECEIVING EQUIPMENT

New designs, new features, new low prices. Immediate delivery, in any quantity. Illustrated catalog and technical manuals available in all commonly used languages.



McELROY TAPE PULLING HEAD
TPH-400

Admits tape from any angle from the right; prevents breakage; permits tape to come from any level on receiving table. \$45.00

McELROY WHEATSTONE CODE TAPE PERFORATOR
PFR-400

Designed to modernize small stations, at sea, ashore or on the air. For 110-120 volts, AC or DC. \$95.00

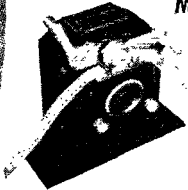

McELROY KEYING HEAD
HED-400

Complete with built-in polarized relay. Made without a Star Wheel opening in contact case; this assures clean contacts. \$240.00

McELROY UNIVERSAL DRIVE
MSD-400

Permits rapid interchangeability of keying head and tape pulling head. Save money on maintenance and spares. \$195.00

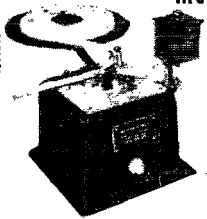
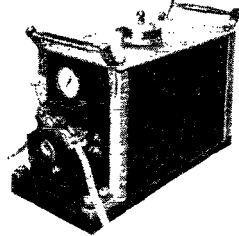

McELROY INK RECORDER
REC-400

Capable of speeds up to 700 words per minute. Tape holder, which is part of equipment, may be attached to right or back of case. \$195.00

McELROY RECORDER AMPLIFIER
MRD-400

Designed to drive the Ink Recorder at speeds to 300 words per minute. Cabinet or rack mounting. \$195.00



McELROY PHOTOTUBE KEYER
PTK-400

Delivers a tone code signal to from 1 to 50 headphones for operator training, and runs at low or extremely high speeds. \$45.00

McElroy engineers never copy, never imitate. We create, design, build . . . we are never satisfied with mediocrity.



McElroy MANUFACTURING CORPORATION

82 BROOKLINE AVENUE

BOSTON, MASSACHUSETTS

NEWARK SCORES AGAIN!

Fortunate buy of Government Surplus Gives Us

POWER TUBES!

Limited Quantities . . . All J.A.N. Specifications . . . All Standard Brands

RK34.....	\$2.25	HK24G.....	\$4.25
803.....	\$14.50	830B.....	\$6.75
811.....	\$2.25	HY114B.....	\$1.65
801A.....	\$1.85	HY615.....	\$1.65
5CP1.....	\$10.95	15E.....	\$8.95
211.....	\$6.45	15R.....	\$8.95



TAKE YOUR "TIME" WITH NEWARK!

Newark's Time Payment Plan

Minimum Sale \$50.00

6 per cent to be added to total unpaid balance

Down Payment 20 per cent of total, plus sales tax where sales tax exists

Unpaid Balance *Payable per Month*

\$40.00 to \$60.00.....	\$5.00
\$61.00 to \$100.00....	\$10.00
\$101.00 to \$150.00....	\$15.00
\$151.00 to \$200.00....	\$20.00
\$201.00 to \$300.00....	\$25.00
\$301.00 and over.	In twelve (12) equal monthly payments.

CHICAGO
Newark *ELECTRIC* **Company**
NEW YORK
 115-117 W. 45th St. NEW YORK 19 323 W. Madison St. CHICAGO 6
(ADOLPH GROSS) "Service is the Foundation of our Business" (SAM PONCHER)

SEE FACING PAGE
FOR OTHER BARGAINS



HAMS ... here are all the things you've been waiting for in **NEWARK'S** two big stores. Order from the store nearest you for fast service.

THIS MONTH'S FEATURES

McELROY KEY

The Deluxe — Model CP 810 **\$9.75**

0-500 D.C. MA. 2" round Bakelite case..... **\$3.50**

G.E. METERS

0-8 RF ammeter, 2" round Bakelite case..... **\$4.00**

ABBOTT TR-4

Compact, efficient 2½ meter transmitter-receiver less tubes and power supply **\$39.00**

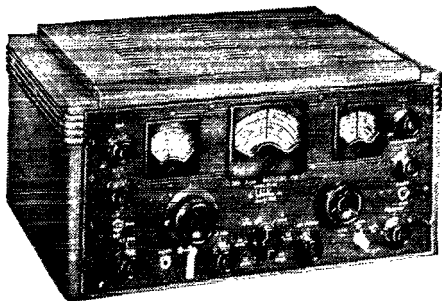

HALLICRAFTERS

SX-28A	Super Skyrider with crystal, less speaker.	\$223.00
S-20R	Sky Champion with built-in speaker.....	60.00
S-22R	Skyrider Marine with built-in speaker...	74.50
SX-25	Super Defiant with crystal, less speaker..	94.50
S-39	Sky Ranger portable, AC/DC and battery	110.00
SX-36	FM/AM receiver.....	415.00
S-37	V.H.F. FM/AM receiver.....	591.75
PM-23	10" PM speaker in cabinet for use with SX-25, SX-28A.....	15.00

TUBE BARGAIN

250TH (Famous make. Fully guaranteed.)..... **\$15.95**

NEWARK TRANSFORMER BARGAINS

45556	778 V.C.T. at 200 M.A. 115 V. 60 Cycle 6.3 V.C.T. at 5A. 5 V. at 30 amp. 91 lbs....	\$3.95
45557	15 H. 150 MA. 200 ohm 2000 V. Insulation 3½ lbs.....	\$1.95

CLOSE OUT ON METERS. \$4.95 EACH

Western Electric Micro-ammeter, Bakelite case fits 3¾" hole. Radium dial 150-0-150. Can be used with 0-200 micro and amp scale costing 15¢ additional. Excellent as a 5,000 ohm-pervolt meter or null, sound level and galvanometer indicator. Instruction included. No priority required.

4½" square 0-200 Micro-ammeter.

4½" square 100-0-100 Micro-ammeter.

NEWARK GUARANTEE

All merchandise advertised carries the usual Newark Electric guarantee of complete satisfaction!

HAMMARLUND

HQ-129X (with tubes).....	\$129.00
ASP-210X.....	318.00
ASP-210SX.....	318.00

Available for rack mounting at same prices

NATIONAL

NC-2-40C and speaker..... **\$240.00**

RME

RME-45 and speaker..... **\$166.00**

The famous Newark bargain oil-filled, oil-impregnated

FILTER CONDENSERS

Fully guaranteed at rated voltages

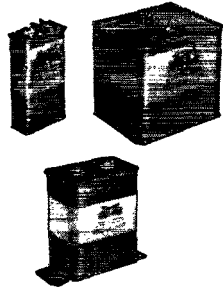

Capacity	Working Voltage	Height	Width	Depth	Wt.	Price
1 mfd.	1500 V. D.C.	2¾"	1¾"	1"	4 oz.	\$.79
17½ mfd.	1500 V. D.C.	3¾"	4¾"	3¾"	3 lbs.	2.75
11½ mfd.	1500 V. D.C.	5"	3¾"	1½"	1 lb. 10 oz.	2.00
5 mfd.	2000 V. D.C.	4"	3¾"	1¼"	1 lb. 4 oz.	2.15
8 mfd.	2000 V. D.C.	4½"	3¾"	2½"	2½ lbs.	2.75
.25 mfd.*	2000 V. D.C.	3¾"	1¾"	1"	6 oz.	.69
*Special Porcelain Insulators						
10 mfd.	3000 V. D.C.	4¾"	3¾"	3¼"	3 lbs. 8 oz.	4.75
15 mfd.	3000 V. D.C.	4¾"	4¾"	3¾"	5 lbs.	5.25
6 mfd.†	3000 V. D.C.	6¾"	6½"	3"	5 lbs. 6 oz.	3.25
†With mounting feet. Width includes mounting feet						
8 mfd.	3000 V. D.C.	7¾"	6½"	3¾"	7 lbs. 4 oz.	3.95
2 mfd. & 4 mfd.	600 V. metal can	4¾"	2½"	1¼"	14 oz.	.80

Get Your Name on Our Mailing List

Be first to get announcements of merchandise available, special bargains, etc., etc. Send name and address on post card. State whether amateur, engineer, school, industrial or service man. Address orders and inquiries to Dept. Q, at NEWARK store nearest you.

ALL PRICES SUBJECT TO CHANGE WITHOUT NOTICE

NEW YORK
Newark ELECTRIC Company
CHICAGO

115-117 W. 45th St.
NEW YORK 19
BRYANT 9-4735
(ADOLPH GROSS)

"Service is the Foundation of our Business"

323 W. Madison St.
CHICAGO 6
DEARBORN 0083
(SAM PONCHER)

COMPONENT PARTS

that make news . . . in stock at

HARVEY!

Do you wonder where you can get the parts you read about in your favorite magazines? Many of them are in stock at HARVEY. Yes, the very latest developments in radio and electronic components are here on our shelves (some military devices just released for ham use). And all favorite standard items you need, besides. Even if you don't see them in our ads, write in to ask about them. If HARVEY has them, we'll ship them immediately. Fast . . . reasonable . . . convenient, too!



Look... A
"LIGHTHOUSE"
TYPE TUBE
as mentioned in
Nov. QST!

General Electric's VHF
Triode, GL-446A—Brand
New; guaranteed perfect
\$8.00

A popular
necessity!

General Electric's 3 inch
square D.C. Milliammeter—
range: 0-150. \$3.95

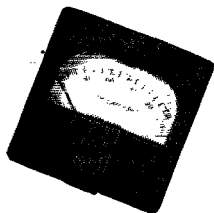

And the book all hams
are talking about!

Radiotron Designer's Hand-
book, Third Edition—One of
today's clearest and most
complete books on the
subject..... \$1.00

Telephone: LOngacre 3-1800

hrc
HARVEY
RADIO COMPANY

103 West 43rd St., New York 18, N. Y.

(Continued from page 86)

in the exiter! 5HW, former president of the Okanagan Amateur Radio Club, is in Edmonton and turns out to Club meetings. 5MJ has been advised that he will use the call 4HC in this district until the expected change-over on April 1st. AEV and ALO worked W1KSF, portable KB6, on Tinian in the Mariana Islands on 28-Mc. phone. ALO got an R5 S7 report from "Gil." Mary McIntyre, one of WH's two YL operators, has hopes of getting a rig on the air soon. The NARC is organizing classes for prospective hams. Code class and then a period of questions and answers and instruction on getting receivers and rigs on the air will be the general format. XE sneaked around to LQ's recently with a couple of vicious-looking absorption wave-meters to get them spotted on the 40-, 20- and 10-meter bands. Dick is having a bit of trouble getting grid drive to his 10s down on 28 Mc. We heard some U. S. 10-meter station calling MO the other day. The above report was written up by LQ.

PRAIRIE DIVISION

MANITOBA — SCM, A. W. Morley, VE4AAW — Only news this month comes from AHE. Harold reports ARE ready for 3.5 Mc. ALE has been in Australia with RCCS. ASP, who received his call just before the war, will be active on all bands. AJC, who has been with the Royal Navy, is on 4 months leave before reporting back. 73. Arz.
SASKATCHEWAN — SCM, Arthur Chesworth, VE4SY — The reorganization meeting of the Moose Jaw Amateur Radio Club was held at the home of OM. The following hams were present: JS, OP, KAM, ABI, ACO, ABA, HW, L. Nelson, SY, and one 4ZB. OM was elected pres. and ABI secy.-treas. Regular meetings will be held the second Friday of each month at the Army-Navy club rooms at 8 P.M. The finances of the club are in good shape and we are off to a very good start. At the conclusion of the meeting a very nice lunch was served by Mrs. Capper. All of the gang are overhauling the old rigs and several have been heard on 28 Mc. JV has been transferred to Regina and had the rig back on shortly after the ban was lifted. SY spends every Wednesday visiting YD at Medicine Hat. I find I am unable to handle the SCM duties for this district because of the work I am now doing. Being away from home from Monday morning until Friday night does not leave me much time to attend to the SCM position. So, boys, please get busy and elect a new SCM as soon as possible. Thanks a lot for the support you have given to me previous to the war and please extend the same to your new SCM. 73.

Strays

Radio communication might have been impaired and the work of producing quartz crystals materially increased had not an accidental fracture of a crystal revealed the usefulness of small size crystals. A South African amateur, after dropping his precious "rock," reported his accident to the American crystal manufacturer when ordering a replacement, stating that his crystal was now in tiny fragments which still worked!

From this chance remark grew the design changes that produced millions of military crystals at an enormous saving in quartz and expense. The former one-inch square crystals were replaced by tiny bits of quartz averaging less than three-tenths of a square inch in area. The thickness of the new crystals runs from fifteen to eighteen thousandths of an inch. Reduction in crystal size resulted in the production of more plates per pound of raw quartz and also in the use of quartz of a size and quality formerly considered non-adaptable to radio use. The saving in quartz is estimated at 1200 tons.



RME Owners Say!

ANRU

ALGEMEENE NEDERLANDSCHE RADIO UNIE NV.

*

AMSTERDAM.
Ketzersgracht 430
Telefoon 35770

Radio Manufacturing Engineers Inc
302 First Avenue,
PEORIA,
Illinois (U.S.A.)

REPORT about the use of Receiver RME 69 in service at the
Corps Government Communication Service at Amster-
dam and Amersfoort.

Gentlemen:

This receiver was in 1941 placed at the disposal of the underground organization Corps Regeerings Berichten Dienst (Government Communication Service) during the years 1941, 1942, 1943, 1944 and 1945. The receiver was handled daily for some hours to receive the daily news bulletins on shortwave length and to listen to signals of secret stations in England, which were transmitting secret messages to the underground forces in the Netherlands.

During the whole period of 5 years of the war the receiver has never been repaired. In September 1944 the receiver was sent to a farm in the neighbourhood of Amersfoort to act as communication receiver on a secret radio station. It has been in use on batteries and under all conditions.

In March 1945 the receiver was shipped to Amsterdam, but the Germans controled the transport and opened the case, in which the receiver RME 69 was packed. We foolisshed them in telling that the receiver was a laboratory test instrument and they believed it.

So the RME 69 reached its destination and was for 24 hours daily in service on the radio station P.A.D., transmitting station of the Corps Government Communication Service in Amsterdam. A picture of the RME 69 "in service" is enclosed herewith.

We are convinced for ever that the RME communication receivers belong to the most reliable receivers in the world.

Sincerely yours,

J.M.F.A. van Dijk,
Director



FIVE YEARS IN DUTCH UNDERGROUND.



FINE COMMUNICATIONS EQUIPMENT

RADIO MFG. ENGINEERS, INC.

Peoria 6, Illinois U. S. A.

STATION TESTED*

*an added
proof of Quality!*

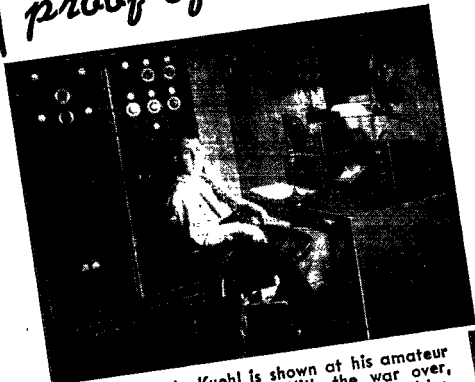

*Pres. W. A. Kuehl is shown at his amateur radio station W9EZN. With the war over, Walt is again pursuing his favorite hobby.

DRAKE RADIO SOLDERING IRONS

Yes, Drake irons are *right for radio*. And these sturdy irons have proved their dependability and worth in use on countless other jobs, too, for over 25 years. That's why we say — whatever your needs, you are certain to find a Drake iron that fills the bill exactly!



600-10—the Drake No. 600-10 is ideal for those all important connections when rewiring your rig. Get back on the air fast. Make good dependable connections with this 100 watt $\frac{3}{8}$ " tip.



400—the Drake No. 400 is the perfect iron for work in small places. Only 9 inches long, it is especially designed for tight corners and delicate connections. 60 watt, $\frac{1}{4}$ " tip.



Ask your nearest supplier or write for the name of the distributor nearest you . . . and give yourself the advantages of these superior irons.

DRAKE ELECTRIC WORKS, INC.
3656 LINCOLN AVE. CHICAGO 13, ILL.

It Seems to Us

(Continued from page 18)

ham-type receivers would be welcome, as well as various measuring equipments and a very few models of transmitters. Where can we buy 'em? Well, the military isn't tossing out all their stuff. In fact, they will probably dispose first of the special-application gear, tending to retain for their postwar establishments such items as ham-type general communications receivers and pieces of measuring apparatus. They're storing a lot, too, since in peacetime their equipment appropriations are never sufficient to permit them to acquire adequate new gear to keep their communications installations up to snuff. Some gear overseas will be destroyed, or utilized in local rehabilitation. And, of course, so long as any material is classified as to secrecy, it can never be released.

Unlike most editorials, this one has no stated conclusion or moral. Principally, we want you to understand the general picture a little better and not get too excited over wild stories. You will hear plenty. Most will be untrue or at least exaggerated, as was the Dayton story. One ham found his local junkyard selling brand-new $\frac{1}{4}$ -inch aluminum rack panels at the scrap metal price! But most of the equipment released as surplus will come to us via regular channels.

The whole thing is a problem. We know that. We are still working on it from the amateur's standpoint. We are unable to move the mountains of red tape or alter the basic laws, and we don't expect to achieve the impossible. But we have a project or two under way concerning surplus communications gear whose possibilities — if they are not short-circuited by basic law — will be mighty interesting, OM, mighty interesting.

J. H.

Strays

The Veteran Wireless Operators' Association extends an invitation to their "Coming of Age Party" — their twenty-first anniversary dinner-cruise — to be held at the Hotel Astor in New York on February 16, 1946.

During 1945 a two-way radio weighing only 15 pounds was designed for private aircraft to permit the flier to use the radio range system for navigation; to communicate with airport control towers or range stations; or to enjoy broadcast programs.

A new magnetic material known as Alnico V is two and a half times more powerful than the best available prewar magnetic material. It makes possible lighter and more sensitive loudspeakers.

Buenos tardes, amigo...
 "Good evening, my friend..."

For more and
 clearer QSO's

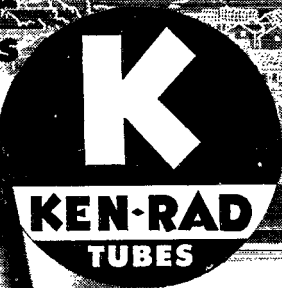

Type 6L6
 \$1.95

Reception will be crisp, clean, sure! Chile will come through to you as clear as the signal from a local rig! *Ken-Rad tubes are ready to help you span the earth*—tubes tested by the million under war's toughest conditions, now available to you for better performance than you've known before. The 6L6 beam power amplifier typifies the ruggedness, compactness, improved shielding, and short lead-length design of Ken-Rad all-metal tube construction. Basic ratings are given below. For more complete information see your Ken-Rad distributor or dealer.

Ratings of Type 6L6

Heater voltage	6.3 v	Max plate dissipation	... 18.5 w
Heater current	.9 amp	Max screen dissipation	... 2.7 w
Max plate voltage	350 v		
Max screen voltage	250 v		

175-E2-8850

KEN-RAD

DIVISION OF GENERAL ELECTRIC COMPANY
 OWENSBORO, KENTUCKY

Make the nearest Ken-Rad distributor or dealer your preferred source of supply for amateur tubes



1915. First successful transoceanic radio telephone experiment between Arlington, Virginia, and Paris and Honolulu, made use of this type of Western Electric speaker.



1921. Western Electric "morning glory" horn of the type used at the dedication of the Tomb of the Unknown Soldier in Arlington.



1924. Cone speaker designed for the broadcasting industry became immensely popular as a home radio loudspeaker.



1926. Folded exponential horn used with the first sound motion pictures, developed hitherto unmatched volume.



1928. Combination "Tweeter and Woofer" used one horn for low frequencies and another smaller one for high frequencies.



1936. Single radiator "Bull Horn" designed for carriers and battleships, still in use at the outbreak of the war.



Today: Modern 753 type commercial speaker. It's ok for FM—and tops for AM too.

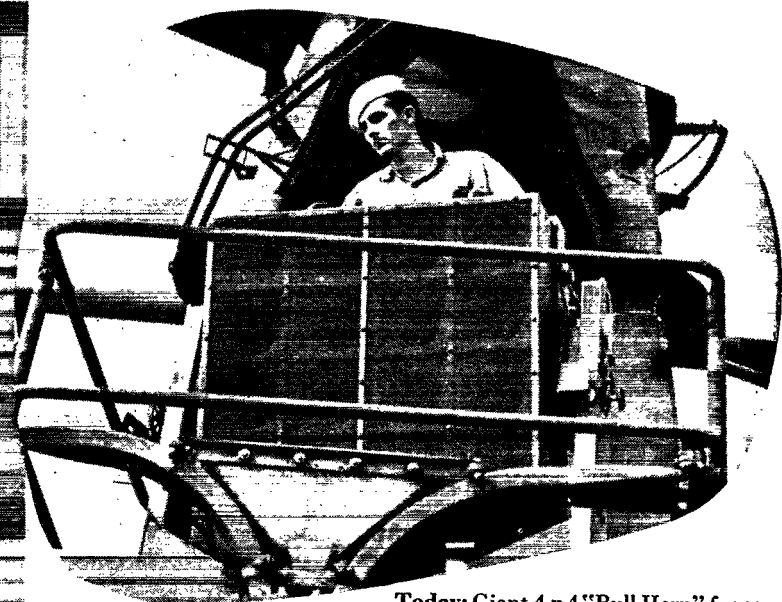

Today: Giant 4 x 4 "Bull Horn" for carrier flight decks makes use of searchlight-type mounting for "aiming" sound.

Western Electric

SPEAKERS THAT MADE HISTORY

Back in 1877, Western Electric manufactured a direct radiating loudspeaking telephone. This was the forerunner of the public address loudspeakers demonstrated in 1913. With the advent of the vacuum tube amplifier—applied to communications by Western Electric in 1915—the use of loudspeaker equipment expanded rapidly. Western Electric speakers have continued to make history from the earliest models to the giant bull horns used today on aircraft carriers and battleships. You can be sure that Western Electric will continue in this tradition with new and finer loudspeakers for radio broadcast and sound distribution.

HERE'S A NEW CIRCUIT ELEMENT that displays non-ohmic characteristics



IMAGINE a circuit element that *violates* Ohm's Law. One that exhibits *polarized* non-linear current-voltage characteristics.

Such an element has now been made commercially available for the first time . . . Sylvania Electric's 1N34 G_x metal Crystal Diode. This tiny unit (shown full size in illustration) opens up many interesting potentialities in circuit design. Withstanding relatively high voltages, it is extremely useful as a circuit element.

Light in weight and equipped with pigtail leads, it is conveniently soldered into place . . . no sockets required. No heater supplies are needed—eliminating hum and noise, permitting both terminals to be connected far above ground potential.

The 1N34 Diode gives superior performance at high frequencies and with low values of load resistance.

Tentative Characteristics of the 1N34

Peak Inverse Anode Voltage	50 volts
Average Anode Current	0-22.5 ma.
Peak Anode Current	60 ma. max.
Surge Current	200 ma. max.
Back Conduction at 50 volts	2 ma. max.

(Surge current refers to transient values; peak current refers to the maximum value of an applied AC signal.)

Where Can You Use an Element Like This?

Among the expected applications of the 1N34 Diode are: DC restorers in television receivers; frequency discriminators in FM sets; peak limiters; video detectors; meter rectifiers; bias rectifiers; modulators and demodulators.

Perhaps *you* can see many other ways in which you can put this revolutionary circuit element to work. We'll be glad to send you further technical information to assist you in planning applications, and to discuss specific uses with you.

SYLVANIA ELECTRIC

Electronics . . . 500 Fifth Avenue, New York 18, N. Y.

MAKERS OF ELECTRONIC DEVICES; RADIO TUBES; CATHODE RAY TUBES; FLUORESCENT LAMPS, FIXTURES, WIRING DEVICES; ELECTRIC LIGHT BULBS

EVERYTHING FOR THE HAM

WRITE

Leo, W9GFQ

For Fast Delivery!



Get Leo's own personal, sudden-service on your radio needs. Leo will help you get back on the air quickly with first delivery on anything in radio.

HAM NEEDS

Transmitting tubes, condensers, mikes . . . everything for the Ham. One of the country's largest stocks of Ham equipment. Write Leo, W9GFQ, today, and be first with the latest. We invite inquiries for special equipment of all kinds.

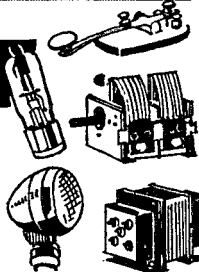

TRANSMITTERS

For peak performance and more dollar for dollar value, get a WRL Transmitter Kit . . . designed in Leo's own laboratories . . . tested and proven. Available in 15, 35, 70, and 150 watt kits as well as kits custom built to your own specs. Write Leo today for complete details, prices and terms.

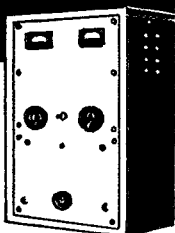

RECEIVERS

Here are just a few of the many well-known receivers offered by Leo:

- Hallcrafters SX-25 \$ 94.50
- Hallcrafters 8-20R \$ 60.00
- Hallcrafters SX-28A \$223.00
- Echophone EC-1A \$ 29.50
- Hammarlund HQ-129X \$129.00
- National NC-2-40C \$225.00

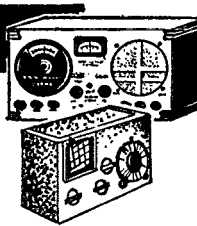

Free!

NEW POST WAR 52 PAGE FLYER

52 pages packed with real buys in radio, electronic, and general merchandise. Write for your free copy today.

- Send for these exclusive items:
- Tube and Circuit Book 10c
 - Giant Radio Reference Map (size 3 1/2' x 4 1/2') 15c
 - Handy Tube-Base Calculator 25c

Write for details of our trade-in plan and easy terms.

Address Dept. QST-2
Council Bluffs, Iowa

Wholesale
RADIO LABORATORIES



Design for U. H. F.

(Continued from page 18)

ing condenser rotor should not be grounded. A ceramic coupling or shaft is to be preferred over one made of bakelite, since at the higher frequencies bakelite is not a good insulator.

The other uses to which this oscillator may be applied may best be left to the ingenuity of the individual. More important, however, the application of the principles discussed should be helpful in the design of other tuned circuits operating in the v.h.f. bands.

Receiver/Converter

(Continued from page 20)

bottom plate on the receiver, however, the mixer oscillator coupling is decreased, and the increase in mixer current will be considerably less. However, the injection seems to be adequate, and the pulling is so slight that we consider this the best way to run the converter.

Operation

By the time one has tested the converter he will be rather familiar with its operation, and there is no need for any detail on this point. As mentioned above, c.w. reception is preferable with headphones, and 'phone reception is best with a b.c. receiver following the converter. Weak 'phones can best be spotted with the b.f.o. in an oscillating condition.

The antenna should be, of course, the best you can get for the band, and that usually means your transmitting antenna. If a single long wire is used, the empty antenna binding post should be grounded to the receiver chassis.

If there seems to be too much hum in the set, check the mixer tube by placing a shield over it. In some locations where there is a strong 60-cycle field, hum will be picked up and the glass 6SN7 must be shielded. However, in an ordinary home location it should not be necessary. A bottom plate for the chassis is recommended, for further shielding and because the feet raise the tuning knob off the table a bit more.

Unfortunately we cannot give any exact figures on the performance of the unit because our laboratory signal generator has some leakage at 28 Mc. However, the leakage from the generator gives a perfectly readable signal in the converter, and this compares quite favorably with several commercial communications receivers tested under the same conditions. Ten-meter signals from three continents have been heard, using an indoor antenna, but this is not advanced as proof of any superior performance but only as encouragement for one who thinks a simple affair like this isn't worth its salt.

Announcing TAYLOR'S New

TB-35

BEAM TETRODE

The Wizard Tube!

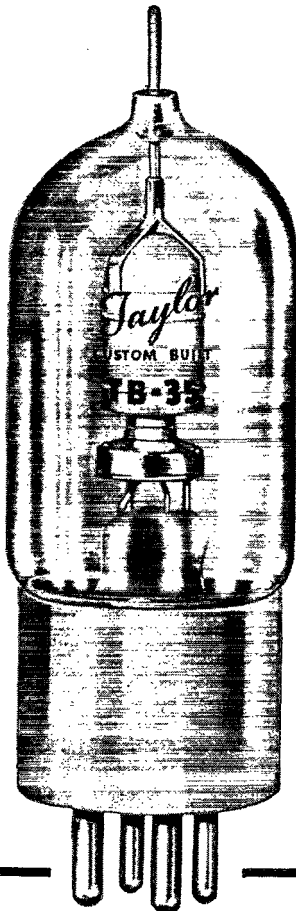

ACTUAL SIZE

\$10.00

FOR SALE AT ALL
LEADING RADIO
PARTS DISTRIBUTORS

- 35 Watts Plate Dissipation
- Tantalum Plate and Grids
- No Neutralization
- Easy Drive
- Nonex Glass

FREQUENCY LIMITS

Full Input.....	250 MC
Half Power.....	400 MC

GENERAL CHARACTERISTICS

Fil. 6.3 Volts (Thoriated Tungsten).....	2.75 Amps.
Amplification Factor.....	65
Mutual Conductance.....	2750
Grid to Plate Capacity.....	.2 MMF
Input to Capacity.....	6.8 MMF
Output Capacity.....	1.8 MMF
4 Prong UX Base — Plate Lead at Top	
Size: 4 7/8" by 1 1/4" Maximum	

TYPICAL OPERATION

D.C. Plate Volts.....	1500
D.C. Plate Current.....	110 MA
D.C. Control Grid Volts.....	-300
D.C. Control Grid Current.....	15 MA
D.C. Screen Grid Volts.....	375
D.C. Screen Grid Current.....	22 MA
Driving Power.....	4.5 Watts
Power Output.....	130 Watts

Write for Complete Technical Data Bulletin

Taylor HEAVY **CUSTOM BUILT** DUTY **Tubes**

TAYLOR TUBES INC., 2312-18 WABANSIA AVE., CHICAGO 47, ILL.

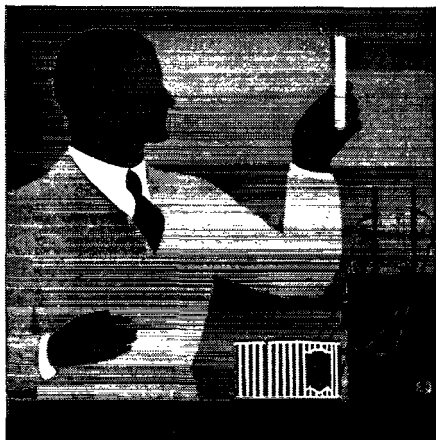

PREFERRED
BY ENGINEERS

BURGESS BATTERIES

RECOGNIZED BY THEIR
STRIPES • REMEMBERED
BY THEIR SERVICE

CODE SENDING SPEED
RECEIVING SPEED

Have Skill, Accuracy

Be a "key" man. Learn how to send and receive messages in code by telegraph and radio. Commerce needs thousands of men. Expansion of air commerce and freight after war should create an even bigger peacetime demand for operators. The famous Candler System, maker of world's champions, teaches you the "knack" of sound sense and sound consciousness that is the secret of speedy sending and receiving. Good pay, adventure. Learn at home quickly.

FREE 52-PAGE BOOK explains extra course of training. Rush name for it today. It's absolutely free

CANDLER SYSTEM CO.
Dept. 4-B, P. O. Box 928 Denver 1, Colo., U. S. A.
and at 121 Kingsway, London, W.C.2, Eng.

Two-Meter Receiver

(Continued from page 56)

range of the detector circuit, but the spacing of the turns in the coil will have to be changed if the position of the tap is materially different from that given.

When the detector is found to be in the band, the r.f. stage may be put into operation. With any of the shields removed, or with no antenna connected, the 6AK5 will probably oscillate, blocking the detector, but this effect will disappear when the two compartments are completely assembled and an antenna attached by means of the coaxial connector. If the r.f. stage is operating properly there will be slight change in the character of the hiss when the stage is tuned through resonance. Using a signal generator (the harmonic of any oscillator which falls in the 144-Mc. band will do) or the signal of a 144-Mc. station, there will be a pronounced drop in background noise and a slight change in dial setting of the detector when the r.f. stage is tuned "on the nose." Once the r.f. tuning is adjusted for maximum response, preferably on a weak signal near the middle of the band, it may be left at that setting for all except the very weakest signals at either end.

Performance

The r.f. stage gives a worthwhile gain in sensitivity, in addition to preventing radiation. Signals have been heard on this receiver with solidly-readable characteristics, when a similar receiver having no r.f. stage produced only an unintelligible murmur on the same antenna. There is a slight increase in selectivity also, and local QRM is somewhat less troublesome.

Radiation characteristics have been checked in several ways. A very sensitive field-strength meter² was set up with its pick-up antenna one inch from dipole connected to the receiver. No trace of meter movement could be seen when the receiver was tuned. The same setup, but with a superregenerative receiver using a 9002 detector and no r.f. stage, produced a meter reading of 40 on a 100-unit scale, even though this detector was operating with less than 20 volts on its plate. The radiation from the new receiver can be heard on another superregen operating in the same room, but even under these conditions it produces less disturbance than any of several receivers more than a half mile distant from our hill-top location. Several operators in the Hartford area have listened, in vain, for any sign of it. This is the first superregenerative receiver we've ever used which would pass these tests — with or without an r.f. stage!

² See "The World Above 50 Mc." December, 1945.

**SWITCH
TO SAFETY!**



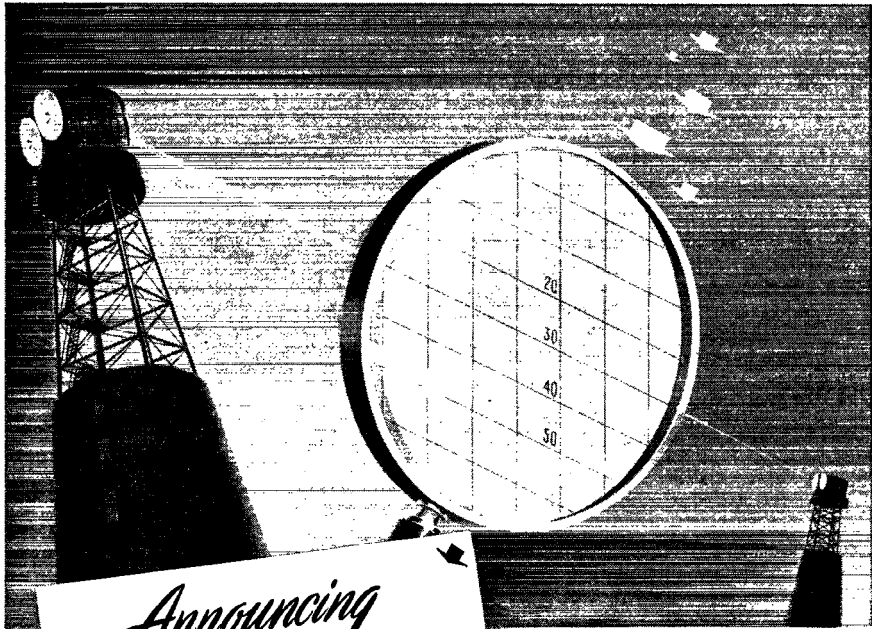

Announcing
THE NEW
SPERRY *Microline**

As a reading glass aids visual search, so MICROLINE test and measurement equipment provides means for making all measurements at microwave frequencies.

Sperry announces a comprehensive line of microwave test and measurement equipment for labora-

tory and field use. The new line... the MICROLINE... is the outgrowth of years of research and experience in modern microwave techniques beginning with the development of the Klystron.

Write our Special Electronics Department for further information.

Available now:

- WAVEMETERS • WATTMETERS
- BARRETTOR ELEMENTS AND MOUNTS
- DIRECTIONAL COUPLERS
- KLYSTRON SIGNAL SOURCES
- STANDING WAVE DETECTORS
- ATTENUATORS
- IMPEDANCE MATCHING EQUIPMENT
- WAVEGUIDE AND COAXIAL COMPONENTS

TRADE MARK

SPERRY GYROSCOPE COMPANY, INC. GREAT NECK, N. Y.



Division of the Sperry Corporation

★
 LOS ANGELES • SAN FRANCISCO • SEATTLE • NEW ORLEANS
 CLEVELAND • BROOKLYN • HONOLULU

GYROSCOPICS • ELECTRONICS • RADAR • AUTOMATIC COMPUTATION • SERVO-MECHANISMS

PLASTICON* CAPACITORS



* PLASTICONS—
plastic film
dielectric capacitors

OBSOLETES PAPER CONDENSERS!

Smaller, lighter, more economical. Specified by Signal Corps, Air Corps and Navy for more severe operating conditions than oil-paper capacitors. Closer tolerances, wider temperature range, greater safety factor, longer life. Now available at the following prices:

PLASTICONS TYPE AOC

Mfds.	DC-WV	Dimensions	List Price	Your Price
4	600	4" x 2" x 1 1/4"	\$ 2.80	\$ 1.68
1	1000	2 3/4" x 1 13/16" x 1 1/16"	3.65	2.19
2	1000	3 1/2" x 2" x 1 1/4"	4.70	2.82
4	1000	4" x 2 1/2" x 1 3/16"	5.85	3.51
6	1000	4" x 3 3/4" x 1 1/4"	7.65	4.59
8	1000	4" x 3 3/4" x 1 3/4"	8.40	5.04
1	2000	2 3/4" x 2" x 1 1/4"	5.20	3.12
2	2000	3 1/2" x 2 1/2" x 1 3/16"	6.10	3.66
3	2000	3 1/2" x 3 3/4" x 1 1/4"	7.50	4.50
4	2000	3 1/2" x 3 3/4" x 1 3/4"	8.40	5.04
1	3000	4 1/4" x 2 1/2" x 1 3/16"	11.00	6.60
2	3000	4 1/4" x 3 3/4" x 1 1/4"	14.00	8.40
4	3000	4 1/4" x 3 3/4" x 1 3/4"	19.35	11.60
1	4000	4 1/4" x 3 3/4" x 1 1/4"	25.00	15.00
1	5000	4 1/4" x 3 3/4" x 1 3/4"	30.00	18.00
1	7500	3 1/2" x 3 3/4" x 4 9/16"	45.00	27.00
1	10000	4 1/4" x 3 3/4" x 4 9/16"	80.00	48.00

ALL PLASTICON CAPACITORS are guaranteed for six months.
Order from your distributor. If he cannot supply you, write direct.



Condenser Products Company

1375 NORTH BRANCH STREET • CHICAGO 22, ILLINOIS

HARRISON HAS IT!

ALL STANDARD LINES

We are Factory Authorized Distributors for the top quality manufacturers and we now have in stock lots more new, latest improved production Ham gear! Visit our stores, or send us your order for *everything* you need. We promise you fresh, clean material — quicker — at the lowest current prices — and, above all, our sincere desire to be of friendly, helpful service.

73 de

Bill Harrison, W2AVA

NATIONAL HRO RECEIVER

Latest model — with pack, speaker, and coils 1.7 to 30 Mc. **\$226.30**
With coils 50 Kc. to 30 Mc; **\$314.50**

NEW! HALLICRAFTER SKYRIDER, JR.

A fine little six-tube receiver that is a worthy successor to the world famous Echophone EC-11 AC-DC — three bands, 550 Kc to 30 Mc — electrical bandspread — noise limiter — built-in speaker. Grey or white cabinet (state preference). Model S-41.....**\$35.00**

COMING SOON!

The NEW Hammarlund "400" Super-Pro. Covers both BC and 10 meter bands. Send in your order now for a top spot on our "Preferred List."

Hammarlund HQ-129-X **\$129.00**

GROUND PLANE ANTENNA

Get your radiation angle where it will do some good! The Corlab GP-144 Antenna will do the trick on 2 meters. Fully adjustable 144 to 148 Mc. Sturdy, lightweight aluminum construction, lucite insulation. Mounts easily on 3/4" pipe. Hange or ohm cable. With detailed instructions. List price, **\$15.00**. Amateur net, **\$8.82**. (Other frequencies available)

Brush PL-20 TRANSCRIPTION PICKUP

One of the finest! High output with wide rangersponse. With equalizer for "Constant Velocity" recordings. **\$26.46**. New Shure "Glider" pickup. **\$3.23**.

If you want to be among the very first to get any new, or not immediately available equipment, put your name on our "Preferred List."

The factories owe us plenty — and as it comes in rush it right out!

You can make sure of getting yours quicker by telling us now what you want. (Naturally, orders with deposit come first.) If you change your mind you can cancel at anytime before shipment without obligation.

CRYSTALS

Peterson type Z-2. Low drift, high output. Mounted in latest type compact, sealed holder with 1/2" pin spacing. 7000 to 7400 Kc. Large assortment to select frequency. **\$2.65**. Bliley type AX-2. New, improved model. .002% accuracy, .02% temperature stability. 7 to 3,222 Mc. **\$2.80**. (Crystals for other frequencies and purposes available quickly)

Brush CRYSTAL HEAD-PHONES

Model A. General purpose. High sensitivity, wide range. **\$6.52**.

Model B.J. Communications type. Lightweight, soft rubber cases, easy on the ears. **\$8.53**.

HANDIE-TALKIE

Patterned after the famous military models! A compact, sturdy, 2 meter transceiver with an effective range of 2 to 5 miles or more. Lightweight, metal case 10 3/4" x 2 3/4" x 2 3/4". Self-contained microphone, earphone, telescoping antenna, and batteries. Uses two flashlight cells and one XX-45 battery. Complete, with two 154 tubes and batteries, ready to operate. **\$24.75**.

HALLICRAFTERS

SX-28-A.....**\$223.00**
PM-23.....**15.00**
S-20R.....**60.00**
S-22R.....**74.50**
SX-25.....**94.50**
S-36A.....**415.00**
S-37.....**591.75**
S-39.....**110.00**
HT-9.....**225.00**

HARRISON HAS IT!

HSS

HARRISON SELECT SURPLUS

Your assurance of good, usable, guaranteed, surplus material at sensationally low prices — top value always! Come in and browse thru our large, *entirely separate* HSS Department (Harrison Select Surplus).

HALLICRAFTERS ARMY TRANSMITTERS

Signal Corps BC-610 transmitters, as used in the famous SCR-299. The battle proven version of the pre-war HT-4B. 450 Watts output on CW, 325 watts on phone, continuous operation. Frequency range 2 to 18 Mc. Complete with tubes, speech amplifier, and coils for 80, 40, and 20 meter bands. Brand new, and guaranteed. **\$750**.

SCR-211 Frequency Meters

Crystal controlled, 125 Kc to 20 Mc. Accuracy guaranteed to .01%, dial readable to 1 part in 50,000. These are the completed units, accepted by the Signal Corps, having the *calibration charts*. With crystal and spare tubes, less batteries. **\$95**.

For that mobile rig — DYNAMOTORS

6 or 12 volts DC input. Output 500 volts DC at 160 ma continuous operation, 224 ma intermittent duty. Dependably made for military use. Ball bearings — high efficiency — internal hash filter for UHF — moisture proofed — fully shielded. 5" dia., 11" long, with mounting plate. Brand new, with spare set of brushes. **\$17.75**

Leach ANTENNA RELAYS

Four poles — two double throw and two normally closed. 1/2" solid silver contacts. Coil for 95 to 135 volts AC. 3 1/2" x 3 1/4" x 1 1/2". List price **\$8.50**. HSS, **\$2.79**.

We have a limited supply of the

1946 RCA TUBE REFERENCE BOOK

Ask for a copy, free, with your next purchase

TUBES

All new, fully guaranteed. Limited quantities. 805. 500 watts of class B audio. Navy inspected. HSS, **\$6.90**. 812. RCA. HSS, **\$2.76**. 1624 Beam power amplifier. **\$1.69**. Raytheon Tubes: RK-38, **\$7.95**. RK-39, **\$2.25**. RK-63, **\$12.85**.

A POST CARD will put your name on our mailing list to receive new catalogs, bulletins, additional HSS bargains, and details of how you may obtain, without cost, a copy of "Electronic Parts and Equipment," our new 800-page Buyers' Guide. Please send it today!

XMITTING TUBES

RCA, EIMAC, TAYLOR, RAYTHEON, HYTRON, UNITED, HK, AMPEREX, EE, GE, HARRISON EAS IT! Practically all types in stock! (And of course everything to go with 'em — sockets, shields, clips, etc.)

MICROPHONES

● Carbon ● Crystal ● Dynamic ● Velocity
All makes — all types —
Harrison has it!
(Also stands, cable, connectors, etc.)

TEST EQUIPMENT

Multimeters, Tube Checkers, Signal Generators, Bridges, Ohmmeters, Capacitor Checkers, Oscillographs, Decade Boxes, Electronic Switches, VT Voltmeters, Panel Instruments, Audio Oscillators, Chanalysts, Appliance Testers, Analysts, Dynamic Demonstrators, Wattmeters, Etc.

We are prepared to supply your every Test Equipment requirement — from the smallest pocket battery checker to a complete test laboratory — with the products of all well known manufacturers. Your inquiries and orders are solicited — deliveries from Harrison are quicker than you might expect!

HAM HEADQUARTERS
Since... 1925!



HARRISON RADIO CORPORATION

12 WEST BROADWAY • NEW YORK CITY 7

BARCLAY 7-9854

JAMAICA BRANCH — 172-31 Hillside Ave. — REPUBLIC 9-4102

THE RADIO AMATEUR'S LIBRARY

• Many requests are received for the complete list of our publications. The list follows:

Title	Price
<i>QST</i>	\$2.50 per year*
List of Stations.....	Discontinued
Map of Member Stations	Discontinued
Operating an Amateur Radio Station	Free to members; to others 10¢
The Story of The A.R.R.L.	Discontinued
The Radio Amateur's Handbook	
a. Standard Edition.....	\$1.00**
b. Special Defense Edition..	\$1.00
The Log....	35¢ each; 3 for \$1.00
How to Become a Radio Amateur	25¢
The Radio Amateur's License Manual.....	25¢
Hints & Kinks for the Radio Amateur.....	50¢
Lightning Calculators:	
a. Radio (Type A).....	\$1.00
b. Ohm's Law (Type B).....	\$1.00
Amateur Radio Map of the World.....	\$1.25
Two Hundred Meters and Down: The Story of Amateur Radio	Out of print
Building an Amateur Radio-telephone Transmitter	Out of print
A.R.R.L. Antenna Book.....	50¢
Emergency Communications Manual.....	10¢
The Minilog.....	25¢
Learning the Radiotelegraph Code.....	25¢
A Course in Radio Fundamentals	50¢

*In the United States and Possessions — other Countries \$3.00 per year.

**Postpaid in Continental U. S. A. — \$1.50, postpaid, elsewhere.

(No stamps, please.)

THE AMERICAN RADIO RELAY LEAGUE, Inc.

West Hartford 7, Connecticut

QSO Contest

(Continued from page 57)

Each 'phone to c.w., or c.w. to 'phone QSO 2 pts.

A station may be worked only once on each band. The same station may be worked additional times, if on different bands.

Add all QSO points to determine total contact credits.

MULTIPLIER: The total contact credits are to be multiplied by the number of different ARRL Sections in which stations have been worked, *plus one*, if at least one station has been worked outside the 71 ARRL Sections. The result will be the final score. (See page 6 for list of Sections.)

REPORTS: Mimeographed reporting forms will be furnished upon request to HQs in advance of the contest, but are not required. Mail reports to ARRL Communications Department, West Hartford, Conn., immediately upon close of the contest. Closing date for receipt of reports is April 1st for participants in ARRL Sections, April 15th for all others.

List calls of stations worked by bands, indicating date and time of each contact; information exchanged (both ways, or one way); whether 'phone, c.w., 'phone-c.w., or c.w.-'phone; mode of communication at your station; and points claimed for each QSO. Total the contact credits. List different ARRL Sections claimed (including at least one outside country if an additional point), showing call of one station worked in each Section and date and time of contact.

Total contact credits times the "multiplier" gives the final score. Time record must be included with report, showing each operating session, with "on" and "off" times listed consecutively, and total hours indicated.

Strays

QST readers stationed in the South Pacific were kept supplied with copies while Larry Schwab, OPLD and an ARRL member, was a flight radio officer with the ATC. Schwab made the trip from the states to the South Pacific many times and at each airfield he made it a point to search out the radio amateurs, chew the fat with them and then surprise them by giving them copies of the latest *QST*. This special form of mail delivery probably kept many a ham dreaming over his post-war rig.

Schwab is now working with Captain Eddie Rickenbacker and Colonel Hans C. Adamson on a thirteen-week radio show devoted to retelling the most famous American flights from the Wright Brothers right up to tomorrow's radio-controlled atomic-powered plane under the title "The World's Most Honored Flights." It will be broadcast over a national network starting Sunday, February 3, 1946.



Because *QST* is informative, helpful and interesting...because it talks the ham language and reaches radio amateurs everywhere...The Astatic Corporation, since 1933, has used its advertising columns to reach our great host of amateur friends and customers. With the reawakening of interest in amateur activities, Astatic looks forward to again serving this important field of radio through its many authorized jobber outlets. The story of our engineering progress and our dependable products will be brought to Y-O-U, month after month, through *QST*.

Astatic Crystal Devices
 manufactured under Brush
 Development Co. patents

THE *Astatic*
ASTATIC CORPORATION
 CONNEAUT, OHIO
 IN CANADA: CANADIAN ASTATIC LTD., TORONTO, ONTARIO

Now! A Better Soldering Tool... THE KWIKHEAT

Has Built-in
Thermostat
Control!



6 TIP STYLES

#0—\$1.25

#1—\$1.25

#2—\$1.25

#3—\$1.25

#4—\$1.75

#5—Melting Pot
for tinning—\$1.25

HOT, READY FOR USE ONLY 90 SECONDS after plugging in! Kwikheat is the only soldering iron with a thermostat built into the tool itself*—maintaining the proper level of heat for most efficient, economical operation. **SAFE!** ... Cannot overheat—**ECONOMICAL!** ... Lasts longer—saves tips and requires less retinning. **POWERFUL!**—225 watts—yet exceptionally light weight (14 oz.). Well-balanced with cool protecting plastic handle. Modern streamlined design. Six interchangeable tip styles adapt one Kwikheat Iron to all your soldering jobs. You will be proud to own America's finest and most versatile soldering tool... from tip to plug Kwikheat is in a class by itself. Ask your dealer to demonstrate the quick-heating feature now!

*patented
Kwikheat Iron with choice of #0, #1, #2, #3 or #5 tips \$11.00
Set of 5 tips, consisting of #0, #2, #3, #4, and #5 . \$6.00



Dept. Q-2, Kwikheat Division of
SOUND EQUIPMENT CORP., 3903 San Fernando Rd., Glendale, 4 Calif.

Above 50 Mc.

(Continued from page 61)

this writing, but it appears to be at least 355 miles. Certainly it is well beyond the 335-mile record held by W2MPY/1 and W1JFF.

The new record is the more impressive when it is understood that this was work between two home stations, at close to sea level. It proves that altitude is only a very minor consideration in long-haul v.h.f. work. Weather, good equipment, and smart operating are much more important. This performance should stand as an everlasting refutation of the old "line-of-sight" bugaboo which has served to discourage serious workers through all the history of v.h.f. endeavor. This work brings 112 Mc. up practically to 56 Mc. in extended-local capabilities, and indicates that we should be able to do equally well on 144, when weather conditions are equally fortunate. The record-breaking QSO was not an isolated "freak" as W1BJE also worked W3FAM, Halethorpe, Md., the same night. This is about 335 miles, and would have qualified as a new record, in that it, also, was between two home stations. Scores of contacts beyond 250 miles were made during the Labor Day weekend, the whole length of the Atlantic Seaboard, from Maine to Virginia.

Which brings up the point of reporting work on 144 Mc. What is happening on 2 meters? How is it working out in comparison to 2-1/2, and what is the greatest distance worked to date? Here in the Hartford area coverage is somewhat down as compared to 112 Mc., but the disparity between the two bands is being reduced gradually, as 144-Mc. technique improves. We are receiving very little information by mail, however, and consequently have only a foggy idea of what is happening elsewhere. How about writing us the details of 144-Mc. doings in your locality?

Several workers have reported interesting results with horizontal polarization, particularly in connection with reception of vertically polarized signals from beyond line-of-sight. Here at W1HDQ, tests with horizontal systems, both simple dipoles and multi-element arrays, as well as long wires of various sorts, indicates that many stations using vertical antennas actually have horizontally-polarized signals at distant points, especially when hills intervene between the transmitting and receiving locations. Three stations, W1JLK and W1EJI, of Tolland, Conn., and W1BEQ, South Coventry, all about 25 miles away and far from line-of-sight, come in well at our location on horizontal antennas, though all are using verticals. W1JLK, in particular, is several S-units stronger when a simple receiving dipole is rotated from vertical to horizontal, and is extremely strong on our 4-element horizontal array, or on our 125-foot "V." W1JLK is a particularly interesting subject for this sort of test, as he is directly behind a sizeable hill, in a location which would be considered "impossible" at first examination. More tests along this line are needed, and observations of this sort are invited.

(Concluded on page 118)

25 OSCILLATORS

- Each unit includes two separate Pierce oscillators and these have an auxiliary counter. Original application was for checking the difference between the frequencies of a standard crystal and one being produced. This unit includes power supply, one 0-1 mil meter for activity and another meter used as a counter meter. Original cost \$100.00 each.

- Can be easily modified for Ham transmitter driver for two frequencies. Sale price \$25.00 per set. 10 meter predimensioned crystals in FT243 holders \$2.75 each.

HATCHER & FISK, INC.

125 Kansas Avenue, Topeka, Kans.

THE AMATEUR'S BOOKSHELF

A balanced selection of good technical books, additional to the ARRL publications, should be on every amateur's bookshelf. We have arranged, for the convenience of our readers, to handle through the ARRL Book Department those works which we believe to be most useful. Make your selection from the following, add to it from time to time, and acquire the habit of study for improvement. *Prices quoted include postage.* Please remit with order.

Theory and Principles

BASIC RADIO PRINCIPLES, by M. G. Suffern. Elementary radio principles, circuits and components described in simple practical language, without mathematics. 271 pages, illustrated. 1943. \$3.00

BASIC ELECTRICITY FOR COMMUNICATIONS, by W. H. Timbie. A practical treatment of the electrical principles which underlie communications, circuits and practice. 603 pages, illustrated. 1943. \$3.50

PRINCIPLES OF RADIO, by Keith Henney. A medium-level text covering both electrical and radio fundamentals, particularly written for home study. 549 pages, illustrated. 4th edition, 1942. \$3.50

BASIC RADIO, by J. Barton Hoag. A complete treatment of the circuits used in radio, television and electronics apparatus, including up-to-date applications. 380 pages, illustrated. 1942. \$3.25

FUNDAMENTALS OF RADIO COMMUNICATIONS, by A. R. Frey. A more advanced treatment requiring previous background. Authoritative, clearly written, well organized. 393 pages, illustrated. 1944. \$4.00

RADIO ENGINEERING, by F. E. Terman. A comprehensive treatment covering all phases of radio communication. An all-around book for students and engineers. 813 pages, illustrated. 2nd edition, 1937. \$5.50

Engineering and Reference

RADIO ENGINEERS' HANDBOOK, by F. E. Terman. Broad scope and detailed treatment make this book serve both as text and reference handbook. 1019 pages, illustrated. 1943. \$6.00

RADIO ENGINEERING HANDBOOK, Keith Henney, Editor. An authoritative handbook for engineers, with technical data on all fields and aspects of radio, contributed by 23 specialists. 945 pages, illustrated. 1941. \$5.00

PRINCIPLES OF ELECTRON TUBES, by H. J. Reich. A condensed but complete treatment of the theory, characteristics and applications of electron tubes. 398 pages. 1941. \$3.50

PRINCIPLES OF AERONAUTICAL RADIO ENGINEERING, by P. C. Sandretto. Covers radio aids to air navigation and air communication from the applied engineering viewpoint. 414 pages, illustrated. 1942. \$3.50

FREQUENCY MODULATION, by August Hund. An advanced engineering text on f.m., presenting both theory and practice. 375 pages, illustrated. 1942. \$4.00

PRINCIPLES OF TELEVISION ENGINEERING, by D. G. Fink. Information on the fundamental processes of television technique, with design data and descriptions of modern equipment. 541 pages, illustrated. 1940. \$5.00

V.H.F. and U.H.F.

ULTRA-HIGH-FREQUENCY RADIO ENGINEERING, by W. L. Emery. Written for engineering students, this book provides an excellent transition treatment for amateurs. 295 pages, illustrated. 1944. \$3.25

COMMUNICATION CIRCUITS, by Ware and Reed. From low-frequency transmission line and network theory, this volume leads the student into wave guides and advanced u.h.f. techniques. 330 pages, illustrated. 2nd edition, 1944. \$3.50

HYPER AND ULTRA-HIGH FREQUENCY ENGINEERING, by Sarbacher and Edson. A digest of published literature covering all phases of technique from 30 Mc. to 10,000 Mc. 644 pages, illustrated. 1943. \$5.50

FIELDS AND WAVES IN MODERN RADIO, by Ramo and Whinnery. An extensive theoretical treatment of field and wave theory, requiring a knowledge of engineering mathematics. Revealing and important. 502 pages, illustrated. 1944. \$5.00

ULTRA-HIGH-FREQUENCY TECHNIQUES, by Brainerd, Koehler, Reich and Woodruff. A complete text on radio engineering, emphasizing v.h.f. and u.h.f. aspects. 534 pages, illustrated. 1942. \$4.50

MICROWAVE TRANSMISSION, by J. C. Slater. A comprehensive treatment of principles and techniques employed in the region between 300 and 3000 Mc. For the advanced student or engineer. 309 pages, illustrated. 1942. \$3.50

Experiments and Measurements

MEASUREMENTS IN RADIO ENGINEERING, by F. E. Terman. A comprehensive engineering treatment of the measurement problems encountered in engineering practice, with emphasis on basic principles. 400 pages, illustrated. 1935. \$4.00

RADIO FREQUENCY ELECTRICAL MEASUREMENTS, by H. A. Brown. A laboratory course in r.f. measurements for communications students. Contains practical information on methods. 384 pages, illustrated. Second edition, 1938. \$4.00

EXPERIMENTS IN ELECTRONICS AND COMMUNICATION ENGINEERING, by Schulz and Anderson. A laboratory text describing 108 experiments covering all aspects of radio and electronic fields. 380 pages, 1943. \$3.00

Commercial Equipment and Operating

HOW TO PASS RADIO LICENSE EXAMINATIONS, by C. E. Drew. Gives answers and explanations for the paraphrased questions in the FCC study guide, covering all six elements of the commercial examination. 320 pages, illustrated. 2nd edition, 1944. \$3.00

PRACTICAL RADIO COMMUNICATION, by Nilton and Hornung. Covers basic principles and technical requirements in the commercial fields—broadcasting, police, aviation and marine communication. 927 pages, illustrated. 2nd edition, 1943. \$6.00

THE RADIO MANUAL, by G. E. Sterling. An excellent practical handbook, invaluable to the commercial and broadcast operator and engineer. Covers principles, methods and apparatus of all phases of radio, 666 pages, illustrated. 2nd edition, 1938. \$6.00

Miscellaneous

MATHEMATICS ESSENTIAL TO ELECTRICITY AND RADIO, by Cooke and Orleans. Provides the essentials of algebra, geometry and trigonometry needed to solve everyday problems, with practical examples. 418 pages, illustrated. 1943. \$3.00

RADIO AS A CAREER, by J. L. Hornung. A comprehensive discussion of the opportunities to be found in the various radio fields and the relationship of the radio amateur to these fields. Prewar, but not obsolete. 212 pages. 1940. \$1.50

PRINCIPLES AND PRACTICE OF RADIO SERVICING, by H. J. Hicks. Receiver circuit fundamentals and their application to general service practice. Covers modern testing equipment and business principles in servicing. 391 pages, illustrated. 1943. \$3.50

Burlington

★ **PANEL INSTRUMENTS**

Guaranteed ACCURACY

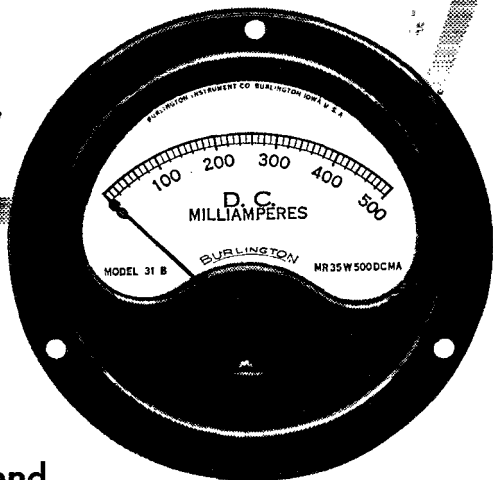

Due to design characteristics and close control of manufacturing processes, Burlington instruments embody the following advantages:

PERMANENCE OF CALIBRATION . . . All DC instruments employ Alnico magnets which are known to be more highly resistant to shock, heat, vibration, and stray fields than any other magnetic material.

FREEDOM FROM STICKING . . . Clearances for all moving parts are such that the results of entrance of small particles as encountered in field service are reduced to a minimum.

STABILITY OF OPERATION . . . All instruments are "NORMALIZED" after assembly to eliminate "zero shift" and other calibration errors due to ageing.

Exceptionally high torque to weight ratio of control springs to moving element insures minimum error under conditions of shock, vibration, and other rough usage.

Alignment of jewels and magnet core piece is such that the center lines of these parts coincide within plus or minus .002". The design of the brass movement frame and components is such that mechanical tolerances are reduced to a minimum in assembly. As a result, jewel and pivot wear is uniform which reduces "frictional torque" of the moving coil.

All series resistors and coils are heat treated and impregnated after wrapping to insure stability and long life.

All ranges AC & DC are available in 2½", 3½" and 4½" sizes, both square and round, flush mounting.

*Engineering service furnished for specialized applications.
No obligation. • Write today for further information.*

BURLINGTON INSTRUMENT CO.
800 Fourth Street • Burlington, Iowa

RADIO PARTS

ELECTRONIC EQUIPMENT



AMATEURS!

Mail Coupon Below NOW for
CONCORD'S
Money-Saving "Victory"
Clearance Flyer—Sent FREE

A treasure-book of values for radio fans, hams, set builders! 32 bargain-packed pages listing thousands of standard-make, top-quality radio parts and electronic supplies — now available without priority at low **Victory Clearance** prices. The values listed at the left are typical of the important savings offered in Meters, Condensers, Transformers, Resistors, Controls, Switches, Relays, Test Equipment, Generators, Microphones, Tools, and hundreds of Repair, Replacement, and Accessory Parts.

Quick Shipment from CHICAGO or ATLANTA

Huge stocks in two convenient warehouses — one in Chicago and one in Atlanta — are ready to supply you quickly with needed parts of dependable, nationally-known quality — and at **Victory Clearance** prices that mean real savings. Mail the coupon below NOW for your **FREE** copy of **CONCORD'S Victory Clearance Flyer**.

Check These Typical CONCORD Values:

- G.E., A.C. rectifier type 0-250 milliammeter. 2 1/2" flange mounting type. Q5B4119 \$3.95
- G.E. rectifier type -10 to +6 db meter. 2 11/16" flange mounting type. Q5B4120 \$4.95
- 850 Volt, 200 M.A. C.T. Power Transformer. 115, 117, 120 volt primary. Q5B5035 \$4.29
- Tube to line transformer. Pri. Z = 21000 ohms. Sec. Z = 220 ohms. Q5B5005 \$1.95
- 90 mmfd. 3000 V. mica condenser. Q5B5031. \$3.95
- 400 mmfd. 3000 V. mica. Q5B5034 \$3.95
- .02 mfd. 1000 V. mica condenser. Q5B3041... 59¢
- .01 mfd. 2500 V. mica condenser. Q5B4043.. 89¢
- 400 mmfd. 5000 V. mica. Q5B3044 49¢
- Precision resistor, 2.80 ohms. Q5B104 10¢*
- Wire wound precision resistor. 1 megohm. Q5B243 \$1.49
- Ferrule Type 8000 ohm, 200 watt resistor. Q5B109 \$1.79

CONCORD RADIO CORPORATION

LAFAYETTE RADIO CORPORATION

CHICAGO 7, ILL. ★ ATLANTA 3, GA.
 901 W. Jackson Blvd. 265 Peachtree Street

CONCORD RADIO CORPORATION

901 W. Jackson Boulevard
 Dept. ST-26, Chicago 7, Illinois

Please RUSH FREE copy of CONCORD'S new 32-page VICTORY CLEARANCE Flyer.

Name

Address

City State

DEPENDABLE PERFORMANCE

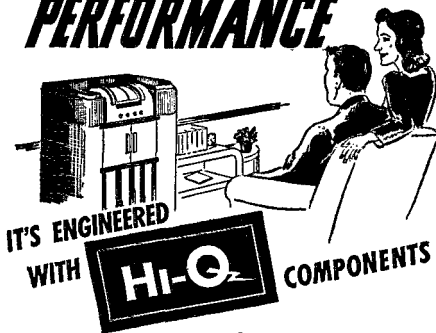

IT'S ENGINEERED

WITH **HI-Q** COMPONENTS

CERAMIC
CAPACITORS



WIRE WOUND
RESISTORS

CHOKE COILS



**ELECTRICAL REACTANCE
CORPORATION**
FRANKLINVILLE, N. Y.

An Unusual

EMPLOYMENT OPPORTUNITY

The world wide demand for seismic crews provided by Seismograph Service Corporation requires an immediate expansion of its technical personnel.

Men who will enter foreign service, with training in the theory of and practical experience with electronics and radio maintenance and repairing are offered an opportunity leading to responsible positions in petroleum exploration.

Applicants must be free to travel and should preferably be under 26 years of age and single. Those who are accepted will be given training in SSC methods, and when proved competent will be considered for assignments on seismic crews throughout the world.

• • •

In writing for details as to training, salary, living allowances, etc., please state your qualifications and age.

SEISMOGRAPH SERVICE CORPORATION

Kennedy Building • TULSA 1, OKLAHOMA, U. S. A.

P.O. Box 1590

Above 50 Mc.

(Continued from page 114)

WIKB, Haverhill, Mass., suggests that a common cause of trouble with HY-75s may be the melting of the solder in the plate caps. The very short plate lead (one of the tube's best features) undoubtedly gets very hot, and the high circulating current characteristic of v.h.f. tank circuits contributes to external heating, with the result that it is usually difficult to keep a good connection to the plate. The tube temperature may be reduced materially by directing a small fan at it, preferably by means of a cardboard tube or a section of stovepipe.

Tests with this type of cooling, while using a G. R. hummer for continuous tone modulation, show that transmissions as long as 25 minutes can be made without excessive tube heating or noticeable drift. Without the fan, the tube will kick out in less than ten minutes, and drift is very bad.

WIKB also makes a plea for the low-power enthusiast, saying that the low-power boys are often smeared by stations using high-powered modulated-oscillator rigs. We agree that the use of high power carries with it the obligation to make the signal as sharp as possible, and this can be done only by going to crystal control or its equivalent. We feel that there is little justification for running more than 25 watts or so to the oscillator type of rig, and even this amount of power can cause more QRM than 200 watts crystal controlled. Certainly, the user of high power should have provision for reducing his input to the minimum amount needed for satisfactory communication, especially in the purely-local work which constitutes such a large part of activity on any v.h.f. band. Four megacycles is a relatively narrow band, with the type of equipment that most of us are using — let's all try to operate so as to give the other fellows on the band a break.

~~Strays~~

This really happened: An up-and-coming radio serviceman took his widowed lady friend and her toddling offspring out for a drive in his car — the back seat of which was loaded down with about \$450 worth of radio tubes, his long awaited new stock for the year. Working on the principle that two is company and three a crowd he took his honey-chile for a stroll through the green-sward after parking his car at the edge of a cliff. Upon his return he was horrified to see only a few remaining tubes left. When he asked the brat what happened to the rest he was told in baby talk that, "I frew dem over the hill and heard dem go pop."

P.S.: When last heard from he was being detained by the homicide squad.

620-watt input  power tube —
ECONOMICAL TO BUY AND USE!

SAVES

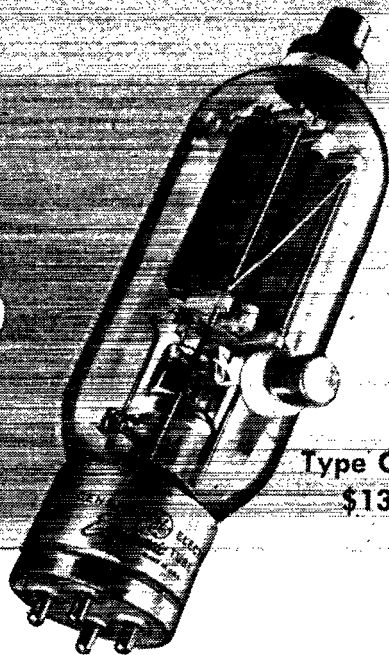

Type GL-810
 \$13.50

You get your money's worth *plus* in the low-cost service which Type GL-810 gives — a result of high plate efficiency with low driving power and relatively low plate voltage.

A high- μ tube, the GL-810's plate efficiency is substantially aided by the design of the heavy-duty filament. This is shielded at both ends to save input power by eliminating bulb bombardment and electron "strays".

Designed for modern rigs, the GL-810, at full ratings, will operate at frequencies up to 30 megacycles; at reduced ratings, up to 100 megacycles. The tube's short internal leads permit compact circuit layout, making neutralization easy.

These features and others make Type GL-810 a power triode that will do a real job, with real economy, in your up-to-the-minute transmitter. Ask your nearest G-E distributor for complete information, or write *Electronics Department, General Electric Company, Schenectady 5, New York.*

CHARACTERISTICS of Type GL-810

Filament voltage	10 v
Filament current	4.5 amp
Max plate ratings (ICAS), Class C telegraphy:	
Voltage	2,250 v
Current	0.275 amp
Input	620 w
Dissipation	150 w
Amplification factor	36

ELECTRONIC TUBES OF ALL TYPES FOR THE RADIO AMATEUR

GENERAL  ELECTRIC

161-E4-8850

Foreign Notes

(Continued from page 71)

SOUTH AFRICA

The South African Radio Relay League has now been fully reactivated, with all divisions again active. In negotiations with the Postmaster General's office, the League has stressed the story of amateur radio and its achievements during the war. At present, however, the government has made no commitments on the return of amateur bands but has chosen a committee to consider the question. It is believed that action for the re-opening of the 80-40-20 bands will be timed to coincide with the release of those frequencies in the United States and Great Britain.

SWEDEN

A brief letter from SM5SM reports that in September the government announced Swedish hams would be on the air in the near future, but with new regulations. He says there is great enthusiasm over postwar plans for operation, and many newcomers.

SWITCH TO SAFETY!



BOOK REVIEW

Electronics Dictionary, by Nelson M. Cooke and John Markus; published by the McGraw-Hill Book Company, Inc., N. Y. 433 pages, 6 x 9; illustrated. Price, \$5.00.

The first impression gained from a casual perusal of this dictionary of electronics words and terms was that it "explained the obvious," but upon trying it as a means of answering various electronic questions, it was found to contain many very useful definitions. To anyone familiar with radio terminology, many of the words and phrases defined will seem simpler than the definitions, this being characteristic of dictionaries in general. Actually, this volume should prove to be a very handy reference book on radio and electronics, as it contains not only readily-understood definitions, but a wealth of information on the thousands of subjects covered. Examples of its style:

Doppler effect The apparent change in frequency of a sound wave reaching an observer, due either to motion of the source toward or away from the observer, to motion of the observer, or both.

Superregenerative detector A vacuum tube detector which oscillates continuously at the frequency being received. The oscillation is broken up or quenched at a frequency slightly above the audibility limit of the human ear by a separate oscillator connected between the grid and the plate of the tube, to prevent the regeneration from exceeding the maximum useful amount. Advantages are extreme sensitivity, simplicity, and a minimum number of tubes and parts. Disadvantages are broadness of tuning and radiation that can cause interference in other receivers.

Nearly 6500 terms used in radio, television, industrial electronics, facsimile, and sound recording are defined in this manner, with more than 600 appropriate diagrams and sketches which enhance the book's usefulness and interest.

— E. P. T.

Calling all..

FM
AMATEURS HF

SHUR INTERCEPTOR

(Patent Pending)

**ALL
Tuning Factors
Simply • Easily • Adjustable**

Models ready— 54MC—56MC 144MC—
148MC 167MC—168MC

Easily assembled—marked for middle of the
bands • Adjustable Spacing • Adjustable
Lengths • Screw "Lead In" Connections • Dural
Elements • Treated for Weather Endurance •
Low Loss Insulation—Synthane • Lightweight
Ideal As Transmitting Antenna

UNIQUE • DURABLE • ECONOMICAL

SHUR-ANTENNA-MOUNT INC.

Eastern Division Western Division
SEA CLIFF, N. Y. PORTER BLDG., KANSAS CITY, MO.

UNUSED SURPLUS-REDUCED

GENERAL ELECTRIC FILTER CONDENSER

2 microfarads • 4000 peak D.C. volts • Pyranol
dielectric • G. E. cat. No. 23F47 • List price \$28.00
Special price: \$7.00 • Stock No. L-10802-1

ANDREW CO. • 363 East 75th St. • Chicago 19

Founded in 1909

**RADIO TELEPHONY
RADIO TELEGRAPHY
ANNOUNCING**

Courses ranging in length from 3 to 9 months. Dormitory accommodations on campus for men and women students. Advanced students eligible for practical training at KPAC, 1 KW broadcast station owned and operated by Port Arthur College. New students accepted each month during year. If interested, write for details.

PORT ARTHUR COLLEGE PORT ARTHUR
TEXAS

Look! QRG?

Crystalab AMATEUR CRYSTALS
IMMEDIATELY AVAILABLE!

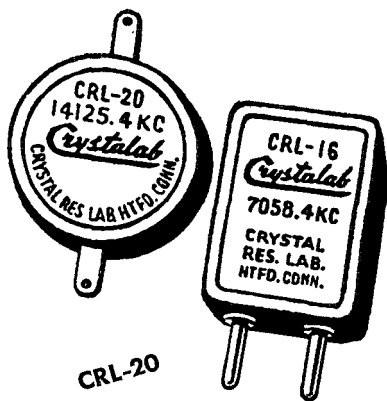

CRL-20

14,000 to
14,850 KC

7,000 to
7,425 KC

CRL-16

14,000 to
14,850 KC

7,000 to
7,425 KC

for frequencies released Nov.
15th by F. C. C. for Amateurs

• These units are supplied at frequencies between the limits set by the F. C. C.; exact crystal frequency is marked on each holder. The 14 meg. crystals can be used by doubling directly to operating band. The 7 meg. crystals are at $\frac{1}{4}$ of operating frequency. All units are low drift, precision cut crystals. CRL-16 has $\frac{1}{2}$ " between pins (plug-in type — fits std. octal socket) CRL-20 can be soldered in place — Soldering will not affect performance of unit.

Look for this trade mark



symbol of time proven precision crystals for
Police Communications, Aircraft, Laboratory
and Industrial Applications.

See your local radio dealer, or write to:



CRYSTAL RESEARCH LABORATORIES

INCORPORATED

LABORATORIES AND MAIN OFFICE: 29 ALLYN STREET, HARTFORD 3, CONN.
New York Office: 15 E. 26th Street, New York 10, N. Y. Phone MU 5 2957

NEW IF TRANSFORMERS FOR HIGH FREQUENCY IF'S

Wartime developments in high frequency receivers required new I.F. transformers with superior performance at high I.F. frequencies. These units, now available to amateurs, are ideally suited to FM receivers. The IFK unit, illustrated at the left, operates at 15.1 MC and has a bandwidth of about 150 KC. Type IFJ is similar in construction but has a bandwidth adjustable from 60 KC to 350 KC. Type IFM is similar to Type IFK, but is designed for the popular 10.7 MC I.F. frequency. Bandwidth is 150 KC. For operation in FM receivers at 3 MC, on I.F. transformer, Type IFG, and a Discriminator, Type IFH, are available in a construction similar to National standard frequency I.F. transformers.



NATIONAL COMPANY
MALDEN, MASS.

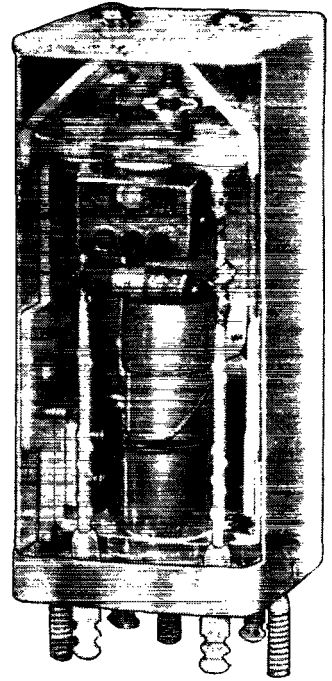

TERMINAL IS YOUR BEST BET FOR BETTER BUYS!

HEADQUARTERS FOR AMATEUR EQUIPMENT



Fresh Stock! 20 AND 40 METER MOUNTED CRYSTALS

Wide selection of frequencies. Plug into octal tube socket. Low temperature coefficient versus temperature change less than two cycles per megacycle per degree centigrade. Calibration accurate within .01 percent. Mtg. space less than 1/2 x 3/4 inch.

20 meter band—Type Z-3
40 meter band—Type Z-2

\$3.50 net
\$2.65 net

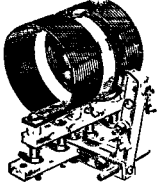

BARKER & WILLIAMSON COILS

Complete stock of B & W coils, assemblies and low-loss jack bars. Write for complete list.

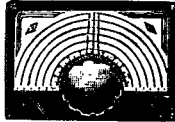

NATIONAL ACN DIALS IN STOCK!

Type ACN dial \$3.00 net
Other National dials in stock!

Write for "Specials" lists!

STRUTHERS-DUNN TIME-DELAY RELAY

SPECIAL! For use in preheating your 866's, etc. 30 second delay, coil voltage 120 volts AC, 20 amp contacts. Rugged construction throughout. This is one of the best relay buys ever offered. Net price **\$4.65**

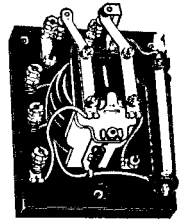

ADVANCE TYPE 400 TRANSMITTER RELAY
Isolantite insulation, DPDT contacts. Antenna change-over, 1/4" pure silver contacts. 110 volt AC coil. Net **\$5.29**

Visit our Communication RECEIVER DEPT. All sets on demonstration. Prompt Deliveries!

TERMINAL Radio Corporation

85 CORTLANDT STREET • NEW YORK 7, N. Y. • WORTH 2-4415

*Ask Your
Jobber for*

PR

The Standard Crystal For the Amateur Bands

▶ P R, the standard crystals for the amateur bands, are now available at your favorite supply jobber. Ask him for P R—they're the best—accurately calibrated, low drift over wide temperature range. Write for your copy of our descriptive booklet on P R amateur crystals.



PETERSEN RADIO COMPANY

2800 WEST BROADWAY—TELEPHONE 2760

COUNCIL BLUFFS, IOWA



Get on 10 Meters in a Hurry

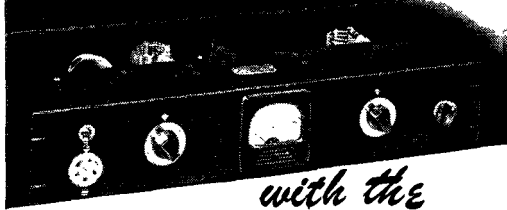

with the Millen 90800 Exciter

This 50 Watt Xmtr-exciter gets you on the re-opened 10 meter band RIGHT NOW. Order today giving your Xtal frequency - and we'll ship the day your order arrives. 108 page catalog free on request.

Net price less tubes
\$37.50 with one
Set coils
Shipped Express
Collect.



65 models, sizes from 350 to 35,000 watts. A.C. types: 115 to 650 volts, 50, 60, 180 cycles, 1 or 3-phase; 400, 500 and 800 cycles, 1-phase. D.C. types: 6 to 4000 volts. A.C.-D.C. combination types available. Write for engineering assistance and literature. Model shown is from ATC lightweight series.

Over 250,000
Now in Service

Electricity FOR RADIO AND ELECTRONIC APPLICATIONS

Onan Electric Generating Plants supply electric service for electronics applications and general uses, mobile, or stationary. Driven by Onan-built, 4-cycle gasoline engines, they are of single-unit, compact design and sturdy construction.

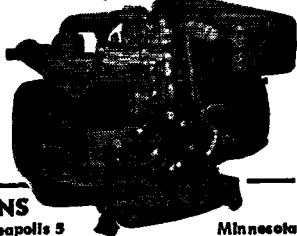

D. W. ONAN & SONS
2634 Royalston Ave., Minneapolis 5

Minnesota

TRANSMITTING TUBES RECTIFIERS CATHODE RAY TUBES

We have been appointed a sales agent by Defense Supply Corporation of Government surplus tubes and rectifiers. All are first grade Government tested and inspected tubes — not rejects.

SPECIAL — VT127A HF Triode
Approx. Plate Dis. 90 Watts
Fil. 5V. 10 Amps. Amp. Factor 14-17
Cost the Govt. up to \$30.00
Price.....\$3.50

Many other types available

Trade discounts to dealers on standard packages • Write for prices

LEWIS ELECTRONICS 16 Lyndon Avenue
Los Gatos, California

Loran

(Continued from page 66)

dependent receiver gain control on the upper and lower traces, is actuated by the square-wave generator. It can be adjusted to bias the third i.f. tube during the time that the signal to be discriminated against is on.

The other items in the block diagram are probably sufficiently clear or are unimportant to the discussion, so that more detailed treatment may be omitted here.

Navigators' Charts

Charts furnished by the Hydrographic Office are similar to that shown in Fig. 17, except that lines resulting from a chain of stations are printed in different colors, one for each pair. This illustration shows a portion of a chart drawn for a short-range experimental system. The Loran coordinates for Cincinnati (middle right) are 2H6-1500 and 2H7-1717. The first figure shows the radio-frequency channel, the letter shows pulse-rate group (33 $\frac{1}{3}$ pulses per second and above in this case), and the third figure gives the rate-switch position at which pulses stand still on the indicator traces. The four digits following the dash give the actual delay in microseconds between arrival of signals. On a chart with many lines available, the navigator must choose which lines give the most accurate navigation and then select the appropriate signals by means of his indicator rate switch before matching and reading delays. If he is navigating at night beyond the range of ground waves, he reads off the skywave corrections printed on each chart before determining his line of position or fix. In Fig. 17, these corrections are shown in circles for the areas in which they apply. It should be noted that the preparation of Loran charts requires the expenditure of many thousands of man-hours of work, and yet, when this time is divided among the large number of navigators' observations, its cost per observation becomes extremely low. There is a corresponding saving of the navigator's time because of this pre-computation.

One important consideration in the choice of Loran for a peacetime system of navigation is its potential accuracy. Accuracy largely depends upon the care with which the navigator uses it. To state the matter simply, we may say that the accuracy at the baseline between two transmitters is ± 500 feet and the average error is 0.25 per cent to 1 per cent of the distance from navigator to the chain. At 1200 nautical miles, then, the average error would not often be less than ± 3 miles nor more than ± 12 miles.

In conclusion, some brief mention should be made of the large percentage of licensed or previously-active amateurs involved in development of Loran at the Radiation Laboratory. They include W1ACI, W1ADA, W1BPI, W1GKM, W1JVL, W1KZD, W2AFX, W2MPP, W3RNL, W8JBY, W8RAN, ex-W1AG, ex-W1AOV, ex-W1AG-EBF-IHY, ex-W1EB, ex-W1JGR, ex-W1VJ-DSR, ex-W2KIC-3FYF, ex-W5CBK.

ORDER YOUR NEW Communications Receiver NOW from ALLIED *For Earliest Delivery*

**Available on Time-Payments
Trade-ins Accepted**

BE ONE OF THE FIRST to own and enjoy one of these celebrated receivers. All models cover amateur, short-wave, and broadcast bands. War-proved features... plus latest engineering developments. Allied is a leader in the distribution of communications receivers. Orders are filled in turn. Place your order now.

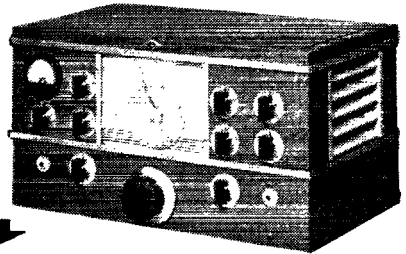

NATIONAL NC-2-40C

490 kc. to 30 Mc. range in 6 bands. Accurate single dial control. Temperature compensation. Automatic voltage stabilization. Adjustable series-valve-noise limiter. Flexible crystal filter. Phonograph or high level microphone pick-up jack. Net.....\$225
Speaker in matching cabinet, net.....\$15.00

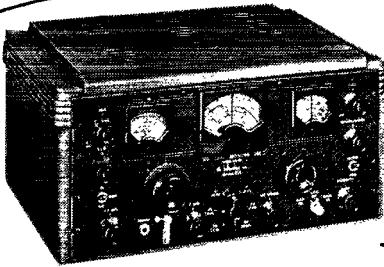

HALLICRAFTERS SX-28A

550 kc. to 42 Mc. continuous in 6 bands. Accurately calibrated tuning dial. Separate calibrated bandspread dial. Two r.f. stages. Lamb type 3 stage adjustable noise limiter. 6 position i.f. and crystal filter selectivity switch. Oscillator temperature compensated.
Net.....\$223
PM23 Speaker, net.....\$15.00

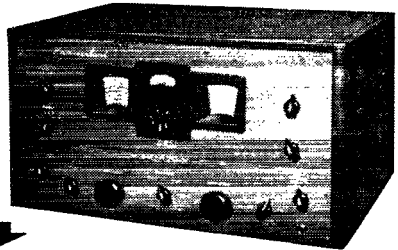

HAMMARLUND HQ-129X

Full range .54 to 31 Mc. accurately calibrated. 4 calibrated Ham bands and 1 arbitrary scale. Variable selectivity crystal filter. Low drift beat oscillator for code and locating stations. Antenna compensator. Voltage regulation. Compensated oscillator to reduce drift during warm-up. Automatic noise limiter.
Net.....\$129
Speaker, net.....\$10.50

Other well-known receivers such as:

Hallicrafters SX-25.....\$ 94.50
Hallicrafters S-36A.....\$415.00
PM23 Speaker.....\$ 15.00
National HRO.....\$197.70
RME 45.....\$166.00
RME DB-20.....\$ 59.30

Net, F.O.B. Chicago
(All prices subject to possible change)

ALLIED RADIO

Everything in Radio & Electronics
833 W. Jackson Blvd. • Chicago, Ill.

ALLIED RADIO CORP., D. I. Warner W91BC
833 W. Jackson Blvd., Dept. 27-BB-6
Chicago 7, Illinois.

Date.....

- Please ship..... Model.....
 Enclosed \$..... Full Payment Part Payment
(Balance C.O.D.)
 Send literature on Receivers and Time Payment Plan.
 Send Allied Catalog of Radio Parts and Equipment.

Name.....

Address.....

City..... Zone..... State.....

TURNER "Han-D"

9X Crystal

Hang it, hold it, mount on any standard mike stand. Does the job of several units. Engineered for maximum voice response yet delivers smooth response to music pickups. Use indoors or out. Moisture-proofed crystal stands abuse. Level -52DB. Range 60-7000 cycles. Finished in rich chrome. With 7 ft. removable cable set.



9D Dynamic

Same style and finish as 9X. Recommended for use under more severe service conditions. Withstands bad climate, heat, and rough handling. No blasting from close speaking. Rugged dynamic cartridge. Level -50DB. Range 60-7000 cycles. Available in 30-50 ohms, 200 ohms, 500 ohms or high impedance. With 7 ft. removable cable set.

Positive Contact Slide Switch on Both Models Permits On-Off Operation

• Ask Your Dealer or Write •



TURNER



TURNER

THE TURNER COMPANY
917 17th Street N. E.
CEDAR RAPIDS, IOWA

Pioneers in the communications field

Microphones

Complete Microphone Catalog
available for Your Free Copy

Crystals licensed under patents of the Brush Development Co.

N-Y-T can put a finger ON YOUR TRANSFORMER REQUIREMENTS

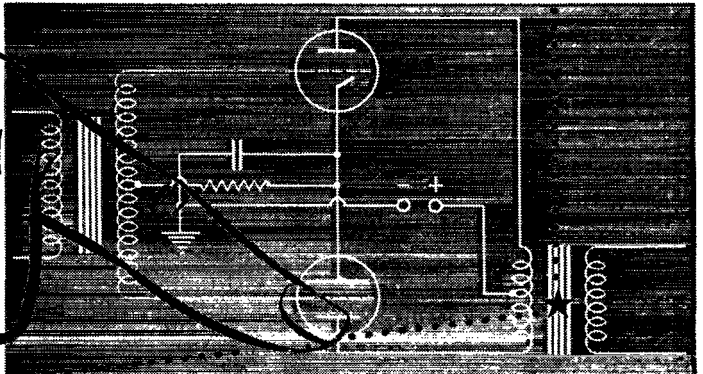
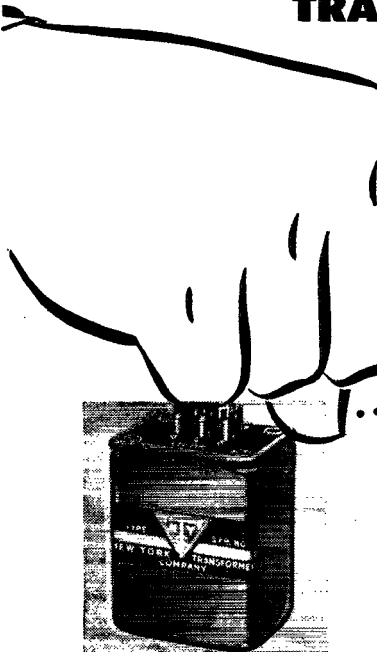

—with emphasis on electrical and mechanical suitability!

The N-Y-T Sample Department has demonstrated its ability to continuously supply advanced transformer, choke and filter designs for most electrical and electronic needs. In every instance, all requirements are fulfilled efficiently, and economically. Let us take care of any samples you may need for new equipment being designed. Address inquiries to Dept. Q2

NEW YORK TRANSFORMER CO.
62 WILLIAM STREET, NEW YORK 5, N. Y.

TRAIN NOW at home FOR RADIO-ELECTRONICS!

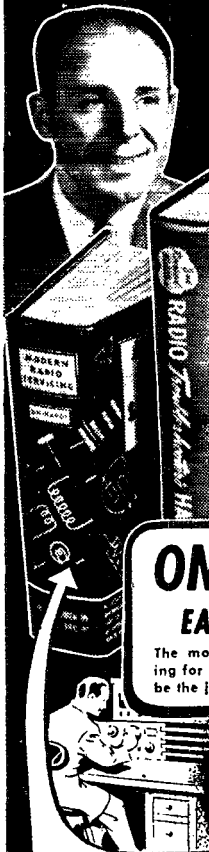

A Complete, 972-page BASIC RADIO-ELECTRONIC EDUCATION

FOR BEGINNERS—36 COURSES IN ONE

FOR ONLY

More widely used for home study and by more Signal Corps, Navy and civilian schools and colleges than any other book or course of its kind.

\$5

Here is the big, 3 1/4 lb. profusely illustrated book that makes it easy for beginners to start in the fascinating fields of Radio-Electronics-Television. A. Ghirardi's 972-page RADIO PHYSICS COURSE book gives you exactly the basic training you need—**ALL YOU NEED**—easier, better, faster—**FOR ONLY \$5 COMPLETE**. Actually, this giant book is 36 different courses in one. If sold in lesson form as a course, you'd regard it as a bargain at \$50 or more!

You'll be surprised how easily RADIO PHYSICS COURSE helps you master subjects that other courses make seem very complicated.

You'll be delighted how quickly you will understand every phase of the subject. Step by step, it carries you from Basic Electricity through to the most modern Radio-Electronic-Television developments.

LEARN FAST—LEARN RIGHT

Hundreds of users have completed it in a few weeks. All you need is a little reading time plus a desire to get started. NOW for a better paying future in the fastest-growing industry in the world. Our 5-DAY UNRESERVED MONEY-BACK GUARANTEE is your absolute protection!

ONLY \$5 EACH

The most and best Training for your money—You be the judge!

Get a better job—start a business of your own in fascinating Radio-Electronics!

THE ONLY COMPLETE BOOK ON MODERN RADIO REPAIR WORK

Learn at Home—Without an Instructor

Ghirardi's MODERN RADIO SERVICE is the only inexpensive 1-*vol.* course that gives you a COMPLETE MODERN EDUCATION in radio test instruments, troubleshooting and the truly PROFESSIONAL radio repair methods that will be your "Open Sesame!" to the big-money opportunities. It is a complete, professional servicing course from A to Z—easy to read, easy to understand. Not only will it help you handle radio repair jobs fast and profitably, but it will give you the kind of training to equip you for industrial electronic work.

GET A BETTER JOB—START A BUSINESS OF YOUR OWN

Gives complete data on all types of test instruments; how to use them; preliminary trouble checks, scientific circuit analysis; troubleshooting; parts repair, replacement, substitution; obscure troubles; aligning and neutralizing; color codes—and hundreds of other subjects including How to Start and Operate Your Own Radio-Electronic Service Business. Contains 1300 pages; 706 illustrations; 720 Self-Test Review questions. \$5 complete. SEE MONEY-SAVING COMBINATION OFFER IN COUPON!

EASY TO READ—EASY TO UNDERSTAND

An Exact GUIDE FOR LOCATING and REPAIRING RADIO RECEIVER TROUBLES

Tells exactly WHAT to do—exactly HOW to do it on over 4800 Radio Models

Like to repair radios for fun and profit? Then Ghirardi's big, 4 lb. RADIO TROUBLESHOOTER'S HANDBOOK is just the manual you need to show you how to do the work quickly without a lot of previous experience or costly test equipment. This 744-page HANDBOOK brings you specific repair data for common faults that account for almost 90% of ALL troubles in practically every Radio in use today. Simply look up the Make, Model and Trouble Symptom of the radio you want to repair. Clear instructions

tell exactly what the trouble is likely to be, exactly how to fix it. Specific data cover over 4800 home and auto radio receivers and automatic record changers of 202 manufacturers!

Also the HANDBOOK includes over 300 pages of repair charts, tube charts, tuning alignments data, transformer trouble data, etc., etc.—all designed to help you repair any radio ever made better, faster, more profitably! Only \$5 complete. Sold on 5-DAY MONEY-BACK GUARANTEE.

5-DAY MONEY-BACK GUARANTEE

MURRAY HILL BOOKS, INC., Dept. Q-26
232 Madison Avenue, New York 16, N. Y., U. S. A.

Enclosed find \$..... for books checked; or send C.O.D. (no foreign C.O.D.'s) for this amount plus postage. If not fully satisfied, I may return the books within 5 days for refund of my money.

- | | |
|-------------------------------------------------------------------------------|--------------------------------------------------------------------------------------------------------------------------------------------------------|
| <input type="checkbox"/> RADIO PHYSICS COURSE \$5 (\$5.50 foreign) | <input type="checkbox"/> MODERN RADIO SERVICING \$5 (\$5.50 foreign) |
| <input type="checkbox"/> RADIO TROUBLESHOOTER'S HANDBOOK \$5 (\$5.50 foreign) | <input type="checkbox"/> MONEY-SAVING COMBINATION: Modern Radio Servicing AND Troubleshooter's Handbook (BOTH BIG BOOKS) only \$9.50 (\$10.50 foreign) |

Name.....

Address.....

City & Dist. No..... State.....

REPAIR ANY KIND OF RADIO EQUIPMENT

DeLuxe SPEED KEY

Model
CP 810

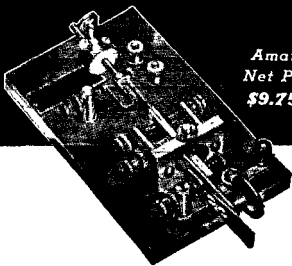

Amateur
Net Price
\$9.75

One of the finest commercial or amateur bugs available. Chrome finished base and superstructure. Springs made of selected blue spring steel for uniform performance in all keys. Nine points of adjustment to suit the most critical touch. Fully adjustable. Silver contacts 3/16" diameter.

MODEL CP 510 SPEED KEY • Similar to above except the base is Battleship gray wrinkle finish. Amateur Net Price \$6.75

TELEGRAPH Apparatus Co.

325 WEST HURON STREET • CHICAGO 10, ILL.

COMMERCIAL RADIO INSTITUTE

A RADIO TRAINING CENTER FOR 24 YEARS

Resident Courses Only • Broadcast, Service, Aeronautical, Television, and Marine telegraphy classes now forming for mid-year term Feb. 1. Literature upon request. Veteran training.

Dept. B, 38 West Biddle Street, Baltimore 1, Maryland

ASK FOR OUR BARGAIN BULLETIN

Phone, Wire or Write

WHOLESALE

Radio-Electronic Parts
Tubes, Sets and
Equipment

R. G. SCELİ & CO.

317 Asylum St. Hartford, Conn.

Telephone 2-1144

BRANCH: 83 ELM ST., BRIDGEPORT, CONN.

Crystal Ball

(Continued from page 68)

have proven their versatility and dependability in such critical applications as aircraft instrument approach systems, remote operation of radio range stations and on high-speed communication circuits.

This v.h.f. remote control system is only one of the many applications of such devices that can be made by the v.h.f.-minded amateur.

— Pfc. Stanley W. Jeffcoat, W5KPY, ex-W4EPF

NOTE:

We like W5KPY's idea but think that his system would have more appeal as a means of operating by remote control between two fixed locations, rather than from a moving automobile. Such an arrangement would be of value when the transmitting facilities are located in a desirable but remote spot (to avoid b.c.l. trouble, for instance) and it would seem to be applicable to joint operation from several stations — a likely radio club project. Of course, the operators of such a system would be required to comply with all FCC regulations concerning remote-control operation. — *The Judges.*

I.F. CRYSTAL FOR CALIBRATION POINTS

IN VIEW of the increasing use of v.f.o.s in amateur transmitters, it is imperative that the calibrated receiver bandspread dial be right on the nose as many amateurs set their frequency by their receivers. I propose to use a 450-kc. i.f. (with a 450-kc. crystal in the filter). By adding a twin triode in a multivibrator circuit and switching the crystal into the b.f.o. circuit it is possible to get 50-k.c. check points all through the receiver tuning range. With a small trimmer on the oscillator tuning condenser (tuned from the panel) it would be possible to correct the dial calibration with the 50-kc. check points so that all variables (age, rough use, temperature, etc.) are eliminated. Incidentally, by zero-beating a signal with the crystal switched in the b.f.o. you will know the signal is tuned on the exact i.f. frequency, and also that the dial reading will be extremely accurate. This adds one tube, a few parts, and some tricky switching, but should not increase the cost of the receiver very much and yet definitely puts it in the "frequency meter" class.

— C. D. Justis, W1JVS

BUILT-IN SAFETY AT W3JOP

I PLAN to protect the components of my equipment, as well as myself, against high voltage. I'll use old familiar conventional methods plus a few new ideas of my own:

1. Proper fusing of all high-voltage and filament supplies will protect these units. Fuses can protect the meters and a high-voltage fuse will serve in lieu of an overload relay, but, of course,

(Continued on page 128)



**SCREWDRIVER
or SLIDE RULE
... which will YOU be
using 2 years from now?**



**What's Ahead for You? Add CREI
Home Study Training to Your Present
Experience—Then Get That BETTER Radio Job You Want!**

Face the facts! Thousands of new men entered the radio-electronics industry during the war. Now, many more thousands are returning as they are being discharged from the Services.

Where will you fit into this picture? What are your chances of holding down a good-paying job — of advancing to a better one?

No matter what your past radio-electronics experience has been — no matter what your training — you must start anew to add to your store of radio-electronics knowledge — to improve your ability by keeping pace with the rapid developments that have been taking place in the industry.

You *must* keep pace with such new developments as U.H.F. Circuits, Cavity Resonators, Wave Guides, Klystrons, Magnetrons and other tubes. All these largely revolve around U.H.F. applications, and here is where CREI technical training can help you — by providing you with the know-how and ability to keep pace with these new developments and to keep ahead of competition for the good jobs.

In our proved method of instruction you learn not only *how* — but *why!* Easy-to-read-and-understand lessons are provided well in advance, and each student has the benefit of personal guidance and supervision from trained instructor.

This is the basis of the CREI method of training for which many thousand professional radio-men have enrolled since 1927.

It's up to you to decide if you will be a "screwdriver" mechanic or a real technician in a responsible engineering position. Let CREI train you now to trade that "screwdriver" for a slide-rule. Our proved program of home study training should increase your technical ability and equip you to advance to the better-paying jobs that offer security and opportunity.

The facts are in the free booklet. Send for it today.

WRITE TODAY FOR FREE BOOKLET

**"YOUR OPPORTUNITY
IN THE NEW WORLD
OF ELECTRONICS"**

If you have had professional or amateur experience—let us prove to you that we have something you need to qualify for a better radio job. To help us to intelligently answer your inquiry—PLEASE STATE BRIEFLY YOUR BACKGROUND OF EXPERIENCE, EDUCATION AND PRESENT POSITION.



CAPITOL RADIO ENGINEERING INSTITUTE

HOME-STUDY COURSES IN PRACTICAL RADIO-ELECTRONICS ENGINEERING FOR PROFESSIONAL SELF-IMPROVEMENT

Dept. Q-2, 3224—16th Street, N. W., Washington 10, D. C.

*Contractors to U. S. Navy—U. S. Coast Guard—Canadian Broadcasting Corp.
Producers of Well-trained Technical Radiomen for Industry*

MEMBER: NATIONAL COUNCIL OF TECHNICAL SCHOOLS

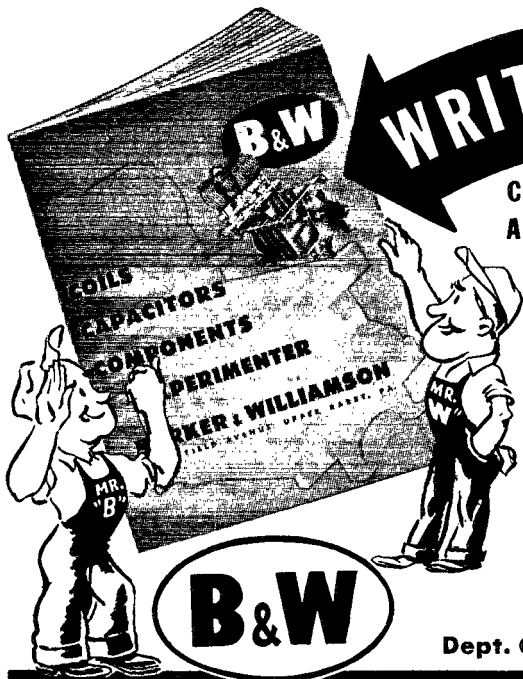

WRITE FOR YOURS

COMPLETE DATA ON THE LATEST B & W AIR-WOUND INDUCTORS, CAPACITORS, ETC.

INCLUDES HELPFUL CIRCUIT HINTS

Write today for your copy of the new B & W catalog. Lists coils, turrets assemblies and accessories for every amateur radio need—also famous B & W Type CX Heavy-Duty Variable Capacitors. Includes installation hints, circuit suggestions and data every ham should know about inductors and variable capacitors.

BARKER & WILLIAMSON

Dept. Q-26, 235 Fairfield Ave., Upper Darby, Pa.

INDUCTOR HEADQUARTERS



Bob Henry is Delivering Receivers

We are delivering these models as fast as available:

Skyrider Jr. S41.....	\$33.50
Hallcrafters S20R.....	60.00
Hallcrafters S22R.....	74.50
Hallcrafters S39.....	110.00
Hallcrafters 5X-25.....	94.50
Hallcrafters 5X-28A.....	223.00
Hallcrafters S36A.....	415.00
Hallcrafters S37.....	591.75
ECTA.....	29.50
National N-2-40-C.....	225.00
National One-Ten.....	56.10
National HRO Sr.....	197.70
RME-45.....	166.00
Hammarlund HQT29X.....	129.00
Hammarlund Super Pro.....	318.00
HT-9 transmitter.....	225.00
T350XM transmitter.....	850.00

Demand for some models exceeds supply. A few models we ship at once. Enter your reservation for earliest delivery. You can trade in your receiver. You can order on our 6% terms. Write for information. We specialize in receivers and transmitters but also have crystals, transmitting tubes, microphones, test equipment, etc. Your inquiries welcomed.

Bob Henry
W9ARA

BUTLER, MISSOURI

HENRY RADIO SHOPS

LOS ANGELES 25, CALIF.

"WORLD'S LARGEST DISTRIBUTOR OF SHORT WAVE RECEIVERS"

*Enduring Accuracy
in Vital R.F. Applications*



OHMITE RESISTORS & CHOKES

The unique characteristics of these Ohmite units have made them especially suitable for many r.f. applications. Proved by use in the most critical service . . . they'll be more popular than ever with radio amateurs and engineers.

GLASS-SEALED NON-INDUCTIVE DUMMY ANTENNA RESISTORS—for testing and measuring power output accurately. 100-watt and 250-watt sizes in variety of resistances.

R. F. PLATE CHOKES—single-layer wound on low power factor steatite cores, with moisture-proof coating. Built to carry 1000 M.A. 5 stock sizes from 2½ meters to 160 meters.

PARASITIC SUPPRESSOR—small, light, compact non-inductive resistor and choke, designed to prevent u.h.f. parasitic oscillations.

NON-INDUCTIVE VITREOUS ENAMELED POWER-SIZE RESISTORS—useful in wide variety of radio frequency applications. 50-watt, 100-watt and 160-watt stock sizes in many resistances.

Authorized Distributors Everywhere

OHMITE MANUFACTURING CO.
4864 FLOURNOY STREET • CHICAGO 44, U. S. A.

Be Right with

OHMITE

RHEOSTATS • RESISTORS • TAP SWITCHES

Send for Catalog No. 18
Gives helpful data and
information on stock
units. Address Ohmite
Mfg. Co., 4864 Flour-
noy St., Chicago 44, Ill.



(Continued from page 122)

Quality PRODUCTS
Since 1923

A complete line of
WIRES, CABLES, HOOK-UP WIRES,
RADIO HARDWARE, SHIELDED
MICROPHONE CABLE and S. J. CABLE
Complete Stock at Your Dealer

BIRNBACH

BIRNBACH RADIO CO., Inc.
145 HUDSON ST. NEW YORK 13, N. Y.

RCA INSTITUTES, INC.

Offer thorough training courses
in all technical phases of
RADIO and TELEVISION

WEEKLY RATES DAYS—EVENINGS

VETERANS: RCA Institutes is approved
under G. I. Bill of Rights
For Free Catalog write Dept. ST-46
RCA INSTITUTES, INC.
A Radio Corporation of America Service
75 Varick Street, New York 13, N. Y.

**AMATEUR
GEAR**

HATRY & YOUNG

8 Connecticut and Massachusetts Ham Stores

Hartford	C	Stamford
New Haven	O	New London
Bridgeport	N.	Waterbury

BOSTON—MASS.—LAWRENCE

The **ELECT** in Electronics

- could not be reset when an overload occurs.
- The complete encasement of the final tank and antenna tuning section in Plexiglas will keep dust and fingers out of the gear. Tests have proven that this covering has little effect on the output and wires can be drilled at will through the cover if required.
- Meters will be protected against spark-over by mounting them on a sub-panel of Presdwood behind a Plexiglas panel.
- Meter dials will be marked with a red line at the proper operating voltage so that the operator can tell at a glance if his gear is operating normally. Controls will be marked by placing suitable nomenclature beneath small protective plates of Plexiglas, beveled at the edges for beauty's sake.
- A high voltage and primary switch, mounted inside the transmitter cabinet, will open the primary circuit and short out the filter condensers when interior adjustments are to be made.
- And one thing more — a grounded bus-bar on the operating table, the rack and the other units! This will aid in further protecting the gear — and the operator.

— T/Sgt. Glen W. Smith, W3JOP

Strays

A highway "locomotive" is being used to test the latest very-high-frequency radio equipment for railroad communications. Cruising within a radius of ten miles from the Bendix laboratories, radio technicians in the "locomotive," a specially fitted truck, test the new equipment under conditions approximating railroad operation. Records are made of changes in terrain and all factors are checked for their influence upon reception and transmission. Valuable data is also being compiled on the relative merits of a.m. and f.m. equipment for mobile communications as the truck equipment is switched from a.m. to f.m. every ten seconds to provide comparative data on both types.

T/3 Gene Emmett Clark, W6DQH, won second prize in the radio play division of the second annual play-writing contest of the National Theater Conference, which was open to all servicemen in the United States. The play, written in verse and named "The Plot to Tear the Statue Down," warns against the danger of blindness to homefront threats against liberty while pursuing a foreign war. W6DQH, now a technical writer for the Fort Monmouth Signal Corps Publications Agency, was a free-lance radio writer in civilian life, and was director of radio shows which were aired by N.B.C., C.B.S. and the Blue networks

"Jet-propelled planes fly so smoothly that a vibrator is necessary on the instrument panels to keep meter pointers from sticking." — *Electronics*

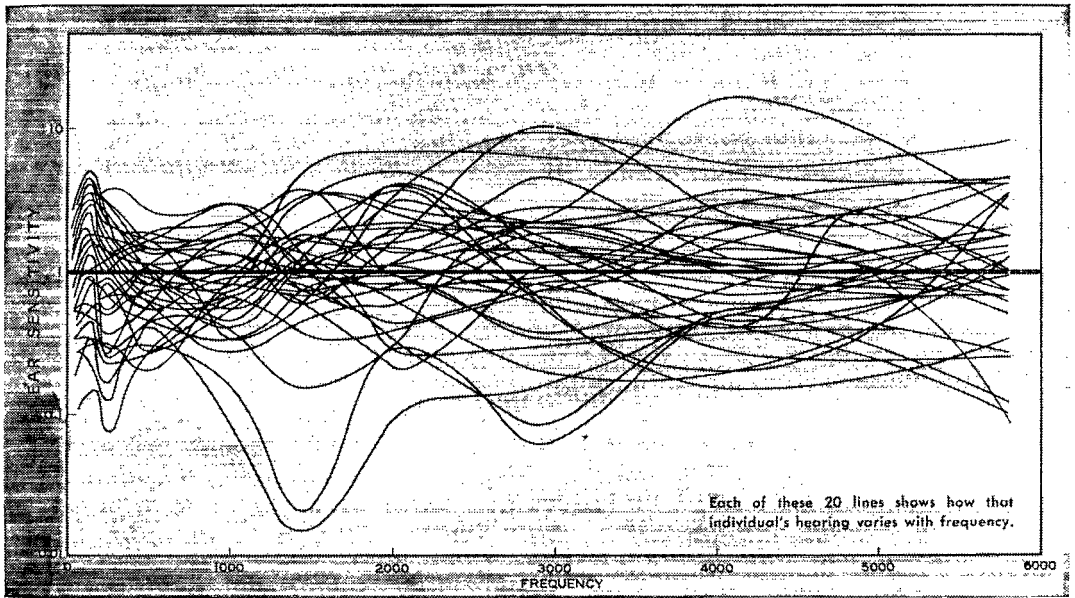

To measure is to know

Twenty-five years ago, one standard of sound power was the ticking of a watch, another was the clicking of two coins; and the measure was how far away the tick or the click could be heard. That test was made in measuring people's hearing, a field of interest to the Bell System scientists because the ear is the end-point of every talking circuit.

Accustomed to exact measurements, Bell scientists proceeded to develop a method of measuring hearing-sensitivity in terms which could be precisely defined and reproduced. After plotting hundreds of runs like those above, they decided on a particular sound intensity, representing an average "threshold of hearing," as a starting point.

Sounds delivered by a telephone line had been evaluated by listeners who compared their loudness with that of a standard source. There were wide variations in ears, so engineers replaced them by electrical instruments. When later their associates developed the Western Electric radio and public address systems, measuring circuits were promptly forthcoming. A noise meter followed, used in quieting airplanes and automobiles.

"Through measurement to knowledge," said a famous Netherlands scientist. The principle finds wide application in Bell Laboratories, whether the quest be for a way to measure sound, a new kind of insulation, or more economical telephone service.



Hearing was first measured reliably by engineers in the Bell Telephone Laboratories.



For good reception, program loudness must stay within certain limits. Volume-meters help to hold it there.

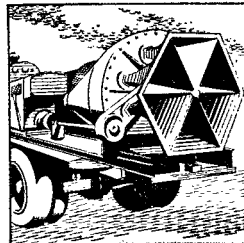

From the throat of this mighty air-raid siren comes the loudest sustained sound ever produced.

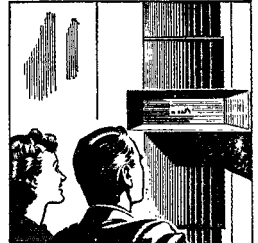

Visible Speech, result of telephone research, turns sound into "pictures" that the deaf can read.



BELL TELEPHONE LABORATORIES *Exploring and inventing, devising and perfecting for continued improvements and economies in telephone service*

**Buy Direct from Indiana's
Most Exclusive "HAM-GEAR"
Supply House**

New Models Now at Lowest Prices

● **National**
● **Hammarlund**
● **Hallicrafters**

• RME • RCA • HK • B & W • Aerovox •
Astatic • Bliley • Presto • Stancor • Taylor
• Triplett • Temco • Vibroplex

and 100 other top lines to choose from.
Rush us your order now with a \$5.00
deposit for quickest possible delivery.

We're making deliveries NOW!

W9KJF, W9VLI W9MMJ, W9QEK, W9VEK, W9TE

**VAN SICKLE
RADIO SUPPLY CO.**

34 West Ohio Street
INDIANAPOLIS 6 INDIANA

UNUSED SURPLUS-REDUCED

GENERAL ELECTRIC R. F. AMMETER

4 amperes, 2% accuracy • Expanded scale 2.19"
diameter body • G. E. type DW-52 • List price
\$19.75 • Special price: \$4.00 • Stock No. K-10801

ANDREW CO. • 363 East 75th St. • Chicago 19

IN A CLASS BY ITSELF! . . .

GENUINE
EASY-WORKING
"ORIGINAL"

VIBROPLEX

Reg. Trade Marks: Vibroplex, Lightning Bug, Bug

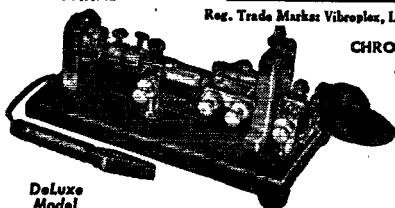

DeLux
Model

CHROMIUM
FINISHED
BASE

PATENTED
JEWEL
MOVEMENT

\$19.50

America's finest radio key — the deluxe performer that sets new standards of sending excellence and operating ease. The jewels used in DeLux Vibroplex keys are the same as those placed in the finest made watches and precision instruments, providing watch-like precision, feather-touch action, lifetime service and ease of operation unapproachable by any other key. Chromium finished base. Bright machined parts. Colorful red switch knob, finger and thumb piece. DIE CUT contacts and main spring. 3/16th contacts. Circuit closer, cord and wedge. DeLux finish also available in "Lightning Bug" and "Blue Racer" models. Order NOW! Money order or registered mail. FREE catalog.



The "BUG"
Trade Mark
identifies the
Genuine
Vibroplex.

Accept No
Substitute

THE VIBROPLEX CO., Inc.

833 Broadway

New York 3, N. Y.

Correspondence from Members

(Continued from page 70)

sorts of data. All in all the *Handbook* has to be within reach at almost any time.

Because of its size, it's a bit inconvenient to lug around. So — let's make the bible portable — sort of streamline it. Let's build the book the size of *The Reader's Digest*. Let each chapter be separately bound with a paper cover, the whole to be connected together by two metal opening rings which feed through two perforated holes going through each bound chapter.

Thus, if one wants to read up on receiver theory for example, he puts that binder in his pocket and has it at his finger-tips at any idle moment during the day or when commuting, waiting for the dentist, at lunch, or what have you. I for one would welcome this as an opportunity to have the *Handbook* with me more often and a chance to become better acquainted with its contents. Let's hear what the boys think of it.

— Bernard Stark, W3EEG

WAR TRIALS

Nürnberg, Germany

Editor, *QST*:

My wife forwarded your card to me inquiring as to my War Service record. At the present time I am in Nürnberg, Germany, for the trial of the top 23 war criminals, which is scheduled to start November 20. There are five of us under the direction of Major Robert Vincent, who is in charge of the Sound and Recording Division. We all flew over here from Washington particularly for the job. . . .

We are going to record every word spoken on the floor of the court. This will be done on discs, wire, film, and German magnetic tape, which is excellent in fidelity. In addition the I.B.M. company has furnished us with a set of gear which we use to facilitate the interpretation of the four languages spoken in the court — English, German, French and Russian. A staff of interpreters speak *sotto-voce* into close-talking mikes, and appropriate amplifiers distribute the interpretations to everyone via earphones.

At the present time (November) we are just putting all our equipment in the courtroom, which has been extensively rebuilt and is almost completed. The courthouse has been somewhat hit by bombs but is now very well repaired and heated. Winter is just about in full swing here. I expect to see snow any day now. . . .

Previous to induction, I worked for CBS in the New York engineering department.

— Phil Erhorn, W3LAH

MORE ON 24-HR. TIME

3030 Dumaine St., New Orleans 19, La.

Editor, *QST*:

In regard to discussion in November *QST*, the time system suggested is the best for use anywhere. Only one thing can be done to simplify it further: that is to add two characters for the month or four more for the year and month.

For example: 12050930 would read December fifth at nine thirty, or 4512050930 would mean 1945, 12th month, fifth day, ninth hour and thirtieth minute. We wouldn't need to get too technical and use something for the seconds. The eight character group is very long, the ten character group longer, but it could be divided into two five character groups and made easier yet. . . .

— Earl Kelley, RM2c, USNR

2019 Grant St., Toledo 6, Ohio

Editor, *QST*:

Having just come back from the Argentine, a country that uses the 24-hour clock system, I agree it is just the thing for ham radio. Once you get used to it it's much simpler than the standard system and also more accurate. I certainly hope you've changed over by the time I get a license.

— P. A. Weygandt

(Concluded on page 138)

OVER AND OVER AGAIN THE IMPOSSIBLE BECOMES POSSIBLE

Over and over again, Hytron has licked the problem of making smaller and smaller radio tubes. Its BANTAM GT, which other tube engineers said was impossible, telescoped glass receiving tubes to the T-9 bulb (bantam and loktal), and has since become the most popular receiving tube.

Next Hytron sweated out development of the BANTAM JR.—the first subminiature. The HY155 was soon superseded by the even tinier HY255.

It was only natural that the Navy and OSRD should turn to Hytron in 1940, to design diminutive, rugged tubes for the VT or variable time fuse. Fired from a gun, such tubes, despite their size, must withstand 20,000 G's and 475 rps.

Months of research at Hytron resulted in the smallest tube which has ever been mass-produced. The tube's internal cubic volume is approximately half that of the smallest competitive tube. Again new horizons were explored by Hytron. New techniques and production equipment solved fabrication, assembly, glass, and exhaust problems.

The same skills which created the BANTAM GT, the BANTAM JR., and the smallest VT-fuse subminiature are now concentrated primarily on production of Hytron GT's and T-5½ miniatures for home receivers. You can count, however, on Hytron's continuing leadership in vacuum tube development.

ALL TUBES ACTUAL SIZE

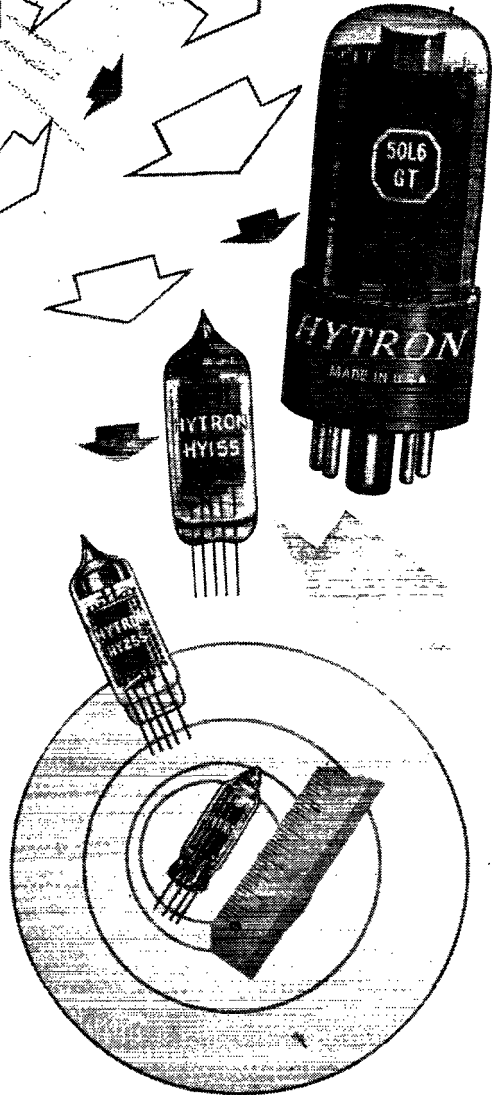

OLDEST MANUFACTURER SPECIALIZING IN RADIO RECEIVING TUBES



HYTRON

RADIO AND ELECTRONICS CORP.



MAIN OFFICE: SALEM, MASSACHUSETTS

LONG SCALE, WIDE RANGE VOLT-OHM-MILLIAMMETER

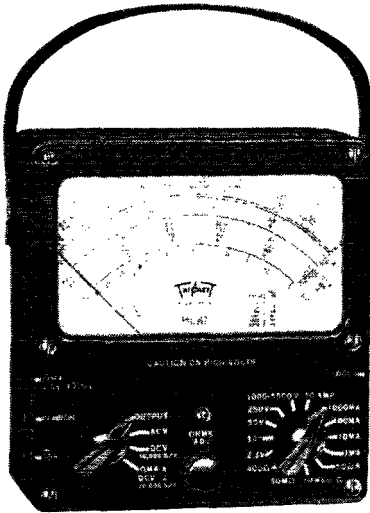

**DOUBLE SENSITIVITY
D.C. VOLT RANGES**
0-1.25-5-25-125-500-2500 Volts
at 20,000 ohms per volt for greater accuracy on Television and other high resistance D.C. circuits.
0-2.5-10-50-250-1000-5000 Volts,
at 10,000 ohms per volt.

A.C. VOLT RANGES
0-2.5-10-50-250-1000-5000 Volts,
at 10,000 ohms per volt.

OHM-MEGOHMS
0-400 ohms (60 ohms center scale)
0-50,000 ohms (300 ohms center scale)
0-10 megohms (60,000 ohms center scale)

**DIRECT READING OUTPUT LEVEL
DECIBEL RANGES**
-30 to +3, +15, +29, +43, +55, +69
DB

**TEMPERATURE COMPENSATED
CIRCUIT FOR ALL CURRENT
RANGES D.C. MICROAMPERES**
0-50 Microamperes, at 250 M.V.

D.C. MILLIAMPERES
0-1-10-100-1000 Milliamperes, at 250
M.V.

D.C. AMPERES
0-10 Amperes, at 250 M.V.

OUTPUT READINGS
Condenser in series with A.C. Volts for
output readings

ATTRACTIVE COMPACT CASE
Size: 2 1/4" x 3 1/4" x 6". A readily port-
able, completely insulated, black
molded case, with strap handle. A
suitable black, leather carrying case
(No. 629) also available, with strap
handle.

LONG 5" SCALE ARC
For greater reading accuracy on the
Triplet RED • DOT Lifetime Guar-
anteed meter.

**SIMPLIFIED SWITCHING
CIRCUIT**
Greater ease in changing ranges.

Write for descriptive folder giving full
technical details

Precision first . . . to last

HERE'S THAT NEW
**TRIPLETT
625-N**

Triplet

ELECTRICAL INSTRUMENT CO. BLUFFTON, OHIO

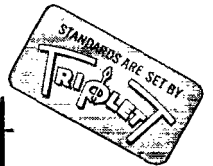

HAM HEADQUARTERS FOR Equipment and Information

15 Years of Service

to HAMS throughout the U. S. and Canada.

Complete Line

of nationally famous Radio & Electronic Parts and
Equipment.

Thousands of Items

in stock right now . . . comprising every well-known
brand of Component Parts and Equipment.

FREE WRITE TODAY for our current bulletins
about extraordinary values in surplus Radio
and Electronic Component Parts and
Equipment.

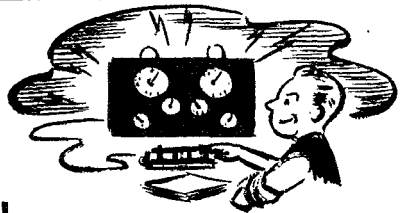

GET STARTED ON YOUR
"DREAM SET" TODAY!

We have all the component parts and
equipment and our HAM department,
which is staffed by Engineers, will gladly
help you with your problems. Write,
phone, or visit us today.

Radio Product Sales Company

238 WEST 15TH STREET
LOS ANGELES 15, CALIFORNIA
PRospect 7471

FOR
Easy
LISTENING



CHANGE TO
**MURDOCK
RADIO PHONES**

EVERYBODY in Radio knows MURDOCK. MURDOCK Radio Phones are built by sound manufacturing methods to give service — traditionally outlasting ordinary radio phones by years of service.

Since 1904 "precisioneering" has made MURDOCK Head Phones famous for super-sensitivity, clear reception, trouble-free performance, and durable, shock-proof construction. Naturally, then, you get keen *hear-ability* under all operating conditions.

No other listening experience is like hearing through the "Ears-of-a-Nation" — produced by MURDOCK engineers

and craftsmen. Thousands are now listening without strain or discomfort, thanks to MURDOCK'S research through the years. They get the message right . . . the first time . . . all the time.

MURDOCK Radio Phones have been a **FIRST** for over 40 years with unusual features that mean effective, **EASY** listening. Be sure to consult with us for sturdy, solid-built Head Phones.

JOBBERS

Our Radio Phones are now available to you in greater quantities. Write us for full details today.

Get the Full Story of What These Radio Phones Can Do for YOU. Write for Catalog!

WM. J. MURDOCK CO.
213 Carter St., Chelsea 50, Mass.

G. E., AEROVOX AND SPRAGUE Filter Condensers



GE Pyranol
4 mfd 2000 v.....**\$2.75**

LIST PRICE \$10.80

Sprague Oil-filled
8 mfd 2000 v.....**\$3.75**

LIST PRICE \$14.88

Aerovox Oil-filled
1 mfd 5000 v.....**\$6.90**

LIST PRICE \$30.00

Add postage to above prices

All perfect, first grade, Army-Navy inspected. High voltage porcelain terminals.

Other Items Available • Write for List

ELECTRONIC NAVIGATION

Box 126

Woodside, Long Island, N. Y.

CALLING ALL HAMS

Just what you've been waiting for. All your requirements from one central source. Only products of reputable manufacturers stocked. Our technical staff trained—abreast of new developments. Write, Wire, Phone.

R. I. DISTRIBUTING COMPANY

19 Dexter Street, Pawtucket, R. I.

Perry 3142

Adson RADIO CO.

Dept. Q--221 FULTON ST. N. Y. 7, N. Y.

EVERYTHING FOR AMATEURS AND SERVICEMEN
COMPLETE LINE OF ELECTRONIC EQUIPMENT

Carter

THE PREFERRED POWER SUPPLY

Carter Dynamotors, Magmotors, DC to AC Converters and Genmotors provide the finest rotary power for your mobile rig. Widely used and preferred by leading State and City Police Mobile Networks. Wide range of receiver and transmitter models, filter and starting relays available. Send today for the latest free bulletin.



1408 MILWAUKEE AVENUE

CARTER ... A well-known name in radio for over 20 years!

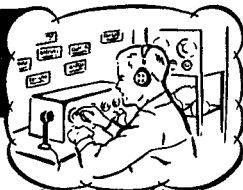

(Continued from page 134)

FIRST ON?

Philippine Sea Frontier, Manila

Editor, *QST*:

I had intended writing you before I left the States with reference to the opening of the v.h.f. amateur band. On the day the Federal Communications Commission approved an order to allow amateurs to again operate on the 112-116 Mc. band, which occurred approximately at four o'clock in the afternoon, I received a telephone call from a friend in the Commission at 8:00 p.m. that evening informing me of the fact. I immediately called several of the licensed amateurs who had been previously operating on this band in connection with the War Emergency Radio (WERS) hook-up and told them to listen. After giving them time to get their receivers warmed up, I sent a CQ signing my call. Of course they were taken by surprise and I immediately explained the situation to them and I believe that I can readily say that I was the first amateur to send a CQ on the amateur band since December 7, 1941. The other stations were W3REK, W3BWA and W3EFO — all of Norfolk, Va.

At the conclusion of World War I, W3RZ and I had the same experience except that we did not wait for information from the FCC (at that time the Department of Commerce). We immediately went on the air at the signing of the Armistice and I believe again that makes us the first amateurs then to go on the air after the cessation of hostilities.

I would like to let you know that I miss my *QST* very much but the mail situation is so bad out here that it is practically impossible to get anything other than first class air mail, which takes from 10 days to two weeks, so I will have to content myself until my return home and then do a lot of back reading out of *QST*.

— Lt. Comdr. J. C. Mellon, *W5NT*

Strays

Here is a "nut-shell" explanation copied from *Hydro-News* and sent to us by VE3RD.

"In the case of f.m., which is being used by the Toronto hydro, the wave has regular limitations and reception is, therefore, free from static. The a.m. curve, on the other hand, has irregular extremities called "spill" which cause static interference."

There, does that answer your question?

—♦♦♦—

While in the Far East, the *ARRL Handbook* was greatly appreciated, especially by several who were unlucky enough to become Jap POWs. *Handbooks* were smuggled in and a few ex-hams built secret radios there in Java. The *Handbooks* were also used in planning our post-war rigs.

— F/Lt. L. R. Montgomery, *RCAF, ex-VE2JT*

COMPLETE RADIO TRAINING!

Prepare now to accept a responsible position in Commercial Radio. New developments will demand technicians with thorough basic training, plus a knowledge of new techniques discovered during the war. Training open to high school graduates or those with high school equivalency. Courses 6 to 18 months' duration in RADIO AND ELECTRONICS. Approved Veteran training in Radio. Write for Particulars.

VALPARAISO TECHNICAL INSTITUTE
Dept. TN Valparaiso, Ind.

Radio Instructor Wanted

Capable of teaching Radio Theory and Shop. Must teach both day and evening classes. Location New York City. \$3600 year.

**BOX 145, QST WEST HARTFORD
CONN.**



GOOD NEWS!

for RADIO STATION ENGINEERS...MANAGERS

...and for those who plan a "Dream Station"

**SOON
AVAILABLE**

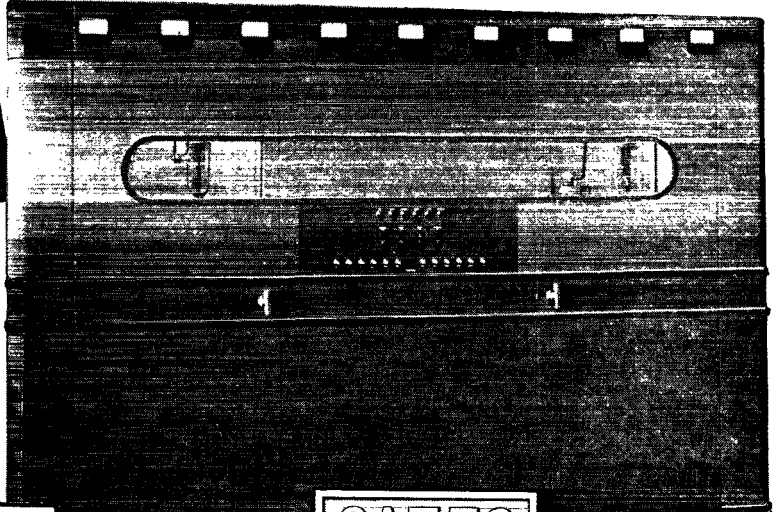

GATES

NOTE THESE SPECIFICATIONS

CARRIER FREQUENCY STABILITY
Plus or minus 10 cycles maximum.

AUDIO DISTORTION
Less than 3%, 95% modulation,
50 to 7500 cycles.

AUDIO FREQUENCY RESPONSE
Plus or minus 1½ Db., 30 to 10,000
cycles.

CARRIER AND HUM LEVEL
Better than 60 Db. below 100%
modulation, unweighted.

POWER SUPPLY
230 volts, 3 phase, 60 cycles.

5 AND 10 KILOWATT TRANSMITTERS

They're modern—with built-in technical features that fulfill every demand for versatile 5 and 10 Kilowatt Transmitters—and they'll soon be available, both for stations now operating or for that "dream station" you may be planning.

Engineered by skilled GATES men with 24 years of "know-how" back of them, these new models (BC-5, BC-10) afford not only a perfected broadcasting technique, dependability, and efficiency but a prideful investment in engineering distinction and prestige.

**Install them for Engineering Perfection . . .
Dependability . . . Efficiency . . . Versatility!**

WRITE FOR COMPLETE DETAILS

. . . *Everything for Radio Broadcasting from the Plans to the Completed Station* . . .

NEW YORK OFFICE
9th Floor, 40 Exchange Place

GATES RADIO CO.
QUINCY, ILLINOIS

SOLD IN CANADA BY
Canadian Marconi Co., Ltd.,
Montreal

EXCLUSIVE MANUFACTURERS OF RADIO TRANSMITTING EQUIPMENT SINCE 1922

HAM-ADS

(1) Advertising shall pertain to radio and shall be of nature of interest to radio amateurs or experimenters in their pursuit of the art.

(2) No display of any character will be accepted, nor can any special typographical arrangement, such as all or part capital letters be used which would tend to make one advertisement stand out from the others.

(3) The Ham-Ad rate is 30¢ per word, except as noted in paragraph (6) below.

(4) Remittance in full must accompany copy. No cash or contract discount or agency commission will be allowed.

(5) Closing date for Ham-Ads is the 25th of the second month preceding publication date.

(6) A special rate of 7¢ per word will apply to advertising which, in our judgment, is obviously non-commercial in nature and is placed and signed by a member of the American Radio Relay League. Thus, advertising of bona fide surplus equipment owned, used and for sale by an individual or apparatus offered for exchange or advertising inquiring for special equipment, if by a member of the American Radio Relay League takes the 7¢ rate. An attempt to deal in apparatus in quantity for profit, even if by an individual, is commercial and all advertising by him takes the 30¢ rate. Provisions of paragraphs (1), (2), (4) and (5), apply to all advertising in this column regardless of which rate may apply.

(7) Because error is more easily avoided, it is requested signature and address be printed plainly.

Having made no investigation of the advertisers in the classified columns, the publishers of QST are unable to vouch for their integrity or for the grade or character of the products or services advertised

QUARTZ — Direct importers from Brazil of best quality pure quartz suitable for making piezo-electric crystals. Diamond Drill Carbon Co., 719 World Bldg., New York City. **AMATEUR** radio licenses. Complete code or theory preparation for passing amateur radio examinations. Home study and resident courses. American Radio Institute, 101 West 63rd Street, New York City.

CRYSTALS available — all types, including 100 kc., 465 kc. and 100 kc. Broadcast and Aircraft given prompt attention. Scientific Radio Products, Council Bluffs, Iowa.

RADIO Tests — Pre-examination tests for radio operators. Tests your knowledge before you appear for commercial radio operator license examinations. Avoids failures. Guides your preparation. Saves your time. Worth investigating at once. Also books for home study. Write for free circulars 5 Q. Nilson Radio School, 51 E. 42 St., New York 17, N. Y.

ALASKAN hams: Here is a source of supply closer to home. Stocking leading brands of ham gear, communication receivers, parts, accessories, engine generators. Save time and money. Robbie's Radio Supply, Alaskan jobbers. P.O. Box 1835, Anchorage, Alaska.

IN STOCK: new Signal Corps Super-Pros, \$97.50; BC-342, \$82.50; BC-312a, \$60; Signal Corps BC-610, HT4E transmitters, complete, \$695; other receiver and transmitter bargains. In stock: New TR-4s, \$38.22; 3" O-1 milliammeters, \$5.95; meter rectifiers, \$1.95; Signal Corps DeLuxe headphones, \$1.95. For sale: reconditioned SX28s, \$184.50; SX-25s, \$70.85; SuperPros, HROs, NC-200s, RME-69s, etc. Write for receiver list. Henry Radio, Butler, Mo.

WRITE, wire, phone Bob Henry, W9ARA, Butler, Missouri, 24 hour service; new and used receivers, transmitters, test equipment, amateur radio parts. Code machines for sale or rent.

WRL Transmitting kits — 15, 35, 70, and 150-watt units — low priced. All makes of receivers, both new and reconditioned. Leo offers best trade-in deal, and easy time payment plan. One of the country's largest parts supply houses. Write today for free catalog, special radio map offer, tube-base calculator offer and other items. Leo, at Wholesale Radio, Dept. HA, Council Bluffs, Iowa.

CRYSTALS: complete units mounted in holders 3/4" pin spacing to fit 5-prong socket 3.5 mc., 14 mc. bands within 5 kc. your selected frequency, \$3.30 ea. Blanks: large 3/4" by 1/4" oscillating blanks, 3.5 mc. and 7 mc. bands, \$1.00 each. Immediate shipment. No priority required. Rex Bassett, Inc., Ft. Lauderdale, Fla.

FOR SALE: October and November, 1916 QST. Make offer. Smith, W8QV, 2307 Allison, University Hts., Ohio.

CRYSTAL plus holder, BT out, mounted, 5 kc. of desired frequency, \$2.75. Exact frequency, \$3.75. Borri Electric Co., Granville, Ill.

HIGH frequency and microwave plumbing and equipment built to your specifications or will design equipment to do your job. Ham prices. Jeffrey, Crillas Machine Co., 54 Kallen Ave., Schenectady, N. Y.

FOR SALE: Two 32-watt input, 300 v — 100 Ma. vibrator supplies, \$10. Schuch, Jackson, Mo.

ANTENNA elements 3/4" aluminum tubing, 12' long in straight lengths, 84¢. 5" RCA scope, excellent condition, \$125. Clough Brengle Audio oscillator lab model, \$75. Two Eimac 304Ts, new and one 833A used, for \$100. Jesorek, Wilmington Manor, New Castle, Del.

WANTED: QSTs before 1921. Name your price. Howard, W6ERS, 700 Rolph St., San Francisco 12, Cal.

QSLs-SWLs. Meade, 1507 Central Ave., Kansas City, Kansas.

WANTED: QST, September 1919 and September, 1921. Dick Dunham, W1EWF, River Ridge, Hanover, N. H.

LOOK 4 mfd. 2000 volt d.c. G.E. Pyranol condensers, rectangular can, guaranteed A-1, \$3 ea., 5 for \$14, plus shipping. W2JRL, 9727 Glenwood Rd., Brooklyn 12, N. Y.

750-1000 watt phone and bug transmitter, 2 racks, 42" x 72", complete, including oscilloscope, mikes, 2 receivers, IRME 66 remote control, etc., Make reasonable offer. Estate Wm. W. Birney, W2LVE, 319 Parkville Ave., Brooklyn, N. Y.

WANTED: 100 to 200-watt transmitter for 10, 20, 40, and 80 meter fone-s.w. Would prefer commercial built rig. W9OUU, Bush, 1227 Exchange St., Emporia, Kansas.

WANT National HRO, NHU, SW3 or equivalents, power transformers up to 1 kw, 6000 volt c.t.; pair Class B transformers for 200-watts audio, 500 mill filter chokes. Pay cash or swap. National 1-10 all coils, Eimac 100 TLa, HK 24s, RCA 826s, Weston meters and parts. Albert Weiss, 2115 P Street NW, Washington 7, D. C.

RECEIVERS: Hallicrafters, Hammarlund, National, RME. Broadcast models coming. Conklin Radio, Bethesda, Md.

BREITING 12 wanted in good condition, with speaker, for cash. W6SN, 525 So. Westgate, Los Angeles 24, Cal.

QSLs? QSLs? SWLs? Samples. Sakkers, Holland, Mich. QST subscriptions, Cal. books.

WANTED: television equipment described October 1940 QST. H. E. Legler, W9PB, Hiawatha, Kansas.

COAX cable, Type RG-34U. Handles a kw. with ease. Loss 2 db. per 100 ft. at 100 Mc. Special price, 15¢ per ft. Limited quantity. Willard S. Wilson, 405 Delaware Ave., Wilmington, Del.

WANTED: motor with indicator for 3 element rotary. State feed system, condition, price. Cantor, W2LMQ, 944 East 24th, Brooklyn, N. Y.

SELL QST complete from Jan. 1925 up to date. Radio News complete from June 1922 up to date. In good condition. Make offer for either complete series. Carl Fastje, W9REG, Denison, Iowa.

WANTED: Rider's Manuals, test equipment, ham receiver (prefer SX-28, NC-200, NC1-10) H. Lippert, W3FIS, Easton, Penna.

QSLs. Samples, prices for hams. W2AEY, Groebe, 338 Elmora, Elizabeth, N. J.

BEST offer over \$100 takes army tank 10-tube f.m. revr., or swap for panoramic adaptor or swap with 14-tube Meissner communications revr for SX28. C. E. Nichols, 12 Prescott St., Wellesley Hills, Mass.

SALE or swap: Western Electric 5" radar oscilloscope, model BC-412-A, modified. Twelve tubes including brand new 5" white phosphor cathode ray tube. Size of scope 12" by 20" by 25". Two built-in, all Thordarson equipped power supplies. It's really bruiser. First \$150 takes it, express collect, or swap for camera, receiver, or what have you. Lt. Clarke, Movement Control, ABFTC, Camp Crowder, Mo.

CRYSTALS, amateur license holders only, 9000 to 9250 Kc., 16th harmonic to 144-148 Mcs band, 1/4 square blanks, BT out-peak activity, Stable at 25 deg. C. Blank only, in band, \$1.50; Blank only (your choice of frequency within 10 Kc.), \$2; blank and electrodes (your choice of frequency within 10 Kc.) \$2.25; complete cased crystal unit (your frequency within 200 cycles), \$4.00. Besumont Elec. Supply Co., 1319 So. Michigan Ave., Chicago, Ill.

UPPER Michigan hams! New National receivers and products in stock. W9TRJ, c/o McNally Electrical Service, Manistigue, Mich.

ELECTROMAGNETIC tube, licenses. Hoskinson, Norman, Okla.

OSCILLOSCOPE, Supreme model No. 546, \$82.50. Audio oscillator, Jackson model No. 652, \$72.50, f.o.b. W8REJ.

SELL: Some "AT" cut crystals for 160-meters, 80 meter phone and c.w. and 2625 to 2687 k.c. crystals for 15 meters at \$1.50 ea. Anthony Sivak, 1722 W. Highland Ave., Milwaukee 3, Wis.

WANTED: Voltmeter, Multitester, ammeter, or what have you. Clyde Keeler, W2NQW, 50 Seward Ave., Port Jervis, N.Y.

HAM crystals: \$2.50 within 10 kc. of specified frequency; excellent oscillators guaranteed; 2500 k.c. to 8000 k.c.; Army type, FT 243 holders. L. Kipp, 377 Broadway, N.Y.C. 7

TUBES never used: 2 Eimac 250THs, \$12 apiece; 3 RCA 805s, \$5 apiece; two 807s, \$1.50 apiece, individually or lot, or swap for late model Weston or Triplett tube-tester. W8UPJ, 97 Moreland St., Buffalo, N.Y.

SELL or trade new RCA 806, two used A-1 condition, 809 and 807. Want ham gear, camera. Watt, W9HYQ, Ontonagon, Mich.

NO WAITING FOR THIS
Famous Receiver



**NATIONAL
HRO-W**

\$217.35

Net F.O.B. Boston

complete with tubes, crystal, PM speaker, power supply, and four sets of general-coverage coils (military type)

We have these receivers on hand for immediate shipment! They are brand new sets, of the military type, built with the extra safety factors demanded by global service. The four sets of general-coverage coils include popular amateur bands as follows:

FULL COIL RANGE	HAM BAND	
	FREQUENCY	SCALE LENGTH
14-30 mc	28-30 mc	11 $\frac{3}{4}$ inches
7-14.4 mc	14-14.4 mc	6 inches
3.5-7.3 mc	7-7.3 mc	8 $\frac{1}{2}$ inches
1.7-4 mc	3.5-4 mc	20 $\frac{1}{2}$ inches

While our stocks last, we'll make "same-day" shipments — it's first come, first served so send us your order today. Don't delay if you want to be one of the lucky hams to own this superlative communications set.

We can also furnish coil sets for other bands, as listed below.

FREQUENCY NET per set	
50-100 kc	\$24.00
100-200 kc	\$19.80
180-430 kc	\$18.00
480-960 kc	\$13.20
900-2050 kc	\$13.20

You can also get other famous receivers at the Radio Shack — Hallicrafters, Hammarlund, R.M.E., Echophone — write for prices and deliveries.

**HERE'S A BUY
YOU SHOULDN'T
MISS!**

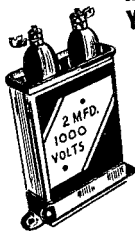

Xmtg condenser
— 2 mfd — 1000
volts — oil im-
pregnated — oil
filled — hermet-
ically sealed —
famous make.

Regularly sold for \$3.96.

YOUR COST ONLY 79 cents
Pls incl. 10c packing & postage chg.

UHF ACORN TUBES

Types 954-955-956-959

Six tubes ... \$2.95

same type or assorted

These tubes are not suited to military use but fine business for experimental and commercial use. Isolantite sockets for acorn tubes ... 88c each.

Pls incl. 10c packing & postage chg.

**SEND FOR OUR FREE
108-PAGE CATALOG**

The **RADIO
SHACK**

★ 167 WASHINGTON ST.
BOSTON, MASS.. U.S.A. ★

Designed for



Application

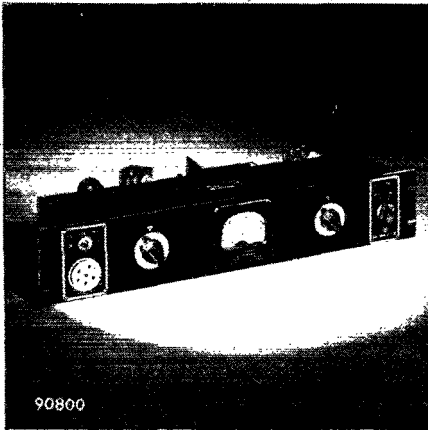

90800

**THE 90800
"50 WATT"**

Transmitter-Exciter

Again in production is the No. 90800 transmitter-exciter unit. Based on an original Handbook design, this flexible unit is ideal for either low power amateur band transmitter use or as an exciter for higher power PA stages. Priced at only \$37.50; less tubes, but with coils for one band operation. Unless otherwise requested, coils furnished are for 10 meter output with 40 meter crystal. Tubes used are 807 and 6L6.

**JAMES MILLEN
MFG. CO., INC.**

MAIN OFFICE AND FACTORY
**MALDEN
MASSACHUSETTS**



Index of Advertisers

	Page
Adson Radio Co.	96
Aerion Company	92, 93
Allied Radio Corp.	125
American Lava Corp.	89
American Phenolic Corp.	89
American Tel. & Tel.	133
Andrew Co., The	120, 134
Astatic Corp., The	113
Barker & Williamson	130
Birnbach Radio Co.	132
Billie Electric Co.	83
Burgess Battery Co.	108
Burlington Instrument Co.	116
Candler System Co.	108
Capitol Radio Eng. Institute	129
Cardwell Mfg. Co., Allen D.	84
Carter Motor Co.	138
Centralab	7
Collins Radio Co.	2
Commercial Radio Institute	128
Concord Radio Corp.	117
Condenser Products Co.	110
Crystal Research Labs.	121
Drake Electric Co.	102
Eitel-McCullough, Inc.	1
Electrical Reactance Corp.	118
Electronic Navigation	138
Gates Radio Co.	139
General Electric Co.	119
Hallerafters Co., The	4, 5
Hammarlund Mfg. Co., Inc.	81, 95
Harrison Radio Co.	111
Harvey Radio Co.	100
Harvey Radio Laboratories	90
Hatcher & Fish	114
Hatry & Young	132
Henry Radio Shop	130
Hudson-American Corporation	96
Hytron Elec. & Radio Corp.	135
Jensen Radio Mfg. Co.	91
Ken-Rad (Div. of Gen. Motors)	103
Lewis Electronics	124
Maguire Industries	86, 87
Mallory & Co., P. R.	82
Marion Elec. Instrument Co.	3
McElroy Mfg. Co.	97
McGraw-Hill Book Co.	96
Millen Mfg. Co., Inc., James	142
Murdock Co., Wm. J.	137
Murray Hill Book Co.	127
National Co., The	79, 122, Cov. III
New York Transformer Co.	126
Newark Electric Co.	98, 99
Ohmite Mfg. Co.	131
Onan & Sons, D. W.	124
Panoramic Radio Corp.	Cov. II
Peerless Elec. Prod. Co.	94
Peterson Radio Co.	123
Port Arthur College	120
RCA Institutes	132
RCA Mfg. Co.	Cov. IV
Radio Manufacturing Engineers	101, 143
Radio Products Sales Co.	136
Radio Shack Corp., The	124, 141
Raytheon Manufacturing Co.	144
Rhode Island Distributing Co.	138
Scall & Co., R. G.	128
Selsomograph Service Corp.	118
Shur-Antenna Mount, Inc.	120
Shure Brothers	88
Sound Equipment Corp.	114
Sperry Gyroscope Co.	109
Sylvania Elec. Products Co.	105
Taylor Tubes Co.	107
Telegraph Apparatus Co.	128
Terminal Radio Co.	122
Triplett Elec. Instrument Co., The	136
Turner Co., The	126
United Electronics	85
Valparaiso Technical Institute	138
Van Sickle Radio Supply Co.	134
Vibroplex Co., The	134
Western Electric Co.	104
Wholesale Radio Labs.	106

TEN METER BAND!

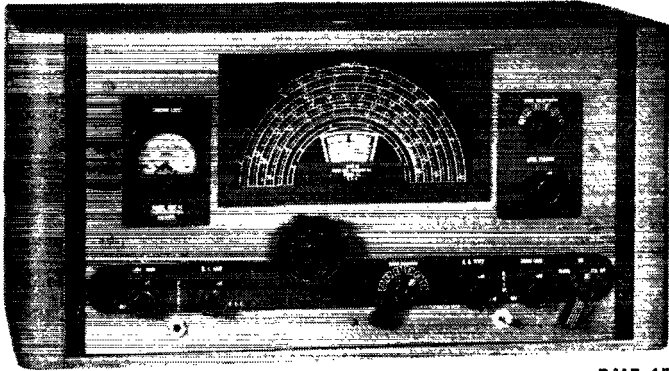

RME 45

Brilliant receiver performance on ten meters is the goal everyone is seeking because peak performance on the highs usually means peak performance on all frequencies. Here's why the new RME 45 gives you exceptional performance on these frequencies:

SENSITIVITY—Most receivers are sensitive on low frequencies but only an exceptionally well designed receiver has the same degree of sensitivity on the highs. RME's peak performance on the highs is made possible by the use of loctal tubes, shorter leads, reduced distributed capacity, exceptionally well designed inductances, and a score of additional refinements—each making its individual contribution to increased efficiency.

STABILITY—Receiver drift is a nuisance making necessary repeated and continuous retuning—especially when working CW. With the RME 45, set the dial on the station and it stays tuned, thanks to accurate temperature compensating padders which are built right into the receiver. There are no dials to preset, no pre-adjusting of padders, no recheck points to observe. After a station is once logged, it remains logged until you wish to tune in another.

Ignition QRM—Ignition QRM on ten meters has long been a stumbling block to 100% QSO's on high frequencies. Not so with an RME 45. This modern receiver incorporates a highly efficient automatic noise suppressor which is always in the circuit—always on the job.

Little wonder that thousands of hams are insisting on the new RME 45!

PROVING
GROUND
FOR
RECEIVERS

Features

- Calibrated band spread scale on all amateur frequencies from 10 to 80 meters.
- Fine adjustment through dual drive control mechanism which gives approximately five revolutions of smaller knob to one revolution of larger knob.
- Relay control and break-in terminals.
- Streamlined two-tone cabinet.
- Acoustically designed speaker housing.
- Relay rack mounting panel.
- Six bands, 550 to 33,000 K.C.

LITERATURE SENT ON REQUEST



RME

FINE COMMUNICATIONS EQUIPMENT

RADIO MFG. ENGINEERS, INC.

Peoria 6, Illinois U. S. A.

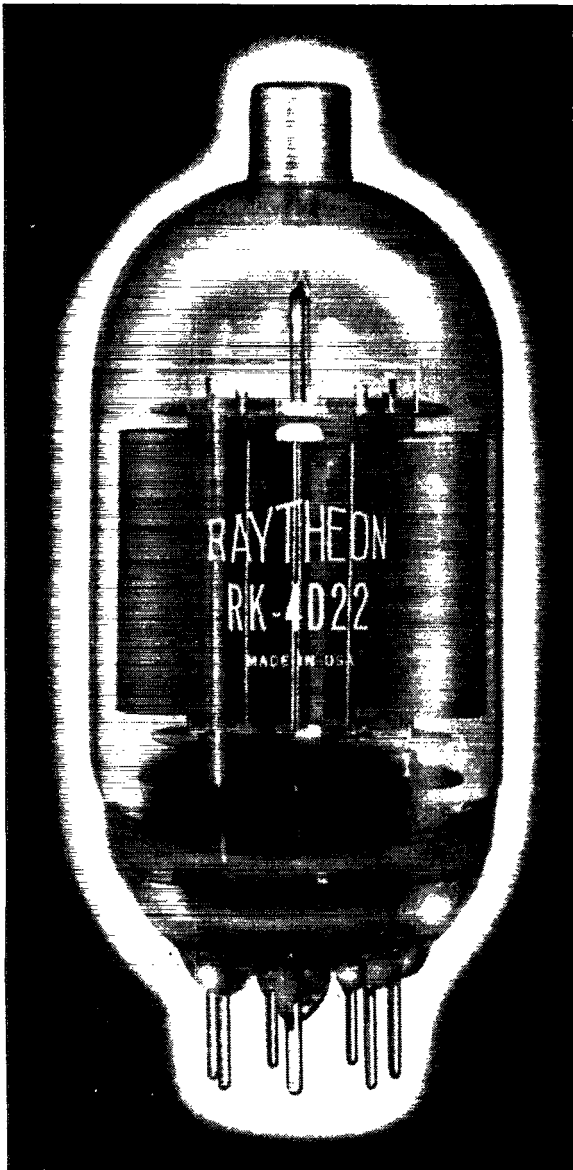

ACTUAL SIZE

New RAYTHEON BEAM AMPLIFIER

100 watts at 600 volts

Six Important Facts About RK-4D32 and RK-4D22

- ① Over 100 watt output at 600 plate volts.
- ② Low driving power requirements less than 1.25 watts required for full output.
- ③ High efficiency due to beam tetrode construction.
- ④ Full efficiency and no neutralization up to 60 megacycles.
- ⑤ Ruggedized construction for mobile and aircraft service.
- ⑥ 125 watts of undistorted audio output can readily be obtained from a pair.

Of special interest is Raytheon's newest cathode type beam amplifier. Capable of delivering 100 watts output with only 600 volts on the plate, this product of Raytheon research is of ruggedized construction designed particularly for ham use. It offers particular advantages for making a low powered, low cost, 100 watt band switch transmitter.

This new beam tetrode typifies Raytheon advanced engineering and precision manufacture. For any other tube application you may have, there is a Raytheon tube engineered to do that job, give you continuing satisfaction.

RATINGS

FILAMENT RATINGS

RK-4D32	6.3 volts at 3.75 amps.
RK-4D22	25.2 volts at .8 amps. or 12.6 volts at 1.6 amps.

MAXIMUM RATINGS CLASS C TELEGRAPHY

D.C. Plate Voltage	750 volts
D.C. Grid Voltage	—200 volts
D.C. Screen Voltage	350 volts
Plate Dissipation	50 watts
Screen Dissipation	12 watts



Excellence in Electronics

**POWER TUBE DIVISION
WALTHAM, MASSACHUSETTS**

COPYRIGHT 1946 RAYTHEON MANUFACTURING COMPANY

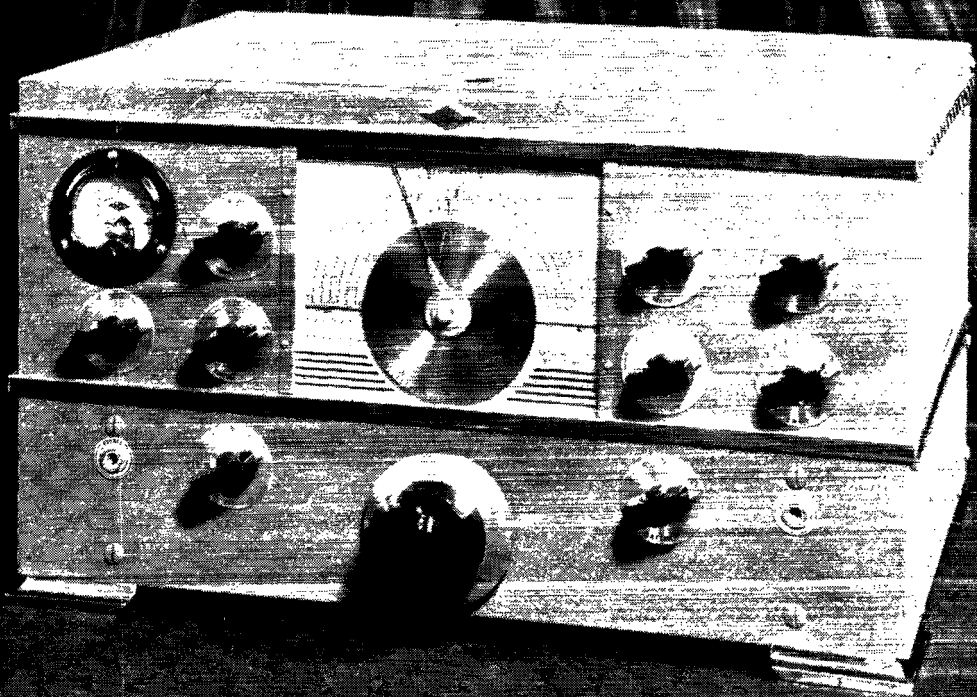

THE NC-2-40C

This superb new receiver reflects National's intensive receiver research during the war period. Many of the NC-2-40C's basic design features stem from the NC-200, but to them have been added circuit and construction details that set it apart as a performer. Stability and sensitivity are outstanding. A wide range crystal filter gives optimum selectivity under all conditions. The series-valve noise limiter, the AVC, beat oscillator, tone control and S-meter are among the many auxiliary circuits that contribute toward the all-around excellence of the NC-2-40C. See it at your dealer's.



NATIONAL COMPANY, INC.

MALDEN, MASSACHUSETTS, U.S.A.

MALDEN
MELROSE

RCA-807—push-pull beam-power tube. A hot type for all three bands.

RCA-829-B—push-pull beam-power tube. Full output to 200 Mc.

RCA-832-A—push-pull beam-power tube. Ideal for UHF.

RCA-1624—companion to RCA-807, but with quick-heating filament.



6 OUTSTANDING RCA BEAM POWER TUBES for Current Amateur Bands

Whether you intend working 28, 50 or 144, the beam-power principle will provide you with more sock for less money

AS A GROUP, RCA beam-power tubes require less drive and deliver more output at lower plate voltage, than any other representative type of transmitting tube. You get the same results with fewer stages, smaller tubes and a less elaborate power supply.

Moreover, it is seldom necessary to neutralize a beam-power stage, which means that you can build a multi-band transmitter capable of quick band changing without re-neutralizing for each frequency.

Remember, too, that the unusual characteristics of beam-power tubes make them efficient as modulators, frequency doublers and modulated finals.

The Fountainhead of Modern Tube Development is RCA

COMPARATIVE TECHNICAL DATA*
(R-F Amplifier, Class C, Telegraphy, CCS)

Tube Type No.	Plate Watts	Driv. Pow. at Tube	Max. Rat. Freq. Mc.	Plate Volts	Amateur Net Price
807	60	0.2	60	500	\$1.95
813	360	0.5	30	2000	18.00
815	60	0.2	125	400	4.50
829-B	120	0.7	200	500	17.00
832-A	36	0.2	200	500	13.00
1624	54	0.5	60	600	2.40

*For detailed operating conditions, see the Radio Amateur's Handbook or the RCA Transmitting Tube Guide.



TUBE DIVISION

RADIO CORPORATION of AMERICA

HARRISON, N. J.