

QST



november, 1945

25 cents

35c in Canada

devoted entirely to

amateur radio

In This Issue:

An A. M. - F. M. Transmitter for 50 Mc.

A Four-Tube Superheterodyne for 144 Mc.

Crystal Control in the New Ham Bands

Getting Acquainted With the
"Lighthouse" Tube





Yes, for you
there could very well be a citation
which would read
"For distinguished service
to the American people . . ."
. . . that is, there could be
if the nation only realized
as well as we,
who have worked with you,
what a splendid job you have done
as a radio technician
during the emergency.

If they only knew
how you overlooked the word *overtime*
and how an *eight-hour day*
lost its meaning
when we most needed
to be informed.

If they only knew
how you coddled and repaired

the irreplaceable tools
of your trade
so that not even one
valuable radio moment
was lost in wartime.

If they only knew
how the nation was kept informed
each twenty-four hours
because of your personal effort.

. . . Well, perhaps they don't realize
to whom the thanks belong,
or their tongues don't give voice
to their feelings . . .
but in their homes and hearts
there has been mute appreciation
for the privilege you extended to all,
the privilege that could not
have been forfeited easily,
the privilege that is used so casually,
the privilege of switching on the radio.

AMPEREX ELECTRONIC CORPORATION

25 WASHINGTON STREET



• • • BROOKLYN 1, N. Y.



KEY MAN

THE AMATEUR *... key man in world-wide peace-time communications*

Hallicrafters New \$600,000 Home
Now Under Construction

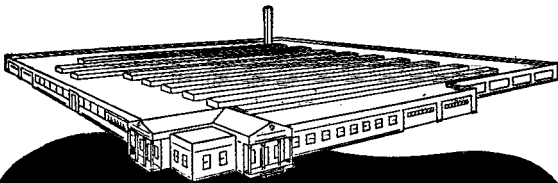

hallicrafters RADIO

THE HALLCRAFTERS CO., MANUFACTURERS OF RADIO
AND ELECTRONIC EQUIPMENT • CHICAGO 16, U. S. A.

The key man in world wide peacetime communications is the amateur. Just as the amateur proved himself an invaluable asset to the country's war effort, so will he continue to make important contributions to the science of communications in a peacetime world. The amateur's quest for something new, something better, the accomplishment of something that "can't be done" leads inevitably to further progress. Hallicrafters, backed by a score of years experience, will spark this progress with new and better amateur equipment. Amateurs high up in the management of the company, amateurs on the engineering and production staffs and thousands of amateurs from all over the world serve to keep Hallicrafters close to the amateur ideal and in the van of high frequency developments. The amateur will be the key man in communications . . . Hallicrafters will be the key company in producing constantly improved equipment for the amateur.



COPYRIGHT 1945 THE HALLCRAFTERS CO.





CLAIM STAKING

Hallicrafters and Very High Frequency

Hallicrafters New \$600,000 Home
Now Under Construction



hallicrafters RADIO

Based on the facts in the case, Hallicrafters can stake out a very strong claim to leadership in the very high frequency field. The facts include such things as the Model S-37, FM-AM receiver for very high frequency work. The Model S-37 operates from 130 to 210 Mc.—the highest frequency range of any general coverage commercial type receiver.

Hallicrafters further supports its claim to domination in the high frequency field with the Model S-36A, FM-AM-CW receiver. The 36A operates from 27.8 to 143 Mc., covers both old and new FM bands and is the only commercially built receiver covering this range.

Further developments in this direction can soon be revealed—adding further support to Hallicrafters claim to continued supremacy in the high frequency field.



THE HALLICRAFTERS CO., MANUFACTURERS OF RADIO
AND ELECTRONIC EQUIPMENT • CHICAGO 16, U. S. A.

COPYRIGHT 1945 THE HALLICRAFTERS CO.

NOVEMBER 1945

VOLUME XXIX

NUMBER 11



STAFF

Editorial

KENNETH B. WARNER, W1EH
(Managing Secretary, ARRL)
Editor

GEORGE GRAMMER, W1DF
(Technical Director, ARRL)
Technical Editor

DONALD H. MIX, W1TS
BYRON GOODMAN, W1JPE
J. VENABLE FITZHUGH, W5VL
Assistant Technical Editors

A. DAVID MIDDLETON, W2OEN
Department Editor

EDWARD P. TILTON, W1HDQ
V.H.P. Editor

WALTER F. BRADLEY, W1FWH
Technical Information Service

Production

RALPH T. BEAUDIN, W1BAW
Superintendent

ELSIE C. HOCHMEISTER
Assistant

Advertising

F. CHEYNEY BEEKLEY, W1GS
Advertising Manager

Circulation

DAVID H. HOUGHTON
Circulation Manager

RALPH T. BEAUDIN, W1BAW
Assistant Circulation Manager



OFFICES

38 La Salle Road
West Hartford 7, Connecticut

Subscription rate in United States and Possessions, \$2.50 per year, postpaid; all other countries, \$3.00 per year, postpaid. Single copies, 25 cents. Foreign remittances should be by international postal or express money order or bank draft negotiable in the U. S. and for an equivalent amount in U. S. funds.

Entered as second-class matter May 29, 1919, at the post office at Hartford, Connecticut, under the Act of March 3, 1879. Acceptance for mailing at special rate of postage provided for in section 1103, Act of October 3, 1917, authorized September 9, 1922. Additional entry at Concord, N. H., authorized February 21, 1929, under the Act of February 23, 1925.

Copyright 1945 by the American Radio Relay League, Inc. Title registered at U. S. Patent Office.

QST

devoted entirely to

AMATEUR RADIO

PUBLISHED, MONTHLY, AS ITS OFFICIAL ORGAN, BY THE AMERICAN RADIO RELAY LEAGUE, INC., AT WEST HARTFORD, CONN., U. S. A.; OFFICIAL ORGAN OF THE INTERNATIONAL AMATEUR RADIO UNION



CONTENTS

It Seems to Us	9
Getting Acquainted With the "Lighthouse" Tube <i>Philip S. Rariff, W1DBM</i>	11
Finding the 144-Mc. Band	15
Extended-Range Television Reception — Part I <i>Marshall P. Wilder, W2KJL</i>	18
An A.M.-F.M. Transmitter for 50 Mc. <i>E. P. Tilton, W1HDQ</i>	23
A Four-Tube Superheterodyne for 144 Mc. <i>Byron Goodman, W1JPE</i>	27
A 2I-Tube All-Purpose Receiver <i>Joseph Marshall</i>	31
Crystal Control in the New Ham Bands <i>John Holmbeck, W9KZO</i>	38
Hams in Combat Mobile with the 5th Armored Division <i>Merton T. Meade, W9KXL</i>	40
Happenings of the Month	42
In QST 25 Years Ago This Month	44
Improved Driver Stages for Class-B Amplifiers <i>Elliott A. Henry, W9FEN</i>	45
The Crystal Ball	51
Technical Topics Waves and Wave Guides	54
On the Very Highs	59
In the Services	60
Correspondence from Members	64
Operating News	65
Amateur Activities	68
The Month in Canada	98
Silent Keys	122
Feedback	122
Ham-Ads	124
QST's Index of Advertisers	126

Centralab

Medium Duty Power Switches

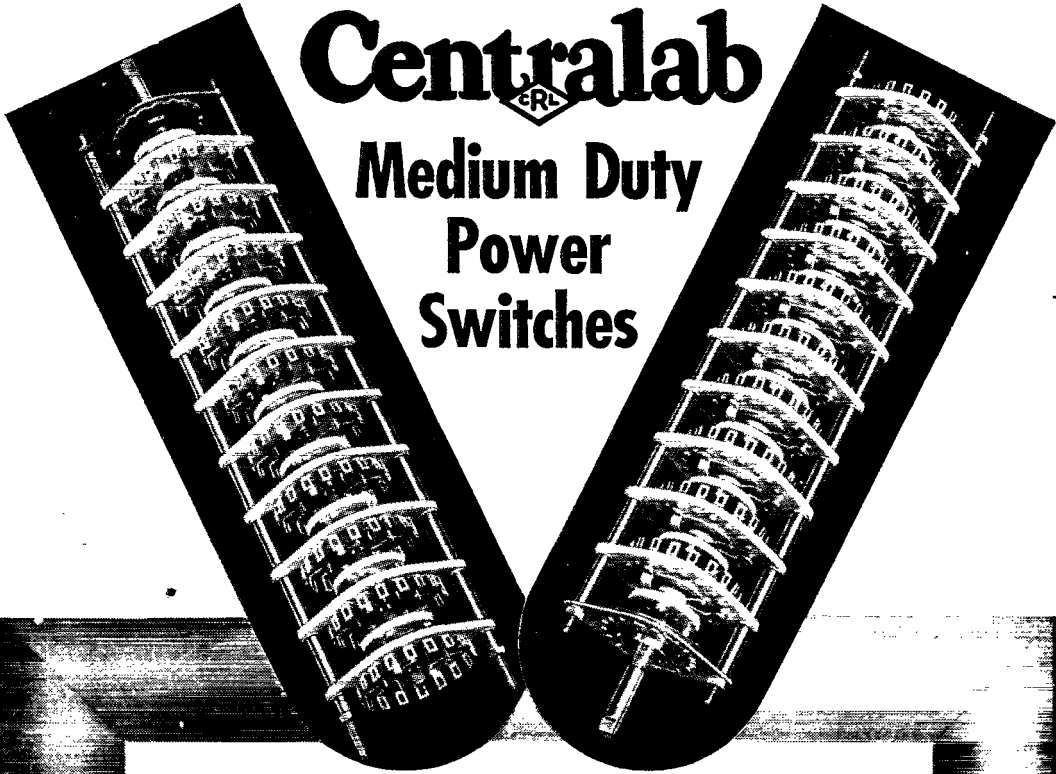

- 7½ amp, 115 V, 60 cycle A. C.
- Voltage breakdown 2500 V to ground D. C.
- Solid silver contacts
- 25,000 cycles of operation without contact failure
- Fixed stops to limit rotation
- 20° indexing

Centralab medium duty power switches are now available for transmitters (has been used up to 20 megacycles) power supply converters and for certain industrial and electronic uses.

It is indicated in applications where the average Selector Switch is not of sufficient accuracy or power rating. Its accuracy of contact is gained by a square shaft, sleeve fit rotor, and individually aligned and adjusted contacts. It is assembled in multiple gangs with shorting or non-shorting contacts. Torque can be adjusted to suit individual requirements. Furnished in 1 pole . . . 2 to 17 positions (with 18th position continuous rotation with 18th position as "off"); and 2 or 3 pole . . . 2 to 6 position including "off".

Centralab

Division of GLOBE-UNION INC., Milwaukee

PRODUCERS OF Variable Resistors • Selector Switches • Ceramic Capacitors • Fixed and Variable • Specialty Resistors and Silver Mica Capacitors

Eimac
TUBES

THE COUNTERSIGN OF DEPENDABILITY IN ANY ELECTRONIC EQUIPMENT

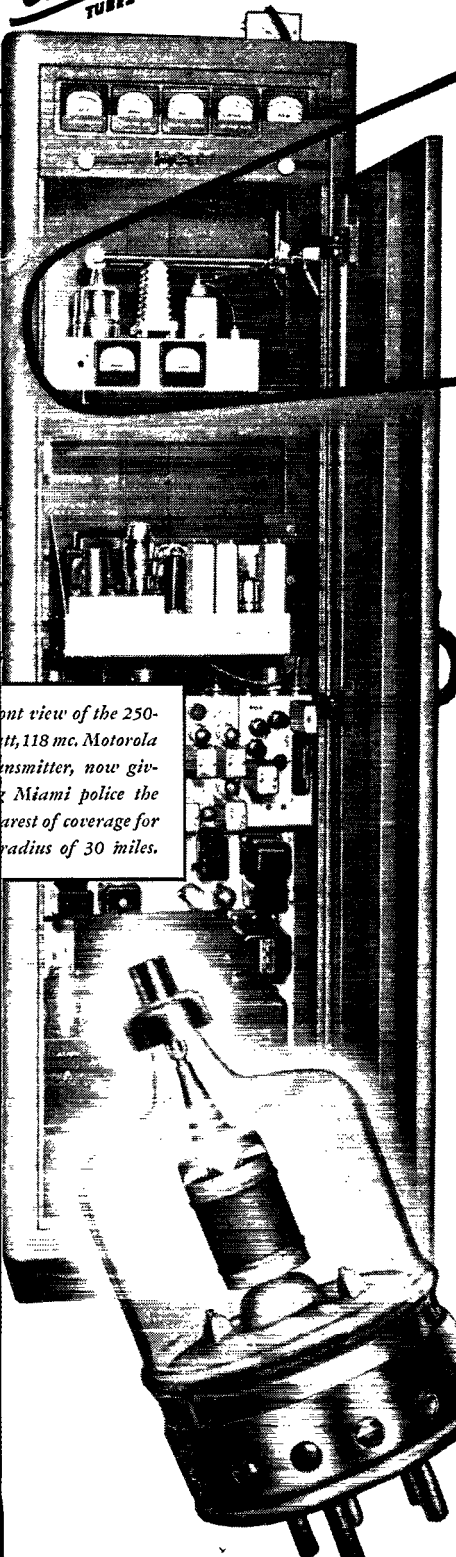

Front view of the 250-watt, 118 mc. Motorola transmitter, now giving Miami police the greatest of coverage for a radius of 30 miles.

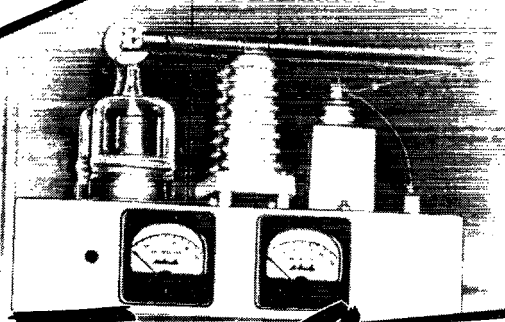

Top Spot

IN FM POLICE SYSTEMS



EIMAC TETRODE 4-125A

Top honors to Galvin Manufacturing Corporation for building it, and a salute to the police and fire departments of Miami, Florida, for putting it to work in spite of the skeptics! It's the first two-way police radiotelephone system in the United States on frequencies above 100 mc. Twenty-four hours a day, 12 patrol cars in Miami's busy area tune in on signals as solid as a dinner-table conversation from this Motorola 250 watt, 118 mc. FM transmitter.

From the earliest experimental stages of FM broadcasting, Eimac tubes have been lending a hand. Naturally, there are Eimac 4-125A tetrodes (pictured above) in the vital power output stage of Galvin's new Motorola success. Eimac 4-125A's were a logical choice for this transmitter because of their superlative high frequency performance capabilities and their low driving power requirements.

FOLLOW THE LEADERS TO

Eimac
REG. U. S. PAT. OFF.
TUBES

Ask for your copy of *Electronic Tests*, the 64-page booklet giving the fundamentals of electronics. It will help electronic engineers explain the subject to laymen. Available in English and Spanish. No obligation, of course.

EITEL-McCULLOUGH, Inc., 1074 San Mateo Avenue, San Bruno, Calif.
Plants located at: San Bruno, California and Salt Lake City, Utah
Export Agents: Frazar & Hansen, 301 Clay St., San Francisco 11, Calif., U. S. A.

1074

ELECTRICAL CHARACTERISTICS - 4-125A TETRODE

Filament: Thoriated Tungsten	Direct Interelectrode Capacitances (Average)
Voltage 5.0 volts	Grid-Plate (Without shielding, base grounded) 0.03 μ fd.
Current 6.2 amperes	Plate Dissipation
Plate Dissipation (Maximum) 125 watts	Input 10.3 μ fd.
Transconductance ($i_b = 50$ ma., $E_s = 2500$ v., $E_{c2} = 400$ v.) . 2450 μ mhos	Output 3.0 μ fd.

Section Communications Managers of the A. R. R. L. Communications Department

Reports Invited. All amateurs, especially League members, are invited to report communications activities, training plans, code classes, theory-discussion groups each mid-month (16th of the month for the last 30 days) direct to the SCM, the administrative official of ARRL elected by members in each Section whose address is given below. Radio Club reports and Emergency Coördinator reports representing community organized work and plans and progress are especially desired by SCMs for inclusion in *QST*. **ARRL Field Organization appointments**, with the exception of the Emergency Coördinator and Official Broadcasting Station posts, are suspended for the present and no new appointments or cancellations, with the exception named, will be made.

ATLANTIC DIVISION			
Eastern Pennsylvania Maryland-Delaware-District of Columbia Southern New Jersey Western New York Western Pennsylvania	W3BES W3CIZ W3GCU W8UPH W8NCJ	Jerry Mathis Hermann E. Hobbs Ray Tomlinson Charles I. Otero R. R. Rosenberg	623 Crescent Ave. 9701 Monroe St. Silver Springs P. O. 623 E. Brown St. 4158 Ridge Road, West 927 East 23rd St.
CENTRAL DIVISION			
Illinois Indiana Kentucky Michigan Ohio Wisconsin	W9NUX W9EGO W9ARU W8DPE W8MFP W9RH	David E. Blake, II Herbert S. Brier Darrell A. Downard Harold C. Bird Carl F. Wiehe Emil Felber, Jr.	4501 N. Malden St. 385 Johnson St. 2077 Sherwood Ave. R.F.D. 2, Box 228 122 St. Albert St. 1625 N. 18th St.
DAKOTA DIVISION			
North Dakota South Dakota Northern Minnesota Southern Minnesota	W9EVP W9GVP W9LWZ W9VWQ	Raymond V. Barnett P. H. Schultz Armond D. Brattland Millard L. Bender	406-17th St. 118 N. Yankton Ave. Birchmount Drive 608 N. Huron Ave.
DELTA DIVISION			
Arkansas Louisiana Mississippi Tennessee	W5GED W5DKR W5HAV W5WP	Ed Beck Eugene H. Treadaway P. W. Clement James B. Witt	2503 Bishop St. P. O. Box 44 524 Santini St. R.F.D. 6, Shady Dell Trail
HUDSON DIVISION			
Eastern New York N. Y. C. & Long Island Northern New Jersey	W2HZL W2KDC W2CQD	Ernest E. George Charles Ham, Jr. Winfield G. Beck	2044 Lexington Parkway 151-06 84th Drive 617 Spruce St.
MIDWEST DIVISION			
Iowa Kansas Missouri Nebraska	W0FJR W0AWP W0UOD W9FQB	Leslie B. Veunard A. B. Unruh Mrs. Letha A. Dangerheld Arthur R. Gaeth	2712 Washington St. 1617 S. Seneca St. 411 Moffett Ave. 6105 N. 37 St.
NEW ENGLAND DIVISION			
Connecticut Maine Eastern Massachusetts Western Massachusetts New Hampshire Rhode Island Vermont	W1KOY W1AOL W1ALP W1WJ W1FTJ/4 W1HRC W1NLO	Edmund R. Fraser G. C. Brown Frank L. Baker, Jr. William J. Barrette Mrs. Dorothy W. Evans Clayton C. Gordon Burtis W. Dean	48 Willow St. 379 N. Main St. 91 Atlantic St. 319 Columbia St. 1435 Snowden Ave. 70 Columbia Ave., Gaspee P. O. Box 81
NORTHWESTERN DIVISION			
Alaska Idaho Montana Oregon Washington	K7GNN W7AVP W7CPY W7GNJ W7FWD	James G. Sherry Don D. Oberbillig Rex Roberts Carl Austin O. U. Tatro	P. O. Box 486 Box 1088 1137 Federal 513 N. Central
PACIFIC DIVISION			
Hawaii Nevada Santa Clara Valley East Bay San Francisco Sacramento Valley Philippines San Joaquin Valley*	K6ETF W6CWX W6IUZ W6T1 W6RBI W6MDI K4LGR W6BXB	Francis T. Blatt N. Arthur Sowle Earl F. Sanderson Horace R. Greer William A. Ladley Vincent N. Feldhausen George L. Rickard Edward H. Noack	837 16th Ave. Box 2025 600 Acacia Ave. 414 Fairmount Ave. 200 Naylor St. 143 South Quincy St. Box 849 811 West Magnolia St.
ROANOKE DIVISION			
North Carolina South Carolina Virginia West Virginia	W4CYB W4BOE/ANG W3AKN W8JRL	W. J. Wortman Ted Ferguson Walter G. Walker Kenneth M. Zinn	P. O. Box 566 3422 Rosewood Drive 217-51 St. P. O. Box 132
ROCKY MOUNTAIN DIVISION			
Colorado Utah-Wyoming	W9VGC W6LLH	H. F. Hekel Victor Drabble	2743 Julian St. 1024 Oak St.
SOUTHEASTERN DIVISION			
Alabama Eastern Florida Western Florida Georgia West Indies (Cuba) (Puerto Rico-Virgin Islands)	W4GBV W4IP W4MS W4FDJ CM2OP K4KD	Lawrence J. Smyth Robert B. Murphy Lt. Edward J. Collins Ernest L. Morgan Mario de la Torre Everett Mayer	808 Winona Ave. 3302 S.W. Grapeland Blvd. 1409 N. 10th Ave. R.F.D. 2 Escobar 110 (Altos) P. O. Box 1061
SOUTHWESTERN DIVISION			
Los Angeles Arizona San Diego	W6QVV W6RWW W6CHV	H. F. Wood Douglas Aikken Ralph H. Culbertson	429 So. Fairview 341 S. Mt. Vernon Ave. 7172 Eads St.
WEST GULF DIVISION			
Northern Texas Oklahoma Southern Texas New Mexico	W5ALA W5AVL W5JC W5HJF	Jack T. Moore Ed Oldfield James B. Rives J. G. Hancock	5712 Berkshire Lane 2141 N.W. 35th St. 1721 Kentucky Ave. 110 S. E. Nevada St.
MARITIME DIVISION			
Maritime	VE1DQ	A. M. Crowell	69 Dublin St.
ONTARIO DIVISION			
Ontario	VE3EF	Wing Commander Donald R. Gunn	c/o Canadian Bank of Commerce New Toronto, Ont.
QUEBEC DIVISION			
Quebec	VE2CO	Lieutenant L. G. Morris	4114 Hingston Ave. Montreal 28, Que.
VANALTA DIVISION			
Alberta British Columbia	VE4GE VE5DD	C. S. Jamieson C. O. I. Sawyer	581 W. Riverside Drive 2634 West 31st Ave. Drumheller, Alta. Vancouver
PRAIRIE DIVISION			
Manitoba Saskatchewan	VE4AAW VE4SY	A. W. Morley Arthur Chesworth	26 Lennox St. 1084 Redland Ave. St. Vital Moose Jaw

*Officials appointed to act temporarily in the absence of a regular official.

TORQUE

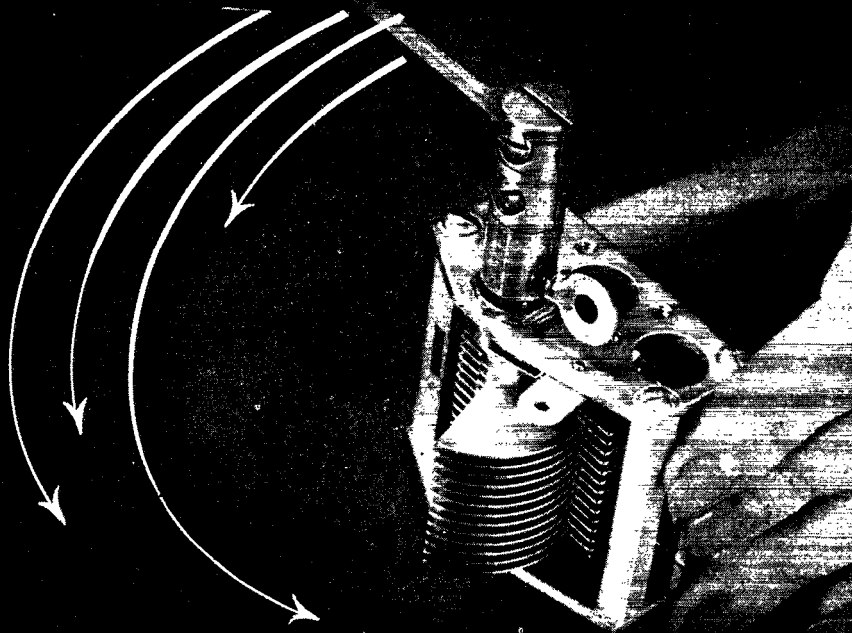

Hammarlund precision variable capacitors have just the right amount of TORQUE, to permit smooth and accurate adjustment. You don't have to fight rough and jumpy action when you tune with Hammarlund variables.

HAMMARLUND

THE HAMMARLUND MFG. CO., INC., 460 W. 34TH ST., N.Y.C.
MANUFACTURERS OF PRECISION COMMUNICATIONS EQUIPMENT



ESTABLISHED 1910

THE AMERICAN RADIO RELAY LEAGUE, INC.,

is a noncommercial association of radio amateurs, bonded for the promotion of interest in amateur radio communication and experimentation, for the relaying of messages by radio, for the advancement of the radio art and of the public welfare, for the representation of the radio amateur in legislative matters, and for the maintenance of fraternalism and a high standard of conduct.

It is an incorporated association without capital stock, chartered under the laws of Connecticut. Its affairs are governed by a Board of Directors, elected every two years by the general membership. The officers are elected or appointed by the Directors. The League is noncommercial and no one commercially engaged in the manufacture, sale or rental of radio apparatus is eligible to membership on its board.

"Of, by and for the amateur," it numbers within its ranks practically every worth-while amateur in the nation and has a history of glorious achievement as the standard-bearer in amateur affairs.

Inquiries regarding membership are solicited. A bona fide interest in amateur radio is the only essential qualification; ownership of a transmitting station and knowledge of the code are not prerequisite, although full voting membership is granted only to licensed amateurs.

All general correspondence should be addressed to the Secretary at the administrative headquarters at West Hartford, Connecticut.



Past Presidents

HIRAM PERCY MAXIM, W1AW, 1914-1936
EUGENE C. WOODRUFF, W8CMP, 1936-1940

Officers

President.....GEORGE W. BAILEY, W1KH
Washington, D. C.
Vice-President.....CHARLES E. BLALACK, W6GG
Yuma, Arizona
Secretary.....KENNETH B. WARNER, W1EH
West Hartford, Connecticut
Communications Manager.....F. E. HANDY, W1BDI
West Hartford, Connecticut
Treasurer.....DAVID H. HOUGHTON
West Hartford, Connecticut

General Counsel.....PAUL M. SEGAL
1026 Woodward Building, Washington 5, D. C.

Directors

President
GEORGE W. BAILEY.....W1KH
1530 P St., N.W., Washington 25, D. C.

Vice-President
CHARLES E. BLALACK.....W6GG
Box 108, Yuma, Ariz.

Canadian General Manager
ALEX REID.....VE2BE
240 Logan Ave., St. Lambert, P. Q.
Alternate: Leonard W. Mitchell.....VE3AZ
78 Raglan Ave., Toronto, Ont.

Atlantic Division
WALTER BRADLEY MARTIN.....W3QV
25 Arbuta Rd., Abington, Pa.
Alternate: Herbert M. Walleze.....W8BQ
P. O. Box 18, Drums, Pa.

Central Division
JOHN A. KIENER.....W8AVH
3462 Edison Rd., Cleveland Heights,
Cleveland 21, Ohio
Alternate: Earl S. Nelson.....W8DS
22551 Hadden Rd., Euclid 17, Ohio

Dakota Division
TOM E. DAVIS.....W9VVA
915 W. Becker Ave., Willmar, Minn.
Alternate: Aaron E. Swanberg.....W9BHY
1487 Breda St., St. Paul 4, Minn.

Delta Division
E. RAY ARLEDGE.....W5SI
P. O. Box 286, Pine Bluff, Ark.
Alternate: Samuel H. Dowell.....W5ERV
1057 Mildred St., Shreveport 15, La.

Hudson Division
ROBERT AKERIDGE KIRKMAN.....W2DSY
Werah Pl., R.F.D. No. 1, Box 61, Long Branch, N. J.
Alternate: George Ruliff, Jr.....W2CJY
38 Brookwood Drive, Manhasset, L. I., N. Y.

Midwest Division
FLOYD E. NORWINE, JR.....W9FFC
7405 Hlawatha Ave., Richmond Heights 17, Mo.
Alternate: C. A. Colvin.....W9VHR
% Omaha & Council Bluffs St. Railway Co.,
Omaha 2, Nebr.

New England Division
PERCY C. NOBLE.....W1BVR
37 Broad St., Westfield, Mass.
Alternate: Clayton C. Gordon.....W1HRC
70 Columbia Ave., Warwick, R. I.

Northwestern Division
KARL W. WEINGARTEN.....W7BG
3219 N. 24th St., Tacoma 7, Wash.
Alternate: R. Rex Roberts.....W7CPY
110 W. Brennan St., Glendive, Mont.

Pacific Division
J. L. McCARGAR.....W6EY
66 Hamilton Pl., Oakland 12, Calif.
Alternate: Elbert J. Amarantes.....W6FBW
1675 Dale Ave., San Jose, Calif.

Roanoke Division
H. L. CAVENESS.....W4DW
2607 Vanderbilt Ave., Raleigh, N. C.
Alternate: J. Frank Key.....W3ZA
Box 707, Buena Vista, Va.

Rocky Mountain Division
C. RAYMOND STEDMAN.....W9CAA
Address correspondence to the Acting Director:
HOWARD R. MARKWELL.....W9TFP
355 Monroe St., Denver 6, Colo.

Southeastern Division
WILLIAM C. SHELTON.....W4ASR
527 Revilo Blvd., Daytona Beach, Fla.
Alternate: William P. Sides.....W4AUP
Fleming Road, Montgomery, Ala.

Southwestern Division
JOHN E. BICKEL.....W6BKY
1834 E. Whittier Blvd., Whittier, Calif.
Alternate: Eldridge E. Wyatt, Jr.....W6ARW
P. O. Box 3597, Long Beach 3, Calif.

West Gulf Division
WAYLAND M. GROVES.....W5NW
Box 1314, Seagraves, Texas
Alternate: Jennings R. Poston.....W5GAJ
P. O. Box 348, Curundu, Panama Canal Zone

"IT SEEMS TO US —"

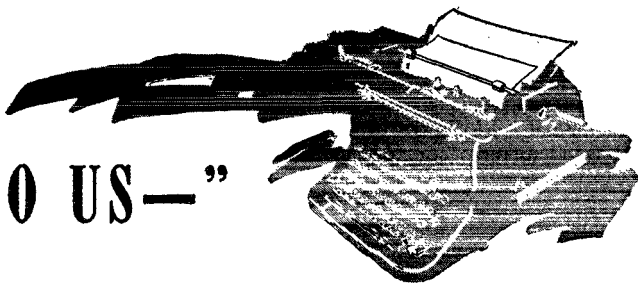

RECONVERSION HEADACHES

THE world is not finding it as easy to return to the ways of peace as all of us at first imagined. Take a look at the troubles of the world as displayed in your morning newspaper and you'll see that everybody from the Council of Foreign Ministers to Sam's Hamburger Stand is bedeviled by worries of all sorts — delays, strikes, lack of materials, disagreements, shortage of personnel, tired minds and bodies, tremendous new problems. Many people find themselves thinking almost wistfully of those days a few months back when all we had to do was win a war. The road back is a far from smooth one.

That is precisely the situation in radio, including amateur radio. Things have not moved with the speed and facility that first seemed possible, and, although the difficulties are but temporary, they are disappointing to a group filled with such high hopes as our gang. This is in the nature of a report to you on the score to date. In telling you the way things seem to be we must simultaneously warn you that plans and intentions change, particularly as to dates, both for better and for worse. The only reliable information will be the current information of the moment. Keep yourself posted.

The best source of information will be W1AW. We are pleased to say that our headquarters station is back on the air, on a special limited authorization arranged through the collaboration of IRAC and FCC, for this very purpose. The frequencies are 3555, 7145 and 14,280 kc. The hours are 8 to 11 P.M., E.S.T., Monday through Friday, and week-ends too when there is hot news. Transmissions will generally take the form of broadcasts repeated at 8 P.M., 9 P.M. and 10 P.M. Make it a habit to listen daily. Incidentally, some idea of the difficulty of finding channels these days is given by the fact that the clearing of just these three channels for us took a month of work by the Signal Corps, Air Forces and Navy and involved both the Pacific and European theatres and diplomatic negotiations with Canada.

There are two major problems in our restoration. One is licensing arrangements and the other is the release of our frequencies. FCC has not yet been able to set up shop and open its doors for the receipt of new amateur applications. That is an extensive activity, requiring about thirty people. While we had it before the war, it was not in operation when the last budget was made up, and

the money to pay for it now is not available until FCC gets a new appropriation from Congress. The Amateur Unit is not alone in this trouble; it affects every branch of FCC. The Commission's last appropriation was geared to wartime conditions. Now the entire vast structure of civilian radio is ready to roll and the whole national economy requires that FCC be given immediate funds to administer the greatly-expanded post-war activity of the country. That problem is on the way to solution but meanwhile it has prevented readying things as rapidly as we had hoped. Forms are being printed and distributed, regulations looked over, orders drafted. It may still be some weeks away but soon the whistle will blow and licensing will be resumed. W1AW will carry the news.

In the meantime FCC has done the best it could for us: it has put all presently-licensed amateurs back on the air on a temporary blanket authorization, on the only frequency band available. If formal relicensing isn't available by the end of the temporary period, the latter will be extended. As additional bands are released for our use by the military, FCC will make them available to presently-licensed amateurs by announcement. Simple, workable and sensible.

The 112-Mc. band is scheduled, at the moment of writing, to be shifted to 144-148 Mc. about November 15th. It will not happen until FCC announcement. Thereafter there must be no working on 112-115½. Don't put money into gear for the old band; instead, prepare for the new one. Copy W1AW.

Now for more pleasant news — in fact, momentous news: As we write, we are on the very verge of being reopened on every amateur frequency above 28 Mc.! Yes, including the 10-meter band, although its DX performance will probably be pretty disappointing right now. Yes, including the 5-meter band, although at its new location of 50-54 Mc. (which now makes it a 6-meter band) — as soon as television is shifted. Yes, including our new assignments above 200 Mc. But not including the new band at 144-148, the move to which will be the subject of a separate order. The military services find they can release these frequencies to us soon by temporarily retaining sharing rights on a non-interfering basis. Don't rely upon this paragraph for your operating authorization, because there may be changes; but you can get reliable information from night to night by listening to W1AW — which is why the

station is operating. And the frequencies are on the way! Get rolling, OM!

One word of caution: Despite the definiteness of the FCC allocation of new v.h.f. and u.h.f. bands, it is our belief that some of the amateur assignments between 200 and 2000 Mc. may be subjected to further change and we recall that FCC itself said that its higher allocations would be changed to accord with any international treaties to which the country might become party. So we advise that you do not risk too much money yet on elaborate apparatus unless it can accommodate itself to the possibility of small shifts in months to come.

The armed forces are not yet in position to release any of our frequencies below 28 Mc. While their traffic loads are considerably reduced, their network organization still requires as many frequencies as before, it is said. They report that real relief will come only as bases and camps are actually closed. They are trying hard and there is no doubt of the sincerity of their effort, both on behalf of amateurs and for the various commercial services whose frequencies they are also using. It is a question of time, purely. It could be midwinter before we get DX frequencies again, but there should be considerably more definite information available in another month. As we write, we hear that HB, HK, PY, U and VK amateurs are back on the air on all bands and probably enjoying the freedom from W interference. What a pity that we're not there with them! Yet it is our country that has the largest and most extended military establishments and whose communication needs will endure the longest, and we must prepare ourselves to wait until our restoration is reasonably possible. We cannot demand precedence in reestablishment over all other radio services; but ARRL is insisting that we be put back on the air just as fast as any other service. Our advice to you is to get your outdoor work done before bad weather fouls you up, for we can expect DX before the winter is over. And for fast information in between the issues of *QST*, again refer to W1AW's broadcasts.

The matter of the 160-meter band is not likely to be settled finally until about the first of the year but, for the information of those planning new stations, you should of course understand that there will be no assignment for general amateur working in this band. However, the prospect is that we shall have a nonexclusive assignment for disaster-relief networks, jointly with other services, and that the frequencies made available for this purpose will turn out to be 1750-1800 kc. It is not definite yet and you should await further word, but that is what you may tentatively expect. We recommend to the former 160-meter 'phone crew, by the way, that they try the 10-meter band, with emphasis on antenna systems designed for good ground-wave coverage.

The Rio conference, which lasted most of September, ended with no actions of direct or immediate concern to us. We shall have a report in an early issue from Assistant Secretary Budlong, who represented us there. There is now a

new regional convention, replacing the Habana Convention and establishing an Inter-American Telecommunications Office, but nothing in this document directly affects us. The Santiago Arrangement was not revised and won't be until after next year's world conference. No allocations were changed but there was discussion of future allocations and all the Americas now embark upon preparations for the international conference, using the U. S. allocation proposals as the basis for study. Throughout the world numerous additional groups are preparing, small conferences are being held, and soon we shall be approaching another worldwide meeting — where, among other things, the question of our 21-Mc. band will be decided.

Meanwhile we all have much to do and plenty of opportunity for interesting work. The Hq. Gang itself is hard at it, planning, writing, traveling to Washington, working in labs. We shall transmit information and reports to you as rapidly as possible — technical, operating, regulatory. Our postwar world begins to unfold. The outlook is an entrancing one. Dream yourself up some plans, OM, and get in on the fun!

K. B. W.

WE GO TO WORK

THANKS to exploding atoms, we now have our impatiently-awaited chance to sink our teeth into the sixty-four dollar question: what part of the tremendous technical development during the war is going to have a place in amateur radio? There hasn't been a sufficient lapse of time to get a real perspective — nor are the restrictions on wartime secret information by any means completely removed — so the answer isn't obvious. What is obvious is that so many inviting avenues are opening up that it's hard to decide which are the most promising for the initial plunge.

So far as we can see at this juncture, nothing that has come out of this war is going to revolutionize amateur communication on the old standby frequencies — at least not in the same sense that c.w. supplanted spark after World War I. There will be better equipment, yes; and there are such things as carrier-shift keying to look into and appraise from the ham standpoint. There are immensely interesting and useful developments in predicting the distances that can be covered on various frequencies, methods which promise to make DX work an exact science rather than a fishing expedition. But these things are in the nature of refinements rather than fundamental changes. We haven't heard, for example, of the invention of any system that makes it possible for many stations to work without interference where only one could work comfortably in prewar days. With the probability that the amateur population will increase manifold we badly need a system of that sort. But it looks as though we'll have to find the answer — if there is one — for ourselves.

Most of the developments of technical interest are centered in the region above 300 megacycles.

(Concluded on page 110)

Getting Acquainted With the "Lighthouse" Tube

A Simple Transmitter for the 144-, 220- and 420-Mc. Bands

BY PHILIP S. RAND,* WIDBM

ONE of the tubes most likely to enjoy widespread use by the amateur in our new u.h.f. bands is the disc-seal type known as the "lighthouse." It is made in several different types and sizes, but the ones to be discussed in this article are manufactured by General Electric and are

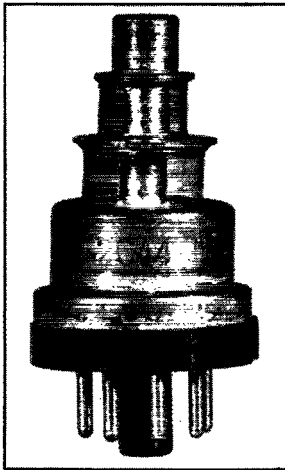

One of the family of "lighthouse" tubes developed during the war for v.h.f. use. This particular tube (2C44) is a triode rated at 20 watts maximum input. The plate connection is at the top, the grid connection is the metal disc in the center, the metal part of the base is the r.f. cathode connection, and the heater and d.c. cathode connections are through the octal base.

designated the 2C40, 2C43 and 2C44. These tubes are low-powered types and operate very nicely with a plate voltage of from 350 to 400 at 20 to 30 ma. This represents an input of from 7 to 12 watts, a level which can be readily modulated by anything delivering from $3\frac{1}{2}$ to 6 watts of audio.

Referring to the photograph of a 2C44,¹ the tube is conventional only in that it has an octal base. The wide metal band immediately above the base is

Here is a very practical application of one of the high-frequency tubes developed during the war and now available to amateurs. The tube makes possible three-band operation with conventional pre-war technique in the region between 2 and $\frac{3}{4}$ meters.

the r.f. cathode connection, which is coupled by a built-in 100- μ fd. condenser to the d.c. cathode connection brought out through the Nos. 3, 5 and 8 pins in the base. The cathode pillar extends up to within a few thousandths of an inch of the grid disc (the central metal disc) and has its emitting surface only on the flat end of this pillar. The heater is mounted inside the pillar directly under the cathode surface. The grid disc has a hole punched in its center (slightly larger in area than the cathode surface) across which is stretched the fine mesh of the grid. The plate pillar extends down to within a few thousandths of an inch of the grid, and connection is made at the top.

The lighthouse tube is a normal triode tube with the usual frequency-limiting factors designed out of its construction. Use of short and large-diameter cathode and plate leads reduces their inductance to a minimum, while the grid lead inductance is reduced by making it a disc instead of a single or double wire. The transit time is minimized by the close spacing of the elements. The third limiting factor, inter-electrode capacitance, has been reduced considerably in proportion to the power-handling capabilities of the tube, although the actual values resemble other triode capacitances. Nevertheless, reduction of inductance and transit time results in a tube that handles as well in conventional parallel-line circuits at 420 Mc. as does an HY75 at 144 Mc.

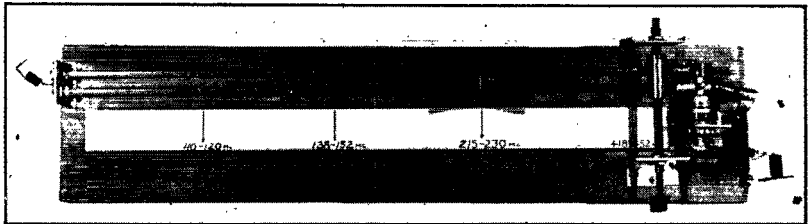

A three-band amateur transmitter using the 2C44. The shorting bar on the parallel lines is moved to the proper point and locked, and tuning over the band is accomplished by the home-made variable condenser mounted at the ends of the lines near the tube.

*Remington Rand, Inc., Electronics Div., Middletown, Conn.

¹ For a cross-sectional view of a "lighthouse" tube, see QST, October, 1944, p. 42.

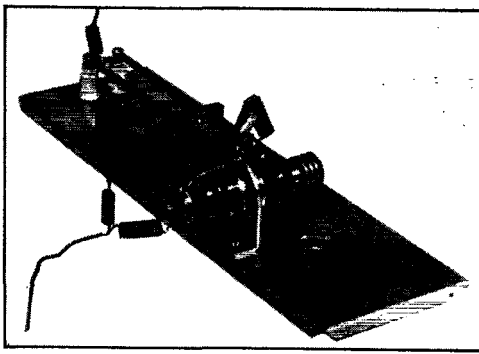

Another model using the lighthouse tube. This oscillator, with no tuning condenser across the line, goes easily to 700 Mc.

However, for the next amateur band (1145-1245 Mc.) it is necessary to go to either a radial- or concentric-type cavity. The steplike arrangement of the plate, grid and (r.f.) cathode is an intentional part of the design to permit plugging the tube into a cavity. A discussion of cavity construction for the lighthouse tube must be reserved for some future article.

A Three-Band U.H.F. Amateur Transmitter

The lighthouse tube is a "natural" for the 144-, 220- and 420-Mc. bands. Using parallel lines, it is only necessary to change the position of the shorting bar to obtain output on any of the three bands. A simple transmitter of this type is shown in the photograph. The shorting bar is moved to a previously-calibrated point on the lines and locked, and any frequency within the amateur band is obtained by a proper setting of a tuning condenser connected across the lines at the point where they connect to the tube. The antenna coupling loop is connected to the shorting bar so that the two are moved simultaneously.

The circuit is shown in Fig. 1. It will be recognized as the conventional circuit used in most 112-Mc. gear. The only critical component in the unit is RFC_2 , the grid choke. There is an optimum value of choke for any one frequency, with which maximum output will be obtained at that frequency, but the value shown is a good compromise for the three-band range of this transmitter. The cathode is above ground by RFC_3 and RFC_4 , but these inductors do not seem to be too critical.

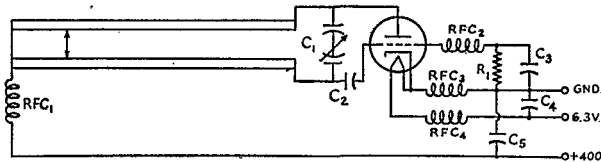

Fig. 1 — Circuit diagram of the three-band oscillator.

- C_1 — See text and Fig. 2.
- C_2 — 10 μ fd. ceramic.
- C_3, C_4, C_5 — 100 μ fd. mica.
- R_1 — 3000 ohms, 1-watt composition.
- RFC_1 — 13 turns No. 18 enam., $\frac{1}{4}$ -inch diam., close-wound.
- RFC_2 — 25 turns No. 18 enam., $\frac{3}{8}$ -inch diam., spaced wire diam.
- RFC_3, RFC_4 — R.f. choke (Ohmite Z-1).

The transmitter is built on a 6- by 28- by 1-inch board. The "cold" ends of the $\frac{1}{4}$ -inch rods used in the line are supported by two panel bushings mounted in an aluminum bracket which is fastened to the baseboard. These two panel bushings are of the locking type and make it a simple matter to position the rods properly. The plate rod is terminated at the plate and in a hole in the plate cap. The plate cap consists of a $\frac{1}{2}$ -inch length of $\frac{3}{4}$ -inch diameter brass rod with a $\frac{3}{8}$ -inch hole drilled in the center and a $\frac{1}{4}$ -inch hole drilled in the side. Holes are drilled at right angles to the large holes and tapped for 6-32 set screws. The $\frac{3}{8}$ -inch hole fits over the plate cap of the tube, and the $\frac{1}{4}$ -inch hole slides over the end of the plate rod. The grid half of the parallel line is approximately one inch shorter than the plate rod, to provide room for the grid condenser, C_2 . The grid end of the line is supported by a small polystyrene post, and the grid socket is made by forming a narrow band of copper around the grid disc of the lighthouse tube and tightening it with a 2-56 machine screw and nut.

The shorting bar for the parallel lines is made of two locking-type panel bushings set in a copper strap. These bushings are tightened just enough to insure good contact and still allow the bar to slide without too much effort. It is imperative, therefore, that the two rods be smooth and straight, although they can be either brass rod or

brass tubing. The coaxial-cable connector for the antenna feed line and the antenna loop are mounted to a piece of $\frac{1}{16}$ inch bakelite bolted to the shorting bar. The antenna loop rides under the lines so that it will not hit the tuning condenser

when the shorting bar is moved near the tuning condenser. The size of the loop may vary with different antennas but, in general, it should be

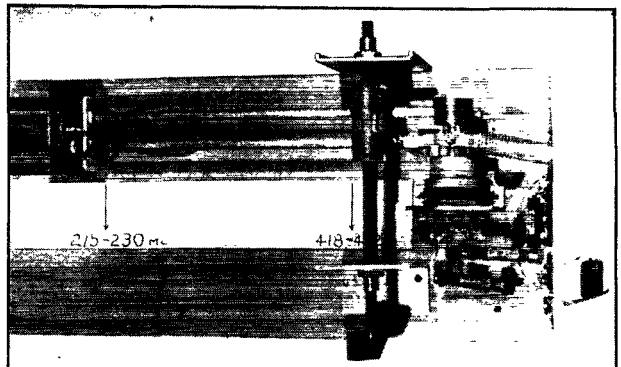

A close-up view of the tuning condenser also shows the details of the socket mounting and tube connections.

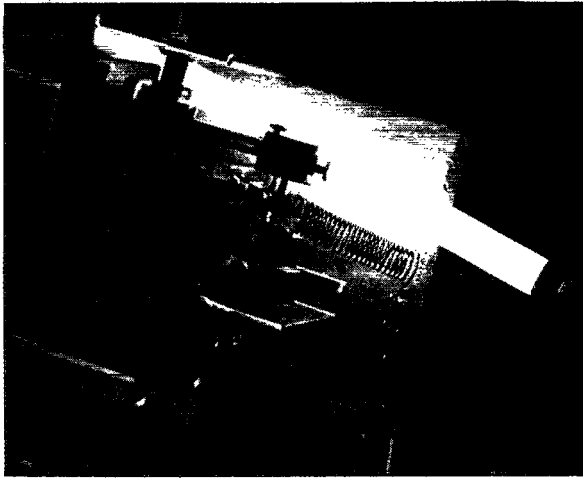

Proof of the output on 420 Mc.! A 6-watt fluorescent tube lit almost to full brilliancy.

about 2 inches long and spaced the same as the lines. The coupling can be increased by bending the loop closer to the lines.

The tuning condenser is of the split-stator type with the rotor floating. The stator plates consist of two strips of copper, $\frac{3}{16}$ inch wide by 1 inch long, formed in two arcs and soldered to the tuning rods (see Fig. 2). The rotor uses a piece of $\frac{3}{4}$ -inch diameter polystyrene rod through which is drilled a $\frac{1}{4}$ -inch diameter hole for a bakelite or polystyrene shaft. If desired, the solid polystyrene can be replaced by a $\frac{3}{4}$ -inch diameter coil form by cementing a disc of polystyrene to the open end of the coil form.

The rotor plate, a U-shaped strip of copper one inch square, is formed and then cemented to the polystyrene form. A U-shaped piece is necessary because it was found that at 450 Mc. the rotor plate acted as a capacitor plate as it was first brought near the stator plates, but after rotating the rotor still further it began to act as a shorted turn in the field of the lines, thus counteracting the effect of the additional capacity and limiting the tuning range to only a small frequency variation. Two metal brackets with panel bushings are used to support the rotor shaft. It is a good idea to mount the panel bushings in slots rather than the usual clearance holes, so that the shaft can be moved toward the stator plates until the desired capacity range is obtained.

The tube socket is mounted on an aluminum bracket which is screwed to the baseboard. No connection is made to the r.f. cathode connection because the oscillator was found to work better over the entire range that way, although a 300-700-Mc. oscillator mounted on a metal chassis worked fine with the r.f. cathode connection grounded.

Speaking of metal chassis for a line oscillator like this, they can be unforeseen sources of trouble. On one such 12-inch job (the chassis was approximately one-half wavelength long), it was possible to light a 6-watt fluorescent lamp brightly at both ends of the chassis, demonstrating only too well its uselessness as a ground.

Tuning Up

The tune-up procedure for this oscillator is much the same as for any 112-Mc. oscillator, with the exception that forced ventilation must be used on the tube if anything like the rated maximum input of 20 watts is to be used. As much of the plate heat as possible must be conducted away by the plate rod, and for this reason the connection between plate and rod must be as good as possible from a heat as well as an electrical standpoint. The forced ventilation of the plate can best be obtained by the use of a small electric fan whose blast is directed at the plate connection whenever the plate power is applied. A small blower tube can be rigged up from stiff cardboard and attached to the fan if a regular blower housing is not available.

Assuming all three or four connections are made properly, the rig should oscillate without any trouble, and oscillation can be determined by using a small neon bulb or a flashlight lamp and loop of wire held close to the lines. Grid current is also an excellent oscillation indicator. If no oscillation is obtained, it probably means an incorrect

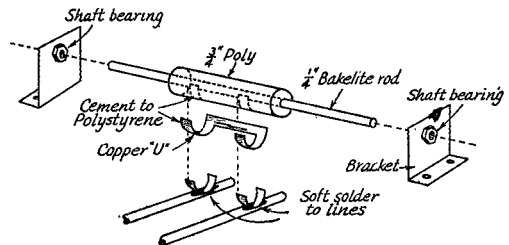

Fig. 2 — Construction and assembly details of the tuning capacitor.

grid choke, and its construction should be checked or modified slightly. To get the best efficiency, particularly on any one band, may require some slight revision of the grid choke or in the value of the r.f. by-pass capacitors while watching the output as indicated by the lamp load and the

input as indicated by a plate milliammeter. Tuning up should be done at reduced plate voltage, say around 250 or 300, at which value the loaded plate current should run around 15 to 20 ma., after which the maximum input of 40 ma. at 500 volts can be applied if considered necessary. A 6-watt fluorescent light also makes a good indicator, and with this rig we have been able to light one to almost full brilliancy at 450 Mc.²

A good set of Lecher wires or an accurately-calibrated absorption wavemeter is essential for finding the different amateur bands. Although a wire line is probably the most convenient for the 144- and 220-Mc. bands, a more rigid line for the 420-Mc. band can be made by using 1/4-inch rod or tubing, supporting it in the same manner that the tuned circuit was supported for the oscillator. After the oscillator has been calibrated, a cardboard scale can be added to the baseboard and the positions marked for the three amateur bands. The approximate settings of the shorting bar follow, although it is realized that they will probably differ slightly in other rigs:

Distance from Center of Plate of 2C43 to Shorting Bar	Frequency Range
14 inches	138-152 Mc.
8 1/4	215-230
2 1/2	418-452

Considerable care must be exercised in moving the shorting bar (and in removing the tube from its socket) because of the possibility of breaking the tube seals.

The Antenna

Separate antennas will be required for each band, unless a rhombic or similar broad-band antenna is used. It is highly desirable to use coaxial instead of open-wire transmission line at 420 Mc. (if one has access to the low-loss coax developed during the war) because of the lower radiation losses. An intriguing thing about the 420-Mc. band is the small size of the antenna, and a rather decent system can be built in a small space. One of the photographs shows a four-element beam consisting of a folded dipole, one reflector and two directors, and the antenna is only 13 inches high. The length of the elements and their relative spacing should be adjusted to

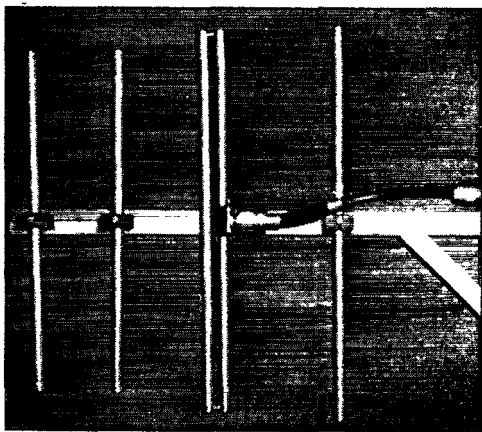

A four-element beam for 420 Mc. The folded dipole antenna is 13 inches long, the reflector is 13 1/2 inches, and the two directors are 11 1/2 inches. Spacing between the directors and director and radiator is 2.6 inches, and 4 inches between radiator and reflector.

obtain the highest possible forward radiation as indicated on a field-strength meter.

All elements are made of 3/8-inch diameter aluminum rod secured to the wooden framework by blocks of bakelite. The ends of the folded dipole are bolted together with 6-32 brass machine screws and 1/4-inch brass spacers.

General

The 2C43 and 2C44 types perform very well in the v.h.f. region, not only as oscillators but also as neutralized amplifiers and frequency multipliers. For example, a single 2C44 will double from 75 to 150 Mc. and drive a pair of 2C44s in push-pull which in turn triple to 450 Mc., all with conventional L-C and linear circuits.

The 2C40³ is a receiving-type lighthouse tube and with the others makes a complete set of tubes for the 200- to 1500-Mc. range. As soon as these tubes and their sockets become readily available on the market, the 420- and 1145-Mc. bands should see considerable activity.

² Ratings of the 2C44 are given on page 44 of *QST*, November, 1944.

³ See *QST*, August, 1945, page 46.

"Good News" Department

Switzerland — Amateur equipment has been returned by the Government and amateur activities were resumed on the 80-meter band Sept. 30, 1945.

Colombia — Governmental decree of October 9, 1945 authorized amateur operation, on all bands, subject to pre-war regulations.

U.S.S.R. — CBS news dispatches of October 12, 1945 stated that activity on all amateur bands had been authorized and that amateurs were not restricted to domestic contacts.

Australia — Amateur equipment to be returned by the Government and amateurs have been released from their wartime silence by Postmaster General, according to a report via United Press on October 6, 1945.

Trinidad — VP4s may go on any pre-war band, even 7-Mc. 'phone, according to a report from VP4TI, via W2NYC.

Brazil — Amateur operation on the 3.5-, 56- and 112-Mc. bands has been reestablished. 14- and 7-Mc. activation is expected shortly.

Finding the 144-Mc. Band

A Review of Frequency-Determining Methods Above 50 Mc.

THE re-opening of the 112-Mc. band for amateur radio has, aside from the pleasure it affords us in being able to engage once again in our favorite hobby, forcibly brought home the fact that u.h.f. radio is growing up. No longer can we operate in the bands above 100 Mc. with little fear of interrupting some other service if we inadvertently get out of the band. Instead we are sandwiched in between other interests in much the same fashion as on the lower frequencies, and our moral obligation to keep our records spotless is as definite as it is below 54 Mc. The recent complaints of amateur interference with aircraft services on 116.1 Mc. (when our limit is 115.5 Mc.) bring out strikingly the fact that many of us are using frequency-determining methods that are too casual (or nebulous!) for modern operation. Imagine anyone seriously explaining why he was operating on 27.4 or 30.6 Mc. before the war and you will see what we mean. The matter will be no less serious when we move to the 144- to 148-Mc. band.

A favorite procedure in establishing one's equipment in a new high-frequency band has been to identify the second or fourth harmonic from one's transmitter on the next lower-frequency band where the frequency is known accurately. This is a simple method when bands are harmonically related to one another, but the new u.h.f. bands have not been allocated this conveniently. The limits of the imminent 144- to 148-Mc. band bear no direct harmonic relation to any of the limits of our other bands (with the single exception of the 4-Mc. limit of the 80-meter band), and the same is true of the 50- to 54-Mc. band. The following paragraphs contain nothing new in band-limit-determining technique, but they describe the methods available to amateurs at the present time.

Lecher Wires

Lacking an accurately-calibrated absorption-type frequency meter (which might be a home-made affair resulting from considerable pre-war foresight or the manufactured article built by several instrument companies), the simplest and least expensive piece of frequency-determining equipment is a set of Lecher wires. "Lecher wires" is the name given to a two-wire transmission line used for direct wavelength measurement by observation of the distance between maximum current loops of standing waves along the line. The line is a simple thing to build, the single strict requirement that only air dielectric exist between the portions of the line where the measuring is done being an easy one to satisfy. The wires are usually stretched tightly between in-

The movement into the 144-Mc. band will be accompanied by many doubts as to the limits of the band, if the pattern of past such expeditions is followed. The FCC is tolerant of our doubts but not of our out-of-band operation, and it is every amateur's solemn obligation to know without doubt that he is operating inside of the band and to maintain his frequency within the band limits. Unfortunately there are no tailor-made markers or other devices the amateur can use, and he must rely upon the more basic principles outlined in this article.

ulating supports, and a spacing of an inch to an inch and a half is about right for 150 Mc. and lower. The line must be at least one wavelength long, to insure the existence of at least one full half wavelength, and the current loops are found by using a "shorting bar" which can be slid along the line to vary its effective length. The longer the line is made, in terms of half wavelengths, the sharper will be the readings that are obtained, because of the more rapid phase shifts present in the longer line.

A practical Lecher-wire system has been described recently,¹ and it should not be necessary to repeat all of the constructional details here. The Lecher-wire assembly should be built in more or less permanent form, although it is quite feasible to stretch the line temporarily along a wall or a large plank laid on the floor. A permanent system is probably best constructed along the lines of the reference article, by constructing a T beam of two pieces of one- by two-inch wood at least eight feet long and supporting the wires from insulators fastened to brackets at the ends of the T beam. This type of construction has the additional advantage that it provides a guide for a carriage on which the shorting bar can be mounted. The shorting bar should be a piece of brass or copper sharpened almost to a knife edge. The wire can be any bare copper wire larger than No. 18.

The frequency of a transmitter can be checked by loosely coupling the Lecher wires (by a hairpin loop at one end of the line) and finding two spots on the line where shorting the line causes an increase in the plate current of the transmitter. The distance between these two points on the line bears the following relation to the frequency:

$$F_{Mc} = \frac{5906}{\text{Distance (inches)}}$$

If the distance is measured in meters, the relation is

$$F_{Mc} = \frac{150}{\text{Distance (meters)}}$$

¹ "A Lecher Wire System for U.H.F. Measurement," *QST*, Oct., 1941.

The Radio Amateur's Handbook, 1945 edition, page 410.

In many cases the change in plate current will be too small to observe on the plate milliammeter, and a small loop of wire and flashlight lamp coupled to the transmitter must be used as an indicator. Then when the shorting bar is placed properly the lamp's brilliance will be reduced. For maximum accuracy with this method, the indicating lamp and the Lecher wires should be coupled as loosely as possible consistent with any indication at all, because of the possibility of "pulling" of a self-excited oscillator. No such care is necessary with a power amplifier excited by an isolated oscillator. For low-powered rigs, where coupling a flashlight lamp will result in too much pulling of the frequency, it may be necessary to use an absorption-type wavemeter using a crystal detector and milliammeter indicator. Many of the low-powered rigs will be transceivers, and the frequency check can be made in the "receive" position with the technique used for any superregenerative receiver.

Checking a superregenerative receiver with Lecher wires consists of advancing the regeneration control from the "off" position up to the point where the receiver just starts to superregenerate, with the Lecher wires loosely coupled. There will be found points on the Lecher wires where shorting the line will reduce the hiss in the receiver, and these represent the current loops along the line. In the case of a transceiver with no regeneration control, it will be necessary to couple in the Lecher wires until an indication is obtained. Except in the case of a transceiver which is oscillating too hard in the "receive" condition, it will be possible to get accurate indications.

A word of caution might well be repeated here concerning transceiver operation. Most transceivers do not transmit on exactly the same frequency to which they are tuned in the "receive" condition, with the result that two operators working each other with transceivers very often "walk" across the band during a QSO in steps representing this frequency difference. If the operators of the transceivers do not constantly watch the frequency-setting dials on their respective rigs, it is a simple matter to drag each other out of the band and into some other service which is also entitled to part of the spectrum. Often this service consists of some prosaic communications set-up that cannot be made to understand why it should stand by and listen to the amateurs.

Final checking with Lecher wires of either a transmitter or receiver should be done with the antenna coupled in the way it is to be used in practice, to determine that coupling the antenna has not disturbed the frequency calibration of the equipment. When an antenna is coupled to a transmitter, the feeder current will dip slightly as the proper points are shorted on the Lecher wires, and this is another convenient indicating method for this type of frequency check, although it requires an r.f. ammeter or flashlight bulb for indicating feeder current.

With careful technique, one can measure frequency with Lecher wires accurately to 0.14% at 144 Mc. This represents measuring the distance

involved to 0.05 inches, and if repeated measurements check to within less than this figure, one can rely upon the measurement to within 200 kc. at 144 Mc. However, this does not take into account the frequency modulation and other undesirable by-products of modulated oscillators. Many modulated oscillators are just plain sour and splash several hundred kc. either side of their unmodulated frequency. Any energy splashing outside the band represents a violation of the law in exactly the same way that having the steady carrier tuned to outside the band limits is a violation, and this is one place where the amateur must figuratively and literally "keep his skirts clean."

Harmonics for Frequency Checking

The preceding method of frequency checking is the most convenient for the amateur without any low-frequency gear because it requires a minimum of new equipment. However, the pre-war amateur with low-frequency equipment will most likely resort to the use of harmonics from his low-frequency gear for checking frequency in the 50- and 144-Mc. bands. It is, however, the accurate checking of the *fundamental* frequency of the harmonic generating oscillator that is the important thing. If, for example, one is using the harmonics from a crystal in the 3.5-Mc. band (and thus anything from the 36th to the 42nd harmonic), the error in measuring the frequency at 80 meters is multiplied by about 40 at 144 Mc. Depending upon the accuracy of calibration of a crystal and the circuit in which it is used, a crystal can vary perhaps 2 or 3 kc. at 80 meters and thus could be in error 100 kc. or more at 144 Mc. This is, of course, unimportant to the amateur willing to stay within 400 or 500 kc. of the band edges, but it should be borne in mind by anyone with a desire or tendency to "crowd the edges" that it is not sufficient to accept the nominal frequency of a crystal when using its high-order harmonics for accurate checking.

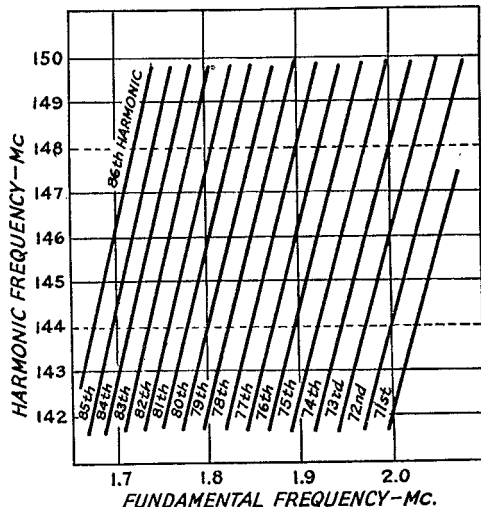

Fig. 1 — Harmonics of oscillators in the 1.7- to 2.0-Mc. range with harmonics in the 2-meter amateur band.

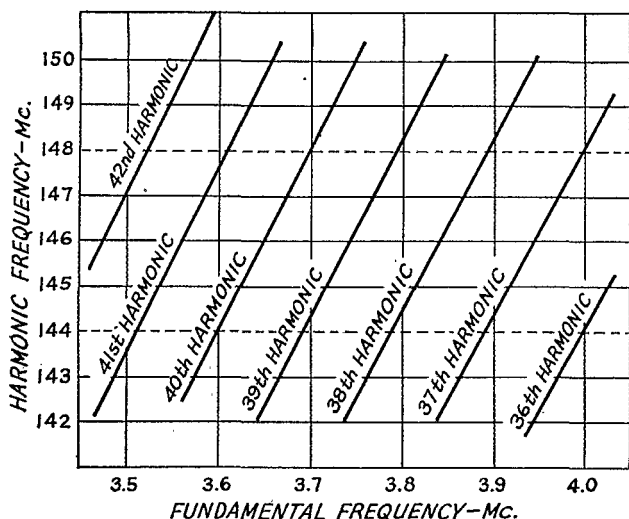

Fig. 2 — Harmonics of oscillators in the 80-meter amateur band falling in the 144-Mc. band.

The charts in Figs. 1, 2 and 3 show the harmonics from various amateur-band crystals, which fall in the 144- to 148-Mc. band. Fortunate indeed is the amateur with a crystal (or self-excited) oscillator which is precisely on 2,000 Mc. since, as can be seen from Fig. 1, the 72nd and 74th harmonics give the band edges exactly, and the 73rd harmonic is an extra point in the center of the band. An oscillator right on 4,000 Mc. is almost as convenient, since the 36th and 37th harmonics fall on the exact edges of the 144-Mc. band. Any 2.0- or 4.0-Mc. oscillator using a 6V6, 6F6 or 6L6 running at 5 or 10 watts input will have strong-enough harmonics in the 144-Mc. band to be heard readily if the oscillator and receiver are within a few feet of each other.

It is not enough, however, to have an oscillator below 8 Mc. for finding the 144-Mc. band because of the very good possibility of spotting the wrong harmonic and ending up out of the band. A self-excited oscillator whose frequency can be set accurately in the 28-Mc. band by using a 100-ke. frequency standard and calibrated receiver is quite useful, since the 5th harmonics of 28.8 and 29.6 Mc. give the band edges at 144 and 148 Mc. with little chance for confusion (it is unlikely that one will miss the band by almost 30 Mc.). An oscillator accurately set at 14.4 and 14.8 Mc. also provides a chance to mark the band edges but requires more care in selecting the correct harmonic. In any event, the necessary equipment is an oscillator of enough power to generate harmonics in the 144-Mc. band and a means for accurately determining the fundamental frequency. In most cases the latter will be a communications receiver and a 100-ke. oscillator.² If the harmonic-generating oscillator has a fundamental frequency higher than 14 Mc. it probably will not be necessary to have an additional check on frequency,

² Woodward, "A Simple Method of Frequency Measurement for WERS," *QST*, September, 1942.

³ *The Radio Amateur's Handbook*, 1945 edition, page 409.

but if the fundamental frequency is below 14 Mc. it is highly advisable to use Lecher wires for a rough check to insure operation within the band. In the case of a super-heterodyne receiver, Lecher wires can be used to check the frequency of the local oscillator if the i.f. is low enough to bring the oscillator within the range of the Lecher wires. Some experimenting will be necessary to get the proper coupling between the Lecher wires and the local oscillator.

When the band limits have been established accurately on the receiver by the harmonic method, the receiver can be used to check the transmitter frequency if the transmitter is low-powered and the receiver is remote enough to preclude the possibility of the transmitter blanketing the receiver. However, it

is at best an unsatisfactory method unless the receiver is a well-shielded superheterodyne, and a better plan is to calibrate an absorption-type wavemeter³ from the receiver and use it to check the transmitter frequency. The wavemeter should have decent bandspread so that close readings can be made.

The serious u.h.f. amateur will, of course, not be satisfied until he has a good secondary standard for measuring frequencies in the region above 50 Mc., and the references in the bibliography are recommended for ideas along this line.

BIBLIOGRAPHY

- 1) Adams, "A Junk-Box Frequency Meter for 112 Mc.," *QST*, November, 1943.
- 2) Bliss, "Frequency Measurement in the WERS," *QST*, December, 1943.

— B. G.

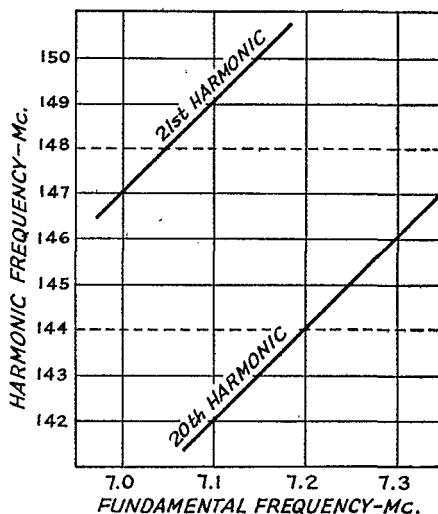

Fig. 3 — Crystals between 7.0 and 7.050 Mc. and 7.2 and 7.3 Mc. have harmonics in the 144-Mc. band.

Extended-Range Television Reception

A Receiving System for Weak-Signal Areas In Three Parts—Part I

BY MARSHALL P. WILDER,* W2KJL

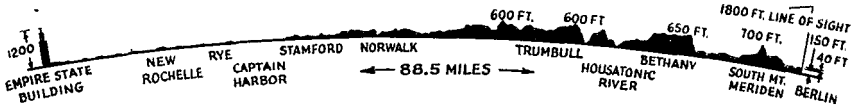

Fig. 1—Cross section showing the signal path between the Empire State Transmitter and the author's home in Berlin, Conn. The receiving antenna is approximately 1000 feet below the line of sight.

It is usually taken for granted that reception of television broadcast programs is confined to the area in which the signal can be received over a substantially line-of-sight path. For reliable, day-after-day reception this is no doubt true. However it does not mean that those who live outside the normal service area have to go without television entirely—not, that is, if they are willing to take the extra pains necessary to make the most of the signal that does penetrate the outlying regions. While it is not to be expected that reception always will equal that obtainable within a stone's throw of the transmitter, the fact is that the entertainment quality can be high for a surprising percentage of the time. At least that has been the writer's experience at a location in Berlin, Conn., almost 90 miles from the Empire State transmitter and well below the line of sight. Consistent reception of WNBT (51.25-Mc. picture carrier, 55.75-Mc. sound carrier) has been obtained over the path¹ shown in cross-section in Fig. 1, a result which, while naturally dependent upon atmospheric conditions, has been made possible by a receiving system that includes a high-gain antenna as well as a receiver of advanced design.

* Electronic Division, Remington Rand Inc., Middletown, Conn.

¹ For the method of constructing such a map, see P. S. Rand, "Choosing U.H.F. Sites," *QST*, September, 1945.

² Fink, *Television Standards*, McGraw Hill Book Co.

Beginning with the December, 1937, issue the writer published a series of articles in *QST*, "Introducing Modern Electronic Television to the Radio Amateur." During the intervening eight years the art has progressed considerably, and standards of good engineering practice have developed both as a result of action taken by the Federal Communications Commission and by the industry as a whole. For instance, modern television calls for a receiver capable of quasi-single-

sideband reception (type RA) as indicated in Fig. 2.³

The picture reproducing tube and associated deflection circuits should be capable of linear deflection of the beam at a frequency of 15-750 traces per second horizontally, and 60 traces per second vertically. The rate of horizontal deflection of the return trace of the beam is approximately five times faster than the trace time. The return trace

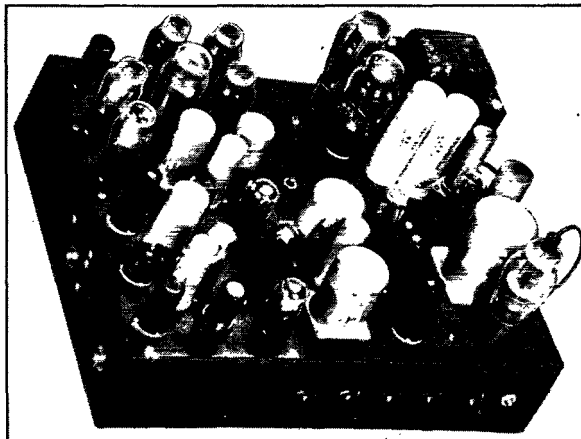

This chassis contains the video amplifier, limiters, automatic frequency control synchronizing circuits, vertical and horizontal deflection circuits, and the d.c. power supply. Layout of components is described in the text.

The author of this article has been getting good television reception for a considerable proportion of the broadcasting time at a location nearly 90 miles from the nearest broadcaster and a thousand feet below the line of sight. This is a description of the equipment with which it is done.

time of the vertical deflection is approximately twelve times faster than the trace time. A total of 525 lines is traced in one-thirtieth of a second. Interlacing is accomplished by dividing one complete picture or frame into two "fields," each forming a 262½-line picture scanned in 1/60th second. The lines of the second field fit in between the scanning lines of the first so that a 525-line picture is achieved, although alternate lines are

second has been established by the Federal Communications Commission.

The principal requirements for a receiver operating under the conditions encountered when signals must be received over non-optical paths are a good inherent signal-to-noise ratio, ample gain, and a method of synchronization which is as insensitive as possible to the upsetting effects of local interference such as automobile ignition. For the most part the circuits in the receiver to be described follow designs which will be fairly familiar to those who have kept in touch with television development, hence the discussion will be concentrated on those aspects that are particularly useful for weak-signal reception.

Two unusual features of this receiver are the means for synchronization, employing the fly-wheel or electrical inertia type of circuit, and electronic regulation of the d.c. power. A noise limiter is an important element in the receiver. The description to follow covers the units furnishing power, synchronization, beam deflection, video signal amplification, noise limiting, and low-frequency restoration. Fig. 3 is a block diagram of the receiver.

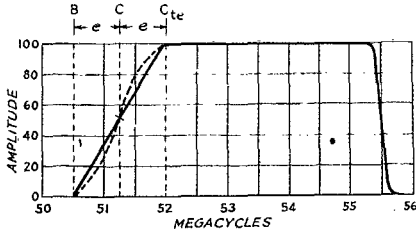

Fig. 2 — Ideal receiver response characteristic for reception of 525-line television transmissions (based on 51.25-Mc. picture carrier).

separated in time by 1/60th second. At the end of the first field, when the scanning beam has moved only a half line across the bottom of the picture, the beam is returned to the top of the picture to finish the line. Because the beam is moving down the picture (as a result of the continuous vertical

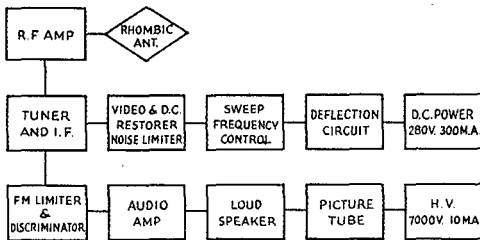

Fig. 3 — Block diagram of receiving system.

deflection) at the same time that it is moving across, this process places the last half line above the last half of the first line of the first field, the displacement being just the width of one line. The lines of the second field thereby are automatically placed between the lines of the first as the scanning continues. The reason for interlacing two fields is to achieve a picture interruption rate of sixty times a second rather than thirty, thereby achieving a decided reduction in picture flicker. The brighter the picture, the higher the interruption rate has to be to avoid annoying flicker. An interruption rate higher than approximately thirty-five fields per second is not noticeable at ordinary levels of picture brightness. To insure against the development of noticeable flicker as pictures are further increased in brightness, an interruption rate of sixty fields per

A.F.C. Synchronization

Aside from band width, horizontal and vertical resolution depend on the accuracy of synchronization as well as the intensity of the noise impressed on the kinescope grid. This is especially true when signals are weak or the noise level is high. If methods of synchronizing other than automatic frequency control are used there are often conditions when horizontal resolution is reduced, regardless of the pass band of the receiver.

A report based on an original paper by Wendt and Fredendall,³ prepared by the television section of RCA Laboratories, Princeton, N. J., for the Radio Technical Planning Board, Panel 6, Television Committee 2, describes an automatic frequency-synchronizing circuit. This circuit will not follow sudden changes in the synchronizing-pulse repetition rate and is recommended for all receivers operating at or near the fringe of television service areas. The repetition rate, line by line and field by field, is held rigidly at the broadcasting station. At the receiving point any spurious pulses such as those generated by auto ignition or other local interference will not cause loss of synchronization unless the rate of the

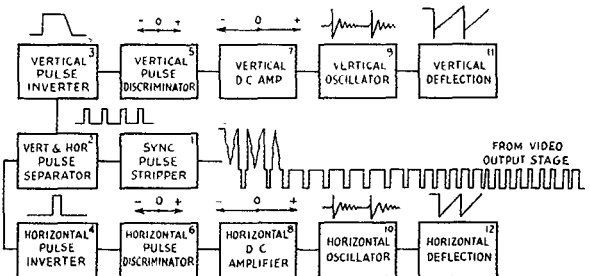

Fig. 4 — Block diagram of circuits for sync separation, a.f.c. synchronization, and deflection. Approximate waveforms at each point are indicated.

³ Wendt and Fredendall, "Automatic Frequency and Phase Control of Synchronization in Television Receivers," *Proc. I. R. E.*, January, 1943.

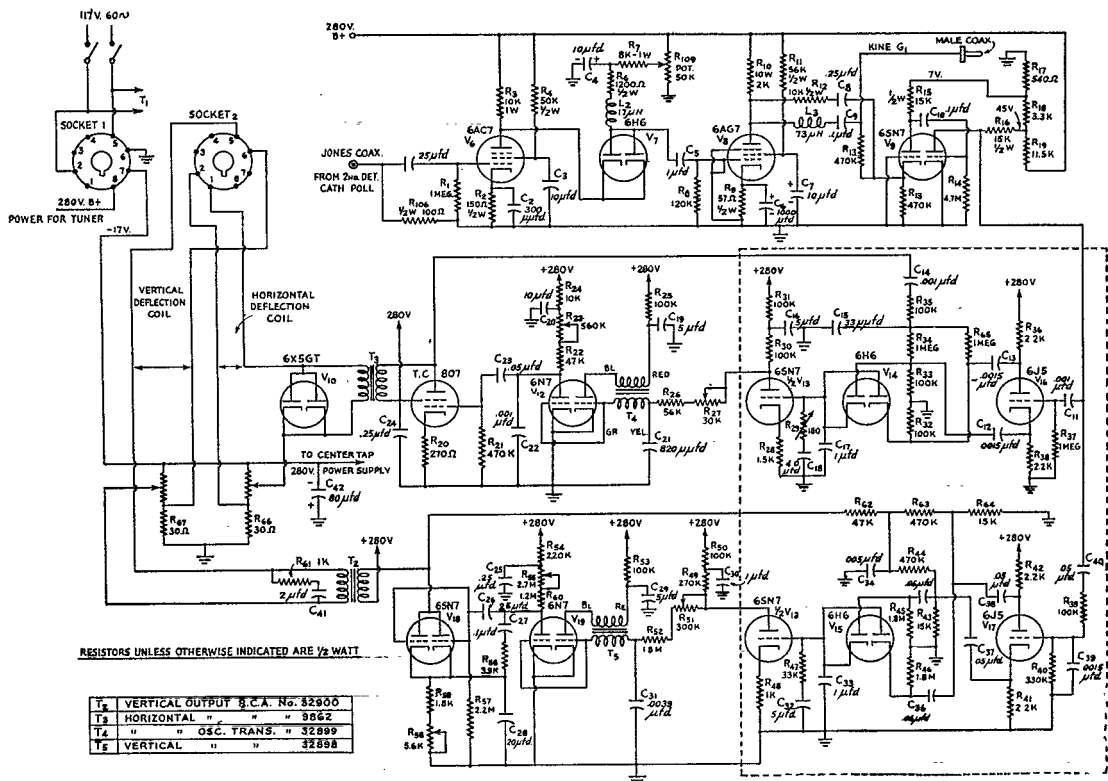

Fig. 5 — Wiring diagram of the video, synchronizing and deflection circuits.

interfering pulse is very near that of the picture sync pulse for an extended time, a very unlikely coincidence. The synchronizing circuit employed in this receiver, shown in block form in Fig. 4, is essentially the type described in the RTPB report.

Fig. 5 is the detailed wiring diagram of the video, synchronizing and deflection circuits. Referring to this figure and to Fig. 3, the tuner chassis transmits the composite video-sync signal from the second detector via a cathode follower to the grid of V_6 , where it is amplified and passed on to the noise limiting diode, V_7 . R_{109} sets the voltage on both plates of V_7 to allow the video to pass through, along with the synchronizing pulses. V_7 clips off noise pulses to the top of the synchronizing pulses. It will be noted that compensation for high-frequency losses in the plate circuits of V_6 and V_7 , including the grid of V_8 , is accomplished by an inductance, L_3 , in series with the load resistor, R_6 , for V_7 . Further high-frequency compensation is effected by C_2 , R_2 . Two stages of video amplification are used instead of one, to permit greater freedom in design, noise limiting, and simpler high-frequency compensation. The output tube, V_8 , is a video power output tube capable of supplying 75 volts peak-to-peak to the grid of the kinescope with a pass-band of 4.5 Mc. Series peaking is employed.

The video signal is supplied from the video output tube, V_8 , through R_{12} and C_8 to the

cathode of tube V_9 (Block No. 1, Fig. 4). The high value of R_{13} , in combination with the low voltage applied to the plate of V_9 , results in saturation of all signals except the tips of the synchronizing pulses.

It is a feature of this type of synchronizing circuit that the wave form need not be sharply defined; that is to say, considerable high-frequency content can be lost without affecting the quality of synchronization. It will be noted that the input to V_9 is through a series resistor of not less than 10,000 ohms, a decided advantage in retaining high frequencies on the grid of the kinescope.

The second triode section of V_9 inverts, amplifies and clips off the top of the sync pulses to a common level. Both the vertical and horizontal pulses are fed to the grids of V_{16} (Block No. 4) and V_{17} (Block No. 5) via RC components designed to separate and apply essentially horizontal pulses to the grid of V_{16} and vertical pulses to the grid of V_{17} . The purpose of V_{16} , in the horizontal deflection case, is to apply signals of equal amplitude but opposite polarity to V_{14} (Block No. 6), a diode bridge-type phase discriminator. At the same time a portion of the sawtooth appearing in the plate circuit of the output tube, V_{11} (Block No. 12), is fed back to the bridge through C_{14} . These two voltages, one from V_{16} and derived from the received signal, and the other from the plate circuit of V_{11} and generated

A circuit diagram for the high-voltage power supply is given in Fig. 7. Too much emphasis cannot be placed on the personal danger involved when dealing with the high voltage required in a television receiver. High-voltage sources of power resulting from rectification and filtering of either high-frequency oscillators or fly-back voltage developed in a horizontal output tube are to be preferred whenever it is possible to obtain components. Unfortunately such transformers and other components were not available and a conventional high-voltage supply of prewar design had to be used.

A 12AP4 or 9AP4 is recommended for use in this receiver. However, if a suitable deflection yoke is employed the 7CP1 and the 9JP1 can be used without essential changes in the circuit. Most of the writer's experience has been with the 7CP1.

The average brightness of the picture is controlled by R_{s2} in the cathode circuit of the kinescope.

the photographs. The tube in the lower left-hand corner is the first video stage, V_6 . The next tube above is the noise limiter, V_7 , followed along the chassis edge by V_8 , the video output tube. Two VR150s, V_{21} , V_{22} , and a 6SJ7, V_5 , regulating the d.c. power supply, complete the line of tubes along

the edge. The second row starts with the horizontal phase-inverter tube, V_{16} , followed by the d.c. restoring sync separator, V_9 . Next in line is the vertical-pulse phase inverter, V_{17} , followed by two 6Y6s, V_1 and V_2 , part of the d.c. regulator. The third row begins with the horizontal discriminator, V_{14} , the vertical and horizontal d.c. amplifier, V_{13} , the vertical phase discriminator, V_{15} , and the other two d.c. regulators

(6Y6s), V_3 and V_4 . The fourth line of tubes starts with the horizontal blocking oscillator, V_{12} , followed by the vertical oscillator, V_{19} , and the vertical output tube, V_{18} . The two 5U4G rectifiers, V_{19} and V_{20} , are above. The last line of

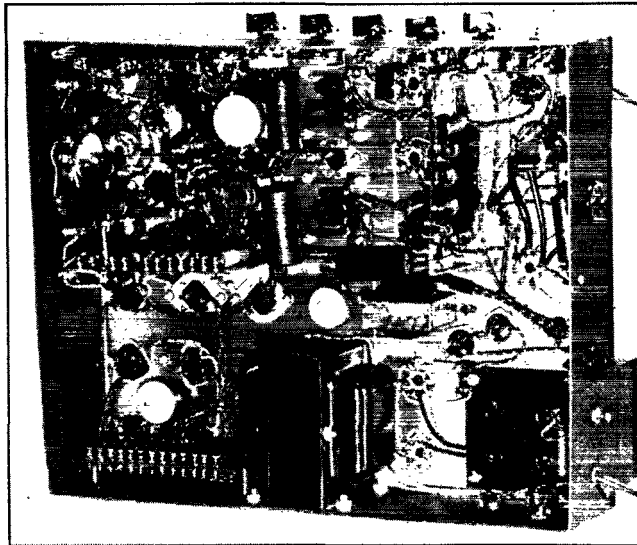

Bottom view of the video-sync-deflection chassis. Insofar as possible, small parts such as resistors and paper condensers are mounted on terminal boards, with cabled leads to tube sockets and other chassis-mounted components.

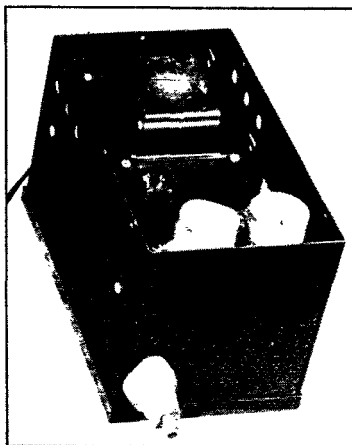

Left — The 7500-volt power supply for the picture-reproducing tube is built in a metal cabinet separate from the other chassis units.

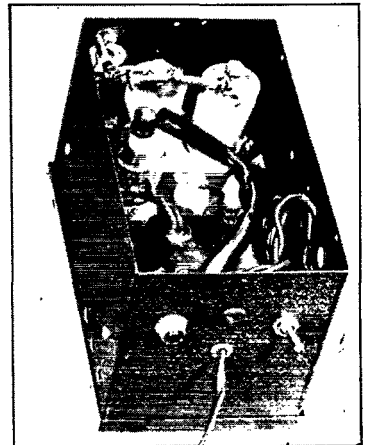

Right — The rectifier tube and filter condensers are visible in this bottom view of the high-voltage power supply.

Chassis Arrangement

A top view of the d.c. power supply, video amplifier and limiters, automatic frequency control synchronizing circuits, and vertical and horizontal deflection output circuits is given in one of

tubes consists of the 807 horizontal output tube, V_{11} , and the 6X5 damping tube, V_{10} .

The large cans contain transformers and are adjacent to the tubes with which they operate.

(Concluded on page 112)

An A.M.-F.M. Transmitter for 50 Mc.

Combining Crystal and V.F.O. Control in the New Six-Meter Band

BY E. P. TILTON,* W1HDQ

The new band at 50-54 Mc. will not require a different approach in transmitter design — the familiar double-double-amplify system still can be used — but it is no longer possible to multiply from ham band to ham band. Until the new crystals become available a v.f.o. offers an easy way out. Here's a transmitter that combines crystal, v.f.o., f.m. and a.m. — just about everything you'll need when 50 Mc. gets the green light.

IN PREWAR days it was customary to make one exciter unit do for operation on all bands. In view of the harmonic relation then existing between the low-frequency ends of all the bands, this was not too difficult a proposition, even for those contemplating work on 56 and 112 Mc., but now that harmonic relation stops at 28 Mc. some other approach is in order for the v.h.f. worker. Some exciters which give output on 28 Mc. can be made to work on 50 Mc. also, but the difficulty of attaining this end indicates that a separate exciter for 50 Mc. and higher is the simplest way out.

bands. The unit herein described provides for either v.f.o. or crystal control, with amplitude or frequency modulation, and may be used as a complete transmitter or exciter for 50 Mc., or as a source of excitation for a power tripler to the 144-Mc. band. It includes an electron-coupled oscillator and a Tritet crystal oscillator — both doubling in their common plate circuit, a doubler stage whose output is in the range between 48 and 54 Mc., and a final amplifier which delivers up to 40 watts. A reactance modulator is provided for operating on f.m., and the unit may also be used for c.w., or for amplitude modulation if the necessary 30-watt modulator is available. The complete circuit diagram is shown in Fig. 1.

By designing our tuned circuits to cover a little more than the range required for six-meter operation, we are able to generate power over a range which will be useful in tripling to the two-meter band as well. Even though multistage design is not contemplated for the higher frequency, a source of r.f. having reliable frequency characteristics is mighty handy in finding the band and in lining up transmitters and receivers to be used there, as anyone who has hunted for 144 Mc. will testify. Thus our v.f.o. grid circuit is made to tune from 12 to 13.5 Mc., the range from 12 to 12.35

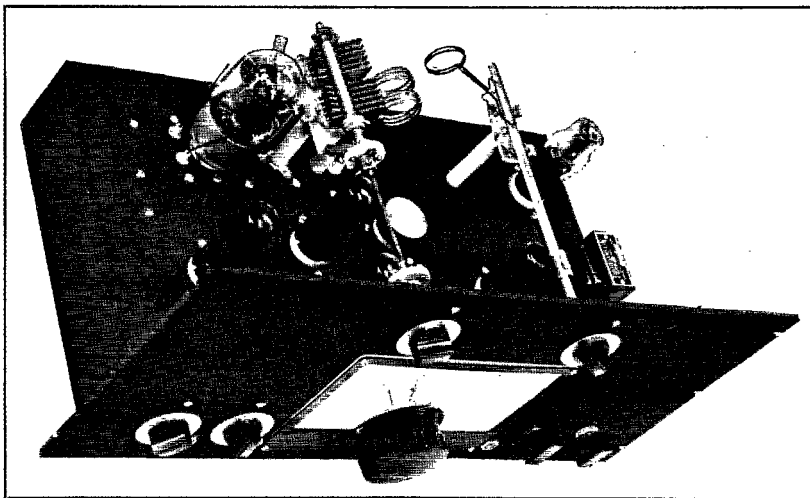

Front view of 50-Mc. a.m./f.m. transmitter. The r.f. section of unit occupies the left-hand portion of the chassis. The VR-150, 6SA7 reactance modulator, and microphone transformer are at the right. Note neutralizing capacity wires at the left of the 815.

By planning an exciter for v.h.f. only, maximum efficiency can be obtained, and features not required for low-frequency work can be built in without disturbing the gear used on our prewar

* V.H.F. Editor.

giving us the 144-Mc. band, and 12.5 to 13.5 the 50-Mc. band. Crystals for this range soon will be available from several manufacturers at moderate cost. The common oscillator plate circuit tunes to the second harmonic of this range, or from 24 to

27 Mc. Because amateur communication by means of frequency modulation is still in the experimental stage, it is often desirable to make quick changes from a.m. to f.m. in order to compare results with the two modes of operation. This is accomplished by using two separate oscillator tubes with a common plate circuit, a switch being provided to close the cathode circuit of whichever oscillator is desired. To prevent any possibility of accidental frequency modulation when amplitude is being used, a three-position switch is employed, giving us a front-panel choice of crystal or v.f.o. control, or v.f.o. with f.m.

Stabilizing the V.F.O.

Stability under changes in supply voltage is attained by the simple expedient of supplying the v.f.o. screen from a VR-150. The screen volt-

age is thus held at 150 when the plate voltage is varied over a range from 150 to 600 volts. The cathode current to the oscillator, measured in J_2 , remains practically constant when the plate voltage is varied over this wide range, and the total frequency shift is only a few hundred cycles. With variations in plate voltage which would result from even the most severe line-voltage fluctuations, the frequency shift in the oscillator is only a few cycles. It is thus not necessary to resort to expensive and complicated regulated power supplies to obtain entirely satisfactory v.f.o. stability.

Of course, fluctuation in supply voltage is only one of several sources of v.f.o. instability. We must also guard against excessive tube and component heating, variations in circuit capacity due to non-rigid mechanical design, and interaction due to improper placement of components. In this design, oscillator input is held to less than

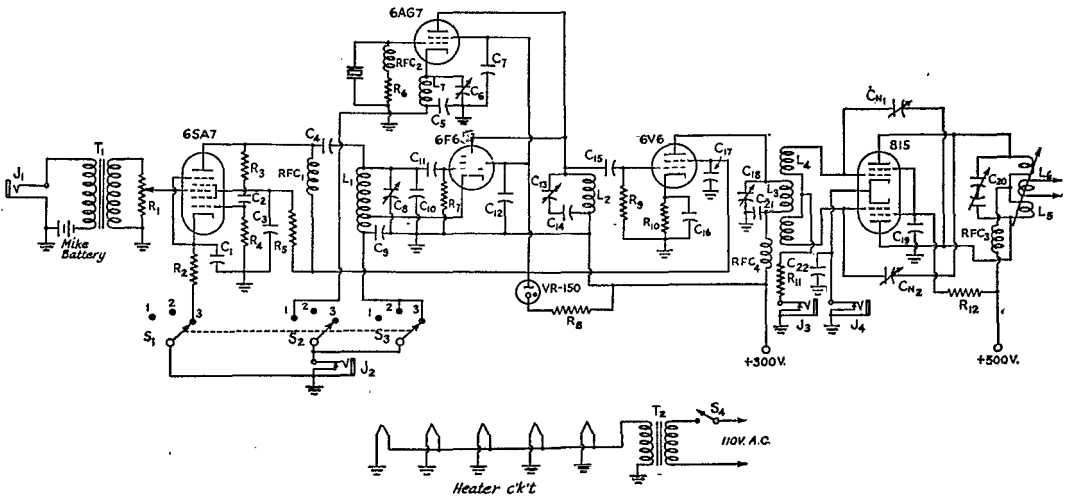
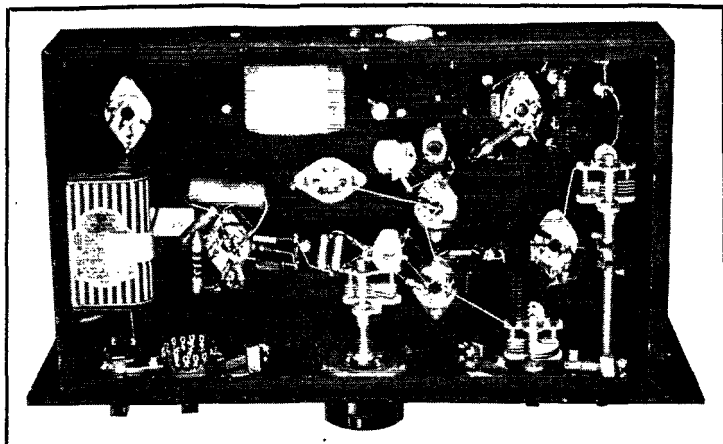

Fig. 1 — Wiring diagram of 50-Mc. a.m./f.m. transmitter.

- C₁ — 0.01- μ fd. 400-volt paper tubular.
- C₂ — 0.001- μ fd. mica.
- C₃ — 8- μ fd. 450-volt electrolytic and 0.005- μ fd. mica in parallel.
- C₄, C₁₉ — 500- μ fd. mica.
- C₅, C₇, C₉, C₁₂, C₁₄, C₁₆, C₁₇, C₂₁, C₂₂ — 0.002- μ fd. mica.
- C₆ — 100- μ fd. midget variable, screwdriver adjustment (Hammarlund APC-100).
- C₈ — 50- μ fd. variable, "straight-line-frequency" type (Hammarlund MC-50-M).
- C₁₀ — 100- μ fd. and 50- μ fd. in parallel (Sickles Silvercap). See text.
- C₁₁ — 100- μ fd. mica.
- C₁₃, C₁₅ — 50- μ fd. variable (Hammarlund MC-50-S).
- C₁₅ — 50- μ fd. mica.
- C₂₀ — 35- μ fd. per. section, split stator (Hammarlund MCD-35-MX).
- C_{m1}, C_{m2} — Neutralizing capacity. See text.
- R₁ — 0.5-megohm volume control, switch type.
- R₂ — 750-ohm, $\frac{1}{2}$ -watt.
- R₃ — 50,000-ohm, $\frac{1}{2}$ -watt.
- R₄, R₆ — 0.25-megohm, $\frac{1}{2}$ -watt.
- R₅ — 5000-ohm, $\frac{1}{2}$ -watt.
- R₇, R₉ — 0.1-megohm, $\frac{1}{2}$ -watt.
- R₈ — 5000-ohm, 5-watt.
- R₁₀ — 250-ohm, 1-watt.
- R₁₁ — 15,000-ohm, 1-watt.

- R₁₂ — 15,000-ohm, 5-watt.
- RFC₁, RFC₂, RFC₄ — 2.5-m.h. r.f. choke (National R-100).
- RFC₃ — 2.5-m.h. r.f. choke, end mounting (National R-100-U).
- J₁ — Open-circuit jack.
- J₂, J₃, J₄ — Closed-circuit jack.
- S₁, S₂, S₃ — 3-position, 3-contact rotary switch (Malory).
- S₄ — Switch on deviation control, R₁.
- T₁ — Single-button microphone transformer (Thordarson T-83A78).
- T₂ — 6.3-volt, 4-amp. filament transformer.
- L₁ — 8 turns No. 18 tinned, $\frac{3}{4}$ -inch diameter, 1-inch length, on National PRF-2 form.
- L₂ — 10 turns No. 14 c., $\frac{1}{2}$ -inch diameter, spaced one diameter, air-wound.
- L₃ — 4 turns, No. 14 c., $\frac{1}{2}$ -inch diameter, spaced one diameter, air-wound.
- L₄ — 5 turns each section, No. 14 c., $\frac{1}{2}$ -inch diameter. Adjust spacing for best transfer of energy. See text.
- L₅ — 3 turns each section, No. 12 tinned, $1\frac{1}{2}$ -inch diameter, spaced one diameter.
- L₆ — 2 turns No. 14 c., 1-inch diameter, swinging link. See photos and text.
- L₇ — 35 turns, No. 24 d.c.c., close-wound on 9/16-inch diameter form (National PRE-3).

Under-chassis view. At the lower center are the v.f.o. grid coil and associated components. Over these are the crystal and cathode circuit for the 6AG7 crystal oscillator. At the upper right are the inductively-coupled doubler plate coil and final grid coil. The coil and condenser at the lower right comprise the plate circuit which is common to both oscillators. The doubler plate tuning condenser is at the far right.



half the rated plate dissipation of the tube, keeping drift due to tube heating to a minimum. All circuit components are mounted below the chassis, away from the heat given off by the metal tubes, and in such position as to prevent interaction as far as possible without extensive shielding. A silvered-mica fixed condenser is used in parallel with the grid coil, and rigid components are used throughout. The net result of these precautions is a v.f.o. whose stability compares favorably with that of the associated crystal oscillator, with any of several crystals tried.

Choosing the Tubes

Several types of tubes were tried in the v.f.o., and it was found that there was little choice between the 6F6, 6V6 and 6VGT. All showed similar freedom from drift and had practically the same output, but the 6F6 had a slight edge in the matter of frequency shift when the plate circuit was tuned through resonance. The 6AG7 was good in this respect, but was rejected because of its greater tendency to microphonics. The 6AG7 was used for the crystal oscillator, however, because of its low output capacitance, it being desirable to keep the total capacity across the common oscillator plate circuit to the lowest possible value.

The same tubes were tried in the doubler stage, and again there was little difference in performance, so the 6V6 was used because it is readily available. As the final stage is very easily driven it is unnecessary to push the doubler hard, or to strive for maximum efficiency at any point in order to get adequate drive to operate the final stage at full input. The doubler screen is also supplied from the stabilized source, and input to this stage is about the same as that to the oscillator — namely, about 5 watts, with a plate voltage of 300.

For the final stage, low overall cost and simplicity of design dictated the choice of an 815. An 832 or 829 might have been used, in which case neutralization might have been avoided — and somewhat higher output attained, in the case of the 829 — but neutralization presented no diffi-

culties, and for most v.h.f. workers the considerable difference in cost would not be made up by the slight improvement in performance. An 829 would be a likely selection for tripling to 144 Mc., however.

Mechanical Details

The transmitter is built on a standard 10 × 17 × 3-inch chassis, and all components except tubes, crystal and the final-stage output circuit are mounted below the deck. An experimental model was made using a 7-inch chassis, but much better circuit layout and accessibility were obtained with the larger base used in the final model.

Viewing the unit from the top front, the microphone transformer and 6SA7 reactance modulator are at the right front, with the VR-150 at the rear, adjacent to the antenna coupling assembly. The crystal, crystal oscillator, and v.f.o. are grouped near the middle of the chassis, with the doubler and final tubes at the left.

The front panel is a standard 8¾ × 19-inch crackle-finished masonite unit. The v.f.o. tuning dial is centrally placed, with the oscillator and doubler tuning condensers at the left, and the a.m./f.m. switch and deviation control at the right. The final plate tuning knob is above the v.f.o. dial, at the left, and the swinging-link adjustment at the right. Jacks, from left to right, are *J*₄, *J*₃, *J*₂ and *J*₁.

R.f. wiring is of No. 16 and 18 tinned wire, with other circuits being wired with No. 18 "push-back." Needless to say, r.f. leads should be made as short and direct as possible, though the balance of the wiring may be arranged for neatness.

Two wires may be seen protruding through the chassis close to the 815. These are neutralizing "condensers," labeled *C*_{n1} and *C*_{n2} on the schematic diagram. They consist of two pieces of No. 14 enameled wire, soldered to the grid prongs of the 815 socket, crossed under the chassis, and brought through the chassis and held in position by two small isolantite feed-through bushings (Millen 32150).

Tuning Up

Adjustment is simple and straightforward. The tuning range of the v.f.o. should be checked first. This may be done with only the two oscillator tubes in place, and the a.m./f.m. switch on the v.f.o. position. The oscillator plate condenser should be tuned for maximum r.f. indication in a neon bulb adjacent to L_2 , and the frequency checked in a receiver having a fairly accurate calibration for the region around 12, 24, or 48 Mc.

The size of the v.f.o. grid coil, L_1 , is extremely critical, and if some pruning of this coil is to be avoided it would be advisable to make the 50- μ fd. section of C_{10} an adjustable padder condenser, such as a Hammarlund APC-50, which can then be adjusted until 12 Mc. appears at about 90 on the v.f.o. vernier dial. The high-frequency limit, 13.5 Mc., should then come at approximately 10, giving a spread of about 18 divisions for the 144-Mc. band and 54 divisions for the 50-Mc. band.

Operation of the crystal oscillator may next be checked. With a 100-ma. meter inserted in J_2 , and the a.m./f.m. switch on the "crystal" position, adjust the crystal-oscillator cathode tuning, C_6 , until the current dips sharply, indicating oscillation. This control should be set at the point which gives the lowest cathode current consistent with easy crystal starting. Cathode current should be similar for both oscillators — about 20 ma.

The doubler stage may then be tested by installing the 6V6 and 815 tubes, leaving the plate power off the 815. A meter having a 10-ma. range should be used to measure the grid current in the 815, at J_3 . The current should come up to about 6 ma. when the spacing between L_3 and L_4 is optimum, though this is more than is actually needed for satisfactory operation of the 815.

Next the position of the neutralizing wires can be adjusted. The 815 plate tuning condenser, C_{20} , should be rotated slowly, meanwhile watching the grid current for any variation. The position of the neutralizing wires should be adjusted until there is no sign of fluctuation in grid current as the tuning condenser is rotated. A length of wire extending about one inch above the metal ring on the 815, at a position about $\frac{1}{8}$ inch from the glass envelope, should be sufficient. If this should be inadequate, small tabs of copper or brass can be soldered to the ends of the wires to make additional capacity to the tube plates. These tabs were incorporated in our experimental model, but were removed when the wires alone were found to suffice. The neutralizing capacity, however small, was found to be necessary in both models in order to secure completely stable operation.

Power may then be applied to the 815 plates, while noting the cathode current as indicated on a 200-ma. meter plugged into J_4 . The dip at resonance should bring the current to about 50 ma. with no load. A 25-watt lamp connected

across the swinging link terminals should then give a full-brilliance indication when the link is adjusted for maximum coupling. This is with 500 volts applied, which should be used only after it has been determined that everything is functioning properly. If trouble is encountered, further tests should be made with reduced voltage to avoid damaging the tube.

When the rig is put on the air, the full 500 volts at 150 ma. may be used for f.m. or c.w. operation. For plate modulation, the voltage should be reduced to about 400 for maximum tube life, even though the tube plates may show no color at the higher voltage.

For frequency modulation, the 6SA7 reactance modulator provides the simplest possible means of obtaining the desired swing in frequency. It may be operated with a single-button microphone plugged into J_1 , or the modulator may be driven from a speech amplifier and crystal or dynamic-microphone set-up which most amateur 'phone stations will have on hand. The output of the speech amplifier should then be connected to the high end of the potentiometer, R_1 . In either case, R_1 serves as a deviation control, the swing being adjusted to suit the receiver at the station being worked.

Post Mortem

The experimental model made provision for the use of a parallel line in the final plate circuit, and though it was finally discarded in favor of the coil-and-condenser tank circuit shown, some observations made of the performance of various lines may be of interest here. The first line was made of $\frac{1}{4}$ -inch copper tubing 28 inches long, spaced one inch between centers. To conserve space, the line was folded back on itself, the radius at the bend being about $1\frac{1}{2}$ inches. Tuning this line with a small capacity tapped down about one-third of the length of the line from the hot end, the minimum cathode current was found to be 56 ma. Substituting the coil and condenser shown in the photographs brought the minimum current down to 46 ma. Checking the output by means of a lamp load and an exposure meter, it was found that a given amount of output which was obtained with a current of 85 ma. with the line required only 77 ma. when the conventional tank circuit was used. Straight and folded lines of several conductor sizes were tried and some improvement was noted when straight lines of smaller conductor sizes were used, but the difficulty of supporting such lines ruled them out.

The coil-condenser tank had another advantage which was important; it permitted the use of a swinging link which could be controlled from the front panel. When using f.m. or c.w., the 815 may be operated at full rating. When shifting to a.m. it is desirable to reduce the input slightly. The swinging link is also useful as an excitation adjustment, in case the unit is used as an exciter for a high-powered final. No reaching around in back of the rack is required for any adjustment — an important safety consideration.

A Four-Tube Superheterodyne for 144 Mc.

Some Design Considerations in V.H.F. Receivers

BY BYRON GOODMAN,* WIJPE

Here is a high-performance superheterodyne for 144 Mc. that will give anyone a good start on the band. It uses the 6J6 miniature twin triode as mixer and oscillator, and it features a simple tuning system that allows high *L-to-C* ratios at this frequency.

A SUPERREGENERATIVE receiver is often quite satisfactory for v.h.f. operation, but it suffers from certain inherent disadvantages that can only be overcome by a superheterodyne type. It suffers from antenna loading effects which necessitate resetting of the regeneration control while tuning over the band, it is lacking in selectivity to such a degree that it is almost hopeless in a crowded band (this lack of selectivity increases with frequency), and its radiation is a serious source of QRM to other stations up to several miles away. On the other hand, the superheterodyne using a superregenerative second detector requires no resetting of the regeneration control as the band is covered, it is more selective because the superregenerative detector is on a lower frequency, and the radiation is reduced to such a low value that no QRM results unless several receivers are operating in the same room. If suitable tubes are used, the superheterodyne will pick up any signal a straight superregenerative receiver will, and will do it with considerably more convenience and certainty. Any argument that "a superhet is too selective for many modulated oscillators" is only a confession that a lot of modulated oscillators are too broad to be on the air, since a superregenerative second detector at 25 Mc. (where they are often operated) is better than 200 kc. wide at -3 db. points.

During the war many new types of miniature receiving tubes were introduced. Most of these have advantages over the larger tubes at high frequencies and they will undoubtedly find their way into a considerable portion of the future gear built for 50 Mc. and above.

* Assistant Technical Editor.

◆
The four-tube 144-Mc. superheterodyne, dressed up in a modern cabinet. The large dial is oscillator tuning, and the small dial and lock is for mixer tuning. The two knobs control regeneration (right) and volume (left).

The 6J6, a miniature twin triode, looked like a natural for a mixer-oscillator combination for a 144-Mc. superheterodyne, and the receiver described on these pages was built around that tube. If an r.f. stage had been planned, a different type of tube might have been used for the mixer, but in any superhet with no preselection the best signal-to-noise ratio is obtained with a triode mixer. The 6J6 has a higher transconductance (5300 μ mhos) than any other suitable triode and appears to be the best mixer available at the present time.

The Circuit

There is little to be gained by using anything but conventional tubes in the second detector and audio circuits because the signal-to-noise ratio, once established in the input circuit, is not affected if the input stage has sufficient gain. Therefore the circuit, shown in Fig. 1, consists of a 6J6 mixer-oscillator, a 6J5 superregenerative second detector at 25 Mc., a 6J5 audio stage and a 6F6 output stage. No coupling is shown between the mixer and oscillator because the capacity between grid pins on the tube socket gives adequate oscillator injection. Since the 6J6 has a common cathode connection, it is necessary to return the grid of the oscillator portion to cathode, and the grid of the mixer is returned to ground through R_1 . It might appear at first glance that the mixer is degenerative through R_2 , but examination of the circuit will show that no signal current flows through R_2 because all r.f.

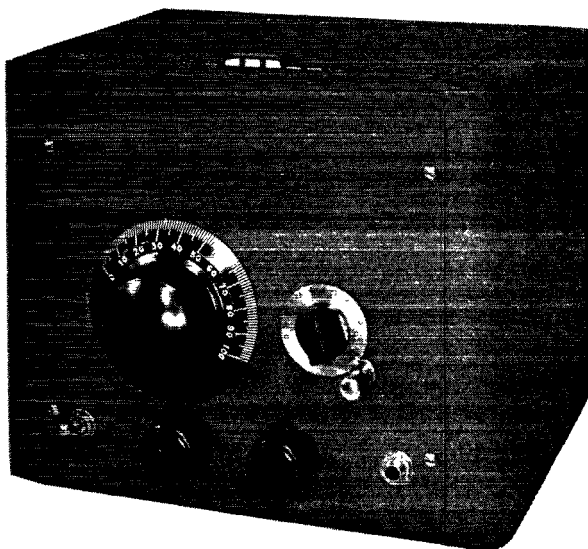

returns are made directly to the cathode. The mixer plate is by-passed for signal frequency by C_4 , which also serves to tune the primary, L_4 , of the i.f. transformer. The i.f. transformer is adjustable only in the secondary circuit, since with just one stage there is no tuning requirement other than that the primary and secondary be tuned to the same frequency. If the adjustable condenser were placed in the primary side — which could be done so far as i.f. is concerned — it would not have been physically possible to have so short a return from the mixer plate to cathode for signal and oscillator frequencies. Regeneration in the superregenerative second detector is controlled by R_7 , and this stage is resistance-coupled to the audio amplifier. Audio gain is adjusted by R_9 , and the headphone output can be obtained from J_1 . A switch, S_1 , removes the plate voltage from the second detector and following stages during transmission periods, but plate voltage is left on the oscillator (and mixer) to avoid drift. This is probably an unnecessary refinement, since the local oscillator only drifts 6 or 7 kc. when the plate power is first applied. Most transmitters encountered will drift that much or more.

The circuit diagram shows that inductive tuning of the oscillator and mixer circuits is used, and

a word or two is in order as to why we went to this trouble when variable condensers are still available. At low frequencies, leads an inch or two long have negligible reactance and their length is relatively unimportant. However, above 100 Mc. it is almost impossible to get a true lumped circuit of inductance and capacitance between grid and cathode — or grid and plate, in the case of an oscillator — by using a conventional coil and variable condenser, because the reactance of the leads from the variable condenser to the tube becomes high and, further, the tank capacitance is divided between the variable capacitor and the interelectrode capacitance of the tube. The obvious solution is to lump the capacitance across the socket, but this becomes awkward constructionally if a variable condenser is used, so we go to a fixed capacitance and a variable inductance. The inductance is varied by moving a copper vane which acts as a low-resistance shorted turn in the field of the coil. As the vane is moved into the field, the inductance is reduced. No current flows through the insulated shaft supporting the vane, and consequently there is no "jumping" of frequency such as is caused by erratic contact to a condenser rotor. Actually the performance of the oscillator tuning surpassed our expectations, since

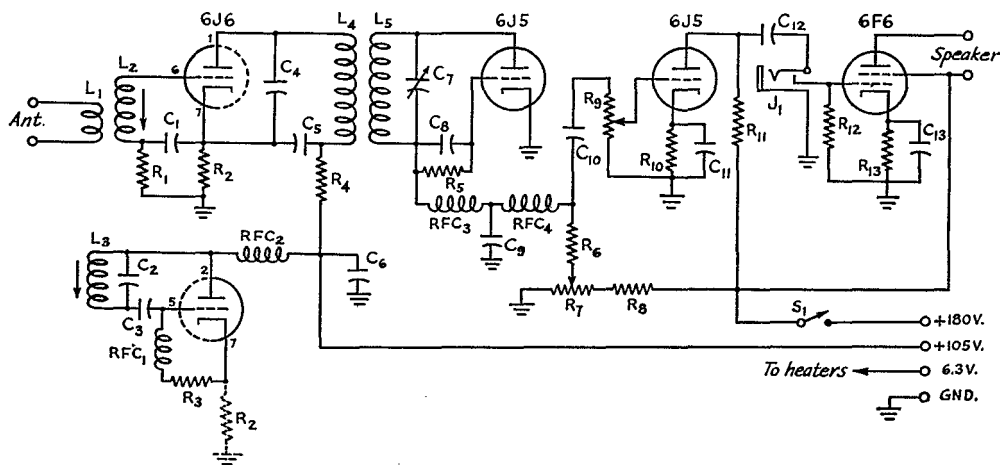

Fig. 1 — Wiring diagram of the 144-Mc. superheterodyne.

- C_1 — 250- μ fd. mica.
- C_2 — 40- μ fd. silver mica (two 20- μ fd. silver mica in parallel).
- C_3, C_4 — 10- μ fd. mica.
- C_5 — 500- μ fd. mica.
- C_6, C_8 — 100- μ fd. mica.
- C_7 — 4 — 20- μ fd. adjustable ceramic trimmer (Centralab or Erie).
- C_9 — 0.002- μ fd. mica.
- C_{10} — 0.01- μ fd. 400-volt paper.
- C_{11}, C_{13} — 25- μ fd. 25-volt electrolytic.
- C_{12} — 0.1- μ fd. 400-volt paper.
- J_1 — Closed circuit telephone jack.
- L_1 — 2 turns No. 12 enam., 1-inch diam., spaced wire diameter.
- L_2 — 2 turns No. 12 enam., 1 $\frac{1}{8}$ -inch diam., spaced twice wire diameter.
- L_3 — 2 turns No. 12 enam., 1 $\frac{1}{8}$ -inch diam., spaced to occupy $\frac{1}{8}$ inch.
- L_4 — 16 turns No. 22 enam., close-wound on 9/16-inch diam. form.

- L_5 — 10 turns No. 22 enam., close-wound on same form as L_4 and spaced $\frac{1}{2}$ inch from L_4 .
- R_1 — 0.25 megohm, $\frac{1}{2}$ -watt.
- R_2 — 50 ohms, $\frac{1}{2}$ -watt.
- R_3 — 7500 ohms, $\frac{1}{2}$ -watt.
- R_4 — 1000 ohms, $\frac{1}{2}$ -watt.
- R_5 — 5.0 megohms, $\frac{1}{2}$ -watt.
- R_6 — 75,000 ohms, $\frac{1}{2}$ -watt.
- R_7 — 50,000-ohm 2-watt potentiometer, preferably wire-wound.
- R_8 — 50,000 ohms, 1-watt.
- R_9 — 0.5-megohm volume control.
- R_{10} — 2500 ohms, $\frac{1}{2}$ -watt.
- R_{11}, R_{12} — 0.1 megohm, $\frac{1}{2}$ -watt.
- R_{13} — 500 ohms, 1-watt.
- RFC_1 — 21 turns No. 22 enam., close-wound on $\frac{1}{4}$ -inch diam. form. See text.
- RFC_2 — 48 turns No. 22 enam., close-wound on $\frac{1}{4}$ -inch diam. form. See text.
- RFC_3 — One pie from 4-pie 2.5-mh. choke. See text.
- RFC_4 — 80-mh. iron-core r.f. choke (Meissner 19-6846).
- S_1 — S.p.s.t. toggle switch.

A top view of the receiver shows the construction of the inductive-tuning devices used in the oscillator and mixer circuits. The tubes along the back, from left to right, are superregenerative second detector, audio and output.

we were able to tune it in and out of zero beat while listening to the oscillator on a v.h.f. communications receiver with an ease and precision comparable to good 7-Mc. performance. If we ever build a communications receiver for 144-Mc. c.w. reception, a similar tuning device will most certainly be used.

When the receiver was first wired, the oscillator plate choke, RFC_2 , was connected to the grid side of L_2 and the oscillator output was erratic and low. Looking up the 6J6 interelectrode capacitances, it was found that the plate-to-cathode capacitance was only 18 per cent of the grid-to-cathode capacitance. Since the oscillator circuit is actually a Colpitts which uses these capacitances for voltage division (and thus excitation control), the plate-to-cathode capacitance was increased by connecting RFC_2 to the plate side of L_2 . The result was a perfectly rational oscillator, and we relate this experience as a tip for experimenters trying new tubes for the first time in old circuits.

Construction

The receiver is built to mount in an 8 by 10 by 8-inch cabinet, but the cabinet is a refinement that is not absolutely necessary. The panel, part of the standard cabinet, measures 8 by 8 inches. The chassis was bent out of $\frac{1}{8}$ -inch aluminum and is $6\frac{1}{4}$ inches wide and 7 inches deep. A $2\frac{1}{2}$ -inch lip is bent down at the rear and a $1\frac{3}{4}$ -inch lip is formed at the front. The front bend is made shorter to avoid the lip at the bottom of the cabinet. The chassis is held to the panel by the two potentiometers (regeneration and volume controls) while a $\frac{3}{8}$ -inch square dural bar bolted to the edge of the $2\frac{1}{2}$ -inch lip picks up two screws through the bottom of the cabinet to give a rigid structure.

Black bakelite sockets were used for the audio tubes and a mica-filled bakelite socket was used for the superregenerative detector, just in case there is any difference in performance. The miniature tube socket is the ceramic one made by Eby and others and is heartily recommended over any other type for v.h.f. work. A metal shield to match the socket also acts as a tube lock. The socket is mounted with the No. 5 pin towards the panel. Devising a suitable mounting for the mixer, antenna and oscillator coils bothered us for a while until we picked up some National FWA binding posts and mounted them in National XP-6 polystyrene buttons. These allow the coils to be changed readily for experimental and band-changing purposes. The antenna and loud-

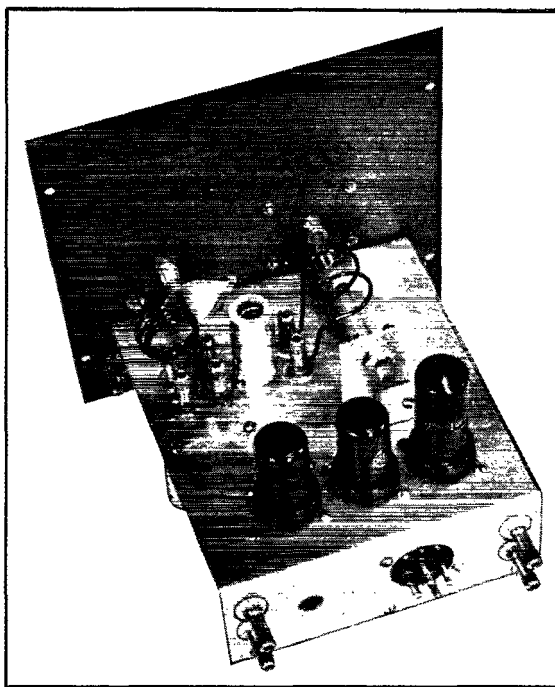

speaker leads are brought out to similar posts at the rear of the chassis.

The $\frac{1}{4}$ -inch diameter polystyrene rod used for the oscillator tuning vane shaft is supported at the panel end by the National A dial and at the other by a panel bushing mounted in an aluminum bracket. A friction dial of some kind should be used because the tuning vane is not mechanically balanced. The vane is made of a piece of thin copper soldered to a brass shaft coupling. After soldering the vane to the coupling, the copper was cut roughly in the form of a straight-line-wave-length condenser rotor plate. It was trimmed up later to give something resembling straight-line-frequency tuning, but this is hardly essential. By moving the vane closer to the coil the tuning range can be increased, and vice versa. The tuning vane for the mixer coil is fastened to a piece of $\frac{1}{8}$ -inch polystyrene by small machine screws and nuts, and the poly is fastened to a shaft which is filed flat on one side and tapped for two 6-32 screws. The shaft is part of an ICA No. 1248 panel bearing assembly. A Millen 10050 dial lock working against the small metal dial prevents any undesired change in the position of the mixer tuning vane.

Small bakelite forms for winding r.f. chokes are being made but were not available in the local radio stores at the time of writing, so RFC_1 and RFC_2 were wound on $\frac{1}{4}$ -inch diameter 1-megohm resistors. A small notch was filed at each end of the resistor to keep the wire in place, and the wire for the chokes was soldered to the leads of the resistor. A 1-watt size was used for RFC_1 , and a 2-watt size for RFC_2 . RFC_3 was made by mounting a single pie from a 2.5-mh. 4-pie r.f.

choke on a 1-megohm 1-watt resistor similar to that used for RFC_1 . This may seem like a waste of a good 2.5-mh. choke, but when you consider that you get four good 25-Mc. chokes for the price of one choke and four resistors, it isn't too bad. The easiest way to remove the pies from the ceramic form on which they come is to melt the metal from one end of the choke with a hot soldering iron and then force a sharp ice pick or nail down the hole in the center of the ceramic form until the ceramic splits. The pies can then be removed and one mounted on the resistor with Duco cement.

The i.f. transformer is wound on a National PRE-3 polystyrene form. Two additional small holes, 90 degrees apart, are drilled in the form between the two windings, and one lead of C_5 is snaked through to furnish a support for one end of the condenser as well as a tie point for one end of L_4 and the isolating resistor R_4 .

In wiring the receiver, it is convenient to wire the heater circuits first. On the metal tubes, pins Nos. 1 and 2 are grounded to lugs fastened under the screws holding the sockets to the chassis. On the miniature socket a jumper goes from pin No. 4 to the central shield of the socket and thence to a lug under one of the screws fastening the socket to the chassis, on the pin No. 7 side. Some care should be taken in wiring the r.f. components on the miniature socket, to insure short leads. One side of R_2 , R_3 , C_4 , C_5 and C_1 go directly to pin No. 7. C_2 (two condensers in parallel) mounts between pin No. 2 and the binding post supporting the grid side of L_3 , and C_3 is mounted from this post to pin No. 5. C_6 , C_9 and R_1 return to the ground lug for the 6J6 heater circuit mentioned

above. A small tie point is used at the junction of RFC_1 and R_3 .

The two wires from the antenna binding posts to the posts supporting the antenna coil are No. 14 enameled, and further support is given them by running them through holes in a PRE-3 form.

Adjustment

Checking of the receiver is best done by starting at the output and working toward the input. Connect heater voltage and high voltage to check the superregenerative detector operation. With a speaker or headset connected, advancing the regeneration control should result in the familiar superregenerative hiss provided the volume control isn't turned full off! At this point the 105 volts for the mixer and oscillator can be connected, because the adjustment on C_7 should be made with plate voltage on the mixer. With the regeneration control only slightly beyond the point where the hiss starts to be heard, adjust C_7 for the point which requires maximum advancing of R_7 for oscillation. This brings L_5C_7 into resonance with L_4C_4 . If it is found that the second detector won't oscillate at one very sharp setting of C_7 , the coupling between L_4 and L_5 is too tight. In this event the coils should be backed away from each other, if possible, or else C_7 can be detuned slightly. The former procedure is preferable. In any event, the setting of C_7 where the primary circuit pulls the detector out of oscillation should be quite sharp — if it isn't, the setting isn't right. When the detector is oscillating and C_7 is not set properly, it is quite likely that the hiss will also contain some unpleasant high-frequency whistles. These give another indication

of mistuning (actually they indicate too light loading on the detector) but will clear up when primary and secondary are in resonance. The exact frequency of the i.f. can be checked on a calibrated communications-frequency receiver, if desired, but a frequency check is not essential. With the constants given the i.f. will be around 25 Mc.

Knowing the i.f. makes it a bit easier to adjust the oscillator portion of the 6J6, because an absorption wavemeter or Lecher wires can be used to put the oscillator on the right frequency. If one knows the i.f. and has some means of checking the oscillator frequency, the oscillator can be adjusted to give a tuning

(Concluded on page 108)



A view underneath the chassis, showing the arrangement of parts. Note the ceramic trimmer condenser between the second detector socket and the i.f. transformer. This trimmer condenser is adjustable from above the chassis. To the left of the ceramic condenser can be seen RFC_3 , the single-pie r.f. choke.

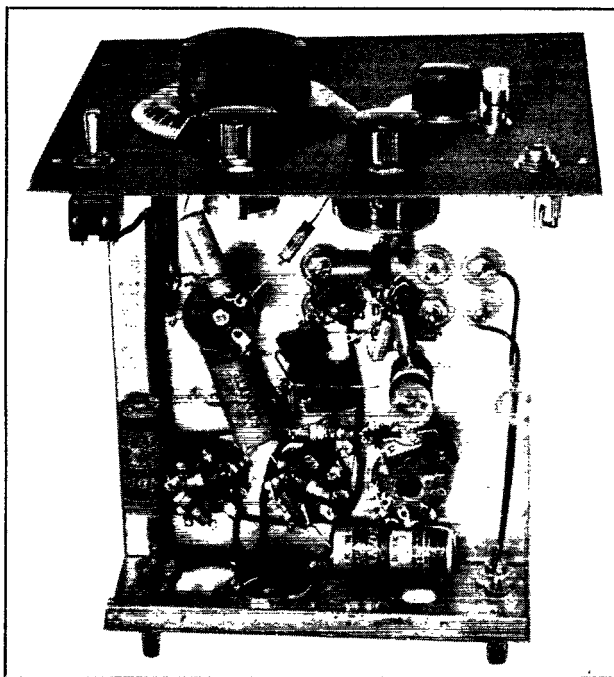

A 21-Tube All-Purpose Receiver

Combining High Fidelity and Single-Signal Selectivity

BY JOSEPH MARSHALL*

I SUPPOSE most of us suffer, or enjoy, it is sometimes difficult to tell which, some sort of obsession about our radio gear. For some this may take the form of convenience of operation, such as single-dial control of transmitters; for others it may be antenna efficiency; for still others it may be pushing the DX communications spectrum higher and higher into the kilomegacycles. Such concentration along defined lines is undoubtedly a strong force in the progress of the art, for it

drives us to a more intense effort which often leads toward an approximation of ideals which might otherwise appear to be unattainable. In my case, the obsession has taken the form of a receiver which combines the signal "getability" of a first-class communi-

cations receiver with the fidelity of a really first-class broadcast receiver. This stems most immediately, I suppose, from the simple fact that the family purse would find it somewhat difficult to sustain the cost of two high-grade receivers, say an HRO or Super-Pro for ham use, and a Scott or Stromberg-Carlson for music. But I believe also that it arises from the innate sense of economy of means shared by most hams who dislike the use of two instruments or tools when one could do the job.

Now at first thought the ideal represented by this objective appears to be incapable of anything but a remote approximation. The characteristics of a receiver for communications purposes and those of a receiver for high-fidelity broadcast reception are not only different but in several aspects diametrically opposed. It would seem that at best one could attain only a compromise which would perform with some adequacy in both fields but which would not be so good in either field as a receiver designed for maximum performance in that field. Although formerly I accepted this generally-held belief, I no longer do so. I believe it is perfectly possible to design a receiver which will do as good a job in both fields as the best receivers available will do in either field. It goes without saying that such a receiver may involve a good deal of complication but not

sufficiently more above that required for a top-notch communications receiver to incur a handicap. The receiver shown in the photographs is an example of what can be done along the proposed lines.

In this particular receiver I have compromised somewhat for the simple reason that priority-free junk boxes would not yield quite the necessary stuff to reach the ideal and because, so far as I was concerned, a full solution was not practically justifiable. However, the basic design is there and it would take only minor changes to come close enough to a complete solution so that argument could be reduced to mere abstract quibbling. Moreover, the receiver involves elements which are not found in commercial receivers and which present important performance improvements over the commercial jobs.

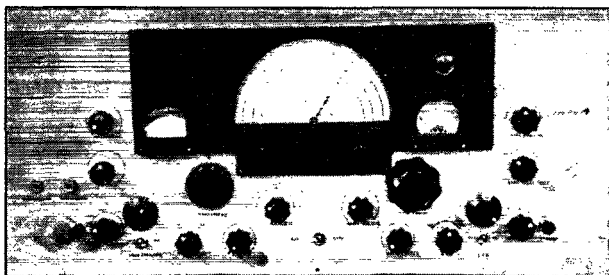

Control panel of the 21-tube receiver. It is made of Presdwood covered with pine-panelling wallpaper to match the walls of the operating room. The escutcheons are of crystalline-finished Presdwood, coated with India ink.

Tube Line-Up

A total of 21 tubes is employed. However, since three of them are double triodes, actually there are 24 tube circuits, including the rectifiers. By a coincidence there are also 24 controls and switches. That's a lot of tubes and switches admittedly, and the complication is justified only by the fact that this is a good deal more than just a receiver, for it provides mike, phonograph and recording facilities as well. Also, it is designed for the highest possible performance. In any case the receiver is not intended for the use of the kids in the family — nor the XYL either, for that matter.

Here is the tube line-up as shown in the circuit diagram of Fig. 1: 1852 r.f. amplifier, 6SA7 converter, 1851 h.f. oscillator, two 6S7Gs as i.f. amplifiers, 6B8 meter tube and a.v.c., 6F8G detector and b.f.o., 6T7G noise limiter, 6F5 squeelch, 6L5G radio pre-amplifier, 6B8 mike pre-amplifier, 6F8G mike-phonograph mixer, 6L5G tone control and bridging amplifier, 6F8G driver, two 45s as loudspeaker amplifiers, 6L5G recording pre-amplifier, 6V6G recording amplifier, VR150 voltage regulator, 5U4G and 6W4G rectifiers.

The controls are: r.f. trimmer, converter trimmer, main tuning, bandspread tuning, band-switch, r.f. regeneration, i.f. gain, i.f. selectivity,

*The Bleachers, Ozone, Tenn.

crystal phasing, crystal selectivity, a.v.c. switch, noise limiter, b.f.o. switch, stand-by switch, squeelch switch, tone selector, tone control, recorder on-off switch, phono volume, radio volume, mike volume, meter adjuster, loudspeaker on-off and main power switches.

H.F. Circuits

For purposes of description and analysis, the receiver may be broken down into two parts, namely, the tuner, and the audio amplifier. The tuner probably is of greatest interest and widest application; moreover it contains the most novel features — some of them not found in any other receiver so far as I know. Hence it will be taken up in greatest detail. Before proceeding with that, however, I should like to point out that the complete receiver in every detail is out of the junk-box. Not a single new part was purchased. The foundation was the coil assembly; the i.f. transformers and the Varitone transformer were taken out of the receiver which has served us for the past eight years. The chassis base and tube shields, one power pack and amplifier, as well as many small parts and hardware came out of a 1932 Scott receiver. The remainder was salvaged from various old receivers and the workshop junkboxes which, through the years, have accumulated a little of everything. Many parts were fabricated on the spot, even the dial scales, the tuning drives, escutcheons, cabinet, panel, and many other parts. The project from design on paper to final tuning up kept me occupied for several months; the actual construction alone consumed the better part of a week, working full time. There were moments when the casual bystander might have marvelled that anyone could call such a process fun!

Most of the problems in a design like this, lie in the r.f. and i.f. ends. There is no difficulty, relatively speaking, in designing an audio amplifier capable of any degree of fidelity desired. So far as the audio end is concerned, the only thing neces-

sary for communications reception, which a high-fidelity amplifier does not offer, is some means of providing, when needed, a narrow pass band which will favor the voice or beat note at the expense of static, heterodynes and other noise elements. This can be provided by incorporating some sort of filter which can be switched in as necessary. There are numerous such circuits available, including the one employed here.

The r.f. and i.f. sections are something else again, for it is here that the conflicts between the demands of communications selectivity and of high-fidelity are greatest. The simplest adequate way of treating an r.f. end for the combined needs of fidelity, and "getability," would be that employed in the SX28 and SX32 in which a single r.f. stage is provided on the broadcast band, where sideband cutting is most serious, and two stages are used on the high-frequency bands where sensitivity and image rejection are most needed. The fanciest method would be that of the Scott receivers where the r.f. stage selectivity is variable.

Unfortunately, neither method was available to me. The best r.f. unit I could find was the Meissner five-band coil assembly in my old receiver which uses only one r.f. stage. There was nothing to do but to hop it up by various means to serve the purpose. A homemade bandspread condenser was added. To improve the image rejection, the r.f. stage was made slightly regenerative by the simple expedient of by-passing the complete cathode resistor, and by putting the leads from the bandspread condenser to the main condenser in such proximity that at maximum gain a little feedback was introduced. This is controlled by the variable cathode resistor, R_1 . As is well known, regeneration provides image rejection about equivalent to that of an extra r.f. stage.

Almost equally important was the incorporation of panel-controlled trimmers, C_3 in the r.f. circuits so that tracking could be adjusted at any

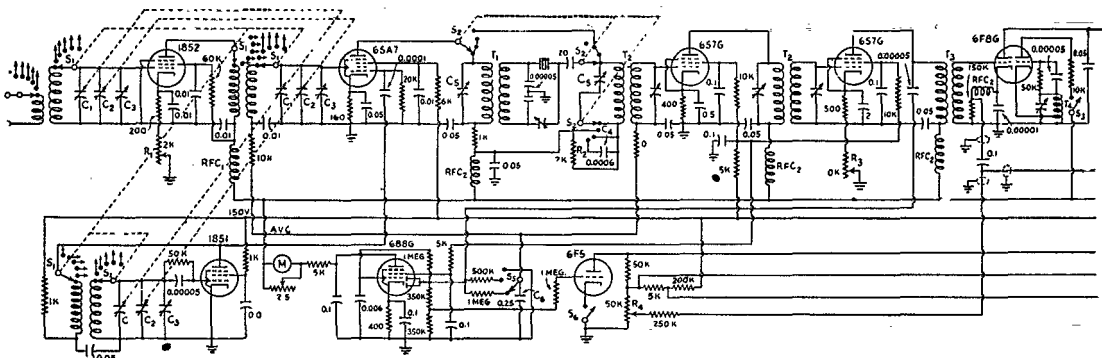

Fig. 1 — Circuit diagram of the 21-tube receiver.

- | | |
|--|---|
| C_1 — Ganged main tuning condensers. | R_2 — Selectivity-control resistor. |
| C_2 — Ganged bandspread condensers. | R_3 — I.f. gain control. |
| C_3 — Air trimmers. | R_4 — Noise-limiter threshold control. |
| C_4 — Selectivity-control condenser. | L — Audio coupling choke. |
| C_5 — Crystal-filter input-transformer tuning condenser. | S_1 — Section of band switch (28 to 0.5 Mc.). |
| C_6 — A.v.c. time-constant condenser. | S_2 — Section of selectivity switch. |
| R_1 — R.f. gain control. | S_3 — B.f.o. switch. |

point in the tuning range. This combination has resulted in thoroughly satisfactory image suppression. There is no significant image interference below 10 Mc. Above that to 20 Mc., regeneration and exact tracking reduce it to a degree which provides little actual annoyance. Above 20 Mc., with an i.f. of 450 kc., there is no good solution, except a separate converter with a high i.f. The regeneration has some disadvantages, but the total result is r.f. sensitivity and image rejection about as good as that of any commercial receiver I've tried.

The bandsread condenser was fashioned from one of the gang condensers in the old Scott by removing plates until only one stator and one rotor plate remained. The bandsread provided is considerably better than recommended in the *Handbook*. Besides the calibrated scale, there is a 0-100 scale on the bandsread knob, which revolves four times for each bandsread range, thus providing 400 points in each range. The combination of main scale and index scale provide readability down to 10 kc. or less on the 10-meter band and considerably less on the lower frequencies. The 0-100 dial was contrived by cutting out the "second-hand" scale from the old Meissner dial and gluing it onto the knob. The drive for both condenser gangs is of the fishline type employing parts from the old Scott. The old metal-drum scale foundations are used for pulleys and give a smooth flywheel effect.

Both dials are home calibrated on Bristol board. The big escutcheon is made of crackled Presdwood painted black with India ink which gives a nice crystalline finish. The two square meter escutcheons also are made of Presdwood. The meter actually is an old round-case meter, mounted on the back of the panel, but viewed through the square escutcheon.

The sensitivity of the r.f. end is excellent, not only because of the ability to peak all r.f. channels at any point, but also because of the gain obtained. The 1852 is used without a.v.c. to ob-

tain the greatest signal-noise ratio. The mixer is fed a.v.c. voltage and, since a separate h.f. oscillator tube is employed, there is no instability because of the a.v.c. The d.c. voltage to the oscillator is regulated by the VR150. This and the perhaps equally or more important fact that the cabinet contains no transformers, chokes or output tubes to warm it up (these are constructed as separate external units) result in excellent stability. After the initial warm-up drift, the additional drift is inconsequential. As a consequence, no effort was made to introduce drift correction with negative coefficient condensers.

The I.F. Amplifier

So much for the front end. The real thought and work has gone into the i.f. amplifier which has several quite novel features. To attain variable selectivity and variable fidelity, Hammarlund variable-coupling transformers, T_2 , are used in the first two stages; the third stage has a fixed coupling transformer, T_3 . The three are so matched as to provide a very sharp curve in the maximum-selectivity position and a very nice flat-top in the high-fidelity position. Both i.f. stages may work at full gain. This is possible because of rather heroic methods to prevent oscillation. First of all, all plate leads are fed through coaxial cable. Second, all plate leads have decoupling chokes and so has the detector output. The chokes are in the round cans in the below-chassis view; they came from the Scott receiver. The cans also contain the plate by-pass condensers, so that no opportunity for radiation is provided by condenser leads. All other by-pass condensers are metal-covered bath-tub types taken from the old Scott or other ancient receivers. There was room for them and they provide additional shielding. In the first stage the cathode by-pass is a bathtub-type 0.5- μ fd unit; in the second stage a 2- μ fd. (no decimal point). The first stage runs with a minimum bias of a trifle over 3 volts; the second a trifle under 5 volts.

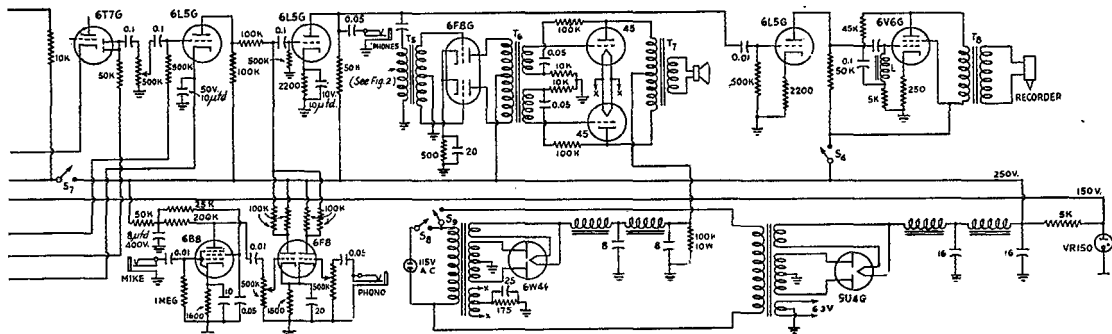

- S₄ — Recorder switch.
- S₅ — A.v.c. switch.
- S₆ — Squelch switch.
- S₇ — Stand-by switch.
- S₈ — Master power switch.
- S₉ — Power switch.
- RFC₁ — 2.5-mh. r.f. choke.
- RFC₂ — 60-mh. r.f. choke.
- T₁ — Crystal-filter input transformer (see text).

- T₂ — Variable-bandwidth i.f. transformer, 465 kc. (Hammarlund).
- T₃ — Fixed-bandwidth i.f. transformer, 465 kc. (Hammarlund).
- T₄ — B.f.o. circuit (see text) (Hammarlund).
- T₅ — Audio-filter transformer (UTC Varitone).
- T₆ — Push-pull plates to push-pull grids.
- T₇ — 5000 ohms to voice coil.
- T₈ — 5000 ohms to 8 ohms.
- M — 0-1 ma. meter.

A.v.c. is applied to only the first stage and the converter because we have no strong signals to contend with here in the mountains and because running the second stage with fixed bias has several advantages. First, modulation rise — a type of distortion which occurs when a tube is operated on the bend of its characteristic — is all but completely eliminated. Second, the a.v.c. action is greatly improved; and lastly, the swing on the S meter is greater. To prevent overloading on strong signals the second stage has a manual gain control, R_3 . In the city or in close proximity to high-power stations, a.v.c. would have to be applied to this stage or the r.f. stage, or both. Fortunately, in our location, it was not necessary.

Crystal Filter

The crystal-filter circuit is somewhat unusual. First, it will be noted that the whole filter circuit can be switched out. There is an excellent reason for this. Fidelity is fully as important in this design as is gain or selectivity. The Hammarlund transformers are balanced to give a very nice flat-top in the high-fidelity position. The addition of the crystal-filter transformers, etc., raises hob with this flat-top. My experiments have proved that this can be corrected only by removing the crystal circuit entirely. Since all of the switching is done at the same r.f. potential and considerable care expended in shielding and placement, there is no instability or loss of gain. In short, fidelity was served at no expense to "getability."

The i.f. transformers provided a range of selectivity from a bandwidth of something less than 5 kc. to over 20 kc. In addition, the crystal-filter selectivity is variable over a wide range and the combination provides any degree of selectivity from about 400 cycles to over 20 kc. The crystal selectivity control, incorporated in S_2 , is a combination of the two best-known methods and is perhaps the simplest of all. Only one switch section is used for this purpose. (It could be applied to almost any receiver with a few cents worth of parts.)

In the first position of S_2 the entire crystal circuit is switched out of the i.f. channel. In the second position, selectivity is broad. This broad response is obtained by inserting a 2000-ohm resistor, R_2 , in series with the output transformer, as in the Hammarlund receivers. In the next position the selectivity is sharp — that of the crystal circuit alone. In the final position, the selectivity is maximum and is obtained by detuning the output circuit by inserting a padding condenser, C_4 , in series with the tuning condenser. (This is the method used in the National receivers except that they detune to the low side by using shunting capacitance.) This arrangement makes possible the greatest possible variation in crystal selectivity. The Hammarlund method permits a decrease of selectivity but not an increase over that of crystal alone; the National an increase but not a decrease, although both obtain a greater range by circuit adjustment. The method used here provides variations in both directions, although full use of it is not made in this receiver.

More switch sections and a choice of resistors and detuning capacitances could provide any desired selectivity from that of the tuned circuits alone to the maximum possible with a crystal filter. I used only three positions because the variable i.f. transformers provide an additional range, and the combination more than adequately meets the need. In the broad crystal position, music can be heard sufficiently well for a degree of enjoyment; in the sharpest position the selectivity is beyond the ability of the tuning controls to tune easily and the trimmers need to be used to tune "on the head."

The circuit has another very considerable virtue. First, no switching is done across the crystal; thus no capacity is added and the phasing range is considerable. More important, the gain of the crystal circuit actually is greater with than without the crystal and this compensates for that psychological apparent reduction in sensitivity with the more conventional crystal circuits. The increase of gain is accounted for by the fact that since the output transformer in the high-fidelity positions is tuned to resonance, it is detuned to the high side when the circuit is switched to the "crystal on" positions because the tube output capacitance and the capacitance of the shielded coaxial cable are removed. It is well known that as the crystal circuit is detuned, especially on the high side, the overall gain increases up to a point. The gain is highest in the medium position, lowest in the broad position. In the maximum position the detuning in this instance does not go beyond the gain-increase point so it too profits. This effect, although not intentional, is the result of fidelity considerations but, of course, it is highly desirable. So here is one case where the high-fidelity needs actually increase communications performance. We'll have more later.

The crystal circuit and its associated components are mounted in a heavy steel box fashioned from parts of the condenser shields of the old Scott and can be seen at the front-right of the chassis view. The input transformer, T_1 , was manufactured from an old Lamb noise-silencer type. Half the turns were removed from the secondary to produce a better match for the crystal impedance. Also the two coils were moved up to within a half inch of each other to provide maximum signal transfer. The primary condenser, C_5 , is an air type from an old i.f. transformer. The switch is a band-switch from a Midwest. If it weren't a shorting type we would have arranged the circuit so that in the crystal positions the lower end of the output transformer would be grounded. This would have provided an increase in selectivity because, as it stands, the power-supply resistance in series has a broadening effect. But you can't very well switch a circuit from high voltage to ground with a shorting-type switch; so we took what we got, which in any case was sufficient for our purposes.

B.F.O. and A.V.C. Circuits

Following the i.f. comes the first 6F8. The top-grid section is used as an infinite-impedance de-

lector for the sake of fidelity. Another means was needed to provide a.v.c. and was found with interesting dividends as we shall see later. Meanwhile, the first dividend comes in the b.f.o. circuit which employs the other section of the tube. The main feature of this b.f.o. is that it can be used with perfect satisfaction *with the a.v.c. on*. The reason is very simple: the b.f.o. voltage is injected after the a.v.c. diode and therefore does not affect it. This is not accomplished, however, simply by putting it there on paper; careful construction was necessary. There is no direct connection between the b.f.o. and the i.f. channel; coupling is effected by the close proximity of the elements within the tube. Since the injection is quite weak this way, the b.f.o. tube operates with almost the full 250 volts on the plate. To make sure that the b.f.o. is not fed to preceding stages, the whole detector and b.f.o. sections are shielded. Even the under side of the tube socket and all of the associated resistors, condensers, etc., are contained in one of the cans from the old Scott chokes. This results in confining the injection to the detector stage. Putting on the b.f.o. makes a barely perceptible motion in the very-sensitive S meter — evidence that there is practically no feedback at all.

The results are extremely worth while as any c.w. operator can appreciate. In practice I never find it necessary to shut off the a.v.c., even on the weakest signals, although there is provision for this. It is said that with a.v.c. on c.w. there is an objectionable increase in background noise between characters. This is true if the a.v.c. action is faster than the interval between characters. But if the a.v.c. action is made slow, so that the character interval is shorter than or equal to the time constant of the a.v.c. system, the a.v.c. action never quite catches up with the signal and there is practically no change in gain and thus no increase in background noise, except on extremely slow fists. Since the receiver provides for a slow action, as well as a fast one as will be seen directly, this nuisance does not occur in this receiver and the operation on c.w. is eminently satisfactory. But it cannot be overstressed that the operation of the circuit depends entirely upon successful shielding of the b.f.o. circuit from previous stages. It isn't too difficult to do at that; in this instance no changes were necessary after the initial installation.

The a.v.c. circuit itself also is unusual. A

separate 6B8 is used and its diodes coupled to the primary of the final i.f. transformer. This results in some loading but less than if it were coupled to the secondary and, at any rate, it is not sufficient to make any appreciable difference in performance. The justification for a separate tube, aside from the b.f.o. benefit described above, is this: it is desirable to disassociate the a.v.c. diode from any tube carrying a.f. or i.f. currents because, if it is not, the diode can feed harmonics of the i.f. into the channel via tube capacities, if nothing else, and this will result in "birdies" on frequencies which are harmonics of the i.f.; i.e. 910, 1365, etc. In a receiver as sensitive as this one, such "birdies" can be very strong and annoying, and their reduction or elimination is well worth the extra tube. In this case the "birdies" are just barely audible at maximum gain at 910 kc. but at no other point. The choke in the detector output leg helps to account for this as well.

A.v.c. is applied only to the mixer and the first i.f. and, in our location, this application is sufficient to give excellent control. A switch, S_5 , provides a means of varying the time constant of the a.v.c. by changing the value of the filter resistor. In the slow position for high fidelity the constant is about 0.3 second; in the fast position, just half of that. It could be made faster by using a condenser of lower value at C_6 , but these constants have worked out very well. The a.v.c. can be removed from the controlled tubes, but it is not removed from the meter tube nor from the squelch, *thus the meter is usable with the a.v.c. off and the squelch likewise.*

The Signal Meter

The pentode section of the 6B8 is used as a

meter amplifier and in effect forms a vacuum-tube voltmeter. Since this tube has an extremely flat plate-grid curve, a meter in its plate circuit permits the use of a much more linear scale than usual. Full advantage of this flatness cannot be taken in the "a.v.c.-on" position because the controlled tubes have bending curves and this

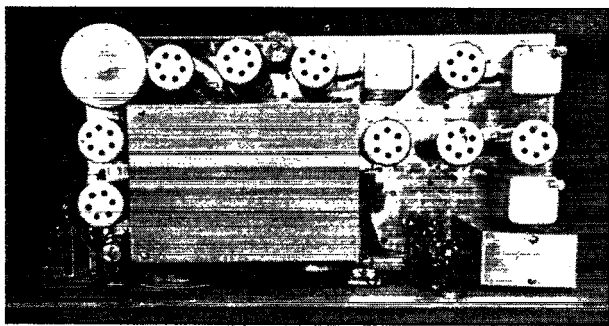

Plan view of the 21-tube superhet. The large compartment contains the h.f. tuning gang, tubes and associated by-pass condensers. The crystal-filter unit is in the lower right-hand corner, while the round shield can in the upper left-hand corner covers the microphone pre-amplifier. The i.f. strip runs along the top and down the right-hand edge of the chassis.

of course is reflected in the receiver gain. However, the meter can be used with a.v.c. off — that is, not applied to i.f. or r.f. tubes. In this position the linear scale can be employed to full advantage, especially on weak signals, and for field-strength measurements.

I suppose the idea of having the meter operate with a.v.c. off will not at first strike one as of

revolutionary benefit. However, it grows on one quickly with use. For instance, it is perfect for aligning the receiver. It is well known that receivers should be aligned at maximum gain — therefore with a.v.c. off. In the usual receiver, cutting off the a.v.c. cuts off the meter as well. Not so here. Moreover, a meter is just as handy for measuring signal strength and for tuning without a.v.c. as it is with a.v.c. Finally, with the linear scale, which is easily calibrated from the tube characteristic curves in the tube manuals or with dry cells, it is possible to give much more accurate signal-strength or field-strength reports with the a.v.c. off. Indeed, with the aid of a calibrated microvolter, the meter and the manual gain could be calibrated directly in microvolts. Not having the facilities I could not do so. However, I have incorporated what I call an "X" scale to render more meaning to field-strength reports. On this scale "0 X" is in the middle. Deviations above are calibrated as "2 X," "3 X," "10 X" etc.; those below in "½ X," "¼ X," etc. The signal to be measured or reported is adjusted with the manual gain until it hits "0 X." Any deviation upward or downward, as with antenna adjustment, can then be reported quite accurately as "2 times as strong," or "half as strong," etc. There is a db. scale also, so readings can be given either in "X" or db.

With the a.v.c. off the meter is extremely sensitive. A 25-microvolt signal produces cut-off. The mere peaking of the trimmer will make a variation of 5 or 6 S points. So the receiver makes an ideal meter for antenna adjustments, harmonic-suppression adjustments, etc.

Noise Limiter and Squelch

Next in the line-up we have a 6T7G used as a series-diode noise limiter. Any other diode or triode connected as a diode would do. I happened to have this and the filament current was conveniently low, so it was used. The circuit is standard and works very well up to the point where the noise is great enough to affect the a.v.c. considerably. Fortunately, in our location this contingency does not arise often so the additional complication of the Lamb type of limiter was not necessary. The arrangement used has the advantage that it operates as well on power-leak type of interference and even natural static, when it is greater than the signal, as it does on ignition interference. There is a manual threshold control, R_4 .

The noise limiter is followed by a squelch circuit. To my mind no ham receiver should be without a squelch. The benefit to the nerves alone is worth several times the cost and trouble of incorporating one in a receiver. A 6F5 is used as a trigger tube controlling the 6L5G radio pre-amplifier. The combination is very sensitive — so sensitive, in fact, that it was found necessary to feed only half the available a.v.c. voltage to the trigger in order to get proper control at maximum gain. The manual i.f. gain control, R_3 , acts as a threshold control and is set so that any signal

above the noise level will trip the squelch. A signal lower than the noise level obviously cannot operate a squelch circuit without tremendously complicated tripping devices. The squelch operates regardless of whether the a.v.c. is on or off. Properly operated, it is a great convenience, not only in cutting interchannel noise, and in break-in operation, but also in other ways. For instance, if two stations are operating on the same frequency intermittently, the squelch can be set to cut in only when the stronger of the two is on.

This completes the tuner section. I believe that so far as it is concerned I have achieved the end of providing both maximum communications performance and maximum fidelity. No sacrifice is made at any point in favor of one or the other. Indeed, as we have seen, the incorporation of elements intended originally to further the fidelity have led to communications-performance improvement. At any rate, the tuner yields the highest quality results for either communications or for high-fidelity listening. In this case, the fidelity is limited to 10 kc. for reasons mentioned later. But it could be extended easily enough to 15 kc. by double-tuning the transformers. Indeed, as it is, a slight amount of double tuning is employed to attain the 10-kc. range, for if single-tuned, the i.f. channel would yield a minimum selectivity of about 8 kc.

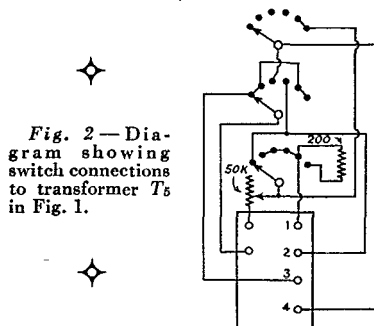

Fig. 2 — Diagram showing switch connections to transformer T_5 in Fig. 1.

Audio Amplifiers

The audio end of the receiver probably is of more interest for p.a. than for ham purposes. However, I shall give a brief description. It starts with a three-stage pre-amplifier, mixer, tone control and bridging amplifier. Phono, radio and mike employ separate channels and are mixed before injection into the 6L5 tone-control and bridging amplifier. The tone-control circuit employs a UTC "Varitone" transformer and a three-deck switch, shown in Fig. 2, for various sorts of equalization and tone-control effects. In the first position, left to right, we have bass boosting; in the second, treble boosting; in the third and fourth, two different forms of both treble and bass boosting; in the fifth we attenuate all but the voice frequencies; and in the last we attenuate all but 1000 cycles for c.w. use. The potentiometer in Fig. 2 allows 20 db. of compensation in each position. The two last are ideal for communications use and result in a tremen-

dous cutting of background noise. Signals can be read which are deep in the noise otherwise, and thus the effective sensitivity of the receiver is increased greatly. The other positions provide various sorts of equalizations for records, recording and the like.

The 20-db. loss through the tone control accounts for the many a.f. stages. It was felt desirable to provide enough gain so that full output could be obtained with full equalization. I have used this tone-control circuit now for eight years and have found it the most versatile I've ever tried. The headphones and recorder benefit from the tone control, although it might seem that they are hooked up ahead of it.

The output of this stage feeds both the loudspeaker amplifier and the recording amplifier, as well as headphones, without interaction. The insertion of the headphones or of the recording amplifier makes no difference in the quality or volume from the loudspeaker. A separate recording amplifier is used because such an arrangement has many advantages. First, it is possible to record without cutting off the loudspeaker. Second, the recording amplifier can be designed specifically for the application and thus given characteristics tailored to the need. Here, for instance, the arrangement is such that when the loudspeaker output is adjusted to give the desired tone quality, the recorder automatically compensates to produce this result on play-back. This is achieved by giving the recording amplifier about 6-db. bass attenuation as compared to the main amplifier. It was found possible to get this result simply by removing the by-pass condensers and by reducing the input-condenser value to 0.01 μ fd. A choke is used in the 6V6 grid because it was available (out of an old GE radio) and also because it provides a simple means of obtaining inverse feedback which, of course, is essential in view of the single-ended beam power stage and the variable load of the recorder. The recording quality is excellent. As a matter of fact, the frequency response with the 6V6 with inverse feedback is better than with 45s without feedback.

The loudspeaker amplifier uses a push-pull driver with a 6F8 and a pair of 45s with inverse feedback operating Class AB. This is the revamped amplifier out of the old Scott. It operates

strictly Class A until the output load is about 6 watts; then it begins to draw grid current and operates AB₂. The inverse feedback, however, aside from correcting for deficiencies in output-transformer response, cuts the distortion to such a degree that about 15 watts is available before distortion is sufficient to be audibly noticeable.

The speaker, an eight-year-old 12-inch Cinaud-graph, is mounted in a partition wall of the house providing a tremendous baffle area. As a result, the low-note response is below 20 cycles (that's where our piano leaves off and I can't measure below that!). The high-frequency response is just below 10,000 cycles. The addition of a "tweeter" would provide complete audio fidelity and its lack accounts for the fact that the receiver does not completely meet the most exacting high-fidelity definitions.

Since I keep the receiver in my study, I dislike metal cabinets. The receiver is well enough shielded not to require one, so it is housed in a wood cabinet to match the room paneling. All controls are calibrated in the commercial manner with pen and ink.

Performance

So much for description. How about the performance? From the fidelity angle, the performance, if not perfect, is entirely adequate to reproduce faithfully all programs received at our location. The overall frequency response is from under 20 cycles to just under 10,000 cycles. Aside from merely arithmetical fidelity, the acoustic fidelity is really excellent. Both voices and music are reproduced with great naturalness and brilliancy.

Some might quibble that unless the high-frequency range is extended to 15,000 cycles the receiver is not truly high fidelity. This, in a receiver designed for a.m. listening, is a pure abstraction. At least in our location no station delivers a signal with that audio range and the expenditure of extra funds and the additional complications necessary to achieve a perfect response would be rather pointless. However, nothing but the cost of higher-quality transformers and speakers stands in the way of attaining such a response.

As for the communications end, the receiver

(Concluded on page 114)

Bottom chassis view of the combination high-fidelity and single-signal receiver. The round cans contain r.f. chokes and by-pass condensers, except for the one at the top center which covers the socket of the detector-b.f.o. tube and all related components. The can in the upper right covers the microphone jack. The single-frequency coil assembly occupies the central compartment.

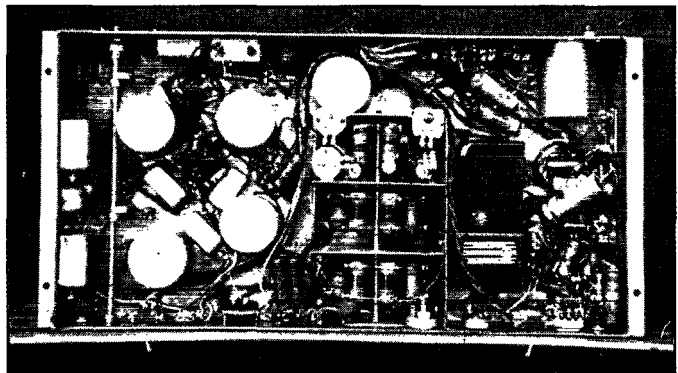

Crystal Control in the New Ham Bands

How to Get to the 144-, 50- and 21-Mc. Bands with 1.75-, 3.5- and 7-Mc. Band Crystals

BY JOHN HOLMBECK,* W0KZO

It is well known by now that the FCC table of proposed amateur frequencies includes some higher-frequency bands which are not in even-harmonic relationship with the lower-frequency bands, and yet they are frequencies at which the use of crystal control may be desirable.

A little meditating and consequent doodling with figures discloses some interesting conclusions which should prove useful to a lot of us in solving frequency-control problems in the proposed new amateur bands around 21 and 144 Mc. Three major problems which have been worked out by the author are those of getting crystal control on the 144-Mc. and 50-Mc. bands and using any crystal in the 7-Mc. band for control in the proposed 21-Mc. band, all making use of crystals now in the 1.75-Mc. band.

The 144-Mc. Band

Since the new 144-Mc. band is not related to our lower-frequency bands by convenient harmonics, crystal control with crystals useful also in other bands looks a little messy, but by applying a little fourth-grade math and some superhet theory, a multitude of solutions and practical possibilities make themselves evident. So let's see what we have.

First, the maximum practical fundamental frequency of most crystal cuts is in the vicinity of 10 to 12 Mc. To obtain a rough estimate of the number of times we must multiply our crystal frequency to hit that band, let's divide 144 by about 10, giving us 14.4. This is not a very convenient number for frequency multiplying but it is very close to 16 which is an ideal number. So, dividing 144 by 16 we get 9 Mc. and by dividing 148 by 16 we get 9.25.

The next problem is that of getting to 9 Mc. with crystals now in other bands without changing their frequencies. By delving into superhet theory we find the statement that if two alternating voltages of different frequencies are applied to a non-linear impedance, the result is not only the two original frequencies but also their sum and difference, and we can select any one of the four we wish by an appropriate tuned circuit. In words of one syllable, this means that if we feed two frequencies into a mixer tube, we can get their sum and difference from the output.

We also want to find a use for those 1.75-Mc. crystals. If we combine the output of a 2-Mc. crystal with that from a 7-Mc. crystal, we can get to 9 Mc. and a 2-Mc. rock combined with a 7250-kc. slab will give us 9.25 Mc. Thus, by means of a couple of quadruplers we can hit the edges of

the 114-Mc. band. Another advantage of a 2-Mc. crystal is that its harmonics are very useful for band-edge spotting. The following list will show examples of a few possible combinations and their results.

Crystal Frequencies	Output Frequency
2000 kc. + 7000 to 7250 kc.	144 to 148 Mc.
1950 kc. + 7050 to 7300 kc.	144 to 148 Mc.
1915 kc. + 7085 to 7300 kc.	144 to 147.44 Mc.
1750 kc. + 7250 to 7300 kc.	144 to 144.8 Mc.

Of course, you can work out plenty of others to suit your own crystals. The block diagram of Fig. 1 may be of some help in getting the idea.

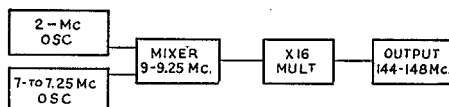

Fig. 1 — Block diagrams showing how 2-Mc. crystals in combination with crystals in the 7-Mc. band may be used to control transmitter output at 144 to 148 Mc.

With these combinations, it is obvious that our 7-Mc. crystals are as useful as ever for 7, 14 and 28 Mc. and, we hope, for the 21-Mc. band. Besides that, our 1.75-Mc. rocks are good for operation in the 3.5- and 7-Mc. bands, which gives us even more possibilities. Two 1.75-Mc. crystals can be used by quadrupling one into the 7-Mc. band before feeding to the mixer and a doubled 3.5-Mc. crystal will do as well. Using two 160-meter crystals, with certain combinations of them, by exchanging their places, another spot in the 144-Mc. range is available.

Excellent frequency stability can be had by using crystals with opposing temperature coefficients, since drift of one may be used to compensate somewhat for the other one. One good combination is an X-cut on 40 (negative temperature coefficient) and a Y-cut on 160 (positive temperature coefficient). Since the cycles-per-degree-per-megacycle drift of a Y-cut often is about four times that of an X-cut, and since the "megacycle" factor of the X-cut is about four times that of the Y, it all cancels out nicely.

50-54 Mc.

Several combinations will give crystal control in the 50-54-Mc. band. For instance, the edges can be reached by using 3.5- and 4-Mc. crystals in conjunction with a 2-Mc. slab. The sums will be 5.5 and 6 Mc. of which the 50- to 54-Mc. band is the 9th harmonic which may be reached by tripling twice. Other combinations are shown in the table on the following page.

* A.P.O. 218, % Postmaster, New York.

Crystal Frequencies	Mixer Output	Multiplication After Mixer	Output Frequencies
7 to 7.3 Mc. - 2 Mc.	5 to 5.3 Mc.	(5) (2)	50 to 53 Mc.
7 to 7.3 Mc. + 1.75 Mc.	8.75 to 9.05 Mc.	(3) (2)	52.5 to 54 Mc.
7 to 7.3 Mc. - 1.75 Mc.	5.25 to 5.55 Mc.	(5) (2)	52.5 to 54 Mc.
7 to 7.3 Mc. - 4 Mc.	3 to 3.3 Mc.	(4) (4)	50 to 53.5 Mc.
7 to 7.3 Mc. + 3.5 Mc.	10.5 to 10.8 Mc.	(5)	53 to 54 Mc.
3.5 to 4 Mc. + 2 Mc.	5.5 to 6 Mc.	(3) (3)	50 to 54 Mc.
3.5 to 4 Mc. - 2 Mc.	1.5 to 2 Mc.	(4) (4) (2)	50 to 54 Mc.

The 21-Mc. Band

Now for using more of our 40-meter rocks in the 21-Mc. band for which we are hoping. By tripling from 40, if the new range is 21 to 21.5, only crystals from 7000 to about 7166 will hit the band, and a lot of us have crystals higher than that. Going back to grammar-school math, we find that if we want to get to the new frequency by quadrupling, we must start between 5250 and 5385. The following table and the block diagram of Fig. 2 will show how it is done a lot faster than verbose rambling.

Crystal Frequencies	Output Frequency
2000 kc. + 7250 to 7300 kc.	21 to 21.2 Mc.
1950 kc. + 7200 to 7300 kc.	21 to 21.4 Mc.
1915 kc. + 7165 to 7300 kc.	21 to 21.5 Mc.
1750 kc. + 7000 to 7135 kc.	21 to 21.5 Mc.

It will be noted that the 1915-kc. crystal is useful in obtaining complete coverage of the 21-Mc. band, and almost complete coverage of the 144-Mc. band as well, when used in conjunction with existing 7-Mc. band crystals. Also, in heterodyning to 21 Mc., use is made of crystals above 7165 kc., while straight tripling makes use of those below 7165 kc.

The proud possessor of a v.f. crystal is in a good spot. If he gets to 21 Mc. by tripling—assuming he can shift 5 kc. at 7 Mc. his shift is 15 kc. at 21 Mc., but if he beats back to 5.25 and quadruples, he can shift 20 kc. Of course with this system, 80 and 160-meter crystals can be used by multiplying down to 40 before feeding to the mixer.

Frequency Modulation

These examples are intended only to give you ideas you can work out in detail yourselves. Another handy use for the heterodyne idea will be in f.m. Here is the reason. At the present time, reactance-tube modulators are the most practical for ham work, and the less deviating the oscillator has to do, the easier it is to keep it linear. So, if we want to get enough deviation in the output frequency, we've got to multiply the output of the oscillator frequency several times. However, since it is also easier to get a given number of kilocycles deviation of the oscillator at the higher frequencies, it is to our advantage to both heterodyne and multiply.

Thus, if we beat the f.m. oscillator with a rock to get a lower frequency and we still do not disturb our deviation, then we can multiply more times to hit a given band. Also by using a crystal which drifts in the same direction as the modulated oscillator, the frequency stability is greatly improved.

This dope is not intended to be the complete story; it's just to remind us of a few practical possibilities of the heterodyne principle. Good use can be made of receiver tubes which are designed to be mixers. Tubes like the 6K8 make good oscillator-mixers, or a 6N7 may be operated, both oscillators feeding into a 6L7 or 6SA7. The use of low power required by these tubes presents the advantage of low crystal current which means less temperature drift. The disadvantage of needing a lot of power amplification and frequency multiplication can be overcome by using the new

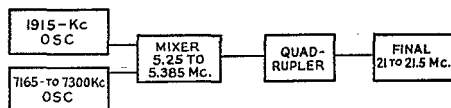

Fig. 2—Diagram showing the heterodyne arrangement which may be used to obtain crystal-controlled output at 21 Mc. from 2- and 7-Mc. crystals. Cutting off the low-frequency oscillator makes the mixer an isolating amplifier for straight-through operation when desired for simple frequency multiplication.

television tubes with their excellent power gains. Coil switching is no difficulty with the small parts permissible, in fact pretuned circuits can be switched right along with the crystals or the use of a Pierce oscillator will save a lot of grief.

There is another point to be welcomed by the c.w.-v.f.o. bug. It is highly undesirable to key a self-excited oscillator, but for break-in work we can't have the oscillator or its harmonics fall on the spot where we want to copy. So if we beat a rock against an e.c.o. we can keep the e.c.o. off the receiver frequency but leave it on and key the crystal oscillator which can be tuned up and almost forgotten. Also the power required by either oscillator is almost nil. A 6K8 is ideal for this; the oscillator section is perfect for crystals, and by putting plenty of bias on the signal grid it need pull no power from the e.c.o.

While crystals whose harmonics fall in the new ham bands undoubtedly will be available to those who wish to construct crystal-controlled equipment, nevertheless it is interesting and useful to know that standard-band crystals may be used, though the new bands may not be in direct harmonic relation to the crystal frequency. This article shows some combinations which may be used to control by the heterodyne method.

Hams in Combat



Mobile with the 5th Armored Division

BY MERTON T. MEADE,* W9KXL

ERASE those pictures of racks of Super-Pros, of neat rhombics and V-beams, of clean-shaven operators in neat uniforms busy with their bugs and mills. We're going out into the shootin' war! We are going to ride with an armored division on the move!

We have become part of Combat Command Team B of the Fifth Armored Division and in this fast moving column one vehicle always catches the eye of any radio man. That's the truck with many antennas and with a power unit trailer bouncing along behind. It's another of those famous SCR-399s.

The vehicular markings show this set to be assigned to the 145th Armored Signal Company. This is a spare set, to be sent where the need is the greatest. Its job is to maintain communications when the higher powered sets fail to get through.

Our vehicle looks out of place moving along between the tanks, scout cars, half-tracks and low-slung "peeps." The 399 looks naked and helpless. But inside, there's a sense of security as the walls deaden much of the noise of travel and

*145th Armored Signal Company, APO 255, c/o P.M., N. Y. C.

of battle. Inside, a radioman feels at home, here he is in familiar territory.

But there is no over-confidence. The dial lights are blacked out, the green and red pilot lights are painted over until only a pin point of light remains. For night operation we throw a switch and automatic switching is in effect. When somebody opens the door, off go all lights, a homemade blackout gadget, simple but effective.

Meet the crew. Up in front are the driver, T/5 Meyer and the crew chief, T/Sgt. Thachuk who also handles the .50 cal. machine gun while on the move. In the insulated shelter at the operating positions there are three men: T/3 Meade, W9KXL, T/5 Mitchell and T/4 Guyber-son, who has only recently joined this crew. This is a veteran and experienced radio crew.

We move out and drive towards Munster. Behind us lies the Rhine and burning and flattened Wesel. Behind us are hundreds of road miles since the break-through at St. Lo. Hundreds of miles and thousands of messages.

We are driving fast and it is impossible to copy messages on the operating table. We put our message book on a copying board held between the left elbow and hand, and attempt to copy as

we sway and bounce with the truck. If necessary, we can use a leg key strapped above our right knee. But we continue to use the fixed table key. We don't hold on to the key but hold our hand slightly above it and swoop down on it with a swift motion born of practice. Occasionally the key eludes us when the traveling is rough and we muffle a character or two. We send solid and heavy.

We come upon the burning city of Munster. A hidden 88, attracted by our antennas, fires almost point blank at us. Jerry took too long a lead and the shell screams by a couple of feet ahead of us. An enemy machine gunner fires low, and misses. We do not tarry long enough to let him correct his range.

The weather is bad but Meyer gets us through many soft spots. We bog down once and a tank pulls us out. We are getting out of the range of most of our protective fighter plane bases. The weather grounds more of our planes and the German planes get bolder and more numerous. The weather is better to the east, where the jerries still fight back.

Communications with the Division Headquarters is becoming poor. At night we are often the only set in the Combat Command in contact with Division. One of the operators who handles our traffic back there at Hq. is T/4 Talty, W9TXO, of Des Moines. His prewar neighbor and buddy, T/3 Silverstein, is also back there operating in the Corps net.

At night, the QRM is terrible but we stick with it. There's a brief chance to switch to voice, but a German jammer soon hits us. But it's the incidental QRM rather than the enemy jamming that gives us the biggest headaches.

We have reached the Wesser. Here we shift to the headquarters net of Combat Command A and we are on the move again.

Past Hannover, past Brunswick, we keep moving most of the time. Our columns weave back and forth, by-passing some resistance points, crushing others. We take "impossible" roads to smash the flanks and rear of the retreating Germans.

QRM has grown worse. Every net in every Army system seems to be operating. The distances are such that at night our weak ground waves must compete with more distant but stronger skywaves. Several times we shift to other nets to clear urgent "must" traffic.

Inside the 399 there's a bedlam of noise. Two receivers are whistling on c.w., and another

carries the f.m. voice net. The clicking of the key and the turning wheels of the cipher machine add to the confusion. Tempers grow short, our eyes are red from lack of sleep. We're awfully tired of "C" and "K" rations. We copy and decode combat traffic and the operators are busy, even on the move. One is operating, another is working with the codes and ciphers, the third man handles f.m. traffic, and acts as a runner on temporary halts. He gives and takes messages from the message-center peeps on the fly. The fourth man handles the .50 caliber machine gun, which speaks out loudly every now and then. German planes are frequent and unwelcome visitors.

When we finally stop for the night we arrange two-man watches and take our turns in getting several hours of sleep. By now we are so accustomed to copying code in an exhausted semi-conscious state that it is often hard to get to sleep. We lie there automatically copying code coming from our vehicle or one of the neighboring half-tracks.

Morning comes and we are on the move again. At Bismark we suddenly are aware of just how deep we have penetrated into Germany. We keep on, competing with the Second Armored Division for the lead in the race for Berlin.

Communication with Division Hq. goes sour, so they send out a relay station. Communications smooth out but the relaying cuts our traffic-carrying capacity in half. The Urgent and Priority traffic is cleared, but the routine stuff piles up. We soon have direct contact again, and as always, our net is busy. We handle much traffic normally routed over other nets. Ours is the only net that can now maintain consistent contact between Division Hq. and the Combat Commands.

We keep moving up. Near the banks of the Elbe River we meet stiff opposition. We stop for an afternoon and put up an extra antenna. Now we clear the hook of that backlog of routine traffic. Out come the small gasoline stoves and water cans. We wash, shave and have some hot coffee. The day is sunny and many planes are buzzing around and they bear swastikas! We are attacked a dozen times but we meet them with a curtain of fire. Six jerries go down in flames. One crashes in the middle of our bivouac, its guns firing to the last. Out of the vast explosion and flames comes one of the large engines bounding over the ground like a giant rubber ball. Miracu-

(Continued on page 114)

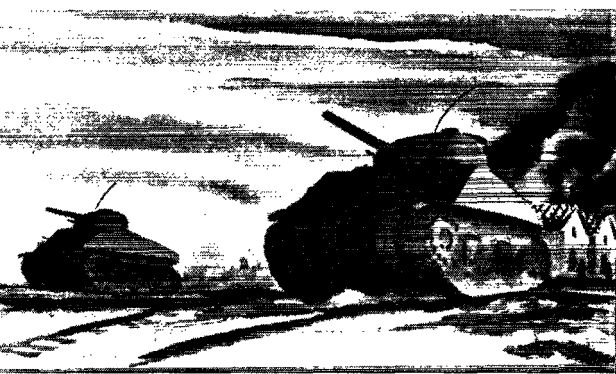

HAPPENINGS OF THE MONTH



ELECTION NOTICE

TO ALL Full Members of the American Radio Relay League residing in the Delta and Midwest Divisions:

You are hereby advised that no eligible candidates for alternate director of your respective divisions were nominated under the recent call. By-Law 21 provides that if no eligible nominee be named, the procedure of soliciting and nominating is to be repeated. Pursuant to that by-law, you are again solicited to name Full Members of your respective divisions as candidate for alternate director thereof. See the original solicitation published at page 23 of August *QST*, page 21 of September *QST*, which remains in full effect except as to dates mentioned therein: Nominating petitions must now be filed at the headquarters office of the League in West Hartford, Conn., by noon EST of the 20th day of December, 1945. Voting will take place between January 1st and February 20, 1946, on ballots to be mailed from the headquarters office the first week of January. The new alternates will take office as quickly as the result of the elections can be determined after February 20, 1946, and will serve for the remainder of the 1946-1947 term. You are urged to take the initiative and file nominating petitions.

For the Board of Directors:

K. B. WARNER,
Secretary

October 1, 1945.

ELECTION RESULTS

This is election year in six ARRL divisions. In the Pacific, J. Lincoln McCargar, W6EY, and Elbert J. Amarantes, W6FBW, respectively the director and alternate, were the only candidates nominated and have been declared reelected for 1946-47. Exactly ditto was the case of the Southeastern, where Director William C. Shelton, W4ASR, and Alternate William P. Sides, W4AUP, carry on.

Balloting for director is occurring in the Atlantic, Dakota and Midwest Divisions. The Delta and Midwest did not name eligible candidates for alternate and are being resolicited hereinabove. Both the Atlantic and Dakota have new alternate directors, however, single eligible candidates having been declared elected without the need for balloting. The new alternate in the Atlantic is J. Victor Brotherson, W8BHN, of Erie. He is by occupation supervisor of installation and shop for the Pennsylvania Telephone Corp. An assistant director of the Atlantic for the last ten years or so, he is a director of the Radio Association of Erie and a past-president of the Erie Amateur Radio Club. H. M. Walleze, W8BQ, the incumbent alternate, was also nominated but withdrew his name. The Dakota's new alternate is Harold

B. Love, W9ZRT, a chiropractor and dairy operator of Mandan, N. D.

The Delta Division has a new director. Ray Arledge, W5SI, was not a candidate for reelection and the sole nominee was declared elected without balloting. He is Dr. George S. Acton, W5BMM, dentist, of Plain Dealing, La. Doctor Acton is ORS, OO and A-1 Op., and was active in AARS.

EXAMINATION SCHEDULES

The schedule of FCC amateur operator examinations for 1945, published on page 21 of our January issue, is necessarily altered in some spots by the recent change of Government offices to the five-day week. FCC offices are no longer open on Saturdays and whenever examinations at a district office were originally scheduled for that day a change has now occurred. In other cities, where exams are given by traveling inspectors, they will sometimes continue to be held on Saturdays.

Refer now to your January *QST* and note the following changes for the rest of this year. Where exact dates or places are not shown, information may be obtained from the Inspector-in-Charge of the district. Asterisks (*) indicate that dates are subject to change and should be verified from the inspector. No examinations on holidays. All examinations begin at 9 A.M. except as noted.

Boston: Now Monday through Friday.
New York City: Monday through Friday.
Philadelphia: Requiring code test, Wednesday at 9 A.M. and 1 P.M. Class A without code, possibly daily; inquire.
Baltimore: Wednesday and Friday.
Norfolk: Now Friday only.
Atlanta: Tuesday and Friday, 8 A.M.
Galveston: Tuesday and Friday, 8:30 A.M.
Dallas: Monday through Friday, 8:30 A.M.
San Antonio: November 15th.
Los Angeles: Wednesday, 9 A.M. and 1 P.M.
San Francisco: Monday, 8:45 A.M.
Portland, Ore.: Friday only, 8:30 A.M.
Denver: First and second Thursdays each month.
Salt Lake City: December 22nd.
St. Paul: First and third Fridays each month.
Kansas City: Friday.
St. Louis: November 9th or 10th; verify.
Chicago: Friday.
Detroit: Friday and by appointment.
Buffalo: First and third Thursdays each month.
Pittsburgh: November 7th-8th-9th *
Williamsport, Pa.: November 12th *
San Juan: Monday through Friday, by appointment.
Cleveland: First and third Fridays each month.
Grand Island: Monday through Friday, 10 A.M. to 3 P.M.

ARE YOU LICENSED?

When joining the League or renewing your membership, it is important that you show whether you have an amateur license, either station or operator. Please state your call and/or the class of operator license held, that we may verify your classification.

STAFF NOTES

TO THE busy accompaniment of carpenters and half a dozen other kinds of artisans, former members of the Headquarters staff are making their way back to West Hartford from the armed forces and wartime laboratories and the usual hum at 38 LaSalle Road is now a crescendo of activity. Our new laboratories and shops are rapidly taking form. Partitions are being moved and departments shifted to gear us better to the job ahead.

We are pleased to say that Colonel Handy, WIBDI, and Lieutenant Commander Battey, WIUE, have resumed their old desks as Communications Manager and Assistant CM, respectively. Joseph A. Moskey, WIJMY, has returned from the Radiation Laboratory and is now C.D. Assistant for organized operating activities. Miss Lillian Salter, who held the fort during the terminal months of the war, has been named C.D. Assistant for field-organization administration. All that the Communications Department needs now is a few long-distance bands on which to conduct some contests! We are similarly pleased to report the return of Chief Radioman John Huntoon, USCG, WILVQ, to his wonted duties as Assistant Secretary of the League — to the great delight of Warner and Waggoner.

An old friend is now introduced as a full member of the staff: Edward P. Tilton, W1HDQ, famed as our nonresident contributing v.h.f. editor for many years past, now joins the ARRL Technical Department to specialize in v.h.f. matters and will continue as *QST*'s V.H.F. Editor. His enthusiastic readers know that that means accurate reporting and pleasant reading.

We regret to announce the resignations from our staff of Clinton B. DeSoto, W1CBD, the editor of *QST*, and of his assistant, Mrs. Louisa B. Dresser, LSPH. Clint DeSoto has been our editor during the four war years, following twelve years as an assistant secretary of the League, during which his reputation was firmly established as a reporter of amateur events, notably by his history of the amateur movement, "200 Meters and Down." During the war there was full play for his extraordinary talents and your *QST*'s of the last few years yield evidence of the unbelievable amount of work done in reporting the changing radio scene during the period of technical censorship and of an overloaded small technical staff at Hq. It was principally through his labors, aided by Mrs. Dresser, that you found *QST* so interesting and helpful during the long years of the war. The editorship is now being resumed by the Secretary.

The names of two more Hq. men who have long been on leave of absence are regretfully dropped from our masthead. James J. Lamb, W1AL, ARRL research engineer and the inventor of the single-signal superhet, has been with Remington-Rand, Inc., on secret war developments since 1941 and has now become the chief engineer of the electronics division and director of electronic research for that firm — at Middletown and So. Norwalk, Conn. Sgt. Vernon Chambers,

SORRY WE'RE LATE

The production of our special Navy issue of *QST* last month proved such a formidable task that it threw our publication schedule out of oscillation and we regret to say that we were several weeks late in appearing. This poses quite a problem for us, in which we ask your forbearance. The present issue is late, too, although not so much so. We must make up the time gradually, and so the next issue will also be a little late. We hope to be back on schedule with our January issue. Don't worry, then, if your intervening issues are a little late — they'll come!

W1JEQ, of our technical information service, is home from the wars and has resumed development work with Remington-Rand, with whom he was associated on a leave-of-absence basis before being called up.

MARITIME RADIO TEACHERS WANTED

METROPOLITAN Vocation High School, a maritime high school in New York City, needs teachers for several maritime subjects, including radio. Salaries range from a base of \$2148, which increases by annual increments to \$4500 maximum. Accepted applicants are first employed as permanent substitutes on a basis yielding about \$2280 — plus, at the moment, a war bonus of \$350 a year. Minimum requirements are junior high school graduation, nine years of approved maritime experience, age between 23 and 38, 480 clock hours in approved teacher training courses. Latter may be acquired after acceptance while serving as substitute, at nominal fee. Possession of first-class operator license and experience in work with boys, training of cadets, etc., desirable. Interested men should write, with outline of education and experience, to Franklin J. Keller, Principal, MVHS, Oliver, Oak & James Sts., New York 2, N. Y.

LICENSE TERM INCREASED

THE Communications Act forbids FCC to issue licenses for a longer term than five years. Amateur licenses for many years have been issued on a three-year basis. Seeing no reason why ham tickets shouldn't have as great a life "as the law allows," ARRL suggested to FCC that an increase in the term for postwar licenses would save them some licensing work and be a convenience to us. The Commission approved the idea on October 3rd when Section 12.28 of our regulations was amended to read:

12.64 *License term.* Amateur station licenses are normally issued for a term of five years from the date of issuance of a new, renewed, or modified license.

and operator licenses were similarly treated by the adoption of a new section:

12.28 *License term.* Amateur operator licenses are normally issued for a term of five years from the date of issuance.

This does not extend existing licenses. It means simply that when FCC gets set up to issue new pasteboards, postwarwise, they will all be for five years instead of three.

NOTICE TO MEMBERS DISCHARGED FROM THE MILITARY SERVICES

THE requirement of continuous membership in the League for eligibility to ARRL offices has been waived for members serving in the uniform of the United States. See particulars on page 39 of *QST* for July last. Those desirous of taking advantage of this arrangement are asked to claim the right when renewing membership, stating the beginning and ending dates for their military service.



S. KRUSE, assistant electrical engineer at the Bureau of Standards, begins in *QST* for November, 1920, his report on the "BuStans-ARRL Tests of Short-wave Radio Signal Fading." This installment describes the stations and the method used. Operation was on 250 meters, with a distance to the average observer of 400 miles. Results will be reported in the next installment. . . . A. L. Groves, our indefatigable correspondent at Brooke, Va., reports an almost complete absence of signals from near-by stations for a week in October, yet 5ZP came in very QSA night after night from a thousand miles. What has been happening?

The League has grown to the place where it needs a full-time traffic manager. J. O. Smith, 2ZL, who has brought us splendidly so far, has resigned with the gratitude of all ARRL men, to give way to Fred H. Schnell, our Chicago city manager, who has come to Hartford as our first paid traffic manager. . . . The resignation of Harry C. Gawler, popular first-district inspector, comes as a big surprise; he is being succeeded by Charles C. Kolster whom we welcome from Chicago, where he has given the amateurs splendid cooperation. . . . Harvey Mitchell Anthony, head of the Department of Applied Electrical Engineering of the Muncie (Indiana) Technical High School, has been elected to the ARRL Board of Direction. . . . Herb Walleze of 8BQ has been appointed District Superintendent for his district. . . . Charles A. Service, jr., 3ZA, has found it necessary to resign as Division Manager, Atlantic Division, and has been succeeded by Charles H. Stewart, 3ZS. . . . John Clayton, manager of the Delta Division, reports that "W. L. Barrow of 5EA was laid up with a stroke of lightning which knocked his station completely out." . . . Frederick E. Terman advises from Stanford University that 6SR and 6AE have joined forces and will operate a joint station under the call 6AE, Mr. Franklin signing JF and Mr.

Terman FT. . . . Maine held its first convention September 15th, with 250 present under the chairmanship of Ass't. Div. Mgr. H. W. Castner.

On its editorial page *QST* stops temporizing with i.c.w. and comes out flatly for straight c.w. — which is what we have secretly had in mind all along in advocating tube transmission. Receivers must be improved: it is hard to heterodyne the high frequencies we use and we must have vernier tuning and shielded cabinets to avoid hand-capacity effects. . . . NSF is reported heard in Bristol, England, and there have been numerous reports from ship operators several thousand miles away. But who really has the long-distance record, anyway?; "just what constitutes the supreme amateur DX record for approximately 200 meters?" . . . We propose that amateurs assist the police in helping recover stolen automobiles. At certain hours of the day, each of us could transmit data obtained from our local police, describing stolen machines, and we could all copy that information and telephone it to our own local police. This would be a fine thing for all concerned except the thief. It would be the first time that amateur radio stations would be put to a real practical use all over the country.

In "Correspondence," Boyd Phelps describes the fan antenna at 9ZT. He particularly emphasizes the desirability of having all current paths the same length. When this is done, the antenna tunes just as sharply as did an older antenna of two vertical wires — contrary to the experience of other amateurs. The editor invites comment, there being a dearth of data on aerial design.

Strays

W2MQB, writing in the Crystal Ball Department this month, tells of his plans for phonograph recording and playback equipment in his ham shack. Don's idea is very timely and brings to mind the tantalizing question of the *availability* of recordings of ham signals before we closed down on Dec. 7, 1941.

Let's hope that somewhere there are many recordings of "hot nights" on 20 and 40 meters and that someone caught snatches of that elusive 56-Mc. DX. Did anyone think ahead far enough to record the signals from those very rare and never-to-be-forgotten DX stations, some of which were manned by operators now silent forever? How about a platter cut on 40 meters during the peak of a Sweepstakes contest, or on 80 during an ORS party?

Information on the *availability* and *location* of such historical recordings will be compiled at ARRL Hq., upon receipt of data from you fellows who were smart enough and who possessed the equipment to record ham signals during the pre-war years. Drop us a line, and give us the dope. Just mark it "Phonograph," c/o ARRL Hq., and we'll do the rest.

Improved Driver Stages for Class-B Amplifiers

The Cathode-Follower as a Power Amplifier

BY ELLIOTT A. HENRY,* WOFEN

The versatile cathode-follower lends itself admirably to overcoming the performance limitations of conventional driver stages for Class-B audio amplifiers or modulators. The advantages of the cathode-follower power amplifier are: practically perfect regulation, large damping factor, low distortion, and wide frequency response. Design principles, typical examples, and additional applications are discussed.

WHILE cathode-followers have found wide application in video-amplifier design and as impedance-changing devices, little attention has been given to their use as power amplifiers in audio work. For applications involving reactive or variable loads this type of amplifier is ideal. Typical of this type of load is the dynamic loud-speaker or the load presented by Class-B amplifier grids. The most important characteristic of the cathode-follower power amplifier is its practically perfect regulation. For normally-used tubes the regulation is in the order of 5 per cent with any load between full load and no load. Of almost equal importance is the high damping factor. The effective damping across the primary of the output transformer is approximately equal to the reciprocal of the grid-to-plate transconductance and normally is in the order of a few hundred ohms. Reduced harmonic distortion and increased frequency response also result from the 100-per-cent inverse feedback. The increased frequency range is interesting in that it is possible to get an equal or better frequency range with very cheap transformers than may be obtained with very expensive ones in conventional circuits.

With all these advantages, it is only natural to look around for the "catch," and there is one. This "catch" is the high input voltage required. As all of the output voltage is in the grid-cathode circuit and therefore out of phase or bucking the input voltage, the input voltage must always exceed the output voltage. This is another way of saying that the voltage gain of the stage is always less than unity. This is not too difficult a problem to overcome in the light of the many other advantages. This will be discussed later with the design information. At this point it should be em-

phasized that while the *voltage* gain is less than unity, the *power* output is unaffected by the 100-per-cent feedback. All that is necessary is to supply a higher driving voltage.

Basic Operation

Since several excellent articles on cathode-followers have recently been published in *QST* and other magazines, the discussion to follow will be concerned primarily with power-amplifier applications of cathode-followers and will deal with basic design theory only where such theory is necessary for the proper understanding of these applications.

For an explanation of the amplifier characteristics referred to above, let's examine Fig. 1. This is the simplest type of cathode-follower power amplifier. In this circuit R_1 is used to supply additional bias since the d.c. resistance of the output transformer primary is generally too low to provide adequate bias. Condenser C_1 is of such a value that its reactance is negligible at the lowest frequency. If this is so, then the cathode impedance, Z_k , will be the primary impedance of the transformer T_1 . This impedance will, of course, be a complex impedance, but over the mid-frequency range may be considered as resistive. Assuming that a signal in the mid-frequency range is applied, on the positive half of the cycle the grid is driven positive which increases the plate current. This current flowing through the cathode impedance will produce a voltage drop making the cathode more positive with respect to ground. With respect to ground, the cathode and grid voltages are in phase. The effective driving voltage, however, is the voltage between the grid and cathode, labeled E_o , and, since E_{in} and E_{out} have the same polarity with respect to ground, they are effectively in series across the grid-to-

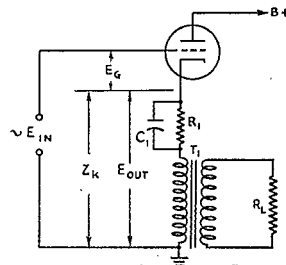

Fig. 1 — Triode cathode-follower power amplifier.

* Electronic Division, Maguire Industries, Inc., Greenwich, Conn.

cathode input, their polarities will be in opposition or out of phase, and E_g will be the difference voltage. If the input and output voltages are in phase, the cancellation will be perfect and E_g will be the algebraic sum of the two voltages. If, however, Z_k is reactive, the output voltage will not be in phase with the input and the cancellation will be less effective. The effective grid-driving voltage is

$$E_g = E_{in} - E_{out} \cos \theta, \quad (1)$$

where θ is the phase angle.

It is this feature which provides good frequency response with poor-quality transformers. For example, a common way of reducing the cost of a transformer is to reduce the number of turns. This results in lower inductance and poor low-frequency response. However, in the cathode-follower circuit, the decreasing impedance of the transformer primary with a decrease in frequency which results from the decreasing reactance of the primary inductance, causes the phase of the output voltage to change with respect to the input voltage. Thus the cancellation will be less and E_g will increase, causing the tube to be driven harder. For an explanation of the good-regulation feature, reference again is made to Fig. 1. With E_{in} constant, any tendency for E_{out} to rise, as might accompany the sudden removal of the load, would reduce E_g , and this in turn would reduce E_{out} , thus tending to stabilize the output voltage for any given input voltage, regardless of any decrease in load from full load. This regulation also can be seen from the formula for voltage gain of a triode cathode-follower. The voltage gain is

$$\text{Voltage Gain} = A = \frac{\mu Z_k}{Z_k (\mu + 1) + R_p} \quad (2)$$

From this equation it can be seen that the higher the value of μ , Z_k , or both, the closer to unity the gain becomes, but the gain never can exceed unity. With normally-used tubes and loads, gains of 0.90 to 0.95 are to be expected and since the load never will rise to infinity, regulation in the order of 5 per cent may be secured.

Application of inverse-voltage feedback does not change the plate resistance of the tube but, as a result of the feedback action, the effect is similar to that resulting from a change in plate resistance. This is important for two reasons. First, it tells us that the same load impedance should be used in a cathode-follower power amplifier as would be used with the same tube or tubes in a conventional circuit where the load is in the plate circuit; that for maximum power output the plate resistance is unchanged and must be matched. This simplifies one problem in that special transformers are not necessary. Second, it offers an explanation for the high damping factor obtained in this type of amplifier. The apparent impedance looking into the tube is

$$Z = \frac{R_p}{\mu + 1} \cong \frac{1}{G_m} \quad (3)$$

This impedance is effectively in shunt with the primary of the transformer and is reflected to the secondary in accordance with the impedance

ratio of the transformer. For example, a 6L6 operating with 250 volts on the plate and screen has a damping resistance of 22,500 ohms, while the same tube used as a cathode-follower has a damping resistance of only 166 ohms.

Pentode or Beam Tubes

Thus far the discussion has been devoted to the use of triodes. Pentodes or beam tubes also may be used and are even superior to triodes. Their use requires an additional provision to keep the cathode and screen at the same a.c. potential so that true pentode operation may be secured. In a conventional amplifier the screen grid is bypassed to ground, as is usually the cathode. The screen therefore is maintained at a constant d.c. potential above the cathode but they are both at effective a.c. ground potential. The input signal then causes the plate voltage to vary up and down while the cathode and screen voltages remain fixed. In a cathode-follower circuit, however, the plate voltage remains constant and the cathode rises and falls in accordance with the input signal. Thus, if true pentode operation, and as a consequence full power output, is to be obtained, the screen grid must be made to rise and fall with the cathode. Two methods of accomplishing this are shown in Figs. 2 (B) and 2 (C). Fig. 2 (B) makes use of a special transformer, T , with a third winding, labeled Sec_2 . This winding has the same number of turns as the primary, $Pri.$, and is connected so that the screen and cathode voltages are in phase. It can be readily seen that if Sec_2 and $Pri.$ have the same number of turns, there will always be a fixed voltage difference between the screen and cathode. This voltage difference will be equal to the d.c. voltage applied to the screen. The condenser C_1 is added to make negligible any variation in the transformer construction and to insure zero phase difference between the two voltages. Its value should be large so that the reactance is small at the lowest frequency. In Fig. 2 (C) the same

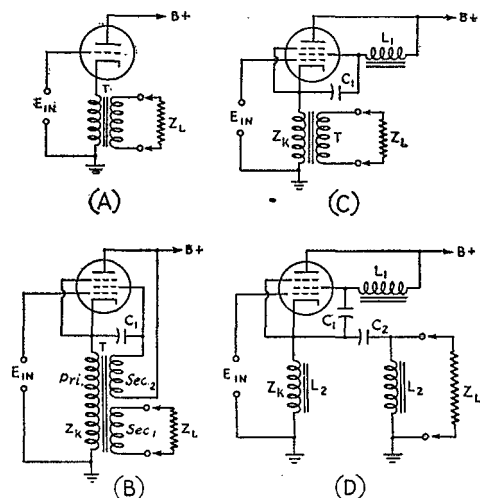

Fig. 2 — Single-ended stages with cathode coupling.

thing is accomplished without the use of a special transformer. In this circuit the condenser C_1 again is connected between the cathode and screen and the choke L_1 is used to provide a low-resistance path for the screen d.c. while presenting a very high impedance to the a.c. Condenser C_1 again has a low reactance and the same result is obtained as with the special transformer. L_1 may be quite small in size but should have a reasonably-large inductance.

Single-Ended Stages

Four types of single-ended cathode-follower power-amplifier circuits are shown in Fig. 2. No provision for d.c. bias is shown since this may be added in a similar manner to that shown in Fig. 1. Fig. 2 (A) uses a triode and has been fully covered in the foregoing discussion. Although Figs. 2 (B) and 2 (C) are shown using pentodes, the circuits are equally applicable to beam tubes. The difference between these two circuits is the manner in which true pentode operation is obtained. The gain and power output is the same for both. Since tube data usually give the transconductance instead of the μ for pentodes, the following formula is to be preferred in calculating the gain of single-ended pentode or beam-tube cathode-followers.

$$A = \frac{G_m Z_k}{1 + G_m Z_k} \quad (4)$$

How this knowledge of the gain is made use of will be covered in more detail in the design section which follows. Fig. 2 (D) utilizes a single-section high-pass π filter as the coupling network. Again a pentode has been used for illustrative purposes, although a beam or triode tube might be used as desired. The gain is calculated from Eq. (4) and Z_k may be assumed to be equal to Z_L . In designing this coupling network, F_c , the cut-off frequency, is chosen to be slightly lower than the lowest frequency it is desired to pass, and the capacity of C_2 is given by

$$C = \frac{79580}{F_c Z_L} \quad (5)$$

while the inductance of the chokes, L_2 , may be determined from

$$L = \frac{0.14916 Z_L}{F_c} \quad (6)$$

where C is in microfarads, L is in henrys, F is in cycles, and Z is in ohms. This circuit, usually used in push-pull, is illustrated in Fig. 7 and is to be preferred in very high-power installations and wherever the utmost in quality is desired. Any transformer used to drive a Class-B audio stage is required to have very-low leakage inductance to permit the high currents to flow. Also it must be designed to have considerable extension of the low-frequency range to prevent the magnetizing current from absorbing so much of the power from the driver tubes that there is insufficient power left to supply the peak demand of the Class-B grids. Transformers meeting these specifications are very large and expensive. The circuit

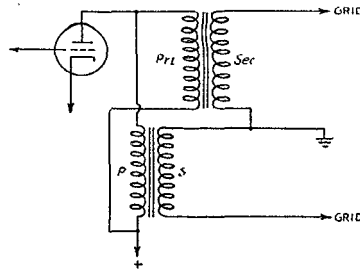

Fig. 3 — Circuit for increasing voltage gain.

in Fig. 7 overcomes this problem by eliminating the transformer and substituting the symmetrical π filter. Leakage inductance is eliminated and the chokes may be of a reasonable size. This circuit has been included more as a point of interest and not with the expectation that it will find much application in amateur transmitters.

The Input Transformer

Before getting down to practical circuits and design data, a practical method of supplying the high input voltage to the cathode-follower without resorting to high plate voltages should be discussed. The wide frequency response of the cathode-follower can be preserved throughout the amplifier by having several cathode-coupled stages in cascade. The overall gain then will become essentially the gains of the transformers but the number of required stages will be increased if the same overall voltage gain is to be obtained as with a conventional amplifier. From the standpoint of "understandability" in communication work, the wide frequency response is neither necessary nor desirable. A frequency range of about 200 to 3500 cycles generally is conceded to supply the greatest intelligibility. This is leading up to suggesting the use of an input transformer with a high step-up ratio and one whose primary is driven from the plate circuit of the preceding stage. Transformers with large step-up ratios usually have low-inductance primaries, to keep the cost and size down, so the use of such a transformer as suggested will probably mean that the overall frequency response will be down about two or three db. at 200 cycles. This seems to be a logical solution, since the number of stages is kept to a minimum and our low frequencies, which waste power and add nothing to the "understandability" of the speech, are eliminated. Fig. 3 illustrates an extreme case where two transformers might be used to secure high step-up ratios by connecting the primaries in parallel and the secondaries in series. However, this will not be necessary unless it is desired to use some old transformers from the "junk box" which happen to have low turns ratios.

Push-Pull Stages

The push-pull versions of the circuits in Fig. 2 are shown in Figs. 4, 5, 6, and 7. Fig. 4 uses a pair of 6N6Gs to represent the triode-type of cathode-follower. The 6N6G actually is two triodes con-

nected in cascade in one envelope but may be treated as one tube for design purposes. Fig. 5 is an example of the use of beam tubes, such as the 6L6 or 6Y6, with a standard-type Class-B input transformer. These two circuits are the most practical and a step-by-step design will be made for each. The use of the push-pull cathode-follower stage modifies the gain formulas given in Eq. (2) for triodes and Eq. (4) for pentode or beam tubes. The gain formula for push-pull triodes is given by

$$A = \frac{\mu Z_k}{Z_k (\mu + 1) + 2 R_p} \quad (7)$$

For push-pull pentodes or beam tubes the gain formula becomes

$$A = \frac{G_m Z_k}{2 + G_m Z_k} \quad (8)$$

In these equations, the value of μ or G_m is for one tube, while Z_k is the total impedance, cathode to cathode.

This modification of the formula is necessary to allow for the plate resistance of both tubes. Beam tubes again are used in Fig. 6 and the special transformer, T_2 , is used to secure true pentode operation. While there are no transformers of this type on the market of which we know, it is expected that there may be before too long.

Design Procedure

The design procedure for the triode cathode-follower stage in Fig. 4 starts with the selection of the Class-B input transformer, T_2 . If the Class-B stage is assumed to be a pair of 805s, the peak load represented by their grids will be approximately 5000 ohms across half of the secondary, and since the correct load for the 6N6Gs is 10,000 ohms, plate to plate, a transformer with an impedance ratio, primary to one-half the secondary, of 2 to 1, or a turns ratio of 1.41 to 1, will be required. The tube manual supplies the information that the 6N6Gs will deliver 8 watts of power across this 10,000-ohm load. The peak voltage delivered across this load will be

$$E_{peak} = 1.41 \sqrt{WR} = 1.41 \sqrt{(8)(10^4)} = 400 \text{ volts.}$$

The next step is to determine the required peak input voltage.

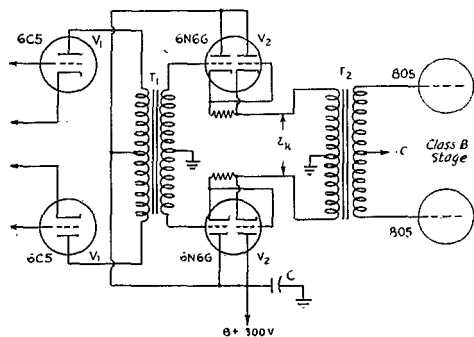

Fig. 4 — Cathode-coupled push-pull triode stage.

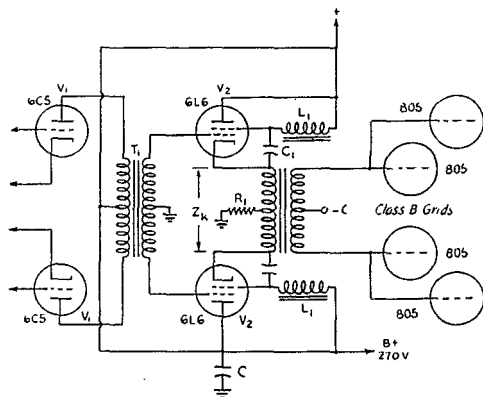

Fig. 5 — Circuit for beam-tetrode push-pull stage with cathode coupling.

Before this can be done the voltage gain must be determined. This gain is given by Eq. (7). The μ is 58 and R_p is 24,000, according to the tube manual. Substituting these values in Eq. (7),

$$A = \frac{(58)(10^4)}{[(10^4)(58 + 1)] + [(4.8)(10^4)]} = \frac{(58)(10^4)}{(63.8)(10^4)} = 0.91 = \text{gain.}$$

The peak input voltage then will be required to be

$$E_{in} = \frac{E_{out}}{A} = \frac{400}{0.91} = 440 \text{ volts peak, grid to grid.}$$

The final step is the selection of the input transformer, T_1 . If we use a pair of 6C5s for V_1 , an output of 150 peak volts is readily obtained with an input of about 15 volts. Therefore transformer T_1 should have a minimum step-up ratio of 1 to 3. The voltage amplifier driving the 6C5s is left up to the individual preference of the constructor. The condenser C should have a low reactance in order to keep the plate impedance to ground low; 30 to 80 $\mu\text{fd.}$ would be entirely satisfactory.

This circuit certainly has a minimum of components and the voltage step-up of the input transformer has eliminated the need for any additional stages resulting from the loss of voltage gain in the cathode-coupled stage. The effective damping resistance, R_d , across the primary of T_2 will be

$$R_d = \frac{2 R_p}{\mu + 1} = \frac{48000}{58 + 1} = 813 \text{ ohms,}$$

or about half of that of a pair of 2A3s used in the conventional manner. The damping resistance of beam tubes is considerably lower than that of triodes, when both are used as cathode-followers.

The circuit of Fig. 5 might be used to drive four 805s in push-pull parallel. In that case the peak load across half the secondary of T_2 would be 2500 ohms and the recommended plate-to-plate load for the 6L6s operating Class A with 270 volts on the screen and plate is 5000 ohms. Therefore the impedance ratio of the transformer again would be 2 to 1, primary to one-half secondary.

It would have to be capable of handling the additional power. Referring to the tube manual, we find that these tubes will deliver 18.5 watts into the 5000-ohm load. The peak voltage will be

$$E_{peak} = 1.41 \sqrt{WR} = 1.41 \sqrt{(18.5)(5000)} = 430 \text{ volts.}$$

The voltage gain, given by Eq. (8), will be

$$A = \frac{G_m Z_k}{2 + G_m Z_k} = \frac{(0.0055)(5000)}{2 + (.0055)(5000)} \\ = \frac{27.5}{29.5} = 0.93,$$

the G_m being 5500 μ mho or 0.0055 mho. The peak voltage across the grids then will be required to be

$$E_{in} = \frac{E_{out}}{A} = \frac{430}{0.93} = 462 \text{ volts.}$$

If a pair of 6C5s is used again as the driver delivering an output voltage of 150 peak volts, the minimum turns ratio of the input transformer should be 1 to 3.08 or a standard ratio of 1 to 3.5. An input transformer with a higher step-up ratio may be used with the consequent increase in voltage gain. The values of the chokes L_1 and the condenser C_1 are not too critical. The principal requirement is that the reactance of the condenser be low and that of the choke high. A value of 12 to 20 μ f. for the condenser and 30 or more henrys for the choke will be satisfactory. This value of inductance should be readily obtainable in a small physical size, since the d.c. through each choke will be only 8 or 9 ma.

In selecting the cathode-biasing resistor, it is necessary to know the d.c. resistance of the primary of T_2 . The tube manual again furnishes the information that a biasing resistor of 125 ohms is required for the two tubes. But this assumed that all of the plate current is flowing through this resistor. In our circuit half the current flows through each half of the primary and some voltage drop occurs in the transformer. If we assume that the resistance of each half of the primary winding is 50 ohms, then of course the total effective resistance for biasing purposes would be 25 ohms and R_1 would have a value of 100 ohms. The value of C should be large to keep the plate-to-ground impedance low. As with the triode stage, 30 to 80 μ f. will be satisfactory, actually the higher

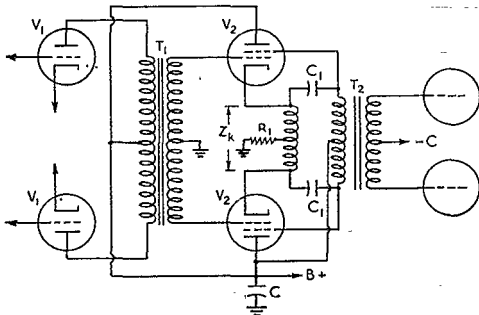

Fig. 6 — Push-pull stage with special transformer.

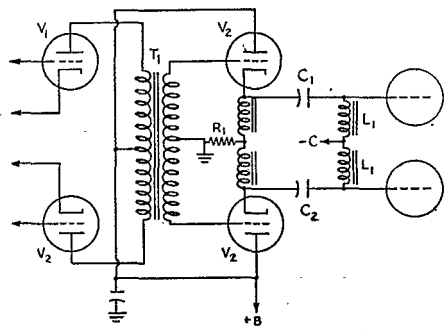

Fig. 7 — Push-pull stage with filter-coupling network.

the better. The damping resistance is

$$R_d = \frac{2}{G_m} = \frac{2}{0.0055} = 364 \text{ ohms.}$$

Other Applications

There are many additional applications for amplifiers of this type. Among them there are two which would probably be of general interest. The first is the use of the cathode-follower amplifier as the output stage of a radio receiver. The loudspeaker presents a resistive load over a very restricted range around 400 cycles and is reactive at all other frequencies with the magnitude of this reactance varying widely. This means that the output tubes work into quite a varying load and rather high distortion results. The cathode-follower power amplifier is an ideal solution, since the voltage output is independent of the load, within a few per cent, over the range from full load to no load, the damping factor is very high, and the 100-per-cent inverse feedback reduces distortion to a minimum. The distortion will be only about 1 per cent of that of a stage with the same components used in the conventional manner.

The second application is in amplifiers for public-address work. Here the number of speakers required may change from day to day or even several times during the course of the day. This requires special matching and this matching must be changed every time a speaker is added or removed and, further, the gain must be readjusted if the volume level is to be held constant. By the use of the cathode-follower, speakers may be added or removed, up to the full load, without changing the volume level or requiring the matching to be changed. This can be accomplished in the following manner.

Assume that the amplifier will deliver 40 watts to a nominal line impedance of 200 ohms. The line voltage then will be 89.3 volts r.m.s. and, as we have seen, will remain essentially constant from full load to no load. If ten speakers of 2000-ohm impedance are connected in parallel across this line, the total impedance of the speakers will be 200 ohms, or full load, and the power delivered to each speaker will be

$$W = \frac{E^2}{R} = \frac{8000}{2000} = 4 \text{ watts.}$$

Fig. 8 — Response curve of a typical cathode-coupled audio amplifier.

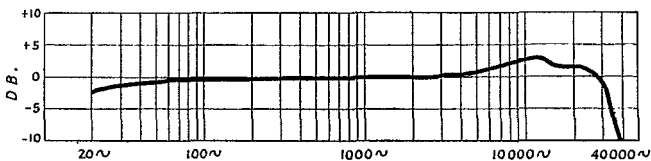

If one or more of the speakers is disconnected, the power delivered to each of the remaining speakers will not change, since the line voltage has remained constant. The result is that the amplifier is delivering less power. This indicates that the power output is inversely proportional to the load for any load between no load and full load.

stages to preserve the wide frequency response, while using transformers to secure the higher driving voltages required by the large feedback factor. The use of transformer coupling with high step-up ratios eliminates the need for the high plate voltages which would be required if resistance coupling were used.

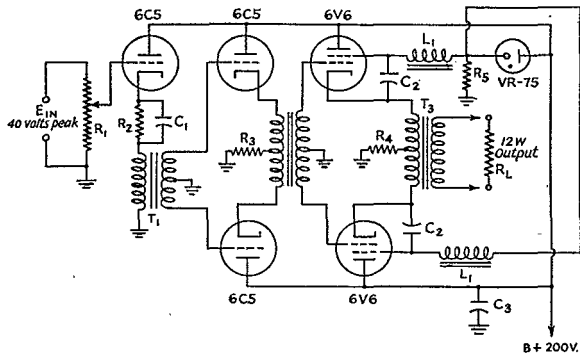

Fig. 9 — Circuit of a practical cathode-coupled amplifier.

- C₁ — 25- μ fd. electrolytic.
- C₂ — 12- μ fd. electrolytic.
- C₃ — 80- μ fd. electrolytic.
- R₁ — 500,000-ohm potentiometer.
- R₂ — 1500 ohms.
- R₃ — 800 ohms.
- R₄ — 20 ohms.
- R₅ — 50,000 ohms.
- T₁ — Coupling transformer (Stancor A-64C).
- T₂ — Push-pull coupling transformer (Stancor A-4155).
- T₃ — Output transformer (Stancor A-3800).
- L — 30-h. filter choke.

Any combination of power outputs to different speakers can be made which do not in combination have a total impedance of less than 200 ohms. For example, with the same amplifier, two speakers taking 8 watts each and twelve taking 2 watts each can be used by having the impedance of the 8-watt speakers 1000 ohms and the 2-watt speakers 4000 ohms each.

For either of these applications it is suggested that cathode-coupling be used in two or three

Fig. 8 is the response curve of the experimental amplifier in Fig. 9. The transformers used are in the low-priced group and the response is down only 2.4 db. at 20 cycles. The high-frequency limit, taken at the half-power point, is 33 kilocycles. This performance would be very difficult to obtain, even with very expensive transformers, in conventional circuits. The 3-db. rise at 12 kc. results from resonance in the output transformer, T₃, and is not objectionable. The resonance peak would be several db. higher in an amplifier with a lower feedback ratio. The overall frequency response can be modified, such as to provide bass and treble boost, in the voltage amplifier stage or stages preceding the cathode-coupled stages. The curve in Fig. 10 resulted when a transformer with a very high distributed capacity was substituted for T₃ in the circuit of Fig. 9. Even with the use of this transformer, which would be very unsatisfactory in a conventional amplifier, the frequency range is 20 to 13,000 cycles.

Summary

From a general-design standpoint, the most satisfactory tubes to use are those with high values of transconductance and which work into low recommended values of plate load. The high G_m insures better damping and will allow the voltage gain to be closer to unity and therefore the regulation will be better. The use of tubes with lower plate loads will simplify the design in that the required input voltage to the grids will be lower for full-power output and the step-up ratio of the input transformer will be in the range

(Concluded on page 118)

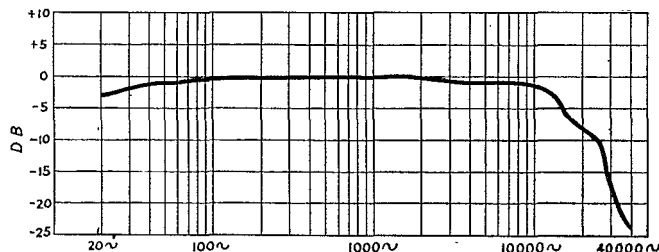
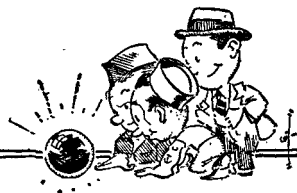

Fig. 10 — Response curve of cathode-coupled audio amplifier with a transformer having high distributed capacity.

THE CRYSTAL BALL



CONDUCTED BY A. DAVID MIDDLETON,* W2OEN

MANY of the 112-Mc. rigs throughout the country must have a built-in combination PPI and crystal ball, because the boys have been working out in all directions and yet they found time to send in some excellent, detailed reports on their crystal gazing. Most of the contributions are worthy of being passed on to the gang and we regret that space limitations do not permit publication of all the ideas submitted.

Here's the latest dope relayed by us to you from the amateur CIC Rooms of the world.

MORE OF THE SAME—ONLY BETTER, SAYS W9LQE

My crystal ball seems to tell me "not to be the first by whom the new is tried, nor yet the last to lay the old aside." So the new rig at W9LQE will be an improvement over the old one but it will not be essentially different. The power input, 350 watts, 'phone, and 400 watts, c.w., will remain. Components will be operated well within their ratings, so that when emergencies arise it will be practicable to operate the transmitter day and night, continuously, if necessary.

I'll have break-in c.w., satisfactory, noiseless, and as smooth as silk. (I haven't found the answer to this one, but it will come.) The a.f. and r.f. systems will be in separate, completely enclosed metal cabinets.

BCI will be reduced as much as the state of the art permits. Every possible precaution in the design and operation of the new transmitter and every possible preventive measure will be used to effect this.

As to frequency control, both crystals and v.f.o. will be used. The oscillators positively shall not have too much work to do. A 45-volt B battery will probably furnish their plate voltage.

Crystal control will be used for c.w., because the only way to get a crystal note is to use a crystal. A "pdc" note is good, but it is not and cannot be the characteristic *crystal* note. The old-timers know this, regardless of the flattering reports the boys give on the notes coming from v.f.o.s. C.w. must be really good, with no clicks, no thumps, no chirps, no yoops, no lag, and with a musical tone as steady as the hills. I want one that sounds as though it were coming from Gabriel's trumpet and carrying the sock of an A-bomb. I still maintain that it is harder to get a c.w. transmitter to work properly than it is to get a 'phone rig to work acceptably well. *Good c.w. is no cinch.*

* Department Editor.

Good looks in the rig will add much to my enjoyment of operating. Pressing a key, or throwing not more than one switch must put the rig on the air or take it off.

There is one more thing — the safety measures! You can bet that there will be a "big switch" to cut the 240 volts, a.c., and it will be in a handy place to cut off all the juice in an instant. Every piece of metal housing the rig, and every piece of groundable metal in the rig, will be connected to the grounded side of the a.c. line. White wire will be used throughout for the grounded neutral. *QST* carried on a campaign for safety measures in ham stations, and it would be a good thing for all of us to review the many splendid suggestions on this subject in past issues before we plan our new rig.

— Joseph A. Terstegge, W9LQE

BUILT-IN CONVENIENCE AT W1HRC

CLAYTON C. GORDON, W1HRC, SCM of Rhode Island, has some definite plans for his new layout. He writes as follows:

"I plan to lean more heavily on adequate test equipment so that I can better determine the performance characteristics of my gear. A start in this direction made recently resulted in the assembly of an a.c.-d.c. volt-ohm v.t.v.m. and an oscilloscope. I also overhauled some of my frequency measuring equipment.

"In the past, my station was heavily built in the best rack and panel manner. Being bulky, it had to stand some distance from the operating position, making the rapid change of frequency or bands too much of a job to encourage the best possible use of the available spectrum. In my new layout, the transmitter components and assembly will be scaled down so that it can be placed right on the operating desk. The power supplies, neces-

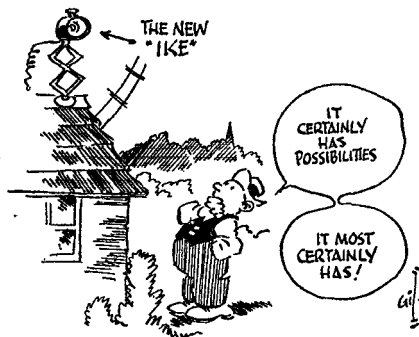

sarily heavy, will remain in racks and will be relay-operated with their outputs brought to the transmitter in conduit.

"I believe that the proper use of the bands and frequencies therein will greatly outweigh the questionable advantages of 'brute-force high-power.' Therefore, I am determined to lick the problem of how to make a *good* v.f.o.

"In the past, I never was able to lick the problem of break-in on spot-frequency nets as I never liked the banging in my ears. There *must* be a way to work break-in without such annoying disturbances in the receiver. I don't mean to just put up with that racket, but to eliminate it!

"My 'phone operation will be of the 'narrow-band' type as I believe that 'broadcast quality' on the ham bands is selfish. I will use a carbon mike with a breast-plate holder in order to keep my hands free to manipulate the controls, or to make notes in the log.

"In my transmitter, I would like to incorporate front panel plug-in coils, similar in fashion to the HRO or FB7 type of plug-ins. Maybe some coil manufacturer will come out with some workable system of that sort.

"As to the v.h.f. and u.h.f. bands . . . when the lid of secrecy is lifted, I hope to be able to delve into the mysteries of these bands. I am holding an open mind on this part of the spectrum, waiting without forming any prejudices, to see what is in store for us."

INTRODUCING "THE PEEKMETER"

FER yrs hv hd trubl getg tfc into N. Jer. fm Ohio. Wn wntd QSP msg home wud push into tfc net in erli eve es tn folo it sloly cross cnty into AtCity or P Amby. Tn Jer op gets fone call, "mani fish just off shore" so he leves msg on hk es goes fishin. Tha fwng Monda he mails it and it is missent to sum place in Ga or Okla. Tn mi OW rites "Son — why did you send me a card from Oskiluski, Gaokla! What were *you* doing down there?"

In order to folo tfe es fer otr uses I hv inventd the "Peekmeter" based on Iconoscope. An Ike wl reproduce visually anitng focused on it bt up to nw they hv all focused in rong manner. Wid mi new scope will be able sit bk es folo each msg from W8ISK rite to wastebasket at W4IR. Bi slite chng in depth control, wl b able read msg tht is rite under mine in his basket, as it's probly fer me aniwy.

Antr use is when sum bird wid cheap elec razor dwn st mks too much QRM wid his W6 note I cn crank up the "Peekmeter" es sloly scan dwn st til find his house. Tn I'l call him on fone es while he is raving into dead line, cn finish mi QSO wid tht YL in Dallas.

Natrlly, my devise is fer tfc men only bt it hs wide possibilities such as "Who was tht lady I seen u wid lst nite" for now u gotta talk fast to get outta tht one nw!

— Bart Havens, W8ISK

MULTI-FRONT-END RECEIVER WITH DUAL I.F. CHANNELS AND SINGLE OUTPUT CIRCUIT

MY RECEIVER will probably consist of a dual i.f. amplifier (with a.m., f.m., and a b.f.o.) and several front-end converters, which can be switched into the proper i.f. strip. A common a.f. amplifier and power supply will save components and space.

I plan to use a 5-Mc. i.f. for reception below 148 Mc. and a 30-Mc. i.f. for all the higher frequencies, as shown in the block diagram, Fig. 1.

— James W. Brannin, W6OVK

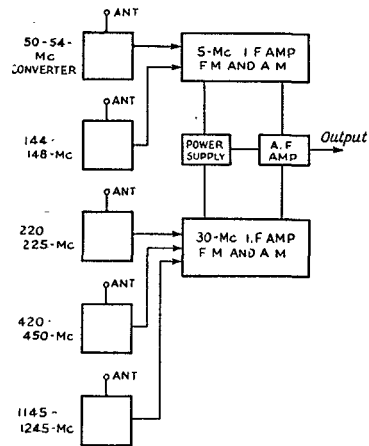

Fig. 1 — Block diagram of proposed receiver layout at W6OVK. A dual i.f. amplifier, complete with a.m., f.m. and a b.f.o., will permit the desired i.f. amplifier to be connected to any one of the several front-end converters. Directional antennas for the various bands will be permanently connected to these converters.

November Prize Winners

Contributors to the Crystal Ball Department are awarded monthly prizes consisting of a \$25 Victory Bond as first prize; \$10 in Victory Stamps as second prize, and \$5 in Victory Stamps as third prize. One dollar in Victory Savings Stamps is awarded the writer of each additional published letter not receiving a major prize.

The most interesting letters are selected by two members of the Headquarters staff: the conductor of this department and a "guest judge." This month's winners, chosen by Leroy T. Waggoner, W9YMY (Assistant Secretary, ARRL) and W2OEN are: Jos. A. Terstegge, W9LQE, first prize; Clayton C. Gordon, W1HRC, second prize; James W. Brannin, W6OVK, third prize; Lt. London K. Allbright, W6SLF; Wm. S. Bell, W3HHN; Bart Havens, W8ISK; Donald A. Miller, ACRM, USN, W2MQB/K4; S/Sgt. Jesse D. Wheaton, OPLO.

OPERATING A RIG FROM THE DARKROOM

SOME fellers just never can get enough of their hobbies, so they rig up ways to combine two of them! Comes now S/Sgt. Jesse D. Wheaton, OPLO, who tells how he is going to operate from *inside* his photography darkroom! There are few minor details, such as logging (maybe with invisible ink, or something) still unexplained, but here is what OM Jesse says:

"Seeing that I am also interested in photography as well as ham radio, I plan to have my shack right next to the darkroom as shown in Fig. 2-A.

"My rig will be all tuned up, and the receiver set on my working frequency. A remote-local switch on the operating table will permit push-to-talk operation in either room. A foot-pedal-operated switch under the darkroom work bench will turn on the rig, and a mike suspended over the bench picks up my voice. A loudspeaker, working in parallel with the one in the radio shack will give me the signals from the other station.

"Fig. 2-B shows one way that the transmitter and receiver relays could be connected. The relays could be either the normal type or the 'push-to-operate, push-to-release' variety."

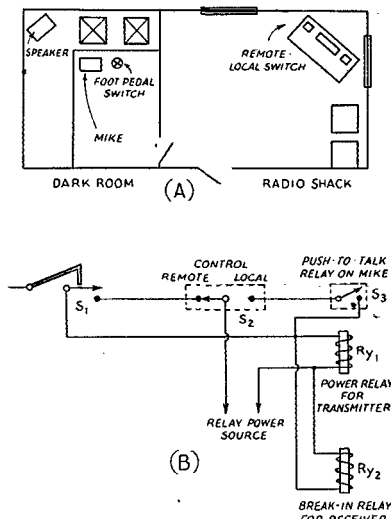

Fig. 2 — Operation of an amateur station from inside a photography darkroom. The shack is next door to the darkroom as shown in (A) and contains a foot pedal-operated press-to-talk switch, a microphone and a speaker. A remote-local switch in the operating room cuts in the darkroom or ham shack control circuit as shown in (B). Ry_1 turns on the transmitter and Ry_2 cuts off the receiver when either S_1 or S_3 are closed.

ONE HAM'S IDEAL RECEIVER

IN RESPONSE to the request of one radio manufacturer, I drew up a list of the features I'd like to have in my postwar receiver. In the past, I have noticed that many of the necessary "little" things were omitted from ham equipment and I hope that such will not now be the case.

In addition to general coverage and sensitivity, stability and selectivity characteristics commensurate with "the state of the art," I would like to have the following features incorporated in my station receiver:

- Single dial tuning.
- Calibrated bandspread.
- Phonograph input jacks.
- Output connection for a recorder head.
- Crystal filter with variable selectivity.
- B.f.o., variable pitch.
- Iron-core i.f. transformers.
- Break-in and relay terminals.
- Noise silencer, adjustable.
- Noise-balancing antenna circuit.
- Connections for panoramic adapter.
- Standard relay rack panel mounting.
- "R" meter calibrated in "S" and "Db."

For mobile operation I would like to have a v.h.f. superhet converter working into my auto radio for i.f., a.f. and power connections. Such a tuner, with provisions for 50, 144 and 240 Mc., would be very welcome.

— Lt. London K. Albright, W6SLF

LIGHT-HOUSES, BUTTERFLIES AND PLUMBING

Now, you OMs and YLs go right ahead gazing into your pet crystal ball trying to get a look at life on the postwar ham bands but I wore three xtal-balls down to marble size before the Great Swami finally broke through the cranium insulation and delivered the message that provided the first practical step for the days to come. He said, "Lissen OM, the Post Office has a \$100 Victory bond that'll put you smack in the middle of any two of those new u.h.f. bands for only \$75. Whatsay?"

With that slick new \$100 bond marking the u.h.f. section of the *Handbook*, the 420-450-Mc. and the 1145-1245-Mc. bands began to have a lot more significance. Of course, the first love, 40 meters, will have my call punching through it now and then, and a rig to handle that has been lined up for months, but what about u.h.f.?

In looking over some of the recent tube announcements, the light-house tube strikes a promising note. Also, the "butterfly" circuit seems to wrap around the light-house tube. Such a combination, together with a little plumbing, gives one solution to a two-band rig on the u.h.f. The electrical requirements for the tuned circuits call for a few pieces of coaxial cable about 4 inches long which are going to make the dimensions quite practical, in size and on the pocket-book.

The receiver problem seemed a bit more complicated at first, but one of the recently announced tubes and the plain "butterfly" solves that difficult problem. A superhet using a light-house tube, or a 6E4, as a regenerative 1st detector giving an i.f. of around 20 Mc. looks quite feasible. From the i.f. on, ordinary tubes will handle the job. The wide tuning range possible

(Continued on page 118)

Waves and Wave Guides

THE microwave field that was so fruitfully explored during the war is characterized not only by strange-looking devices, but as well by new ideas and a new language. New, that is, to those who were not exposed to microwave equipment in wartime, those whose experience has been confined to the region half-jokingly, half-scornfully dubbed "d.c." by the explorers above 300 megacycles. Now that we amateurs have microwave bands of our own to exploit, we'll have to extend some of our concepts of how things work. For example, for years we've dismissed electromagnetic waves as something that obviously had to exist if there is to be any radio communication, but hardly a subject to be worried about in detail. But in the microwave region waves are contained in the station equipment itself as well as in the space between the transmitter and receiver. We can't ignore them any longer.

Wave Representations

There appears to be no really satisfactory way of representing an electromagnetic wave in an ordinary drawing. This is not surprising, because a wave has no physical substance. The "conventional" representations usually are plots of mathematically-expressed properties of the wave, and bear no more resemblance to the actual wave than a sine curve does to the alternating current it is supposed to describe. However, we *do* have a satisfying mental picture of electrons moving through wires, and are so accustomed to the relationship between the sine curve and current intensity variation with time that the absurdity of visualizing alternating-current flow in caterpillar-like convolutions along a wire hardly ever occurs to us. Yet it is only too easy to form an equally-absurd picture of a wave — lacking even the electron, intangible though it is, to tie things down. But, having nothing better, we are compelled to stick to the various conventional forms of representation, continually keeping in mind that these forms are not to be taken literally but must be properly interpreted.

Everyone who has done a little reading on radio knows that an electromagnetic wave in space consists of traveling fields of electric and magnetic force. The two fields are separate but not independent, and go through identical variations with time when viewed at a fixed point in space. In the case of a "pure" wave, or one involving only a single frequency, these time variations follow a sine curve; hence we draw (as in Fig. 1) the same curve to represent them that we use to show the variation with time of an alternating current. In the case of the alternating current, the ordinate above the zero axis commonly would be labeled

"plus" and that below "minus," to indicate that the current is flowing in the positive direction whenever the curve is above the axis and in the negative direction whenever the curve is below the axis. That is, each time the sine curve passes through the axis the direction of current flow reverses.

As applied to a wave, Fig. 1 says that the field (either one, electric or magnetic) exerts its force in some unspecified direction whenever the curve is above the axis and that this direction is reversed whenever the curve is below the axis. The curve does not show the *actual* direction; it has no means of doing so. By definition, the direction of an electric field of force is the direction in which a small positive charge would move when placed in the field; similarly, the direction of a magnetic field is the direction in which a small north pole would move in the field.

Let us assume that we have a field which at some instant such as A on the time scale starts from zero and increases in intensity, the direction — it might be south, for example — being indi-

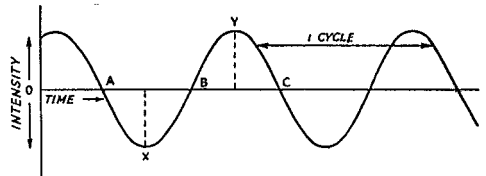

Fig. 1 → Sine-curve representation of intensity variations in a wave field with time, at a fixed observing point.

cated by the fact that the curve is below the axis. The intensity reaches a maximum at a later time X, then dies away until at a still later time B it has dropped to zero. During all this time the direction of the field is still south. After reaching zero the field again begins to grow, but this time the direction is just opposite — north, in this case. The intensity increases until time Y, then dies away again until at time C it has once more returned to zero. However, during the time interval between B and C the direction always was north — unchanging until the curve once more dropped below the axis beyond C.

This is a basic point that must be grasped before one can hope to form a clear mental picture of the wave. Since the time element is important, it may help to consider the drawing in a slightly different way. Imagine the sine curve as moving at constant speed toward the left — the whole curve, not simply a point traveling along it like a car on a roller coaster. If we select the intensity ordinate at the left as the observing point, then the height of the curve as it cuts across the or-

dinate will be the relative intensity of the force, measured from the zero axis. When a zero-intensity point, such as A, reaches the ordinate the direction reverses and the intensity increases with time in the opposite direction. What we see as the curve moves by is a continuous change in intensity (and, periodically, a change in direction), a change which has nothing to do with height except that the height of the curve represents its value. The curve itself definitely is not a picture of the wave.

When the intensity variations have gone through the whole gamut of possible values, one cycle has been completed and the whole thing starts over again. Each succeeding cycle is exactly like the first since we have assumed a wave of constant frequency. If the curve moves at constant speed, then, it will move the same distance during each cycle, hence the familiar relationship between speed (or, as it is usually called, "velocity of propagation"), frequency and wavelength.

By changing the label on the horizontal axis from "Time" to "Space," as in Fig. 2, we can get a different interpretation from the same curve. Now we assume that instead of making our observation at a fixed point in space and letting time run on, we take an instantaneous snapshot of the intensity variations in the field as they are distributed along a line parallel to the direction in which the wave is moving. If we could make time stand still while we moved along such a line measuring the field intensity, the value of the field at any point along the axis would be proportional to the height of the curve above or below the axis at that point. Again we should find a periodic reversal in direction. However, the curve merely says that the direction reverses; it does not say what the direction is. The distance between any two points having the same direction and intensity is equal to the wavelength of the wave, as shown on the drawing. But obviously the curve does not give an actual picture of the wave — no more than it did with the different label in Fig. 1.

Another form of representation is shown in Fig. 3, with the corresponding sine curve shown above. In this case the intensity is indicated by the closeness of spacing of the lines and the direction by the arrowheads. This form at least elimi-

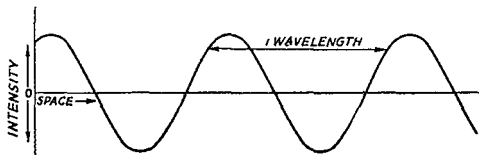

Fig. 2 — By changing the label on the horizontal axis, the sine curve can be made to represent intensity variations in space at a fixed instant of time.

nates the undulatory aspect of the sine curve and to some extent gives a better physical picture of the wave. But limitations still exist, particularly with respect to the extent of the wave. To illustrate, suppose that the wave is moving north. Then if we could take a group of simultaneous measurements along an east-west line we should

find that the same value of intensity and direction exists at every point. Likewise, a similar group of measurements made at various heights over a fixed point on the ground would show the same intensity and direction. In other words, intensity and direction would be the same, at any given instant, at any point in a plane perpendicular to the direction in which the wave is traveling. The wave is called a plane wave for that reason. (Strictly speaking, no wave can be truly plane except at an infinite distance from its source, because radiation traveling in all directions from the source resembles an expanding sphere. How-

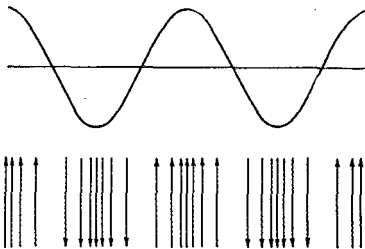

Fig. 3 — In this drawing, the spacing between arrows indicates the relative intensity of the field — the closer the spacing the greater the intensity — and the arrowheads indicate the field direction.

ever, for all practical purposes the curvature at a reasonable distance from the source is so small that the wave is substantially plane.)

With the interpretation and limitations of the diagrams in mind, it is not too hard to form a picture of the traveling field. This picture becomes more complicated when it is remembered that there are *two* fields to consider in an electromagnetic wave. However, the second field goes through the same variations as the first; the difference is that the *direction* of one field always is at right angles to the direction of the other. Further, the directions of *both* fields are at right angles to the direction in which the wave itself is traveling. If the wave be traveling north, for example, the direction of the electric field at some chosen instant at a fixed observing point might be west, in which case the magnetic field direction at the same instant and same spot would be downward; both these directions are perpendicular to north and to each other. At some later time the electric field at the point of observation will have reversed and will be directed east; at the same instant the magnetic field will be directed upward. Both fields, in other words, always have directions transverse to the direction of propagation. Such a wave consequently is called a "transverse electromagnetic" wave, usually shortened to "TEM" wave.

Waves Along Transmission Lines

The TEM wave is the type found in space and also is the type that travels along a two-conductor transmission line, either parallel or coaxial. In the line case, the electric lines of force extend from one conductor to the other, their direction being at right angles to the direction of propaga-

tion, which is the direction of the line itself. The magnetic lines surround the conductors of the parallel line, and form concentric circles between the conductors of the coaxial line; they are everywhere perpendicular to the electric lines and to the direction of propagation. This is shown in Fig. 4. The intensity of the fields varies along the line at any instant just as in the case of the space wave whose intensity-space variation is shown in Fig. 2, and the intensity varies with time at a given point as shown in Fig. 1.

There are no frequency limitations on such lines; they will carry power at any frequency from d.c. right on up. Of course, if the spacing between the conductors of a parallel line becomes comparable to the length of the wave being carried the line moves into the antenna category rather than

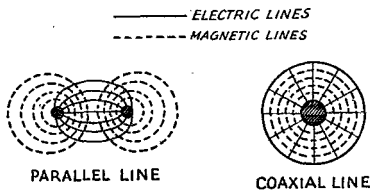

Fig. 4—Electric and magnetic field distribution in two-conductor transmission lines, looking into the lines through a cross section. The direction of propagation is either perpendicularly into or perpendicularly out of the paper, depending upon the relative directions of the electric and magnetic fields.

operating without losses from radiation, but that is somewhat beside the point of the present discussion.

An Important Principle

In dealing with waves theoretically it is customary to assume that conductors and dielectrics have no losses. Such assumptions greatly simplify the calculations; modifications to take losses into account can be and are introduced afterward to make a satisfactory approximation of actual conditions. If a conductor is perfect (i.e., has zero resistance) then the direction of any electric field which touches it must be at right angles to the surface at the point of contact.

A description of the reasoning that leads to this conclusion tends to become somewhat involved, but the general idea is this: If the field has a component directed along the conductor (and there will be such a component if the field direction is other than perpendicular to the surface) there will be a difference of potential between any two points along the conductor. Because of the difference of potential a current will flow through the conductor, and since the resistance is assumed to be zero the current will be infinitely large. An infinitely-large current — and particularly an infinitely-large alternating current — leads to all sorts of physical impossibilities. On the other hand, if the field is perpendicular to the conductor surface, just enough electrons are drawn to the surface (or repelled from it, depending upon the direction of the field) to produce a charge that will balance the field intensity at the

surface. There they are held — “bound” — by the field, and there is no current flow because there is no difference of potential between points along the conductor. Current flows only when the intensity of the field is changing, and the value of the current is just that which corresponds to the electrons adjusting themselves to the new field conditions.

This principle is fundamental in dealing with waves in metallic guides. Consider again the representation in Fig. 3, remembering that this is an instantaneous picture and that the field strength at any point is continually changing as the wave moves along, say to the right. From the previous discussion the lines of force could be visualized as lying in planes perpendicular to the page on which the drawing is printed, each plane marking off a very thin slice of space in which the field is everywhere the same. The same, that is, at a given instant. At any later time, however short the interval, the field strength in the same slice of space has changed, but again it has the same value throughout the slice. Fig. 5 repeats Fig. 3 in showing a side view with this method of representation, but includes additionally what might be called an end view of the wave, showing by the uniform spacing of the arrows that the field is uniform both left and right and up and down. Naturally, this can only represent a small section of the wave; actually, the set of arrows should be extended indefinitely to the left and right and their length should be enlarged to any value that the imagination can encompass. Furthermore, it represents only one of the two fields — either one — so the other must be visualized as having the same time- or space-intensity variations, but with its direction always perpendicular to the first and to the direction in which the wave is moving. However, it is easier to deal with only one of the two, and for the moment we are chiefly interested in the electric field.

Now suppose we place a hollow rectangular pipe in the electric field of the wave in such a way that the length of the pipe is parallel to the direction of wave motion, giving us in Fig. 6 an end view of the wave trying to carry on through the open end of the pipe. Remember that the field

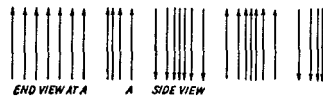

Fig. 5—Side and cross-section representations of space distribution of field intensity in a wave at a given instant. A cross-section taken at another point than *A* would show different spacing between the lines, indicating a different field strength in that cross section. However, in any given section the field strength is uniform throughout.

exists just as much between the lines depicted as on them; the spacing between lines is just an attempt to represent the relative field strength by agreed-upon symbols. The lines of force are perpendicular to the top and bottom of the pipe, hence are in agreement with the principle discussed above. But at the sides of the pipe the

field direction is *parallel* to the walls of the conductor. And since this means that an infinitely-large current would flow in the side walls, the existence of a wave of the plane type in a hollow wave guide becomes impossible. If it is to fit into a pipe, the wave cannot have uniform field strength in a plane perpendicular to the direction of wave travel. The field in such a plane must be distributed in such a way that the lines of electric force are always perpendicular to the walls of the guide at points where the field touches the walls. Either that, or the electric field at some or all of the walls must be zero.

If a field distribution such as that shown in Fig. 3 could be achieved perpendicular to the direction of propagation, these requirements would

Fig. 6 — A uniform field cannot be enclosed by a rectangular hollow conductor, shown here in cross section by the dashed line.

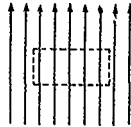

be met. However, Fig. 3 must be given a somewhat different interpretation — always we run up against the impossibility of showing on a flat page a continuous four-dimensional phenomenon. We now visualize Fig. 3 as representing not a wave seen from the side and traveling to the left or right, but as a *stationary* distribution of field intensity in space. The *time* variations that take place are now simply in the intensity of the field; although the intensity at any point varies with time according to the sine law, the field is always zero at the same spot in space and always has its maximum value midway between two zero locations.

In other words, we might imagine Fig. 3 to be an *end* view of a new type of wave having fixed maxima and nulls along a line perpendicular to the direction in which the wave is traveling — a sidewise standing-wave phenomenon in space. If we do this, it becomes perfectly possible to fit the wave into the rectangular pipe; all that is necessary is to place the guide so that its side walls coincide with a null, or zero line of electric field, as in Fig. 7. The field at the surfaces of the side walls being zero, no current will flow in these walls.

Standing Waves

No single wave can have this kind of field distribution. On antennas and transmission lines, standing waves result only when there are reflections so that the wave traveling out along the line or antenna meets another wave coming back. In this familiar case the two waves follow exactly the same paths, although in opposite directions, and the length of the standing wave is exactly the same as the length of a single wave traveling along the same transmission line. But if we are to have a *sidewise* standing wave the reflections must take place from the *sides* of the pipe; a simple reflection from the far end would give just the same kind of standing wave as on an ordinary transmission line, one that is wholly along the di-

rection of transmission. So waves traveling in pipes must go sidewise at the same time that they move forward.

A simple graphical approach to this requires still another method of depicting the wave. Suppose that the sine curve of Fig. 2 showing the space distribution of the field intensity at a given instant is imagined to exist in three dimensions, resembling corrugated paperboard or a corrugated tin roof. Then Fig. 2 is a view of the edge, and a rough indication of the top view of the curve is given by Fig. 8, where a thin line represents a null, a solid heavy line a positive maximum and a dashed heavy line a negative maximum. Keep in mind that the lines in this method of representation are not lines of force (that is, they do not show the direction of the field) but simply mark the regions in space where maxima and nulls exist. We are looking down on the wave in much the same way that we can look down on ripples in a stream from the vantage point of a bridge. The direction of travel is perpendicular to the lines of maxima and minima, just as the direction of travel of water waves is perpendicular to the "ridges" in the water. The distance between any two adjacent lines in the direction perpendicular to them is a quarter wavelength, between any two alternate lines a half wavelength, and so on.

Now suppose we use this method of representing the electric fields of two waves traveling at some angle to each other, as in Fig. 9. We can imagine one wave as moving from upper left to lower right and the other from lower left to upper right. Then there is a series of straight lines, *XX*, *YY* and *ZZ*, along which the field strength always is zero because the positive maximum of one wave always is met at that line by the negative maximum of the other, giving a net field of zero. The same cancellation is true of intermediate values in corresponding parts of the waves. (A water-wave analogy of this phenomenon can be

Fig. 7 — The space distribution of field shown here can be enclosed by a rectangular hollow conductor (dashed lines) because there is zero field at the side walls, while the field is perpendicular to the top and bottom walls.

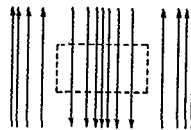

found, too; nearly everyone has observed the standing waves that exist on the surface of a pond when two sets of traveling waves intersect at an angle.) A metallic conductor such as the side wall of a rectangular pipe could be placed along any of these null lines without causing any disturbance.

The two waves combine to form a resultant single wave, just as two forces combine to form a single resultant force. And since the waves are assumed to have equal amplitudes, the resultant wave travels along a line bisecting the angle between them, from left to right in the case assumed in Fig. 9. Note that the null lines likewise bisect the angle between the directions of travel of the two waves; in other words, the null lines are parallel to the direction in which the re-

sultant wave propagates. This being the case, the side walls of a rectangular pipe can be placed along any pair of these lines and the wave will travel through the pipe.

Along a line, such as AA, perpendicular to the direction of propagation the field intensity will vary from zero at the null lines to a maximum just half-way between any pair of lines. This is indicated by the fact that the *same* type of maxima intersect midway between the null lines; for example, between YY and ZZ the negative maxima add together along the line AA. Thus we obtain — as a standing wave — the type of field distribution shown in Fig. 3 as an instantaneous picture.

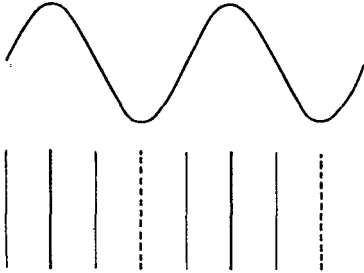

Fig. 8 — The representation at the bottom shows, by alternate light, heavy and dashed lines, the locations of nulls and maximum in a "corrugated sheet" sine wave when viewed from the top.

Two possibilities are shown in Fig. 9. If the side walls of the guide are placed at YY and ZZ the stationary electric field distribution as measured along AA will go through one variation from zero through a maximum and back to zero; that is, through one "half-period" variation. The term "half-period" is used intentionally in preference to "half-wave" for reasons which will become clear in a moment. If the side walls are placed at XX and ZZ, the stationary field as measured along AA will rise from zero through a positive maximum, back to zero, then through a negative maximum and finally back to zero again. This is a "full-period" variation, or two half-period variations. Any number of these half-period variations can exist, provided the side walls are separated the proper distance to accommodate them.

In a way, building up a picture of wave propagation in a guide in this fashion is putting the cart before the horse, because we have assumed *two* waves and then put the side walls of the guide at the locations dictated by the necessity for having zero electric field at these walls. The two waves in a guide are separate waves in the same sense that the outgoing and reflected waves on a transmission line are separate. In other words, the second wave is simply the first after reflection from a side wall of the guide. The reflected component cancels the primary component at the

wall — that is, the electric field is reflected with a reversal of phase — because, since the lines of force are not perpendicular to the conductor, this field must be zero at the surface of a perfect short circuit. This is true whether it be the short at the end of a transmission line or the wall at the side of a hollow guide. Fig. 9 is a means by which a picture of the locations of the zero-field lines can be formed with a minimum of complications. But it is also a true picture of what happens when a wave is introduced into the guide; reflections occur all along both side walls since both are equally exposed to the incoming wave, and the total effect is the same as though two separate waves actually were present. Since the angle of reflection is equal to the angle of incidence, the direction of propagation is straight down the guide.

The physical spacing between the null lines depends upon the wavelength of the two waves or components and the angle between them. Obviously, if the wavelength is made longer or shorter, leaving the angle fixed, the null lines will be farther apart or closer together, respectively. This merely corresponds to changing the scale in Fig. 9. But if the angle between the wave directions is varied, the spacing between the null lines will increase as the angle is made smaller. When the angle becomes zero degrees the two waves merge into one and the spacing between null lines becomes infinite, which is simply another way of saying that a single wave component cannot exist in a guide.

When the angle between the two wave directions is 180 degrees the waves again merge, but the resultant wave is then simply traveling crosswise in the guide and there is no propagation *through* it. In this limiting case the distance in which the field goes through a half-period variation is the same as a half wavelength in space, since the direction of wave travel is the same as the direction in which the distance across the guide is measured. The side walls cannot have any closer spacing than this; anything less would be

(Concluded on page 180)

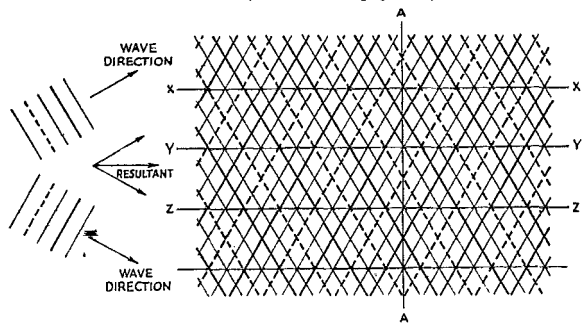

Fig. 9 — The fields of two travelling waves add at any point in space to give a resultant at that point having an amplitude and direction dependent upon the amplitudes and directions of the two component waves. This drawing represents a space distribution for a single instant of time. The two wave components, assumed to have equal amplitudes, are shown at the left, with the direction of propagation indicated. The resultant wave direction is shown by the small drawings between. Along lines such as XX, YY and ZZ the resultant amplitude always is zero, giving rise to standing waves in space.



ON THE VERY HIGHS



CONDUCTED BY E. P. TILTON,* W1HDQ

WERE you caught off base too? The sudden ending of the war, and the unexpected reactivation of the 112-Mc. band in essentially its prewar form, found a large part of the country's v.h.f. population without the means to get going quickly, and many of them away from home. That first week or so was a hectic period, but it didn't take long for things to get rolling.

By Labor Day there was a definitely prewar sound to the 112-Mc. band in most of the populous areas along the East Coast, in the area around the Great Lakes, and in many of the cities of the Pacific Coast. It was a haywire beginning, generally; there was little time for refinements in that first mad rush, and the gear would only be in use for a short time anyway, in view of the conversion to 144 Mc. to be made within a few weeks. It was strange, too, at first, to find that you couldn't always remember names; it was hard to know just what to say, after years of inactivity, or, at best, the use of the stilted forms of WERS or military communication; but all those who took part in those first nights of activity stored up memories of an experience that will stay with them for many a day.

Credit for the first DX reported goes to Art Laverty, a recent licensee, who, with W4HVL/9, operating from an elevated location near St. Charles, Ill., worked SCM W9EGQ, Gary, Ind., a distance of about 60 miles, on the night of August 28th. They were using a 15-watt mobile job and a 4-element beam. Other contacts included W9PK, Downers Grove, Ill.; W9MAT, La Grange; W9CYT, Evergreen Park; and W9MVZ, Gary.

On September 2nd, W9YQC/8, operating mobile from a bluff overlooking the Lake, near Benton Harbor, Mich., worked W9DUT and W9EGQ of Gary, Ind., and W9BAY, Chicago Heights; and W9FCN, La Grange, Ill.; the distance being around 75 miles to the Illinois stations. W9YQC/8 and W9FCN both used crystal-controlled 815s at 30 to 50 watts input and 4-element beams. W9EGQ has 14 watts input to an 807 doubler, and an eleven-tube superhet, which gives excellent results, especially on weak-signal reception of stabilized rigs.

W9PK, Downers Grove, Ill., reports 34 stations worked between August 22nd and September 10th. Jack has a stabilized rig using an 815 in the final at 30 watts input, and a four-element horizontal array. The polarization question, as always, is a problem in the Chicago area. Most stations are using verticals, but the advocates of horizontal polarization are gaining ground.

W8CVQ, Kalamazoo, Mich., was heard in both Chicago and Gary on September 4th. This distance of 100 miles or more is the next mark for the boys to shoot at, and W9EGQ reports that W9BAY has heard Indianapolis WERS signals on several occasions — a path of some 200 miles.

Labor Day week-end provided the East Coast with its first taste of inversion DX, with conditions hitting the peak on the night of September 5th. It was a typical late-summer session, and numerous contacts were made between stations in Rhode Island, Massachusetts and Connecticut, and those in New York, New Jersey and Pennsylvania. W1KOE, Wakefield, R. I.; W1BJE, Westport Harbor, Mass.; and W1IJ, Madison, and W1JLK, Tolland, Conn., were working into the second and third call areas. Contacts beyond 100 miles were numerous, and several neared the 200-mile mark. W1KOE worked W2COK, Staten Island, N. Y.; W9BBD/2, Eatontown, N. J.; W3BES, Glenside, Pa.; and W6SGX/3, 8 miles west of Philadelphia, a distance of close to 200 miles.

W1LLL, Hartford, still doing business at the same old stand, heard many signals from beyond the normal range, including W1KGE, Darien, Conn.; W1LWE/2, Glen Cove, L. I.; W1LUD/1, Mt. Greylock, Mass.; W1BJE and W1KOE; W3AC, mobile; W3BES; and W2OEN/2 at Speculator, N. Y. Your conductor was in the throes of his first postwar DX that night, operating from a 1000-foot elevation near Somers, Conn., where he yelled himself hoarse at various W2's — to no avail!

W3ELI, Norfolk, Va., writes that most call areas are represented by stations working portable in that vicinity. By late September, the following were being heard: W1LVN, W2DOR, W3ELI, W3HKE, W3HWT, W3NT, W5HHU, W6IQL, W7FAE, W8BUJ, W8VGO, and W9AWL, as well as numerous others who had not been identified. Army planes in the vicinity, calling Washington, more than 150 miles distant, on 116.1 Mc., sounded like rather good DX for that frequency, even though they were at 9000 feet.

W9BBD/2, Eatontown, N. J., reports 39 stations worked up to September 10th. He is using an f.m. exciter driving an 815 at 75 watts input, and a vertical folded doublet. A 400-watt final for a.m. or f.m. is in the works. Checks on f.m., with stations equipped to receive it properly, have resulted in excellent reports; but a.m. has to be used most of the time for maximum readability in the superregenerative receivers generally in use.

We have no direct reports of activity from the West Coast, but we understand that Twin Peaks, San Francisco, is taking its customary beating, and the mountains back of Los Angeles have already seen plenty of mobile and portable activity. W6OVK, formerly of Tucson, Ariz., is in San Francisco, and rarin' to go; but his gear is spread out over various parts of the country (a commonly heard complaint) and his pet receiver, an a.m. f.m. job with 5- and 30-Mc. i.f. channels and separate converters for the various v.h.f. bands, has been lost in shipment.

W7GSJ, Whitefish, Mont., writes that he ex-

(Concluded on page 110)

* V. H. F. Editor, QST



IN THE SERVICES

MANY novel means of getting in touch with fellow hams have been mentioned in these columns; here is an addition to the list. SKT3c Edwin Thaiss painted his call, W8PCS, on the back of his dungaree shirt and "worked" these calls: W1HWN, W1MGL, W2LUN, W3LZR, W4ART, W4EWQ, W4FWS, W4HRH, W5HAT, W5JBM, W6BPQ, W6DWN, W6GUV, W6MQF, W6ONX, W6OPC, K6PAS, W6PCO, K6PUL, W6PVS, W6QQV, W6RXV, K6TCW, K6UOK, W7AGX, W7ENH, W8HTM, W8NGF, W8TEC, W8VJB, W8WBT, W9AOP, W9BNJ, W9CAX, W9FVO, W9JLY, W9KNO, W9LRT, W9PVG, W9QII, W9RDH, and many others whose calls he failed to record.

ARMY—SIGNAL CORPS

1GEV, Wiggin, 2nd Lt., Pine Camp, N. Y.
 1MDM, Phillips, T/4, foreign duty
 1MFO, Boucheron, 2nd Lt., foreign duty
 1MPA, Curley, T/Sgt., foreign duty
 1MPF, Beckman, T/4, Ft. Jackson, S. C.
 1NDJ, Becker, T/4, Pine Camp, N. Y.
 2BWY, Brody, S/Sgt., foreign duty
 2CR, Bleier, Pfc., Pine Camp, N. Y.
 2LCW, Emaus, T/4, foreign duty
 2MRJ, Engert, T/4, foreign duty
 2NPG, Staiano, Sgt., foreign duty
 3FEL, Shenberger, T/3, foreign duty
 3QS, Ricketts, T/3, foreign duty
 ex-3UG, Lansford, Col., foreign duty
 4CZS, Whitley, 2nd Lt., foreign duty
 4FFE, Foster, foreign duty
 4FSA, Wing, T/5, Pine Camp, N. Y.
 4GYS, Frase, T/5, foreign duty
 4HSS, Elkins, Pfc., Ft. Monmouth, N. J.
 5CSR, Gallegos, Capt., Ft. Monmouth, N. J.
 5KNG, Reeves, foreign duty

MARINE CORPS

1LCP, Machen, S/Sgt., foreign duty
 5JHO, McClure, Lt. Comdr., foreign duty
 5JHQ, Heath, MT/Sgt., Beaufort, N. C.
 ex-6JTM, Mattison, W/O, foreign duty
 7FJQ, Scarpelli, Lt., Quantico, Va.
 9IUL, Bolduan, MT/Sgt., South Gate, Calif.
 9IUO, Bolduan, Lt., foreign duty
 9JHF, Blomberg, T/Sgt., Camp Lejeune, N. C.

Operator's license only:

Hayward, Sgt., Philadelphia, Pa.
 Schaffer, Cpl., El Centro, Calif.
 Wernts, MT/Sgt., Philadelphia, Pa.

COAST GUARD

1AIN, Lavallee, Lt., Baltimore, Md.
 2HSB, Naegler, CRM, Arverne, L. I., N. Y.
 2NPD, Braendle, Lt. Comdr., foreign duty
 3GPU, Stewart, CBM, Philadelphia, Pa.
 ex-4ADKS, Hamner, CRM, New Smyrna, Fla.

4EUV, Johnson, Ft. Lauderdale, Fla.
 4FKI, Chinnis, CRE, Baltimore, Md.
 4HMF, Freeman, CRT, Newark, N. J.
 5JPM, Cox, CRM, Baltimore, Md.
 6LYB, Langenbeck, Ens., Cambridge, Mass.
 6RNL, Robin, RE, foreign duty
 ex-7BLN, Worthley, Lt(jg), Coos Bay, Oregon
 K7IUT, Reynolds, RM2c, Crescent City, Calif.
 8DBD, Kaderbek, CRT, Norfolk, Va.
 8VCB, Young, RM1c, New Smyrna, Fla.

Operator's license only:

Adams, RM2c, Portsmouth, Va.
 Coats, RM2c, foreign duty
 Drinkard, RM1c, Galveston, Texas
 Godward, CRT, Baltimore, Md.
 Sumner, RM1c, foreign duty
 Thompson, RT2c, San Francisco, Calif.
 Walker, RM1c, Baltimore, Md.
 Wilson, CRT, Baltimore, Md.

ARMY—AIR FORCES

ex-1JEG, Glinka, Pvt., Scott Field, Ill.
 1JIN, Katsanos, Cpl., foreign duty
 1KBX, Fowler, T/Sgt., Greensboro, N. C.
 1MHX, Ton, S/Sgt., Muroc, Calif.
 1NSD, Copley, Lt., Hondo, Texas
 2DBN, Kirschnek, Sgt., Tampa, Fla.
 2HAO, Ayrault, M/Sgt., foreign duty
 ex-2HGX, Zemek, Capt., foreign duty
 2IEQ, Borowski, Sgt., Gulfport, Miss.
 2IOL, Mitchell, Major, foreign duty
 2NMF, Brinkmann, Cpl., Tucson, Arizona
 2NMG, Gillingham, Pvt., Trux Field, Wis.



Lt. Ray Long, W5ERM, Signal Corps, believes in "fraternizing." Here he is, near Altkirchen, Germany, kneeling with a German "friend." The enemy was just across the Scig river at that time.

2OIM, Nash, Lt., Barksdale Field, La.
 2OKQ, Bonnell, Major, Arlington, Va.
 3DIP, Waters, Sgt., Columbia, S. C.
 3FYH, Johnson, Cpl., Dale Mabry Field, Fla.
 ex-3GI, Smith, Sgt., Boca Raton Field, Fla.
 3HOZ, Beatrice, F/O, foreign duty
 3JWA, Virgin, Pfc., Laredo, Texas
 4GLQ, Rhodes, Major, Dalhart, Texas
 4IDV, Painter, T/Sgt., Orlando, Fla.
 4IBT, Street, Cpl., Spence Field, Ga.
 5BKM, Jolly, Capt., Nashville, Tenn.
 5HKD, Worrell, Cpl., foreign duty
 5IGQ, McKenzie, S/Sgt., foreign duty

ARMY—GENERAL

1IJT, Bourdeau, Pvt., Aberdeen Proving Grounds, Md.
 KA1JK, Fowler, T/Sgt., foreign duty
 ex-1LVT, Bixby, Capt., foreign duty
 ex-2EAC, Riker, T/Sgt., Ft. Knox, Ky.
 2IVY, Krainen, T/Sgt., foreign duty
 2MDP, Csulik, T/3, Woodbridge, N. J.
 2NCL, Malony, Sgt., Brooklyn, N. Y.
 2NXS, Soled, Pvt., Jersey City, N. J.
 3GIF, Hamilton, Pfc., Brooklyn, N. Y.
 3HMT, Young, M/Sgt., foreign duty
 3JRZ, Staub, Pfc., foreign duty
 4DYC, Hunt, Capt., Pine Camp, N. Y.
 5FMQ, Lee, Capt., Camp Beale, Calif.
 5KGS, Maddux, Sgt., foreign duty
 5KNR, Towery, S/Sgt., Toole, Utah
 6BUF, Ewing, Major, foreign duty
 6BDW, Heinsman, Lt., foreign duty
 6LQC, Wiley, Major, Lawton, Okla.
 ex-6MNB, Smith, Pvt., foreign duty
 6TIS, Kawaminami, Pfc., foreign duty

MERCHANT MARINE AND MARITIME SERVICE

1BQR, Nash; 1KKS, Matchett; 1NCE, Beck; 2GSS, Cavigha; 2HJZ, Depew; 2IQX, Tamburo; 3HUH, Pearlman; 3JOL, Blume; 4HIP, Thomas; 4ICQ, Willner; ex-6AAV, Philbrook; 6APE, Lane; 6EBE, Haydon; 6GYK, Schulte; 6LMI, Meek; 6LYS, Richards; 6NSQ, Larter; 6OUQ, Post; 6PIV, Pearson; 6KTCQ, Sundstrom; 7NCJ, Gannon; 8NED, Mills; ex-8OIV, Lalic; 8SDQ, Antenen; 8TVY, Sntzer; 8UBB, McLaughlin; 8WVSU, Gutasa; 8AYB, Wilson; 8JRA, Mak; 8NII, Battcher; 9TCB, Basler; 9YCG, Falk; 9YFV, Schmeichel, and 9YKO, Sheehan. Bridget, Brown, Faust, Flint, Hansen, Hood, Klischimer, Kirkvold, and Lightfoot hold operator's license only.

NAVY—GENERAL

ex-1ASR, Rand, Lt. Comdr., Oakland, Calif.
 ex-1BTE, Hall, Ens., Boston, Mass.
 1CGM, Janik, Lt., Boston, Mass.
 ex-1CUM, Watson, Lt., foreign duty
 ex-1PMC, Henderson, Lt(jg), Boston, Mass.
 1JTI, Thompson, RM2c, foreign duty
 1LTO, Learned, Lt(jg), Boston, Mass.
 1MZO, Cobb, S2c, Los Angeles, Calif.
 1NRU, Saltonstall, RM2c, address unknown
 2DJK, Gunter, Sic, foreign duty
 ex-2DVK, Cattermole, Lt. Comdr., Annapolis, Md.
 ex-2ECS, Ward, Lt., Washington, D. C.
 2EQT, Beck, RM2c, address unknown
 2FGM, Maslanka, CRM, Gulfport, Miss.
 2FTT, Hansen, Lt., Bayside, N. Y.
 2FVJ, Shiffer, EM1c, foreign duty
 2GDU, Somers, Lt., Washington, D. C.
 2GE, Wells, CRE, foreign duty
 ex-2HH, Panzer, RM3c, foreign duty
 ex-2HHH, Weber, Lt. Comdr., Annapolis, Md.
 2HSX, Sheridan, Lt., address unknown
 2ICQ, Daly, Lt., Annapolis, Md.
 2IDQ, Vanderford, Lt. Comdr., address unknown
 2IDY, Sheldon, CRM, San Diego, Calif.
 2IEA, Littell, Sic, Chicago, Ill.
 2JLT, Ruch, Lt., Washington, D. C.
 2KJL, Plaisted, Comdr., Washington, D. C.
 2KVV, Grill, RM1c, foreign duty
 2LTD, O'Connell, RM1c, foreign duty
 2LNN, Wicoff, CRE, foreign duty
 2MNS, Obermiller, Lt(jg), Washington, D. C.
 2NFK, Parody, Lt., Washington, D. C.
 2ODC, Lester, Sic, Great Lakes, Ill.
 2OED, Schroeder, RM2c, foreign duty
 2OKY, Davidson, Sic, Great Lakes, Ill.
 3AKY, Uher, Lt. Comdr., address unknown
 3ANJ, Godwin, Lt., address unknown
 3BDF, Wilkinson, CRM, Chatham, Mass.

3BWK, Shall, Lt. Comdr., Washington, D. C.
 3CHC, Phillips, CRM, Washington, D. C.
 3CXJ, DeBattencourt, Lt. Comdr., Washington, D. C.
 3DOM, Anderson, CRM, Madison, Wis.
 ex-3DWF, Helfrich, Lt. Comdr., Annapolis, Md.
 3EFL, Lamb, Lt., Washington, D. C.
 ex-3EL, Gustof, Comdr., Washington, D. C.
 ex-3EY, McIntyre, Comdr., Washington, D. C.
 3GGE, Duncan, Ens., Washington, D. C.
 3GOR, Riohardi, Lt., Baltimore, Md.
 3GYS, Volkert, S1c, Great Lakes, Ill.
 3HCY, Marsh, Lt., address unknown
 3HKJ, Beaulieu, Sp(Q)TE3c, Washington, D. C.
 3IMN, German, Lt. Comdr., address unknown
 3IOY, Hawley, CRM, Chatham, Mass.
 3IOZ, Groom, Lt.(jg), Great Lakes, Ill.
 3JGJ, Crabill, RM2c, foreign duty
 3JIM, Zorzy, RM2c, address unknown
 3JZJ, Shostak, Lt., Washington, D. C.
 ex-3PE, Williams, Lt. Comdr., address unknown
 ex-3TL, Dow, Capt., Washington, D. C.
 ex-3XY, Appleby, Lt. Comdr., New York, N. Y.
 3ZN, Doe, Lt., Philadelphia, Pa.
 ex-4ABA, Hyers, Comdr., Washington, D. C.
 ex-4APB, Durst, Lt., address unknown
 4BIH, Knight, Lt. Comdr., address unknown
 4BLF, Griffin, Lt. Comdr., foreign duty
 4BYV, Dickinson, Lt.(jg), address unknown
 ex-4DL, Hilgedick, Lt. Comdr., Washington, D. C.

4DRI, Fox, A/S, Great Lakes, Ill.
 4DRU, Turner, Lt., foreign duty
 ex-4DTF, Miller, CRM, foreign duty
 ex-4DJC, Daniel, Lt. Comdr., Boston, Mass.
 4DVK, Westfall, CEM, Davisville, R. I.
 4DZC, Lee, CRM, Jupiter, Fla.
 4EAC, Menneken, Lt. Comdr., Annapolis, Md.
 ex-4EBJ, Spano, RM1c, foreign duty
 4EEA, DeLay, RM1c, address unknown
 4EUD, Paxon, Lt., Alameda, Calif.
 4EZ, Clark, Lt. Comdr., address unknown
 ex-4FF, Towse, CPhOM, Patuxent River, Md.
 ex-4FIY, Turberville, BM1c, foreign duty
 4FQJ, Mayo, Lt.(jg), foreign duty
 4GKE, Ayres, S2c, Great Lakes, Ill.
 4GYL, Johnson, Lt. Comdr., Chatham, Mass.
 4GZU, Pratt, Midshipman., Annapolis, Md.
 4HGD, Martin, Lt.(jg), foreign duty
 4HIG, Miner, Midshipman., Notre Dame, Ind.
 4HKK, Yarns, A/S, Great Lakes, Ill.
 4HME, Sanderson, RM2c, foreign duty
 4HNB, Ferris, S1c, Indianapolis, Ind.
 4HOW, Nelms, S1c, foreign duty
 4HWD, Kelly, RM3c, foreign duty
 4IEQ, Fogle, RM1c, Chicago, Ill.
 4PE, Tompkins, Lt. Comdr., Pensacola, Fla.
 4SQQ, Patterson, CRM, Washington, D. C.
 ex-5ACZ, Conroy, Lt. Comdr., foreign duty
 5AEB, Chaney, Lt. Comdr., Annapolis, Md.
 ex-5AZZ, Goolsby, Lt. Comdr., Annapolis, Md.
 ex-5BYU, Hullett, CEM, foreign duty
 5CMY, Utley, Lt. Comdr., Annapolis, Md.
 ex-5DB, Lisk, Lt., Washington, D. C.
 ex-5DK, Wallace, Lt. Comdr., San Diego, Calif.

ex-5DRW, Stockton, Lt. Comdr., Great Lakes, Ill.
 5EJK, Wilkins, CRE, foreign duty
 5FGT, Soule, RM1c, address unknown
 5FJE, Senter, Ens., Cambridge, Mass.
 5FOR, Emery, S1c, Great Lakes, Ill.
 5FUS, Hudnall, Lt.(jg), foreign duty
 5FXG, Boswell, RM1c, foreign duty
 5FXS, French, RM3c, address unknown
 5GFL, Mills, CRM, Seattle, Wash.
 5GMW, Hausman, Ens., Washington, D. C.
 5GPP, Bradshaw, CRM, Los Alamitor, Calif.
 5HI, Miller, Lt., foreign duty
 5HKP, Zammit, Lt., foreign duty
 5HWX, O'Bannon, Lt. Comdr., Astoria, Ore.
 5HYX, Westerfeld, RM1c, Jupiter, Fla.
 5IVX, Fonopulos, RM3c, New Orleans, La.
 5IWX, Bacehus, Lt.(jg), foreign duty
 5JQZ, Singer, Sk1c, Pittsburg, Kansas
 5KNM, Kenyan, Ens., foreign duty
 5KNO, Peavey, Lt. Comdr., Miami, Fla.
 5KPC, Tullos, Ens., foreign duty
 5TR, Chiles, Lt. Comdr., Washington, D. C.
 5KAIU, Thomas, Comdr., foreign duty
 6BHR, Ludemann, Lt. Comdr., foreign duty
 6BSI, DuVall, CRE, address unknown
 6BTY, Theile, Lt., Washington, D. C.
 6BYS, Green, CRM, Gulfport, Miss.
 6CRP, Cullom, RM3c, address unknown
 ex-6CYY, Lasky, S1c, Michigan City, Ind.
 6CXM, Knepper, Lt. Comdr., Washington, D. C.
 6DAA, Munter, Lt. Comdr., Highland Park, Ill.
 ex-K6DBE, Goldman, CRE, foreign duty

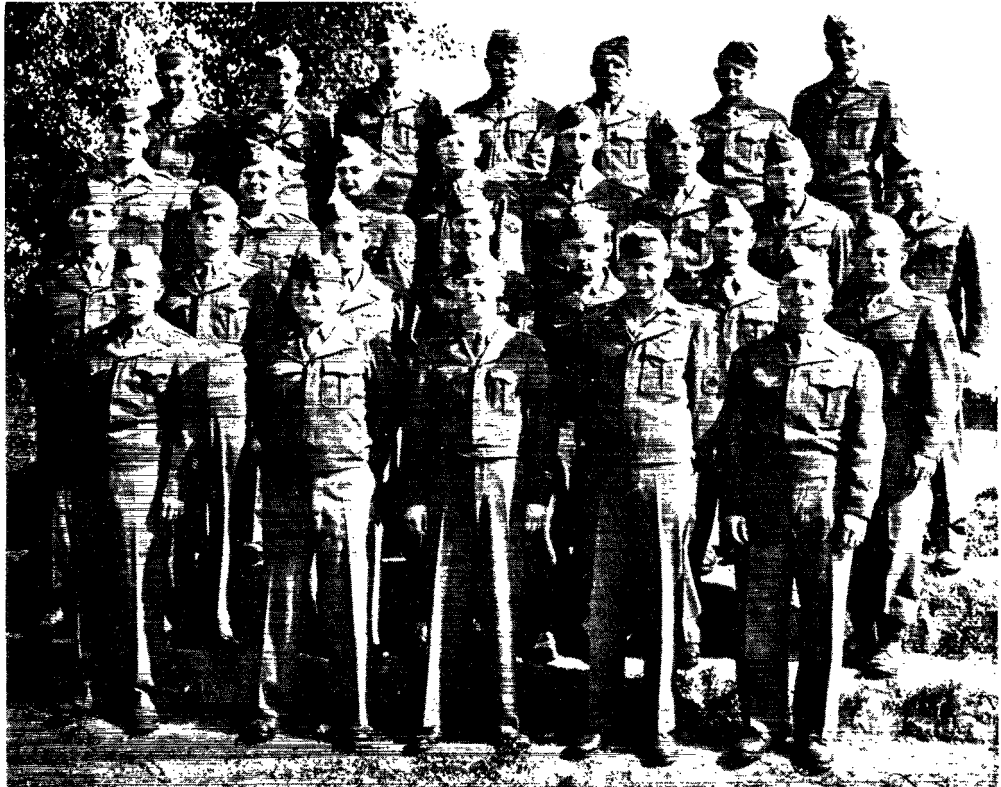

Not until the shooting was over were these hams able to get together in Wiesbaden, Germany, for the purpose of having this photo taken. *Left to right, front row:* T/Sgt. Snyder, W3HTX; Capt. Dietsch, W6FTO; Lt. Clifford, W9SYO; T/Sgt. Bridge, W6MXH; T/Sgt. Juring, W9YTO. *Second row:* T/4 Goldbach, W2CLJ; T/3 Hillert, W8VJG; T/3 Phillips, W1MDM; T/Sgt. Double, W8GZF; T/Sgt. Curley, WIMPA; T/3 Leupold, W9TFQ; T/5 Hall, W9UAL. *Third row:* T/5 Engert, W2MRJ; T/5 Putnam, W8PGF; S/Sgt. O'Lone (operator's license); T/5 Dolan, W6TYX; T/4 Emaus, W2LCW; T/5 Sheehan, T/5 Wingert (operator's license); M/Sgt. Wilhelm, W2LQB. *Fourth row:* T/5 Cole, W1LGM; T/5 Goldman, W8USC; T/5 Kelley, W9FAQ; T/5 Munn, W5IWM; T/Sgt. Thompson, W3DRQ; T/4 Farnsworth, W9GOG; T/Sgt. Morris, W2KHP.

6EO, Button, Lt.(jg), Gulfport, Miss.
 6EUP, Fuhner, Lt., Washington, D. C.
 ex-6EWS, Johnston, CRM, foreign duty
 6EWZ, Lawrence, CRM, foreign duty
 6GBB, Davis, S2c, Gulfport, Miss.
 6GCT, Jones, RE, Clearfield, Utah
 ex-6GTB, Engle, CRE, Chicago, Ill.
 6GWY, Prather, Lt. Comdr., foreign duty
 ex-6IEN, Chambers, RM2c, address unknown
 6IIL, Willett, CRE, foreign duty
 6IYZ, Lane, Ens., Baltimore, Md.
 6JFX, Twomey, Lt.(jg), Arlington, Va.
 6JJO, Fuller, Lt.(jg), foreign duty
 ex-6JPK, Duncan, CRM, foreign duty
 6JZF, Jackson, CRM, foreign duty
 ex-6KJA, Stewart, RE, Chicago, Ill.
 6KVV, Thompson, CRM, address unknown
 ex-KOKY, Alverson, RE, Baltimore, Md.



For heroic achievement in action in Germany last February, Pfc. Carl Lassen, jr., W1MGS, has been awarded the Bronze Star medal. Carl was serving with the 744th Light Tank Battalion at that time. He hails from Stratford, Conn., and was active in WERS before entering the service.

6LGO, Hanawalt, Midshipman, Notre Dame, Ind.
 6LLY, Needham, Lt. Comdr., foreign duty
 ex-6LTM, Thompson, RM1c, foreign duty
 6MAT, Moses, Lt., Washington, D. C.
 6MMB, Montgomery, CRM, foreign duty
 6MWC, Trent, Ens., foreign duty
 6NDZ, Blythe, CRM, foreign duty
 6NFC, Gates, Fic, foreign duty
 6NGW, Beam, Ens., San Francisco, Calif.
 6NQO, Talbot, CRE, foreign duty
 6KNWC, Leigh, Comdr., foreign duty
 6NWX, Wason, CRM, San Diego, Calif.
 6NX, Quement, Lt. Comdr., address unknown
 6KOBG, Sergeant, Comdr., San Diego, Calif.
 6OEO, Hatcher, Comdr., address unknown
 6OHO, Sobke, CRM, foreign duty
 6OMN, Walling, Comdr., Washington, D. C.
 6OUU, Masiello, CWO, North Beach, Md.
 6OWC, Hibbard, Lt., La Jolla, Calif.
 6PCI, McGinnis, Lt., Washington, D. C.
 6KPHK, Wildman, Lt.(jg), Washington, D. C.
 6PIM, French, RM1c, foreign duty
 6PKQ, Dunham, CRE, foreign duty
 6PQS, Classman, Lt. Comdr., address unknown
 6PRP, Cavalli, CRM, address unknown
 6QQA, Warner, RE, foreign duty
 6QQU, Funston, RE, foreign duty
 6RFE, Hulse, Sic, Great Lakes, Ill.
 6RJI, Brock, Lt. Comdr., foreign duty
 6K6RSJ, Johnson, Lt.(jg), Washington, D. C.
 6RVC, Cameron, Lt.(jg), Oakland, Calif.
 6RYN, Dreesen, RE, Chicago, Ill.
 6SIV, Francis, RM1c, foreign duty
 6SKI, Webb, QM1c, foreign duty
 6SBNF, Lane, Ens., address unknown
 6UX, Burke, Lt., Annapolis, Md.
 6UKW, Cobb, S2c, Gulfport, Miss.
 6GUNV, Andrewkovich, RM1c, Boston, Mass.
 6UPM, Roth, RM2c, Lompoc, Calif.
 ex-6YAR, Sandorf, Lt. Comdr., Annapolis, Md.
 6ZK, Mangelsdorf, Lt. Comdr., Washington, D. C.
 6K7AO, Pemberton, Lt., foreign duty
 ex-6TAP, Johnson, Lt., Washington, D. C.
 6ZBEZ, Blue, Lt. Comdr., address unknown
 ex-6CLK, Dombroski, CRM, foreign duty
 ex-6OZC, Williams, CRM, address unknown
 6DHW, Weedman, Ens., Washington, D. C.

7DUA, Arlin, Lt., Annapolis, Md.
 7BJG, Bailey, RM1c, foreign duty
 ex-7ERR, Randall, Lt. Comdr., Great Lakes Ill.
 ex-7ETM, Gavin, Lt. Comdr., foreign duty
 7EZR, Moseley, RM1c, foreign duty
 7FLR, Wood, Lt.(jg), foreign duty
 ex-7GC, Whiting, RM1c, foreign duty
 7GYV, Thistle, EM1c, address unknown
 7HBT, Smith, CRE, foreign duty
 7IDW, Adam, Ens., foreign duty
 7IHE, Andrus, RM3c, foreign duty
 7IMH, Newcomb, CRE, foreign duty
 7MP, Lindahl, Lt., address unknown
 ex-8ABF, Keyworth, Lt., Washington, D. C.
 ex-8AK, Clark, Lt. Comdr., Washington, D. C.
 ex-8AQF, Huggins, Sic, foreign duty
 8AQN, Follmer, CRM, address unknown
 8BTV, Graff, RM1c, Gulfport, Miss.
 8CAL, Evans, Lt. Comdr., Portsmouth, N. H.
 8CFZ, Cook, Lt. Comdr., address unknown
 8EAW, Paddock, Lt., Washington, D. C.
 8EEZ, Alanan, RE, Piney Point, Md.
 ex-8EIJ, Beers, RM2c, Sampson, N. Y.
 8FGL, Green, Lt. Comdr., Portsmouth, Va.
 8GPN, Payne, Sic, foreign duty
 8GYQ, Nusky, RM2c, foreign duty
 8HFK, Tracesser, RE, Chicago, Ill.
 8HWE, Haas, Lt., address unknown
 8KD, Herbet, Lt.(jg), address unknown
 8KRG, Hildebrand, Lt. Comdr., San Diego, Calif.
 8KTS, Wladyka, CRM, Chatham, Mass.
 8KVZ, Dickey, Lt., foreign duty
 ex-8EFG, Allen, Lt. Comdr., Washington, D. C.
 8LXD, Hebing, S2c, Great Lakes, Ill.
 8MEI, Green, RM3c, Washington, D. C.
 8MJA, Giles, Ens., Mechanicsburg, Pa.
 8MWQ, Nesta, RM1c, Bellmore, N. Y.
 8NLQ, Maxwell, CRM, Seattle, Wash.
 8OFE, Galbraith, CRM, foreign duty
 8OLG, Schooley, CRM, foreign duty
 8ONO, Zukowski, CRM, foreign duty
 8ONZ, Boczek, CRM, foreign duty
 8OTR, Young, CRM, Chicago, Ill.
 8PCS, Thais, SKT3c, foreign duty
 8PQT, Davies, RM3c, foreign duty
 8PV, Booth, Comdr., Washington, D. C.
 8QND, Emery, Lt.(jg), foreign duty
 8REP, Wilson, CRM, Washington, D. C.
 8RHS, Flanagan, CRM, Winter Harbor, Me.
 8SC, Malinosky, RM1c, foreign duty
 8SHW, Oerlein, Lt., Washington, D. C.
 8SSC, Driscoll, RM3c, foreign duty
 8TCC, Schwesinger, Lt.(jg), Boston, Mass.
 8TPE, Tomkins, Lt., Seattle, Wash.
 8UHX, Morrison, CRM, address unknown
 8VEC, Doolittle, Midshipman, Notre Dame, Ind.
 8VWJ, Rhodemyre, Lt. Comdr., Gulfport, Miss.
 8WBC, Hicks, RM3c, foreign duty
 8WCA, Roller, RM2c, foreign duty
 8WND, Jonke, RM2c, foreign duty
 8WVJ, Neureither, Lt.(jg), address unknown
 9AAY, Weyrauch, Lt., Annapolis, Md.
 9ACO, Hlavaty, Lt.(jg), address unknown
 ex-9AUZ, Burks, Sic, Little Creek, Va.
 9AVP, Phillips, Lt., Chicago, Ill.
 9BDX, Hare, Lt.(jg), Great Lakes, Ill.
 9BVB, White, Sic, Great Lakes, Ill.
 9CUE, Kolehmainen, EM1c, foreign duty
 9DEM, Gallagher, Sic, Great Lakes, Ill.
 9DFO, Steavenson, CRM, Little Creek, Va.
 9DH, Leach, Lt., Mechanicsburg, Pa.
 9ELS, O'Dowd, CRM, foreign duty
 ex-9ER, Pivonka, CEM, Mare Island, Calif.
 9ERS, Reiss, Lt. Comdr., address unknown
 ex-9ESU, Keane, RM1c, foreign duty
 9FDR, Novy, Lt., Washington, D. C.
 9FFD, Hansen, Lt. Comdr., Philadelphia, Pa.
 9GM, Harrington, CSp(T), Indianapolis, Ind.
 9GQM, Hegler, Lt.(jg), Portsmouth, Va.
 9GSU, Seacrist, CSp(T), Memphis, Tenn.
 9EHT, Choisser, CM1c, foreign duty
 9ELX, Thompson, Lt., address unknown
 9IEZ, Schermerhorn, RM1c, foreign duty
 9JBF, Lerch, Sic, Michigan City, Ind.
 9JMF, Spue, SP(1)c, address unknown
 9JWE, Keifer, Lt.(jg), address unknown
 9KEL, Timme, A/S, Great Lakes, Ill.
 9ENO, Miller, RM1c, foreign duty
 9LGM, Moore, Lt., Washington, D. C.
 ex-9LMC, Newberry, Ens., Columbus, Ohio
 9LTI, Liley, Ens., foreign duty
 9LUI, Whitley, EM1c, Miami, Fla.
 ex-9MNE, Strause, CRM, Chicago, Ill.
 9MXO, Torgerson, Ens., foreign duty

9NHR, Sumner, RM2c, foreign duty
 9NKZ, Icenbice, Sic, Chicago, Ill.
 9NLD, Linsley, Lt., Washington, D. C.
 9OKM, Chandler, A/S, Great Lakes, Ill.
 9OSJ, Goralline, SCP(T), Chicago, Ill.
 9OVU, Rieck, foreign duty
 ex-9POE, Utvos, CRE, foreign duty
 9PQR, Buchanan, Lt., Washington, D. C.
 9QAI, Ownbey, Sic, Corona, Calif.
 9QBN, Kuntz, A/S, Great Lakes, Ill.
 9QN, Edwards, QM1c, foreign duty
 9QV, Meissner, Ens., foreign duty
 8SZM, Polson, CMM, Great Lakes, Ill.
 9TRG, Geisinger, RM3c, foreign duty
 9TTZ, Sloane, Lt., Melbourne, Fla.
 9TYV, Peters, Sp(V)c, address unknown
 ex-9TZN, Malone, CRE, Washington, D. C.
 9URT, Will, Lt., Washington, D. C.
 9UZX, Willis, Ens., Boston, Mass.
 9VSF, Gleschinski, S2c, Oakland, Calif.
 9VX, Critton, Ens., Bremerton, Wash.
 ex-9VKU, Read, Lt., Boston, Mass.
 9WVS, Bailey, Lt., foreign duty
 9WVY, Gill, RE, Chatham, Mass.
 9WZY, Farris, Lt.(jg), address unknown
 9YHV, Little, Sic, Great Lakes, Ill.
 9YLU, Come, S2c, Great Lakes, Ill.
 9ZSP, Chadet, RM2c, Memphis, Tenn.
 9ZVX, Campbell, RM1c, Notre Dame, Ind.

Operator's license only:
 Allen, RM3c, Notre Dame, Ind.
 Amerson, RM1c, foreign duty
 Anderson, A/S, Maryville, Mo.
 Arnold, RM1c, foreign duty
 Ask, RM3c, Chatham, Mass.
 Bartley, RM1c, foreign duty
 Blum, Lt., Hoffman Island, N. Y.
 Bohn, S2c, Madison, Wis.
 Breslaw, S2c, Notre Dame, Ind.
 Cardledge, Sic, Great Lakes, Ill.
 Chabunick, A/S, Lawrence, Kansas
 Clark, Lt. Comdr., address unknown
 Devita, RM2c, Notre Dame, Ind.
 Dillisi, RM3c, foreign duty
 Enderlin, Comdr., foreign duty
 Gillaspay, RM3c, Notre Dame, Ind.
 Goslin, RM2c, Notre Dame, Ind.
 Hodges, A/S, Lawrence, Kansas
 Hoggins, RM1c, Great Lakes, Ill.
 Housal, RE1c, Washington, Ia.
 Humphrey, RM3c, foreign duty
 Kras, RM1c, foreign duty
 Lafore, Lt. Comdr., address unknown
 Lazar, RM3c, foreign duty
 Lewis, RM3c, Bainbridge, Md.
 Lilliehill, Midshipman, Notre Dame, Ind.
 MacLeod, RM1c, address unknown
 McManon, RM1c, foreign duty
 Montague, RM2c, address unknown
 Morris, Comdr., foreign duty
 Nelson, RM2c, Indianapolis, Ind.
 Paglione, RM, Bronx, N. Y.
 Paterbin, Y1c, address unknown
 Roberts, RM3c, Annapolis, Md.
 M. Slaker, Sic, Great Lakes, Ill.
 Sloan, RM3c, foreign duty
 Threcek, RM3c, Treasure Island, Calif.
 Trogresso, RM1c, foreign duty
 Van Patten, Sic, Indianapolis, Ind.
 Van Wyck, RM3c, Chatham, Mass.
 Voss, Sic, Great Lakes, Ill.
 Wescott, EM3c, foreign duty
 Whitina, F2c, Gulfport, Miss.

NAVY—SPECIAL DUTY
 1GTS, Chadwick, CRT, Chicago, Ill.
 1JUS, Mekalian, RT1c, Chicago, Ill.
 1MRZ, Thurston, RT3c, Chicago, Ill.
 1MOH, Fisher, RT3c, Chicago, Ill.
 ex-2ARL, Helwith, RT1c, Chicago, Ill.
 2CMZ, Jelinek, RT1c, foreign duty
 2GEL, Heaton, RT1c, Chicago, Ill.
 2HBA, Thorgensen, RT3c, Chicago, Ill.
 2RUR, Worne, RT3c, Chicago, Ill.
 3CDJ, Charlesworth, RT2c, foreign duty
 3GEC, Wein, RT1c, Chicago, Ill.
 5JLP, Blackert, RT3c, Chicago, Ill.
 5JOL, Powell, RT3c, address unknown
 5JFY, Latimer, RT1c, foreign duty
 5KJA, Jeffery, CRT, foreign duty
 6ARD, Walton, CRT, Treasure Island, Calif.
 6CCQ, Wilson, CRT, address unknown
 6GCT, Denny, CRT, Chicago, Ill.
 6JQY, Dougherty, CRT, Mechanicsburg, Pa.
 6KHE, Knotts, CRT, foreign duty
 6LSJ, Harbridge, RT1c, Houma, La.
 6NSI, Jones, RT3c, Treasure Island, Calif.

6PDK, Rosenthal, RT1c, foreign duty
 6PHZ, Stott, RT3c, Treasure Island, Calif.
 6QVM, Kats, RT3c, Treasure Island, Calif.
 6RLB, Archer, CRT, foreign duty
 6SCB, Shacklett, RT2c, foreign duty
 6SUW, Meador, RT3c, Treasure Island, Calif.
 6TFL, Sheldon, S1c, Chicago, Ill.
 6TQK, Wallis, RT1c, foreign duty
 6UAY, Stone, CRT, Chicago, Ill.
 6UFA, Dias, RT1c, address unknown
 ex-7AXL, Reynolds, CRT, Chicago, Ill.
 7CVJ, Hungerford, S1c, Moscow, Idaho
 7BRX, Lister, RT1c, foreign duty
 7ESL, Brandon, RT3c, Tacoma, Wash.
 7FLX, Garbarino, RT1c, Chicago, Ill.
 7FOU, Pendleton, CRT, Chicago, Ill.
 7GBW, Nelson, CRT, Chicago, Ill.
 7GOG, Janacek, CRT, Gulfport, Miss.
 7EYF, Kester, CRT, foreign duty
 7EOD, Servidio, CRT, Washington, D. C.
 7IBK, Engle, RT1c, foreign duty
 7IJK, Hansen, CRT, Chicago, Ill.
 ex-8BWS, Roser, CRT, Chicago, Ill.
 8EVL, Keller, CRT, Chicago, Ill.
 8EZE, Bevan, RT3c, Oakland, Calif.
 ex-8KMW, Giffen, RT2c, foreign duty
 8LCA, Golloway, RT3c, Chicago, Ill.
 8LGD, Soroka, RT2c, Chicago, Ill.
 8LUD, Allyn, RT2c, Lansing, Mich.
 8MTZ, Eddy, RT2c, foreign duty
 8FMC, Frather, RT2c, Chicago, Ill.
 8FSD, Curtis, RT1c, Chicago, Ill.
 8RQG, Ferguson, RT2c, Solomons, Md.
 8RPL, England, RT3c, Chicago, Ill.
 8RSM, Dorsett, RT1c, Chicago, Ill.
 8SEL, Bitting, RT2c, Washington, D. C.
 8TRJ, Paananen, CRT, foreign duty
 8TZL, Peikhtel, RT2c, Chicago, Ill.
 8UES, Camp, CRT, Chicago, Ill.
 8UTY, Price, RT1c, Chicago, Ill.
 8VPT, Schenmer, CRT, Chicago, Ill.
 8WJF, Donaldson, CRT, Great Lakes, Ill.
 8WFG, James, RT1c, Chicago, Ill.
 8WVQ, Mack, RT2c, foreign duty
 9ALL, Wooster, CRT, foreign duty
 9AOR, Deiker, RT3c, Chicago, Ill.
 9BIL, Kramer, RT1c, Chicago, Ill.
 9CZX, Marwick, RT3c, Glenoco, Ill.
 9DNE, Artus, RT3c, Chicago, Ill.
 9BMA, Whitehorn, RT1c, Chicago, Ill.
 ex-9PH, Hill, RT2c, foreign duty
 9FVK, Rawlins, CRT, foreign duty
 9FWQ, Matheson, RT3c, Chicago, Ill.
 9GEA, McClelland, RT3c, Chicago, Ill.
 9GMU, Campbell, RT1c, foreign duty
 9IEX, Sparks, RT1c, Beaver, Ia.
 9IMI, Elvidge, RT3c, Chicago, Ill.
 9JAJ, Cornelius, RT1c, Chicago, Ill.
 9JVN, Davis, RT1c, foreign duty
 9KCM, Becker, CRT, foreign duty
 9KNW, Lampi, RT1c, foreign duty
 9MQE, Booker, RT1c, foreign duty
 9OEX, Johnson, RT3c, Chicago, Ill.
 9PMM, Gehr, CRT, Chicago, Ill.
 9PMN, Haugen, RT2c, Chicago, Ill.
 9PXF, Cartwright, RT3c, foreign duty
 9RIO, Marks, RT1c, Chicago, Ill.
 9RMG, Dewell, RT3c, Chicago, Ill.
 9RQC, Kesselhuth, RT3c, Chicago, Ill.
 9RRV, Tyner, RT3c, Chicago, Ill.
 9TNX, Huisenga, RT2c, Chicago, Ill.
 9TRS, Wilde, RT1c, Chicago, Ill.
 9TTM, Berglund, RT2c, foreign duty
 9VMB, Yund, RT1c, Chicago, Ill.
 9VPO, Marshbank, RT3c, Chicago, Ill.
 9VWD, Hesky, RT1c, Chicago, Ill.
 9VZC, Hemmen, RT3c, foreign duty
 9WWX, Patton, RT2c, Chicago, Ill.
 9ZOU, Norman, CRT, foreign duty

Operator's license only:

Booker, RT1c, foreign duty
 Cederstrand, S1c, Great Lakes, Ill.
 Coker, RT2c, foreign duty
 D'Asaro, S1c, Great Lakes, Ill.
 Fleming, RT1c, foreign duty
 Lustig, RT3c, foreign duty
 Marden, RT2c, foreign duty
 McMann, S1c, Great Lakes, Ill.
 Rogers, S1c, Great Lakes, Ill.
 Smith, CRT, foreign duty

NAVY — AERONAUTICS

1NCK, Daigle, ART3c, Miami, Fla.
 5DYT, Whitwood, ART3c, Corpus Christi, Texas
 6EJU, Hicks, ACMM, foreign duty
 ex-6EZF, Kessler, Lt., Corpus Christi, Texas

K6KQZ, Clausen, ACMM, foreign duty
 6MIB, Amass, Lt.(jg), Corpus Christi, Texas
 K6ORD, Huddleston, Ens., Lake City, Fla.
 6RJZ, Bomar, ART1c, Key West, Fla.
 6SDS, Brady, ACRT, Beattie, Wash.
 6SUN, McCarthy, ART1c, Westerly, R. I.
 6UBX, Lockhart, ART1c, foreign duty
 6UKB, Rees, ACRT, foreign duty
 K7CNO, Stump, ACRT, address unknown
 7IGP, Carlson, ART3c, Oakland, Calif.
 ex-80AI, Cooper, ARM3c, foreign duty
 9KBS, Smith, Rees, ACRT, foreign duty
 9KZL, Wyman, Comdr., Bunker Hill, Ind.
 9VFN, Johnson, ACRM, Oakland, Calif.
 9ZAJ, Austin, ART2c, foreign duty
 9ZSK, Pfaffner, ART1c, foreign duty

Operator's license only:

Blankenship, AAM1c, Jacksonville, Fla.
 Campbell, ARM3c, foreign duty
 DeCamp, ARM2c, foreign duty
 Eubanks, ACRT, foreign duty
 Henderson, ART1c, foreign duty
 Oeljen, Lt. (jg), Camp Edwards, Mass.
 Palmer, ART1c, foreign duty
 Steves, ART3c, Corpus Christi, Texas

CIVIL SERVICE

1BFA, Bracy, CAA, Great Falls, Mont.
 1GFC, Hopkins, Navy Dept., Washington, D. C.
 1NFB, Saunders, instructor, Medford, Mass.
 2BSL, Jacobs, SC, Belmar, N. J.
 2BYM, Crammer, Navy Dept., Lakehurst, N. J.
 2BZE, Taylor, Navy Dept., Brooklyn, N. Y.
 2FEA, Schultz, AAF, Newark, N. J.
 2NR, O'Connell, SC, Camp Evans, N. J.
 2NH, Sutherland, OWI, foreign duty
 2OKF, Barton, AAF, Wright Field, Ohio
 ex-3HJH, Shaw, SC, Philadelphia, Pa.
 3IQH, Jarfisiian, Navy Dept., Philadelphia, Pa.
 3IWL, Ratynski, AAF, South River, N. J.
 ex-4ART, Norrell, Navy Dept., Pensacola, Fla.
 4BSW, Sample, technician, address unknown
 4BVP, Merrill, electrician, Huntville, Ala.
 4BVU, Bromfield, CAA, Miami, Fla.
 4DDY, Connell, technician, address unknown
 4GZQ, Idorton, Miami, Fla.
 5BCZ, Sikes, Ordnance Dept., Camden, Ark.
 5BNF, Byart, Navy Dept., foreign duty
 5EVN, Meador, technician, address unknown
 5EVQ, Hooe, AAF, Alexandria, La.
 5JAC, Long, technician, address unknown

5JKB, Marshall, FCC, Kingsville, Texas
 5KMW, Childress, SC, Chicago, Ill.
 ex-6WQ, Harris, SC, Philadelphia, Pa.
 ex-K6BOE, Leavitt, Navy Dept., foreign duty
 6DNW, Beslin, Navy Dept., San Diego, Calif.
 6GYE, Bennett, AAF, Washington, D. C.
 6JVK, Lowe, radio engineer, Hampton, Va.
 6LZD, Teel, chief engineer, San Francisco, Calif.
 6KFUL, Cowden, Navy Dept., foreign duty
 K7CNA, Laier, CAA, airways engineer, foreign duty
 7CJL, Hill, Navy Dept., inspector, Olalla, Wash.
 7EEN, Partlow, AAF, Spokane, Wash.
 K7EGW, Arlin, CAA, engineer, foreign duty
 7FFW, Coleman, AAF, radio mechanic, Alliance, Nebr.
 7FRF, Eastwood, CAA, San Lorenzo, Calif.
 7LD, Koeki, Weather Bureau, Seattle, Wash.
 ex-8FYA, Willson, AAF, inspector, Bridgeport, Conn.
 8GWF, Krupiarz, radar mechanic, Utica, N. Y.
 8QUK, Murphy, NRL, field engineer, Washington, D. C.
 8RRH, Kreski, SC, inspector, Hamtramck, Mich.
 8RSD, McDonald, SC, engineer, Detroit, Mich.
 8SSC, Rose, AAF, engineer, Wright Field, Ohio
 ex-9AFK, Mayer, AAF, operations analyst, Cedar Rapids, Ia.
 ex-9DJV, Bisenres, AAF, inspector, St. Paul, Minn.
 9DST, Wright, SC, inspector, Berwyn, Ill.
 9GBV, Long, AAF, radio engineer, Dayton, Ohio
 9IGM, Gripe, electrician, Pueblo, Colo.
 9JBQ, Himmelheber, AAF, inspector, Jeffersonville, Ind.
 9KYZ, Dornbrook, AAF, instructor, Truax Field, Wis.
 9SMD, Taylor, AAF, instructor, Chicago, Ill.
 9SWE, Albert, AAF, Trux Field, Wis.
 9TMQ, Weintraub, AAF, instructor, Chicago, Ill.
 9TRI, Kemmir, AAF, McChord, Wash.
 9UID, Baker, SC, inspector, Wright Field, Ohio
 9VWL, DeWageneire, AAF, instructor, Chicago, Ill.

Operator's license only:

Renfro, AAF, mechanic, Brookley Field, Ala.
 Rogers, CAA, Gage, Okla.

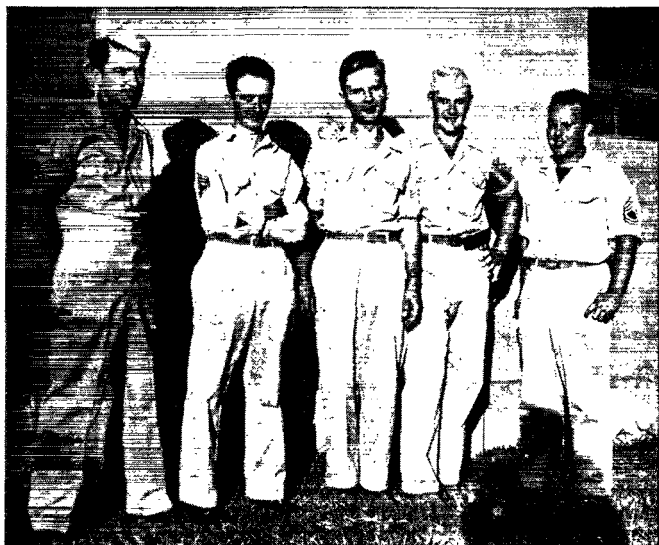

Amateurs at an AACS station in India express nostalgic wishes to come back home and get on the air with improved ham rigs. Left to right: Preston (operator's license); Ingalls, WINNJ; Chesnick, W2LNO; Jacobs, W2MAC; Tracy, W2MCY.



CORRESPONDENCE FROM MEMBERS

The Publishers of *QST* assume no responsibility for statements made herein by correspondents.

24-HOUR TIME

72 Bowler St., East Lynn, Mass.

Editor, *QST*:

I suggest and strongly urge that the ARRL adopt and use the 24-hour clock system. It has the advantages of simplicity, and no AM and PM appendages. It surely should be pointed out as a sensible and progressive move for better operating efficiency in amateur operating. One can keep in mind the number of hours off Greenwich Civil Time, and thus quote GCT during DX contacts, which would be a courteous gesture.

— *Harold W. Ryall, W1NKW*

Editor, *QST*:

Some time back in 1939, I suggested that we adopt the 24-hour system of logging time, in preference to the use of AM and PM as with the 12-hour system. Now that so many of us have had to use the newer method during the war, it would seem to be a propitious time to bring up the subject again.

— *Harold R. Fearon, ex-W1KY*

A GREAT DAY COMING

Camp Detroit, France

Editor, *QST*:

From now on you can send *QST* to the following address in good old Massachusetts — yes sirc — 67 Sheridan St., Chicopee Falls. . . that's the place and the XYL has been instructed to file them up on the operating table which incidentally has not been moved since Dec. 7, 1941.

You just have no idea of how we feel about all this being over with, with the prospects of going on the air very shortly again. W1MYZ is looking forward to that twenty-meter band after having sweated out the war with a Class-A ticket that he never had the chance to use.

In my four years in this man's Army I've made some mighty fine contacts with fellows from all over the U. S. and it is really going to be a pleasure to get back and work them, especially when now we'll know who we are talking to. Just imagine the type of ragchews that will go out over the ether. I want to extend my thanks for the way you forwarded the *QST* to the boys over here all during the war, even to the extent of sending copies to make up for several that were lost in the mail, as was my case. It was certainly a fine gesture on your part.

— *Major Bernard L. Beaudoin, AC, W1MYZ*

A REPORT FROM IE SHIMA

Ie Shima, Ryukyus Is., Japan

Editor, *QST*:

Well, now it can be told. . . I'm on Ie Shima, just off Okinawa. The island was in the news this year because Ernie Pyle was killed here and also because the Jap planes and envoys stopped here on the original peace mission to Manila to see General MacArthur.

Ernie's grave is just below me here, in the island's military cemetery. The stone, raised by the 77th Div. on the spot where he was hit by the Jap machine gun bullet, is also nearby.

I got in on the Jap peace mission deal, and was plenty busy for a while, as that was one event that had to go off without a hitch. My control towers handled the planes in and out, and coming in. I was on duty in one tower while my C.O. stood the main trick at the other tower where the Jap planes landed. I had the satisfaction of copying the message sent by the Jap pilot in halting English, giving us his arrival time at Ie Shima.

The Jap planes showed evidence of a hasty very streaked white paint job. One could see the red suns beneath the green crosses, too. I got some pictures of the planes both arriving in the air, and after they got on the ground.

When the envoys returned from Manila a few days later in one of our deluxe C-54 airliners, and changed to their Jap Bettys here I was again fortunate to be in on the deal. This time I had to know a few facts for tower clearance, and so I jeeped right down the strip to the Jap plane and talked with the Jap pilot at the cabin door of his plane. One of the envoys acted as interpreter for me. The paper that I gave the Jap pilot to write both Jap and Arabic figures on is a highly prized souvenir of the occasion. I said "hello" in Japanese to the pilot at one point and he gave me a smile and a salute in return.

Thought you'd be interested in this. I enjoyed it when it happened.

— *Lt. P. M. Cornell, SC, W8EFW*

LSPHs REPORTED ENTHUSIASTIC BY W9PHB

W. Pacific Area

Editor, *QST*:

Just a few comments from the other side. Now that the war is over and the new frequency allocations are known, wherever you go you find the boys designing their future rigs. I have observed that some of the most enthusiastic ones that I have met, are the boys licensed since Pearl Harbor.

— *Clayton C. DeWitt, W9PHB*



OPERATING NEWS

F. E. HANDY, WIBDI, Communications Mgr.
E. L. BATTEY, WIUE, Asst. Comms. Mgr.

J. A. MOSKEY, WIJMY, Communications Asst.
LILLIAN M. SALTER, Communications Asst.

A Challenge. Activities of the War Emergency Radio Service will terminate November 15th. As a temporary wartime service, designed to fill a wartime need, WERS, with the assistance of many non-amateurs, served its purpose admirably well. It was a vital and important part of our civilian defense. We must be forever thankful that the emergency communications facilities it developed and maintained in continuous readiness were never needed during actual enemy action against our land. But the fact stands that there did exist throughout the nation a highly efficient organization prepared to render invaluable aid if the need had arisen; and the men and women who worked so unselfishly to make WERS a success are to be commended for their untiring and ceaseless efforts.

But what of the future? The job of furnishing emergency communications in times of disaster traditionally has belonged to the radio amateur for more than a quarter-century. Indeed, we have come to accept disaster preparedness as an obligation; and our past performances in times of emergency have demonstrated clearly the seriousness with which we have accepted that obligation. Currently we hear the questions asked: Will the amateurs step in promptly and pick up where WERS leaves off? Will they do the job in peacetime as effectively as WERS did in wartime? These queries constitute a challenge to amateur radio's ability to organize for this vital work. It has been and still is a big job. Can we measure up to the requirements?

ARRL will sponsor and broadly direct a post-war emergency preparedness program. The success of such a venture, however, depends on the energies put forth by individual amateurs in the field. None of us can undertake such a task alone or in small groups. The cooperation of *all* civic-minded amateurs is essential. The goal of the prewar ARRL Emergency Corps remains our slogan: **AN AMATEUR RADIO EMERGENCY STATION IN EVERY COMMUNITY!** That should be our minimum requirement for organizing to do an effective job when the low-frequency bands are once more available. Our more immediate objective is to have ready local v.h.f. networks wherever possible, and particularly in areas of large population.

Details of a complete emergency plan are being worked out at Headquarters. *QST* will carry full information in the near future. Meanwhile, every amateur who possesses equipment capable of operation on 112 Mc., and the proposed band 144-148 Mc., is urged to contact his Section Communications Manager (address listed on pages 4-6 in each

issue of *QST*), ARRL Emergency Coördinator if known, or local radio club, to learn how he can be of assistance in present organizing. In addition, we suggest reference to the Operating News Section in October *QST* for supplementary information.

Participation in fifty-odd major communications emergencies since 1919 has contributed as much or more than any other single factor to the glorious history of accomplishment in amateur radio. Here is a golden opportunity to win additional public respect. In the true spirit of amateur radio let us now prepare to carry on our traditional responsibility to community and nation. Act now!

Amateur Radio Clubs. Since V-J Day we have been extremely gratified to note increased interest in the formation of new clubs. In order to help these clubs get started on the right foot we have available to organizers of new amateur associations, literature containing suggestions for organizing, keeping up interest, courses of study, sample constitutions, etc. These mimeographs may be procured, free of charge, by directing a request to the Communications Department.

In addition, the League will grant affiliation to any amateur radio society having at least 51 per cent of its licensed amateurs also ARRL members that indicates its willingness to cooperate with the ARRL in its objectives. Affiliation must receive the approval of the Director of the Division in which the club is located. The necessary forms to start affiliation proceedings will be forwarded, upon request, to any existing amateur radio association.

Numerous affiliated radio clubs, inactive during the war, once again are coming back to life, and these will be returned to our active files and mailing lists upon receipt of information concerning activities in which the club is participating, and return of the questionnaire which we will send to the organization. Let's hear from all active associations, affiliated or not. We'll try to help as much as possible with suggestions for the upbuilding of the organization.

Press Schedules. Radiotelegraph transmissions of press information provide excellent practice for anyone desiring to improve his code copying ability. A revised list of commercial press schedules is now available upon request to Headquarters. Many of the schedules listed are subject to change without our knowledge and we would appreciate hearing of any such changes or additional stations noted. Please give the call, time (GMT), frequency (kc.), origin and speed. *QST* will continue to publish revised and supple-

mentary lists of commercial press schedules from time to time.

C. D. Staff Notes. It is our pleasure to announce the return to Headquarters, in mid-October, of Mr. F. E. Handy, ARRL Communications Manager, and his long-time associate, Mr. E. L. Battey, Assistant Communications Manager. Both have been serving with Uncle Sam's armed forces.

Mr. Handy has been on active duty with the USAAF since spring, 1942. At the time of release he held the rank of colonel. His experience in matters of military communication during the war will prove of inestimable value in the administration of C. D. affairs during the period which lies before us.

Mr. Battey is with us again after a tour of duty commencing October, 1940. "Ev" did his part in no small way as one of those N.C.R. amateurs who assisted the Navy so nobly in an extensive radio operator training program and was lieutenant commander when released from duty. His additional background of experience, acquired during the war years, likewise will be of immense benefit to this department.

On September 17th the Headquarters staff was happy to welcome back Joseph Moskey, W1JMY, who left us in early 1942 to work at M.I.T. on a special project in connection with secret devices. Mr. Moskey took over the C. D. office previously handled by Mr. Battey upon the latter's entrance into the Navy, and is well qualified to carry on the duties which have been assigned to him as assistant in charge of organized operating activities.

All hands will join with us at ARRL in heartfelt congratulations to "Ed," "Ev," and "Joe" upon their records of faithful service to our country. Theirs was a contribution of which we may be justifiably proud. Welcome home, fellers!

— L. M. S.

September Hurricane Finds Miami WERS Ready

ONCE again WERS has come through, this time in the hurricane which struck Miami on September 15th during which WKNW, Dade County, Florida, proved that a well-trained emergency system is a valuable asset in any disaster.

Our WERS set-up for hurricane emergency allowed for ten district headquarters stations to cover the county and to work direct into the control station on the roof of the fifteen-story Technical Vocational Building; a Ford Red Cross mobile disaster unit with a rack and panel m.o.p.a. and superhet receiver; and a number of privately-owned mobile units running from three to twenty-five watts to dispatch to emergency locations and to work over the devastated area with the mobile disaster unit as a subcontrol. Operation was to begin as soon as the wind subsided enough to permit an operator to get his emergency location. Those not needed at home were to man control in order to protect equipment against possible damage and to keep everything in order so that we could get on the air as soon as possible. Another unit was assigned to be set up at Red Cross Disaster Headquarters previous to the storm.

The day before the blow, Callahan, Unit No. 52; Mennitt, No. 60; Paup, W6TRD; Hall, W4FVW, No. 30; Seignious, W4VV, No. 36; Bumpus, W1DFY, No. 14; Marvin, No. 45

and Bryan, ex-W4AI, wrestled a 750-watt gas-driven generator and other equipment up to the penthouse and set up for emergency operation.

Following the emergency plan, control was manned Saturday, September 15th, with Callahan as chief operator, while Ed Doll, W4CFC, No. 68, set up in District Three headquarters. Our regular extended Zepp was taken down and secured on the roof to be erected as soon as was practical. W4VV set up No. 66 at Red Cross Disaster Headquarters and Bivins, W4AEW, No. 35, as chief operator, manned the unit with Richardson, W1JIT and Cox, W4CNC, as assistant operators and Verna and Arline Delling to handle phone lines.

While the wind was blowing at about seventy miles an hour, Petruff, No. 12, Paup, and Mennitt climbed to the roof of the penthouse to get the outdoor antenna in place. This antenna blew away three times during the evening and finally not enough of it remained to be of any use. Operation was carried on with a coaxial-fed extended Zepp indoors but this antenna was so inefficient that our range was cut to ten or twelve miles. At five-thirty the commercial power went off and the station went on emergency power.

In the meantime, things were buzzing at Disaster Headquarters. South of us all lines were down and radio was the only means of contact. Soon the phone line to Jackson Memorial Hospital went out and Ray Russell, No. 32, was dispatched to that location. Within fifteen minutes this important link was re-established and continued to operate during the evening.

Shortly before 10 P.M. the Disaster Unit, No. 30; Bumpus W1DFY, No. 14; Seignious, W4VV, No. 36; and Conley, W4HNL, No. 46, were started toward Homestead. In the Disaster Unit with Hall, W4FVW, were his XYL, Max Marvin, No. 45, and Gus Rizzola, an AP photographer. Bowers, W4NB, No. 2, and Seley, Pan-American flight radio officer, proceeded to South Miami to set up at the shelter there.

W4BYF, No. 17, relayed orders to No. 30 for the mobile contingent to proceed slowly toward Homestead, taking care to have at least one unit precede the communications truck to warn of dangerous highway conditions. Meanwhile, the Navy's enormous blimp base at Richmond had burned to the ground with a reportedly high casualty list. As No. 17 arrived at the South Dixie highway intersection a long convoy of Navy and Coast Guard ambulances and trucks appeared bound southward. No. 17 pulled in behind this convoy and relayed instructions to the mobile crowd. The head of the convoy caught up with No. 46 just north of Kendall and No. 46 was heard passing the warning on to No. 30. Just then No. 30 arrived at a bad road block and at the same time, several State Highway patrol cars arrived with instructions to the Navy crowd to return as the casualty report had been in error and no additional help was needed. Getting this Navy convoy turned around on the debris-covered highway was a herculean task for all and precious time was lost before our mobile units could proceed.

Because of the poor antenna at control we soon experienced difficulty in working Miami so No. 30 back-tracked until communication was again one hundred per cent while the others strung out along the highway in the hope of getting a complete relay to Homestead. No. 5, stationed at Homestead and equipped with auxiliary power, was not able to get on the air. No. 17 took the south end of the relay. Distances between mobile units soon proved too long and finally No. 17 proceeded to Homestead to pick up Preston Bird, in charge of Red Cross disaster activities there, and bring him back to where No. 30 was in direct communication with Disaster Headquarters in Miami. Bird was able to give Mrs. Beatrice Vines, executive director at Headquarters, a full report of the storm damage and relief requirements. Having accomplished our main objective, all units returned to Miami at about 4 A.M.

On Sunday the gang determined to make another try to get a Homestead relay established, so Sammon, K4FCL, No. 51; Marvin, No. 45; W4FVW; W4VV; and ex-W4AI proceeded south with No. 30 to set up No. 51 at the State Forestry Service tower at Princeton. Here they lugged a gas generator and the No. 51 almost to the top and set up. After hours of heartbreaking effort they had to dismantle and return to Miami.

The next day Bushnell, Henke, Don Pursell, Gillette and W4BYF removed the coaxial line from the antenna at control and replaced it with an open line and set it up on the roof of the penthouse. Meanwhile, W4FVW, W4CNC, and

W4VV, with mobile No. 36, started south. Gillette, Henke, and Pursell joined them later. Both No. 30 and No. 36 then worked control continuously all the way to Homestead. At 7 P.M. our long-lost Homestead station, No. 5, was heard at control and direct communication was established. Traffic then moved in both directions until the Homestead Red Cross office closed at midnight. Henke remained to operate at No. 5 and the rest of the gang returned to Miami.

On September 18th, W4CNB, with Pursell, Bushnell, Gillette, and Grafe, No. 71, took the truck south and cleared traffic at Goulds, Perrine, and other intermediate points.

On Wednesday, No. 30, minus Pursell but with the addition of W1JIT, again covered this area. During the afternoon Western Union managed to get a line through to Homestead. Several telephone circuits were opened up and the need for WERS operation ceased. All units closed down at 4:45 P.M.

The fellows deserve the highest possible commendation for the wonderful spirit of coöperation shown, and none of us will forget how they carried on in spite of numerous handicaps. The following, who worked tirelessly at control after communication with Homestead was established, deserve special praise: W4NB; Christensen, W4AFF; Goodson, No. 45; Powell, No. 54; Thwing, W1KVB; Doll, W4CFC; Jenard, W1JMT; and Meeker, W4ANP. The gang certainly has the heartfelt thanks of all of Dade County and particularly those of this humble person, whose rare privilege it was to coördinate these activities and work with as fine a crowd as exists anywhere on this earth.

W. E. MacArthur, W4BYF, Unit No. 17,
Radio Aide WKNW, Dade County, Fla.

WERS of the Month



Mercer County, Pa.

ONE of the hardest tasks in organizing a WERS unit in any one place, it was found, was to convince some of the city officials that the possibilities of a radio system could extend beyond the range of civilian defense. The negative attitude of the city administration proved to be the beginning of Mercer County's radio system. The radio amateurs of the County decided it was high time the officials were shown what radio activity could mean to a community. Therefore, without further hesitation these boys nominated a leader to act as radio aide for an intended radio net.

In October, 1942, a special meeting of all leading amateurs, servicemen, and radio enthusiasts gathered at the Mercer County Courthouse to discuss the matter and elect those necessary to form a nucleus of a reliable organization. There was no publicity, no soliciting, and no advertising to get members interested. The few remaining amateurs and interested servicemen who were still at home had one thing in common, to show those who had nothing but doubts that amateur radio could be put to practical use.

Thus, with the first meeting of this newly-organized group, plans for the administration, organization, procedure, and locations were under way. The radio aide and his assistant immediately began work on filing application forms, mapping locations, and working up some procedure form for operation of a WERS net. After careful consideration application was made for ten radio units to be distributed throughout the Sharon and Farrell areas. These ten stations have been included in Mercer County WERS ever since its licensing, although there have been new operators. On October 1, 1943, Mercer County was granted a license for ten units, nine composite units and an Abbott TR-4, under the call WKXV, and became the first organized net in Western Pennsylvania. However, while waiting for the application to be approved the boys were constructing apparatus from whatever material they could find available and whatever circuits could be obtained from *The Radio Amateur's Handbook*. By the time the license arrived, the units were ready to give the gear its first real test.



This picture shows some of the men responsible for the success of the Mercer County WERS net. *Left to right, front row:* E. Hlinsky, W8AOE, assistant radio aide; Ens. Sanford Schaftz; H. Campbell, W8QCN. *Back row:* A. C. Heck, W8GEG, radio aide; Mike Barbat; Wm. Fleckenstein; Sidney Kappell. Other active members not shown are: Dick Reed, W8JUR; Jim Catron, now at Penn. State College; Dixon, W8VUR; Robert H. Morgan, W8VNL, and Paul Trice, W8QHS.

By this time civilian defense in this area was taking an interest in radio communication, so the WERS net control was established at its headquarters. However, the arrangement proved to be a failure simply because of the location underground, which was shielded by girders, metallic material, and high tension lines. Tests were carried out, but the inadequate facilities for u.h.f. antennas proved to be a problem. Too little coöperation from civilian defense authorities proved that the net control would have to be relocated in order to maintain a more efficient organization.

Operating problems were not as bad as anticipated, although there were, and still are, only two experienced traffic men in the net. Others learned the procedure quickly. To speed up procedure, radio drills in traffic handling was one of the "musts" of each drill session. To further improve traffic handling a channel for i.c.w. operation was put into use. Although there is no rag-chewing, radio communication with our neighboring State, Ohio, proved to be an incentive to all stations of the WKXV net. Signal reports as far distant as eighteen miles are exchanged between the Mahoning County, Ohio, and the Mercer County nets. Exchanges of practice radio traffic has been made on many occasions. The coöperation of these two nets is noteworthy. Definite channels have been established so as not to cause undue interference with each other.

We at WKXV can justly be proud of our net. We have gained through experience and profited by our mistakes. We have solved the mysteries of the ultra-high frequencies. We have proven to ourselves that we can face the task of helping out in whatever emergency arises. And those of us who are new in the amateur radio game feel that radio will be an integral part of our peacetime national life.

— Ernest J. Hlinsky, W8AOE,
Assistant Radio Aide, WKXV

Affiliated Club Honor Roll

THE following clubs are additions to the "ARRL Affiliated Club Honor Roll" which appeared in the July, 1945, issue of *QST*, on page 57:

Amateur Radio Club of Seattle, Wash.
Frankford Radio Club, Pa.
Shy-Wy Radio Club, Wyo.

BRIEF

Each amateur is urged to inform the secretary or other club officer of the radio club in his vicinity of his future plans to enable the club to start peacetime activities as soon as possible.

AMATEUR ACTIVITIES

ATLANTIC DIVISION

EASTERN PENNSYLVANIA — SCM, Jerry Mathis, W3BES — 3HFE suggests that a traffic net be set up to reach to Hartford. We need OBS and EC applications now; other appointments will be reactivated soon. Aspirants to the BPL must reckon with a new OM/XYL combination, 3AKB and 3BWT, who were married in Washington in August. 3DPU paid a visit for the first time in three years and expects to be back soon. 3FLA, with the RID in Allegan, Mich., wants news of Eastern Pennsylvania W8s. A swell letter from 3HTM gives some light on the activities of various members of the Beacon Radio Club. 3HTM, who is in the USCG on an attack transport, says when last heard of 3HTF was at Navy Radio School in Chicago. 3GRF was last in New Guinea. 3JBC wants me to put his new transmitter on the air so he can hear how it sounds in Germany. 3BXE called up from Washington to say that he expects to attend the next meeting of the Frankford Radio Club. 3DOT brought back an Aussie souvenir in the form of a YF. We hear that 3HQE no longer is in command of the USS *Jaccard* and may be back here soon. 3DGM is back in circulation. 3HFO stopped to say hello on his furlough. 3GVZ has a fine rotary beam perking. The West Philadelphia Radio Association set up amateur equipment in the lobby of the YMCA in West Philadelphia and demonstrated message handling. The Association has started the ball rolling for a hamfest to be held in December. 73, Jerry.

MARYLAND-DELAWARE-DISTRICT OF COLUMBIA — SCM, Hermann E. Hobbs, W3CIZ — The Washington Radio Club held its first meeting of the season on Sept. 8th in the CREI Building, corner of Park Road and 16th St., N. W., with an election of officers. New officers are: Richard M. Houston, pres.; Gordon Walter, vice-pres.; Barbara Peck, secy.; George R. Sugar, treas. New code classes were started. EKZ, in Paris, France, on furlough, writes that he is on his way home. AKB, our old time cryptographer of AARS days, and BWT were married Sept. 8th in Washington. D. C. Lt. BES is in Seguin, Tex. JJN has moved back to 728 E. Biddle St., Baltimore, Md., and reports the arrival of a jr. operator on Aug. 16th. I1IN has moved to 117 Allegheny Ave., Towson, Md. He is with the Bendix Radio Corp. and expects to hold down 20, 40, and 80 when the ban is lifted.

SOUTHERN NEW JERSEY — SCM, Ray Tomlinson, W3GCU — Asst. SCM, Ed. G. Raser, W3ZI; Regional EC, ASQ. OBS appointments have been authorized by Headquarters and a few of the boys already are pumping out official messages from Headquarters as they are released. State Radio Aide Dallas Fogg has reported that activity has dropped off in most of the WERS organizations. The WKPX organization of Hamilton Twp. is going strong following a special meeting of the Hamilton Twp. WERS Operators' Association which was held in Hamilton Twp. Police Headquarters Sept. 10th, at which time it was decided to comply with the request of township officials to carry on WERS work until Nov. 15th. We wish to correct last month's report stating that EED was soon to follow JOL in discarding the merchant marine for civilian life — Les again shipped out with the merchant marine on Sept. 11th on a trip to Hawaii. He has also changed his home QTH to 724 Parkway Ave., Trenton, N. J. GRW lost a lot of gear when his ship struck a mine and was blasted out from under him. JAG is somewhere around the Persian Gulf with the merchant marine. ISZ has given up his position with the merchant marine to take over the post of chief operator at one of RCA's new stations in Germany. ZI sends some interesting dope on fan old section member, EOG, now 1NQX. 1st Lt. William B. Michael, Det. 103rd AACs Sqdn., is stationed at Scott Field, Belleville, Ill. as communications officer. Since 1922 Mike has held the following calls: 8DFO, 8OK, 8VR, 8EQF, EOG, and 1NQX. He wants to know the whereabouts of 3BND. Lt. Col. 2PF, Signal Corps, is back from overseas and has turned up at Fort Dix, as has Maj. DQ, returned from the Air Corps in India. DQ spent the night at ZI's home. 2MLW, recently returned from the Middle East and Africa, spent some time with ZI while en route to Washing-

ton, D. C. The latest visitor to drop in on ZI was RN, of So. Bound Brook. The last time ZI met RN was aboard the SS *Pastores* in the West Indies, South American run, ten years ago. In the interim Bill has been a student at N. Y. U. where he got an E.E. degree, has spent a few years with the RCAC and when the war started went to Cambridge M.I.T. Labs. as a project engineer on a very secret deal. Bill was sent abroad and spent many months doing secret work in England, Africa, Australia, Hawaii, and Alaska. Those enjoying themselves on the 112-Mc. band include ITS, IDY, AXU, and UK. BWF has recently purchased 112 Mc. equipment for the purpose of lining himself up with those who have been appointed as Official Broadcasting Stations. Among the OBS appointees are ITS, IDY, and UK. We can use plenty more of the fellows if they wish to help out by broadcasting Official ARRL bulletins as they are released for transmission. AVC and HBZ, of Bordentown, N. J., are among the 2½-meter enthusiasts. After Oct. 1st, ASG will divert to his former status, reserve officer, U. S. Army, and his permanent QTH will be in Haddonfield, N. J. The DVRA Bond Wagon is holding its own and the building fund for our own club house is steadily growing. The boys contemplate rebuilding the club rig for operation on 2½ meters. ITS has been trying to "raise" someone on c.w. on the 112-Mc. band. 73, Ray.

WESTERN NEW YORK — SCM, William F. Bellor, W8MC — With the opening of the 112-115.5-Mc. band much activity was noted around Rochester way. Those heard were: DFN, OGC, PPR, RQX, JIC, NOL, and MC. Among the DX signals was ECM, and AFQ was heard working PCZ from Brockport to Kenmore, N. Y. QUQ's QTH is: Cpl. Norm Miller, Squadron B, 812 AAF, Pope Field, N. C. Norm would like to hear from any of the boys in radar work. If the Binghamton gang is active we want to hear from them so we can pass the news along. We hear that OQC is back from the wars and has been visiting the gang. The State Guard WERS group got some GI equipment and a new frequency on 80 meters. With its discontinuance on Nov. 15th, WERS will leave a great record of achievement which will be a challenge to amateur radio to organize an emergency network able to meet any emergency. 73, Bill.

WESTERN PENNSYLVANIA — SCM, R. R. Rosenberg, W8NCJ — Members of the Radio Association of Erie held what is believed to be the first hamfest in this country since V-J Day at the Conneaut Country Club, Conneaut, Ohio, on Sept. 8th, where they were guests of the Astatic Corp. More than 100 were present. Several members had portable 2½-meter equipment in their cars and contacts were established between stations as well as with walkie-talkie outfits. BOT and Lt. L. R. Droney, discharged veterans, related their exciting wartime radio experiences. NUH writes that PDP dropped in to see him while home on leave from the Navy, and that RBK plans to stay in the Army. AOE comes along with a nice report; UVD is practicing with the key and will be active on 80 c.w. as soon as the go-ahead signal is given. KCV is stationed in Manila and hopes to be home for Christmas. While home on a thirty-day furlough IYQ is making up for lost time spent in a prison camp. TTD has returned to the Mid West, where he has accepted a teaching position at Cranby, Mo. TVA still is down in Brazil but hopes to return home soon. AAT, the lone station in Hadley, reports that MSP is a first lt. in ATC and is stationed in the Pacific. CJF's XYL is back from Pittsburgh hospital and getting along fine. AOE, president of the newly-organized Mercer County Radio Association, writes that the Association has over twenty active members with many more showing great interest. Meetings are held at the local b.c. station. There were twenty-three present at the picnic held Aug. 25th. VNE has returned to Washington, D. C., after a recent leave getting the transmitter ready to go on the air and now needs only that go-ahead signal from FCC and release from the Navy. UHO is running a movie projector for troops in Germany. T/3 KXS writes from Santa Fe, N. M., where he is with S.E.D. Bob holds radiophone 1st-class and radiotelegraph 2nd-class licenses in addition to his amateur Class A ticket, and hopes to return to State College and resume operation of 8YA. NUG sends the following fine report: S/Sgt. MHD recently was discharged from the Army after twenty-five months in the services. IOY and NUG have constructed a.c. impedance bridges as described in July, 1944 *QST*. HRD has dusted off the HRO as well as the 500-watt rig. The Amateur Transmitters Association of Pittsburgh held its initial postwar meeting on August 31st in the Assembly Room of the *Pittsburgh Press*, with about thirty-five members and visitors present. AVY

(Continued on page 70)



★ ★ ★

DURING the war, most of us waited with a show of patience for the things we needed or wanted. Right now, we want to know how much longer we have to wait. Amateurs being just like everybody else in this respect, we can hardly do better than to use this page to set forth how postwar things stand here at National.

The strictly amateur receiver, having special coil ranges expanded to cover one amateur band each, is a temporary casualty. The reason is that the amateur frequencies have not been definitely assigned. Prophecy is not among our talents, so Science will have to wait while Law deliberates. We hope it will not be for long, but in the meantime you will have to wait for receivers like the NC-200 or parts like exciter coils.

Many National receivers were accepted as standard by the armed forces during the war with only minor modifications. We think it was a fine tribute to their inherent quality and performance that stock models were able to exceed military specifications, both here and abroad. The British Admiralty used large numbers of HRO's in key positions, for instance, which were standard even to having amateur bandspread ranges. Stock receivers were not only used but copied, both by our allies and our enemies. This is a story in itself, and we will not go into details now. The point we want to make is that National receivers were comparable to the best military designs when the war started. During the war, constant improvements kept them abreast of the art as it progressed.

As matters stand, we have a group of receivers which are tops by any standard. We do not see any sense in abandoning them just to have new postwar models. As far as the amateur is concerned, they *are* new models. The HRO may look about the same, but it has been so improved during the war years that it could be called a new design.

The NC-2-40C is a new receiver based on the NC-200. It resembles the 200 in appearance, except for the addition of a separate vernier dial for high precision in logging. Inside the receiver, refinements in circuits and in construction details make the 2-40C a really outstanding performer.

The NC-45 has been so completely overhauled that we have given it a new type symbol. Listed as the NC-46, it is designed to be a high quality AC-DC set. As compared to the NC-45, it has many refinements including a much better AVC and a two watt push-pull output stage.

For the immediate future, these three basic receivers — the HRO, the NC-2-40C and the NC-46 — are the ones on which our production will concentrate. These are the ones you will find on your dealers' shelves shortly. They will look like old friends, but they will perform like the postwar jobs you have been hoping for.

WILLIAM A. READY



NATIONAL COMPANY, INC., MALDEN, MASS.

(Continued from page 68)

presided and FCC Order No. 127 was read and discussed. SWX read an interesting letter from PA6SC relating his experiences during the occupation of his country by the Germans. Much interest was displayed in the "long line" oscillator for 5 and 2½ meters and an "acorn tube" receiver demonstrated by JAV. News on Butler hams reaches us from EH, who has been in Hawaii with R.I.D. for nearly eight months. He ran across IXP, who is working for OWI, and stopped in Los Angeles to visit MKL. Ed was last reported to be working for Army Signal Corps as radar technician at San Francisco. OE is believed to be located on the East Coast. RWJ and 3GJY recently received discharges from the Army. Amateurs in localities not now adequately covered by emergency facilities are urged to contact the SCM with regard to EC appointments. 73, Ray.

CENTRAL DIVISION

ILLINOIS — SCM, David E. Blake, II, W9NUX — DSO is back from Ethiopia, where he ran the Army radio station, of which 2JWW is chief engineer, for the American Legation. BXL, 1833 W. Cermak Rd., Chicago, is looking for a real live local amateur radio club. ARN and FXB have been reappointed EC for the Peoria and Chicago areas respectively. 1st Lt. 4CYC is in the Granite City Engineering Depot. Ex-2nd Lt. SGC's temporary address is 3001 Exposition St., Shreveport, La., and he now is employed by the Atlas Oil Refinery Co. as refinery electrician. SMD, 723 E. Ash St., Taylorville, wants those in the Taylorville area to get in touch with him to help organize an amateur club. FWU is back at his post at FCC after his operation. FXB had a check-up to find out if he still is among those living. Someone bought the building from under TLQ so he will have to find himself a new location. ARN lost his beams and aerials in a bad storm several years ago but his rigs are all set to fire up with the "go" light. Sic VQE, USNR, Co. 934 NTC, Great Lakes, Ill., would like to hear from the local boys and the gang in the Austin Radio Club. Other hams in his company are KRZ, and OWI. The Chicago South Area transmitter hunt was held Sept. 9th. AVY/WHHI-227 was hidden and located first by UMU. Others taking part were: DXU, KBO, CYT, YTM, 8TZO/9, WHHI-160, WHHI-145, SWG, LUT, FXB, VRV, SCF, SYZ, SVE, HXW, Jim Lys, Lee O'Rourke, Bud Breen, and Hank Wood. The Chicago North Area transmitter hunt was held Sept. 23rd. FXB/WHHI-40, with NUX at the mike and FXB's XYL as log-keeper, was hidden and was located first by UMU. Others participating were: 8TZO/9, SYZ, KBO, BON, SWG, CYT, AVY, VRV, EAL, AZK, and YTM. 73, Dave.

INDIANA — SCM, Herbert S. Brier, W9EGQ — HZY is home after four years in the Navy as ACRT. ABB is stationed in the States after a long time on Guam. OOG was home on furlough when the Japs surrendered. NVA is constantly searching for more information on wire recorders. PUB is sweating out another half-point or so before he gets his release from the Navy. HUV is slowly getting a 112-Mc. transmitter together and building a new communications receiver. PQL and EHT have been trying hard to get together in Seattle. EHT broke his wrist while on "active duty" at a skating rink. EBB reports a great resurgence of amateur spirit around NRL since the return of hams to 112. SVH's antenna stayed up throughout the war, falling down V-J Day plus one. ONB is studying radar for the Navy. ZYJ served with five armies in Europe. AB and ZYK have emergency communications already firmly established on a ham basis in Mishawaka and St. Joseph County. EGV looks up at his antenna with a gleam in his eye every time he enters and leaves the house. ZNC enjoyed a seven-day furlough on the French Riviera. UMK spent a few days while on a rest leave in the former home of the puppet ruler of the Philippines. BPX worked on the atom bomb. QG is not too happy about losing 160 meters, but will be on 80 as soon as the good word comes. SNF is on his way across the Pacific in the ATC. PBS has a 350-watt phone-c.w. transmitter about ready to go. BDL is getting a 112-Mc. transmitter going. He and the Terre Haute gang are going to attempt to bridge the 32-mile gap between them. TIY is somewhere in California. IUM has been busy with his work. FDS is building a small transmitter and a better receiver. ART1c RDC was killed recently when his ship, the USS *Bunker Hill* fought an engagement with the Japs. DUT and EGQ have worked Benton Harbor, Mich. on 112, about 65 miles. MVZ has a four-element rotary beam, which works very well. WKN also has a beam. 73, Herb.

KENTUCKY — SCM, Darrell A. Downard, W9ARU —

AHL made the first report to the SCM after the blackout was lifted. Charlie Troutman, 8AWX/9, Ft. Knox, is on 114 Mc., as are 3JEI and 9OIT, same location. WJKE-22 has been dismantled. CVW has gone in for 112 Mc. URG traded his wings for a PT boat. DFW has gone nuts on ground plane antennas. ARU still is trying to locate equipment after moving over three months ago. 5IEZ/9 has a larger stock of radio parts than the local stores. TXC is using a swell ground plane antenna. CNE, JEI, IEZ, and NJY are burning up the air on 112. CNE is burning up his mobile power supply. YXF says his job on the road keeps him off the air. ARRL official broadcasts will be posted on the bulletin board at P.I. Burks. ARTS meetings are held at 6:30 p.m. the second Saturday of each month at the Canary Cottage. All hams, ex or potential, are invited. The first postwar meeting of the Central Kentucky Amateur Radio Club was held in the main studio of radio station WLAP in Lexington with a fair attendance.

MICHIGAN — SCM, Harold C. Bird, W8DPE — 8MV reports that the boys at WAR are talking ham language again. Several 112-Mc. rigs are going and more are under construction. 8FX, our secy-treas., spent a few days around Rogers City recently and reports that 8PVB is nearly ready to get on QMN. 8YGR reports that one of his pupils brought home some German equipment, and Earl Schurr saw action in Leyte. 8FWU is waiting for the green light on the QMN frequency. 8ROV says he finally heard from 9DEN. He hopes to see us on QMN in the near future with a new rig. 8DED writes that he likes to dream about his future rig. 9OWB thanks us for sending him the bulletin at Memphis Training Camp. He would like to have heard from 8VIV and sends greetings to MCH and DYH. 8NIT was at Scott Field awaiting his discharge when he wrote us a very fine letter recently. Sam Martin, a future ham, writes that he may be back in civilian life soon. His address is: 108 AACs, Sqdn., Hendricks Field, Sebring, Fla. 8AMS writes that he expects to attend the hamfest, and that 8RYP lost his home and all the contents by fire. 8SQQ writes from Fishermans Lake, Liberia and extends congratulations to us for the swell job of reporting Michigan ham activities during the war. Capt. 8KNP writes from Manila and asks for Pete Fuller's address. 8QBZ, from Houghton Heights, is not too busy to inquire into the future of ham radio. 8LPQ and his son-in-law, 8MPQ, started first on 112 Mc. followed by 8IHF, 8TPT, on furlough, 8UIG, 8TRB, and 8MYA. 8COW is thinking of getting on. 8LPQ and 8IHF are having fair luck with mobile and have 8ESA and 8FXM interested. Local News: Heard 8HUD working 8TNO on 112 Mc. recently. 8DIV tells us of many contacts with Detroit from his home in Pontiac. 8DIV uses 'phone and i.c.w., using a beam antenna with one reflector and four directors right in his radio shack. Boys in Detroit report an R9 signal. On Labor Day members of the Pontiac WERS club furnished communication during the boat regatta at Sylvan Lake. Equipped with 112-Mc. walkie-talkie outfits, the following hams furnished excellent two-way communication between various points on the course: 8DPE, 8SPUI, 8TNO, 8PDB, 8FQW, 8RBU, and 8SJH. Let's dust off the QMN Net crystals and rigs and be ready to furnish the State with one of the best public radio services there is. Regular League appointments will be forthcoming as soon as the remainder of our bands are returned to us. If interested, drop us a card at the proper time. 73, Hal.

OHIO — SCM, Carl F. Wiehe, W8MFP — Toledo reports a very enjoyable WERS WTRJ picnic with about seventy-five present. Attendance at meetings and code classes continues good. Experiments with crystal-controlled 146 Mc. transmitters are being conducted by ARF. PZA reports the usual well-attended and enjoyable meetings at Cleveland. LZE, recently discharged from the Army, told some of his experiences during the three years he spent in North Africa, Sicily, Italy, and England. Capt. WV, of the Navy, recounted his experiences while in China. WSM, a merchant marine radio operator, was an unexpected visitor at the meeting and described the excellent radio gear used on the Liberty ships. OFF, of the merchant marine, spent his vacation fishing. WLP is now at Kessler Field, Miss. QQ, of Columbus, reports the hams are swinging merrily along on the 2½-meter band. SNQ, SUD, and TXI recently received discharges from the Army. UFN, with the AACs in Alaska, was home on a 30-day furlough. SYK, of the merchant marine, was home recently. DV is flight radio officer with Pan-American Airlines. CBI reports that VHN has returned to California after a recent visit to Dayton. MFV

(Continued on page 78)

**ONLY
PERFORMANCE
PAYS OFF!**

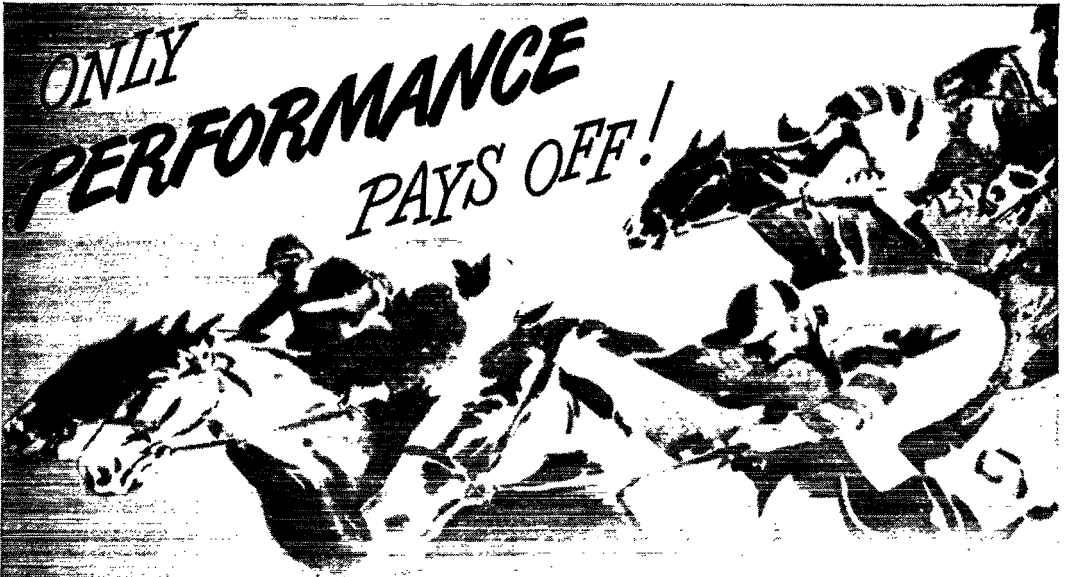

It's no photo finish with the new HQ-129-X. This new professional-type receiver is way out in front when it comes to performance. Every feature of the HQ-129-X is the outgrowth of years of building commercial receivers.

Write for descriptive booklet — place your order with your dealer today to insure early delivery.

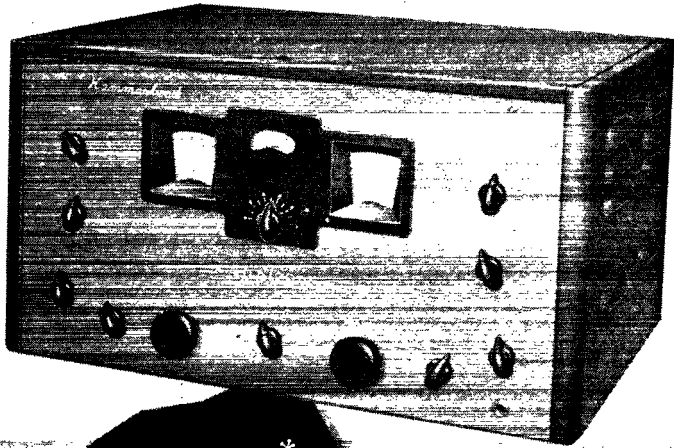

HQ-129-X \$129*
AMATEUR NET
LESS SPEAKER



WRITE TODAY FOR BOOKLET!

ESTABLISHED 1910

HAMMARLUND

THE HAMMARLUND MFG. CO., INC., 460 W. 34TH ST., NEW YORK 1, N. Y.

MANUFACTURERS OF PRECISION COMMUNICATIONS EQUIPMENT

(Continued from page 70)

writes from the Arctic that he expects to be back in the fall. Dayton WERS units Nos. 5, 8, 12, 28, and 44 are heard regularly in Springfield. PNQ reports from Cincinnati that the QCEN held its seventh and eighth transmitter hunts. Both 1½- and 2½-meter rigs were hidden. First prize went to PNQ and Fred Schaber. SDJ and Roland Zimmerman were second. The rigs were hidden within a 70-square-mile area and were found in the near-record time of 1 hr. 6 min. The latest QCEN picnic was attended by a gang of eighty-eight enthusiastic hams. 73, Carl.

WISCONSIN — SCM, Emil Felber, jr., W9RH — UFX taught over 16,500 men and women the code at Madison and plans to continue teaching code over the air. For information write to Ted Kennedy, 225 Owen Dr., Madison 5, Wis. The Four Lakes Amateur Radio Club will meet shortly to discuss plans relative to going back on the air. HMG is eyeing a big tree in back of his house. FVX is looking for a rag-chewer certificate already. PCX, located in Brazil, is planning to get on 40 there if international QSOs are allowed. MJJ is teaching school in Tucson, Ariz. AVM is painting Camp McCoy. UFX wants the address of RBI. CJN hopes to return home sometime in Oct. HMO, formerly civilian radio instructor at Truax Field and the U. of Ill., reports that he will be inducted into the Army. ARE has relocated in Milwaukee after several years in Washington, D. C. Capt. DOR was a visitor at the MRAC. Lt. KFB and 4ERZ were also present. KLM, formerly operator with N. W. Airlines, is shooting again for WTMJ. JPS has returned to civilian life. JWN, at Great Lakes, should be "demobbed" by now. Lt. ANA, USNR, is on his way home. GRM Sam Strzelczyk participated in five major amphibious assault landings in Europe and a reinforcing landing at Leyte, P. I., and now is headed for Japan. DYO, ARM 3/c, has been in Memphis, Tenn. for 2½ years. Comdr. DTK, USNR, is returning to the States from Saipan. ACRM ADI is at Pensacola, Fla. Sgt. Don Hayner should be home from Naples, Italy. T/4 Ed. Strzelczyk expects to be home soon from Oslo, Norway. CRE Ted Kercher, USN, K6SNW, ex-HWY, wrote from Londonderry, Northern Ireland, that after seven years in the Navy he expects to be "demobbed" by Jan. 1st. YKC has been appointed publicity chairman for the MRAC. The WERS gang at WMFI has been instructed to take the units home and remove the antennas from each location before the cold weather sets in. H. F. Wareing, radio aide of WMFI, wishes to thank the 101 men who qualified for operator permits and who devoted considerable time, effort, and money to the construction, installation, and operation of the fixed and mobile stations. SYT, EC of Milwaukee County, wishes to form an emergency amateur net and wants all information on equipment, etc. sent to his QRA, 1723 W. Fond du Lac Ave., Milwaukee 5, Wis. Clubs upstate, please send me the name of your candidate for EC. 73, Emil.

DAKOTA DIVISION

NORTH DAKOTA — SCM, Raymond V. Barnett, WEVVP — Plans are under way to organize a radio club serving all of central North Dakota with headquarters in Bismarck. At an informal meeting held recently, GJJ was elected temporary president and SSW temporary secretary. At present three men are studying for the Class B exam. All members of WERS here will continue schedules until Nov. 15th. Amateurs in WERS contemplate moving to the new 144-148 band when possible and will continue to perfect the emergency organization and equipment. Your SCM acknowledges a personal call from ZRT. Doc parted with an HT9 at the start of the war so is keeping his eyes open for a new rig. EVP has his power supply ready, is building a new exciter, and already has finished foundations for a 70-ft. self-supporting mast. GJJ is worrying about power supply to pull his pair of 809s. RBS made the rounds for a short while in Bismarck recently. GZD reports that NAW still is at Camp Adair, Ore. with Hq. Det. His famous kw. rig, usually on 40 c.w., is intact at his office in the "Chicago Cafe" in Grand Forks. TUF is building a new addition to his house. HSR of Hatton is building a new house during his free hours. DM is teaching math at Central High School. He is working on a broad frequency receiver for high fidelity b.c., listening. Victor Kleweno, former Minnesota ham, now with CAA as aircraft communicator, is on the Forks roster of hams now. MGR, Carrington traffic handler, is somewhere on the West Coast as brakeman for GN railroad. TJT is building h.v. power supply for his final. GZD has his p.p. 807s final finished now. He is working on

ideas for impressing a bit of audio on whatever the 807s put out in case somebody wants to hear what his voice sounds like on 75, 20, and 10. How about a line from Wahpeton, Fargo, Williston, and the rest of the State. 73, Ray.

SOUTH DAKOTA — SCM, P. H. Schultz, W9QVY — ZBU reports that MBA is at Camp Schumaker, Calif. TJX, ex-7HLE, was on Swan Island for CAA in 1944, was field radar engineer for Raytheon Co., and now is radar engineer with Watson Labs. at Leesburg, Fla. He would like to hear from the Sioux Falls gang. Lt. DUC, USNR, is radar officer in a combat aircraft service unit forward, temporarily at NAS, Alameda. His address is Box 955, Oakland 4, Calif. TZJ, of Rapid City, is back from England. AKO is out of the Army and has entered the School of Mines. YKY is back in Rapid City. The Rapid City gang held a meeting and all old officers were retained. 73, Phil.

NORTHERN MINNESOTA — SCM, Armond D. Brattland, W9FUZ — Some of the gang are on 2½ in St. Paul and several are building. The first cross-town contact was made between MPI and BHY. GVO puts in a nice signal from Bald Eagle and OPA is busy building some nice gear out there and keeping a schedule with GVO meanwhile. JNC faithfully reports to this column. KRV is with KWBW at Hutchinson, Kans. JRI, at Eagle Mountain Lake, Tex., expects to be released from USMCR in the near future. NCS is teaching radio in USCRG at Atlantic City, N. J. ORT, located at Truax Field, Madison, is on furlough at Bemidji and visited FUZ. ODY is at Mare Island, Calif. MTH is enlarging his ham quarters and is putting up a new mast. RPT is located at Fairmont, where he is employed as production engineer at Fairmont Railway Motors Co. The St. Paul Radio Club held its first postwar meeting. ZWW, still with AACS, sent a cable of good wishes for its continued success. BMX is rapidly recovering from his recent illness. IFW is building an m.o.p.a. for 2½. IBD is back as department head at NWA. Ben was one of the key men at the bomber modification center in St. Paul. BBL doesn't know when he will be out of the Coast Guard. PAL and RPT were visitors at BHY. UCV is building for 2½, having completed his receiver. JIE, president of the St. Paul Radio Club, is lining up the general long range club program. OVB shortly will be making a study of the by-laws to find out how they may be improved. BHY has completed Beecher's latest electronic bug and reports it works like a charm. HZV is talking about taking up flying. FUZ, still at Bemidji, plans to go back to sea as operator for the merchant marine. 73, Army.

HUDSON DIVISION

NEW YORK CITY AND LONG ISLAND — SCM, Charles Ham, jr., W2KDC — T/Sgt. Brosnan reports from Washington, D. C., that he is building a transceiver. UK, of DX contest fame, writes from New Brunswick, where he is assistant engineer in charge of RCAC transmitting station. Sgt. JAP writes from Madison, Wis., and wonders about portable operation away from home. NYC writes from Mobile, Ala., where he pounds brass on B-24s and C-54s for Panam. ONI is shop maintenance adviser and inspector at March Field, Calif. He is in need of 2½-meter equipment. DOG reports from Riverhead that WLSB went inactive but now uses amateur calls performing the same service. ADW is most active. DOG's 815 went to tube heaven recently. HAC is in Jackson Heights after a year in Africa with PAA. He won a pair of 812s at the last hamfest and traded them for 615s before opening the boxes. JVO also attended the hamfest. MSF, of Rego Park, is building a 28 Mc. rig in his spare time. IAG is in a valley, which is not so good on 2½. 7FQF/2 just married. 7GEG/2 moved to the East. LFX, ex-major, has just been released and is on 2½ from Manhasset. BKZ is searching vainly for a radio room. OG's new soundproof shack is so perfect he doesn't hear the supper bell. MYE had a nice write-up in the local rag. SM5NM visited KDC recently. We repaired to the shack where Gunnar gave the boys on 2½ their only foreign contact, it being his first QSO in 6 years. KDC is looking for live wires for appointment as Emergency Coördinator and will welcome suggestions as to the formation of emergency nets to replace WERS. 73.

NORTHERN NEW JERSEY — SCM, Winfield G. Beck, W2CQD — The Union County Amateur Radio Association held its first big meeting at the Elizabeth "Y" on Sept. 13th with IIN presiding. It was a fine meeting and a bunch of good fellows attended, including LI and BTZ. Drop around to the club and meet the boys any Thursday

(Continued on page 74)

Try
it!
Compare
it!

\$129*

AMATEUR NET
LESS SPEAKER

HQ-129X

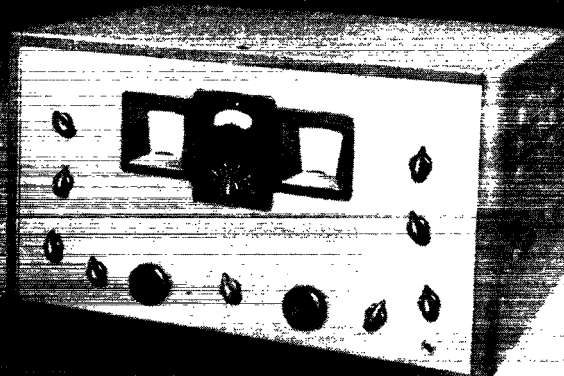

PRICES SUBJECT TO CHANGE
WITHOUT NOTICE

Try—then compare, and you'll agree that this professional receiver is an outstanding value. It is built by craftsmen who specialize in communication equipment. The HQ-129-X has endless improvements which are fully described in an eight-page booklet... Write today for complete technical information.



ESTABLISHED 1910

HAMMARLUND

THE HAMMARLUND MFG. CO., INC., 460 W. 34TH ST., NEW YORK 1, N. Y.
MANUFACTURERS OF PRECISION COMMUNICATIONS EQUIPMENT

(Continued from page 76)

evening. There are code and theory classes, too. For further information get in touch with GIZ, secretary of the Elizabeth "Y." OAV recently dropped in to say hello to your SCM. He is going to school in Angola, Ind. MUP just received a QSL card from KC4USC, the snow cruiser in the Antarctic. He worked him on 10 meters on Oct. 2, 1940! Calls heard on 2½: MUP, HMV, EUI, HVK, 3AC, AGH, NUM, MLW, IBL, OMY, LI, NPJ, ECP, GIZ, CQV, LYW, COT, ATK, NLY, DFV, 3HOH, 9BBD, LOC, KTC, JN, CWK, and HUX. 73. "Win."

MIDWEST DIVISION

IOWA — SCM, Leslie B. Vennard, W9PJR — EFI renewed his EC appointment. URK, UFL, and AED are new OBS. More are wanted. KZI got some Chinese money from WLH, who has big plans for the future. DJY built a 20 x 22 brick ham shack in the back yard, and has renewed his EC appointment. AHP is building a four-legged 60' tower in his spare time and reports MTS is out of the serv ices. UFL reports that WERS is working fine and UNJ is the proud papa of twin girls. ETS has moved to Kansas City with CAA. Ex-SCM CTQ is expected home very soon.

KANSAS — SCM, Alvin B. Unruh, W9AWP — Comdr. DEB, USNR, visited friends in Wichita en route to his West Coast station. BCZ has returned after working in the OWI. Ens. KFH now receives mail, care Electronics Division, Navy Yard, Mare Island, Calif. Sgt. MJU graduated from Scott Field, Ill., radio school and was assigned as flying radio operator air crewman. VBQ, formerly RM and NCS of the KN net, is active on 2½, as is NSB, also at Lawrence. WGM is active on 2½ in Topeka. JZU still was in Massachusetts in late August, at which time his YF was a patient in Veterans Hospital. QEF expects a discharge soon, and is interested in 2½ meters, and other bands when available. QQI is attending State College at Manhattan, where he expects to finish his E. E. course. He worked as electronics test engineer at Boeing-Wichita until V-J Day. Another Boeing confidential electronics engineer, 5HEH, an E. E., will specialize in designing large antennas on the farm he purchased near Parsons following V-J Day. AWP, also in the electronics test engineering group, is staying on to finish new equipment in an experimental ship, after which he will devote full time to commercial brasspounding. YYW returned from overseas on furlough to visit ZUY, his YF. OZN, a Signal Corps sgt., is home on furlough after service in the European theater. CVN purchased a new SX-28 receiver. GSW accepted a position with Kansas Gas and Electric. QMB, YVI, ABJ, and others are making plans to reactivate the Wichita Amateur Radio Club. 73, Abt.

MISSOURI — SCM, Mrs. Letha A. Dangerfield, W9QUD — ZVS became the proud papa of a baby daughter on Aug. 1st. He talked with KIK via telephone about getting the old AARS club in St. Louis rolling. MBE, in the Pacific area, has been taking the 42-lesson course in radio engineering that the Navy gives for its 2/c men, and has enrolled in a Capital Radio Institute in broadcast engineering. MOZ sent a picture of VEW with a write-up for Gold Stars. Picture and clipping were loaned by 6UTZ, ex-HDK of Willard. GCL is a radio and teletype operator for CAA at the airport in Kansas City. Jim Harvey writes that he has all the equipment ready to go as soon as tickets are issued again. 4HLN, ex-IGW, with the merchant marine, asked us to get him application blanks for renewal. The BMS-ODU radio shop, in the garage at the rear of 411 Moffett, has been in operation a month with very fair results.

NEBRASKA — SCM, Arthur R. Gaeth, W9QFB — MLB made reapplication for EC appointment. ZNI hooked ROE and contacted Lincoln, and also heard EKK. ROE reports VKT 88. The first successful message relay from Omaha to Lincoln and return via EKK, ROE, EAT, and DMQ took place on Sept. 14th at 9:12 p.m. FDG moved to Bellevue and is active on 2½. WWV now is in Hastings. RWV, with KMMJ, has four-bit kilowatt ready for 7 Mc. "phone. K6TXV, ex-MUK, reports as a civilian from his home in Lincoln and is trying out the late WOA's receiver. CDZ, formerly of Le Mars, Iowa, now of Omaha, made application for a job on the fire department. 5ABI, former SCM of Arkansas, just listens. LIQ was inducted into the Army on Sept. 26th. ZPZ attended CAP camp at Ashland and reports hearing FQB while flying at 6000 feet ten miles west of Lincoln. KHKN-43, Henry Petersen, is studying hard for a ham ticket. VKT hears ROE and EAT quite regularly, and purchased a new SX-28. UFD has purchased a new RME-43. YMU has a 40-foot pole ready to hoist,

with an 8JK for twenty. SHF has two 10-meter crystals and a new rig ready to fire up. KHKN-15, Paul Russum (LSPH), purchased FQB's 6L6-809 exciter rig. JHN is back on the job after having been on loan to Western Electric Co. EKK reports as follows: Copying ROE, EAT, ZNI, and HQQ, and have arranged schedules with them for OBS relay from FQB; IXD, Hamburg, Iowa, visited the shop and left with ideas of a parabolic reflector beamed at Omaha; VFL also visited the shop. PDG is working for EKK; BNT's Capt. Gray borrowed an S-27 and is listening on 2½. NNU is in Germany, and received a decoration from the Belgian Government. RT1c Charles Wadell (LSPH), is instructor at Treasure Island and is living in Berkeley with his new XYL. Sgt. QUA reports from Menzinger, Germany, and inquires about HTE. UEV moved to a higher location and no longer can be called "The Voice of South Omaha." Sgt. NYU is in Linz, Austria, with a new service group and GCO is 4QH. Dick Eilers inquired about ham radio and was furnished the dope pronto. "Cellophane" (LSPH) is looking for permanent quarters so she can start building the rig. FQB redecorated and rewired his operating room and added new poles for half-wave on forty. 73, Art.

Traffic: W9ROE 4, EAT 4, EKK 2, DMQ 2.

NEW ENGLAND DIVISION

CONNECTICUT — SCM, Edmund R. Fraser, W1KQY — WR now has two grandchildren. His son, Maj. John Vanderpool, recently was released from the U. S. Army Air Corps after being decorated with the D.F.C. for raids on Balikpapan and Borneo. WR advises that GM6RG, well-known, 10-meter ham, plans to visit this country again soon. RT3c KAK, USN, at San Bruno, Calif., expects to leave for the Pacific. He has just finished eleven months of radio technical courses at Bliss, Md., and Naval Research Laboratory in Washington, D. C., where he received his commercial radiotelephone 1st-class license. Steve Tabor (LSPH) sends 73 from Saipan, where he is operating station WXLD. LOP, 1st Lt. U. S. Army Air Corps, writes from Tinian that he has completed thirty-four missions and has been awarded the D.F.C., four air medals, and two battle stars, and is eligible for discharge. He advises that NAT is getting actress June Haver interested in ham radio while at Hollywood. With the reactivation of amateurs on the 112-115.5-Mc. band, the Connecticut section on Sept. 15th & 16th, held its first "QSO" Party since the war. WERS units will continue operation on a reduced scale until Nov. 15th. The faithful operation and attendance shown by the majority of these WERS operators deserves high praise. BW has completed his e.c.o. and reports operation very satisfactory. GDC is working at G.E. Co. in Bridgeport and was a recent visitor at "GB" along with HSX. FMV has put his rig in shape for 80, 40, 20, and 10. FJE is building a rig for the 144-148-Mc. band. GC and BGT are trying out antennas for 112 Mc. MVH and TD are studying for the commercial 2nd-class radiotelephone exam. Charlie Davidson, "GB" member, has been discharged from the merchant marine and is working at broadcast station WNAB. AIY is using tape code wheel on 112 Mc. which sounds FB. LZH and MVE are dusting off their transmitters awaiting return of the low-frequency bands. Geo. Dunbar, Fred Burkle, and Ed Bates, members of GB, are anxiously awaiting assignment of their station licenses. Steve Van Eesen (LSPH), former West Haven radio aide, recently paid TD a visit while en route to Hammarlund. Stations heard operating on 112 Mc. are: IJ, KAT, FMV, GB, GC, BW, DXL, ATH, CTI, EH, NEK, EYM, DBM, MVH, LTB, LTZ, LZM, JQD, TD, DGG, IND, EAO, ASO, UZ, ZT, MTQ, BQQ, GQV, BGT, LLL, EJI, AIY, KHL, BFW, GDG, LVX, AYY, WR, 2OEN/1, GSP, MSB, EER, ILD, IGT, CLH, FPM, LFL, AYE, KYD, FUW, FSH, GYA, IQI, 80SD/1, NQY, KGE, 2IQI/1, NH, HQD, MAI, LUZ, MRP, ANC, GTH, KAI, MWN, LWB/2, and others. The following OBS appointments have been made: IJ, NEK, BW, EAO, LTZ, JQD, EYM, KAT, IND, FMV, FSH, DBM, DGG, BCG, CTI, ALW, EEM, and TD. Other appointments will be considered. 73, Ed.

MAINE — SCM, G. C. Brown, W1AQL — CBV and UP have consented to become OBS and will receive their official tickets soon. Drop a line to your SCM for details on the OBS appointment. JYA, Fitchburg, Mass., was in town recently while routing wind-recording machines for the Army. 6SVR is an operator at Flight Control, Dow Field. 2HNP is chief controller for the CAA in Bangor. 2KIF is with the AACs, Dow Field. Lt. D. T. McKenzie, Seguin,

(Continued on page 76)

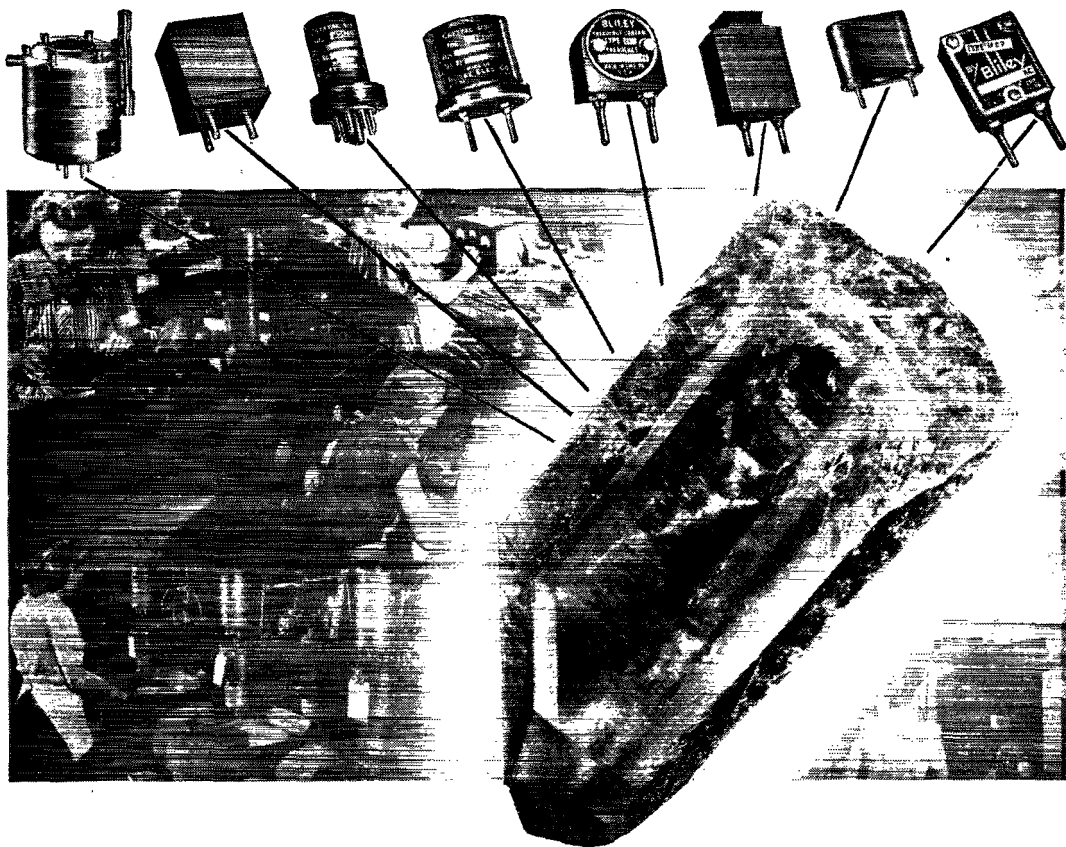

You name the application . . .

BLILEY has the crystals

Post VJ Day production of Bliley acid etched* crystals for FM receivers, Aircraft and Marine radios, Railroad communications equipment and many other applications is proceeding with the same skill and efficiency that marked our war-time operations.

Substantial quantities of these crystals are in the hands of foresighted manufacturers who planned in advance with Bliley engineers for frequency stabilization in their post-war models.

Now, more than ever before, you need the versatile experi-

ence of Bliley engineers and craftsmen gained through more than 15 years of quartz crystal engineering exclusively. Whether your requirements are one crystal or a million, you can be sure of top quality—top design—and top performance—in Bliley crystals.

+ + +



Another star has been added. Our 5th citation for outstanding achievement in producing materials essential to the war effort.

**Acid etching quartz crystals to frequency is a patented Bliley process.*

Bliley

CRYSTALS

Radio Engineers—
write for temporary
Bulletin Q-26

BLILEY ELECTRIC COMPANY • UNION STATION BUILDING • ERIE • PENNSYLVANIA

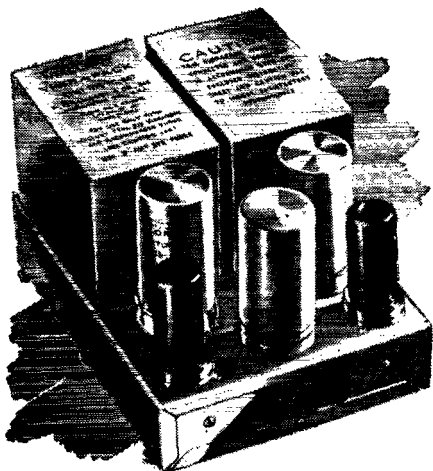

Daddy of them all

Introduced by Mallory in 1937, the popularity of Vibrapacks* has grown by leaps and bounds. But these "perfect portable power supplies" didn't spring into existence overnight.

The "daddy" of all Radio Vibrator Power Supplies or Vibrapacks was the Mallory-Elkon "B" Eliminator, manufactured and sold as far back as 1931 to power the early automobile receivers designed for use with "B" batteries. Fourteen years of experience! No wonder Vibrapacks have such an enviable reputation for long life, efficiency, low cost!

Vibrator power supplies provide the ideal source of plate power for receivers, transmitters, direction finders and countless other radio and electronic devices where commercial AC power is unavailable. When you select vibrator power supplies, select the best—Get Vibrapacks, built exclusively by P. R. Mallory and Co., Inc.

Write today or see your Authorized Mallory Distributor for a free copy of Form E-555E, describing stock types of Vibrapacks. Inquiries are invited from manufacturers regarding special models for original equipment service.

*Trade Mark Reg. U.S. Pat. Off.

P. R. MALLORY & CO., Inc.
INDIANAPOLIS 6 INDIANA



P. R. MALLORY & CO. Inc.
MALLORY

(Continued from page 74)

Tex., says he plans to get into ham radio after his release from the Army. IES writes that he has been released from the armed forces and is looking for a job in radio or radar. According to latest reports, QH is headed for the Philippines. APU called by phone to ask about the prospects of getting back on the air. MN has been released from the Navy and is back with the Telephone Company. Don't forget to drop the SCM a line about reappointment and appointment as OBS. 73, "GC."

EASTERN MASSACHUSETTS—SCM, Frank L. Baker, jr., WIALP—The following have been heard on 112–115.5 Mc. recently: MYE, SS, PI, IHA, IS, MMH, BDM, CPB, EHT, EKT, JLL, HIL, EPE, KDK, MUD, AKD, LYL, IHI, JCT, ALP, JNV, NOV, GDY, MOR, MWF, IB, JXZ, FWS, JKR, LWI, AWA, HNR, BNS, KZD, MUI, LOV, NQA, MBB, AEM, AQA, FNR, HHU, MCR, QA, KLW, MUA, NPF, FH, AOZ, JB, LZW, LFD, LAT, LZL, RD, MJE, KBS, NBC, KDH, MAL, DAN, NAV, LBQ, LMG, KQJ, MSW, FIK, MON, NFK, CTW, IN, COX, AFE, AGR, IXI, LJT, IPA, HSB, NBS, BB, JBY, MUO, MSK, JZB, FED, 2CGH, LIX, MXB, 3ILL, 6IAH, 7FZD, 8DMW, 9FXD/1IDR, 9QMY, AWX, JPM, JDO, RX, KAO, GWE, CRW, EU, WS, EYR, CBW, LBQ, HMH, BJE, and LFD. JFS sends in a list of hams on 2½: KEK, MNK, TY, AGX, LVZ, NF, NME, IOC, KVQ, AWO, LQQ, DIA, HPZ, NPN, IXO, AMT, NVB, JIX, LN, KB, MJ, JOY, and NEW. EHT says that the first meeting of the 56 Mc. Minutemen was held at his house with HUV, VT, IN, DA, EKT, and MJ present. A card from Lt. D. T. McKenzie, Sequin, Tex., states that he is going after his license as soon as he gets out of the Army. LYB and 2KHA/9SAG are working at M.I.T. Andy Ring (LSPH), of Brooklyn, N. Y., is a CPO in the Navy and is located at Squantum Naval Base. Capt. IID writes from Watson Lab., Red Bank, N. J., that he is in charge of the Foreign Equipment Unit. By now he is in Tokyo. Other hams at Watson Lab. are: Capts. 9DSN, 2GFR, 4ERZ, and 8SAN. JOJ has gone to N. Y. C. to work for CBS. LEM still is in California in the Supply Depot. MPT, who was home for a few days, is on a sugar boat between Boston and Cuba. LZW has a new son and LAT has a new daughter. GAG had a letter from MQO, the first ham on 2½ in Hawaii. The South Shore Amateur Radio Club held its meeting with the following present: 4HBV/ex-1JOB, ALP, DMS, IS, FWS, IB, BDM, CPB, CPD, LZB, DPI, CT, IHA, MMH, KXN, 5JLO, the Mugford twins, Hoxie and Coquette. MQE says he would like to work the States from Iwo Jima. JMW was home recently. KUB is home. LTS would like to be home on the air. JFS says that the boys are painting his mast red and yellow so planes won't run into it. He had a visit from ex-AFF, KDK and his XYL, MJE, MNH and his YL, JMW, KTY, KEK, and JKY. MON says that the two Brockton clubs have joined forces and will meet the first and third Mondays of each month starting in October. JBY still is in the Navy in Virginia. LYL has a new jr. operator and is doing radio service work. LZV, ALP, and 8DMW have compiled a list of hams that have worked at M.I.T. Radiation Lab. If you are not listed, please send your name and call to me. HDJ now is in Germany with a radio squadron. MXG is a radio officer on the *Geo. E. Badger*, and has been in the tropics. LID writes from Manila and says he will be on his way to Tokyo by way of Biah. MBQ writes from Vineyard Haven that he has a new shack with an oak floor, hot water heat and a powder room for the YL. Ex-CIL has been working at M.I.T. 73, Frank.

WESTERN MASSACHUSETTS—SCM, William J. Barrett, WJAH—The Pittsfield Radio Club held its second picnic of the year on Sept. 16th, with thirty members in attendance. Among those back on the air are BKG, IZN, JLT, LUD, LKO, KZS, IFE and FXO. The favorite spots seem to be Berry Pond and Mt. Greylock. Calls heard include 8FPC, 2MRO, 8LWA, 1UZ, 1NE, and 2KLM. Two P.R.C. members will be out of circulation: Jack Fitzpatrick has enrolled at Northeastern U., and Bob Seace has signed up for a hitch in the regular Navy. Dick Atwood reports that before Nov. 15th, the WJBB gang will hold a last meeting with AQM as radio aide, and will establish a new Worcester Radio Club. Among the gang back on 2½ are AQM, AYE, IHI, IYY, JDI, KJO, MIA, NJY, and NUI. WJBB-3, located at Paxton, reports hearing over two hundred calls since the band was opened. BCT reports from Leominster that he and EHH are active and would like to contact more of the Worcester and Boston gang. EHH, portable on Mt. Wachusett, worked IND, portable at Prospect, Conn.

(Continued on page 78)



The Raytheon type CK1012 full wave gas rectifier was developed to supply the requirements at high rectification efficiency for those applications which require more power than is obtainable with conventional receiving tubes and yet cannot justify the size and expense of transmitting type tubes. In this category are the larger fm and television receivers and small fixed or mobile transmitters.

The CK1012 is contained in an ST-14 bulb, which is the size of a type 80. The emitter can be directly heated—or, under the proper conditions noted below, ionically heated for greater efficiency and elimination of heater windings.

The very rugged construction is ideal for mobile equipment, and the use of an inert gas allows it to operate over a wide range of ambient temperature. No preheating time is required, and consequently full output is obtainable almost instantly. Any tendency to generate noise in radio frequency applications can be minimized by proper filtering and shielding of the tube and associated wiring.

Whether or not CK1012 fits your requirements, it is an example of the advanced engineering and painstaking manufacture found in the entire Raytheon tube line. For best results, specify Raytheon High-Fidelity Tubes for your products.

TYPE CK1012 RATINGS—FULL WAVE RECTIFIER SERVICE

	IONICALLY HEATED*	DIRECTLY HEATED	
Filament Voltage	0	1.75	volts
Filament Current	0	2.00	amp
Maximum Peak Inverse Voltage	1200	1200	volts
Average D.C. Voltage Drop	25	20	volts
Maximum D.C. Output Current	300	300	ma
Minimum D.C. Output Current	70	0	ma
Minimum Starting Peak Voltage	400	300	volts
Maximum Steady State Peak Anode current per anode	900	900	ma

*This condition is not recommended for rapid intermittent operation

All Four Divisions Have Been Awarded Army-Navy "E" with Stars



DEVOTED TO RESEARCH AND THE MANUFACTURE OF TUBES

ELECTRONIC EQUIPMENT FOR THE NEW ERA OF ELECTRONICS

PORTABLE POWER PROBLEMS

THIS MONTH—COMMERCIAL SOLVENTS CORP. PENICILLIN TEST

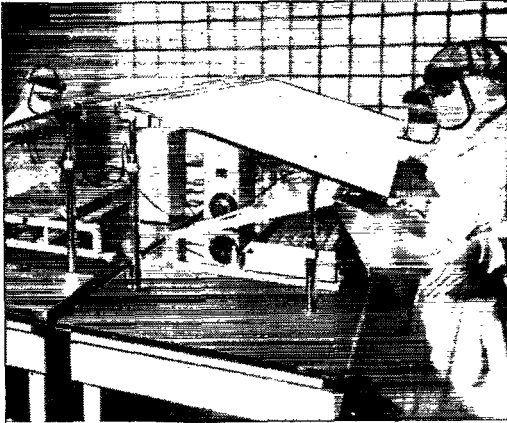

LIFE-SAVING PENICILLIN salt solution is carefully tested by battery-powered pH meters before it is placed in vials by white-clad technicians at the modern Commercial Solvents Corporation plant. Throughout the entire manufacturing process, rigid pH checks against excess acidity and alkalinity must be maintained while the penicillin is in solution.



FOUR pH METERS, powered by Burgess Industrial Batteries, are employed by Commercial Solvents Corporation on a 24-hour a day basis to assure necessary, uniform product control. Burgess Industrial Batteries are built to meet specific requirements of test and control instruments. Whatever your portable power problem may be, Burgess engineers are equipped to find the answer. Write us today about your needs, or request free, 80-page Engineering Manual on characteristics of dry batteries. Dept. Q-7. Burgess Battery Company, Freeport, Illinois.

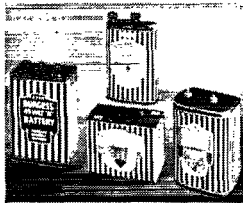

BURGESS BATTERIES

(Continued from page 78)

MND expects to be on soon, while CHB is tuning up the 20-meter rig. 73, Bill.

NEW HAMPSHIRE — SCM, Mrs. Dorothy W. Evans, W1FTJ/4 — LVG, last reported in Tucson, Ariz., is with a B-29 squadron and hopes to be home shortly. LBD is back in the States after a tour of duty at Pearl Harbor. MUW's husband, JMY, is back at ARRL. CME was home for a vacation and has returned to his work in Florida. ADR is back on the job after a rather serious tangle with the 2200-volt distribution line in Derry. 3MY has been discharged from the Army and is back home. JSL has been on Okinawa. DUK has been retired from the Navy and is back in Rochester. ILN wrote a nice letter from Naples, Italy, and says he hopes the U. S. hams get on the air soon, as he can work the Ws easily on 20 or 40 meters from there! MLO is hard at work at West Point. AVJ's son arrived home in Concord on V-J Day, after a long tour of duty in the Pacific area. Bob has a radio room all picked out at his new QTH. By the time this gets into print, FTJ and BFT probably will be back in New Hampshire and starting their civilian life all over again by reopening their radio business and fixing up their dog kennels. Drop in on us at Bow, fellers!

VERMONT — SCM, Burtis W. Dean, WINLO — At the annual meeting of the BARC the following were re-elected: LWN, pres.; Ray Fields, vice-pres.; and NLO, secy.-treas. The Burlington gang is making plans for a club station. Code classes are held every Monday night at the club's shack, rear 25 Bay View St. Visitors are welcome. GAN and his XYL visited DQK and KEP. GNF reports that AHN is married. GKA has left Harvey Labs. and is working for Colonial Airlines at the Burlington Airport. SKOH, ex-KDB, and family were recent visitors in Burlington. LWN has resigned from the WCAX engineering staff and has gone back to UVM to finish his education in E.E. After several years at sea as a radio operator ex-8CZJ has become a landlubber and has taken LWN's place at WCAX. A hamfest will be held Saturday night, Nov. 10th, beginning with supper at 6:00 p.m. in the Waterman Bldg. cafeteria; 7:00 p.m., Electronics Lab., Room 325; 8:00 p.m., Room 239, Hallicraft's movie "Voice of Victory," a talk on tubes by 2DC of G.E., followed by an ARRL Club Award Code Contest. 73, Burt.

NORTHWESTERN DIVISION

MONTANA — SCM, Rex Roberts, W7CPY — The Butte Amateur Radio Club held its annual picnic at Basin on Aug. 5th and a good time was had by all. There were thirty-five in attendance with EQM and CJN and their families camping on the spot the night before. The club has purchased a 300-watt, 110-volt a.c. generator for future portable work. AW, of Custer, was in Glendive recently. The WERS organization in Great Falls still is intact as there are so few licensed amateurs there at present it was felt that a good workable net under regular operation could not be organized at this time. The regular Glacier Park hamfest was held on the west side of the park on July 14th-15th. 73, Rex.

OREGON — SCM, Carl Austin, W7GNJ — HAL burned out his 112-Mc. power supply trying to get going, but mentions that FHJ, FNK, CYT, DDG, BNW, GAN, and 6TYT/7, the latter two being mobile, are on. HLH and HWH are working 113 Mc. using a parabolo funnel antenna, beaming the signal straight up. Dwight says that FMQ is itching for traffic, and that EXF is gathering parts for u.h.f. T/4 HNY spent the past twenty-four months in the Fiji Islands, New Guinea, and now is on Luzon. The SCM will furnish his address to those who wish to write him. ALU, who is about 10 degrees from the equator, has a pair of 813s in h.f. final which he hopes to use soon. K6CIB is electrician at Chemawa Indian School, and is applying for a W7 call. GLF is back home dusting off the rig, after many months in Sitka and the Aleutians. He worked with GIN for six months. Joy says QP, GUA, and himself are the only hams back so far. BS is in Milton, where he is city manager in charge of electric and hydro plants. FHB reports on the Eugene gang as follows: Recent visitors were FHM and FRH, both CRM; FBO passed his exam at Treasure Island, and is now an ensign; A9O is back in London supervising aircraft radio servicing; ILQ, the club station, is ready to go on 7 and 3.5 Mc. The Eugene Vocational School is to have a 250-watt f.m. b.c. station, and Roger will be chief engineer. ALY, who was radio operator on a 4-motored transport in nearly all operations from Port Moresby to Leyte, reported in person recently. ARZ has finally un-

(Continued on page 82)

The New Collins 21A, 5kw Broadcast Transmitter

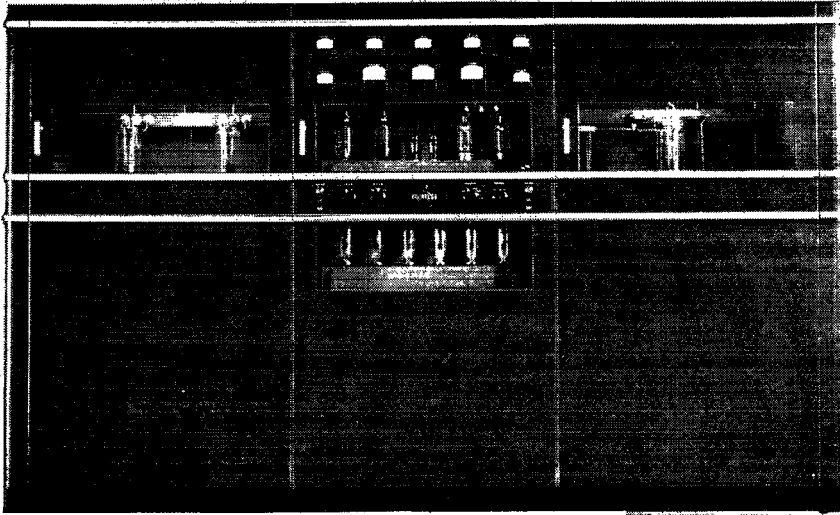

Fulfilling the Tradition of Collins Quality Leadership

THE 21A is a thoroughly developed 5 kw AM broadcast transmitter, and an excellent example of characteristically superior Collins engineering and construction.

Based on sound, well-proved principles of design, the 21A has been completely modernized within recent months. New components of improved design, with longer life and higher safety factors than were previously available, assure reliable continuous operation.

The response curve is flat, within $\pm 1/2$ db. from 30 to 10,000 cycles. Reduced power to 1 kw is obtained by instantaneous lowering of plate voltages, permitting uninterrupted program transmission.

We will be glad to send you detailed information regarding the 21A, other Collins transmitters, the 12Y remote amplifier, the 12Z four channel remote amplifier and Collins high quality studio equipment. Collins Radio Company, Cedar Rapids, Iowa; 11 West 42nd Street, New York 18, N. Y.

FOR BROADCASTING QUALITY, IT'S ...

Collins equipment is sold in Canada
by Collins-Fisher, Ltd., Montreal.



The Collins 12Y Remote Amplifier

A one channel remote amplifier for unattended operation from a 115 volt a.c. power source, the 12Y provides the advantages of quick set-up, small size, light weight, high fidelity, simple operation, utmost reliability and low cost. It is practically hum free due to the removal of the isolation transformer, which is in the power cable.

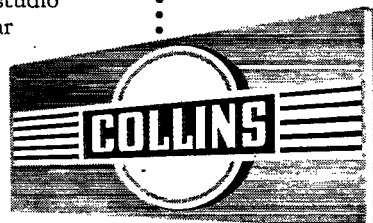

The best of all that's new in home radios

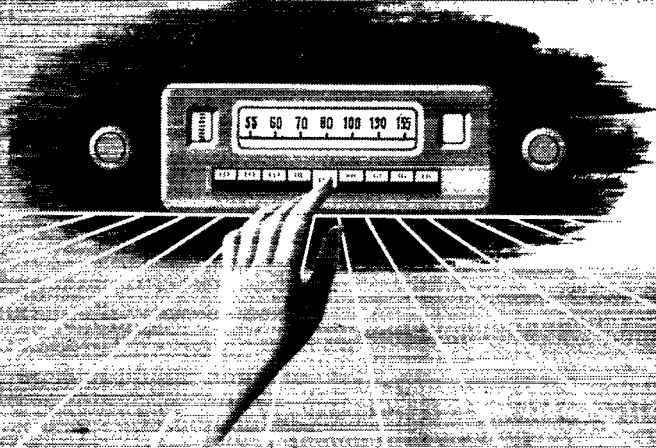

Yes, there will be F-M and A-M Delco home radios . . . combinations,
too . . . styled to win the eye and engineered to delight the ear . . .
in console models, table models and portables that cover the range
of customer demand. Delco home radios and Delco auto radios will offer
the best of all that's new . . . backed by Delco Radio's long
experience in radio building and merchandising . . . distinguished by the
combination of engineering vision and manufacturing precision that
made Delco Radio a major supplier of radio and electronic
equipment for the armed forces.

ENGINEERING VISION—



MANUFACTURING PRECISION

DELCO RADIO



A UNITED MOTORS LINE

Delco Radio
DIVISION OF
GENERAL MOTORS

BUY VICTORY BONDS FOR A LASTING PEACE

HYTRON TRANSMITTING AND SPECIAL PURPOSE TUBES

If your new equipment designs include v-h-f, instant-heating, miniature, or medium-power tubes, these abbreviated characteristics will interest you. More complete data are yours for the asking in the new Hytron catalogue. Write for it today.

HYTRON TRANSMITTING AND SPECIAL PURPOSE TUBES

Description	Type No.	Filament Ratings		Type	Max. Plate Volts	Max. Plate Ma.	Max. Plate Dis.
		Volts	Amps.				
LOW	3A5	1.4	0.22	Oxide	150	30*	2*
	6J5GTX	2.8	0.11				
	10Y	6.3	0.3	Cath.	330	20	3.5
AND	HY24	2	0.13	Oxide	180	20	2
	HY40	7.5	2.25	Thor.	1000	125	40
MEDIUM	HYS1A	7.5	3.55	Thor.	1000	175	65
	HYS1B	10	2.25	Thor.	1000	175	65
MU	801A/801	7.5	1.25	Thor.	600	70	20.
	841	7.5	1.25	Thor.	450	60	15
TRIODES	864	1.1	0.25	Oxide	135	5	—
	1626	12.6	0.25	Cath.	250	25	5
	HY30Z	6.3	2.25	Thor.	850	90	30
HIGH-MU	HY31Z	6	2.55	Thor.	500	150*	30*
	HY40Z	7.5	2.6	Thor.	1000	125	40
	HYS1Z	7.5	3.55	Thor.	1000	175	65
TRIODES	6	3.2					
	HY1231Z	12	1.6	Thor.	500	150*	30*
V-H-F	2C26A	6.3	1.15	Cath.	3500	NOTE	10
	HY75	6.3	2.6	Thor.	450	80	15
	HY114B	1.4	0.155	Oxide	180	12	1.8
	HY615	6.3	0.175	Cath.	300	20	3.5
	955	6.3	0.15	Cath.	200	8	1.8
	E114B	6.3	0.175	Cath.	300	20	3.5
	9002	6.3	0.15	Cath.	200	8	1.8
BEAM	2E25	6	0.8	Thor.	450	75	15
	6AR6	6.3	1.2	Cath.	630	60	10
	6L6GX	6.3	0.9	Cath.	500	115	21
	6V6GTX	6.3	0.45	Cath.	350	60	13
	HY60	6.3	0.5	Cath.	425	60	15
	HY61/807	6.3	0.9	Cath.	600	120	25
TETRODES	HY65#	6	0.8	Thor.	450	75	15
	6	4.5					
AND	HY67	12	2.25	Thor.	1250	175	65.
PENTODES	HY69	6	1.6	Thor.	600	100	30
	6	3.2					
	HY1269	12	1.6	Thor.	750	120	30
ACORNS	1625	12.6	0.45	Cath.	600	120	25
	837	12.6	0.7	Cath.	500	80	12
	6AK5	6.3	0.175	Cath.	Sharp cut-off pentode		
MINIA-TURES	954	6.3	0.15	Cath.	Sharp cut-off pentode		
	9001	6.3	0.15	Cath.	Sharp cut-off pentode		
RECTIFIERS	Type No.	Filament Volts	Filament Amps.	Type Rect.	Peak Plate Ma.	Max. D.C. Ma.†	Inv. Peak Pot.
	HY866 Jr.	2.5	2.5	Mer.	500	250	5000
	866A/866	2.5	5.0	Mer.	1000	500	10000
	1616	2.5	5.0	Vac.	800	260	6000
6AL5	6.3	0.3	Vac.	60	20	460	
GASEOUS VOLTAGE REGULATORS	Type No.	Average Operating Voltage	Operating Min.	Operating Ma. Max.	Av. Volts Reg.	Min. Starting Voltage	
	OA2	150	5	30	2	185	
	OB2	108	5	30	1	133	
	OC3/VR105	108	5	40	2	133	
	OD3/VR150	150	5	40	3.5	185	

*Both sections of twin triode. †Discontinued; 2E25 supersedes and replaces. ‡Current for full wave.

NOTE: Not recommended for C.W. Consult Hytron Commercial Engineering Dept. for data.



HYTRON RADIO & ELECTRONICS CORP., SALEM, MASS.

Presenting

NO. 150,003,414

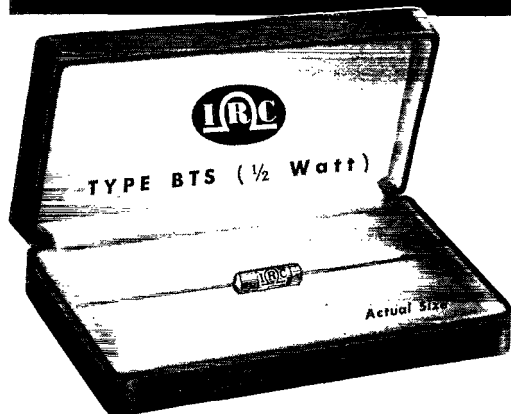

With a war record of more than a hundred and fifty million successful "missions" to their credit, IRC's NEW TYPE BTS 1/2 WATT RESISTORS have a proven record of unquestioned dependability. The exact counterparts of these efficient, precision engineered veterans are now available from your IRC Distributor for use in your new rigs. Only 13/31" long and no bigger 'round than a bump on a wire, this mighty mite has excellent electrical characteristics. Rates a full half watt at 40° C. ambient . . . 350 volts maximum continuous voltage. Power rise at rated load is but 45° C.

You'll find plenty of applications where BTS is "just what the doctor ordered." For further details consult IRC's new Service Catalog No. 50—yours for the asking at your IRC distributor; or write direct to Dept. 18-K.



INTERNATIONAL RESISTANCE CO.

401 N. BROAD ST., PHILADELPHIA 8, PA.

In Canada: International Resistance Co. Ltd., Toronto

IRC makes more types of resistance units, in more shapes, for more applications, than any other manufacturer in the world.

(Continued from page 78)

wrapped his 125-watt 'phone rig and is frequently seen gazing at the top of a 110-foot line tree in his back yard. IM, back from the Aleutians, called on GNJ/HHH recently. He is teaching radio and teletype in Seattle. 73, Carl.

WASHINGTON — SCM, O. U. Tatro, W7FWD — KFIQ has arranged to return all equipment to its owners Nov. 15th and the City of Olympia will be advised that most of the equipment with personnel will be available for emergency through the local radio amateur of the ORC with such other equipment as will be authorized by the FCC. GBH, KFEY radio aide, successfully contacted EOP at Angle Lake from Devil Mt., a distance of about 65 miles. The YARC gang is trying to decide whether their 2 1/2-meter gear should be f.m. or a.m. This may be decided at the first postwar club meeting, to be held at CAM's house. Old-timers will have to be careful that clique does not chill the new-comer, reports HCE, EC. 9VUL writes that he soon will be out of the Air Corps as assistant communications technical inspector and will settle in Seattle. RT was in Seattle on leave from the Aleutian Islands, where he was running an ACS Station handling over 1000 messages a day, and will report to a station in Missouri. HAD, in the Navy since the beginning of the war, is the proud papa of a 6-lb. 4-oz. girl. He is now at Corpus Christi, where GVK was for a while, and says he is all set for 21 Mc. HMJ is fixing radios aboard a small harbor craft at Okinawa. HAY is back in Tacoma from overseas. IVE reports that EXJ will return to Tacoma after a stay in Wyoming. 6SBV is at Fort Lewis and is trying to get on 2 1/2 with an HY75. FCD, with Boeing the past five years as flight test engineer, says his 8-lb. YL was born July 28th. He is building an oscillator for 2 1/2. IVK says 112 Mc. is tougher than the Police 128. 9PZN is with Tacoma police radio. EOF is at Elma as railway station agent and servicing radios. EHQ demonstrated the new patented "Mann Russell" circuit on 2 1/2 and it worked. Present were J. W. Mann and G. F. Russell, ex-1BE, 8YE, creators of the circuit, AEA, IMB, FWR and yours truly. EHQ is ambitious to reach Olympia with his signal. 73, Tate.

PACIFIC DIVISION

EAST BAY — SCM, Horace R. Greer, W6TI — EC, QDE; EC v.h.f., FKQ; Asst. EC v.h.f., OJU; OO v.h.f., ZM. At the WERS dinner meeting, held on Sept. 20th at the Women's City Club, the following were present: MFZ, TI, ZM, AHG, QDE, SQ, PB, EE, BBJ, MYC, AEX, MIX, SUK, THO, AD, TNM, JJB, UHM, EJA, HHM, 7IFL/6, E. W. Berg, A. Ahronian, P. Coppeshall, and Inspector A. J. Morgenthal, in charge of the Oakland Police radio station, KALT. An FB meeting was held and enjoyed by all those present. The special committee appointed by EE promises all hams and their XYLs a good time at the large ham get-together, or hamfest, to be held in Oakland October 14th. AUI, now KOS, lt. commander in the Navy, will receive an honorable discharge from the services about Nov. 1st. ARL is returning to civilian life soon. CAX is out of the services and is thinking of looking for a radio instructor's job. OCZ soon will be out of the Navy. BEZ made a trip to Pearl Harbor for Wessco. GPY bought a new house in Orinda and is back with the Pac. Tel. & Tel. VX went on 2 1/2 c.w. but no one could work him. The following members of the SARO gang are on 2 1/2 meters: OMC, CEO, BEZ, OCZ, NQJ, BUY, SSN, EE, DDO, MEX, and IMA. MUC is returning from Santa Fe to Oakland. CBX is awaiting orders at Pearl Harbor to come home. LCH is back with the Pac. Tel. & Tel. Bob Waters is back in Oakland from Nevada. KZK still is in Manila. ZM reports the following were on 2 1/2 meters shortly after peace was declared: AD, AEO, AGS, BEZ, BGU, DJR, DOT, EE, EFH, EQA, ESH, FJX, FKQ, GFW, GIZ, IFM, IJA, JQC, JSB, JSF, JWM, KCV, KGF, KNH, LCM, LES, LFD, LFZ, LZD, MAX, MFZ, MTD, MYC, NIO, NJW, NNK, NTU, OCZ, OLL, OMC, ONP, OZA, PCG, PTS, QIN, RBQ, RCN, RZS, SFT, SFN, SUK, THO, TNM, UDE, UFD, UHM, WB, ZM, 2HUK/6, 3JAK/6, 7CNF/6, 7ENS/6, 7HML/6, 7IFL/6, 9EYH/6, 9IHR/6, and 9TJN/6. LJC writes that he still is doing WAC by the visit method and trying to contact Rio hams. He sends 73 to the East Bay gang, especially to ONQ, CDA, OBJ, TT, and IT. SXK writes from Okinawa that he gets a lot of pleasure from reading the Amateur Activities section in QST. He is master of the ship on which 9YCG is 2nd radio operator and GYK is deck engineer. A lieutenant, who signs himself O.I.E.O.M.,

(Continued on page 84)

McElroy
Keeps building them better!

NEW!

McELROY Tape Pulling Head TPH-400

With an original arrangement that stops the re-wind when the tape pressure wheel is raised. Another novel arrangement admits the tape from any angle from the right which makes for smoother flow, prevents breakage, and permits the tape to come from any level on the receiving table. \$45.00.

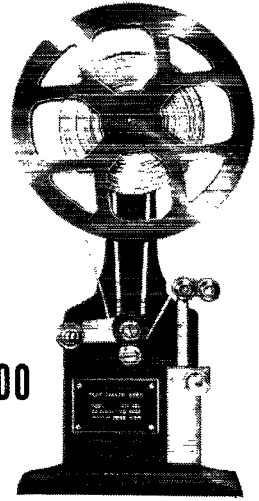

NEW!

McELROY Keying Head HED-400

Complete with built-in polarized relay. An ingenious McElroy design places the studs that pull the transmitting tape on the feed drum, not on the Star Wheel in the contact case. The absence of a Star Wheel opening in the contact case assures clean contacts and less headaches for you. \$240.00.

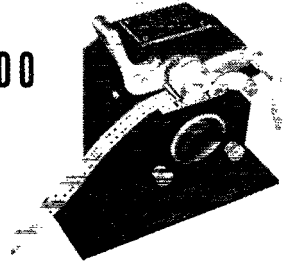

NEW!

McELROY Ink Recorder REC-400

Although smaller and lighter than previous models, it is capable of speeds up to 700 words per minute. The tape holder, which is part of the equipment, may be attached to either the right or back of the case. Operates from either AC or DC by snapping a toggle. \$195.00.

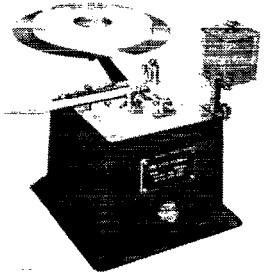

McElroy engineers never copy, never imitate. We create, design, build . . . we are never satisfied with mediocrity. And we deliver.



McElroy **MANUFACTURING CORPORATION**

82 BROOKLINE AVENUE

BOSTON, MASSACHUSETTS

HENRY RADIO

is delivering RECEIVERS

We are delivering the following models:

National NC-240-C, less speaker . . .	225.00
National One-Ten	56.10
National HRO Sr.	197.70
Hammarlund HQ-129X, less speaker . .	129.00
Hammarlund Super Pro with speaker . .	318.00
Hallicrafters EC-1A	29.50
Hallicrafters S20R	60.00
Hallicrafters S22R	74.50
Hallicrafters S39	110.00
Hallicrafters SX-25	94.50
Hallicrafters SX-28A	223.00
Hallicrafters S36A	415.00
RME-45 with Xtal, S Meter, speaker . .	166.00

Mail, phone, or wire your order. Demand will exceed supply for a few months. Reserve your receiver early. No priority required. No restrictions. You can send \$5.00 and pay balance C.O.D. You can trade in your receiver. You can buy on terms. Write for full information. Tell us your wishes. We will help you get the best receiver for your use and will see that you are 100% satisfied. We also have a complete stock of amateur parts, transmitters, etc. Send to us for any amateur apparatus in any catalog or advertisement at the lowest prices shown. Your inquiries welcomed.

HENRY RADIO

BUTLER, MISSOURI AND
LOS ANGELES 25, CALIF.

"WORLD'S LARGEST DISTRIBUTOR
OF SHORT WAVE RECEIVERS"

(Continued from page 82)

writes from Nome, Alaska, that SUP, of Hayward, is up there and is doing a bang-up job for AAC. 73, "TI."

SAN FRANCISCO — SCM, William A. Ladley, W6RBQ — Phone RA. 8340, ECs, DOT, KZP; OO u.h.f., NJW, Capt. 7JEA, ex-PPO, at Seattle, writes that 2½ is going strong. RAH is back in town and will start his new civilian work with KQW as technician. The State Guard received its license and now is KALG, with operation on the high end of 2½ and on a special frequency of 3827 kc. New operating procedure and schedules are being arranged. The code class headed by CVP is progressing with the beginners' class up to about 6 and the advanced class up to 20 w.p.m. The technical class will start soon. Talk of a new radio club is in the air. BUJ and LES spent their vacation on the Russian River. Lt. Pinky De Lasaux is serving at Miami, Fla. Such notables as WB and AJF are on 2½ running medium power. WN and MZ visit State Guard drills. KJN is building a new super for u.h.f. operation. Frances Jessen spent her vacation at Inverness. Frances Drake is holding down company clerk duties for CSG Communications Det. Elizabeth Harwood is brushing up on the code and preparing to take the amateur exam. 4TZ, 2NAK, 9IHN, 5FDR, 9EKY, 9BPN, 1NHN, and 7IBC, visited RBQ during the month. NJW and EKZ are preparing to get back on the u.h.f. band. 5FDR is moving his family from Houston, Tex., to Oakland. DJI is back on u.h.f. with a new antenna. PGB is building a new u.h.f. rig for his car. PVC opened a cocktail lounge at San Rafael. AHH is on 2½ meters. FVK, of the San Rafael Radio Club, is back on the air. His u.h.f. signal was heard in Sacramento by PIV. GPB is repairing radios in his spare time. QUC is reported building a new super and transmitter with a pair of 24s in final. RBQ works PIV, Sacramento; 9TJM/6, at De Witt Hospital, Auburn; a portable-mobile rig on Mt. St. Helena; 2NPF/6, at Sacramento; LGW, at Alamo; RBM, at San Mateo; 7IAN/6, at Belmont; and AED, on Mt. Hamilton on 2½ meters portable-mobile from Mt. Diablo. OCZ and NQJ can be worked at Bolinas. WB is doing grand work with his new crystal-controlled transmitter, superhet receiver and rotary beam and can be heard using c.w. as well as voice. NKE reports from Oahu, T. H. BIP is back on the air and expects to make a trip to St. Paul soon. LGC is reported about ready to invade 2½ with power. KME is vacationing near Sacramento. GAS is attending submarine school at New London, Conn. JWF advises he is headed toward Camp Beal for discharge. LLW is back on the band with a portable rig. 9ICN writes in from Japan. EKZ is getting the urge to be back on the air and is planning to use a parabolic reflector on 2½. CIS, reporting from P. I., is due home soon. 9FA underwent an appendix operation in Guam. Capt. Wally Howland writes in from Germany, where he has served with the field artillery. 73, Bill.

SAN JOAQUIN VALLEY — Acting SCM, Edward H. Noack, W6BXB — The following information has been sent in by QFR: MGN and GCF have succeeded in establishing 2½ between their homes — one block separates them. Tom sold his transmitter to Sheldon Anderson, who is putting it on the air to be heard commercially from Tulare. MYP is tougher to break in on at Rosenberg's than a 160 net. TO has moved to his new location and has a swell store waiting for ham activity to develop. NOH's fingers itch to break the seal on the transmitter on his new 40-foot cruiser. Among other boat enthusiasts is QFR, who will be heard mobile on 10 and from his boat running competition with NOH. JCB and FTA have been working mobile on 2½ with some very swell reports. PSQ is about to be released from his Army station in Santa Ana and will be heard mobile on 2½. JPU is tinkering with 2½ mobile. KPW is torn between two loves — the roof on his cabin at Bass Lake and 2½ meters. "It's either the rain and a leaky roof, or 2½," says George. BWK moved his "modulation" to the coast for the summer, claiming that there is nothing so helpful as a sea breeze for competition. GWM assists. KB, with Market News Service at Salinas, was in town the other day and ferreted out his transmitter, which has been in storage. Another visitor was QD, who has been with Eimac. All the hams in Fresno join in wishing BXB, of Stockton, who recently suffered a heart attack, a speedy recovery. Thanks go to QUE, of Stockton, for carrying on.

ROANOKE DIVISION

SOUTH CAROLINA — SCM, Ted Ferguson, W4BQE/ANG — EXJ is stationed in the Philippines. HEV is headed for the "Land of the Sunken Sun." DNR, home on leave, says that he is afraid that he will have a time with the

(Continued on page 83)

THIS VERSATILE RECTIFIER TUBE

is conveniently supplied in two base types

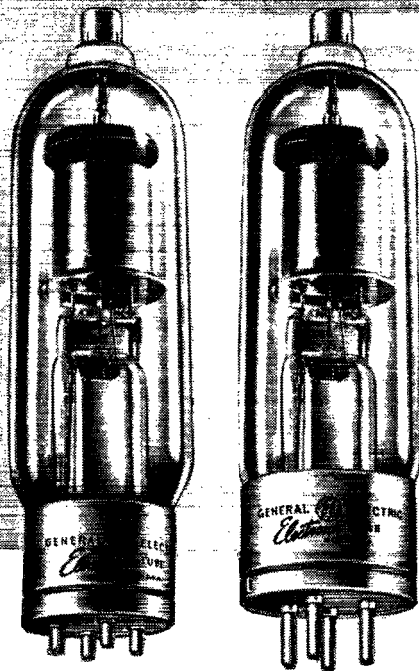

TYPE GL-872-A/872
Fitted with 4-pin jumbo base. (Ratings same as Type GL-8008.)

TYPE GL-8008
Fitted with heavy-duty base. (Ratings same as Type GL-872-A/872.)

GENERAL ELECTRIC offers you the GL-872-A/872 and GL-8008 (identical in design, but with different bases) as low to medium-power rectifier types with an unusually wide range of applications. Here are some typical uses:

- To rectify plate power for the low and intermediate stages of large transmitters.
- To serve as rectifiers for smaller transmitters, "ham" sets, and police-radio, ship-to-

shore, aviation, and other communications equipment.

- To convert power from a-c to d-c for small industrial equipment, such as electrical testing apparatus, diathermy units, fractional hp motors, etc.

Ratings at the right are conservative. The mercury vapor in the tube assures (1) the ability to pass high peak currents, and (2) a low internal voltage drop. These qualities spell long service-life and exceptional efficiency.

Your equipment will use Type GL-872-A/872 or Type GL-8008, depending on your basing requirements. For further data see your nearest G-E

Office or distributor, or write to *Electronics Dept., General Electric Company, Schenectady 5, New York.*

CHARACTERISTICS

of Types GL-872-A/872 and GL-8008

Half-wave, mercury-vapor rectifier tubes, 2-electrode type, with filamentary cathode. Convection-cooled. Cathode voltage and current are 5 v and 7.5 amp; typical heating time is 30 seconds. Approximate tube voltage drop is 10 v. Maximum anode ratings are: peak inverse voltage 10,000 v, instantaneous current 5 amp, average current 1.25 amp.

Type GL-872-A/872, with 4-pin jumbo base, is adapted to much existing equipment which calls for this type of base. The heavy-duty base of Type GL-8008, giving greater pin-contact area, will be found preferable for newer rectifier installations.

G.E.'s new manual of industrial electronic tubes is the most comprehensive book in its field. Over 400 large pages, price \$2. Write for complete description.

GENERAL ELECTRIC

161-D11-8850

TRANSMITTING, RECEIVING, INDUSTRIAL, SPECIAL PURPOSE
TUBES • VACUUM SWITCHES AND CAPACITORS

HARVEY

delivers

RADIO AND ELECTRONIC EQUIPMENT

WITHOUT PRIORITY

anywhere in the **U. S. A.**

With Government regulations eliminated, HARVEY can now fill your needs for radio, electronic, test and laboratory equipment more quickly and efficiently from the finest and largest stocks in our history.

HARVEY carries the lines of leading American radio and electronic manufacturers. Their long-promised postwar products will be on our shelves the very moment they are released.

Our experienced staff is ready to serve you.

Special Buy!

**HEAVY DUTY
DESK PANEL
CABINETS**

8 $\frac{3}{4}$ " high x 19" long
x 14 $\frac{1}{4}$ " deep

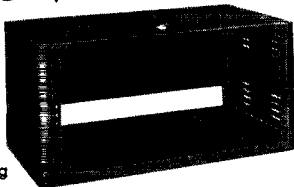

Ideal for small transformers, public address amplifiers, oscillators, test equipment, etc.

These cabinets are rigidly constructed of 1/16" cold rolled steel, with all joints electrically welded. Louvres provide ample ventilation through sides and back. Top door is mounted with piano type hinges, and locks with flush mounted snap catches. Two sturdy handles are mounted on each side and semi-recessed. Black ripple finish. Suitable for standard 8 $\frac{3}{4}$ " x 19" relay rack panel or any size chassis up to 13" x 17". Price..... \$4.95



Telephone Orders to LO 3-1800

HARVEY
RADIO COMPANY
HARVEY
103 WEST 43rd ST., NEW YORK 18, N. Y.

(Continued from page 84)

"Q" signals where he is headed. Capt. ICK is stationed in California after making it to the Philippines and back. Lt. IAI is in the Philippines. EDQ is stationed at Charleston. DQY has gone back to "Yankee Land" for a refresher in his work. CZA still keeps them going at the Charleston Ordnance Depot. CZN is now at Charleston with Eastern Air Lines. AFQ can be found at Sikes Radio Company. HMG has the 2 $\frac{1}{2}$ -meter bug and hopes to be on soon. GKD can be seen with his camera, looking for material for the front pages of the *Record*. DIP is in Columbia and can be found at the State Paper. Dr. DTU is very busy. VL is teaching the "young squirts" a little about accounting at the U. of S. C. CO says the "land lines" keep him busy. Cpl. 1JEQ, of ARRL, is stationed at the Columbia Army Air Base. The Columbia amateurs held a meeting on Sept. 2nd with the following servicemen present: 6TGJ, 9YKW, 4FBD, 9JNC, 9EKD, 9CRL, 9RCL, and William S. Disdale (operator). Your SCM asks that you pass along some dope about yourself and the fellow hams that you know. 73, *Ted*.

VIRGINIA — SCM, Walter G. Walker, W3AKN — There is a great deal of activity on 112 Mc. in the Norfolk, Portsmouth, Newport News, and Hampton areas. Norfolk: HKE, with a new vertical coaxial antenna, reports working Fort Story, a distance of eighteen miles. 3NT is crystal-controlled and consistently gets out eighteen to twenty miles with an antenna 77 ft. high. BEK is experimenting with an 83.2 crystal-controlled high-power rig. The following are on the medium-power rigs and get consistent results eight to ten miles: EFO, HWT, DGG, BSY, JQE, BWA, 4GJJ, 5HHU, 4PKY, 5HAQ, 6UFX, and 6QLL. Portsmouth: 7IIS and 8TDS, are building rigs. Hampton: AJA is on with a TR-4 and a coaxial antenna matched with Q-bars. 9QAF is on with his TR-4 operating both portable from his car and fixed from his home. He has established contact with NT across Hampton Roads. Newport News: GGP has a new rig going, consisting of a 6V6 modulated oscillator and a superregenerative receiver. AKN has completed a superregenerative using 9000 series tubes; he has a new four-element beam up but still has to build a transmitter. HPW is on 112 Mc. in Copeland Park, a suburb of Newport News. How about reports from Richmond, Roanoke, Lynchburg, Arlington, and Alexandria? The SCM knows that active stations exist there. NE, radio operator on the SS *J. W. Van Dyke*, sailing in Pacific service during the war, is heading for the Atlantic and should be home soon. T/Sgt. GGI is being transferred from the AAF Boca Raton station to Fort Monmouth, N. J. 73.

ROCKY MOUNTAIN DIVISION

COLORADO — SCM, H. F. Hekel, W9VGC — EHC expects to be looking for a civilian job about January or February and until that time is at 326 Raymond Ave., Alexandria, Va. Jim Lindsey (LSPH), ex-KFND-35, is in the Navy and Bob Perske is waiting for the day when he is turned out and headed for home. 6SSA has a baby girl and CNL has a boy. YKP is back in town and expects to stay. This time all he needs is a job or someone to feed him three meals a day. CAA put a new paint job on the old rig (he painted the two knobs on the front panel) and is all set to go on the first band that is opened. His health is on the mend now; he was down to 122 lbs. and so thin that every time he took a big drink of water he had to let his belt out a notch or two. I heard him on 112 Mc. the other day. YXS passed his audition test on 112 Mc. over ACA's rig. 20JF is located on the high ground just a little south of Littleton, where he has quite a set-up on 112 Mc. I hadn't been there more than five minutes when he ups and lets me talk to his wife. 3JIN spent a few days in bed with a misery of some kind that started up in Wyoming. The Western Slope Gang held its last roundup of the season on Aug. 23rd. The whole works was in town except GKW, who was out in the Pacific with the Navy. The XYLs herded all together for a blowout and the score at the start read something like this: GMB with his wife and mother; LZP and mother; GLT; VQY, now head man for A.T. & T. at Telluride, and wife; GDC and wife; FQT and wife, daughter, and son; Bill Idler, who has a commercial ticket, and wife. GMX says he and several others were there, too. VQY's daughter, KUB, is in Florida now. GMX wants to sell his rig, all new tubes and 140 watts input, 'phone or c.w. 73, by *Heck*.

UTAH-WYOMING — SCM, Victor Drabble, W6LLH — The Ogden Amateur Radio Operators Club has been re-organized and the newly-elected officers are: 8MDP, pres.,

(Continued on page 80)

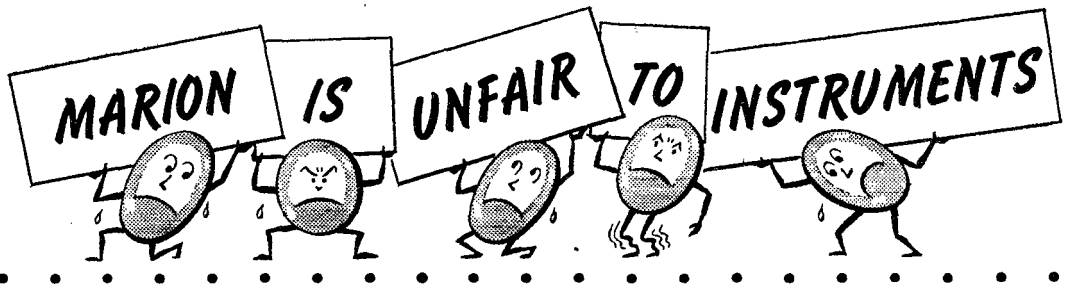

We weren't satisfied to test our hermetically sealed instruments for temperature, humidity and salt spray individually — we went whole hog and combined the three conditions in a beaker of boiling brine. This test, which really exacts more from an instrument than is normally necessary, was conducted for two weeks without failure or permanent error in excess of 1%. The maximum zero shift was .75%, the current sensitivity plus .5% — and the instrument showed no moisture penetration and no leaks as was evidenced by further production vacuum checking.



What may be "unfair" in a test of Marion hermetically sealed instruments is only fair to their users. Whether you're a manufacturer or a consumer, our tests serve to prove the quality and dependability of our instruments. They are an assurance that when these "hermetics" are installed in any equipment, and used in any part of the world, their trouble-free performance will be sustained. Remember — Marion glass-to-metal hermetically sealed instruments are positively interchangeable, and cost no more than standard conventional types. Write for our 12-page brochure

Marion Glass-to-Metal Truly Hermetically Sealed 2½" and 3½" Electrical Indicating Instruments



WHAT CAN MARION "HERMETICS" DO FOR ME? WRITE—WE'LL SUPPLY THE ANSWER

• • •



TINY GIANT WITH A HISTORY

Long before the war, the men who design your Bell Telephone System were looking for an electron tube with frequency capabilities never before attained. With it, they could transmit wide bands of telephone messages—hundreds of them simultaneously through coaxial cable—economically, and over long distances.

They developed a tube which set a new standard in broad-band, high-frequency amplification. So minute that its electrode system had to be inspected under a magnifying glass, the tube could amplify either the voices of 480 people talking at the same time, or the patterns of television. Long-distance, broad-band transmission became a commercial reality.

6AK5

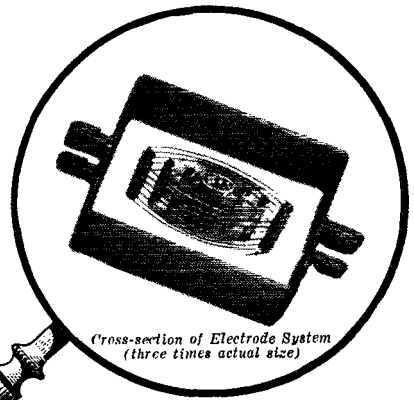

*Cross-section of Electrode System
(three times actual size)*

When war came, this tube excelled all others as an amplifier in certain military equipment. It then grew into the 6AK5, one of the great little tubes of the war. Besides producing 6AK5's in large quantities, the Western Electric responded to emergency needs of the Army and Navy by furnishing design specifications and production techniques to other manufacturers, of whom at least five reached quantity production. On every battlefield it helped our ships and planes to bring in radio signals.

Developing electron tubes of revolutionary design has been the steady job of Bell Laboratories scientists ever since they devised the first practical telephone amplifier over thirty years ago. Now tubes like the 6AK5 will help speed the living pictures of television, as well as hundreds of telephone conversations simultaneously over coaxial highways of the Bell System.

BELL TELEPHONE LABORATORIES

Exploring and inventing, devising and perfecting for continued improvements and economies in telephone service.



PRECISION is a weapon in MT. CARMEL, ILL.

They use it effectively, too, these men and women who make up Meissner's *precision-el*, for many of them have sons, brothers and loved ones on the battle fronts. The photographs on this page show a few of these precisioneers who fight on the home front with precision and electronic skill as their weapons.



Precision is a family affair at Meissner. Here a letter from the front lines affects two families, and you can see that it's good news that will be reflected in the quality of their work when their rest period is over.



He's a veteran back from active service in the Pacific, but he's still fighting—this time on the home front with the men and women of Meissner. The traditions of precision quality he's learning here will be a weapon he can use after peace.

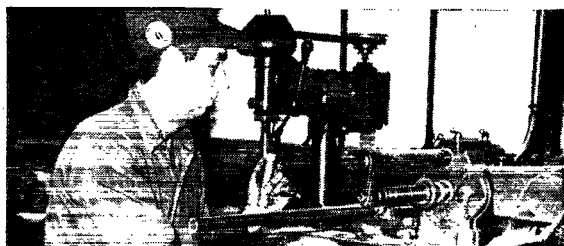

He splits thousandths of an inch as he does his war job. The "know how" that he and hundreds of Meissner *precision-el* have acquired is one more reason why you will be able to depend on Meissner quality after V-Day.



On the way to battle are these cartons of electronic war equipment. He sends them off with a smile, for he knows that the work of Meissner's *precision-el* will help bring his family together again soon.

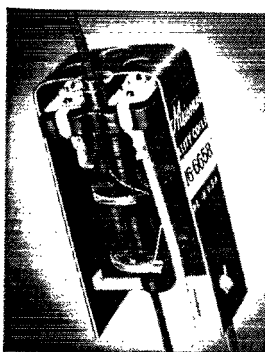

"Step Up" Old Receivers!

These Meissner Ferrocatt I. F. input and output transformers are getting top results in stepping up performance of old worn receivers. Special powdered iron core permits higher "Q" with a resultant increase in selectivity and gain, now available for frequency range 127-206. Ask for numbers 16-5728 input, 16-5730 output. List \$2.20 each.



MEISSNER

MANUFACTURING COMPANY • MT. CARMEL, ILL.

ADVANCED ELECTRONIC RESEARCH AND MANUFACTURE
Export Division: 25 Warren St., New York; Cable: Simontrice

TO OUR READERS

Who are not A.R.R.L. Members

Application for Membership

American Radio Relay League

Administrative Headquarters:

West Hartford, Connecticut, U. S. A.

.....194...

AMERICAN RADIO RELAY LEAGUE,
West Hartford, Connecticut, U. S. A.

Being genuinely interested in Amateur Radio, I hereby apply for membership in the American Radio Relay League, and enclose \$2.50 (\$3.00 in foreign countries) in payment of one year's dues*, \$1.25 of which is for a subscription to QST for the same period. Please begin my subscription with the.....issue.

The call of my station is.....

The class of my operator's license is.....

I belong to the following radio societies.....

Send my Certificate of Membership or Membership Card (indicate which) to the address below:

Name.....

A bona fide interest in amateur radio is the only essential requirement but full voting membership is granted only to licensed radio amateurs of the United States and Canada. Therefore, if you have a license, please be sure to indicate it above.

*The dues are \$2.50 per year in the United States and Possessions. All other countries \$3.00 per year

(Continued from page 88)

60KF, vice-pres. 4IHV/6NPU, secy.-treas. 90LL has gone back to Denver. 6FRN is working for United Air Lines. 6TPT has gone back to his old job as operator with KUTA. 6JUE, 6UOM, and 6LLH are looking for jobs, as the Army and civil service have released them. 6DLR is holding down a maintenance job for the Ogden Municipal Air Depot. 6SYD and 9NFX are having trouble getting "out" with their 2½-meter rigs. 6SYD is the first man to be enlisted for appointment as OBS. More appointments are needed. 73, Vic.

SOUTHEASTERN DIVISION

ALABAMA—SCM, Lawrence J. Smyth, W4GBV—HKZ, ex-5DRZ, writes that he sits at the radio in Berlin waiting for someone to come through on the ham band. HDI, in radio at Corpus Christi, says that DEW also is there. GOX writes from Frankfort that he is working with some high-power stuff, 60 kw. DGS, former SCM, writes that he is on 2½ meters with an HY75 molested by a 6L6. EOX is there with him. The first guy worked was DRZ/3 and the second was FGU/3. About 40 stations are active there. DGS gives a list of 4s in the electronics division of the Bureau of Ships: AEL, CRP, CYU, EHO, ERE, EVI, HDN, and HEW. IDZ was in Montgomery for a few days. EW has great postwar plans. GDV and GDU are in Montgomery; GDV works at Eastern Air Lines there. AUP hopes someone near becomes interested in 2½ meters. 73, Larry.

EASTERN FLORIDA—SCM, Robert B. Murphy, W4IP—Our Director, ASR, paid the Miami district a visit recently. We called an "open" meeting of the Dade County Radio Club at which he, as guest speaker of the evening, supplied us with details on what ARRL is doing for the amateur and gave us the low-down on 2½ meters. There were sixty to seventy present. 5SI, Director of the Delta Division, was a surprise guest. On Sept. 15th and 16th came the big "wind" from out of the South Caribbean which caused us to alert the 2½-meter Hurricane Red Cross net. This net did an excellent job under the able direction of BYF. 1MGP, a m/sgt. at Ft. Myers, gives us information on the following hams now in Miami: 1MR is an RT1c and comes from No. Haven, Me.; HLD, ex-1LIK, now is a married man. Al Rioux, a member of PAA A & O Flight, was a very active member of the Fall River Radio Club in Massachusetts and operated 1ACT; HKY, ex-1GUO, and his XYL have a jr. operator. Beverage tried to contact 1KIE and 1LIM but was unable to do so. 1MGP, who expects to be out of the services soon, has contacted CQZ, our EC in Ft. Myers, and DGB, 3ELA, and 9VRV. IBS, assistant foreman of the PAA Overhaul Shop, enjoyed a real vacation in the North this past summer. HYQ passed through Miami and has headed for the So. Pacific again where he will ship on an oil tanker. CO7CX passed through Miami from the Mayo Clinic. HLO is in Lakeside, Calif., and would like to have the address of CPG. AYW, formerly of Johnson City, Tenn., now is located in Umatilla, Fla. HJQ, who was a very active ham in Key West, is on the *Tuscaloosa* in the Pacific and wants someone to write to him. VP5EM, in Jamaica, writes that he and his crowd are looking forward to the bands opening up again so they will be able to contact some of their old friends in the States. Metcalf is president of the ham club there. ACZ is to be appointed assistant EC to GJI. DZH expects to go to Balboa for PAA soon. The following Cuban Amateurs have completed a tour of instruction in the PAA Overhaul Shop and will return to Cuba soon: CO2AL, CO2CG, CM2MN, CM1ML, and CM2DU. EYI writes that it looks like the old gang is coming back to town. IE is back in Sarasota after a tour of duty with the League. ES missed the hurricane by making a business trip to Washington and New York about a week earlier. BXL is back on a tanker in the Pacific after a month's stay in Miami. I wish to welcome a new SCM in Western Florida, MS, and hope everything will run along smoothly for him. 73, Merf.

WESTERN FLORIDA—SCM, Lt. Edward J. Collins, W4MS—JV is working on the big rig and looking over the 112-Mc. gear. UW is busy with WCOA and police radio as well as the rig. VR is rebuilding the big rig and wants a new QRA. QK is rehabing the old rig and is looking at 112-Mc. diagrams. DAO has a transmitter on 112 and is rebuilding the big rig with T-55s in the final. BKQ has taken down the four-element Yagi and is rebuilding it. DXZ has some "acorns" and is getting really het up about 112. DXQ will be our best local DX when he gets perking on 2½, as he lives approximately ten miles out of town. AXP is building a power supply for his transceiver and should be active on 112

(Continued on page 98)

ALL AMATEUR TRANSMITTER CONTEST

Inaugurated by

Taylor Tubes

WIN YOUR "DREAM TRANSMITTER" PLUS EXTRA
VICTORY BONDS WITH YOUR IDEA OF THE
"IDEAL HAM TRANSMITTER"

TWO FIRST PRIZES

Prizes in each of two power class divisions will be a complete radio transmitter designed by the winner, built by Taylor Tubes, Inc., and presented to him with all accessories except antenna.

TWO EXTRA BOND PRIZES

In addition to receiving completely built transmitters of their own design, the winners in each power class division will divide the total of Victory Bonds volunteered by the participant manufacturers sponsoring the contest.

Here Are the Highlights of the Contest

Entries must be postmarked on or before February 15, 1946—the official contest closing date. Transmitter design in either of two power classes may be entered. Class 1—input power to the final transmitter stage up to 250 watts. Class 2—input power to the final transmitter stage of from 251 to 1000 watts. Contestant must submit entry blank, full schematic diagram and front panel drawing, with sufficient data necessary to build his "Dream Transmitter." Each entry must be accompanied with a 150-250 word statement by the

contestant as to why he believes his transmitter design is outstanding and should win. The prize winning transmitters in each power class will be built by the engineering department of Taylor Tubes, Inc., and presented to the winning contestants as soon as practicable after all entries have been judged and the winning designs selected. The Victory Bond prizes in each power class will be presented to the winners immediately after the winning designs have been announced. See the official entry blank for complete particulars.

Participating Sponsors

Aerovox Corporation, New Bedford, Mass.; American Phenolic Corporation, Chicago, Ill.; Barker & Williamson, Upper Darby, Pa.; Bliley Electric Co., Erie, Pa.; Gothard Mfg. Co., Spring-

field, Ill.; International Resistance Co., Philadelphia, Pa.; E. F. Johnson Co., Waseka, Minn.; Solar Mfg. Corporation, New York, N. Y.; United Transformer Corporation, New York, N. Y.

Contest Judges

Fred Schnell, W9UZ—Former Communications Manager of A.R.R.L. and now Chief of Radio Dept., Chicago Police; Oliver Read, W9ETI—Editor, Radio News; Cyrus T. Reed, W9AA—Former Assistant Secretary of A.R.R.L.; John Potts—Editor CQ and Radio; Frank J. Hajek, W9ECA—President, Taylor Tubes, Inc.; Rex Munger, W9LIP—Sales Mgr., Taylor Tubes, Inc.; Karl A. Kopetzky, W9QEA—Former Managing Editor, Radio News.

Secure Your Entry Blank at Your Radio Parts Distributor
or Write Directly to Taylor Tubes, Inc.

Taylor **HEAVY** **CUSTOM BUILT** **DUTY** Tubes

TAYLOR TUBES INC., 2312-18 WABANSIA AVE., CHICAGO 47, ILL.



Can You "Measure Up"
to a good-paying radio job with a
secure peacetime future?

"Post-War" Is NOW!

Don't be caught unprepared! Add CREI
home study training to your present ex-
perience and step ahead of competition

What's ahead for you in the field of Radio Electronics?
One thing is certain. Now that peace is here, Radio
Electronics will surge forth as one of America's foremost
industries, offering promising careers for radiomen with
modern technical training.

NOW is the time to take the time to prepare yourself
for the important, career jobs in radio-electronics en-
gineering. You will find the knowledge gained from your
CREI course useful almost from the beginning.

In our proved home-study course, you learn not only
how . . . but *why!* Easy-to-read-and-understand lessons
are provided you well in advance, and each student has
his personal instructor who corrects, criticizes and offers
suggestions on each lesson examination. This is the suc-
cessful CREI method of training for which more than
10,000 professional radiomen have enrolled since 1927.

Your ability to solve tough problems on paper and then
follow up with the necessary mechanical operation, is a
true indication that you have the *confidence* born of
knowledge . . . confidence in your ability to get and hold
an important job with a secure, promising future. In-
vestigate now the CREI home-study course best suited
to your needs, and prepare for security and happiness
in the New World of Electronics! *Write for all the facts
today.*

● WRITE FOR FREE 36-PAGE BOOKLET

If you have had professional or amateur radio
experience and want to make more money—let
us prove to you we have something you need to
qualify for a better radio job. To help us intelli-
gently answer your inquiry—please state briefly
your background of experience, education and
present position.



Capitol Radio Engineering Institute

Home Study Courses in Practical Radio-Electronics Engineering for
Practical Self-Improvement

Dept. Q-11, 3224 16th St. N. W., Washington 10, D. C.
Contractors to the U. S. Navy, U. S. Coast Guard and Canadian
Broadcasting Corporation

Producers of Well-trained Technical Radiomen for Industry
MEMBER: NATIONAL COUNCIL OF TECHNICAL SCHOOLS

92

(Continued from page 90)

soon. AXF is after the OM to have the 14-Mc. 'phone rig
perking in time. HJA wants to see the 112 gang working and
then promises to dive all the way in. FHQ is getting that
FB 7-Mc. rig ready. MS has the oscillator built on the 112
transmitter and a swell receiver built by 7IQJ and 8MJX.
EQR has his transmitter perking swell on 112 and is gather-
ing parts for a receiver. ECT has been loaned a transceiver
by AXP so we should hear from Navy Point soon. FJR
wants a 2½-meter c.w. rig. DAO has a swell new bug that
sends dashes fully automatic. 6PNI now is a civilian and is
on his way to W6-land. 9MEI is busy taking flying instruc-
tions but has time to think about 2½. 5IVP, ex-ERR,
dropped in on us and wants to get on 2½. GRF, of the
CAA, has joined us from K6-land. HVM was a visitor from
New Orleans. 7IQJ can't put up the 112 antenna he wants at
his QTH but will get something perking. 8MJX says his re-
ceiver will go to 144 Mc. OK. 7EHB has just been promoted to
commander. 7CSS was a visitor and gave us some good
data on 112. HQB is here as an instructor and is planning a
real nice rig. 5AQW still is around and we hope will join us on
2½. 1LUB is here and anxious to get going again. ACB is
the proud owner of a SX-28A and is getting on 2½. FPE
is about talked into getting on 2½. BOW is up in W3-land
and doing big things. Ex-QA was seen with a new *Handbook*
so it looks like he'll get going again. AXW was a visitor
and will be remembered as QU in the roaring 20s. BJB still is
the spark plug in Panama City. KB wants to get on again
but is busy building houses. CVP, in Alabama, says he is
listening on 2½ but hasn't heard any of us yet. We haven't
heard what QR's plans are for getting back on. BSJ has been
reported as being in E. Fla. DMW is building a real super-
duper receiver, Lt. Ex-ZZAO, USN, was a visitor. Let me
have your stamped envelopes for those DX QSLs. The Pan-
ama City gang have organized the Panama City Radio Club
with GTJ as president. Two new hams are coming up in
Young and McKenzie. FOX is an Army lt. home on leave
from Europe. AUV, of Marianas fame, now is in Panama
City. LT should make himself heard as soon as the band
opens. EGO is looking forward to the lands opening again.
JG is another OT who is 'arin' to go. GVH is dusting off the
rig. The gang told GZB to rebuild or they would buy him a
megaphone. The Panama Club is 100 per cent ARRL. ACB
wants to know how about a 112-Mc. relay net across Western
Florida. 73.

SOUTHWESTERN DIVISION

LOS ANGELES — SCM, H. F. Wood, W6QVV — Had the
pleasure of a land line call recently from LIS, who was
in the South visiting his folks. He tells me that MFJ, on the
Penny when she was hit, evidently is all right. PQM, now
with United Air Lines, dropped in at the house to see what
was new. How about hearing from the Pasadena Radio Club?
SSU dropped in from Mexico City recently; he expects to get
back into his own home in the near future. UQL is out of the
Army now and "arin' to go" with his new ECO. SCQ re-
ports a lot of old-timers in the store buying up gear and com-
ponents for new and larger rigs. ESX is waiting for someone
to urge him to put up his new antenna and AEL is getting
the bug very badly. MSO reports that the City of Inglewood
has expressed a strong desire for continuation of the WERS
net there in their Major Disaster Emergency Council set-up
and EQM reports the same about Los Angeles. It is hoped
that each radio aide will contact his local authorities and
offer his services so that this work can be carried on. As soon
as you do this please inform me so that EC and Asst. EC
appointments can be made. I urge that each radio aide meet
with his assistants so that they may recommend such ap-
pointments as they see fit and get busy and develop their
nets. I would like to know the amount of equipment avail-
able, and the names, addresses, and phone numbers of your
administrative personnel. Also, please recommend a suitable
station to act as Official Broadcasting Station in your particu-
lar community. If possible, I shall be glad to attend any
initial meetings. Let me know as far in advance of the date as
possible. I would like all former appointees still available
to get in touch with me so that new certificates may be
issued and duplications avoided. 73, Ted.

ARIZONA — SCM, Douglas Aitken, W6RWW — The
Phoenix bunch are talking of reviving their club. The gang
down there is going in strong for the 2½-meter band, with
LSK, MAE, NEL, QLZ, HIB, FUU, TJG, TKL, NGJ, IXC,
and OAS having a good time with local rag-chewing. Vic
Clark, ex-KFC, writes from New York that he had the pleas-
ure of attending the first postwar hamfest in the New York

(Continued on page 98)

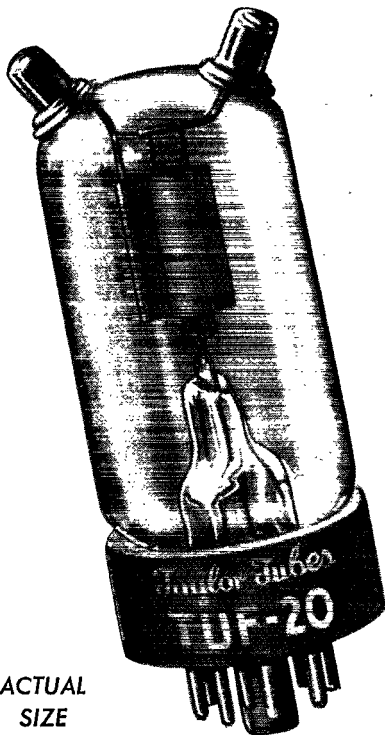

Announcing Taylor Tubes

NEW | **TUF-20** "The Tuffy"

It's a High Frequency Triode that can "Take It and Put It Out" on Frequencies up to 1¼ Meters

**FOR PORTABLE, MOBILE
AND FIXED STATIONS**

ACTUAL
SIZE

\$4⁹⁵

- ★ Tantalum Anode
- ★ Nonex Glass
- ★ Octal Base
- ★ Heavy Tungsten Leads Support Grid and Plate, Eliminating Internal Insulators
- ★ High Input for Fixed Station Operation
- ★ Good Efficiency at Low Voltage for Mobile Operation

General Characteristics

Fil.....6.3 Volts.....2.75 Amps.
Plate Dissipation.....20 Watts
Amplification Factor.....10

Interelectrode Capacities

G-P 3.5MMF • G-F 1.8MMF • P-F 0.9MMF

Overall Dimensions

3¾" high • 1½" diameter • Octal Base

Typical Operation

(Can be Operated at Full Input at Frequencies up to 250 MC.)

OSCILLATOR AND CLASS C RF AMPLIFIER

Plate Volts.....300.....750
Plate Current.....100MA.....80MA
Grid Bias.....-60 Volts.....-150 Volts
Grid Current.....15MA.....15MA

"MORE WATTS PER DOLLAR"

At Your Radio Parts Distributor Now

Taylor

HEAVY

**CUSTOM
BUILT**

DUTY

Tubes

TAYLOR TUBES INC., 2312-18 WABANSIA AVE., CHICAGO 47, ILL.



Burlington

★ PANEL INSTRUMENTS

Guaranteed ACCURACY

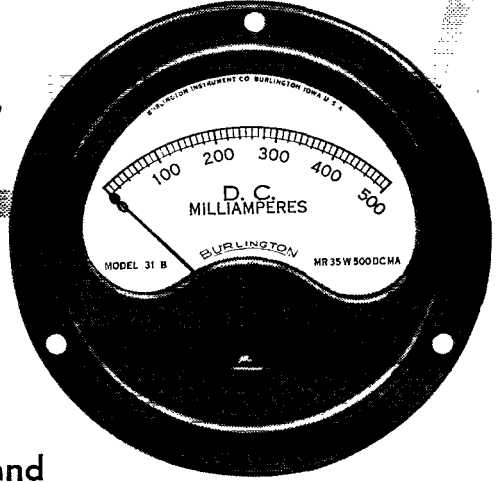

Due to design characteristics and close control of manufacturing processes, Burlington instruments embody the following advantages:

PERMANENCE OF CALIBRATION . . . All DC instruments employ Alnico magnets which are known to be more highly resistant to shock, heat, vibration, and stray fields than any other magnetic material.

FREEDOM FROM STICKING . . . Clearances for all moving parts are such that the results of entrance of small particles as encountered in field service are reduced to a minimum.

STABILITY OF OPERATION . . . All instruments are "NORMALIZED" after assembly to eliminate "zero shift" and other calibration errors due to ageing.

Exceptionally high torque to weight ratio of control springs to moving element insures minimum error under conditions of shock, vibration, and other rough usage.

Alignment of jewels and magnet core piece is such that the center lines of these parts coincide within plus or minus .002". The design of the brass movement frame and components is such that mechanical tolerances are reduced to a minimum in assembly. As a result, jewel and pivot wear is uniform which reduces "frictional torque" of the moving coil.

All series resistors and coils are heat treated and impregnated after wrapping to insure stability and long life.

All ranges AC & DC are available in 2½", 3½" and 4½" sizes, both square and round, flush mounting.

*Engineering service furnished for specialized applications.
No obligation. • Write today for further information.*

BURLINGTON INSTRUMENT CO.

800 Fourth Street • Burlington, Iowa

Out of the War Comes the MECO TUBULAR PLASTIC PLYWOOD SECTIONAL MAST

AN amazing development, used for radio antenna masts and for aircraft landing and launching gear.

Now available for commercial and amateur radio use—light, easily handled, amazing strength, low in cost. Will withstand horizontal and vertical loads at the head as great as 10,000 pounds. In sizes from 3" to 8" diameter, heights from 12 to 125 feet, in 12 ft. sections.

Stays every 25 ft. of height are corkscrew anchored. Hinged base and erecting boom are part of installation, making it easy to raise or lower at any time.

Secret lies in the sectional tubular construction, of alternate layers of wood veneer and fabric, convolutely wound and bonded with waterproof phenol-resin. Weatherproof, strong, light, resistant to corrosion, mold, rot or insects.

12 ft. sections easy to handle, positive coupling.

READ THESE 8 ADVANTAGES

1. Non-metallic — does not interfere with radiation pattern of U.H.F. antennas.
2. Strong, light, weather-proof.
3. Easy to erect.
4. Readily removed to new site.
5. Short sections, easy to transport.
6. Good looking, clean, modern.
7. Low-cost.
8. Minimum maintenance.

SEND FOR DATA

write

MARYLAND ENGINEERING CO.

PIKESVILLE

BALTIMORE 8, MARYLAND

FREE!

MECO MAST

Maryland Engineering Co.
PIKESVILLE
BALTIMORE 8, MARYLAND

ERECTING BOOM

Erecting boom and hinged base make erecting and dismantling easy, quick, economical.

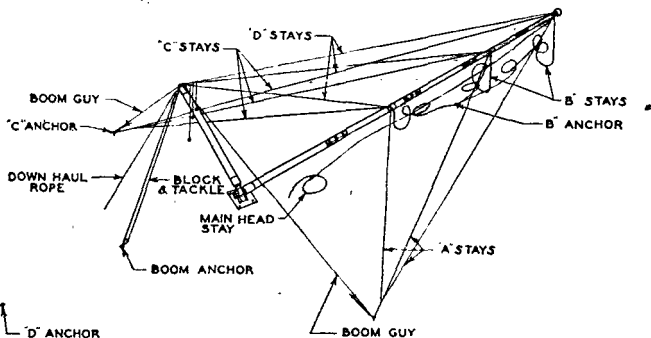

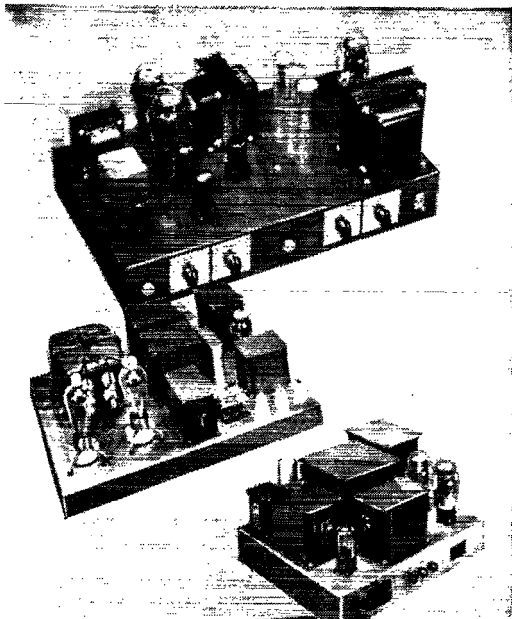

The Symbol of
**QUALITY, VALUE AND
 GUARANTEED PERFORMANCE**
 in Amplifier Kits . . . Transmitter Kits
 and Component Parts

THESE time-tested STANCOR Kits for Amateurs are designed for simplicity, efficiency and usefulness. Backed by the recognized and respected STANCOR guarantee against defects in material and workmanship, they render complete satisfaction.

Full data furnished on each unit . . . description, diagram, illustration . . . for proper assembly, wiring and operation. "Standardized" punched chassis simplifies set-up . . . accommodates variety of equipment without structural change. STANCOR units make possible maximum performance with minimum labor and expense. See your Jobber or write for full details.

STANCOR
 STANDARD TRANSFORMER CORPORATION
 1500 NORTH HALSTED ST. CHICAGO 22, ILLINOIS



(Continued from page 98)

area. Things are picking up over in the Verde Valley district. SQN reports that RLC has been home on a vacation and now has a TR-4 in his car. LJN has his 2 1/2-meter rig going, along with SNI. The Tucson gang still holds club meetings. Fifteen attended the last meeting, and after the meeting were served with "foam" by the 25 Club. Those attending included RNB, RMB, JHF, TXM, TJH, OMX, OZM, SLO, GS, 9DZA, and 9QEH. Glad to report that MLL is feeling better. NRF has also been ill. REJ still is in the Philippine area. QWG is on a tanker in the Pacific area. 73, Doug.

SAN DIEGO — SCM, Ralph H. Culbertson, W6CHV — Asst. SCM, Gordon W. Brown, W6APG — Activity on the 112 to 115-Mc. band is increasing rapidly. New calls noted on the band include AA, APG, ELL, EZM, OCJ, TFL, UNU, and 5QE/6. QEZ has just returned from the So. Pacific and is en route to New York. MQF, of Santa Ana, visited EOP recently and expects to be on the air shortly. Ted Thomas expects to open The Radio Shack soon and has been lucky in obtaining the services of MHL as manager. OIN has been working some very PB tests with OZH on his 112-Mc. portable-mobile rig. EZM reports his 112-Mc. receiver is giving him lots of trouble. The WERS net still is operating on schedules. 2KAT, now in La Jolla, expects to have his discharge soon and plans to make his home in San Diego. ACW was married recently and his XYL is studying for her ham license. RGY has been very ill but expects to be back at Western Radio shortly and says they will have a full line of amateur equipment soon. 73, Ralph.

WEST GULF DIVISION

NORTHERN TEXAS — SCM, Jack T. Moore, W5ALA — BNQ and ISM have left Lockheed to return to their radio businesses. 3JSL, ex-9ZJB, reports that the following amateurs are stationed at Love Field with him and are interested in seeing some club activity in Dallas and Ft. Worth: EZY, 6JRK, 6MFO, 9BQV, and 9ORR. LM reports that the Temple gang are hot and bothered about the ultra-high frequencies and that AMK and GGQ each have a new SX-28A. AMK recently gave a talk on crystals before the Dallas-Ft. Worth section of IRE. LM says that GGQ is cleaning up his Fibber Magee's closet (ham shack) before trying the new receiver. LM is going to clean up the old rotary and paint the big mast as soon as his boy is home from the services. AHX, still in the banking business, says that GOS received his E.E. degree from Texas Tech. and has been with G.E. at Bridgeport, Conn., since June 1942, and that GMC also received his E.E. degree from the same school and is an ensign in the Navy, stationed near New York City. JGX has departed from Lockheed to work for Dallas Aero Service. 9GKI has left Lockheed but will remain in Dallas. IZU is busy rebuilding his rig, which will be both 'phone and c.w. with a pair of 812s in the final working on 20, 40, and 80. Frank sends the following: KJO plans to rework his rig as well as buy a new receiver; HJJ has a good offer to stay in the Hawaiian Islands after he is discharged from the Signal Corps; FCU drops over to Tyler from Longview once in a while and IZU is burned up because ASA does not stop by to see him; EME was in Tyler recently on a Victory holiday from teaching duties at Texas U.; PH is ready to go; he rebuilt his rig in 1941 and got on the air about sundown of Dec. 7th only to have IYJ answer his first CQ and tell him that all hams were ordered off the air; IZU would like to hear from ASA, EN, EEW, HEJ, IWR, and KHR. Bob Wagner (LSPH) has returned to Dallas after twenty-six months service at New Delhi, India, and has opened up a radio service shop. Bob has just bought an SX-25 and reports that IXD is an operator for Delta Airlines at Meecham Field in Ft. Worth. ILJ writes from Manila that he is anxious for frequency allocation news. Joe says that he enjoyed a recent visit with his old college roommate, IWE, also in Manila, and that HTH is still on Morotai doing radio repair work. PO advises that he is doing radio repair work at camp Maxey, Paris, Tex. HZB, at Hendricks Field, Sebring, Fla., is anxious to get back on the air. HZB sends the following: FRE (HZB's father) is keeping posted on his frequency standards by means of the I.R.E. proceedings. HYE has transferred to the Air Corps. AJG and JCN are working on the 112-Mc. band and soon will be putting out official broadcasts. AJG is working for KRLD and reports that IQT and HMH are active on 112 Mc. and RG will soon have his pilot's license. JBD is working in Wichita Falls. ICB has checked out of Lockheed. ILP sends the following dope: ACT is building a new shack over his garage; AKZ is a

(Continued on page 98)

RADIO INTERFERENCE ?

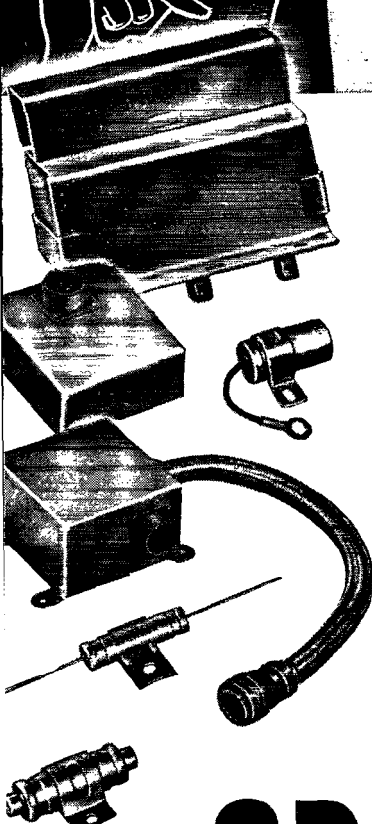
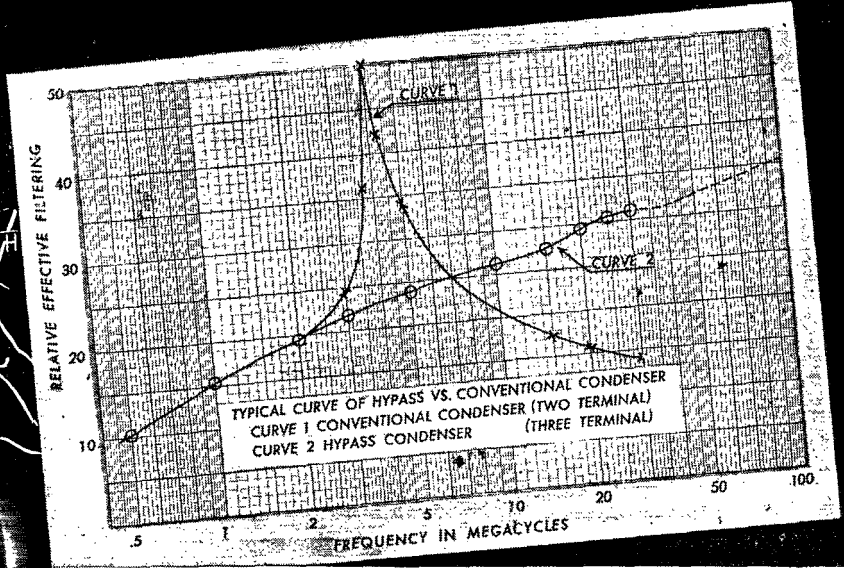

SPRAGUE HAS *the Answers!*

From inexpensive noise suppression capacitors for automotive use, to heavy-duty designs for service on power equipment, and for current ratings from 5 to 200 amperes capacity, Sprague produces modern filter units for practically any need. An unsurpassed background of engineering experience in dealing with all types of radio noise interference problems, is here at your disposal. Write for Sprague Capacitor Catalog 20.

ANTI-RESONANT FREQUENCY PROBLEMS SOLVED

Have you a vibrator "hash" problem that a conventional by-pass capacitor shunted by a mica capacitor only partially solves?

Write for details on Sprague *HYPASS Capacitors, the 3-terminal networks that do the job at 100 megacycles or more!

*Trademark Reg. U. S. Pat. Off.

SPRAGUE ELECTRIC COMPANY
North Adams, Mass.

SPRAGUE



5-Times Cited for Distinguished Wartime Service

PIONEERS OF ELECTRIC-ELECTRONIC PROGRESS

Special CRYSTAL OFFER

100 KC.

Wartime Production Methods And Improved Technique Enable Us To Offer A Limited Quantity Of The New Improved XL 100 Standard Frequency Crystal At A Reduced

NET COST OF \$7.10



Latest design insures accurate and stable operation in frequency standard, monitors and frequency meters.

IMMEDIATE DELIVERY

Purchase direct from your local radio distributor or if not in stock order direct from factory.

NO PRIORITY REQUIRED

VALPEY

Crystal Corp.

CRAFTSMANSHIP IN CRYSTALS SINCE 1921
HOLLISTON, MASSACHUSETTS

(Continued from page 96)

major in the Army; AXP is an operator with the Texarkana Police Dept.; BDB and EKF are with RCA; BEK has lost his eyesight and is in very bad health; GKP is a radio operator in the Navy. IXM was home recently on a short furlough after completing his Naval training at NRL in Washington. 9YSB has purchased a home in Dallas and would like to see some radio club activity in that city. CPW is working for WRR. VU is looking for a new QTH with DX possibilities. IBC reports that he has received his discharge from the Navy and will return to West Texas in about three months with a Class A ticket. FVE has received his discharge from the Navy and is going to live in New Jersey. DOB has received his discharge from the Marines and has returned to Hamlin. He reports that BYV is with RCA in Indianapolis since his release from the Navy. NW has appointed the SCM as an assistant director of the West Gulf Division. 73, Jack. OKLAHOMA — SCM, Ed Oldfield, W5AYL — The Oklahoma City Amateur Radio Club met September 5th, and agreed to meet the first Wednesday in each month thereafter. Those attending were: EIH, CVJ, BXC, KD, QL, AXM, KBA, FSW, FIL, ex-NG, EHR, HXJ, ex-AEC, HXT, FAB, ATL, CXE, and AYL. Visitors are welcome to attend meetings. Time and place can be obtained from AYL or CXE. HFX is serving in the Navy somewhere in the Pacific. Capt. EHP is at a hospital in California doing X-ray work. ERY says he's ready to work Oklahoma City from Edmond on 112 Mc. EHR has a 2 1/2-meter rig and is itching to use it. CXE is building a 2 1/2-meter rig. We need a lot of activity on this band so that we will be equipped to handle emergency communications. ARRL and ham radio need your support. Ed.

SOUTHERN TEXAS — SCM, James B. Rives, W5JC — FAH and his sister, GKE, report that the fellows are planning big things in Brownsville. There are about fifty-five hams with Pan-American Airways and they have a club room and office where a complete station is under construction. Ex-4CW is assistant chief flight radio officer. CRI is communications officer at Waco Army Air Base and expects to be a civilian shortly. IWU is in the radio repair section at Waco Air Base. ATW recently moved from Houston to Waco and is connected with the new Hargis Radio Supply. BIN is getting set to get back on the air. TG is located in Waco with the Interstate Theaters, doing sound equipment maintenance. R. C. Hall recently was elected president of the Houston Amateur Club. APM is in the radio service business in San Marcos and has purchased a new receiver. KA keeps busy with his radio supply house in Austin and flying during his spare time. GGQ, LM, and HAL have new receivers. AMJ is stationed at Maxwell Field, Ala., and has a new jr. operator. Your SCM enjoyed a good rag-chew with Mr. McCabe, who is back in Galveston as RI with the FCC. Lt. 8BUK is assistant chief, Comm. Eng. Section, at Kelly Field. GR has moved to Dallas. BIP is back in the broadcast game in Wichita Falls. Capt. K4GTE is C.O. of the AACs detachment at Kelly Field and is all set to go on the air in San Antonio as soon as he gets his equipment from Puerto Rico. The San Antonio Radio Club has offered prizes to the gang to stimulate interest in the 112 Mc. band. 73, Jim.

NEW MEXICO — SCM, J. G. Hancock, W5HJF — 9DDU is a civilian again after forty-three months overseas and is living at his new home in Albuquerque. GXL reports that he, HPZ, and JZT are planning to go on 112 Mc. soon from Las Vegas. DER and ISN are trying to get on in Clovis. We would like to hear from the gang in Albuquerque. HJF would like to go on but there is no other station within range. 73, Jake.

The Month in Canada

QUEBEC—VE2

From L. G. Morris, VE2CO:

BILL TOONEY, VE2HS, has been working on radar as a commissioned officer with the RCAF. We note with deep regret the passing of Fred Reevely, 2JI, who died suddenly in Toronto while watching a lacrosse game. Geoff. Field, 2BO, arrived back in Canada after more than four and a half years foreign duty with the air force. Another returnee is Major Reg. Varcoe, 2JA, who was seriously wounded overseas. Reg. was awarded the Order of the

(Continued on page 102)

"MUSTS"

FOR EVERY HAM'S BOOKSHELF

 *"The All-Purpose Volume
On Radio"*

The Radio Amateur's Handbook

Text, data book, operating manual—it is all these and more. As a text it is probably more used in radio schools and colleges than any other single volume. As a practical constructional handbook, it stands in a class alone. As an operating manual, it provides information available from no comparable source.

The latest Edition of THE RADIO AMATEUR'S HANDBOOK is the largest ever published. It includes a comprehensive chapter dealing with War Emergency Radio Service plus other new material—all added without sacrificing the essential information in previous editions which made the HANDBOOK the world's most valuable and widely-used radio book. The theory and design sections cover every subject encountered in practical radio communication, sectionalized by topics with abundant cross-referencing and fully indexed.

\$1.00 in Continental U.S.A.

\$1.50 Elsewhere

\$2.00 Buckram Edition

A Course in Radio Fundamentals

By GEORGE GRAMMER

 this book greatly smooths the way for the student of the technicalities of radio. It contains interesting study assignments, experiments and examination questions for either class or individual instruction. It describes in detail 40 experiments with simple apparatus giving a complete practical knowledge of radio theory and design. Price 50c

The objective in preparing this course was to accent those principles most frequently applied in actual radio communication. "A Course in Radio Fundamentals" is a study guide, examination book and laboratory manual. Its text is based on the "Radio Amateur's Handbook." As a text,

Learning the Radiotelegraph Code

By JOHN HUNTOON

 operator or access to a code machine. It is similarly helpful home-study material for members of code classes. Adequate practice material is included for classwork as well as for home-study. There are also helpful data on high-speed operation, typewriter copy, general operating information—and an entire chapter on tone sources for code practice, including the description of a complete code instruction table with practice oscillator. Price 25c

This booklet is designed to train students to handle code skillfully and with precision. Employing a novel system of code-learning based on the accepted method of sound conception, it is particularly excellent for the student who does not have the continuous help of an experienced op-

The A.R.R.L. Antenna Book

By GEORGE GRAMMER and BYRON GOODMAN

 Feed systems and their adjustment. Construction of masts, lines and rotating mechanisms. The most comprehensive and reliable information ever published on the subject. Over 100 pages. Price 50c

A comprehensive manual of antenna design and construction. Sixteen chapters, profusely illustrated. Both the theory and the practice of all types of antennas used by the amateur from simple doublets to multi-element rotaries, including long wires, rhomboids, vees, phased systems, u.h.f. systems, etc.

AMERICAN RADIO RELAY LEAGUE, INC., West Hartford 7, Conn., U.S.A.

HUDSON AMERICAN

TRANSFORMERS

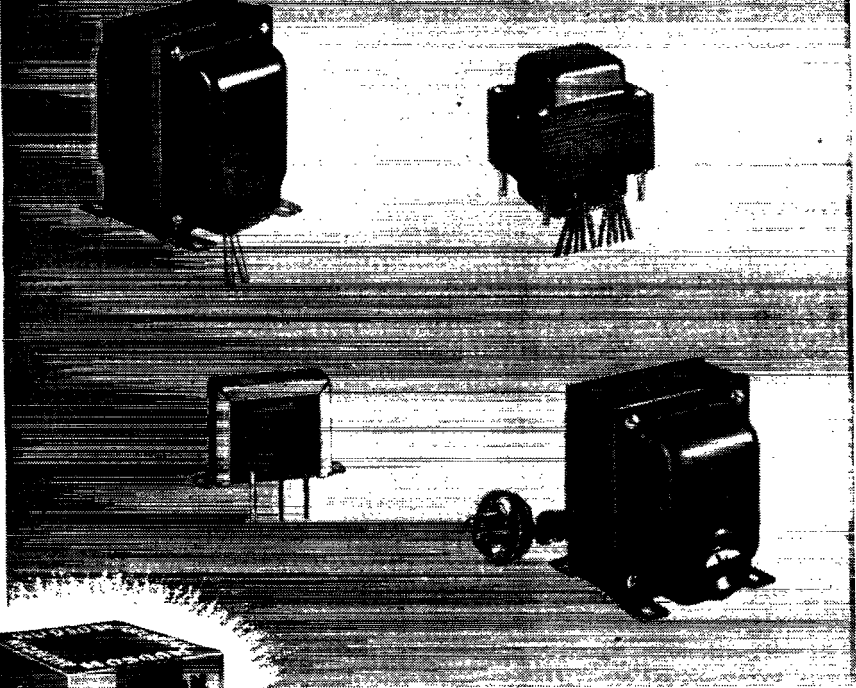

Look for this distinctive package



FOR GENERAL PURPOSE AND REPLACEMENT USE IN RADIO AND ELECTRONIC EQUIPMENT

HUDSON AMERICAN'S engineering experience in designing and manufacturing high quality transformers extends over a period of more than 20 years.

HUDSON AMERICAN'S up-to-date facilities include the most modern coil producing machinery available—vacuum impregnating equipment for wax or varnish and completely automatic production test apparatus. HUDSON AMERICAN Transformers are precisely wound—meticulously assembled—thoroughly impregnated and carefully finished. Continuous inspection and quality control insure maximum uniformity.

For dependability and economy, specify HUDSON AMERICAN Transformers for your radio and electronic requirements. They cost no more than ordinary transformers.

Write for catalog 1045

HUDSON AMERICAN CORPORATION

(A subsidiary of Reeves-Ely Laboratories, Inc.)

25 WEST 43rd STREET, NEW YORK 18, N. Y.

HAMS ... here are all the things you've been waiting for in NEWARK's two big stores. Order from the store nearest you for fast service.

THIS MONTH'S FEATURES

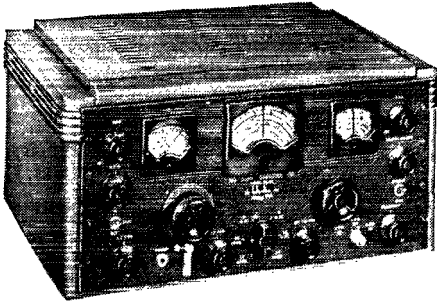

HAMMARLUND

- HQ-129X (with tubes)..... \$129.00
 - ASPC-210X..... 318.00
 - ASP-210SX..... 318.00
- Available for rack mounting at same prices

NATIONAL

- NC-2-40C and speaker..... \$240.00

RME

- RME-45 and speaker..... \$166.00

HALLICRAFTERS

- SX-28A Super Skyrider with crystal, less speaker. \$223.00
- S-20R Sky Champion with built-in speaker..... 60.00
- S-22R Skyrider Marine with built-in speaker... 74.50
- SX-25 Super Defiant with crystal, less speaker... 94.50
- S-39 Sky Ranger portable, AC/DC and battery 110.00
- SX-36 FM/AM receiver..... 415.00
- S-37 V.H.F. FM/AM receiver..... 591.75
- PM-23 10" PM speaker in cabinet for use with SX-25, SX-28A..... 15.00

THORDARSON TRANSFORMER

(POWER TRANSFORMERS AND CHOKES)

- T-45556 or T-92R21 leads out of side, 778 V. C.T. at 200 MA. 115 V. 60 Cycle 6.3 V. C.T. at 3A. 5 V. at 30 amp. 91 lbs..... \$5.29
- T-13C30 8H. 150 MA. 200 ohm 1600 V. Insulation 2 1/4 lbs..... 1.41
- T-4557 or T-74C29 leads out of side. 15H. 150 MA. 200 ohm 2000 V. Insulation 5 1/4 lbs..... 2.82

WESTERN ELECTRIC MICRO AMMETERS



Bakelite case fits 3/8" hole. Radium dial 150-0-150. Can be used with 0-200 micro and amp scale listed below. Excellent as a 5,000 ohm-per-volt meter or null, sound level and galvanometer indicator. Instructions included.
No priority required..... \$7.50
0-200 paper scale for above..... .15

The famous Newark bargain oil-filled, oil-impregnated

FILTER CONDENSERS

Fully guaranteed at rated voltages

Capacity	Working Voltage	Height	Width	Depth	Wt.	Price
1 mfd.	1500 V. D.C.	2 3/16	1 3/4	1"	4 oz.	\$.79
17 1/2 mfd.	1500 V. D.C.	3 3/8	4 3/8	3 3/8	3 lbs.	2.75
11 1/2 mfd.	1500 V. D.C.	5	3 3/4	1 1/2	1 lb. 10 oz.	2.00
5 mfd.	1500 V. D.C.	4	2 3/4	1 1/4	14 oz.	1.65
5 mfd.	2000 V. D.C.	4	3 3/4	1 1/4	1 lb. 4 oz.	2.15
8 mfd.	2000 V. D.C.	4 1/2	3 3/4	2 1/2	2 1/2 lbs.	2.75
.25 mfd.	2000 V. D.C.	3 3/4	1 3/4	1	6 oz.	.69
Special Porcelain Insulators						
10 mfd.	3000 V. D.C.	4 3/8	3 3/4	3 3/4	3 lbs. 8 oz.	4.75
15 mfd.	3000 V. D.C.	4 3/4	4 3/8	3 3/8	5 lbs.	5.25
6 mfd.	3000 V. D.C.	6 3/8	6 1/2	3	5 lbs. 6 oz.	3.25
with mounting feet, width includes mounting feet						
8 mfd.	3000 V. D.C.	7 3/8	6 1/2	3 3/8	7 lbs. 4 oz.	3.95
2 mfd. & 4 mfd.	600 V. metal can	4 3/8	2 1/2	1 1/4	14 oz.	.80

McELROY KEY

The Deluxe — Model CP 810..... \$9.75

0-500 D.C. MA. 2" round Bakelite case..... \$3.50

G.E. METERS

0-8 RF ammeter, 2" round Bakelite case..... \$4.00

ABBOTT TR-4

Compact, efficient 2 1/2 meter transmitter-receiver \$39.00

Get Your Name on Our Mailing List

Be first to get announcements of merchandise available, special bargains, etc., etc. Send name and address on post card. State whether amateur, engineer, school, industrial or service man. Address orders and inquiries to Dept. Q, at NEWARK store nearest you.

ALL PRICES SUBJECT TO CHANGE WITHOUT NOTICE

NEW YORK
Newark ELECTRIC Company
CHICAGO

115-117 W. 45th St.
NEW YORK 19
Bryant 9-4735
(Adolph Gross)

"Service is the Foundation of our Business"

323 W. Madison St.
CHICAGO 6
DEArborn 0083
(Sam Poncher)

THE RADIO AMATEUR'S LIBRARY

• Many requests are received for the complete list of our publications. The list follows:

Title	Price
<i>QST</i>	\$2.50 per year*
List of Stations.....	Discontinued
Map of Member Stations	Discontinued
Operating an Amateur Radio Station Free to members; to others 10¢	
The Story of The A.R.R.L.	Discontinued
The Radio Amateur's Handbook	
a. Standard Edition.....	\$1.00**
b. Special Defense Edition..	\$1.00
The Log....	35¢* each; 3 for \$1.00
How to Become a Radio Amateur	25¢
The Radio Amateur's License Manual.....	25¢
Hints & Kinks for the Radio Amateur.....	50¢
Lightning Calculators:	
a. Radio (Type A).....	\$1.00
b. Ohm's Law (Type B)....	\$1.00
Amateur Radio Map of the World.....	\$1.25
Two Hundred Meters and Down: The Story of Amateur Radio	Out of print
Building an Amateur Radio- telephone Transmitter	Out of print
A.R.R.L. Antenna Book.....	50¢
Emergency Communications Manual.....	10¢
The Minilog.....	25¢
Learning the Radiotelegraph Code.....	25¢
A Course in Radio Fundamentals	50¢

*In the United States and Possessions — other Countries \$3.00 per year.

**Postpaid in Continental U. S. A. — \$1.50, postpaid, elsewhere.

(No stamps, please.)

THE AMERICAN RADIO RELAY LEAGUE, Inc.

West Hartford 7, Connecticut

(Continued from page 98)

British Empire for his work on radar. Bill Pentney, 2JJ, is now a keen model airplane fan. A. McVicar, 4PH, formerly with the RAF Transport Command, is now located in Montreal. Recent visitors to the metropolis were Jack Paddon, G2IS, and Val Sharp, 2CR. Bob Prissick, ex-2CX, returned from overseas and is now in Ottawa. Bob expects to go back to B. C. upon discharge. 2AX, 2EM and 2FK have been planning u.h.f. gear. 2BK has been demobilized and has returned to complete his studies at McGill University. Tom Walker, 2BF, is engaged to be married.

ALBERTA—VE3

From W. W. Butchart, VE4LQ:

VE4IX, TED CARELESS, Hackett, Alta., formerly of Bymoor, Alta., visited Edmonton recently, and stayed with 4EY, Bill Careless. An item in the *Edmonton Journal* recently stated that Ron Watts and YF were celebrating the birth of a jr. op. Could that be our Ron, 4MR? Possibly the most interesting news which has come our way in the past month, came in the form of a letter from 5ADD, Stan Jones, ex-4ABH, Edmonton. It appears that he has been doing more than a little globe-trotting during the past two years or so, and I think we'd better spike that rumor that was going the rounds a few months ago to the effect that Stan was with the RCAF at NW Air Command here in Edmonton! He has actually been at sea, and at the time of writing was in the Caribbean Sea aboard a Swedish oil tanker. Stan is wireless officer aboard the tub. He has visited many ports in India, Ceylon, Persia, Australia, etc. During the fall of 1944 he was ashore in Western Australia, where he picked up his 1st Class commercial ticket, and during his stay there noted that the VK hams showed a marvelous spirit of ham hospitality. He visited many of the VK6s, among whom were 6NO, 6FL, 6WH, 6SA, 6AZ, 6KG, 6KR and 6JE. Apparently the VK6s were visited by many of the U. S. boys who were stationed in Australia during the war, but VEs were few and far between.

4EA, Roy Usher, of Edmonton, has just finished his annual holiday out Vancouver way, but this time sans car! He met quite a flock of the boys, and renewed acquaintances with the 75 meter 'phone gang. Before I go further, has anyone heard of 4AOZ, Slim Marsden, formerly of Milo? It's about time he forwarded his new QTH so that we can tell you where he is going to hang his sky-wire for postwar activity. During the course of a chemical warfare display put on by the U. S. Army for the Reserve Army boys in Edmonton, I managed to meet up with some U. S. Signal boys, and had the pleasure of seeing the "innards" of the handie-talkie they were using. And speaking of portable equipment, 4AH, Frank Makepeace, of Edmonton and 4VJ, Ken Angus, of Edmonton, both on the staff of CFRN, are very busy these days planning a pack set for portable remote broadcast work.

A small hamfest, complete with cats, was held at CFRN's transmitter shack recently, when 4VJ, 4AH and myself (4LQ) got together for an evening, along with Hector Hill and Larry Fead of CFRN's xmtr. staff, Mrs. Hill, and Mr. and Mrs. Angus (VJ's folks). The boys proudly displayed the new emergency rig of CFRN, which is the work of AH and VJ. By the way, 4AH is beginning to look around for ham gear again, and is scratching his noggin for ideas for the new rig and receiver which he will be needing as soon as the VEs are allowed back on the air. 4VJ is also taking stock of the situation, and admitted without any hesitation on his part, that he is seriously thinking of throwing a "blooper" together just to see how things sound on the short waves.

4BW, Ted Sacker, of Edmonton, having acquired a couple of good sticks was seen dragging vast quantities of sash cord home the other evening. As reported last month, Ted's enthusiasm is running high, what with a new receiver on the way, and news that the American boys are allowed on 112-Mc.s now. Was talking to 4JL, Jake Allen, R. L., of Edmonton, the other day, and he too is waxing enthusiastic about getting on the air again. Jake, by the way, informed me that 4AO, W. R. Pottle, of Regina, Supervising Radio Inspector for Saskatchewan passed away on the 28th of May last. 4AO was one of the really old timers in the radio game, having been a wireless operator aboard ship back in the old days of spark. As a ham, he has been on the air for years, and will be remembered by all the old gang in Western Canada.

I have noted the progress of 4AEN, Geo. Marion, of Edmonton, in this column from time to time, and now,

(Continued on page 106)

*Enduring Accuracy
in Vital R.F. Applications*



OHMITE RESISTORS & CHOKES

The unique characteristics of these Ohmite units have made them especially suitable for many r.f. applications. Proved by use in the most critical service . . . they'll be more popular than ever with radio amateurs and engineers.

GLASS-SEALED NON-INDUCTIVE DUMMY ANTENNA RESISTORS—for testing and measuring power output accurately. 100-watt and 250-watt sizes in variety of resistances.

R. F. PLATE CHOKES—single-layer wound on low power factor steatite cores, with moisture-proof coating. Built to carry 1000 M.A. 5 stock sizes from 2½ meters to 160 meters.

PARASITIC SUPPRESSOR—small, light, compact non-inductive resistor and choke, designed to prevent u.h.f. parasitic oscillations.

NON-INDUCTIVE VITREOUS ENAMELED POWER-SIZE RESISTORS—useful in wide variety of radio frequency applications. 50-watt, 100-watt and 160-watt stock sizes in many resistances.

Authorized Distributors Everywhere

OHMITE MANUFACTURING CO.
4864 FLOURNOY STREET • CHICAGO 44, U. S. A.

Be Right with

OHMITE

RHEOSTATS • RESISTORS • TAP SWITCHES

Send for Catalog No. 18
Gives helpful data and
information on stock
units. Address Ohmite
Mfg. Co., 4864 Flour-
noy St., Chicago 44, Ill.

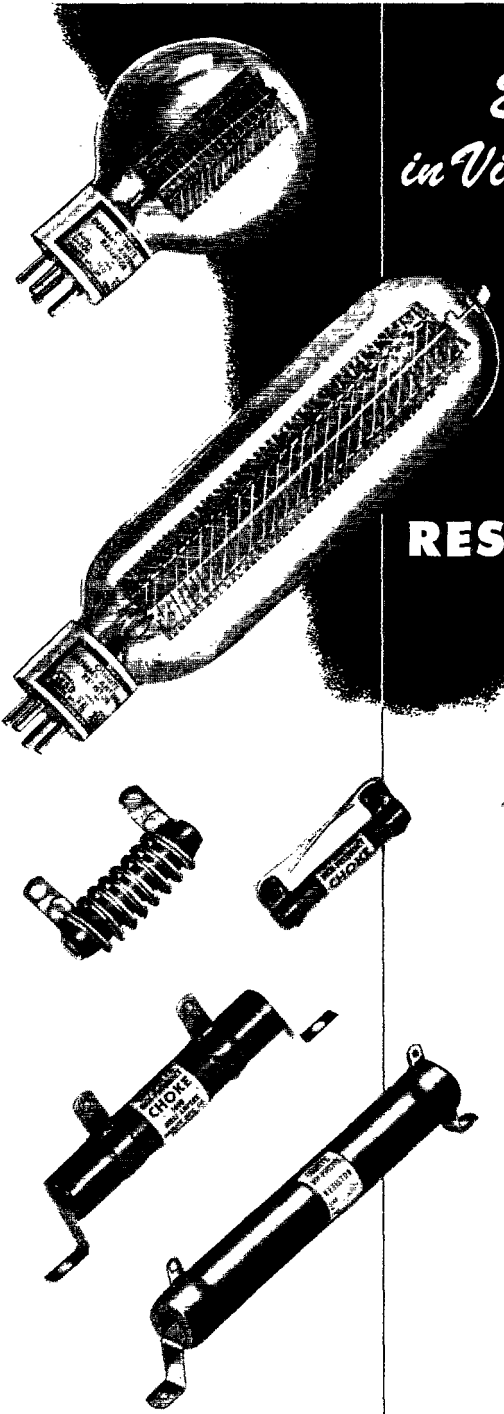

V...—Again We Can Serve YOU...



CONCORD
RADIO CORPORATION
LAFAYETTE RADIO CORPORATION

An Old and Trusted Company
WITH A NEW NAME

WITH victory achieved the signal has flashed that will start amateur radio on the greatest boom in its history! And again leading the parade with *complete stocks of all standard lines of radio parts* — plus the equipment, resources and technical staff to help you with the new war-born developments — **CONCORD RADIO** is again ready to serve you with the same friendly, personal interest which

has made us the amateur's dependable source of radio parts and electronic equipment for 25 years. Here you have immediate access to vast stocks and to wide selections. Your every requirement, request and problem is handled by a staff of seasoned technical experts who **KNOW** amateur radio — many of them hams themselves. We invite you to avail yourself of **CONCORD'S** dependable service.

ALL STANDARD LINES

**Hallcrafters • National • Hammarlund
 Receivers and Equipment**

CONCORD is famous for carrying in stock for immediate shipment hundreds of nationally known lines of amateur radio parts and equipment. Below is a partial list:

Aerovox, Amphanol, Amperex, Amperite, Astatic, B & W, Bliley, Brush, Burgess, Cardwell, Centralab, Clarostat, Cornell-Dubilier, Dumont, Echobone, Eimac, General Electric, Hallcrafters, Hammarlund, Heintz & Kaufman, Hickock, IRC, Janette, Jensen, Johnson, Mallory, McElroy, Meissner, Millen, National, Ohmite, Pioneer, Presto, Racon, RCA, Readrite, Shure, Simpson, Solar, Sprague, Stancor, Subreme, Thordarson, Trimm, Triplett, Turner, UTC, Universal, Utah, Vibroplex, Weston, Warner.

Complete Catalog FREE

In addition to all standard brands of quality items, this Catalog and Buying Guide contains items not available at any price during the war, it offers many new post-war developments, it shows the last word in modern radio parts and electronic equipment. Many of the recent advances in the science of radio communication are included. You'll find this Catalog a priceless reference guide and a valuable addition to your library. Mail the coupon below for a copy. It's absolutely **FREE**.

TO OUR FRIENDS OVERSEAS: We are prepared and eager to resume the pleasant relations we enjoyed before the war. A complete and efficient export department is at your service.

Order Today for Shipment Tomorrow

CONCORD RADIO CORPORATION

LAFAYETTE RADIO CORPORATION

CHICAGO 7, ILL. ★ ATLANTA 3, GA.
901 W. Jackson Blvd. 265 Peachtree Street

CONCORD RADIO CORP., Dept. ST-115
 901 W. Jackson Blvd., Chicago 7, Ill.

Gentlemen: Send me at once a **FREE** copy of your latest Catalog and Buying Guide, listing standard lines of Radio Parts and Electronic Equipment.

Name.....
 Address.....
 City..... Zone..... State.....

VALUABLE FREE PRIZES for Amateurs

Since, at this printing, there is only the 112 to 115.5 megacycle band available for amateurs . . . Since Crystalab's policy is to give the amateur exactly what he wants, we are asking you, the amateurs, for suggestions as to the type of crystal kit you desire, and awarding valuable prizes for the best suggestions.

We want your ideas for an ideal crystal kit:

the kind you most want to buy - in not more than 300 words. Literary form is not important - ideas will win. We'd like to know your wants as to FREQUENCY, BLANKS, HOLDERS, LAPPING COMPOUNDS; COMPONENTS FOR A CRYSTAL KIT, SECONDARY STANDARDS, CRYSTAL APPLICATION SUGGESTIONS FOR NEW AMATEUR, INDUSTRIAL AND COMMUNICATIONS USES.

28 Prizes

FIRST PRIZE: Crystalab Secondary Standard

SECOND PRIZE: \$50 Victory Bond

THIRD PRIZE: \$25 Victory Bond

25 \$5 PRIZES: (Awarded in crystals).

JUDGES

Raymond W. Woodward, PhD General Research Laboratories Underwood Corporation	Ernest B. Lewis, Chief Crystallographer Crystal Research Lab., Inc.
--	---

Russell G. Sceli, Prominent Radio
Components Dealer

JUDGES DECISION FINAL

Contest open only to amateurs not associated with Crystal Research Laboratories, Inc., or affiliates.



Contest closes Dec. 15, 1945. Time is short. Write us today!

★ CRYSTAL RESEARCH LABORATORIES ★

29 ALLYN STREET HARTFORD 3, CONN

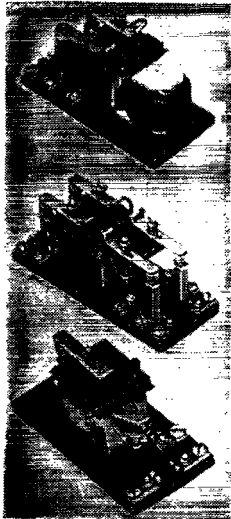

HEAVY DUTY RELAYS

Relays No. 130 are available for radio, electronic and industrial applications. Heavy duty contacts. One to four poles with wide variety of contact arrangements. Molded phenolic bases. New catalog gives complete data. Write for your copy now.

WARD LEONARD ELECTRIC CO.

Radio and Electronic Distributor Division
53 WEST JACKSON BLVD., CHICAGO, ILL.



(Continued from page 108)

again, after five or six months with only a hasty letter, Geo. turns up in person, on 58 days leave from HMCS *Uganda*. He has travelled 75,000 miles in five months aboard the cruiser. Geo. was in on the shelling of Truk, and was within 40 miles of the Jap mainland on one patrol. He saw the Jap Kamikaze planes diving at him (fortunately no direct hits), and altogether saw very much in a short time. Questioned as to future activity, Geo. says that he has applied for discharge, and that at the conclusion of this leave he will probably be put back on "Civvie Street" for good. He will have his former job with RCA in Edmonton to return to. In the meantime, he and his XYL are enjoying his leave together, and they have taken an apartment on 115 Street, Edmonton.

When 4EA was in Vancouver scrounging around the various ham rendezvous he met 4GE, Stu Jamieson, of Drumheller, our present SCM in Alberta. Stu just doesn't write letters, and we've had a hard time localizing his whereabouts, but Roy says he's a Petty Officer in the RCN and should be back in Alberta some time fairly soon. The Alberta 'phone men will recognize the call 5RV, Vancouver, owned and operated by "Dud" Meakins. At the time of LQ's trip to the coast in September, 1939, Dud had just joined up in the RCAF as radio op. Well, Dud is out of uniform again, and I presume he is back at work in the big radio store in which he was employed prior to enlistment. 4EA gave us the dope on the Vancouver boys, and incidentally, he says that 5ABA, Jack Wilson, of Vancouver, and his sister, Bessie, have been working for Boeing in that city. Bessie was laid off at the time of the cut-back, and Jack is still on the job. The two boys at 5GD, Bob Dunn and Marv. Wilson, of Vancouver, are both there — Bob still in the Bank of Nova Scotia, and Marv. out of the Air Force since April, has entered into partnership with another chap in a magneto sales and repair business.

Gordie Sadler, 4NU, of Grande Prairie, paid us a visit the other day. He has been on holidays from CFGP for a month now, and as noted last month, was celebrating the arrival of a jr. op. Gordie visited his old side-kick, 4AKK, Bob Lamb, of Edmonton, Calgary, who is with CFCN in the Southern City. They made a trip to Banff together, and also out to Strathmore, where CFCN's heap is located. He says that Bob is doing a very FB job as CFCN's technician at Calgary. 4NU made the trip out from Grande Prairie by car, and has left to go back now. His XYL and the jr. op. are leaving by plane this week. The news of 4ABL's, Art (Schultz) Sherwin, of Edmonton, imminent marriage has been made public. Your writer is a personal friend of Art's YL, and if I'm not right "off the beam," it looks as if we're going to have a new YL (or is it XYL?) op. in Edmonton. Roy Cable, one of the Cable Bros. of 4YX, in Edmonton, now in the RCN, is home on leave, and probably pawing over the junk box with brother Cecil to find out if they have enough to get a rig slapped together when the time comes to "get going" again!

The N.A.R.C. reorganization meeting went ahead as scheduled. Fifty-five hams and SWL's attended, and among those present were W9KGQ, Wm. R. Davies, Pontanet, Ind.; W9UYD, W. L. Hampel, Crystal City, Mo.; W8UAV, John Connor, Pittsburgh, Pa.; and Fred Andrews, Portland, Ore., all members of the U. S. Army, stationed in Edmonton. We also had a scattering of hams from Saskatchewan, Manitoba and Ontario, which included, 4PE, Jack May, Saskatoon; 4AIO, Howard Greer, Winnipeg and 3AOG, R. F. Chinnick, Chatham, Ont. New slate of officers for the club are: Roy Usher, 4EA, president; R. J. Ducey, 4TU, vice-president; and Stan Mitchell, 4ATH, secretary-treasurer. The bug being raffled off by the N.A.R.C. was won by 4BP, H. B. Doughty, of Edmonton. The 'phone men all agreed that it was just as well that a good c.w. man won the gadget, anyhow!

That's about all for now, gang. Hope you don't get tired out reading all the dope this month. 73.

ONTARIO — VE3

From L. W. Mitchell, VE3AZ:

THE W.A.O.O. started the new season with a bang on Sept. 20th. It's a long time since such a gathering of hams has been seen in Toronto. There was a great deal of back-slapping and hand shaking as the old gang got together, and main topic of conversation was, "How soon do we get back on the air?" That question was answered by Bill Winter, 3APA, who explained that, due to the unavoidable absence of 3AZ, Len Mitchell, he had been delegated to inform the

(Continued on page 108)

Now! A Better Soldering Tool... THE KWIKHEAT THERMOSTATIC SOLDERING IRON

Has Built-in Thermostat Control!

6 TIP STYLES

- #0 — \$1.25
- #1 — \$1.25
- #2 — \$1.25
- #3 — \$1.25
- #4 — \$1.75
- #5 — Melting Pot for tinning — \$1.25

HOT, READY FOR USE ONLY 90 SECONDS after plugging in! Kwikheat is the only soldering iron with a thermostat built into the tool itself*—maintaining the proper level of heat for most efficient, economical operation. **SAFE!**... Cannot overheat—**ECONOMICAL!**... Lasts longer—saves tips and requires less retinning. **POWERFUL!**—225 watts—yet exceptionally light weight (14 oz.). Well-balanced with cool protecting plastic handle. Modern streamlined design. Six interchangeable tip styles adapt one Kwikheat Iron to all your soldering jobs. You will be proud to own America's finest and most versatile soldering tool... from tip to plug Kwikheat is in a class by itself. Ask your dealer to demonstrate the quick-heating feature now! *patented

Kwikheat Iron with choice of #0, #1, #2, or #3 tips \$11.00
Set of 5 tips, consisting of #0, #2, #3, #4, and #5 . \$4.00

Dep't. PS-11, Kwikheat Division of
SOUND EQUIPMENT CORP., 3903 San Fernando Rd., Glendale, 4 Calif.



WORLD'S FASTEST PLANE *uses* ANDREW COAXIAL CABLES!

Lockheed's sensational new jet-propelled super fighter, the P-80 "Shooting Star," is the world's fastest and highest flying plane.

★ It is highly significant that Andrew coaxial cables were chosen for the vital radio and radar equipment installed in the P-80. They were selected because they are much more resistant than ordinary solid dielectric cables to the high temperature encountered in the tail of the plane.

Andrew Co. is a pioneer manufacturer of antenna tuning and phasing equipment, including a complete line of ceramic insulated coaxial cables and all necessary accessories. *Write for catalog.*



**ANDREW
CO.**

**363 EAST 75th STREET
CHICAGO 19, ILLINOIS**

A Two-Range Source of Laboratory D.C. Power

The HARVEY Regulated Power Supply 206 PA fills the need for a constant source of laboratory D.C. power between the ranges of 500 to 1000 volts.

The HARVEY 206 PA operates in two ranges: Low range — 500 to 700 volts at 1/4 amp . . . High range — 700 to 1000 volts

at 1/2 amp . . . Regulation is 1% or better . . . Output is constant even though line voltage varies between 95 and 130 volts . . . Output is constant within 1% from no load to full load in each range.

For details get in touch with HARVEY of CAMBRIDGE.

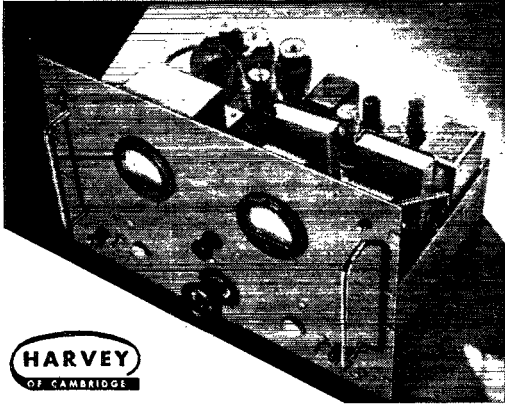

HARVEY RADIO LABORATORIES, INC.
451 CONCORD AVENUE • CAMBRIDGE 38, MASS

RADIO CHASSIS PUNCH



Saves hours of work cutting clean, accurate holes in radio chassis—for connectors and other receptacles. Simply insert cap screw in hole to be enlarged (drill small hole if necessary), turn with ordinary wrench to force punch through the metal. No reaming or filing—hole is smooth and clean. No distortion—die supports metal. Ten sizes from 3/4" to 2 1/4"; also up to 3 1/2" for meters. Write for free catalog 33E to Greenlee Tool Co., 1871 Columbia Ave., Rockford, Ill.



(Continued from page 106)

boys that both Ottawa and Washington are doing their best to straighten out the situation, but until such time as the ham bands are no longer required by the armed forces we shall have to bide our time, and spend it readying our rigs and receivers for the grand opening. The meeting, which was attended by 150 hams and hope-to-be hams was presided over by President Alf. Edmonds, ARRL, who opened his remarks with a word of greeting to our ex-service boys. Several were asked to identify themselves, these being 3AYJ, 3FO, 4QA, 3MV and 3XV. They were given a splendid reception and welcome home. Sam Trainer, jr., 3GT, of the VE Ops Ass'n., was introduced to the meeting and gave an interesting chat on the activities of the organization. He also produced a copy of *Radio News of Canada*, dated Dec., 1924, which contained an article concerning the origin and activities of the W.A.O.O. in the early days of wireless. We have certainly made amazing strides since those days in the dim past. The Chairman introduced the speaker of the evening, Mr. Chas. J. Bridgland (Eng. Dept. R.E.L. Leaside), whose paper was entitled "Wave Propagation." Frank Bowkett proposed a hearty vote of thanks to the speaker, which was enthusiastically endorsed by the meeting. An appeal for subscriptions to ARRL and *QST* brought forth several applications, and about 20 new members were added to the W.A.O.O. roster.

Officials of the Canadian Radio Operators Association, from their headquarters at Leaside P. O., report that they have recently published the second issue of *Xtal*, which is a big improvement over the previous issue, containing in all 36 pages. Anyone interested may receive a copy on request. The future plans of the VE Ops include a headquarters station operating on all ham freq., both phone and c.w.

MANITOBA—VE-1

From A. W. Morley, VE4AAW:

THE Flin Flon Radio Club is in full swing again having got away to a good start early in August. Among those at the initial meeting were 4OB, 4AEQ, 5DV, Howard Beckman (call unknown), as well as several members of the services who are intending to break into the game. News was heard of 4WU who is in the USA. 4AEO is still with the Navy as is 4AMI. Wally Paylor (call unknown) is still overseas with the RCAF. The Club express a keen desire to do a bit of experimenting on the u.h.f. Thanks for this news Bill and best of everything to the Club.

4FS is out of the RCAF and has left for Regina where he is looking after things for his old employer. 4YM is out of the Navy and back with CKRC. 4AMC is out of the RCAF and intends to work in Winnipeg. With things moving so fast and discharges right and left, it is hard to keep track of everyone, but I'm not going to ask you for any news, but remember no news, no column. 73.

Four-Tube Superheterodyne

(Continued from page 80)

range from 143 Mc. minus the i.f. to 149 Mc. minus the i.f. In the case of a 25 Mc. i.f., this would be 118 to 124 Mc. The tuning range is adjusted by spacing the turns of L_3 and by moving the vane on the shaft. Moving the vane closer to the coil will increase the tuning range but increases the minimum frequency a trifle, and vice versa. If a calibrated 144-Mc. superregenerative receiver or transmitter is available, it can be used as a signal source and the oscillator tuning range can be adjusted without knowing the i.f.

The mixer coil and antenna coupling can be checked by listening to a weak signal (whose weakness is under your control, however), or to ignition noises, and it will be found that best sensitivity will be obtained with quite tight coupling. The mixer circuit will not tune sharply, and it is only necessary to retrim it when going from one end of the 144-Mc. band to the other.

Your Post-war RECEIVER is here!

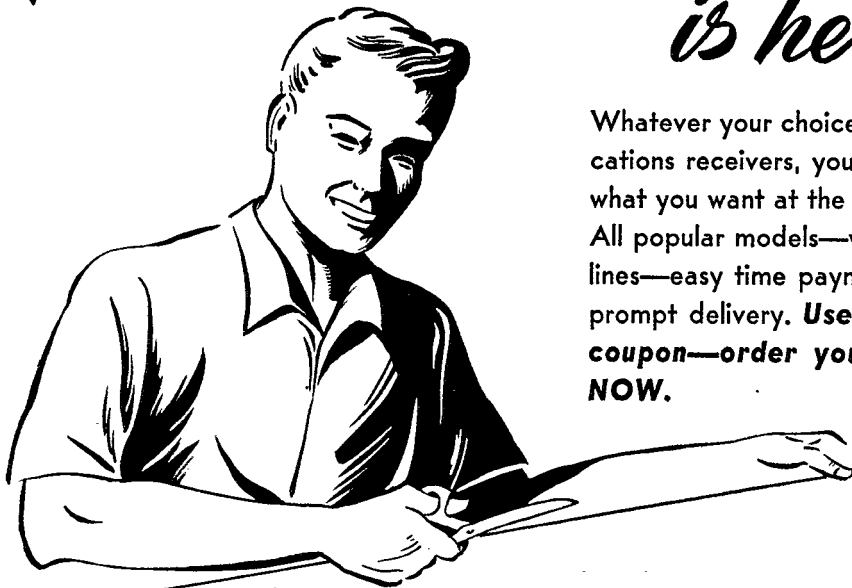

Whatever your choice in communications receivers, you can get just what you want at the Radio Shack. All popular models—world famous lines—easy time payment terms—prompt delivery. **Use this handy coupon—order your receiver NOW.**

Radio Shack Corporation
167 Washington Street
Boston 8, Massachusetts

Gentlemen:
Sure I want a new receiver — enter my order NOW for early delivery of the receiver checked below.

Model Number	HALICRAFTERS	Net Price
SX-28A	Super Skyrider—Complete	\$238.00
SX-25	Super Defiant—Complete	\$109.50
S-20R	Sky Champion—Complete	\$60.00
S-22R	Skyrider Marine—Complete	\$74.50
S-39	Sky Ranger—Complete	\$110.00

The famous HRO with 6 sets of general coverage coils, tubes, power supply, and spkr \$314.00
 NC-240-Cabout \$225.00

Model Number	HAMMARLUND	Price
HQ-129X	Complete	\$129.00
EC-1A	Complete	\$29.50

Here's my check money order for the \$5.00 deposit on my receiver.
 I'll pay the balance when you ship the set.
 I want to use your liberal time-payment plan.

Name..... City..... State.....
 No..... Street.....

HIGH FREQUENCY SPECIAL
 Acorn tubes, types 954, 955, 956, and 959, 75c each, net f.o.b. Boston.
 Isolantite socket for Acorn tubes, 88c net.
 Please include 10c postage and packing charge with orders for these items.

The RADIO SHACK
 167 WASHINGTON ST.
 BOSTON, MASS., U.S.A. ★

HARRISON HAS RECEIVERS!

Also
PARTS, TUBES, ETC.

**ALL FOR IMMEDIATE
DELIVERY WITHOUT
RED TAPE**

SEE OUR OCTOBER
QST ADVERTISEMENT—

SEND IN YOUR ORDER FOR
ANYTHING YOU NEED

HAM
HEADQUARTERS
Since
1925!

HARRISON RADIO CORPORATION
12 WEST BROADWAY • NEW YORK CITY 7
BARCLAY 7-9854
JAMAICA BRANCH — 172-31 Hillside Ave. — REPUBLIC 9 4102

G. E., AEROVOX AND SPRAGUE Filter Condensers



GE Pyranol
4 mfd 2000 v..... **\$2.75**

LIST PRICE \$10.80

Sprague Oil-filled
8 mfd 2000 u..... **\$3.75**

LIST PRICE \$14.88

Aerovox Oil-filled
1 mfd 5000 v..... **\$6.90**

LIST PRICE \$30.00

Add postage to above prices

All perfect, first grade, Army-Navy inspected. High voltage porcelain terminals.

Other Items Available • Write for List

ELECTRONIC NAVIGATION

Box 126 Woodside, Long Island, N. Y.

(Continued from page 10)

In this field progress has been rapid and vast — along certain lines. The most spectacular u.h.f. devices are not, superficially, ones that lend themselves to amateur communication. Our problem is one of adapting the basic principles to our own purposes. For instance: Will pulse transmission and visual reception give us longer ranges than more conventional modulation and detection systems? What about pulsetime modulation? Are there possibilities of getting reliable communication beyond line-of-sight by bouncing signals off mountains, or buildings, or clouds — or airplanes? What about the effects of atmospheric refraction — will they be enough greater at, say, 1150 Mc. to make that band much more desirable than 144 Mc.? How can we make satisfactory centimeter equipment in our home workshops and thus avoid the prohibitive cost of the military-type gear?

This is only skimming the surface, of course. There are years of interesting work ahead for the experimenters among us. Here at Headquarters we've initiated a program of investigation into these and similar problems that is going to keep us as fully occupied as the proverbial hen on the hot griddle. It is going to take an enlarged technical staff, more shop and lab facilities. As this is being written we're in the midst of rearranging space, getting equipment together, and polishing off the other necessary preliminaries to going ahead at full speed. But the real job is going to take more than that — it's going to need the active cooperation of every amateur in putting these new bands of ours to work. Only when enough of us get going can we find out what they're good for. That they will be an important part of amateur radio of the future we have no doubt. That future is here, right now, and full of promise, so let's crack it!

G. G.

On the Very Highs

(Continued from page 59)

pects to be traveling the Great Northern Route to Rochester, Minn., in late October. He is taking portable gear with him, and hopes to work stations en route, and also at Rochester, where he is going for medical attention.

Thus we come to the end of our first postwar batch of activity reports. We also, with this issue, mark the sixth anniversary of the appearance of this column in the pages of *QST*. It is the last one to be prepared by your conductor in the capacity of a non-staff contributor, for, by the time this appears in print, we shall have moved to West Hartford to take a full-time job as a regular member of the Hq. staff.

If you, the v.h.f. enthusiasts of the country, have found this column of interest or value, it is principally because you have taken the trouble to write to us, telling of your activities and passing along your ideas. For your enthusiastic cooperation through the past six years, we wish to extend our heartfelt thanks. Your help will be of even more value as v.h.f. work assumes an ever-increasing importance in the postwar world of amateur radio — may we count on it?



SA OM

HERE THEY ARE* Save Weight — Save Space

- In the Shack
- Working Portable
- Working Mobile

For High and Ultra-High Frequencies! — Short leads *within* the tubes and *outside* the tubes mean FLAT response in these new and interesting bands.

* These tiny tubes — more than 100 million of them — were pioneered and built by Sylvania for the famous Navy Project A — the proximity fuse where a complete radio transceiver is shot from a gun!

SYLVANIA ELECTRIC

Emporium, Pa.

Makers of Radio Tubes; Cathode Ray Tubes; Electronic Devices;
Fluorescent Lamps, Fixtures, Wiring Devices; Electric Light Bulbs



Premax Antennas

Available in Aluminum,
Monel and Steel

The tested and approved types which achieved such a fine war-time record. Send for complete details — or see your dealer.

Premax Products

Div. Chisholm-Ryder Co., Inc.
4615 Highland Av., Niagara Falls, N. Y.





SEATTLE

HEADQUARTERS FOR
AMATEUR - PROFESSIONAL RADIO

- ✓ WE HAVE THE MOST COMPLETE STOCK
- ✓ WE HAVE THE NEWEST INFORMATION AND CATALOGS
- ✓ OUR PRICES ARE COMPETITIVE
- ✓ WE LIKE TO HAVE YOU COME IN AND BROWSE

WRITE FOR OUR BULLETIN

RADIO PRODUCTS SALES CO.

1214 1st AVENUE
SEATTLE 1, WN. MAin 1035

Television Reception

(Continued from page 22)

The small cans are electrolytic condensers. The controls are in a row along the front edge of the chassis. From left to right, they are as follows: horizontal speed, vertical speed, horizontal amplitude, vertical speed, horizontal centering and vertical centering. The control for the noise limiting diode, V_7 , is between the input and output coaxial sockets on the left edge of the chassis.

In the bottom view of the chassis, the video amplifier occupies the upper left-hand corner. The resistors and condensers for the horizontal sync control are on the card at the upper left, while those for vertical sync control are located at left center. The card in between and at right angles to the first two is for the sync separator and d.c. amplifier circuits. The card above and to the right of center mounts the components for the sweep circuits, and the card in the lower left-hand corner mounts all components for the d.c. regulator circuit. The upper socket at the right-hand edge of the chassis is for deflection power output, and the lower socket is for power output to the tuner unit.

The two potentiometers to the left of the two large paper condensers in the upper left-hand side of the chassis adjust the delay filters in the horizontal and vertical discriminator circuits. The vertical output transformer is in the lower right section of the chassis just to the right of and slightly above the d.c. filter choke mounted on the lower wall.

In the top view of the high-voltage power supply, the bottom of the socket for V_{13} , the high voltage rectifier tube, appears between the transformer and the two high voltage condensers. The high-voltage output terminal is in the lower left foreground. In the bottom view, the high-voltage filter condensers are at the top, above the 879 tube, V_{18} . Two feed-through insulators for the 879 filament are between the condensers and the transformer. On the lower edge are the on-off switch, pilot light and line cord.

(Part II of this article, covering the intermediate-frequency amplifier and detailed methods of alignment, will appear in an early issue.)

Strays

W2BCN, Bloomfield, often works W2BOV in Newark, New Jersey. W2BCN now lives in the Bloomfield QTH BOV occupied eighteen years ago, and BOV is living in BCN's old Newark QTH. Both ops sine "Joe." It's all very confusin'.

W3GSL reports that he recently met HA1S, the w.k. 20-meter 'phone man, working as a civilian in Austria. HA1S said that his 1-kw. 'phone rig had been left in his Hungarian home town which had later been occupied by the Russians.

Obviously HA1S plans to return to the air — he borrowed W3GSL's *Handbook!*

NEW YORK'S LEADING AMATEUR RADIO SUPPLY HOUSE

Here are some typical **TERMINAL SPECIALS!** And there are thousands of other Great Values in stock, too! No Priorities Required! And regardless of the low prices, everything you buy at **TERMINAL** is **FULLY GUARANTEED!**

TERMINAL RADIO for **SERVICE VALUES COMPLETE STOCK**

Pocket Multi-Meter SUPREME Model 542



\$22.49

Compact, Volt.-Ohm.-Milliammeter, 2 1/2" square, 3" square, 5000 ohms per volt. Ranges: DC Milliamperes—0/0.3/6/30/150. DC Volts—0/6/30/150/300/1500. AC Volts—0/6/30/150/600. Decibels: —6 to —50 in four scales. Four ohmmeter ranges up to 2 megohms operate from self-contained batteries. Also provides 4 output ranges.

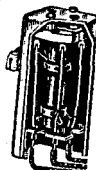

RCA 456 KC IF Transformers

Iron Core, Permeability Tuned, Aluminum Case. An unusual buy for the builder who wants Top Quality. 1st and 2nd stage, per pr. **\$2.47**

BRUSH Crystal Phones



Type A — High sensitivity and wide range response, with BIMORPH crystal elements, high impedance. Light and comfortable. Padded, adjustable lock-type headband. **\$7.95**

ACME PHONES, Made by Trimm — A superior headset in light weight, molded bakelite. Cap and shell of nets. 6 ounces, 2000 ohms **\$1.49**



OIL FILLED High Voltage Filter Condensers

Conservatively rated, Fully Guaranteed despite their Low Price! Complete with Mounting Brackets.

- 4 mfd.—1000 VDCW—
4 1/4 x 2 1/2 x 1 3/16 **\$1.19**
- 8 mfd.—1000 VDCW—
4 3/4 x 3 3/4 x 1 1/4 **1.88**
- 2 mfd.—2000 VDCW—
3 3/4 x 3 3/4 x 1 1/4 **2.45**
- 1 mfd.—5000 VDCW—
5 1/2 x 4 1/2 x 3 3/4 **7.50**
- 4 mfd.—600 VDCW—
4 1/2 x 1 1/2 dia **1.35**

WESTON 772 Supersensitive ANALYZER

20,000 Ohms per Volt. Ranges: AC and DC Volts: 2.5/10/50/250/1000. DC Mills: .1/1/10/50/250. DC Amperes: 1/10. Ohms: 3000/30,000/3 meg./30 meg. Decibels: —14 to +54 in 5 scales. Large 4 1/2" meter. Complete in hardwood, portable case.

\$49.50



HYTRON HY 75 U.H.F. 15 Watt Triode

Ultra High Frequency Triode rated 15 watts continuous service. Filament: 6.3 v — 2.5 A. Plate: 450 V — 100 Ma. Graphite Anode, Lava Insulation, Coiled Filament, Ceramic Base.

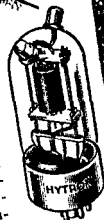

\$3.95



SHURE Crystal MICROPHONE Type 707A .. Net **\$7.35**

A low cost Crystal Mike. Ideal for Amateur and P.A. use. Bimorph Crystal Unit is isolated from case. Wide Range, Smooth Response. With 7 ft. shielded cord.

Black Crackle STEEL CABINET

19" x 12" x 10". For 8 3/4" x 19" panel. Top door with snap lock. Heavy duty constr. Special **\$3.98**
Steel Panel **.88**
Steel Chassis (11 x 17 x 2) **\$1.35**

For That New Rig!

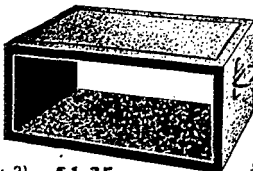

STRUTHERS-DUNN — TIME DELAY RELAY

Heavy duty unit for use in pre-heating your 866's. 30 second delay. Coil Voltage 120 AC, 20 Amp. contacts. Special **\$4.65**

25% Deposit Required with All C.O.D. Orders!

**DE JUR 0-200
Microammeters**
3" size, 0-200 movement.
BRAND NEW STOCK!
\$7.95

TERMINAL RADIO CORP.

Home of Sound Radio Values

85 CORTLANDT STREET · NEW YORK 7, N. Y. · Worth 2-4415

DeLuxe

SPEED KEY

Model
CP 810

Amateur
Net Price
\$9.75

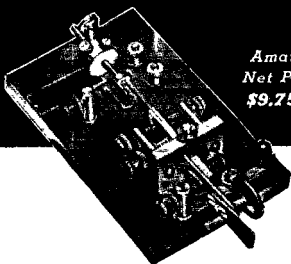

One of the finest commercial or amateur bugs available. Chrome finished base and super-structure. Springs made of selected blue spring steel for uniform performance in all keys. Nine points of adjustment to suit the most critical touch. Fully adjustable. Silver contacts 3/16" diameter.

MODEL CP 510 SPEED KEY • Similar to above except the base is Battleship gray wrinkle finish. Amateur Net Price \$6.75

TELEGRAPH Apparatus Co.

325 WEST HURON STREET • CHICAGO 10, ILL.

Now—a really
high-powered

RADIO ENGINEERING LIBRARY

- especially selected by radio specialists of McGraw-Hill publications
- to give most complete, dependable coverage of facts needed by all whose fields are grounded on radio fundamentals
- available at a special price and terms

THESE books cover circuit phenomena, tube theory, networks, measurements, and other subjects—give specialized treatments of all fields of practical design and application. They are books of recognized position in the literature—books you will refer to and be referred to often. If you are a practical designer, researcher or engineer in any field based on radio, you want these books for the help they give in hundreds of problems throughout the whole field of radio engineering.

Free Examination • Special Low Price • Easy Terms

McGRAW-HILL BOOK CO., 330 W. 42nd St., New York 18
Send me Radio Engineering Library, 5 vols., for 10 days' examination on approval. In 10 days I will send \$3.00, plus few cents postage, and \$3.00 monthly till \$24.00 is paid, or return books postpaid. (We pay postage on orders accompanied by remittance of first installment.)

Name.....
Address.....Company.....
City and State.....Position.....QST 11-45



5 VOLS.
3319 PAGES,
2289

ILLUSTRATIONS

1. Eastman's Fundamentals of Vacuum Tubes
2. Terman's Radio Engineering
3. Everitt's Communication Engineering
4. Hund's High Frequency Measurements.
5. Henney's Radio Engineering Handbook

21-Tube Receiver

(Continued from page 37)

takes no back talk from commercial models and can give points on some features, such as in the b.f.o. and a.v.c. circuits. In a side-by-side test with a Super-Pro in perfect condition, any choice was in favor of the home-built. Even the image rejection was as good, and the tone control enabled the reception of some weak signals not readable with the Super-Pro.

In another test, a high-gain regenerative pre-selector was hooked up in front. The image rejection was somewhat improved on the 10-meter band, but there was no significant improvement in sensitivity. The signal strength on the meter was greater but the readability was precisely the same. The receiver sensitivity goes well into the tube-noise level and no amount of additional amplification makes any significant difference.

The receiver has every desirable feature standard to communications receivers and several additional ones not found in any other receiver. All in all, it appears to be a very satisfactory solution to the problem of high fidelity with communications performance—so much so that it appears necessary to look for some other obsession!

Hams in Combat

(Continued from page 41)

lously the damage and casualties are slight. And through all this excitement our operators have been clearing traffic. The air raids have not occasioned even an extra AS in that SCR-399's shack.

In the evening we move out again. It's late at night when we pull to a stop while our artillery pounds a German strong point. The Germans throw some shells our way, but their effort seems feeble in comparison to ours.

Tired and sleepy, we spurn the damp safety of a fox hole and pull our folding cots from the power unit trailer. We just ignore the enemy artillery fire.

In the morning we go again, this time to Stendal. There we see many German prisoners. They wear a white armband and are allowed to wander around town. They'll be gathered up later.

We hear of the death of President Roosevelt but must hear it repeated several times before we believe it.

Our troops are on the Elbe. The bend in the river makes us the U. S. troops closest to Berlin. The Germans have blown the bridges but our engineers are preparing to get us across. Our cry is "On to Berlin." In England our general told us the Fifth Armored would take Berlin and we are ready to back him up. We had felt cheated when we had swung north at the outskirts of Paris and the honor of liberating the city went to others. We were disappointed when our breaching of the Siegfried Line, in mid-September, could not be followed up.

We take off a couple of days for preparation. We clean the radio equipment and power unit.

(Continued on page 116)

McELROY'S "MORSE"

Most of the operators and would-be operators who read *QST* will recall that Ted McElroy said in the October issue that he was going back to sea (he'd been sailing the North Atlantic during the war) — now to bring back the boys brought "over there" several years ago. I don't believe there is much more we can tell you about the distributor business he has established. He'd hoped to be here on the job and burn up his typewriter writing letters to guys who wanted to buy Hallicrafters receivers. The gang here hopes that you fellows will still tell your friends about Hallicrafters receivers because the word of a radio operator counts with people on radio sets. We will try to pinch hit for Ted during his five or six weeks' absence. Send us your inquiries or orders and I promise we'll get them out in good shape.

CODE COURSE

None of us here have seen the old guy work as hard in years as he did in sweating onto a typewriter everything he has learned in thirty years of operating experience. Here, for the first time in the memory of those of us who work with Ted, have we seen him pour everything he has onto a typewriter. We can't put into words right now the full story of what this new Code Course of Ted's will do. We won't try. We'll simply say that here at last is an opportunity for anyone, anywhere, regardless of age or previous experience, to become a really good operator — and fast.

JUST FOR EXAMPLE

Assuming that the average person will practice several hours the first day, we can tell you — because it has actually worked with three of our girls and four of the men at the factory — we can tell you that you'll be copying, **THAT FIRST DAY**, words and sentences at the rate of 20 words per minute. The thing is that ingenious! Ted has taken one-half the alphabet which appears on his Chart No. 1, prepared a practice tape which runs for at least one full hour without attention at the rate of 20 words per minute. And by the time you reach the end of that first roll you're copying words and sentences containing those thirteen letters at the rate of 20 wpm. You won't copy twenty full words in one minute. But each letter you write will hit your ears at a full 20 wpm and the space between letters becomes progressively shorter as the rolls go along.

SEND FOR A SAMPLE

At no charge and with no obligation whatever (and we won't pester you with follow-ups) we'll send you this complete course of instruction so that you can see for yourself what it'll do. Then, if you decide to go ahead with the job and become a real good operator, **AND FAST**, you can send us the \$25.00 down payment and we'll send the equipment and first four rolls for first four weeks' instruction. You then pay \$10.00 per month for five months until the full price of \$75.00 is reached for the complete outfit.

Frank Bascomb and the boys

Ted McElroy

32 BROOKLINE AVENUE • BOSTON, MASSACHUSETTS

(Continued from page 114)

We change several faltering relays in our gear. Then, after a couple of nights of good sleep, we are ready to move out again.

We are really disappointed now, as we are not to cross the Elbe. Instead we are to go back to dispose of a German task force whose mission was to cut the communications of our armies. We move out over roads we used in our forward drive. And as usual, it is drive, drive, drive! We often fill our thirsty power unit on the move. The constant battering of our whip antennas by limbs overhanging the road break some of the sections. We replace them on the run whenever we hit a clear stretch of road.

We are sent out to act as a relay station to maintain communications with the infantry. At the designated point we hunt in vain for the rendezvous, but the infantry has moved on. Who are we to defy the roaming German tanks with our radio truck? We grope around in the darkness until we locate a GI outfit and attach ourselves to it. We move away from our intended location but we handle the traffic successfully and without difficulty. At one of the other stations is T/4 Ridnour, W9KZJ, of Knoxville, Iowa, and another Signal Company ham.

After several days' work we rejoin CCA Hqs. We now can hear the Russian voice stations on our frequencies. We can tell British and German c.w. stations from the procedure used. We don't follow the c.w. procedure used by the Russians.

We are on the Elbe again and have met the British. This is our Division's last mission in the European War. Our ride is over.

Soon we will be relieved and then wait out the official V-Day, the point system and things to come. Our radio truck and crew will return to Division Hq. Other signal company crews will also be coming in with their weary and slightly "dit-happy" operators. Many men swear they are finished with radio operations. Sure! They'll even transfer to the foot infantry. But they will soon be engaged in friendly arguments. Who handled the most messages? What net operated the best? Who was right in certain procedure? Just try and get them out of radio operations and you'll have a battle on your hands.

Out with the other units of the division there are many other operators. Some do not carry as high MOS numbers as many of the signal company operators and they have not had as much radio schooling and practice. But they greatly outnumber us. They are often overlooked, these operators from the infantry, tank artillery, tank destroyer, ordnance, engineer and medical battalions—but radio operating is not a Signal Corps monopoly. There are many fine operators in those other units. Few of the boys can use a bug or copy on a mill. They print rather than use long-hand and are slowed down accordingly. But the amateur 13 w.p.m. test won't bother them, and they have had their baptism of QRM. They do not know much of the hams' lingo, but can give many a ham a lesson on Q signals and operating procedure.

Quality PRODUCTS Since 1923

CERAMIC—PORCELAIN & STEATITE INSULATORS
for every purpose

BIRNBACH RADIO CO., Inc.
145 HUDSON ST. NEW YORK, 13, N. Y.

Read AUDEL'S MECHANICS GUIDES for profit

INVEST IN KNOWLEDGE 15 MINUTES A DAY

Every Mechanic can Step Up his Skill with AUDEL'S GUIDES. Containing Practical Inside Information in a Handy Form. Covers facts and figures of your Trade. All illustrated and explained. Books sent to you for 7 Days Free Examination. Send No Money—Nothing to Pay Postman. Check and Mail Coupon Today.

MAIL ORDER

AUDEL, Publishers, 49W. 23 St., New York 10, N.Y.

Mail for 7 days free trial books marked (X). I agree to mail \$1 in 7 days on each book ordered and \$1 a month until purchase price is paid. If I am not satisfied with guides, I will return them.

- | | | |
|---|--|---|
| <input type="checkbox"/> WELDERS \$1. | <input type="checkbox"/> AUTOMOBILE \$4. | <input type="checkbox"/> REFRIGERATION \$4. |
| <input type="checkbox"/> BLUEPRINT 2. | <input type="checkbox"/> RADIO 4. | <input type="checkbox"/> MATHEMATICS 2. |
| <input type="checkbox"/> MACHINIST 4. | <input type="checkbox"/> PLUMBERS 6. | <input type="checkbox"/> CARPENTERS 6. |
| <input type="checkbox"/> ELECTRICITY 4. | <input type="checkbox"/> SHEET METAL 1. | <input type="checkbox"/> DIESEL 2. |

Name _____

Address _____

Employed by _____ Q.S.T.

ORDER YOUR NEW Communications Receiver NOW from ALLIED *For Earliest Delivery*

Available on Time-Payments
Trade-ins Accepted

BE ONE OF THE FIRST to own and enjoy one of these celebrated receivers. All models cover amateur, short-wave, and broadcast bands. War-proved features... plus latest engineering developments. Allied is a leader in the distribution of communications receivers. Orders are filled in turn. Place your order now.

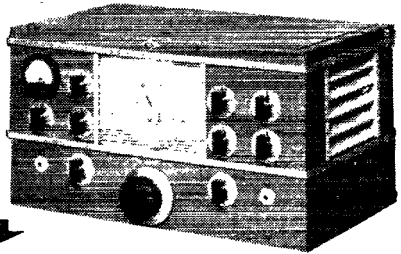

NATIONAL NC-2-40C

490 kc. to 30 Mc. range in 6 bands. Accurate single dial control. Temperature compensation. Automatic voltage stabilization. Adjustable series-valve-noise limiter. Flexible crystal filter. Phonograph or high level microphone pick-up jack. Net..... **\$225**
Speaker in matching cabinet, net..... **\$15.00**

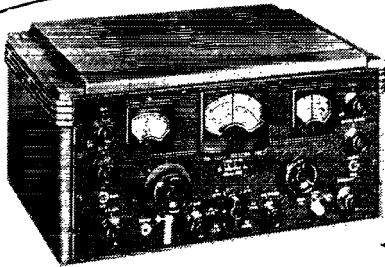

HALLCRAFTERS SX-28A

550 kc. to 42 Mc. continuous in 6 bands. Accurately calibrated tuning dial. Separate calibrated bandspread dial. Two r.f. stages. Lamb type 3 stage adjustable noise limiter. 6 position i.f. and crystal filter selectivity switch. Oscillator temperature compensated.
Net..... **\$223**
PM23 Speaker, net..... **\$15.00**

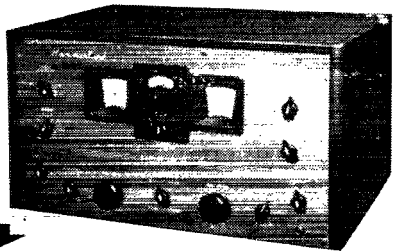

HAMMARLUND HQ-129X

Full range .54 to 31 Mc. accurately calibrated. 4 calibrated Ham bands and 1 arbitrary scale. Variable selectivity crystal filter. Low drift beat oscillator for code and locating stations. Antenna compensator. Voltage regulation. Compensated oscillator to reduce drift during warm-up. Automatic noise limiter.
Net..... **\$129**
Speaker, net..... **\$10.50**

Other well-known receivers such as:

Hallcrafters SX-25	\$ 94.50
Hallcrafters S-20R	\$ 60.00
Hallcrafters S-39	\$110.00
Hallcrafters S-36A	\$415.00
PM23 Speaker	\$ 15.00
Echophone EC-1A	\$ 29.50

Net, F.O.B. Chicago
(All prices subject to possible change)

ALLIED RADIO

Everything in Radio & Electronics
833 W. Jackson Blvd. • Chicago, Ill.

ALLIED RADIO CORP., L. M. Dezettel W95FW
833 W. Jackson Blvd., Dept. 27-LL-5
Chicago 7, Illinois.

Date.....

Please ship..... Model.....

Enclosed \$..... Full Payment Part Payment
(Balance C.O.D.)

Send literature on Receivers and Time Payment Plan.

Send Allied Catalog of Radio Parts and Equipment.

Name.....

Address.....

City..... Zone..... State.....



Founded in 1909

**RADIO TELEPHONY
RADIO TELEGRAPHY
ANNOUNCING**

Courses ranging in length from 3 to 9 months. Dormitory accommodations on campus for men and women students. Advanced students eligible for practical training at KPAC, 1 KW broadcast station owned and operated by Port Arthur College. New students accepted each month during year. If interested, write for details.

PORT ARTHUR COLLEGE PORT ARTHUR TEXAS

LEARN CODE

Improve Your Sending
G. C. Automatic
"KEYER"

Will Teach You Code—
Speed Up Your
Receiving

TYPE "A" \$25

New, Different, Efficient. Adjustable speed, silent induction type A.C. Motor. In small walnut finished case with carrying handle. Complete with 10 rolls of selected double perforated tape. A wide variety of other tapes available at 50c per roll.

If Your Dealer Can Not Supply You, Write Us

GARDINER & COMPANY Box 56, Stratford
New Jersey, U. S. A.

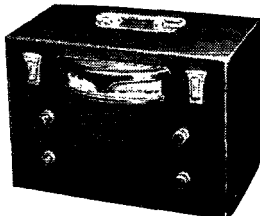

Phone, Wire or Write

WHOLESALE

**Radio-Electronic Parts
Tubes, Sets and
Equipment**

R. G. SCELİ & CO.

227 Asylum St. Hartford, Conn.

Telephone 2-1144

BRANCH: 84 ELM ST., BRIDGEPORT, CONN.

Class-B Amplifiers

(Continued from page 50)

readily obtainable. Ratios of 1 to 3 and 1 to 4 are common. It is possible to effect further economies by using a very high step-up ratio and driving the push-pull stage with a single 6C5. There is no necessity for by-passing the cathode resistors in a push-pull stage since the a.c. components flowing in this resistor are out of phase and cancel. The plate supply should be at low impedance to ground. If this impedance is high, some a.c. voltage will develop across it, resulting in a loss of power output and the possibility of positive feed-back to some of the preceding stages through this common power-supply impedance.

Mitchell, "The Cathode-Follower Stage," *Wireless World*, April, 1944.

Hansen, "Cathode-Follower Amplifier Design," *Australasian Radio World*, October, 1944.

Lee, "Recent Transformer Developments," *IRE Proceedings*, April, 1945.

Reich, "Features of Cathode-Follower Amplifiers," *Electronic Industries*, July, 1945.

Smith, *Radiotron Designers Handbook*, Chapter Six.

Oman, U. S. Patent No. 2,313,962, issued March 16, 1943.

Crystal Ball

(Continued from page 63)

with a "butterfly" tuner is a good answer to the tuning problem although some tricky mechanical arrangements still have to be solved.

In looking over the u.h.f. antenna situation it appears nothing very alarming has developed in print so far. The outstanding fact is that the pencil-size antennas are going to be just plain fun to work with. Those fancy directive arrays the textbooks illustrate will be right down our alley. A simple dipole with a window-screen untuned reflector is a very neat solution to the directivity problem and with small, light-weight antennas, a couple of fractional horse power electric motors will allow squirting the soup either up or down or left or right.

The behavior of u.h.f. sigs in the lower atmosphere defies resolution in my crystal ball but if television sigs bounce off of buildings, hills and clouds, I wonder if we couldn't "squirt at and bounce off" a signal from a cloud mass on the horizon and hop over that "line of sight" limitation.

— William S. Bell, W3HHN

RECORDING AND PLAY-BACK EQUIPMENT ESSENTIAL TO HAM SHACK

ONE of the "musts" in my postwar ham shack will be a phonograph turntable complete with a cutting head and play-back pickup.

Imagine a ham's surprise when, after turning the circuit back to me, he hears his own remarks come back to him. Afterward, I can send him the record if he so desires. Many hams have little or no idea how they sound over the air. This applies to c.w. as well as to 'phone stations.

(Continued on page 120)

REBUILDING?

A B & W tank assembly with its exclusive double stator tuning capacitor will give your rig new efficiency. The coil assembly mounts *directly* on the tuning condenser. Tubes may be mounted directly behind. Plate leads will be shortened to a few inches. Built-in neutralizing condensers at the rear permit two short grid leads, thus making a far more compact, more efficient assembly than would otherwise be possible.

And don't forget the famous B & W Air Inductors. New types! New, improved designs! Ask your distributor today!

COMPLETE NEW CATALOG and Air Inductor and Variable Capacitor Guide Book now in preparation. Available in December.

B&W

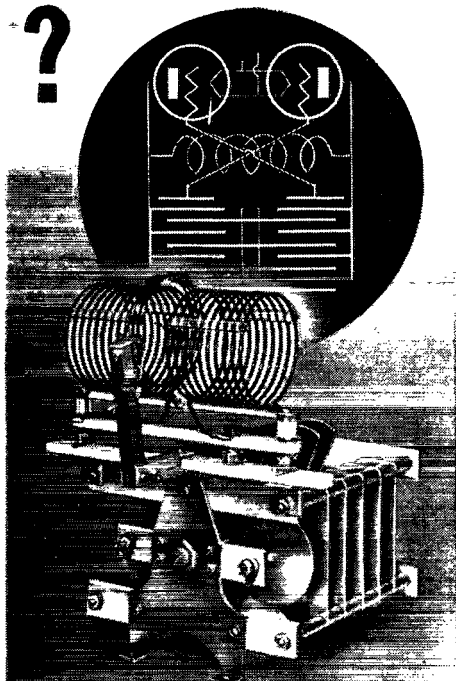

BARKER & WILLIAMSON • 235 Fairfield Ave., Upper Darby, Pa.
EXPORT: Lindeteves, Inc. • 10 Rockefeller Plaza, New York 20, New York, U. S. A.

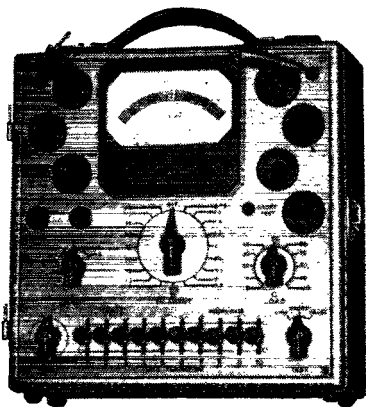

The New Speed-Chek Tube Tester

MORE FLEXIBLE • FAR FASTER • MORE ACCURATE

Three-position lever switching makes this sensational new model one of the most flexible and speediest of all tube testers. Its multi-purpose test circuit provides for standardized VALUE test; SHORT AND OPEN element test and TRANSCONDUCTANCE comparison test. Large 4" square RED • DOT life-time guaranteed meter.

Fast simple operation gives control of each tube element.

New SQUARE LINE series metal case 10" x 10" x 5½", striking two-tone hammered baked-on enamel finish. Detachable cover. Tube chart 8" x 9". Simple settings marked in large type.

Model 2413



is another member of
the **NEW TRIPLETT**
Square Line

Triplett

ELECTRICAL INSTRUMENT CO. • BLUFFTON, OHIO

Additional Features

- Authoritative tests for tube value; shorts, open elements, and transconductance (mutual conductance) comparison for matching tubes.
- Flexible lever-switching gives individual control for each tube element; provides for roaming elements, dual cathode structures, multi-purpose tubes, etc.
- Line voltage adjustment control.
- Filament Voltages, 0.75 to 110 volts, through 19 steps.
- Sockets: One only each kind required socket plus one spare.
- Distinctive appearance makes impressive counter tester.

**NEW 1945 ENLARGED
EDITION OF THE
PHILLIPS CODE**

Unquestionably the year's outstanding contribution to the advancement of wire and radio telegraphy. A thoroughly tested method of Steno-telegraphy arranged for use in wire and radio communication. It's definitely new, completely standard, strictly up-to-date. In addition to changes and additions to previous editions, it contains Radio Code Signals, International Morse, American Morse, Russian, Greek, Arabic, Turkish and Japanese Codes, World Time Chart, United States Time Chart, Commercial "Z" Code, Aeronautical "Q" Code, Miscellaneous Abbreviations used on international wire, submarine cable and radio telegraph circuits. An invaluable aid to every trained and student operator. Price \$1.50 postpaid.

LIBERAL DISCOUNT TO DEALERS

THE VIBROPLEX CO., INC.

833 BROADWAY • NEW YORK 3, N. Y.

RF Inductors • RF Chokes • IF Transformers
Condensers • Mica Molded Condensers • Trimmer
Condensers • Miscellaneous Apparatus
The F. W. Sickles Co., Chicopee, Mass.

SICKLES *Electronic Specialties*

RADIO

RADIO Technician and Radio Communications courses. Register now for new classes starting first Monday of each month. Day and Evening Classes.

AMERICAN RADIO INSTITUTE
101 West 63d St. New York 23, N. Y.

Approved under GI Bill of Rights

**CRABTREE'S
WHOLESALE RADIO**

2608 Ross Ave. Dallas 1, Texas



Electricity

FOR RADIO AND ELECTRONIC APPLICATIONS

Onan Electric Generating Plants supply electric service for electronics applications and general uses, mobile, or stationary. Driven by Onan-built, 4-cycle gasoline engines, they are of single-unit, compact design and sturdy construction.

65 models, sizes from 350 to 35,000 watts. A.C. types: 115 to 650 volts, 50, 60, 180 cycles, 1 or 3-phase; 400, 500 and 800 cycles, 1-phase. D.C. types: 6 to 4000 volts. A.C.-D.C. combination types available. Write for engineering assistance and literature. Model shown is from AIC lightweight series.

Over 250,000
Now In Service

D. W. ONAN & SONS
2629 Royalston Ave., Minneapolis 5

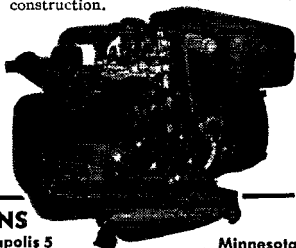

Minnesota

(Continued from page 118)

Another use of such equipment would be in calling CQ, using a carefully made and perfectly announced CQ record. (A short and snappy one, we hope. — Editor)

Visitors in the shack would be pleased to have a souvenir record of their voice cut while they were actually on the air at your station.

Recordings could be made of the transmission of messages received for a person not in the shack at the time. Imagine Mrs. Joe Jones' delight in receiving a record of her Joe talking from the other side of the world or the country, via ham radio!

These are but a few of the many useful and versatile jobs that recording and play-back equipment could perform in a ham shack.

— Donald A. Miller, ACRM, USN, W2MQB/K4

Technical Topics

(Continued from page 58)

too small to meet the requirement that the field at the walls must be zero. This means, simply, that the guide must be at least a half wavelength wide or the wave cannot get into the pipe. If the guide is *exactly* a half wavelength wide, the wave can get in but it does not go anywhere. But just as soon as the guide becomes a little more than a half wavelength wide — enough to permit an angle less than 180 degrees between the directions in which the two components of the wave travel — the wave will go through the guide. Or, to look at it from a slightly different standpoint, in a guide of given width there is a "cut-off" frequency — the frequency having a half wavelength in space equal to the width of the guide — below which the guide will not carry energy. Any frequency above the cut-off frequency will get through; the two wave components simply adjust themselves to the proper angle to position the null lines at the actual walls of the guide.

— G. G.

Strays

Last summer the Government of the USSR invited a distinguished group of American scientists to attend the 220th anniversary celebration of The Russian Academy of Sciences.

One of the group was asked to submit a number of purely American publications dealing with non-commercial activities and interests of the American people.

Although the weight of baggage allowed on the plane was strictly limited, a copy of the ARRL *Handbook* was taken along.

When the various publications were reviewed by the authorities of the Library of The Russian Academy of Sciences one of those chosen, for permanent inclusion as part of the library, was the ARRL *Handbook*.

ONE OF MANY APPLICATIONS

Astatic GDN Series Dynamic Microphones have many uses and applications. That's why you find them included in countless modern installations such as the airline control and dispatching office illustrated here. When mounted on *Astatic's* popular Grip-to-Talk Desk Stand with relay operating ON-OFF Switch for remote control of transmitters and amplifiers, as shown, *Astatic* Microphones are ideally suited to most types of modern communications systems.



Transmitting equipment designed and manufactured by Wilcox Electric Co. of Kansas City, Mo.

"You'll HEAR MORE from Astatic"

THE *Astatic* CORPORATION
 CONNEAUT, OHIO
IN CANADA, CANADIAN ASTATIC LTD., TORONTO, ONTARIO

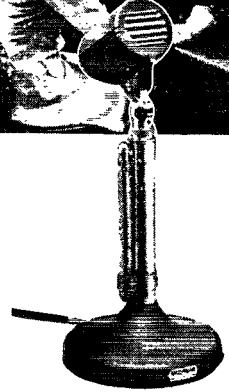

Precision Methods Followed

BY SKILLED AND TRAINED HANDS

For precision radio communications equipment, precision manufacturing is imperative.

The equipment produced by Wilcox has reached a new standard of perfection for war-time communications and from this vast experience have come many new developments now being incorporated into post-war designs.

Many items in this expanded and improved line are now available, subject to military priorities. Your inquiries invited.

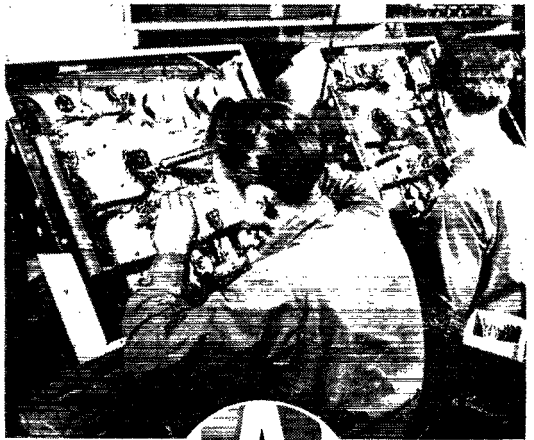

Dual Channel Audio Amplifier

Each channel 70 db. gain. Power output 2 watts. Frequency response 200-7000 cycles.



WILCOX ELECTRIC COMPANY, INC.

Manufacturers of Radio Equipment

FOURTEENTH AND CHESTNUT KANSAS CITY, MISSOURI

Makes Sending Easy . . .

Genuine
Easy-Working

VIBROPLEX

Reg. Trade Marks: Vibroplex, Lightning Bug, Bug

Simply press lever —
Vibroplex does the rest

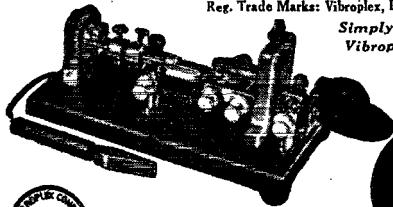

PATENTED
JEWEL
MOVEMENT

\$19.50



The "BUG" Trade Mark identifies the Genuine Vibroplex.

Accept no substitute

The jewels used in DeLuxe Vibroplex keys are the same as those placed in the finest made watches and precision instruments providing watch-like precision, feather-touch action, lifetime service and easier sending than you ever dreamed sending could be. Chromium finished base. Bright machined parts. Colorful red switch knob, finger and thumb piece DIE CUT contacts and main spring. 3/16th contacts. Circuit closer, cord and wedge. Order yours to-day! Money order or registered mail. FREE catalog.

THE VIBROPLEX CO., INC.
333 BROADWAY • NEW YORK 3, N. Y.

RADIO COURSES

- RADIO OPERATING
- RADIO SERVICING
- CODE
- ELECTRONICS

• REFRIGERATION SERVICING

Personal Counselling Services for Veterans
Write for Latest Trade & Technical Catalog

Y. M. C. A. TRADE & TECHNICAL SCHOOLS
4 W. 64th Street New York City

COMPLETE RADIO TRAINING!

Prepare now to accept a responsible position in Commercial Radio. New developments will demand technicians with thorough basic training, plus a knowledge of new techniques discovered during the war. Training open to high school graduates or those with high school equivalency. Courses 6 to 18 months' duration in RADIO AND ELECTRONICS. Approved Veteran training in Radio. Write for Particulars.

VALPARAISO TECHNICAL INSTITUTE
Dept. TN Valparaiso, Ind.



RCA INSTITUTES, INC.

Offer thorough training courses
in all technical phases of

RADIO and TELEVISION

WEEKLY RATES DAYS — EVENINGS

VETERANS: RCA Institutes is approved
under G. I. Bill of Rights
For Free Catalog write Dept. ST-45

RCA INSTITUTES, INC.
A Radio Corporation of America Service
75 Varick Street, New York 13, N. Y.

EASY TO LEARN CODE

It is easy and pleasant to learn or increase speed the modern way — with an **Instructograph Code Teacher**. Excellent for the beginner or advanced student. A quick, practical and dependable method. Available tapes from "beginner" alphabet to typical messages on all subjects. Speed range 5 to 40 WPM. Always ready, no QRM, beats having someone send to you.



ENDORSED BY THOUSANDS!

The **Instructograph Code Teacher** literally takes the place of an operator-instructor and enables anyone to learn and master code without further assistance. Thousands of successful operators have "acquired the code" with the **Instructograph System**. Write today for full particulars and convenient rental plans.

INSTRUCTOGRAPH COMPANY

4709 SHERIDAN ROAD, CHICAGO 40, ILLINOIS
Representative for Canada:
Radio College of Canada, 54 Bloor St. West, Toronto

Silent Keys

It is with deep regret that we record the passing of these amateurs:

- W1AHD, Alfred G. White, Ashmont, Mass.
- W1AMH, Harold J. Morse, Hartford, Conn.
- W2NMJ, Rev. Fr. Kenneth Sullivan, Paterson, N. J.
- W5HLF, D. E. Nuckols, Texarkana, Texas
- W6OSV, CRE Albert A. Gajewski, San Pedro, Calif.
- W8RZB, Pfc. Joseph J. Garard, Toledo, Ohio
- W8TID, Wilbur J. Sumpstine, Bethany, W. Va.
- W9VEW, William T. Merriman, jr., Wil-lard, Mo.
- W9ZD, E. B. MacDowell, Kansas City, Mo.
- VE2JI, F. Reevely, Toronto, Ontario, Canada
- CM20P, Mario de la Torre Fernandez, Habana, Cuba
- ZL1LH, C. A. Hutchinson, Auckland, New Zealand

FEEDBACK

IN THE September issue, at the bottom of the right-hand column, page 24, the term 0.004475 should not appear under the radical. Near the bottom of the left-hand column on page 25, the expression for X_s should be

$$X_s = \frac{B_P}{G_P^2 + B_P^2}$$

On page 26 in the same article, left-hand column, the diagonal should not appear in the 11th line, the term being $2X_c$. In the expression for L which appears below the diagram in the same column, the equivalent should be inverted. In the diagram on page 28, the right-hand terminals are the antenna terminals and the figure 0.103 in the L_2 column of the chart for two- and three-element arrays should be 1.03.

In the article describing the electronic key, condenser C_1 in the circuit diagram on page 45 should have a value of 0.5 μ f.

COMMERCIAL RADIO INSTITUTE

A RADIO TRAINING CENTER FOR 24 YEARS

Resident Courses Only • Pre-Induction, Broadcast, Service, Aeronautical Television, and Marine telegraphy classes now forming for mid-year term Feb. 1. Literature upon request. Veteran training.

Dept. B, 38 West Biddle Street, Baltimore 1, Maryland

NEW, Improved VT-73 DESK MICROPHONE

**A WORLD-WIDE FAVORITE WITH
PROMINENT HAMS FOR QUALITY REPORTS**

Stepped up in both performance and styling, the New, Improved TURNER VT-73 is engineered with a **rising curvature of response** between 500-4000 cycles. Produces more power at intelligible voice frequencies without over-modulation to result in crisper, cleaner signals. Designed especially for quality speech recording, P.A. and ham use. High capacity moisture-proofed crystal has output of -52DB. Range 50-7000 cycles. Finished in rich black crinkle and chrome, with ball swivel head, stand, and 7 ft. cable.

You'll want the VT-73 for your rig

ASK YOUR DEALER OR WRITE

Free Turner Catalog with complete information and prices on all TURNER Microphones. Write for your copy.

The TURNER Company
917 17th St., N.E. • Cedar Rapids, Iowa, U.S.A.
Crystals Licensed Under Patents of the Brush Development Co.

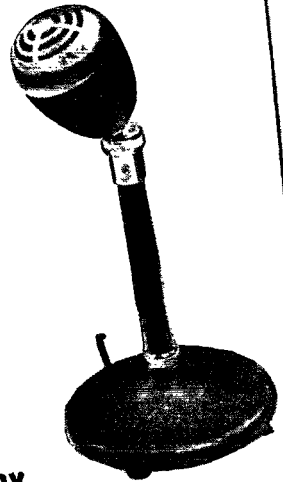

TURNER

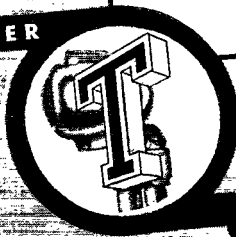

TURNER

Pioneers in the communications field

Microphones

▶ TRANSMITTING TUBES RECTIFIERS CATHODE RAY TUBES

We have been appointed a sales agent by Defense Supply Corporation of Government surplus tubes and rectifiers. All are first grade Government tested and inspected tubes—not rejects.

The following types are immediately available:

826 (HF Triode)	Cathode Ray Tubes
VT 127A (HF Triode)	5AP1
304 TL	5BP4
872A M. V. Rectifier	5AP1

Trade discounts to dealers on standard packages • Write for prices

LEWIS ELECTRONICS 16 Lyndon Avenue
Los Gatos, California

RECEIVING SENDING
CODES *speed* *without strain*

CHAMPIONS ENDORSE CANDLER WAY

Get skill, accuracy, speed with the highly endorsed Candler System. Learn to send and receive by telegraph or radio code. Government service and commerce need thousands of better trained operators. Air commerce, mail, freight, etc., demand expert, reliable operators. Good pay. Get the Candler System, the maker of champions. It teaches you the "knack" of sound sense, alertness, speedy sending and receiving without strain. Adventure—good pay. Learn at home or wherever you are. Rush name today for free book.

FREE! **CANDLER SYSTEM CO.**

Dept. 4-M, Box 928, Denver 1, Colorado, U.S.A.
and at 121 Kingsway, London, W.C. 2, England

HAM-ADS

(1) Advertising shall pertain to radio and shall be of nature of interest to radio amateurs or experimenters in their pursuit of the art.

(2) No display of any character will be accepted, nor can any special typographical arrangement, such as all or part capital letters be used which would tend to make one advertisement stand out from the others.

(3) The Ham-Ad rate is 30c per word, except as noted in paragraph (6) below.

(4) Remittance in full must accompany copy. No cash or contract discount or agency commission will be allowed.

(5) Closing date for Ham-Ads is the 25th of the second month preceding publication date.

(6) A special rate of 7c per word will apply to advertising which, in our judgment, is obviously non-commercial in nature and is placed and signed by a member of the American Radio Relay League. Thus, advertising of bona fide surplus equipment owned, used and for sale by an individual or apparatus offered for exchange or advertising inquiring for special equipment, if by a member of the American Radio Relay League takes the 7c rate. An attempt to deal in apparatus in quantity for profit, even if by an individual, is commercial and all advertising by him takes the 30c rate. Provisions of paragraphs (1), (2), (4) and (5), apply to all advertising in this column regardless of which rate may apply.

(7) Because error is more easily avoided, it is requested signature and address be printed plainly.

Having made no investigation of the advertisers in the classified columns, the publishers of QST are unable to vouch for their integrity or for the grade or character of the products or services advertised

QUARTZ — Direct importers from Brazil of best quality pure quartz suitable for making piezo-electric crystals. Diamond Drill Carbon Co., 719 World Bldg., New York City.

COMMERCIAL radio operators examination questions and answers. One dollar per element. G. C. Waller, W5ATV, 6540 Washington Blvd., Tulsa, Okla.

WHY not turn your unused equipment into ready cash which may be applied towards new and better equipment after the war? Leo, W9GQF, offers you the best cash prices for communications receivers and test equipment. Write today for large illustrated catalog. Wholesale Radio Laboratories, 744 W. Broadway, Council Bluffs, Iowa.

CRYSTALS available — all types, including 100 kc., 465 kc. and 100 kc. Broadcast and Aircraft given prompt attention. Scientific Radio Products, Council Bluffs, Iowa.

CRYSTALS: complete units or blanks. All types. Your specifications and tolerances. One or one million. Refinishing and repairing of your present units. Rex Bassett, Incorporated, Ft. Lauderdale, Fla.

RADIO TESTS — Pre-examination Tests for Radio Operators. Tests your knowledge before you appear for commercial radio operator license examinations. Avoids failures. Guides your preparation. Saves your time. Worth investigating at once. Also books for home study. Write for free circulars 5 Q. Nilson Radio School, 51 E. 42 St., New York 17, N. Y.

LINE to single or PP grid transformer. 1 to 10 or 20 turns ratio. Small, shielded, BC quality — \$4.00 each. Also 80 inch coaxial cable with end fittings — \$1.00. Jobbers or manufacturers ask for special quantity prices. Van Sickle Radio, Indianapolis 6, Ind.

WHEN amateurs are on the air again there will be a complete line of James Knights Precision Crystals for every amateur activity. The James Knights Company, Sandwich, Ill.

AMATEUR radio licenses. Complete code or theory preparation for passing amateur radio examinations. Home study and resident courses. American Radio Institute, 101 West 63rd Street, New York City.

COMPLETE radio kits, \$10.95. Multitester kits, surplus navy receiving, transmitting, test equipment, free details. Radio, 120 Cedar Street, New York 6, N. Y.

FABERADIO crystals are now available. Write for prices. Faberadio, Sandwich, Ill.

AMATEUR and radio servicemen's supplies. Albert Arnold, W5WX. 111 East 8th St., Amarillo, Texas.

QSLs, order now before rush! Fritz, 1213 Bridgegate, Joliet, Ill.

WRITE, wire or phone: Bob Henry, W9ARA, Butler, Mo. 24 hour service: new and used receivers, transmitters, test equipment, radio parts of all kinds.

FOR SALE: Skyrider S-10 model, S-21, \$40. Stancoor 20-P phone-c.w. transmitter with coils for 5 bands and tubes in cabinet, \$50. P.p. T-125 final for 10-20-40 with tubes and coils for 10, \$39. Speech and modulator 838s, Class B with tubes, \$35. P.p. 211-D final with T-40 buffer in same unit for 75-160 with tubes and coils, \$27. Send for detailed list of high grade parts, h.v. transformers, chokes, filter condensers and transmitting tubes, etc. Arch Foster, W8RBI, R. D. No. 2, New Castle, Penna.

WANTED: used HRO or HRO, Jr. W. Nielsen, W2KYT 519 Brussels St., San Francisco, Calif.

WANTED: Utah Kits 2 or 5. Ferguson, 1350 Dennison Avenue, Columbus, Ohio.

FOR SALE: QSTs: 1923, 1930. Good condition. Make offer. Paul Carginan, W1LKH, 35 Florence St., Providence 9, R. I.

WANTED: Hallicrafters HT- β transmitter in good condition. J. R. Henthorn, Coast Guard, Salem, Mass.

ABBOTT DK-2 and cash for MRT-3 or TR-4. Morton Burdfield, 4 Brinsley St., Dorchester, Mass.

FOR SALE: QSTs: November, 1919 "Lid Off" issue and 1922 to date. Make offer. Price, W3QHS, 508 Baldwin, Sharon, Penna.

SWAP pair 813s, or RK-65s for receiver or what have you. Cromwell, W5GEA, P.O. Box 54, La Combe, La.

WESTINGHOUSE generators, inputs 12 v.d.c., 6 v.d.c. outputs 1000 v.d.c. 400 Ma., 500 v.d.c., 400 Ma. \$25.00 or equipment. W2LGT.

CRYSTALS without priority! Prompt delivery of those Edison fine crystals. Highest quality commercial units available throughout the 100-12,500 k.c. range. Also repair and regrinding. Over ten years of satisfaction and fast service! We are as near as your telephone. "Eidson's", Temple, Texas, Phone 3901.

SIGNAL shifter repairs and alignments. Coils, all ham frequencies, \$4.00 per band. Order direct. Seven years experience. Rodgers & Harris, 727 Main Street, Mount Carmel, Ill.

FOR SALE: amateur net prices, new Stancoor driver transformer X-4762, 15 watts multi-match; Stancoor modulation transformer, X-A3893, 75 watts multi-match; Stancoor filter chokes, 15 henry at 200 m.a., C-1911; Stancoor plate transformer, 1200 volts, c.t., at 200 m.a., 5 volts at 3 a. (2) 6.3 volts, at 5 a., M-1634; Stancoor swinging choke, C-1400; Utah plate and filament transformer, Y-612; Thordarson plate transformer, T-19P57; Thordarson filament transformer, T-19F89; Johnson 200 FD20 transmitting condenser, 207 μ f. each section, split stator, 2000 volts breakdown — \$6.00; Johnson 200 f.d. 35 transmitting condenser 202 μ f. each section, split stator, 3750 volts, breakdown, \$7.00. Used Thordarson plate transformer, T-3773, 550 — 550 at 200 m.a., \$4.00; Jefferson choke 12 H. at 250 m.a., \$3.50; UTC S70 fil. transformer 6.3 v. at 5 a., and 6.3 v. at 5 a. \$3.00. F. Craven, 2216 South 7th St., Philadelphia, Penna.

FOR SALE: Deluxe transmitter, bandswitching 10, 20, 40, and 80 meters, high-fidelity phone and c.w., RCA 813 final; Gray Parmetal Deluxe cabinet, 5'6", eight Simpson meters in National safety panels; National 2" oscilloscope panel. Siamese double-deck beam (10 and 20 meter arrays); Bassett elements, direction indicator, synchronous motor, continuous reversible rotation, demountable tower. B&W coils, all bands, all stages for 1 k.w. transmitter. Numerous other ham gear and parts, tubes, crystals, condensers, resistors, meters, insulators, wire, etc., new or good as new. Send 25¢ for photographs and mimeographed lists. C. Price, W9OQB, 545 North Franklin Street, Deatur 7, Ill.

FOR SALE: Astatic D104 mike. Factory overhauled, \$15. Want good tube tester. Gordon Wilkinson, Tule Lake, Calif.

1 KW. C.w. Phone transmitter, preamplifier, microphone and tubes for sale or trade for Ekra Leica or Contax with accessories. B. Mitchell (ex-W3FCB), 109 Gulliver, Milton 80, Mass.

SELL Sky Buddy receiver, best cash offer. Strite, W3IHF, 31 North Grant, Waynesboro, Penna.

RADIO HAMS, experimenters! Quartz crystal kit now available containing all necessary material to finish your crystals at home, complete with plug-in holders, processed quartz blanks, and instructions. Experimental kit, \$5.00, professional kit \$10.00. (When ordering professional kit, state fundamental frequency desired). Selectronics, Inc., P.O. Box 200, Carlisle, Penna.

SPAGHETTI triple-dipped, \$13-16, 18-20, 35 ft. 70¢; red and black resistor kit, 1 watt, 25 for 98¢; 1/2 watt, 35 for 98¢; potentiometers 2 watts, 1/4, 1/10 megs. 32¢. Neutron Electronic Supply, 35 Maiden Lane, N. Y.

WANTED: QST, April, May, June and August, 1916. Sell SX-15 Sky Challenger receiver. Bradshaw, W2ELN, 89-19 78th Street, Woodhaven, 21, L. I., N. Y.

WANTED: inexpensive code instructor, with tapes. All in good condition. S. Rubinstein, 250 East Gun Hill Rd., Bronx 67, N. Y.

FOR SALE: Instructograph, electric motor, eight rolls practice tape. Very good condition. \$35.00. Charles Schrader, 1611 Caroline St., South Bend 14, Ind.

FOR SALE: Complete 7-tube All-Star Senior receiver and peak pre-selector. Good condition. \$25.00. Howard Sayers, 6804 Northwest Hwy., Chicago 31, Ill.

TELEVISION correspondence course for the radioman, amateur television, commercial receiver repair, transmitter theory and practice. Instructor is Edward M. Noll, author of practical math series in QST, 1944-45, and television series Radio News, 1945. Lacey Park, Hatboro, Penna.

SELL: Meters 3" Weston 50, 100, 200, 300 mils. d.c., 1500 volts d.c. Jewell 5 amp. r.f., 12-v. d.c.; Triplett 10, 150 volt, a.c.; pair each HK54, T20, 100T; Biley 7MC crystals; UTC S20, S10, S2; 20TVH coil. R. Brandt, Star 1, Red Bank, N. J.

**A real communications receiver
at a sensationally low price**



MODEL EC-1A

ECHOPHONE COMMERCIAL

The 1946 Echophone, Model EC-1A, is a 6-tube AC/DC communications receiver of outstanding value. With electrical bandspread throughout its frequency range of .55 to 30 megacycles, BFO for CW reception, and a new automatic noise limiter to suppress interference from automobile ignition, etc., the EC-1A provides genuine communications receiver performance in the lowest price range. Standard 115-volt AC or DC operation; also available for 220 to 250-volt operation.

SPECIFICATIONS

TUBE LINEUP: 1—12SA7 Mixer; 1—12SK7 I.F. Amplifier; 1—12SQ7 Second Detector, First Audio Amplifier and AVC; 1—35L6GT Second Audio Amplifier; 1—12SQ7 Beat Frequency Oscillator and Automatic Noise Limiter; 1—35Z5GT Rectifier.

CONTROLS: TUNING, BAND SPREAD, VOLUME, BAND SELECTOR, CW/AM, NOISE LIMITER, PHONES/SPEAKER, STAND BY. (BFO pitch adjustment conveniently located on rear of chassis.)

EXTERNAL CONNECTIONS: (On rear of chassis.) Power line cord, phone tip jacks, antenna (doublet or single wire and ground).

PHYSICAL CHARACTERISTICS: The EC-1A is housed in a metal cabinet attractively finished in machine tool gray wrinkle lacquer. The cadmium plated steel chassis is substantially constructed. The PM dynamic speaker is mounted in the top of the cabinet and is protected by special sound projecting louvers instead of the ordinary grill.

DIMENSIONS: 8" high, 11 $\frac{1}{4}$ " wide, 8 $\frac{3}{8}$ " deep; overall. Act. wt., 11 lbs. Ship. wt., 22 lbs. Model EC-1A—Amateur Net Price—\$29.50.

FEATURES

1. Frequency coverage, .55 to 30 mc, complete in three bands.
2. Electrical bandspread on all bands with dial indicator.
3. Dial calibrated in megacycles with all important service bands identified.
4. Beat frequency oscillator for CW reception.
5. Automatic noise limiter.
6. Self-contained PM dynamic speaker.
7. Headphones or speaker selected by panel switch, headphones completely isolated by means of phone circuit transformer.
8. AC/DC operation 115 volts or 220 to 250 volts available with external line cord.
9. Good selectivity combined with exceptional sensitivity.
10. Modern 6-tube superheterodyne circuit.

ECHOPHONE

ECHOPHONE DIVISION • THE HALLICRAFTERS CO.
2611 INDIANA AVE., CHICAGO 16, U. S. A.

Designed for



Application

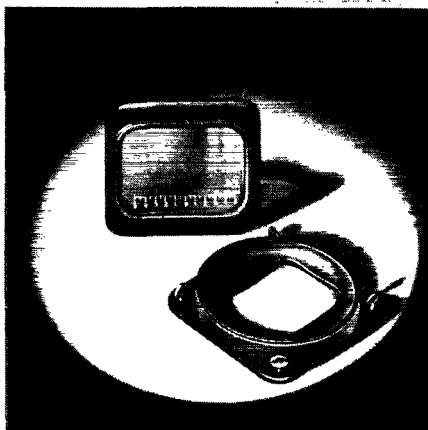

**THE NO. 80075 BEZEL
FOR
5" CATHODE RAY TUBE**

Another item in the Millen line of "Designed for Application" components. Bezel of cast aluminum with black wrinkle finish. Complete with neoprene cushion, green lucite filter scale and four "behind the panel" thumb screws for quick detachment from panel when inserting tube. Mounts in 5" diameter panel hole.

**JAMES MILLEN
MFG. CO., INC.**

MAIN OFFICE AND FACTORY
**MALDEN
MASSACHUSETTS**



Index to Advertisers

	<i>Page</i>
Allied Radio Co.	117
American Radio Institute.	120
American Tel. & Tel. Co.	88
Amperex Elec. Products, Inc.	Cov. II
Andrew Co., The.	107
Astatic Corporation, The.	121
Audel Co., Theodore.	116
Barker & Williamson.	119
Birnbach Radio Co.	116
Biley Electric Co.	75
Burgess Battery Company.	78
Burlington Instrument Co.	94
Candler System Company.	123
Capitol Radio Engineering Inst.	92
Centralab.	4
Collins Radio Co.	79
Commercial Radio Institute.	122
Concord Radio Co.	104
Crabtree Wholesale Radio.	120
Crystal Research Laboratories.	105
Delco Radio, Div. Gen. Motors.	80
Echophone Radio Co.	125
Eitel-McCullough, Inc.	5
Electronic Navigation Co.	110
Gardiner & Co.	118
General Electric Co.	85
Greenlee Tool Co.	108
Hallcrafters Co., The.	1, 2, 128
Hammarlund Mfg. Co., The.	7, 71, 73
Harrison Radio Co.	110
Harvey Radio Co.	86
Harvey Radio Laboratories, Inc.	103
Henry Radio Shop.	84
Hudson-American Corp.	100
Hytron Corporation.	81
Instructograph Co.	122
International Resistance Co.	82
Lewis Electronics.	123
Mallory & Co., P. R.	76
Marion Electric Instrument Co.	87
Maryland Engineering Co.	95
McElroy Mfg. Corp.	83, 115
McGraw-Hill Book Co., Inc.	114
Meissner Mfg. Co.	89
Millen Mfg. Co., James, Inc.	126
National Co., Inc.	69, Cov. III
Newark Electric Co.	101
New York YMCA Schools.	122
Ohmite Mfg. Co.	103
Onan Electric Co., D. W.	120
Port Arthur College.	118
Promax Products Co.	112
RCA Institutes, Inc.	122
RCA Manufacturing Co., Inc.	Cov. IV
Radio Manufacturing Engineers.	127
Radio Prod. Sales.	112
Radio Shack Corporation, The.	109
Raytheon Mfg. Co.	77
Seeli & Co., R. G.	118
Sickles Co., F. W.	120
Sound Equipment Corp.	106
Sprague Electric Co.	97
Standard Transformer Co.	96
Sylvania Electric Products.	111
Taylor Tubes, Inc.	91, 93
Telegraph Apparatus Co.	114
Terminal Radio Corp.	113
Triplet Elec. Instrument Co., The.	119
Turner Company, The.	123
Valparaiso Technical Institute.	122
Valpey Crystal Co.	98
Vitroplex Company, Inc., The.	120, 122
Ward Leonard Electric Co.	106
Wilcox Electric Co.	121
Waxley (Mallory & Co., P. R.)	76

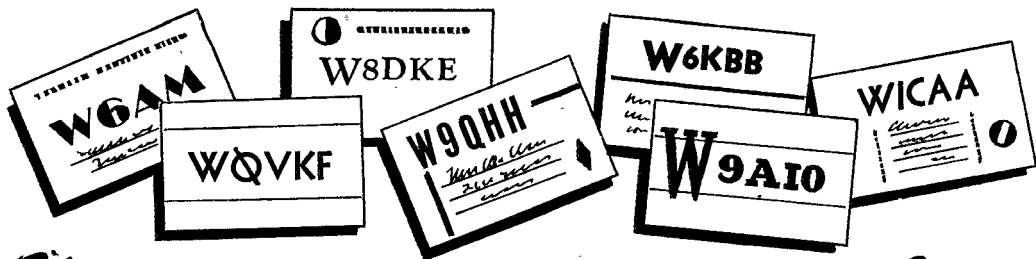

New STATION CALLS OR Old?

Regardless of the proposed changes in postwar call areas, you'll call for RME communications equipment when planning your new station.

While producing for war—RME and its staff of engineers developed gear that will best serve the amateur or commercial operator during postwar.

Take the new RME 45, for example. It delivers peak

performance on ALL frequencies—500 to 33,000 KC.

The new VHF-152 is another illustration. To make VHF operation really practical when amateur activity is resumed, the new VHF-152 Converter was designed to fill this need.

Just as RME was the first to introduce an R meter in a receiver, so it has continued to pioneer with the finest first!

PERFORMANCE BACKED BY PRECISION

VHF-152 CONVERTER

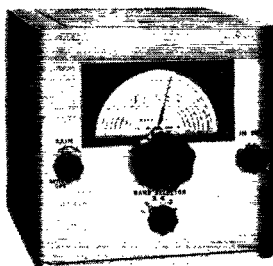

For VHF operation on 28 to 30 MC, 50 to 54 MC and the new 144 to 148 MC band. At modest cost, the VHF-152 far exceeds any present day method for working these frequencies, through the double detection method.

THE DB-20 PRESELECTOR

Over-all gain of from 20 to 25 db is achieved throughout the entire tuning range of 550 to 33,000 KC, covered in six bands. The DB-20 gives true preselection—optimum gain with best signal to noise ratio.

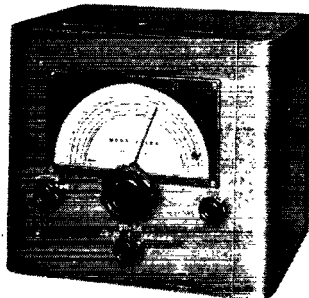

RME

FINE COMMUNICATIONS EQUIPMENT

RADIO MFG. ENGINEERS, INC.

Provia 6, Illinois U. S. A.

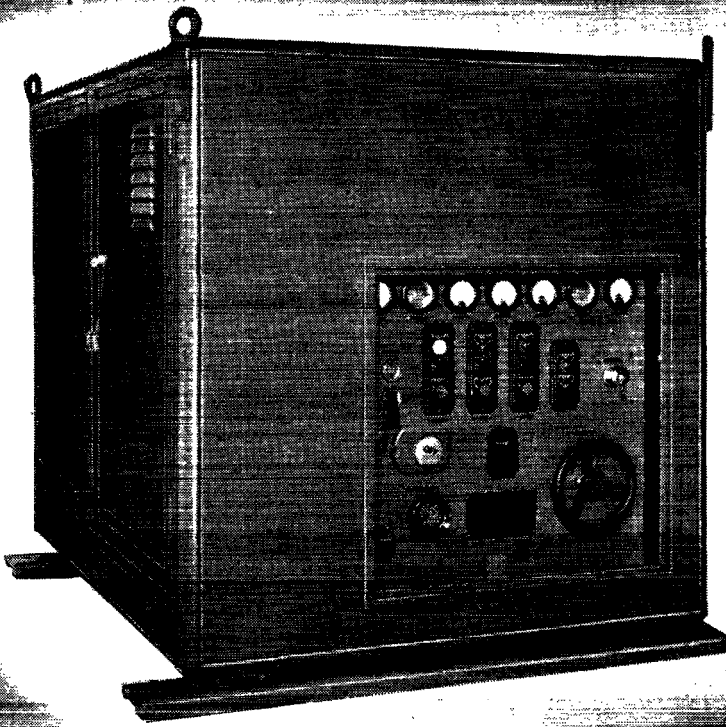

POWER

HIGH VOLTAGE POWER SUPPLY

This is the RA-38 power supply—another of the numerous valuable items in the group of government radio and electronic supplies offered for general distribution through the Hallicrafters Co., agent for RFC under Contract SIA-3-24.

Output voltage continuously variable from 0 to 15,000 volts. Can be easily adapted to deliver up to 6,000 volts at 1 ampere. Excellent power supply for laboratory work or can be used as power source for broadcast stations, induction heating equipment, vacuum tube life tests and many other industrial applications.

THESE VALUABLE ITEMS

Available Now or very soon.

Write, wire, phone for further information

- head phones • test equipment • component parts • marine transmitters and receivers • code practice equipment • sound detecting equipment • vehicular operation police and command sets • radio beacons and airborne landing equipment.

hallicrafters RADIO

HALLICRAFTERS CO., AGENT OF RFC UNDER CONTRACT SIA-3-24
MANUFACTURERS OF RADIO AND ELECTRONIC EQUIPMENT

CLIP THIS COUPON NOW

RFC DEPARTMENT 215, HALLICRAFTERS
5025 West 65th Street • Chicago 38, Illinois

- Send further details and price on RA-38 Power Supply
- Send listings of other available items

Especially interested in.....

NAME.....

ADDRESS.....

CITY.....ZONE.....

STATE.....

For Eimac's

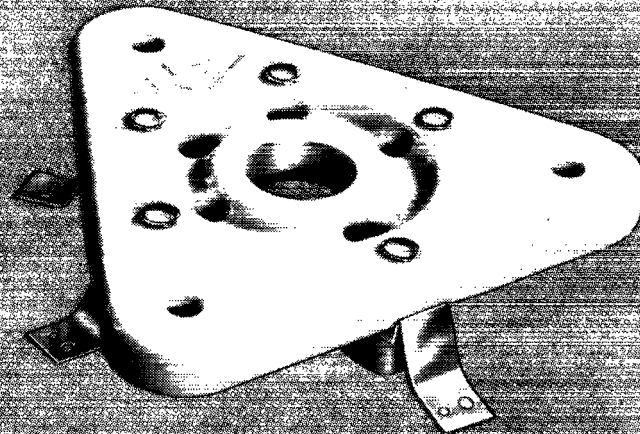

FOR EIMAC TETRODES 4-125-A, 4-250-A AND OTHERS

The HX-100 is a husky low-loss socket that will handle any tube using the Giant™ 5-pin base, including the Eimac 4-125-A and the Eimac 4-250-A. The HX-100 is of the wafer type with a low-loss ceramic body. Contacts are of the heavy duty type with auxiliary springs to provide ample contact pressure. In every detail, HX-100 is designed to contribute top performance through a long, trouble-free life.

Deliveries to dealers will begin about the time this issue of QST appears.

HX-100 Socket List Price, \$3.30.

HX-100S Socket with three stand-off insulators, List Price, \$4.25.

NATIONAL COMPANY, INC.
MALDEN, MASS., U.S.A.



RCA Tube Plant, Lancaster, Penna.
RCA manufactures cathode-ray tubes, as well
as power tubes, in this modern plant.

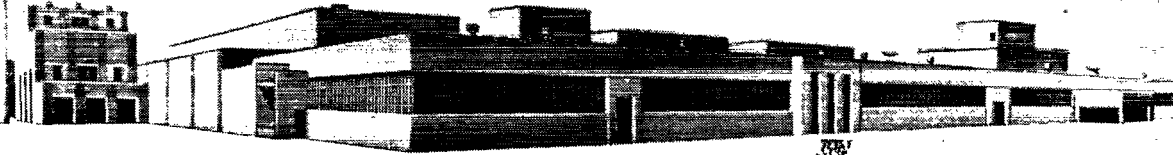

Last year the production of
POWER TUBES
by the Tube Division of RCA
was greater than that of
any other manufacturer in the world

THE FOUNTAINHEAD OF MODERN
TUBE DEVELOPMENT IS RCA



RADIO CORPORATION OF AMERICA

TUBE DIVISION • HARRISON, N. J.



MORE BANDS!

U.S.A. and Canada on November 15th Open
10 and 5-Meter Bands and Four Microwave
Bands; 2½ Shifted; International DX Restored

JUST as this issue of QST is ready for the bindery, and with barely time enough for us to slip in this extra sheet, the Federal Communications Commission for the United States and the Department of Transport for Canada on November 9th have simultaneously announced important actions restoring amateur radio on frequencies above 28 Mc. The actions are effective at 3 A.M., E.S.T., on November 15th.

The FCC action is covered by its Order 130 and replaces the temporary authorization of last August under which we operated until Nov. 15th. While it is expected that by early December FCC will be able to set up the machinery to issue new station licenses (and begin the renewal and modification of old ones), such facilities are not yet available. The only action possible at the moment is therefore to continue a temporary authorization to those of us already licensed. Station licenses that were valid at any time between Dec. 7, 1941, and Sept. 15, 1942, are validated for another six months — until 3 A.M., E.S.T., May 15th. (During that time there will be FCC instructions on how to apply for renewals.) Such stations are then authorized to operate on a newly-stated group of frequency bands. The action applies to all areas under FCC jurisdiction except the central, southern and western Pacific areas. Unfortunately, at the time of releasing the order military clearance had not been completed for Hawaii and the U.S. island possessions in the Pacific, and they are excluded. (The prohibition is but temporary and it is possible that it will be lifted even before Nov. 15th. K6 amateurs should keep themselves informed by listening to W1AW's broadcasts. Here are our new frequency bands after Nov. 15th:

TEN METERS

The postwar band 28–29.7 Mc. is opened in its entirety to c.w. The portion 28.1 to 29.5 is available for a.m. 'phone (A-3), while f.m. 'phone may use from 28.95 to 29.7 Mc. The 'phone figures are reportedly derived from some FCC postwar planning and do not represent ARRL suggestions. It is needless to say that 'phone stations should observe them carefully.

FIVE METERS

We open up temporarily on our old band: 56–60 Mc. is available for c.w., i.c.w., a.m. 'phone and facsimile, and 58.5 to 60 Mc. for f.m. 'phone, precisely as before the war — until March 1st. At that time, subject to further FCC order, television is to vacate our new band 50–54 Mc. and it will be assigned to us in lieu of 56–60.

TWO AND A HALF SHIFTED

The new band 144–148 Mc. now takes the place of 112–115.5 and no operation on the latter is now permitted. The new band is available for c.w., i.c.w., 'phone and fax, and also for f.m. 'phone and f.m. telegraphy. But in some areas part of the band is still in use for military control circuits, with the result that amateurs within 50 miles airline of Washington, D. C., and Seattle, Wash., are denied the use of 146.5 to 148 Mc. For them the band is temporarily only 144–146.5 Mc. (It is probable that, when K6 is reactivated, the same thing will be true within 50 miles of Honolulu.) Let all hands take careful note of these figures and, where indicated, keep clear of the military portion. Full bandwidth is to be expected in these areas in a few months.

MICROWAVES

We do not yet get our assignments at 220–225, 420–450 and 1145–1245 Mc. They are temporarily held up because of some conflicts but further news is to be expected in a few weeks. We do get the remaining four microwave bands,

2,300 to 2,450 Mc.
5,250 " 5,650 "
10,000 " 10,500 "
21,000 " 22,000 "

and they are open to all imaginable types of transmission except pulse, i.e., c.w., i.c.w., a.m. 'phone, fax, television, f.m. 'phone and f.m. telegraphy.

WAR RESTRICTIONS REPEALED

The Commission then canceled a handful of its temporary wartime restrictions of unhappy memory. Gone now are Order 72 and its amendments, which prohibited communication with foreign countries, and Order 73 and its amendments, which forbade portable and mobile operation below 56 Mc. Also off the books are Orders 87 and 87-A, which closed us down and took away our frequencies, and Order 87-B which instructed that no further station licenses be issued or modified. The way is thoroughly cleared. We may work foreign DX if we can find it on ten, and we may work v.h.f., u.h.f. and s.h.f. with Canada and Mexico. Huzzah and hooray!

CANADIAN ANNOUNCEMENT

The restoration of Canadian amateurs was accomplished by a press statement by the Honorable C. D. Howe, Minister of Reconstruction, who announced that the seven bands of frequencies above enumerated would be placed at the disposal of Canadian amateur radio effective Nov. 15th. Only the over-all band figures were mentioned, with no stipulation of subdivision by types of emission. The band 56-60 was only allocated temporarily, he said, and would be replaced in approximately six months' time by 50-54 Mc.

"At the outbreak of war, an order was issued suspending the operation of all Canadian amateur radio stations," the Minister said. "This order has now been rescinded and, effective November 15, 1945, all amateur experimental station licenses which were in force immediately prior to the war are reinstated and will be effective until March 31st next. It is essential, however, that all who hold a 1939 Amateur Experimental Station License must first obtain permission from the nearest Government Radio Inspector before going on the air. Radio Inspectors have likewise been instructed to furnish full information to prospective amateurs."

The Minister stated that every effort was being made by Canada and the United States to clear other frequency bands for radio operations, particularly the 3.5-4, the 7-7.3, and the 14-14.4 Mc. bands. Announcement would be made at the earliest possible date as to final postwar frequency allocations to amateur stations but in the meantime it was essential that amateur radio operators confine their activities to the frequencies now released.

There were approximately 4,000 Canadian amateur radio operators at the outbreak of the war and the Honorable Mr. Howe paid tribute to the manner in which they had foregone their interesting hobby, in conforming with the governmental order, so as to enable these frequency bands being utilized by the armed forces or other essential war services. "Canadian amateur radio operators have contributed materially to this country's war effort," he said. "Most of our amateurs were young men and they responded enthusiastically to the call of their country, especially during the early stages of the war when the Armed Services urgently needed large numbers of radio operators.

"They served at sea with the Royal Canadian Navy and the Canadian Merchant Navy. They served with the Army, the Royal Canadian Air Force and the Government radio services. They also provided the essential instructor personnel for the training of Canadian and Empire airmen under the British Commonwealth Air Training Plan. Many have paid the supreme sacrifice. Several have won high honors for gallantry on the field and a few have risen to the higher executive brackets in the Armed Services. We have just cause to be proud of our amateur radio operators."

— • • • —

And so, fellows, we take another major step toward restoration. There will be further developments at short intervals. Make it a habit to listen for WIAW, which will always give you the newest news on these matters — Mondays through Fridays at 8, 9 and 10 P.M., E.S.T., on 3555, 7145 and 14280 kc., by special authority of FCC and the special cooperation of the armed forces. Meanwhile, may you find juicy DX on 10 meters, nice bending on 5, and lots of fun with your microwave ideas.

— K. B. W.

— • • • —

— • • • —