

QST

October, 1945

25 cents

35c in Canada

devoted entirely to

amateur radio

In This Issue:

★ THE U. S. NAVY ★



*Communications
Electronics*

RADIO ★ RADAR

SONAR ★ LORAN

PUBLISHED BY THE AMERICAN RADIO RELAY LEAGUE



WHY CHOOSE UTC?

FOR WAR AND POSTWAR COMPONENTS

1. *UTC IS THE LARGEST TRANSFORMER SUPPLIER TO THE COMMUNICATIONS INDUSTRY.*
2. *OUR RANGE OF PRODUCTS IS THE WIDEST IN THE INDUSTRY.*
3. *OUR REPUTATION FOR QUALITY IN THE INDUSTRY IS ACCEPTED . . . WE DESIGN TO YOUR NEEDS.*
4. *OUR DELIVERY SCHEDULE IS HIGHER THAN EVER.*
5. *OUR RECORD OF SERVICE IS BACKED BY MANY YEARS OF EXPERIENCE. UTC IS NOT A WAR BABY.*
6. *OUR POLICY IS TO MAKE UTC'S PRICES RIGHT AND DELIVERIES ON TIME.*

United Transformer Corp.

150 VARICK STREET

EXPORT DIVISION: 13 EAST 40th STREET,

NEW YORK 13, N. Y.

NEW YORK 16, N. Y., CABLES: "ARLAB"



ALL PL



hallicrafters RECEIVERS

AVAILABLE NOW IN LIMITED
QUANTITIES

SEE NEXT PAGE FOR
DETAILS ABOUT HOW
YOU CAN GET YOUR
HALLICRAFTERS SET
NOW . . .

COPYRIGHT 1945 THE HALLICRAFTERS CO.

hallicrafters RADIO



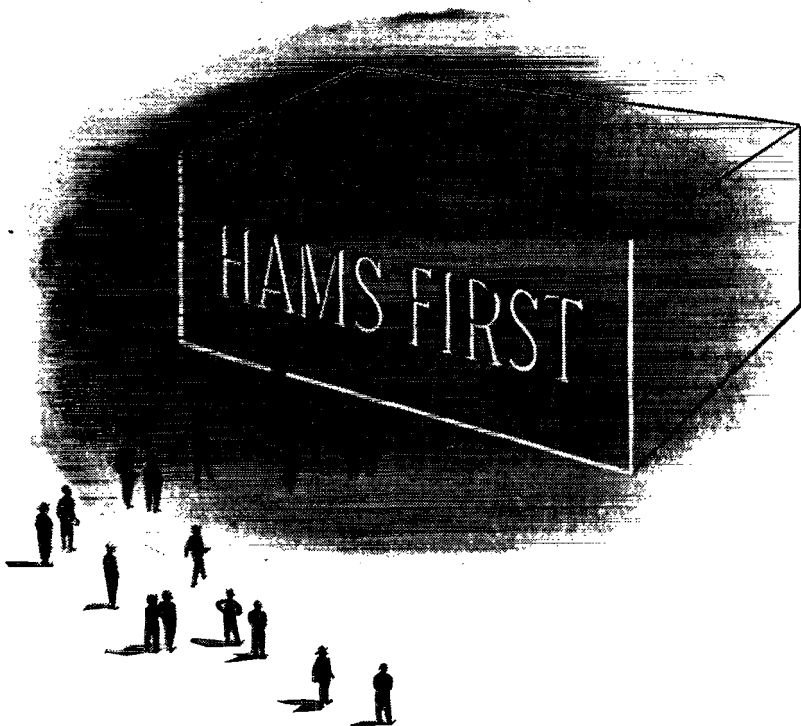

First models off the peacetime production line at Hallicrafters go to hams. Designed originally for and by amateurs, Hallicrafters equipment comes back from the wars even further refined and perfected . . . ready to fit into your ham shack.

Available Now limited number of Hallicrafters models that have won the respect and admiration of amateurs everywhere. As we return to private business our slogan is now, and will continue to be . . . "hams first." At this time available merchandise will be carefully channeled out to regularly established Hallicrafters distributors to be sure that it reaches our primary market first . . . the amateurs.

THE HALLICRAFTERS CO., MANUFACTURERS OF RADIO AND ELECTRONIC EQUIPMENT • CHICAGO 16, U. S. A.



SEE YOUR LOCAL DISTRIBUTOR NOW



hallicrafters RADIO

Buy a Victory Bond Today!

COPYRIGHT 1945 THE HALLICRAFTERS CO.

OCTOBER 1945

VOLUME XXIX

NUMBER 10



STAFF

Editorial

KENNETH B. WARNER, W1EH
General Manager of ARRL
Publications

CLINTON B. DESOTO, W1CBB
Editor

A. DAVID MIDDLETON, W2OEN
Assistant Editor

GEORGE GRAMMER, W1DF
Technical Editor

DONALD H. MIX, W1TS
BYRON GOODMAN, W1JPE
J. VENABLE FITZHUGH, W5VL
Assistant Technical Editors

EDWARD P. TILTON, W1HDQ
Contributing Editor, V.H.F.

WALTER E. BRADLEY, W1FWH
VERNON CHAMBERS, W1JEQ*
Technical Information Service

LOUISA B. DRESSER, LSPH
Assistant to the Editor

ELSIE C. HOCHMEISTER
Editorial Assistant

Advertising

F. CHEYNEY BEEKLEY, W1GS
Advertising Manager

Circulation

DAVID H. HOUGHTON
Circulation Manager

RALPH T. BEAUDIN, W1BAW
Asst. Circulation Manager

*On leave of absence



OFFICES

38 La Salle Road
West Hartford 7, Connecticut

Subscription rate in United States and Possessions, \$2.50 per year, postpaid; all other countries, \$3.00 per year, postpaid. Single copies, 25 cents. Foreign remittances should be by international postal or express money order or bank draft negotiable in the U. S. and for an equivalent amount in U. S. funds.

Entered as second-class matter May 29, 1919, at the post office at Hartford, Connecticut, under the Act of March 3, 1879. Acceptance for mailing at special rate of postage provided for in section 1103, Act of October 3, 1917, authorized September 9, 1922. Additional entry at Concord, N. H., authorized February 21, 1929, under the Act of February 23, 1925.

Copyright 1945 by the American Radio Relay League, Inc. Title registered at U. S. Patent Office.

QST

devoted entirely to

AMATEUR RADIO

PUBLISHED, MONTHLY, AS ITS OFFICIAL ORGAN, BY THE AMERICAN RADIO RELAY LEAGUE, INC., AT WEST HARTFORD, CONN., U. S. A.
OFFICIAL ORGAN OF THE INTERNATIONAL AMATEUR RADIO UNION



CONTENTS

It Seems to Us	11
Splatter	13
Special U. S. Navy Feature Section:	
Navy Communications and the Amateur	
<i>Rear Admiral Joseph R. Redman, USN</i>	14
The Navy Ashore	16
The Navy Afloat	52
The Navy in Combat	58
[All photographs in this section are official U. S.]	
[<i>Navy photographs unless otherwise indicated.</i>]	
Happenings of the Month	65
Using the New High-Power Beam Tubes	
<i>Donald H. Mix, W1TS</i>	67
On the Very Highs	70
<i>E. P. Tilton, W1HDQ</i>	
Converting 112-Mc. Gear for 144	
<i>Philip S. Rand, W1DBM & Walter E. Bradley, W1FWH</i>	72
The Crystal Ball	74
Know Your Coupled Circuits	76
<i>Dawkins Espy, W6UBT</i>	
In QST 25 Years Ago This Month	81
Book Review	81
Strays	82
Correspondence from Members	83
Operating News	85
Amateur Activities	90
The Month in Canada	108
Silent Keys	120
Ham-Ads	140
QST's Index of Advertisers	142

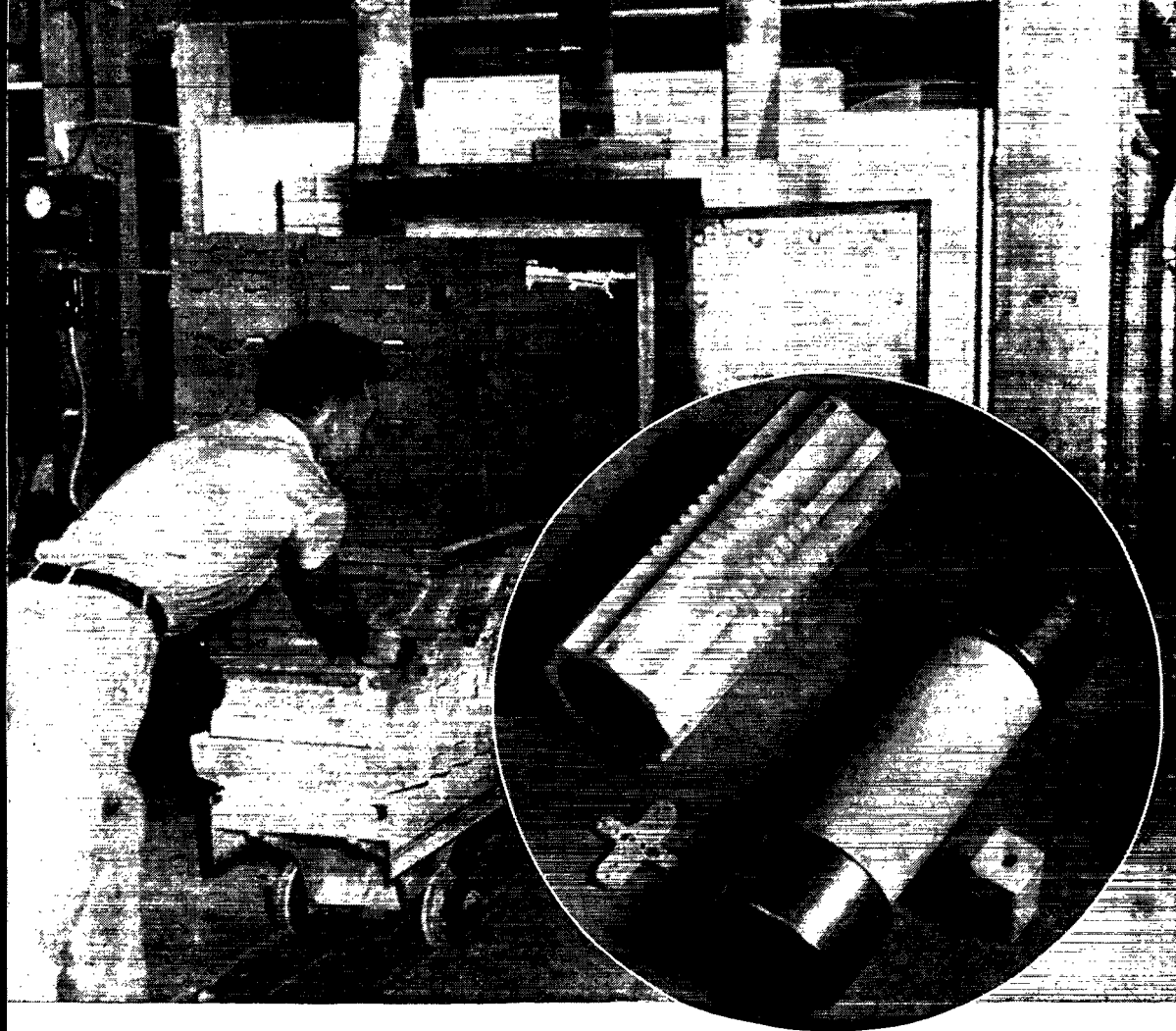

BORN AT 2500° F.

ALSiMAG is master of power and heat because it takes its final, strong, hard, *rigid* form in furnaces at the white heat of 2500°F.

This inorganic material cannot char. It withstands red heat temperatures of 1800°F. ALSiMAG is highly resistant to thermal and electrical shock.

ALSiMAG insulators do not distort with loading nor cold-flow with time. They are non-corrodible.

Uniformity and dimensional accuracy of ALSiMAG Insulators facilitate assembly. Whatever you are planning in the electronic or electrical field—specify ALSiMAG for long-lived, dependable performance. Our Engineering and Research men are anxious to work with you. Literature applicable to the various fields of ALSiMAG uses, available on request.

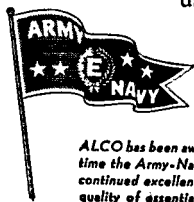

ALCO has been awarded for the fifth time the Army-Navy "E" Award for continued excellence in quantity and quality of essential war production.

AMERICAN LAVA CORPORATION
CHATTANOOGA 5, TENNESSEE

ALSiMAG
TRADE MARK REGISTERED U. S. PATENT OFFICE
STEATITE CERAMIC

3 OUTSTANDING FEATURES OF THE NEW EIMAC 4-125A TETRODE

LOW DRIVING POWER

With but 2.5 watts driving power, the 4-125A will deliver 375 watts output at frequencies as high as 120 Mc. The low driving power requirement has been achieved without the use of excessive secondary emission. The control grid is specially processed to reduce both primary and secondary emission.

HIGH FREQUENCY PERFORMANCE

The Eimac 4-125A will deliver 200 watts output at 250 Mc. The performance curves below show the relationship between driving power and power output at frequencies up to 250 Mc.

FOLLOW THE LEADERS TO

Eimac
REG. U. S. PAT. OFF.
TUBES



EITEL-McCULLOUGH, Inc., 1085 San Mateo Avenue, San Bruno, Calif.
Plants located at: San Bruno, California and Salt Lake City, Utah

Export Agents: Frazer & Hansen, 301 Clay St., San Francisco 11, Calif., U. S. A.

LOW GRID-PLATE CAPACITANCE

The grid-plate capacitance of the 4-125A is only 0.03 *uufd*. This low value allows operation up to 100 Mc. without neutralization. Stability is further assured by the special grid processing which reduces secondary emission.

A technical bulletin on Eimac 4-125A Power Tetrode contains full specifications and detailed discussion of the tube's characteristics, circuit diagrams and constant current curves. Write for your copy today.

The Eimac 4-125A is the first of many new Eimac tubes that are on the way. Watch for future announcements.

ELECTRICAL CHARACTERISTICS

Filament: Thoriated Tungsten	
Voltage	5.0 volts
Current	6.2 amperes
Plate Dissipation (Maximum) 125 watts	
Direct Interelectrode Capacitances (Average)	
Grid-Plate (Without shielding, base grounded)	0.03 <i>uufd</i> .
Input	10.3 <i>uufd</i> .
Output	3.0 <i>uufd</i> .
Transconductance ($i_b = 50$ ma., $E_b = 2500$ v., $E_{c2} = 400$ v.)	
2450 μ ms	

1085

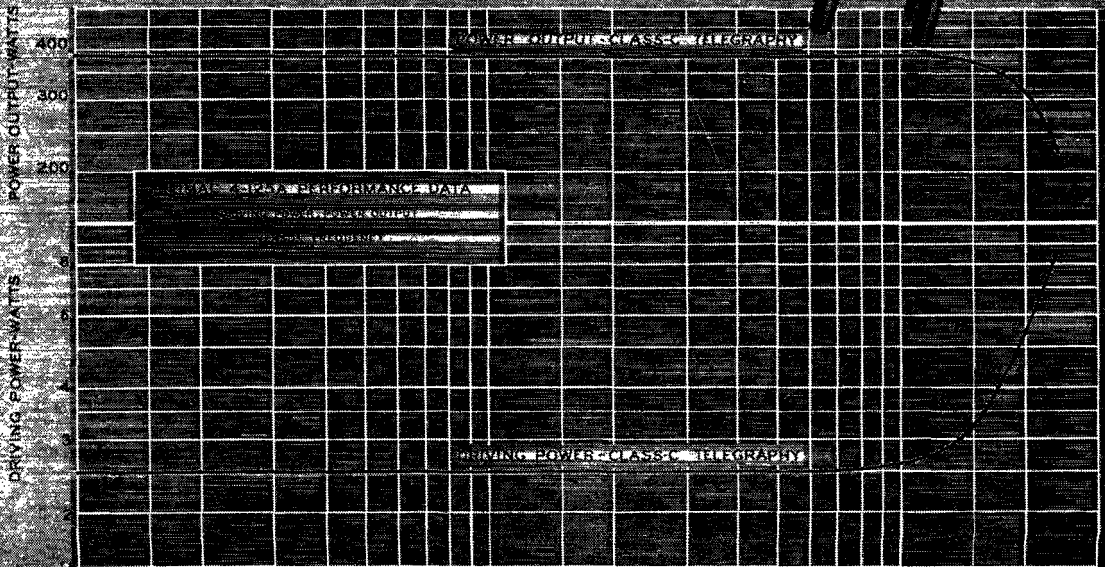
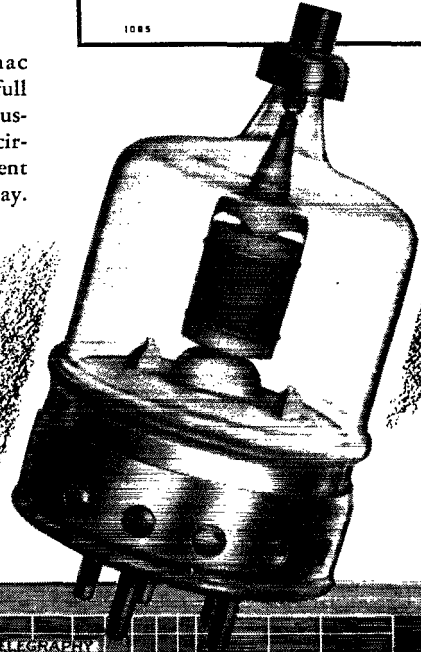

THE COUNTERSIGN OF DEPENDABILITY IN ANY ELECTRONIC EQUIPMENT

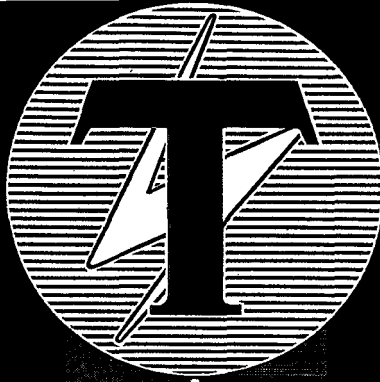

SINCE 1895

Transformer Specialists . . .

Thordarson's tradition of quality provides the underlying reason for its past half-century of progressive leadership in the specialized manufacture of dependable transformers, components and other electronic devices. This same tradition, upheld through every phase of *Thordarson* design, engineering and manufacturing is

your guarantee of the finest transformers for requirements Tomorrow . . . and years to come. With confidence . . . gained by this ability to produce quality merchandise and coupled with novel sales policies . . . *Thordarson* looks forward to supplying the expanding demands of the radio and electronic industries.

500 WEST HURON ST., CHICAGO, ILL.



ORIGINATORS OF TRUE-FIDELITY AMPLIFIERS

THORDARSON

ELECTRIC MANUFACTURING DIVISION

MAQUIRE INDUSTRIES, INCORPORATED

**SPECIALISTS IN DESIGN
AND MANUFACTURE OF
FINE ACOUSTIC EQUIPMENT**

**NEW Jensen
PRODUCTS—
WATCH FOR COMING
ANNOUNCEMENT**

FREE to the Armed
Forces, Colleges,
Technical Schools,
Libraries.

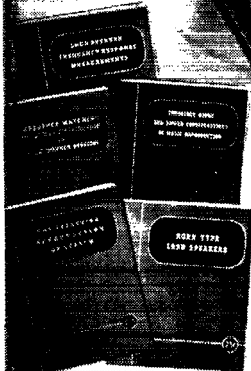

MONOGRAPHS AVAILABLE

- Loud Speaker Frequency-Response Measurements.
- Impedance Matching and Power Distribution.
- Frequency Range in Music Reproduction.
- Effective Reproduction of Speech.
- Horn Type Loud Speakers.

25c



Jensen
SPEAKERS WITH

ALNICO 5

THROUGHOUT the war JENSEN remained true to a more than fifteen-year-old tradition of specialization in the design and manufacture of fine acoustic equipment. Very shortly now this persistent adherence to specialization will again bring forth new and improved JENSEN Loud Speakers and related products. Their quality and performance ability, in the JENSEN tradition, will suggest their use by all who want the best. Watch for further announcements.

JENSEN RADIO MANUFACTURING COMPANY • 6611 SOUTH LARAMIE AVENUE, CHICAGO 38, ILLINOIS
IN CANADA—COPPER WIRE PRODUCTS, LTD., 137 RONCESVALLES AVENUE, TORONTO

Section Communications Managers of the A.R.R.L. Communications Department

Reports Invited. All amateurs, especially League members, are invited to report communications activities, training plans, code classes, theory-discussion groups each mid-month (16th of the month for the last 30 days) direct to the SCM, the administrative official of ARRL elected by members in each Section whose address is given below. Radio Club reports and Emergency Coordinator reports representing community organized work and plans and progress are especially desired by SCMs for inclusion in *QST*. **ARRL Field Organization appointments**, with the exception of the Emergency Coordinator and Official Broadcasting Station posts, are suspended for the present and no new appointments or cancellations, with the exception named, will be made.

ATLANTIC DIVISION				
Eastern Pennsylvania	W3BES	Jerry Mathis	623 Crescent Ave. 9701 Monroe St. Silver Springs P. O.	Glenside Gardens
Maryland-Delaware-District of Columbia	W3CIZ	Hermann E. Hobbs	623 E. Brown St.	Linden, Maryland
Southern New Jersey	W3GCU	Ray Tomlinson	186 Dersey Rd.	Trenton 10
Western New York	W8MC	William Beller	927 East 23rd St.	Rochester
Western Pennsylvania	W8NCJ	R. R. Rosenberg		Erie
CENTRAL DIVISION				
Illinois	W9NUX	David E. Blake, II	4501 N. Malden St.	Chicago 40
Indiana	W9EGQ	Herbert S. Brier	385 Johnson St.	Gary
Kentucky	W9ARU	Darrel A. Downard	2077 Sherwood Ave.	Louisville 5
Michigan	W8DPE	Harold C. Bird	R.F.D. 2, Box 223	Port Huron 2
Ohio	W8MFP	Carl F. Wiehe	122 St. Albert St.	St. Bernard 17
Wisconsin	W9RH	Emil Felber, Jr.	1625 N. 18th St.	Milwaukee 5
DAKOTA DIVISION				
North Dakota	W9EVP	Raymond V. Barnett	406-17th St.	Bismarck
South Dakota	W9QVY	P. H. Schultz	118 N. Yankton Ave.	Pierre
Northern Minnesota	W9FUZ	Armond D. Brattland	Birchmont Drive	Bemidji
Southern Minnesota	W9YNQ	Millard L. Bender	608 N. Huron Ave.	Spring Valley
DELTA DIVISION				
Arkansas	W5GED	Ed Beck	2503 Bishop St.	Little Rock
Louisiana	W5DKR	Eugene H. Treadaway	P. O. Box 44	LaPlace
Mississippi	W5HAV	P. W. Clement	524 Santini St.	Blount
Tennessee	W4SP	James B. Witt	R.F.D. 6, Shady Dell Trail	Knoxville
HUDSON DIVISION				
Eastern New York	W2HZL	Ernest E. George	2044 Lexington Parkway	Schenectady 8
N. Y. C. & Long Island	W2KDC	Charles Ham, Jr.	151-06 84th Drive	Jamaica, L. I., 2
Northern New Jersey	W2CQD	Winfield G. Beck	617 Spruce St.	Roselle
MIDWEST DIVISION				
Iowa	W9PJR	Leslie B. Vennard	2712 Washington St.	Burlington
Kansas	W9AWP	A. B. Unruh	1617 S. Seneca St.	Wichita 12
Missouri	W9AUD	Mrs. Letha A. Dangerfield	411 Moffett Ave.	Joplin 2
Nebraska	W9FQB	Arthur R. Gaeth	6105 N. 37 St.	Omaha 11
NEW ENGLAND DIVISION				
Connecticut	W1KOY	Edmund R. Fraser	48 Willow St.	West Haven 16
Maine	W1AOL	G. C. Brown	379 No. Main St.	Brewer
Eastern Massachusetts	W1ALP	Frank L. Baker, Jr.	91 Atlantic St.	North Quincy 71
Western Massachusetts	W1JAH	William J. Barrett	239 Columbia St.	Adams
New Hampshire	W1FTJ/4	Mrs. Dorothy W. Evans	1435 Snowdon Ave.	Memphis 7, Tennessee
Rhode Island	W1HRC	Clayton C. Gordon	70 Columbia Ave., Gaspee	Plateau, Providence 5
Vermont	W1NLO	Burtia W. Dean	P. O. Box 81	Burlington
NORTHWESTERN DIVISION				
Alaska	K7GNN	James G. Sherry		Homer
Idaho	W7AVP	Don D. Oberbillig	P. O. Box 486	Boise
Montana	W7CPY	Rex Roberts	Box 1088	Glendive
Oregon	W7GNJ	Carl Austin	1137 Federal	Bend
Washington	W7FWD	O. U. Tatro	513 N. Central	Olympia
PACIFIC DIVISION				
Hawaii	K6ETB	Francis T. Blatt	837 16th Ave.	Honolulu
Nevada	W6CWF	N. Arthur Sowle	Box 2025	Reno
Santa Clara Valley	W6IUZ	Earl F. Sanderson	600 Acacia Ave.	San Bruno
East Bay	W6TI	Horace R. Greer	414 Fairmount Ave.	Oakland 11
San Francisco	W6RBO	William A. Ladley	200 Taylor St.	San Francisco 12
Sacramento Valley	W6MDI	Vincent N. Feldhausen	113 South Quincy St.	McCloud
Philippines	KA1GR	George L. Rickard	Box 849	Manila
San Joaquin Valley*	W6BXB	Edward H. Noack	811 West Magnolia St.	Stockton
ROANOKE DIVISION				
North Carolina	W4CYB	W. J. Wortman	P. O. Box 566	Morganton
South Carolina	W4RQE/ANG	Ted Ferguson	3422 Rosewood Drive	Columbia 25
Virginia	W3AKN	Walter G. Walker	217-51 St.	Newport News
West Virginia	W8JRL	Kenneth M. Zinn	P. O. Box 132	Clarksburg
ROCKY MOUNTAIN DIVISION				
Colorado	W9VGC	H. F. Hekel	2743 Julian St.	Denver 11
Utah-Wyoming	W6LLH	Victor Drabble	1024 Oak St.	Ogden, Utah
SOUTHEASTERN DIVISION				
Alabama	W4GBV	Lawrence J. Smyth	808 Winona Ave.	Montgomery
Eastern Florida	W41P	Robert B. Murphy	3302 S.W. Grapeland Blvd.	Miami 33
Western Florida	W4MS	Lt. Edward J. Collins	1409 N. 10th Ave.	Pensacola
Georgia	W4FDJ	Ernest L. Morgan	R.F.D. 2	Lyons
West Indies (Cuba)	CM2OP	Mario de la Torre	Escobar 110 (Altos)	Habana, Cuba
(Puerto Rico-Virgin Islands)	K4KD	Everett Mayer	24 Lindberg St.	Santurce, P. R.
SOUTHWESTERN DIVISION				
Los Angeles	W6QVV	H. F. Wood	429 So. Fairview	Burbank
Arizona	W6RWVW	Douglas Aitken	341 S. Mt. Vernon Ave.	Prescott
San Diego	W6CHV	Ralph H. Culbertson	7172 Eads St.	La Jolla
WEST GULF DIVISION				
Northern Texas	W5ALA	Jack T. Moore	5712 Berkshire Lane	Dallas 9
Oklahoma	W5AYL	Ed Oldfield	2141 N.W. 35th St.	Oklahoma City 6
Southern Texas	W5JIC	James B. Rives	1721 Kentucky Ave.	San Antonio 1
New Mexico	W5HJF	J. G. Hancock	110 S. E. Nevada St.	Portales
MARITIME DIVISION				
Maritime	VE1DQ	A. M. Crowell	69 Dublin St.	Halifax, N. S.
ONTARIO DIVISION				
Ontario	VE3EF	Wing Commander Donald R. Gunn	c/o Canadian Bank of Commerce	New Toronto, Ont.
QUEBEC DIVISION				
Quebec	VE2CO	Lieutenant L. G. Morris	4114 Hingston Ave.	Montreal 28, Que.
VANALTA DIVISION				
Alberta	VE4GE	C. S. Jamieson	581 W. Riverside Drive	Drumheller, Alta.
British Columbia	VE5DD	C. O. I. Sawyer	2634 West 31st Ave.	Vancouver
PRAIRIE DIVISION				
Manitoba	VE4AAW	A. W. Morley	26 Lennox St.	St. Vital
Saskatchewan	VE4SY	Arthur Chesworth	1084 Redland Ave.	Moose Jaw

*Officials appointed to act temporarily in the absence of a regular official.

In Post War its—
HAMMARLUND
Performance
FOR EVERY HAM

HQ-129-X

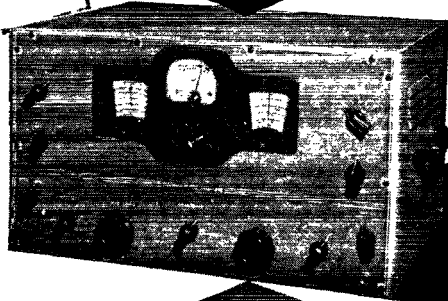

AMATEUR
NET \$129⁰⁰*
LESS SPEAKER

*PRICES SUBJECT TO CHANGE WITHOUT NOTICE

The famous top performance of the HQ-120-X has been surpassed in this new HQ-129-X. See it — hear it — judge for yourself!

- Professional performance in every respect
- Full range selectivity for all receiving conditions
- Special high-precision tuning unit
- Accurately calibrated band spread dial
- Medium impedance input to work with all antennae
- Adjustable input trimmer for maximum image rejection
- Priced within the range of every "ham's" purse
- Write for descriptive folder

HAMMARLUND

THE HAMMARLUND MFG. CO., INC., 460 W. 34TH ST., NEW YORK 1, N.Y.
 MANUFACTURERS OF PRECISION COMMUNICATIONS EQUIPMENT



THE AMERICAN RADIO RELAY LEAGUE, INC.,

is a noncommercial association of radio amateurs, bonded for the promotion of interest in amateur radio communication and experimentation, for the relaying of messages by radio, for the advancement of the radio art and of the public welfare, for the representation of the radio amateur in legislative matters, and for the maintenance of fraternalism and a high standard of conduct.

It is an incorporated association without capital stock, chartered under the laws of Connecticut. Its affairs are governed by a Board of Directors, elected every two years by the general membership. The officers are elected or appointed by the Directors. The League is noncommercial and no one commercially engaged in the manufacture, sale or rental of radio apparatus is eligible to membership on its board.

"Of, by and for the amateur," it numbers within its ranks practically every worth-while amateur in the nation and has a history of glorious achievement as the standard-bearer in amateur affairs.

Inquiries regarding membership are solicited. A bona fide interest in amateur radio is the only essential qualification; ownership of a transmitting station and knowledge of the code are not prerequisites, although full voting membership is granted only to licensed amateurs.

All general correspondence should be addressed to the Secretary at the administrative headquarters at West Hartford, Connecticut.



Past Presidents

HIRAM PERCY MAXIM, W1AW, 1914-1936
EUGENE C. WOODRUFF, W8CMP, 1936-1940

Officers

President GEORGE W. BAILEY, W1KH
Washington, D. C.
Vice-President CHARLES E. BLALACK, W6GG
Yuma, Arizona
Secretary KENNETH B. WARNER, W1EH
West Hartford, Connecticut
Communications Manager F. E. HANDY, W1BDI*
Chevy Chase, Maryland
Treasurer DAVID H. HOUGHTON
West Hartford, Connecticut

General Counsel PAUL M. SEGAL
1026 Woodward Building, Washington 5, D. C.

*On leave of absence. Address correspondence to the Acting Communications Manager, LeRoy T. Waggoner, W9YMY, at the Headquarters office.

Directors

President
GEORGE W. BAILEY W1KH
1530 P St., N.W., Washington 25, D. C.

Vice-President
CHARLES E. BLALACK W6GG
Box 103, Yuma, Ariz.

Canadian General Manager
ALEX REID VE2BE
240 Logan Ave., St. Lambert, P. Q.
Alternate: Leonard W. Mitchell VE3AZ
78 Raglan Ave., Toronto, Ont.

Atlantic Division
WALTER BRADLEY MARTIN W3QV
25 Arbutha Rd., Abington, Pa.
Alternate: Herbert M. Walleze W8BQ
P. O. Box 13, Drums, Pa.

Central Division
JOHN A. KIENER W8AVH
3462 Edison Rd., Cleveland Heights,
Cleveland 21, Ohio
Alternate: Earl S. Nelson W8DS
22551 Hadden Rd., Euclid 17, Ohio

Dakota Division
TOM E. DAVIS W9VVA
915 W. Becker Ave., Willmar, Minn.
Alternate: Aaron E. Swanberg W9BHY
1487 Breda St., St. Paul 4, Minn.

Delta Division
E. RAY ARLEDGE W59I
340 N.E. 20th Terrace, Apt. 7, Miami 37, Fla.
Alternate: Samuel H. Dowell W5ERV
1057 Mildred St., Shreveport 15, La.

Hudson Division
ROBERT AKERIDGE KIRKMAN W2DSY
Werah Pl., R.F.D. No. 1, Box 61, Long Branch, N. J.
Alternate: George Rulifis, Jr. W2CJY
38 Brookwold Drive, Manhasset, L. I., N. Y.

Midwest Division
FLOYD E. NORWINE, JR. W9EFC
7405 Hiawatha Ave., Richmond Heights 17, Mo.
Alternate: C. A. Colvin W9VHR
% Omaha & Council Bluffs St. Railway Co.,
Omaha 2, Nebr.

New England Division
PERCY C. NOBLE W1BVR
37 Broad St., Westfield, Mass.
Alternate: Clayton C. Gordon W1HRC
70 Columbia Ave., Warwick, R. I.

Northwestern Division
KARL W. WEINGARTEN W7BG
3219 N. 24th St., Tacoma 7, Wash.
Alternate: R. Rex Roberts W7CFY
110 W. Brennan St., Glendive, Mont.

Pacific Division
I. L. McCARGAR W6EY
66 Hamilton Pl., Oakland 12, Calif.
Alternate: Elbert J. Amarantes W6FBW
1675 Dale Ave., San Jose, Calif.

Roanoke Division
H. L. CAVENESS W4DW
2607 Vanderbilt Ave., Raleigh, N. C.
Alternate: J. Frank Key W3ZA
Box 707, Buena Vista, Va.

Rocky Mountain Division
C. RAYMOND STEDMAN W9CAA
925 So. Gaylord St., Denver 9, Colo.
Alternate: Howard R. Markwell W9TFP
355 Monroe St., Denver 6, Colo.

Southeastern Division
WILLIAM C. SHELTON W4ABR
527 Revilo Blvd., Daytona Beach, Fla.
Alternate: William P. Sides W4AUP
Fleming Road, Montgomery, Ala.

Southwestern Division
JOHN E. BICKEL W6BKY
1834 E. Whittier Blvd., Whittier, Calif.
Alternate: Eldridge E. Wyatt, Jr. W6ARW
P. O. Box 3597, Long Beach 3, Calif.

West Gulf Division
WAYLAND M. GROVES W5NW
Box 1314, Seagraves, Texas
Alternate: Jennings R. Poston W5AJ
P. O. Box 848, Curundu, Panama Canal Zone

"IT SEEMS TO US —"

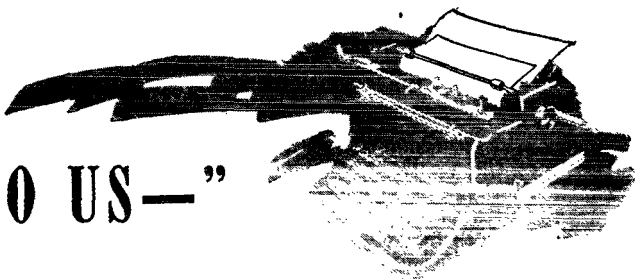

LADIES & GENTLEMEN, THE NAVY!

TOGETHER with the rest of a grateful nation *QST* in this issue proudly salutes the United States Navy on its unbelievable accomplishments in the winning of a war which, in essence, truly was its own particular war.

A year ago we devoted an issue to radio in the Army establishment, as viewed chiefly through the common denominator of the Signal Corps, at a time when Army performance had just hit its stride in the European theater. At that time we began the planning of a similar special issue on the Navy and radio, and it is sheer coincidence that its final preparation coincides with the ending of the Pacific war.

With no detracting from the glorious accomplishments of all our arms, none will dispute that the major role in the Pacific has been the Navy's, and indeed in a very real sense it can be said that it is the Navy which has won this war. In similar fashion it appeals to us that it was electronics that made this victory assured, for there is ample evidence that the deciding factor at stage after stage was our superiority in radio and radar. And, as we look this issue over the last time before it goes to press, we cannot escape the feeling, even if we should want to try, that the American radio amateur has had a most significant part in making that superiority possible.

Hams do literally everything in naval radio and radar, in all ranks from seaman to flag officer. The Naval Communications Reserve brought several thousand selected amateurs to active duty for the whole duration, followed by additional thousands in communications work as the war unfolded. The development of radar provided a whole new field peculiarly suited to the talents of the skilled amateur and in it he has, by the thousands, written his name to as exciting a bit of American technical history as was ever disclosed. For radar is indisputably a vital weapon, one which in this war overshadowed all others. As a single illustration, do you remember the arguments at the beginning of the war on whether bombardment aviation had made the battleship obsolete? Regardless of what the answer might have been without radar, with it there is no argument. Equip a battleship with search radar and radar fire control and she is an utterly different thing, able in large measure to take care of herself. Search radar brings a new kind of

seeing, and radar fire control aims guns with higher accuracy than guns themselves can hold. Thus, with argument evaporated into nothingness long ago, the fleet still possesses battlewagons which, in fleet actions or shore bombardments, can deliver as much fire power as hundreds of heavy bombers. Multiply this one example by the hundreds of types of craft and operations in the Fleet and you will have some appreciation of what electronics has contributed toward victory and of the kind of work our brother hams in the Navy have been doing.

This issue of *QST*, representing the work of many hands over many months, will tell you much about our Navy which you've never known before. It undertakes to describe both the Navy ashore — the Department, the technical and training activities, and the organization; and the Navy afloat — the Fleet, with its ships and aircraft and bases and its tactics. Finally it will tell you something about radio amateurs in the Navy. In a way our story is that of the Navy as an entity, but more particularly it is that of the Navy's achievements in terms of the hams participating, more or less through their eyes. It will show you, of course, how the nation has been served by the Navy. It will show, equally, how the nation has been served by its radio amateurs.

Fellow amateurs, the United States Navy!



REOPENING:

AH, BUT it is good to be back on the air! — a humble reopening, to be sure, but a start from which great things will quickly come.

In a shrieking crescendo of events that still tax comprehension, the war is over. The appalling expenditure of blood and treasure is ended. We are back in the ways of peace.

No major nation has ever acted so rapidly in its reconversion processes. President Truman announced the Jap acceptance on the evening of August 14th. Next day ARRL moved with BWC and FCC for amateur reopening. On the 16th, BWC told FCC it had no objection to the temporary restoration of amateurs in the 112-Mc. band; there was not time to do more but that would serve as a starter. On the 21st, slashing through miles of red tape, FCC put us back on the air on that band — as a beginning, and until more can be done and things regularized. Like that! we were going again!

In our department "Happenings of the Month" are the texts of the FCC order and announcement. You must read them. You will note that this is a temporary restoration, expiring November 15th. Before that time it will be replaced by a permanent FCC order that will set forth the details of our reconstruction.

You know that our 112-116 band is to be given over to aviation ranges and that our postwar spot is to be 144-148. Aviation isn't quite ready to take over our band, won't be until November, nor is the 144 band yet cleared for us. Meanwhile we have gear for the 112 band. WERS is doomed to die, and communities are crying for emergency-communication service. So the logical thing was done: no wait for licensing arrangements to be reestablished but the old gang put back on the air at once, so that they can take over from WERS, organize everywhere for emergency communication, and prepare leisurely for the change-over to 144-148. At this writing we can't be certain that that change will occur on November 15th — there may be a postponement. In no event is operation authorized on 144-148 until FCC so orders. Keep yourself posted.

So far this is our only band. Hq. has been deluged, right since the first day, by phone calls, wires and letters from eager amateurs who say, in effect, "The war's over; we've been good; why can't we have all our old frequencies back instantly?" The question of when is obviously the hottest thought in every ham's mind. Well, OMs, we aren't off the air just because it wasn't safe to let us use our frequencies during a war. Another reason was that the Army and Navy needed those frequencies. We are told that, with the possible exception of the 112 band, every single ham frequency has been in use somewhere in the military services. The Army and Navy have vast establishments spread over thousands of miles. Their needs are not suddenly reduced to zero just because the japs say they are quitting. The proclamation of unlimited national emergency still stands. It will take a little time, until they whittle down some of their activities, and we'll have to be as patient as we can for a while. The whole attitude of Army and Navy is to get us going again as quickly as possible, and IRAC and BWC are cooperating with FCC to that end. Many of our frequencies have been used only for training purposes or temporary mobile uses and these should come along as rapidly as programs can be condensed. In the world above 200 Mc. most of our new bands are slices from wider bands used by military aviation with present equipment, and to make room for us the existing services must contract as their activities slow down. All these things have to be done in an orderly manner, almost as part of the process of demobilization, and the orders that set our bands free for our use can come only from the competent Army and Navy communications people. Unhappily for us, most of the key

people in this work are out of the country at the moment of writing, attending the Rio conference, and we can't tell you in this issue just how fast it will be possible to do the things we all want. This we can say: (1) ARRL is keeping in close touch with the situation; (2) Army and Navy will gladly move as fast as they can; (3) FCC is more than willing. In fact, one reason we got opened as fast as we did was the genuine feeling in FCC that the amateur's war record entitled him to special consideration.

Now FCC is arranging to resume station licensing. That means that application forms must be revised and printed and distributed to the Inspectors. Some minor revisions of our regs will be necessary, notably to effectuate the rearrangement of call areas. The examining and licensing staff must be built up anew. There will be some complicated legal gymnastics to get through, undoing the close-down orders and the temporary orders that preceded Pearl Harbor, and clearing the way so that band after band can come back into the amateur field as the military release them. War's end found FCC as short-handed as every other civilian agency, and now doubly loaded with reconversion problems for all services. We don't know when they will be ready to resume station licensing; perhaps early October. Then there will be an announcement that causes all of us with our temporarily-revaluated but actually-expired licenses to step up and make it legal by getting a formal renewal; and all of us who have changed address can get modifications; and the LSPH crew can get their first station licenses; and the way will be open for GI Joe and Mac and Sal to get their tickets. But please note well that, until specific FCC announcement, no such facilities exist — Order 127 temporarily revalidates the Old Guard but offers no facilities for the New Guard until the machinery can be set up.

Hq. will keep directors, SCMs and clubs informed on developments. Try to keep yourself posted. Meanwhile we want to restore our OBS system as fast as possible, of course working locally on only the 112 band at first, then extending as other bands open. See if you can hear an OBS in your city in the 112 band with direct news from ARRL Hq. (If not, would you like to be the OBS for your city? Write to the acting communications manager.) To supply fast and authentic news to the OBS system and to amateurs generally, the League has asked for the special advance reactivation of W1AW on one c.w. frequency in each of the 3.5-, 7- and 14-Mc. bands. Press associations and broadcasters did a bad job of reporting the first BWC and FCC actions and confused many amateurs into jumping the gun. If we get the requested authority we'll be putting out the real news from W1AW on the three bands simultaneously — at 8, 9 and 10 P.M., E.S.T., on most week-day evenings for a starter.

Meanwhile let all hands note that the right to operate is confined to those stations that were under valid station license any time between Pearl Harbor and September 15, 1942 (date of last station license issued), and not since revoked; and only by persons holding a valid amateur operator license. Amateur op licenses valid at Pearl Harbor or issued since are still good if the operator filed proof of citizenship and has not since been suspended. Note particularly that we were not given the whole 112-116 band but only as high as 115.5 Mc. It is very important that the band limits be observed, particularly at the upper limit, as there is a Government snivvy on a near-by frequency that positively must not be QRMed. The usual regulations apply to operating, except that there is no facility yet for applying for modifications. Stations not now located at the last address of record (as shown on the license) must affix the portable designator to their calls, but notice to the Inspector is not required until operation is authorized on frequencies below 28 Mc. Amateurs and WERS may not intercommunicate. Persons holding WERS certificates only may not operate ham stations, although they may speak over the microphone. Keep your noses clean, fellows!

Now about emergencies. One reason for opening us up fast was to permit us to extend facilities for the relief of natural disasters to the many communities of the nation, not just the few served by WERS. The latter goes out in November and we must be prepared to take over. We'll be hard put to it to do as good a job as WERS, with its disciplined nets, can do. We must proceed forthwith to set up shop and do an orderly job of planning local emergency communications in the 112-115½ band, based on a thought-out communications plan tailored to each community's most likely emergencies and revolving around aid to some specific agency that needs our services — such as the municipal safety services or the local Red Cross chapter. Every amateur is asked to

make it his business to assist in doing a local job that will be a credit to amateur radio. Read the ACM's letter in this month's "Operating News" and let's show 'em that we haven't forgotten how!

How's intercity DX? Your SCM (address on page 6) wants a monthly report on your activities. Canada promises to open soon, so we'll have 112 crisscrossing the border. The PYs and LUs, by the way, have been going in the 56 and 112 bands throughout the war and . . . well, you know, you never can tell!

Have you any idea of the feeling that pervades us at Hq. these days? Boyohboyohboy! We've lived through the war and now we can go places. We have a going organization to get us back on the air, so different from the last war. Through the troubled years now ended we here had several successively lengthened goals. At first our only activities were to ensure that the institution of amateur radio contributed effectively in the nation's great need. We know we can be eternally proud of what amateur radio did in the war and we think we can feel some pride in the way ARRL helped them to do it. After a while it seemed possible to us to aspire to keep our organization together throughout the war, so that we would not have to go through the painful process of complete rebuilding as we did after the last war. As it became evident that we could hope to succeed in that, and that our country would win the war, our major ambition of course became to preserve our frequencies and to see amateur radio restored to the ether. That goal is now in sight. In turn it is replaced by a new one: to see the whole structure of amateur radio gloriously rebuilt, ever so much more interesting and useful than it was before. We're full of ideas at Hq. and getting rolling on them. Progress will be slow at first but it will gather momentum and then snowball, and we have high and confident hopes. We turn now to that rebuilding job. The war is over and we are on our way!

K. B. W.



SPLATTER



OUR COVER

IT WAS a perplexing problem, creating an appropriate cover for this special Navy Day issue of *QST* which would symbolize adequately the vast U. S. Navy communications-electronics establishment. The theme finally selected, is that of a mighty carrier task force — keystone of combat at sea in this war.

Heart of all task-force operations, both pictorially and in tactical importance, are the huge Essex-class carriers aligned in an oblique column across the page, and, tiered above and below, the lighter Independence-class CVLs. Dispersed protectively are their guardians, the mighty battle-

ships; these in turn preceded and flanked by cruisers, heavy and light. Strategically intermingled are the watchful destroyers — small but potent terriers of the seas. And finally, winging overhead are returning elements of two squadrons of bombardment aircraft, circling before landing — dive bombers above, torpedo bombers below.

The spectral silhouette-like quality is intended to epitomize communications — for to an enemy this would be a ghost fleet from which death can come winging.

— . . . —

FOOTNOTES

THE following is by way of enforced confessions from an assorted blue-clad group which might well be designated the Navy's "Quist Quintette."

(Continued on page 122)



THE Navy appreciates the patriotic work of the United States radio amateurs in preparing themselves for service in the defense of their country and then loyally entering the service at the outbreak of the war.

I concur with the statements made by Admiral Joseph R. Redman, USN, Director of Naval Communications, and add my commendation of work "well done."

James Forrestal
Secretary of the Navy

A Statement on

Navy Communications and the Amateur

*By the Director of Naval Communications
Rear Admiral Joseph R. Redman, U.S.N.*

THESE are the days of victory, in which the lifting clouds of war enable us to view in retrospect the course of the defeat of our enemies in Europe and the Orient. The task that once seemed so insurmountable, the task now so well done, takes perspective in history as we look back upon it with time for thoughtful consideration. At the same time, we find ourselves looking ahead to the opportunities of peace, in our eagerness for which we must not forget its grave responsibilities.

Many today, among ourselves, our Allies and our enemies alike, are asking the question: What was the secret by which the United States, peaceful and unprepared, could rise in such might and fury to the achievement of total victory? No single word supplies the answer; but I should like to add a different note to the too often casual reference to "production and natural resources." I should like to point with pride to the *fundamental readiness, willingness and ability of our people to do.*

We realized, at the very onset of war, that this was to be a *mechanized war*. The aircraft, the ship, the tank, the jeep, and the electronic gear of all our machines — these were to be the tools of the defeat of our enemies. In the early days of our barren armory, these were the same tools so successfully wielded by our enemies against us and against our Allies. We determined to make them faster and better than our enemies, and in quantities of overwhelming proportions. We were able to do so because in the United States were more people ready, willing and able to drive cars, build machines, operate radios, service telephones, run railroads — to do all of the thousands of jobs of mechanical production — than in all the rest of the world together.

We had been doing these jobs because we liked to do them, whether for profit or for fun. This inexhaustible American ability to tinker, to build, to take apart and put together again, to figure out a better, quicker way to do the job,



that was harnessed to the consuming demands of war. Without this national characteristic and experience we should never have conquered. It is epitomized in that typical Americanism: "know-how."

There is no better or more important example of this national asset of "knowing" and "doing" than the radio amateur. There were sixty thousand of them in 1941 — men and women who were ready, willing and able, with surprisingly little additional training, to do a large part of the tremendous communication and electronic job that faced us. No one of our enemies had as many as one thousand licensed transmitting radio amateurs in 1939.

Naval Communications has long recognized the value of the amateur. He had contributed materially to naval communication operations in World War I. In the interim years of peace, the Navy never forgot the importance of this rapidly growing group of self-trained men. It was the Navy's consistent policy to encourage every possible interest in amateur radio, in the knowledge that there was no better way to develop basic electronic training and technical "know-how." The Navy further realized that the one thing required to keep amateur radio alive was space in the radio frequency spectrum, for practical experimentation and actual practice in radio communication. The spectrum needs of amateur radio never failed to receive its support.

During that period the U. S. Naval Communications Reserve formed the connecting link between the Navy and amateur radio. At the outbreak of war the Naval Communications Reserve numbered about 650 officers and 3,000 radiomen. The great majority of these men were radio amateurs, or professional radio people whose interest in radio stemmed directly from their "ham" days. The Naval Communications Reserve provided the nucleus around which Naval Communications built its great wartime expansion. The reservoir of active amateurs was thus the first and most valuable source from which the needs of expansion were supplied. As a result, out of a total of some 30,000 amateurs engaged in the armed forces or vital war industry, more than 6,400 have been recorded as serving in the Navy, Marine Corps or Coast Guard.

Literally, they did everything. They learned quickly, and taught others well. They designed, serviced, operated and supervised in the fields of communications and electronics. They served



Rear Admiral Joseph R. Redman, USN, the Director of Naval Communications.



with ability, enthusiasm and unflinching devotion to duty. Their individual accomplishments have won praise on every ship, on every beachhead, and in every laboratory, radio station, or communication office in which they have served. As individuals, they have received many a richly deserved "well done." To amateur radio as a whole I would like to tender an added word of appreciation by the Navy Department, for performance "in the highest traditions of the Naval Service."

Many who have served with such loyalty and efficiency in this field will soon return to civilian life; to old jobs and new jobs; to homes and families — and, we are all happy to know, to "ham" radio, with all its modern refinements. Yet in no sense is this "hail and farewell." The Navy will forever carry to its advantage the marks of the work of the radio amateur and its service; and he, in turn, will carry with pride through the years the mark of the Navy upon him. In a very practical sense, too, we do not say "farewell," for the Navy will at all times continue its whole-hearted support of the interests of amateur radio. The Naval Communications Reserve will function again, reorganized for increased vitality and an expanded scope of endeavor, and utilizing to the fullest possible extent the new techniques and devices born of war. We came forward together in the past to achieve the fruits of victory. Let us go forward together in the future to preserve the riches of peace.



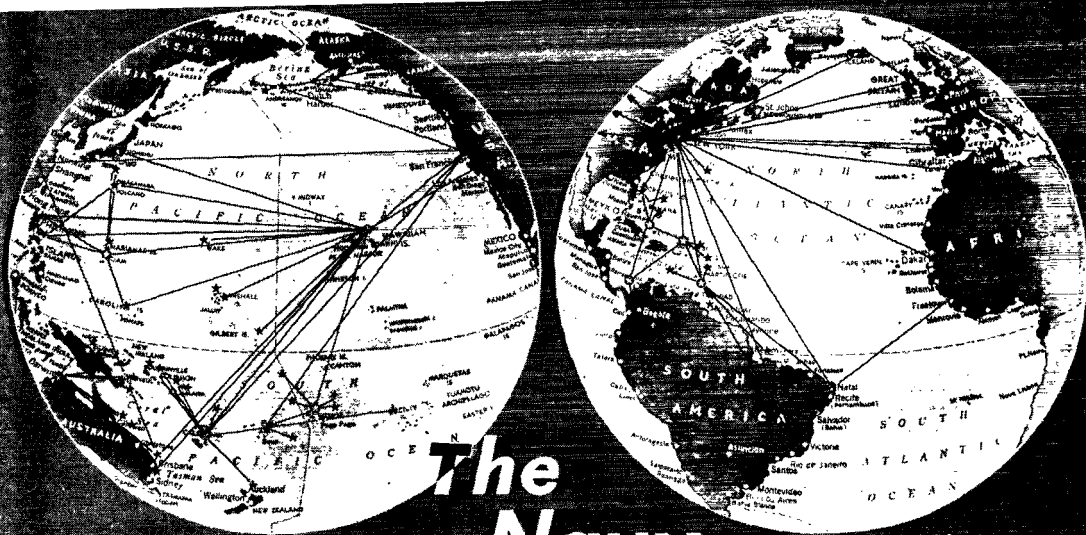

The Navy Ashore

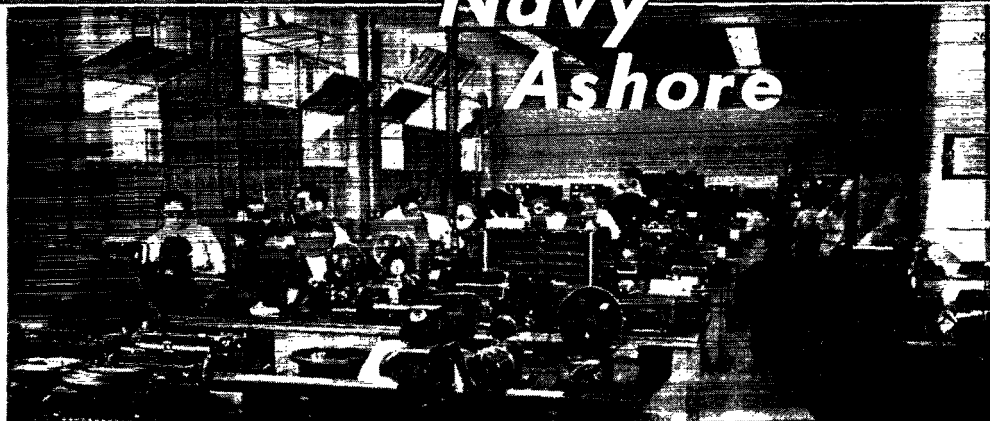

The fingers build a bridge of words spanning the seven seas via multiplexed radio circuits in Op-19's automatic radio room — heart of the Navy's far-flung communications system. Through "Radio Washington," nerve center of Naval Communications, passes all Navy communications.

THE story of the Navy's electronic victories in this war begins with the elongated shadow of the Washington Monument. There more or less literally, in the great monument's shadow are centered the heart and brains of the naval establishment.

Its central headquarters, the Navy Department building, is a huge, rambling structure covering acres of floor space. There the Secretary of the Navy, the Chief of Naval Operations, the various Bureau chiefs, more than 10,000 naval officers, civilian officials, experts and clerical and other workers — all focus a structure in which the clicking of telegraph keys and typewriters is a catalyst which converts the raw materials of the nation's fighting power into the roar of battleship salvos in the far corners of the world.

This is the Navy Department — the organization which backs up the fighting fleet at sea. It is a story not only of the design and building of ships and guns and planes — and particularly the component radio and electronic equipment — but also of the vast organization that administers, originates, plans, maintains, repairs and equips

the Navy's weapons, and recruits and trains the men who use them.

Under the President of the United States, as commander-in-chief of both Army and Navy, the Secretary of the Navy executes "such orders as he may receive from the President relative to the procurement of naval stores and materials and the construction, armament, equipment, and employment of vessels of war, as well as all other matters connected with the naval establishment." He is aided in carrying out these duties by an Under Secretary and two Assistant Secretaries of the Navy, and by the naval officers who serve as chief of the various bureaus to assist him in the operation and management of the Navy.

The Chief of Naval Operations, the senior officer in the Navy, is charged with the responsibility for the operations of the fleet and with the preparation and readiness of plans for its use in war. Incorporated in his office is "Op-20" — the Division of Naval Communications.

The Director of Naval Communications is responsible for the organization, administration and operation of the Naval Communications

service. He also supervises merchant ship communications, determines the communications aspects of legislation, treaties and agreements, supervises the preparation and distribution of communication publications and operates the Navy Department's communication office. He maintains liaison with other agencies on communication matters and electronic equipment — JCB, CCB, BWC, ITC and IRAC.

Of the seven Bureaus, those directly associated with this story are: the Bureau of Naval Personnel, charged with the procurement, education, training, discipline, and distribution of officers and enlisted personnel of the Navy. This includes the Naval Reserve and Reserve Officers Training Corps (except the professional education of officers, nurses, and enlisted men of the Medical Department); the Bureau of Ships, responsible for the strength, stability, design, building, fitting and repairing of all parts of ships of the Navy, including electronics except as relates to ordnance matters; the Bureau of Ordnance, charged with the upkeep and operation of all ordnance establishments — magazines, gun factory, torpedo stations, proving grounds — and the manufacture of arms, armor, and explosives — including electronic fire-control gear.

CNO (DNC)

Within the office of the Director of Naval Communications are performed many and varied functions. (It is significant, therefore, that the officers in "Op-20" are 80 per cent ex-amateur.)

First, there is the Deputy Director, who is an alternate member of CCB and BWC. He has two special assistants, one on communication aspects of legislation, the other dealing with international and regional conferences and special projects.

Then there are assistant directors responsible for various basic categories of activities: the assistant director for shore, responsible for inter-continental radio and cable, coastal radio, shore service radio, NTX, telephone, TWX and miscellaneous leased wire facilities, and an assistant director for plans and operations in charge of communications plans (including Navy), joint-combined control liaison with other services and the duties of official historian, procurement, assignment and protection of Naval frequencies; serving on IRAC, FAC, USJCB and advisor to international telecommunication conferences; and traffic studies, and weather, time, hydrographic broadcasts, including circuits and schedules.

For purposes of practical detail there is an assistant director for fleet (technical), responsible for all radio equipment, along with antenna systems and measuring equipment, amphibious and photographic (radio) equipment and invisible light signaling systems, and automatic systems and teletype adaptations. The assistant director for fleet controls such matters as visual signaling recognition



Commodore J. V. Murphy, USN, Deputy Director of Naval Communications



One of the rewards of our hard-earned victory is the return of amateur radio. With the removal of wartime restrictions, the radio amateur will again be able to return to his peacetime hobby and to further the development of radio. The amateur is gentlemanly, loyal, progressive, friendly, balanced and patriotic. As always, his conduct will be governed by the high standards of that code. It was in the spirit of this code that the amateur served the Navy so well and contributed so much to the successful prosecution of the war. I hope that the amateur's loyalty and patriotism will be further preserved and strengthened by serving in the post war organization of the Naval Communications and Electronic Reserve.

— Commodore J. V. Murphy, USN, W3FN

and USN and combined call signs; merchant ship communications (BAMS); communication instructions, publications, and training; CIC publications; wave propagation programs; and fleet communications. The assistant for aeronautics has cognizance of aeronautical communications: air-ground and ground-air, point-to-point, NATS, air liaison with AAF, ATC and CAA, air station and airborne equipment and personnel studies; air station communication and liaison for air-navigational aids and instrument approach equipment; aeronautical d/f nets; air-sea rescue, and U.S. Coast Guard liaison.



CNO (DNC) Op-20-B, shore stations section, includes these hams. Left to right: Lt. Roy E. Kelly, USNR, W3HPI; Lt. Bernard J. Orscheid, USNR, W9MUX; Lt. Cdr. John Wall, USNR, N8LJQ; Lt. Cdr. Frederic H. Smith, USNR, N9DLL; Lt. Cdr. Louis A. Harrison, USNR, N3DEL; Lt. Cdr. Burton P. Williams, USNR, N8ZAE.

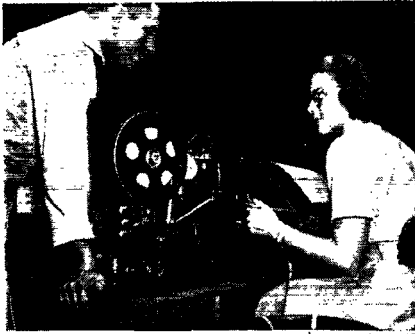

Right — WAVE reservists serve along with Navy operators on manual circuits in the radiotelegraph branch of the Naval Communications office in Washington — sending and receiving the vital messages reporting the progress of the war.

Left — Checking slip keying a high-speed auto transmitter in contact with an overseas base.



Other specialized officials deal with such matters as communications intelligence activities, cryptographic systems, publications, communication counter-measures, communication security and postal affairs.

Naval Communications

There is a familiar Navy saying which goes: "Communications may be correct 999 times out of a 1000 and yet receive no credit for its work. It is the one mistake in a thousand that brings down the wrath of the gods."

Communication in wartime is a matter of getting the information, interpreting it, and then acting upon it. Human error is not allowable. So great is its importance, so many the men directly involved in handling the administration, the operation and the instruments of communications, that of all phases the point most stressed in Navy radio is the flawless performance of the function radio communication is designed to serve — not the technical details of the transmission itself.

This is the philosophy underlying the Navy Communications System. Naval communication is a *service* — one that must be provided at all times for both command and administrative information.

The responsibility of establishing and maintaining such service is placed on the Division of

sets designed to fit in a Marine paratrooper's pocket.

Under the supervision of the Naval Communications Officer, "Op-19" — the Navy's radio central — serves as focal point for the Navy's worldwide message traffic. Here, in vast sprawling rooms all the Navy's incoming and outgoing radio and wire communications are transmitted and received.

In a newly created automatic room, using a system so complex that an adequate explanation would require the aid of many pages of charts and diagrams, radio contact with any Navy activity anywhere on the globe may be established by the simple procedure of dialing a telephone number connecting up the appropriate transmitter, beam array, and frequency.

Methods used for the transmission of messages by radiotelegraph are the *Receipt* (R), *Broadcast* (F), *Intercept* (I) and Basegram methods.

In wartime the most widely used is the Broadcast (F) method in which messages are sent blind on one or more frequencies and copied by all ships or stations required to guard these frequencies. One disadvantage to this method is the lack of assurance that the message has been received by the addressee, no station or ship being permitted to use its transmitter in any manner that might be connected with the "F" transmissions. This disadvantage is outweighed, in part, by the absence of the possibility of the location of the ships

Amateurs attached to "Op-19," Washington, include, *left to right, sitting*: Lt. Cmdr. V. H. Cook, W8RNH; RM2c Irma R. Montague; Lt. Cmdr. F. Mousley, W3FI-W3EQR; RM2c E. B. Saltontall, WINRU; Lt. R. W. Lindahl, W7MP; CRM W. P. Morrison, W8UHX. *Standing*: Lt. G. E. Milius, jr., W2NIF; RM1c A. Mazzoni, W1MAB; Y1c W. M. Peterbin; Lt. Cmdr. F. K. Knight, W4BIH; Lt. Cmdr. H. L. German, W8KOB-W3IMN; Lt. D. L. Cameron, W8RNH; RM1c R. E. Straughn, W9LCW; RM1c W. L. Little, W2OJJ; RM1c P. Panzarino, W2NSC; Lt. E. H. Glunt, W8QBK-W3JZP.



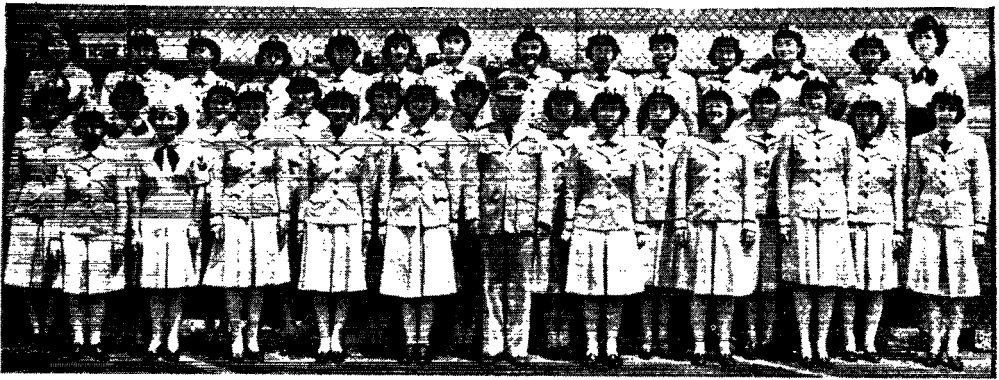

Commodore J. B. Dow with a group of WAVE technicians in the Electronics Division, Bureau of Ships.

at sea by the enemy due to absolute radio silence. However, in practice this method has proved satisfactory, through the use of proper frequencies, adequate power and repetition of transmissions on more than one schedule. The "F" method is the principal means of transmission from shore stations to the forces afloat.

Equipment Allowances

Allowances of equipment for the various types of ships, planes, shore stations, and bases also are specified by the Chief of Naval Operations.

The CNO (DNC) organization works directly with the commanders in chief and the operating forces in establishing operational needs. Instructions for airborne equipment are transmitted to BuAir, to BuOrd for ordnance, and to BuShips for ship and shore station equipment.

All contract and production administration involving electronics is handled by the Electronic Division of BuShips, except for the fire-control and other specialized equipment handled by the Bureau of Ordnance. Installation and maintenance of the latter is handled jointly by BuOrd and BuShips, through the RMO field organization. All other radio, radar, sonar and related electronic material installed aboard ship and on shore is handled by BuShips through the same field organization; airborne equipment is handled by BuAir after initial distribution by BuShips.

Altogether, since December 7, 1941, some 300,000 complete equipments, each comprising two to fifteen major units, were installed in more than 38,000 vessels and landing craft. The unit cost varied from a few hundred dollars for a simple receiver to \$250,000 for the most complex item.

The Navy's aircraft equipment program was similarly large. By mid-1945 the Navy had over 38,000 service airplanes—all equipped with transmitters, receivers, radar, altimeters, direction finders, homing devices, and related gear varying in number from three complete sets for the smaller planes to ten in the largest.

Delivery of communications and electronic equipment rose from approximately \$4 million monthly in 1941 to considerably over \$100 million per month in 1944-1945. During the calendar year 1944 the Navy purchased in excess of \$1,300,000,000 worth of radio, radar and sonar equipment, exclusive of a large amount obtained

from the Army. This expenditure continued unabated during the first months of 1945.

Electronics Division

It is the function of the Electronics Division of the Bureau of Ships to provide the electronic weapons of modern war. This includes (a) the design of all types of electronic apparatus, the coordination of research and development, and redesign based upon combat experience; (b) installation and maintenance, including installation planning, sifting of failure reports, and coordination of repair activities; and (c) procurement, production and shipment.

To perform these duties, the Division is organized into three main branches—Design, Equipment, and Installation & Maintenance.

The Design Branch administers the research, development and design work conducted in government and commercial laboratories and plants, prepares technical specifications for materials, components and equipment, and handles matters of a technical nature involving production, inspection, and standardization.

The Equipment Branch is charged with the translation of CNO directives into procurement requests, selection of qualified contractors, establishment of delivery schedules, supervision of production through naval material inspectors, and distribution of material after production.

The Installation & Maintenance Branch administers the electronic field organizations at Navy Yards and shipbuilding activities, works with fleet and shore station activities on installation and maintenance problems and collaborates with other divisions of BuShips on ship plans.

The basic requirements for electronic equipment established in CNO (DNC) are in the form of



Capt. D. R. Hull, USN, ex-ICBU, Deputy Director of Electronics.



Lt. J. Ceilikoff, USN, ex-WIAT-CMBHR R. A. Manjil, W18WH Lt. R. H. Sprout, USNR, W1GID Lt. H. K. Hudson, USNR, W1QYZ D. L. Ryan, W11MC Lt. (jg) S. S. Corlier, USNR, W1JEX



Comd. A. B. Jank, USN, W1MFE, ex-WJADD, etc. Lt. J. H. Pizman, USNR, W1N8K Lt. (jg) D. F. Calburn, USNR(O), W1N9Y Lt. G. P. Casper, USNR, ex-W2A0E Lt. (jg) R. E. Study, USNR, ex-W2A0U Gustave Liebermann, ex-W2ANT



H. S. Ray, ex-W2A2XJ Lt. B. F. Bersedy, USNR, W1ATK, ex-W1T71 Lt. Cdr. J. V. Cosmon, USNR, ex-W2CER Lt. Cdr. R. D. Chipp, USNR, W21N8 Lt. Laule Koch, USNR, W21ET Lt. W. H. McNeil, USNR, W21CM



BuShips Ham Gallery

1st Lt. C. L. Parody, USMC, W2NFK A. J. Stobbs, W3ALZ, ex-USAJ W. A. Duncan, W3ASH Lt. E. Boddock, USNR, W3BAY



W. M. Clevestine, W3CUD John C. O'Connell, Jr., W3DAI Capt. H. E. Bessak, USN, W3EJ, ex-W1KO 504H Lt. W. E. Duffin, USNR, W3ETT Gordon Walker, W3EYX Lt. (jg) J. A. Saffin, USNR, W3FKT



M. C. Bly, W3PFL J. W. Miller, W3FRW Dean Young, W3FZ W. L. Smith, W3QKP J. Hemingway, W3HUM A. P. Mossey, W3HYI



Earl Springer, W3IFO, ex-W98WV Lt. G. C. Kuehl, Jr., USNR, W31QJ Lt. Col. F. A. Remsey, Jr., USMC, W31YI Lt. Col. D. S. Wicks, USNR, W3DK, ex-W3DZ Lt. Arnold Shastak, USNR, ex-W3JZF-10YM W. B. Parline, W3ZE



Comdr. T. C. Hyers, USNR, ex-W4ABA Lt. (jg) J. H. Boyd, USNR, W43CP R. Heckler, W4CYU J. F. Thompson, W4DOS Lt. R. M. Hoskins, USNR, W4RZ W. M. Shoup, W4EHO

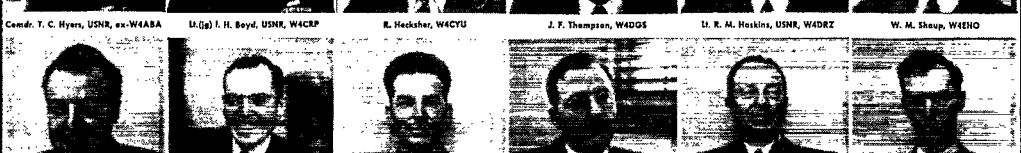

C. E. Marchburn, W4EL Enr. F. S. Andreas, USNR, W4EOX Lt. J. G. Cormack, USNR, W4ERE Lt. W. C. Thomas, ex-W4EVI Lt. W. R. Reese, USNR, W4HDN C. T. Isley, Jr., W4KEW



G. T. DeLaMotte, ex-WSBR



Lt. L. C. Harlow, USNR, WSCYO



Lt. James L. Lutz, USNR, ex-WSDR



F. C. Twiss, WSFR



Capt. James H. Lavigne, USNR, ex-WSHT



WO J. P. Freeman, USNR, WSHOT



Lt. J. O. Lewis, USNR, ex-WSLWY



Lt. W. W. Smith, USNR, WSCCK



Lt. W. E. Theile, USNR, WSBTY



L. N. Higgins, WSCAE



V. H. Tompa, USNR, WACGU, ex-WXBYV



Lt. Albert F. Starbuck, USNR, ex-ACY



Lt. I. F. Lynde, USNR, WDEPF



Roy L. Dewley, WADHG



Lt. A. C. Fluher, USNR, WATUP



H. P. Gates, Jr., ex-WGEVE



Lt. Cdr. J. C. VanCress, USNR, WGGFY



Lt. P. T. Moses, USNR, WMAAT



Lt. G. O. Line, USNR, ex-WAMH



Lt. Col. L. L. Hahn, USN, WNGI, ex-KAIRM, ZUMH

BuShips Ham Gallery



Lt. C. W. Service, USNR, WOOD, ex-WGCF



CRE W. J. Beaver, USNR, WATE



W. L. Robinson, WAUHZ



Lt. J. H. Brown, USNR, WGVH



Lt. H. S. Johnson, USNR, ex-WPAPA



Lt. Cdr. H. J. Scott, USNR, ex-7RG



Lt. Cdr. T. V. Ehnson, USNR, WTVS



Comdr. P. K. Laberman, USNR, ex-WHT WTL



Lt. J. G. Keyworth, USNR, ex-WBARF



F. J. Reddy, WBECK



J. L. Treneman, WBOVI



Lt. Cdr. J. H. Altan, USNR, ex-WELJO



W. D. Henderson, WEMOW

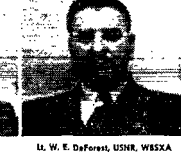

Lt. W. E. DeForest, USNR, WSSKA



Lt. S. T. Gorman, USNR, WBUEJ



G. K. Glass, WBUOR



H. G. Werness, ex-WBSHV

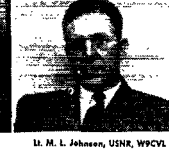

Lt. M. L. Johnson, USNR, WPCVL



Lt. M. M. Haza, USNR, WPDKJ



Lt. J. F. Noy, USNR, WYFDR

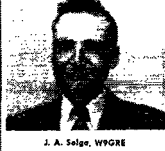

J. A. Selzer, WPGRE



Maj. B. E. Hargrove, USN, WNTLE, ex-WNMR



R. F. Tschannen, WYLUO

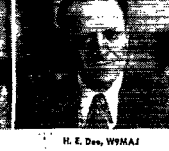

H. E. Dee, WYNAJ



G. L. Madril, WYHEV

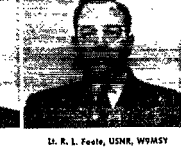

Lt. R. L. Foote, USNR, WYMSY



Lt. J. F. Linley, USNR, WYNSD

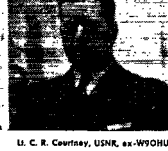

Lt. C. R. Courtney, USNR, ex-WYOHU

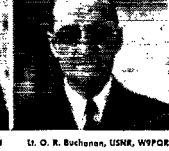

Lt. O. R. Buchanan, USNR, WYPCR

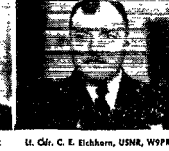

Lt. Cdr. C. E. Eichhorn, USNR, WYPRC

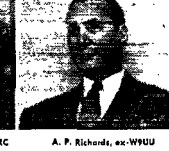

A. P. Richards, ex-WYQUU



P. A. Loh, WYWHO

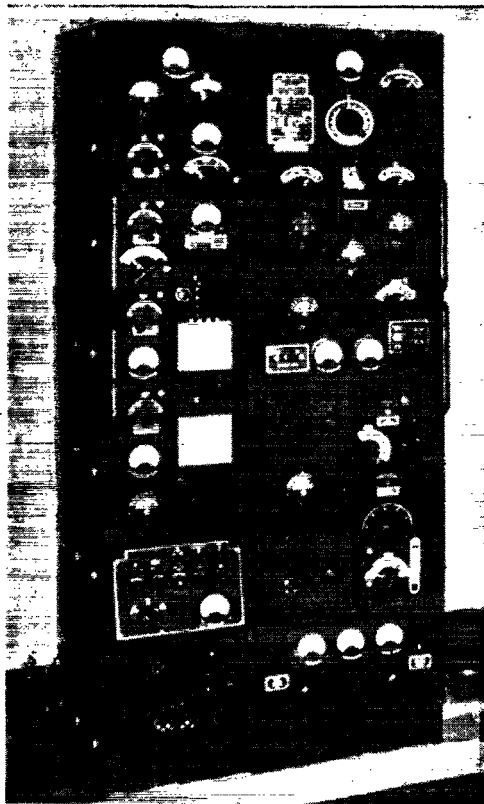

The Navy's Model TBK, typical of shipboard-type transmitters, operates in the medium- and high-frequency ranges with 500 watts output on c.w.

directives indicating only the military requirements, rather than as instructions for the installation of some particular set. For example, having decided upon some tactical phase of a coming operation, the CNO might direct that BuShips equip all aircraft carriers with a transmitter capable of communicating with aircraft over a certain frequency range, stipulating only the number of channels required and the approximate range to be covered. The details are up to BuShips.

"Type Desks"

Within the Bureau are a number of groups, known as "type desks," each of which is responsible for all aspects of the design and building of a particular type of ship. In the example referred to above, the engineer in charge of installing communication equipment on carriers would take up the problem with the carrier type desk. How much primary power will the transmitter require, and how will this fit into the complicated over-all system? Will the electrical generating plant be capable of supplying the total load? Where will the transmitter be placed? What space is available for it? Is the location chosen as best from the space and weight standpoint also the most convenient when viewed in the light of how the transmitter will be used in battle?

All these questions and more must be answered and the necessary compromises effected.

As another example, take the case of a new class of destroyers on which radio, radar, and sonar gear must be installed. A destroyer is a very fast but comparatively small vessel whose prime purpose is to nose out and strike hard, lightning-fast blows against the enemy. Thus weight becomes a paramount problem. Antennas, cabling, power supply — each element of the complex installation adds weight to the ship, some of it well above the keel. Stability of the vessel must be safeguarded by careful study of the proposed location and weight of each item. Antenna requirements and locations must be studied from both stability and interference standpoints. Delicate parts must be arranged with an eye on the location of the heavy guns; special shock mountings may be provided, and cabling must be laid out for maximum protection against damage.

These examples suggest only a small part of the over-all problem. The Navy consists not only of carriers and destroyers, but of several hundred different kinds of vessels. Since even the comparatively small destroyer may carry perhaps six transmitters and nine receivers, plus several complicated radar and sonar equipments, the complexity of the job becomes apparent.

It Could Not Fail

The Navy had plans for much of the equipment now in use long before the war began. Years of work went into the current "new" designs. Special radio sets had been designed for battleships and aircraft carriers, for cruisers and submarines, for tanks and jeeps and landing craft — equipment built to withstand the coagulating cold of the Arctic and the dissipating dampness of the tropics. Radio sets for the Pacific, for example, had to be built of materials capable of withstanding the triple tropical assault of heat, dampness, and bugs. In Guadalcanal the best commercial-type equipment on hand fell apart in a few weeks — but the new Navy gear could take it!

Millions of dollars had been spent to develop protective methods which would withstand not only exposure to salt spray but prolonged complete submergence — the result was equipment that could be safely thrown overboard and allowed to float ashore. At Saipan some of the radio gear on landing craft was completely drenched during the early landing; nevertheless, it functioned successfully throughout the entire operation. That gear, literally, helped to win Saipan.

For various reasons, the accomplishments of BuShips in developing radio and electronic equipment cannot be told here in full. Their very number is so vast as to make individual description impossible for this reason alone. Yet even so much of the story as can be told attests that the speed with which the Navy's overwhelming might drove the Jap from the seas and brought our land forces within the shadow of Tokyo would have been greatly lessened and the ultimate achievement far more costly in both men and ships without these electronic weapons.

"Equipping the Fleet. . . ."

BY THE DIRECTOR OF THE
ELECTRONICS DIVISION, BUREAU OF SHIPS

WHEN war broke out December 7, 1941, the naval shipbuilding program, which at that time had been greatly expanded, created a requirement for large quantities of radio, radar, and sonar equipment. As the war progressed the shipbuilding program, involving both combatant and noncombatant type vessels, was increased again and again until the United States Fleet included in all categories some 40,000 naval vessels. To fit out and equip a fleet of such vast size was a job of staggering proportions. Radio equipment was needed for each ship, along with underwater sound devices and, of course, the miraculous radar.

In order to direct the program under which these tremendous quantities of electronic equipment were to be designed, purchased, and installed, it was necessary to recruit as officers and civilian engineers hundreds of men who knew radio.

One of the best sources of men trained in electronics was the large group of radio amateurs. In the Bureau of Ships alone some 300 officers and civilian engineers, all of them ex-radio amateurs, have, since early in the war, been successfully engaged in equipping the fleet with electronic apparatus. In addition to these, 300 other ex-radio amateurs have been employed at Navy yards, repair facilities, supply points, and advanced bases in performing the installation and maintenance

of billions of dollars' worth of electronic equipment. I wish here to pay tribute to the enthusiasm, skill and technical com-

petence of these key electronic officers and engineers whose assistance has been invaluable to the Navy in the successful prosecution of World War II.

The radio amateur has always, in peace or in war, cooperated in full with the Navy, and I am confident that the Navy can always depend on this fine group of men for cooperation and assistance. The "ham" has contributed much enthusiastic experimentation and research which have been responsible in large measure for the rapid advance of the electronics art in

this country, and I know that he will continue to make major contributions to further knowledge and development of electronic application.

It is the hope of all our people that this country will not again become involved in war. If war should break out again, however, and involve this country, some of the most potent weapons of offense and defense will be those involving the use of electronic principles. The Army and Navy will consequently again require large numbers of men who are trained in electronics and I feel sure that the American radio amateur will answer the call to service with the patriotic enthusiasm he has always displayed.



Commodore J. B. Dow, ex-W3TL

Below: Officers, engineers and technicians in the Electronics Division, Bureau of Ships — hams every one.



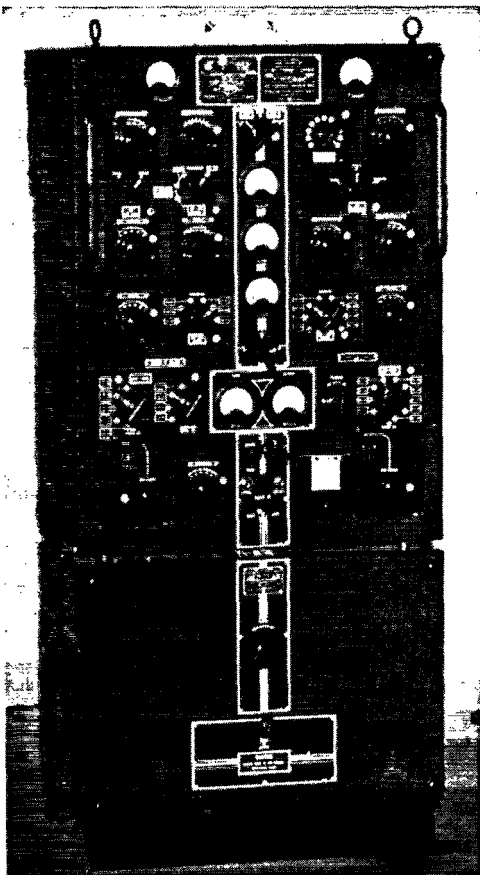

The TDE shipboard-type transmitter.

Radio Equipment

Today's naval vessels literally bristle with antennas. Even the tiny MTB (motor torpedo boat) carries seven types of radio and radar gear, while the mighty 45,000-ton Iowa-class battle-ships carry as many as 80 major operating installations — not including the complicated fire-control equipment, electronic test gear, and other specialized radio apparatus aboard. The installation in a large carrier comprises more than 100 complete equipments — the term "equipment" meaning a complete receiver or transmitter and its associated components. Certain types of landing craft have as many as thirteen complete sets; others as few as three — one transmitter and two receivers each.

More than one hundred different types of radio transmitters are required to serve various needs aboard ship and at Navy shore stations. Not all of these represent completely individual designs, of course; some models closely resemble each other and utilize identical basic elements, differing principally in power or frequency. Certain sets are designed for maximum flexibility in frequency coverage or range, or in the type of emission — whether high-speed auto, c.w., m.c.w. or voice — while others are created for special functions.

Navy transmitters may be roughly classified according to their primary use as (1) ship, (2) shore, (3) semi-portable, (4) portable, (5) para-troop, and (6) life-raft. However, many types primarily intended to be used on shore are also to be found on shipboard.

Obviously, prohibitive space would be required to describe all of these different combinations in detail. This discussion, therefore, will be limited to typical units from the major categories. Additional types are pictured in the training-school views on page 34 of this issue.

Ship Transmitters

Approximately thirty transmitter types are used aboard ship, the larger vessels carrying up to a dozen of these different types. These types include some of great flexibility, operating equally well at low, medium or high frequency. Some transmitters are designed for operation at both "high frequency" and "very-high frequency," while others are designed for v.h.f. operation only.

Typical of shipboard-type transmitters is the Model TBK (see page 22), operating in the m.f. and h.f. ranges with 500 watts output on c.w. It is powered from a 5 h.p. three-unit m.g. set, supplying 3000 v. d.c. at 350 ma. for the final power amplifier plate and 2000 v. d.c. at 750 ma. for the intermediate amplifiers. The low-voltage unit supplies 1000-volt d.c. at 750 ma. for the master-oscillator and 275 volts d.c. at 1.3 amperes for bias and field excitation. A.c. filament supply is derived from slip rings located on the driving motor.

All tuning and operating controls, together with access doors to the tube compartments and relays, are located on the front panel of the TBK. The bottom compartment contains control and filter circuits and terminal boards for all external connections. Directly above, on the left, is the electron-coupled master oscillator and doubler stage using a Navy-type 860. This stage is

A representative Navy station installation for small shore-station and general use, with one multichannel 500-watt transmitter and dual operating positions.



mounted within the transmitter as a separate unit, removable for servicing. The set is equipped with a flexible antenna tuning system which facilitates coupling to antennas of widely varying characteristics.

Shipboard transmitters, even where designed for similar power and/or frequency specifications, may vary widely depending on the type of vessel in which they are to be installed. Size and weight determine to a large extent the physical characteristics which may be adopted. For example, the TAJ-8 transmitter was designed primarily for installation on destroyers and light cruisers. This transmitter is, therefore, a very compact, light-weight unit. It operates in the low- and medium-frequency ranges, with an output of 500 watts on c.w. and 250 watts on m.c.w.

The tubes in the TAJ-8 are mounted on shelves accessible through a door located on the right-hand side. Another door at the bottom of the panel provides access to the first shelf, containing control and filter circuits. The set is powered by a three-unit motor generator, one unit supplying 1500-volt d.c. at 250 ma. for the driver, the modulator one delivering 3000 volts d.c. at 400 ma. for the power-amplifier plate, and a low-voltage bias generator providing for screen voltage and field excitation.

Where size and weight are not so vital a consideration somewhat more elaborate units may be used, like the TAQ-9, which is designed for medium-frequency high-power operation on battleships and light cruisers. Despite the comparative bulk of the Model TAQ-9, when uncrated each separate unit is capable of passage through a door 25 × 54 inches or a 30 × 36-inch hatch.

The TAQ-9 employs one m.o. stage, one i.p.a., two peak amplifier tubes, and an audio oscillator tube. "E.c.o."-style frequency control is provided by the master oscillator. Keying is accomplished by a relay capable of handling 100 w.p.m. Like other Navy shipboard transmitters, it employs a flexible antenna tuning system, making possible efficient antenna coupling into the widely varying capacities of the various shipboard antennas.

Then there is the TBM, one of the most extensively used shipboard transmitters. It is also a medium-power rig operating in the m.f. to h.f. range, providing telegraph, modulated c.w., and voice communication. It employs an 860 master-oscillator tube, with additional 860s in the first and second intermediate p.a. stages and an 861 in the output amplifier. On the audio end, two 807s are used in the driver amplifier for the modulator, one 807 in the voice relay circuit, two 6D6s in the input speech amplifier, a pair of 803s are used as modulators, one 1616 in the modulator limiter and one 25Z5 in the compressor limiter.

Shore Transmitters

Shore radio equipment naturally also differs considerably in size and characteristics, depending upon the purpose to which it is put.

Typical of Navy shore station transmitters is the 2-kw. TAB series. These transmitters are designed to be installed at shore bases where

high-power c.w. equipment is required on both low and medium frequencies. Provision is made for the use of two antennas, output being switched from one to the other by a manually operated panel switch.

The 3-kw. TDH quick-shift transmitter, on the other hand, is a considerably more complex outfit. Capable of 100 per cent modulation, it is designed for completely unattended remote-control operation with A1, A2, or A3 type emission. The frequency coverage is continuous from 2 Mc. to 18 Mc., with 11 preset channels automatically selectable in that range and complete manual coverage throughout the range.

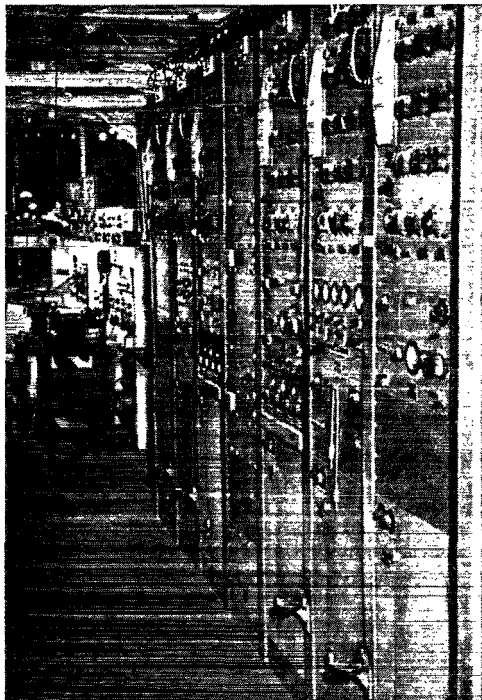

These racks constitute an RBP diversity-type dual receiving unit. Supervisor's desk is in the background.

Receivers

A notable feature — from the ham standpoint — of standard Navy receivers is that many are standard amateur-type communications receivers, the principal distinction being in the paint job and, perhaps, the use of a different escutcheon and knobs. The only other changes are those necessary to meet Navy longevity or non-radiation standards. Thus HROs, SX28s, SuperPros, SX27s, HQ120s, NC100s, RMEs and the like — all these are commonly found in Navy radio stations, ashore or afloat.

The Navy's RBG, for example, is an HQ120 behind a special Navy-style panel. The RBK bears a close resemblance to the S-27D which may be reposing on your dealer's counter, while the RAS series is the identical twin (except for face make-up) of the NC-100.

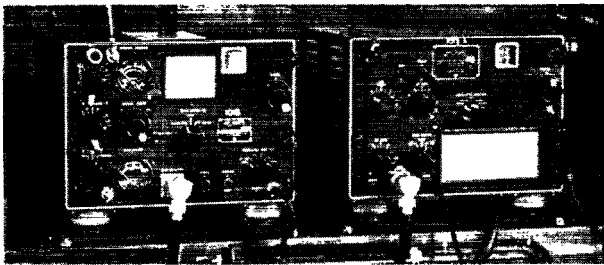

The famous Navy TCS transmitter-receiver combination gives output of 25 watts on c.w., 15 watts on voice. Tubeline-up is as follows. In the transmitter: master oscillators (2), 12A6; buffer-doubler, 12A6; power amplifier, (2) 1625s; modulator (2) 1625s. In the receiver the r.f. amplifier is a 12SK7, with a 12SK7 converter, 12A6 oscillator, 12SK7 first and second i.f. amplifiers, two 12SQ7s in the detector, and a 12A6 audio amplifier.

☆

As in the case of the higher-power transmitters, which are "custom-made" to Navy specs, there are certain types designed especially for Navy use — these being mainly the elaborate diversity or non-fading dual or triple (simultaneous reception on harmonic multiples) jobs. The equally unorthodox RBY "visual image" series consists, however, of a regular ham-type SX-28 with a panoramic adapter. While the receiver continues in normal operation a visual image of the passband is displayed on the c.r.o. screen of the adapters. The antenna used with the RBY is usually an inverted-L, 75 feet long and raised as high as possible.

Among the more specialized Navy types is the model RAZ, designed for shipboard use, covering 15 to 600 kc. in four bands. This receiver was designed originally for battery operation, but subsequent modifications providing for a rectifier-type power supply and also a preselector stage improves the preselectivity and gain and, most important, reduces undesired radiation to a negligible degree. The RAZ has a crystal detector mounted on the rear of the removable tube door, for emergency use when no separate tubes are available or the receiver power supply is disabled. The t.r.f. circuit involves an r.f. amplifier, regenerative detector, first a.f. amplifier and audio power output using 6K7s in the r.f. amplifier, regenerative detector and first audio stages, with a 6A6 as the second audio amplifier.

Another familiar Navy receiver is the RBJ, used both on shore and aboard ship. It is a superheterodyne covering the frequency ranges from 40 to 44 kc. and from 480 to 30 Mc. in nine bands. Output power is 2 watts undistorted on the loud-speaker, 10 milliwatts in the 'phones.

Most elaborate of all, the type RBP receiving equipment is a space-diversity system designed for use at shore stations. With three long-wire antennas in a triangular arrangement, spaced approximately one thousand feet apart, the signal will almost never fade out on all three at the same time. Feeding the signal from each antenna through a separate receiver and combining the three rectified outputs, gives a relatively constant output level. The RBP covers from 3 to 24 Mc. in three ranges. Each range has its own antenna-coupling circuit, three stages of r.f. amplification, heterodyne oscillator, and a heterodyne detector with an i.f. output at 250 kc. The i.f. from the strongest receiver at any instant is then passed through two stages of amplification, where it is mixed with the output of a 400-kc. oscillator

to produce a 50-kc. second i.f. signal. It is then passed through one of three selectable band-pass filters and an isolation amplifier. A variable oscillator beats with the signal applied to the detector to give an audible note. In telegraph operation keying speeds as fast as 500 dots per second can be handled. On voice the over-all fidelity of the RBP is of commercial quality. It has an output undistorted of 15 milliwatts.

Portable and Semi-Portable

Notable among the semi-portable and portable types is the TCS series of transmitter-receiver combinations. Used primarily on Navy small craft, often the TCS is the first set in operation ashore during beachhead landings. It is universally employed on fire, rescue and crash trucks, as well as on jeeps and command cars.

Another portable ship-to-shore (or any combination thereof) transmitter-receiver which saw extensive use is the single-unit TBX series with a power output of 9 watts on c.w., 3 watts on voice, in the m.f.-h.f. range. These sets are intended for ship-shore and similar communication over distances of approximately 30 miles on c.w. and 15 miles on voice. The major units are supplied with canvas-pack carrying cases, the entire outfit being fitted into a vulcanized fiber-plywood shipping chest with wooden inner partitions. All units are watertight and submergence-proof.

The Navy also uses ham-brand v.h.f. transceivers! An Abbott TR-4, for example, Navy-bought but still in the familiar dovotone metal cabinet, attained incidental distinction as the first radio set in operation ashore during the Kiska landing.

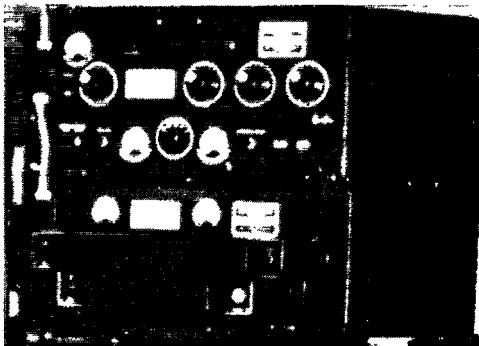

The TBX transmitter-receiver is rated at 9 watts output on c.w., 3 watts on voice. The superheterodyne receiver unit covers a frequency range of 2 to 8 Mc.

●●●RADAR●●●●●●●●●●RADAR●●●●●●●●●●RADAR●●●●●

Radar is the most versatile weapon of modern warfare. Its adaptations range all the way from small units fitting a flashlight case to complex 370-tube assemblies.

A heavy bomber carries what would seem a good bit of radar — search gear for navigation and bombing, an identification set, a radar altimeter, a tail-warning set, as many anti-night-fighter radars as required for the control of its gun turrets and, perhaps, RCM — radar countermeasures — gear. By comparison, however, a warship is literally festooned with radar. Both main and secondary gun batteries — meaning both five-inch dual-purpose and 14- to 16-inch heavies — have their own fire-control radars. There will also be several search radars nestling in the superstructure, with associated IFFs, silently maintaining watch for enemy ships, submarines and planes.

Since the war began more than 150 proved experimental types have been developed, at least 100 of them placed in production. Significantly, among over 200 prime contractors and 10,000 subcontractors, the most outstanding are those who before the war manufactured ham gear — designed to meet ham standards, than which there can be no more demanding. Largest single supplier of airborne and shipborne radar for the Navy, and third largest in the entire industry (exceeded only by WE and GE) was Raytheon Mfg. Co., originator and sole manufacturer of the famed SG shipborne sea search radar pictured on this page, found on every U. S. Navy combatant ship — destroyers, carriers, cruisers and battleships.

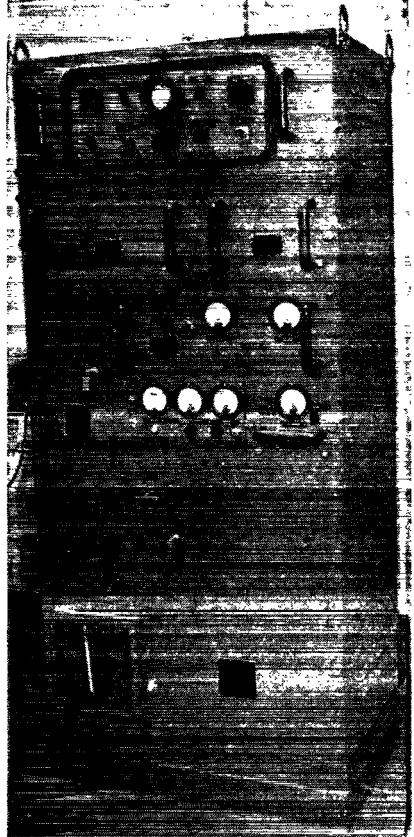

Right — Main transmitter frame of the SG (ship search) radar, first commercial microwave equipment made in America.

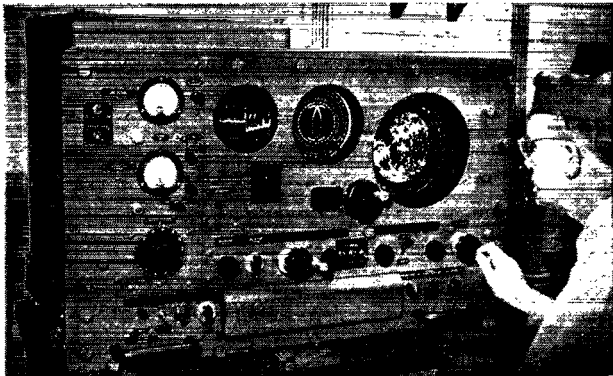

Above — Despite its inherent circuit complexity and numerous panel controls, the actual operating controls on the SG receiver are few. Glowing light pips and markers determine exact range and compass bearing of all objects in the region surrounding the ship. High-precision readings are obtained on auxiliary scan at left.

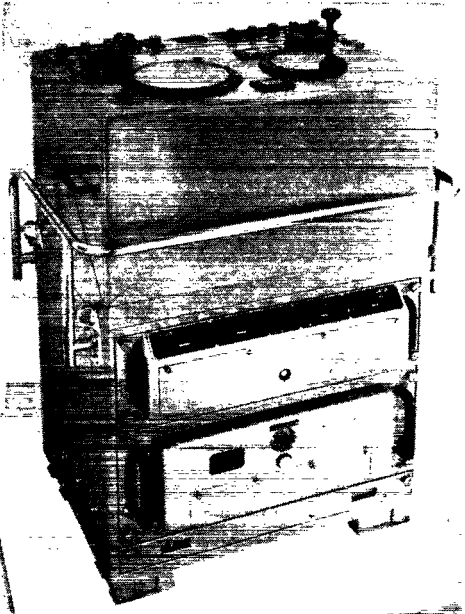

Above — SG radar repeaters are installed in all control centers aboard ship. Left — Close up of panel of remote repeater unit. PPI screen is shown at left; on the right rectangular-plot scan gives range and bearing relative to the ship. On this scan target is enlarged.

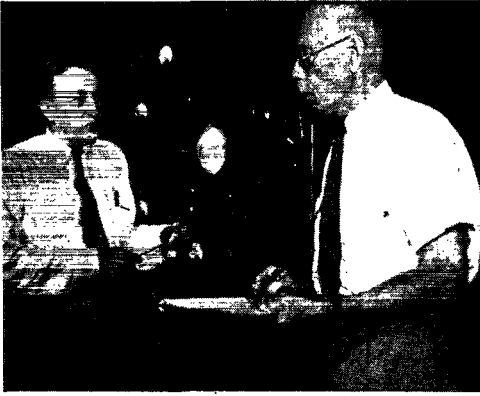

"Among those in the U. S. who had a hand in [radar's] development were a Navy quartet of physicists and radio hams — Albert H. Taylor, Leo C. Young, Robert M. Page and Louis A. Gebhard — who pioneered radar in the '20s and '30s. . . . — *Time Magazine*"

Above, pioneer workers in radar and former hams. Dr. A. Hoyt Taylor, ex-9YA, (right), Chief Consultant and Chief Coördinator of Electronics at the Naval Research Laboratory, Anacostia, D. C., and his long-time associate, Leo C. Young, reminisce over the "scope" of radar's history beside the first radar set at the Research Laboratory.

"A"-Scan

The popular concept of radar apparatus and its employment is most nearly approximated by what are known as "early warning" (or AWS, aircraft warning systems), incorporating a pulse-keyed transmitter and a receiver with c.r.o. tube indicator, triggered by a common timing base calibrated in range (time for return of echo), and equipped with antennas adjustable as to azimuth (bearing) and elevation. Range was read on a calibrated timing scale; direction and elevation were scaled on the universal-jointed antenna drive.

The signal display on the c.r.o. indicator in this simple system was, of course, in the form of a bright base line across the screen, each received echo being marked by a V-shaped pip projecting above or below the line. Later a dozen or more variants on this scheme were evolved. Where in the simple "A"-scan the vertical deflection served only as an approximate indication of the strength of the signal, by the use of a more complex sweep circuit and adjusting the beam intensity just below visibility the application of a received signal resulted in a bright spot apparent only while it was being applied. Replacing the horizontal timing sweep with information received from another of the variables — bearing, for example — both items of information became apparent visually on the single viewing screen. Thus, by the use of either two or three c.r.o. indicators all of the desired information became apparent instantaneously and simultaneously as shown by the location of a bright spot on a calibrated graph.

Moreover, if the returned signal were caused to vary the intensity of the spot in addition to (or instead of) deflecting the beam, causing narrow lines to extend on either side resembling the end-on view of an airplane, the resulting target

pattern would resemble an approaching aircraft, its attitude and distance being approximately indicated by the extent of the bright "wing" lines and their angle — the "electric gunsight."

PPI

When the development of microwave technique to overcome other practical operational difficulties made it possible to construct a dipole the size of a hairpin, and also to concentrate the radiated energy into a relatively sharp beam by use of a parabolic reflector about the size and shape of an automobile headlight, the logical next step was to rotate the array by a geared-down motor at a rate synchronized with the radar timing base.

Then, by rotating the c.r. sweep mechanically or by the use of complex arrangements of radial and circular electronic sweeps, each point on the screen being scanned could be displayed separately, resulting, in the time of one synchronized revolution of both antenna and scan black-and-white in a "plan" on the face of the tube comparable to a map of the entire sector of terrain being scanned.

This is the basis of the famed PPI. As used in Navy ASV searchgear, the circular PPI (Plan Position Indicator) scope provides a maplike representation of the area below, despite intervening clouds and darkness. Topographical features such as peninsulas, headlands or islands can be discerned as far as 150 miles away; a fleet can be picked up 100 miles distant, and a single ship can be spotted at twice this distance. Merely throwing a switch spreads the scale on the screen to reveal close-up the detail of targets close at hand. The newer ASV sets are so sensitive that a well-trained RO can detect cloud formations and weather fronts.

The use to which this search set can be applied in bombing should be obvious. In the dark of night, in fog, or through heavy layers of clouds, the PPI tells the operator what is below and thus enables him or the navigator to see landmarks and spot the bombing target. The regular search set is used for these BTO (bomb-

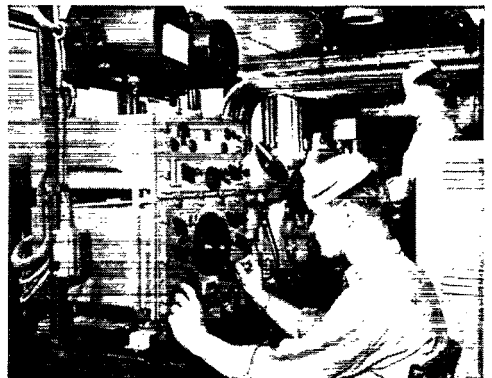

Raytheon's SO radar, a smaller, simplified version of the SG ship search radar, now in use on thousands of large landing craft, PT boats, attack transports, auxiliaries and patrol craft.

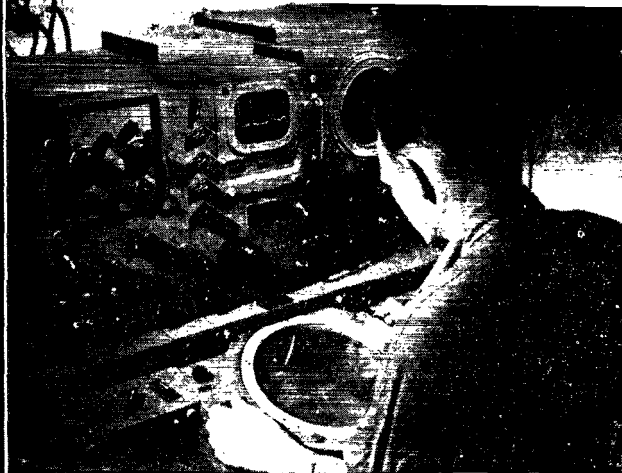

Left — An enlisted Navy radar operator is "peaking the echo" for accurate determination of distance and range during a test at Naval Research Lab, Anacostia. The tube-like "visor," padded at the viewing end to avoid head injury in "crash" operation, excludes external light and ensures sharp definition.

Right — Modified construction with the PPI screen conveniently placed for maximum convenience in viewing. On the panel (at top center) A-scan shows range only with linear horizontal timing base similar to an ordinary oscilloscope. Photographed during experiments at NAS, Anacostia.

RADAR SCANS

Below, left — Photograph of simple PPI screen showing Oahu in the Hawaiian Islands as seen from a Navy plane. Spot of light in center marks position of the plane, axis of which is on vertical plane here; the island is the large white area. The two elongated "pips" between the first and second range circles are ships. *Center* — Cape Cod, Mass., as viewed on ship search gear (SG) radar screen with compass bearings

on azimuth scale. Azimuth-stabilized PPI indicator maintains North (true or compass) at top of screen. Topographic details are displayed by dark shadows. *Right* — Radar view of New York City, taken with new high-definition ASV-type apparatus. The outline of Manhattan Island clearly shows the Hudson river with its shipping docks, while the Metropolitan Museum juts out into Central Park.

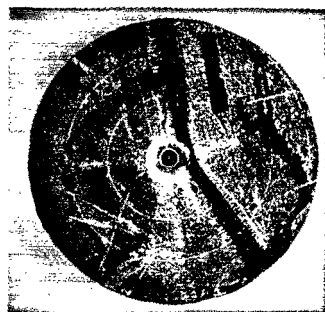
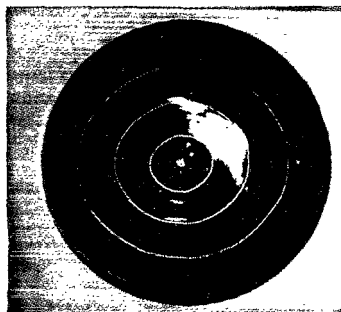

Below — Experimental radar equipment at NRL's Chesapeake Bay Annex made this "search" of the surrounding terrain. Lettered on the photographs of the PPI (Plan Position Indicator) screen are designations of points picked up by the radar pulse. Compare the two in terms of scale — the expanded screen view at the left exhibits increased distortion near the center. The pips converge when the range is widened, diverge when the range is lessened.

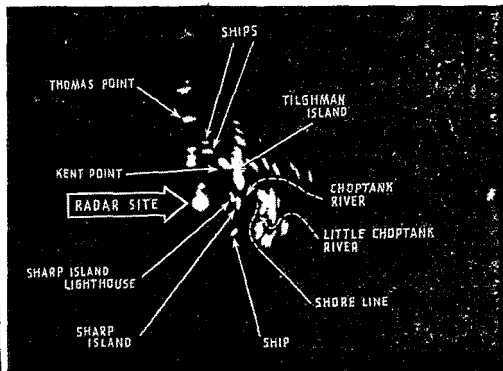
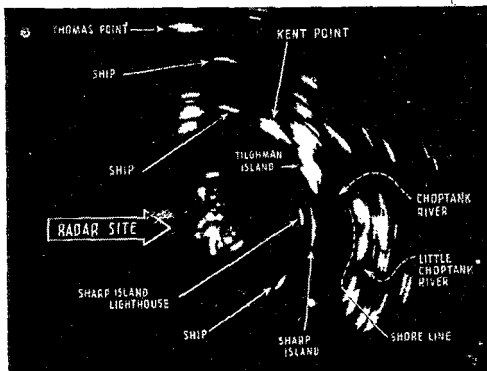

ing through overcast) operations, in combination with an H2X ranging unit and a bomb computer that is part of the Norden bombsight that accomplished such accurate visual egg-laying.

The city that is the target can be picked up 50 miles away by the radar operator in his PPI scan. He directs the pilot over the intercom during the bombing run. As the blob of yellow light and shadow that form the target's pattern slide beneath a heading line and ranging circle that are projected onto the PPI screen, the RO keeps the bomber on course. When the line and circle intersect, he releases the bombs. The "eggs" can also be set for automatic release when the proper point is reached.

Navy Development

Starting with the original 200-Mc. British design, which had seven antennas in all — some of them 16 feet long, resulting in a drastic total reduction in the plane's performance — the Naval Research Laboratory set out first to reduce the number and size of antennas.

Meanwhile the problem of equipping carrier-based aircraft was urgent. So NRL went to the 500-Mc. "medium-wave" band and produced a new airborne radar, the first light-weight set for carrier-based aircraft. After production got under way in 1942, 27,000 sets were manufactured — more than any other single type of search radar. This was the set that can be said to have fought the war, until the last few months, for naval aircraft. Thousands of these sets are still in use. Then came the further-improved "microwave" or "S-band" ASV, working in still higher frequencies than had previously been used (well above 1000 Mc.) and therefore permitting extensive gain with only a small antenna.

Radar Navigation

Radar navigation divides into three categories:

- 1) Mapping or "search" of the immediate

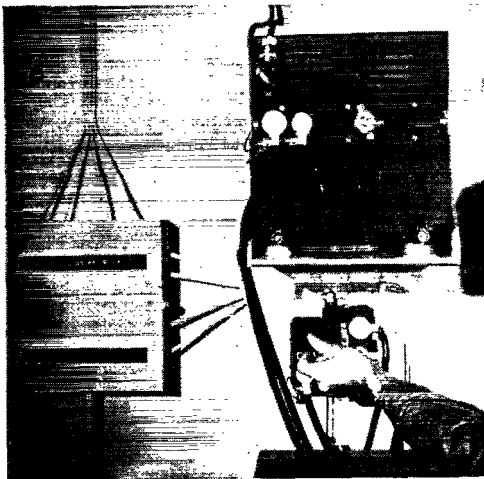

The flick of a switch on a shipboard IFF installation during a radar search determines whether a "pip" picked up on the radar scope is identifiable as "friend or foe."

terrain by SG, ASG (or BTO), etc., performed wholly within the craft itself.

- 2) Long-range ranging and position finding by means of automatic radar beacons — in a manner akin to radio d/f except that the bearing is taken by the radar operator in the craft rather than by cooperating d/f operators ashore.

- 3) Remote control by a ground operator watching the radar-piloted plane on a viewing screen, from the viewpoint of an external observer.

The basic radar equipment for distant reconnaissance and navigating is the ASV (Air to Surface Vessel) search set, employing a fully rotating dish antenna mounted in a radome.

"Racons" (RADar beacons) are twin transmitter towers, permanently located, which permit homing on their signals or their use for plotting position. The beacons usually operate only when the sharply beamed pulses from an airplane's search radar are in contact, automatically triggering off the beacon transmitters.

The plane's IR (Interrogator-Responder) receiver is tuned to catch these beacons. The pulses are emitted as coded signals, and each beacon has its own identifying code. In the radar scan, the plane's navigator can determine by the light traces the identifying number of the beacon station's beam. Each beam's path is represented as a curved line on a chart. The navigator then tunes in another station to get a cross bearing. Where the lines intersect is the position of the plane.

Loran

Loran operates in a lower frequency range not radically different from the ranges with intermediate characteristics which partake both of high- and medium-frequency propagation characteristics. At loran frequencies the waves are reflected from the ionosphere, following the curvature of the earth as do broadcast frequencies.

Loran fixes can be taken at distances of several hundred miles from the coastal chain of ground stations with a degree of accuracy as high as by celestial observation. Moreover, such checks are easier to take and interpret than are celestial fixes and are available regardless of weather or visibility conditions.

In operation, the navigator aboard an aircraft on an over-water route tunes in to such stations that have been established along coastal boundaries throughout the world. These stations emit synchronized variable pulses which are combined in the receiver and the resultant viewed on an oscilloscope screen. The delay interval between the two received signals is then measured by radar timing methods, employing two controls. From this data, by conventional extrapolation and triangulation methods, the position of the plane itself obviously can be calculated.

[ERROR'S NOTE — The foregoing fragments represent only a portion of the material, much hitherto unpublished, on radar, sonar and loran techniques and applications originally contemplated for this section, but which time did not permit writing up as part of this issue.

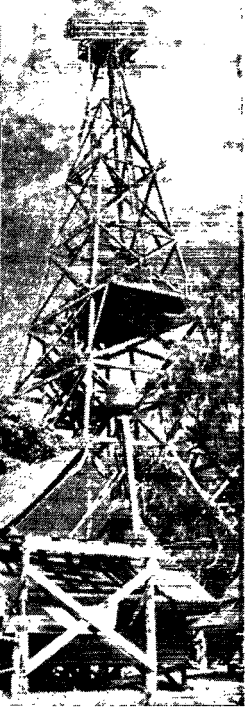

Left—Ground station radar tower at Espiritu Santo, showing the large bedspring search antenna atop the mast and a microwave radome near the ground. *Below*—As General Motors Avenger is hauled up short by arresting device, Yagi-type radar antennae (shown enlarged in close-up) project from the lower surface of the bomber's starboard wing.

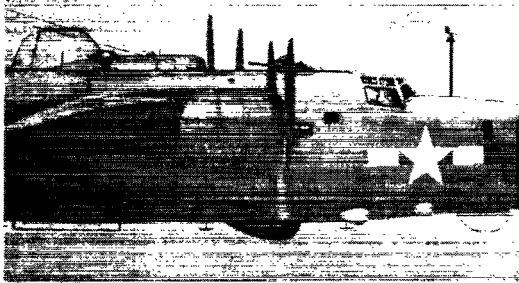
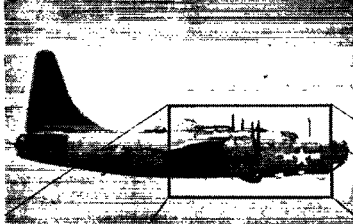

Radar spines and radomes—feelers for the fleet—sprout all over the Navy's new, deadly sky-giant, the Privateer (Navy patrol-bomber version of the B-24 Liberator). Atop the fuselage, behind the gun turret, is the IFF antenna. *Below, right*—Fire-control director on Essex-class CV turret.

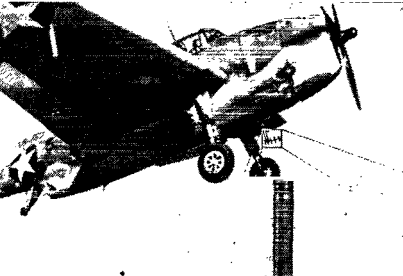

• • • • **RADAR ANTENNAS** • • • •

Radomes! *Left, below*—ASV radome on the wing of a Navy Grumman Hellcat spotted on the flight deck of an escort carrier (with close-up view of enclosure below). *Bottom left*—Thinking cap and feelers of patrol boats, radome and whip antennae are indispensable to hard-hitting PTs which operate under cover of night. *Below*—Bulging like a bullet, radome exemplifies improvised installations on many naval aircraft. . . . Below it is a more modern under-wing installation on a Curtiss Seahawk scout-observation plane, being recovered after a flight.

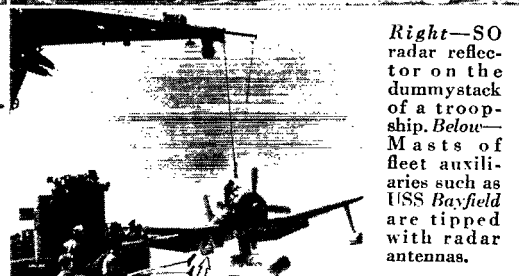
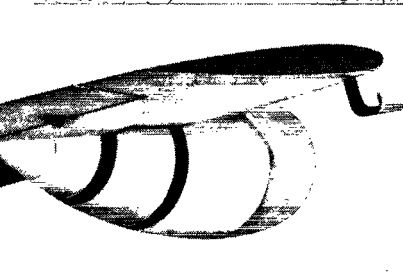
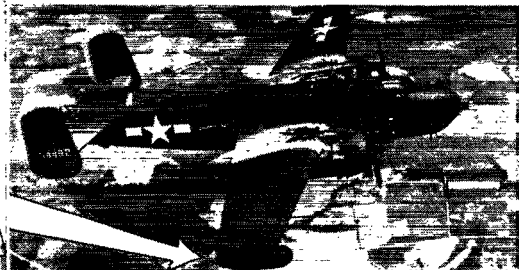
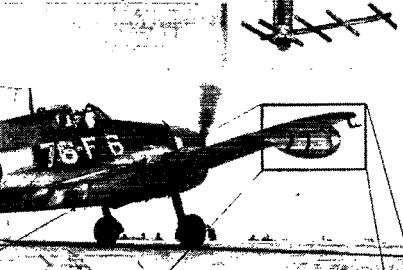

Right—SO radar reflector on the dummystack of a troopship. *Below*—Masts of fleet auxiliaries such as USS Bayfield are tipped with radar antennas.

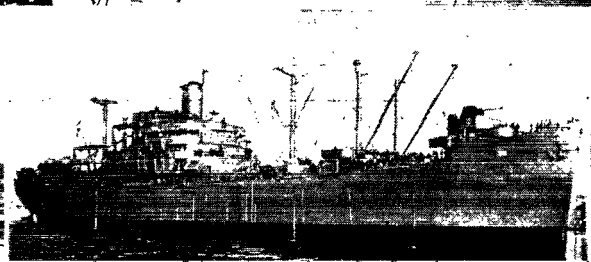
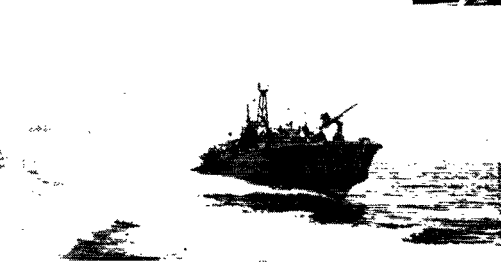

BuPers

In 1939 the Navy had on active duty 11,585 officers and 110,872 enlisted men — total, 122,457. By the fall of 1942 the Navy accepted each month a number of men equal to total strength of the peacetime Navy. At the end of 1944 there were 3,200,000 officers and enlisted Navy.

Recruitment, training and assignment of these added millions of men — and women — was the task of the Bureau of Personnel. BuPers was responsible for the procurement, discipline and welfare of the personnel of the Navy, as well as for keeping detailed records of each individual.

Apart from the mere physical job of manning the new Navy there was the herculean task of training new personnel to proficiency in more than 450 enlisted specialties and petty officer ratings. The modern Navy is a huge aggregation of the most intricate mechanical and electronic devices ever created. Its weapons are complicated machines — and the best machinery in the world is useless without men who know how to use it and how to keep it in shape for use.

It's a long step from binoculars to radar for spotting enemy warships. BuPers never did discover how to wave a wand and produce a technical officer or an enlisted radar fire-control technician in thirty days. Such specialists had to be *trained*. It takes a year and a half to train an all-around radio, radar and sonar man. A radio technician must be in training not less than one year before the date he may be needed to carry the day in a crucial engagement.

Something like a quarter of a million radio and electronics men were needed — and the Navy did not have them. They had to be made out of American boys off the farms and the streets, out of the schools and factories. They had to master principles of engineering, advanced mathematics and applied physics equivalent to the schooling of a college-trained engineer of a few years past.

No, the Navy couldn't procure a quarter of a million pre-trained radio and electronics experts overnight. They did, however, have access to the national reservoir of skilled radio amateurs.

When the communication training program first started, the bulk of the planning, organizing and administering of schools fell to members of

the Naval Communication Reserve — and the letters NCR are almost synonymous with "ham."

In the first days of the accelerated Navy training program, contracts were made with a number of universities and colleges, together with civilian technical schools to operate radio training programs. The large majority of the instructors in these schools — and usually the officer in charge! — were amateurs. The ARRL Personnel Bureau was of valuable assistance in supplying the names of prospective instructors; through it many men were located to replace those drafted.

Another major problem in the early days of the training program was lack of equipment. Here, too, the hams came through with the answer. It is officially acknowledged that in many cases the equipment used was supplied by hams among the instructors and trainees from their shacks.

In fact, radio amateurs literally were the backbone of the Navy's radio operator and technician training programs. A large percentage of trainees in radio operator schools in 1940 and much of 1941 were amateurs; and it was they who carried the Navy communications burden until new recruits could be trained.

RM

The radioman is not a Navy Radioman unless he can copy code satisfactorily. C.w. reception is the axis around which all training revolves. If he can't learn code, he can't become a Radioman — which means a radio operator. Thousands of man hours and more thousands of dollars have been spent on studies to determine the best and fastest way of teaching radio code. The Navy has attempted to apply all of the tested, successful ideas in a program designed to turn out the best trained operator in the shortest possible time. Every man must be able to receive 26 words a minute in code and to send 18 words in mixed code; to insure his proficiency in this essential accomplishment he is required to practice at least an hour a day for the first twenty-five weeks, and 30 minutes a day thereafter. If a student fails to pass his weekly test in code reception, he must attend night-study classes — timed, with devilish ingenuity, to begin before the first picture show was over and to end after the second show was well started.

Top left — The master control room at NTSch (Radio), USS *Despatch*, San Francisco, Calif. A very flexible system of distribution of code signals and voice emanates from here to all classrooms and the radio receiving and sending stations. *Top center and right* — Distribution panel in the code control room at NTSch (Radio), University of Idaho, Moscow, Ida. Built by a ham, the set-up did everything but put out the cat at night. In addition to usual distribution of code, an electronic beat whose speed could be varied as desired was supplied to typing rooms replacing the usual metronome for rhythm control. A unique gadget developed here was a circuit monitor to facilitate the checking of the many circuits. Speed control was very accurate by means of the specially built speed drive. *Second row: Left* — A close-up of an instructor's control panel in the Blackhawk Code Room, NTSch (Radio), University of Wisconsin. Each of the six panels in the room is equipped with victrola record play-back, both key and voice. *Center* — The code control room at NTSch (Radio), A. and M. College of Texas, College Station, Texas. *Third row: Left* — The main code instruction room at NTSch (Radio), University of Chicago. *Center* — Waves receiving code practice at NTSch (Radio), Miami University, Oxford, Ohio. *Right* — NTSch (Radio), Bainbridge, Md. *Fourth row: Left* — Students are compelled to type by the touch system because, in addition to blanked-out keys, typing shields are used in beginning typing instruction. Headphones on tables are used in connection with electric metronome for rhythm drills. NTSch (Radio), Farragut, Idaho. *Center* — A hand-sending instruction room at Northwestern University, Sampson, N. Y. *Right* — A section circuit drill room, NTSch (Radio), Mass. Radio and Telegraph School, Boston, Mass. Instructors can individually monitor each student without his knowledge or break in to give him additional instruction. *Bottom row: "FOX" broadcast watch-standing classes, which include four-hour watches, in session at (left) the NTSch (Radio), Charleston Navy Yard, S. C.; (center) NTSch (Radio), Northwestern University, Evanston, Ill., and (right) NTSch (Radio), Camp Robert Smalls, Great Lakes, Ill.*

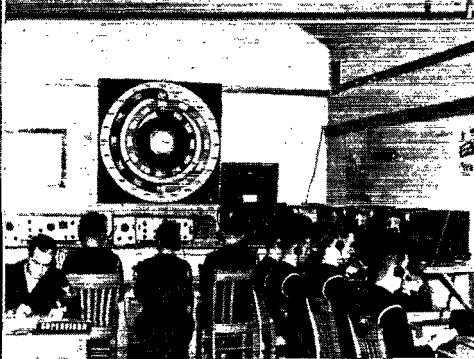
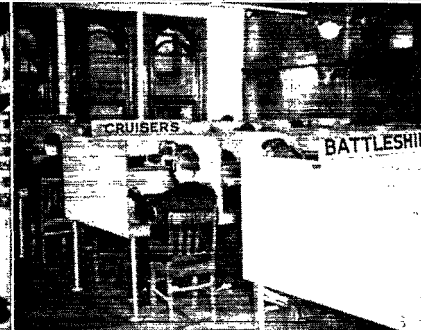
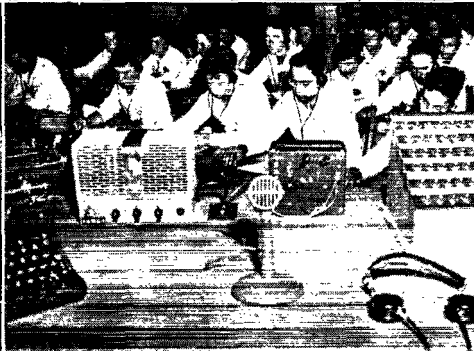
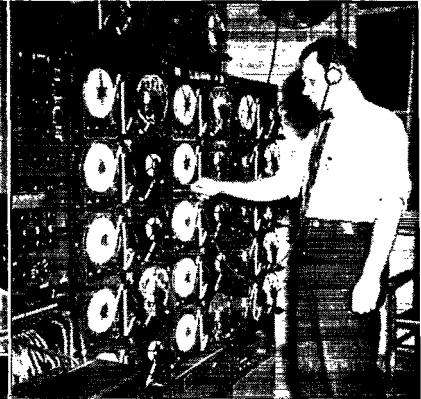
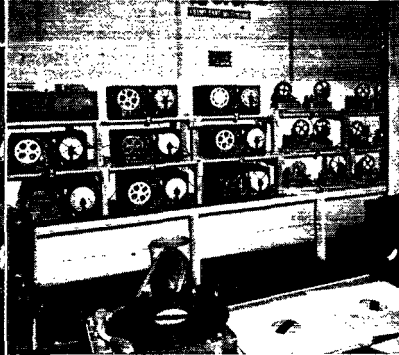
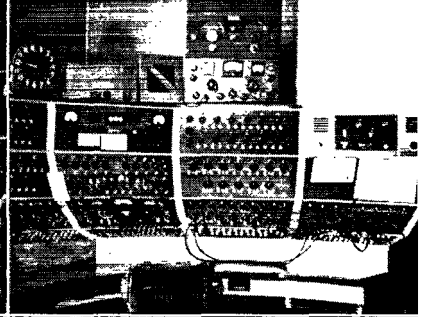
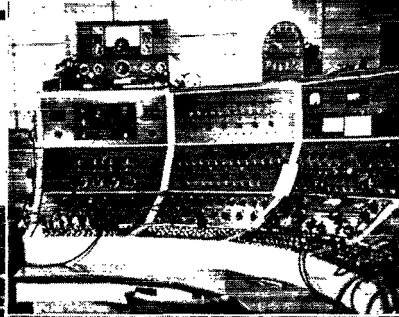
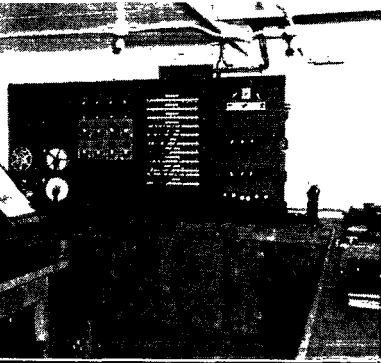



Above—The transmitter instruction room at NTSch (Radio), San Diego, Calif. Below—Repairing a receiver which is part of the training equipment at NTSch (Radio), Farragut, Ida.



Above—The transmitter room at NTSch (Radio), Yerba Buena Island, San Francisco, Calif. Left—The d/f instruction room at NTSch (Radio), University of Wisconsin.



Above— WAVES have played an important role in all branches of Naval communications. Here Ens. Emma D. Shelton, a communications officer in the Sixth Naval District, watches Richard W. Tripps, RMI/c, check an amplifier in the radio repair shop. Above right—The receiver and d/f instruction room at NTSch (Radio), San Diego, Calif. Left—Radio materiel laboratory at NTSch (Radio) University of Idaho, Moscow, Ida. Right—The basic laboratory at NTSch (Radio), Farragut, Ida. The laboratory has 40 complete positions and is fully equipped for audio-visual aids such as films and slides. Bottom—Students in radio theory and practice classes at NTSch (Radio), Farragut, Ida., are guided in their jobs with as many printed instructions and visual aids as are practical. At the left is material used in connection with the soldering job board. All student jobs are developed in similar manner to help students as much as possible and to get the most training out of the time allocated to radio theory and practice. At the center is a soldering job board containing ten soldering jobs ranging from a simple wire soldering job to more complex jobs. A board is furnished each student who unsolders all connections upon completion of his job sheet. Boards are stored in drawers, each drawer providing for ten positions on one table. Design of boards and of drawers aids in reducing handling time of parts, and increases time available for student jobs. Bottom right—A parts identification box used to help students identify parts. Through actual handling, the students quickly acquire a physical knowledge of the parts.

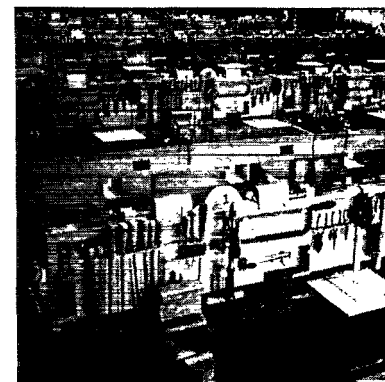

ter is a soldering job board containing ten soldering jobs ranging from a simple wire soldering job to more complex jobs. A board is furnished each student who unsolders all connections upon completion of his job sheet. Boards are stored in drawers, each drawer providing for ten positions on one table. Design of boards and of drawers aids in reducing handling time of parts, and increases time available for student jobs. Bottom right—A parts identification box used to help students identify parts. Through actual handling, the students quickly acquire a physical knowledge of the parts.

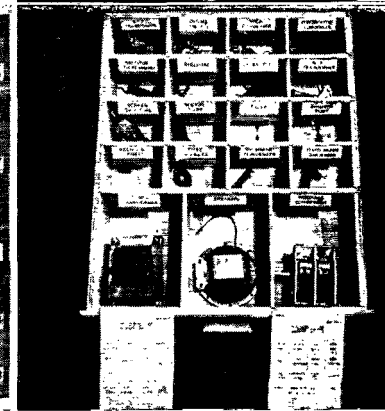
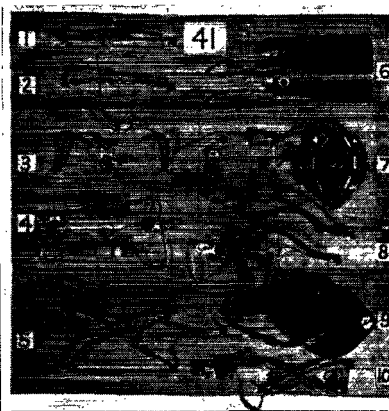
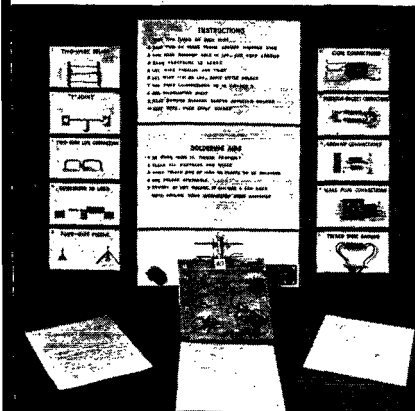

The Navy's entire system of instruction is designed to fit the individual. Constant analysis of a student's progress is required to give him a sound basis on which to build speed. If a man does not have a solid foundation — if he does not know all characters "cold" — he will never become an operator. So, the first step is to teach the characters. This accomplished, the only remaining requirement for progress is constant and systematic practice.

During wartime, radio silence was the rule rather than the exception. The primary task for the radioman aboard ship, therefore, was copying the Navy's "F" method broadcasts, known as FOX schedules, which contain messages for all units of the fleet. Since they consist almost entirely of coded material, the training burden lay chiefly in developing an operator who could copy coded material. Plain language was minimized. There has been much controversy as to whether it was most desirable to train men to copy coded groups at the expense of plain language, or vice versa.

Unfortunately, there was not too much time for experimentation; the job had to be done. If the FOX could not be copied satisfactorily, the entire communication system would break down. Thus the training methods aimed first at solid FOX copy, such time as remained being devoted to plain language and press. So effective was the training in copying coded material that cases were found where operators actually copied plain language in five-letter groups!

Drill material and methods were designed specifically to accustom men to copy behind. This appeared to be one of the most difficult problems in code teaching. It comes with practice, — but time was limited and techniques had to be developed to get results without delay.

As concerns the performance of radio amateurs as code trainees, it was found that those most adaptable to operator training were the old traffic handlers. They had been accustomed to writing down what they received. The rag-chewers, many of them whizes when copying "in their head," usually found that their speed dropped considerably when they had to actually put copy on paper. DX men excelled in copying weak signals. The 'phone operators, with few exceptions, were at a definite disadvantage and usually had to almost start at the beginning with elementary classes. All amateurs were good at plain language but weak on coded groups. Practically all amateurs were good at copying through interference. All classes of amateurs were on an equal footing when it came to touch typing. If they couldn't touch-type, they had to learn. If they could touch-type but had never copied code on a mill, they had to learn the telegraphic keyboard and master the art of coordination of code and typing. But in every case amateurs as trainees had the edge on other students because of the inherent enthusiasm born of their ham radio background.

While all Navy Radiomen must know how to touch-type, typewriters are not available on some small craft. Moreover, mills *do* break down oc-

asionally. It was necessary, therefore, that proficiency in pencil copy also be maintained. Training is given in standard printing and practice in copying with the stick is carried throughout the course.

On the theory that a man can't know how to send until he knows how code sounds, instruction in hand sending does not start until the fifth week. Sending instruction aims at accuracy and readability; speed develops with practice.

Instruction in naval radio operating procedure is, of course, one of the essentials of RM training. It is here that the operator is taught how to use his new language. He must have a thorough understanding of the meaning and usage of all forms of messages, prosigns, operator's signals. He must understand precedence and be drilled in the principles of security. He must know the procedures for types of operation. In wartime he may never get to work an actual two-way circuit — but, should he have to handle only one message, there must be no slip.

Circuit drills in rooms especially wired to simulate fleet circuits serve to put into actual practice the principles learned in procedure lectures. Here is the test of how well instruction has progressed. Weaknesses in receiving and sending abilities are immediately evident, knowledge of procedures is gauged by performance in actual work. The main objective is to put each operator on his own, simulating actual conditions insofar as possible. Schools have done everything to make training realistic, succeeding in practically everything except making the room roll and rock like a ship, and developing the resultant seasickness.

As a follow-up and final polishing off on circuit work, several actual on-the-air circuits were maintained between schools. Trainees in the more advanced stages of learning stood watches on these circuits, which were operated with regular Navy calls and procedures. Discrepancy watches were maintained and errors and weaknesses noted were used as the basis for classroom discussion. Although traffic handled was strictly of a training nature, the practical experience was invaluable in overcoming "buck fever" before the trainee was assigned to actual duty.

During the last three weeks of the course, trainees stand regular 4-hour FOX watches. In most cases these watches are operated around the clock and students rotated so that experience is gained in standing watch under varying conditions and at all times of day and night. These watches do more to instill the ability to make solid copy than any other part of the course. Trainees must stay at their posts for four solid hours, without relief, and must copy everything they hear in the same manner as aboard ship.

The RM also receives some rudimentary instruction in radio theory and practice. He is not a technician and there is not time in a nineteen weeks' course to make him into both an operator and technician. His instruction in theory, therefore, is designed to give him a general knowledge of radio gear and components and to equip him to perform the basic radio shack functions



Above — A signalman on a light cruiser stands by blinker to answer message from escorting destroyer. *Below* — A semaphore class under instruction at NTSch (Signal), University of Illinois. By placing students in accurate positions instructors are able to pick out sloppy characters.



Below — All rates in the Navy must be proficient in the use of sound-powered telephones, which are used for the various intra-ship battle circuits, etc. The three compartments shown are a section of the twenty-four booths used in training at the NTSch (Radio), Yerba Buena Island, San Francisco, Calif. By use of a plug any booth can be connected to any one of the five circuits.



Right — One hour per day of training in all Navy specialized schools is devoted to physical training, for a healthy body is conducive to a healthy mind. Boxing and obstacle course running are two forms of physical training conducted at the NTSch (Radio), University of Idaho, Moscow, Ida. *Below* — "The Colors" returning to the Armory after review at the NTSch (Radio Naval Armory), Indianapolis.

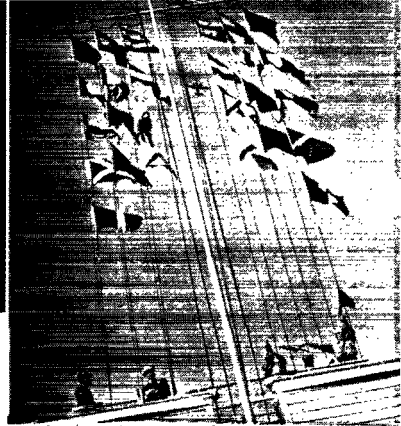
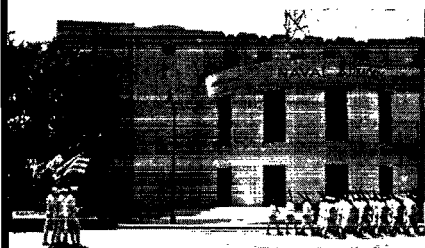

Above — Semaphore at sea. *Left* — Close-up of a signal tower used in flaghoist and semaphore instruction at NTSch (Signal), Great Lakes, Ill.



Above — Six signal towers as two divisions. *Left* — Instruction in bending on flags and use of the long glass. *Lower left* — Instrument practice at NTSch (Signal), Great Lakes, Ill. Shown here are compass for changing ship's head, blinker gun, twenty-four hour clock, using Greenwich time, and movable pelorus for taking true and relative bearings.



Above — A new class receiving sending practice on blinker keys. The men are standing as they will have to when operating blinker aboard ship. NTSch (Signal), University of Illinois, Urbana, Ill. *Below* — Review day at NTSch (Radio), Miami University, Oxford, Ohio. Students must also be kept aware that they are in the Navy.



expected of a radioman. He must know how to tune and calibrate receivers and transmitters, how to operate a direction finder, and how to locate simple troubles.

The aim of all Navy training is to produce a graduate who can take his place in the fleet with a minimum of additional training. Curricula are, therefore, constantly undergoing adjustments in line with what the fleet needs. Currently, radio-teletype is coming into its own, and instruction in teletype is being added to radiomen's training.

RT

The radical newness and extremely rapid changes in development of electronic equipment in this war would in itself create a very difficult training problem. Add to these factors the intricacy and delicacy of much of the gear, the inability at first to produce equipment in sufficient quantity to meet even urgent battle needs, and finally the necessity of observing the strictest security regulations to prevent leakage of information to the enemy — and the magnitude of the training problem involved can be seen.

From 1925 until World War II, the Naval Research Laboratory at Washington had trained warrant officers and radiomen in the maintenance of radio equipment. When the war came, bringing new electronic equipment by the tons, their duties became exceedingly complex. It became apparent that the operational and the maintenance duties of radiomen should be clearly differentiated. In April, 1942, the rating of radioman was applied to operational matters primarily, and a new rating of Radio Technician was created.

First step in the expansion of the training program was to enlarge the Radio Materiel School at NRL. Late in 1941, however, it was realized that NRL would be inadequate for the tremendous number of enlisted technicians required. Accordingly contracts were let to civilian institutions all over the country for instruction of naval personnel in various phases of electronics.

Radio technician candidates first attended one of four pre-radio materiel schools.¹ These, current all in the Chicago area, are Theodore Naval School, Wright Junior College, Hugh Manley High School, and Naval Reserve Armory, Michigan City, Indiana.

At the end of three weeks the prospective radio technician packs his bag and moves on to one of the Elementary Electricity and Radio Materiel schools, located at 190 N. State Street, Chicago; Gulfport; Miss.; Del Monte, Calif.; Great Lakes, Ill.; and Dearborn, Mich. For three months the trainee attends classes and laboratories for 8 to 10 hours a day, exclusive of physical training. (Only morning sessions on Saturday, though!)

The basic course in radio prepares him for the study of Navy electronic equipment. This study occurs at one of three NTSchs (Radio Materiel Schools). First and oldest, of course, is the one at

Naval Research Laboratory, Washington. Then there is famous Treasure Island, at San Francisco, and the newest and largest at Navy Pier, Chicago. Aviation radio technicians have their own NTSch (Airborne Electronics Maintenance course) at Corpus Christi. (Here, incidentally, trainees receive a limited amount of flight time in testing equipment under airborne conditions.)

A solid 28 weeks is spent at one of these advanced schools studying naval electronics equipment, including radio receivers and transmitters, radar equipment, loran navigational gear, radio direction finders, underwater sound equipment (sonar), and countermeasure techniques. Emphasis is placed on actual maintenance and troubleshooting. Laboratories are completely equipped with the most recent models of Navy equipment — just like the gear the radio technician will have to maintain and repair in the Fleet.

Great reliance is placed on training aids in this program. Movies show operation of sets under actual shipboard conditions. "Breadboards" with wiring diagrams drawn on the front of a panel on which the actual circuit elements are mounted, make circuit theory easier to comprehend. "Mock-ups" of actual equipment enable students to become familiar with gear which is not available; sometimes they show the operation of the equipment better than the actual sets. Particularly in the latest equipments, many of the parts are jeweller's jobs — precision-made to minute specifications and almost impossible to study. Here the scale model principle is used in reverse, scaling sizes upward instead of down. Frequently experimental set-ups are utilized operating on the same principles as the original but with all action slowed down tenfold or a hundredfold. This is particularly helpful in the study of timing circuits which must measure millionths and even ten-millionths of seconds.

RdM

The manifold electronic equipment utilized in this war resulted in the creation of an entirely new staff of specialists in various phases of operation and tactical employment. In the first days of the war, not only radiomen and radio technicians, but seamen, yeomen and storekeepers — among others — were assigned the duty of operating and interpreting radar equipment.

An analysis of the radar operator's job revealed a number of definite skills which were made the basis of a new rating. In July, 1942, BuPers published the qualifications for Radarman (RdM) 2c and 3c. Later that year the grades of RdM1c and CRdM were added.

Training of radarmen as such began in November, 1942, when Fleet Service Schools at Norfolk began training radar operators at Virginia Beach. In December the NTSch (Radar Operators), then under the Director of the U. S. Naval Radio and Sound Laboratory, San Diego, California, convened its first class.

In April, 1943, the Pacific Fleet Radar Center began instructing radar operators. Much of the experience gained there has since been

¹ De Soto, "The Navy Trains Radio Technicians," *QST*, November, 1942, p. 13.

Lillie, "Radio Amateurs in Navy Radar," *QST*, April, 1945, p. 24.

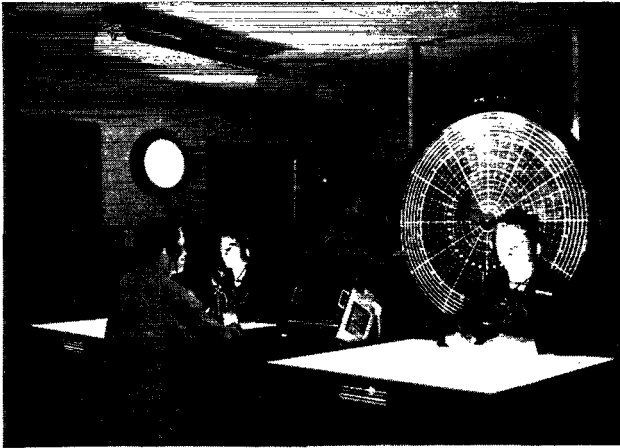

Left — Simulated radar plot at a Naval Air Station. In the foreground an illuminated screen centered on the radar's location and another showing an expanded section of a map from which operators relay information to plotters at a vertical plotting board. Plotting is done from the rear of the transparent screen so that plotters won't obstruct the view of controllers assigned to determine what action should be taken as situations develop. *Below* — Future flag officers of the U. S. Navy receive indoctrination in the functioning and tactical employment of radar. Clustered around a "mock-up" of a radar plot room on a warship, midshipmen at the U. S. Naval Academy do exercises in tactical radar operation.

incorporated into the curricula of the mainland schools. In August the NTSch (Fire Controlmen (R)) at Fort Lauderdale, Fla., began a sixteen-week course. Immediately following, instruction for search radar operators was initiated at the Trade Winds Hotel, Fort Lauderdale.

In the Radar Department a busy pace is always maintained. "You should see how eager the men are to get in this department," an instructor says. "This is what they've been waiting for!"

Radar operator trainees are recruited from boot camps on the usual basis of qualifying scores on the General Classification, Clerical Ability, Reading, and Arithmetical Reasoning tests. Technical knowledge and qualifications played no part whatsoever; the important factors are reactions, speed, sound judgment — and good telephone voices! Obviously, the percentage of RdM (W) is high!

The first part of the radar operators course covers only some general principles of radar, presented very briefly, telephone talking, and the functioning of CIC. The second part of the course includes operation of specific equipments for definite Fleet assignments.

Aviation radar operators learn their jobs at two NTSch (Aviation Radar Operators), either at NATTC, Memphis, Tenn., or NATTC, Norman, Okla.

SoM

There were few improvements in anti-submarine offensive techniques or in submarine detection gear between 1918 and the early 1930s. After Pearl Harbor, however, wholly new equipment and personnel had to be procured — fast.

During 1941 the rating of Soundman (SoM) was established and qualifications set for both operational and matériel aspects of sonar equip-



ment, which in submarine warfare accomplishes the same purpose as radar but operates under water. A training course for these ratings was established at the Fleet Sound School at Key West and the West Coast Sound School at San Diego.

In 1943, the "Soundman" designation was changed to Sonarman (SoM). Sonarman are all given operational training; some are given additional maintenance training, depending upon the Fleet's needs. However, radio technicians now are primarily charged with the matériel aspects of sonar equipment, and technical qualifications have been removed from the requirements of a sonarman. The more important qualities for the job are coolness, perseverance, aptitude, and excellent hearing.

Sonar trainees are selected both from recruit training centers and the Fleet. A six-week course serves to train the operator in the use of his equipment; sonarman still charged with maintenance require an additional twelve weeks. During 1944 knowledge of radio code was added to the qualifications for sonarman.

The complex installation job required for even a sonar training unit is most impressive. The sonar apparatus installed in a typical school is built in a two-story arrangement. On the upper deck are the receiver-indicators; on the lower deck, the hoist-train equipment and drivers; and in water tanks below, projectors may be submerged.

Shakedown cruise: To develop fighting men to man fighting ships, final phase in training is the shakedown cruise on which trainees aboard try their sea legs and learn how to work and fight their ships. *Right* — Enlisted men in a radar training unit intently watch as instructors explain

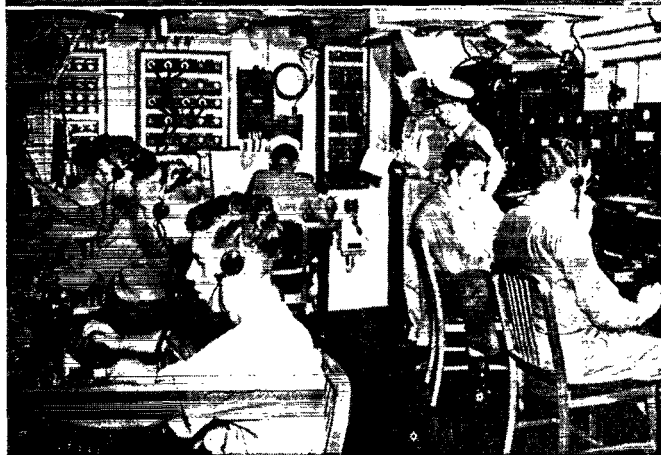
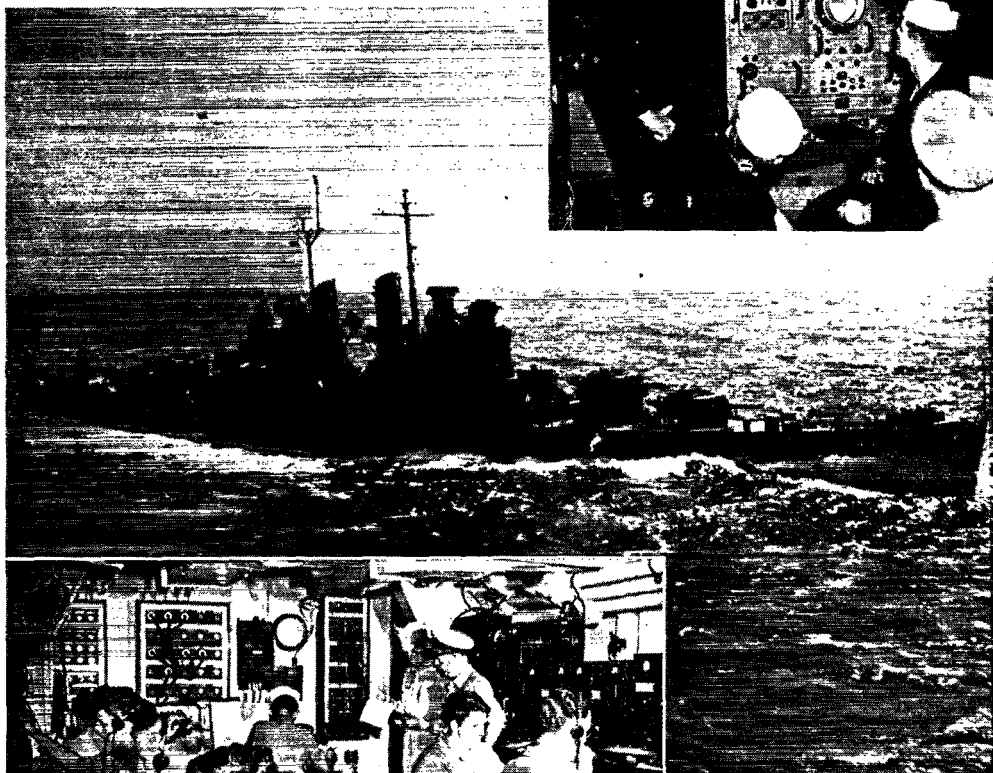
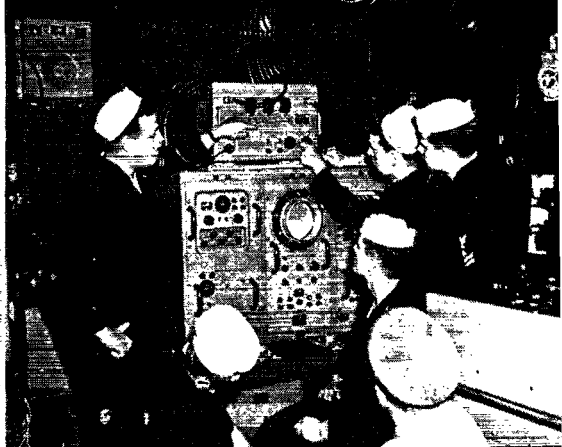

functioning of radar gear during shakedown cruise aboard a modern light cruiser off the Pacific Coast. *Left* — Nerve center of the ship is the "shack" — the communication office. Amid a maze of cabled wiring, typewriters, transmitters and receivers, operators contact other ships of the fleet and bases.

Electronics Officers

During 1941, the only Navy training available for electronics officers was a postgraduate course in radio engineering offered by the Naval Academy. This included two years of study at the Academy proper, followed in some cases with a third year of advanced work at either Harvard, Yale, or the University of California.

While electronics training officers were deciding what measures to institute, a new accelerated course convened at Bowdoin College in Maine. After three months at Bowdoin the class was sent to NRL for an additional three months' work on such radar sets as were available for training purposes, then went out to teach or fight.

Meanwhile, among the laboratories engaged in developing new equipment and perfecting exist-

ing gear, M.I.T.'s Radiation Lab in Cambridge was established as a leader in the field of radar.

Soon the M.I.T. Radar School opened as a combined Army-Navy project, with all radar officer training being given there.

Activity mushroomed; the roof of the school began to look like something from a Buck Rogers cartoon; strange structures blossomed periodically only to be immediately shrouded in canvass and mystery. Soon the roof space gave out, and pent-houses were built housing radar antennas.

Meanwhile, the capacity of Bowdoin had been exceeded, and a pre-radar school was established at Harvard. Finally, a third Army-Navy school was established at Princeton in mid-1943.

Yet another problem was to find the men to train. Practically anyone with radio engineering

experience was commissioned outright and ordered directly to a school with no preliminary naval indoctrination.

Prospective technical officers were chosen on the basis of their officer qualification test scores, together with a special pre-radar aptitude test. The relatively small group thus available had to be tapped carefully since any large drain would result in choking off the development and manufacture of sorely needed equipment.

Procurement activities hunted for officer candidates with electrical engineering education or hobbies in radio and electricity. Physicists and mathematicians were screened by interviews at procurement centers. At one time officers whose civilian background bore almost no relation to electronics were accepted for training. Some of these worked out fairly well, too. However, experience made clear that experienced engineers and skilled amateurs made the best electronic officers.

The radar officer first goes to pre-radar school. However, placement examinations given when the student officer arrives are used to determine whether he may omit part of the training. Some officers, who have had excellent educational backgrounds and perhaps have even worked for factories producing radar equipment, occasionally skip the whole course and go directly to M.I.T.

While at M.I.T. the student officer studies and works on several typical equipments in his field, called "vehicle" equipments. These illustrate basic principles of the different general types of radars in the fields of air and surface search, early warning, and fire control, and from the knowledge gained on them the officer may quickly become familiar with other sets.

One of the most interesting features recently introduced at M.I.T. is a week devoted to "special topics," when the student is confronted each day with a different non-operating radar upon which he has received no formal training. With only the manufacturer's instruction manual for the equipment in question he sets out to put it into operation. This helps bridge the gap between closely supervised training and conditions at sea, when a technical officer may be called upon to service completely new equipment with only the help of the accompanying instruction book.

Tactical Officers

Action reports from the Fleet indicated a demand for tactical officers trained in techniques of electronic warfare as well as technical officers who understood the matériel problems.

Aboard a warship, for example, the officer who supervises radar operation and interprets the information received is the CIC (combat information center) watch officer. The enlisted men who work under him are radarmen. Numerous other officers and men also are concerned primarily with the operation of electronics equipment.

The first step was to enable CIC watch officers to study use of the information provided by electronic devices. Instruction in the techniques of fighter direction was initiated in midsummer of

1941. Because information on radar then was highly classified, classes received little radar instruction until mid-1942. The schools were forced to use tricycles, link trainers and other improvised devices to simulate tactical problems.

Among the first fighter director schools was that at San Diego, which was moved to Pearl Harbor in the spring of 1942, and that at NAS, Norfolk, opened in August 1941. Because of air congestion in and around Norfolk, in May, 1943, CominCh directed that the Fighter Director School be moved to NAS, St. Simons Island, Ga. This school opened in June, 1943, as the U. S. Naval Radar Training School administered by BuPers with CominCh retaining primary interest. At this time fighter direction training was finally consolidated at the St. Simons school.

Meanwhile, new tactical information from Fleet experience and new tactical doctrine led to the establishment in March, 1944, of the NTSch (Tactical Radar), at Hollywood Beach. The primary purpose of this school was to train CIC Watch Officers in the operational use of CIC equipment. This school offered courses in CIC organization, communications, navigation, surface and AA gunnery, countermeasures, tactics, and Fleet doctrine.

Additional Training

Apart from the formal training programs described there were many special programs providing instruction on special equipment in the field.

New gear was continually being designed to fill war needs, and as quickly moved to ships. To take full advantage of the latest developments, training of personnel had to keep abreast of improvements. For this reason special short courses in specific equipment often were necessary.

In addition to the formally established service schools, many other training courses were started informally whenever a naval activity confronted with a need for on-the-spot trained personnel.

At a Navy yard, for example, the RMO (Radio Matériel Officer) would establish short courses for the men under his cognizance. These courses started under the supervision of the Bureau of Ships. CAP training was given on the various types of gear on hand at the particular yard, equipment being obtained by informal "loan" from the yard's pool. Considering that many RMOs are hams, this procedure might be considered another example of fraternal cooperation.

Factories producing electronic equipment also cooperated with the Navy to offer courses in their gear. An example is the many special courses offered by the M.I.T. Radiation Labs as new equipment was developed there, or the training given by the Bell Telephone Labs, Western Electric, RCA, Raytheon, and other companies which also offered their facilities and services to the Navy. The aggressive spirit of improvisation which was constantly being shown in the field went far to solve the difficult and ever-changing problem of electronics training.

Gradually these schools grew in size, capacity and scope, and ultimately they represented a highly important part of the Navy's electronic training. In the latter part of 1944, the Bureau of Personnel took over their administration, setting them up on a more formal basis as NTSchs (Electronics). Up-to-date training was given at the navy yards on both coasts in NTSch (Electronics) and NTSch (Loran). Only at such Navy Yard schools that training can be given men on new electronic equipment during their ships' availabilities. In this way officers and men could be kept up-to-date on new trends and equipment. Recognizing the importance of maintaining close coöperation with the RMO activities, the organization of the NTSch (Electronics) provided that the RMO would continue to be Officer-in-Charge.

Operational and Refresher Training

The most effective teacher always has been experience. Men learn their jobs best at sea under actual operating conditions.

In the later phases of the war, to decentralize the training program, it was divided into two fields: basic training (at the regular recruit and advanced schools), and operational training (on-the-job training by groups, as crew-members aboard a ship or personnel of an advanced base unit). There has been a high degree of decentralization in the latter field. Operational training commands of the Atlantic and Pacific Fleets were

established, responsible for team training — shakedown cruises, pre-commissioning cruises on vessels of a similar type, etc. Then when the Navy had to man another ship it withdrew from operating vessels a small number of experienced officers and men to form the nucleus of the new ship. In addition to providing trained men for key jobs, this device of the nucleus crew was of assistance in providing relief and rotation from combat areas back to the United States.

Similarly in radio and radar training, individual training would be often followed with group or team training, as well as shakedown and under-way training.

Such operational training was found to weld individuals into CIC or other electronics teams and then fit the team into shipboard patterns. This applied not only to CIC team training, but to ASW, countermeasures, and training in specific installations for particular types of ships.

Associated with this was a major device in officer placement instituted by BuPers — the "fleeting-up" system, which took cognizance of the fact that junior officers aboard a ship or at an advance base gain additional knowledge as they perform their tasks. Then, to man new construction, the Navy would skim off the cream of the more experienced officers, fleeting-up the newer ones behind them into the jobs so vacated. A similar technique was followed with enlisted men.

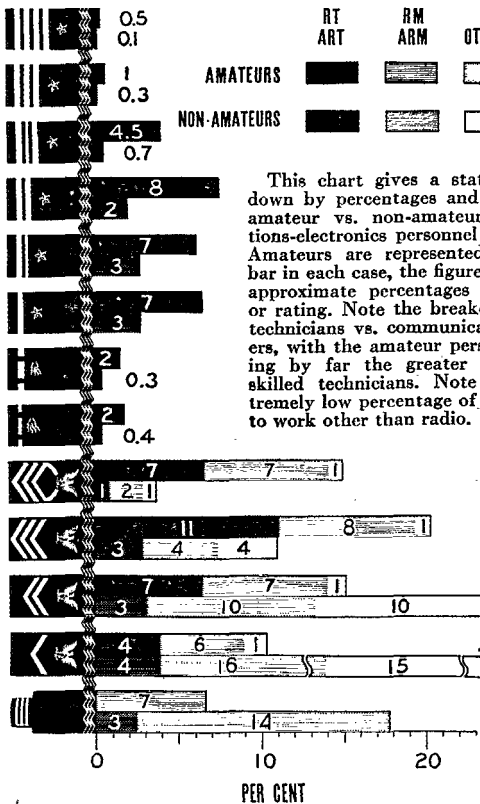

This chart gives a statistical breakdown by percentages and specialties of amateur vs. non-amateur communications-electronics personnel in the Navy. Amateurs are represented by the top bar in each case, the figures representing approximate percentages in each rank or rating. Note the breakdown of radio technicians vs. communicators and others, with the amateur personnel supplying by far the greater proportion of skilled technicians. Note also the extremely low percentage of hams detailed to work other than radio.

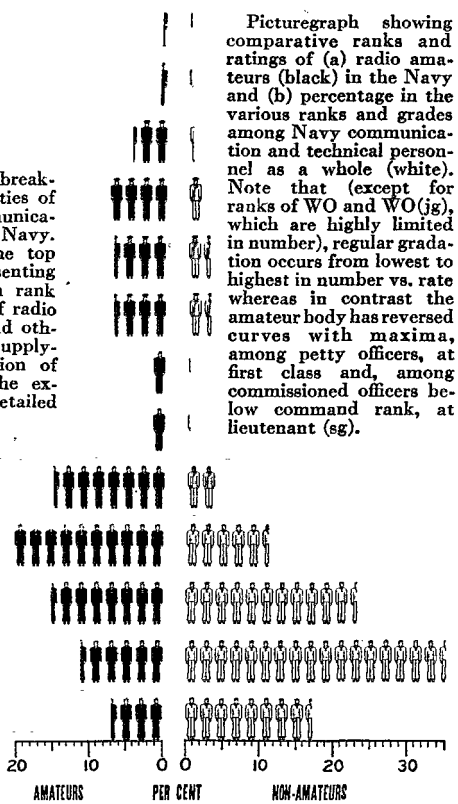

Pictograph showing comparative ranks and ratings of (a) radio amateurs (black) in the Navy and (b) percentage in the various ranks and grades among Navy communication and technical personnel as a whole (white). Note that (except for ranks of WO and WO(jg), which are highly limited in number), regular gradation occurs from lowest to highest in number vs. rate whereas in contrast the amateur body has reversed curves with maxima, among petty officers, at first class and, among commissioned officers below command rank, at lieutenant (sg).

Refresher training was given to Fleet personnel under a rotational plan which was designed to return officers and men who had been but eighteen months or more. These men would be sent to school for brush-up courses.

Reserve radio technicians and aviation radio technicians, of whom such a high percentage are amateurs, are being encouraged to remain in the Navy. Recent discharge for these ratings was authorized to permit immediate four-year reenlistment in the regular Navy.

This group also is eligible for reenlistment allowance. Men in the first three pay grades (CPO, PO1c and PO2c) are entitled to \$50 for each full year of continuous active service in the Naval Reserve served during the reserve enlistment immediately prior to discharge. Other enlisted personnel (fourth through seventh pay grade) are entitled to \$25 reenlistment allowance. Reenlistments in the regular Navy are to be in the permanent rate held at the time of discharge, with authority granted for immediate advancement to the temporary rate held at the time when the discharge was granted.

About 10 per cent, or 30,000, of present Naval Reserve officers will be needed for the postwar Navy, according to Under Secretary of the Navy Artemus L. Gates. Of the approximately 350,000 officers now in the Navy less than 4 per cent are graduates of the Naval Academy. Nearly all the rest — well over 300,000 — are Reserves. Thus the Navy which played such a tremendous part in winning this war is, in fact, a civilian Navy.



Acorn Assembly and Training Detachment, Amphibious Training Command, Port Hueneme, Calif. *Left to right, kneeling:* ART2c R. M. Saper; ART2c J. H. Tudor, W6UAL. *Back row:* Lt. S. L. Jacobsen, W6KVF; RM1c C. L. Kelley, W4GOP; CRM L. M. Stuart, ex-6BWH; RM1c H. M. Meyer, W1MFI; ART2c A. L. Oberg; CRM L. H. Robertson, ex-2KE; RM1c L. G. Smith, W8GMI.

Shore Establishments

THE Navy's floating establishment is paralleled by an equally ramified shore organization which operates the many dry-land services to the fleet — the Navy yards, schools, hospitals, supply depots, airfields, barracks and naval training stations. Bases are as important to navies as ships in preserving lines of communication — and that applies to both meanings of the term.

Because of the unprecedented expansion of the Navy's air arm, it was necessary to establish hundreds of Navy air stations, both for operational and training purposes. The elaborate radio, radar and racon installations at these air stations now spin a communication and navigation web extending to the four corners of the globe.

The Navy maintains a large number of shore radio stations for direct contact with the various units of the fleet and with the communications centers of both U. S. Navy and Allied headquarters. In addition to the hundreds of shore radio stations within continental U. S. A., many advanced base stations were established in strategic areas to facilitate command and operational communications. As the fleet moved forward with increasing momentum, additional units were established around the perimeter of operations.

Navy Yards

All Navy yards include in their organization an Industrial Manager, who is an officer-engineer responsible to the Commandant for all ship construction, conversion and repair.

Under the Industrial Manager are included the Planning, Production and the Radio Matériel Organizations. These three organizations play an important part in building and outfitting of naval combatant vessels with the many varieties of electronic apparatus.

The planning organization prepares all plans for the installation of electronic equipment. In addition to the advance planning, and authorizing the work for the many shops in the Navy Yard and outside contractors, this department orders all types of material other than electronic.

The production organization, in turn, processes all work in the shops and on the shipways — assigning ship superintendents during construction, overhaul or conversion periods and workmen to the various shops and shipways depending on the needs of the fleet.

RMOs

The effectiveness of our Navy's ships and planes is measured by the percentage of the time they can be kept functioning at sea or in the air. Time spent in repair operations is valuable time taken from the job of fighting the enemy.

Key man in the supply and maintenance organization is the Radio Matériel Officer who is under the Industrial Manager. At every repair base within the United States and at island bases there is an RMO crew for field maintenance work. In the early days of the war lack of shipping caused serious shortages of vitally needed spare parts. These men and their staffs performed unbe-

Naval Air Technical Training Centers abound with amateurs. Right — Stationed at Memphis, Tenn., are: *Left to right, first row:* ACRM H. C. Oefinger, W1GUP; Lt. Cdr. C. B. Evans, W1BFT, former SCM of New Hampshire; ACRM R. H. Snider, W9MNG; CSp(T) W. McFadden, W9RJM; Lt. B. S. Webb, W5CRU-W9OZC; CSp(T) S. V. Chaplan, W9CIB; ACRT S. W. Stephens, W5HZD; CSp(T) H. O. Preston, W9SJA; ACRM G. A. Davison, W1FWQ; ACRT E. H. Pulliam, W9LBQ. *Second row:* ACRM W. L. Bourgeois, W5IAO; ARM3c E. J. Smith, W9DYC; ARM1c F. B. Carroll, W4EAT; ARM2c B. P. McKay, W9KAH; ART2c R. L. House, W7BUR; ARM2c H. Jensen, W9WXE; ARM3c C. E. Robb, W9LFP; ARM2c J. G. Valentino; ARM2c J. H. Smith, W3JPA; RM2c E. J. Chadek, W9ZSP. *Third row:* Sp(T)1c L. L. Dean, W9JIB; ARM2c C. B. Green, W3IPD; Sp(T)2c J. A. Marks, W4DVQ; Sp(T)1c J. L. Stevens, W4DEB; ART3c D. W. Sutton, W4GEK; ARM3c R. B. Prince, jr., W3JGZ; S1c M. Wendroff, W2BWA; S2c Fujawa, W9ONB; RM2c C. Bryan, W9QNP. *Right — Amateurs at NATTC, Gainesville, Ga. L. to r. first row:* Lt. E. Barber, ex-7GI; Lt. J. F. Sodaro, W9AAR; Ens. R. L. Sorensen, W9ZFP; Lt. (jg) H. L. Bigelow, W6AAA; Lt. L. H. Johnson, W6JUH. *Second row:* Ens. J. F. Zwaska, W9RJS; Ens. M. T. Hatley, jr., W4GJA; Lt. W. D. Pierce, W1FGX; Lt. R. L. Coggins, ex-W6ENS; Lt. G. T. White, W6PBJ. *Third row:* ART2c Dean Hutchinson, W9PWV; RT1c J. E. Lindsay, USCG, W1EXG; RT1c Bill Hebson, USCG, W9QVS; ART1c E. L. Chine, W6EAO; ART2c A. J. Cicora, W9NXX; S1c Phil Jensen, ex-9FYA; ART1c D. Monos, W8LCE; ART1c W. Reed, OPLO; ART1c R. W. Thompson, W4GMP. *Top row:* RT2c T. V. Sale, USCG, W1BZS; RT1c H. G. Stott, USCG, W3GVV; Rdm3c Paul Sullivan, ex-9BWD; ART1c E. A. Jank, W5EJT; ACRM J. L. McDonald, K6SDM; ACRT F. E. Comer, W4FXK; ACRT W. C. Bledsoe, W4EQM.

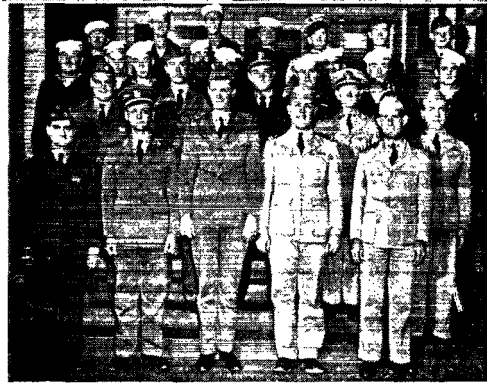

lievable feats in keeping equipment in good working order, and ham ingenuity played an important part in the repair of electronic equipment. Accustomed to making use of whatever materials happened to be at hand in their own stations, the hams often fabricated replacement parts from discarded tin cans and scrap from downed Jap planes. To keep the ships and planes in fighting condition these trouble-shooters often worked straight twenty-four-hour daily shifts to get the job done.

The RMO, who is carefully selected for his technical and administrative ability and who in many cases is an amateur, is responsible for all the radio, radar, sonar and counter measures work within his area, including the ordering, distribution, installation and maintenance of the gear. The technicians and electronic engineers in his organization constitute a smoothly working team providing dependable service to the fleet.

A feature of the many facilities and services which the RMO provides is the electronic schools

Left — Radio amateurs stationed at the Naval Air Station, Olathe, Kans. Left to right: RT3c T. A. Lantz, W9ZCK. CRM(T) C. E. Gibbs, W5FPX; ACRT D. Shelley, W6NXT; ACRT J. A. La Manna, W2HPE; CRT N. F. Carr, W9KHZ and RT1c T. S. Kepner, W5JOC. *Right — NATC, Pensacola, Fla. Left to right, front row:* ACRM R. B. McLaughlin, USN, W7IQJ, ex-W6QJN; Lt. A. R. McMullen, USN, W4GBM; Lt. Cdr. A. W. Blenner, USNR, N7EHB; Lt. H. E. Taylor, USNR, W6PNI; Lt. (jg) R. Chandler, USNR, W5KIQ, ex-W2JLM. *Back row:* ARM1c W. E. Elliott, USNR, ex-W4DMV; RM1c J. P. Trimmer, USNR, W9ZGU; RM1c A. R. Turner, USNR, W9KSF and ART1c F. L. Rinehart, USNR, W9MEL.





Top — NRS, Cheltenham, Washington, D. C., left to right, front row: CRM James C. Blume, NY1AF; CRM F. W. Balliet, W6LWD; CRE R. L. Williams, W3BSE; CRM R. M. Acheson, W6PZG; CRM K. M. Beall, W4EZT. Back row: RT2c L. B. McCreery, W3IOM; RM3c J. R. Green, W8MEI; RM1c L. W. Briggs, W2NUC. Bottom — NRS, Annapolis, Md., left to right, front row: RM1c M. J. Schreiber, W2MGL; RM1c L. E. Stoner, W8IMS; CRT J. F. Goveia, W1LQB; RE R. D. Johnson, K6NSD. Back row: RM3c T. Z. Urbanski, W8NCA; RM1c A. E. Irving, W1BFR; CRT F. R. Poteet, W9NLN; RM3c C. N. Roberts, OPLO.

covering the practical aspects of electronic equipment, as discussed more fully in the section devoted to operational training.

When war was declared, the Navy Department anticipated the need to install and service a great variety of relatively complicated radar equipment. Field engineering contracts were let and factory-trained field engineering organizations were established to assist Navy technicians in this work.

Today, civilian field engineers are stationed at all major Navy yards and Navy bases and are associated with the RMO offices. These factory-trained experts are constantly on call and in addition to cooperating with installations, visit the ships as they arrive in port to check the operation of the equipment and instruct the ship's personnel in details of operation of new equipment. An important function of the field engineers is to install the many improvements and modifications of the equipment which result from lessons learned under battle conditions.

"GREAT LAKES" — Naval Training Center and Hq. 9th Naval District, Great Lakes, Ill. Left to right, front row: Lt. (jg) R. C. Smithwick, W9KTL; Lt. Cdr. W. Munter, W6DAA; Lt. Cdr. L. A. Morrow, W9VKF; Lt. Cdr. R. H. Comfort, N9LGZ; Cdr. J. E. Parrott, W7KX; Lt. Cdr. A. A. Kirchner, N8MZA; Lt. Cdr. N. H. Randall, W7ERI; Lt. M. E. Conelius, W7GXU; Lt. (jg) A. C. Hare, W9BDX. Second row: T2c Marian Goddard, WAVE, OPLO; CRM G. A. Phillips, N3HNY; CMM V. L. Polson, W9SZM; RM1c K. S. Perry, OPLO; CRM J. F. Miller, W6QB; CRM F. V. Collins, W8QN; RN2c Gail D. Chamberlain, WAVE, OPLO. Third row: S1c E. A. Samson, W9HZX; MM2c L. E. Norman, W9SRK; EM3c R. A. Cumpston, W6IBN; RT1c W. J. Walters, W6QAA; S1c R. H. Dundas, W8WVA; S1c W. C. Davidson, W2OKY; RM1c A. J. Hoggins, OPLO; RM1c W. T. Lent, OPLO; RM1c N. F. Wasson, W6NNV; and T3c G. Storey, W6NTK. Fourth row: RT1c E. J. DeChambeau, W8TST; RT2c C. J. Bolvin, W8LVV; RT1c W. N. Sapp, W4DAJ; RM1c J. H. Archambeau, W6HBR; AS R. D. Chandler, W9OKM; S1c R. W. Steele, OPLO; EM2c J. R. Anderson, W8TH; S2c T. C. Ayres, W4KE; S2c R. R. Cone, W9YLU, and L. R. Voss, OPLO. Fifth row: S1c L. Cartledge, OPLO; AS J. F. B. Yarns, W4HKK-5HCZ; S1c F. A. Slaker, OPLO; S1c M. H. Asp, W9WEF; SK3c R. C. Duvall, OPLO; S1c D. H. White, W9BVB; S1c H. M. Wolkert, W3GYS; RT2c G. O. Alfred, W7JDP; S1c H. L. Lester, W2ODC; S1c V. E. Little, W9YHV, and S1c R. C. Wampole, W8TMY.

★ ★ ★

BOSTON — A few of the amateurs at the Hq. 1st Naval District are, left to right: Lt. Cdr. L. G. Thompson, ex-WIADA; Lt. (jg) H. F. Craig, ex-6HC-AC2HC; CEM S. E. Hyde, W6IAH; Lt. Cdr. C. C. Chisholm, W1F, Assistant District Communication Officer, Hq. 1st ND.

★ ★ ★

BALTIMORE — At the Norfolk Navy Yard, Baltimore, Md., are, left to right: Lt. (jg) D. H. Donahue, W3GXS; Ens. E. G. Laue, W6IZF; Lt. J. A. Richardi, W3GOR; WRE G. D. Alverson, K6KYD.

★ ★ ★

NORFOLK — At the Norfolk Navy Yard, Portsmouth, Va., are, left to right: Lt. Cdr. D. A. Green, W8FGI; Lt. Cdr. H. E. Legler, N9BP; Cmdr. Boyd Phelps, N9BP Asst. RMO; Lt. J. C. Melton, W3NT; Lt. (jg) B. E. Hegler, W9GQM; Lt. J. S. Turner, ex-W3AMJ.

★ ★ ★

CHARLESTON — Hq. Sixth Naval District, Charleston, S. C., hams include, left to right, front row: Lt. M. H. Hawkins, W9BPH, PRO, Fleet Administration Office, Charleston; CRE V. B. Momborg, N6FJB; Lt. A. Mayer, K6SHG, Radio Officer, NAS, Charleston; Cmdr. J. L. Skinner, W6AWX-7ERB, CO of Naval Air Station, Charleston, and District Aviation Officer of 6th ND; Cmdr. T. I. Dean, W4DAW, Communications Officer, NAS, Charleston; Lt. Cdr. R. R. Kibler, W4GW, OINC, Radio Charleston; Lt. Cdr. C. H. Steed, W5DRR-4HHB; Lt. M. Fox, W9GVM. Back row: RT1c M. E. Hall, W4CXD; RE R. E. Winn, W6HWH; RE A. C. Neergaard, W3ILZ; RE F. R. Cheese, W8CCR; CRT D. R. Saltow, W9BIW; CRM W. C. Howard, W2VP, and RT1c J. F. Oncken, W8ASV.

★ ★ ★

MIAMI — Amateurs stationed at Hq. Gulf Sea Frontier and Hq. 7th Naval District Miami, Fla., include, left to right, first row: RM1c A. DesHotel, W5NWD; Y2c B. W. Lyerly, OPLO; CRM D. J. Mullaly, W6NLZ-8KKY-KIG; SoM3c W. Kosteki, W1NSH; RM1c J. M. DeLay, W4EEA; RM1c E. L. Miller, W5CMQ. Second row: S1c (RM) H. W. Danner, W4IAG; RM1c C. T. Cosner, W6LWO; S2c L. W. Kuebler, W3HKL; S1c D. C. Stedman, W9WLO; RM1c F. G. Gray, W5IXJ; S2c F. A. Johnson, W1AVR-BYB; SaD2c E. J. Buklad, W8QZB; RT2c F. W. Jenard, W1JMT. Third row: CRM E. W. Nyberg, W8FHG; Ens., J. J. Doane, W4HAU; Lt. (jg) M. Chakin, W2FLL; Lt. Cdr. P. B. Collison, W2IXE-ex-2KN, Radio-Sonar Officer, Gulf Sea Frontier; Lt. Cdr. F. B. Hoselton, W4ADP-ex-9BZH, Assistant District Communication Officer, 7th ND; Lt. Cdr. B. Farkas, W8FOL; Lt. C. N. E. Fontaine, W1LXQ, Communication Officer, NTC, Miami; RE L. Pratico, W6RQI; CRT E. C. Coughran, W9ZEE.

Advanced Bases

Far-flung, strategically located and strongly held bases may well swing the balance between victory and defeat in battle. A much weaker navy in terms of ships, but one able to operate from a string of strategic bases — to jump from one base to another and sally out to do battle from any one of them — may exercise commanding leverage upon a large part of the world.

To provide jumping-off points for attacks on the stepping-stone islands leading to Japan, the United States had to unravel the string of islands stretching from Hawaii to Australia and convert them into fully equipped air and naval bases. These reservoirs of supply, repair and manpower which following the fleet, made possible its ad-

vances, vary in size and equipment. Some are tiny outposts; others huge depots capable of repair jobs of the greatest magnitude. At the time our forces were gathering momentum for the final thrust at Japan, there were over 300 such bases integrated in a global supply system over which more than 100,000 tons of supplies moved each day. Five million different items — soldering lugs to 3-kw. transmitters — were delivered where they were needed.

Initial maintenance at the advanced bases is by "Acorn" — advance airfield assemblies, a typically American product of prefabrication, all packaged and ready to follow landing forces into enemy territory — and the "CASU" — carrier aircraft service unit — which moves in shortly thereafter.

CINCLANT. *Left to right*, RT3c J. A. Wall, W3AAE; Lt. Cdr. W. B. Bernard, W4ELZ, and RM3c J. J. Creevay, W2KHY.

BERMUDA — Amateurs at the Naval Operating Base, Bermuda. *Left to right, kneeling*: RM1c S. R. Ellis, W3JPW; AMM1c C. E. Miller, jr., W8UOC; RT3c R. H. Hartley, W1MNC. *Standing*: Lt. Cdr. S. N. Siegel, W2NEM, Base Communications Officer; Cmdr. R. B. Meader, W1KG, Base Supply and Accounting Officer; Ens. K. Barlow, W1DLL.

SAN JUAN — U. S. civilian technicians in the CAA employed at the Naval Radio Station, San Juan, P. R. *Left to right, front row*: G. E. Mayer, K4HEB; C. A. Long, W5JAC; T. L. Lindsey, W4IHH. *Back row*: J. A. Brigman, W4IEN; H. Cagle, W4DYX; E. W. Mayer, K4KD; W. C. Thomas, W4BZA.

Upper right — Two of the many Navy hams at NRS, San Juan are Lt. Cdr. A. E. Snow, W1RZ, and Cmdr. E. J. Gluck, W4CQ.

Right — In the Radio Material Office, 10th ND, San Juan, P. R.: Lt. (jg) E. J. Dufour, W6EHS, Asst. RMO 10th ND, and Sonar Officer; Cmdr. F. Muller, sr., W2MR, RMO, 10th ND; Lt. L. K. Boyd, W3JGG, Asst. RMO shore stations; and CRE J. P. Fitzwilliam, W9KFH, asst. RMO and radar officer.

TRINIDAD — At the NOB, Trinidad, B.W.I., are, *left to right, seated*: Lt. (jg) R. H. Sneed, ex-W5BNW; Lt. R. C. Horne, W7FBR; Lt. H. D. Kimberly, W9CWM; Cmdr. P. S. Pfeifer, ex-W9TLW; Lt. J. W. Fulmer, ex-3BNL; Lt. R. W. Barton, W9LOG; RE F. C. W. Lazenby, W1IRD; D. F. Beyersdorf, technician, W9PFK. *Back row*: CRT H. C. Warner, W6QBR; CRT T. F. Dudek, W8SST; CRM G. S. Craig, W3MH-

ex-W3AEI-EPA-5AT; P. Susko, technician, W8CEU; W. R. Singletary, technician, W4GBD; RT1c W. T. Heller, W3BVL; RT1c C. B. Tendick, W6TDR; HA1c S. E. MacCready, OPLO.

SOLANT — Serving with the South Atlantic Force are, *left to right, front row*: CRT J. A. Michael, W3JPI, ComSoLantFor; Lt. Cmdr. J. H. Doig, W6EA, ComSoLantFor; Lt. C. C. Anderson, W6FFP, ComSoLantFor; CRM (T) H. G. Butler, W9OVF, Radio Pina. *Back row*: RM1c J. W. Suter, W5FEW, ComSoLantFor; RM1c M. A. Albie, W9OZO, Radio Pina; CRM (PA) A. Hughes, W4BCA, Radio Pina; CRM (T) C. G. Berninger, W8MOY, Radio Pina; RM1c R. J. Siegler, W2NZA, Radio Pina.

PANAMA — Some of the amateurs attached to the Radio Material Office, Navy 121, Panama, C. Z. *Left to right, seated*: Lt. Cdr. J. E. Desrosiers, KALJD, Asst. RMO; CRT M. Ramsey, W6MAK, and J. W. Stanton, technician, W9PSP-JKE. *Standing*: Lt. Cdr. J. A. Slusser, W9BCW, District RMO; Lt. (jg) L. B. Mos, W3JHL-ex-4HDH, Asst. Ships Superintendent for Radio; K. Taylor, technician, W1ADA; Lt. B. F. Bailey, jr., W9DPM-ex-W8QS, District Ships Superintendent.

Bottom — Amateurs at the Naval Radio Station, 15th ND, Summit, C.Z. *Left to right, seated*: CRT C. R. Frederick, W4HTE; RM1c A. E. Paladino, W1LBZ; RT1c J. C. Blazek, ex-W7BJT; RT1c H. A. Smith, W5KAA-ex-9DGP. *Standing*: CRM P. E. Miller, ex-W4DTF; RT1c J. W. Walsh, ex-W1MA; CRM J. C. Duncan, W4CEW; RT1c B. R. Mikutajcis, W1MSF. Executive Office at 15th ND is Lt. J. T. Lyman, W4FMZ.

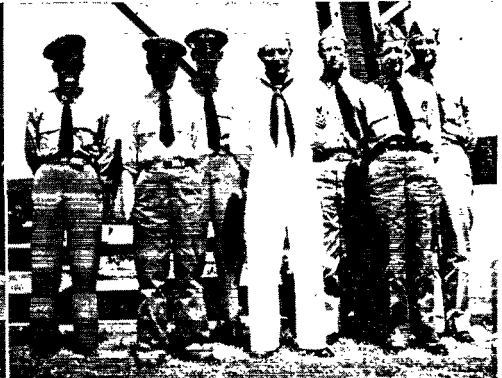

Naval Air Station, Navy 116. *Left to right, front row*: RM1c A. E. Collins, W6QVS; RM1c C. D. Spano, ex-W4EBJ; RM1c H. W. Dail, W2OGV. *Back row*: CRM J. G. Storms, jr., W4EIA; CRM G. C. Timmons, W5IBZ; CRM D. C. Layman, W4ACP; CRM R. K. Dussinger, W8UJV; CRM E. B. Kerr, W3CCC; CRM E. J. Bittner, W3HCK. *NAS, left to right*: ACRM D. L. Carmean, W6PQE; ACRM D. A. Miller, W2MQB; ACRT W. R. Butler, W8HGK; ART1c R. H. Hjelm, W9KKK; Lt. C. A. Conard, W2MJJ; Lt. (jg) J. E. Bradford, jr., W3ELC; Lt. (jg) E. E. Pearson, W4RU.



CINCLANT

BERMUDA IS. (Br.)

BERMUDA

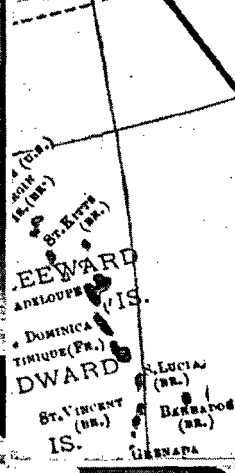

TRINIDAD



SOLANT





★ HONOLULU

Below, left — Naval Air Station, Honolulu, T. H. On duty in the communications department of Air Transport Squadron Eleven are these radio amateurs, posed before a four-engine Douglas Skymaster which their squadron operates over a 15,000-mile Pacific network linking western U. S. with the Philippines. *Left to right:* ACRM J. J. Treatsorth, W5GUV; ACRM J. R. Lister, W5JNV; ACRM W. L. Baird, W5GXU; ACRM W. B. Hollis, W5FDR; ARM2c R. F. Oatfield, W7BOI; ARM2c F. C. McReaken, W6USO.

Left, above — At the Naval Operating Base at Adak, Alaska, are (inset, left to right): CEM J. B. Redfearn, W5AVM; RT1c W. M. Hebson, W9QVS; RT2c F. N. Kacsmar, W8LNV, and, not shown, RE A. A. Sternberger, W4HIQ. *Top* — At Dutch Harbor are, *left to right, kneeling:* S1c (ARM) R. W. Power, W7YP; ARM1c K. F. Heuer, W9KNX; RM2c C. F. McCann, W5IGH; RM1c W. B. Drown, W6SOI, and RT2c E. L. Cotter, W9GOA. *Standing:* CRT C. M. Haverlandt, W9TED; RM1c E. J. Bachner, W2HPB; Ens. L. R. Fischer, W3-DZV; Lt. Cdr. R. C. Berry, W9MN; RE A. W. Lauffenburger, W6LOJ, and RT1c R. R. Blanchard, W9JKC.

Opposite page, top — On duty at the 12th Naval District Headquarters at San Francisco are, *left to right, front row:* Cmdr. F. K. Tiffany, W9DEB, OINC, Registered Publication Issuing Office; CRE S. A. Burnett, K6KSL, photo-radio officer, Radio San Francisco; Lt. Cdr. C. I. Shields, W9PWO, communication-operations officer; Lt. Cdr. H. E. Heiner, W8FUW, OINC Registered Publication Issuing Office, Pearl Harbor. *Rear row:* Lt. Cdr. R. E. Chronne, W5AEW; Lt. J. P. Sales, W6HFF; Lt. Cdr. E. W. Ross, W6ASE, OINC, master control station, Radio San Francisco.

Below, right — Hams of Air Transport Squadron Ten: *Left to right, seated:* Ens. D. R. Lane, K6SNF; Lt. Cdr. E. A. Nutter, W6CMS. *Standing:* Ens. W. T. Porter, W1BFC; ART1c H. F. DeGroot, W9TEV; ART1c G. D. Gosnell, W6UFU; ART1c E. R. Perry, W8VBZ; ART3c W. H. Parish, W6UCQ; ART3c V. L. Yarbrough, W9-YYW; ART1c S. L. Hart, W2JNK; ACRT L. S. Black, W4GHG; ART1c R. V. H. Alves, W6RDI; ACRT J. A. Stump, K6CNO; CRE H. A. Makahon, W2NBV.

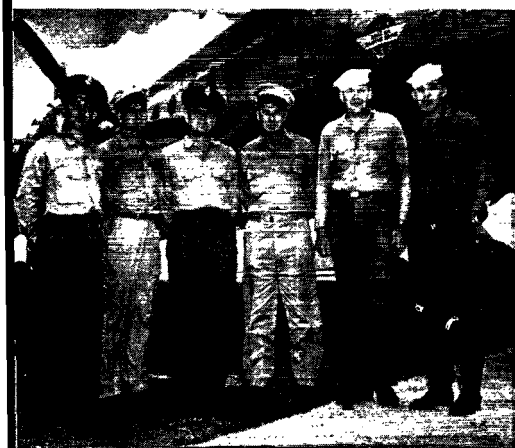

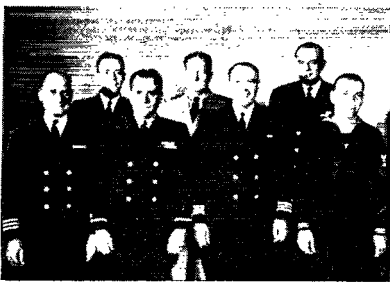

Below — At Terminal Island, Calif., are, left to right, first row: Huff, ex-W6DOL; Lt. (jg) Crossley, Benham, W6RPI; Engelman, W9SAA; Lt. Cdr. Davis, ex-9Kz; Lt. Cdr. Thomas, W7FEZ; Lt. Faulkner, W8NTV; Lt. Holsler, W6NNC; Lt. (jg) Hachten, W9ZNA; Lt. Guiley, W8LKJ. Second row: Pleasants, jr., W6QZP; RT1c Crystal, W6ANH; Haggerty, W6JMI; Beck, W5GED; Kelly, W5JHC;

Filizola, W6RVA; Olsen, W8OET; Peterson, W2KMJ; Moses, W6SXS; Bender, W8NWC; Appleman, W6ELX; Souter, W8UOX. Third row: Berry, W9MYR; Gibbs, W6RDM; Chapman, ex-W6DYI; LaGasse, W6DTD; Nordberg, W6ARO; Taylor, W6EBX; Beddow, W6SMW; Reid, W7HR; Wood, W61WE; Phillips, jr., W6SPZ; Cannoughton, W5HMI; Hall, ex-W9BBC.



Below — Stationed at Mare Island Navy Yard are (left) from left to right: RT2c K. G. Finch, W9EWA; RM1c D. L. Johnson, W7FTR-4IHE; Ens. J. H. Johnson, W6NIC; Lt. D. D. MacDougall, ex-9DAU; Lt. (jg) W. K. Howard, ex-W6APP; Lt. (jg) S. A. Sullivan, W9SAB; RT1c A. R. Corbett, W7FYV. Right: Lt. J. Rizk, W4CDP; Lt. L. D. Mealer, W6AK; Lt. Cdr. C. B. MacLean, W1DG, electronic planning superintendent radio lab., NYMI; Lt. Cdr. T. E. Erdmann, W7DND, ACO, NYMI; Lt. L. E. Fritzinger, W6PBU.

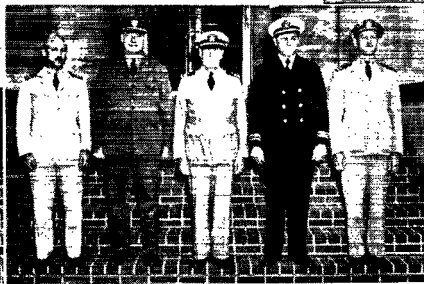

Below — Amateurs stationed at San Diego, Calif., are (left) l. to r., front row: Lt. Cdr. Lucking, W6H0S, Hq. CO, 11th ND; Lt. Cdr. Kinch, W6DZC; Lt. Cdr. Hazelett, W9VZA; Lt. Cdr. Brewer, W9JFD. Back row: RM3c Beckwith, W8ODI; CRT Podrosky, W8NUS; CRM Rogatsky, W6LUJ; CRM LaPlante, W9LRW. Right, front row: Lt. (jg) Lusk, W7BBO, CRM Seaward, K6MHX; CRM Stewart, W6QWV; CRM Jones, W8LVZ; CRM Jackson, W6RCM; RE Jackson, W1DCE; Cmdr. Underwood, W6ES, OINC, NRS, Imperial Beach. Back row: RM1c Powell, W6MJC; RM1c Smith, W3HE; CRM Stevens, W6IDD; CRM Plummer, W3DIA; CRM Jacobsen; CRM Miller, W9WTW; CRM Sheldon, W2IDV.

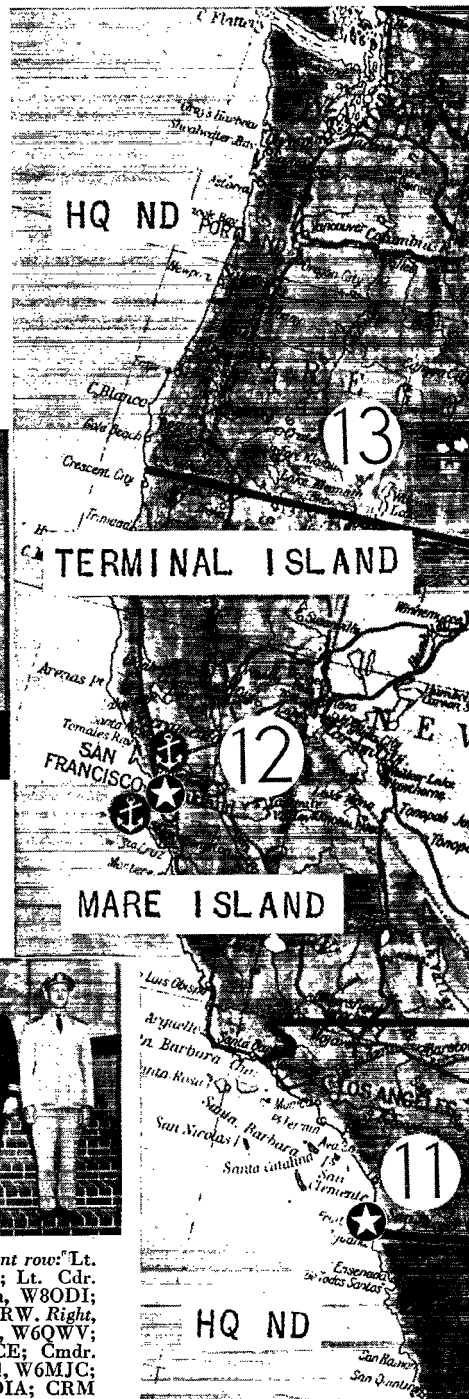

"PEARL"

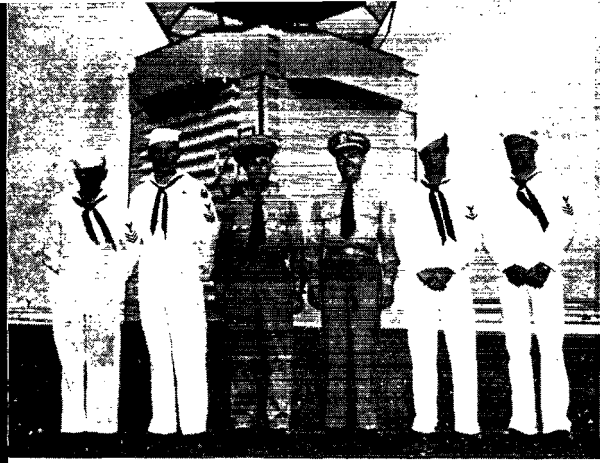

Above — NAS, Honolulu. L. to r.: PhMlc Augenblick, W3EON; SF1c Walawender, W8MY; CEM Chilton, W5EEF; CRE Cabanillas, jr., W2BNJ; RM3c Casalett, W8TRG; EM1c Barber, W1KXX. Top right — DCO, 14th ND, Pearl. L. to r., standing: CRM Erdman, W6CUZ; CRM Bjorman, W6TDY; Lt. Cdr. Swearingen, jr., W6FVL; RE Elkerton, W6PTN; CMoMM Hartman, K6ACW. Kneeling: RT2c Sprick, W2LPV; RT1c Davis, W3EU.



Above — RMO, Pearl. Left to right, front row: RT1c E. F. Arnold, W7IYI; Lt. A. R. Culver, W6PCO, RE W. A. Rutz, W5DSN; Lt. W. S. Baumgartner, W9ZIR; Lt. Cdr. M. J. Fickas, W6BII-ex-K5-BIM, etc.; CRE A. Goldman, K6DRE; Lt. Cdr. D. T. Snider, W7CBO; Sic G. V. Jones, W7RXV/YN1GJ. Back row: RE R. L. Aamodt, W6FPJ; CRT D. J. Miller, W6AHI; Lt. Cdr.

Above — Amateurs in the Radio Lab, Pearl. Left to right, front row: F. T. Blatt, K6ETF; A. B. Martin, K6ORB; W. F. Hage; C. M. Finley, W9YCE; J. H. Baker, W3GKJ; E. E. Hansen, W9AF; R. G. Haller, W9TYP. Back row: R. M. Hornung, K6EXP; C. S. Heppard, W9VSS; J. B. Allison, W3AWZ; W. G. Adams, OPLO; D. L. Hock, W6IJF; L. B. Adams, OPLO; D. W. Vallow, W9NHI; I. Hueske, ex-5IT-5QN; J. P. Fetter, W8HTM; L. Sample, W6MHW; W. E. Winters, W6RPT; L. C. Lee, W3GGR; T. S. Kimsey, W4ADK; D. W. Fuller, W6CND.

J. A. Purdy, W3JMF-ex-W8BZD-FKE; Lt.(jg) H. L. Proppe, W6NHS; Cmdre. G. W. Clark, K6OPR-ex-7CV; Lt.(jg) J. L. West, W6QNJ-ex-W5GYZ; Lt. H. C. Cameron, W6FUL; MM1c B. Burka, W8SSK.



Right — At CINCPAC, *left to right, seated*: Lt. Cdr. F. C. Mashburn, W5IAP; Lt. Cdr. E. R. Smith, W9GMO. *Standing*: CRM D. F. Karrman, W1DBW; Lt. Cdr. E. F. Lorentz, W8ELO; Lt. R. R. Ennes, ex-W6AFT; Lt. (jg) W. B. Lane, W2FNR.

Below — At CMOSOPAC, Noumea, *left to right, kneeling*: RM3c R. H. Vargus, W1ARI; M/Sgt. H. B. Maon, USA, W8YLH; RT1c Wm. Hodgson, W9FBI. *Standing*: Lt. (jg) H. F. Ebbs, W9FPM; Lt. Cdr. H. M. Whitney, W6DJQ; 1st Lt. G. H. Williams, USA, W9BNB.



At advanced bases a working knowledge of small arms was a definite need. At Attu, when the enemy broke through the outposts, the radiomen became combat troops. In one South Pacific landing, search radar was installed by half the crew before the area was cleared of the enemy while the other half stood guard. On the other hand, radio crews have arrived in advanced areas hopefully loaded down with machine guns and ammunition which never got used!



Opposite page, bottom — Field Engineers, Pearl. *Left to right, front row*: Whiddon, ex-W1ML, Westinghouse; Wedge, ex-6CTN, W.E.; Stark, W6KTZ, Submarine Signal; Womack, W4CQA, Sub. Sig.; Draper, W8TOY, Hazeltine; Laessele, ex-W3ARV, RCA; Leedy, W8JH, W.E. *Second row*: Dunlap, W3DHR, Hazeltine; Nelson, ex-W9NX, W.E.; Worrall, ex-3XQ-W3APR, Civil Service; Johnstone, K6KMB, Civil Service; Prince, W3JGZ, Raytheon; Burgraff, W6SER, W.E.; Mowrey, ex-9ER, Hazeltine; Carver, W3JJB, Westinghouse; Lercari, W6BIN, Sub. Sig. *Third row*: Bohnsack, W9PEQ, W.E.; Haase, W7DZA, W.E.; Austin, W9PI, Raytheon; Imler, ex-W6CKF, G.E.; Lauge, W4CVJ, RCA; Davidson, W9SIQ, Raytheon; Pease, W4BIK, Raytheon; Mason, W6AJM-ex-W4CCB, W.E.



At small bases the radio station may be contained in a single Quonset hut, while at extensive bases the receiving station, code room and communications office are placed near the headquarters, the transmitters being remotely controlled. Navy advanced bases include all shop facilities for the installation and maintenance of ship radio, radar, IFF, loran and sonar and d/f equipment.

An example of how the advance base network paid off occurred in the Battle for Leyte Gulf. The Jap fleet steamed out to do battle confident that, since our Third Fleet had been away from its base for two months and engaged in sixteen combat missions, it must be low in ammunition and other vital supplies; also that our 7th Fleet also must be in the same condition after its bombardment of Leyte to pave the way for the landings. But the supplies had gone through — enough to sink three Jap battleships, four carriers and seven cruisers and send the rest of the Jap warships limping away.

Advanced bases in the Pacific. *Left* — Navy 3025, *left to right, first row*: S1c (RM) D. D. Lind, W7HQB; CPhM (PA) S. B. Pinckney, W5BRI; RT1c P. B. Lätimer, W5JPY; RM1c C. D. Phillips, W9TAR. *Back row*: CRT M. L. Jackowski, W2GOJ; Lt. (jg) R. P. Boyd, CE1BJ-ex-CE3CJ-W2BHW; Lt. Cdr. F. W. Dana, W4AGR; RM1c W. L. Rhoads, W3GQC.

Below — Navy 140, *left to right, front row*: Lt. D. J. Ciana, W3GML; Lt. J. L. Tucker, W5DHG; Lt. F. R. Bergseth, W7EXL; RE W. K. Stoecker, W8ICB. *Back row*: CM3c (CB) V. A. Catania, W8LEF; EM3c M. W. Shimer, W6QCP; RT3c R. J. Walker, W8BCD; Msc D. E. Mann, W9SEM.



NAVAL warfare differs from land warfare in the objectives aimed at, the implements used, and the terrain over which it is waged.

The purpose of naval operations historically has been much more limited than that of land warfare. Even today, in "conventional" warfare navies exist chiefly to aid and sustain land armies and air forces; it is the latter which achieve the final decision. On the other hand, the warship — the chief instrument of sea power — fulfills a role

The Navy Afloat

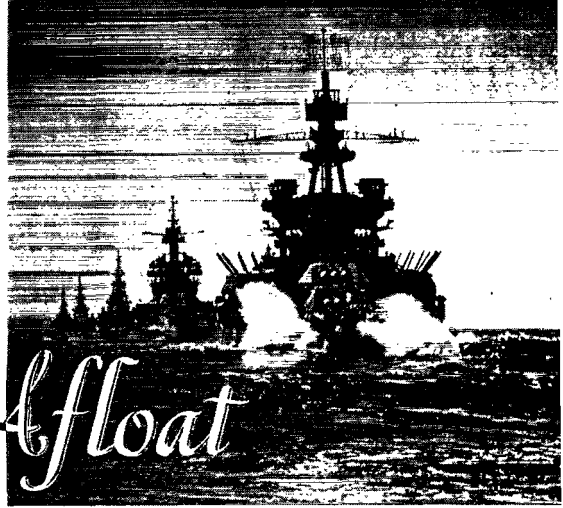

unmatched among the implements of land warfare for mobility and for tactical and strategic independence.

Historically and on the basis of common sense, the fleet must be so constituted and organized as to provide one element whose primary mission is that of fighting sea battles — the great fleet actions; a second element with the primary mission of securing information, cutting off or destroying enemy commerce, and keeping the sea lanes open; and a third element with the mission of maintaining the service of supply and the necessary base facilities and protection.

No single type of ship possesses all of the necessary characteristics to carry out even one of these missions alone. Thus the fleet must be organized into groups, each composed of the types best suited to the particular mission — "tasks" — assigned. These specialized units are called task groups.

The combat portion of a navy — the battle fleet proper — is primarily an aggregation of many warships of various types, each fulfilling a specific range of functions, all operating from strategically placed and strongly fortified advanced bases.

The core of the battle fleet is the hard-hitting line of battleships, accompanied by a protective screen of fast light cruisers and destroyers, and the "fast wing" — the group of aircraft carriers — likewise each with its screen. Each of these is, in surface terms, a close concentration. The area of the sea which it covers is relatively small — a circle thirty to fifty miles in diameter.

To increase the area of sea swept by the fleet, a large and far-flung force of scouting aircraft and scouting vessels is sent out. The important ship units of the scouting force are the cruisers and destroyers, while the aircraft used in reconnaissance is the long-range patrol bomber operated from a land base on dawn-to-dark flights covering thousands of square miles at sea.

Birth of the Task Force

The United States Navy in the Pacific, once it was reborn with new vessels, operated with a number of units known as "task forces," each composed of a combination of aircraft carrier and the various other types of ships required for full-

scale defensive or offensive operation. These task forces, initially relatively small, at first carried on only vital defensive operations or hit-and-run raids. Small task forces proved the best course at the outset to meet the widely diversified strategic requirements imposed upon a dangerously weakened force to fight a war on all the seas.

Later, as additional warships came out of the fitting docks, far greater concentrations were built up. Realizing that to defeat Japan it would be necessary first to defeat, or at least immunize, her fleet, the Allied Joint Command followed the basic military principle of "concentration and economy of forces," combining the scattered small task forces into what was actually a huge fleet, with dozens of the brand-new battleships as its backbone, accompanied by vast numbers of aircraft carriers and hundreds of the cruisers, destroyers and land-based aircraft — all mustered into one great tactical unit.

This was the historic Task Force 58, of which more will be said in the combat section. Meanwhile, to return to the basic general outline, one combat group of great importance so far unmentioned is the submarine force, which may be used against enemy fleet objectives, operating either as an arm of (and sometimes in company with) the fleet, or sent to attack enemy commerce.

The battle fleet with all its elements — main body, fast wing, screen, scouting forces — is backed by the "train." This is the retinue of slower-moving supply ships devoted to logistics — supply, repair, fueling, hospitalization, and other similar uses. The train is composed of tankers, repair ships, "beef boats," hospital ships, ammunition ships, tenders, colliers, and many more — all indispensable for restoring the fleet's battle readiness after an engagement without long voyages back to land-based repair bases.

Craft of many other highly useful categories also serve the fleet. The minesweeping and mine-laying forces have the arduous duty of preparing minefields to protect the fleet's operating and repair bases, and sweeping up minefields laid by the enemy. Net layers, net tenders, motor patrol boats, gunboats, transports, many lowlier vessels — all have their own uniquely important missions.

The Battle of the Atlantic

More than most phases of the European war, the grim, relentless, unceasing struggle which was the Battle of the Atlantic was a technical conflict. This was true in every phase of the deadly duel; keen minds were as important as courage.

It was a battle of cycles, with temporary victory residing in an improved depth charge; with higher-powered explosives resulting in a greater killing radius, keeping the enemy at bay for a time; in which a new streamline body that gave a predictable underwater trajectory constituted a triumph. It was a battle in which ships hunted down submarines, sighted by radar and tracked by sonar; in which rockets, launched from ships and planes alike, holed and killed the U-boats; of a score of other technical devices which played important roles.

From the outset Germany allocated a major part of her total energy to the destruction of Allied shipping by concentrated U-boat warfare. World War I had proved that a German victory depended, in the last analysis, upon breaking the chain of Allied supply via the seas.

Before the European war began in 1939, the British were over-confident; they had mastered the U-boat in World War I and felt they could do so again. They forgot the time required to develop anti-submarine devices; they forgot the vast flotilla of warships required to carry them.

From June of 1940, to June, 1941, the monthly losses in Allied and neutral shipping from all causes exceeded 400,000 tons. By far the greater portion was caused by the U-boats. The entire shipbuilding resources available to the British

— that is, those of the British Commonwealth itself and of the United States — could hardly replace in a year the amount of shipping that was going down in every fifteen-week period.

The submarines, which in the first World War had always operated singly, now were operating in packs. The same radar and other detecting devices which made it possible for destroyers to find submarines

also made it easier for U-boats to communicate with each other while submerged, and thus to coordinate their action.

The British, with their new devices and land-based air patrols, did succeed in driving the U-boats out of the narrow channels in the approaches to England — and in the first World

War such a victory would have been sufficient. But in this war the U-boats were equally able to find and attack convoys on the broad seas.

Nor did the bombing of submarine factories and submarine pens turn out to be decisive, so fantastically thorough was the job the Nazis did in building bombproof shelters. It was at sea, therefore, that the Battle of the Atlantic ultimately was won.

At War With the U-Boats

Such was the job of five Navy patrol bombing squadrons of Fleet Air Wing 7. Front-line fighters in the Battle of the Atlantic, they battered away month after month at the very bulwarks of Germany's U-boat campaign — hunting down the enemy in his own waters before he could reach Allied convoy lanes to loose his torpedoes.

The perseverance and vigilance of those patrols is something beyond portrayal. In the gray light of an English dawn, the black Catalinas and the ponderous white-bellied Navy Libs would waddle down the runway. Lifting slowly into the sky, out over Devonshire's rocky coast and the choppy waters of the Channel they would streak south toward the Bay of Biscay, hunting grounds where lurked the enemy's undersea fleet. Twelve grueling hours later the big planes would wearily settle down on the flare path and come to rest one by one on the hardstands. Some pilots piled up more than 200 missions — 10, 12, 18 hours at a stretch, with the roar of the engines drumming in their ears. They learned it by rote, the slogan of the antisubmarine patrol: "Even if you don't bomb 'em, you can help keep 'em down."

It became apparent soon after the start of the



While a powerful U. S. Navy destroyer pounds through heavy seas, bound on a mission in the Pacific, radar's all-seeing eye centers on Borneo. An air of electric tension permeates the radar plot room as a U. S.-Ausisic operations "team" makes computations for the shelling of Brunei Bay.

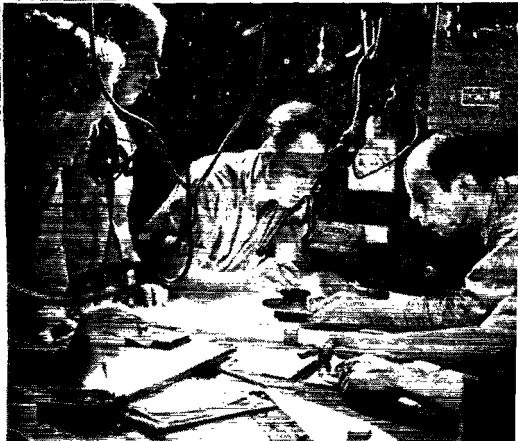



ASV radar in blimps (pilot's position with radar scan viewing visor shown at right) and patrol bombers unerringly picked off surfaced U-boats lurking in the Atlantic, while sonar tracked down submerged craft.

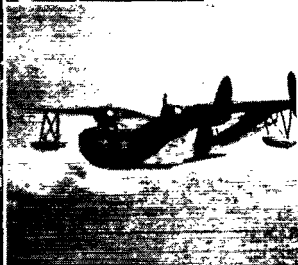
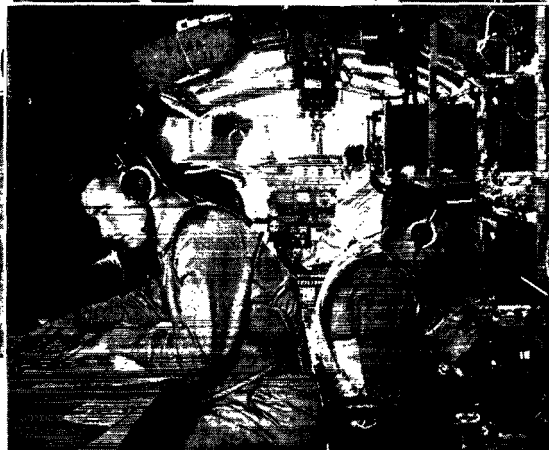
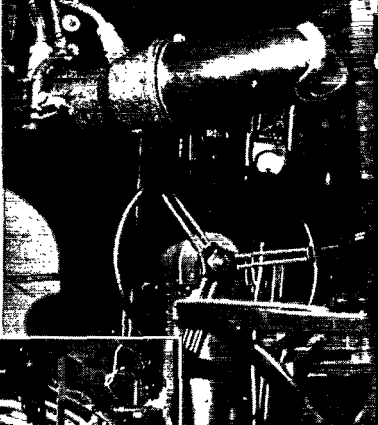

Above — Radioman-gunner on the alert for enemy sub tracked down by Black Cat (PBV).

Left — Interior of an ever-vigilant PBM Mariner (above) sweeping the seas.

war that detection of both surfaced and submerged submarines was demanded.

Consider the enormous difficulty of locating, in an area covering hundreds of square miles of sea on a pitch-black night, a metal object projecting above the water's surface little more than the height of a man.

Long before this war, the basic idea of sound detection was used in depth-finding devices. But when the Battle of the Atlantic began, it became essential to develop equipment which could detect a target much smaller than the ocean bottom.

The Navy already had a solution, a proved and tested design for an underwater detector. It was called sonar — **S**ound **N**avigation **A**nd **R**anging.

Sonar functions in water the way radar does in air — a detection device that seeks out the enemy hiding in the ocean. Where radar uses radiated electromagnetic waves, sonar uses "sound" waves — except that they are supersonic.

Working against the steadily mounting toll of Allied shipping losses, industry's scientists and engineers raced side-by-side with Navy men and university experts to develop and manufacture sonar equipments by the thousands. They turned out apparatus which could transmit energy at high power and which could focus sounds into a beam to probe the waters ahead. They mounted these sonar devices on an avenging fleet of fast, deadly anti-submarine vessels. They trained men to use these equipments, and developed methods for their use.

The result was ships equipped with the most powerful underwater detecting devices ever built.

They would race through the ocean, day or night, poking and probing into the waters around them with their sound beams. For days, weeks, months, some of them operated without results. But eventually . . .

One sound signal went out — nothing.

Another went out — nothing.

A third went out — and an echo came back! "Contact," the sonar operator shouted.

At once the ship sprang into action. "Hard left rudder! Sound General Quarters! Stand by the depth charges!"

While up in the sonar hut, the sonar operator would bend over his equipment, adjusting the controls and sending target information to the captain, until the depth charges went off and the sub slowly dropped, crushed and broken, to the bottom.

The Navy's record in protecting convoys across the Atlantic is nothing short of remarkable. The total loss by all types of ships in convoy was only $\frac{1}{10}$ of 1 per cent. Radar played a major part in this record, from the Navy initiation of the convoy system.

The first airborne radar set — called ASV (Air to Surface Vessel) — was installed in aircraft in 1939. This was actually the first instance of airborne radar being used in the war. But radar as used for the detection of aircraft was inadequate for surfaced craft.

Early in 1942 a microwave version of ASV was introduced which was capable of detecting surfaced U-boats. This eventually robbed the commanders of those vessels of immunity from aerial

attack at night when they were accustomed to surface.

The Germans soon realized that aerial attacks on their U-boats were suddenly occurring much too often to be explained by coincidence, assuming complete reliance on visual sighting. Radar was suspected, for they had already captured intact one of the ASV radars of the type the British Coastal Command was using in the spring of 1942, similar to the American version U. S. forces were using. The Navy also, as reported before, had a similar unit designed at the Naval Research Laboratory, but which operated at a still higher frequency. After capturing the British equipment, the Germans countered by designing a receiver for installation on U-boats which covered the frequency range employed by the ASV radar. This receiver was intended to give a response whenever the beam from the radar swept the submarine, giving this response while the radar-equipped airplane was still sufficiently far from the U-boat to permit the latter to submerge and escape attack. These receivers were hurriedly built and installed during the summer of 1942. By the end of that summer it was clear to the Allies what was going on. While the number of visual sightings changed very little, the number of radar sightings declined markedly. The number of radar "pips" which disappeared from the scope during the plane's run-in on the target told the story.

But the Navy also was interested in equipping its blimps and patrol aircraft with microwave ASV, and in February, 1942, initiated the development of an improved set for this purpose. The Navy's modified version made the Allies ready with their next weapon — ASV on a wholly new frequency.

In March, 1942, a lend-lease Liberator carrying an experimental set was flown to England for Coastal Command trials against British submarines. It was soon followed by a second prototype installation; subsequently 15 more sets were constructed here and delivered to the British before the end of 1942.

A preproduction model was flying in a blimp by July. Through superhuman effort on the part of the development engineers, production equipment began to appear in January 1943, the number delivered rising rapidly thereafter. The success of this equipment led Coastal Command to order and install in quantity a British equivalent of the American microwave ASV. This entered operational use during February and March, 1943. Hundreds of these equipments have been delivered to the British on lend-lease.

The sequence of events was, then, that the British started to use airborne radar to hunt submarines, the Germans started to escape by using a receiver to pick up the ASV signals — during the winter of 1942-1943 the sub campaign increased in boldness — and by spring of 1943 significant quantities of microwave ASV, which the German receivers couldn't detect, were in operational use.

The impact of microwave ASV on the sense of security into which the listening receiver had lulled the U-boat captains had a phenomenal

result. During May, June, and July of 1943, nearly 100 confirmed submarine kills were made, two-thirds of them by aircraft. These kills destroyed the confidence of the German submarines in their security against air attack, and sent the technical men into a frenzy of guessing and development work.

Now began one of the greatest stories of the war, which for drama, bitter comedy, and significance can scarcely be equalled. Among the various suggestions dredged up by the German technicians was a possible modification of the old ASV which would make it proof against the listening receiver as it was then designed; a simple modification in the receiver would cope with this. This modification was made, and happened to be tried just in the area where a few planes were operating — the only ones — with that particular ASV change. The submarines came back with excited stories of signals on the new receiver that couldn't be detected on the old. Hope ran high, and worries were soothed. Yet the U-boat kills went on.

It was thought that the Allies might be using an infra-red detection device, so submarines were painted with a special paint. Yet the U-boat kills went on.

It was pointed out that the listening receiver itself radiated a good deal of radio energy (just as old-fashioned radio sets used to make squeals in the receiver next door). Perhaps the Allies had an airborne device for detecting this radiation and homing on it. One new design of listening receiver after another was hurriedly built and rushed through installation into use, with promises that it would be the one, give plenty of warning, and would not radiate perceptibly. But the U-boat kills went on.

Not until the fall of 1944 did the Nazi Navy get this mess all sorted out. By this time, they had decided that the only way for a submarine to live was not to come up at all, and they were busy installing an air-tube they called Schnorkel, which enabled a U-boat to breathe and to run its Diesels while still remaining submerged.

Scientists worked feverishly, not only to develop improved shipboard search radar, but to train expert installers for every Navy yard and turn out the thousands of trained operators needed. Soon all escort ships in the Atlantic were equipped. Surfaced Nazi submarines could be detected and attacked as easily at night as in broad daylight. Convoy losses took an abrupt and permanent drop. New electronic navigational aids also helped materially in the general navigation problem and in rendezvous.

Radar also eliminated stragglers from convoys which had previously been easy meat for the U-boats which trailed nearly every convoy for just such game. In preradar days, the convoy commodore and escort commander anxiously counted noses every morning to see how many of their charges had dropped behind or wandered off unnoticed during the hours of darkness. If there were any, they could almost be written off as sure losses. Search radar, however, enabled the escort commander to keep a 24-hour watch on the entire



Sunset over the Atlantic finds another United Nations' convoy moving peacefully towards its destination, with a U. S. Navy blimp, hovering watchfully overhead, on radar lookout for any sign of enemy submarines.

formation. A straggling or wandering ship was quickly discovered and an escort dispatched immediately to bring it back to the rest of the flock or to stick with it, protecting it from submarines. The Nazis were deprived of the helpless sitting ducks they so loved to find.

Employment of the same radar units reduced the losses that had previously beset many a convoy. Too often the first warning of the blacked-out hulk of a ship in the path of a vast convoy had been the crunching of hull against hull and the radioed calls of distress. Now radar enabled all ships in the path of a convoy to be intercepted in time to divert their course.

As fast as they could be built, escort carriers (CVEs) were sent with the convoys where they were most needed. Their planes were equipped, of course, with the same search radar already described. They marked the real doom of the Nazi submarine menace. By 1944, the United States Navy had so many CVEs and DEs (destroyer escorts) that it was putting to sea special task forces whose sole mission was to hunt out U-boats in the mid-Atlantic the way patrol planes had hunted them nearer the shores. From one side of the Atlantic to the other, day or night, clear weather or foggy, there was hardly a square mile where a U-boat was safe from the prying eyes of radar, airborne or shipborne.

During the last twelve months of the war U-boats were being sent to the bottom at the rate of nearly one a day. That the war in Europe came to a successful conclusion when it did was due, in large measure, to the failure of the U-boats to halt the vast flow of invasion supplies. And that they failed can be largely attributed to radar and sonar.

Fleet Unit

A fleet is uniquely adapted to realization of the fundamental principle in strategy that strength

lies in concentration. It is more readily coordinated and directed by a single man than is an army in the field, and superiority in total strength can therefore more easily be made to register on the enemy. A fleet on the offensive is permitted a more complete concentration than is possible to an attacking army. The latter must disperse a great deal of strength, perhaps a major portion, in defending long fronts and lines of communication outside the immediate area of the offensive. The fleet has its obligation to provide escorts to convoys, but these do not usually require important ships of the larger categories, and there are no such things on the sea as positions which need to be defended.

In action the units of a fleet are not only mutually supporting, each adding to the fire of its neighbors and sharing the burden of providing a target for the enemy, but are also contributing to the group effort at the same moment of time. No important vessels present are held in reserve or prevented from taking part by the narrow confines of the field. It is the first preoccupation of the admiral to prevent such a thing from occurring. He wants all his battleships speaking against the enemy in the same instant.

The newest and most formidable class of battleship in our Navy is the 45,000-ton *Iowa*. The main battery is similar to that of its immediate predecessor, the *North Carolina* class, and is composed of nine 16-inch 50-caliber guns disposed in three triple gun turrets, two of which are forward of the control power and the third one abaft the superstructure. This arrangement permits all nine guns to be fired on both broadsides — six through a wide arc forward from a short distance past the midship line on one side to the same angle on the other side, and from a spot well forward of the midship line on one side to the same distance on the other.

As each 16-inch projectile weighs well over a ton, approximately ten tons of metal are hurled by each broadside. For example, suppose only the moderate rate of one salvo per minute is assumed, the weight of metal which can be delivered in one hour from these broadside guns alone would be 600 tons! With the high velocity of the projectile, the exactness in the fire control instruments, and the expertness of personnel, officers and crew, high accuracy of fire is attained to a distance in excess of 25 land miles.

The main battery guns are installed not only for use against other battleships which are heavily armored. Where there happen to be no battleship targets available they are very effective against smaller surface craft and in repelling attacks by torpedo-carrying airplanes, as well as for shore bombardment in amphibious operations to support landing expeditions.

These nine 16-inch guns must be augmented by many guns of lesser caliber in order to meet attacks made by aircraft carrying bombs and torpedoes, and by destroyers carrying torpedoes. The secondary battery as originally designed comprised twenty 5-inch double-purpose guns (that is, guns which can be used either against surface craft or aircraft), sixteen quadruple 1.1-inch anti-aircraft guns, and a large number of machine guns of smaller caliber.

Battleships must have protection against projectiles fired from guns of the largest caliber installed. The generally accepted rule is that there must be one inch of armor for each inch in the caliber of the gun against which protection is needed. Battleships must be able to stand up against ships with 16-inch guns. Therefore the side armor must be not less than 16 inches in thickness.

This side armor is distributed in such a way as to protect the engines, boilers, magazines, and other vital compartments within the hull. The same thickness of armor, or perhaps more, covers all of the main battery turrets and the vertical passages between the turrets and the magazines through which the ammunition reaches the guns. The captain's battle station, the conning tower, part of which is set aside for fire control, and the vertical passages which connect with the central station and plotting room (both deep down in the hull) are also protected by the maximum thickness of armor.

In order to protect the engines, boilers, and magazines from bombs and high-angle gunfire an armored horizontal deck extends over all these vital compartments from beam to beam. The thickness of this armored deck on the *Iowa* is not less than 6 inches anywhere.

For protection against torpedoes and mines the outer part of the ship's hull is honeycombed with thousands of small compartments. Along the full length of the ship on each side are several longitudinal bulkheads a few feet apart and extending vertically from the armored deck to the inner bottom. These are traversed by athwartship bulkheads at small intervals in each place where such construction will not interfere with some mechanized feature necessary for the operation

of the ship. Thus, when a torpedo or mine explodes against the hull of the *Iowa* its damaging effect will be absorbed by the spaces in these small compartments, the bulkheads of which will prevent damage to the ship's vitals.

Ten scout cruisers, authorized in the period 1915 to 1918 and completed in the early 1920's, contained in their characteristics the best features of their day. They displaced 7500 tons; they were fast — 35 knots; they were well armed — twelve 6-inch guns plus a battery of four 3-inch a.a. guns and two 21-inch triple torpedo tubes; and their cruising radius approached some 13,000 miles.

Originally they were called sea scout cruisers. They had tall, slender masts to carry the antenna for the long-distance radio of the time, which enabled them to range the seas and send word of their enemy contacts to the commander in chief no matter where they might be.

Today, however, the ten *Omahas* have been quite radically changed. Their tall, slender masts have been cut down — but not, by any means, the number of antennas. All batteries greatly improved; much splinter protection been added. Originally these cruisers had little more armor protection than did destroyers, whose well-deserved nickname is "tin can." These ships were designed in a day before all the lessons of modern war and its attendant damage has been learned. Nevertheless these ships have shown tremendous vitality under punishment. The *Raleigh* received extensive underwater damage at Pearl Harbor but was saved to fight again. The saga of the *Marblehead* is an epic of the sea. Repeatedly bombed and hit by the Japanese early in the war, through the valiant and untiring effort of her officers and crew she was brought home after a cruise of more than 13,000 miles.

The menace from the air has created an all-antiaircraft-gun ship for use as an escort to convoys or naval squadrons in zones near enemy air bases. Thus far no ships have been built specifically for this purpose, existing models being mostly old cruisers with converted armament; but all our newer cruisers carry so profuse an anti-aircraft armament as to be in effect dual-purpose cruisers. And our new *San Juans*, with their main batteries consisting exclusively of dual-purpose guns, are frequently called "antiaircraft cruisers," although they are not officially designated as such and were not conceived for a primarily defensive function.

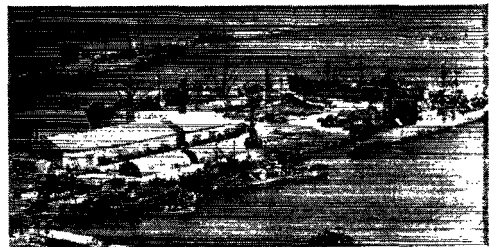

The "A"-train reaches its station, a North African invasion port. A transport, freighter, tanker, gunboats and landing barges, along with LCVs and LCIs.

Carrier War

The aircraft carrier is the great naval weapon of this war. Home base for fighter, dive bomber and torpedo bomber, which neither surface ship nor submarine can resist, it has vastly extended the usefulness of the airplane. In the Atlantic the escort carrier tipped the scales against the U-boat at a time when the United Nations were in danger of losing the war of transport. In the Pacific the striking power of the task forces built around giant flat-tops has made that ocean an Allied lake.

At the beginning of this war, Japan had the superior strength in carriers. Only radar and the courage of our carrier personnel managed to hold off the enemy until an aroused nation could outbuild Japan's naval strength.

The employment of aircraft carriers in battle is, in principle, at least, relatively simple. The carrier itself does not engage the enemy at all, except defensively, when enemy planes attack it. Over the target ships, on the other hand, the action of the carrier's planes is comparable to that of land-based planes of similar types. The general object is so to coordinate fighter, dive-bomber, and torpedo-plane attack that the enemy's defenses in fighter planes and anti-aircraft guns will suffer the greatest possible dispersion or neutralization.

Against capital ships, for example, the torpedo plane carries the most menace but it is at the same time the most vulnerable. If the fighters are not preoccupied with enemy fighters, they will strafe the anti-aircraft gunners on the ship's decks with their machine guns. The idea is to strike the enemy carriers by radar surprise, while their attack planes are still on board, but if such surprise is not achieved the battle resolves itself into a contest between opposing aircraft and between aircraft and anti-aircraft guns.

Thus the formation in which the carriers move

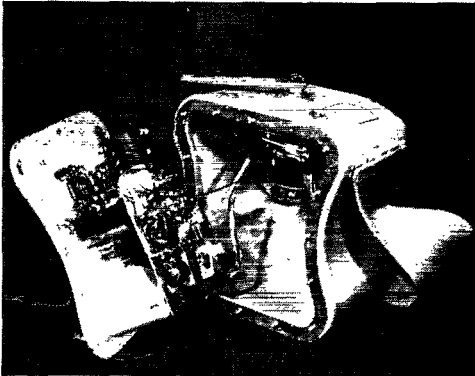

Inside the Coast Guard Radio Laboratory's version of the SCR-578 — the widely publicized "Gibson Girl" lifeboat set. In this experimental model transmission is on 500 kc. for approximately 20 seconds, after which a cam on the drive-shaft of the hand-cranked generator inside the set switches the transmitter to a high frequency for about 20 seconds, the sequence being repeated as long as the crank is turned. In later models transmission is automatic on 500-4140-8280 kc. The tube line-up includes a 12SC7 dual-triode, 1G4C, and 12A6 output tube.

is of little consequence except in terms of providing the smallest possible target area for enemy submarines and the best possible disposition for avoidance of enemy air attack. During the early stages of the war it was thought that one ship could not give much support to another, and that the sensible objective was to give each vessel as much maneuvering room as possible. Experience showed, however, that the increasing accuracy of anti-aircraft gunnery made it feasible for a ship to give very real and effective support to a neighbor under attack. Later practice, therefore, was to keep the vessels in a formation fairly close together under attack, which enabled them to present the enemy with a united fire. The ability of ships so to maneuver with minimum danger of collision was much augmented by the universal use of TBS (Talk Between Ships or limited-range v.h.f. radio), which almost replaced the older, slower method of signaling by flags or blinker lights.

As has been seen, the United States Navy already had in service air- and surface-search radar equipment, and work was forging ahead in constantly improving these types. To these, during the first years of the war, was added long-range micro-wave equipment designed specifically for control of defending fighters, and a start was made on the difficult problem of AI (Air Interception) for the Navy single-seat fighters. Meanwhile, the Navy at sea was working out doctrines for integrating these various types of radar for the defense of their task forces.

The result of their work was the creation of CIC — Combat Information Center — a concentrated, complex, highly dramatic center of radar activity on men-of-war. The purpose of CIC is to coordinate information — predominantly from radar, but also from look-outs, from other ships, and from technical devices other than radar — and to evaluate this information and determine the enemy's probable intent. The resulting information is then channeled to other essential control stations throughout the ship. CIC has grown and developed hand-in-hand with shipboard radar. Originally called Radar Plot, its function was just that — to plot the movement of planes and ships tracked by radar, and to direct friendly fighter planes to an interception point whenever enemy raids developed. As supplementary equipment grew in scope and application, so Radar Plot expanded into the complex present-day set-up.

The organization and primary operational functions performed in CIC naturally vary on different types of ships. On carriers defense is emphasized, being concerned primarily with fighter direction, control of aircraft, and a.a. defense. In battleships, cruisers, and destroyers CIC operations are primarily concerned with gunnery or torpedo attack procedures, with anti-aircraft defense playing a secondary role.

In the case of ships at sea the primary protection is by a constant combat air patrol. This is necessary because the time required rigging air-

(Continued on page 186)

— AIR NAVY —

Panoramic action scenes aboard a heavy 25,000-ton 800-foot long Essex-class carrier.

Left—Typifying the Navy's joint sea-air brand of modern warfare, a TBF Avenger speeds in silhouette past the carrier's manifold all-seeing radar antennas outlined against the sky. In the foreground are the carrier's 5-inch gun batteries, their fire also radar directed. *Right*—Search radar data is charted on the transparent expanse of the giant vertical plotting screen in the radar plot room. *Below*—Operations officers tensely but calmly plot death for Japs in the China sea, working with data provided by the extrasensory perception lent them by radar.

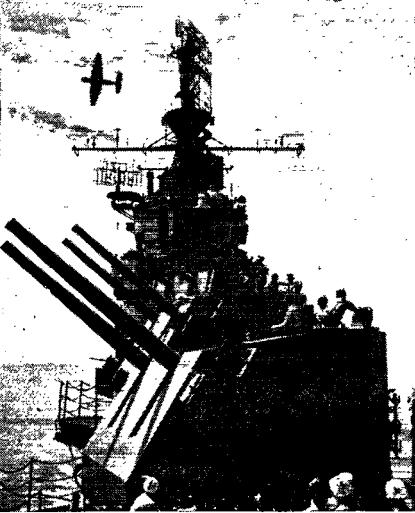

Below—Slim, angular elbows of radar antennae on the folded wings of beetle-like Curtiss Helldivers waiting to attack.

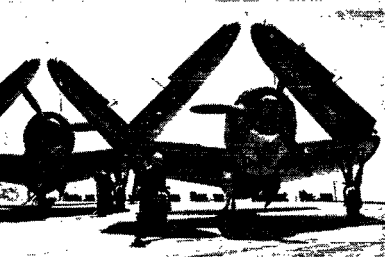

Below—The bull-horn blows a battle call, and pilots, crewmen and deck handlers hurry to action stations.

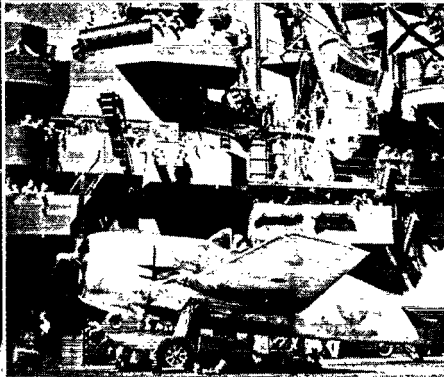
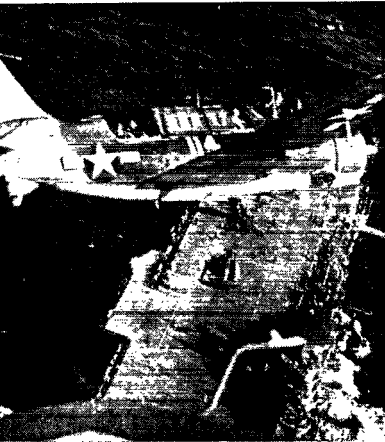
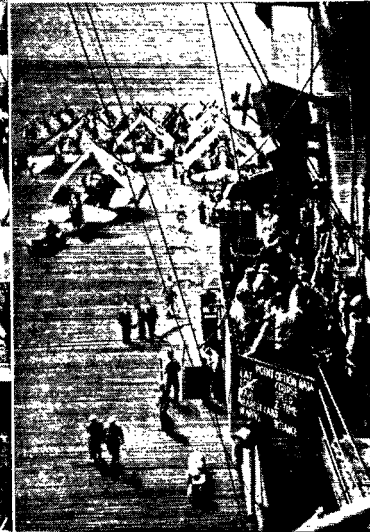

Left—"Pilots—man your planes!" Prop idling, the first Grumman Avenger to take off is readied for launching.

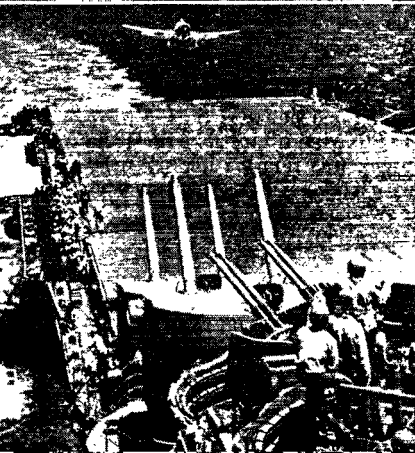

Above left—Mission completed, a Curtiss Helldiver circles the flight deck, heading home, arresting cable extended. *Left*—Flats down, a Hellcat floats smoothly over the flat top's stern. Note the carrier's lowered radio masts at left; normally these masts are vertical while cruising. *Right*—Its strike completed, the massive CV sails serenely on its victorious course over a molten-glass sea.

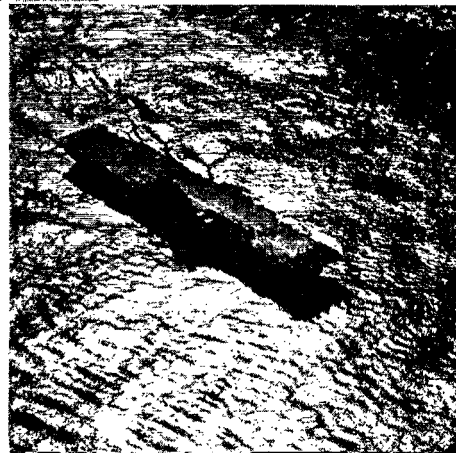



THE NAVY IN COMBAT

UNTIL December of 1941, to some two hundred thousand American youths, "radio" meant Bob Hope and Crosby and Benny Goodman and on Sunday afternoons the New York Philharmonic. It meant the World Series and the Army-Navy Game, the weather forecast and the dull drone of the eleven o'clock news . . . which somehow never interrupted conversation until the significant item had been missed.

Then, one Sunday afternoon, it meant the never-forgettable: "We interrupt this program . . . *Pearl Harbor has been attacked . . .*"

To the men of the Fleet, radio still means these things — and more. It has been their link with home. It was the swing music of Radio Tokyo; it was relief from mosquitoes and "K" rations, and from heat and sheer boredom.

But in the past four years or more, above all it came to mean lightning-fast communication — communication that spelled the difference between life and death.

It was: "RUSH NAVY YARD PEARL HARBOR 20,000 GALLONS AVIATION GASOLINE 100,000 ROUNDS 50 CALIBRE SHELLS 100 POUNDS 5 GRAIN SULFANILAMIDE TABLETS."

It was: "*Watch it! Four Zeroes coming in at eleven o'clock — pour it on 'em!*"

It was: "PROCEED TO THE BONIN ISLANDS AND THERE ENGAGE THE ENEMY. . . ."

It was: "*The Nips are attacking — get us support from the other side of the Island. . . .*"

Radio communication enabled the Army and Navy to operate as a team in amphibious operations. Radio signaled the attack. Radio controlled the landings, making possible the required split-second timing. Radio directed hitting a score of beaches at exactly the right moment to attain greatest tactical advantage, sending reinforcements here, concentrating air power there, keeping the artillery barrage moving a few yards ahead of advancing troops. Radio got the planes up, guided them to their targets, brought them

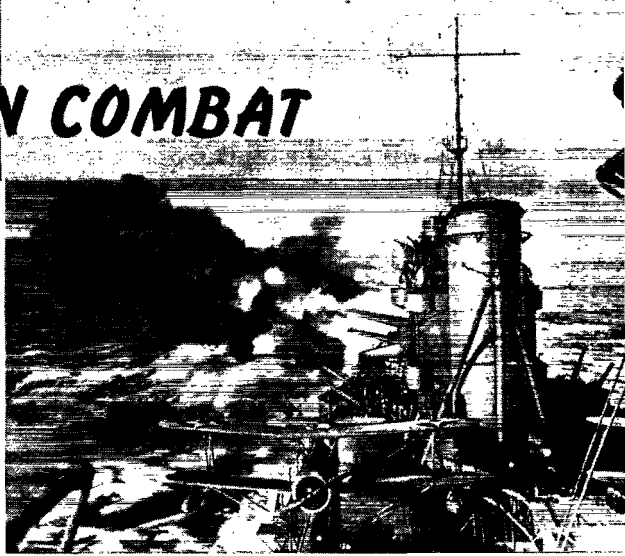

back. Radio whipped the jungle, kept isolated groups in touch, spotted the artillery support where and when it was needed to pulverize enemy strongpoints, brought up the flame-throwers when the Jap opposition got stubborn, called for planes to drop food and medical supplies, protected the transports and supply ships and guided them to the pin specks on the map.

Holding the Line

Communications men serving in the Pacific during those desperate early days of 1942 still marvel at the mere fact that communications existed at all. Naval aviator Edward E. Wood, W8QXQ (most recently a lieutenant in Production in BuAir), was attached to a torpedo squadron on patrol duty in the Pacific during the summer of 1942. The squadron had planes, a few torpedoes, and even a home base (of a sort) — but no radio station for air-ground communication. W8QXQ spent weeks grinding down 80-meter crystals, taking one side at a time, always somehow managing to wind up just one molecule layer too thin. Stock was running low when he finally emerged with a crystal approximately one-fourth inch square which oscillated perfectly. The station was in operation constantly for about five months; and he believes it to be still in use.

But they held the line. Then, out of the naval war in the Pacific a new star arose: Task Force 58,

a fleet unit conceived specifically to meet the demands peculiar to the war against Japan. This great task force—the most powerful in the world, made up of the finest fighting ships ever built—is a closely coordinated, near-perfect combination of many types of combatant ships, each calculated to do a specific job but all working together to accomplish one objective—the defeat of the enemy wherever he could be found.

Task Force 58 steamed in the vanguard, clearing the way as U. S. forces set out for the invasion of Saipan; its battleships, aircraft carriers and other warships carrying such unprecedented offensive and defensive power that the men of the force were more than willing to tangle with the Japanese Grand Fleet itself, if only the enemy dared to risk its strength in battle.

Now commanding officer of Torpedo Squadron 31, later, aboard a CVL with Task Forces 58 and 38, Lt. Edward E. Wood, W8QXQ, took part in all major engagements from the occupation of the Marshall Islands through the occupation of Palau and the first carrier raids on the Philippines. His citations include the Navy Cross for the attack on the Japanese Battle Fleet in the First Battle of the Philippine Sea, the Distinguished Flying Cross for the first carrier raid on Truk, and a Gold Star in lieu of his second DFC for action during the carrier raid on the Bonin Islands.

With Task Force 58 in the fast carrier strikes on Tokyo last February was Lt. Stuart D. Cowan, jr., USNR, W2DQT, now communications officer for Commander, Destroyer Squadron 60, and CRM Stacie O'Dowd, W9ELS.

Another member of Task Force 58 was ACRM W. B. Hollis, W5FDR, an old-timer who also saw service in the Navy during the last war. He was a part of all major carrier strikes in the Pacific between January–August, 1944, flying a TBF in raids on Kwajalein, Truk, Palau, Saipan, Tinian, Hollandia, Ulithi, Woleai, Iwo Jima, Chichi Jima—not to mention the invasions of Kwajalein, Saipan, Tinian, Guam, and the first battle of the Philippine Sea. Total: 22 bombing missions, two torpedo runs, eight aerial combats.

Following close behind the mighty task force, protected by its aircraft and firepower, were the vessels of the amphibious fleet that were to land the men, guns, tanks and equipment which drove the Japs from their island defenses—so perilously close to Japan itself. These vessels ranged from the LST, the tank-landing ship which is capable of transporting tanks and other heavy equipment across the Pacific, to small LCI(R) rubber boats especially designed for scouting operations and commando-type attacks.

Bringing up the rear was the large carrier-protected train of provisioning ships and auxiliary vessels calculated to keep the warships in fighting trim and battle readiness at all times.

On a fleet oil tanker, cog in such a provision train, CRT Warden G. C. Wooster, W9ALH, saw Guadalcanal, New Guinea, New Ireland, Tulagi, Marshall Islands, Caroline Islands, Saipan, Philippines, South China Sea and Iwo Jima.

"I suppose lady luck was with our LST 485 and another LST in the invasion of Treasury Island in the Solomon group," CRM (AA) Forrest W. Balliet, W6LWD, tells it.

"The two LSTs and several DDs and APDs made up the invasion force. Marines were landed from the APDs. These Marines were at once pinned down by mortar and shell fire from Jap positions on the island. Our job was to beach and to unload heavy equipment to support the first wave of Marines.

"Not knowing from where we were that the fire on shore was so heavy, we started in—only to be waved off by the landed troops who exposed themselves to enemy fire to warn us of the danger. Knowing that the heavy equipment was needed, our commander ordered us on in. The two ships beached, and at once the Jap fire was directed toward us. Japs could be seen running around on the beach ahead of the Marines.

"The destroyers were unable to enter the narrow harbor, which left us at the mercy of the Jap gun positions. For some reason the shore batteries stopped firing and only one mortar position continued to fire upon the ships. This position was located over a small hill in a creek, quite out of the range of our 3-inch gun.

"We broke radio silence at once and started calling for fire support from the destroyers. Receiving no answer after several calls, we set up another transmitter on the designated frequency and continued our calls, to no avail.



On May 11, 1945, during the battle for Okinawa, a Kamikaze pilot dived through combat patrol and crashed onto the deck of the USS *Bunker Hill*. Fires raged; then a Judy dropped a 500-pounder on the flight deck and crashed into the base of the island. At the end of three agonizing hours of her successful fight for survival, the *Bunker Hill* counted up 393 lives lost, 264 wounded. Among those killed were ART1c Edward H. Nighthenelser, W9RDC (*top inset*), and ART1c William Nemetz, W11IK. W9RDC had served aboard the *Bunker Hill* for nearly two years in actions at Rabaul, Tarawa, Saipan, Leyte, and in many other bombing raids. W11IK joined the crew shortly before the Iwo Jima landings.

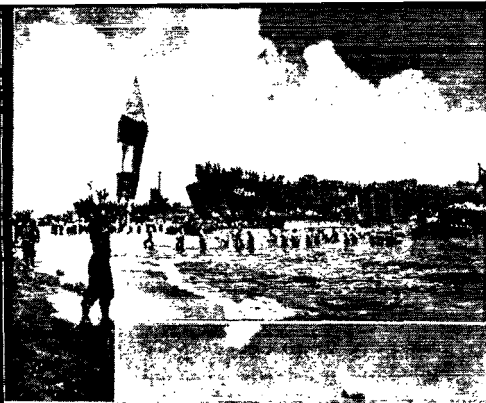

Left — A beachmaster directs landings at Rendova Island while ammunition is being unloaded.



Above — Planes, pontoons, alligators and ships make the beach at Tinian a busy place while Sea-Bees set up shop to convert the island into a U. S. base. Right — A powerful weapon, although it carries no guns, a bulldozer is unloaded from an LCM during the invasion of the Marshalls.



Right — Men and machines are put ashore during the A-day assault on Leyte. The attack force numbered over 500 ships — the largest naval force ever assembled for a single strike against the Japanese in the Pacific.



we finished putting the aerial back up. That was the loudest explosion I ever want to hear! . . . However, the job went on and the aerial was back up just one hour and forty-five minutes from the time it was shot down."

It was on D-Day of the Normandy invasion that Lt. Stuart D. Cowan, jr., USNR, W2DQT, got himself decorated by establishing impromptu radio contact with a group of Army Rangers, surrounded at Point-du-Hoe near Target No. 1, on

You never can tell what's going to happen at one of these "shore parties," or to whom — or by whom! Under Admiral Hall's Flag, CRM Bamberg A. Laverne, W9KCR, took part in several. "I participated in three invasions — Sicily, July 10-12, 1943; Salerno, Sept. 9-10, 1943; and Normandy, June 6-27, 1944. The first two were on the USS *Samuel Chase* and the last was on the USS *Ancon*. The two invasions on the *Samuel Chase* were by far the most interesting because we installed and placed in operation 90 per cent of the equipment used. The *Ancon's* was a 'factory job.' There are many incidents that could be related. . . . The one that comes to my mind most happened at Gela, Sicily, the morning of July 11, 1943. Forty-eight German bombers of all types came over to do their damage. Of course, we threw everything but the gas range at them; in fact, during all this firing one of the gun-crew members shot down our entire aerial system. While the bombing raid was still in progress we attempted to put up the aerial by making temporary repairs. The disappointing thing was that the aerial had fallen across the rotating search radar screen and got wound up in it before we could get it stopped. All in all, with bullets and bombs whistling all over the place I can't help but admire all hands for the attention they gave to their duty. . . .

"A Liberty ship, loaded to the gunwales with all types of ammunition and lying not over a thousand yards away, was hit direct just about the time that

"The mortar shells were hitting both our ship and the other LST, causing serious delays in unloading. Then the Japs, to further delay us, blew up their small arms ammunition dump — a maneuver which, in effect, covered both ships with a curtain of fire.

"Finally a voice answered our calls, saying that help was on its way. We of the radio gang were overjoyed to get an answer; it had seemed that our transmitter would never reach the DDs."

"Hours later (it seemed to us) through the narrow opening of the harbor glided one of our destroyers. The Japs no doubt saw the destroyer also, for they stopped firing on the Marines and ships. The Marines at once advanced and wiped out these positions. From then on the invasion went according to schedule. Our damage was relatively slight; unloading was completed by night-fall."

the Normandy coast. This circuit was used successfully for eight hours, directing naval gunfire which disrupted a German counterattack against this point and relaying vital Army traffic. Then attached to the staff of the commander of a destroyer squadron, W2DQT worked skillfully under constant threat of enemy submarine, surface and aerial opposition. For his essential contribution to the success of these combat operations he was awarded the Bronze Star Medal.

A recent detailed examination of some hundreds of typical amateurs in naval service has disclosed that meritorious service awards and the like are still, in the military tradition, usually awarded only for exceptional combat performance. Although instances of other outstanding service are many, rare indeed are such exceptions to the general rule as this commendation to CRT S. A. Mooring, USNR, W5HSQ: "10/14/3: Commended for his initiative and ability in the construction of a high-frequency direction finder on board the USS *Core* while at sea. It is particularly noteworthy that this h.f. d/f maintained contact with a plane, which was forced down at sea, when all other means of maintaining contact failed, and was directly instrumental in the rescue of survivors of the crashed plane."

For the specialist, constantly moved from the key spot in one operation to the next, amphibious operations came to resemble a hectic traveling man's route. Take the case of CRT(AA)(T) Elton E. Heubach, W9CQN, who received "Meritorious Mast" commendation for "expert services in maintaining the USS *Lloyd's* electronic equipment under conditions of almost constant use and with practically no tender or base assistance." In the preceding forty days he had participated in ten full-scale landing operations: Ormoc Bay, Leyte; San Jose, Mindoro; Lingayen Gulf, Luzon; San Felipe, Luzon; Grande Island, Subic; Palawan; Zamboanga, Mindanao; Cebu Island; Legaspi Port, Luzon; Malabang-Parang, Mindanao.

It wasn't necessary to go ashore to see action during combined operations, either. Take the radio crew of the high-speed troop transport, USS *Chilton*, APA 38: Lt.(jg) Lloyd R. Clark, W7GMK; RE Murray Blum, W2MY; CRM O. E. Lawrence, W6EWZ; CRT Glen J. Jensen, W9IX; RT1c John Pavlovich, W3GDW and RM3c Henry O. Panzer, ex-W2HH.

During the invasion of Kerama Retto, a Japanese bomber dove on the *Chilton*, its downward course impeded only when it struck one of the transmitter antennas, cutting same in two. As a result the bomber had a wing sheared off, deflecting the fuselage proper into the sea. In utter disregard of the fact that the attack was in progress, the amateur crew aboard formed a repair party, removing the loose ends of the antenna from the structure and rigging an emergency replacement antenna.

To which the CO of the *Chilton* added: "All of the foregoing radio amateurs at various times prior to and subsequent to the commencement of hostilities answered the call to the colors at a time when the need for trained technical per-



Gold Stars

IN LIEU of the customary individual write-ups, Gold Stars in its final appearance this month is devoted to a listing of those amateurs of the U. S. Navy, Marine Corps and Coast Guard so far reported to us who have given their lives during the war while employing their radio knowledge in the service of their country. Let us not forget that their keys will ever more be silent only that ours may carry on the best of amateur radio's traditions.

W1BPN, Lt. Malcolm H. Robertson, USNR
ex-W1FU, Lloyd L. Rounds, USCG
W1GBK, Norman Unsworth, RM2c, USNR
W11IK, William S. Nemetz, ART1c, USNR
W1LQK, Frank J. Bednarz, ARM2c, USNR
W1PQ, Henry F. Rand, ACRM, USN
W2BZ, Lt.(jg) Samuel Jackson, jr., USN
W2NGC, Joseph Smith, RM3c, USN
W3IRI, Ens. Bernard F. J. Nolan, USN
W4AFC, Lt.(jg) Ralph Hollis, USNR
ex-W4CQT, Cadet William G. Lee, Jr., USN
W4FB, Lt.(jg) Aaron Bush, USNR
W4HGM, ex-K6NYD, Lt. Cdr. Archibald W. Greenlee, USN
W5EOO, Lt. Luther C. Smith, jr., USMCR
W5JWA, John Earl Black, RM2c, USNR
W6PSS, Lt. Cdr. John C. Mitchell, USNR
W6UNY, William F. Grabe, jr., S1c, USNR
W7BHH, Lt. Cdr. William O. Beach, USNR
W7GFI, A. L. McLeod, USCG
W7IZV, Donald D. Kruse, RT1c, USNR
ex-W8AAO, Lt.(jg) Robert W. Lally, USNR
W8BOW, Lt. W. W. McLain, USN
W8DSK, Murvill A. Peacock, RT2c, USN
W8STU, Robert L. Long, RM2c, USN
ex-W9AO, Lt. Cdr. Fred L. Schoenwolf, USN
W9IWB, Robert T. Duncan, RM2c, USNR
W9LFN, Lt.(jg) Allen H. Barstow, USNR
W9LKJ, ex-W6JQW, Lt. Carl J. Schneider, USMCR
W9MDA, Hugh A. Middaugh, RM3c, USNR
W9NZW, Ensign Marvin J. Zimmerman, USNR
W9RDC, Edward Harmon Nightenhelser, ART1c, USN
W9RUJ, Floyd R. Clarke, RT1c, USNR
W9RYZ, H. L. Newell, RT1c, USNR
W9WDR, Lt. Frederick C. Harrington, USNR
W9XM, Cdr. Malcolm P. Hansen, USN
W9YVJ, Cpl. Stephen J. Weber, USMCR
W9ZUX, Elmer L. Schultz, CRM, USNR
Ensign John J. Person, USNR
KA1CW, Lt.(jg) Charles Wesley Woodin, USNR
Lt. Robert J. Haire, USMC

In addition to the above, these men have been reported to be missing in action following naval engagements:

W1KOO, Paul E. Hope, RM2c, USCG
W4FRS, Jack Gifford Ehlerding, RM1c, USN
W6QGN, Thomas Churchill Nelson, RM1c
W6S JL, Clifford D. Garrabrant, S/Sgt., USMC
W7BDB, I. D. Winn, ART1c, USNR
W7HLW, Charles M. Rafferty, RM2c, USNR
W8AQD, Clarence Reed, RM1c, USNR
W8QCR, Frank R. Bartosik, RM2c, USNR
W8TWG, Gilbert Howie, jr., USN
W9EXF, M. S. Levy, RM2c, USNR



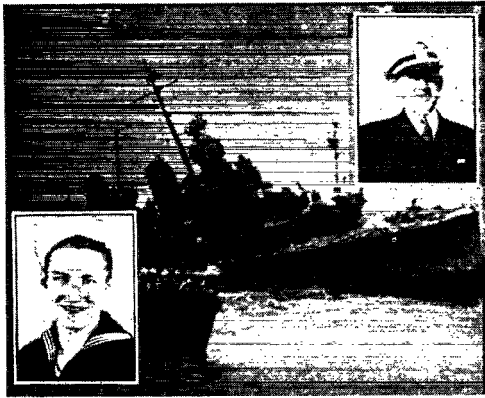

Jap suicide planes, both Kamikaze and Baka, while unable to halt the Navy's unflinching drive to the gates of Tokyo, did take a deadly toll of ships and men. Two destroyers sunk by their action were the USS *Abner Read* in Leyte Gulf on October 2, 1944, during the Second Battle of the Philippines, and the USS *Hazelwood*, sunk off Okinawa on April 29, 1945. Lt. Malcolm H. Robertson, W1BPN (inset top right), communications officer aboard the *Hazelwood*, went down with the ship on which he had served since the commissioning in June, 1943 — in the meantime having seen action at Wake, Tarawa, Gilberts and Marshalls, Peleliu and the Philippines. Radioman aboard the *Abner Read* RM2c John E. Black, W5JWA (lower left) survived the sinking, only to be killed later in an accident at Treasure Island. He was posthumously awarded the Bronze Star. Jack's ship was first to sail into Attu (where it was torpedoed) and participated in all of the steps back to the Philippines.

sonnel was urgent. All were serving with USS *Chilton*, APA 38, in the Pacific area campaign, and are participants in the engagements of said vessel, which are enumerated as follows:

"The initial invasion and occupation of Kerama Retto, Ryukyu Islands, against enemy opposition including several direct suicide attacks by enemy planes resulting in the destruction of two enemy planes by USS *Chilton*.

"The initial combat landing and occupation of Ie Shima, Ryukyu Islands, repelling fanatical enemy air attacks during this engagement.

"The landing of reinforcements on Okinawa Jima. During this operation USS *Chilton* was shelled by enemy coastal batteries and subjected to intense enemy air attacks."

Taken as a lot, the records of these men of the *Chilton* provide a revealing collection of case histories of a typical group of combatant Navy hams.

Lt.(jg) Lloyd R. Clark, USN, W7GMK, a radio amateur since 1936, enlisted in the Navy in 1937 and has been on active duty ever since. A graduate of the Naval Radio Matériel School at Bellevue, he rose through the ranks to his present status as RMO aboard the *Chilton*. He is also a veteran of the South Pacific theater, having served aboard the USS *Regal*, the USS *Cuyama* and the USS *Tern*.

Warrant RE Murray Blum USNR, W2MY, has been an amateur since 1920. Enlisting in the Navy in 1942, he is a graduate of the Naval Radio Matériel School, Treasure Island. In addition to his service aboard USS *Chilton* in his capac-

ity as Assistant RMO, he served in the ETO during the Normandy invasion as a member of the crew of USS *Meredith*, DD 726, which was lost in action during the landing operations. Prior thereto, he had served under the RMO of the Naval Frontier Base, Staten Island, N. Y. He is a member of the Brooklyn Radio Club and has been active in ARRL for some time.

CRM O. C. Lawrence, USNR, W6EWZ, has been a radio amateur since 1931. Giving up civilian activity to devote his full experience to the Navy, an expert c.w. operator he soon rose to rank of chief radioman. He has had considerable convoy experience, having served in the Pacific, Caribbean and South Atlantic escort services, as well as at the Trinidad Naval Radio Station prior to reporting aboard USS *Chilton*. CRM Lawrence has been active in ARRL and is a member of Marin Radio Amateurs, an affiliated club.

CRT Glen J. Jensen, USNR, W9IX, in addition to being an experienced amateur was a member of the Naval Reserve for the period 1933 to 1937, and reported for active duty in 1942. He is a graduate of the Naval Radio Matériel School, Bellevue, Washington, D. C., and since graduation has been a member of the crew of the USS *Chilton*.

RT1c John Pavlovich, USNR, W3GDW, was another active amateur to answer the call to the colors. In civilian life he was an ardent DX enthusiast both on 'phone and c.w. and an active member of the Trenton Radio Society and ARRL.

RM3c Henry O. Panzer, USNR, ex-W2HH, is an "old-timer." He is a top-notch operator and handles traffic aboard USS *Chilton*. He has been in service for three years and was another of the hams who felt impelled by a sense of loyalty to join up at a time when the services of trained personnel were needed most. He has been identified with amateur radio since 1920.

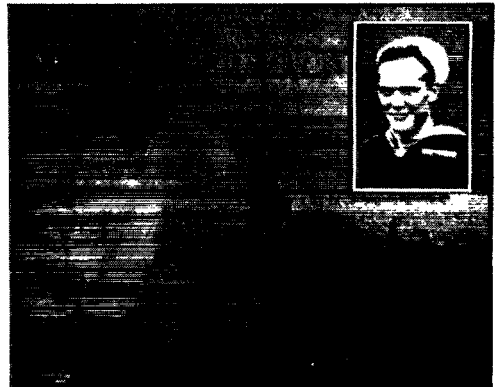

Landings in Lingayen Gulf on January 9th were met by the Japs with intensive air attacks resulting in the loss of a CVE and several other vessels, among them the mine sweeper USS *Long*. Radar operator aboard the *Long*, CRM Elmer L. Schultz, W9ZUX, was killed in the action. On active duty since 1941, W9ZUX had seen action throughout the Pacific, first at Attu and Kiska in the Aleutians, and then at Guadalcanal, Tulagi, the Gilberts and Marshalls, Palau, Leyte, Mindoro and finally Luzon.

HAPPENINGS OF THE MONTH



FIRST REOPENING ORDER

HERE is the text of FCC's announcement of August 21st on the first reopening of amateur radio. For background and more news, be sure to read "It Seems to Us —" in this issue.

The Federal Communications Commission today announced that effective at once amateur radio operators in good standing who have been off the air since Pearl Harbor may operate until November 15, 1945, in the 112 to 115.5 megacycle band.

They will share this band with the War Emergency Radio Service, which was established as a temporary radio service for emergency communication in connection with national defense and conditions jeopardizing public safety. Many of the operators in this service were amateur volunteers. This WERS service will be terminated on November 15, 1945.

About 60,000 amateur operators were licensed at the time the Commission ordered them off the air after the outbreak of war. All of these, except those whose operator licenses were suspended or whose station licenses were revoked, will be eligible to operate in the 112 to 115.5 megacycle band thrown open by the Commission today.

Before the end of the provisional period announced today, the Commission will announce a further policy on future amateur operation. It is anticipated that other bands allocated to amateurs in the recent FCC frequency allocations will be made available to them as soon as they are vacated by present users.

And here is the actual FCC order itself, with the terms of which every amateur should be thoroughly familiar:

ORDER NO. 127

At a session of the Federal Communications Commission held at its offices in Washington, D. C., on the 21st day of August 1945;

WHEREAS, under the provisions of Orders 87 and 87-A the Commission has ordered the complete cessation of all amateur radio operation and, under the provisions of Order 87-B, has ordered that no renewed or modified amateur station licenses should be issued from September 15, 1942, until the further order of the Commission; and

WHEREAS, the Board of War Communications on August 17, 1945, notified the Federal Communications Commission that it had no objection to the reactivation of amateur operation in the band 112 to 115.5 megacycles for a period of 90 days; and

WHEREAS, the frequency band 112 to 115.5 megacycles is now available to stations operating in the war emergency radio service; and

WHEREAS, the said war emergency radio service was established by the Commission as a temporary radio communication service solely for emergency communication in connection with the national defense and security and has now or will shortly have fulfilled the purpose for which it was established; and

WHEREAS, Section 15.52 of the Rules and Regulations governing the operation of stations in the war emergency radio service provides for the change or cancellation by the Commission, without advance notice, of all licenses authorizing the operation of stations in this service; and

WHEREAS, Section 15.105 of the Rules and Regulations governing all operators of stations in the war emergency radio service provides for the change or cancellation by the Commission, without advance notice, of all war emergency radio service operator permits;

IT IS ORDERED, That, notwithstanding the provisions of Commission Orders 87, 87-A, and 87-B, all amateur radio station licenses which were valid at any time during the period December 7, 1941, to September 15, 1942, and which have not heretofore been revoked BE, AND THEY

HEREBY ARE, REINSTATED for a period commencing with the date of this order and ending November 15, 1945 (3 a.m. Eastern Standard Time) for the sole purpose of authorizing during that period the operation of such amateur radio stations in the frequency band 112 to 115.5 megacycles by duly licensed amateur operators and in accordance with the Commission's Rules Governing Amateur Radio Stations and Operators; and

IT IS FURTHER ORDERED, That all war emergency radio service station licenses and operator permits, and the Rules and Regulations governing the operation of stations and operators in this service, BE, AND THEY HEREBY ARE, CANCELLED, effective November 15, 1945 (3 a.m. Eastern Standard Time).

ALLOCATION NOTES

RECONVERSION problems of one sort or another have so occupied Washington energies in recent weeks that there is still no news to report on the FCC-IRAC final examination of allocation matters in the range below 25 Mc. Ultimate disposition of these frequencies of course rests with an international conference, so the same urgency has not attended this part of the study as did the allocation above 25. There has been no further announcement about the world conference but it is reported that Anglo-American frequency discussions have begun. The Rio regional conference is now in session and there may be something to report from that source soon, although nothing of great interest to amateurs is to be expected. More news when there is news.

STAFF NOTES

WITH the ending of the war, ARRL headquarters has moved at once to start rebuilding its staff and undertaking the many jobs that confront us in our postwar reconstruction. Many of our old staff members are now on their way back to LaSalle Road and by the time you read these lines things will be humming at Hq.

We are particularly pleased to announce the return to our staff of George Grammer, W1DF, and Byron Goodman, W1JPE, both of whom were on leave during the war and engaged in secret laboratory work: One of the biggest jobs ahead of the League is the application to amateur radio of the many new things that come out of this war. To prepare ourselves for this work we have created at Hq. a Technical Department, which will be headed by George Grammer under the title of ARRL Technical Director. The work of course will far transcend that of the old technical branch of our Editorial Department, involving lab development programs and the unearthing of much wartime dope, from which we expect that great things will flow into the operation of amateur radio.

F. Edward Handy, W1BDI, our communications manager on leave of absence, is now a full colonel, AAF. Everett L. Battey, W1UE, our assistant CM, is a lieutenant commander in the

Navy, on active duty since 1940 in supervising the training of Navy radio personnel. If we have any luck, both officers will be back at their old Hq. desks by the time you read this, and in any event it won't be long.

Charles A. Service, jr., W4IE, who has been serving as assistant secretary the last two and a half years and more lately also as acting communications manager, to give us a lift during the duration, has returned to his home in Sarasota to resume his business. He is succeeded by LeRoy T. Waggoner, W9YMV, of Indianapolis, who comes to us from two years in the merchant marine in the Pacific. At the outbreak of war Roy was our SCM for Indiana and did a notable job in building up the Indiana state emergency network.

PERSONNEL BUREAU FOLDS

THE Personnel Bureau of the League was instituted early in the war to provide a means of putting war agencies and industries in touch with hams who had the necessary technical qualifications. It was instituted solely as a wartime activity, and was instrumental in placing hundreds upon hundreds of amateurs so that their highly developed technical abilities might be usefully employed in the national effort. Many of our guys and gals enlisted, or voluntarily applied for induction, for berths in the various armed services requiring special skills, through the instrumentality of the League's Personnel Bureau. It has, in addition, aided hundreds of hams in the service who found themselves in nonradio classifications, to effect transfer to communications or electronic work, where their ham knowledge could be utilized fully. It has assisted in the procurement of radio amateurs for a wide variety of special projects, generally of the hush-hush type. Perhaps one of the foremost among these in recent news is the Manhattan Project, which developed the A-bomb that contributed materially to the successful conclusion of the war. Other projects include monitoring for the Radio Intelligence Division of FCC, intercept for various other governmental agencies; research, development, and maintenance work on underwater sound, radar, fire control, CAA navigational aids. In fact, activities run the gamut of everything in which an electron is put to work.

We are proud of the fact that amateur know-how has been utilized in these activities to aid in the prosecution of the war. The League is happy to have been instrumental in obtaining ham personnel for jobs for which they were badly needed and were ideally suited. Our Personnel Bureau has served its purpose well but it is no longer needed. It is, therefore, discontinued. Our thanks to the many who cooperated so heartily to make it a success.

MANHATTAN PROJECT

THE atomic bomb project has required persons of many categories of technical skill. You'll be interested to know there are numerous amateurs in this work, most of them finding their way there via the ARRL Personnel Bureau.

The League had one less pleasant contact with this program a couple of years ago when we accepted for publication a humorous bit of imaginative scientific fiction involving the use of the cyclotron in the postwar ham shack. It was back in the days when we had to submit page proofs of our contemplated complete issue to the Office of Censorship. OC promptly blew up and said that we ought to know better, and our place swarmed with FBI agents who wanted to know how-come we had secret information. It seems that that contributed article came much too close to the truth!

WARNING TO CARRIER-CURRENT AND INDUCTION-FIELD EXPERIMENTERS

IT HAS been brought to our attention by FCC that it has been necessary in several cities to prosecute cases of illegal operation of carrier-current systems and low-power transmitters which should come under the low-power-devices provision. In no case were amateur communications involved. In most instances the persons were engaged in local "broadcasting."

The regulations governing such operation are quite specific. In carrier-current operation, the field strength at a distance of $\frac{1}{8}$ wavelength from a power line which might be carrying the signal must not exceed 15 microvolts per meter. The same restriction applies to the field about any conductor used in r.f. induction transmissions. Furthermore, and in any case, there must be no interference to other radio communications. This latter, for example, makes it practically impossible to comply with the FCC regulation if operation takes place within the band of broadcasting frequencies, even though the field strength may not exceed the legal limit.

After a careful study some time ago of the carrier-current frequencies in use by public utilities, we recommended the use of frequencies between 160 and 200 kc. for wartime amateur and experimental work. Lower frequencies should not be used because of the possibility of interference to established public-utilities communications and control systems, while higher frequencies are capable of legal communication only over negligible distances because of the limiting regulations.

QST DUTCH & CZECH HAMS!

CZECH and Dutch persons living in Canada, trying to trace missing relatives and friends in their home countries, are being aided by the Red Cross and the facilities of the Canadian Broadcasting Corporation. The messages of inquiry are broadcast over Canadian station CHTA on 15.2 Mc. (19.71 meters). Transmissions are made daily, those to the Netherlands at 1930 GMT and those to Czechoslovakia at 2000 GMT. Communications in Europe being greatly disorganized, much help is needed in the reception and delivery of the messages. Amateurs for the most part have the only short-wave receiving apparatus. If PAØ and OK hams will assist by engaging in this task and by calling it to the attention of other amateurs, it will be a useful work that will be most gratefully appreciated.

Using the New High-Power Beam Tubes

Postwar Rigs for the Low-Frequency Ham Bands

BY DONALD MIX,* W1TS

In addition to the many new tube types developed in recent years for the higher frequencies, improvements in the design of a few have resulted in better performance at the lower frequencies. This article describes two high-power rigs requiring very little excitation.

WE HAVE heard much during the past two or three years about the extensive new developments in radio brought about as a direct result of the necessities of war. Naturally most hams wonder how drastically these changes are going to influence the picture of amateur equipment in the postwar period now beginning to open up. It is probably safe to say that by far the larger portion of wartime radio development has been in the direction of new applications of the art, rather than in that of strictly new improvements in communications equipment in which we hams have the greater interest. It is true nevertheless that the application of radio to such devices as radar has served to stimulate the design of apparatus which will work at much higher frequencies than any used in the past for practical purposes and this has been reflected in the use of some of these higher frequencies for certain types of communication.

Equipment for the lower frequencies which have borne the substantial part of amateur activity in the past has not, it seems, undergone such radical change. This is no less than might be expected, however, since these frequencies have been in use for a sufficient length of time to permit bringing the equipment close to peak performance. Most of the advancement evident from what we have seen consists principally of improved mechanical arrangements for frequency shifting and simplified control. There are a few developments, however, which will be of interest to the DX and traffic gangs and the rest of those who normally populate 80, 40 and 20. The most important of these perhaps is some of the newer tubes which will deliver high-power output with little in the way of excitation and which are shaped physically to fit more naturally into a simple constructional layout.

These new tubes, typified by the Eimac 4-125-A and the Heintz and Kaufman 257-B, are screen-grid types, of course, but they constitute consider-

able improvement over similar prewar models in the matters of physical size and input-output isolation. Whereas with older types of screen-grid tubes often it was a question of which was the worse of the two possibilities — triodes with their neutralizing circuits and high-power driving requirements or screened tubes with their stabilization headaches — these newer tubes require only a reasonable amount of external shielding to provide excellent stability over any of the lower-frequency bands.

A Push-Pull Amplifier

The push-pull amplifier shown in the photographs makes use of a pair of 4-125-As. It will handle a power input of 1 kw. readily on c.w. A crystal oscillator will drive it easily, thus making a receiving-tube exciter practicable even for the highest power permitted in amateur operation. The circuit is shown in Fig. 1.

The mechanical arrangement is very simple. The only shielding required is a can for the grid coil and a pair of small baffle shields which was found necessary to eliminate feed-back through the small capacity formed by the plate of each tube and the adjacent stator of the grid tuning condenser. These baffles could have been dispensed with if the grid tuning condenser had been mounted underneath the chassis. They are the price paid for an arrangement which would present a symmetrical pattern of tuning controls.

The submounted sockets for the tubes are made by National and are designed especially for the 4-125-A. Ordinary "jumbo" five-prong sockets will not do, since the tube seal protrudes from the

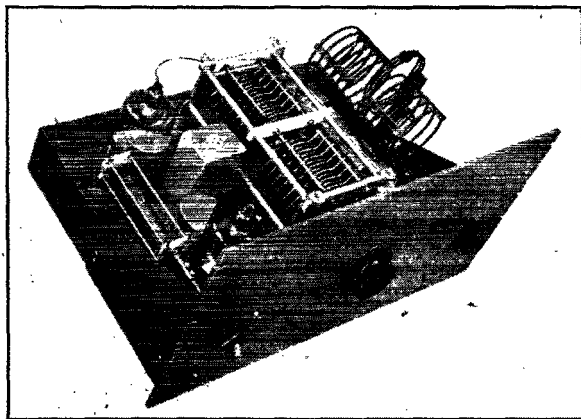

A push-pull amplifier using high-power beam tetrodes. The panel is 10½ inches high while the chassis is 13 inches deep, 3 inches high and 17 inches long for standard rack mounting.

*Technical Department, ARRL.

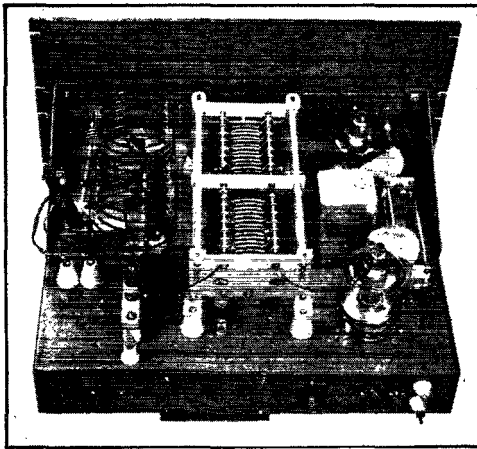

Rear view of the high-power push-pull amplifier. The small baffle shields between the tubes and the grid tank condenser are bent up from sheet aluminum.

base making it necessary to provide a hole in the center of the socket. Grid tank-circuit leads drop through clearance holes in the chassis at either end of the tuning condenser to the coil-socket terminals underneath.

The plate tank condenser is mounted in an inverted position on $1\frac{1}{4}$ -inch ceramic insulators and metal angle pieces to bring the stator terminals up at the same height as the plate terminals of the tubes. The plate coils are the B & W HDVL series. The jack bar is mounted on short ceramic stand-offs while the high-voltage line to the center tap of the coil comes up through a feed-through insulator set in the chassis.

Filament and screen by-pass condensers are soldered directly to the socket terminals underneath. The filament transformer also is mounted under the chassis to keep leads short and prevent excessive voltage drop.

No grid-leak resistor or screen voltage-dropping resistors are included in the unit itself, since the specific arrangement to be used will depend upon details of the voltage source and the value of plate voltage at which the amplifier is to be

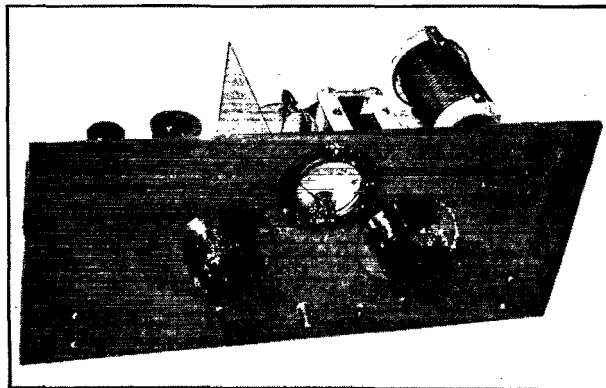

A two-tube medium-power transmitter. The panel is $8\frac{3}{4}$ inches high and the chassis measures $7 \times 17 \times 3$ inches.

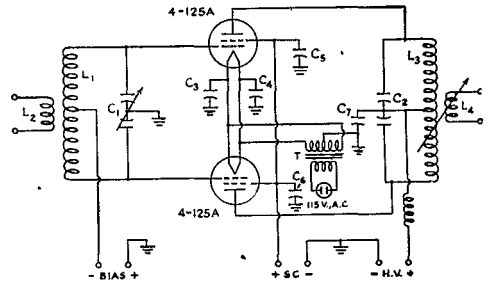

Fig. 1 — Circuit diagram of the high-power push-pull tetrode amplifier.

C_1 — 150- μ fd. per section variable (Hammarlund HFAD-150-B).

C_2 — 100- μ fd. per section variable, 0.17-inch spacing (National TMA100DA).

C_3, C_4 — 0.01- μ fd. paper.

C_5, C_6 — 0.001- μ fd. mica, 600 volts.

C_7 — 0.001- μ fd. mica, 10,000 volts.

T — Filament transformer, 5.25 volts, 15 amperes.

L_1 — Grid coils, all wound on Millen 1-inch-diameter forms mounted in National PB10 shields with 6-pin bases; all coils tapped at center.

3.5 Mc. — 46 turns No. 22 enameled, close-wound.

7 Mc. — 30 turns No. 22 enameled, $1\frac{1}{4}$ inches long.

14 Mc. — 16 turns No. 22 enameled, $1\frac{1}{4}$ inches long.

28 Mc. — 10 turns No. 18 enameled, 1 inch long.

L_2 — Input link winding — 5 turns for 3.5 Mc., 3 turns for 7 Mc. and 14 Mc., 2 turns for 28 Mc.

L_3 — B & W HDVL series coils with variable-link coupling. Appropriate inductance values are as follows:

3.5 Mc. — 40 μ h.; 7 Mc. — 15 μ h.; 14 Mc. — 5 μ h.; 28 Mc. — 1.2 μ h.

L_3 — Output link winding.

operated. While series voltage-dropping resistors or a voltage divider are satisfactory as a means of supplying screen voltage, once the amplifier is tuned and loaded, they are rather difficult to adjust for proper operating conditions, since the screen current, and thus the voltage, varies widely depending upon the plate voltage, plate current or loading. From this consideration, it may be more desirable to obtain screen voltage from a fixed source of correct voltage. In many cases it will be possible to operate the screens from the exciter plate-voltage supply, although means should be provided so that screen voltage will not be applied for long periods without simultaneous application of plate voltage.

Sufficient fixed bias should be applied to the grids to cut off plate and screen currents when the amplifier is not being driven. This may be obtained economically from batteries, since the required voltage should not exceed 90 and the grid current is low, assuring long battery life. The additional bias required when the amplifier is excited under operating conditions may be obtained from a grid-leak resistor in series with the battery. Its value may be obtained by dividing the required *additional* bias by the grid current in fractions of an ampere.

Bias also may be obtained from an a.c. pack with a voltage divider across its output. Both the total resistance of the divider and the position of the bias tap should be adjusted experimentally until the correct operating bias is obtained when excitation is applied and rated grid current flowing, and at least cut-off voltage is obtained with excitation removed. It always is advisable to have the pack output voltage as close to the required cut-off voltage as possible, if the biasing voltage is not to exceed the correct operating value when grid current flows.

The plate tank-condenser spacing is sufficient for operating at a plate voltage of 3000 on c.w. or 2000 with plate and screen modulation. Maximum plate-current rating is 225 ma. per tube. The screens should be operated at a voltage of 350. Normal grid current is 8 ma. per tube and the operating bias is -150 volts.

A Compact Two-Stage Transmitter

Fig. 2 shows the circuit diagram of a simple two-stage transmitter which will deliver a power output of over 200 watts at a plate voltage of 2000. It consists of a 6L6 Tri-Tet crystal oscillator capacitively coupled to an HK257-B. As the photographs show, the chassis is divided into two

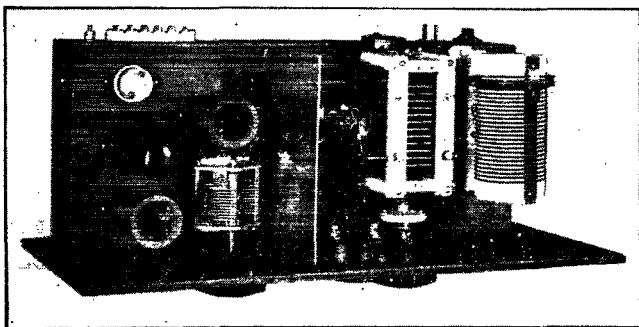

A baffle shield separates the oscillator and amplifier sections of the two-tube medium-power transmitter. Power terminals are at the rear.

sections by a baffle shield, the oscillator components on one side and the amplifier tube and output tank circuit on the other.

In the oscillator section the sockets for the crystal, oscillator tube and cathode coil are in line along the end of the chassis. The oscillator plate coil is directly behind the tuning condenser with the stator lead passing down through a clearance hole in the chassis to the coil terminal underneath.

The amplifier tube socket is spaced about 1½ inches below the chassis so that the glass envelope just clears the top surface of the chassis. This forms part of the shielding system. The base shell of the 257-B must be grounded. The ground

(Continued on page 118)

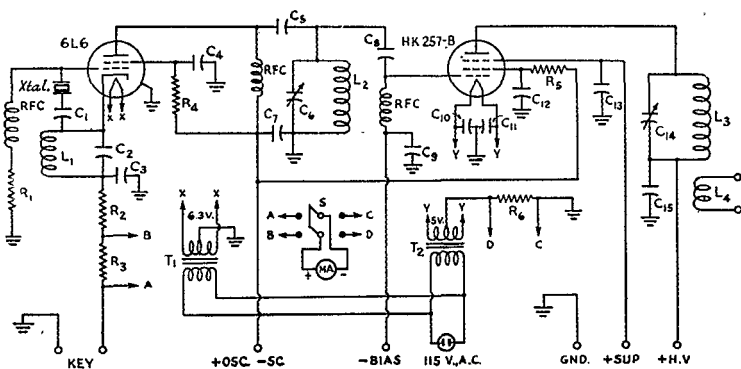

Fig. 2 — Circuit diagram of the two-stage medium-power transmitter.

- C₁, C₅ — 0.001- μ fd. mica.
- C₂, C₈ — 100- μ fd. mica.
- C₃, C₄, C₇, C₉, C₁₀, C₁₁, C₁₂, C₁₃ — 0.01- μ fd. paper.
- C₆ — 250- μ fd. variable (National TMS-250).
- C₁₄ — 100- μ fd. variable, 0.085-inch plate spacing (National TMH-100).
- C₁₅ — 0.001- μ fd. 5000-volt mica.
- R₁ — 0.1 megohm, ½ watt.
- R₂ — 500 ohms, 1 watt.
- R₃ — 25 ohms, 1 watt.
- R₄ — 50,000 ohms, 10 watts.
- R₅ — 50 ohms, 1 watt.
- R₆ — 25 ohms, 10 watts.
- RFC — 2.5-mh. r.f. choke.
- MA — D.c. milliammeter, 300-ma. scale.
- S — D.p.d.t. toggle switch.
- T₁ — Filament transformer, 6.3 volts, 2 amperes.
- T₂ — Filament transformer, 5 volts, 7.5 amperes.
- L₁ — For 3.5-Mc. crystals — 10 turns No. 22, 1 inch

- long, 100- μ fd. mica mounted in form connected across winding.
- For 7-Mc. crystals — 6 turns No. 22, ½ inch long.
- L₂ — 3.5 and 7 Mc. — 15 turns No. 18 enameled, ½ inch long.
- 7 and 14 Mc. — 6 turns No. 18 enameled, ½ inch long.
- Above coils wound on Hammarlund 1½-inch-diameter forms.
- L₃ — All coils wound on National XR-10-A 2½-inch-diameter forms.
- 3.5 Mc. — 25 turns No. 14 enameled, wound in successive grooves.
- 7 Mc. — 14 turns No. 12 enameled, wound in successive grooves.
- 14 Mc. — 6 turns No. 12 enameled, wound in alternate grooves.
- L₄ — Output link winding: 4 turns for 3.5 Mc., 3 turns for 7 Mc., 2 turns for 14 Mc. (see text).



ON THE VERY HIGHS



CONDUCTED BY E. P. TILTON,* W1HDQ

IT'S BEEN many months, fifteen to be exact, since this column has appeared in the pages of *QST*. During most of this time your conductor was engaged in naval radar work at various Pacific bases, principally Pearl Harbor and Guam. Though we've been far from home, we've not been out of touch with amateur radio by any means, for a large percentage of our associates have been hams.

For those not familiar with the "Navy way," most work in connection with electronic devices (radio, radar, underwater detection devices, intercom systems, electronic controls) is handled through a Radio Material Office, one of which will be found at practically every Naval base, anywhere in the world. At long-established Navy Yards, such as those at Boston, Philadelphia, New York, San Francisco and Pearl Harbor, the RMO will be a complex organization employing hundreds of men and women, both civilians and service personnel. At advanced bases it is more apt to be a small group of officers, a crew of well-trained enlisted technicians, and perhaps a few field engineers. At the newest island bases, the RMO may even be aboard a tender, or it may be one of the Navy's marvelous new electronic repair ships. The important thing, to the ships and men who were doing the fighting, is that at any port where they may put in they will find a group of electronics specialists ready to put their complex gear into topnotch operating condition, to give them assistance on any problems concerned with use and maintenance of their equipment, or even to bring it up to date if improvements have been developed.

Each of these offices is under the command of a Radio Material Officer, invariably a man of long experience in radio, and, more often than not, a ham. His staff will usually assay a high percentage of past, present, or future hams. At Pearl Harbor, for instance, all U. S. call areas were represented among the RMO personnel, the roster being too long for listing here. At Guam, the Radio Material Officer was Comdr. C. L. Engleman, W6UQR, whose list of ex-calls includes W2, W3, and W6, and starts with 7QQ, from way back when. On his staff were Lt. Cdr. Linell, W1AJK; Lt. Green, W3BEN; Ens. Patterson, W4GYF; Ens. Hax, W9DIF; CRE Parker, W8NNW-OTF-SAA; CRT Shrack, W8POE; Browne, W4COZ, RT1c; Nance, W6UME; Shacklett, W6SCS; Beahr, W6UKG; Risley, W2HCA, all RT3c; and the following field engineers: Krudwig, W9GTF; Jablonsky, W9MCX; Zipf, W2MOZ; Robinson, W6BZR, and Bishop, W1EWD, all of Raytheon; Pugarelli, W2LWL, and Draper, W8TOY, Hazeltine Corp.; Brown, W9PFL, of Western Electric; Mockus, W6UOS-

*329 Central St., Springfield, Mass.

ex-W9BZC, of Westinghouse; Hilburn, W9JYT-W2NMO, of RCA; and Schwenden, W6JG; Richmond, W3EJF; and Tilton, W1HDQ, of Submarine Signal. There were others, in addition, whose identity or calls we were unable to learn.

Traveling to and from the Pacific we had opportunities to see a little of the fabulous State of California, and to experience its "built-in temperature inversions," about which we were wont to theorize in these pages some years ago. Visiting with W6QT at his future ham shack in the Blue Mountains on the western edge of the Sacramento Valley, and later flying over the same terrain, we drew a conclusion or two about the possibilities for DX records in our new post-war v.h.f. bands. The existing record of 335 miles on 112 Mc., held jointly by W2MPY/1 and W1JFF, will never be broken — but only because there will be no 112-Mc. band in the post-war v.h.f. picture. The Sacramento and San Joaquin Valleys seem to provide close to ideal conditions for setting up some records in our new bands for the rest of the world to shoot at.

Some of the possibilities of this terrain were demonstrated on July 4, 1940, when W6BJI/6, flying down the San Joaquin Valley, maintained contact with W6KIN/6 at Mt. St. Helena, for a distance of 255 miles. We feel, however, that this notion that great height must be reached before appreciable v.h.f. DX can be worked is essentially false. Line-of-sight DX is easy, up to about 200 miles or so, but after that you have to get mighty high up to overcome earth curvature. If a temperature inversion is present you may well be above the altitude where its beneficial influence is felt; in fact, you may even have upward bending, from the top of the inversion, which would tend to reduce the working range. Then, too, portable operation usually involves low-powered equipment of questionable efficiency, and precludes the employment of high-gain antennas.

We have the idea that two stations using a fair amount of power, good receivers, and high-gain directive arrays, situated in the right locations in the Sacramento and San Joaquin Valleys, and operating on schedules arranged with one eye on the weather, could work some surprising distances. From some point near Bakersfield, Calif., for instance, we would not be at all surprised to see someone work distances beyond 300 miles on any of several of the new v.h.f. bands. Distances up to 400 miles were worked on 56 Mc., without the aid of skip; the 112-Mc. record is 335 miles, the 224-Mc. record 135. Who will set the first records on the new 144-, 220-, and 420-Mc. bands?

As this material is being prepared, just shortly after cessation of hostilities in the Pacific, we can imagine feverish activity going on in ham shacks everywhere. Just when we will break the

war-imposed silence we do not yet know. The important point is, will we be ready?

Radio has "grown up" while we've been off the air. For years we've recognized that many of our customs, procedures, allocations, and regulations were becoming obsolete. The war close-down provided the perfect time to correct all that. We have our new allocations — but are we ready for the conditions they impose?

In the v.h.f. spectrum, particularly, we will find a picture quite different from that we left, so suddenly and unwillingly, back in December, 1941. For one thing, we will now have company, and plenty of it, on all sides. In prewar times, we thought of the region above 28 Mc., as pretty much our own territory. We had our bands, and as far as 28 and 56 Mc. were concerned we stayed within them, and operated transmitters of a fair caliber therein. But we never worried much about harmonics, and BCL trouble was quite remote. Now look at the picture: if a ten-meter 'phone radiates a strong second harmonic (and how many didn't?) it's going to land smack in a television channel. If our 50-Mc. rig splatters, just look at what we're going to spread out in — television channels on both sides. And those television channels are going to be *occupied* this time.

Above 100 Mc. we're going to have to become quality conscious as never before, for the v.h.f. spectrum has gone to work in the postwar world. We never worried much about band limits with that transceiver on $2\frac{1}{2}$ — what was a megacycle more or less, when there was nobody out there anyway. But there is somebody out there now, and it's up to us to see to it that when we have interference, as we certainly will, that our equipment is not responsible for it. That's television and f.m. in them thar hills; we've got them for channel neighbors, whether we like it or not!

What do we see for this bright new postwar world when we look into W2OEN's Crystal Ball? We've been hearing a lot about all the marvelous electronic developments during the war — what do they mean in terms of improved results for the postwar v.h.f. enthusiast? Not quite as much as claimed in some quarters, we venture, but still there's enough new to make v.h.f. operation vastly more interesting than ever before. The most interesting aspect, to us, is the line of new tube types to which we have fallen heir, many of them unknown before the war, and not a few of them practical low-cost answers to the prayers of many a v.h.f. enthusiast, who formerly struggled to get a few watts of stable r.f. from tubes which were never designed for operation on more than 20 Mc. or so.

We look for a vast improvement in the stability and efficiency of oscillators operated in the region between 100 and 500 Mc. We had tubes with low interelement and input and output capacitances before the war, but how about filaments, which assume so much importance as you go over 100 Mc.? Conventional tube base design, and the necessity for using a socket for filament connections, practically eliminated any chance of success with tuned filament lines; but look at the

line of tubes now at our disposal, which have no base at all, in the old sense. There should be no excuse for not having tuned filament circuits with such tubes as the 15-E, the 127-A and 327-A, to name a few. And those beautiful little miniatures — those single and double triodes and high-gain pentodes, which operate up to 500 Mc. and higher. They should go to town in receivers and low-powered transmitters.

What may we expect to inherit from radar, and other v.h.f. and u.h.f. applications unknown before the war? What is there for the amateur, up where you begin to count your megacycles by the thousands? Pulse transmission, with its tremendous peak power, visual reception, hair-line beam patterns? We think not; in fact, we take the dim view of amateur radio at frequencies above a few hundred megacycles or so, even though we've spent the last couple of years working on frequencies higher than we ever dreamed of back in 1941.

Undoubtedly a lot of fellows are going to want to see what happens when you voice-modulate and listen, instead of pulse-modulate and look; quite a few are going to be interested in generating r.f. up in the thousands of megacycles, when klystrons, magnetrons, and Shepherd tubes are released for amateur use; but we can't escape the feeling that the average ham (at least the variety that filled our prewar bands and call-books) is a gregarious creature at heart. He is in ham radio because he likes contact with his fellow man. He is an experimenter, yes, but principally because by constant experimentation and improvement he is able to talk to more hams, or to those farther away. He thrills to DX, whether that means the other side of town or the other side of the world; he likes to call CQ, and plow his way through a welter of answers; he fights QRM, but he loves it; he handles traffic, and gets a kick out of batting out c.w. at top speed; he furnishes communication when all other means fail.

Will we find these thrills, or some substitute for them, when we explore the territory above 500 Mc.? We hope so, for it is well-established tradition that amateur radio shall blaze the trails to new radio horizons. But right now we're more interested in putting that new 6250, 5-kc. rock to work controlling a few hundred watts on 50,004 kc. We've had enough of dipoles one inch long or less — we itch to get back to 8-element arrays, a rhombic, and a V-beam or two — and the sooner the better!

Following the preparation of the above copy the 112-Mc. band, as you no doubt know and as is reported elsewhere in this issue, was reopened to general amateur use on a temporary basis. Activity has been keen and those prewar DX records may be broken after all. On September 5th, for instance, the band opened up with first district hams working in the third district. More details next month.

Converting 112-Mc. Gear for 144

Simple Adjustments of Existing Equipment for the New Bands

It is expected that the 112-Mc. band will be shifted within the next few months to the region 144-148 Mc. In these articles the authors show what changes are required to convert typical 112-Mc. gear for the new band.

Shifting the TR-4

BY PHILIP S. RAND,* WIDBM

THE reopening of 112-Mc. as the first of the prewar ham bands to be restored and the prospects of swapping this band for the range of 144-148 Mc. in the near future pose the natural question of the possibility of converting existing 112-Mc. gear for 144-Mc. operation. It is an important question because of the considerable quantity of 112-Mc. equipment developed for WERS work, much of which will be available for emergency and general ham use. Of course, manufacturers of "boughten" units may be expected to bring out new versions of their gear, designed to fit the new frequencies, but owners or users of 112-Mc. gear first will want to know what, if anything, can be done to revamp the sets they have on hand which, after all, will be the quickest and most economical way of shifting over.

Of the prewar manufactured gear, the Abbott TR-4 is probably as good an example as one can find, since it has been adopted as standard equipment in many WERS networks and was very

* Remington Rand, Inc., Elect. Div., Middletown, Conn.

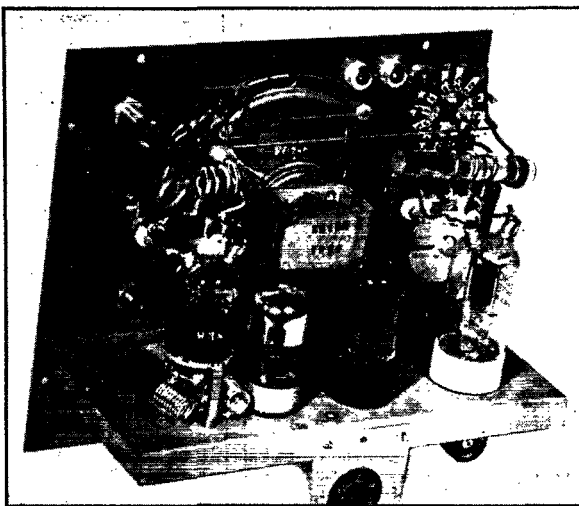

Rear view of the TR-4 showing the reduction in tank coil size for 144 Mc. and the filament chokes for the HY615.

popular in 112-Mc. installations before Pearl Harbor. With a few simple alterations, it can be made to perform about as well at 144 Mc. as it does on two-and-one-half.

As the photographs show, the necessary changes involve very little labor or expense, the toughest part at the present time being the job of spotting the band. The coil for the HY615 in the receiving section was reduced from the original six turns to four turns of the same dimensions and the tap was placed at the center turn of the coil. The coil for the HY75 in the transmitter was cut down from 4 turns to 3 turns and the turns

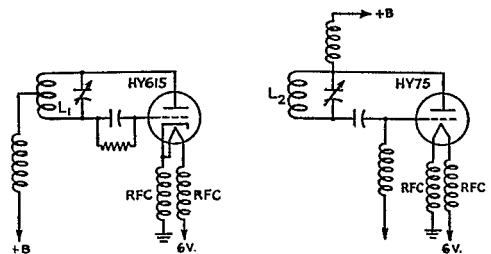

Fig. 1 — Partial circuit diagram showing the insertion of filament chokes.

L₁ — 4 turns No. 14, 1/2-inch diameter, approximately 3/4 inch long.

L₂ — 3 turns No. 14, 1/2-inch diameter, approximately 1 inch long.

RFC — 10 turns No. 18, 3/8-inch diameter, turns spaced slightly to prevent short-circuiting.

were spaced slightly farther apart than previously. With only these changes the TR-4 functions fairly well. However, it was found that it was necessary to advance the regeneration control considerably more than normally to obtain superregeneration in the receiver, while the HY75 in the transmitter drew 50 ma. with no loading.

From previous experience, it was thought that perhaps filament chokes might help, so some small chokes were wound using No. 18 tinned wire. They consisted of 10 turns each, 3/8 inch in diameter with the turns spaced just enough to keep them from short-circuiting. In the HY615 circuit, one of these chokes was placed between one side of the filament and cathode connection and the chassis ground. Another was placed in series with the other filament lead. They are soldered directly between the socket prongs and the grounding lug on the socket-supporting pillar. With these chokes in place, it was found that the regeneration control could be backed off to the normal position and the sensitivity came back to approxi-

mately the same as it had been on 112 Mc. After placing chokes in series with each filament lead of the HY75, the plate current dropped to between 25 to 30 ma. with no load and the output came up to approximately the same as that obtained at 112 Mc. with the antenna connected.

The new band occupies about the same space on the dials as the 112-Mc. band. It can be shifted one way or the other slightly by squeezing together or spreading the turns of the coils. In this particular case the 144-148-Mc. band was located through the use of a Ferris u.h.f. signal generator and a calibrated Millen wavetrap, although Lecher wires, or any other of the various methods suggested in *The Radio Amateur's Handbook* could be used.

Converting QST Units for 144 Mc.

BY WALTER E. BRADLEY,**
W1FVH

It was generally expected that 112-Mc. gear using high-frequency tubes would function just as well in the new band as in the old. The many hams who have built rigs around standard receiving-type tubes, however, face the question of what to do to make the change-over as well as the question of whether or not this type of apparatus will do a worth-while job in the 144-Mc. band. Of specific interest is the performance in the new band of such lowly but more readily available tubes as the 6J5, 6J5GT, 6V6GT and the 6L6. To find the answer to the question several of the units described in *The Radio Amateur's Handbook* and previous issues of *QST*, which have been duplicated frequently, were brought out for revamping.

Typical of this type of gear is the transceiver described in the December, 1943, issue of *QST*.¹ Of major importance is the fact that it uses a 6J5 or 6J5GT detector-oscillator. After some experimenting with various *L/C* ratios and the insertion of r.f. chokes in the heater leads, as described by W1DBM, excellent results were finally obtained. The sensitivity and power output using these tubes were every bit as good on 144 Mc. as on 112.

Moving the oscillator up to 144 Mc. was comparatively simple, but a few interesting facts were brought to light in the process. First, a high *L/C* ratio is necessary for smooth superregeneration. Secondly, r.f. chokes in the heater leads with the cathode return through one choke are essential for both detector sensitivity and good oscillator output. Third and last is the fact that r.f. feed-back from the oscillator to the audio tubes, when all are fed by a common voltage supply, undoubtedly will occur if a mica by-pass condenser does not tie the "hot" side of the heaters to a good ground. It was also discovered that the 6J5's performance was slightly improved by tying its shell directly to ground.

** Technical Information Service, ARRL.

¹ Bradley, "A Transceiver for Mobile WERS Work," *QST*, December, 1943, p. 48.

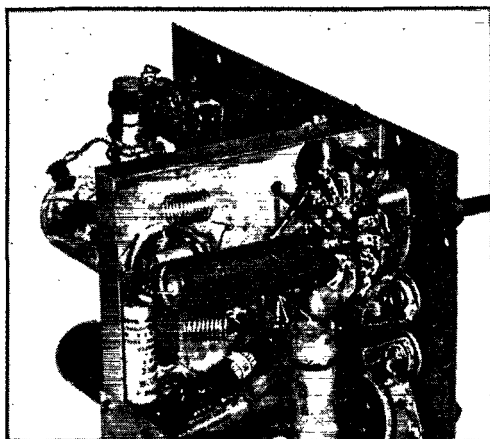

Bottom view of the TR-4 showing the placement of the filament chokes in the transmitter circuit.

A new tank coil consisting of three turns of No. 12 enameled wire wound with a $\frac{1}{16}$ -inch inner diameter and pulled out to a length of $\frac{5}{8}$ inch was found to work best with either the 6J5 or the 6J5GT. Making no other changes, as yet, either tube worked on 144, but the output on transmitting wasn't worth bragging about nor was the fact that it required 80 volts to make them superregen. The answer to both problems, of course, was the insertion of r.f. chokes in series with the heaters right at the tube socket. These chokes are of the same dimensions as those described previously for the TR-4. The cathode is connected directly to one of the heaters at the detector-oscillator socket so that its return circuit is through one r.f. choke to ground. The other choke is connected in the "hot" side of the heater. Since the audio-tube heater is connected in parallel, its connection to the supply line must be shifted to the "bottom" end of the r.f. choke so that the choke will be in series with the detector-oscillator heater only. The lower end of the choke must be by-passed. A capacity of 50 μ fd. is sufficient. Incidentally, a 0.01- μ fd. paper condenser at these frequencies acts more like a coil than a condenser.

These three changes are all that are necessary to crank the old 112-Mc. rig up to the 144-Mc. band and have it behave just as nicely. Under these conditions, good upward modulation, as indicated by a neon bulb or a 2.5-volt flashlight bulb soldered to an absorption loop, can be obtained and superregeneration will start with 37 volts on the detector.

The "Horseshoe" Oscillator

Putting the popular "horseshoe" oscillator, described in the ARRL *Handbook* and *QST* for December, 1941,² on the new frequencies is no trouble at all. As a matter of fact, it will tune to the 144-Mc. band just as it is without changing a thing but the tuning capacity. This isn't so good,

(Continued on page 118)

² Grammer, "112-Megacycle Emergency Gear," *QST*, December, 1941, p. 9.

THE CRYSTAL BALL

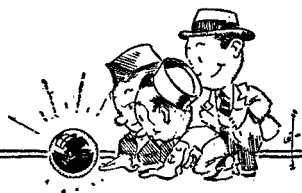

CONDUCTED BY A. DAVID MIDDLETON,* W2OEN

THE cessation of hostilities did not dim the dazzling light of those heavy-duty crystal balls. Many types of proposed gear were covered by the various contributions and from these we have chosen a diversified group of ideas to present in this, the second appearance of the previews from the ham's own crystal balls.

A MICROWAVE SYSTEM WITH BREAK-IN OPERATION

MICROWAVE transmission with break-in operation is proposed utilizing equipment as shown in Fig. 1. The stations consist of a circular or square wave guide terminated with a horn or a parabolic dish. Power from a microwave generator enters the guide through a probe. A crystal detector is coupled into the guide by means of another probe inserted into the guide. The detector probe is placed at right angles to the transmitter probe, as shown in views of the wave guide in Fig. 1-A and -B.

When the two equipments are exactly in line with each other, each detector is in parallel with the other station's transmitting probe and will receive signals from the distant station. If the transmitter and receiver probes in a given equipment were exactly 90° apart, the detector would receive none of the power from its own transmitter. The receiver for such a system would consist merely of a crystal detector plus an audio-frequency amplifier. However, as it would be very difficult to attain such a balance it is better not to attempt such operation, especially since improved performance can be obtained using a different method.

In this alternate system, the probes are displaced deliberately so that a crystal current of from 1/10 to 1/4 milliamperes is obtained from the adjacent transmitter output. Each station has identical i.f. amplifiers and the transmitter frequencies differ by the intermediate frequency. The transmitter at each station acts as a local oscillator and a bit of its output mixes in the de-

tor with signals received from the other station to form beats of the proper intermediate frequency.

Even when station A is talking he can still hear station B if he breaks in because the modulation of the i.f. will be the same whichever carrier is being modulated. Another feature of this system provides that if either station A or B adjusts his transmitter frequency to produce maximum response on his "S" meter in his i.f. amplifier, he thereby automatically tunes the other station since both i.f.s are built for the same frequency and the two carriers beat together to form the i.f. at each receiver.

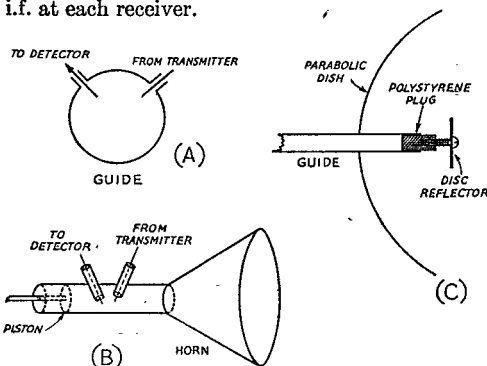

Fig. 1 — Details of a microwave communication system proposed by W3CHO. Placement of probes is shown at (A) and (B). A wave guide, terminated by a horn aperture and with a piston-type tuning device also is included at (B). Another type of termination, a parabolic dish, is shown at (C). An adjustable disc reflector also is detailed.

The i.f. amplifier system is also desirable because of its greater stability and sensitivity as the i.f. is much lower than the carrier frequencies. An extremely small frequency modulation swing, which can be produced very easily with a reflex klystron, will furnish an f.m. communication circuit. If designed solely for f.m. the i.f. amplifier may end up in a discriminator, but even if only a simple second detector is used f.m. may be re-

* Assistant Editor, QST.

OCTOBER PRIZE WINNERS

Contributors to the Crystal Ball Department are awarded monthly prizes consisting of a \$25 Victory Bond, first prize; \$10 in Victory Stamps, second prize and \$5 in Victory Stamps, third prize. One dollar in Victory Stamps is awarded the writer of each of the published letters not receiving a major prize.

The most interesting letters are selected by two members of the Headquarters staff, the conductor of the department and a "guest judge." This month's winners, chosen by Walter E. Bradley, W1FWH, of ARRL's Technical Information Service, and W2OEN, follow: W. van B. Roberts, W3CHO (first prize); John A. Kiener, W8AVH (second prize); N. H. Stinnette, jr., W4AYV (third prize); Karl M. Young.

ceived by adjusting the beat frequency to one of the sloping sides of the i.f. amplifier.

A parabolic dish, as shown in Fig. 1-C, may be used. After the wave guide is pushed into the dish the proper distance for the sharpest beam, operation is simple. If a horn is used even this preliminary adjustment is unnecessary but a horn becomes unwieldy in length if very short waves are used and a very sharp beam is required. (Formulas for optimum horn design are given in Terman's *Handbook*.)

Actual operation of these stations should be much simpler than that of a conventional ham station. Probably the greatest difficulty in the case of good sharp beams would be to get both horns or dishes aimed just right at the same time and to get the correct frequency difference while the beams are in line. However, once a signal is picked up, the beams can be easily swung to the optimum direction and fastened. Subsequent contacts can be made by merely placing the dish in that direction and by varying the frequency adjustment to pick up the calling station. As soon as a signal is picked up it can be broken and the calling station knows by the reading of his "S" meter when he has been tuned in by the distant microwave station.

Ranges up to 100 miles, with clear line of sight, should be obtained using reflex klystrons such as the 723A/B type. Due to the difficulty of getting the beams lined up the systems may be limited to fixed installations, or in stations with adequate equipment for the determination of the proper direction prior to an attempt to establish contact.

— *W. van B. Roberts, W3CHO*

ONE-UNIT POWER SUPPLY AT W8AVH

JOHN A. KIENER, W8AVH, of Cleveland, Ohio, director of ARRL's Central Division, submits an idea that should save both space and money. W8AVH proposes to build a "super-duper" power supply for his new station. In his prewar rig he had a variety of uncoordinated power supplies, including one or more for each transmitter. This involved considerable expense, some confusion and equipment duplication. Whenever he wanted to try some new idea or experiment, he had to tear into his outfit to get the proper voltages.

He now thinks that method is out-moded and a waste of space and gear and is planning a single power unit containing integral supplies from which he could obtain the various voltages required for the main and supplementary equipment and which also would provide suitable voltages for experimentation. This one-unit supply would be equipped with an autotransformer, filament transformers (with assorted useful outputs), high and low plate voltages, bias supplies and appropriate metering. Safety and protective devices will be included. Standardized output terminals will make the outputs available to any equipment in the station or workshop.

W8AVH insists that postwar amateur operation will require the effective use of plate-power reduc-

tion as a means to cut down QRM, which he (and a lot of us) believes is going to be tough enough without needlessly adding to it. John is going to include such provisions in his new power supply.

AIRCRAFT WARNING TOWER FOR HAM STATION

U.H.F., DX and the like have never held much interest for me, although I have dabbled in them. My first love has always been traffic handling and frequency measurement. I expect to go back to traffic handling and hope to get into some real frequency measurement. I built a frequency meter about a month before Pearl Harbor and got to use it enough to know that it would not give me the degree of accuracy that I wanted. So I am going to buy the best commercial frequency meter I can (within my pocketbook). The article about RID in *QST* a few months ago gave me some ideas. I hope to erect a directional antenna, etc., and have even toyed with the idea of getting one of those aircraft warning towers which are seen all over the country, and which could probably be purchased cheaply. This would be ideal to house the ham shack and hold the directional antenna.

— *N. H. Stinnette, jr., W4AYV*

SINGLE DIAL CONTROL AND AN AUTOMATIC ANTENNA

KARL M. YOUNG, of Pasadena, Calif., describes his proposed ham station layout as follows:

"My transmitter will be a multistage affair with the legal ham input and as high an output as possible. All tuning controls will be ganged and operated by a single dial, calibrated directly in frequency, adjustable to 1 kc: on all but the 10-meter band.

"The transmitter will be crystal controlled by adapting a principle which has been known to radio for years but which has never been used to control transmitter frequency. This rig will have great flexibility and can be set at any point in any of the five low-frequency ham bands. The frequency stability of this rig will be 0.001 per cent or better!

"Plate modulation with both automatic modulation control and voice-operated break-in will be employed. A vertical end-fed antenna, consisting of two telescopic tubes, will be so arranged that the antenna will automatically be adjusted to the proper length for either fundamental or harmonic operation.

"Truly, this is the answer to many a ham's dream. Complete flexibility, with rock-steadiness, single dial control and an automatically tuned antenna. What more could any ham require? (How about the perfect location for that job? — EDITOR.)

"How will I do it? Well, you'll have to wait a while for the details. This answer to a ham's prayer is still in the laboratory stage but it is no pipe-dream. It can and will be built."

Know Your Coupled Circuits

Factors Involved in Inductance-Coupled Systems

BY DAWKINS ESPY,* W6UBT

This article constitutes a discussion of the principles involved in inductively-coupled circuits in simplified language. It provides an excellent basis for an understanding of such circuits which are to be found in almost every radio or electronic device.

ALMOST every type of radio and electronic apparatus employs coupled circuits to provide a transfer of energy from one circuit to another in some desired manner. Such wide use is only natural, since coupled circuits are relatively simple to design and construct.

A thorough grasp of the fundamental facts of coupled circuits is essential if one is accurately to predict and understand their operation. The more common uses we have for coupled circuits are to couple Class-C amplifiers to each other, to couple transmitters to antennas, and to serve as r.f. and i.f. transformers in receivers.

Fig. 1 shows the most frequently encountered form of coupled circuit, the double-tuned transformer. Ordinarily, both circuits are resonated to the same frequency. Under this condition, there is an alternating voltage across the primary circuit whose magnitude depends upon the impedance of the circuit, the amount of secondary loading, and the manner in which the primary is fed.

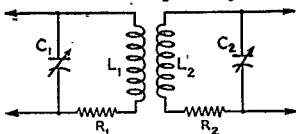

Fig. 1 — The double-tuned circuit.

This a.c. voltage across the primary causes an alternating current to flow in L_1 which, in turn, causes magnetic flux lines to exist. The flux lines cut the conductor of coil L_2 and thereby induce a voltage, E_S , in series with the coil. E_S causes a current to flow in L_2 and C_2 . E_2 is the resulting voltage across the secondary condenser.

Reflected Impedance

A convenient manner of discussing the behavior of coupled circuits is in terms of the effective impedance of the primary as a result of conditions in the secondary. Such discussions refer to the additional impedance added in series with the primary circuit. The general expression for this reflected impedance is

$$\frac{(\omega M)^2}{Z_2} \quad (1)$$

where ωM is the mutual reactance and Z_2 is the series impedance of the secondary with the primary removed. If Z_2 consists of resistance and reactance, one may write for the reflected components

$$\text{Reflected resistance} = \frac{(\omega M)^2 R_2}{R_2^2 + X_2^2}, \quad (2)$$

$$\text{Reflected reactance} = \frac{- (\omega M)^2 X_2}{R_2^2 + X_2^2}, \quad (3)$$

where R_2 is the series resistance and X_2 the series reactance, components of Z_2 , considered as though the primary were not present. Note that X_2 becomes a reactance of opposite sign when it is reflected into the primary circuit; that is, a capacitance becomes an inductance and vice versa. The reflected impedance for any set of circumstances may be easily determined. The proportion of the total energy in the primary circuit which is transferred to the secondary is determined by the ratio of the reflected resistance, shown in Eq. (2), to the total primary resistance (existing plus reflected). Similarly, the extent of the detuning of the primary as a result of the presence of a secondary may be calculated by considering the change in the reactance of the primary circuit (as a series circuit) caused by the reflected reactance, given by Eq. (3).

For the special case of both circuits resonant at the same frequency, Eq. (3) becomes zero because X_2 is zero and Eq. (2) becomes

$$\text{Reflected resistance} = \frac{(\omega M)^2}{R_2}. \quad (4)$$

Eq. (4) is plotted in Fig. 2.

For a given position of the coils, it can be seen from Eq. (4) that the reflected resistance will be high when the secondary resistance is low. In other words, increasing the Q of the secondary (or primary for that matter) yields the same effect as increasing the coupling between the coils. From Fig. 2 it can be seen that if the series resistance of the secondary is 1 ohm and ωM is 0.5 ohm a resistance of 0.25 ohm is reflected in series with the primary.

When the resistance reflected into the primary is equal to the value existing in the primary, we say that the circuit is critically coupled.

Thus for critical coupling,

$$R_1 = \frac{(\omega M)^2}{R_2}. \quad (5)$$

The coefficient of coupling is defined as

$$k = \frac{M}{\sqrt{L_1 L_2}} \quad (6)$$

* Gilfillan Bros., Inc., Los Angeles, Calif.

This may be written

$$k = \frac{1}{\sqrt{\frac{L_1 L_2}{M^2}}} \quad (7)$$

Eq. (5) may be written

$$M^2 = \frac{R_1 R_2}{\omega^2} \quad (8)$$

or

$$\frac{1}{M^2} = \frac{\omega^2}{R_1 R_2} \quad (9)$$

Substituting Eq. (9) in Eq. (7) we get

$$k = \frac{1}{\sqrt{\frac{(\omega L_1)(\omega L_2)}{R_1 R_2}}} \quad (10)$$

Recalling the definition of Q ,

$$Q_1 = \frac{\omega L_1}{R_1} \text{ or } Q_2 = \frac{\omega L_2}{R_2} \quad (11)$$

Then Eq. (10) may be written as

$$k = \frac{1}{\sqrt{Q_1 Q_2}} \quad (12)$$

If the Q of the primary and secondary circuits are equal, Eq. (12) may be expressed as

$$Qk = 1 \quad (13)$$

Thus for critical coupling and equal Q s, the product of the Q of the circuits and the coefficient of coupling of the coils is unity.

Response Curve¹

For the case where both the primary and secondary circuits are resonant at the same frequency, a small amount of coupling does not reflect much resistance into the primary, thus the selectivity is approximately the net effect of the individual circuits.

If two response curves are expressed in terms of percentage of the voltage at resonance, the result of their corresponding circuits operated in tandem is the product of the percentage figures for the various deviations from resonance. If two response curves are expressed in "db. down" from the voltage at resonance, the result of their corresponding circuits operated in tandem may be determined by taking the sum of the "db. down" of the individual circuits.

As the coupling is increased, the reflected resistance increases and the response curve is broadened. When critical coupling is reached, the bandwidth where the response is down 10 db. or more, is about 1.5 times the bandwidth of the same two circuits with negligible coupling.

As the coupling is increased beyond critical, separate peaks appear on either side of resonance with a valley at resonance. The greater the coupling the greater will be the distance between the peaks. The amplitude of the peaks at any degree

of over-coupling is approximately the same as the amplitude at resonance with critical coupling.

When a double hump appears, the resistance reflected at resonance is large, thus the primary current and induced secondary voltage are small.

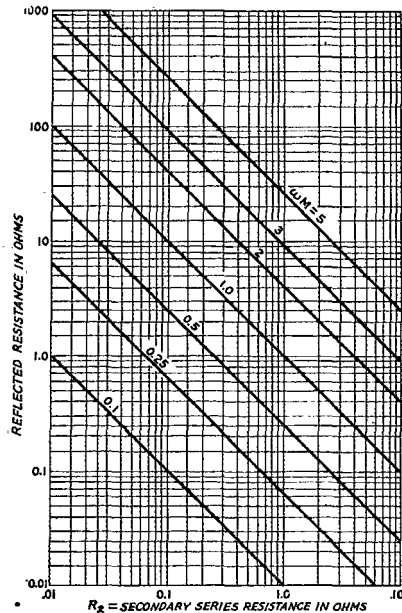

Fig. 2 — Graph obtained from the plotting of values given in Eq. (4).

Also the reactance coupled into the primary is inductive below resonance (because of the predominating capacitive reactance in the secondary) and capacitive above resonance (because of the predominating inductive reactance in the secondary). Above critical coupling, the effect of these reflected reactances is to resonate with the corresponding detuned primary reactances, which are opposite in type to the reflected reactances. This results in the divergence of the single peak into two. Fig. 3 shows the changes in the response curve for various degrees of coupling.

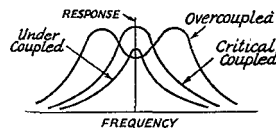

Fig. 3 — Response curves for various degrees of coupling.

The width of a pass-band, in which the gain at any frequency within the band varies 1 db. from the average gain, is given by

$$\frac{\text{Bandwidth}}{\text{Resonant frequency}} = 1.2 k \quad (14)$$

Also for a 1-db. variation from the average pass-band gain,

$$Qk = 2 \quad (15)$$

Fig. 4 is a plot of Eqs. (14) and (15).

¹ Espy, "Double-Tuned Transformer Design," *Electronics*, Oct., 1944, p. 142. Reprints may be had without cost by addressing a request to the author.

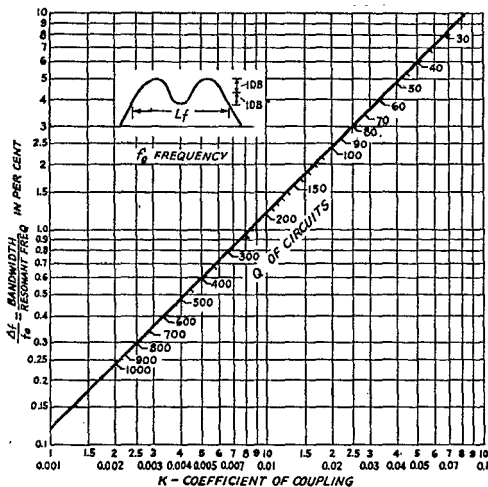

Fig. 4 — Values obtained from Eqs. (14) and (15) (level variation within pass-band 1 db.).

As an example, it is desired to design the i.f. transformers for a single-stage i.f. receiver. The i.f. is 456 kc. and the response must be flat within ± 2 db. for 15 kc. either side of resonance. Since two transformers are required, a 1-db. pass-band variation can be assigned to each, allowing the use

of Fig. 4. $\frac{\Delta f}{f} = \frac{(2)(15)}{456} = 6.58$ per cent, and

from Fig. 4, $k = 0.055$ and $Q = 36.5$.

In order to adjust a coupled circuit to the desired Q , it is frequently necessary to resort to shunting resistors. The lower the value of the shunt resistor, the higher the equivalent series resistance of the circuit becomes. This shunting

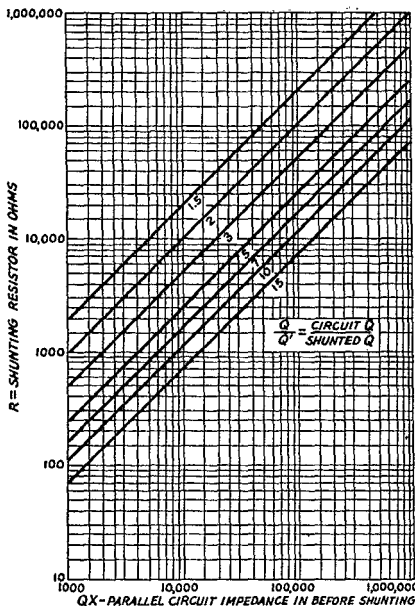

Fig. 5 — Chart based on Eq. (16) showing values of shunting resistance required to obtain a desired Q .

can be considered equivalent to a reduction in circuit Q . The value of R required to shunt a circuit from one Q to a new lower Q' is given by

$$R = \frac{QQ'X}{Q - Q'} \quad (16)$$

where X is the reactance of the coil or condenser in the tuned circuit at the resonant frequency. A graph of Eq. (16) is given in Fig. 5. If in the example just given above $Q_1 = Q_2 = 120$, the circuits could be shunted with resistances to reduce the Q to the desired 36.5. $\frac{Q}{Q'} = 3.29$, and if the coil reactance is 1200 ohms, then QX is 144,000 ohms. From Fig. 5 the shunting resistor, R , should be 52,000 ohms.

A common measure of the effectiveness of double-tuned transformers is their shape factor, i.e., the ratio of the bandwidth at 60 db. down to the bandwidth at 6 db. down. Values of this factor usually range from $2\frac{1}{2}$ to 5.

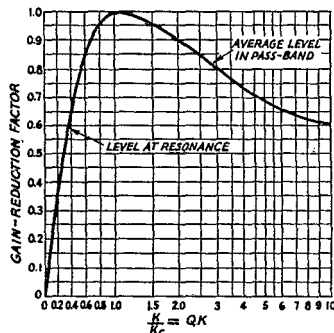

Fig. 6 — Output level as a function of coupling.

Because of the fact that at critical coupling the resistance reflected into the primary by the secondary is equal to the resistance which exists there without the presence of the secondary, the effective Q of the primary has been reduced by a factor of 2. Since for pentode amplifier stages the gain is proportional to the Q of the load circuit, the voltage across the primary circuit at critical coupling will be reduced to half the value with negligible coupling. The equation for amplification at critical coupling would therefore become

$$\text{Gain} = \frac{GmQX}{2} \quad (17)$$

where Gm is the transconductance of the tube in mhos, Q the Q of the coils and X the reactance of the coil or condenser in ohms.

The conditions for transfer of voltage from the primary to the secondary are ideal at critical coupling. This is the only amount of coupling which gives a secondary voltage equal to the primary voltage at resonance for a pair of identical circuits. For circuits which are not identical, the ratio of the secondary to primary voltage is

$$\frac{E_2}{E_1} = \sqrt{\frac{L_2}{L_1}} \quad (18)$$

where L_1 and L_2 are the primary and secondary inductances respectively. Eq. (18) assumes that the resistance of the coils is proportional to their inductance.

Eq. (18) shows that it is possible to get a voltage gain from the primary to the secondary of a double-tuned transformer by choosing L_2 larger than L_1 , and using the appropriate values of capacity to maintain resonance.

Gain Reduction

As a result of the lack of reflected resistance at low values of coupling and double-humping when circuits are over-coupled, the resonant-frequency gain at couplings other than critical are always less than at critical. Fig. 6 shows how the gain-reduction factor varies for various values of Qk . The curve is plotted for resonant gain for values of Qk below critical coupling and average pass-band gain for values of Qk above critical coupling.

For the above example of i.f. transformer design, $Qk = 2$, and Fig. 6 shows that this corresponds to a gain-reduction factor of 0.9; that is to say the gain is 0.9 of that given by Eq. (17).

Since the coupling coefficient does not vary with frequency in the case of inductive coupling, it is apparent from Eq. (14) that as the resonant frequency increases, so will the bandwidth. Thus bandwidth is proportional to resonant frequency for inductively-coupled double-tuned circuits. The Q ordinarily will remain reasonably constant with frequency, and thus the relation of $Qk = 2$, Eq. (15), for gain constancy in the pass-band, is approximately fulfilled.

Phase Relations

Frequently, the relative phase of the voltage across the primary and secondary of a resonant double-tuned transformer is of interest. The following analysis applies to coils wound in the same direction and placed end-to-end, with the adjacent connections of the center grounded. An equivalent circuit for the double-tuned transformer is shown in Fig. 7-(A).

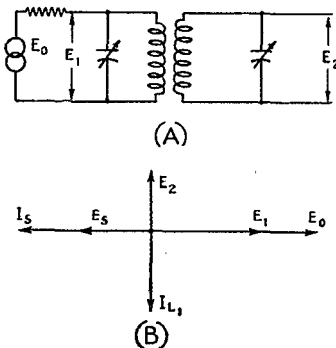

Fig. 7 — (A) — Equivalent circuit for phasing discussion. (B) — Phase-shift vector diagram.

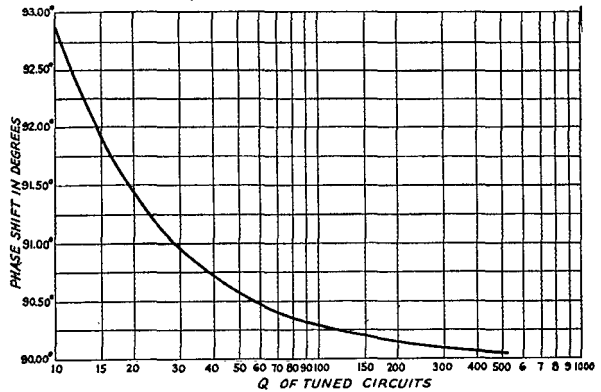

Fig. 8 — Graph of double-tuned-circuit phase shift at resonance vs. the Q of the tuned circuits from Eq. (19).

Referring to Fig. 7-(B), the voltage E_1 is in phase with the generator voltage, E_0 . The current in the coil, I_{L1} , lags by almost 90 degrees if the Q of the circuit is high. E_{S1} , the voltage induced in series with the secondary circuit, lags the primary current, I_{L1} , by 90 degrees. Since the secondary circuit is in resonance, the voltage E_S causes a current I_S , which is in phase with the voltage to flow around the secondary loop.

I_s flowing through the secondary condenser causes a voltage, E_2 , across it which lags by almost 90 degrees for circuits with high Q .

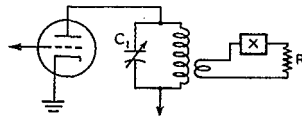

Fig. 9 — Final-amplifier tank circuit coupled to the antenna.

Thus for a double-tuned transformer at resonance, the voltage across the secondary lags the primary voltage by approximately 270 degrees. This may be considered equivalent to the secondary voltage leading the primary voltage at resonance by 90 degrees.

The exact formula for the angle of lead of the secondary voltage with reference to the primary voltage is:

$$\text{Phase shift} = 90^\circ + \tan^{-1} \frac{1}{Q_1 + Q_2}, \quad (19)$$

where Q_1 is the Q of the primary circuit and Q_2 that of the secondary circuit.

Fig. 8 gives a plot of this relation for equal coil Q_s . For circuit Q_s of 50, the phase shift is 90.58 degrees.

Effect of Detuning Class-C Tank

As was pointed out in the discussion of reflected impedances, a predominating reactance in a circuit reflects a reactance of opposite type in series with a coupled circuit. This frequently occurs for a Class-C amplifier connected to an antenna or transmission line, as illustrated in Fig. 9. It is possible to cancel the reflected reactance, as in-

indicated by Eq. (3), by detuning the primary tuning condenser, C_1 . However, Eq. (2) shows that if there is a net reactance in the secondary loop, the reflected resistance is smaller. But we are trying to load the Class-C stage to a certain plate cur-

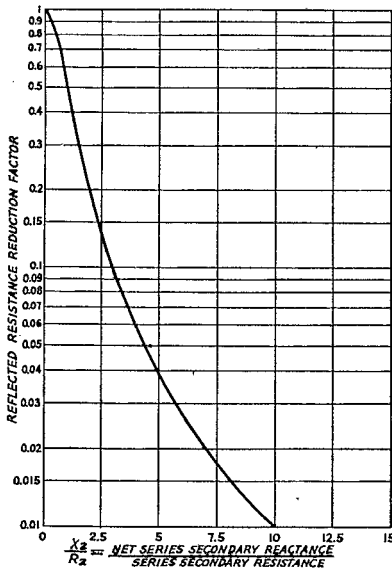

Fig. 10 — Chart showing reflected-resistance reduction as a result of detuning.

rent and this current will be less if less resistance is reflected into the primary. Thus, if the primary tuning condenser is altered from its resonant value (as determined when uncoupled from the load) in order to return a primary with reflected reactance, the coupling must be increased over the amount that would have been required had the secondary been resonated by some variable reactance located in the secondary.

The amount of secondary reactance to be tuned out by primary adjustment with a corresponding reflected-resistance reduction factor for various values of mutual reactance is shown in Fig. 10.

The secondary of a double-tuned circuit is detuned so that the net series reactance of the secondary is 5 ohms. The series sec-

ondary resistance is 1 ohm. $\frac{X_2}{R_2} = 5$ and,

from Fig. 10, when the primary is returned to balance out the reflected reactance, the resistance reflected is reduced to 4 per cent of the original value.

Link Coupling

Link coupling, as indicated in Fig. 11, frequently is used to couple tuned transmitter circuits. Because the link, considered as a series circuit, is inductive, capacitive reactances are reflected in series with each of the tuned circuits. This raises the resonant frequency of the tuned circuits, and requires additional inductance or capacitance to restore the original resonant frequency.

The expression for the coupling coefficient of two circuits coupled by a link is

$$k = \frac{M_1 M_2}{(L_p + L_s) \sqrt{L_1 L_2}} \quad (20)$$

where M_1 and M_2 are the mutual inductances between the link and the primary and secondary circuits, L_p and L_s are the self inductances of the links, and L_1 and L_2 are the primary and secondary inductances respectively.

It is seen, therefore, that link coupling is entirely equivalent to ordinary mutual-inductance coupling, and that is limited only by the values of mutual inductance which can be obtained by coupling two unlike coils. For two coaxial coils of the same diameter with a given spacing, maximum coupling results when the coils are identical. Thus, the value of coupling which is physically realizable may have only relatively small magnitude. Typical k values for Eq. (20) are 0.1 to 0.2.

The total coupling effect is the product of the couplings at the two ends of the link. The decrease of coupling caused by a small number of turns at one end of the link can be compensated by the use of a larger number of turns at the other end.

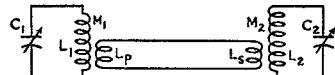

Fig. 11 — Link-coupled circuits.

Power Efficiency of Coupled Circuits

In a Class-C final amplifier with a tank and an antenna-coupling loop, the efficiency of the circuit is given by

$$\% \text{ efficiency} = \left(\frac{Q_{\text{circuit}} - Q_{\text{effective}}}{Q_{\text{circuit}}} \right) (100), \quad (21)$$

where Q_{circuit} is the Q of the tank with the antenna load disconnected and $Q_{\text{effective}}$ is loaded operating Q , with values ordinarily from 8 to 12.

Fig. 12 gives a plot of Eq. (21).

If the unloaded $Q = 100$, and the operating $Q = 10$, the efficiency of the circuit is

$$\left(\frac{100 - 10}{100} \right) (100) = 90 \text{ per cent.}$$

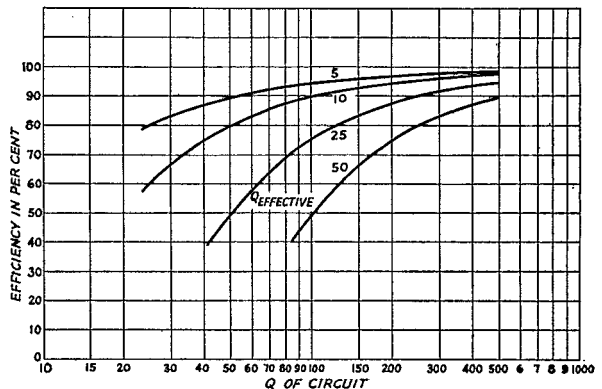

Fig. 12 — Curves showing final-amplifier tank-circuit efficiencies depending upon Q of circuit from Eq. (21).



25 YEARS AGO THIS MONTH

A YEAR ago this month we got back on the air, says *QST* for October, 1920, and now, with the subsiding of summer static, we are all set for a winter that "will make last season look like the vacuum in an audion, which is our idea of nothing. Coast to coast? Why not? The Azores? Who can say?"

In early September the Central Division held its first convention at the Edgewater Beach Hotel in Chicago, an affair which out-conventioned anything yet pulled off in amateur radio. All districts but the sixth and seventh were represented, by amateurs whose ages ran from 14 to 84. We lift our hats to Ralph Mathews, Central Division Manager; Fred Schnell, chairman of the Executive Council of the three clubs which gave the convention; and Radio Inspector Kolster, chairman of the Trial Board of the Executive Council.

The leading technical article, a Radio Club of America paper by Professor L. A. Hazeltine, is on "Bulb Oscillators for Radio Transmission" and presents a circuit devised by the author for giving sharp valve action in bulbs in the variation of the resistance of the plate circuit, to improve efficiency. Several technical articles describe apparatus constructed by the authors: L. A. Bartholomew, 6LC, on "An Oil-Dielectric Transmitting Condenser"; F. S. Huddy, III, on "A Simple Radiophone Operating on 'B' Batteries"; and Sumner B. Young, 1AE, "Concerning Cages." 1AE's cage antenna is 60 feet long, of six No. 12 wires separated on six hoops 12 feet apart. The hoops are 2 feet in diameter and made of 3/8" copper rod. There's an antenna worth scrapping in War II! Dr. John F. Gray, 6MZ, authors "A Paper on QRM," originally presented before the Sunset Radio Club at San Diego, which we hail as the best article ever seen on this important topic, with pointers on the cooperation which alone can lessen our difficulties. "Tewpieye" again supplies the necessary humor with "Radio-telephotophone Personalities," a wild story showing what 'phone QRM will do to a fellow.

On Tuesday and Thursday nights during October ARRL will conduct another series of fading tests for the Bureau of Standards. Nonparticipating stations are requested to confine their transmitting to a minimum. . . . The long-looked-for Department of Commerce "List of Amateur Radio Stations" is promised for delivery in October, our first callbook since the war, price 15¢.

"Who is this guy 1HAA?" "I don't know, but the call sounds vermilya." Thus we introduce the station of Irving Vermilya at Marion, Mass., as the leading station description. 1HAA has a U. W. coffin feeding a 20-wire fan antenna on two 100-foot poles. A description of 5ZP, New Orleans' leading station owned by Hubert E. deBen, completes the department. He has worked 1000 miles and has been heard in 20 states.

Some old-timers have begun to complain that there is no romance in tube transmission like there is in spark work. We think that is the last argument of the dwindling members of the Old

Guard. "What can equal the romance of getting something out of these little bulbs that have nothing in them?" The AudioTron tube is now free from restrictions and it is your last chance to get an old fashioned two-filament one, as new models with bases are expected to appear soon. Transmitting tubes have not yet reached the open market but an advertisement announces that F. S. McCullough, vacuum tube expert of Cleveland, will give a vacuum tube correspondence course covering a period of twelve months and will "loan" two 100-watt power tubes with each course. The price of the course is \$45. Among the new apparatus is the Parkin variable condenser, one "plate" of which is formed by a semicircular pool of mercury in a thin cylindrical housing. The first double-spread ad ever to appear in *QST* announces the advent of the Paragon RA-10 regenerative tuner, made by Adams-Morgan Co. It tunes from 160 to 1000 meters and is 24 per cent more sensitive and selective than the prewar RA-6. The price for tuner alone, without detecting and amplifying equipment, is \$85.

★ BOOK REVIEW ★

UHF Radio Simplified, by Milton S. Kiver; published by D. Van Nostrand Co., N. Y. 238 pages, 5½ × 8; illustrated. Price, \$3.25.

It is not an easy task to present in understandable fashion the elements upon which u.h.f. techniques are based — at least one would judge that to be the case from much of the published material. Usually the treatment becomes involved in tangles of unfamiliar and hard-to-understand theory, or goes to the opposite extreme of over-simplification.

In this volume the author has, on the whole, hit a happy medium. Anyone with a moderate background of technical knowledge should have no difficulty in forming a mental picture of the things that go on in u.h.f. circuits, since the information is conveyed in a manner easy to assimilate.

There are nine chapters in the book, beginning with a comparison of low and high frequencies in terms of circuit constants and working through special u.h.f. tubes and oscillators, transmission lines, wave guides, cavity resonators and antenna. Information on wave propagation and measurements at ultrahigh frequencies also is included. The book concludes with a set of questions grouped according to chapter contents, a short list of references, and an index.

There are a few inaccuracies which appear to be largely inadvertent; for example, the statement on page 104, in discussing wave guide nomenclature, that "there is no component of electric field in the Y dimensions." Obviously what is meant is that there is no variation in the field, since the field illustrated has a Y component only. The chapters on wave guides and cavity resonators are likely to leave some misleading impressions as a result of avoiding detailed explanations; in particular, one is likely to assume that widths of rectangular guides must be equal to a multiple of a half wavelength of the wave being transmitted, and it is intimated that resonant dimensions in cavities are the same as multiples of half wavelengths in space. It is also somewhat unfortunate that the nomenclature used for rectangular guides is not in accordance with present practice. But instances of this sort do not materially detract from the overall accomplishment — a really understandable and non-mathematical introduction to ultrahigh frequencies. — G. G.



STRAYS



A plan for television and f.m. broadcasting from airplanes flying in the stratosphere which could revolutionize the present-day concept of national radio networks was announced recently by Westinghouse and the Glenn L. Martin Co. Under the plan a chain of 14 planes, each cruising over a fixed area at an altitude of 30,000 feet, would be sufficient to span the continent and provide service for 78 per cent of the population of the U. S. It is estimated that it would advance the possibility of h.f. service to rural areas by many years and that the cost for maintaining the service would be about one-thirteenth that of an equivalent ground network. Plane failure would be taken care of by providing replacements, one of which would be in the air simultaneously with the plane in service.

How secret are "secrets"? The two most closely guarded developments of World War II were radar and the atomic bomb. Only 2½ million people knew about the first more or less in detail, and a mere half a million knew of the atomic bomb — until the Japs were let in on the secret.

It has been reported that a Washington policeman held up the world-awaited Jap surrender message for ten fateful minutes when he scolded two RCAC motor messengers who were speeding from the Swiss Legation to the White House. The policeman told the two RCAC messengers that they couldn't "feed him those horsefeathers" when they tried to explain they were delivering the Jap message.

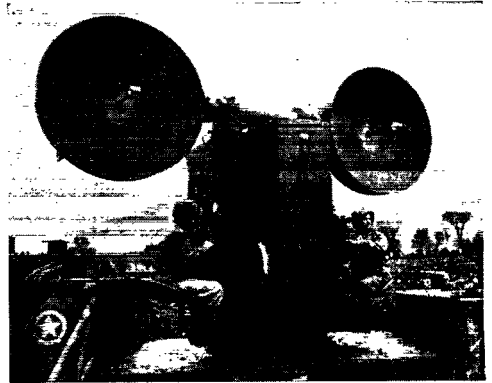

This radar equipment SCR-547, known as "Mickey Mouse" because of the shape of its antennas and used for aiming anti-aircraft guns, was installed near an anti-aircraft emplacement at Migano, Italy.



Radar was revolutionized at M.I.T.'s Radiation Laboratory by the use of microwaves instead of long waves, a development made possible by the British invention of the cavity magnetron. In the above photo, E. G. Bowen (seated), member of a British scientific mission which brought the first magnetron to the M.I.T. Lab in 1940, is being shown an American-made copy by Radiation Laboratory Director L. A. DuBridge (left) and Asst. Director I. I. Rabi (right).

Major Lloyd C. Sigmon, SC, W9YNJ, has been awarded the Legion of Merit for "especially meritorious conduct in the performance of outstanding services" which include a major role in the story of radio communications in Europe from preinvasion days to the conquest of Germany. His work covered extension of signal facilities in England, including the radio system which carried first news of the invasion by voice, radioteletype and radio photo, installation of radio circuits in Paris, and completion of the 60-kw. portable Signal Corps transmitter known as SigCircus. (See Strays, *QST*, Aug., 1945, p. 55.)

August 14th was a day of double celebration for Cmdr. Carl B. Evans, W1BFT, and Dorothy Evans, W1FTH. Not only was it V-J day, but a new son joined the Evans family. Dot, SCM for New Hampshire, claims to be the first SCM ever to bear two children while holding office.

Near Rocky Point, L. I., and opposite the great maze of RCA's antennas is a tourist camp named "Tune Inn." — *W4ZZ*.

Canadian Patent 429,525 titled "ham processing" has been assigned to Armour and Co. Will the FCC object to this? — *ex-W9FFL*.



CORRESPONDENCE FROM MEMBERS

The Publishers of *QST* assume no responsibility for statements made herein by correspondents.

IT'S GREAT TO BE BACK

700-798 York St., San Francisco, Calif.

Editor, *QST*:

It would indeed be selfish if we radio amateurs, in our mad rush back to the air, did not pause and wonder how come or what made it possible. Just in case no one else in my section remembers to send you, of our Headquarters Staff, a word of appreciation for your efforts, I'm taking this privilege of so doing for all.

Thanks! It's great to be back.

— Bill Ladley, W6RBQ,
SCM, San Francisco

GIs TO QSO FOLKS VIA HAM RADIO

Griffin, Ind.

Editor, *QST*:

There will be a vast number of fellows back from overseas, and service in general, who will not be discharged and sent home immediately. This group will be located in the various hospitals and rest camps throughout the country, in order that they may regain their health and be properly fitted to return to civilian life. These fellows will be counting the days until they can go home. If they had some means by which they could talk with the folks back home, it certainly would make a few pleasant moments for them, and their families. Of course, we have long distance telephone, telegraph and such, but these facilities are and will be filled to overflowing for quite some time to come.

Why can't we work out a method whereby amateur radio can render a very useful service in this type of work? What would give hospitalized Joe more satisfaction than talking to Pop, Mom, or the XYL for as long as he wanted to, asking personal questions and receiving answers, without the irritating "Please limit your call to five minutes." Let them talk until the plates in the final glow like Christmas trees!

I have seen the satisfaction and gratitude from parents and friends who have had this privilege. Prior to Pearl Harbor, I was fortunate to be one end of several of these contacts. Words cannot describe my own personal satisfaction of a job well done, seeing tears come into a mother's eyes, and hearing the hearty boom of a father's voice after he realized that his own son was on the other end. Truly it is a real pleasure.

It is possible that the American Red Cross would be interested in arranging schedules, provided we could show that we were really interested and organized for the effort. It will be possible to reach our possessions on the ten- and twenty-meter bands, whereas toll calls from these

remote parts of the world are beyond the reach of the average service man.

Finally there is the good will part, not to be overlooked. When a goodly portion of your modulated r.f. gets mixed up with the neighbor's favorite soap opera, he will be more inclined to say, "That's the fellow over across town, who let us talk to Johnny last week for two hours," rather than some of the things I know they have said in the past.

— Russell M. Price, W9GWL

21 TO 30 MC.

2536 Westmont Blvd., Columbus 8, Ohio

Editor, *QST*:

As a really practical proposition, it seems hard to see why amateur services should not have a majority, if not all, of the frequencies from 21 to 30 Mc.

These bands are relatively useless for point to point and long distance mobile services because of the extremely short time during which communication can be had from one point on the earth to another via the ionosphere. A circuit can be established only for one or two hours at most on these frequencies, and the time varies so considerably from day to day and season to season that it is very difficult to see how they can be used for reliable services.

The proof of this can be had from the use of a list of frequencies and a receiver. Hundreds of stations are licensed to use frequencies in this band, yet the occupancy of them appears to be only a hundred or so channel-hours per year. The international broadcasting and point to point assignments seem only to have been used to assert priority, and never for actual service of any kind.

On the other hand, the success of the few local services established here is only because the services are few. A local service in the 21-30 Mc. band is liable, at any daylight hour, to interference from distant stations at levels of hundreds of microvolts, an intolerable condition for the great majority of such services.

Thus we should not feel shy of pressing our claims to these frequencies at any and every opportunity. We should take all of them that are offered (including, at the moment, sharing of the "QRM" band) and ask for more.

As for low frequencies, let's just make a guess and be prepared for the day when the a.m. broadcast band gets narrower! At this time we should be prepared to obtain restoration of some or all of the 160-meter band or its equivalent on a lower frequency.

— G. M. Foley, W8UKI

FREEDOM RINGS

Torenstraat 58, Huizum near Leeuwarden,
Netherlands

Editor, *QST*:

. . . I am in good health, but some PA-hams never will key again. PA0QQ and PA0MO are dead. On 24th October, 1944, I was imprisoned by the Gestapo. I do not believe that we will recover our transmitters for I believe that they were stolen by the Gestapo. All my tools, radio instruments and many household articles, worth about \$2000 were stolen by the Sicherheits-Dienst.

But we are free, that is most important. It is impossible for us to describe our gratitude for the freedom that we have obtained again by the forces of the Allies. Five long years we have been living, and how terribly, under the heels of the German tyrant. But we will try to make the best of it. We now know what it means in your song, "From every mountain side, let freedom ring."

Greetings to Headquarters and to all hams!

— G. Werema, ex-PA0APX

Glimmet, Groningen, Holland

Editor, *QST*:

Happy days are here again! We are free and still alive. Free from the German beast that killed millions of European civilians. You cannot understand what this freedom means to us. Not only food, light and clothes, but now we may speak what we think. We don't need to be afraid any longer of being shot down without reason, or of being taken to a German concentration camp. We have lived five years with one leg in prison and one leg in the grave. But now all is over. We could stand it because we knew that our brothers from America surely would come to free us. Thanks for the part the W and VE hams did for the liberation of Holland. We will never forget it.

— Han B. Gortz, PA0GN

LISTENING POSTS

Sevenoaks Farm, Lambertville, N. J.

Editor, *QST*:

The British Channel Islands of Guernsey and Jersey were occupied by Nazi forces for five years. At the time of the invasion all radio sets were confiscated, in theory, and penalties of two years' hard labor imposed on anyone found in possession of a radio. For distributing news, received illicitly by radio, the penalty was several months' imprisonment.

Despite these restrictions, twenty-five per cent of the houses in Jersey had crystal sets in their homes, hidden in alarm clocks, shoes, saucepans, cushions, rabbit hutches and match boxes. The smallest known set was concealed in a small box designed to contain phonograph needles.

Islanders received all the BBC broadcasts daily through these devices, passing on the news as soon as received, so that no important event took place in any part of the world without their knowledge. A conniving telephone official supplied them with headphones. Very few people were caught, al-

though the Nazis kept a sharp outlook and had spies trained especially to combat the practice.

It was because of their ability to obtain true information with which to combat the propaganda given them daily by their unwelcome guests that these brave people were able to keep their morale unbroken through five long years of privation, hunger and anxiety.

— Alfred S. Campbell

EDITOR'S NOTE: Mr. Campbell is the author of "Golden Guernsey," and "The Sunny Isle of Jersey."

NEWS FROM THE PHILIPPINES

Editor, *QST*:

This is the first opportunity I've had to put together a few bits of news on Philippine amateurs. . . .

A couple of Sundays ago I borrowed our jeep long enough to pay a visit to George L. Rickard, KA1GR, secretary of the Philippine Amateur Radio Association and SCM before the war. Despite nearly two years of internment during the Jap occupation, George is looking well and is in fine spirits. He was more fortunate than many others caught by the war. A shrapnel hole in the roof is about the only damage caused to the family home in suburbia San Juan. His wife was somehow able to conceal and save his files of *QST*, log books and the diary which he has kept for 45 years. KA1GR is a veteran of the Spanish American War and is active in a wide variety of patriotic and civil organizations. He was among the group at Santo Tomas who were held prisoner by the Japs after the liberation of the majority of the internees by the boys of the 1st Cavalry.

Here are a few notes on other KAs . . . most of which were furnished by KA1GR. The following were interned at Santo Tomas: KA1BH, Mrs. Joseph Reich; KA1CO, A. A. Werner; KA1CS, Frank C. Swan; KA1CW, C. W. Woodin; KA1GR, George L. Rickard; KA1GG, George B. Gould; KA1HS, H. O. Schroeder; KA1JM, Alfred F. Duggleby; KA1JP, J. K. Pickering; KA1JR, John R. Schultz; KA1LB, L. E. Bennett; KA1MM, Myrvan Morley; KA2OV, Samuel J. Douglas; interned at Cabanatuan: KA1ME, W. J. Ellis. From Santo Tomas KA1BH and KA1CW were later transferred to Los Banos.

Two met death at the hands of the Japs: Samuel J. Douglas, KA2OV, and Alfred F. Duggleby, KA1JM. KA2OV was known to many Americans as operator of the Long Beach summer resort near Manila. I could learn no details concerning his death. Duggleby was an American mining engineer and chairman of the family relief committee at Santo Tomas. Two months before the arrival of American forces, he was suddenly removed from the camp and beheaded by Japanese troops.

Except for KA2OV and KA1JM, all the other KAs in the foregoing list are understood to have been released safely. Some of those interned have already returned to the States.

(Continued on page 180)



OPERATING NEWS



LEROY T. WAGGONER, W9YMW
Acting Communications Manager

LILLIAN M. SALTER
Asst. Communications Manager

Planning for Emergency Communications. We think that every ham will want to take an active part in planning for emergency communications, to enable us to assume, without a hitch, the job that has been traditionally ours since the beginning of ham radio. We hope that you will find the following appeal interesting, and respond to it:

TO ALL DIRECTORS, ALTERNATE DIRECTORS, SECTION COMMUNICATIONS MANAGERS, EMERGENCY COÖRDINATORS, WERS RADIO AIDES, AND AFFILIATED CLUBS:

On August 21, 1945, FCC reinstated practically all amateur station licenses for the purpose of authorizing amateur operation in the band 112-115.5 Mc. By the same order, FCC terminated WERS operation, effective November 15th. Our return to the air at this time was authorized with the understanding that we, as hams could, and would, assume our traditional obligation to stand ready to furnish emergency communications in event of natural disaster. We think hams can, and will, do this job well.

However, our CD field organization has a tremendous task in store. It will require the active participation of every amateur in the country to turn in a creditable performance of our emergency communications obligation. Every director, and alternate director, can play a vital part in this program by lending his experience and guidance to the solution of problems that may arise in his particular division.

SCMs, who form the backbone of our field organization, should coöperate fully in the perfection of organization in their respective sections. Emergency Coördinators have, throughout the war, assisted materially in attaining the high degree of success enjoyed by WERS set-ups, and must now use their talents to the fullest in perfecting our ham emergency organization. WERS radio aides, in many cases also ARRL ECs, are in the same category. Affiliated clubs can contribute to emergency communications preparedness by fostering programs on portable and portable-mobile gear, controlled nets, and related subjects; by coöperating with local ECs in making known the availability of personnel and equipment for emergency use. Every individual ham, from Maine to California, and from Washington to Florida, must be prepared to do his bit. Each of us has a duty to perform in our own community, section, and division, if we are to have well organized, efficient, and smooth running emergency communications systems.

The War Emergency Radio Service may well be proud of its record of a fine performance during the war. It had a job to do, and has done it well. We, as hams, are proud of the part we took in it. But WERS was essentially a wartime service, created to fill a wartime need. Amateurs can, and will, perform the duties incident to emergency preparedness that have been so creditably discharged by WERS. We think that WERS methods, tailored to fit the most probable needs of each community, may well be carried over into ham operation. We like the idea of controlled net operation, with regular drills, as a part of a purposeful plan for disaster preparedness.

Now, what to do? We must have a complete organization, ready to furnish communications in any eventuality, in full readiness by not later than November 15th. To effect this, it is necessary that every member of our CD field organization must know what to do, and must do it immediately. With this in mind, here are suggestions:

Section Communications Managers: Each SCM should solicit applications for EC appointments for every community in his Section that does not already have a live-wire ham on the job. We think that, whenever possible, the local WERS radio aide should also be the ARRL EC, thus facilitating the utilization of that portion of existing WERS organization that may be applicable to ham operation, and permitting the radio aide to employ to the best advantage the knowledge of controlled net operation gleaned from his experience in WERS.

The SCM should supervise, through the ECs of his section, the formation and operation of controlled nets, and the liaison between these organized groups and the city fathers or other agencies that need communications facilities in event of flood, earthquake, fire, tornado, or the like.

He also should supervise and encourage the formation of 2½-meter intercity relay nets. Probably this may be accomplished best by appointment of a state or section EC, one of whose functions would be to organize such a net, tying existing or contemplated community organizations together, with NCS of local nets constituting the relay stations, to form a state-wide system. The SCM and/or section EC should represent such a net in liaison contact with state agencies — Red Cross, State Police, etc. — who would need such facilities in event of disaster.

Finally, the SCM should report these activities fully for the Amateur Activities section of *QST*, so that every ham in the section may be fully cognizant of what is going on in communities other than his own.

Radio Aides and Emergency Coördinators:

We urge every radio aide, who is not also the local EC, to apply, if eligible, to his SCM for appointment as ARRL Emergency Coördinator. In communities that have not had WERS, the EC will have to build an organization from the ground up. He should list all available ham equipment and personnel. Meetings should be called, to determine drill periods. A net control station should be selected, and working frequencies assigned. Sufficient fixed stations should be set up to ensure adequate coverage of the community. Enough portable and portable-mobile stations should be at hand to furnish complete facilities for any condition that might arise. Regular drills will then smooth out the entire set-up into a smoothly operating unit, ready for any eventuality.

Meanwhile, think over and decide to whom you will offer your services. Generally, it is the safety departments of the city governments that need our special kind of help in disasters. The Red Cross in most instances has great need of our facilities at such a time. Public utilities frequently require aid in emergency communications. Whatever agency it may be that you are going to aid — perhaps all of them — you, as Emergency Coördinator, should go to them and say, "I represent the radio amateurs of this community. We are organizing to be prepared to furnish necessary communications if our town or city needs us in any emergency. Please coöperate with us. We will be ready."

Affiliated Clubs: In some communities, there is no appointed EC. We urge you to select a live-wire ham and ask him to apply for that appointment. Since haste in our emergency organizing is imperative, we are prepared, if necessary because of temporary absence of the SCM or other reasons, to appoint ECs directly from Headquarters, on a *pro tem* basis, subject to later ratification by the SCM. We must have immediate action. If your SCM is unavailable for any reason, submit the name of the ham whom you think should be EC, and, if he is eligible, we'll appoint him as EC *pro tem* immediately.

Coöperate fully with your EC. Find out what gear can be used and furnished by the members of your club. Assist your EC in naming a time for drill periods. Perhaps your club room may be the ideal location for a fixed station in your emergency network. Plan programs on 2½ gear and operation. Appoint committees to determine the location of fixed stations, and the general territories assigned to portable and portable-mobile stations; to learn the availability and plan the assignment of personnel; and to devise a system of operating procedure that will be adopted by the controlled net. A liaison committee may be needed to make the necessary representations to the city fathers, or to the Red Cross, or public utilities. In short, get behind your EC, with every assistance your club can offer, to make the emergency communications program in your community the success it should be. The club is already an organization; it needs only to apply that

organization to the problem of furnishing emergency communications.

Every individual ham in the country can do his bit by getting in immediate touch with his EC or club and making known what 112-115.5-Mc. gear he has available, and at what times he is free to participate in controlled net drills. He can aid by volunteering his services as EC in communities not having such appointee.

Here is our chance to be prepared to render a most important public service, and have a lot of fun doing so. I should like to hear from every amateur to whom this letter is addressed, or who reads it in *QST*, who has comments to make, suggestions to offer, or ideas to propose for the speedy getting ready for any eventuality, so that, as always, hams will be in there pitching when the going is tough.

It will be gratifying to have reports from every community in these United States on the progress of their emergency communications planning, to be passed on for the benefit of all. May I expect a letter from you?

— L. T. W.

— — — — —

SCM Nominating Petitions Requested.

Now that the war has been terminated it is time for us to begin to build up a strong field organization. In looking through these pages you will find listed under "Election Notices" a number of SCMs whose terms have expired or are about to expire. Some of these sections are fortunate in having SCMs who will carry on until an election can be held. Other sections have been left for some time with no leader whatever. It is urgently requested that members in all the sections concerned send in valid nominating petitions for qualified amateurs. Be sure that they are mailed to reach this office by the closing date.

A suggested form for a nominating petition is given under "Election Notices." Also ARRL has a mimeographed form which will be sent to anyone wishing to start a petition. Be sure that the nominee, who should be a dependable amateur capable of doing a good job, has been a licensed amateur for at least two years and a *full* member of the League for at least one year immediately prior to nomination. Above all, make certain that all signers (there should be at least five) are *full members* of the ARRL. Get those petitions in so that we may have a full complement of active SCMs by the time the remainder of our bands are opened up to us. And get those reports on your activities in to your SCM (his address is in the front of each issue of *QST*) so that he'll have something to write about for Amateur Activities. Don't sit back and wait for the other fellow to do it. Let's have the strongest field organization possible.

Field Organization Appointments. Recently the FCC issued Order No. 127 giving amateurs in good standing the use of 112-115.5 Mc. for three months. This band is to be shared with WERS, although amateurs and WERS operators may not communicate with each other. We

contemplate organizing for emergency work in the 112-Mc. band in order to carry on after November 15th, when WERS will be discontinued. In this connection a considerable number of active Emergency Coordinators will be required to lead local emergency groups. If you are interested and qualify for this appointment, please get in touch with your SCM at once. It is especially urged that those formerly holding an EC appointment which was allowed to expire take steps to be reinstated. This appointment runs for one year and must receive annual endorsement of the SCM in order to be continued. At the present time plans are being made to reactivate the Official Broadcasting Station appointment. We require a number of amateurs in all sections of the country capable of passing along pertinent information which we will give them from time to time on changes that occur, so that you will have this news at the earliest possible moment. If you have the equipment and are willing to act as OBS on 112-115.5 Mc., or if you know one or two local amateurs interested in and equipped to do this work, please inform your SCM at once. Other field organization appointments will not be reactivated immediately, but as they are taken off the suspended list you will be notified. It must be noted that it is necessary for an applicant to be a member of the League to be eligible to hold any Communications Department field organization appointment.

Our booklet, *Operating an Amateur Radio Station*, contains detailed information on all appointments. This pamphlet will be sent, free of charge, to any ARRL member who wishes a copy, and will be supplied to any amateur who sends in ten cents and specifically requests a copy. Send in now for yours.

— L. M. S.

Boston Radio Sealing Unit

UNTIL recently the subject of Radio Sealing has been kept confidential and the work done by radio amateurs has been unknown. Now, however, the facts can be made public.

In the early part of 1943 the U. S. Coast Guard, Captain of the Port in Boston, decided that because of a shortage of Regulars possibly "radio sealing" could be done by the C. G. Temporary Reserve. Consequently, Lt. C. M. Cobb was requested to try to form a unit and it was suggested that he get in touch with radio amateurs in the USCGR(T). He immediately visited Flotillas No. 411 and No. 412 in Winthrop, Mass., and appointed R. C. Wallace, W1CZO as officer in charge, and S. S. Perry, W1BB, as operations officer and, after talking with them at length about the feasibility of the plan, asked them to form the unit.

Because of the technical and confidential nature of the work involved it was at once decided that it could best be done by radio amateurs and men with commercial radio experience. Qualified men already in the Temporary Reserve were: R. C. Wallace, W1CZO, Flotilla No. 412; S. S. Perry, W1BB, ex-commercial, 411; C. A. McElroy, ex-W1CCL, commercial, 511; G. H. Malone, ex-commercial, 411; A. Moro, W1LQX, 411; F. A. Waden, W1LNZ, radio manufacturer, 411; R. H. Simpson, ex-commercial, 407; A. R. Cameron, jr., W1NKK, 407; R. Hanscom, W1ISK, radio serviceman, 411; M. Woods, ex-commercial, 411; G. W. Scott, radio manufacturing, 512; J. M. Wade, W1QT, radio manufacturer, 511; and G. Dwyar, N. E. Tel. & Tel., 407. In addition, the following men were located and taken into the Temporary Reserve at once for this unit: B. H. Chace, W1BDU, jeweller, 411; and C. W. Hatch, radio serviceman 407. This formed the original group, which started to function June 25, 1943, operating out of the Communications Office COTP, 5th Deck, 40 Central St., Boston, Mass. Originally I Israel, RM1c, acted as liaison between the TR unit and that office, followed shortly by R. E. McFarlin, RM1c, with D. W. Proctor, BM1c, assisting. A short time later McFarlin was assigned to active duty elsewhere and BM1c Proctor took charge as liaison between the unit and the office.

As the original group was not large enough, authorization was given to enlist eligible members into the TR for the sole purpose of doing this specialized radio sealing work. Great care was taken to select only reliable and qualified men and the following were chosen: A. Costa, RM1c, ex-USCG, 411; H. Daziel, aircraft radio, 510; L. H. Smith, W1KYX, 511; G. E. Surette, W1HMK, radio manufacturer, 411; A. Jones, W1NW, and radio operator of W1DHF, 512; D. H. Shulkey,



Shown here are members of the USCG Temporary Reserve who specialized in radio sealing work. *Left to right, front row:* A. Moro, W1LQX; A. Costa; G. H. Malone; S. S. Perry, W1BB; Lt. C. M. Cobb; R. C. Wallace, W1CZO; A. Jones, W1NW; C. A. McElroy, ex-W1CCL; J. M. Wade, W1QT. *Second row:* G. E. Surette, W1HMK; F. Lopez, W1KPB; R. Hanscom, W1ISK; B. H. Chace, W1BDU; D. W. Proctor; J. P. Furrier, W1PZ; L. H. Smith, W1KYX; D. H. Shulkey, W1BLR; R. H. Simpson. *Third row:* J. E. Johnston; J. A. DeYoung, W1HHW; C. W. Hatch; G. Dwyar; A. R. Cameron, jr., W1NKK; G. W. Scott.

WIBLR, 510; J. P. Furrer, WIPZ, 511; J. A. DeYoung, WIHHW, commercial, and electronics engineer, 411; F. Lopez, WIKPB, radio manufacturer, 411; D. D. McLeod, radio manufacturer, 411; and J. E. Johnston, radio serviceman, 411.

Before going out to seal it was necessary for each sealer to report in person to the COTP office to get the assignment and the kit for sealing, including sealing tools and supplies. After the job was finished he returned to report and sign out the sealing equipment.

The primary duty of the unit was to board cargo vessels of all nationalities, fishing vessels, and other craft, at the request of the COTP, to make sure that all transmitting radio apparatus aboard was "sealed" so that the equipment could not possibly be used at unauthorized times. A brass tag was attached with the seal reading as follows: "Do not break seal except in case of emergency-distress or enemy action — U. S. Coast Guard." A certificate report of inspection was made out for each ship, signed by the Master, First Mate or Chief Radio Operator. One copy was posted in the radio room and the original kept by the COTP. All transmitters, including main, emergency, lifeboat transmitters — and even in some cases radiating receivers which could be trailed by submarine radio direction finders if used — were sealed.

This work fell into several main categories, as follows: (a) Inspect and SEAL boat just entering harbor. (b) Inspect and SEAL boat which had service work done on the radio equipment by radio service companies, with authority to break the seal for repairs after permission by USCG, but no authority to re-seal. (c) Break seal already installed. Send "test" code signal and either test, assist, or stand by while operator makes adjustment tests. These jobs came thick and fast when convoys were making up. Coast Guard picket boats and jeeps stood by to assist in this quick work but a number of times the ships were under way before the sealers left the ship. (4) Miscellaneous calls. At times the Master or operator wanted to be sure the right procedure was being followed in regard to security, wrong calls, suspected tampering with equipment, and stand-by during lifeboat drills when lifeboat radio transmitters were tested.

All sealers were required to know the International Code Flags, as their boat assignments were given by numbers and it was necessary to read the hoist in order to board the right ship. Several times it was necessary to chase a ship all over the harbor before locating her because of the quick movement and scheduling of the convoys during makeup. A number of cases of suspected tampering and unauthorized procedure were reported and in due course turned over to the intelligence division for proper action.

One of the most interesting phases of the work was the personal contacts with operators of all nationalities, and many amateurs were encountered. It was extremely interesting to be "in" on the excitement of making up a convoy, seeing the ships "loaded to the gunwales" with tanks, jeeps, ammunition, etc. Numerous times sealers were able to help operators with perplexing problems because of their technical experience and training, and on occasion even found it necessary to retune transmitters so they would radiate properly when some dial or other part had been knocked out of adjustment or was accidentally moved.

In order to board ship it was necessary to have a rating and, with one or two exceptions, all members were either RM1c or RT1c. There were four Chiefs: R. C. Wallace, S. S. Perry, G. H. Malone, and Allan Jones.

Because of the excellent performance of the group, in February 1945, Rear Admiral W. N. Derby, District Coast Guard officer, and Capt. F. M. Meals, COTP, complimented each and every member of the unit on his very fine work, by letter through Lt. W. G. Butterworth.

The unit is indebted to Lt. C. M. Cobb, who was always eager to serve and assist over the rough spots, for his wholehearted support; and also to BM1c D. M. Proctor, USCG, who did a splendid job of liaison and assignment between the Communications Office of COTP and the unit.

— S. S. Perry, WIBB

ELECTION RESULTS

Valid petitions nominating a single candidate as Section Manager were filed in a number of Sections, as provided in our Constitution and By-Laws, electing the following officials, the term of office starting on the date given.

North Dakota	Raymond V. Barnett, W9GVP	July 2, 1945
Western Florida	Lt. Edward J. Collins, W4MS	July 2, 1945
East Bay Indiana	Horace R. Greer, W6TI Herbert S. Brier, W9EGQ	Aug. 16, 1945 Aug. 16, 1945

ELECTION NOTICES

To all ARRL Members residing in the Sections listed below:

The list gives the Sections closing date for receipt of nominating petitions for Section Manager. The name of the present incumbent and the date of expiration of his term of office. This notice supersedes previous notices.

In cases where no valid nominating petitions have been received from ARRL full members residing in the different Sections in response to our previous notices the closing dates for receipt of nominating petitions are set ahead to the dates given herewith. In the absence of nominating petitions from full members of a Section the incumbent continues to hold his official position and carry on the work of the Section subject, of course to the filing of proper nominating petitions and the holding of an election by ballot or as may be necessary. Petitions must be in West Hartford on or before noon on the dates specified.

Due to a resignation in the San Joaquin Valley Section, nominating petitions are hereby solicited for the office of Section Communications Manager in this Section, and the closing date for receipt of nominations at ARRL Headquarters is herewith specified as noon, Monday, October 15, 1945.

Section	Closing Date	Present SCM (resigned)	Present Term of Office Ends
San Joaquin Valley	Oct. 15, 1945	Antone J. Silva
Sacramento Valley	Oct. 15, 1945	Vincent N. Feldhausen	June 15, 1941
Alaska	Oct. 15, 1945	James G. Sherry	June 14, 1942
Southern Minn.	Oct. 15, 1945	Millard L. Bender	Aug. 22, 1942
New Hampshire	Oct. 15, 1945	Mrs. Dorothy W. Evans	Sept. 1, 1942
West Indies	Oct. 15, 1945	Mario de la Torre	Dec. 16, 1942
Idaho	Oct. 15, 1945	Don D. Oberbillig	April 15, 1944
South Dakota	Oct. 15, 1945	P. F. Schults	May 18, 1944
Alabama	Oct. 15, 1945	Lawrence Smyth	May 22, 1944
Los Angeles	Oct. 15, 1945	H. F. Wood	July 1, 1944
Arkansas	Oct. 15, 1945	Edgar Beck	Aug. 17, 1944
Virginia	Oct. 15, 1945	Walter G. Walker	Oct. 15, 1944
New Mexico	Oct. 15, 1945	J. G. Hancock	Oct. 15, 1944
Tennessee	Oct. 15, 1945	James B. Witt	Nov. 15, 1944
Georgia	Oct. 15, 1945	Ernest L. Morgan	Nov. 29, 1944
Kentucky	Oct. 15, 1945	Darrell A. Downard	Dec. 15, 1944
Mississippi	Oct. 15, 1945	P. W. Clement	April 1, 1945
Rhode Island	Oct. 15, 1945	Clayton C. Gordon	April 15, 1945
North Carolina	Oct. 15, 1945	W. J. Wortman	May 3, 1945
Northern Minn.	Oct. 15, 1945	Armond D. Brattland	June 15, 1945
Vermont	Oct. 15, 1945	Burtis W. Dean	Aug. 16, 1945
Northern N. J.	Oct. 15, 1945	Winfield G. Beck	Sept. 23, 1945
Md.-Del.-D. C.	Nov. 15, 1945	Hermann E. Hobbs	Dec. 1, 1945
Connecticut	Dec. 3, 1945	Edmund R. Fraser	Dec. 13, 1945
San Francisco	Dec. 3, 1945	William A. Ladley	Dec. 15, 1945

1. You are hereby notified that an election for an ARRL Section Communications Manager for the next two-year term of office is about to be held in each of these Sections in accordance with the provisions of the By-Laws.

2. The election will take place in the different Sections immediately after the closing date for receipt of nominating petitions as given opposite the different Sections. The Ballots mailed from Headquarters will list in alphabetical sequence the names of all eligible candidates nominated for the position by ARRL full members residing in the Sections concerned. Ballots will be mailed to full members as of the closing dates specified above, for receipt of nominating petitions.

3. Nominating petitions from the Sections named are hereby solicited. Five or more ARRL full members residing in any Section have the privilege of nominating any full member of the League as candidate for Section Manager. The following form for nomination is suggested:

(Place and date)

Communications Manager, ARRL
38 La Salle Road, West Hartford, Conn.

We, the undersigned full members of the ARRL residing in the Section of the Division hereby nominate as candidate for Section Communications Manager for this Section for the next two-year term of office.

(Five or more signatures of ARRL full members are required.)

The candidates and five or more signers must be League full members in good standing or the petition will be thrown out as invalid. Each candidate must have been a licensed amateur operator for at least two years and similarly a full member of the League for at least one continuous year, immediately prior to his nomination or the petition will likewise be invalidated. The complete name, address and station call of the candidate should be included. All such petitions must be filed at the headquarters office of the League in West Hartford, Conn., by noon of the closing date given for receipt of nominating petitions. There is no limit to the number of petitions that may be filed, but no member shall sign more than one.

4. Members are urged to take initiative immediately, filing petitions for the officials of each Section listed above. This is your opportunity to put the man of your choice in office to carry on the work of the organization in your Section.

— LeRoy T. Waggoner,
Acting Communications Manager



★ ★ ★

WHILE chatting with a radio amateur a while ago, we mentioned writing one of these pages. He expressed surprise that we wrote advertising for the National Carbon Company. He was not half so surprised as we were. We hold the National Carbon Company in the highest esteem, but after publishing this page for nearly twelve years it does seem like the height of something or other that *QST* readers do not even know who we are. We had hoped that we should be known to posterity as the makers of the HRO and other proud products, but it appears we may go down in history as the Great Anonymous Advertiser.

Not wishing to carry modesty to such extremes, we have decided to put our name and address on this page. We make this explanation so our new boldness will not be misunderstood.

When we started this page, it was our intention to devote it to amateurs' problems. We felt that the less it tried to advertise National and National's products, the more friends it would make. The absence of National's name was intended partly as a reminder to us to leave out "plugs" and partly as an aid toward the informal atmosphere we hoped to establish. Over a period of years the character of "Page 57" has become well established as a place to air controversial subjects of mutual interest, and our reasons for originally playing down National's sponsorship have disappeared.

As we write this page, Japan has decided to quit, but the formal surrender has not yet taken place. We are starting out on the strange new era of the post-war world. The chapter that has just closed was full of hectic days for National. Our products went everywhere with the British and United States Navies and made a record in which we take a lot of pride. A flood of material came from our factories and some of this flood turned up in strange places after strange adventures. Looking back, we take more pleasure in such things as the part our equipment played in saving the lives of downed fliers than in their contribution to such developments as the atomic bomb. It takes all sorts of things to win a war, and National had some part in a surprising number of them.

Someday we will tell stories about National equipment, but at the moment we are more inclined to take stock of the future than to dwell on the past. There will be new techniques and new products to talk about here and we will try to keep you posted. There will still be old principles, too, and you may expect to hear from us on old topics like feedback whenever we think there is something interesting to be said.

This page, we hope, will stay about the same. Amateur radio is a friendly pastime, and we would like this page to be a friendly and comfortable place to discuss the best of all hobbies.

WILLIAM A. READY



NATIONAL COMPANY, INC., MALDEN, MASS.

AMATEUR ACTIVITIES

ATLANTIC DIVISION

EASTERN PENNSYLVANIA — SCM, Jerry Mathis, W3BES — 3HFD threw a party for 3CBT, recently returned from overseas, attended by 3AGV, BGR, CBT, CHH, CIS, DOU, EQ, FIL, IXN and BES. 3GJY wishes to be remembered to the ORS. 3GYV, who is going to school in Italy, probably will be home soon. 3JBC is operating in a point-to-point station in Germany. 3CHH went to Wisconsin for a vacation. 3DMQ still is cruising the South Seas in the merchant marine. 3IJN is sailing coastwise on the East Coast with the merchant marine. 3HXA received his Class A ticket. 3CPS is rebuilding his rig. 3HFD has a new transmitter under construction. 3JBC purchased the HRO from 3FRY's widow. 3ENH is getting his equipment out of the moth balls. The three-year layoff was too much for 3BES's NC101X; it ran a few hours and the power transformer burned up. 3IXN put up his new skywire and is rar'ing to go on his modulator. 3HFE is modifying his 5-meter gear to work on the new 6-meter band. 3GHM is going to build an electronic bug while killing time over on the Ledo Road. 3BES, 3HRE, and 1KQY had an FB three-way QSO on the phone discussing moves to get back on the air. The Frankford Radio Club soon will own another gas-driven generator. *Very 73, Jerry.*

MARYLAND-DELAWARE-DISTRICT OF COLUMBIA — SCM, Hermann E. Hobbs, W3CIZ — The Washington Radio Club holds code classes each Saturday night and club meetings each second and fourth Saturday at the C.R.E.I. School on 16th Street. CQS is rar'ing to go from his new address, 735 Silver Spring Ave., Silver Spring, Md. The president of the YLRL, CDQ, has retired from that position. Washington WERS, WJDC, has disbanded for the present, while the Arlington members have organized a gang of their own. Maryland WERS, WJMD, is active in connection with the fire department and the police and Red Cross in case of emergency, as is Baltimore and Frederick. 73.

SOUTHERN NEW JERSEY — SCM, Ray Tomlinson, W3GCU — Asst. SCM Ed. G. Raser, W3ZI; Regional EC, W3ASQ. The last WERS activity reported by ASQ is the participation of the Hamilton Twp. WKPX network in the V-J Day coverage in cooperation with the Hamilton Twp. police. During this operation the WKPX net control station was not activated and control was taken over by unit No. 2, located in police headquarters, at which Earl Van Horn, operator No. 9, maintained active control. All fixed units except No. 15 were activated together with five mobile units and several portable units. However, the territory covered by No. 15 was taken care of by No. 14, and the entire WKPX district was adequately covered. A total of sixteen operators were present over the four-hour period during which the network functioned. The Hillsboro/Branchburg Twps. network, WKKQ, and the Bridgewater Twps network, WJMN, are in readiness for any emergency that may arise. Dick Henrie, a radio striker on one of Unk Sam's subchasers, states his intention of becoming a radio amateur as soon as he is discharged from Naval service. The Delaware Valley Radio Association, of Trenton, is accepting into membership under special arrangement, any servicemen interested in radio. Further information may be obtained from Ed. G. Raser, ZI, secretary, 315 Beechwood Avenue, Trenton, N. J. IWF, still in Northern Italy, reports that he is instructing classes in everything from code practice to antennas. When Jack was in Camp Shelby he was instructor with Radio Intelligence on direction finders. ATF has his discharge from the Marines, and is perking up on some u.h.f. gear. JOL has accepted a position with local b.c. station WTTM. It is reported that EED soon will follow JOL's footsteps and get back to civilian "grind" after serving with the merchant marine. ITS has completed his vacation. ASQ is at the shore on his vacation. JAG, with the merchant marine, is reported on his way home. Ex-SBRJ has just returned from vacationing somewhere in Pennsylvania. HAZ, the man of many QTHs, has a new address: Sgt. Wm. F. Petty, Co. P, 800th Signal Tng. Regt., Camp Crowder, Mo. GRW still

is with the Roundtree Lines on a European run with the merchant marine. It is reported that EEQ, formerly with IBM now is with Press Wireless in Manila, P. I. ITR has been transferred to Naval Air Training Center, Pensacola, Fla., upon successful completion of Naval Air primary flight training at Naval Air Station, Bunker Hill, Md. FBC has received a discharge and is back in town. CCC has accepted a position with Public Service Electric, doing meter maintenance. HWO advises that his son Bobby is stationed in Hawaii at one of the Signal Corps monitoring headquarters. The South Jersey Radio Association has moved its meeting headquarters from Hotel Walt Whitman, in Camden, to new quarters which have been graciously donated by Radio Electric Service, 51 Cooper St., Camden. JJV is constructing a brand-new shack at his home in Pemberton. BO may now be addressed: Gordon Kressel, 1133 Princess Ave., Camden, N. J. The SJRA has voted an increase of from \$1.00 to \$3.00 in initiation fee, the increase to be placed in a special fund for the building of their own postwar club house. FBZ is doing his stuff on Okinawa. JNZ is looking for a 1500-volt 500-mil. power transformer; George says he will trade a pair of 211s or 242s. JJV wants a phono-motor without the turntable! *Very 73 Ray.*

WESTERN NEW YORK — SCM, William F. Bellow, W8MC — FU, who is operating on board a collier, sends news on the boys up Amsterdam way. DRJ is working at WSNY in Schenectady. HF and GAZ moved to Broadalbin. FSF is in India with the merchant marine. AGS is in the merchant marine in the Pacific area. AKS is a foreman at the G. E. Co., Schenectady. UID has returned from a German prison camp. FEU has started a radio parts business in Amsterdam. TOX is eagerly awaiting the opening of the ham bands. JJQ is with the Army at Madison, Wis. VFH, JOZ, and TKA are in Europe with the Army. SXJ has gotten himself engaged. NWC is with G. E. Co. radar at Long Beach, Calif. STD, radio aide of WKBS, paid a visit to the boys of WHNH recently and heard how WKBS-30 gets into Rochester. WHNH-1 was heard in Rome, N. Y. at WKOM, TEX and MC, back from a fishing trip to Quebec, brought home the fish to prove their stories. DFN has just finished remodeling his house and is eyeing the old rig. OQC, now a captain, was in town on leave from England. 73. *Bill.*

WESTERN PENNSYLVANIA — SCM, R. R. Rosenberg, W8NCJ — TOJ reports as follows on Warren hams: Lt. NBD is home on a long furlough after release from the German prison camp where he was confined from March 1943 to May 1945. T/Sgt. NTJ is home on a 30-day furlough after seeing considerable action in the ETO. In honor of these two returning veterans, TOJ held a "hamfest" at his home with BOZ, HKU, JSQ, VMW, NTJ, NBD, and TOJ in attendance. BOZ is holding Warren WERS, WKLY, together and plans are being made for conducting special field tests. TOJ is communications officer for Pennsylvania Wing of the CAP with the rank of major. DDC drops a card from Garden City, N. Y., where he is employed at the Sperry Gyroscope Co. AOE sends the usual FB report. MWV has been promoted to Navy CWO, and is stationed in Italy. IYQ is back in shape after a 60-day furlough and is ready to report back for service in Miami. TTD is managing a new Cash Store in Neosho, Mo. Lt. SHY writes from the N. W. Pacific that he gets QST. Among his friends at the same camp are K5AJ, 1JSL, 5IID, and 9QVL. Jack would like to know what has happened to the old AARS "phone gang, including KBJ, BHN, CKO and TWI. Members of the Mercer County WERS net, WKKV, recently were guests of the Youngstown, Nahoning County, WERS net, WKML, with approximately twenty operators present. A regular meeting was first held under the direction of newly-appointed Youngstown radio aide, RIO. A newly-formed radio club is being organized in Mercer County to be known as the Mercer County Radio Association. AOE is temporary president. CJF became the first active member. VNL has been released from the merchant marine and is working as engineering assistant at Westinghouse. KCV flew from New Guinea to the Philippines. Sgt. TVA writes to his friends regularly from Brazil. TTD dropped in to visit UVD, OMG, and several other Jeannette amateurs while traveling through that locality. UVD writes that he is in possession of two German tubes which his brother brought home for him. The following items were sent in by UVD: OWF has taken unto himself an XYL and is headed for Fort Dix, N. J. VNE is en route home from French Morocco. M/Sgt. 3GJY spent a 25-day fur-

(Continued on page 98)

NEW!

HO-129-A

\$129⁰⁰ AMATEUR
NET
LESS SPEAKER

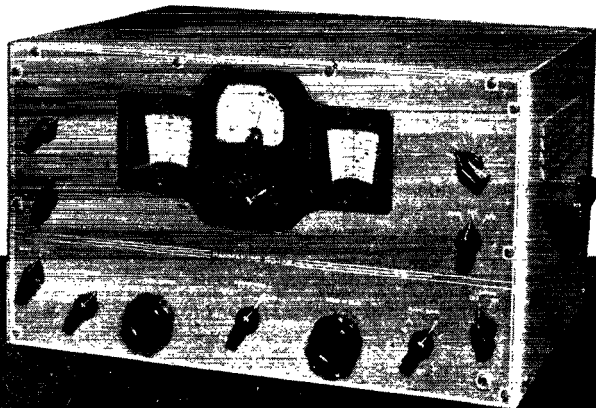

PRICES SUBJECT TO CHANGE
WITHOUT NOTICE

WRITE TODAY

A postcard will bring description
of this outstanding new receiver.

FINEST LOW COST RECEIVER

By all measurement this is unquestionably one of the
greatest values ever offered to amateurs . . . Here is "ham" communication
at its best, streamlined for highest performance at a modest cost . . .

WRITE TODAY. Send card for descriptive folder.

HAMMARLUND

THE HAMMARLUND MFG. CO., INC., 460 W. 34TH ST., NEW YORK 1, N.Y.
MANUFACTURERS OF PRECISION COMMUNICATIONS EQUIPMENT

(Continued from page 90)

lough with his XYL at Ambridge. From the Naval Training School at Del Monte, Calif., where he is engaged in technical radio instruction, Lt. KWA writes that he is glad to see some reports from this section in QST. The RAE recently held a family picnic at Zook Park, Erie, on August 19th. Very 73, Ray.

CENTRAL DIVISION

INDIANA — SCM, Herbert S. Brier, W9EGQ — HJJ is building a new receiver. NQB is recovering from being a war prisoner at Camp Artterbury. NSF is a radio repairman and motion picture projector. OMD is a doctor for the AAF. JDW polished his antenna insulators. ARI has a fine service shop. CIP is with Farnsworth. DOK despairs of ever getting his rig off 160. EHT knows where the Navy keeps its 35Z5s. LVT is a member of Indiana CAP. JIS's junk-box unit, WKVY-45, works! NGS tested and polished the 80-meter rig; cleaned his bug, and is waiting now. WVP also waits. HUV has noticed a correlation between inversion and the distance sound travels. UMK has seen too much of the Far East. EGV thinks I translate Spanish a little too freely. PQL was home recently for the first time in over a year. YMV is working at ARRL. AB brags about having two rolls of No. 120 film. UYP is in India. ZNC sent some pictures from Germany which never arrived. NVA has a little time to devote to WERS, and works for Richmond police radio part time. OOG brought a 13-centimeter magnetron and some Telfunken TS-50 tubes from Germany. DQK, WIB, and PUB were home on leave recently. ONB finished a Navy radio course and is taking a radar course. EBB has given up hope of ever getting a vacation. ABB is on his way home from Guam. EBQ gets as much distance with a golf club as he ever did with his transmitter. LMO has opened a radio service shop. 73, Herb.

KENTUCKY — SCM, Darrell A. Downard, W9ARU — The third district (WERS) lost two more operators, Jack Parkhurst and Orville Cox, to the armed forces, and gained one when Bill Hague moved back into the city. Bob Cooper and Johnny Gaylord passed their license exams. A new coaxial antenna rises 40 feet above station No. 3. Judy Conway, in the WAVES, paid us a visit recently. The fourth district has a real operator in Michael Atlas, who recently received his RRT operator license. Dave Jarett's station, WJKK-432, will be out of service until he gets a suitable antenna at his new location. Gates has been out of town a great deal recently in connection with his work for the S.B.T. & T. Co. David Abell has his operator license. Lloyd King is vacationing. Miss Billie Martain was guest operator at WJKK-4 recently. The SCM moved into the 4th district from the 2nd. A new addition to station No. 4 is Lenore Wurmser. Donald Hardt has been assigned to district No. 5. Mobile units in the district have located practically all the dead spots in that area and can work the headquarters' station from most outlying points. The eighth district has eight stations on the air. A new coaxial antenna at No. 8 helps the signal. Lively's new rig in mobile No. 832 sounds like high power. Agnes Snyder is back at No. 8 after having been on the sick list. No. 80 was heard from WAVE studios all the way to the transmitter, through the Municipal Bridge over the Ohio, in Jeffersonville and out on the Hamburg Pike about five miles. The transmitter was a transceiver using an HY615. Jack Gardner says No. 8 will soon have a superhet to complete the layout of two transmitters and two receivers. No. 81 has been off the air due to modulation trouble. Bill Brian, in No. 830, changes cars so often it should give the police a headache. Asa Magruder, USN, and a former employee of WAVE, paid the station a visit. The ARTS meetings are still held at the Canary Cottage on the second Saturday of each month.

MICHIGAN — SCM, Harold C. Bird, W8DPE — 9GQF informs us that 9PDE is brightening up his QTH with a bit of paint. The Hiawatha Radio Club will be revived soon. 8BQA comes through with a letter and tells us that he is teaching radio and electronic servicing at Foster, Mich., for the State Board of Control. 8OCC is plugging along with his work at the new plant and keeping busy with the electrical end. 8MVC say he met 8QC, who claims he used to work 8DYH on the police network. 8LHH is sparks on the Liberty Ship SS *Wm. J. Duane*, 8IFT is with W.E. Co., N.Y.C. 9ONB thanks us for sending the *QMN Bulletin* and reports that he is attending ARM school in Memphis. He sends his 73 to MCB and DYH. The DARA held an impromptu meeting at a wiener roast in Palmer Park, Detroit, recently.

Bill Bruening was there in his lieutenant's uniform. We also had the pleasure of seeing our old friend, SCW, 73, Hal.

WISCONSIN — SCM, Emil R. Felber, jr., W9RH — After twenty months in Ireland CRE, in the USN, had the pleasure of speaking to his family via trans-Atlantic phone. T/Sgt. Jesse D. Wheaton has received a commendation from his commanding general. V TZ would like to hear from RPW and RRT. He's located in China and his QRA is Sgt. H. Haunfelder, 1088 Sig. 68 Ser. GP, APO 211, o/o Postmaster, New York, N. Y. CRM JWN paid a visit to HRM and is back on sea duty. QIH, CRM in the USNR, spent his 5-day furlough in San Francisco getting married. Sgt. Gil Rink is located in Southern France. Sgt. Curtis Schultz wrote from Burma and sends 73 to the NYA bunch. RM1c ZIE is in the Philippines. Lt. ANA, USNR, located at Luzon, expects to be home shortly. Ed. Thornley, 81c (RT), states the weekly tests at Great Lakes are really tough. Pfo. Paul Ripple, at Esslingen, Germany, is operating teletype and expects to be sent out CBI way. Capt. JWT, USMCR, wrote HRM from Pelelitu stating he expects to be back this fall. Sgt. Bernie Kellner is instructing native soldiers in the Philippines. Sgt. Frank Detzek has been transferred to Brownsville, Tex. Lt. VKC, after spending his 45-day leave, found himself a civilian again, with over two hundred dollars in a locker in India. The WMFI gang were the first fellows to return to the air with their ham rigs. The following Milwaukee hams are now operating on 112 Mc.: CCD, CDY, CID, GIL, GVL, RSA, RUF, ACM, DZZ, NSC, LSH, PYM, JPK, and RH. 73, Emil.

DAKOTA DIVISION

NORTH DAKOTA — SCM, Raymond V. Barnett, W9EVP — I would like very much to get in touch with League members throughout the State, particularly in Wahpeton, Fargo, Grand Forks, Minot, Williston, and Dickinson, on whom I could depend to keep me informed as to the activities of hams in those areas and of hams now in the services. KHIU, Burleigh County WERS, is maintaining activity during the summer months with six units participating. DXC, EVP, GJJ, KZL, SSW (radio aide), and Don Birch are the active members. RBS is in the radio servicing business at Dickinson. DXC is with Mandan Electric Supply and interested in carrier-current. GJJ sold his mobile 112 Mc. rig to DXC and is building another using a 7N7. ZTL is instructor with the Navy at Chicago. JWB is ditto at New Orleans. NAN is with Operadio at Chicago. KOY, still at Stanton, reports that Lt. Comdr. MLE is spending the summer at Dorset recuperating from his operation and expects to return to the West Coast for the coming winter. ONE recently was married but is keeping the old rig brushed off and ready to go. FKP and JDH are the only hams left in Hebron. FKP sold all his equipment to the U. of N. Dak. when the war started but JDH is ready to go. CYN is traveling over the State with a portable moving picture outfit. BCU has received his discharge from the Army and when last heard from was in Milwaukee. GZD sends congratulations to the SCM on his election and includes the following: "After serving overseas with the Army I was discharged and then taught at Texas A. & M. College for a year. Last fall I came to the U. of N. Dak. where I am enrolled as a student. I also am engineer at KILO. My brother, OCI, RT1c in the Navy, was home in Carrington recently. He is in Navy Officers' school for commission as communications officer. Arnold Petrich, ex-TJF, of Enderlin, is chief engineer at KILO. DM is professor of mathematics at Central High School here. HSR, of Hatton, is married now and is manager of Northern States Power Co. ILT, formerly of Hanks, is back from the Philippines and is in McCaw General Hospital, Walla Walla, Wash. Ray would like some mail. I've got my NC-100XA receiver and Signal Shifter here and am building up a 6L6 buffer into p.p. pair 807s which I hope to fire up soon." 73, Ray.

SOUTH DAKOTA — SCM, P. H. Schultz, W9QVY — DB is back in Milbank and has a permanent location near the edge of town with six acres in which to string up antennas. TI is going into the radio business at Milbank. PZI, of Milbank, is a radio instructor at Ft. Sill. OXC, of Pierre, is the proud possessor of a 1st-class commercial radiotelephone license. 73, Phil.

NORTHERN MINNESOTA — SCM, Armond D. Bratland, W9FUZ — Another good report was received from JNC. Jim has taken his wait for final radar course as patiently as possible. FVO, at New Guinea, has made plans

(Continued on page 94)

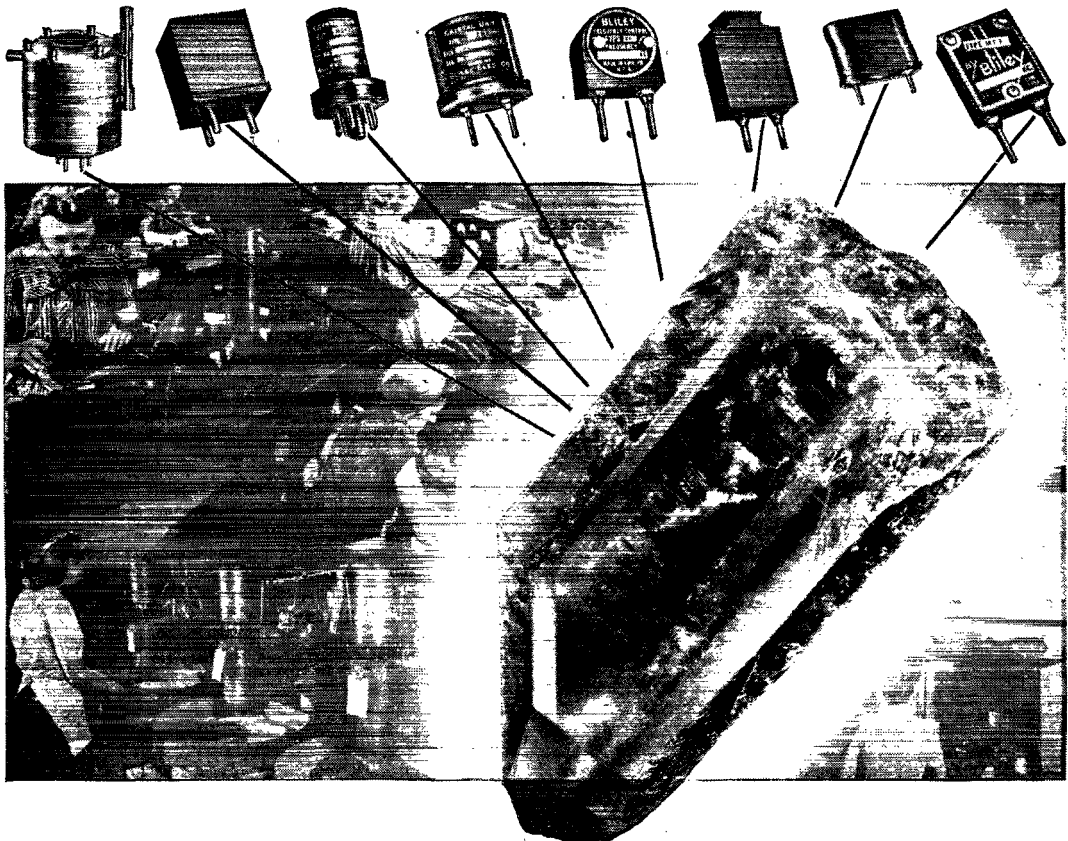

You name the application...

BLILEY has the crystals

Post VJ Day production of Bliley acid etched* crystals for FM receivers, Aircraft and Marine radios, Railroad communications equipment and many other applications is proceeding with the same skill and efficiency that marked our war-time operations.

Substantial quantities of these crystals are in the hands of foresighted manufacturers who planned in advance with Bliley engineers for frequency stabilization in their post-war models.

Now, more than ever before, you need the versatile experi-

ence of Bliley engineers and craftsmen gained through more than 15 years of quartz crystal engineering exclusively. Whether your requirements are one crystal or a million, you can be sure of top quality—top design—and top performance—in Bliley crystals.

+ + +



Another star has been added. Our 5th citation for outstanding achievement in producing materials essential to the war effort.

** Acid etching quartz crystals to frequency is a patented Bliley process.*



Radio Engineers—
write for temporary
Bulletin Q-26

BLILEY ELECTRIC COMPANY • UNION STATION BUILDING • ERIE • PENNSYLVANIA

(Continued from page 98)

to rebuild. LPL is waiting for a discharge. QIN, from Tulsa, expects to be home soon. TYN is in the USN at St. Marys College, Calif. YLZ/PZT, chief engineer of KANN, suggests that returning hams call on him at the sheriff's office. RPT is moving to Fairmont and will become production engineer for the Fairmont Railway Motors. YCR is now married. IFW is building an m.o.p.a. job for 2½ meters. BHY or MTH, in St. Paul, will be glad to calibrate transmitters. ZGU may be released from the Navy soon. WGY was involved in a Jap suicide attack and suffered some burns. GBG is back in St. Paul, discharged from the Navy and now back on the job as police radio dispatcher. GFG is living in Winona. WVM is back at WCCO. MTH is ready to go on 2½ meters and is getting the big rig ready for the other bands. GVO also plans on a 2½-meter rig at White Bear. No doubt OPA will get on the air shortly on 2½ meters. JIE reports that the first club meeting will shortly take place in St. Paul. HNB is building for 2½ meters. BMX recently returned from the hospital after a short illness and will be dusting off the meat grinder for ten. ZWW writes his thoughts on the matter of regulations, modes of operation on the various bands. By the time this is printed, FUZ will be back at sea. 73, Army.

DELTA DIVISION

LOUISIANA — SCM, Eugene H. Treadaway, W5DKR — JET's new address is USS *Chinua* (A068), Fleet Post Office, San Francisco, Calif. Besides being a busy mail carrier, KC is working overtime repairing radios. BUK is now a lieutenant in the Pacific area. JFM is now a W6. EBB is in Rome. CQF sends 73 to the gang. IBL is CRM on USS *Spadefish*. GXI was a visitor in New Orleans recently. DAQ is a lt. comdr. in the Navy. IRO, of Hodge, visited HHT in New Orleans. GXQ is living in New Orleans. BPL is out of the Army and wants to get going on 80 meters. IKV is in the Coast Guard. JHM is now in the States. GUK is fixing up the old receiver. AVO is active as a radio repairman. AOZ is making plans to change the old 160-meter 'phone rig. CXQ is a busy soundman. The SCM would appreciate hearing from the gang. 73, Gene.

HUDSON DIVISION

EASTERN NEW YORK — SCM, Ernest E. George, W2HZL — Your SCM will welcome word from any returning veterans, especially those who held ARRL appointments. A request has already been received from BLU for ORS appointment as soon as appointments are reactivated. BLU comments on seeing many ham calls on freight cars, even those of the 6th, 7th, and 9th districts, with 80QI the leader. ACB was seen back in Schenectady after being on a war job in Florida for some time. With the General Electric Co. moving its radio departments to Syracuse, the ham population in Schenectady will suffer a great loss in the very near future.

NEW YORK CITY AND LONG ISLAND — SCM, Charles Ham, jr., W2KDC — Lou Roth, DKH, secretary of the Federation of Long Island Radio Clubs, wants to hear from the secretaries of all radio clubs in this section. His telephone number is LA5-1380. The Sunrise Radio Club would like to hear from former members and code trainees. Contact CJY or LFY. IOT is having trouble securing furniture and a place to live after acquiring a bride several months ago. 3AIX and 3IOE, formerly of Philadelphia, are giving Sperry their best, as is OBU. HMJ, who operates for Eastern Air, writes that he is itching for the old ham QRM. DOG reports on WERS activity on Eastern Long Island, WLSB. Unit No. 5, ADW, will have a mast raising early in Sept. Unit No. 1 has an FB 7-tube super on 2½ meters. 1MJK/2, formerly of Newton, Mass., writes from Rego Park. IOP is dreaming of his postwar shack. Bill Leiber sends an interesting bulletin entitled "CQ" from the Grumman Amateur Radio Club.

NORTHERN NEW JERSEY — SCM, Winfield G. Beck, W2CQD — S/Sgt. MEO, of Woodbridge, writes from Ankara, Turkey, that he's going into his 27th month overseas with the AACs. RT1c Ted Tajkowski, "I" Division, 3rd Section, USS *Charles S. Sperry*, DD 697, c/o Fleet Post Office, San Francisco, Calif. sends the following news: 2nd Lt. MAX is in the Aleutians. Sgt. OAE is in the Philippines. Pfc. MRZ was last heard from around Nürnberg, Germany. RT3c JSE is finishing advanced radar school in Chicago. NWA is now RT1c; he met many hams who were

technicians on destroyer tenders. FDL, secretary for the Intercity Amateur Radio Club, is doing WERS work. MTZ, I.H.S. Radio Club, still teaches code and theory to students. Nick Camenares, in the Pacific area, writes: "A couple of days ago the chief radioman from the *Murray*, a destroyer, came over. We got to shooting the breeze and I finally found out that he was 8NXN (K6UOK in Honolulu). He said that Ens. 9QVY also is on the same ship. I met RM1c G. J. Sallet, LCK, USN, who is on the USS *Bagley*, a destroyer." Geissinger, an SWL of Rochelle Park, sends along the following dope: 3FZY is among the W2's now since his migration from Madison to Fair Lawn. He's working in Aneco Products, Paterson, and has acquired an XYL. He is also active in CAP-WERS and WBBH. ITL is chief engineer at Dumont Television station WABD. MHL has his own radio repair shop in Passaic. NRM is with NIDISCO (Cliffside Branch). NHZ is in the U.S. Navy. MB moved from Clifton to Fair Lawn. MKT has been with the U.S. Maritime Service as a ship "sparks" for a couple of years now and has an XYL. F. Alexander, a prospective ham, associated with HIE in 1937-1938, now is somewhere in Mindanao, P. I. 73, Win.

MIDWEST DIVISION

IOWA — SCM, Leslie B. Vennard, W9PJR — FDL became the dad of a 7 lb. boy on July 3rd. KZI, new EC at Ottunwa, says that LAR has moved to Arkansas and FLR is working on radio at the Naval Air Station. CCE and URK renewed their EC appointments. IPQ spent two years in England and had regular QSOs with 2HGP and 7IDZ, in the same camp. IPO has gone to the So. Pacific. LAC holds license KAAAT and reports that WERS is coming along fine. URK reports that WERS is working out fine with twenty-seven stations. 73, Les.

KANSAS — SCM, A. B. Unruh, W9AWP — MDI, Signal Corps inspector (Chicago zone), stationed at San Antonio ASF Depot, received a fifty-dollar award for his suggestion for improving the performance of a Signal Corps hand generator. ART2c JCY left Corpus Christi for the West, after completing radio and radar course. He reports SIL is stationed in the Navy A & R shop in California. GUJ was at Corpus Christi. Ens. KFH and his new YF, were recent Wichita visitors en route to San Francisco, where "Fritz" will be stationed. On a recent trip to Wright Field in W8-land, this SCM met 1LOW, 1CDT, 4IDX, and NLM. BCY and DMF have tentative plans for a commercial radio venture. QQI will finish his electrical engineering education. GSW says he will get on the air first and worry about work later. ZUY wants her hubby, YYW, back permanently as soon as the Navy can spare him. DJL and 5HHF claim they will tour the country and look for work. NMT plans to go the West Coast, and may pound brass at sea for a time. AWP plans to do some commercial brass-pounding also. According to newspaper reports, QKV, who received his Master's Degree at K.U. in 1944, worked at the Eastman plant as a physicist until theory work on the atomic bomb was completed. He now is with the Oceanographic Company in Massachusetts. YYW will be stationed on the West Coast. 73, Abie.

MISSOURI — SCM, Mrs. Letha Dangerfield, W9OUD — The new QTH for OUD and BMS, is 411 Moffett Ave., Joplin, Mo. BMS has a radio service shop in the garage at the rear of the house. OUD has most of her possessions located and in usable state. HIC merits congratulations on his marriage to a Texas YL on Aug. 4th. While on furlough he visited HCL's wife and daughter. KPM sent us several Jap bills which he picked up on Okinawa, where he is a telephone lineman. GBJ got the dope on VEW, of Ash Grove, which was requested by MOZ. VEW was radio operator on a bomber which crashed over Germany. QCO suffered a serious heart attack and has been in the hospital. GHD, in the Aleutians, caught 72 trout fly fishing; he says AEJ is expected home on leave when his ship reaches port for repairs. 73.

NEBRASKA — SCM, Arthur R. Gaeth, W9FQB — The CAP has three units in operation to date, namely KCHK-4, 8, and 18. KHKN-33 was assigned KCHK-18. ZPZ, KHKN-62, KCHK-4, is installing CAP units. YDC, KHKN-4, returned from vacation and found his chickens had sprouted wings and were flying high. SPM, KHKN-20, Plattsmouth, is active and trying to contact the net. VKT, KHKN-9, reports a peculiar fade on July 25 while in QSO with KHBW-1, whose signal strength alternated between zero

(Continued on page 96)

Ready: Collins Transmitters for airport applications

Collins Autotune Transmitters

IN DESIGN AND CONSTRUCTION the Collins Autotune transmitters, shown below, reflect extensive laboratory and field research, and intense engineering endeavor, both before and since Pearl Harbor. The most advanced refinements are combined with military ruggedness on a production line basis!

The Collins Autotune is a repositioning mechanism which quick-shifts all tuning controls simultaneously and with extreme precision to any one of ten preselected frequencies at the flip of a dial, either at the transmitter or from a remote point. The standard models are crystal controlled, and special models are available with tunable master oscillator control.

The renowned Collins pi network matches into a wide variety of single wire or vertical antennas. The 231D-13 also matches into a 600 ohm balanced transmission line from 4 to 18 Mc.

Frequency-shift keying is available, making it possible to use these transmitters in printing telegraph circuits.

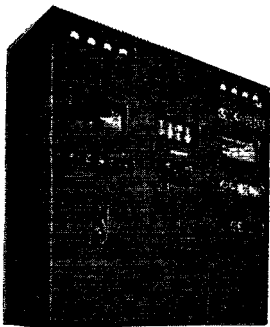

Collins 231D-13 — Nominal power output: 3000 watts phone; 5000 watts c.w. Frequency range: 2 to 18 Mc. Ten quick-shift frequencies.

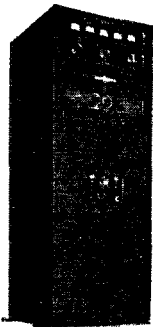

Collins 16F-9—Nominal power output: 300 watts phone; 500 watts c.w. Frequency range: 2 to 18 Mc. Ten quick-shift frequencies.

**COLLINS RADIO COMPANY, CEDAR RAPIDS, IOWA
11 W. 42nd ST., NEW YORK 18, N. Y.**

Collins equipment is sold in Canada by Collins-Fisher, Ltd., Montreal.



IN RADIO COMMUNICATIONS, IT'S . . .

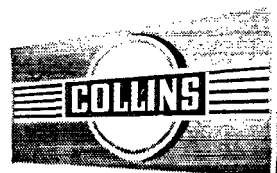

Collins Multi-channel Transmitters

THE COLLINS 1000-C 2500 watt multi-channel airport transmitter shown at right, below, provides an ingenious balance of quality, efficiency and economy. The radio frequency cabinet contains two vertical r.f. sections. Each section can be used interchangeably on two channels located anywhere within 2 to 20 Mc. The cost per section compares with that of conventional single channel sections. The cost per channel is thus cut approximately in half. In addition, relays permit selection of three crystals per channel (six per vertical section). Twelve frequencies are therefore available in a single cabinet.

The Collins 32RA transmitter shown at left, below, is a compact low-powered crystal controlled unit which finds ready application for continuous duty in control towers, or as a stand-by. Instant selection of any one of four frequencies within its range is accomplished by means of a special gang switch actuated by a single panel control.

Your inquiry is invited. We will be glad to make recommendations for your particular applications.

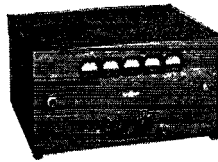

Collins 32RA—Nominal power output: 50 watts phone; 75 watts c.w. Frequency range: 1.5 to 15 Mc. Four instantly selected frequencies.

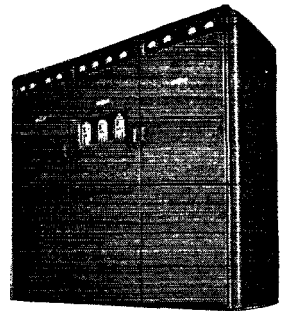

Collins 1000-C—Nominal power output: 2500 watts. Frequency range: 2 to 20 Mc. Additional a.f.-modulator & r.f. multi-channel sections available.

GOOD!



They're Better than Ever!

Long considered standard by the industry, Mallory Vitreous Enamel Resistors are improved by war-born developments that mean even greater reliability, better appearance, greater accuracy—at no increase in price! These new resistors, withstanding the rigors of military service, bring you

- More permanent and constant resistance—thanks to the use of welded terminal connections
- Minimum temperature co-efficient
- Stock resistance values for all usual applications

Mallory Vitreous Enamel Resistors are available from your nearest Authorized Mallory Distributor. If you do not have a distributor near you, write us today. Direct inquiry is also invited from manufacturers whose products employ Vitreous Enamel Resistors.

P. R. MALLORY & CO., Inc.
INDIANAPOLIS 6 INDIANA



P. R. MALLORY & CO. Inc. MALLORY

(Continued from page 94)

and nine at unit No. 9 and unit No. 2, who was also in contact at the time. GEU, KHKN-37, has left Martin Co. and is working for EKK. 5ABI, KHKN-13, finds fishing and radio service work interfering with WERS activity. KHKN-43 reports his 3-year-old jr. operator jumped off the porch and fractured his leg. KHKN-15 reports the Rockies tough climbing with a 50-lb pack on the back. YMU, KHKN-59, has a transceiver on 1¼ meters and is looking for someone to join him there. The Ak-Sar-Ben Radio Club was honored with a visit by HK5EM. At the meeting Mr. Bert Smith, of the Bell Telephone Co., explained their emergency set-up. ROE has forsaken the petrol station for radio servicing in Ashland, and says that EAT has an HY75 and expects to be active on 2¼ meters soon. EKK is conducting radio communication tests for railroads, and reports NNU is with the 9th in Germany and has a Bronze Star and five battle awards. NNU says that German Command car fenders make good bottle openers. CCR left KFAB and is with KBON. DI, formerly of Tobias, a field engineer for RCA Services Company in Camden, N. J., reports that DMY still is in Hebron. S/Sgt. TQD, of Fairbury, now in the Signal Corps, is somewhere in the Pacific. Also visited with ANZ in Lincoln last June, and still has radio gear stored in the "old home State." Capt. BZV likes technical articles. CDZ moved to Omaha and is working for U.P.R.R.; he has a radio shop on the side. His brother, RM1c DKV, is in the Aleutians. Capt. HTE is sweating it out after thirty-one months in the Pacific. FQB redecored his radio shack. 73, Art.

NEW ENGLAND DIVISION

CONNECTICUT — SCM, Edmund R. Fraser, W1KQY — WERS News: Frank Sanchione, Bridgeport radio aide, reports twenty units and operators still are operating consistently in that area. During the Aug. 19th test WKA0-4 heard WKOB-14, WKAE-4, WLSB-7 and 15, WJTR-2, and others. Middletown: DBM, district radio aide, reports ten units and ten operators on consistently. Hitchcock, operator of WKNQ-7, has been experimenting with a double-extended Zepp and a 4-element beam. New Haven: WJLE-13, operated by Jack Harper and KQY, was in operation Aug. 19th when the band was open, working WKAE-4 in Montclair, N. J., operated by 2JN; WKOB-14, New London; WLSB-7, East Hampton, N. Y.; WKNQ-1 and 7, Middletown and East Hampton, respectively; and WKA0-4, 40, and 42, Bridgeport. Also heard were WJXW-8, Verona, N. J.; several WKLK units in New Jersey, and WMHF-47, Springfield, Mass. WKWG-70, WKNQ-1, WKNQ-7, and WKOB-14 worked WJXW-8 and WJBB-3, Worcester, Mass. Norwich: Eli Crumb, ex-BIJ, reports units WJLH-39, 32, and 13 were heard along with WKNQ-1, 7, and 29, WLSB-3, WKWG-70, and WJXW-8. Norwich has four units and four operators attending drills. EX-BIJ intends to take the amateur exam shortly. LZM reports that JHN is in the KA area. 3BES, 3HRE and KQY had a recent QSO over the 'phone lines discussing the future of amateur radio. JFG and his XYL were blessed with another jr. operator. RM1c BEO writes from Key West, Fla. that he has been operating at Naval radio station NAR. Amateur operation has been resumed on 112-115.5 Mc. and stations heard and worked around the State were: ATH, BW, FMV, FSH, DBM, KAT, LZM, MSB, ZT, UZ, ILG, MVH, IND, JQD, NEK, LVX, and KQY. 73, Ed.

EASTERN MASSACHUSETTS — SCM, Frank L. Baker, jr., W1ALP — BDM already has two rigs ready to go when we get back on the air. NOV says he is going to put up his new antenna. 4AIJ has a new son. KDK, formerly of Hartford, is living in Quiney. SE is working in Attleboro. When last heard of FL and FSK were at Grenier Field, Manchester, N. H. The South Shore Amateur Radio Club held its meeting with the following present: MD, ALP, IS, LZW, IHA, FWS, Dan Hoxie, and R. Mugford. MAL is very busy at his job. HSB writes that all his gang are busy. Lindsay Russell is going to M.I.T., and says besides himself George Tiffany is the only WERS operator he has left. James Lees is in the Army at Fort McClellan, Ala. Don Hollis is at the Eddy School in Chicago. MWF is working in a radio store on Boylston St., Boston. MIH is busy in Hyannis doing repair work. JFS sends in some news: JNK is in Manila. MQE is in Iwo Jima; he sent Les a small Jap resistor. AAT is home on furlough from the Navy. Correction: AMT lives on Hobart St., Danvers. AGX lost his dad in July. GRV's XYL is going to camp with the Cub Scouts. JKY spent two

(Continued on page 58)



GREAT GENERAL-PURPOSE TRANSMITTING TUBE

TYPE GL-805

10



Here is a leader in General Electric's highly developed, *complete* line of transmitting tubes! Type GL-805 not only gives you high power output at relatively low plate voltages (see ratings below), but the tube's grid-bias requirements are unusually low (zero for many Class B conditions).

Type GL-805 does a wide variety of jobs efficiently. It is used in the low-power stages of large transmitters, and also as a power amplifier in smaller stations. An

excellent amateur tube, as well as standard for other communications, the GL-805 is one of the more versatile transmitting types.

High amplification factor, and a frequency range above most power-tubes in its class (30 megacycles at maximum plate output; 80 at reduced ratings)—these are still other advantages. See your nearest G-E office or distributor for further information, or write *Electronics Department, General Electric Company, Schenectady 5, N. Y.*

Check these ratings

New Booklet ETX-5 gives ratings and prices on General Electric's complete line of transmitting tubes. Ask for your free copy.

Continuous ratings	Class B A-F service (two tubes)	Class C R-F service, plate-modulated	Class C R-F service, without modulation
Filament voltage	10 v	10 v	10 v
Filament current	3.25 amp	3.25 amp	3.25 amp
Max plate voltage	1,500 v	1,250 v	1,500 v
Max plate current	210 ma (per tube)	175 ma	210 ma
Max plate input	315 w (per tube)	220 w	315 w
Max plate dissipation	125 w (per tube)	85 w	125 w
Driving power (approx.), typical operation	7 w	16 w	8.5 w
Plate power output, typical operation	370 w	140 w	215 w

GENERAL ELECTRIC

161-D10-8850

TRANSMITTING, RECEIVING, INDUSTRIAL, SPECIAL PURPOSE
TUBES • VACUUM SWITCHES AND CAPACITORS



**"Post-War"
Is Now Here!
You Must Act Fast
To Step Ahead of
Competition**

CREI Home Study Training in Practical Radio Electronics Engineering Combined With Your Own Experience Assures You of Peacetime Security and an Interesting, Profitable Career.

Now that the war is over, it is "the survival of the fittest." Employers will once again be "choosy." Only the best qualified men will be selected for the best jobs.

NOW is the time to take the time to prepare yourself for these important, career jobs in radio-electronics engineering. CREI can show you the way by providing you with the "tools" to build a firm foundation of ability based on a planned program of technical training.

In our proved home study course, you learn not only how . . . but why! Easy-to-read-and-understand lessons are provided you well in advance, and each student has his personal instructor who corrects, criticizes and offers suggestions on each lesson examination. This is the successful CREI method of training for which 10,000 professional radiomen have enrolled since 1927.

Investigate now the CREI home-study course best suited to your needs, and prepare for security and happiness in this New World of Electronics! Write for all the facts now.

● WRITE FOR FREE 36-PAGE BOOKLET

If you have had professional or amateur radio experience and want to make more money—let us prove to you we have something you need to qualify for a better radio job. To help us intelligently answer your inquiry—please state briefly your background of experience, education and present position.



Capitol Radio Engineering Institute

Home Study Courses in Practical Radio-Electronics Engineering for Professional Self-Improvement

Dept. Q-10, 3224 16th St. N. W., Washington 10, D. C.
Contractors to the U. S. Navy, U. S. Coast Guard and Canadian Broadcasting Corporation

Producers of Well-trained Technical Radiomen for Industry

MEMBER: NATIONAL COUNCIL OF TECHNICAL SCHOOLS

(Continued from page 96)

weeks in Maine. KYT also spent a week in Maine, closing his radio store. Bill Langdon, of Lynn, is home from Florida. Lt. R. J. Hill sends 73 to the North Shore gang from his carrier in the Pacific. Ex-AFF and his XYL are busy with their garden. Ex-CLE, a lieutenant in the Signal Corps, just got back from England and had a 30-day furlough.

WESTERN MASSACHUSETTS—SCM, William J. Barrett, WIJAH—MIM says her OM, LDV, still is in the Pacific. LXE was home on 32-days' leave after service in Germany, and is now at Ft. Bragg, N. C. MND, who was wounded in Germany, has received his medical and disability discharge and is resting up before returning to school to study electrical engineering. FJK is a corporal. MIM has his address. Sic MBL, in the Navy, is studying for a radar technician rating. MVF is on sea duty. EAX is back on the Signal Corps job in Oklahoma after a short vacation. ALR is at the old stand in Fitchburg. Dick Atwood reports for the Worcester WERS net, WJBB. Charlie Richardson, formerly of WJBB-31, is transferred to WLSO-17. Atwood has been experimenting with new Discone antenna of the Federal Telephone type, reporting fair gain over a ground plane vertical or a coaxial antenna. FNY was a recent visitor to AZW. JAD became a bridegroom recently. KLN, back from the wars, is conducting a new radio show over WMAS from 7:15 to 7:30 p.m. Thursdays, and can use any speaking talent among ham vets around Springfield. 73, Bill.

NEW HAMPSHIRE—SCM, Mrs. Dorothy W. Evans, W1FTJ/4—Once again BFT has to fill in for FTJ on the monthly QST report. Dot presented Carl with a second son, Jonathan, born on August 14th, in Memphis, Tenn. CFG is cruising the wide areas of the Pacific on a brand-new hospital ship. AVL joined the ranks of the benedicts this month. Sam still is in Miami, and has recently been promoted to sergeant. Are you fellows interested in setting up the old NHN once again? How about hearing from you on this subject? As BFT has more than enough points to get out of the Navy right now, we expect him to be back in New Hampshire late this fall all set for a good real old-time ham winter. Very 73, Carl.

RHODE ISLAND—SCM, Clayton C. Gordon, W1-HRC—Ernie Grant now is working with Raytheon in and around Quonset, and has built a new 144 Mc. receiver which he says pulls them in at Conimicut from the planes over Charlestown Airport. DIK is stationed at Quonset but expects to be out of the services soon. MDW is anxious to get back on 80. HRC has completed rebuilding the 100 kc. crystal sub-standard and the frequency-meter, and the engineering of a rebuilt v.f.o. is in progress. Let me remind you again that my term as SCM has long since expired. With the gang returning home, no doubt there are some among you who believe it is time for a change. If that is your wish, you will find me ready and willing to cooperate with your choice to fill the vacancy. If you wish me to carry on, I am willing to try to satisfy, as in the past. 73.

VERMONT—SCM, Burtis W. Dean, WINLO—At recent State Guard maneuvers at Camp Johnson in Colchester, BD reports that he and AVP operated the SCR 511s on 3825 with FB results. LWN and NLO have been experimenting with antennas on 114 Mc. and have already worked up to three miles. AD has been listening on 112-115.5 Mc. GAN and KXP are building up 2 1/4-meter equipment to install in their cars. JVS and XYL have been vacationing. They visited Gan, LWN, and NEO while stopping off in Burlington. "Cedar" has purchased a 75-watt modulator and an 813 tube and has started construction on his postwar rig. JVS's QTH is RFD, Marshallton, Del. Diok Evans (ESP) is stationed in Alexandria, La. GAE/7 and family are living at Ellensburg, Wash. Jim is with the CAA. BD reports his Siberian cheeshound can dig fox-holes, climb telephone poles and fences. 73, Burt.

NORTHWESTERN DIVISION

MONTANA—SCM, Rex Roberts, W7CPY—Lt. (jg) BMX paid a visit to Great Falls on the way to the Coast. Capt. GBI, ATC, is on leave in the Falls. Bud has built a new 5-meter Superhet and is eager to try out that new 50-54 band. DSS reports that the Great Falls Club and WERS are having the usual summer quiet. Gang, read the article in QST entitled "What is an SCM?" 73, Rex.

OREGON—SCM, Carl Austin, W7GNJ—Lt. George Riddle, who was stationed at NPE, Astoria, during 1936 and 1937, is now OIC, Electronics, U. S. Naval Training

(Continued on page 100)

For a Job Well Done

OHMITE

SALUTES THE NAVY



HATS off to Navy Radio teamwork . . . and to the 8000 or more radio amateurs in the Navy whose work was vital to Victory.

From the very beginning, Ohmite was privileged to help by supplying innumerable resistance-control units for radio and radar . . . for shipbuilding . . . and for many other phases of naval operation . . . ashore, at sea and in the air.

With peace, Ohmite rheostats, resistors, chokes and tap switches are ready to serve radio amateurs and engineers again . . . just as dependably as before.

OHMITE MANUFACTURING COMPANY

4863 FLOURNOY STREET, CHICAGO 44, U.S.A.

Be Right with

OHMITE

RHEOSTATS • RESISTORS • CHOKES • TAP SWITCHES

PORTABLE POWER PROBLEMS

THIS MONTH—ILG MOTOR TEMPERATURE TEST

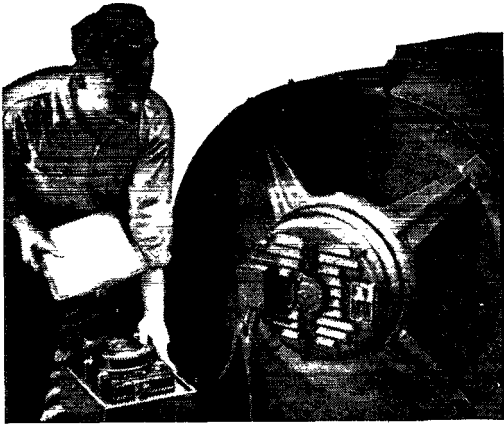

BURGESS INDUSTRIAL BATTERIES power ohmmeters to determine temperature rise in fan motors manufactured by Ilg Electric Ventilating Company. Thousands of industries using test and control equipment rely on your Burgess Batteries for dependable service. Your local Burgess distributor can fill your needs from the line designed to meet industrial requirements. For full information on the *complete line* of dry batteries write for the name and address of your nearest Burgess distributor.

2 OUT OF 3 SELECTED BURGESS BATTERIES as their *first choice* in a recent nation-wide survey of manufacturer electronic engineers. If you require a special battery for a new application, Burgess engineers can solve your problem with the right battery type.

*Burgess Battery Company,
Freeport, Illinois.*

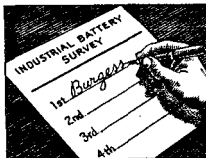

Loose Talk is Still Dangerous!

BURGESS BATTERIES

VOTED FIRST IN NATION-WIDE SURVEY

(Continued from page 98)

School, Galveston. FNM is trying to rig up a bet with FRO, who thinks hams will not get on the air again. IDJ, still in Maine, bought another bug so he could get the old fiat ready for ham work. HXG and his XYL are at Middleton Island, Alaska, with ACS. On their way in they visited the station at Unalakleet, run by FTA/ITZ. They mentioned that HXV is at Fairbanks, doing maintenance work for CAA. ENC is back in the States, and will do some sort of desk job at Sacramento, Calif. QP is out of the services and back at the radio game. GPS, CAA inspector, has a very FB mobile job finished, using 6L6-807, modulated by a pair of 6L6s. CZJ has been in a hospital in Chicago. Pop now reports his new rig completed, using 6L6-807-pair 812s. HBO is ACRM at Corpus Christi. HAL says his fingers are itching to get the key going again. HHH is trying to get GNJ to rebuild her h.f. r.f. section, and wants a 15-meter crystal and set of coils, as well as a 10-15-20-meter rotary beam for her rig. Very 73, Carl.

WASHINGTON—SCM, O. U. Tatro, W7FWD—KFIQ and KFNV found 120 miles too much distance but they still hope to bridge that space with 2½ meters. However, Units No. 1, No. 14 and No. 21 of KFNV in Everett were heard from Mt. Baldy on the test. ABF, after intensive training at Fort Schuyler, Harvard, M.I.T., and Corpus Christi, was made a Naval income tax expert at Norfolk but is now a radio-radar engineering officer at Seattle. BKW is in Washington, D. C. and says that when he was in the So. Pacific he missed BVT, who is now back in the States. He recently built a recording table and an f.m. receiver. IHJ is out of the armed forces and is looking for a location in Seattle to practice his profession. IHK, his XYL, hopes to be on the air soon. IJZ is RT at M.I.T. HNS is at Barstow, Ariz. HWG is leaving the State Forestry and moving to Spokane. He recently qualified for 1st-class phone. VQ4KSL, of East Africa, was a recent visitor and expects to open up code classes in Olympia soon. HAK is leaving Skagway. EGV is building his postwar transmitter. ERU is building a wide range audio oscillator. IOQ is bear hunting. Let's have more reports from the ECs. 73, Tate.

PACIFIC DIVISION

NEVADA—SCM, N. Arthur Sowle, W6CW—Asst. SCM, Carroll Short, jr., W6BVZ. MWF reports from Fort Myer, Va. that he is operating WAR in Washington. RFY is in the Pacific area. BIC is on the Coast enjoying the salt sea air and a needed rest. PDV is leaving Reno for Santa Barbara on a new assignment. There is much antenna polishing and rig dusting going on now that the war is over. Everybody is eager to put out that first CQ. 73, Art.

EAST BAY—SCM, Horace R. Greer, W6TI—EC, QDE; EC v.h.f., FKQ; Asst. EC v.h.f., OJU; OO v.h.f., ZM. On August 16th another WERS dinner-meeting was held with such FB results that everybody present voted to have a repeat performance on Sept. 20th. AM was a recent visitor to East Bay. KZN recently was seen around these parts. DUB and TT say that business is FB. ITH, local manager of United Press, is giving us firsthand information on any news out of Washington concerning FCC reports on amateur doings. CDA sends his regards to all his friends. We have been asked to confine our 2½-meter rag-chewing to 112-115.5 Mc. Be seeing you, TT.

SAN FRANCISCO—SCM, William A. Ladley, W6RBQ—Phone RA8340. ECs DOT, KZP; OO u.h.f., NJW. LV left Eimac in July and is in business with other members of the family. WN is at Eimac. MZ spent his vacation at home. 9YMV passed through on his way to ARRL Headquarters to take over the posts of Assistant Secretary and Acting Communications Manager. He visited Director EY and RBQ. A letter was received this month from CIS, who still is near Manila. 9FA is on Guam. 9ICN writes from Okinawa. DJI is back in town working for the government on radio repairs. K6TTY writes that he is a civilian after Army discharge with over 131 points and is living in New Orleans. Joe mentions that K6TOP is at Fort Sill, Okla. State Guard WERS is progressing well in San Francisco. CVP, JKN, and LPZ are doing a great job. An overnight bivouac was recently held at Fort Cronkhitte with the Signal Det. furnishing both communications and portable lighting. Chief Warrant Officer CIS and Major RM recently met in the Philippines. TMB is in San Francisco. RM1c 7IBC is back from another trip to the Philippines. RM1c INHN still is located at T.I. 5FDR is permanently located

(Continued on page 108)

NEW "EVEREADY" "MINI-MAX"

"B" Battery has started Engineers figuring

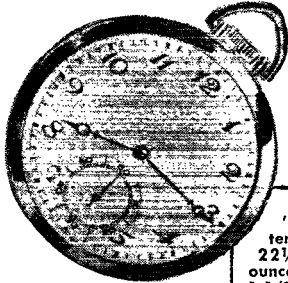

This is "Eveready" "Mini-Max" "B" Battery No. 412. It furnishes 22½ volts, weighs 1⅓ ounces. Dimensions are 2" by 1-1/32" by 5/8". Compare its size with that of a pocket watch.



No. 412

WE BELIEVE IT WILL START YOU FIGURING TOO!

THIS is the latest "Mini-Max" 22½ volt "B" Battery made with National Carbon Company's exclusive construction. It is a challenge to the best inventive brains in the radio and electronics fields.

Why? Because this "Mini-Max" battery packs 22½ volts into the smallest unit ever dreamed of—well under half the size of anything of comparable voltage!

Imagine a battery as light and easy to carry as a pocket watch. Imagine what it means to portable radios and many electronic devices. It means sets that will be carried among the individual's personal effects—sets small enough to go into vest pocket or handbag. It means a whole new world of merchandise—new customers—new opportunities.

And to speed these important develop-

ments in your postwar business, National Carbon Company, Inc. invites the engineers and designers of America to consult its technical advisors... take advantage of its laboratory facilities and experience. From such cooperation can come important new merchandise for the future of the industry.

EVEREADY

TRADE-MARKS

MINI-MAX

RADIO "B" BATTERIES

NATIONAL CARBON COMPANY, INC.

Unit of Union Carbide and Carbon Corporation



General Offices: NEW YORK, N. Y.

The trade-marks "Eveready" and "Mini-Max" distinguish products of National Carbon Company, Inc.

IRC RESISTOR CHART

SHOWS ALL... TELLS ALL!..

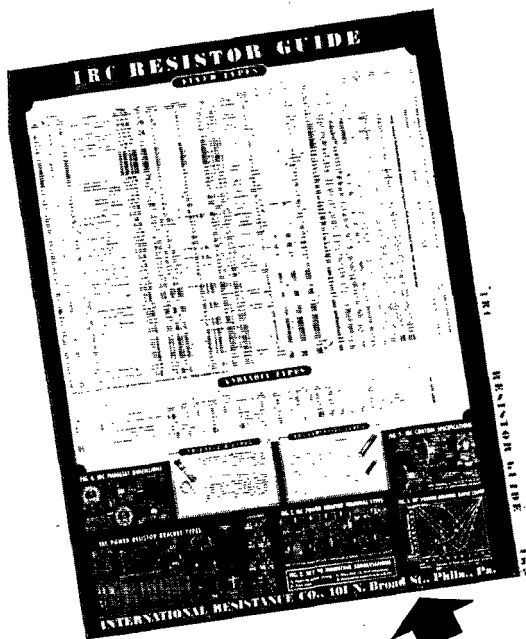

IMPORTANT DATA at a GLANCE

Here's a compact engineering chart on resistors that has earned the acclaim of hams and professionals alike.

At a glance you can quickly determine the right resistor for the applications at hand. All the essential information you need on 122 sizes in 18 standard types of IRC fixed and variable resistors is at your finger tips. The chart embraces such important data as Type numbers, wattage and voltage ratings, variations, dimensions, resistance values, temperature rise, type of terminals, methods of mounting and other useful and pertinent facts. Also included are a color-code chart, volume control curves and a table of RMA Preferred Number Ranges.

Of convenient size and adaptable for wall or desk use, the IRC resistor chart is yours for the asking. For your free copy address Dept. 18-J.



INTERNATIONAL RESISTANCE CO.

401 N. BROAD ST., PHILADELPHIA 8, PA.

IRC makes more types of resistance units, in more shapes, for more applications, than any other manufacturer in the world.

(Continued from page 100)

at Alameda base. 2NAK and 2ILE are in San Francisco. Be seeing you on the air soon, I hope. 73, Bill.

ROANOKE DIVISION

VIRGINIA—SCM, Walter G. Walker, W3AKN—GGP reports on the following hams: IFJ is a military policeman at Camp Stoneman, Calif. Sgt. IKT, AAF, is in the China Theater of Operations. Lt. Bent, operator license, is in the Marines in Okinawa. S/Sgt. GGI is in the Army in Boca Raton, Fla. HKE is in Norfolk. Lt. NT, USN, is in Norfolk. HOC, AAF is in Los Angeles, Calif. JHC reports the following: JHJ, of Richmond, recently was married. JNH, signalman 1st class, USN, was home on leave from the Pacific area. Carlton, and also your SCM, would like to hear from the rest of the Richmond gang. Your SCM has had letters from the following within the past two months: NE, merchant marine, Pacific area; Lt. IEX, Navy, So. Pacific; Brig. Gen. HWJ, AAF, Tampa, Fla.; M/Sgt. HBH, Army, o/o APO, San Francisco, Calif.; BZE, in the AAF, Egypt. Apologies are offered for the error in NE's address in a past SCM column of QST. The correct address is A. C. Jones, W3NE, S.S. J. W. Van Dyke, Atlantic Refining Company, o/o Postmaster, San Francisco, Calif. HBH suggests a campaign via QST to secure news from all Virginia hams. 73, Walt.

ROCKY MOUNTAIN DIVISION

COLORADO—SCM, H. F. Hekel, W9VGC—CNL has been standing by waiting for a little girl which he has been promised. He has been spending most of his time designing three-cornered costumes to eliminate the most dangerous thing in the U. S., the safety pin. 6SSA is looking for a jr. operator, and when asked whether he wanted a boy or a girl said he would be satisfied with one of each. Chick is, or was, a part of the U. S. Army Signal Corps in camp near Fort Leavenworth, Kans. EHC now is out of the hospital. CAA is waiting for his health to get back to normal. During the few days left in the 1945 fishing season you can expect to hear a lot of tall tales about the big ones that got away. And speaking of fish, I have a tank full of gas, I know where some of the biggest ones are, I'm headed in that direction, and I'll see you when I get back, 73, by Heck.

UTAH-WYOMING—SCM, Victor Drabble, W6LLH—6NPU is attending Teletype School in Chicago. 6SYD and 9NFX are organizing a 2½-meter net for some good old hamming and rag-chewing. 6MDP works on some new Federal Road Engineering projects. 6UOM is building for the 2½-meter band. Ex-7DYI goes back to Montana to take over a broadcast job. 6BLE is engineering on the Inter-mountain Mutual Network. 9CKO wants to get on the 2½-meter band, too. 9OLL also is interested in the 2½-meter band and will get on as soon as his gear is brought from Denver. 6LLH wants to try the v.h.f. bands. 73, Vic. ?

SOUTHEASTERN DIVISION

EASTERN FLORIDA—SCM, Robert B. Murphy, W4IP—Correspondence shows that "Red" Webster is out in the Pacific on the USS *Tuscaloosa* as communications officer. BXL is back from the Pacific and expects to return after a month's furlough from the merchant marine. AR and MD are running the local F.P. & L. Co. high-frequency trouble circuit here in Miami and doing a swell job of it. The following comes from HGO: Lloyd Boyle (LSPH) is in the Florida Senate; Warrant Officer QW is chief radio engineer on Palmyra Island. CPG, with Raytheon Radar, passed through Sanford on his way to San Francisco from Miami. BYR said hello to Dawson on his way through Sanford. DU sent HGO a card telling him he was on 1980 with the CAP Spence comes through from St. Pete and has accepted an EC appointment for the coming year. We are very sorry to hear of the death of GAC, which was reported by EYI. ASR is making the rounds of Miami attending the local radio club meetings. The local 2½-meter net still is a real hot net. Tom Powell, of WKNW-54, expects to leave the Navy soon. WKNW-7-17 has secured a mobile unit from the local Red Cross and has installed a disaster relief unit in it to be known as WKNW-30. This station is manned by Jenard of the No. 3 unit and is set up in Ft. Lauderdale, about thirty miles to the north of Miami, and works into the Miami control station. A spike antenna not more than 12 feet above the ground was used, and the control is about 200 ft. high. The following WKNW stations are active: No. 2 is having relay trouble but expects to fix

(Continued on page 104)

GIRDER CONSTRUCTION...

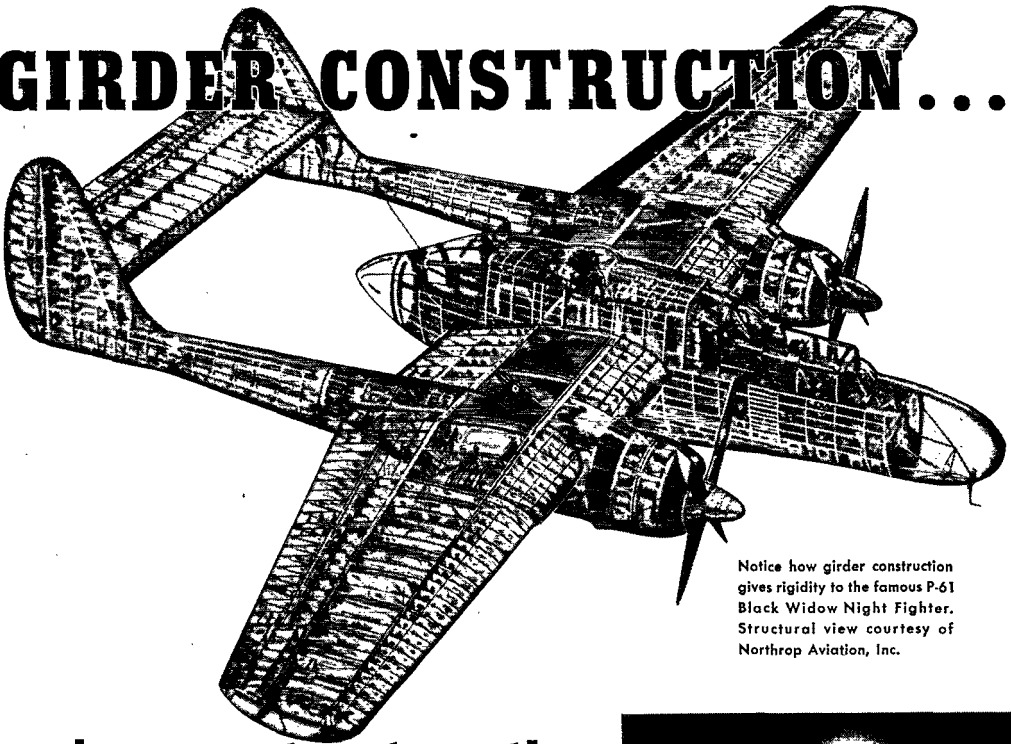

Notice how girder construction gives rigidity to the famous P-61 Black Widow Night Fighter. Structural view courtesy of Northrop Aviation, Inc.

gives greater strength to *Gammatron Tubes*

The same type of construction which gives strength and rigidity to a modern airplane, skyscraper, or bridge has been successfully incorporated into the design of the HK-854 and HK-1054 triodes. Compare the girder construction of the P-61 with the plate and grid supports of the HK-1054—the structural principles are identical! Note particularly how the heavy tripod plate support is welded to large diameter tubing, which in turn is firmly secured to the copper plate cup.

Because of their girder construction, HK-854 and HK-1054 Gammatrons stand up exceptionally well even when subjected to the vibration and stresses which usually accompany their use in such industrial applications as dielectric heating.

This superior internal strength is important since it prevents internal shorts, and variations in the characteristics of the tubes due to movement of the elements.

NEW LOW PRICES NOW IN EFFECT-

TUBE TYPE	NEW LIST PRICE
HK 854-H (High amplification factor) . . .	Now only \$60.00
HK 854-L (Low amplification factor) . . .	Now only 60.00
HK 1054-L (Low amplification factor) . . .	Now only 135.00

KEEP BUYING  WAR BONDS

HEINTZ AND KAUFMAN LTD.
SOUTH SAN FRANCISCO · CALIFORNIA

EXPORT AGENTS: M. SIMONS & SON,
25 WARREN STREET, NEW YORK CITY, U. S. A.

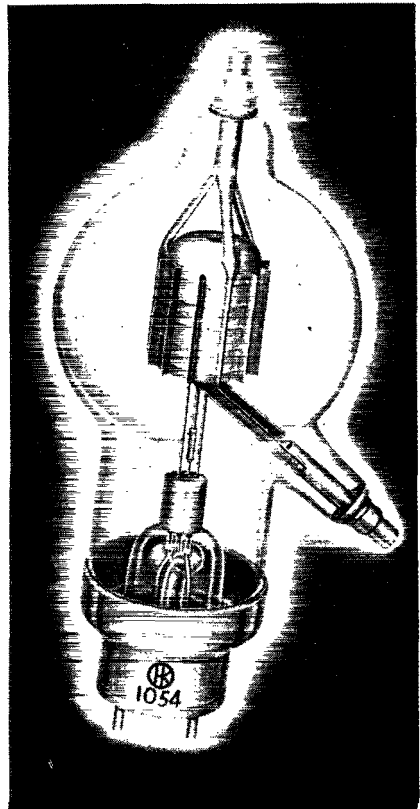

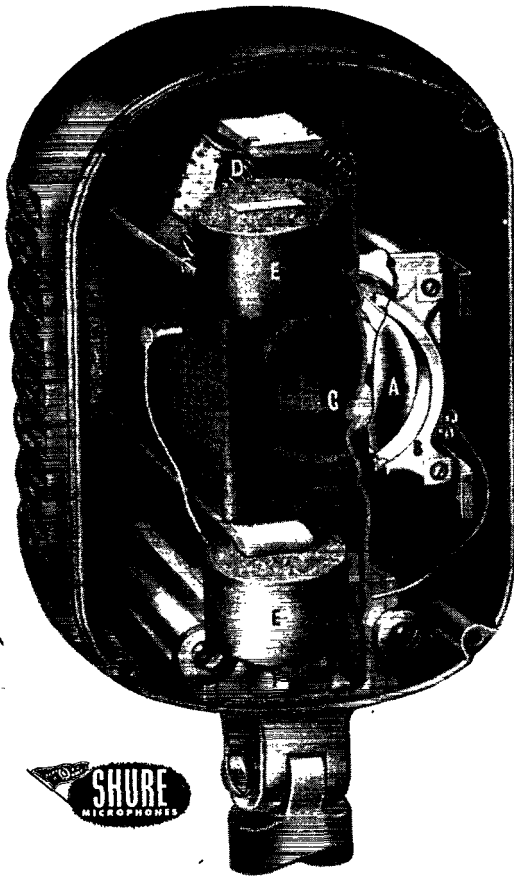

...this is the single unit*
construction of the

SHURE "556" Super-Cardioid Dynamic Microphone

- A. Single moving coil diaphragm.
- B. Rugged 4 point diaphragm suspension.
- C. First wind screen.
- D. Spring mounted mechanism.
- E. Shock absorbers.
- F. High fidelity transformer.

* Using the "Uniphase" principle, an exclusive patented Shure development, this single unit construction is possible in a unidirectional microphone. This eliminates the problems of matching two dissimilar units. This advantage, plus compactness and ruggedness, is available at less cost to you.

SHURE BROTHERS

Designers and Manufacturers of Microphones
and Acoustic Devices

225 West Huron Street, Chicago 10, Illinois

104

(Continued from page 108)

that soon; No. 3 is busy assembling the No. 30 unit; No. 5 reports from Homestead; No. 6 is taking his turn at control; No. 7 has a beautiful shack and a very nice amateur set-up; No. 11 can do a little more running now that gas rationing is over; No. 13 is rebuilding; No. 14 has changed rigs but still is putting in an excellent signal; No. 18 has a very compact fixed portable job; No. 19 is down south for PAA; No. 32 has one of the best mobile rigs in the net; No. 33 put in a very nice receiver signal to control; No. 36, mobile, is very active and has been heard from Ft. Lauderdale; No. 39's modulation trouble has been fixed now; No. 44 believes in plenty of antennas; No. 48 surprised himself by working into control from PAF; No. 51 has a novel device for a transceiver in changing from sending to receiving; No. 55 is experimenting with an extended Zepp; No. 57 is having modulation trouble; No. 61 has an 815 *Handbook* job with grid and plate rods which is very stable; No. 64 makes net, schedules between trips across the pond with A & O. 73. *Merf.*

WESTERN FLORIDA — SCM, Lt. Edward J. Collins, W4MS — HJA is anxious to get going as he was on only a short time before Pearl Harbor. HEP, ex-6NEM, is getting set to get back on 28 Mc. as soon as the word is passed. EQR is working hard to get his new shack finished and the rig set up at his new QRA. AXP says he only has to run wires between units and he will be ready to go. ECT is gathering parts together. DAO is all set except for antennas. EAD has written in for dope on the old reliable Western Florida crystal exciter that we all use down Pensy way. FHQ should be the first Western Florida ham on when the word is passed. DAO visited KB and Jimmy is looking forward to again ruling the 75-meter 'phone band. 5AX has returned to Washington. 6PNI is working hard on his new high-frequency gear. IID-3FZL was a visitor and is looking at gear also. JV has finished checking the Signal Shifter. BKQ says the 35T's should really work the 28 Mc. band over. VR is planning an enclosed rack for his rig and will also have 35T's perking. 5SR-2LNF has been in our midst for a few weeks and we have enjoyed his visits. FJR likes her SX-28 and is looking forward to working the 7 Mc. nets with it. DMV is working on a receiver for the rig when he gets back to Eastern Florida. ACB is rarin' to go on all bands. BJF should have things humming over in Panama City. 8IWW is in our midst. 80SQ flew in for a week end. MS is looking for a suitable QRA and trying to get the new rig together. AXP is looking forward to her old QSOs on 14 Mc. EPT still is out K6 way. EP was a visitor and is recovering from a serious illness. UW is keeping WCOA perking and VR assists him. QK was seen looking at his masts with visions of a new 7 Mc. Zepp. 5AQW is in our midst. DAO has a pair of T55s for his new final. EQR is putting his rig in an enclosed rack. JQ was discovered the other day and a rag-chew followed. DXQ has the shack about ready for operation. Guess the movie show will suffer as soon as we get on, as DXZ is operator. As far as we know, the following Western Florida hams are Silent Keys; GWU, HGM, and AGS. 73.

GEORGIA — SCM, Ernest L. Morgan, W4FDJ — GFF and Ola Mae are in California. FOL and Cookie are sweating it out in the Hawaiians. Doc Pepper is out of the SC repair shop and is in business for himself in Savannah. FCW has a San Francisco APQ address now. EGT is in the East with a shore assignment. WZ visited the gang in Savannah. CRJ, EWY, AMX, and Harry Hill are the standbys in Savannah. DIZ and DNY still are in the States. ERS visited FDJ and it sure was enjoyable; three long distance calls from some of the boys who wanted to know if they could get up steam and "CQ." 73, Pop.

SOUTHWESTERN DIVISION

LOS ANGELES — SCM, H. F. Wood, W6QVV — The L KGLV gang put on a swell picnic in Griffith Park on August 12th. Much credit should be given Cal Tabor for securing the location and Murray Black for his success in obtaining all the donations for our raffle. We must give credit for the donations to Don McCoy, Stan Lambert, Frank Milton, and the following radio stores in this vicinity: Radio Television and Supply Co., Henry's Radio, Dow Radio Supply, Figarts Radio Supply, Radio Products Sales, Radio Specialties, and Universal Radio. The chief prize was the Meissner Signal Shifter, won by Roy Lockwood. Lt. Leo Shepherd was the big winner in the number of prizes won. Rudy Jepsen didn't do as well as usual. Several pieces of new

(Continued on page 108)

"MUSTS"

FOR EVERY HAM'S BOOKSHELF

*"The All-Purpose Volume
On Radio"*

The Radio Amateur's Handbook

Text, data book, operating manual—it is all these and more. As a text it is probably more used in radio schools and colleges than any other single volume. As a practical constructional handbook, it stands in a class alone. As an operating manual, it provides information available from no comparable source.

The latest Edition of THE RADIO AMATEUR'S HANDBOOK is the largest ever published. It includes a comprehensive chapter dealing with War Emergency Radio Service plus other new material—all added without sacrificing the essential information in previous editions which made the HANDBOOK the world's most valuable and widely-used radio book. The theory and design sections cover every subject encountered in practical radio communication, sectionalized by topics with abundant cross-referencing and fully indexed.

\$1.00 in Continental U.S.A.

\$1.50 Elsewhere

\$2.00 Buckram Edition

A Course in Radio Fundamentals

By **GEORGE GRAMMER**

this book greatly smooths the way for the student of the technicalities of radio. It contains interesting study assignments, experiments and examination questions for either class or individual instruction. It describes in detail 40 experiments with simple apparatus giving a complete practical knowledge of radio theory and design. Price **50c**

The objective in preparing this course was to accent those principles most frequently applied in actual radio communication. "A Course in Radio Fundamentals" is a study guide, examination book and laboratory manual. Its text is based on the "Radio Amateur's Handbook." As a text,

Learning the Radiotelegraph Code

By **JOHN HUNTOON**

erator or access to a code machine. It is similarly helpful home-study material for members of code classes. Adequate practice material is included for classwork as well as for home-study. There are also helpful data on high-speed operation, typewriter copy, general operating information—and an entire chapter on tone sources for code practice, including the description of a complete code instruction table with practice oscillator. Price **25c**

This booklet is designed to train students to handle code skillfully and with precision. Employing a novel system of code-learning based on the accepted method of sound conception, it is particularly excellent for the student who does not have the continuous help of an experienced operator.

The A.R.R.L. Antenna Book

By **GEORGE GRAMMER** and **BYRON GOODMAN**

Feed systems and their adjustment. Construction of masts, lines and rotating mechanisms. The most comprehensive and reliable information ever published on the subject. Over 100 pages. Price **50c**

A comprehensive manual of antenna design and construction. Sixteen chapters, profusely illustrated. Both the theory and the practice of all types of antennas used by the amateur from simple doublets to multi-element rotaries, including long wires, rhomboids, vees, phased systems, u.h.f. systems, etc.

AMERICAN RADIO RELAY LEAGUE, INC., West Hartford 7, Conn., U.S.A.

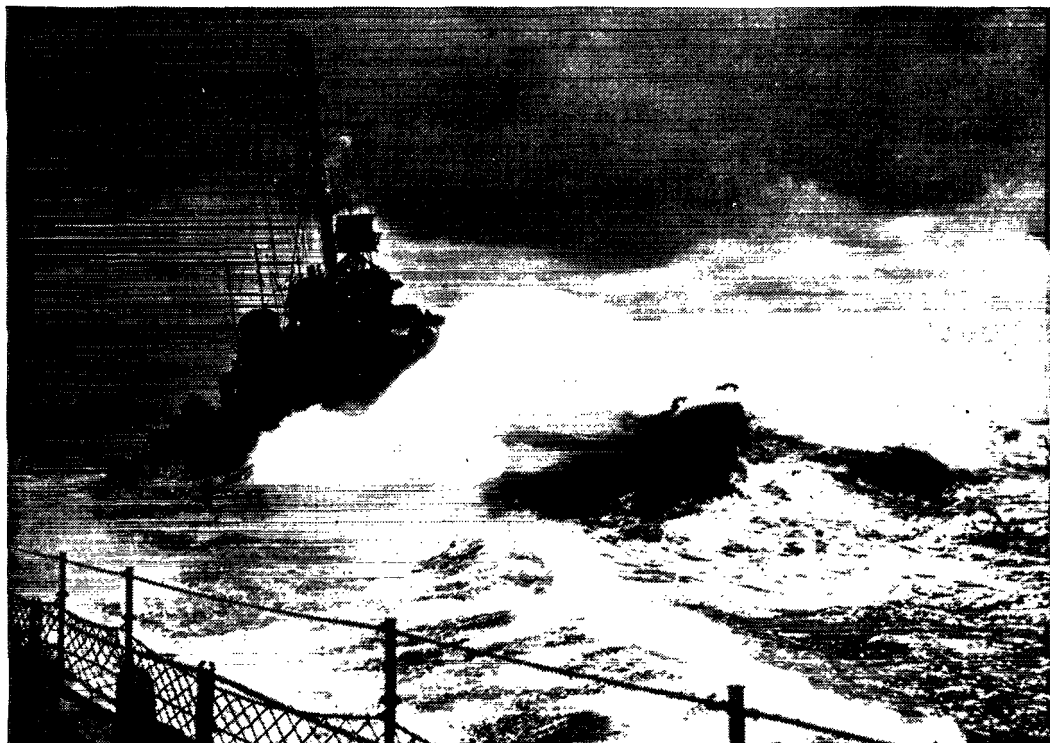

Any port in a storm ... but there are no ports

More than one sailor has said, "It's a helluva place to fight a war!"

That's a miracle of understatement when you know the Pacific as well as the U. S. Navy knows it.

They know how many thousands of miles you have to go before you reach the fighting fronts.

They know there's almost continual rain and bad weather to hamper operations after you get there.

And they know there are no good ports!

Think of the thousands of ships, and the millions of tons of supplies it takes to keep our fighting forces moving toward Japan.

Imagine, if you can, the problem of handling those ships and supplies with no port facilities.

There are no giant cargo cranes... no miles of docks and warehouses... nothing but beaches, and human backs, and a refusal to call any job impossible.

Remember, too:

It takes 3 ships to do the supply job in the Pacific that 1 ship can do in the Atlantic.

It takes 6 to 11 tons of supplies to put a man on the Pacific battleline, and another ton per month to keep him supplied.

It takes a supply vessel, under ideal

conditions, half a year to make one round trip.

Add up those facts, multiply by the number of sailors, soldiers, and marines for whom the Navy is responsible.

Maybe you'll begin to realize what "no ports" can mean in the rough, tough waters of the Pacific.

Maybe you'll see that we have *two* reasons to be proud of the U. S. Navy. *First*, the way they've sunk the enemy's ships.

Second, the way they sail *your* ships... taking the worst the Pacific can hand them... but keeping the supply lines open... keeping the attack *on schedule!*

SPERRY GYROSCOPE COMPANY, INC. GREAT NECK, N. Y.



Division of the Sperry Corporation

★
LOS ANGELES • SAN FRANCISCO • SEATTLE • NEW ORLEANS
CLEVELAND • BROOKLYN • HONOLULU

MAKERS OF PRECISION INSTRUMENTS FOR THE ARMED FORCES

NEW INSTANT-HEATING BEAM TETRODE
Ruggedized 2E25
FOR MOBILE OPERATION



Developed for Signal Corps portable, mobile, or emergency communications equipment, the 2E25 r.f. beam tetrode is easy on the battery. The thoriated tungsten filament permits simultaneous application of filament and plate potentials. Precious battery power is conserved during standby periods.

Completely shielded for r.f., the 2E25 requires no neutralization even at its maximum frequency of 100 megacycles. Other features are: low-loss octal base, plate connection to top cap, filament potential centered at 6.0 volts, and extremely rugged construction.

Consider the advantages of the 2E25 as an instant-heating replacement for the 6V6GT or 6L6G in older equipment, or for use in modern equipment such as the new Kaar mobile FM set illustrated. Remember, the versatility of the 2E25 beam tetrode simplifies the spares problem; this one type can power a whole transmitter—R.F. and A.F. Order your engineering samples today.

HYTRON 2E25	
Instant-Heating 15-Watt R.F. Beam Tetrode	
TENTATIVE ELECTRICAL DATA	
Filament Potential	6.0 ± 5% ac or dc volts
Filament Current	0.80 amp.
Plate Potential	450 max. dc volts
Screen Potential	250 max. dc volts
Grid Potential	-125 max. dc volts
Plate Current	75 max. dc ma.
Plate Dissipation	15 max. watts
Screen Dissipation	4 max. watts
Grid Driving Power (Class C)	0.5 watt approx.
Power Output (Class C)	20 watts
AVERAGE DIRECT INTERELECTRODE CAPACITANCES	
Grid to Plate (with external shielding)	0.18 max. mmfd
Input	8.5 mmfd
Output	6.0 mmfd
MECHANICAL DATA	
Maximum Overall Length	4 ³ / ₁₆ inches
Maximum Diameter	1 ¹ / ₁₆ inches
Bulb	T-11
Cap	Small metal
Base	7-pin med. short shell low-loss octal
The New 2E25 Supersedes and Replaces the HY65	



New instant-heating mobile FM transmitter developed by Kaar Engineering Co. uses 7 Hytron 2E25 and 2 Hytron HY69 or HY1269.

WRITE TODAY to Dept. 24 for these:
 New Hytron transmitting and special purpose tube catalog; 21 x 17 inch sheet illustrating Step-by-Step Assembly of Typical Hytron Tube.

OLDEST MANUFACTURER SPECIALIZING IN RADIO RECEIVING TUBES

HYTRON
 RADIO AND ELECTRONICS CORP.



MAIN OFFICE: SALEM, MASSACHUSETTS

An important statement on

CARDWELL deliveries...

Almost all standard Cardwell Capacitors are now being made at our Plainville, Connecticut, plant. The splendid facilities of this newly acquired plant will permit us to produce greater quantities, and to considerably improve delivery schedules.

Now Ready!

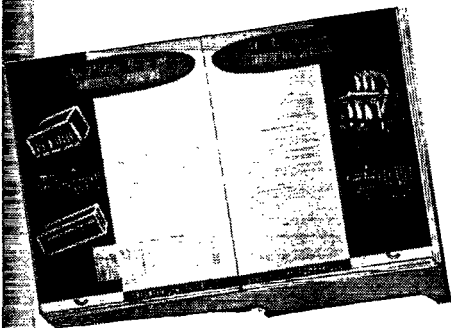

CARDWELL CATALOG No. 46

... a valuable new edition, just off the press. Filled with descriptions, charts and photographs of standard Cardwell capacitors, accessories and precision instruments.

... a handy reference manual of unusual interest to engineers and purchasing agents working on present and postwar projects. Your copy will be sent immediately.

THE ALLEN D. CARDWELL MFG. CORP.
81 PROSPECT STREET
BROOKLYN 1, NEW YORK

Please send me a copy of the Cardwell Catalog #46.

NAME
FIRM NAME
ADDRESS
CITY STATE

THE ALLEN D. CARDWELL MANUFACTURING CORP.

Main Office: 81 Prospect St., Brooklyn 1, N. Y.
Factories: Plainville, Conn. — Brooklyn, N. Y.

(Continued from page 104)

equipment were displayed, and during the regular Sunday afternoon test period the sets were put into operation and proved their worth. Fred Stapp, of KGIC, writes that the new license has been received and the net now covers a total of thirty-eight units. The net has a new frequency-checking station and considerable work is being done on various types of antennas. The Inglewood Club is going strong and will welcome any and all at their regular Friday meetings. FRB of Los Angeles and Fresno, writes from India that LTZ, of Beverly Hills, recently has joined his gang, the 4th Combat Cargo Sqdn., 1st Combat Group. Ken, who is an aerial radio operator, has been with this same group since it was formed and has had over 200 missions. If any of you readers have a good receiver that you would like to trade for the DFC with two clusters, and an Air Medal with three thrown in, write to him at above address. UQL finally got his discharge from the Army and one week end helped me pull wires in the shop. 73. Ted.

ARIZONA — SCM, Douglas Aitken, W6RWW — Doug still is in the hospital so MLL is writing his report. NRP is back in Nogales, having been discharged after spending a year in the So. Pacific, Marianas, and Philippines. NVS, former radio teacher at Phoenix High School, is a radio operator with the merchant marine on a coastwise Alaskan run. He reports his transmitter is a pair of 204-As in self-rectifying circuit and he has a couple of bloopers for receivers. MLL has been ill with arthritis since early July and is taking a year's leave of absence from the Nogales High School. Tucson is planning on WERS. They had twelve out for the last 25 Club meeting. GS is teaching code to twenty Chinese cadets. OZM and PGQ have moved their store in El Paso. OZM, of 418 No. 4th Ave., Tucson, is planning to issue a ham bulletin containing Arizona news. Send your name in to him. Doug would like all of you to let him know where you are. 73. G. C.

SAN DIEGO — SCM, Ralph H. Culbertson, W6CHV — Asst. SCM, Gordon W. Brown, W6APG — The meeting of the Helix Radio Club, held at the home of MMV, turned out to be FB. The meeting was officially opened with a talk and demonstration by OIN on the new butterfly type 2½-meter receiver. Postwar radio was the main topic of the evening. Those present were EOP, OIN, BHF, LYY, MXK, MHL, JRM, OUQ, HL, EDJ, QJK, APG, WLHG, Ted Thomas, and MMV. Paul Winestock is in Florida. HTJ is reported to be in the So. Pacific. Ted Thomas recently purchased the Radio Wholesale business from Roy Davis in San Diego and will open a store for hams next to the main store. A recent visitor at the home of the SCM was 2MRK from New Jersey, temporarily stationed at San Diego. 3IXF has been working at the Naval Air Station for the past year and hopes to make his home in San Diego. EWU has completed a new 2½-meter beam antenna for his transceiver and can work into San Diego over the old hill that has been our biggest bottleneck on our WERS net. WERS is progressing nicely with a total of thirty-seven active operators. Six new applications have been received. Regular schedules are kept with Long Beach and Los Angeles. Lt. Comdr. ILL is stationed in San Diego and expects to make it his permanent home. MKW is reported to be opening a new radio store in Santa Ana. GWY is in Washington, D. C., after spending a 30-days leave at his home. BHF, who is now a captain, reports that the California State Guard is organizing a radio communication company. Anyone interested is requested to get in touch with BHF. Captain CNB is reported to have enough points for a discharge. 73, Ralph.

WEST GULF DIVISION

NORTHERN TEXAS — Jack T. Moore, W5ALA — ISD reports from Linz, Austria, where he is pounding brass for the Army. JCN is working for the Dallas Aviation School. TW and IJR each have bought a home in Dallas. TW says that AJG spent one of the hottest July afternoons cutting the grass at the local QTH and was on his way to the shower when he was advised that the big job out at WRR was off the air because of a blown plate by-pass condenser which put 12,000 volts across a bunch of meters. Ed says that poor old Leroy worked three days and nights before he got everything under control. GML has completed a communication inspector's course at Kelly Field and has returned to Ellington Field at Houston. FXN reports from the Naval Air Technical Training Center at Ward Island, Corpus Christi, Texas, where he and FOR are

(Continued on page 110)

CAN YOU TOP THIS?

"HQ-129-X"
AMATEUR NET \$129.00*
LESS SPEAKER

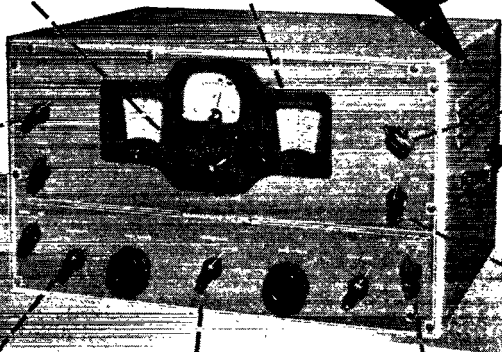

Calibrated
Band
Spread

Accurate
S-Meter

Stable
BF
Oscillator

Variable
Crystal
Filter

MAN-
AVC-
BFO
Control

Better
than 1 mv.
Sensitivity

Efficient
Noise
Limiter

Six Bands
Full coverage
.54-31 MC

PRICES SUBJECT TO CHANGE
WITHOUT NOTICE

All these features and more—You will see the new HQ-129-X at your favorite dealers SOON.

SEND FOR COMPLETE DESCRIPTION



HAMMARLUND

HAMMARLUND RADIO CO., INC. 480 W. 34TH ST., NEW YORK 1, N.Y.
COMMUNICATIONS EQUIPMENT

SOUND VALUES at TERMINAL RADIO

DE LUXE 20-WATT AMPLIFIERS NO. 6419

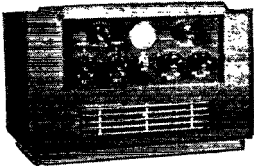

2 Hi-Z Mike Inputs. 2 Phono Inputs with Fader Controls. 1 Master Gain Control. Dual Tone Control, for Bass and Treble. Illuminated Panel. 4-8 or 500 Ohm Output.
2-6SQ7, 1-6SJ7, 1-6SC7,
2-6L6G, 1-5Z3.

Net Price with Tubes.... **\$43.59**

F.O.B., N. Y.

WALNUT FINISH WALL BAFFLES Reinforced Construction

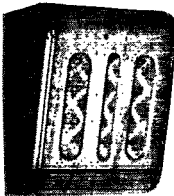

SPECIAL PRICES:

- For 5" Speaker..... **\$1.74**
- For 6" Speaker..... **2.45**
- For 8" Speaker..... **3.01**
- For 10" Speaker..... **3.48**
- For 12" Speaker..... **4.53**

NO PRIORITY REQUIRED

UTAH PUBLIC ADDRESS SPEAKERS

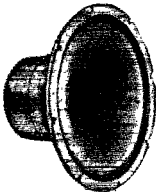

Model

- 8P- 7 Watts- 8" Diam... **\$3.38**
- 10P- 9 Watts- 10" Diam... **5.43**
- 12P- 10 Watts- 12" Diam... **6.61**
- E12P- 13 Watts- 12" Diam... **9.40**
- G12P- 17 Watts- 12" Diam... **14.25**
- GS12P- 20 Watts- 12" Diam... **20.43**
- H12P- 22 Watts- 12" Diam... **25.28**

NO PRIORITY REQUIRED

Other Sizes and Models in Stock

HEAVY DUTY POWER CONTROLS Standard Brands—New Stock



50 WATT

- 16 Ohms
- 32 Ohms
- 50 Ohms
- 150 Ohms
- 250 Ohms
- 300 Ohms

ANY SIZE **\$1.82**

25 WATT

- 6 Ohms
- 100 Ohms
- 250 Ohms

ANY SIZE **\$1.63**

5000 Ohms...\$1.92

NO PRIORITY REQUIRED

STEEL UTILITY CABINET

Size 19 x 12 x 10 for 8 3/4 x 19 Panel

- Top door with snap lock. Heavy duty construction. Black crackle finish. Special price while they last. Only..... **\$3.98**
- Steel Panel..... **.88**
- Steel chassis, 11 x 17 x 2..... **\$1.35**

NO PRIORITY REQUIRED



TERMINAL RADIO CORP.

85 CORTLANDT ST., NEW YORK 7, N.Y. Tel. WOrth 2-4415

(Continued from page 108)

learning radio the Navy way. Jim would like to hear from some of the gang of the N.T.A.C. hama club, EUY, class of 1939, and sends his regard to OL, FEW, and EXW. CDU reports that GTL still is in Alaska and has gotten his commercial 2nd-class ticket. BBH, 3417 Clary, Ft. Worth 3, is a railway mail clerk on the "Twin Star Rocket" between Ft. Worth, Texas, and Caldwell, Kansas, and would like to hear from other hams in the Railway Mail Service. IBH hopes to go back on the air with three or four hundred watts 'phone and c.w., 80 through 10 meters, in addition to some portable equipment on one or two of the higher frequencies. BNQ has ordered an SX-25. IRZ advises that he and GGD did some work on the atomic bombs, but they didn't know what it was at the time. The SCM has added a DB-20 to the receiving equipment at ALA. Have just received a telegram from NW advising that Bailey and Warner are doing everything they can to see that we return to the air as soon as possible. 73, Jack.

OKLAHOMA — SCM, Ed Oldfield, W5AYL — Lt. HZE, radio officer of the 595th Joint Assault Signal Co., Fort Jackson, S. C., would like to hear from the gang. M/Sgt. IQH is at Hammer Field, Fresno, Calif., after service overseas. Sgt. FIG, who saw service in the 14th Army, is in the Burma Theater. He'd like to get back to KAPE. Cpl. JELJ, located at Padre Island, Port Isabel, Tex., is in radar navigation. Bob is looking forward to a good game of chess with AFX and to getting back on the air. Regards, Ed.

SOUTHERN TEXAS — SCM, James B. Rives, W5JC — DTJ reports he just received his Class A ticket. 9IBD is with AACS and is stationed at Kelly Field. IQG is working at one of the b.c. stations in San Antonio. We received a very interesting letter from Major Roydebush, ex-5CBF, in Italy with the 9th Radio Squadron. AJW has recently completed his new home with ample provision for the ham rig. VL, of ARRL Headquarters, spent his vacation in San Antonio and we enjoyed a good rag-chew. SF is contemplating a rushing business as soon as the new radios hit the market. Col. DZ is keeping busy at Randolph Field. BIP, EVK and your SCM are now in the Communications Engineering Section, SAATSC, with headquarters at Kelly Field. FNA is operating at KMAC during the day and tickles the ivory in a dance band at night. The secretary-treasurer of the San Antonio Radio Club, Henry B. Valte, 125 City St., San Antonio urges all amateurs of the Southern Texas section, to get in touch with him so that peacetime organization can be started as soon as possible. 73, Jim.

NEW MEXICO — SCM, J. G. Hancock, W5HJF — State Guard WERS Net, organized by Francis Gormley (LSPH), has been issued the call KAAN and plans have been made to have two or three transmitters in each company of the State Guard over the State. Visitors to the shack of yours truly were: CXP, who is building a push-pull T-40 final on his rig; Harold Wheeler (LSPH), who seems none the worse for the shrapnel wounds received in Germany; Sgt. Art Huestead (future ham), with whom the SCM enjoyed a grand discussion of atomic energy; and 1ESZ, who helped raise the new Zepp antenna here. The Zepp is made of No. 10 hard-drawn copper throughout its 132-foot antenna length and 130-foot feeders with plexiglass spreaders. 73, Jake.

The Month in Canada

QUEBEC — VE2

From L. G. Morris, VE2CO:

BILL SKARSTEDT, 2DR, and your SCM, 2CO, have been demobilized from the Navy and are back at their old jobs in Montreal. Rod McDonald, 2FO, writes to say that he is now with the Charles H. Babb Co., and has moved to New York. F/O J. L. Garshore, 2OL, has been transferred to No. 2 T.S.U., RCAF, Penhold, Alta. W. G. MacDonald, 4BM, is a wire chief with Canadian Pacific Communications in Montreal. A real old timer (first licensed in 1922), 4BM is interested in low-power 'phone and, like many others, is just waiting for the word go.

ALBERTA — VE4

From W. W. Butchart, VE4LQ:

As this is being written, hams all over the world are beginning to take stock of their equipment, etc. Enthusiasm in Edmonton is just as high as elsewhere, and the

(Continued on page 114)



WORLD'S FASTEST PLANE *uses* ANDREW COAXIAL CABLES!

*Lockheed's sensational
new jet-propelled su-
per fighter, the P-80
"Shooting Star," is
the world's fastest and
highest flying plane.*

★ It is highly significant that Andrew coaxial cables were chosen for the vital radio and radar equipment installed in the P-80. They were selected because they are much more resistant than ordinary solid dielectric cables to the high temperature encountered in the tail of the plane.

Andrew Co. is a pioneer manufacturer of antenna tuning and phasing equipment, including a complete line of ceramic insulated coaxial cables and all necessary accessories. *Write for catalog.*



**ANDREW
CO.**

**363 EAST 75th STREET
CHICAGO 19, ILLINOIS**

Ted McElroy

THE WORLD'S MOST ENTHUSIASTIC DISTRIBUTOR OF HALLICRAFTERS EQUIPMENT

Wherever we Yanks travel throughout the world, we get kidded about "world's largest", "world's best", etc. So I figure to be typically Yankee, and grab for myself the title as the world's most enthusiastic distributor of the fine transmitting and receiving equipment produced by the world's largest builder of communications equipment.

I know Hallicrafters. I've known the sets ever since Bill Halligan started making them about ten years ago. And I learned lots more about them during the past few years when they did such a remarkable job for our Armed Forces. And I'm awfully happy to tell you that I have the privilege of supplying these Hallicrafter receivers and transmitters to operators everywhere.

Now I've got to tell you something. All through this lousy war, while my boys and girls joined the Army and Navy and Marine Corps and Merchant Marine, I got itchy and itchier. Too old (so "they" said) for the Army and Navy, I finally was lucky enough to get back into harness as a seagoing radio operator. While I was away, Frank Bascomb ran the factory, and did a good job. So good, that I'm going to let him keep running it. Naturally, I'll continue the design on high speed transmitters and recorders, etc., but actually I'm going to devote myself to a job that'll enable me to be in closer touch with more operators throughout the world.

So strongly do I feel about this job that I'm planning to run the show 100% by myself. I can't write advertising like a regular advertising man. But I ain't selling radios to advertising men, I'm selling them to guys like myself — radio operators.

Radio is my life. When I tell anyone, whether an operator or one of those short wave guys, or fellows out of the Armed Services — when I tell you I'm going to give you the finest equipment with the best personal attention to every letter, inquiry or order — then you can be sure that you're going to get it. No matter where you live — here in the U.S., or Canada, Mexico, Central and South America — anywhere in the world — I'll see to it that your set reaches you in perfect operation — AND FAST.

Supposing you want a swell little set like the EC-1-A, or the Champion, or the Super Defiant. Supposing you want one to go to your brother, your son, or any relative or friend anywhere in the world in our Armed Forces. Send your order and the address, and I'll see to it that the set goes out with as great care as though it were going to my Jackie in Okinawa, or Betty in the Marines in Frisco, or Virginia in Des Moines. Supposing your kid is on "lend-lease" to the Brazilian Navy — what I'm trying to tell you is that we, all of us, must think this Christmas not only of ourselves but of our boys and girls. And I'm the guy that'll see to it that the sets reach the kids just as good as they reach you here in America.

Yes, and I'm providing for time payments and trade-ins, etc. These are details. The real job is to get orders in — and fast. I can ship any receiver in the line right now. Let's go, eh?

73 S





Ted McElroy looks over the SX28 with Panoramic Adapter, as Bill Halligan, President of Hallicrafters, describes the units.

Joe Thompson, Hallicrafters sales, congratulates Ted McElroy on the signing of the franchise to become "the world's most enthusiastic distributor of Hallicrafters"



*Available for Immediate Delivery!
No Priority Needed!*

Echophone, EC-1-A
Champion, S20R
Super Defiant, SX25

*Extremely low-cost Hallicrafter sponsored time payment plan.
Send me your order now, and I'll ship your set the same day.*

Ted McElroy

82 BROOKLINE AVENUE • BOSTON, MASSACHUSETTS



We are delivering the following Hallicrafters models:

EC-1	\$ 28.50
\$20R	60.00
\$22R	74.50
\$39	110.00
SX-25	94.50
SX-28A	223.00
\$36	307.50
PM-23 SPEAKER	15.00

Telegraph, telephone, or mail your order. No restrictions. No priority required. You can send \$5.00 and pay balance C.O.D. You can trade in your receiver. You can buy on terms. Write for full information. Tell us your wishes. We will help you get the best receiver for your use and will see that you are 100% satisfied. We also have a complete stock of amateur parts, transmitters, etc.

WRITE NOW . . . TODAY . . . BE THE FIRST TO GET YOUR LONG AWAITED

hallicrafters

HENRY RADIO SHOPS
 211-215 N. Main 2331-35 Westwood Blvd.
 Butler, Missouri Los Angeles 25, Calif.

"WORLD'S LARGEST DISTRIBUTOR OF SHORT WAVE RECEIVERS"

(Continued from page 110)

Northern Alberta Radio Club has already made arrangements for a general meeting of local hams.

Of the Edmonton gang, 4BW, Ted Sacker, has been placing orders for ham gear, and making arrangements to handle a flood of orders from the ham trade. As far as his own rig is concerned, Ted put an ad in one of the local papers asking for a couple of Tamarac sticks to carry his sky-wire. To his amazement the chap who bought his former residence phoned to say that he could have his two former poles for the taking. A colored chart showing American frequency allocations for postwar is exhibited in BW's joint. Regarding that new band at 21 Mc., 4EA, Roy Usher, notes that it's really not anything radically new, as he once had a rig about the year 1931, which by some strange quirk of fate, tuned up nicely on the third harmonic of his 40-meter rock! 4YD, Pete Fair, Peace River, High River and Medicine Hat, is back on Civvie Street once more, and is at present working in the Canadian Bank of Commerce at Medicine Hat. He apparently doesn't think he'll locate there, so we'll let you know later where his permanent QTH will be. Albert Potoski, official correspondent for the Lethbridge gang, reports doings in the Southern City as follows: Stan Read has acquired a 1938 Super Skyrider to match his rebuilt rig. 4DN, C. H. Kern of Glenwoodville, has the makings of a dandy rig. (In passing, let me, 4LQ, note that I used to hear 4DN on 'phone way back in the early '20s.) Yep, boys, DN is really one of the Alberta OTs. 4ACS also makes his headquarters in Glenwoodville. Bud Becker, 4ACS, was holidaying in Lethbridge for a few days. So far his postwar plans consist of getting on the air with a pair of 6L6s. A. J. Neilson, 4OE, Lethbridge, is back home after serving with the RCAF overseas. Bob Reach, 4OG, has returned to the city after serving overseas. Bill Savage, 4EO, Lethbridge, is busy chasing up subscriptions for *Xtal*. Bill is serving advance notice on Edmonton hams that he will be up here in the fall. Mr. Courtney, of Burmis, figures on doing some mountain climbing, and will try some work with ultra-highs. 4HM, Charles Harris, Edmonton, and his YF just left for a holiday at Jasper Park. Charles was asked by 4AKK, Bob Lamb, Edmonton, Calgary, to check CFCN's shortwave frequency. Apparently the D.O.T. had checked them off-frequency by some few cycles. Charles' check was only cycles away from D.O.T.'s check, which speaks well for HM's frequency-checking equipment and the OM's skill at handling same! HM's daughter Betty of the WRCNS is home on leave at present after completing a course at St. Hyacinthe, P. Q. She has volunteered for Pacific duty, but it would almost appear now that she will be back in civvies again soon! HM's son, Roger, has gained the rank of sub-lieut. in the R.N. Fleet Air Arm, where he has enlisted as pilot. He is training in England at present.

As for LQ's activities, BW has convinced me that I should unveil the old rig and turn on the power supplies so that I can take stock of all the filter condensers. The rig will be substantially the same as I had when we went off the air. By the way, 4EA has neither rig nor receiver, so he'll have to get busy pretty soon now and figure out what he will appear on the air with.

MANITOBA—VE4

From Art Morley, VE4AAW:

CALLING CQ, CQ, CQ. Won't it be swell, but don't beat the gun. It shouldn't be long if you have been reading all the dope in *QST* in the past months. And thank your ARRL when they do let us on.

4QG had just got back to the West Coast when he was sent back to Winnipeg. Bill is on leave prior to being discharged. 4VG is also in the Peg waiting discharge. 4NM who hadn't been heard from for ages was seen around town sporting an RCAF uniform with one ring around his arm. Frank also had a YL in tow. 4YR from the Pas moved to Togo, Sask., since last heard of and in the meantime to quote "gotten myself married so I don't have to rely on Chinese flapjacks as the staff of life." He says that 4XT has enough stock to make the average ham's mouth water. Leo is still projectionist manager of the local film, ahem, emporium. 4LO formerly at the Pas is now with D.O.T. at Edmonton and has joined the ranks of the benedicti in the past year. 4PA at Dauphin managed to get hold of 4AEE before the latter was posted. 4AEE has now been discharged and is working with the CNR. 4PA and Sgt. Scheer of the RCMP have been holding radio classes for some 20 or 25 kids. Scheer should be a ham as soon as the lid is off.

Practice your c.w. up fellows. Six years is a long time. Thanks to all the fellows that made Tuesday come so soon

Get Back on the Air

WITH A NEW RECEIVER

AVAILABLE

APPROXIMATELY

NOVEMBER 1ST



RESERVE YOUR RECEIVER NOW!

The lid is off . . . now you can have that new receiver with new design features, new performance capabilities, and new operating convenience. Supplies will be limited for a while, so order your set promptly. Prices are still low . . . and you can get any of these new receivers on convenient time-payment terms.

Write us for the latest information on other ham gear — transmitters, coils, capacitors, tubes, and keys.

• Available on
TIME PAYMENT
if desired

• Write for
FREE 108 PG. CATALOG
of all ham gear

HALLICRAFTERS

SX-28A

S-20R

SX-25

S-39

NATIONAL

NC-240S

NC-45A

HAMMARLUND

HQ-129

ECHOPHONE

EC-1

The RADIO
SHACK

★ 167 WASHINGTON ST.
BOSTON, MASS., U.S.A. ★

**Because Accuracy
Hangs in Balance**

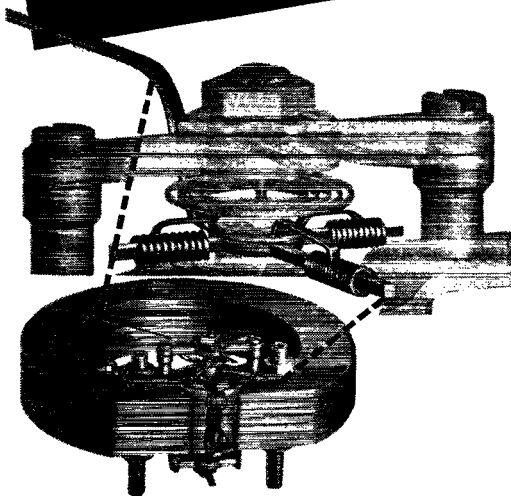

**... Simpson balance weights
are LOCKED IN PLACE**

PERHAPS it's the smaller details, like these balance weights, that best illustrate the value of Simpson's 35 years of experience.

Though only tiny coils of wire, these balance weights have an important function—to offset the weight of the pointer so the moving assembly will swing in perfect balance. If the instrument is to stay accurate, they must stay in place.

So Simpson has devised a method of locking these balance weights in position. This construction not only defeats vibration and shock, it permits even greater initial accuracy and makes possible faster, more efficient production.

Such refinements come from a greater knowledge of the problems of instrument manufacture, and a greater fund of practical experience which can be applied to their solution. This is the simple reason Simpson Instruments are writing such an outstanding service record in posts of vital responsibility. This, too, is your guarantee of the ablest translation of today's advances in tomorrow's instruments.

SIMPSON ELECTRIC COMPANY
5200-5218 Kinzie St., Chicago 44, Illinois



Using High-Power Beam Tubes

(Continued from page 69)

contact is provided by a spring-metal strip which bears against the base shell when the tube is plugged into the socket.

The plate tank condenser is mounted in an inverted position on National GS-2 2½-inch pillar insulators so that its stator terminal is close to the tube plate terminal. The output tank coils are wound on National XR10-A forms. Since the 3.5-Mc. winding requires the full length of the form, the link winding is preformed on a larger diameter which will slip over the ceramic form and is held in place by strips of ¼-inch bakelite. Link coils for the other bands may be wound directly on the form at the "cold" end of the tank coil.

Two filament transformers are required — one delivering 6.3 volts for the 6L6 and the other 5 volts for the 257-B. Space for these will be found underneath the chassis. The toggle switch on the panel serves to switch the milliammeter to read oscillator or amplifier cathode current as desired.

The 257-B is a pentode. Screen voltage is obtained from the oscillator plate-voltage supply, while positive suppressor voltage may be taken from a tap on a voltage divider across the supply. Grid bias should be adjusted as described previously for the 4-125-A amplifier. At a plate voltage of 2000, under typical operating conditions, the plate current when the amplifier is loaded should be 150 ma., the suppressor voltage 60, biasing voltage —180 and the grid current 9 ma.

Converting 112-Mc. Gear

(Continued from page 73)

however, since the L/C ratio will change considerably and spoil the frequency stability which is the outstanding characteristic of this oscillator. The original L/C ratio can be restored by reducing the inductance of the horseshoe tank coil.

The original design of the horseshoe-shaped tank coil purposely included slots in the open ends to permit changing its inductance by the simple expedient of sliding it in and out of its mounting under the stator plates of the condenser. To hit 144 Mc. the mounting bolts under the stator plates should be loosened and the horseshoe slid in as far as the original ¾-inch slots will permit. This leaves a distance of 1½ inches between the outer edge of the horseshoe and the edges of the stator-plate contacts on the copper strips. Resonance at 144 Mc. occurs when the tuning condenser is turned approximately 37 degrees out from the maximum-capacity position. With these adjustments, the performance at 144 Mc. is fully as good as at the lower frequency.

Incidentally, the metal 6L6s and 6V6s also work well in this circuit, but don't try to use the glass versions — their internal leads are too long and it was found that only selected tubes could be made to oscillate at 144 Mc. in this circuit.

The "Wonder Tube"

TZ-40

YOUR BEST BET FOR

2½ METERS

(112 TO 115.5 MC)

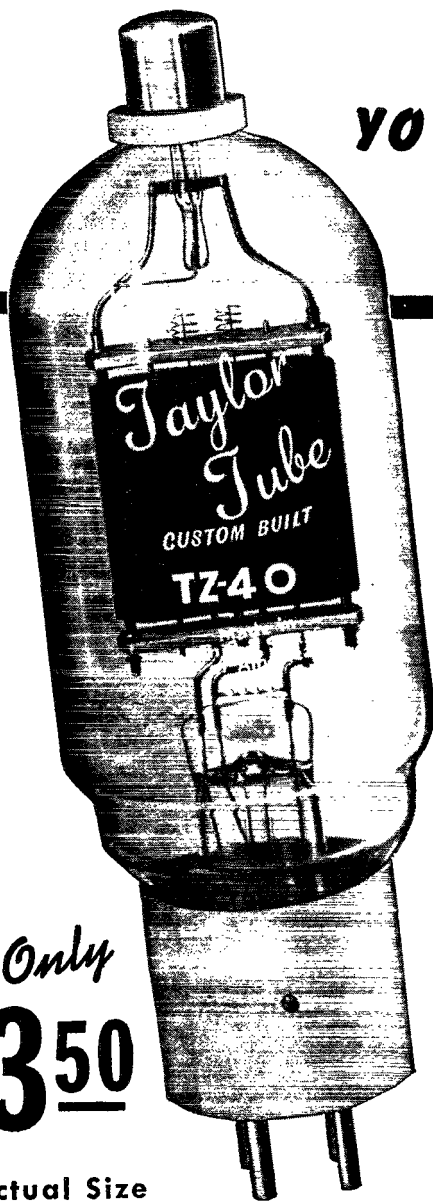

Only
\$350

Actual Size

SEE DIAGRAM 1610
ON PAGE 336 IN
1945 ARRL HANDBOOK

Taylor TZ-40 represents the greatest value among all Transmitting Tubes. An all-purpose Tube that gives you the highest order of efficiency and the greatest Safety Factor.

•
YOURS FOR THE ASKING

The 1945 edition of the Taylor Tube Manual is ready for you. Write for one today!

•
"MORE WATTS PER DOLLAR"

Taylor HEAVY **CUSTOM BUILT** DUTY **Tubes**

TAYLOR TUBES INC., 2312-18 WABANSIA AVE., CHICAGO 47, ILL.

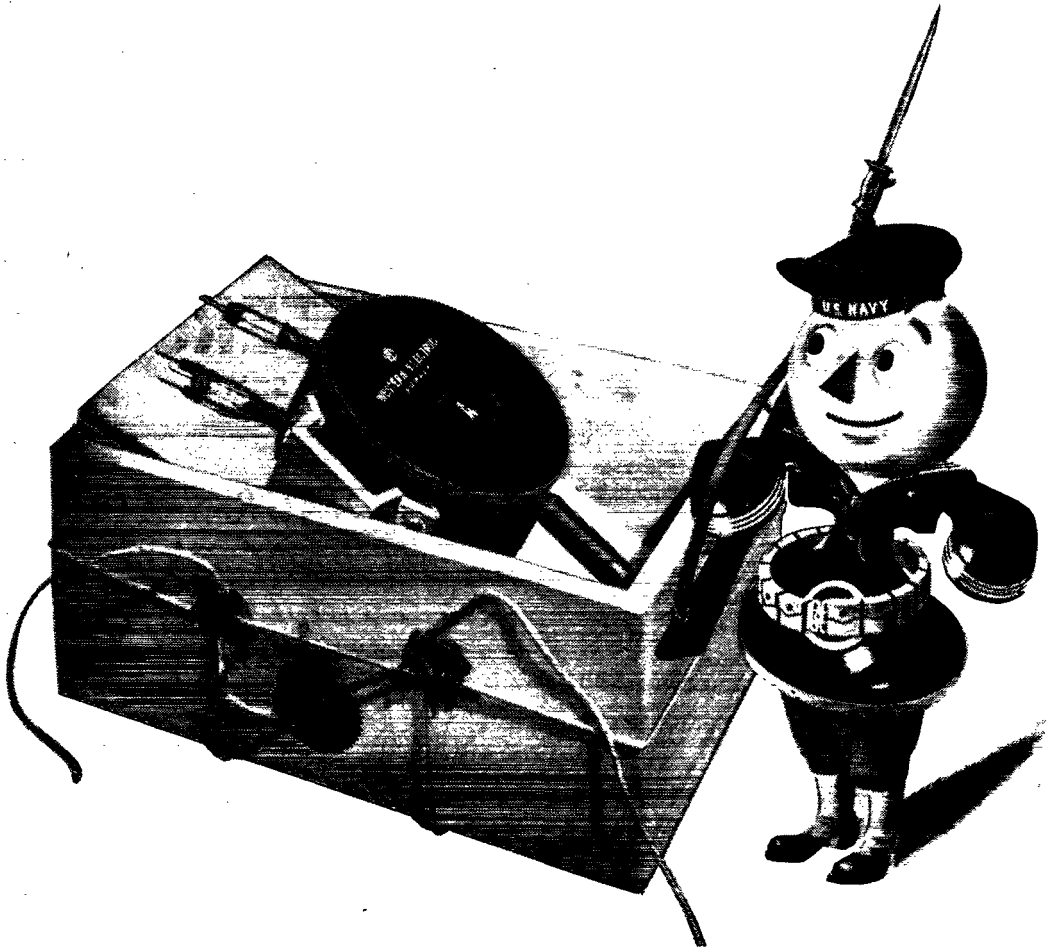

VICTORY REVEALS A MYSTERY

More than two years ago, an engineer of the Laboratories visited *U. S. S. Boise*, returned with a mysterious box which went into the Laboratories' vault. Now, victory opens the box and discloses a special kind of electron tube called a magnetron. It was part of a Radar which furnished data to aim *U. S. S. Boise's* guns during the night action off Savo Island on October 11-12, 1942. Because of the high frequency generated by this magnetron, the Radar was not detected by the enemy, and the action was a complete surprise. Six Japanese warships were sent to the bottom in one of the early Pacific victories.

This magnetron is a symbol of the Laboratories' enormous war program. Half of it was devoted to Radar, the other half gave birth to radio transmitters and receivers, sonar apparatus for the Navy, loudspeaker systems for ships and beachheads, fire-control apparatus for anti-aircraft artillery. Coming months will unfold the story.

Bell Telephone Laboratories' war work began before the war; until now, it claimed practically all our attention. With victory, we will go back to our regular job—helping to bring you the world's finest telephone service.

BELL TELEPHONE LABORATORIES



CRYSTAL BLANKS

to Your
Specifications

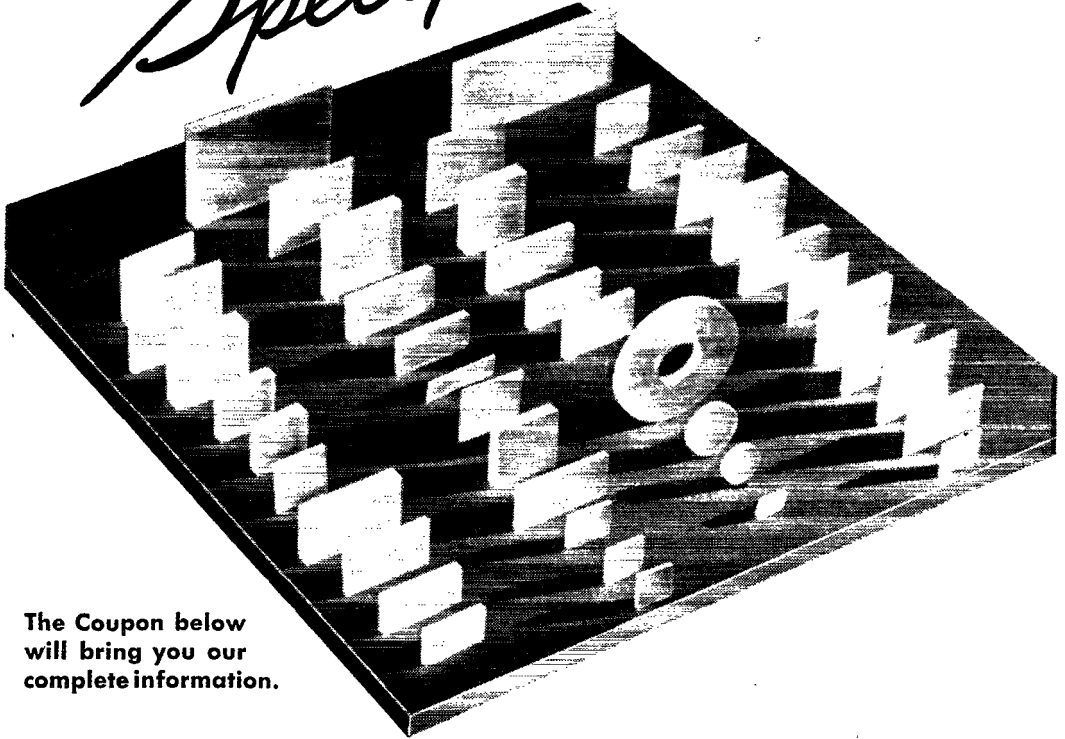

The Coupon below will bring you our complete information.

Our Crystal blanks are cut to specifications from selected Brazilian quartz and guaranteed free from all impurities, mechanical and electrical imperfections. Dimensions, temperature coefficients and

frequencies are guaranteed within your specifications. Supplied in either "rough-sawed", "semi-finished" or "electrically-finished" blanks as desired. Remember Crystal Products when you need crystals.

MAIL THIS COUPON!

CRYSTAL PRODUCTS CO.,
Dept. O, 1519 McGee, Kansas City, Mo.
Gentlemen: I am interested in

NAME.....
FIRM.....
ADDRESS.....
CITY.....STATE.....

Crystal

PRODUCTS COMPANY

1519 McGEE STREET KANSAS CITY, MISSOURI

Producers of Approved
Precision Crystals for Radio Frequency Control

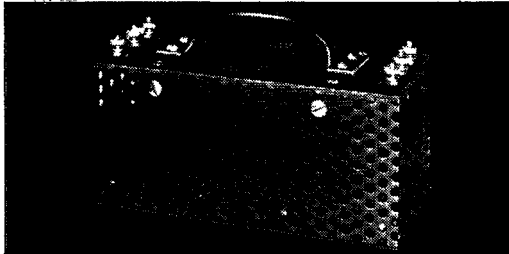

ISOLATING TRANSFORMER

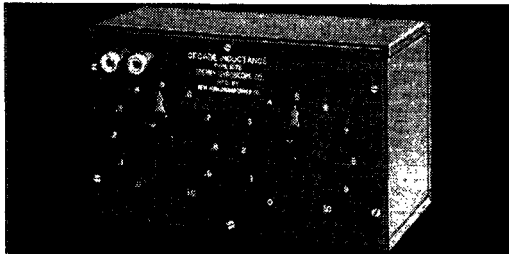

DECADE INDUCTANCE



VOLTMETER CALIBRATOR

Guidance for accuracy

A noteworthy addition to the highly specialized N.Y.T. line of custom designed transformers, chokes and filters is this new precision test equipment. The N.Y.T. Decade Inductance, the N.Y.T. Isolating Transformer and the N.Y.T. Voltmeter Calibrator all embody the high degree of quality and engineering associated with this name.

N.Y.T. engineers have other postwar projections already in the blueprint stage. Each will fulfill a purpose and need in industry.



**NEW YORK
TRANSFORMER CO.**

26 WAVERLY PL., NEW YORK 3, N. Y.

Silent Keys

It is with deep regret that we record the passing of these amateurs:

W2NIN, Violet Schwarz, Forest Hills, N. Y.
 W3FRJ, Edward Richards, Aberdeen, Md.
 W4EF, Capt. Rufus M. Barnes, USA, Atlanta, Ga.
 W4GAC, Lex L. D. Herron, Largo, Fla.
 ex-W8AAO, Lt.(jg) Robert W. Lally, USNR, Akron, Ohio
 W9OEU, Paul V. Brennan, jr., T/5 Chicago, Ill.
 W9RDC, Edward H. Nightenhelser, ART-1c, Arcadia, Ind.
 PAOMO, J. P. Meertens, Zwolle, Netherlands
 PAOQQ, C. A. Gehrels, Eindhoven, Netherlands

Correspondence from Members

(Continued from page 84)

An interesting note which struck me as particularly symbolic of the amateur spirit was that a copy of the ARRL *Handbook* was kept hidden from the Japs and read secretly by the amateurs and other radio-minded internees at Santo Tomas.

Among the Filipino amateurs, Dr. Legarde, KA1AL, and Dr. Reyes, KA1OR, are well and living in Manila. They risked much during the Jap occupation to render aid to their interned American friends. KA1AL was president of the Philippine Amateur Radio Association at the outbreak of the war.

KA1DD, Jacinto Chong, is remembered with high respect by those who knew him personally or had worked him on the air in this area. When war broke out late in 1941, he immediately joined the Army. A few weeks later, he was killed while fighting on Northern Luzon.

Not much is known about M. Karolchuck, KA1YL. That he is with guerrilla forces is certain, but the story of his activities has not yet been revealed. Incidentally, the communications work done by the guerrillas out here during the Jap occupation will make one of the most interesting sidelights on the Pacific war when it is fully told.

— Forrest A. Bartlett, W6OWP

SILVER'S V.T.V.M. ARTICLE

338 Vanderbilt Hall, Boston 15, Mass.

Editor, *QST*:

. . . I would like to express my appreciation of the article in the July and August issues by McMurdo Silver, "Taming the V.T.V.M." Perhaps it's because I entered the radio game through the servicing "door," but in any event I feel that both you and Mr. Silver should be complimented on the job. It's just another example of the good material *QST* has been publishing during these last few years.

— Herbert L. Ley, jr.

BACK

TO PEACE

AND AMATEUR

RADIO!

RECEIVERS

LATEST MODELS OF ALL WELL KNOWN MAKES
NOW AVAILABLE FROM 2 BIG Newark STORES

HERE'S NEWARK! Back again with all the ham equipment you've waited for so long. But HOW NEWARK HAS GROWN since pre-war days... with two stores now to give you faster, better Newark service! Send your orders to CHICAGO or NEW YORK, whichever nearest!

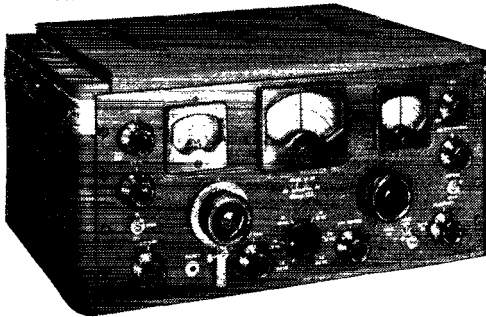

HALLICRAFTERS

- SX-28A. Super Skyrider with crystal, less speaker..... \$223.00
- S-20R. Sky Champion with built-in speaker..... 60.00
- S-22R. Skyrider Marine with built-in speaker..... 74.50
- SX-25. Super Defiant with crystal, less speaker..... 94.50
- S-39. Sky Ranger Portable. AC/DC and battery..... 110.00
- PM-23. 10" PM speaker in cabinet for use with following models: SX-25, SX-28A..... 15.00

NATIONAL

- NC-2-40C. Complete with speaker in cabinet. \$240.00

HAMMARLUND

- HQ-129X. (With tubes)..... \$129.00
- SC-10. Speaker in cabinet..... 10.50

- RME-45 With speaker in cabinet..... 166.00

ALL PRICES SUBJECT TO CHANGE WITHOUT NOTICE

NO PRIORITIES REQUIRED!

WESTERN ELECTRIC MICRO AMMETERS

Recommended by Newark's engineering laboratories for a wide range of applications. Bakelite case fits 3 3/4" hole. Radium dial, 150-0-150. Can be used with 0-200 micro amp scale listed below. Excellent as a 5,000 ohm-per-volt meter, or null, sound level, and galvanometer indicator. Instructions included. **\$7.50**



0-200 paper scale for above..... 15c

GENERAL ELECTRIC METERS

- 0-500 DC MA. 2" round Bakelite case..... \$3.50
- 0-8 RF ammeter, 2" round Bakelite case..... 4.00

The Famous Newark Bargain
Oil Filled, Oil Impregnated

FILTER CONDENSERS

Big shipment just received. We waited 8 months to get them... but they're yours for immediate delivery!

Fully guaranteed at rated voltages.

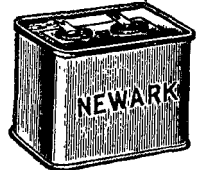

- 11 mfd. 1500 v. DC 3 1/4" x 1 1/4" x 4 1/4"..... \$2.00
- 17.5 mfd. 1500 v. DC 4 1/4" x 3 1/4" x 4 1/4"..... 2.75
- 8 mfd. 2000 v. DC 4 1/4" x 3 1/4" x 2 1/2"..... 2.75
- 2 MFD. and 4 MFD. in ONE CAN
- 600 v. DC 4 1/4" x 2 1/2" x 1 1/4"..... .80c

THORDARSON TRANSFORMERS

(Power Transformers and Chokes)

- T-45556 or T-92R21 leads out of side. 778 v. C.T. at 200 MA.
115 v. 60 Cycle 6.3 v. C.T. at 5 A.
5 v. at 30 amp. 9 lbs..... \$5.29
- T-13C30 8 H. 150 M.A. 200 ohm 1600 v.
Insulation 2 1/4 lbs..... 1.41
- T-4557 or T-74C29 leads out of side. 15 H. 150 MA.
200 ohm 2000 v. insulation 5 1/4 lbs..... 2.82

GET YOUR NAME ON OUR MAILING LIST

Be first to get announcements of merchandise available, bargain lists, etc., etc. Send name and address on postcard stating whether amateur, engineer, school, industrial, or service man. Address orders and inquiries also to Dept. Q at your nearest NEWARK store.

Newark

ELECTRIC COMPANY

NEW YORK
115-117 W. 45th
BRYant 9-4735

CHICAGO
323 W. Madison
DEARborn 0083

(Continued from page 15)

For Experts BY EXPERTS...

that characterizes RADELL-built ham equipment . . . Right now, RADELL corporation is manufacturing communications equipment for the war effort . . . When that job is done and Victory secured, new items will be available—developed from experience gained in producing to meet stringent specifications and specialized applications... This equipment will be built by men who thoroughly know the ham field, who have retained their call letters through the years and who are willing to back their future by designing especially for the amateur who wants the best . . .

It will pay to watch for RADELL



6323-27 Guilford Ave., Indianapolis 5, Ind.

Now—a really
high-powered



RADIO ENGINEERING LIBRARY

- especially selected by radio specialists of McGraw-Hill publications
- to give most complete, dependable coverage of facts needed by all whose fields are grounded on radio fundamentals
- available at a special price and terms

THESE books cover circuit phenomena, tube theory, networks, measurements, and other subjects—give specialized treatments of all fields of practical design and application. They are books of recognized position in the literature — books you will refer to and be referred to often. If you are a practical designer, researcher or engineer in any field based on radio, you want these books for the help they give in hundreds of problems throughout the whole field of radio engineering.

5 VOLS.
3319 PAGES,
2289
ILLUSTRATIONS

1. Eastman's Fundamentals of Vacuum Tubes
2. Terman's Radio Engineering
3. Everitt's Communication Engineering
4. Hund's High Frequency Measurements
5. Henney's Radio Engineering Handbook

Free Examination • Special Low Price • Easy Terms

McGraw-Hill Book Co., 330 W. 42nd St., New York 18
Send me Radio Engineering Library, 5 vols., for 10 days' examination on approval. In 10 days I will send \$3.00, plus few cents postage, and \$3.00 monthly till \$24.00 is paid, or return books postpaid. (We pay postage on orders accompanied by remittance of first installment.)

Name.....
Address..... Company.....
City and State..... Position..... QST 10-45

Ordinarily this column is given over to biographical sketches of the new QST authors in a given issue. This month's issue is (according to KBW) "the product of many hands." It is, of course, infinitely more than that — it is the self-chronicle of the work and struggle of three million men and half a million women, laboring and fearing and fighting and dying for the victory that was so long in coming. . . .

But even the recording of a chronicle requires the work of numerous hands. When planning for this special Navy Day issue of QST began back around the first of the year, through the offices — and office — of the Director of Naval Communications, Admiral Joseph C. Redman, three Navy officers were "assigned to the project, their mission to assist in securing essential data." Initial responsibility for Navy Department liaison and coordination was delegated to Capt. Fred H. Schnell, USNR. Also tagged for the task were Cmdr. Walter Bradley Martin, USNR, and Cmdr. E. H. Conklin, USNR. Cmdr. H. J. Waters, USNR, came into the picture when as special assistant to the chief of the Electronics Division of BuShips, he found himself saddled with the job after our preliminary consultations with Commodore J. B. Dow, Chief of the Electronics Division. Lt. Cmdr. E. L. Battey, USNR, of BuPers was asked to assist because of his intimate knowledge of the type of material required by QST. (Incidentally, no sooner had we got the hamming out of our systems in preliminary ragfests than Conklin was called to the Pacific — leaving the group a quartette.)

Capt. Fred H. Schnell, W9UZ, for nearly thirty years has been one of the Navy's top-ranking amateurs. In World War I, a Naval Reservist called to active duty in May, 1917, after a spell at Great Lakes he was picked for duty at the Trans-Atlantic receiving station at Belmar, where he copied the first message from Italy to President Wilson. Thence youthful Chicagoan "proceeded" to the DNC's office, Washington — where he not only copied the official German message accepting the armistice terms but transmitted the first message to that country after the cessation of hostilities. Then followed an epochal career unique in ham — and Navy — radio. The legends concerning Fred Schnell are legion — warp and woof threading the fabric of radio history. As war neared again Schnell was returned to active duty — serving, by BuPers records, as DCO, 9th ND, at Great Lakes; as base communications Officer, NOB, Bermuda; as DCO, 6th ND, Charleston, and as CO, Radio Stations, 14th ND, Redlands, Calif., until returned to Washington early in 1945 on behalf of the "Quist" project, whence he was transferred to the office of the Industrial Manager in Chicago. W9UZ's liaison

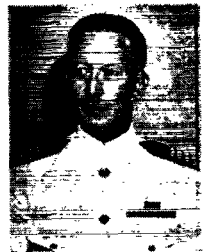

ONE STANDARD TYPE

does the job...

NEW type end seal for extra humidity protection.

WOUND WITH
CERAMIC
INSULATED
WIRE
1000°C.
HEAT-PROOF!

NEW glazed ceramic shell to withstand thermal shock, humidity and corrosive conditions.

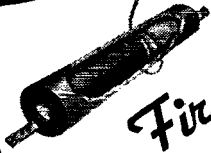

First

with resistors wound with ceramic-insulated wire.



First

with glass-to-metal sealed resistors.



First

and still exclusive with MEGO-MAX, the high-resistance, high-voltage resistors.

and First

with the EXTRA humidity protection features for STANDARD resistors described above.

..in ANY climate!

No more "special orders" to obtain suitable resistors to withstand the extreme thermal and humidity conditions to which your product may be subjected in many parts of the world! STANDARD Sprague Koolohm Wire-Wound Resistors now incorporate these extra protection features — and this means that you can count on STANDARD Sprague Koolohms for maximum dependability in ANY climate, ANYwhere on the face of the globe. Write for new catalog of Sprague Koolohm wire-wound types for every requirement.



SPRAGUE KOOLOHM

TRADEMARK REGISTERED U.S. PAT. OFF.

WIRE-WOUND RESISTORS

SPRAGUE ELECTRIC COMPANY, Resistor Division, North Adams, Mass.

LEO'S SPECIAL!
 Immediate Delivery on this
Multitester
 \$1875
 WRL 300 Less Leads



Handles AC and DC Voltmeter, DC Milliammeter, High and Low range Ohmmeter. Size 5 1/2 x 8 x 3 1/4. 3" meter with sturdy D'Aronsyal movement. Write for priority information today.



PHONO AMPLIFIER KITS
 Complete with tubes, all parts, chassis, diagram, etc. Priority AA-5 or higher. No. 1059. **\$9.50**

We Feature Hallicrafters

Available for immediate delivery on priority. Reserve your Post-War Hallicrafters now! Write Leo for details.

These Items—Exclusive at Leo's
 44 Page Radio Parts Flyer. FREE
 Tube and Circuit Book. 10c
 Giant Radio Reference Map. 15c
 Handy Tube-Base Calculator 25c

Address Leo, W9GFG, Dept. Q-10, Council Bluffs, Iowa

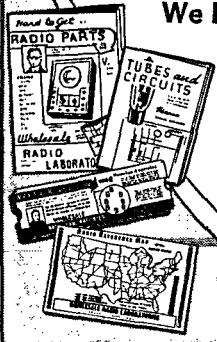

Wholesale RADIO LABORATORIES

NO PRIORITY
 For Harco Radio
MASTS & TOWERS

Revocation of Order M-126 permits manufacturing from surplus inventories. We have adequate surplus stocks to make...

IMMEDIATE SHIPMENTS

HARCO CO. INC.
 ELIZABETH 4, NEW JERSEY

Catalog mailed on request

(Continued from page 122)

role then descended to **Cmdr. Walter Bradley Martin, W3QV**, fresh (?) from a 26-month tour of communications duty in the Pacific—a versatile enthusiastic body-blood-and-soul ham.



Consistently active in the game since 1920, he was elected director of ARRL's Atlantic Division in 1936—which post he has since held continuously. From the Philadelphia Navy Yard, and NAS (LTA), Lakehurst, in crucial 1942 Brad found himself communications officer of grisly, gory Guadalcanal, a billet he

held down until the fevers built him down to a pallid ochre. Blessed with a transfer to Suva, even the charms of the Queen of the Fijis failed to alienate his affection for ham radio. In December, 1943, he joined the staff of ComSoPac at Noumea, returning to Washington a year later.

As Commodore Dow's general handyman, **Cmdr. H. J. Waters** undertook an incidental assignment which developed into a large-scale job. Not at all the communicator type, he is rather the

old-time kitchen-table/special set-builder/experimenter—the kind who goes in for high-fidelity amplifiers, super-quality recording and the like. **Cmdr. Waters** is an Annapolis man, class of '23 and long a member of Chesapeake & Potomac Telephone Co. One of WPB's "dollar-a-year" men in 1941, he was given the job of organizing a Division of Defense Contracts. Holder of a commission in the Naval Reserve since 1933, however, inevitably he received the call. He reported to BuShips in January, 1942, serving in the grandiloquently betitled Maintenance of Minelayers and Minesweepers section, until early in 1944 he was transferred to the Electronics Division.



When it came to the all-important training phase, **Lt. Cmdr. E. L. Battey, W1UE**,—than whom there could be no man better qualified—was called upon. An indefatigable NCRist since back in 1927, Ev Battey bade the ARRL-QST crew farewell in 1940 for active duty at Naval Reserve Radio School in Noroton Heights, Conn. Following Pearl Harbor he took on a recruiting program in the Northeastern Recruiting Division to procure radar maintenance men for the Navy. In May, 1942, he reported for duty in Washington as Communications Schools Liaison Officer in the Quality Control Division. (Hi!) The official list of his duties reads (literally!) from A to N, including periodic visits to some forty schools throughout the nation.



FLASH!!

HARRISON HAS RECEIVERS!

IMMEDIATE DELIVERY WITHOUT RED TAPE . . .

AT LAST! Here's the good news we've all been waiting for. Send in your order and we'll ship you WITHIN 24 HOURS a brand new, latest improved model Communications Receiver!

BUT HURRY! We don't expect even our tremendous stock to be adequate for the pent-up demand. It's first come—first served—so wire or mail your order right now! Include 10% deposit.

HALLICRAFTERS MARINE

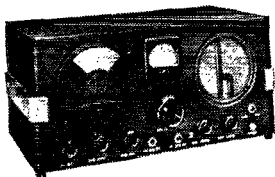

THE SKYRIDER MARINE—an efficient marine receiver at a moderate price. Protected against salt air. AC or DC operation. Top performance afloat or ashore.

Eight tubes, tuning range 110 Kc to 18 Mc, nickel plated chassis, built-in speaker. Model S-22R.

Complete \$74.50

HALLICRAFTERS S-20-R

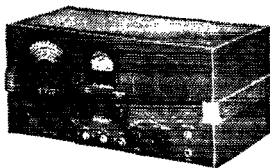

The familiar Sky Champion—strengthened and improved to cope with tough military requirements. Greatest value in the price range.

Nine tubes, 550 Kc to 43 Mc, electrical bandwidth, built-in speaker, noise limiter. Complete \$60

HALLICRAFTERS SX-28A

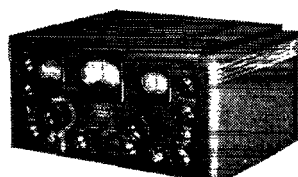

Here's the new Super Skyrider—the receiver that played an outstanding role in War Communications! Improved—up-to-the-minute—a swell job for ham, commercial, or S.W.L.

550 Kc to 42 Mc, 15 tubes, eight watt high quality audio output. Complete, less speaker \$223

2 1/2 IS HOT

GET BACK ON THE AIR, NOW, WITH AN

ABBOTT TR-4

In Stock — \$39.00

(with instructions for easy conversion to new band)

TR-4 with tubes, pack for 6 V. DC and 110 V. AC, cables, plugs, etc. Less microphone and antenna \$78

Hallcrafters-Jensen 10-inch PM dynamic speaker in matching cabinet. . . \$15

130 TO 143 MC!! HALLICRAFTERS S-36



FM—AM—CW, full coverage in three bands, fifteen tubes, 115/230 V. AC operation, audio system flat from 40 to 15,000 cycles, noise limiter. . . \$307.50

130 TO 210 MC!! HALLICRAFTERS S-37

advanced features of design providing peak VHF performance. FM—AM, two RF stages, three I.F. stages, voltage regulated, mechanical bandwidth, 14 tubes, noise limiter \$591.75

Our complete (almost—but soon) stock of Parts, Tubes, Test Equipment, etc. is also on a 24-hour shipment basis. Send your orders in for everything you need—lowest prices of course!

2 μ fd. 1000 volt Capacitors

Compact, oil-filled, cylindrical metal cased type, so convenient for transmitters, amplifiers, etc. 4 1/2" x 1 1/2" diameter. Mounts in one 3/4" hole. Harrison special — 4 for \$2.34

(Regular price for only one!)

ECHOPHONE EC-1

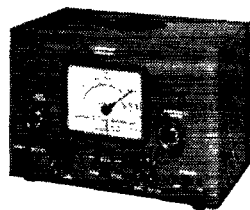

Hogarh's dream boat! The GI's delight in all parts of the globe. Performance you can hardly believe possible at only \$28.50

Six tubes, AC/DC, 550 Kc to 30.5 Mc, electrical bandwidth, BFO, headphone jack, built-in speaker.

All prices subject to change without notice

LITERATURE DESCRIBING THESE RECEIVERS IS AVAILABLE UPON REQUEST.

Do you have "Electronic Parts and Equipment"—our NEW 800-page buyers Guide? You can obtain a copy without cost—Write today.



HARRISON RADIO CORPORATION
12 WEST BROADWAY • NEW YORK CITY 7
BARCLAY 7-9854

JAMAICA BRANCH — 172-31 Hillside Ave. — REPUBLIC 9-4102

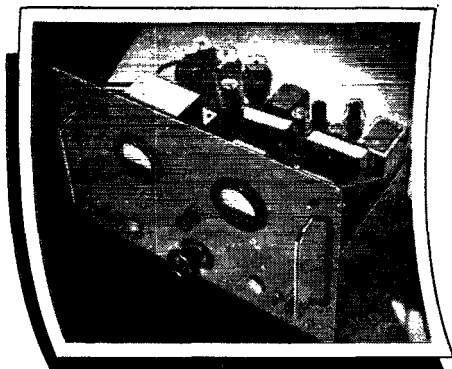

Picture This HARVEY REGULATED POWER SUPPLY In Your Laboratory

The New HARVEY Regulated Power Supply 206-PA operates precisely and efficiently in the 500 to 1000 volt range. It provides a regulated flow of D.C. power in two ranges: 500 to 700 at ¼ amp.; 700 to 1000 at 1/5 amp. Ripple content 1/10 of 1% or better in any voltage. . . . 300 MV at 1000 volts or better. Output is constant within 1% from no load to full load in each range; regulation 1% or better. The HARVEY 206-PA has many safety and operating features that make it as easy and convenient to use as the 106-PA.

If your equipment includes Pulse Generators, Constant Frequency Oscillators, Amplifiers, Measurement Equipment or other apparatus requiring a constant source of D.C. Power, you should look into this HARVEY Regulated Power Supply. We'd be pleased to send the latest bulletin on it. No obligation, of course.



HARVEY RADIO LABORATORIES, INC.

451 CONCORD AVENUE

CAMBRIDGE 38, MASS.

RF Inductors • RF Chokes • IF Transformers
 Condensers • mica Molded Condensers • Trimmer
 Condensers • Miscellaneous Apparatus

The F. W. Sickles Co., Chicopee, Mass.



SICKLES *Electronic Specialties*

**NEW 1945 ENLARGED
 EDITION OF THE
 PHILLIPS CODE**

A thoroughly tested method of Steno-telegraphy arranged for use in wire and radio communication. It's definitely new, completely standard, strictly up-to-date. In addition to changes and additions to previous editions it contains

Radio Code Signals, International Morse, American Morse, Russian, Greek, Arabic, Turkish, and Japanese Morse Codes, World Time Chart, United States Time Chart, Commercial "Z" Code, Aeronautical "Q" Code, Miscellaneous Abbreviations, used on international wire, submarine cable and radio telegraph circuits.

An invaluable aid to every trained and student operator. Every operator should have a copy. Price \$1.50 postpaid.

LIBERAL DISCOUNT TO DEALERS

THE VIBROPLEX CO., INC.

833 Broadway

New York 3, N. Y.

The Navy Afloat

(Continued from page 58)

craft for launching, turning the carriers into the wind, launching the planes, and getting them out to the point of interception with attacking aircraft takes too long to enable adequate defensive measures.

In combat, radar and CIC have revolutionized fleet tactics and made possible a wholly new order of flexibility in surface-ship warfare. Watching the whole situation on a PPI scan, each OOD can maintain his proper station in the task force throughout zig-zags, course changes, and emergency turns, solely on its information. Even without a repeater, CIC relays to him periodical ranges and bearings on the guide and on the ships nearby which may themselves be out of station. And not only are the individual OODs able to handle their ships in perfect safety, but the officer in tactical command of the force can see at a glance the disposition of the formation for which he is responsible.

The problem of defending a fleet of warships from air attack is more complex than that of defending a land area, the differences in the problems being reflected in different radar techniques. First of all, the ships are moving. This means that, since they are not especially vulnerable to high-altitude, heavy-bomber attacks, they will be subjected to close-in dive bombing, torpedo, and even suicide attacks; which, in turn, means that their inner defenses must be powerful. The fact that they are moving also puts a premium on the instant detection and destruction of enemy snoopers and reconnaissance planes. And the additional fact that their carriers are constantly steaming along complicates the navigation of carrier-based planes. Not only do they have to find the way to their target but they must find the way back to a small dot in midocean some hundreds of miles on a zig-zag course from the point of take-off.

Night Fighter

Then there is the night fighter. Patrolling the darkness alone except for his radar screen and the controller's voice in his ears, he truly is king of all he surveys.

Perhaps the radar operator on the ground at a fighter-control station announces the detection of an approaching Jap bomber by radioing one word to a Ventura's crew: "Trade." The crew in the night fighter 65 miles away hear him give the direction and distance of their foe: "Climb to 11,000. Vector, 2--907. Range, 42 miles."

As the Ventura banks around to a northwest course and surges forward at 300 miles per hour, the radar operator on the ground notes its progress as well as that of the Jap plane. At the same time, the radar man in the glassed-in coop in the Ventura's fuselage adjusts his shorter-ranged airborne-intercept (AI) radar.

Invisible radio detection beams then shoot at the Jap from both the ground station and the Navy night fighter. Officers on the ground chart

NO BUBBLE!



NO TROUBLE!

Production vacuum checking of Marion Glass-to-Metal Hermetically Sealed Electrical Indicating Instruments is no haphazard operation . . . After sealing in our dehydrating rooms, the instruments are submerged in glass jars which are partially filled with alcohol. A vacuum of 25 inches is drawn in accordance with newest JAN-1-6 specifications. During the test we watch for air bubbles — no bubble means no trouble. Spot checks for a period of four hours are made in a 29 inch vacuum.

The testing apparatus, illustrated above, is a Marion development, and demonstrates our sincerity of purpose in producing hermetically sealed instruments. We take nothing for granted — we neither suppose nor assume. Because imperfectly sealed instruments entrap condensation, we make certain that every hermetic instrument bearing our name is — perfectly sealed.

**Marion Glass-to-Metal Truly Hermetically Sealed
2½" and 3½" Electrical Indicating Instruments**

Write for our new 12-page brochure. Manufacturers and users of radio and electronic equipment are invited to inquire into the advantages of Marion Glass-to-Metal Hermetically Sealed instruments for postwar use.



MARION ELECTRICAL INSTRUMENT CO.

MANCHESTER, NEW HAMPSHIRE

EXPORT DIVISION • 458 BROADWAY • NEW YORK 13, N. Y., U. S. A. • CABLES: MORHANEX

SPECIAL . . .

a very nice item at a ridiculously low price!

LEACH RELAY

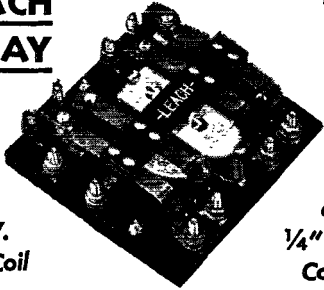

Type
2127

115 V.
AC Coil

6 amp
1/4" Silver
Contacts

D.P.D.T. plus D.P.S.T. = n.o.

Ideal for antenna switching and plate-circuit break, etc. A beautiful relay at a rare bargain price. Limited quantity.

List price \$8.50
SPECIAL AT \$1.95
plus postage

R. G. SCALI & CO.

227 Asylum Street
Hartford, Conn.

84 Elm Street
Bridgeport, Conn.



RCA INSTITUTES, INC.

Offer thorough training courses in all technical phases of
RADIO and TELEVISION

WEEKLY RATES DAYS—EVENINGS

VETERANS: RCA Institutes is approved under G. I. Bill of Rights
For Free Catalog write Dept. ST-45

RCA INSTITUTES, Inc.
A Radio Corporation of America Service
75 Varick Street, New York 13, N. Y.

The Key to Easier Sending

SEMI-AUTOMATIC
RADIO KEY

VIBROPLEX

Reg. Trade Mark: Vibroplex, Lightning Bug, Bug

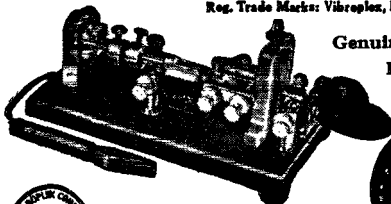

Genuine "Original"
DeLuxe Model

PATENTED
JEWEL
MOVEMENT
\$19.50



The "BUG" Trade Mark identifies the Genuine Vibroplex. Accept no substitute

AMAZING PATENTED JEWEL MOVEMENT. Watch-like precision. Feather-touch action free of tiring effort. Makes sending easier than you ever dreamed sending could be. Adjustable to speed and personal touch. New, non-glare battleship gray base. Bright machined parts. Colorful red switch knob, finger and thumb piece. DIE CUT contacts and main spring. 3/16" contacts. Cord and wedge. Place your order to-day for an "Original" DeLuxe Vibroplex. Money order or registered mail. FREE catalog.

THE VIBROPLEX CO., INC.
833 BROADWAY NEW YORK 3, N. Y.

128

(Continued from page 186)

the two courses on a circular plotting board; as the two aircraft come closer together, a second code word is radioed to the fighter: "Punch."

"Pilot from radar," says the RdM in the night fighter when he sees a pip of light on the screen of his radar that tells him the beam of waves from his apparatus have encountered the Jap plane. He speaks over the plane's intercom: "Target, 11 miles. Bearing, 20 degrees."

"Roger," okays the pilot.

"Judy," the radar operator in the Ventura then calls to his colleague at fighter control on the ground; this means that the fighter has spotted the Jap bomber and is attacking.

Now the RdM in the Ventura must watch the radar scan on his instrument panel to keep from losing the image of the target. (There's a penalty for this; he will be demoted to ground duty if he loses a target three times.) As the Ventura closes in on the Jap in the darkness, he notifies pilot and gunner: "Dead ahead. Range, one mile. Mark, gunner."

That's the gunner's signal to flip a switch which brings the automatic airborne gun layer (AGL) into operation. It will sight and fire the four machine guns at the right instant, even though the men in the Ventura may never have seen the target with their eyes.

The roar of the two big engines is broken by two short bursts of fire from the .50 caliber guns, directed by the fighter's radar eyes. Perhaps the flames reveal a Japanese Betty medium bomber, with a *Baka* bomb snuggled beneath its belly.

Far out on the horizon the night-fighter's tracers streaked across the sky. The result will be reported by one word spoken into the microphone by the RdM in the Ventura to the men on the ground: "Murder!" he'll say.

That is how radar is used in Venturas. The single-seater Corsair and Hellcat carrier-borne fighters have a different kind of radar (AIA instead of AI), which enables the pilot to do everything. The target appears on the radar scope of this apparatus as a large dot of light, and the pilot flies so as to keep that dot lined up in the center of his scope. The relative size of the dot tells him when the target is within range.

Air-Sea Rescue

To aid in the rescue of fighters and other air crewmen downed at sea, there is, of course, the familiar "Gibson Girl," the SCR-578 lifeboat transmitter. The original model operated on 500 kc. and, with 3 watts output, could be heard only over a limited range under the most favorable conditions.

From the Coast Guard Signal Labs came a modernized version of the SCR-578 designed to overcome the limited range of the earlier model. Strictly a product of ham ingenuity, the Coast Guard-modified rig transmits on an automatic sequence of 500-4140-8280 kc., with 3 watts output in 500 kc. and 5 watts on 4140 and 8280. All operation is automatic, the only requirement on the part of the operator being that he turn the crank.

RAYTHEON MANUFACTURING
Company **ELECTRONIC EQUIPMENT DIVISION**

WALTHAM 54, MASS

SWELL JOB — HAMS!

Now that World War II is history, all the world knows how radar licked the Nazi submarines and turned the tide of battle in the early days of the Pacific War. Raytheon is proud of its part in writing radar history — proud to have built the Model SG, the first microwave radar in the Fleet; and the little SO's, originally designed for PT's and later so vital in guiding the landing craft on the beachheads, both in Europe and in the Pacific.

But Raytheon couldn't have done this job for the Navy, either in the plant or in the field, without those hams — over 300 strong — who answered our call and joined the ranks as Raytheon Engineers. In those early days of radar, the hams, more than any other group, were "naturals" for tackling radio's toughest problem. With their help, and that old ham spirit, we got to work and licked another "impossible" job.

Raytheon has always had a warm place in its heart for hams. They have always been an important nucleus of our company. Their resourcefulness, enthusiasm, and devotion to duty have shown what a part amateur radio can play in a world striving for lasting peace.

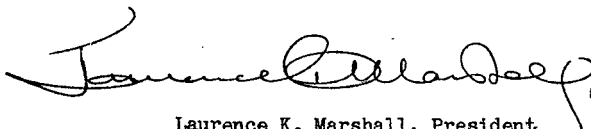

Laurence K. Marshall, President
Raytheon Manufacturing Company

TO OUR READERS

Who are not A.R.R.L. Members

Application for Membership

American Radio Relay League

Administrative Headquarters:

West Hartford, Connecticut, U. S. A.

.....194....

AMERICAN RADIO RELAY LEAGUE,
West Hartford, Connecticut, U. S. A.

Being genuinely interested in Amateur Radio, I hereby apply for membership in the American Radio Relay League, and enclose \$2.50 (\$3.00 in foreign countries) in payment of one year's dues*, \$1.25 of which is for a subscription to QST for the same period. Please begin my subscription with the.....issue.

The call of my station is.....

The class of my operator's license is.....

I belong to the following radio societies.....

Send my Certificate of Membership or Membership Card (indicate which) to the address below:

Name.....

A bona fide interest in amateur radio is the only essential requirement but full voting membership is granted only to licensed radio amateurs of the United States and Canada. Therefore, if you have a license, please be sure to indicate it above.

[* The dues are \$2.50 per year in the United States and Possessions. All other countries \$3.00 per year]

(Continued from page 128)

Also in use is a radio marker buoy. Parachuted into the water, the transmitter begins sending signals as soon as it strikes the surface and continues for 12 hours.

Newest development for life rafts is the "corner reflector" — collapsible flower-shaped antennas made of intersecting surfaces of metallized cloth or screen-like material on an aluminum frame that reflect the pulses from radar transmitters of search planes. The returned pulses create a distinctive pattern on the scope, guiding rescuers directly to the scene.

Radars in Combined Operations

Often during this war it has been necessary for U. S. Navy ships to approach strange harbors in the dead of night — harbors about which only the sketchiest information was known. In the Aleutian campaign the Navy operated by radar for two winters in waters of the most perilous kind which had never been charted. Out in the Pacific radar enabled the largest battleships to come closer to strange shores in the dead of night than they would ever have dared before — close enough for point-blank fire against shore batteries. In the same way, transports and cargo ships were permitted to unload closer to the beaches, lessening the danger to small craft and reducing immensely the unloading time.

Radars came to play an increasingly important role in the advance of Allied amphibious forces across the Pacific and in the preparatory trouncings of the Jap home islands. Whether in the black of night or through the thickest fog, our warships could pinpoint the target.

During 1943 and early 1944 the U. S. Navy made an almost daily routine of blasting Japanese positions in the Pacific. Against Kwajalein Atoll there was loosed perhaps the most intense and concentrated bombardment known up to that time, either on land or sea. But even that bombardment paled against the demonstrations which began on June 6, 1944, when the naval forces which opened the assault on the French Channel coast fired some 2000 tons of shells in the first ten or twenty minutes of bombardment — and continued thereafter for many days to give close and invaluable support to the troops whose landings they had made possible.

Navigation by radar proved of inestimable value in the assault landings in North Africa, Sicily, Italy and Northern France. Mobile naval radar equipment assisted in the defense of anchorages against surface attack and in the control of the enormous masses of shipping which arrived and assembled at the beachheads. On countless occasions radar solved crucial problems of navigation and weather and enabled assault forces to be put ashore at an exact spot exactly at the required time.

The D-Day operations, the greatest in the history of amphibious warfare, were made possible by the immense superiority and quantity of radio and radar equipment fitted in every type of ship. Radar ensured the accuracy and concentration of the assault and stultified the subse-

SEARCH AND RE-SEARCH

Years of engineering research are responsible for

the many well known Hammarlund marine type

variable condensers, which are now playing such

a vital role in the search for

enemy ships over the seven seas.

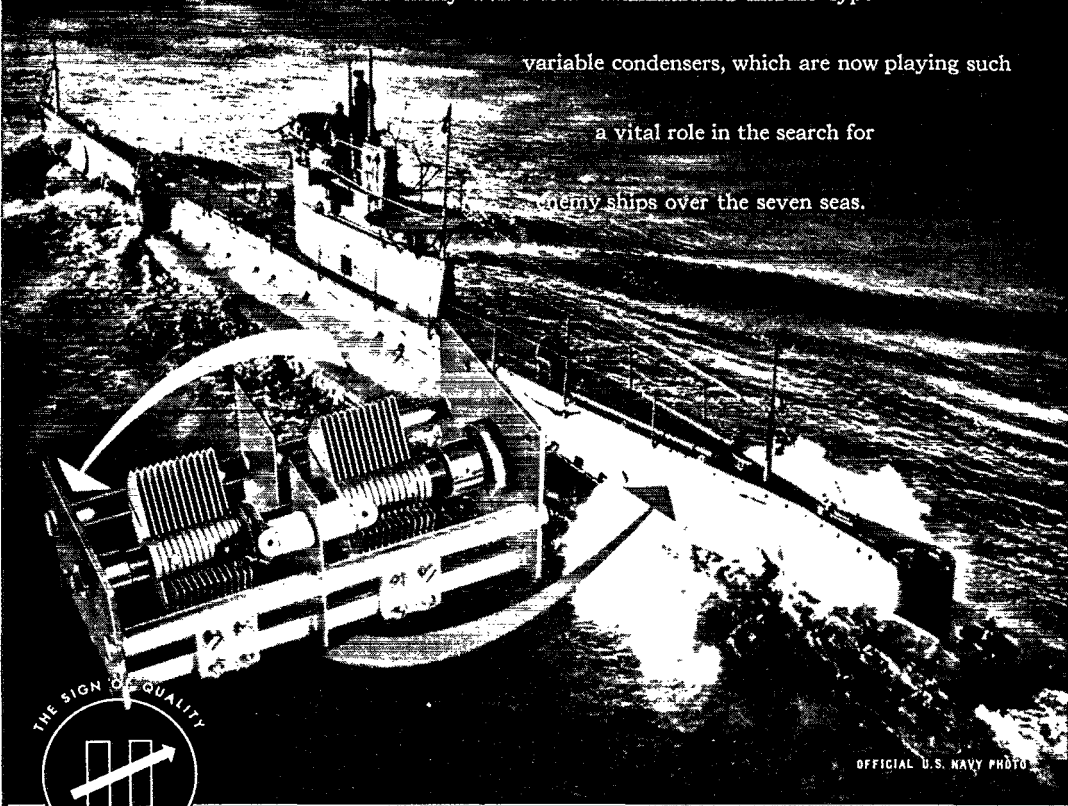

OFFICIAL U.S. NAVY PHOTO



ESTABLISHED 1910

THE HAMMARLUND MFG. CO., INC., 460 W. 34TH ST., N.Y.C.
MANUFACTURERS OF PRECISION COMMUNICATIONS EQUIPMENT

2 NEW RELAYS

Here are two of the new types of Ward Leonard Relays that are being made available to the trade through Radio and Electronic Parts Distributors.

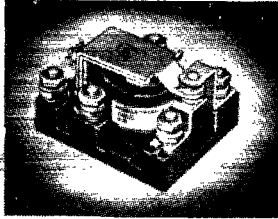

BULLETIN 105 RELAY is useful for controlling small transmitters, public address systems, compressors, and similar devices. Sturdily built on a molded phenolic base. Compact in size. Single Pole unit measures $1\frac{1}{4}$ " wide x $1\frac{15}{32}$ " long x $1\frac{1}{8}$ " high; Double Pole unit measures $2\frac{1}{4}$ " wide x $2\frac{3}{4}$ " long x $1\frac{1}{4}$ " high. Single Pole or Double Pole contacts. Available for A.C. or D.C. operation. New catalogs giving complete data on Bulletin 250 Relays and Bulletin 105 Relays are available. Write for your copy now.

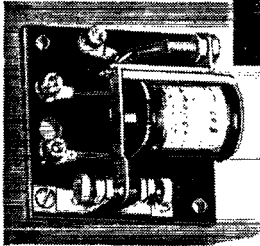

BULLETIN 250 RELAY will operate on minute fluctuations of current, and is easily adjustable to meet circuit or application requirements. It is available for operation on either A.C. or D.C.

WARD LEONARD ELECTRIC CO.



Radio and Electronic Distributor Division
41 West Jackson Blvd., Chicago, Illinois



Carter THE PREFERRED POWER SUPPLY

Carter Dynamotors, Magmotors, DC to AC Converters and Genemotors provide the finest rotary power for your mobile rig. Widely used and preferred by leading State and City Police Mobile Networks. Wide range of receiver and transmitter models, filter and starting relays available. Send today for the latest free bulletin.



1808 MILWAUKEE AVENUE
CARTER . . . A well-known name in radio for over 20 years!



Electricity FOR RADIO AND ELECTRONIC APPLICATIONS

Onan Electric Generating Plants supply electric service for electronics applications and general uses, mobile, or stationary. Driven by Onan-built, 4-cycle gasoline engines, they are of single-unit, compact design and sturdy construction.

65 models, sizes from 350 to 35,000 watts, A.C. types: 115 to 670 volts, 50, 60, 180 cycles, 1 or 3-phase; 400, 500 and 800 cycles, 1-phase. D.C. types: 6 to 4000 volts. A.C.-D.C. combination types available. Write for engineering assistance and literature. Model shown is from ATC lightweight series.

Over 250,000
Now In Service

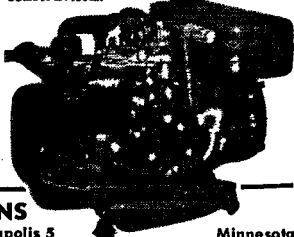

D. W. ONAN & SONS
2629 Royalston Ave., Minneapolis 3

Minnesota

132

(Continued from page 130)

quent enemy attacks on Allied shipping, especially on the vulnerable "Mulberry" harbors.

All bombing of the Normandy beaches before D-Day was done with the aid of radar. Even the German radar installations sets along the coast — 190 of them — were knocked out by our own radar blind bombing. This enabled paratroop planes and gliders to perform so successfully, landing troops behind the beaches before the landing craft nosed in to shore. Radar played a part in landing the gliders, also, for men with marker beacons dropped in the first wave used their equipment to return coded signals back to the gliders and enable them to reach the assigned areas.

Amphibious Warfare

The function of the Navy, Fleet Admiral King has explained, falls into four main phases during an amphibious operation.

"During the 'approach' phase," the Commander-in-Chief said, "the Navy commands passage to the area of landings for the invasion forces, bombards shore batteries, landing beaches and supporting areas, conducts minesweeping operations and removes beach obstacles. Frequently the bombing of landing beaches and shore defenses is a joint function of Army and Navy aircraft. In the 'landing' phase, the Navy, by employment of special landing craft, puts the invasion forces and all their equipment ashore, under cover of ships' guns and carrier aircraft. In the 'support' phase, after the consolidation of the beachhead, the Navy continues to provide artillery and air support to the forces ashore for as long time as they remain within range of ships' guns, and until shore-based aviation can relieve our carrier of the task of air support. In the 'supply' phase, the Navy guarantees the security of supply lines . . . and obstructs the enemy's efforts to reinforce his troops by sea."

An amphibious thrust begins several days or weeks before the actual appearance of the invasion fleet on the scene of action. First, intensive strategic bombing softens up all enemy bases located within supporting distance of the beachhead selected for assault. After this air bombardment has produced the desired results naval gunfire against coastal fortifications begins, accompanied by close tactical bombing by light attack planes as enemy batteries ashore reveal their positions by firing on the American naval units.

When command of the air has been attained, enemy naval interference guarded against and coastal fortifications reduced to impotence, the amphibious forces dash for the shore in landing boats and barges. Immediately preceding the ship-to-shore attack there may be the discharge of battalions, regiments — sometimes divisions — of parachute and air-borne troops from the air against enemy objectives well inland.

Assume that a vast fleet of battleships, cruisers and destroyers has just completed the initial bombardment of enemy installations on the

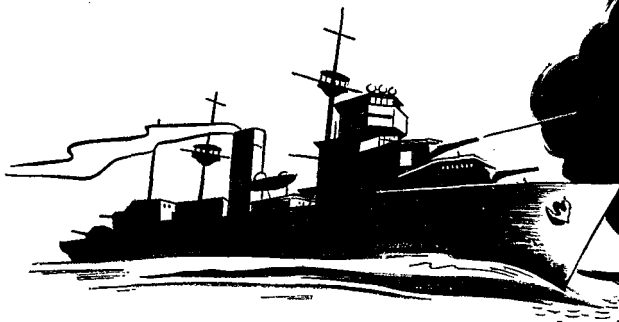

A FAMILIAR NAME with OUR NAVY

On battleships . . . cruisers . . . destroyers . . . carriers . . . on land stations—whether our victorious fleet was in home waters or battling Jap installations on the Inland Sea—a familiar name plate on thousands of NAVY radio units read—**MANUFACTURED FOR THE UNITED STATES NAVY BY THE RADIO MFG. ENGINEERS, PEORIA, ILLINOIS.**

Now that victory is won, thousands of radio operators will be looking for this same name signifying dependable receiving equipment when planning their post-war "dream" station.

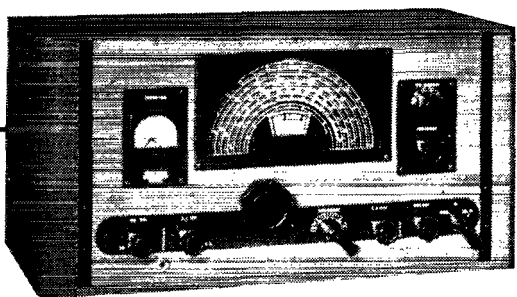

Here's the New RME 45 now on sale at your authorized distributor.



THE RME 45 EQUIPMENT RELEASE BULLETIN WILL BE GLADLY SENT YOU UPON REQUEST.

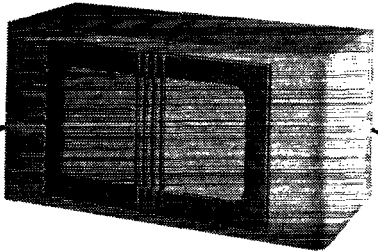

The matching speaker has an acoustically designed housing.



RME

FINE COMMUNICATIONS EQUIPMENT
RADIO MFG. ENGINEERS, INC.
Peoria 6, Illinois U. S. A.

RME SINCE 1933

WESTINGHOUSE ELECTRIC CORPORATION

has a position open for Acoustical Engineer with experience in loudspeaker and phonograph record changer development or laboratory measurement. An attractive position for the man with experience. Wire or write for application:

Manager, Technical Employment
306 Fourth Avenue Pittsburgh 30, Pa.

▶ TRANSMITTING TUBES RECTIFIERS CATHODE RAY TUBES

We have been appointed a sales agent by Defense Supply Corporation of Government surplus tubes and rectifiers. All are first grade Government tested and inspected tubes—not rejects.

The following types are immediately available:

- | | |
|----------------------|-------------------|
| 826 (HF Triode) | Cathode Ray Tubes |
| VT 127A (HF Triode) | 5AP1 |
| 304 TL | 5BP4 |
| 872A M. V. Rectifier | 3AP1 |

Trade discounts to dealers on standard packages • Write for prices

LEWIS ELECTRONICS 16 Lyndon Avenue
Los Gatos, California

Hi-Q

Hi-Q

CERAMIC CAPACITORS

40

WIRE WOUND RESISTORS

CHOKE COILS

ELECTRICAL REACTANCE CORPORATION
FRANKLINVILLE, N. Y.

This is the tenth issue of *QST* for 1945. Can you readily find your first nine issues? You can if they are kept in a

QST BINDER PRICED AT \$1.50 POSTPAID

(For the duration not available outside of the United States and Possessions.) One set of yearly labels (1922-1946) now provided with each binder.

American Radio Relay League, West Hartford, Connecticut



Founded in 1909

**RADIO TELEPHONY
RADIO TELEGRAPHY
ANNOUNCING**

Courses ranging in length from 3 to 9 months. Dormitory accommodations on campus for men and women students. Advanced students eligible for practical training at KPAC. 1 KW broadcast station owned and operated by Port Arthur College. New students accepted each month during year. If interested, write for details.

PORT ARTHUR COLLEGE PORT ARTHUR TEXAS

(Continued from page 132)

island under attack. The moment has arrived for the first assault waves to move in. For several miles beyond the island may be seen dozens of especially designed attack transports, for brevity labelled "APA," and LSTs, all unloading their cargoes of smaller landing craft. Among these are hundreds of LCTs to carry troops and tanks right up to the beach.

The operation proceeds like clockwork, the LCTs moving in perfect formation through the choppy water and surf until they hit the beach. They have all the appearance of being guided in every movement from some central location — which is actually the case. The LCTs are being controlled and directed by means of two-way voice radio from a control point in one of the larger transports or LSTs.

AGC

An operation of this magnitude requires the closest coordination of movement. The amphibious commander's flagship is therefore an AGC, the Navy designation for a communications ship. These ships are of the transport type, specially fitted for communication purposes. Approximately 500 feet long, they have a complement of fifty-five officers and 600 men in the crew.

Their main purpose is the handling of communications in landing operations where large numbers of vessels are involved and complete communications are of utmost importance. They act as relay stations, intelligence centers, repair, supply (electronics spares), and fulfill many other necessary requirements during landings and control of bases after the harbors have been secured, acting as mail and guard ships for the smaller vessels, and issuing orders for boat control parties, fire support, landing parties, casualties, and similar matters.

The communication equipments board consists of approximately fifty transmitters and one hundred receivers, with teletypes intership and ship-to-shore via cable when in a secured harbor. There are approximately two hundred antennas, both transmitting and receiving, installed aboard an AGC ship, the radio spectrum being well covered. All equipments are remotely controlled from various communication spaces — operations rooms and intelligence and bridge control spaces. These require miles of control cables, etc. Radar equipment for all uses is also installed to complete the necessary military requirements. A five-inch battery is mounted fore and aft plus numerous forty and twenty mm. guns to provide defense against air or submarine attacks.

Coordination between Army, Navy and Marine Corps are carried out in these vessels in joint operations rooms. There are various other special spaces, such as voice filter rooms, information centers, coding rooms, air support, fire control, and many others that make up a complete and necessary amphibious force flagship to control these amphibious force operations.

From the time the first wave of assault troops hits the beach, the scene of an amphibious landing

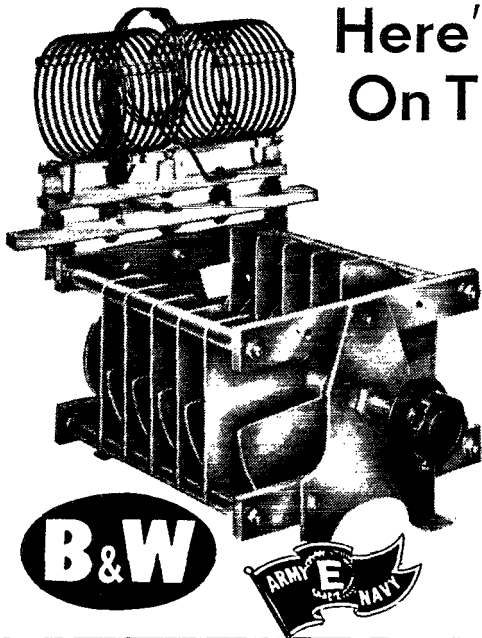

Here's a Good One to Try On That New Rig of Yours

Here's one good way of putting real efficiency into that new rig you're now planning — the one that will knock the spots out of anything you've ever had in the past! B & W Type CX Variable Condensers are half the length of conventional units, have perfect design symmetry, are designed for built-in neutralization with integral mounting of B & W coils thus reducing lead lengths and resulting lead inductance to AN ABSOLUTE MINIMUM. Plan now to use them for a real, honest-to-goodness improvement in your equipment. Bulletin 75-C on request.

BARKER & WILLIAMSON

Dept. Q-105 235 FAIRFIELD AVE., UPPER DARBY, PA.

Exclusive Export Representatives: Lindeteves, Inc., 10 Rockefeller Plaza, New York, N. Y., U. S. A.

ANTENNAS

EST.

BRACH

1906

For every radio purpose

BRACH ANTENNAS

*since the beginning of radio broadcasting
have been pace-makers in their field*

BRACH Antennas, tested and perfected to meet Army and Navy standards, are doing their part for victory on land, on sea, and in the air.

After the war, BRACH Puratone* Antennas will again resume their established leadership for Home and Auto Radios, Television, Marine, F.M. and other services.



*Reg. Patent Trade Mark

L. S. BRACH MFG. CORP.

BRACH

NEWARK 4, N. J.

DeLuxe SPEED KEY

Model
CP 810
#

Amateur
Net Price
\$9.75

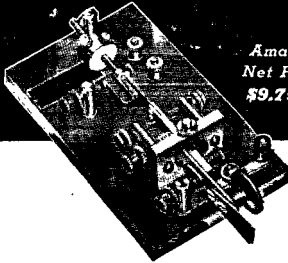

One of the finest commercial or amateur bugs available. Chrome finished base and superstructure. Springs made of selected blue spring steel for uniform performance in all keys. Nine points of adjustment to suit the most critical touch. Fully adjustable. Silver contacts 3/16" diameter.

MODEL CP 510 SPEED KEY • Similar to above except the base is Battleship gray wrinkle finish. Amateur Net Price \$6.75

TELEGRAPH Apparatus Co.

325 WEST AURON STREET • CHICAGO 10, ILL.

RADIO

RADIO Technician and Radio Communications courses. Register now for new classes starting first Monday of each month. Day and Evening Classes.

AMERICAN RADIO INSTITUTE

101 W at 63d St.

New York 23, N. Y.

Approved under GI Bill of Rights

RADIO ENGINEERS DRAFTSMEN WANTED

For development and design of marine radio telephone, telegraph and navigational equipment. Permanent positions available with pioneer company.

write

Mackay Radio and Telegraph Company (Inc.)

MARINE DIVISION

111 EIGHTH AVE.

NEW YORK 11, N. Y.

(Continued from page 134)

seems one of utter confusion. Men are scattered along the shore in apparently haphazard fashion. Aircraft appear to wheel aimlessly like flocks of pigeons overhead. From the transports on the horizon, scores of landing craft plow back and forth. Other craft thread their way across this traffic, while still others simply move in giant circles offshore. The concussion of naval gunfire, the whumping of bombs, the devilish crescendo of the dive bombers — all add a kind of fourth dimension to the confusion.

The fact is that the turmoil is in perfect order. Every one of the tens of thousands of men, each of the scores of ships and the hundreds of small craft and airplanes is doing a specific job. All are integrated into one vast plan which moves on a minute-by-minute schedule.

On Red Beach the beachmaster puts down his walkie-talkie and snaps an order to the signalman at the portable blinker. "Tell the control boat that Red Beach needs two loads of .30-caliber machine gun ammunition." To a signalman with semaphore flags he directs: "Bring in that next wave of LCVPs. We'll get the weasels and the small 'dozers ashore right on time." He hurries on, roaring other orders to distant men through his portable horn.

To control this inflow of men and matériel and to perform the thousand and two jobs incidental to the landing, a special military unit called the shore party lands as the first waves. The group is made up of Navy platoons, the sailors dressed in khaki for shore duty. The Navy personnel in the shore party is known as the beach party.

One of the first tasks of the shore party is to outline the landing areas with markers visible from the sea. A landing region a number of miles long will be divided up administratively into zones known as "Red Beach," "Purple Beach," "Green Beach," and so on. The ends of each beach are marked with distinguishing flags, so that incoming landing craft can direct themselves to the proper points.

Included in the beach party is a hydrographic reconnaissance section that removes underwater and beach obstructions, marks underwater dangers, and buoys safe paths for the landing craft. The beach party's medical section sets up evacuation stations to which wounded men are brought for first aid or transfer to outbound landing craft. The beach party's boat repair section restores slightly damaged craft to service, employing ungainly jehemies that can pick up a landing craft in the surf and trundle it above the high tide line. Special salvage craft lie off the beaches, ready to pass a tow line to a landing craft that has the misfortune to broach broadside on the sand. Other vessels are equipped as fire boats for fighting flames that might be started on a landing craft by enemy action.

Chiefly, the beach party's task is that of regulating the maze of boat traffic so that men and supplies can move across the beach in orderly fashion. The beachmaster is the center of a communication network that extends from the fighting units to the transports offshore. He may

WELCOME BACK!



Astatic

EXTENDS HAND OF
GREETING TO NEW
AND VETERAN AMA-
TEURS RETURNING
TO THE AIR.

In the early thirties, Astatic gave to radio amateurs their first practical and dependable crystal microphone, and continued to supply these "hams," through its jobber outlets, as they increased in number and spread around the world. It's grand to think they're coming back and we can serve them again.

You'll
HEAR MORE
from Astatic

THE
Astatic
ASTATIC CORPORATION
CONNEAUT, OHIO
IN CANADA. CANADIAN ASTATIC LTD., TORONTO, ONTARIO

SALUTE TO THE NAVY

This space is dedicated to our Fighting Navy, afloat and in the air, and to the officers and men who have made it great.

We recall with pride that Coto-Coil was able to make its full contribution to naval victory, and will always remember the very pleasant relationships enjoyed throughout the war.

COTO-COIL CO., INC.

COIL SPECIALISTS SINCE 1917

65 PAVILION AVENUE

PROVIDENCE 5, R. I.

(Continued from page 156)

An Unusual

EMPLOYMENT OPPORTUNITY

The world wide demand for seismic crews provided by Seismograph Service Corporation requires an immediate expansion of its technical personnel.

Men with training and experience particularly in Geology, Physics, Mathematics or Electronics, who will enter foreign service are offered an opportunity leading to responsible positions in petroleum exploration.

Applicants who qualify will be given training in SSC methods, and those who show promise may be sent to South America for further field experience, and when proved competent will be considered for assignments on seismic crews throughout the world.

• • •

In writing for details as to training, salary, living allowances, etc., please state your qualifications and age.

SEISMOGRAPH SERVICE CORPORATION
Kennedy Building • TULSA, OKLAHOMA, U.S.A.

CRABTREE'S WHOLESALE RADIO

2608 Ross Ave. Dallas 1, Texas

COMPLETE RADIO TRAINING!

Prepare now to accept a responsible position in Commercial Radio. New developments will demand technicians with thorough basic training, plus a knowledge of new techniques discovered during the war. Training open to high school graduates or those with high school equivalency. Courses 6 to 18 months' duration in RADIO AND ELECTRONICS. Approved Veteran training in Radio.

Write for Particulars
VALPARAISO TECHNICAL INSTITUTE
Dept. TN Valparaiso, Ind.

CODE SENDING RECEIVING SPEED

Have Skill, Accuracy

Be a "key" man. Learn how to send and receive messages in code by telegraph and radio. Commerce needs thousands of men. Expansion of air commerce and freight after war should create an even bigger peacetime demand for operators. The famous Candler System, maker of world's champions teaches you the "knack" of sound sense and sound consciousness that is the secret of speedy sending and receiving. Good pay, adventure. Learn at home quickly.

FREE 52-PAGE BOOK explains extra course of training. Rush name for it today. It's absolutely free.

CANDLER SYSTEM CO.
Dept. 4-L, P.O. Box 928, Denver 1, Colo., U. S. A.
and at 121 Kingsway, London, W.C. 2, Eng.

order a wave of tank-carrying LSMs to delay their scheduled landing so that badly-needed artillery can be brought ashore first. He oversees the return of the wounded to the boats and maintains a flow of rations, water and fuel inland. Through him orders go to the control boats that dispatch landing boats loaded with supplies to the beaches where they are needed.

The beach parties and the other elements of the shore party must stay at their posts while the front lines move inland. Most of the shore party men must work in exposed positions. They are the special target of enemy aircraft, mortar fire, artillery, and snipers. Each man digs himself a foxhole near where he is stationed, but he can't take time out from his duties to fight back when attacked. For self protection the shore party has its own weapons section that does its fighting for it while the engineers and transportation units perform their assigned functions.

Radio silence is likely to be lifted if the landing is made under fire. Therefore, the first personnel ashore may be an installation crew for a temporary station required to establish the initial communications, or a group to handle the beach end of the unloading of material, depending upon the nature of the landing.

Some operations have called for the establishment of as many as 18 circuits upon landing. Some areas have used trucks and trailers to bring aircraft search, fighter director and essential communication equipment ashore in an operating condition so that it can be used within minutes after it is landed.

If the fleet of LCTs heading for the beach should be attacked by dive bombers, those under attack will radio for assistance and carrier based fighter planes will be promptly sent in to drive off the attacking enemy planes. If one of the LCTs should unfortunately strike coral rock or some other type of shoal, it becomes a vulnerable target for the enemy's island gun emplacements. The radio can be used in a case of this kind to call for prompt assistance. If there are any injuries among the personnel of the LCT during the run to the beach, radio is used to call for another vessel to come alongside and take off the wounded. Upon lowering the ramp at the time of hitting the beach, the LCT group commander may order the vessel by radio to return to the transport to pick up another load. The two-way radio used in this vast fleet of LCTs, LSTs, and APAs to maintain close immediate radio liaison is the versatile standard Navy TCS transmitter-receiver.

The first wave of the ship-to-shore landing force may include ranger battalions and commando troops especially equipped to push back enemy shore guards and form outposts for the landing of heavier troops to follow. These bring with them machine guns, trench mortars, anti-aircraft weapons and light artillery. After them come heavier guns and tanks, all covered in their voyage from ship to shore by an intense naval barrage, shifting inland as the front line of assault troops advances.

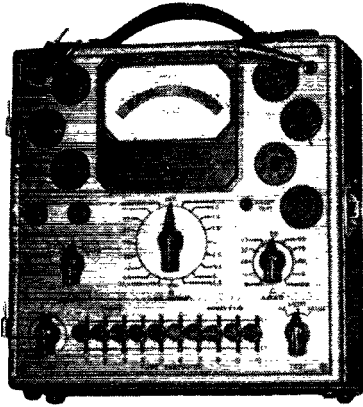

The New Speed-Chek Tube Tester

MORE FLEXIBLE • FAR FASTER • MORE ACCURATE

Three-position lever switching makes this sensational new model one of the most flexible and speediest of all tube testers. Its multi-purpose test circuit provides for standardized VALUE test; SHORT AND OPEN element test and TRANSCONDUCTANCE comparison test. Large 4" square RED•DOT life-time guaranteed meter.

Fast simple operation gives control of each tube element. New SQUARE LINE series metal case 10" x 10" x 5½", striking two-tone hammered baked-on enamel finish. Detachable cover. Tube chart 8" x 9". Simple settings marked in large type.

Model 2413



is another member of
the **NEW TRIPLETT**
Square Line

Triplet

ELECTRICAL INSTRUMENT CO. BLUFFTON, OHIO

Additional Features

- Authoritative tests for tube value; shorts, open elements, and transconductance (mutual conductance) comparison for matching tubes.
- Flexible lever-switching gives individual control for each tube element; provides for roaming elements, dual cathode structures, multi-purpose tubes, etc.
- Line voltage adjustment control.
- Filament Voltages, 0.75 to 110 volts, through 19 steps.
- Sockets: One only each kind required socket plus one spare.
- Distinctive appearance makes impressive counter tester.

THE RADIO AMATEUR'S LIBRARY

Many requests are received for the complete list of our publications. *The list follows:*

Title	Price	Title	Price
QST.....	\$2.50 per year*	Lightning Calculators:	
List of Stations.....	Discontinued	a. Radio (Type A).....	\$1.00
Map of Member Stations.....	Discontinued	b. Ohm's Law (Type B).....	\$1.00
Operating an Amateur Radio Station		Amateur Radio Map of the World.....	\$1.25
Free to members; to others 10c		Two Hundred Meters and Down:	
The Story of The A.R.R.L.....	Discontinued	The Story of Amateur Radio (<i>Out of Print</i>).....	\$1.00
The Radio Amateur's Handbook.....	\$1.00**	Building an Amateur Radiotelephone Transmitter (<i>Out of Print</i>)	
The Log.....	.35c each; 3 for \$1.00	A.R.R.L. Antenna Book.....	50c
How to Become a Radio Amateur.....	.25c	Emergency Communications Manual.....	10c
The Radio Amateur's License Manual.....	.25c	The Minilog.....	.25c
Hints & Kinks for the Radio Amateur.....	.50c	Learning the Radiotelegraph Code.....	.25c
		A Course in Radio Fundamentals.....	.50c

* In the United States and Possessions — other Countries \$3.00 per year.

** Postpaid in Continental U. S. A. — \$1.50, postpaid, elsewhere. (*No stamps, please*)

THE AMERICAN RADIO RELAY LEAGUE, INC.
WEST HARTFORD 7, CONNECTICUT

HAM-ADS

(1) Advertising shall pertain to radio and shall be of nature of interest to radio amateurs or experimenters in their pursuit of the art.

(2) No display of any character will be accepted, nor can any special typographical arrangement, such as all or part capital letters be used which would tend to make one advertisement stand out from the others.

(3) The Ham-Ad rate is 30¢ per word, except as noted in paragraph (6) below.

(4) Remittance in full must accompany copy. No cash or contract discount or agency commission will be allowed.

(5) Closing date for Ham-Ads is the 25th of the second month preceding publication date.

(6) A special rate of 7¢ per word will apply to advertising which, in our judgment, is obviously non-commercial in nature and is placed and signed by a member of the American Radio Relay League. Thus, advertising of bona fide surplus equipment owned, used and for sale by an individual or apparatus offered for exchange or advertising inquiring for special equipment, if by a member of the American Radio Relay League takes the 7¢ rate. An attempt to deal in apparatus in quantity for profit, even if by an individual, is commercial and all advertising by him takes the 30¢ rate. Provisions of paragraphs (1), (2), (4) and (5), apply to all advertising in this column regardless of which rate may apply.

(7) Because error is more easily avoided, it is requested signature and address be printed plainly.

Having made no investigation of the advertisers in the classified columns, the publishers of QST are unable to vouch for their integrity or for the grade or character of the products or services advertised

QUARTZ — Direct importers from Brazil of best quality pure quartz suitable for making piezo-electric crystals. Diamond Drill Carbon Co., 719 World Bldg., New York City.

COMMERCIAL radio operators examination questions and answers. One dollar per element. G. C. Waller, W5ATV, 6540 Washington Blvd., Tulsa, Okla.

WHY NOT turn your unused equipment into ready cash which may be applied towards new and better equipment after the war? Leo, W9GFC, offers you the best cash prices for communications receivers and test equipment. Write today for large illustrated catalog. Wholesale Radio Laboratories, 744 W. Broadway, Council Bluffs, Iowa.

CRYSTALS available — all types, including 100 kc., 465 kc. and 100 kc. Broadcast and Aircraft given prompt attention. Scientific Radio Products, Council Bluffs, Iowa.

CRYSTALS: complete units or blanks. All types. Your specifications and tolerances. One or one million. Refinishing and repairing of your present units. Rex Bassett, Incorporated, Ft. Lauderdale, Fla.

RADIO TESTS — Pre-examination Tests for Radio Operators. Tests your knowledge before you appear for commercial radio operator license examinations. Avoids failures. Guides your preparation. Saves your time. Worth investigating at once. Also books for home study. Write for free circulars 5 Q. Nilson Radio School, 51 E. 42 St., New York 17, N. Y.

IMMEDIATE shipment on priority: New SX28As, \$223.00; SX25s, \$94.50; PM23s \$15.00; S39s, \$110.00; S20Rs \$60.00. In stock Without Priority: Trimmed headsets, McElroy keys, oscillators, bugs, meter rectifiers, \$1.95. Instructographs for rent. Write for our parts lists. Henry Radio, Butler, Mo. and Los Angeles 25, Calif.

HIGHEST prices paid for used receivers, test equipment, bugs, oscillators. What have you? W9ARA, Butler, Mo.

WHEN amateurs are on the air again there will be a complete line of James Knights Precision Crystals for every amateur activity. The James Knights Company, Sandwich, Ill

HEADPHONES: latest type light weight, finest quality, with plug for tuning in on radio, or intercommunication system. 2000 ohm resistance. Headphones: (no headbands, slightly used) \$1.25; Headphones: (no headbands, new), \$1.75; Headphones (with leather covered adjustable headbands, slightly used), \$2.50; Headphones: (with adjustable leather-covered headbands, new), \$3.75, plus 25¢ shipping charges. Send check or money order. Quantity limited. Nico Supply Co., 540 North 17th Street, Philadelphia, Pa.

LINE to single or PP grid transformer. 1 to 10 or 20 turns ratio. Small shielded BC quality — \$4.00 each. Also 80 inch coaxial cable with end fittings — \$1.00. Jobbers or manufacturers ask for special quantity prices. Van Sickle Radio, Indianapolis 6, Ind.

AMATEUR radio licenses. Complete code or theory preparation for passing amateur radio examinations. Home study and resident courses. American Radio Institute, 101 West 63rd Street, New York City.

COMPLETE radio kits, \$10.95. Multitester kits, surplus navy receiving, transmitting, test equipment, free details. Radio, 120 Cedar Street, New York 6, N. Y.

QSL's — Order now, avoid rush. Frits, 1213 Briargate, Joliet, Ill.

FABERADIO crystals are now available. Write for prices. Faberadio, Sandwich, Ill.

AMATEUR and radio servicemen's supplies. Albert Arnold, W5WX, 111 East 8th St., Amarillo, Texas.

MILLIAMETER shunts, out to order. Send \$1.75 per range and meter. W. Budd, 33 Clendenny Avenue Jersey City, 4, N. J.

WANTED: one communication type receiver, small model such as Echophone or similar model, in working order. W. A. Dreier, 1050 Old Northpoint Road, Baltimore 24, Md.

WANTED: receiver, such as S2OR. Sell, trade, unused model airplane motor. Raymond Hitchcock, Sunbury, Ont. Canada.

SELL Collins 32G transmitter, 50 watts phone o.w. coils, 10 and 20 meters, D104 chrome mike, perfect condition. Cost \$325. Best offer. De Claine, W4GIB, 1870 Southwest 24th Terrace, Miami, Fla.

NEW 954 and 955 tubes, \$1.50 each. Used 832 tubes, guaranteed o.k. \$5.00 each. Lanam Radio, 2320 Shattuck, Berkeley 4, Calif.

WANTED: test and aligning oscillator. Also tube tester and receiver. What have you? Williams, W4EYK, 720 Broad, Columbus, Ga.

ALUMINUM tubing, 1" diameter, ideal for u.h.f. antenna. 12 ft length, 84¢ 20 ft. length, \$1.40. Slight charge for crating and shipping. Leonard L. Jezorek, 88 E. Franklin, Wilmington Manor, New Castle, Delaware.

SELL: WERS station, receiver, transmitter, modulator, parts. Craven, W3ERV, 2216 South 7th St., Philadelphia, Penna.

WANTED: National NC-100 and Temoo 100 transmitter, or a 150 to 300-watts input transmitter. Van Valkenburg W9FRH, 812 No. 22nd St., Ft. Dodge, Iowa.

WANT National p.w. dial. Prefer three-gang. Dunn, 218 Spring St., Macon, Ga.

TELEVISION tech correspondence course. Your personal instructor is a former employee of a major television station and a frequent contributor to leading technical periodicals. Television Tech Enterprises, Box 94, Hatboro, Penna.

BILL Conklin, ex-W9BNX now W3JUX. Bethesda, Maryland.

SELL late model NC-101X with "S" meter, complete with speaker cabinet, excellent condition. A. B. Palmer, W1KIO, 111 Wilfred St., West Hartford, Conn.

PIONEER Gen-E motor, 115 d.c. to 115 a.c. 350 watts. Factory rebuilt unused and in original carton. #28. Jonathan Eddy, 63 Park Row New York 7 N. Y.

MEISSNER DeLux signal shifter, mufd 1943, never unpacked. 10 sets coils. 2040 to 8870 k.c., \$45 or good crystal frequency standard. John Isaacs, W6PZV, W 156th St., Gardena, Calif.

S-2OR as new. Will trade for kodak "35" f3.5 w/o pld. r.f. or equivalent. Lt. Alvin Lake, 51st SAW Det., Camp Pinedale, Fresno, Calif.

WANTED: Ready to go Stanco 20N or 10P transmitter or what have you in a good low power rig? Write: John Asaro, E.M. 1/c USMS, Ft. Trumbull, New London, Conn., c/o Radio Department.

TELEVISION receiver, mechanical duplicate of set on page 38 June 1940 QST. Modified for television broadcast, channel #3. Wide-band IF's. Video only. Trade for miniature or graphic camera. H. Morrison, 41 W. Walnut, Merchantville, New Jersey.

CRYSTALS now. Prompt delivery of those Eidson Fine crystals. Highest quality commercial types available throughout the 100-12 5000 k.c. range. Also repair and regrounding. Over ten years of satisfaction and fast service! We're as near as your telephone we can supply you. "Eidson's," Temple, Texas, Phone 3901.

SELL Echophone EC-1, Excellent condition. Best offer. Simmons, 511 E. Scott Kirksville, Mo.

WAR surplus, new National radio parts. List sent. Brownstein, W3GKO, 4653 Boudinot St., Philadelphia 20, Penna.

RECEIVERS arriving in stock. Conklin Radio, Bethesda, Md.

TRANSMITTER: high power, T-55e, 866s, Bud BP-500-watt final; extra kilowatt final chassis tank and grid condensers with Eimac 450T1; standard W.E. 6-ft. racks (2), one r.f.; one phone; all metered; over hundred spare parts, condensers, relays, tubes. Vibroplex, mike, etc. Twelve hundred dollar value, entire lot for \$400. E. S. Hillery, W2GNK/9, Elmwood, Illinois

**"ECHOPHONE'S GADGETS
ON THE CITIZENS'
RADIOPHONE BAND
WILL BRING US
CLOSER TOGETHER
THAN EVER"***

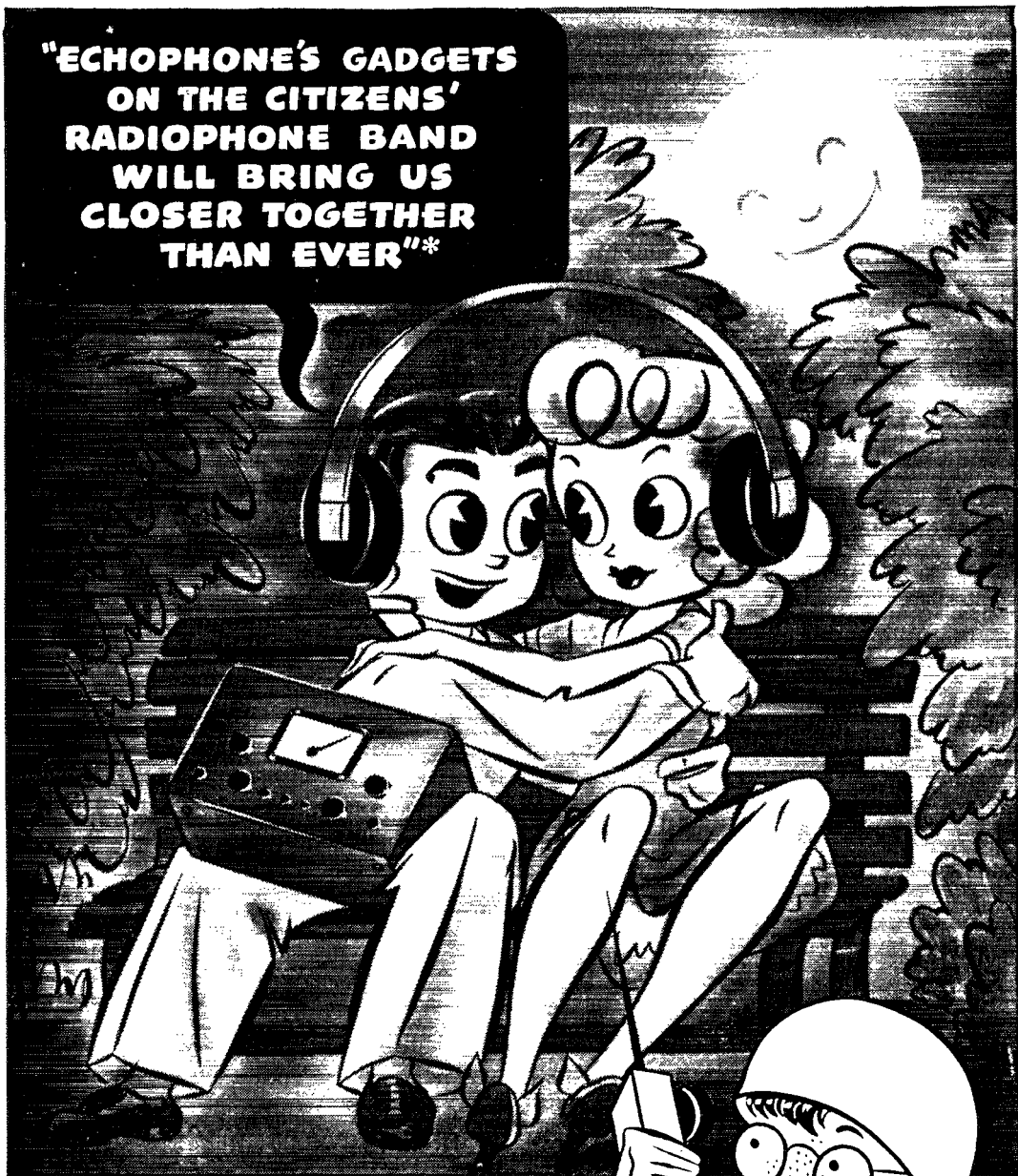

HOGARTH'S PLANS ARE WELL IN HAND

Hogarth's well aware of the future new possibilities for Echophone. There will be Echophone equipment for use on the citizens' radio communications service band. It is certain to be low in price, high in performance and completely dependable. The present EC-1 covers from 550 kc. to 30 Mc. on three bands . . . electrical bandsread on all bands . . . self-contained speaker . . . 115-125 volts AC or DC.

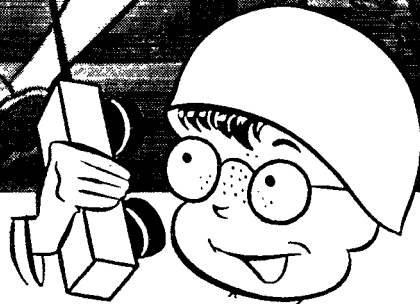

ECHOPHONE
"The Ears of the World"

*Citizen's radio communications service band; 460-470 Mc., recently proposed by the F.C.C

ECHOPHONE RADIO CO., 540 NORTH MICHIGAN AVE., CHICAGO 11, ILLINOIS

Designed for



Application

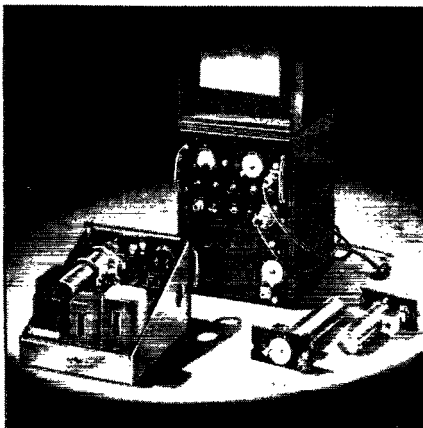

THE 90630

Ultra-High Frequency Calibrator

The Millen 90630 cavity-type Frequency Calibrator covers the frequency range of 200 to 700 Mc. with a maximum error of not over 0.25%. This range is covered by two plug-in cavity-type tuning units which may be easily interchanged. It may be used on harmonics up to 1500 Mc. at somewhat reduced sensitivity.

The calibrator consists of an accurately calibrated cavity-type tuning unit, a crystal detector, a two-stage video amplifier, and a peak reading VT voltmeter.

Send for catalog sheet with full engineering details.

**JAMES MILLEN
MFG. CO., INC.**

MAIN OFFICE AND FACTORY
**MALDEN
MASSACHUSETTS**



Index to Advertisers

	Page
Abbott Instrument, Inc.	**
Aerovox Corporation	**
American Lava Corp.	4
American Radio Institute	136
American Tel. & Tel. Corp.	118
Amperex Elec. Products, Inc.	**
Andrew Company	111
Astatic Corporation, The	137
Ayers Automatic Code Machines	**
Barker & Williamson	135
Billey Electric Co.	93
Brach Manufacturing Corp.	135
Browning Laboratories, Inc.	**
Burgess Battery Company	100
Candler System Company	138
Capitol Radio Engineering Institutes	98
Cardwell Mfg. Corp., Allen D.	108
Carter Motor Co.	132
Centralab	**
Cierostat Mfg. Co., Inc.	**
Collins Radio Company	95
Commercial Radio Institute	**
Communications Products Co.	**
Coto-Coil Co.	137
Crabtree Wholesale Radio	138
Crystal Products Co.	119
Delco Radio, Div. Gen. Motors	**
DX Crystal Company	**
Echophone Radio Company	141
Eitel-McCullough, Inc.	5
Electro-Voice Mfg. Co.	**
Electrical Resistance Corp.	134
Electronic Laboratories	**
Galvin Manufacturing Corp.	**
Gardiner & Company	**
General Ceramics & Steatite Co.	**
General Electric Co.	97
Greenlee Tool Company	**
Hallicrafters Co., The	1, 2, 143
Hammarlund Mfg. Co., The	9, 91, 109, 131
Harco Steel Construction Co.	124
Harrison Radio Company	125
Harvey Radio Company	**
Harvey Radio Laboratories, Inc.	126
Harvey-Wells Communications, Inc.	**
Hazeltine Electric Corp.	**
Heintz & Kaufman, Ltd.	103
Henry Radio Shop	114
Hytrol Corporation	107
Instructograph Company	**
International Resistance Co.	102
Jensen Radio Mfg. Co.	7
Ken-Rad Tube & Lamp Corp.	**
Kenyon Transformer Co., Inc.	**
Knights Company, James	**
Lewis Electronics	133
Mackay Radio & Tel. Co.	136
Mallory & Co., P. R.	96
Marion Electric Inst. Co.	127
Massachusetts Radio School	**
McElroy Mfg. Corp.	112, 113
McCraw-Hill Book Co., Inc.	122
Meck Industries, John	**
Meissner Mfg. Co.	**
Mielville Radio Institute	**
Millen Mfg. Co., James	142
National Carbon Co.	101
National Company, Inc.	89, Cov. III
Newark Electric Co.	121
New York Transformer Co.	120
Nilson Radio School	**
Ohmite Manufacturing Co.	99
Onan Electric Co., D. W.	132
Oxford-Tartak Radio Corp.	**
Pioneer Gen-E-Motor	**
Port Arthur College	134
Premax Products	**
RCA Institutes, Inc.	128
RCA Manufacturing Co., Inc.	Cov. IV
Radell Corp.	122
Radio Manufacturing Engineers	133
Radio Shack Corporation	125
Raytheon Mfg. Co.	129
Radio-Television Institute	**
Scell & Co., R. C.	128
Scientific Radio Products Co.	**
Seismograph Service Corp.	138
Shure Brothers	104
Sickles Co., F. W.	126
Simpson Electric Co.	116
Solar Mfg. Co.	144
Sperry Gyroscope Co.	106
Sprague Electric Co.	123
Standard Radio Electric Co.	**
Standard Transformer Co.	**
Sun Radio & Electronics Co.	**
Taylor Tubes, Inc.	117
Telegraph Apparatus Co.	136
Terminal Radio Corp.	119
Thordarson Electric Mfg. Co.	110
Triplitt Elec. Instrument Co., The	139
Turner Company, The	**
United Transformer Co.	Cov. II
Universal Microphone Co.	**
Valparaiso Technical Institute	138
Vibronlex Company, Inc., The	126, 128
Ward Leonard Electric Co.	132
Western Electric Co.	**
Westinghouse Elec. Corp.	133
Wholesale Radio Laboratories	124
Wilson Electric Co.	**
Yaxley (Mallory & Co., P. R.)	96
Zenith Radio Company	**

All of the above advertisers are cooperating with the A.R.R.L. to permit publication of an editorially adequate QST during this period of war-rationing of paper. Using less advertising space but at higher rates, they continue their customary support of QST. Some are using smaller space in each issue and some are using space only every second or third issue. Of the latter, those whose advertising does not appear in this particular issue are indicated by the ** above.

JUST ONE

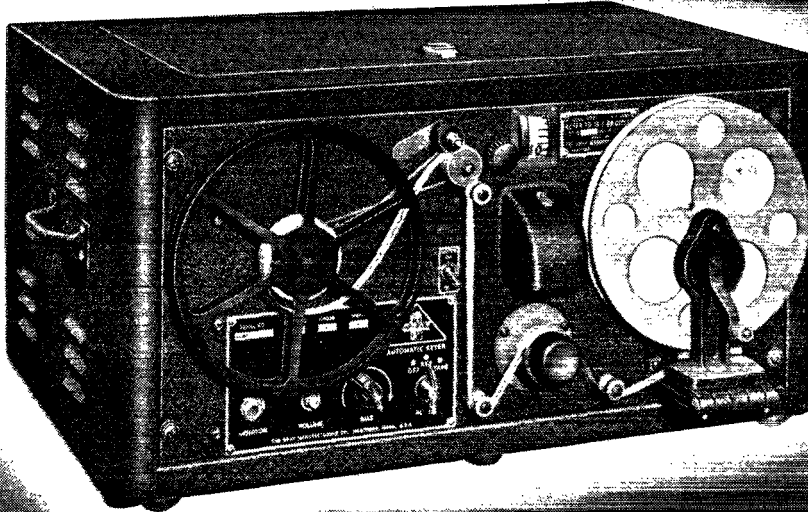

JUST ONE of numerous government radio and electronic items now available through the Hallicrafters Co., Chicago, agent for Reconstruction Finance Corporation.

This is a Keyer TG-10-F, an automatic unit for providing code practice signals from inked tape recordings. Excellent for group instruction, sufficient power to operate up to 300 pairs of head phones. Can be adapted as amplifier of 10 to 15 watts output for use with crystal mike or phono pick up. Completely checked and reconditioned by Hallicrafters engineers. Send coupon for further details and lists of other available items.

THESE VALUABLE ITEMS

Available Now Or Very Soon.

Write, wire, phone for further information

- head phones • test equipment • component parts • marine transmitters and receivers • code practice equipment • sound detecting equipment • vehicular operation police and command sets • radio beacons and airborne landing equipment

hallicrafters RADIO

HALLICRAFTERS CO., AGENT OF RFC UNDER CONTRACT SIA-3-24
WORLD'S LARGEST EXCLUSIVE MANUFACTURERS OF
SHORT WAVE RADIO COMMUNICATIONS EQUIPMENT

CLIP THIS COUPON NOW

RFC DEPARTMENT 109, HALLICRAFTERS
5025 West 65th Street • Chicago 38, Illinois

- Send further details and price on Keyer TG-10-F
- Send listings of other available items

Especially interested in.....

NAME.....

ADDRESS.....

CITY.....ZONE.....

STATE.....

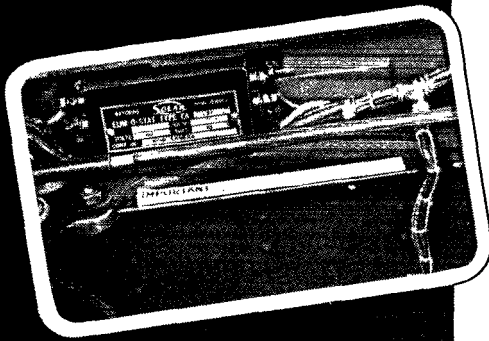

— Quick as a wink the Fairchild Night Owl Camera records enemy movements intended to be hidden by darkness. Quick as a flash the radio of the photo-reconnaissance plane keeps touch with its base — and clearly — for Solar Elim-O-Stats are part of the electronic equipment of these highly perfected cameras. This is but one of many instances where Solar Elim-O-Stats are being used to absorb local interference and keep speech channels free. Let Solar advise you on radio-noise suppression.



⊕ 8013



WEST N. Y. BAYONNE PLANT
PLANT
A TOTAL OF NINE
ARMY-NAVY EXCELLENCE AWARDS

SOLAR MANUFACTURING CORP.
285 Madison Avenue • New York 17, N. Y.

A NEW SOCKET

*for very high
frequencies*

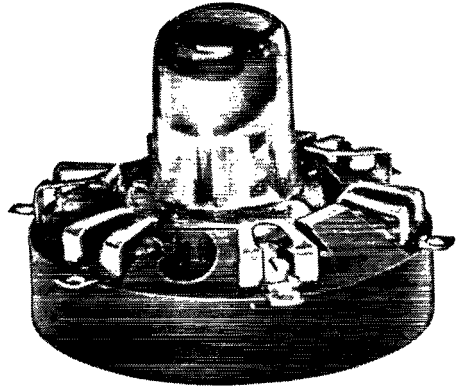

Type XLA

Born of war-time necessity, this new socket, Type XLA, for the 6F4 and the 950 series acorn tubes, has been designed for working frequencies as high as 600 MC. The acorn tube is inserted in position, and rotated to engage the contacts. The tube terminals are held in a vise-like grip which insures permanently low contact resistance. Inductance is low and constant, and leads are short and direct. An internal shield, Type XLA-S, is available for tubes such as the 956. By-pass condensers may be conveniently mounted between the contact terminals and the chassis, but for minimum radiation a special ceramic condenser, Type XLA-C, may be mounted inside the socket in place of the contact screw. The socket is $1\frac{17}{32}$ " diameter. Insulation is low loss R-39. Prompt delivery can be made without priority.



NATIONAL COMPANY, INC.
MALDEN, MASS.

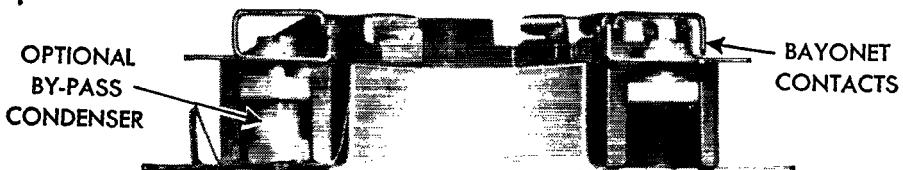

RCA Acorn Tubes For U-H-F Amateur Radio Equipment

9 RCA Acorn-Type Tubes Available for Wide Variety of Compact Equipment; Prices Range from \$2.00 to \$10.25

HEATER-CATHODE TYPES (A.C. OR D.C.)—RCA-954, \$4.50 • RCA-955, \$2.85 • RCA-956, \$5.00 • RCA-6F4, \$10.25 • RCA-9004, \$2.00 • RCA-9005, \$4.00.

The heaters of these types are designed for 6.3-volt operation with the exception of the RCA-9005, which is rated at 3.6 volts.

As an r-f amplifier, the **954** has a gain of 3 or more in circuits of conventional design; it can operate at frequencies up to about 400 mc.

THE 955, a triode, is used as a detector or amplifier in u-h-f receivers, and as an oscillator in low-power transmitters. At 60 megacycles it has an output of half a watt, and only moderate reduction up to 300 mc.

THE 956, a remote-cut-off pentode, is used as an r-f and intermediate-frequency amplifier, or as a mixer, in receivers operating at frequencies up to about 400 mc. It has a gain of 4 or more when used as an amplifier in circuits of conventional design.

THE 6F4, a triode, is designed for oscillator service at frequencies up to 1200 mc. Seven-pin acorn design provides two connections to plate and two to grid. Delivers 1.8 watts at moderate frequencies; about 0.045 watt at 1200 mc.

THE 9004 and the **9005** are diodes, with resonant frequencies of 850 and 1500 mc, respectively.

FILAMENT TYPES — RCA-957, \$3.00 • RCA-958-A, \$6.95 • RCA-959, \$5.00.

The filaments of each of these 1.25-volt types can be operated directly from a standard flashlight dry cell without series resistance.

THE 957, with an amplification factor of 13.5, may be used as a detector, amplifier, or oscillator.

THE 958-A is designed for service as an oscillator or r-f amplifier in transmitters.

THE 959 is a sharp-cut-off pentode for use as an r-f amplifier and detector.

For technical data on these RCA acorn tubes, write to RCA, Commercial Engineering Department, Section 62-72X, Harrison, N. J.

THE FOUNTAINHEAD OF MODERN
TUBE DEVELOPMENT IS RCA



42-4424-7E

RADIO CORPORATION OF AMERICA

TUBE DIVISION • HARRISON, N. J.



Your Amateur War Service Record—What It Means

As every *QST* reader, regular or otherwise, should know by now, we are endeavoring to compile at ARRL Hq. a record of the service of every radio amateur who has served in this war. If you are, or ever have been, a licensed amateur (holder of either an amateur station or an amateur operator license) and have been engaged in military service or in any aspect of communications work where radio know-how counts, we ask you to register with us by filling out the post-card form below and mailing it to us (marked "free," of course, if you're in the armed forces). We need this record whether your service has been in uniform in the armed forces, or in the Civil Service, or in any other branch of government work of a nature essential to the war effort, or in those portions of the radio manufacturing industry devoted 100 per cent to war work. It will take you only a minute to fill out the form and it will be a big help to amateur radio. We would also appreciate similar data on your co-workers of amateur

background. A second card is provided for your convenience in this connection. If you've already sent in your own AWSR, please try to get both cards into the hands of other hams who have not done so.

Don't dismiss this request as trivial and don't minimize the importance of the record we are establishing. It may well be of vital importance to the future security of amateur radio — not only in obtaining our restoration to the air, but sometime in the distant future when active recollection on the part of government authorities of the service we have rendered will have dimmed. The performance of radio amateurs in World War I has always been one of our strongest arguments, but it would have been far stronger had a fully detailed record of that performance been preserved. The same mistake must not be repeated. The amateur's performance in this war must be recorded in full. You do your part and we'll do ours.

POST CARD

ONE
CENT
POSTAGE
HERE

THE AMERICAN RADIO RELAY LEAGUE, INC.

38 LaSalle Road

West Hartford 7, Connecticut, U. S. A.

ITS Dept.

TEAR OUT ALONG PERFORATED LINE

POST CARD

ONE
CENT
POSTAGE
HERE

THE AMERICAN RADIO RELAY LEAGUE, INC.

38 LaSalle Road

West Hartford 7, Connecticut, U. S. A.

ITS Dept.

IN THE SERVICES

MANY amateurs will remember the familiar post-card insert in the September, 1944, (Signal Corps) issue of *QST* by which the League solicited registrations of all United States and Canadian hams in the armed forces, in Civil Service, in laboratories or industries devoted 100 per cent to the war effort. The response was enormous and highly gratifying. Even though a full year has elapsed, these handy registration cards still reach us from amateurs overseas or from those who have returned home to *QST*'s that have been carefully preserved.

The method was so successful we are trying it again in this special Navy issue, knowing there are still some thousands of amateurs who are not

enrolled in our roster because of absence from home or because they are not League members and do not get *QST*. Being double, one half of the insert can be used by a member, if he has not already sent us a card or form, the other half by a friend who may not have heard of our desire to make the list as complete as possible.

If you have already registered, do not duplicate but get two of your friends to complete and return the post cards. Or perhaps you know one or two licensed amateurs on foreign duty, who may never have read *QST* since they left and are unfamiliar with our In the Services roster: you can act for them by sending us the essential information. Regardless of the source, we want more names, *all* names, so the file may truly represent amateur participation in the war effort.

Won't you do your part, OM or YL? Tnx vy.

Last Call, OM!

AMATEUR WAR SERVICE RECORD

Please give this card to a ham friend.

Name

Call, present or ex; or grade of op-license only

Present mailing address

SERVICE

- Army
 Navy
 Coast Guard
 Marine Corps
 Maritime Service
 Merchant Marine
 Civil Service
 Radio industry, 100% war

Rank or rating

Branch or bureau: *Signal Corps, AAF, BuShips, WAVES, etc.*
If civilian industry, give title and company.

AMATEUR WAR SERVICE RECORD

This card is for you to fill out.

Name

Call, present or ex; or grade of op-license only

Present mailing address

SERVICE

- Army
 Navy
 Coast Guard
 Marine Corps
 Maritime Service
 Merchant Marine
 Civil Service
 Radio industry, 100% war

Rank or rating

Branch or bureau: *Signal Corps, AAF, BuShips, WAVES, etc.*
If civilian industry, give title and company.