

July, 1945

25 cents

35c in Canada

devoted entirely to

amateur radio

In This Issue:

**Taming the Vacuum-
Tube Voltmeter**

Bass Boost Circuits

**Directional Antenna
Calculations**

**Military Radio
Operating Procedures**

FCC Allocations



TRANSFORMER COMPONENTS

for every application

RADIO

Set components



Radio Filters



Pulse Transformers

Mine Detection Components

DETECTION

TELEPHONY

Loading Coils



Repeat Coils



Selective Amplifier Filters

Inter-phone Amplifier Components

AMPLIFICATION



Foremost Manufacturers of Transformers to the Electronic Industry



ALL PLANTS

May we cooperate with you on design savings for your applications... war or postwar?

United Transformer Corp.
 150 VARICK STREET
 EXPORT DIVISION: 13 EAST 40th STREET,
 NEW YORK 13, N. Y.
 NEW YORK 16, N. Y., CABLES: "ARLAB"

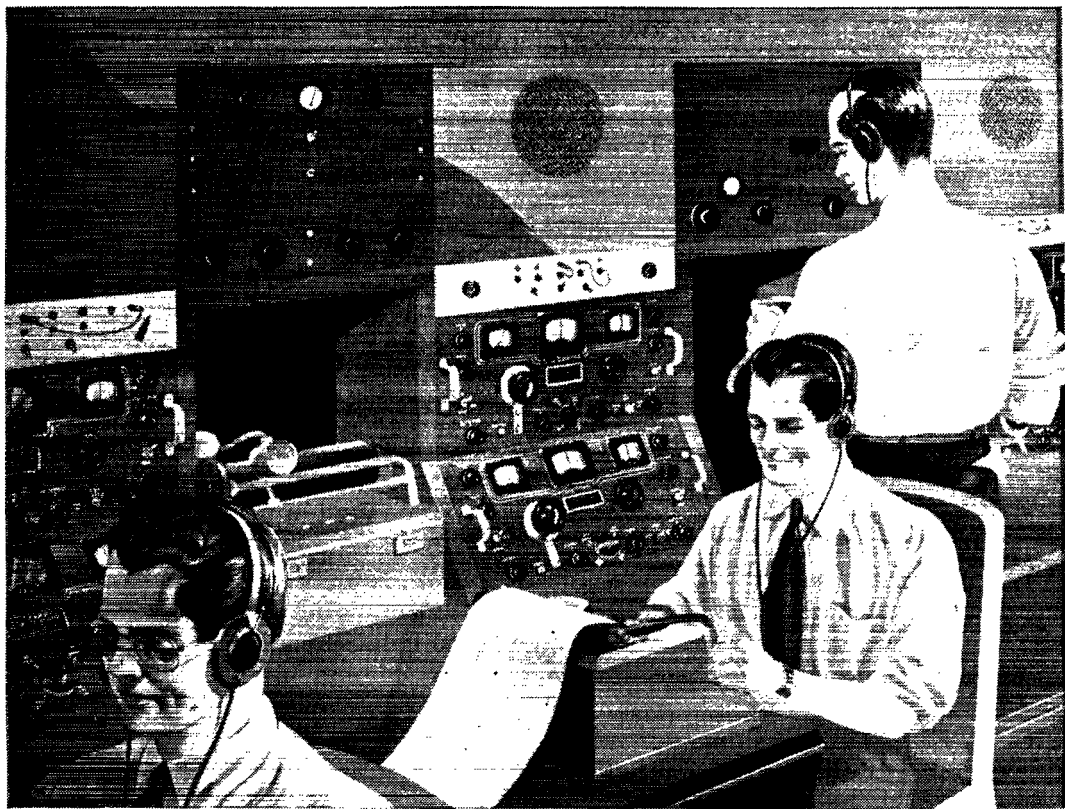

RID at work { **HOW RADIO INTELLIGENCE DIVISION KEEPS WATCH...**

● The radio amateur has distinguished himself outstandingly in the service of his country in time of war. One of his most important jobs is in the RID—Radio Intelligence Division of the Federal Communications Commission. Above you see sketches of typical hams at work in the intercept room of one of the RID's monitoring stations. With high powered, extraordinarily sensitive equipment like this, manned by experts, the RID patrols the ether, spots illegal transmitters, locates lost planes and keeps watch on the entire radio spectrum

to guard home front security. Vigilance like this has put more than 400 clandestine stations out of commission. About 70% of the personnel employed by RID consists of licensed amateur radio operators. For these exacting technicians Hallicrafters has developed the finest equipment that can be made. When the time comes Hallcrafters will be ready with a full line of HF, VHF and UHF communications equipment—designed specifically for the amateur and for all others who need the latest and best combined in "the radio man's radio."

COPYRIGHT 1945 THE HALLICRAFTERS CO.



This is a model SX-28A, a communications receiver operating on a frequency range of 530 kc to 42 Mc, continuous in 6 bands including regular broadcast band.

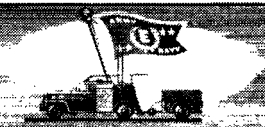

BUY A WAR BOND TODAY

hallicrafters RADIO

THE HALLICRAFTERS CO., MANUFACTURERS OF RADIO AND ELECTRONIC EQUIPMENT • CHICAGO 16, U. S. A.

HOW hallicrafters EQUIPMENT COVERS THE SPECTRUM

MODEL SX-28A — from 550 kc to 42 Mc



HALLICRAFTERS Super Skyrider, Model SX-28A, covers the busiest part of the radio spectrum—standard broadcast band, international short wave broadcast bands, long distance radio telegraph frequencies, and all the other vital services operating between 550 kilocycles and 42 megacycles. Designed primarily as a top flight communications receiver the SX-28A incorporates every feature which long experience has shown to be desirable in equipment of this type.

The traditional sensitivity and selectivity of the pre-war SX-28, ranking favorite with both amateur and professional operators, have been further improved in this new Super Skyrider by the use of "micro-set" permeability-tuned inductances in the RF section. The inductances, trimmer capacitors and associated components for each RF stage are mounted on small individual sub-chassis, easily removable for servicing.

Full temperature compensation and positive gear drive on both main and band-spread tuning dials make possible the accurate and permanent logging of stations. Circuit features include two RF stages, two IF stages, BFO, three stage Lamb-type noise limiter, etc. Six degrees of selectivity from BROAD IF (approximately 12 KC wide) for maximum fidelity to SHARP CRYSTAL for CW telegraphy are instantly available. Speaker terminals to match 500 or 5000 ohms are provided and the undistorted power output is 8 watts.

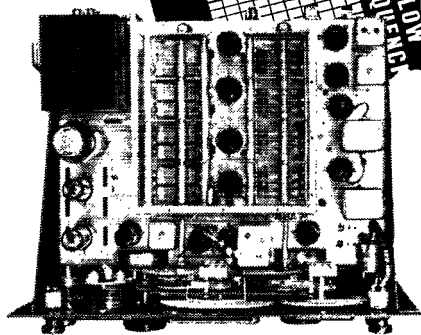

BUY A WAR BOND TODAY

hallicrafters RADIO

COPYRIGHT 1945 THE HALLICRAFTERS CO.

THE HALLICRAFTERS CO., MANUFACTURERS OF RADIO AND ELECTRONIC EQUIPMENT • CHICAGO 16, U. S. A.

JULY 1945

VOLUME XXIX

NUMBER 7



STAFF

Editorial

KENNETH B. WARNER, W1EH
General Manager of ARRL
Publications

CLINTON B. DeSoto, W1C9D
Editor

A. DAVID MIDDLETON, W2OEN
Assistant Editor

GEORGE GRAMMER, W1DF*
Technical Editor

DONALD H. MIX, W1TS
Acting Technical Editor

J. VENABLE FITZHUGH, W5VL
BYRON GOODMAN, W1JFE*
Assistant Technical Editors

EDWARD P. TILTON, W1HQ
Contributing Editor, V.H.F.

WALTER E. BRADLEY, W1FWH
VEENON CHAMBERS, W1JQ*
Technical Information Service

LOUISA B. DRESSER, LSPH
Assistant to the Editor

ELSIE C. HOCHMEISTER
Editorial Assistant

JAMES J. LAMB, W1AL*
Research Engineer, ARRL

Advertising

F. CHEYNEY BEEKLEY, W1GS
Advertising Manager

Circulation

DAVID H. HOUGHTON
Circulation Manager

RALPH T. BEAUDIN, W1BAW
Asst. Circulation Manager

*On leave of absence.



OFFICES

38 La Salle Road
West Hartford 7, Connecticut

Subscription rate in United States and Possessions, \$2.50 per year, postpaid; all other countries, \$3.00 per year, postpaid. Single copies, 25 cents. Foreign remittances should be by international postal or express money order or bank draft negotiable in the U. S. and for an equivalent amount in U. S. funds.

Entered as second-class matter May 29, 1919, at the post office at Hartford, Connecticut, under the Act of March 3, 1879. Acceptance for mailing at special rate of postage provided for in section 1103, Act of October 3, 1917, authorized September 9, 1922. Additional entry at Concord, N. H., authorized February 21, 1929, under the Act of February 23, 1925.

Copyright 1945 by the American Radio Relay League, Inc. Title registered at U. S. Patent Office.

QST

devoted entirely to

AMATEUR RADIO

PUBLISHED, MONTHLY, AS ITS OFFICIAL ORGAN, BY THE AMERICAN RADIO RELAY LEAGUE, INC., AT WEST HARTFORD, CONN., U. S. A.; OFFICIAL ORGAN OF THE INTERNATIONAL AMATEUR RADIO UNION



CONTENTS

It Seems to Us	9
Splatter	10
FCC's Final Allocations Above 25 Mc.	11
FCC's Proposed Allocations Below 25 Mc.	15
Gold Stars — W3GXI, W5E00	16
Taming the Vacuum-Tube Voltmeter — Part I <i>McMurdo Silver</i>	17
Postwar Station Calls . . . <i>Charles A. Service, jr., W4IE</i>	24
"The Crystal Ball"	27
In the Services	28
Military Radio Operating Procedures <i>Lt. Col. Robert Hertzberg, SC, W2DJJ</i>	32
Bass Boost <i>George Grammer, W1DF</i>	35
Happenings of the Month	39
A Crystal-Controlled 112-Mc. Mobile Transmitter <i>Robert A. Waters, W2JST</i>	41
In QST 25 Years Ago This Month	45
Calculations for Antenna Orientation <i>W. E. Marquart, W9CKT</i>	46
Hams in Combat In Burma with the AACCS <i>T/Sgt. Jack Hanley, jr., W7CDW,</i> <i>Sgt. Ken Shane, and Sgt. Will Chasan</i>	48
Strays	51
Hints and Kinks <i>Multipurpose V.H.F. Equipment — A Full-Wave Transformerless Low-Voltage Supply — Notes on Electron-Coupled Oscillators — Caution to Users of Wafer Sockets for Octal-Base Rectifiers — No-Kink Scheme for 'Phone Cords — Improved "Hetrofil" Circuit</i>	52
Correspondence from Members	54
Operating News	56
The Month in Canada	58
Amateur Activities	60
Silent Keys	88
Ham-Ads	100
QST's Index of Advertisers	102

☐ All material appearing in QST conforms with the "Code of Wartime Practices for the American Press" of the U. S. Office of Censorship.
☐ All material involving military security has been reviewed by appropriate military, naval or other competent authority.

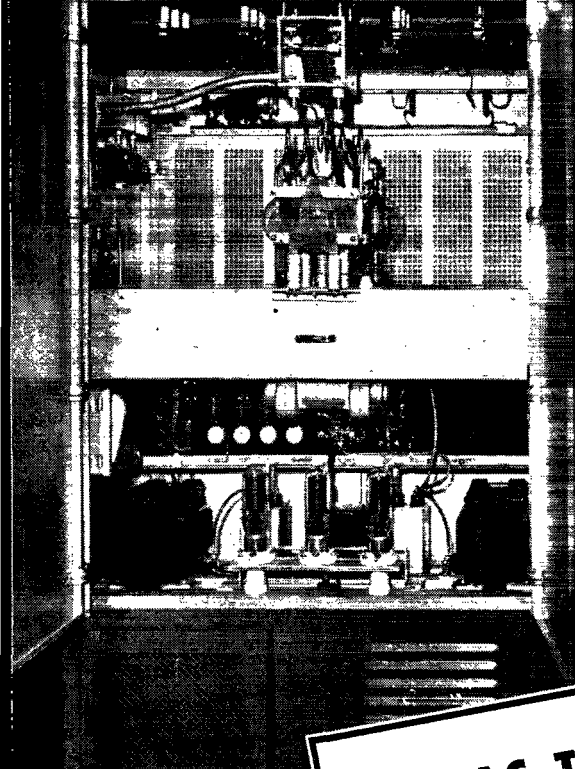

A pair of Eimac 1000-T's give 3 KW output in this Link-built FM transmitter for the emergency services.

Here's a 500 watt supersonic test generator for operation at 1 to 300 kc which uses Eimac 152-T tubes.

**EIMAC TUBES IN THE
EMERGENCY SERVICES
WHERE DEPENDABLE
PERFORMANCE COUNTS!**

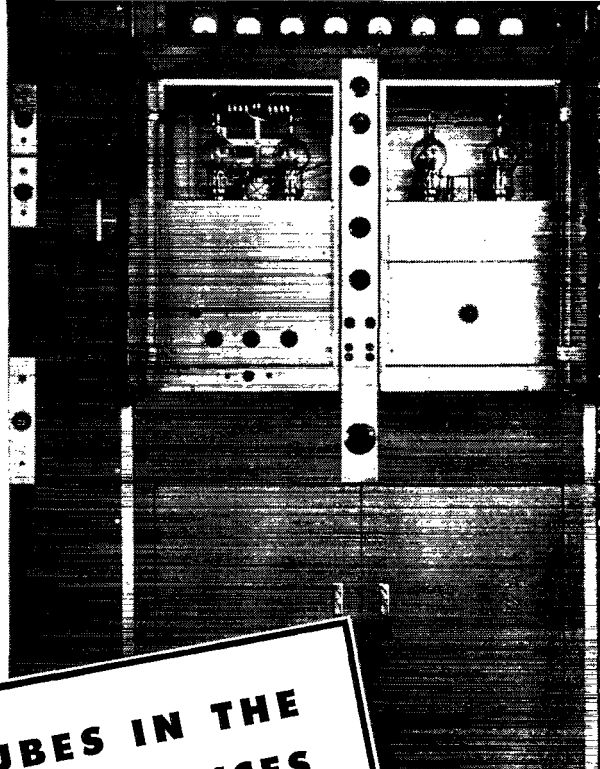

500 watt AM police transmitter for 30-40 Mc operation, built by Fred M. Link using Eimac 250-TH tubes in the final.

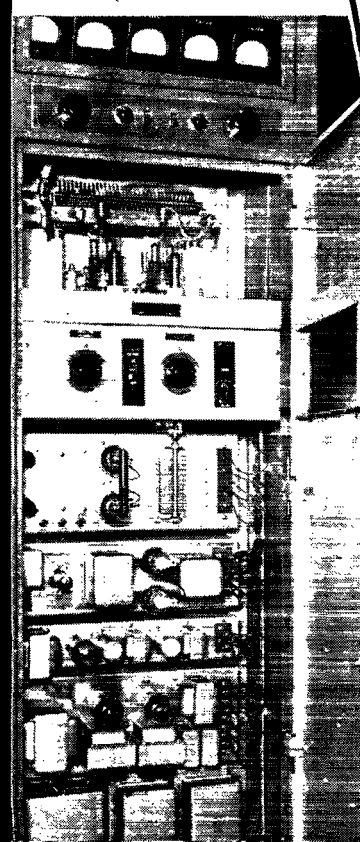

The transmitters shown on this page were developed and built for the emergency services—police, fire and transportation—by Link Radio Corporation of New York City. Recognition such as that enjoyed by the Link organization in this field is built upon sound engineering and the right choice of equipment components. That Eimac tubes occupy the important sockets in these vital transmitters is fitting acknowledgement of their inherently superior performance capabilities. That Fred M. Link specifies Eimac tubes is confirmation of the fact that Eimac tubes are first choice of leading electronic engineers throughout the world.

FOLLOW THE LEADERS TO

Eimac
REG. U.S. PAT. OFF.
TUBES

Get your copy of Electronic Telesis ... the sixty-four page booklet which gives the fundamentals of electronics. This little booklet will help electronic engineers explain the subject to laymen. It's yours for the asking ... no cost or obligation. Available in English and Spanish languages.

EITEL-McCULLOUGH, INC., 1033 San Mateo Ave., San Bruno, Calif.
Plants located at: San Bruno, California and Salt Lake City, Utah
Export Agents: Frazer & Hansen
301 Clay Street, San Francisco 11, California, U. S. A.

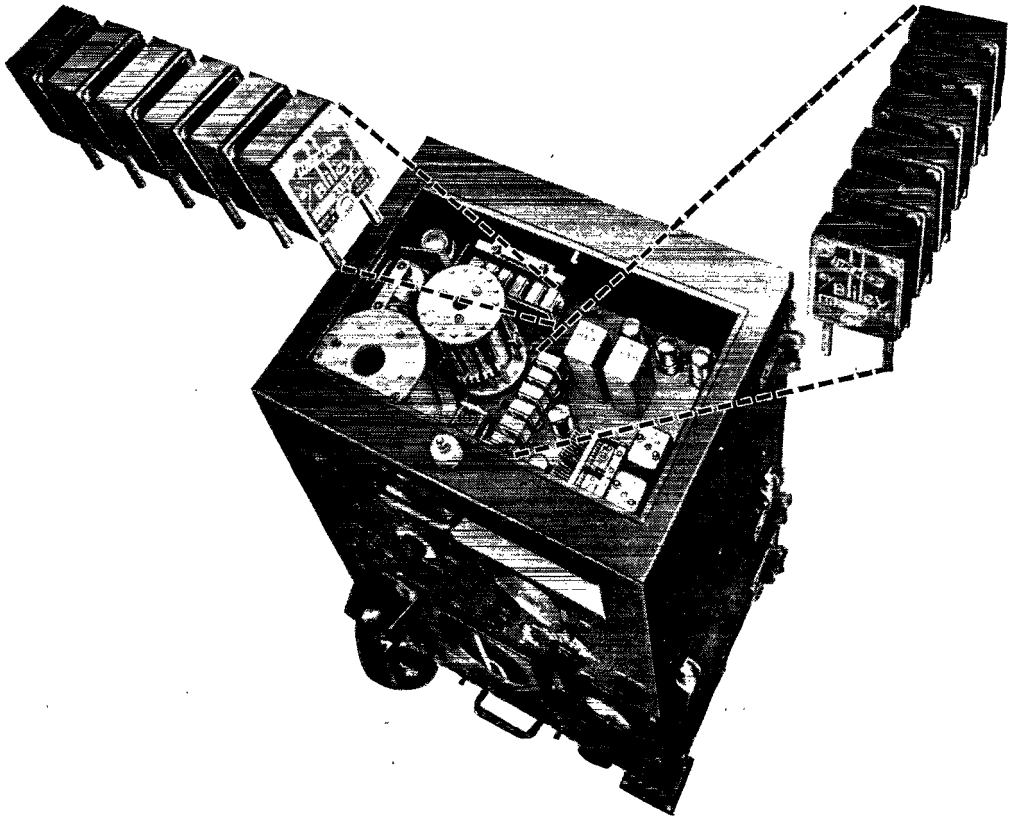

The 6 operating frequencies are **BLILEY CRYSTAL**-controlled

For dependable communications on the high seas here is a battle-tested set incorporating every modern feature that experience has shown to be most desirable for ship-to-shore and ship-to-ship radio-telephone service.

The six Bliley crystal-controlled operating frequencies permit instant and positive channel selection in both

transmitter and receiver.

The Bliley *acid etched** Crystals used in this Hallicrafters HT-14 set were designed to meet specific objectives in the operation of two-way radio-telephone communications. They, too, have been thoroughly battle-tested.

It's a habit with most communications engineers to

specify Bliley for all crystal requirements. This is particularly true when new applications and complex designs require technical excellence in every component. There is no substitute for the 15 years of experience offered by Bliley craftsmen and engineers.

+

**Acid etching quartz crystals to frequency is a patented Bliley process.*



Bliley CRYSTALS

Do more than before . . .

buy extra War Bonds.

BLILEY ELECTRIC COMPANY
UNION STATION BUILDING • ERIE, PENN.

Section Communications Managers of the A.R.R.L. Communications Department

Reports Invited. All amateurs, especially League members, are invited to report communications activities, training plans, code classes, theory-discussion groups, civilian-defense building or planning each mid-month (18th of the month for the last 30 days) direct to the SCM, the administrative official of ARRL elected by members in each Section whose address is given below. Radio Club reports and Emergency Coördinator reports representing community organized work and plans and progress are especially desired by SCMs for inclusion in *QST*. **ARRL Field Organization appointments, with the exception of the Emergency Coördinator and Emergency Corps posts, are suspended for the present and no new appointments or cancellations, with the exception named, will be made. This is to permit full efforts of all in Emergency Corps plans.**

ATLANTIC DIVISION				
Eastern Pennsylvania Maryland-Delaware-District of Columbia Southern New Jersey Western New York Western Pennsylvania	W3BES W3CIZ W3GCU W8MC W8NCJ	Jerry Mathis Hermann E. Hobbs Ray Tomlinson William Bellow R. R. Rosenberg	623 Crescent Ave. 9701 Monroe St. Silver Springs P. O. 623 E. Brown St. 186 Dorsey Rd. 927 East 23rd St.	Glenside Gardens Linden, Maryland Trenton 10 Rochester Eric
CENTRAL DIVISION				
Illinois Indiana Kentucky Michigan Ohio Wisconsin	W9NUX W9EGQ W9ARU W8DPE W8MFP W9RH	David E. Blake, II Herbert S. Brier Darrell A. Downard Harold C. Bird Carl F. Wiehe Emil Felber, Jr.	4501 N. Malden St. 385 Johnson St. 116 N. Longworth Ave. R.F.D. 2, Box 228 122 St. Albert St. 1625 N. 18th St.	Chicago 40 Gary Louisville 12 Pontiac 2 St. Bernard 17 Milwaukee 5
DAKOTA DIVISION				
North Dakota South Dakota Northern Minnesota Southern Minnesota	W9YVF W9QVY W9UJZ W9YNQ	John W. McBride P. H. Schultz Arnold J. Hatland Mihlard L. Bender	620 North Menio Ave. 118 N. Yankton Ave. 232 Western Ave. 608 N. Huron Ave.	Sioux Falls, South Dakota Pierre Laurel, Angeles 7, Calif. Spring Valley
DELTA DIVISION				
Arkansas Louisiana Mississippi Tennessee	W5GED W5DKR W5HAV W4SP	Ed Beck Eugene H. Treadaway P. W. Clement James B. Witt	2503 Bishop St. P. O. Box 44 524 Santini St. R.F.D. 6, Shady Dell Trail	Little Rock LaPlace Biloxi Knoxville
HUDSON DIVISION				
Eastern New York N. Y. C. & Long Island Northern New Jersey	W2HZL W2AZV W2CQD	Ernest E. George E. L. Baunach Winfield G. Beck	2044 Lexington Parkway 107 Central Ave. 617 Spruce St.	Schenectady 8 Massapequa, L. I. Roselle
MIDWEST DIVISION				
Iowa Kansas Missouri Nebraska	W9FJR W9AWP W9OUD W9FQB	Leslie B. Yennard A. B. Unrith Mrs. Letha A. Dangerfield Arthur R. Gaeth	2712 Washington St. 1617 S. Seneca St. Box 123 6105 N. 37 St.	Burlington Wichita 12 Butler Omaha 11
NEW ENGLAND DIVISION				
Connecticut Maine Eastern Massachusetts Western Massachusetts New Hampshire Rhode Island Vermont	W1KOY W1AOL W1ALL W1JAH W1FTI/4 W1HRC W1NLO	Edmund R. Fraser G. C. Brown Frank L. Baker, Jr. William J. Barrett Mrs. Dorothy W. Evans Clayton C. Gordon Burtis W. Dean	48 Willow St. 379 No. Main St. 91 Atlantic St. 239 Columbia St. 1435 Snowden Ave. 70 Columbia Ave., Gaspee P. O. Box 81	West Haven 16 Brewer North Quincy 71 Adams Memphis 7, Tennessee Plateau, Providence 5 Burlington
NORTHWESTERN DIVISION				
Alaska Idaho Montana Oregon Washington	K7GNN W7AVP W7CNP W7GNI W7FWD	James G. Sherry Don D. Oberbillig Rex Roberts Carl Austin O. U. Tatro	P. O. Box 486 Box 1088 1137 Federal 513 N. Central	Homer Boise Glendive Bend Olympia
PACIFIC DIVISION				
Hawaii Nevada Santa Clara Valley East Bay San Francisco Sacramento Valley Philippines San Joaquin Valley*	K6ETF W6CW W6IUZ W6TI W6RBO W6MDI KA1GR W6BXB	Francis T. Blatt N. Arthur Sowle Earl F. Sanderson Horace R. Greer William A. Ladley Vincent N. Feldhausen George L. Rickard Edward H. Noack	837 16th Ave. Box 2025 600 Acacia Ave. 414 Fairmount Ave. 200 Naylor St. 113 South Quincy St. Box 849 811 West Magnolia St.	Honolulu Reno San Bruno Oakland 11 San Francisco 12 McCloud Manila Stockton
ROANOKE DIVISION				
North Carolina South Carolina Virginia West Virginia	W4CYB W4BQE/ANG W3AKN W8JRL	W. J. Wortman Ted Ferguson Walter C. Walker Kenneth M. Zinn	P. O. Box 566 3422 Rosewood Drive 217-51 St. P. O. Box 132	Morganton Columbia 25 Newport News Clarksburg
ROCKY MOUNTAIN DIVISION				
Colorado Utah-Wyoming	W9VGC W6LLH	H. F. Heikel Victor Drabble	2743 Julian St. 1024 Oak St.	Denver 11 Ogden, Utah
SOUTHEASTERN DIVISION				
Alabama Eastern Florida Western Florida Georgia West Indies (Cuba) (Puerto Rico-Virgin Islands)	W4CBV W4IP W4AXP W4FDJ CM2OP K4KD	Lawrence J. Smyth Robert B. Murphy Oscar Cederstrom Ernest L. Morgan Mario de la Torre Everett Mayer	808 Winona Ave. 3302 S.W. Grapeland Blvd. 408 S. Pine St. R.F.D. 2 Escobar 110 (Altos) 24 Lindberg St.	Montgomery Miami 33 Warrington Lyons Habana, Cuba Santurce, P. R.
SOUTHWESTERN DIVISION				
Los Angeles Arizona San Diego	W6QVY W6RWV W6CHV	H. F. Wood Douglas Aitken Ralph H. Culbertson	429 So. Fairview 341 S. Mt. Vernon Ave. 1712 Eads St.	Burbank Prescott La Jolla
WEST GULF DIVISION				
Northern Texas Oklahoma Southern Texas New Mexico	W5ALA W5AYL W5JC W5HJF	Jack T. Moore Ed Oldfield James B. Rives J. G. Hancock	5712 Berkshire Lane 2141 N.W. 35th St. 1721 Kentucky Ave. 110 S. E. Nevada St.	Dallas 9 Oklahoma City 6 San Antonio I Portales
MARITIME DIVISION				
Maritime	VE1DQ	A. M. Crowell	69 Dublin St.	Halifax, N. S.
ONTARIO DIVISION				
Ontario	VE3EF	Wing Commander Donald R. Gunn	c/o Canadian Bank of Commerce	New Toronto, Ont.
QUEBEC DIVISION				
Quebec	VE2CO	Lieutenant L. G. Morris	211 Bolton St.	Ottawa, Ont.
VANALTA DIVISION				
Alberta British Columbia	VE4GE VE5DD	C. S. Jamieson C. O. I. Sawyer	581 W. Riverside Drive 2634 West 31st Ave.	Drumheller, Alta. Vancouver
PRAIRIE DIVISION				
Manitoba Saskatchewan	VE4AAW VE4SY	A. W. Morley Arthur Chesworth	26 Lennox St. 1084 Redland Ave.	St. Vital Moose Jaw

*Officials appointed to act temporarily in the absence of a regular official.

"CQ..."
*we'll hear it
again—SOON*

**THE HAM IS
COMING BACK...
STRONGER THAN EVER**

Who Said The "Ham" Is Finished?

THERE have been rumors to the effect that the radio Amateurs were going to be denied their old frequency bands, and given new bands of such high frequency as to be useless for medium and long distance communication.

Some rumors say "Remember the last War? We are going to get the same treatment this time!"

Now, we don't believe the "Hams" should be denied their rightful place on the air in bands suitable for communication beyond the horizon—and further, we do not believe that our Government would want to see those privileges denied.

Are not the "Hams" fighting on many battlefronts, working in war factories and laboratories for a New World wherein the individual will be able to live and enjoy his hobbies, his church and other personal freedoms which go to make up a healthy, happy world?

It is well-known among Government officials whose task it was to build our great war-time communications system that from the rank and file of amateurs came executives, instructors and thousands of engineers and operators. Without this nucleus of experienced men, it would no doubt have taken a much longer time to reach the present high degree of perfection in the communications branch of our fighting forces.

In every emergency Amateurs have proved their ability and willingness to come to the aid of their Country—who would be so unkind as to want to deny their small place in the radio spectrum? We do not believe these rumors that the "Ham" will be denied his privileges, we believe rather that those who speak so much of justice coming out of this war will see to it that the Amateur receives his just reward.

The entire radio industry knows well, and appreciates the many contributions "Hams" have made for the advancement of high frequency radio communications, and surely they too can be counted on to assist the "Ham" in regaining his privileges when the right time comes.

HAMMARLUND MANUFACTURING CO., Inc.
160 West 34th Street, New York 1, N. Y.

THIS AD APPEARED IN MARCH, 1944

WE never lost faith in the friends of amateur radio. We believe progress up to this very moment indicates that Hams have many friends in high places. Of course, there is a lot of romance to Ham radio, but the place won by the Ham in the hearts and minds of important people is the result of a very practical demonstration of real worth—real American ability.

We wish to openly express our sincere appreciation for the wisdom of those whose job it was to guide amateur radio through these troubled times. And those who have given Hams a just portion of the spectrum are to be commended for their farsightedness.

American amateurs can be thankful they live in a country where ability receives its just reward

LLOYD A. HAMMARLUND, President

HAMMARLUND MFG. CO., INC., 460 W. 34th ST., NEW YORK 1, N. Y.

THE AMERICAN RADIO RELAY LEAGUE, INC.,

is a noncommercial association of radio amateurs, bonded for the promotion of interest in amateur radio communication and experimentation, for the relaying of messages by radio, for the advancement of the radio art and of the public welfare, for the representation of the radio amateur in legislative matters, and for the maintenance of fraternalism and a high standard of conduct.

It is an incorporated association without capital stock, chartered under the laws of Connecticut. Its affairs are governed by a Board of Directors, elected every two years by the general membership. The officers are elected or appointed by the Directors. The League is noncommercial and no one commercially engaged in the manufacture, sale or rental of radio apparatus is eligible to membership on its board.

"Of, by and for the amateur," it numbers within its ranks practically every worth-while amateur in the nation and has a history of glorious achievement as the standard-bearer in amateur affairs.

Inquiries regarding membership are solicited. A bona fide interest in amateur radio is the only essential qualification; ownership of a transmitting station and knowledge of the code are not prerequisite, although full voting membership is granted only to licensed amateurs.

All general correspondence should be addressed to the Secretary at the administrative headquarters at West Hartford, Connecticut.



Past Presidents

HIRAM PERCY MAXIM, WIAW, 1914-1936
EUGENE C. WOODRUFF, W8CMP, 1936-1940

Officers

President.....GEORGE W. BAILEY, W1KH
Washington, D. C.

Vice-President.....CHARLES E. BLALACK, W6GG
Yuma, Arizona

Secretary.....KENNETH B. WARNER, W1EH
West Hartford, Connecticut

Communications Manager.....F. E. HANDY, W1BDI*
Chevy Chase, Maryland

Treasurer.....DAVID H. HOUGHTON
West Hartford, Connecticut

General Counsel.....PAUL M. SEGAL
1026 Woodward Building, Washington 5, D. C.

*On leave of absence. Address correspondence to the Acting Communications Manager, Charles A. Service, W1E, West Hartford 7, Connecticut.

Directors

President
GEORGE W. BAILEY.....W1KH
1530 P St., N.W., Washington 25, D. C.

Vice-President
CHARLES E. BLALACK.....W6GG
Box 108, Yuma, Ariz.

Canadian General Manager
ALEX REID.....VE2BE
240 Logan Ave., St. Lambert, P. Q.
Alternate: Leonard W. Mitchell.....VE3AZ
78 Raglan Ave., Toronto, Ont.

Atlantic Division
WALTER BRADLEY MARTIN.....W3QV
25 Arbutha Rd., Abington, Pa.
Alternate: Herbert M. Walleze.....W8BQ
P. O. Box 18, Drums, Pa.

Central Division
JOHN A. KIENER.....W8AVH
3462 Edison Rd., Cleveland Heights,
Cleveland 21, Ohio
Alternate: Earl S. Nelson.....W8DS
22551 Hadden Rd., Euclid 17, Ohio

Dakota Division
TOM E. DAVIS.....W9VVA
915 W. Becker Ave., Willmar, Minn.
Alternate: Aaron E. Swanberg.....W9BHY
1487 Breda St., St. Paul 4, Minn.

Delta Division
E. RAY ARLEDGE.....W5SI
340 N.E. 20th Terrace, Apt. 7, Miami 37, Fla.
Alternate: Samuel H. Dowell.....W5ERV
1057 Mildred St., Shreveport 15, La.

Hudson Division
ROBERT AKERIDGE KIRKMAN.....W2DSY
Werah Pl., R.F.D. No. 1, Box 61, Long Branch, N. J.
Alternate: George Rullis, jr.....W2CJY
38 Brookwood Drive, Manhasset, L. I., N. Y.

Midwest Division
FLOYD E. NORWINE, JR.....W9EFC
7405 Hiawatha Ave., Richmond Heights 17, Mo.
Alternate: C. A. Colvin.....W9VHR
% Omaha & Council Bluffs St. Railway Co.,
Omaha 2, Nebr.

New England Division
PERCY C. NOBLE.....W1BVR
37 Broad St., Westfield, Mass.
Alternate: Clayton C. Gordon.....W1HRC
70 Columbia Ave., Warwick, R. I.

Northwestern Division
KARL W. WEINGARTEN.....W7BG
3219 N. 24th St., Tacoma 7, Wash.
Alternate: R. Rex Roberts.....W7CFY
110 W. Brennan St., Glendive, Mont.

Pacific Division
J. L. McCARGAR.....W6EY
66 Hamilton Pl., Oakland 12, Calif.
Alternate: Elbert J. Amarantes.....W6FBW
1675 Dale Ave., San Jose, Calif.

Roanoke Division
H. L. CAVENESS.....W4DW
2607 Vanderbilt Ave., Raleigh, N. C.
Alternate: J. Frank Key.....W3ZA
Box 707, Buena Vista, Va.

Rocky Mountain Division
C. RAYMOND STEDMAN.....W9CAA
925 So. Gaylord St., Denver 9, Colo.
Alternate: Howard R. Maxwell.....W9TFP
355 Monroe St., Denver 6, Colo.

Southeastern Division
WILLIAM C. SHELTON.....W4ASR
527 Revilo Blvd., Daytona Beach, Fla.
Alternate: William P. Sides.....W4AUP
Fleming Road, Montgomery, Ala.

Southwestern Division
JOHN E. BICKEL.....W6BKY
1834 E. Whittier Blvd., Whittier, Calif.
Alternate: Eldridge E. Wyatt, jr.....W6ARW
P. O. Box 3597, Long Beach 3, Calif.

West Gulf Division
WAYLAND M. GROVES.....W5NW
Box 1314, Seagraves, Texas
Alternate: Jennings R. Poston.....W5AJ
P. O. Box 848, Curundu, Panama Canal Zone

"IT SEEMS TO US —"

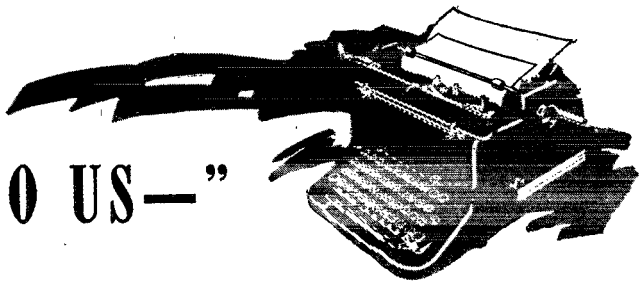

TWO MORE HURDLES

THE course of amateur radio back on to the air after the war is a long and arduous one, beset by many potential obstacles. Two major leaps in this long journey occurred in late May when the Federal Communications Commission announced its definitive postwar allocations above 25 Mc. and its proposed allocations below that figure, IRAC concurring. These actions are the subjects of separate articles in this issue, which we think you should read carefully.

Dividing the spectrum at 25 Mc., FCC is dealing with each installment in two actions. First it issues a proposed report and gives objectors another opportunity to be heard. Then it reviews the matter anew and issues its final findings. It has completed this course above 25 Mc. It is half-way through on the part below 25. Thus in the longer-range part of the spectrum we can now see what our frequencies are intended to be but not yet what they may finally turn out to be.

The United States' decisions for this part of the spectrum are not yet final. That will take until midsummer to determine. And thereafter must come the international conference, the agreement of the rest of the nations. If that conference were long delayed the uncertainties could be most uncomfortable to all the radio services. It was therefore news of considerable moment when it was announced in Washington recently that plans are under way that are expected to result in a world-wide conference next spring to revise the Madrid convention and the Cairo regulations. That promises an earlier completion of the whole long hard task than had seemed possible. It is good news.

Until we can see with considerably more finality what our postwar frequencies are to be below 25 Mc. we cannot profitably begin the overhaul of our own structure, that planning for the most logical employment of our facilities to which we have long looked forward. For a short while longer it will therefore continue to be *QST's* policy to postpone those discussions which are so dear to the amateur's heart, how we should rearrange ourselves in our bands after the war. We must see the frequencies first. Soon, but not yet.

But the allocations above 25 Mc., subject only to the possibility of the United States agreeing to changes at a regional conference,

are now final, except for the delay in spotting in our 5-meter band. With that exception we now see, with as much exactness as we shall ever see, just what our postwar frequencies are to be in this range. From the standpoint of technical matters we can therefore go ahead with our individual plans. The time has come, fellows, to polish up on your technical reading and begin the planning of your apparatus. These are your frequencies. Your daydreaming and sketching can now be channeled into these definite spectrum locations. Materials, components and new apparatus will probably become available with increasing ease over the next few months. Our manufacturers and suppliers, too, can begin similar planning to fill our needs, for these are the amateur bands of the future. Perhaps the not too-far-distant future, either, for there is some hope that we can get going on some of these higher bands without waiting for V-J Day — and that's an added reason for getting busy soon with a sharp pencil and notebook. Many of you, in the armed forces and the laboratories, working with the new developments of this war, will have rather definite ideas on what you want to do. Now that you know the frequencies you can work out your plans to the last dimension. All of us can go that far as concerns the lower bands of this part of the spectrum but many of us will have to await the release of technical information on the higher portions. We don't know when that will be but it has moved much closer and there is much interesting dope just barely outside our present reach which we can hope to be reading in *QST's* pages before many moons pass. In other words, the realization of our whole intense desire to return to the air has moved definitely closer, is moving with increasing speed, and we should make our apparatus plans for the range above 25 Mc. as rapidly as we individually can acquire the necessary knowledge of new components and new techniques.

And that reminds us of the possibilities of new operating procedures. We have previously observed that there has been as much wartime progress in this field as on the technical side. We invite your attention to W2DJJ's comprehensive article on GI procedure in this issue. What do you think about applying some of these procedures to amateur operating after the war? It seems to us that many of these

practices have much to commend them, and we hear many of the fellows in the services say that they intend to use them when we're back on. On the other hand, we have received a few letters from lads who say they are so thor-

oughly fed up on everything GI that they devoutly hope nothing GI will ever find its way into amateur radio. What's your own opinion after reading Colonel Hertzberg's article? Discussion is invited.
K. B. W.

★ SPLATTER ★

OUR COVER

ORDINARILY, about this time of year, 1st Lt. Louis Acin might have been putting up a new stick at W2KIZ back home in Lake Peekskill, N. Y. Instead, this month's cover shows him deep in Germany pointing out the notable features of a newly erected Signal Corps pole to Capt. A. L. Bateman, jr., of Buffalo. Part of a system constructed with record speed at a continental advance section's radio communications center near Mannheim in Germany, it was a vital element in the communications line to the first American supply base east of the Rhine.

... —

FOOTNOTES

ABOUT the same time the cover scene was being photographed, Lt. Col. Robert Hertzberg, SC, W2DJJ, who discusses military operating procedures on p. 32, was observing the third anniversary of his tour of duty in the ETO. A veteran in both Army and amateur radio, Bob was one of the most consistent early supporters of the Army Amateur Radio System and was commissioned a second lieutenant in the Signal Corps Reserve in 1928. His active amateur career dates back to 1917, when he celebrated his 12th birthday by going on the air with a spark coil, rolling-pin tuner, etc. At the ripe age of 18 he became a member of the radio staff of the New York *Globe*, and later was managing editor of *Radio News*. He also did technical publicity and advertising for numerous firms and, while with Pilot Radio, helped in the design of that highly successful early short-wave receiver, the "Super-Wasp." As war drew near, in October, 1940, Bob was called to active Army duty, serving first in Washington and at Fort Monmouth, N. J. Graduating from the Army's Command and General Staff School at Leavenworth, he was sent overseas in June, 1942. For a time W2DJJ served as radio officer of General Bradley's 12th Army Group. Subsequently he became commandant of the ETO's Signal School. At war's end he was billeted at a French chateau — his comfortable room with private bath quite a change from living out of a tin pail for seven months! . . . The career of Robert Waters, W2JST (p. 41), affords a moral of some kind. During most of his radio life — which now totals some fifteen years — Bob worked at anything but radio because he enjoyed the game so much

he didn't want to spoil it as a hobby! But these past four years he's been doing professional radio engineering — and finds that he enjoys radio as a hobby more than ever! W2JST first became interested in the ham game in 1930, but it was 1936 before he worked up the courage required to go after a ticket. His first rig, built under the tutelage of W2BA, was a 210 t.n.t. on 3.5-Mc. c.w. A bit later, while attending New York University, with W3EXP he founded the sonorously named Amateur Radio Society of Washington Square College. On emerging from college he organized his own firm, manufacturing electric arc welding equipment until 1941, when he went to work as an engineer for Western Electric at Kearny, N. J. A veteran by v.h.f. standards, Bob began on 56 Mc. with 45s in a long-lines oscillator but when stability requirements went into effect on 56 Mc., he moved with the crowd to 112 Mc.

Reappearing in this issue, McMurdo Silver (Splatter, March, 1943, p. 90, and Dec., 1944, p. 92) begins a two-part article on the v.t.v.m. (p. 17), and W. E. Marquart, W9CKT (Splatter, April, 1945, p. 96) describes further methods of orienting directional antennas (p. 46).

... —

FEEDBACK

Two typographical errors (one under part!) crept into the math in "Hyperbolic Functions" in the June issue. In Equation (9) da should read dA . In Equation (23), the first term after the equality sign should be u instead of 1.

We regret that several errors appeared in one of the circuit diagrams for "Radio Set SCR-506" in the May issue. Fig. 1 on p. 15 should have included a 10- μ fd. condenser connected in series with the lead between R_7 (plate load for one section of the 100-kc. mv. stage) and the grid of the 20-kc. mv. tube. Also, the R_6 , R_7 , R_9 , R_{13} group should each be 20,000 ohms, 1 watt, instead of the value shown. R_{10} and R_{14} are the 15,000-ohm ganged variable combination.

Going back now to the April issue, an error appeared in the multiple formula in Roy McCarthy's Hints and Kinks piece, "A Vacuum-Tube Volt-Ohmmeter" on page 53. The correct formula reads:

$$R_X = R \left(\frac{I_M}{I} - 1 \right)$$

... —

Retardation

Part IV of the series on "Radar Techniques," originally scheduled for this issue and omitted because of space limitations, will appear in a future issue of *QST*.

FCC's Final Allocations Above 25 Mc.

5-Meter Band Assured But Not Yet Located; 10-Meter Band Clipped; 2½ and 1¼ Shifted; Many New Bands

IN LATE May the Federal Communications Commission announced its final determination of postwar frequency allocations above 25 Mc. Simultaneously the Interdepartment Radio Advisory Committee transmitted corresponding recommendations to the Secretary of State. The new postwar amateur assignments are as follows:

28-29.7 Mc.
44-48 or 50-54 or 56-60
144-148
220-225
420-450 (temporarily shared)
1145-1245
2300-2450
5250-5650
10,000-10,500
21,000-22,000

Thus ends the first phase of the prodigious task of modernizing the allocation table in terms of wartime developments. It will be remembered that, following many months of study by Government and civilian agencies, FCC last summer ordered an allocation hearing to begin in the autumn. It lasted from September until November, during which time ARRL made the "Presentation for the Amateur Service" which we have published in *QST*. These matters dealt with the whole spectrum. On January 15th FCC announced its proposed allocation for the portion above 25 Mc., subject to further hearing and oral argument. The argument began on February 28th and ran into March, ARRL again appearing for the amateur. Then FCC and IRAC, acting respectively for the civilian and Government services, held a further series of conferences which resulted in the determinations now announced. (On May 21st the Commission announced its proposed allocations *below* 25 Mc., as we report in another article. This section will run the same course and eventually result, after further argument and consideration, in a final report for that part of the spectrum.)

The final FCC allocations above 25 Mc. are shown in the table on page 13. You may compare them with the original proposal as published on page 15 of our March issue. FCC says: "These allocations will probably be ordered into effect service by service, with the Commission taking into account such factors as the availability of manpower and materials, the results of inter-American conference at Rio and the preparation of the Commission's rules and standards. Of course, any allocations made by the Commission are subject to being changed to conform to the provisions of international agreements." What that last sentence means is that if the U. S. agrees to changes at subsequent international confer-

ences, FCC will have to alter these allocations to conform.

The greatest difficulty encountered by FCC was on the question of where to put f.m. It still has not made up its mind. There has been a tremendous argument on this for many months; we remember nothing in radio that has been the subject of so protracted a dispute. It has been decided to conduct "measurements and tests of f.m. transmission" this summer, under the auspices of a joint committee of engineers from FCC and the radio industry, operating under the chairmanship of the FCC chief engineer, and to withhold the decision on the allocations between 44 and 108 Mc. until the results can be analyzed. FCC does announce, however, that these 64 megacycles will ultimately be allocated as follows: 4 to amateurs, 36 to television, 18 to f.m., 2 to facsimile and 4 to non-Government fixed and mobile; and it does announce "three possible alternative allocations for this region, which turn upon the exact location of f.m." There is a 4-Mc. amateur provision in each, as will be seen in the adjoining table. A final announcement for the range 44-108 can be expected in the late summer or early autumn. But until that time television and ourselves — and f.m. as well — will not know just where we are going to be spotted.

There has been great argument over whether the incidence of various transmission phenomena, particularly Sporadic E, make it necessary for f.m. to be moved upward in the spectrum, especially if it is to have many more channels. Many briefs have been filed and many days devoted to technical discussions, participated in by many notables of the American radio world, including some closed sessions at which classified data were discussed only by "cleared persons." FCC's decision was to make transmission measurements before deciding. Elaborate plans are under way now whereunder transmitters in each of the three proposed f.m. bands (see table) will be recorded simultaneously at a considerable number of FCC monitoring stations spotted more or less uniformly along straight lines, and thus transmission vagaries should be neatly observed. In a later phase of these tests, aural observation by amateurs may be desired. If such request for amateur collaboration is received, we shall announce it at the first opportunity.

Except for 44-108 Mc., this is the last chapter in FCC allocations above 25 Mc. Everybody has had his day in court, has had two opportunities to file briefs, has been heard formally twice and any number of times informally. After many long months FCC and IRAC, working jointly on behalf of their respective branches of the Administration come now to these decisions and they

are put into effect. This is it. The shooting is over, and we can now see what we have and begin definite plans for our postwar life. There is an immense amount to digest and absorb. The two FCC reports alone are mimeographed books of approximately 275 and 250 pages, respectively. The new technical knowledge is enormous in extent, most of it still unclassified. It will take us years to unfold and understand the new techniques, the new data. There are some features of the FCC action that we of course cannot be expected to like — in the displacement of amateur bands and in their occasional clipping below what seemed reasonable figures, and particularly in the matter of the “diathermy” allocation. But, by and large, the amateur service has fared well in an exceedingly complicated situation. The pressure for channels is unbelievable and incomprehensible until you have lived a while in the world of allocation matters. FCC has found it necessary to transfer to the range above 25 Mc. much of the growing pressure for channels in the lower frequencies, and that has augmented the problems in the higher ranges. Our table does not undertake to detail a very complicated arrangement which FCC has finally evolved to do the best possible job of taking care of all these needs. We content ourselves with displaying the major outlines but you should understand that, for instance, when the table says “non-Government fixed and mobile” there is a detailed stipulation somewhere of the division of all those channels among several dozen types of American services, ordinarily sharing with each other, frequently sharing with television in a region where that particular television channel is not in use, etc.

Let us now examine our postwar allocations band by band.

28-30 Mc.: Our old 10-meter band has been clipped 300 kc. at the high end and now reads 28-29.7. It comes about through an expansion of the provision for the radiation of the industrial heating and medical diathermy apparatus. In the past there has been a small allocation of 30 kc. for this purpose, lying just above 27 Mc. There has been great increase in the use of r.f. for industrial, scientific and medical purposes during the war. In RTPB and at the FCC hearing these services asked for the assignment of 4 megacycles from 25 to 29 Mc.! People just laughed at them and told them to go shield their stuff. The radio industry was a unit in feeling that precious communications frequencies could not be allocated for the radiation of QRM. But they said it couldn't be done, and indeed it seems to have its difficulties when one remembers reports of industrial applications using powers as high as 3000 kilowatts! FCC had us down for 28-30 in its January proposal and there was no evidence of an inclination to change this figure during the March argument, at which time ARRL accepted and supported the entire FCC amateur proposal above 25. But later, in its own councils, FCC became persuaded that it had to make some increased provision for a QRM band; and it established that the minimum practicable tolerance for this apparatus is about

0.5%. Its final decision was to assign a 1% band for this purpose, or 270 kc., as you may see in the table. The effect of this was then transmitted through the adjoining kilocycles to our band, FCC and IRAC deciding that it was impossible to reduce either the Government or non-Government provisions in this region and FCC concluding that there was nothing left to do but cut us. We know no stone that we left unturned in the endeavor to preserve the full width of our band but it has happened, and the decision is final. It is our one serious blow in the allocation above 25 Mc. Originally contemplated to occur at the low-frequency end of the band, it was at least shifted to the high end to preserve our “straight left-hand edges” and some of the displaced fixed and mobile services shifted to the 300 kc. which we are to vacate. FCC also says that it is willing to assign us the 270 kc. of the QRM band (27.185-27.455 Mc.) in addition to our regular band, although it has the good taste not to represent these frequencies as having any particular usefulness. Here is the FCC statement on this band:

“As is pointed out in Section 18 of this Part, increased allocations are necessary for industrial and medical purposes in the 27 megacycle region. It is not possible to reduce the allocations in that portion of the spectrum which have been made to the Government and non-Government fixed and mobile services. Accordingly, the amateur band in this portion of the spectrum has been reduced and will be from 28 to 29.700 megacycles. Amateurs may make such use as is possible of the band centered on 27.32 megacycles assigned for medical and industrial use.”

5 meters: As we said above, we won't know until autumn whether we are to stay at 56-60, be moved to 50-54 as proposed in the January report, or be moved to 44-48, a third alternative which is the selected place for us if f.m. stays at about its present location in the spectrum. ARRL has agreed to a shift to 50-54 but has said that that is as far as we would care to move, and has vigorously opposed the 44-48 alternative. We think we will be justified by the engineering tests this summer, if Sporadic E performs in the usual manner. There is nothing to do but wait and see.

100-Mc. region: The FCC report gives effect to a proposal that every amateur has long known about, to shift our 112-116 band to 144-148 after the war. The change comes about through the creation of an organized block of aviation frequencies beginning at 108, as can be seen by the table, a location for us that would not be very enviable if we could have retained it. You will understand that it is now definite that our new band is 144-148. We can probably get there without too much difficulty with existing gear, and it will be an easy frequency for new apparatus.

200-Mc. region: Our old band of 224-230 now similarly becomes 220-225, the same as in the January report. Originally proposed by IRAC as 218-225, it seems it became necessary to reduce the figure when great pressure developed in this portion of the spectrum, and as part of a re-

F.C.C. FINAL ALLOCATIONS ABOVE 25 MC.

Megacycles

25.015-27.185
27.185-27.455
27.455-28.000
28.000-29.700
29.700-30.000
30.000-40.960

Proposed International Allocation

Fixed; mobile except maritime and aeronautical
Scientific, industrial and medical
Fixed; mobile except maritime
Amateur
Fixed; mobile except maritime
Fixed; mobile except aeronautical

Industrial, scientific and medical
Fixed; mobile except aeronautical

United States Allocation

Government and non-Govt. fixed and mobile
Scientific, industrial and medical
Government and non-Govt. fixed and mobile
Amateur
Government and non-Govt. fixed and mobile
Complicated division, approx. alternate megacycles to Govt. and non-Govt. fixed and mobile
Industrial, scientific and medical
41-42 Govt.; 42-44 non-Govt. fixed and mobile

The range 44-108 Mc. is to be allocated, following tests, on one of the following three alternatives. *Alternative No. 1:* 44-48 amateur; 48-50 facsimile; 50-54 educational f.m. broadcasting; 54-68 commercial f.m. broadcasting; 68-74 television; 74-78 non-Government fixed and mobile — aero markers remain on 75 as long as required; 78-108 television, fixed, mobile. *Alternative No. 2:* 44-56 television, fixed, mobile; 56-60 amateur; 60-66 television, fixed, mobile; 66-68 facsimile; 68-72 educational f.m. broadcasting; 72-86 commercial f.m. broadcasting — aero markers remain on 75 as long as required; 86-92 television; 92-104 television, fixed, mobile; 104-108 non-Government fixed and mobile. *Alternative No. 3:* 44-50 television, fixed, mobile; 50-54 amateur; 54-78 television, fixed, mobile — aero markers remain on 75 as long as required; 78-84 television; 84-88 educational f.m. broadcasting; 88-102 commercial f.m. broadcasting; 102-104 facsimile; 104-108 non-Government fixed and mobile.

108- 112	Air navigation aids (localizers)	Air navigation aids (localizers)
112- 118	Air navigation aids (ranges)	Air navigation aids (ranges)
118- 122	Aeronautical mobile (airport control)	Airport control
122- 132	Aeronautical mobile	Aeronautical mobile (primarily non-Govt.)
132- 144	Aeronautical mobile; fixed	Government
144- 148	Amateur	Amateur
148- 152	Aeronautical mobile; fixed	Government
152- 162	Fixed; mobile except aeronautical	Non-Government
162- 174	Fixed; mobile	Government
174- 186	Broadcasting; fixed; mobile	Television; Government
186- 216	Broadcasting; fixed; mobile	Television; fixed; mobile
216- 220	Fixed; mobile	Government
220- 225	Amateur	Amateur
225- 328.6	Fixed; mobile	Government (military), with adequate channels reserved for civil aviation
328.6- 335.4	Air navigation aids (glide path)	Air navigation aids (glide path)
335.4- 400.0	Fixed; mobile	Government (military), with adequate channels reserved for civil aviation
400- 420	Fixed; mobile (including sonde)	Government (including radio sonde)
420- 450	Air navigation aids (special); amateur	Special air navigation aids; amateur. Note A.

"Norm A. — To be used temporarily for 'Special' air navigation aids. Band to be exclusively Amateur when no longer required for 'Special' air navigation aids; meanwhile Amateur peak power to be limited to 50 watts."

"All non-Government services will be established in the bands above 450 Mc. on an experimental basis pending adequate showing as to need and technical requirements."

450- 460	Air navigation aids (special)	Temporarily special air navigation aids; later to be non-Government fixed and mobile
460- 470	Fixed; mobile	Citizen's Radiocommunication Service
470- 480	Broadcasting	Facsimile
480- 920	Broadcasting	Television
920- 940	Broadcasting	Experimental broadcasting services
940- 960	Broadcasting; fixed	Fixed; experimental broadcasting
960- 1145	Navigational aids	Navigational aids
1145- 1245	Amateur	Amateur
1245- 1325	Fixed; mobile except aeronautical	Television relay
1325- 1375	Fixed; mobile	Non-Govt. fixed and mobile including aero;
1375- 1600	Fixed; mobile	Government
1600- 1700	Air navigation aids	Air navigation aids
1700- 1750	Meteorological aids	Meteorological aids
1750- 2100	Fixed; mobile except aeronautical	Non-Government fixed and mobile
2100- 2300	Fixed; mobile	Government
2300- 2450	Amateur	Amateur
2450- 2700	Fixed; mobile except aeronautical	Non-Government fixed and mobile
2700- 2900	Meteorological aids; air navigation aids	Meteorological aids; air navigation aids
2900- 3700	Navigational aids	Navigational aids
3700- 3900	Air navigation aids	Air navigation aids
3900- 4400	Fixed; mobile except aeronautical	Non-Government fixed and mobile
4400- 5000	Fixed; mobile	Government
5000- 5250	Air navigation aids (instrument landing)	Air navigation aids (instrument landing)
5250- 5650	Amateur	Amateur
5650- 7050	Fixed; mobile except aeronautical	Non-Government fixed and mobile
7050- 8500	Fixed; mobile	Government
8500-10,000	Special navigation aids	Government
10,000-10,500	Amateur	Amateur
10,500-13,000	Fixed; mobile except aeronautical	Non-Government fixed and mobile
13,000-16,000	Fixed; mobile	Government
16,000-18,000	Fixed; mobile except aeronautical	Non-Government fixed and mobile
18,000-21,000	Fixed; mobile	Government
21,000-22,000	Amateur	Amateur
22,000-26,000	Fixed; mobile	Government
26,000-30,000	Fixed; mobile except aeronautical	Non-Government fixed and mobile
30,000- up	Experimental	Experimental

arrangement that assured us a 4-Mc. band in the vicinity of 5 meters.

420-450: Prewar allocations stopped at 300 Mc., so this is the first of our new bands. It is also the last one before the big jump to up above 1000 Mc. and is accordingly the last one on which we can expect operation with conventional lumped circuits and ordinary tubes. The band is at present utilized by one of these wartime "special devices" you hear about, referred to in the table as a special air navigation aid. It has been decided that this service is on the way out of this band and that meanwhile it is perfectly feasible for amateurs and the navigational aid to share its use, provided amateur peak power is meanwhile limited to 50 watts in this particular band. This sharing is only temporary; the band is to be exclusively ours, without special power limitation, when the special gear moves out. We do not know yet when that will be. This is a very wide band — 30 Mc. wide. To appreciate how wide it is, consider that a present-day television channel is 6 Mc. wide. It was especially intended to give us a band, somewhere within early reach, wide enough to support amateur experimentation with television, wide-band f.m., facsimile and similar wide-band methods of emission. This is it, and we should plan accordingly. At this writing we doubt that, with the exception of f.m., we shall be able to afford such methods in any of our lower bands.

Introducing a new term: It is time for us to introduce a new term in our thinking. 1,000,000 kc. is too bulky to handle and even 1000 Mc., which is the same thing, is a little on the big side. The practice becomes definitely oppressive when one gets to dealing with such figures as 22,000 Mc. It is not for *QST* to set new modes in terminology: that belongs to the physicists at international conferences. But there is an accepted term that we believe we can employ to considerable profit: kilomegacycles. 1,000,000 kc. equals 1000 Mc. equals 1 kMc. So, beginning at this point in the spectrum, we shall from time to time make use of this term where it is more convenient to refer to a general region than to a particular frequency. We enter now the microwaves, where allocations are tentative and will be subjected, in time, to further showing of need by all services concerned.

1-kMc. region: Our assignment in this range now reads 1145-1245, a slight shift from the January figures. This band is readily reached with special triodes and a little hardware.

2-kMc. region: Originally projected as 2500-2700 this band was caught up in a general rear-

angement of the proposed allocations which was made in the late days of the studies, so that it came out of the shuffle reading 2300-2450. The shift brings it nicely within the capability of disc-seal triodes, while leaving it equally reachable by newer developments. The new location has the further advantage of being in substantially harmonic relation to the 1-kMc. assignment, which we may find quite useful in our early days on these bands. We'll say, too, that this is the band on which we expect to have the most fun getting our start on microwaves.

5-kMc. region: We took a bit of a beating here. The IRAC proposal, standing through the January FCC report, was 5200-5750. We came out of it with the new band 5250-5650. The decisions, behind closed doors, related to recalculated Government needs and the provision for another aviation aid. We'll probably get along. Beginning with this band, we're definitely in the region of "field techniques," the new developments of this war — such things as klystrons, magnetrons, etc., and their appurtenances. It is interesting to contemplate that wave-guide material for this band is only about 1 X 2 inches. Dope on the special apparatus for this band will come along in *QST* when security considerations permit.

10- and 20-kMc. regions: These bands have retained their original IRAC dimensions, 10,000-10,500 and 21,000-22,000 Mc., respectively. These are the jeweler's bands, where nothing but precision work will get results. We don't know too much about them ourselves — but we'll all learn.

— . . . —

Very few of us have ever operated our own apparatus above 200 Mc. To most of us these new allocations, particularly in the upper reaches of the spectrum, are just so many numbers. It is helpful to try to get a physical image of what our new allocations amount to, perhaps in terms of the wavelength in centimeters or the length of a half-wave antenna in inches. On this page is a table that gives dimensions of some of the things we all understand. We emphasize that we publish this table purely to provide a means of comprehending the general order of magnitude of our new bands — and the attendant new problems. For example, we do *not* expect to be using Lecher wires to measure s.h.f. Now referring to the 5-kMc. band, for instance, it will be seen that the movement of the bridge or slider, between the two ends of the bands, would be only 0.07 inch. One purpose of this tabulation, then, is to show how useless the old techniques are for these fre-

(Continued on page 98)

Band, in megacycles	Wavelength in centimeters	Free-space length of a half wave, in inches, at band midpoint	Travel of Lecher Wire slider, in inches, between the two extremes of the band
28-29.7	1071-1010	204.64	12.08
50-54	600-556	113.42	8.75
144-148	208.3 -202.7	40.43	1.11
220-225	136.4 -133.3	26.53	0.60
420-450	71.43 - 70.59	13.57	0.94
1145-1245	26.20 - 24.10	4.94	0.43
2300-2450	13.04 - 12.24	2.48	0.16
5250-5650	5.714- 5.310	1.08	0.07
10,000-10,500	3.000- 2.857	0.57	0.03
21,000-22,000	1.429- 1.364	0.27	0.01

FCC's Proposed Allocations Below 25 Mc.

**"80-40-20" Unchanged; "160" Gone Except for Emergencies;
New Amateur Band Proposed at 21 Mc.**

IN AN adjoining article we have described how the Federal Communications Commission held an extensive hearing on frequency allocations through the whole spectrum, then issued a proposed report of its decisions on the range above 25 Mc., subjecting it to briefs and oral argument, and finally concluded with a definitive allocation for this part of the spectrum after a series of conferences with the Interdepartment Radio Advisory Committee.

In precisely this same fashion FCC on May 21st issued its report of proposed allocations below 25 Mc., while IRAC simultaneously transmitted concurring recommendations to the Secretary of State. Persons desiring to object may file an appearance by June 6th and briefs by June 13th. Oral argument by those aggrieved will begin June 20th. ARRL has filed an appearance and will be heard at the further argument of this matter. Then, after further consideration, FCC will issue a final report on this range, too.

The Commission proposes that we get our 80-, 40- and 20-meter bands back and a new band at 15 meters, but that we give up the 160-meter band except for amateur disaster networks to be established somewhere in the range 1605-1800 kc. Specifically the proposed allocations are:

3500- 4000 kc.
7000- 7300
14,000-14,400
21,000-21,500

Reporting on the amateur service, the Commission says: "At the hearing, the American Radio Relay League requested that the amateurs be permitted to retain [all their present] bands and in addition it requested the assignment of the band, 21,000-22,000 kc.

"The bands 3500 to 4000, 7000 to 7300, and 14,000 to 14,400 kc. are being retained for amateur use. The 300 kc. band between 1750 and 2050 kc. is being deleted. In lieu thereof the Commission is making provision for amateurs to operate a disaster communications network in the band 1605 to 1800 kc. The exact width of this frequency band and its locations within the range 1605 to 1800 kc. is undetermined at this time.

"In addition, the Commission proposes to assign the 500 kc. band between 21,000 and 21,500 kc. to the amateurs. The Commission is unable to allocate the 500 kc. between 21,500 and 22,000 as requested by the American Radio Relay League because a portion of these 500 kc. are necessary in order to provide for international broadcasting in the band 21,500 to 21,700 kc. and the remainder was allocated to fixed."

For the past year or two practically every amateur has known that the Government does not

propose to return our 1750-2050-kc. band to us after the war. The primary reason for this is that there has been established in our band, during the war, a certain long-range navigational aid which is believed to be of transcendent value to the surface craft and aircraft of the nation and for which no other location in the spectrum so far can be found. A secondary reason is that a new organization of the mobile services is contemplated in the 2000-2250 range, with a new distress frequency for small craft to supplement the use of 500 kc., and additional frequencies were required for that purpose. Ignoring the pleas of ARRL at the hearing last autumn, the only provision made for any 160-meter operation is a proposal to establish arrangements for disaster communications, including amateur disaster networks, at some unstated portion of the 1605-1800 band. In the FCC table of proposed allocations, broadcasting would receive 535-1605 kc., and thereafter would come the following provisions, which we quote in full to show you the contemplated reorganization of this part of the spectrum as it affects our 1750-2050 band:

Frequency Band Kc.	Proposed Int. Allocation	Proposed U. S. Services
1605-1800	(a) Fixed (b) Mobile	Police, aviation, relay broadcast, special, Alaskan, "disaster communication" including amateur disaster networks
1800-2000	Navigation aids	Navigation aids
2000-2050	(a) Fixed (b) Mobile	Government
2050-2065	Maritime mobile	Ship telegraph
2065-2075	Mobile (distress and calling frequency 2070 kc.)	Mobile (distress and calling frequency 2070 kc.)
2075-2100	Maritime mobile	Ship telegraph
2100-2250	Mobile	Ship telephone, relay broadcast

IRAC, it will be remembered, made no provision for us in this band, demanding that the bulk of it be retained for the Government operation of the navigational aid, and the Commission in omitting us has only followed suit, yielding to the requests of the military services. ARRL concedes the importance of the device they are operating but is not persuaded that it has been established that this is the best part of the spectrum for it, believes it likely that some day it will be moved, and proposes to ask that the frequencies be earmarked for return to the amateur service as soon as the device can be moved.

The Commission points out that the spectrum below 25 Mc. is so overcrowded that it has been impossible to meet the requirements of all radio services. It has attempted to make an equitable distribution. Wherever possible, services are ex-

pected to move into the v.h.f. and u.h.f. ranges. Concern is felt over the difficulty of providing adequately for the needs of this country and the rest of the world in the fixed radiotelegraph and international telephone service. "The Commission is of the opinion that only through a properly organized system of assigning frequencies by geographical zones throughout the world will it be possible to accommodate the postwar requirements of all nations." There is increased emphasis on the requirements of aviation communications, including navigational aids. Six bands of 200 kc. each are provided for direct international short-wave broadcasting. IRAC recommended the abolition of this service. High policy determinations restored it to the FCC thinking. The present FCC proposal is substantially the Cairo bands, adjusted to a uniform 200 kc. each and with the deletion of the 25-Mc. band. As the Commission has stated in the quotation earlier in this article, it is its retention of 21,500-21,700 for short-wave broadcasting which prevents proposing for us the full width of the IRAC suggestion, 21-22 Mc.

It does not seem necessary to quote in this article the full long allocation table, although it would help to show you the complexity of modern allocation planning. It seems sufficient to report at this stage that the amateur bands appear with the notation "Amateur" in both columns, both the proposed international allocation and the proposed U. S. services. Except for 14 Mc., this is a change as concerns the international column. The present international allocation of 3500-4000 is amateur, fixed and mobile. It is only at the discretion of the Government that we have it as an exclusively amateur band. FCC proposes, however, that it now be allocated internationally to amateurs exclusively. Similarly with the 7-Mc. band, the present international allocation is amateur from 7000 to 7200 and amateur and broadcasting from 7200 to 7300. The proposed international allocation is amateur. As concerns 21,000-21,500, now proposed to be assigned internationally to amateurs, the present international allocation is fixed from 21,000 to 21,450 and broadcasting from 21,450 to 21,500, the latter in a band which now runs 21,450-21,750 and which FCC proposes to reduce to 21,500-21,700.

There are a lot of hurdles to this business of getting ourselves back on the air. The job is far from done. But this FCC report was one hurdle that we positively had to make and so it is with considerable satisfaction that we read that, although our old friend the 160-meter band is missing, the mainstay bands of amateur radio are provided for — 80, 40 and 20 — and with the prospect of a new band at 21 Mc., a nice supplement to our overcrowded DX bands. All hands should note carefully, however, that this is but the preliminary FCC proposal, that even the U.S. decisions are not yet final, and that thereafter we shall have to run the gauntlet of international conferences. These begin to loom, by the way, with preparations now under way for the inter-American conference at Rio in September and

(Continued on page 74)



Gold Stars

CAPT. HOBART T. WALKER, JR., AAF, W3GX1, 23, was killed on duty somewhere over China on February 11, 1945, while serving in the India-China Division of the Air Transport Command.

Walker left Maryland University in his senior year to enter service with the Army Ferry Command. His aviation qualifications were Civil Aeronautics Authority ground instructor in navigation and radio, flight instructor and instrument rating, and a licensed commercial transport pilot. At the time of his death "Hobo" had accumulated over 3000 hours of flying, in everything from a Piper Cub to a four-engine transport, and held the Air Medal with two Oak Leaf Clusters.

W3GX1 received his ham ticket in 1937 and later added Class A, radiotelephone and telegraph second-class licenses. He was a member of ARRL and the Washington Radio Club. Most of his operating was on 20-, 40- and 80-meter c.w.



L. T. LUTHER C. SMITH, JR., USMCR, W5E00, 27, was killed February 23, 1945, in an airline crash near Rural Retreat, Va. A radar specialist stationed with BuShips in Washington, he was bound for Ft. Worth on a special assignment.

After attending the University of Houston and the University of Texas, Luther did scientific research work for the Carnegie Institute and later became a radio engineer for Stromberg-Carlson. He volunteered for service in the Marine Corps and was commissioned in April, 1944.



W5E00 was a member of the Houston Amateur Radio Club and held an OPS appointment. His main interest, however, was in designing and constructing equipment. On one occasion when in quest of new material, he obtained from W5CVQ a small portable c.w. transmitter from which he designed a "lunch-box" portable. This set later became the "Hero of Hallettsville" when, under the fist of W5HNF, it was in operation for three days and nights in the handling of emergency traffic from Hallettsville, Texas, when that town was isolated by a serious flood in Sept., 1940.



Taming the Vacuum-Tube Voltmeter

Part I—New Methods for Increasing Utility and Dependability

BY McMURDO SILVER*

FOR some years past the vacuum-tube voltmeter has appeared to offer greatest promise in ever-demanding-to-be-improved voltage-measurement technique for d.c. as well as for a.c. up into the u.h.f. region. The use of vacuum tubes as coupling agents between frequency-sensitive or load-sensitive voltage sources and conventional power-consuming meters seems to be the simplest means of preventing the power requirements of conventional indicating meters from deleteriously loading delicate circuits.

Reduced to its simplest expression, a vacuum-tube voltmeter is nothing more than a device applied to a direct-current milliammeter (usually of D'Arsonval type) to raise the quite-low input resistance of the meter itself up into the multi-megohm range in order that the whole meter shall affect the circuit behavior as little as possible when applied to a source of voltage to be measured. In d.c. measurements it is obvious that the higher the voltmeter input resistance may be, the more desirable the instrument.

The same criterion of excellence applies in measurements of a.c. voltages, but here the problem additionally necessitates the insertion between source and meter of a rectifier to translate applied a.c. into d.c. to actuate the meter movement. The usual practice of employing a copper-oxide rectifier satisfies only the basic requirement of low-frequency a.c. voltage measurement, for it limits undesirably both the input resistance and frequency range. It is to be noted that many commercial "vacuum-tube voltmeters" have been such only partially, since their designers resorted to the undesirable expedient of copper-oxide rectifiers for a.c. operation. It is felt that an instrument deserving the name of vacuum-tube voltmeter should be "vacuum-tube" completely in all voltage measurements, a.c. as well as d.c., since the public automatically associates with the term the full merit of complete vacuum-tube operation for all measurements.

Design Problems

The author begs indulgence for the preceding statement of facts, undoubtedly obvious to most readers, upon the ground that a definite and clear premise is essential to comprehension of any problem — and a problem he has most certainly found in the true vacuum-tube voltmeter. His

*1240 Main St., Hartford, Conn.

In this article, the first of two, the author discusses some of the problems involved in vacuum-tube voltmeter design and the steps taken to solve them. In the second article, which will follow in the next issue, he will describe the construction of an instrument containing the features brought out here.

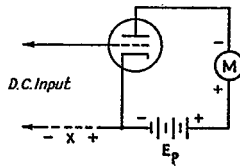

Fig. 1—Basic vacuum-tube voltmeter circuit.

own interest has stemmed from that experience, usual to serious investigators, of finding most available reasonably priced vacuum-tube voltmeters unsuitable for quantitative, precision work. Faced with the need for a vacuum-tube voltmeter departing negligibly from the dependability and accuracy of the basic indicating meter itself, he found himself forced to continual compromise. So acute became the dissatisfaction developed over recent years in his direction of design, development and production of military projects, using any but the most expensive laboratory vacuum-tube voltmeters of decidedly limited utility, that he set himself to the task of simultaneously taming the v.t.v.m., reducing its cost and expanding its sphere of utility. It is hoped that a brief review of some of the problems involved, the individual solutions and, finally, the combination of these individual solutions into an instrument of wide utility and extraordinary dependability will be of interest to prospective constructors.

As stated, the basic concept of the vacuum-tube voltmeter is the employment of a vacuum tube between the voltage to be measured and a suitable indicating meter. The triode possesses the advantage of being able to translate a change in grid voltage into a change in plate current; in other words it is a voltage-to-current transformer. In idealized form the grid resistance, or input resistance, may be made infinite so as to impose zero circuit loading, powerwise. In practice the grid should not be allowed to open-circuit during periods of non-connection to a conductive source, otherwise the meter may be damaged by excessive plate current. Thus it is desirable to close the grid-to-cathode circuit decisively with a grid resistor — of resistance as high as practicable — in order that such grid resistor itself shall not draw significant power from the source.

Although it illustrates nicely the basic principles involved, the meter circuit of Fig. 1 suffers from numerous drawbacks. Unless the grid is kept negative with respect to the cathode during operation, it will draw current and so load the source of voltage to be measured. The grid must be kept more negative than the highest voltage to be

measured. This entails a high plate voltage if the tube is to operate as a Class-A amplifier, desirably linear over any useful range of input voltages. The negative grid will prevent grid current, but the high plate voltage will result in what might be termed "gas" current, or "ion" current in the grid circuit when the resistance therein is high — *even though the grid is negative*. Add to this the unpleasant facts that there is no easy way of covering a multiplicity of widely different voltage ranges and that the calibration of the instrument is extraordinarily dependent upon filament and plate voltages as well as upon long-time changes in tube characteristics, and it becomes apparent that it is of little practical value. Investigation starting from the prior observations of others has revealed that these problems of the simple d.c. vacuum-tube voltmeter can be solved — whereupon more will promptly take their place. But let's take them as they come.

Multiplier "Stick"

An almost unlimited range of full-scale voltage ranges may be obtained most economically by providing a tapped resistance "stick," or resistive input voltage divider, as shown in Fig. 2. This may consist of a multitap switch to move the grid down progressively from the top of the "stick" toward its bottom, the total resistance of the "stick" shunting the source and representing the practical value of meter-input resistance, while the position of the grid tap determines the voltage range in use. Because of inescapable capacitances associated with the (desirably non-inductive) resistors making up the "stick," it will be useless in a.c. measurements without inconvenient capacitive compensation for each step. But there is no need to worry about this yet. The use of this input resistor "stick" allows a great enough number of ranges to make the d.c. vacuum-tube voltmeter quite universal in application, if its initial sensitivity be adequate for the lowest voltage range desired. It will simplify the design of the circuit, since all that is required basically is a single low-range v.t. voltmeter, the variable input "stick" serving to give this single-range meter as many voltage ranges as may be desired.

What of the resistance of this "stick"? Its total resistance must be high if it is not to load high-impedance circuits to the point where the accuracy of measurement becomes seriously af-

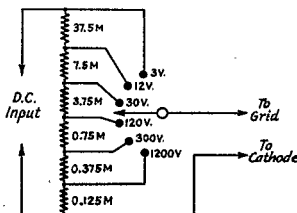

Fig. 2 — Voltage divider or "stick" for obtaining multiple voltage ranges. All resistors are of $\frac{1}{2}$ -watt rating. Each should consist of two lower-resistance units in series matched to an accuracy of plus or minus one per cent.

fect. Fifty megohms seems a desirable total "stick" resistance. This will constitute the vacuum-tube voltmeter's input resistance if all other problems are suitably solved. Fig. 2 gives actual resistance values for such a 50-megohm "stick" with six taps distributed down it to give voltage ranges of 3, 12, 30, 120, 300 and 1200 volts. (Actually, the v.t.v.m. which follows the tap "sees" only 0 to 3 volts total for each of these ranges.)

Eliminating Grid and "Gas" Currents

What about grid or "gas" current when the grid tap is moved from 125,000 ohms progressively upward in increasingly large resistance steps to a total of 50 megohms? The designer and the user can deceive himself by saying, "Zero-set the meter with the input terminals short-circuited." That is *too* simple — and seemingly a too-popular misconception of the proper solution. Its effect is to short-circuit the input grid resistor in order to set electrical meter zero before operation, ignoring the effects of "gas" current which causes a significant initial meter reading when the input terminals are opened and "gas" current appears. If the voltage source to be measured is of low resistance, such as a power supply or battery, this will be permissible in practice since "gas"- or grid-current effects once more will disappear when this low-resistance source is connected between grid and cathode. They will *not* disappear, however, when the source resistance is high, as in amplifier grid-voltage measurements. An instrument requiring that its input terminals be temporarily short-circuited in order to set meter zero initially therefore will render invalid any low-voltage measurements across high-resistance circuits. So we're back at one of the besetting sins of most vacuum-tube voltmeters to date.

To eliminate *grid current* the v.t.v.m. grid must be kept definitely negative with respect to its cathode for all orders of input voltage to be measured. But this does nothing for "gas" current (often mistaken for tube-base leakage, grid current, or almost anything but what it really is). Gas current is a function of the plate voltage applied to a vacuum tube. It does not show up noticeably in ordinary applications until the grid resistance is made very high — of the order of megohms. But, a 50-megohm input resistance is necessary if the v.t.v.m. is not to impair seriously the accuracy of voltage readings taken when it is shunting the high value of grid resistance often found in resistance-coupled amplifier circuits which must be tested by a universal meter.

Indicator Sensitivity

The solution is to apply to the tube of the v.t.v.m. a plate voltage so low that "gas" current cannot occur to any effective degree. This plate voltage will be around 20 volts, preferably less. With such a low value of plate voltage and with the grid negative enough never to allow the maximum-value input voltage to be measured to drive the grid positive, examination of tube characteristics indicates that there will be mighty little plate current to actuate the indicating meter. A 50- or

100-microampere meter is a costly thing at best, and unduly sensitive to mechanical abuse — of which any universal meter will receive plenty in service. It is highly desirable to use a basic meter movement of 0-1-milliampere sensitivity because it is more easily obtained, is more rugged, and imposes a less exorbitant cost premium on the final instrument than a more sensitive meter.

One approach to this particular problem is to use a high-plate-current power pentode operated at low E_p in place of the simple triode. This is workable, but since it is going to be necessary to use two tubes eventually, it is not an ideal solution because it is inevitable that separate tubes, not manufactured identically, will age in a dissimilar manner. The tube manufacturers state that the maintenance of uniformity of sections of dual triodes is greater over a period of time than that of separate tubes. Thus, a dual triode is indicated. Additionally, the fewer and the smaller the elements in the selected tube the better, since the possibility of "gas" current developing over time, even at the ridiculously low plate voltage necessary to eliminate it to start with, is minimized by reducing the amount of metal in the tube's evacuated envelope.

At this point the ubiquitous cathode follower is brought in. A definite and constant order of gas current in the v.t. voltmeter tube can be tolerated if it does not vary, as it would were the input grid resistance to be changed in the course of changing ranges. The cathode follower permits the satisfaction of this requirement and, at the same time, permits the use of a following meter-actuating tube "seeing" a constant grid resistance. The cathode follower may follow immediately the 50-megohm input voltage-divider "stick" of Fig. 2. When operated at about 17 volts on its plate none of the usual and unpleasant errors in meter reading arising from "gas" current will be introduced and since its grid automatically is negative, by virtue of the large and heavily degenerative cathode resistor, R_1 of Fig. 3, there is no cause for worry about grid current. However, at this low plate voltage there is insufficient plate-current change to operate a 1-ma. meter movement directly, exactly as mentioned previously. Also, the circuit will have the nature of a rectifier in the sense that, for a negative voltage applied to the grid, the plate current cannot decrease by the same amount it will increase for an equal positive voltage applied to the grid of the tube.

If any claim to general usefulness is to be made for the instrument, it is necessary substantially to prevent changes in the tube itself with aging from effecting its operation. This can be done by making the cathode resistor, R_1 of Fig. 3, very large. A suitable value is 5 megohms which, with 17 volts on the tube plate, means almost no plate current at all. Sufficient cathode resistance should be used to degenerate the tube gain to a point where age and other factors affect operation practically not at all.

Any departure from Class-A operation, with its associated linearity, which is required in the

final instrument, cannot be tolerated. So the voltage drop across R_1 is determined and a potential sufficient to shift the actual operating grid bias up to a value suitable for Class-A operation and linearity is placed in series with the grid only, as at X in Fig. 3. Having previously assumed a 3-volt basic range for the v.t. voltmeter proper, the grid may be set at about 4 volts negative with

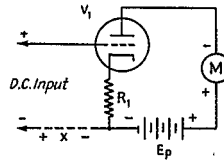

Fig. 3 — Cathode-follower coupling stage. The voltage drop across R_1 is partially bucked out by a fixed voltage at X to provide Class-A operating bias.

respect to its cathode. If this is done the operation of the tube will be found to be linear over a suitable input-voltage range in both directions; i.e., with the grid run 3 volts positive or 3 volts negative. This total 6-volt range is required so that the polarity may be reversed by a suitable switch at the meter itself for reading either negative or positive voltages within the range of the final instrument without the need for reversing input connections.

Meter Amplifier

All of this looks like something promising so far as it goes — a 50-megohm input resistance, enough taps thereon to give all the d.c. voltage ranges reasonably required in the six steps possible with a conventional range switch, freedom from grid current and, most important, absence of "gas"-current effects to a point where the usual short-circuiting of input terminals to set an initial meter zero can be eliminated. Zero is set simply, with the input open or shorted, accompanied by a pleasing order of stability, all thanks to the cathode follower operated at very-low plate voltage.

The voltage appearing across R_1 of Fig. 3 will be a fixed d.c. voltage resulting from plate-current flow through V_1 , upon which will be super-imposed a d.c. voltage varying almost as does the applied grid input voltage. This variation may be used to actuate a second tube which, in turn, actuates the 0-1 ma. meter movement. The initial fixed positive voltage across R_1 can be washed out by another device later on, so let us ignore it for the moment.

The grid and cathode of the second, or meter-actuating triode will be connected across R_1 . This tube must be operated at a sufficiently high plate voltage so that a 3-volt change at its grid will cause a 1-ma. change in its plate current, plus something to spare to allow for variations in individual tubes when first setting up voltage calibration and ranges. In Fig. 4 is depicted the cathode follower at V_1 , exactly as described above, with the meter-actuating tube at V_2 . With R_1 established at 5 megohms, the excessive negative bias which the voltage drop across R_1 would place on the grid of V_1 is offset by means of the

positive bucking bias provided by the potential B_1 , and connections are made so as to apply a replica of the varying input voltage appearing across R_1 to the grid of V_2 . But again, aging of V_2 should not affect too significantly the operation of this now-beginning-to-develop instrument. To obtain

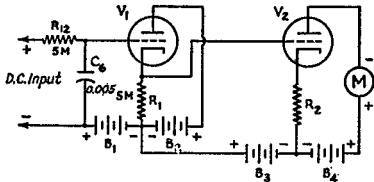

Fig. 4 — Cathode follower and meter-actuating circuits. B_1 and B_3 are bucking voltages.

a 1-ma. current change in the plate circuit of V_2 , for a 3-volt input to V_1 , V_2 must be operated at some more-normal plate voltage than in the case of V_1 . This spells an initial order of "gas" current in V_2 as a result of the 5-megohm cathode resistor of V_1 appearing in the grid circuit of V_2 . Actually, there is no need to worry at all about this, for the value of R_1 never is changed in operation and therefore whatever "gas" current V_2 exhibits will be constant for all practical purposes; its operational effect can be washed out by the zero-set adjustment which will be provided later.

To divorce the variability of V_2 with time, etc., from the situation, cathode degeneration may be employed once again, this time by means of R_2 . If R_2 be about 40 kilohms and the plate potential B_4 about 200 volts, everything will be satisfactory. But once again excessive negative bias must be bucked out, this time upon the grid of V_2 , exactly as was done for V_1 by potential B_1 . This may be done by obtaining some bucking bias for V_2 from the fixed voltage drop across R_1 , already in the grid circuit of V_2 , and by supplementing this bucking bias with a suitable potential at B_3 .

Supply-Voltage Compensation

By following properly all of the preceding steps a portion of the skeleton of a d.c. vacuum-tube voltmeter, free from "gas"- and grid-current effects in their usual ruinous form, has been derived, and simultaneously long-time changes in tube characteristics have been prevented quite effectively from influencing final results, except as they may be compensated for by a meter zero-set not as yet provided. But what of variations in plate and heater voltage? The plate voltage may be regulated at some small expense, but the same does not hold for economical regulation of heater voltage and cathode emission, although power-line operation (with its invariably fluctuating line voltage) certainly is desirable.

When the circuit of Fig. 4 is converted into what looks like a push-pull circuit, significant and sizable gains in stability versus short-time variation in power-line voltage are obtained. The actuality is depicted in Fig. 5. Here V_{1a} and R_{1a} have been added to balance V_1 and R_1 , as have V_{2a} and R_{2a} to balance V_2 and R_2 . If a 6SN7GT dual triode is selected for V_1 and V_{1a} , and another

6SN7GT tube for V_2 and V_{2a} , a condition is obtained where, assuming only commercially-acceptable tubes in each position, the whole circuit is balanced nicely against supply-voltage variations. Simply stated, whatever change occurs in the V_1 - V_2 branch of the circuit occurs in substantially equal degree, but in opposite polarity, in the circuit branch containing V_{1a} and V_{2a} . With this arrangement variations in supply voltages, plate, grid and heater, of 10 per cent cause a change in meter reading of only approximately 1 per cent.

Zero Adjustment

By connecting the 0-1 ma. meter from cathode to cathode between V_2 and V_{2a} , the adjustable resistor, R_3 , can be inserted conveniently in series therewith, providing a means for setting the voltage range; i.e., R_3 is adjusted so that a 3-volt input will give full-scale deflection at M . If R_3 is made about 3 kilohms, this may be done nicely for almost all commercially encountered 6SN7GT tubes which may be used at V_2 and V_{2a} . But first the meter zero must be adjusted electrically by balancing the cathode currents of V_2 , and V_{2a} . Here a 3-kilohm potentiometer, R_4 , in the plate circuits of V_2 and V_{2a} serves with complete satisfaction. Coincidentally it is found that with 1200 volts applied to the 3-volt range, the meter is provided with practically 100 per cent protection against overload burn-out!

Since V_1 , V_{1a} , V_2 and V_{2a} are operated linearly as Class-A amplifiers, investigation of the meter "slope," or deflection vs. applied d.c. voltage, pleasingly reveals that equal increments in input voltage produce equal increments in meter deflection, and that a linear d.c. voltmeter with equal spacing between meter-scale graduations is obtained with this arrangement.

Adding resistor R_{12} in series with the grid of V_1 and C_6 in shunt to ground provides a filter which operates to wash out any effects of a.c. which simultaneously may be superimposed upon the d.c. voltage which is to be measured.

Practical Circuit

Since all of the problems of a 50-megohm input-resistance d.c. vacuum-tube voltmeter have been nicely solved, these accomplishments may be translated into a practical constructable circuit. This is done in Fig. 6, in which all previously referenced parts correspond to those of the preceding diagrams. Included are the input voltage-

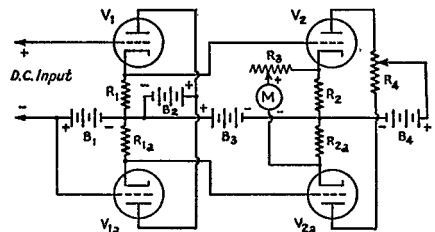

Fig. 5 — This is the circuit of Fig. 4 with the tubes, V_{1a} and V_{2a} added to provide a balanced circuit.

divider range-selector "stick" of Fig. 2, at the left, supplemented by R_9 , a 75-megohm resistor with which any of the six voltage ranges may be multiplied by a factor of 2.5. Thus are realized the six original voltage ranges of 3, 12, 30, 120, 300 and 1200 volts full-scale, all at 50-megohms input resistance, plus six additional ranges (when the input is connected across the terminals marked "3000 v." and "Com.") of 7.5, 30, 75, 300, 750 and 3000 volts. These new and added ranges¹ all are at the seemingly astronomical input resistance (for a stable instrument) of 125 megohms as "seen" by the source to be measured! Yet all positions are equally stable, equally "cool," with no change in meter zero regardless of whether the input terminals are open or short-circuited or ranges switched — quite a contrast to the conditions under which the design started. Batteries B_1 , B_2 , B_3 and B_4 have been replaced by the voltage-dropping resistors R_5 , R_6 , R_7 and R_8 , all connected across the output of the a.c. power supply made up of the rectifier tube, V_3 , filter capacitors C_1 and C_2 , the small power transformer, T , and the "on-off" switch, S_1 . By adding the d.p.d.t. switch, S_2 , the circuit may be arranged to reverse the meter polarity, and thus input polarity, so that positive or negative voltages of anywhere from 0.05 through 3000 volts may be read without reversing input connections — simply by rotating two switch knobs.

Current and Resistance Measurements

At last possessed of a thoroughly practicable, stable and dependable d.c. vacuum-tube voltmeter, truly "vacuum-tube" in its functioning, all that need be done now is to make it function as an ohmmeter, as an a.c. and r.f. voltmeter, db. meter and milliammeter. But the path of the original investigator is easy only when reduced to ultimate written description! Taking the easy ones first, milliampere ranges may be provided by switching suitable shunts across the basic meter, M , by means of an added section on the range switch, this switch and shunts being selected by adding two contacts to what now may be termed the "function" switch, S_2 , and bringing meter and selectable shunts out to suitable input terminals. This is so conventional as to be worthy of little notice, except to select practically useful current ranges just as was done in choosing the voltage ranges — ranges which will permit the most generally made measurements to be read well up on the meter scale where the basic milliammeter is of greatest accuracy.

Fig. 7 shows fundamentally how resistances from 0.2 ohms up through 2000 megohms may be measured, again in six ranges so proportioned that the most-frequent measurements will fall upon "open" portions of the meter scale which, by necessity, is substantially logarithmic and therefore "crowded" at high readings. The six-

¹ Not included on basic range-selector switch for reasons of complexity and necessary high-voltage insulation.

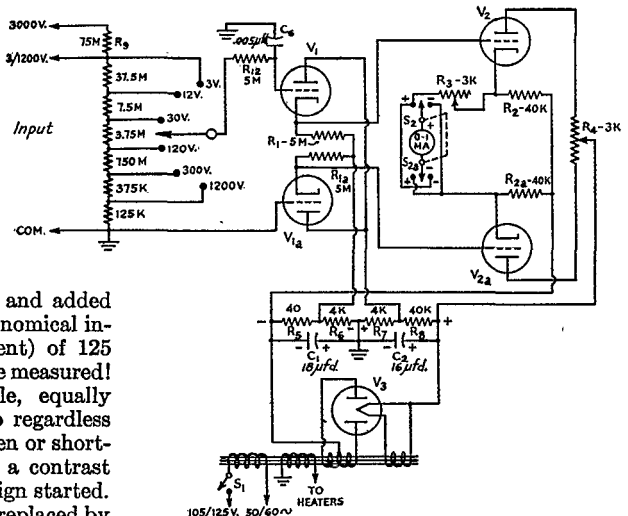

Fig. 6—Practical vacuum-tube voltmeter circuit with values. Symbols correspond to equivalent units in preceding diagrams.

position switch of Fig. 7, may be yet another switch section added to the basic range switch, brought into circuit by suitable switching added to the v.t.v.m. of Fig. 6. The whole principle involved is so simple as to deserve no more than passing mention, except to state that the resistance of an unknown resistor, R_x , is measured, not in the usual terms of the current through it, but in terms of the voltage across it. This gives a *right-reading* ohmmeter scale in sharp and pleasing contrast to the backward-reading ohmmeter scales of more conventional service instruments. By virtue of having switched out the voltage-range "stick" for ohmmeter operation, the v.t.v.m. of Fig. 6 "looks" like an infinite resistance to the ohmmeter circuit. This helps in measurements of resistances up to 2000 megohms using only a 3-volt dry battery. Unfortunately it is not easy to eliminate this battery for resistance measurements in favor of drawing an equivalent voltage from the v.t.v.m. power supply. This is because the voltage regulation of the ohmmeter voltage supply must be exceptionally good. The v.t.v.m. power supply has poor regulation to save

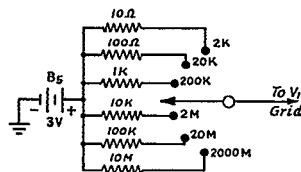

Fig. 7—Circuit added for resistance measurements.

space and weight, since good regulation is not necessary to the v.t.v.m. power supply, regulation in the instrument as a whole being automatic by virtue of its balanced-circuit design. It might be added that two 1½-volt standard "A" cells, procurable at ten cents each, work out more economically than would the cost of parts needed to eliminate them. Their life is indefinitely long

unless they are used consistently to measure resistances of less than 100 ohms — a condition seldom encountered frequently in radio design or servicing in any case.

A.C.-R.F. Operation

At first glance all that is necessary for a.c. voltage measurement (and this *should* mean r.f. up into the u.h.f. region if the instrument is to be worthy of its name) should be to connect a suitable rectifier between the source of voltage to be measured and the d.c. vacuum-tube voltmeter of Fig. 6. It is regrettable that life is not that simple. The presumed simplest form of a.c.-to-d.c. rectifier is a two-element diode vacuum tube. This type of rectifier has been employed in the best instruments heretofore available, but it is not ideal. To begin with, the d.c. output vs. a.c. input curve is not linear over the desired low-voltage range of 0-3 volts. Additionally, a diode draws some power from the circuit to which it is applied, power drawn to keep its input capacitor charged (from which is drawn the steady d.c. voltage to actuate the following d.c. meter). True, this power is very small, and suitable proportioning of the diode circuits can result in an effective input resistance which is desirably high.

Knowing of the excellent linearity of the so-called "infinite-impedance" detector possessed of potentially-infinite input resistance, one is inclined to turn to it — exactly as the author did in an early design. Depicted in Fig. 8, it appears off-hand to be an ideal solution to the problem of an a.c. rectifier for a v.t.v.m. Appearances can be deceiving, however. Theoretically it might be supposed that the capacitor, C_3 , shunting the large (and therefore degenerative) resistor, R_9 , would charge up to the peak value of the a.c. input voltage to be measured, and that if the values of C_3 and R_9 were large enough, this charge would be held substantially until the next input charging cycle. Unfortunately, effects occur upon which the author prefers to express no positive views. The d.c. output voltage does not appear to approximate the 1.41 times the value of sine-wave a.c. input which might be anticipated. This is inconvenient but not ruinous. On the other hand, anticipated linearity, with consequent identicalness of slope between successive voltage ranges for such a rectifier, has been found disappointing. Add to this the fact that the maximum input voltage which may be handled must be significantly less than the available plate-supply voltage

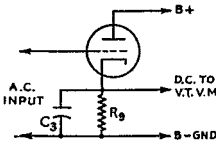

Fig. 8 — Infinite-impedance detector circuit which was tried as a rectifier for a.c. measurements.

and what appeared at first glance to be a very nice solution turns out otherwise. (It is not possible to put a voltage-divider "stick" ahead of the a.c.

rectifier with particularly happy results.) Input capacity, one of the minor unpleasantnesses of properly designed r.f. voltmeters still is present.

Thus we seem to be forced to the conclusion of prior serious investigators that a diode may be the best choice for an a.c. rectifier for a v.t.v.m. if it is to be useful generally from low frequencies right on up through the spectrum to 100 megacycles and beyond. An inexpensive v.t.v.m. covering such a wide range will be a boon indeed in the design and servicing of f.m. and television receivers and transmitters.

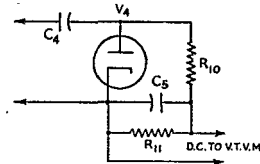

Fig. 9 — Diode rectifier circuit for a.c. measurements.

Diode Rectifier

Fig. 9 shows a diode rectifier circuit in which C_4 insulates the rectifier from d.c., so that a.c. superimposed upon d.c., as in a vacuum-tube plate circuit, may be separated and measured independently. On the positive cycle of the applied a.c. voltage, the diode, V_4 , passes current, thus charging C_4 . On the negative half of the cycle, V_4 is non-conducting, and C_4 discharges slowly through R_{10} and R_{11} — slowly because of the high value of R_{10} and R_{11} and the effectively high value of C_4 with respect to the frequency of the applied a.c. voltage. Here a problem is encountered — the value of C_4 suitable for 20 cycles necessitates a type of capacitor construction seldom satisfactory in terms of losses and inductance at 100 megacycles, for example. In the instrument to be described in Part II of this article, this disadvantage is circumvented by building V_4 into a removable probe which contains a value of C_4 suitable for middle audio frequencies on up to over 100 megacycles; also built into the instrument is a much larger duplicate of C_4 , such as is suitable for low-frequency operation, and an arrangement is provided so that this large C_4 is brought into the circuit only when the probe is plugged into its receptacle in the instrument. Low-frequency measurements are made by means of the d.c. probe cords. For all r.f. (and high a.f.) work the probe is withdrawn, to be contacted directly to the circuit carrying the voltage to be measured without any intervening leads to introduce serious, if not ruinous, errors.

Since it has appeared that making R_{10} and R_{11} large operates to minimize the effects of variation in the internal resistance of individual diodes, R_{10} conveniently may be made 20 megohms. R_{11} then may be the 50-megohm d.c. range "stick" of Fig. 2 and Fig. 6. C_5 is an a.c. filter capacitor intended to complete the a.c. load circuit of the diode V_4 and to aid in removing a.c. from the d.c. v.t.v.m. proper. Making R_{10} 20 megohms serves another useful purpose in addition to making the

a.c. diode load resistance high. To the 50-megohm resistance, R_{11} , the resistance R_{10} bears the relation of 1.4:1, the same relation existing substantially between the peak-voltage output of the a.c. rectifier (1.41 r.m.s. sine-wave a.c. input, approximately) and the r.m.s. a.c. input.

Theoretically it should be possible to connect the output of the rectifier of Fig. 9 to the input of the d.c. v.t.v.m. of Fig. 6 and read a.c. voltages directly upon the d.c. meter scale of the latter. This is a sound assumption only in part. The non-linearity of the diode rectifier will necessitate a new meter scale for the 3-volt range, although the diode will become sufficiently linear to permit doing just this on the higher-voltage ranges. The d.c. recovery vs. a.c. input characteristic of the diode will not work out precisely as expected, so that the d.c. output may not remain in consistent step for successive ranges. This can be compensated for quite nicely by using, not one range-set adjustment, such as R_3 of Fig. 5 and Fig. 6 for all d.c. ranges, but by arranging additional switching to select different values of a.c. range-set resistors as required. In practice this will work out to about four a.c. range-set resistors for six ranges — one for 3 volts, one for 12 volts, one for 30 volts, and one for 120, 300 and 1200 volts. This is not a serious problem physically, but it is somewhat annoying when translated mentally into the behavior-complexity of the seemingly simple circuit of Fig. 9.

Removing Contact Potential

Thus far no mention has been made of contact potential generated within the diode in the absence of any applied voltage (except heater). Suffice it to say that, using a 9006 u.h.f. diode for V_4 , the 70-megohm d.c. load will result in the appearance across R_{11} of about 1.0 volt in the absence of any input voltage whatsoever. This must be eliminated if it is not to cause false meter readings on those voltage ranges low enough for 1.0 volt to represent a significant error — below 300 volts, for example. So again a balancing tube similar to V_{1a} and V_{2a} is added — in this case V_{4a} of Fig. 10. With four resistors in its own "stick" totaling 10 megohms, V_{4a} will produce contact potential equal to or greater than that developed by V_4 across the 50-megohm range-selector "stick," or it can easily be made to do so by interchanging any pair of 9006 tubes so far encountered. On a.c., R_{13} is adjusted initially for meter zero, then left alone. This equal and opposite contact potential is applied to the balance cathode follower, V_{1a} , through a suitable switch. This switch, shown in Fig. 10, selects a portion of the contact potential developed across the four resistors in series comprising the load of V_{4a} in step with that selected from V_4 by manipulation of the range-selector switch controlling the 50-megohm voltage-multiplier "stick" of Fig. 2 and Fig. 6 so as to keep contact potential nicely balanced out for the 3-, 12-, 30- and 120-volt a.c. ranges of the instrument. The error introduced in the 300- and 1200-volt ranges from this source is so small as to be neglected, since it is only on the

order of eight one-hundredths to three tenths of one per cent.

What is the effective a.c. input resistance of such a rectifier? This is questionable for, while diodes are very simple-looking devices, their behavior seems to belie their seeming simplicity. A conventional method of stating the a.c. input resistance might be to say that it is represented by the actual load resistance shunted by the diode-probe capacitance. This is believed to convey a questionable picture and one not directly meaningful in practice. It seems better, after considerable cogitation, to state that the effective loading upon a circuit to which this particular diode network is applied will look like $\frac{r}{2}$ shunted by the diode-probe capacitance, where r is the diode load resistance. Thus it seems conservative to say that the rectifier of Fig. 9 and Fig. 10 will be "seen" by a voltage source to be measured as 6.6 megohms shunted by 8 μ fd. A little calculation will show that this represents, commercially at least, an unusually high order of v.t.v.m. input resistance in a.c. operation. This resistance will diminish as the frequency is increased, but the same thing applies to the practically attainable impedances of tuned circuits across which voltages are to be measured in most cases as the frequency is made higher.

Summary

It is believed that several new and novel features have been described. Specifically these are: the insertion of a low- E_p cathode follower and duplicating balancing tube between a simple two-tube balanced d.c. vacuum-tube voltmeter

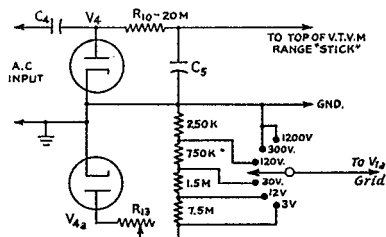

Fig. 10 — Balancing tube, V_{4a} , added to balance out "contact" potential.

and an input range-multiplier network in order to eliminate the deleterious effects of grid and "gas" currents as a result of changing input resistance; the automatic plug-in substitution of different values of a.c. diode-input capacitance in order efficiently to cover a wide frequency range in one instrument; the provision of a variable source of balancing contact potential which may be kept in step with that resulting from a diode preceding a selective resistive voltage-dividing network. It is hoped that these small contributions to the art of v.t.v.m. design may be of interest. The construction of a practical instrument of high accuracy and stability embodying the teachings of the foregoing will be described in the second part of this article which will appear in the next issue — a truly "tamed" vacuum-tube voltmeter.

Postwar Station Calls

Proposed Changes in Call Areas and Assignments for Future Expansion

BY CHARLES A. SERVICE, JR.,* WA1E

FOR some years prior to the war it was apparent that our system of amateur station-call assignments would be insufficient for future needs if amateur radio continued to grow. In fact, the bottom of the barrel had been reached in the 9th call area and FCC had found it necessary to resurrect and reassign old calls that had been vacated by former owners only a few years before. Even that meager supply would have failed had not the war put a temporary stop to further station licensing.

The ARRL undertook the study, therefore, of this problem during our period of shut-down, feeling that if a change had to be made it could best be done before reactivation. It is infinitely more preferable to plan now and have any essential changes effective before our postwar resumption than to institute an alteration in established and listed postwar calls. Some new or supplementary system of call assignments had to be devised for postwar operation, which would care for future needs and still comply with international regulations controlling the form which amateur calls may take.

In addition to statistical data compiled at League Hq., suggestions from the membership were solicited in the February, 1945, issue of *QST*, and all were boiled down to compact form and presented for study to our Board of Directors prior to its annual meeting last May. After discussion at the meeting, as reported elsewhere in this issue, the Board decided on one plan which would satisfy the requirements of the problem and result in the greatest good for the greatest number, and thereupon forwarded it to FCC for consideration.

According to all calculations based on amateur growth following the last war and an appraisal of current indications during this one, the League estimates that our numbers will increase to approximately a quarter million within five years after the restoration of our operating privileges. Our testimony at the FCC frequency allocation hearings last September was based on this expected growth; those interested in the actual figures are referred to *QST* for Dec., 1944, p. 82.

To understand the Board's plan thoroughly and the underlying reasons for its decisions, a review of the factors involved and requirements to be met are worth your study. They are not listed in the order of their importance but each received careful consideration in determining which plan submitted most nearly approached the ideal.

1) *Any acceptable plan must conform to present international regs.* The Cairo regulations provide

*Assistant Secretary, ARRL.

that amateur calls shall consist of "one or two letters and a single figure followed by a group of not more than three letters." That is the system under which calls have been assigned in the past and no deviation is possible without an amendment to the regulations. And an amendment, even if desirable, could not be made until the next international revision becomes effective, some years hence. Several plans submitted violated these provisions by suggesting the use of two numerals and they had to be discarded.

2) *Split-state call areas should be eliminated.* Our present nine call areas are an accidental carry-over from the old Department of Commerce inspection districts and bear no relation to present FCC inspection districts. The split states therein today serve no useful purpose and are the cause of much administrative confusion. In fact, we were advised the Commission intends to eliminate them in any case, whether we recommend it or not. That is a very important point and so we repeat it: FCC tells us that, whether we like it or not, and whether we propose it or not, they intend to do away with the splitting of New York, New Jersey, Pennsylvania and Michigan between two call areas, after the war. That being the case, the sensible thing for us to do is to incorporate that provision in any plan of ours, to assure that the rearrangement is best suited to our needs. But we want all amateurs to understand that the proposal to do away with split states originates in the first instance with the Commission, not the League.

3) *The digit 0, zero, (hereafter written Ø) should be utilized.* International regulations permit its use for amateur calls and it had already been assigned to Netherlands before the war. The increase in call areas from nine to ten — the tenth being the Ø area — would help relieve the coming call congestion, particularly in the disproportionately large 9th area.

4) *The length of calls should not be increased.* While it is permissible, within the requirements of international regulations, to use a call consisting of a two-letter prefix and a numeral followed by three letters, it would certainly prove burdensome, lengthy and confusing. Imagine having to send or — much worse — receive the call WQØJQO! We want to hold calls to not over five characters.

5) *Existing calls should be disturbed as little as possible.* In most cases they are sacred to their owners, real or fancied records and reputations have been built around them, and a wholesale revision would work an unnecessary hardship on all concerned except the QSL-card printers.

6) *Some rearrangement of call areas to contain approximately the same number of amateurs is necessary.* With the expected quadrupling in the number of amateur stations after the war, it is obvious that certain areas containing large prewar amateur populations would exhaust available calls in a short while. Even a new plan contemplating no increase in the number of call characters would be unable to accommodate the 9th, whose call book count is 14,399 and whose future expectancy is at least 57,000.

Here are some statistics showing disproportionate sizes of present call areas. Population figures are non-Negro population from the 1940 census, since the number of licensed Negro amateurs is very small, their numbers in certain areas are very large and, if counted, would not give a true picture. The amateur census was taken from the last amateur call book, published in the spring of 1942, and shows those in continental U. S. only, omitting territories and possessions. The total for continental U. S. is 62,216, for territories and possessions 907, or a grand total of 63,123.

We had understood from FCC that we numbered about 60,000 at Pearl Harbor but the figure was only an estimate. Perhaps the CB is right but perhaps it contains some deadwood of expired calls not yet dropped from the book. But if not absolutely reliable, it should be entirely so relatively. Note the highly significant regional variation of amateurs-per-million population, for which allowance should be undertaken in any new plan.

Call area	Population	Amateur stations	Amateurs per million population
1	8,335,000	5,715	686
2	11,996,000	6,769	564
3	9,365,000	4,589	490
4	11,354,000	3,491	307
5	12,275,000	4,798	391
6	8,041,000	8,795	1,094
7	4,155,000	3,435	827
8	22,260,000	10,225	459
9	29,737,000	14,399	484
		<u>62,216</u>	

In the following figures, the amateur count includes the prewar stations in outlying territories and possessions. The second column is the call book count. The third column figures have been uniformly scaled down to total 60,000 so that both bases are displayed for comparison. Expected growth figures are at the rate shown in our FCC presentation, applied uniformly in expansion of prewar figures without regional allowances.

Area	Approx. no. prewar stns., call book count	Ditto, adjusted to basis 60,000	Expected need in 5 years ($\times 4.16$)
1	5,715	5,400	22,600
2	6,769	6,400	26,800
3	4,589	4,650	18,200
4	3,609	3,400	14,300
5	4,798	4,550	19,000
6	9,243	8,750	36,700
7	3,776	3,550	14,900
8	10,225	9,700	40,500
9	14,399	13,650	57,000
	<u>63,123</u>	<u>60,050</u>	<u>250,000</u>

In each of these call areas there is a total of 16,900 calls available under our prewar system, ($25 \times 26 \times 26$), remembering that calls starting with X are assigned to experimental stations and not to amateurs. This ignores the disappearing two-letter call. It is apparent that all areas but the 4th and 7th are incapable of dealing with anything like the anticipated growth, and that even these areas provide almost no margin for calls standing idle while call books are being revised and wearing out. In some areas the disproportion between expectation and availability is huge. It is also apparent that the simple device of making a second set of calls available, with a total of 33,800 per area, will not solve the matter. This delineates the problem.

7) *Distinctive calls for stations in territories and possessions should be provided.* Our present system of K for stations outside the continental limits of the United States facilitated recognition and any new plan should embrace the same or equally clear means of identification.

8) *Plans involving the use of the prefix N should be avoided.* This has been traditionally confined to the Navy and is probably not realizable for amateur assignment. The prefix A, reputedly informally used by the U. S. during this war and being requested by this country as an additional assignment at the next international conference, might become available for amateur calls after the effective date of next revision, but too late and uncertain to be included in an immediate postwar plan.

9) *Any proposal involving single states as complete call areas must provide for largest state populations and anticipated growth.* For example, prewar New York State amateurs numbered 6,317 and any plan contemplating New York as a separate call area should provide a potential minimum of at least 25,000 calls.

10) *Two-letter calls can be disregarded as a supply for additional assignments.* When vacated by their present owners, FCC will not reassign them, and in any event they provide but 650 calls per area, insufficient to make any noticeable difference.

So now we come to the actual plan as adopted and recommended to FCC by the Board of Directors. It consists of the following changes and additions:

a) Elimination of split states, since that was already FCC intention.

b) Creation of a new zero (Ø) call area within the western part of the present 9th. Since this new area lies wholly within the boundaries of the present 9th, it will simply be necessary to substitute Ø for 9 in the case of prewar stations, the balance of the call remaining unchanged. Thus, during the early important period, any Ø amateur would be immediately recognizable as being the former 9 of the same suffix.

c) A shift of some states from one call area to another, to include approximately the same number of amateurs in each area.

d) Continuation of the present assignment of W calls in continental U. S. until exhausted and thereafter the establishment of an additional

series by moving the digit one place to the right. As an example, when the series W1AAA to W0ZZZ is finally assigned, additional calls would start with W1A1AA and go through WZ0ZZ, thus doubling the number of available calls.

e) If, at some future time, the prefix A is assigned to the U. S. and becomes available for amateur use, it could then be so employed in exactly the same manner as the present and future W-prefix series. It is not probable an A-prefix will ever be needed but it does provide a possible solution, just in case. To illustrate, after all W-calls were assigned, the new series would start with A1AAA and go through AZ0ZZ.

f) It was recommended that wherever a two-letter call now in force must be changed due to redistricting, its owner be assigned the same two-letter call in the new area, if available, or if not, at least another two-letter call. It is the mark of an "old-timer" in amateur radio and a precious thing to its holder. FCC does not otherwise re-assign two-letter calls, once they are vacated, and the actual number involved in the proposed changes is only a few hundred.

g) For territories and possessions, no change in the present system of assigning calls is contemplated.

While it is somewhat difficult to visualize this plan without a map, we now give you the recommended regrouping of states for postwar call areas and some statistics thereon:

Area	Territory embraced	Continental population (non-Negro)	Approx. number prewar amateur stations	Expected needs in 5 years after resumption
1	New England States	8,335,000	5,400	22,600
2	New York State	12,907,000	6,000	25,000
3	New Jersey, Pennsylvania	12,363,000	6,900	28,800
4	Delaware, Maryland, Washington, D.C., West Virginia, Virginia, North Carolina, South Carolina, Kentucky, Georgia, Florida, (plus Puerto Rico, Virgin Islands, etc.)	15,755,000	5,070	21,200
5	Texas, Oklahoma, Arkansas, Louisiana, Mississippi, Alabama, Tennessee	16,005,000	5,520	23,000
6	California (plus Hawaii and the Pacific Islands)	6,907,000	7,930	33,200
7	Washington, Oregon, Idaho, Montana, Wyoming, Nevada, Utah, Arizona, New Mexico, (plus Alaska)	5,825,000	4,600	19,200
8	Michigan, Ohio	11,615,000	5,550	23,200
9	Wisconsin, Illinois, Indiana	13,941,000	6,650	27,800
0	Colorado, North Dakota, South Dakota, Nebraska, Kansas, Minnesota, Iowa, Missouri	14,274,000	6,380	26,800
			60,000	250,600

It will be noted that the population figures vary from something under 6,000,000 to something over 16,000,000 per call area, while our figures take account of a wide variation nationally

in the number of amateurs-per-million population. With the provision of two sets of W calls, aggregating 33,800 per area, it will be seen that this plan takes care of an expected four-fold growth whether this is reached in a five-year period or requires longer. The first will come in the case of the 6th to which is attached territories and possessions of the Pacific. It would be desirable to reduce the size of this area but that is not possible because it has already been brought down to the single State of California and it is not desirable to split a state.

The one objectionable feature of this plan is the obvious displacement of certain existing calls into new call areas. Every alternative was explored in the hope some method could be evolved which would permit all prewar amateurs to retain their calls and at the same time fulfill the primary purpose of providing a sufficient increase in calls for postwar use.

Without increasing the length of present calls, no other satisfactory plan was found. Many individuals will be unhappy over the change in their calls but in terms of the whole, the displacement amounts to less than 20 per cent of actual prewar assignments, not counting those who change from 9 to 0. And most of this is unavoidable, anyway, being inescapable under the FCC intention to eliminate split states. Annually about 10 per cent of amateurs drop out of the game to be replaced by larger numbers of newcomers. With three or four years' shut-down, many prewar licensees will have lost interest and the displacement may possibly affect only one-tenth of our amateur population. The large licensed-since-Pearl Harbor group, never having held station calls, will not care what area they land in as long as they get on the air.

And that primarily is what all of us, old-timers and new-comers alike, are hoping for as soon as possible.

Strays

With the death of Dana Bacon, W1BZR, on May 24, 1945, there passed from the amateur scene a figure who over many years exercised a notable, if not spectacularly publicized, influence in raising to high standards the electrical and mechanical characteristics of the components and equipment utilized in amateur radio. Among his most significant contributions was his work on the design of the famous HRO receiver and original contributions in such radio circuit fields as crystal filters, r.f. coupling arrangements and noise limiters. Associated with the National Co. for some twenty years, following his graduation with a B.E.E. degree from Northeastern University in 1926 and a short period in Boston Edison Co.'s instrument testing laboratory, at the time of his death he held the position of chief electrical engineer. He was a constantly active amateur on the air and in radio clubs.

"The Crystal Ball"

Announcing a New QST Department Devoted to Postwar Brain Storms

ONE of the favorite time-passers of radio amateurs in the services — not to mention those still at home — is that of dreaming up and planning ideas for after-the-war rigs. No other topic so monopolizes both the scheduled and casual ham round-ups, or the day-dreams and "hanger-flying" of both GIs and stay-at-homes.

Now, ideas are swell — but they don't amount to much until they get converted into reality, or at least set down on paper and preserved. And then there's the old one about swapping ideas — if we trade receivers we still have only one apiece, but if we trade ideas we each have two.

So, in order both to circulate these brain storms to all the gang and to encourage more such constructive planning, we propose to inaugurate, in the September issue of *QST*, a monthly department, to be called "The Crystal Ball," in which to present the best of all the ideas submitted.

This department will be for all radio amateurs — old timers, OPLOs and LSPHs, and the "will be" hams as well. We do not solicit complete, lengthy articles, with detailed schematic diagrams and photographs. What we want are suggestions — your ideas and your plans for that station you are going to have after V-J day! What gadgets, refinements, circuits, or equipment have you operated, seen, or invented during this wartime lay-off that you want in your home station? (Naturally, no classified equipment can be described or discussed.)

To make it worth your while and help make those dreams come true, each month *QST* will award U. S. War Bonds and Stamps for those "visions in The Crystal Ball" which, in the opinion of the judges, offer the most interest to the rest of the gang. The winners each month will receive:

First prize — a \$25.00 War Bond.
Second prize — \$10.00 in War Savings Stamps.
Third prize — \$5.00 in War Savings Stamps.

For each additional "vision" previewed in The Crystal Ball but not winning one of the three main prizes, \$1.00 in War Savings Stamps.

Winning letters will be chosen from the material, received during a calendar month, by members of the ARRL Headquarters Staff. Ideas will be judged solely on their merits and *not* on the basis of artistic skill or literary ability. Contributions will be acknowledged, but we cannot answer any unsolicited correspondence concerning your ideas. The selections by the judges will be final.

Send in as many ideas as you wish. Don't worry about style; we'll edit your contribution to the extent necessary in the interests of general readability. We'll take the mass of material received (we hope it comes in by the ton!), pick out the items which appear most interesting and

practical, smooth them up a bit, and print them — illustrated (if necessary) by *QST* artists, from rough sketches sent in with your letters. There is no dead-line for submission of material; The Crystal Ball will be a continuing feature of *QST* for as long as it can serve a useful purpose.

As to subject matter? Well — how do you figure the equipment for our new u.h.f. bands? Are you planning a super-deluxe all-band rotary with automatic selsyn drive and multicolored lights around the border of a map — or will it be a beam-pattern-wide light-beam pointer? Will you have an all-band receiver, operating from 500 kc. to "steen" megacycles, or will it be a flexible i.f. and audio amplifier combination into which you will plug or switch various separate "front-ends"? Are you planning to have a store-bought outfit, or are you planning to drill the holes and solder the joints yourself? How about antenna systems? And how about operating positions? Are you dreaming of racks and panels, or a complete station enclosed in a polished cabinet with a television set plus a miniature bar? What characteristics do you think a 400-Mc. receiver should have? "Band-spread" your imagination as much as you wish, but bear in mind that you are describing *your* station, and you don't want to wait until Aladdin's Genie reappears before you can get on the air.



The Crystal Ball Department is now open for business! Let's have those ideas. Write them V-mail, on a post card, on USO or Red Cross stationery — or on a jeep's fender or even a hunk of a Zero's wing! Anything written in English, American, or good old ham lingo will be considered for publication in *QST*.

Send your ideas and those rough sketches to:
The Crystal Ball Department,
American Radio Relay League,
38 LaSalle Road, West Hartford 7, Conn.
— A.D.M.

IN THE SERVICES

Now that V-E Day has come and some amateurs in the service will return for redeployment or release from active duty, we ask that they let us know the fact so our files may be kept up-to-date. Even if a ham hasn't registered before release, we want information about his war service for a complete record of amateur participation.

ARMY—AIR FORCES

1LEK, Shock, Sgt., foreign duty
 1LPJ, Moore, F/O, foreign duty
 1NMY, Scott, Pfc., Sioux Falls, S. D.
 2CTK, Keen, Cpl., Esler Field, La.
 2FJR, Smith, T/Sgt., Calvin, La.
 ex-2IAQ, Gluss, Capt., Bronx, N. Y.
 2LZX, Gutzeit, Sgt., foreign duty
 2OLQ, Malone, M/Sgt., Lakeland, Fla.
 3CRR, Miller, S/Sgt., foreign duty
 3HKY, Ransome, F/O, foreign duty
 3HOX, Yundt, S/Sgt., foreign duty
 3JKS, Tague, Sgt., foreign duty
 4DZA, Arenburg, Lt., Wright Field, Ohio
 4GVA, Driggers, CWO, Marianna, Fla.
 4IBC, Pryor, Capt., Bossier City, La.
 5FXW, Lacy, Cpl., foreign duty
 5GQE, Lehmann, Lt., Marsh Field, Calif.
 5HDE, Jones, Lt., foreign duty
 5IKW, Mollenaer, Sgt., Esler Field, La.
 5JUF, Papp, Capt., foreign duty
 5KAY, Garrett, Pfc., foreign duty
 6ORK, Beckerman, Capt., Santa Monica, Calif.

8BFX, Bertovich, F/O, St. Joseph, Mo.
 8LS, Kramer, Lt., foreign duty
 8OLI, Carnahan, Lt., Gunter Field, Ala.
 8SYF, Burgin, 2nd Lt., Hondo, Texas
 8VMH, Bowers, Sgt., foreign duty
 ex-9KEN, Hart, Capt., Buffalo, N. Y.
 9QOW, Wilkinson, Cpl., foreign duty

Operator's license only:

Barkalow, T/Sgt., foreign duty
 DeVito, Sgt., Ft. Thomas, Ky.
 Diehl, Sgt., Yuma, Ariz.
 Gillespie, Lt., Ellington Field, Texas
 Hart, M/Sgt., foreign duty
 Hixon, Lt., foreign duty
 Kay, Pfc., Scott Field, Ill.
 Knapp, Pfc., foreign duty
 Lents, T/Sgt., foreign duty
 McCutecheon, Pfc., foreign duty
 Moore, Pvt., Sioux Falls, S. D.
 Schroeder, Sgt., Roswell, N. M.
 Titus, Lt., foreign duty

NAVY—AERONAUTICS

1LGU, Collins, ACRT, foreign duty
 1NRG, Bischert, Sic, Elizabeth City, N. C.
 3IXZ, Korr, ART1c, foreign duty
 5KTD, Shell, A/C, Pensacola, Fla.
 6TYC, Rowan, ARM1c, foreign duty
 6ULU, Peasley, ACRT, Alameda, Calif.

Operator's license only:

Budd, ART1c, foreign duty
 Flynn, ARM3c, foreign duty
 King, ART1c, Miami, Fla.
 Saper, ART2c, Port Huene, Calif.
 Zink, ARM1c, foreign duty



Lt. Comdr. Don S. Hoffman, W3JFE-ex-8UX, volunteered for active duty July, 1940; became OIC of Communications Schools, Training Station, Norfolk, Va., for three and a half years; was sent overseas in 1944; invalided back to the U. S. via four Naval hospitals, and is now on the honorary retired list of the USNR. Of more intimate interest to amateurs is the fact he was variously QST cover artist and cartoonist as early as 1920 and is the originator of the QSL card.

COAST GUARD

2KGD, Farrington, CRM, Brooklyn, N. Y.
 3IER, Tunis, Ens., Alexandria, Va.
 7FZV, Boren, RT3c, Boston, Mass.
 8ICO, Lober, RT1c, St. Louis, Mo.
 9WEH, Remley, CRM, Saulte Ste. Marie, Mich.

ARMY—SIGNAL CORPS

1DNH, Buckley, Capt., foreign duty
 2MEW, Kardasen, Cpl., Ft. Monmouth, N. J.
 ex-2OP, Mulhern, Lt., Red Bank, N. J.
 3BXG, Smith, S/Sgt., foreign duty
 3IBZ, Bull, Pvt., Warrenton, Pa.
 4HRI, Bain, Sgt., foreign duty
 6IZE, Larrabee, Lt., foreign duty
 6SBN, Hitt, Cpl., Ft. Monmouth, N. J.
 7BDL, Call, S/Sgt., Seattle, Wash.
 ex-7DBH, Davenport, T/Sgt., foreign duty
 7EIM, Shull, T/4, Seattle, Wash.
 8LNU, Tape, S/Sgt., foreign duty
 8PWE, Pennock, Capt., foreign duty
 8WGY, Baldwin, Sgt., foreign duty
 8WOO, Potusky, Pfc., foreign duty
 9ADR, Hayes, Sgt., foreign duty
 9EDL, Wooster, T/Sgt., Shenandoah, Ia.
 9JBX, Johnston, T/3, foreign duty
 9NNU, Turner, Sgt., foreign duty
 9OKZ, Ryan, 2nd Lt., foreign duty

Operator's license only:

Armstrong, Sgt., foreign duty
 Brown, T/5, Jefferson Barracks, Mo.
 Gregory, T/5, Petaluma, Calif.
 Herman, Sgt., Camp Blanding, Fla.
 Hollingshead, Pvt., Camp Crowder, Mo.
 Lishitz, T/5, foreign duty
 Silverman, Pvt., Camp Crowder, Mo.
 Varela, Pvt., Warrenton, Pa.

NAVY—GENERAL

1EUZ, Colpitts, CEM, foreign duty
 ex-1FSF, Bottomley, FC(o)3c, Ft. Lauderdale, Fla.
 ex-1LV, Kaulback, Comdr., Washington, D. C.
 1MTM, Sexton, RM1c, foreign duty
 1MKL, Gabriowitz, Sic, Newport, R. I.
 2CIV, Creus, CRM, San Diego, Calif.
 2FYW, Hayman, Sic, Washington, D. C.
 2ILE, Beecher, RM1c, foreign duty
 2NXX, Cranmer, Ens., Shipbottom, N. J.
 ex-3CFE, Vinikoor, Sic, Camp Edicott, R. I.
 3ICV, Draude, S2c, Chicago, Ill.
 ex-4ELK, Sellers, MM2c, foreign duty
 5AX, Hayes, Lt. (jg), Washington, D. C.
 ex-5EQS, Bulman, RM1c, foreign duty
 5FRO, White, RM3c, foreign duty
 5HGS, Adams, S2c, Los Angeles, Calif.
 6BUM, Wessels, Lt. Comdr., Salinas, Calif.
 ex-6DMB, Schwartz, EM2c, Camp Parks, Calif.
 6ES, Underwood, Comdr., Imperial Beach, Calif.
 K6GJF, Brady, foreign duty
 6MJC, Powell, RM1c, San Diego, Calif.
 6MSR, Conway, Y2c, foreign duty
 6PAA, Hale, Ens., foreign duty
 6TMC, Pietrok, RM2c, foreign duty
 7GTE, Brooner, RM1c, foreign duty
 7HIM, Bosselet, Lt., Ft. Lauderdale, Fla.
 8QGS, Stehney, CRM, foreign duty
 8HRJ, Norris, Lt., Fishers Island, N. Y.



Reminiscent of the days of the "matchbox" receiver is this picture of the only polyglot musical canteen in the Southwest Pacific. Constructed by Pfc. Robert Weinberg, W2MCR, this musical establishment consists of a diminutive radio inside a damaged water canteen salvaged from Lingayen beach. Headphones are a battered pair of 1910 WEs from the Normandy beachhead, homespun coils are wound on discarded atabrine tubes from a jungle first aid kit, thumbnail condensers were salvaged from Jap radio equipment, the panel is part of a Jap truck dashboard, the wire is the former property of a German signal outfit, hinges were bought in a Luzon hardware store, the dial is a bit of plastic glass from a wrecked observation plane, the variable condenser cogwheel drive is a combination of parts from a Philippine clock and a fire-gutted typewriter—but the music which comes out is American jive from San Francisco and India. (Official U. S. Army photo.)

8KDX, Perry, Ens., Falmouth Foreside, Me.
 8LAN, Blamey, Lt., Cambridge, Mass.
 8OWD, Wilson, RM3c, foreign duty
 8PWT, Peters, EM1c, foreign duty
 8VZW, Lachimia, RM3c, foreign duty
 8WTF, San Filipo, RM3c, address unknown
 9DEF, Showalter, S2c, Madison, Wis.
 9ECB, Dickgrafe, RM3c, foreign duty
 9ELF, Goetsch, RM1c, Manset, Me.
 9EOT, Luebke, RM1c, foreign duty
 9GPV, Fox, Lt., foreign duty
 9HLJ, Rogers, Lt.(jg), foreign duty
 9KJL, Wilkins, EM2c, foreign duty
 9KKN, Bunger, RM1c, Fall River, Mass.
 9MYR, Hane, RM3c, foreign duty
 9OFT, Hollandbeck, Lt.(jg), foreign duty
 9OVR, Stark, Lt.(jg), Albany, Calif.
 9QJU, Walking, F2c, foreign duty
 9SNA, Frye, M2c, foreign duty

Operator's license only:

Atkinson, Ens., Cambridge, Mass.
 Bunger, S1c, Treasure Island, Calif.
 Caldwell, RM3c, foreign duty
 Carter, SOM2c, foreign duty
 McGoldrick, S1c, foreign duty
 Stockebrand, Lt., Westerly, R. I.

ARMY - AACB

ex-1JIZ, Blanchette, Pfc., foreign duty
 ex-1KE, Strickland, Major, foreign duty
 1MLC, Oakley, Sgt., Robbins Field, Ga.
 1NLZ, Linley, Cpl., foreign duty
 1NPO, Scott, T/Sgt., foreign duty
 ex-2FYZ, Shaymow, Pvt., Lakeland, Fla.
 2GUH, Shepherd, Sgt., foreign duty
 2LFF, Eigner, 2nd Lt., Napier Field, Ga.
 2LNC, Chesnick, Sgt., foreign duty
 2MUC, Harris, Cpl., foreign duty
 3BOP, Keiper, 2nd Lt., Miami, Fla.
 3EHL, Candler, 2nd Lt., foreign duty
 3FEL, Croy, Capt., Presque Isle, Me.
 3GUM, Umberger, M/Sgt., Syracuse, N. Y.
 3JQC, Green, Cpl., foreign duty
 ex-4CQP, Erwin, S/Sgt., foreign duty
 4DPX, Brewer, Capt., foreign duty
 ex-4NER, Krewson, 2nd Lt., Ft. Sumner, N. M.
 4EMI, Reiman, Capt., foreign duty
 4ETQ, Wolfe, Pfc., foreign duty
 4EZG, Gauze, S/Sgt., foreign duty
 4FMO, Stewart, Cpl., foreign duty
 4GGM, Thomason, Cpl., foreign duty

K4GPU, Johns, Major, foreign duty
 K4GTE, Casey, Lt., Kelly Field, Texas
 K5AF, Byrd, Capt., Atlanta, Ga.
 ex-5AKB, Gubis, CWO, Harvard, Nebr.
 ex-5APH, Martin, T/Sgt., Albuquerque, N. M.
 5EZY, Hicks, Lt., foreign duty
 ex-5FAL, Gordon, Sgt., foreign duty
 ex-5FIY, Weeks, T/Sgt., foreign duty
 5FXV, Bilsborough, Pfc., Dodge City, Kans.
 5GWW, Brink, T/Sgt., foreign duty
 5HUD, Taucer, 2nd Lt., Ardmore, Okla.
 5HJL, Elmore, Cpl., Port Isabel, Texas
 5JLJ, Haley, S/Sgt., foreign duty
 5KFD, Sutton, M/Sgt., Sweetwater, Texas
 6BLX, Hildebrand, Major, foreign duty
 6FNG, Weeks, Major, foreign duty
 ex-6HDS, Johnson, Capt., Tucson, Ariz.
 6HUS, Stewart, Lt., foreign duty
 ex-6NEE, Morton, M/Sgt., foreign duty
 6NSU, Titzell, Lt., foreign duty
 6PLW, Young, Sgt., foreign duty
 6PXD, Dart, S/Sgt., Salina, Kans.
 6TFP, Hardcastle, Lt., McClellan Field, Calif.
 6UXX, Terry, Sgt., foreign duty
 6UW, Caldwell, Sgt., Murco, Calif.
 K7IVH, Perry, S/Sgt., Hammer Field, Calif.
 ex-8DQY, Van Vechten, Cpl., foreign duty
 8FYV, Harrison, S/Sgt., Coanelsville, Pa.
 8IHU, Fitzgerald, S/Sgt., Olmstead Field, Pa.
 8JLK, Smith, S/Sgt., foreign duty
 8KKL, Fisher, Cpl., Rapid City, S. D.
 8RLJ, Krzywozycski, Pfc., foreign duty
 8RZL, Ress, S/Sgt., Hayward, Calif.
 8TCG, Hildreth, S/Sgt., foreign duty
 8TIM, Challenger, S/Sgt., Patterson Field, Ohio
 8TLP, Strong, S/Sgt., foreign duty
 8TPB, Fuller, Sgt., foreign duty
 8TSC, Holmer, T/Sgt., New Castle, Md.
 8TVJ, Kiraly, Pfc., foreign duty

NAVY - SPECIAL DUTY

2HLH, Bailey, S2c, Gulfport, Miss.
 3HLM, Fisher, RT1c, foreign duty
 5GJL, Clark, RT3c, foreign duty
 5JDH, Nabors, RT1c, foreign duty
 5KHH, Grant, S1c, San Diego, Calif.
 6PEC, Harford, RT1c, Treasure Island, Calif.
 6E-WWH, Leeper, CRT, Ft. Lauderdale, Fla.
 8EJJ, Buehrle, RT1c, Chicago, Ill.
 9A0Z, Meeker, CRT, foreign duty
 9LRR, Strong, S1c, Great Lakes, Ill.

ARMY - GENERAL

1HKF, Nemeth, T/4, foreign duty
 1KUE, Barrett, T/4, foreign duty
 2EPQ, Major, CWO, foreign duty
 2NBJ, Riccio, Pvt., foreign duty
 2OAA, Paston, Cpl., Ft. Knox, Ky.
 2OPE, Smith, S/Sgt., foreign duty
 3DND, DeBow, Lt., Buffalo, N. Y.
 4HWC, Sneed, Cpl., foreign duty
 5JWM, Montgomery, T/4, foreign duty
 6DCN, Austin, Sgt., Brigham City, Utah
 6JTW, Austin, Capt., foreign duty
 K6TXU, Higa, Pvt., Ft. Leonard Wood, Mo.
 K6UCC, Sunada, Pvt., Camp Wolters, Texas
 8ONG, Makrancy, S/Sgt., foreign duty
 8CSD, Loporati, T/5, foreign duty
 8TDG, Lory, Cpl., foreign duty
 8UXA, Jackson, Pvt., foreign duty
 9DFI, Schulte, Pvt., Camp Hood, Texas
 ex-9KOV, Poska, S/Sgt., Camp Gruber, Okla.
 9NMW, Cooke, S/Sgt., foreign duty
 9QGI, Ettelson, T/4, foreign duty
 9UPV, Placko, T/5, foreign duty

Operator's license only:

Burritt, Pvt., Ft. Knox, Ky.
 Catali, S/Sgt., Ft. Mason, Calif.
 Claytor, Lt., Ft. Jackson, S. C.
 Esterwald, Pfc., Ft. Sill, Okla.
 McDowell, Lt., Mountain Home, Tenn.
 Morris, T/Sgt., Camp Shelby, Miss.
 Nagy, T/5, Warrenton, Va.
 Weiman, Pvt., foreign duty
 Wexelman, Cpl., foreign duty

MARINE CORPS

ex-5GN, Moore, Pfc., foreign duty
 6MYR, Graves, Major, foreign duty
 6OMZ, Goss, Lt., foreign duty
 8KHB, Jones, Pfc., San Diego, Calif.
 9CWU, Nichols, S/Sgt., Mojave, Calif.

MERCHANT MARINE AND MARITIME SERVICE

1KQD, Carpenter; 2CTD, Miner; 2OCY, Saymanski; 3ERU, Bosler; ex-3HRG, Getz; 4BXL, Canfield; 8OHO, Yargovic; 8QPB, White; 8RLA, Bitner; 8TDF, Fullerton; 8WUC, Kroll; 9AAM, Ocha; 9FUL, Hansen; 9GPR, Yost; 9KDU, Hucker; 9RON, Chwiedziewicz; and 9VPV, Hoefner. Bonner, Kayler and Ulrich hold operator's license only.

It would be a hamfest worth talking about if all the amateurs in the 7th AAF could get together. As they are scattered at different bases throughout the Central and Western Pacific no such meeting was possible, but fifteen of them, located in the Marianas, succeeded in getting together for a group photo. *Standing, l. to r.*: Sgt. Smith, W6SVU; Capt. Gulland, K4HZV; Sgt. Bartosz, W2EKS; 1/Sgt. Oerline; 1st Lt. Miller, W5HFU; Cpl. Roberts, W2NSR; Lt. Tobias, W9QDV; S/Sgt. Rowland, W9ZZY; Lt. Titus, op license; Lt. Hixon, op license; Lt. Zorzo, op license, and Capt. Warnick, W8DPQ. *Kneeling*: Capt. Stecker, W2LPP; Lt. Col. Hoskin, K6QMC, and Capt. Beal, W8EYU. (Official AAF Pacific Photo.)



CIVIL SERVICE

1AAU Chestnut, Navy Dept., Boston, Mass.
 1IAB, Davis, Navy Dept., radio electrician, Somerville, Mass.
 1KMK, Nowell, Navy Dept., Boston, Mass.
 1NKQ, Healey, radio and electronic mechanic, foreign duty
 1NNO, Re, Navy Dept., Boston, Mass.
 2ABP, Brady, OWI, radio engineer, foreign duty
 2ESC, Snadye, Navy Dept., electrical engineer, Brooklyn, N. Y.
 3EIQ, Snedaker, technician, foreign duty
 3FIT, Hayes, FCC, RID, monitoring officer
 3ZC, Salmansohn, SC, inspector, Philadelphia, Pa.
 3TL, Durst, SC, inspector, Bridgeton, N. J.
 4AAO, Crumley, CAA, overseas communicator, Miami, Fla.
 4BEC, Smith, SC, shop superintendent, Columbus, Ga.
 5IUI, Kelton, Wright Field, Ohio
 5KHC, Caldwell, War Manpower Commission, area director, Baton Rouge, La.
 6AJF, Jones, AAF, senior radio engineer, Berkeley, Calif.
 6AJR, Kiernan, radio engineer, Navy Radio & Sound Lab., San Diego, Calif.
 6EGH, Gee, FCC, Santa Ana, Calif.
 6FCI, Ross, FCC, RID, Santa Ana, Calif.
 6RSK, Pierce, SC, instructor, Santa Monica, Calif.
 6SYD, Shurtz, radio engineer, Layton, Utah
 K7PFG, Peterson, observer and operator, foreign duty
 ex-8BCY, Kunz, FCC, RID, monitoring officer
 8JXY, Bolg, FCC, RID, monitoring officer
 8MUD, Kantenwein, CAA, principal radio electrician, Pittsburgh, Pa.
 8SXW, Hurd, engineer, Flint, Mich.
 8VQE, Treloar, AAF, superintendent, Minneapolis, Minn.
 9ARH, Simmons, CAA, aircraft communicator, Kirksville, Mo.
 9DDM, Meixner, SC, electrical engineer, Broadview Ill.
 9GVH, Gould, CAA, overseas communicator, Miami, Fla.
 9HDV, Face, CAA, radio electrician, foreign duty
 9VOU, Harris, FCC, monitoring officer
 9YCE, Finley, Navy Dept., radio mechanic, foreign duty

Operator's license only:

Charpentier, Navy Dept., Washington, D. C.
 Huddleston, Navy Dept., radio mechanic, Corpus Christi, Texas
 Shulin, SC, Brooklyn, N. Y.



WRE Robert F. Gaiser, U. S. Maritime Service, who holds an op license and hopes soon to get a call, asks this question: "How can you still publish such an interesting magazine under the prevailing condition of suspension of amateur radio? It is the finest publication of its kind on the market. It has followed me around the globe for the past few years." Answer: continued loyal support of Gaiser, other amateurs, advertisers.

100 PER CENT WAR WORK—INDUSTRY

RCA—Includes RCA-Victor, Radiomarine Corp., RCA Communications, RCA Labs., etc.

1APJ, Tracy, Camden, N. J.
 ex-1CA, Skilling, radio operator and inspector, Arlington, Mass.
 1III, Rosenthal, radio engineer, Camden, N. J.
 1KTH, Jacobs, radio engineer, Camden, N. J.
 1NKE, Houghton, engineer, Camden, N. J.
 1NMO, Sokolowski, testman, Camden, N. J.
 2ADR, Sundberg, supervisor, Bronx, N. Y.
 2BC, Wilks, Rye, N. Y.
 ex-2BEH, Wald, radio engineer, Camden, N. J.
 2BSR, Braaten, research engineer, Riverhead, L. I., N. Y.
 2CBL, Jones, supervisor, Camden, N. J.
 2DOG, Wickizer, research engineer, Riverhead, L. I., N. Y.
 2EBQ, Berge, radio engineer, New York, N. Y.
 2ECX, Nekut, radio engineer, Camden, N. J.
 2FET, Walters, technician, Brooklyn, N. Y.
 2FZQ, Geiger, Camden, N. J.
 2JJD, Brown, foreign duty
 2KAP, Gow, radio engineer, New York, N. Y.
 2KEX, Davis, shop foreman, Astoria, L. I., N. Y.
 2KFO, Leach, radio technician, Tuckerton, N. J.
 2KZQ, Farnsworth, foreign duty
 2QR, Smith, Camden, N. J.
 3ABQ, McCullough, Camden, N. J.
 3AQB, Myers, engineer, Camden, N. J.
 3AVJ, Washburn, Camden, N. J.
 3BYK, LaDage, wireman, Camden, N. J.
 3COT, Welsh, radio engineer, Camden, N. J.
 3CPT, Harrison, Camden, N. J.
 3DVC, Tunnell, supervisor, Camden, N. J.
 3DYV, McClelland, testman, Camden, N. J.
 3EDN, Hjorth, engineer, Camden, N. J.
 3EOB, Koeng, Camden, N. J.

When this photo was taken, Major Bernard L. Beaudoin, W1MYZ, was stationed in France with the 88th Air Service Squadron. He had been in Africa, England, Italy and Belgium previously, engaged in keeping 'em flying with bombs, gasoline, ammo, clothes, vehicles, food, medical supplies and snowless runways. "Some fun," he says, "but I love it, especially when it brings me nearer the day I can get home to the little 'junior operatrix,' whom I have never seen!" Her name is Roberta, in case you are interested.

3ERV, Craven, testman, Camden, N. J.
 ex-3FA, Atlee, Camden, N. J.
 3FAJ, Knocell, supervisor, Camden, N. J.
 3FJT, White, engineer, Camden, N. J.
 3FM, Rau, foreman, Camden, N. J.
 3FTQ, Chambers, Camden, N. J.
 3FX, Fisher, Camden, N. J.
 3GCW, Frederick, engineer, Camden, N. J.
 3GKH, Collings, technician, Camden, N. J.
 3GMT, Hann, Camden, N. J.
 3GOM, Rapp, testman, Camden, N. J.
 3GPX, Williamson, engineer, Camden, N. J.
 3GSP, Harris, Camden, N. J.
 3HAV, Bowers, tester, Camden, N. J.
 3HRD, Snyder, radio tech., Camden, N. J.
 3HYN, Bizik, Camden, N. J.
 3IHH, Walczak, tester, Camden, N. J.
 3IVG, Smith, Camden, N. J.
 3IXL, Lawrence, engineer, Camden, N. J.
 3JRF, McKee, Camden, N. J.
 3JSV, Morrison, engineer, Camden, N. J.
 3JFZ, Peyton, engineer, Princeton, N. J.
 3VX, Jenkins, testman, Camden, N. J.
 4BWN, Cobble, field engineer, foreign duty
 4CXL, Faulstich, Atlanta, Ga.
 4EFR, Tomkins, engineer, Camden, N. J.
 4FKV, McIntyre, engineer, New York, N. Y.
 4FLB, Whitaker, technician, foreign duty
 4FRK, Williams, tester, Camden, N. J.
 5FYJ, Stanbery, sales engineer, Camden, N. J.
 6FGV, Owens, engineer, Long Beach, Calif.
 K6HCO, Pires, technician, foreign duty
 6MZ, Kellogg, inspector, San Francisco, Calif.
 6NIJQ, Ramer, inspector, San Francisco, Calif.
 6NNF, Kuhn, inspector, San Francisco, Calif.
 6PGF, Caveny, inspector, San Francisco, Calif.
 6PGZ, San Francisco, Calif.
 K6SBM, Stillman, technician, foreign duty
 ex-7HYG, Dye, engineer, Camden, N. J.
 8AOM, Eichman, Camden, N. J.
 8BH Y, Mills, field engineer, Portsmouth, N. H.
 ex-8BLZ, Chase, field engineer, Camden, N. J.
 8ESR, Pratt, engineer, Camden, N. J.
 ex-8KRK, Bahls, Camden, N. J.
 ex-8MCU, Schultz, technician, foreign duty
 8OGS, Newton, radio engineer, foreign duty
 8RVM, Aitken, field engineer, Camden, N. J.
 8TOM, Colvin, foreign duty
 ex-9AHC, Demmer, engineer, Camden, N. J.
 9CTG, Eckhart, engineer, Indianapolis, Ind.
 9BNE, Redman, Camden, N. J.
 9FYB, Easton, supervisor, Camden, N. J.
 9HIQ, Dixon, electrical engineer, Bloomington, Ind.
 9MBH, Byquist, Willimantic, Conn.
 9MIC, Masterson, engineer, Indianapolis, Ind.
 9NPF, Hull, Indianapolis, Ind.
 9RQL, Reutter, San Francisco, Calif.
 9SXT, Ciganek, Camden, N. J.
 9TCG, Buder, engineer, Indianapolis, Ind.
 9WMC, Deer, Bloomington, Ind.
 9ZWN, Carter, inspector, Indianapolis, Ind.

Aircraft Accessories Corp., Kansas City, Kans.

5HXN, Simcox, junior engineer
 8OUX, Cravens, inspector
 9AIW, Bergren, radio engineer
 9BNY, Stanley, test engineer
 ex-9CNY, Adams, radio technician
 9EEL, Hope, assistant supervisor
 ex-9EXC, Hanson
 9EYF, McPherson, crystal grinder
 9GDH, Dormois, radio specialist
 9LHM, Burris, assistant general manager
 9LQM, Hedges, radio engineer
 9MIF, Gillespie, radio engineer
 9MMB, Lewis, radio engineer
 9MNN, Berry, radio engineer
 9NJI, Sargent, radio inspector
 9OJC, Payne, superintendent
 9SHR, Miller, junior radio engineer
 9UI, Bishop, engineer
 9VAT, King, supervisor
 9VEX, Showalter, radio specialist
 9ZMO, Harmon, radio engineer

American Jewels Corp., Attleboro, Mass.

1AKD, Johnson, radio engineer
 1BGA, Luther, supervisor
 1BLU, Chase, assistant chief engineer
 1BSD, Walker, supervisor
 1FUR, Pickard, director
 1MKK, Korper, radio technician
 3HNR, Wilson, inspector
 1INZ, Morrill, technician
 1KVX, Burns, engineer

Miscellaneous

- 1NKZ, Hunt, Pratt & Whitney Aircraft
- 2LJC, Camillone, radio technician, Charles J. Bodnar Co.
- 2MLL, Flagg, supervisor, G. S. Allerson Co. ex-2MLP, Cosgrove, Communication Products Co.
- 2MLU, Fleischhauer, Solar Mfg. Corp.
- 2MQF, Garratt, Ferranti Electric, Inc.
- 2MUU, Schuly, research technician, Flushing, N. Y.
- 2MWI, Frenkel, Johns Hopkins University
- 2MWP, Leek, Fairchild Camera & Instruments Corp.
- 2NCM, Klein, Polytechnic Institute

CANADA

WE ARE still way behind in our Canadian registrations. Please let us hear from you, even if you are now out of the service. Also, some photos of VE hams in service would be welcome.

CAA-CA(R)

- 1EU, Croft, Capt., foreign duty
- 2GE, Yull, 1st Lt., address unknown
- ex-2LR, Geddes, Lt., St. Lambert, Que.
- ex-4ZN, Viaud, S/Sgt., Calgary, Alberta

RCAF

- 1CW, Barrett, F/O, Clinton, Ont.
- 3AEU, Rogers, F/O, foreign duty
- 3ALX, Young, F/Sgt., Montreal, P. Q.
- 3BBF, Langford, Sgt., Penhold, Alberta
- 3KW, Bush, F/L, Simco, Ont.
- 3OL, Love, F/L, Blenheim, Ont.
- 3SY, Yearron, address unknown
- 4ABO, Gorby, Sig. Ofcr., Kelowna, B. C.
- 4ALN, Brown, A/C, Dartmouth, N. S.
- 5AFA, Wright, Sgt., Via Zeballos, B. C.
- ex-5HL, Gibbs, honorable discharge
- 5RZ, Davis, Cpl., Patricia Bay, B. C.
- W9JVI, Deck, LAC, foreign duty

RCN

- 1LL, Manning, P/O, address unknown
- 3AEH, Gray, P/O, address unknown
- 3AFM, Ralph, P/O, address unknown
- ex-3AME, Mulvansy, L/Tel., address unknown
- 3ANW, Leveque, P/O, address unknown
- 4ASD, Young, PO/Tel., address unknown
- 3NE, Apps, Lt. Comdr., address unknown
- ex-3PA, Ortwein, P/O, address unknown
- 4AAS, King, E/Lt., Ottawa, Ont.
- 4ABU, O'Connell, CPO, address unknown
- 4AEW, Mewdell, CPO, address unknown
- 4AIY, Baker, PO/Tel., St. Hyacinthe, P. Q.
- 4ANR, Millar, P/O, address unknown
- 5AGX, Elliott, T/O, Aldergrove, B. C.
- 5PF, Ruzicka, Tel., address unknown

RCCS

- 3ATM, Hervey, Capt., foreign duty
- 3AYA, Desson, Signm., foreign duty
- 3AZF, Barker, QM/Sgt., Camp Borden, Ont.
- 3ER, Spall, Signm., Whitehorse, Y. T.
- 4TY, Sheppard, Signm., Barriefield, Ont.

CIVIL SERVICE

- 1JW, McLean, radio electrician, Dept. of Transport, Halifax, N. S.
- 3AFS, Rajaaho, Dept. of Transport, Ft. St. John B. C.
- 3SF, Smith, Waterford, Ont.
- 3WW, Neal, Dept. of Transport, Winnipeg, Man.
- 4ABF, Harding, Dept. of Transport, Y. T.
- 4ALU, Sheridan, instructor, High River, Alberta
- ex-4QL, Gray, Winnipeg, Man.
- 5AAN, Matheson, Vancouver, B. C.

100 PER CENT WAR WORK - INDUSTRY

- 2DW, Taillon, Montreal, P. Q.
- 3AML, Grant, Moncton, N. B.
- 3BW, Shane, address unknown
- 4AOE, McLeod, Edmonton, Alberta
- ex-4MH, James, Winnipeg, Man.
- 4WG, Lunan, Montreal, Que.
- 5DN, Adamson, Calgary, Alberta
- 5GR, Hendstridge, Vancouver, B. C.
- 5HP, Hepburn, Victoria, B. C.

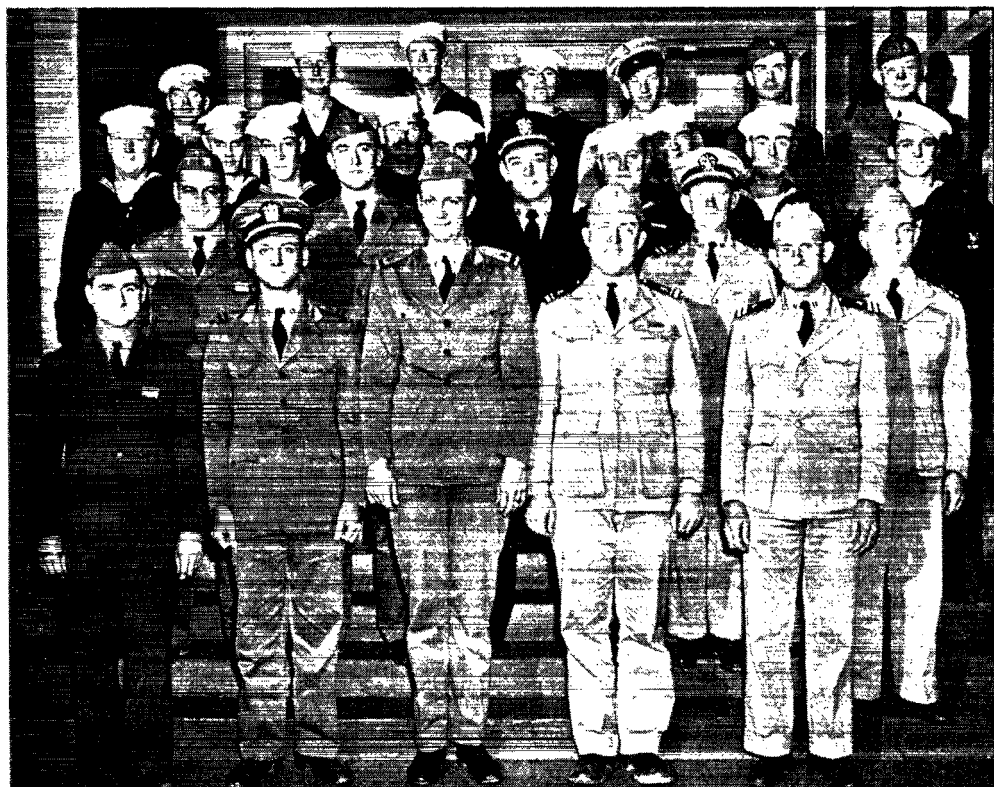

The caption accompanying this official U. S. Navy photo is particularly apt. "A group of hams taken at the Naval Air Technical Training Center, Gainesville, Ga. Students at the school are studying aids to air navigation. Many of the instructors and personnel on the station are hams, which again signifies the large part amateurs are playing in radio in the Navy." *First row, l. to r.:* Lt. Barber, ex-7GI; Lt. Sodaro, W9AAR; Ens. Sorensen, W9ZFP; Lt. (jg) Bigelow, W6AAA, and Lt. Johnson, W6JUH. *Second row:* Ens. Zwaska, W9RJS; Ens. Hatley, W4GJA; Lt. Pierce, W1FGX; Lt. Coggins, ex-W6ENS, and Lt. White, W6PBJ. *Third row:* ART2/c Hutchinson, W9PWV, RT1/c Lindsay, USCG, W1EXG; RT1/c Hebson, USCG, W9QVS; ART1/c Cline, W6EAQ; ART2/c Cicora; W9NXX; S1/c Jensen, ex-9FYA; ART1/c Monos, W8LCE; ART1/c Reed, ex-police op, and ART1/c Thompson, W4GMP. *Top row:* RT2/c Sale, USCG, W1BZS; RT1/c Stott, USCG, W3GVV; Rdm3/c Sullivan, ex-9BWD; ART1/c Jank, W5EJT; ACRM McDonald, K6SDM; ACRT Comer, W4FXK, and ACRT Bledsoe, W4EQM.

Military Radio Operating Procedures

Traffic-Handling Practices in Use by the Allied Armed Forces

BY LT. COL. ROBERT HERTZBERG,* SC, W2DJJ

DURING the early stages of the war, one of the difficulties in the training of radio operators for the armed services was the lack of simple, standardized operating procedures. A year before Pearl Harbor our own Army and Navy had adopted a "joint" procedure which was more or less a variation of long-recognized commercial procedure, but this proved inadequate for over-all use by the Allies when the war became global in character. Confusion developed early in 1942 when we started to pour our men and materials into Great Britain for the assault against the continent. There was no particular uniformity of operating practices among the British services, and few of the individual procedures of the Royal Navy, the RAF and the British Army resembled our own procedures closely enough to permit easy interworking. The venerable International Morse code, presumably a sacred fixture of all radio operating, was not even being used in all cases!

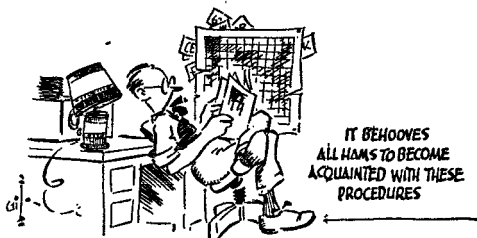

This situation was quickly recognized, and action to correct it was taken by the Combined Communications Board, at Washington, D. C., an agency of the Supreme War Council of the United Nations — the Combined Chiefs of Staff.

This Board, familiarly known as the CCB, published three documents which are now the bibles of Allied radio operators the world over: "Combined Radiotelegraph (W/T)¹ Procedure," better known as CCBP-1; "Combined Operating Signals," CCBP-2; and "Combined United States-British Radiotelephone (R/T)¹ Procedure," CCBP-3. It behooves all radio amateurs to become acquainted with these procedures. If they are of military age and are likely to go into a branch of the services, they will find themselves way ahead of other signal communications personnel if they have acquired this knowledge, and therefore in line for better ratings and jobs. If they are not of

*Commandant, Communications Zone Signal School, European Theater of Operations.

¹ Since radiotelegraph and radiotelephone both cannot be abbreviated into R/T, the latter is used to indicate voice operation. W/T comes from "wireless telegraph," a British term. The common abbreviation c.w. rarely appears in military publications dealing with operating.

military age, they'll want to know them anyway, because when the war is over and ham ranks are swelled by thousands of newcomers who learned their radio in the services, there is a strong likelihood that these military procedures will replace the existing rather loose ham practices. The Army and the Navy naturally are anxious to have the procedures known in advance by recruits because the training problem is thereby eased appreciably. The Army Amateur Radio System and the Naval Communication Reserve have been nursed along for twenty years by the respective services for that very reason.

W/T Procedure

The W/T and R/T procedures as adopted for combined use are excellent compromises incorporating the best features of the individual U. S. and British practices. The W/T procedure is about 85 per cent commercial-amateur, so hams will pick it up very quickly. Its two important features are the intermediate sign and the ending signs; or rather, let us call them "prosigns," as the services do (procedure signals = prosigns). Instead of DE for the intermediate, V is used. The familiar ending prosigns K and AR are retained, but they have these specific meanings:

K Go ahead; transmit. This is the end of my transmission to you and a response is necessary.

AR This is the end of my transmission to you and no response is required or expected.

It is further stated that, "Every transmission must end with either AR or K." This is important in busy military nets consisting of a number of stations operating on one frequency. If two stations are working each other, all the other stations of the net keep quiet as long as the transmissions end with K; this means the first two stations still have business to exchange. However, when either station of a pair signs off with AR they definitely are finished, and any of the other stations may then open up. The ending signal VA, long a part of commercial-amateur operating, is *not used at all*.

The simplicity of this system is evident. One station has a message for another:

ABC V DEF K
DEF V ABK K
ABC V DEF (text) K
DEF V ABC R AR

The R in the above transmission is the standard receipt signal. It means simply, "I have received your last message." It is one of a group of thirty-two "shorthand" prosigns which are used as required to simplify operating and to expedite the flow of traffic. The complete list, with some explanatory notes, is as follows:

- A Originator's sign. (Used in the heading of a message. Is followed by call letters indicating the station that started the message. Used mainly in relays.)
- AA Unknown station. (AA V XYZ K, if you heard someone call you and you missed his call letters).
- AA All after. } These three are used to identify parts
 AB All before. } of the text of a message when repetitions,
 WA Word [after. } verifications, etc., become necessary.
- AR End of transmission.
- AS Wait.
- B More to follow. (Used to keep the other stations on the hook and to warn the rest of the net that they are to keep quiet.)
- BT Long break. (Used at beginning and end of text in usual manner.)
- C Correct. } (These five precedence classifica-
 D Deferred. } tions indicating the relative
 OP Operational priority. } importance of messages. If no
 P Priority. } precedence prosign is used, the
 O Urgent. } message is "routine." In rare
 OU Most immediate. } cases the same message may be
 "routine" to one addressee and
 of another precedence to a second
 addressee, in which case R is
 employed to indicate "rou-
 tine".)

- EEEEEEEE Error. (Not less than eight dots.)
- F Do not answer.
- G Repeat back.
- GR Groups. (Followed by numerals to indicate the number of words or groups between the BT signs.)
- II Separative sign. (This is sent as "didit space didit." It is the only spaced character.)
- IMI Repeat. (Important: This is not used as the question mark, or to correct an error during transmission.)
- INT Interrogatory. (Two-bit word for question mark.)
- IX Execute to follow. } (These two used mostly for fire
 IX Five second dash. } control.)
- J Verify and repeat.
- K Go ahead.
- N Not received, or exempted. (Does not mean "no," for which there is a Q signal.)
- NR Station serial number. (Message identification.)
- R Received (Also routine.)
- T Transmit to. (Used in relays.)
- V From. (The intermediate; replaces DE.)
- W For information to. (Followed by call letters.)

In addition to the usual call letters (or "call signs") for individual stations, a net call sign is also assigned. This corresponds roughly to a CQ; that is, one station making a general call to all other stations of the net transmits the net call, the intermediate V and his own call. The individual stations answer in alphabetical-numerical order of their respective calls. Most net calls are

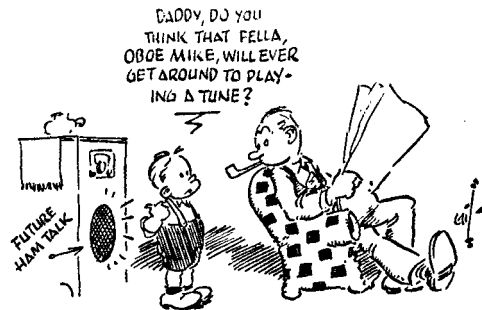

made by the net control station (NCS), which is the station representing the senior headquarters or command of the group.

Some of the message forms permitted under the combined procedures are rather complicated. The writer personally saw and handled one message

at a high headquarters in France that had more than 600 words or groups of operating instructions between the call up and the first BT, but the text itself consisted of only 45 words! Fortu-



nately, this feature of message handling is of no concern of the radio operator. The actual preparation of messages for transmission is the responsibility of the message center of a headquarters; in fact, message center personnel have to know more about radio procedure than do the radio personnel, because they're the ones who have to translate intelligible English into prosigns, and vice versa.

Supplementing the W/T procedure of CCBP-1 is "Combined Operating Signals," CCBP-2. These signals are nothing but our old friends, the Q sigs, very much grown up. Many of the standard international signals have been retained, but of course these were hardly adequate for military purposes, so a couple of hundred new ones have been created. There's only one thing to watch in using the Q signals: to put a signal in its question form, we must transmit INT before the signal — mind you, before the Q signal. This is the only feature of the new procedure that has proved unpopular. In English we instinctively put the interrogation mark at the end of a question, not at the beginning. However, the rules specify the frontal position, so that's how it's done.

R/T Procedure

The R/T procedure is based on Royal Air Force experience, and is beautiful in its simplicity. Once they have memorized the phonetic alphabet, men in the field learn to use voice radio in an hour or two. This alphabet, which should help to clarify postwar chatter on the 'phone channels, follows:

- | | |
|--------------------------|------------------|
| A — Able (Affirm) | N — Nan (Negat) |
| B — Baker | O — Obe (Option) |
| C — Charlie | P — Peter (Prep) |
| D — Dog | Q — Queen |
| E — Easy | R — Roger |
| F — Fox | S — Sugar |
| G — George | T — Tare |
| H — How | U — Uncle |
| I — Item (Interrogatory) | V — Victor |
| J — Jig | W — William |
| K — King | X — X-ray |
| L — Love | Y — Yoke |
| M — Mike | Z — Zebra |
-
- | | |
|--------------|--|
| 1 — Wun | 6 — Six |
| 2 — Too | 7 — Seven |
| 3 — Thuh-ree | 8 — Ate |
| 4 — Fo-ur | 9 — Niner |
| 5 — Fi-yiv | 0 — Zero (Never
"naught" or
"oh.") |

The words in parentheses are used when the United States Navy general signal book is in effect. The differences are not important. As a rule, the jaw-breaking "Interrogatory" is reduced to "Inter," although officially this is not recognized.

The following example demonstrates the method of spelling out difficult words with the aid of the phonetic alphabet:

WE ARE AT CHEMNITZ — I SPELL — CHARLIE, HOW, EASY, MIKE, NAN, ITEM, TARE, ZEBRA — CHEMNITZ.

It is entirely incorrect to say "C for Charlie, H for How, E for Easy," etc.

The procedure for calling and answering is the natural telephone method:

HELLO ABLE BAKER ONE, THIS IS CHARLIE DOG TWO.
MESSAGE FOR YOU. OVER.

CHARLIE DOG TWO, THIS IS ABLE BAKER ONE. SEND YOUR MESSAGE. OVER.

ABLE BAKER ONE, THIS IS CHARLIE DOG TWO. MIKE ZEBRA OBOE, EASY TARE QUEEN. LOVE LOVE YOKE. OVER. (Three-letter cipher groups for text).

CHARLIE DOG TWO, THIS IS ABLE BAKER ONE. ROGER. OUT.

The ending words "over" and "out" correspond exactly to the K and AR of W/T operation, and the same rule applies to them — every transmission must end with one word or the other. The word "Roger" is merely the phonetic equivalent of R, and is therefore the simple signal of receipt.

The actual rules for R/T operation are so brief as to be virtually non-existent. "Say what you have to say, and be brief about it," just about sums them up. Very few formal messages are handled by R/T. In 90 cases out of 100, R/T communication is between responsible commanders who talk informally just as they would over an ordinary telephone, except that they are supposed to remember that radio is most unsecret.



The use of voice radio for direct command purposes has led to the coining of a word that means, in effect, "will comply." This word, publicized universally by writers and comic-strip artists, is "Wilco." It has been adopted enthusiastically by the whole country as the outstanding etymological novelty of the war.

"Roger" vs. "Wilco"

"Terry and the Pirates" notwithstanding, the words "Roger" and "Wilco" never are used together. By definition, "Roger" means: "I have received all of your last transmission." "Wilco" means: "Your last message received, understood, and (where applicable) will be complied with." It can readily be seen that "Wilco" includes the full meaning of "Roger," and in addition says that the receipting party will comply with the orders or instructions contained in the message *if he himself is the one required to act on them*. Failure to observe this important little point has led to confusion in the field, and even to improper action that has resulted in battle casualties.

Take the common situation in small Army units wherein a soldier carrying a pack set such as the SCR-300 (described in previous issues of *QST*) trails an officer — say a company commander. If the battalion commander calls in and says, "Execute Mission Zebra," the operator replies with "Roger." He in turn passes the message on to his captain. If the latter is smart, has the time, and the channel is open, he will call back and say to the battalion commander, "Regarding mission Zebra, Wilco." The fact that the operator said "Roger" to the battalion commander doesn't mean that the order will be followed. The operator may be put out of action then and there, the captain may be out of immediate reach, etc. All sorts of odd things are likely to happen — and usually do.

Frequent use is made of the request "Acknowledge" by the originator of a message. This means: "Let me know that you have received and understand this message." It is intended to cover just such a situation as the foregoing. Observe that a "receipt" and an "acknowledgment" are by no means the same thing. An operator who receives a coded message has no way of knowing what it means, so he merely *receipts* for it with the simple prosign R in W/T and "Roger" in R/T. If the message itself contains a request from the originator that the *addressee* is to acknowledge its receipt, the addressee sends back a separate message of acknowledgment. In R/T, "Wilco" is both a receipt and an acknowledgment, which is one reason it is used so much on the air.

Several points of R/T operation are worth noting. The word "hello" is optional. Usually it is used with the opening call-up, more or less to bring the other operator to attention. Once contact is gained, it is unnecessary. The calling station identifies himself by saying, "This is Able Baker One. Message for you, etc. Over." He does *not* say, "This is Able Baker One *calling*." And the other station does not say, "This is Charlie Dog Two answering." It is evident from the very nature of transmissions just who is calling and answering.

When communication is good and no confusion can result, a shortened form of calling is permissible. The call letters of either the called or the

(Continued on page 98)

Bass Boost

Design Data for Determining Performance

BY GEORGE GRAMMER,* WIDE

THE increasing interest in phono reproduction is easily understandable under present conditions, and it is equally understandable that the amateur, with his usual desire to make his equipment as nearly technically perfect as possible, should be interested in the means by which it can be accomplished. The accent here is on the word "technically"; whether or not the end result is *pleasing* is another question — a question that provides plenty of food for argument but practically none for a definite conclusion. When professional musicians habitually disagree on matters of interpretation, it is hardly to be expected that the mass of lay listeners is going to agree thoroughly on just how reproduced music should sound. But there has to be some starting point, and the accurate reproduction of what was recorded would seem to be the logical one.

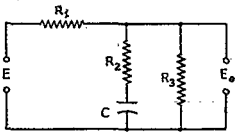

Fig. 1 — The fundamental bass-boost circuit. E is the input voltage, E_0 the output voltage. The circuit will function without R_2 , but this resistor usually is needed as a grid return for a following amplifier tube.

Good reproduction is not to be attributed to any one factor, but rather to the coordination of the entire system from turntable to loudspeaker. One of the many points to be considered is the amount of boost that should be given in the bass end of the output. It appears that it is more or less standard practice, in making commercial recordings, to record by the constant-velocity method at frequencies above about 500 cycles, and to change over to the constant-amplitude method at lower frequencies. If the record is played back with a velocity-sensitive reproducer, such as a magnetic pick-up, compensation is required in the play-back system. To restore the original conditions, the output must be boosted at the rate of 6 db. per octave from 500 cycles down, provided that the remainder of the system — loudspeaker and so on — is flat. We shall assume that the system is flat and that we want to attain the theoretical 6 db. per octave. The compensation circuit should provide such a boost over at least three octaves — that is, down to about 60 cycles — to be effective. Incidentally, although a crystal pick-up is an amplitude-responsive device and therefore should require no compensation at the low frequencies, with records made by the method mentioned above, the fact is that most

crystal play-back systems benefit from a certain amount of bass boost — to the listener's taste.

The common type of bass-boost circuit is shown in Fig. 1. Its operation can be visualized by thinking of it as a sort of frequency-selective volume control. At high frequencies the reactance of condenser C is so low that it is practically a short circuit, so that R_1 and R_2 form a simple voltage divider and the output voltage, E_0 , is a fixed percentage of the input voltage, E , regardless of frequency. At some critical low frequency the reactance of C becomes large enough to affect the operation of the circuit and, as the frequency further decreases, the reactance becomes larger and larger. The increasing reactance increases the impedance of the circuit formed by C and R_2 and, as the frequency is decreased, this impedance becomes a larger and larger proportion of the total impedance of the circuit formed by R_1 , R_2 and C . Hence the output voltage increases, assuming that the input voltage, E , has the same value at any frequency. When the reactance of C becomes large enough in comparison to the resistance of R_3 , the rise in voltage is limited by the latter resistance, since in such a case R_2 and C in effect drop out of the circuit and the voltage divider consists of R_1 and R_3 in series. Thus the output voltage cannot exceed a percentage of E determined by the ratio of R_3 to the sum of R_1 and R_3 . The over-all frequency response of the circuit therefore is flat at high frequencies, rises more or less linearly below a certain critical frequency until a second critical frequency is reached, after which it is again flat down to zero.

Circuit Characteristics

Just as in other compensating systems, something must be sacrificed to obtain the desired result. Bass boost is obtained at the expense of attenuation of the medium- and high-frequency response. Since the medium frequencies determine the average loudness of reproduction, it is

Since it is common practice in making commercial phonograph recordings to cut the lower frequencies at constant amplitude whereas the higher frequencies are cut at constant velocity, for certain types of pick-ups, the amplifier used with a record player should compensate for this by boosting these lower frequencies in reference to medium and high frequencies. A simple arrangement for accomplishing this is described in this article.

*1037 Farmington Ave., West Hartford, Conn.

therefore necessary to increase the gain of the amplifier to restore the medium-frequency output level. The amount of additional gain necessary will depend upon the amount of boost desired.

It is convenient to use R_2 as a base in studying the circuit. The point at which the high-frequency

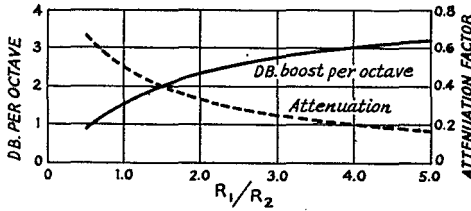

Fig. 2 — Low-frequency rise in decibels per octave as a function of the ratio of R_1 to R_2 (Fig. 1). This is the average rise over three octaves below the cut-off point.

response levels off is determined by the ratio of X_C , the condenser reactance, to R_2 . The transition from a rising characteristic to flat response is not sharp but instead is rather gradual, so it is necessary to select a point on the knee of the curve and decide that it will represent a satisfactory cut-off point. Since the impedance of $X_C R_2$ is only about 12 per cent higher than R_2 when $X_C = \frac{1}{2} R_2$, it would appear that a good choice for the high-frequency cut-off point would be the frequency at which $X_C = \frac{1}{2} R_2$, a choice which is borne out quite well in practice.

The rate at which the output rises, as the frequency decreases below the high-frequency cut-off point, is a function of the ratio of R_1 to R_2 , when R_3 is large enough to be neglected. The larger this ratio the greater the rate of rise, up to a certain limit. Even if both R_1 and R_3 are infinitely large the rate of rise will not exceed an average of 3.8 db. per octave over the three octaves below the high-frequency cut-off point. An infinitely-large R_1 would mean infinite attenuation at the high frequencies, which is hardly a practical case; a decrease in the rate of rise must be tolerated in order to keep the attenuation within reason. Fig. 2 shows both the rate of rise and the high-frequency attenuation as a function of the ratio of R_1 to R_2 , based upon $X_C = \frac{1}{2} R_2$ at the high-frequency cut-off point, and with the rate of rise averaged over the three octaves below this point.

It is evident that it is impossible to secure a rise of 6 db. per octave from the circuit of Fig. 1; the rate only can be increased by cascading such circuits or sections. There are two possible choices: three sections with a 2-db. rise per section, or two sections with a 3-db. rise per section. Although it is not strictly accurate to cascade the attenuations of such sections on the basis of calculations for one section, such a process will give at least an approximation to the comparative attenuation. The three-section arrangement has somewhat lower attenuation than two sections in cascade, for the same over-all bass rise. The difference is not too marked, nor should it be expected to be, since the attenuation which must be tolerated primarily is determined by the amount of bass boost desired. However, the use of three

sections provides a finer degree of control over the amount of boost to be used in actual listening, since the sections readily can be cut in or out to change the rate of rise. This is a most useful feature, since it is a matter of observation that the amount of boost which seems best for one recording may be too great or too small for another — despite the recording standards.

As previously pointed out, the effect of R_3 is to set the frequency at which the output levels off (low-frequency cut-off point) at the low end. From practical considerations, it would appear that the only point of importance in this connection is that cut-off should not occur above about 60 cycles. Because of the phase relationships between the currents flowing in R_3 and in the branch formed by $R_2 C$, the values of the currents in R_1 and R_3 begin to approach equality when the impedance of $R_2 C$ is of the same order as the resistance of R_3 , so that the low-frequency ceiling is established somewhere near the point where these two quantities are equal. For a rise over three octaves the reactance of C increases by a factor of 8, and the impedance of $R_2 C$ is a little less than four times its value at the high-frequency cut-off point. The value of R_3 , therefore should be four or five times the resistance of R_2 (which is practically equal to the impedance of $R_2 C$ at the high-frequency cut-off point) in order to avoid leveling off at too high a frequency at the low end. Since the attenuation also is affected by R_3 , being increased when R_3 is decreased, a better choice all around is to make R_3 ten times as large as R_2 , other circuit conditions permitting.

It appears, then, from these considerations that about the optimum design for a 6-db. per-octave bass boost circuit is achieved when three sections are used and when $X_C = \frac{1}{2} R_2$, $R_3 = 10 R_2$, and $R_1 = 1.5 R_2$. The value to be given R_2 is determined by the associated circuit conditions, principally the magnitudes of the impedances between which the boost circuit is to be connected.

Experimental Measurements

It is not possible always to select standard values of components which will meet these requirements exactly, but fortunately a high degree of exactness is not necessary. Fig. 3 shows the results of measurements made on circuits having one, two, and three sections, the two- and three-section circuits being shown in Fig. 4 at (A) and (B) respectively. The values used were R_2 , 50,000 ohms;

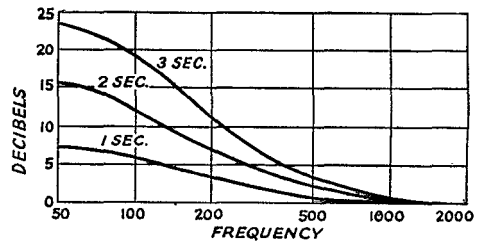

Fig. 3 — Measured characteristics of one-, two- and three-section bass-boost circuits with $R_1 = 2R_2$, $R_3 = 10R_2$, and $X_C = 0.6R_2$ at 500 cycles.

R_1 , 100,000 ohms; R_2 , 0.5 megohm; C , 0.01 μ fd. The reactance of the condenser at 500 cycles is about 30,000 ohms, so that $X_C/R_2 = 0.6$ rather than 0.5, and $R_1/R_2 = 2$ rather than the figure of 1.5 selected above. For the single section, the rise from 500 to 62.5 cycles (3 octaves) is 6.4 db., or slightly more than 2.1 db. per octave. The measured attenuation at 2000 cycles (in the flat part of the curve) was 3.4 times; that is, the output voltage from the boost circuit was 0.29 times the input voltage. With two sections, the average boost is almost 4.5 db. per octave, with an attenuation factor at 2000 cycles of 0.079, while with three sections the average boost is 6.3 db. per octave, with an attenuation factor of 0.021. To maintain the same output level at 2000 cycles with the three-section circuit, the amplification must be increased by a factor of 50. Here is why 6-db. per octave bass boost cannot be added to an

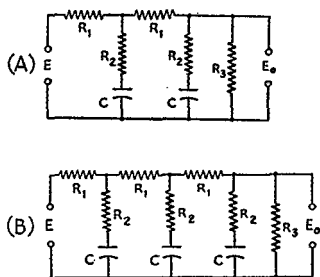

Fig. 4—Shown at (A) are two-section and at (B) three-section circuits.

amplifier which has no large reserve of gain; in most cases a pentode stage must be added to overcome the loss in the boost circuit.

It will be observed that the attenuation factors actually measured do not agree too well with the cascaded attenuation factor for $R_1/R_2 = 2.0$ from Fig. 2. This is because the curves of Fig. 3 neglected the effect of R_3 . Assuming that the reactance of C can be neglected, which is true at frequencies somewhat above the cut-off point, the attenuation can be calculated as follows:

Single section:

$$\frac{E_o}{E} = \frac{B}{A + AB + B}$$

Two sections:

$$\frac{E_o}{E} = \frac{B}{A^2B + A^2 + 3AB + 2A + B}$$

Three sections:

$$\frac{E_o}{E} = \frac{B}{A^3 + 4A^2 + 3A + A^2B + 5A^2B + 6AB + B}$$

In the above, $A = R_1/R_2$, and $B = R_3/R_2$. The equations are useful for determining the additional gain needed to overcome the loss in the bass-boost circuit, for various resistance ratios.

Bass Boost Between Amplifiers

The preceding discussion and experimental results have been based upon a constant-voltage

input to the circuit; that is, a source of voltage having low internal impedance compared to the input impedance of the booster circuit. Although this condition can be realized in some cases, it is probable that in most practical applications the source impedance will be at least of the same order of magnitude as the circuit impedance, and may be considerably higher. For example, a convenient place to install the circuit is between two amplifier stages and, in view of the additional gain required, it is probable that the tube feeding into the booster circuit will be a pentode. In such a case the plate resistance of the pentode will be considerably higher than the input resistance of the booster circuit when practicable circuit values are used. Since the input impedance of the booster circuit rises with decreasing frequency below the high-frequency cut-off point, the amplification of the driving stage likewise will increase with decreasing frequency. This tends to increase the rate of low-frequency rise, and tends also to lower the frequency at which low-frequency cut-off occurs.

A representative circuit is shown in Fig. 5. A switch across each condenser permits cutting out the boosting effect of each section, although the over-all attenuation is unchanged.

Measurements on this circuit, using the same constants as previously described, are shown graphically in Fig. 6. The driving-amplifier (a 6J7) plate resistor was 0.5 megohm in this test. In all cases the output is up a decibel or two at 50 cycles, and the tendency to level off at the low end, quite apparent in Fig. 3, is almost absent in Fig. 6, particularly with two and three sections. The two sets of curves are not strictly comparable since shorting of sections results in greater loads there is more attenuation in the circuit when one and two sections are used in Fig. 6 than for the one- and two-section cases in Fig. 3. However, from a practical standpoint the differences are not large enough to be worth a great deal of consideration.

When working from a high-impedance source the first resistor in the network (the one marked X in Fig. 5) may be omitted if desired, since the source impedance can be used for the same purpose. The difference in over-all performance is not very marked so long as R_1 is not large compared to the internal output impedance of the amplifier.

The constants used in the circuit of Fig. 3 are not optimum for working out of a pentode, since the resistance and reactance values are too low to

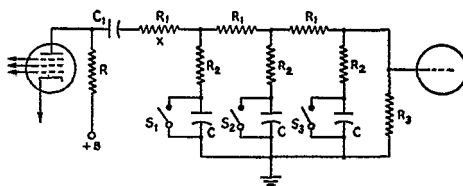

Fig. 5—Three-section circuit between two amplifier stages, with provision for cutting out bass-boost characteristics of sections by short-circuiting the boost condensers. C_1 should have low reactance compared to the input impedance of the boost circuit. A value of 0.1 μ fd. is sufficient for the usual impedances between amplifiers.

provide a good load for the tube. Higher values would result in a higher input impedance for the circuit and thereby increase the amplification throughout the frequency range. A second booster circuit was constructed for the purpose of raising

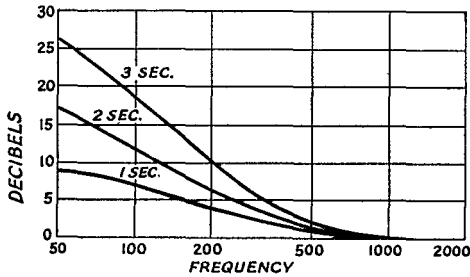

Fig. 6 — Measured characteristics of the filter of Fig. 4 used between stages with pentode.

the impedance and also to come somewhat nearer to the optimum ratios with standard parts, with the results shown in Fig. 7. In this case R_1 was 0.5 megohm, R_2 0.3 megohm, R_3 2 megohms, and C 0.002 μ fd. The limiting factor is R_3 , since too much resistance cannot be used in the grid circuit of the succeeding amplifier if stable performance is to be secured. These values gave ratios of $R_1/R_2 = 1.67$, $R_3/R_2 = 6.7$, and $X_C/R_2 = \frac{1}{2} R_2$, approximately, the reactance of C at 500 cycles being about 0.15 megohm. The rise over the three octaves below 500 cycles is very nearly 18 db., or 6 db. per octave, and is approximately 4 db. per octave with two sections and 2 db. per octave with one. The relative gains at 2000 cycles were as follows:

- Straight amplifier circuit — 1.0
- First circuit, 3 sections — 0.007
- Second circuit, 3 sections — 0.026

Using the higher resistance and reactance values of the second circuit increased the gain over the lower values by a factor of about 4, purely because the high-impedance circuit was a better load for the pentode amplifier tube.

The second set of constants came nearer, as expected, to the desired value of 6 db. per octave rise. However, the ratios are not too critical, as is evident from the experimental results and from the curve of Fig. 3, particularly in view of the fact that a decibel or two in the total rise makes no marked difference in the aural effect.

Other Considerations

In using circuits of this type in which the bass is boosted it is well to remember that the amplifier must handle a power increase of 18 or 20 db. over that normally encountered, if the same output level is to be maintained in the high-frequency range. Under usual listening conditions an average power output of 50 milliwatts is sufficient, assuming a speaker efficiency of the order of 10 per cent. With a 6-db. per-octave bass boost the average level will remain the same in the medium- and high-frequency range, but the amplifier must

be capable of handling 100 times as much power without distortion in the bass range. This calls for a power output of at least five watts. Furthermore, the output must be free from harmonics if the bass is to sound smooth and natural. This calls for a good power stage and an output transformer which will go down to 50 cycles without distorting the waveform. Unless the amplifier is "clean" and working well within its power capabilities the use of 6-db. per-octave bass boost will not add much to the pleasure of listening. Also it should be obvious that the speaker itself should be considered. Small speakers are not capable of handling the power fed to them at low frequencies by such a circuit without distorting. Even if the amplifier and output transformer meet the requirements, still there is the possibility that reproduction will not be satisfactory unless a speaker adequate for the job is used.

Not all of the boost provided by the network may be necessary with many records. From somewhat limited observation it seems that popular-music records require less than, for instance, symphony records. This is understandable in view of the more limited dynamic range of the usual popular-music renderings. It is wise, therefore, to use a switching arrangement so that various degrees of boost can be used to suit the occasion.

Unfortunately, boosting the bass emphasizes such things as hum and turntable rumble. With a 6-db. per-octave boost these undesirable additions become only too noticeable with the usual reproduction equipment. Power-supply hum can be brought down to negligible proportions with good filtering and proper design, but it is difficult to overcome hum transmitted mechanically from the turntable motor to the record and thence to the needle, and it is likewise difficult to get rid of rumble. Unless the mechanical part of the system can be improved it may be necessary to use less than the theoretically-necessary boost. But despite the limitations, there is no question but that the reproduction can be made more pleasing with proper bass boosting.

Circuits of this type have a distinct advantage over the ordinary tone control, which tends to reduce the highs in proportion to their frequency. This results in "boomy" reproduction. With bass boost, the high-frequency response is flat and remains absolutely unchanged when varying degrees of boost are switched in. You simply put in the "bottom" or take it out as you please.

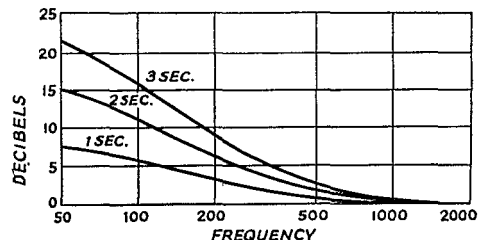
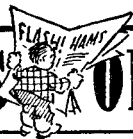

Fig. 7 — Measured characteristics of a high-impedance circuit using the arrangement of Fig. 5. $R_1 = 0.5$ megohm; $R_2 = 0.3$ megohm; $R_3 = 2$ megohms; $C = 0.002$ μ fd.

HAPPENINGS OF THE MONTH



REGULATIONS COMMITTEE

At its annual meeting the ARRL Board created a new committee to study the desirability of changes in amateur postwar regulations. President Bailey has now named the personnel of this committee: Vice-President Blalack as chairman, and Directors Caveness, Kiener, Noble and Norwine. With the exception of Mr. Kiener, replacing former-Director Dosland, this personnel is the same as that of the Board's Planning Committee. The latter committee's task relating to restoration of our frequencies, it is assumed that it will be through its work and discharged while the work on regulations is yet in progress, for which reason it was thought desirable to establish a new committee even though the personnel is substantially the same.

NOTICE TO MEMBERS DISCHARGED FROM THE MILITARY SERVICES

ARRL by-laws provide that an amateur must be continuously a member of the League for at least the preceding four years to be an eligible candidate for director or alternate, and at least one year for SCM. They also normally provide that if a member falls in arrears in his dues for more than thirty days, his continuity of membership is broken. Your attention is invited to the fact that the by-laws have now been amended on behalf of members serving in the armed forces of (only) the U. S. It is now provided that such a member, who becomes in arrears, will not make himself ineligible to hold League office, insofar as concerns a discontinuity of membership while he was in uniform, if he resumes his membership within ninety days after release from active military duty. All such persons are accordingly

advised that if they will renew ARRL membership within ninety days following discharge they will be deemed to have had continuous membership during the period of their military service, so far as the requirement of continuity for office eligibility is concerned. Those desirous of taking advantage of this arrangement are asked to claim the right when renewing membership, stating the beginning and ending dates of military service.

YOUR WAR SERVICE RECORD?

MANY returning servicemen may this month be seeing their first copy of *QST* in years. This is to advise you, fellows, that ARRL Hq. has been engaged for a long time in compiling a record of the wartime services of radio amateurs, to get the statistics that constitute the ammunition whenever it is necessary to defend amateur rights. We have a great many thousands of you registered but we still get scores of new names every week for our records and we know that the job is only half done. We do want very much to make it complete. The data we need are very simple and can be supplied in a moment on the form on this page, or its essentials reproduced on a postcard if you prefer. All we want is to be able to prove the extent to which the know-how of the amateur has contributed to the winning of the war.

If the simple essentials of your wartime service are not on file with us, won't you take a minute out right now to do the necessary and make sure that there is a card in our file bearing your name? Our record system covers both United States and Canadian amateurs engaged in any of the categories listed, military or civilian, where radio talents are employed in the war effort. Many thanks for your cooperation.

AMATEUR WAR SERVICE RECORD

Name

Present mailing address

Rank or rating

Branch or bureau: Signal Corps, AAF, BuShips, WAVES, etc.
If civilian industry, give title and company.

Call, present or ex; or grade of op-license only

SERVICE

- Army
- Navy
- Coast Guard
- Marine Corps
- Maritime Service
- Merchant Marine
- Civil Service
- Radio industry, 100% war

BOARD MEETING

LAST month we gave you the highlights of the annual meeting of the Board of Directors of ARRL, held in Hartford on May 4th. Here, for full details, are the minutes of that meeting:

MINUTES OF 1945 ANNUAL MEETING OF THE BOARD OF DIRECTORS, AMERICAN RADIO RELAY LEAGUE

May 4, 1945

Pursuant to due notice and the requirements of the by-laws, the Board of Directors of the American Radio Relay League, Inc., met in regular annual session at the Hartford Club, Hartford, Conn., on May 4, 1945. The meeting was called to order at 9:07 A.M., Eastern War Time, with President George W. Bailey in the chair and the following other directors present:

- Charles E. Blalack, Vice-President
- Alexander Reid, Canadian General Manager
- E. Ray Arledge, Delta Division
- John E. Bickel, Southwestern Division
- Hugh L. Caveness, Roanoke Division
- Tom E. Davis, Dakota Division
- John A. Kiener, Central Division
- Walter Bradley Martin, Atlantic Division
- J. Lincoln McCargar, Pacific Division
- Percy C. Noble, New England Division
- William P. Sides, Southeastern Division (alternate, acting)
- Karl W. Weingarten, Northwestern Division

Absent, Wayland M. Groves, West Gulf Division; Robert A. Kirkman, Hudson Division; Floyd E. Norwine, jr., Midwest Division, and C. Raymond Stedman, Rocky Mountain Division. There were also present Technical Director George Grammer, Treasurer D. H. Houghton, General Counsel Paul M. Segal, Assistant Secretary and Acting Communications Manager Charles A. Service, jr., and Secretary and General Manager K. B. Warner. Also in attendance, at the invitation of the Board as a nonparticipating observer, was Communications Manager (on leave from ARRL) F. E. Handy. The meeting was welcomed and briefly addressed by President Bailey.

On motion of Mr. Arledge, unanimously VOTED that the minutes of the 1944 annual meeting of the Board of Directors are approved in the form in which they were issued by the Secretary.

At this point Director Groves, West Gulf Division, and Director Stedman, Rocky Mountain Division, joined the meeting, at 9:12 A.M.

On motion of Mr. Davis, unanimously VOTED that the annual reports of the officers to the Board of Directors are accepted and the same placed on file.

On motion of Mr. McCargar, unanimously VOTED that the Board, having examined its mail action by which it refused to accede to certain proposals of RTPB Panel No. 2 concerning the amateur 28-30 and 56-60 Mc. bands, as presented in Secretary's Letter No. 593, and having examined the same, now ratifies the action taken and decides to take this position as of October 30, 1944.

On motion of Mr. Caveness, unanimously VOTED that the Board, having examined its mail action by which it approved the proposed frequency allocations of the Federal Communications Commission for amateur operation above 25 Mc., and having examined the same, now ratifies the ac-

tion taken and decides to take this position as of January 23, 1945.

On motion of Mr. Noble, unanimously VOTED that all acts performed and all things done by the Executive Committee since the last meeting of the Board, and by it reported to the Board, are ratified and confirmed by the Board as the actions of the Board.

At Mr. Reid's request, without objection, the submission of the report of the Finance Committee was ORDERED put over until the afternoon session.

Mr. Blalack, chairman of the Planning Committee, presented a report on behalf of that committee. During its presentation Director Kirkman, Hudson Division, and Alternate Director George Rulfs, jr., Hudson Division, joined the meeting, at 9:15 A.M., the latter as a nonparticipating observer at the invitation of the Board. On motion of Mr. Weingarten, unanimously VOTED that the report of the Planning Committee is accepted and the same placed on file.

On motion of Mr. Groves, after discussion, unanimously VOTED that the annual reports of the directors to the Board of Directors are accepted and the same placed on file.

Moved, by Mr. Stedman, that By-Law 20 be amended by inserting in the sixth sentence thereof, immediately before the first semicolon, the words "and shall arrange to have a certified public accountant present to certify the results of the balloting." The yeas and nays being ordered, the said question was decided in the affirmative: Whole number of votes cast, 14; necessary for adoption, 10; yeas, 11; nays, 3. Those who voted in the affirmative are Messrs. Arledge, Caveness, Groves, Kiener, Kirkman, Martin, McCargar, Noble, Sides, Stedman and Weingarten. Those who voted opposed are Messrs. Bickel, Davis and Reid. So the by-law was amended.

During the foregoing matter Director Norwine, Midwest Division, joined the meeting, at 9:23 A.M.

Moved, by Mr. Bickel, that the by-laws be amended by inserting in an appropriate location the following words: "in the event a director and an alternate is unable to attend a board meeting the director may appoint a member of his division to attend that board meeting." But the said motion was ruled out of order by the Chair, on advice of the General Counsel, because the contemplated action would be unlawful.

On motion of Mr. Kirkman, unanimously VOTED that there is hereby appropriated from the surplus of the League, as of this date, the sum of three thousand five hundred dollars (\$3,500), for the purpose of defraying the expenses of holding this meeting of the Board of Directors, any unexpended remainder of same to be restored to surplus.

On motion of Mr. Caveness, unanimously VOTED that there is hereby appropriated from the surplus of the League, as of January 1, 1946, the sum of three thousand one hundred and fifty dollars (\$3,150), for the legitimate administrative expenses of the directors in the calendar year 1946, said amount allocated as follows:

Canadian General Manager	\$ 150
Atlantic Division Director	200
Central Division Director	400
Dakota Division Director	200
Delta Division Director	200
Hudson Division Director	300
Midwest Division Director	225
New England Division Director	150
Northwestern Division Director	200
Pacific Division Director	200
Roanoke Division Director	100
Rocky Mountain Division Director	200
Southwestern Division Director	200
Southeastern Division Director	125
West Gulf Division Director	300

\$3,150

OFFICERS' REPORTS AVAILABLE TO MEMBERS

In April of each year the officers of the League make comprehensive written reports to the directors. The Board of Directors has made these reports available to the membership of the League. Interested members may obtain copies postpaid at the cost price of 50¢ per copy. Address the Secretary at West Hartford.

any unexpended remainder of these funds at the end of the year 1946 to be restored to surplus.

On motion of Mr. Kirkman, unanimously VOTED that the sum of five hundred dollars (\$500) is hereby appropriated from the surplus of the League, as of this date, for the expenses of the Finance Committee, any unexpended remainder of same on the date of the next annual meeting of the Board to be returned to surplus.

On motion of Mr. Stedman, after discussion, unanimously VOTED that the unexpended balance this date remaining in

(Continued on page 38)

A Crystal-Controlled 112-Mc. Mobile Transmitter

Stability in Addition to Mobility

BY ROBERT A. WATERS,* W2JST

Making use of new tube types somewhat unfamiliar in ham construction, this mobile transmitter gets down to 112 Mc. from a 7-Mc. crystal in a hurry. It employs a total of four single-purpose tubes, including the modulator.

SINCE the beginning of the war, several 112-Mc. crystal-controlled transmitters have been built in Montclair, N. J., for fixed-station use in emergencies. After several drills were held in cooperation with other units, it was found that the needs of the town were not served adequately by the use of fixed stations. The fixed units, with little change, then were adapted to serve as either fixed or temporary mobile stations. Inasmuch as this arrangement did not lend itself to permanent installation in a car, the author decided to design and build a permanent installation in his car so that by the mere flip of a couple of switches and the plugging in of a microphone, the unit could be placed in operation.

A fundamental design requirement was that nothing should be done to damage the car so as to decrease its resale value at the time of trade-in. This meant that no holes could be drilled in any exterior surface of the car body, nor in the dashboard. In the author's car, a 1940 Chevrolet Town Sedan, there is ample space in the trunk for a complete transmitter and its associated power supply. The antenna was readily mounted by means of a shelf arc-welded to an auxiliary bumper guard. This is shown in the picture of the installation. It was further contemplated in the original design to make use of the car broadcast receiver to house and power the v.h.f. receiver. Control of the entire unit was to be push-to-talk, with the switch mounted in the handle of the microphone.

Circuit Considerations

It was desirable that the transmitter be operated as close to twenty-five watts input as permitted by the size of the available power supply. A Pioneer genemotor capable of 420 volts at 125 milliamperes was the largest unit obtainable. With this power level established, the most

practical final-amplifier tube available was the 832, a double beam power tetrode with ideal characteristics for 112-Mc. operation. In order to keep within the narrow limitations of the genemotor, it was necessary to limit the number of exciter stages to two. The availability of a 7-Mc. crystal thus dictated the lay-out of a quadrupling oscillator and an additional quadrupling stage, even at the risk of insufficient final-amplifier grid excitation. Superior mechanical and electrical characteristics led to the use of the new 6AK5 miniature tubes in these stages.

As shown in the circuit diagram of Fig. 1, the transmitter starts with a regular Tri-tet crystal oscillator using a 7-Mc. crystal, taking output at the fourth harmonic. In order not to overload the crystal and thus cause drifting, the rectified grid current is held to one milliamperes. The oscillator output is capacity-coupled by means of a ceramic-type condenser, C_8 , to the quadrupler. The value of the grid resistor, R_4 , is very critical inasmuch as the proper operating angle must be obtained if maximum output is to be obtained. A further increase in output was realized by by-passing the heater with a 500- μ fd. "button"-type condenser, C_9 , located right at the tube socket. Both the oscillator and the quadrupler stages are operated at a plate voltage of 250 which is obtained from the voltage divider, R_{12} , R_{13} and R_{14} , across the power supply. The screens are fed through the series voltage-dropping resistors, R_2 and R_5 . Resistors R_3 and R_6 are used as measuring resistors so that resonance indications may be obtained by connecting a 5000-ohms-per-volt voltmeter across them, resonance being indicated by the lowest voltage reading obtainable. The life of

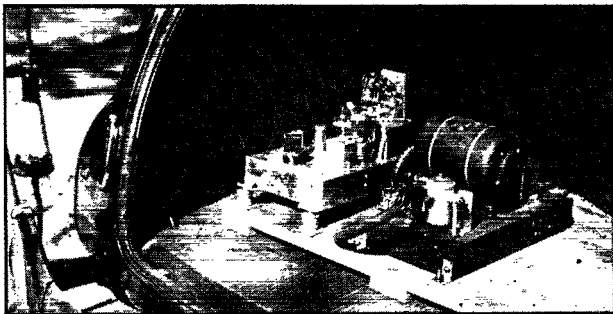

The 112-Mc. crystal-controlled mobile transmitter installed in the trunk of the Chevrolet. This view also shows the method of mounting the antenna insulator on the rear bumper.

*240 Valley Rd., Montclair, N. J.

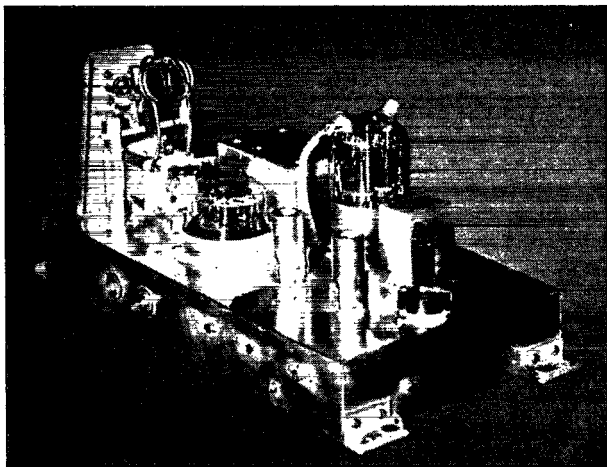

Top view of the transmitter. The two miniature 6AK5s are inside the tube shields in the foreground to the left of the crystal. The 832 is mounted with its socket below the deck, while the output tank-circuit components are grouped at the left-hand end of the chassis. The modulator tubes and transformers are lined up along the rear edge.

the miniature-type tubes under these conditions has been excellent, the original tubes being still in use after a year of operation.

The 832 final is inductively coupled to the quadrupler. According to published information, the bias for Class-C operation requires at least 2.6 ma. through a 25,000-ohm grid leak. In this transmitter, however, normal grid current is but 0.75 ma. through 15,000 ohms. There has been some little concern expressed about running a tube under conditions of insufficient excitation, but in a year's operation no trouble has been experienced with tube life. With this low value of grid current the final cannot be loaded to more than 50 ma. plate current. Neutralization is not necessary since shielding is complete with all the final amplifier plate-circuit components mounted above the chassis, and the grid-circuit components below. The output from the final amplifier is inductively coupled to a 50-ohm concentric cable which feeds the bottom of a three-quarter-wave antenna. The output coil, L_6 , is arranged so that the coupling may be varied by merely swinging it on a shaft radially with respect to the plate coil, L_5 . It was found necessary actually to tune the concentric line in order to adjust the loading of the final. The modulator makes use of an 815 tube as a push-pull Class-A amplifier driven by a single-button carbon microphone through a transformer designed to operate from microphone to push-pull grids.

Modulation of the final is accomplished by means of a special transformer, T_2 , which has separate plate and screen windings, thus eliminating loss of modulator power in the screen-voltage dropping resistor, R_8 . Control of the transmitter is remote from the driver's seat by the use of a four-wire cable which carries the control and microphone circuits.

The r.f. section and modulator are mounted on a 7 × 14 × 2-inch cadmium-plated steel chassis

which is shock-mounted by means of rubber mounts. Special attention was given to short, rigid leads and use is made of a common ground "bus" for all the radio-frequency circuit returns. Generous use is made of terminal strips for mounting resistors and r.f. chokes while all by-pass condensers are mounted right at the points which are to be by-passed. Further, in the quadrupler and final stages, smaller capacities are used in order to permit the shortest possible lead lengths obtainable only in fairly low capacity values.

Construction should be undertaken only after thoroughly studying the lay-out to be used. It cannot be over-emphasized that parts must be jammed into the smallest space if short leads are to result. The larger components are mounted on the chassis first and the heater and ground leads wired. By-pass condensers should be mounted next,

running them from the common ground "bus" to the various points to be by-passed. Resistors, r.f. chokes, and coils then may be installed.

Adjustment

After the oscillator and quadrupler stages are completed, it will be wise to check the operation of these stages. The heater voltage should be applied to the oscillator and quadrupler tubes. A milliammeter with a 25-ma. scale should be inserted temporarily in the plate circuit, and a 5000-ohm-per-volt voltmeter connected across the grid resistor, R_1 . A voltage of 250 should be applied to the junction of R_2 and R_3 . Condenser C_1 then is adjusted, noting the reading on the voltmeter which should be approximately 80 volts. After determining the maximum value, the tuning of C_1 should be continued until the voltmeter reads about 90 per cent of maximum.

It should be stated here that it will be practically impossible to tune this transmitter without the use of a simple absorption-type frequency meter, such as is described in *The Radio Amateur's Handbook* on page 409 in the 1945 edition. The wavemeter should be set to the fourth harmonic of the crystal frequency, 28 to 29 Mc. After loosely coupling the wavemeter to the plate coil, L_2 , condenser C_2 should be tuned for maximum reading on the wavemeter. The tuning of C_1 next should be checked for 90 per cent of peak value. Condenser C_2 then can be tuned for resonance as indicated by minimum plate-current reading of the plate milliammeter.

Plate voltage now should be applied also to the junction of resistors R_5 and R_6 and the plate milliammeter moved to the quadrupler stage. Loosely coupling the wavemeter, which is now set for eight times the crystal frequency, to coil L_3 , condenser C_3 should be tuned for maximum wavemeter reading, and then removed while C_3 is slightly retuned for resonance as indicated by

the minimum-current reading of the milliammeter. If these circuits cannot be tuned in accordance with the instructions, all wiring should be checked over for correctness and socket voltages measured, comparing them with the following table:

	Oscillator	Quadrupler
Plate	250 volts	250 volts
Screen	150 volts	150 volts
Heater	6.3 volts	6.3 volts

If the trouble is not disclosed by this check, it may be that slight adjustment of the coils will be necessary. When these adjustments are completed, the grid coil of the final amplifier and the grid resistor, R_7 , may be mounted.

Next the 832 tube should be placed in its socket without applying any plate or screen voltage. A milliammeter with a 5-ma. scale should be at jack J_1 after which condenser C_3 should be retuned for maximum output as indicated by the grid milliammeter in J_1 . The position of the grid coil, L_4 , with respect to L_3 , should be adjusted until maximum grid current is shown on the milliammeter. It will be necessary to retune the plate condenser, C_3 , when adjustments in the coils are made. A check with the wavemeter should be made to make certain that operation is at 112 Mc. The maximum plate current which may be drawn by the 6AK5 quadrupler is 15 ma.

With no load connected to the output coil, L_5 , plate and screen voltages may be applied to the 832 tube, 400 volts for the plate and 200 volts for the screen. A milliammeter with a 100-ma. scale

then is plugged in at jack J_2 and condenser C_4 tuned to resonance as indicated by the plate milliammeter. The minimum unloaded plate current should be approximately 30 ma. Checks should be made again with the wavemeter to make sure that the output of the final amplifier is at 112 Mc., since in the original transmitter it was found that the final would work as a tripler at 336 megacycles if the coil was not of the correct size. Extreme care must be exercised in tuning the final since the plate current can rise to a very high value which may result in the destruction of the 832 tube. A dummy load should be connected from the "high" side of the output coil, L_6 , to ground. The dummy load may be a 15-watt, 120-volt lamp with clip leads soldered to the base. Again applying voltage to the transmitter, the final plate condenser should be tuned to resonance. If the current is not 50 ma., the coupling should be adjusted by means of L_6 , retuning the final plate condenser to resonance and adjusting the load condenser, C_5 , for maximum plate current and again checking for resonance with C_4 . This procedure should be repeated until the plate current under load is 50 ma. and the brilliancy of the dummy load lamp is at a maximum.

A carbon microphone now may be connected from pin No. 5 of the power socket to ground. The d.c. voltage across the microphone should be approximately two volts as measured by a high-resistance voltmeter. Inspection of the schematic of Fig. 1 will show that the microphone voltage is developed from a portion of the voltage drop

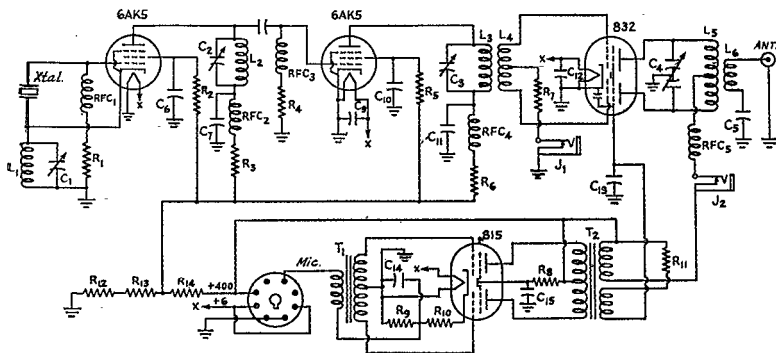

Fig. 1 — Circuit diagram of the crystal-controlled 112-Mc. transmitter.

- C_1, C_2 — 50- μ fd. variable (Hammarlund APC 50)
- C_3 — 50- μ fd. variable with double-spaced plates (Hammarlund APC 50, modified).
- C_4 — 20- μ fd. per section variable (Johnson dual).
- C_5 — 15- μ fd. variable (National UM-15).
- C_6, C_7 — 0.003- μ fd. mica.
- Oscillator-quadrupler coupling — 30- μ fd. Ceramicon.
- C_9, C_{12}, C_{13} — 500- μ fd. mica, "button" type.
- C_{10}, C_{11} — 500- μ fd. mica.
- C_{14} — 25- μ fd. 25-volt electrolytic.
- C_{15} — 8- μ fd. 450-volt electrolytic.
- R_1 — 100,000 ohms, $\frac{1}{2}$ watt.
- R_2, R_5 — 30,000 ohms, $\frac{1}{2}$ watt.
- R_3, R_6 — 1000 ohms, $\frac{1}{2}$ watt.
- R_4 — 150,000 ohms, $\frac{1}{2}$ watt.
- R_7 — 15,000 ohms, $\frac{1}{2}$ watt.
- R_8, R_{12} — 50,000 ohms, 1 watt.
- R_9, R_{10} — 100 ohms, 5-watt wire-wound.
- R_{13} — 25,000 ohms, 1 watt.
- R_{14} — 7500-ohm, 10-watt wire-wound.

- $RFC_1, RFC_2, RFC_3, RFC_4$ — 2.5-mh. r.f. choke.
- RFC_4, RFC_5 — 25 turns No. 22 wound on $\frac{1}{2}$ -inch glass rod, turns spaced the diameter of the wire.
- T_1 — Single-button carbon microphone to push-pull grid transformer.
- T_2 — Push-pull tetrode modulator to 832 plate and screen.
- L_1 — 19.5 turns No. 20 d.c.c., 1-inch diameter, turns close-wound.
- L_2 — 16 turns No. 20 enameled, $\frac{1}{2}$ -inch diameter polystyrene form.
- L_3 — 3 $\frac{1}{2}$ turns No. 14, $\frac{1}{2}$ -inch inside diameter, $\frac{1}{2}$ -inch long, self-supporting.
- L_4 — 4 turns No. 14 enameled (2 turns at each end of L_3 , $\frac{1}{2}$ -inch inside diameter, turns spaced diameter of wire.
- L_5 — 3 turns No. 10 enameled, wound in two sections with $\frac{1}{2}$ -inch space between sections, 1-inch diameter, turns spaced diameter of wire.
- L_6 — 2 turns No. 14 enameled, 1-inch diameter.

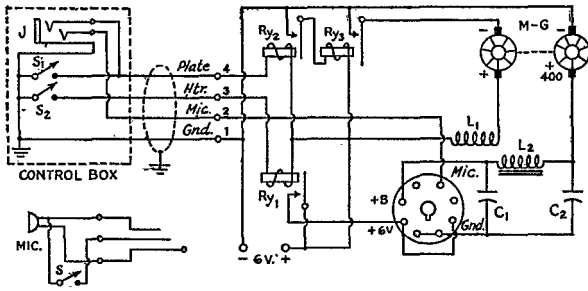

Fig. 2 — Diagram of the power-supply circuit for the 112-Mc. crystal-controlled transmitter.

- C_1, C_2 — 0.25- μ fd. 600-volt paper.
- L_1 — R.f. filter choke, 50 turns No. 12 d.s.c. on small spool, layer-wound.
- L_2 — 5-henry 200-ma. filter choke.
- Ry_1, Ry_2 — 6-volt s.p.s.t. relay.
- Ry_2 — Ford automobile solenoid-type starter relay.
- MG — Pioneer genemotor, 420 volts, 124 ma., 6-volt input.

across the 815 cathode resistor made up of R_9 and R_{10} . It is possible that the modulator stage will oscillate at an audio frequency if the transformer is not connected properly, but the mere reversal of the leads to the primary winding will correct this difficulty. Speaking into the microphone both the final plate-current meter and the dummy-load output should be observed. The plate-current meter should indicate no greater change than 1-ma. in reading while the dummy load should increase in brilliance under modulation. Should the brilliance of the dummy load decrease with modulation, it means that the final is loaded too heavily (more than 50 ma.) or that the grid drive to the 832 is not up to the normal 0.75 ma.

If the transmitter has been tuned according to these instructions, it is ready to be connected to an antenna. The antenna with its coaxial lead should replace the dummy load and plate voltages may be applied to the transmitter. It may be necessary to resonate the final tank condenser and retune the load condenser, C_5 . It should be borne in mind that the plate current to the final amplifier must be limited to 50 ma. if linear operation under modulation is to be obtained.

Power Supply

The power unit for the transmitter whose circuit is shown in Fig. 2, is built on a separate chassis of the same size as the transmitter, and is connected to the transmitter through a cable carrying plate voltage at 400 volts, heater voltage, microphone voltage, and ground. The cable is fitted with octal bases from defunct vacuum tubes which plug into octal sockets mounted on the sides of the transmitter and power units. It will be noted that there are two relays to control the

primary side of the genemotor. This was necessary because the only relay available for controlling the primary genemotor current was a Ford automobile starting relay which draws five amperes. This current is beyond the capabilities of the small contacts in the push-to-talk switch, so that a second relay is used to actuate the large relay. Relay Ry_1 is used to turn on the heaters of the tubes in the transmitter. The primary source of voltage for the transmitter is obtained from the regular car storage battery by means of a length of No. 4 rubber-covered copper cable running from the battery to the rear of the car. This method was used only after a trial period of use of a second battery indicated a life per recharge of over three weeks under normal use of six hours per week. The generator used on late-model automobiles is capable of maintaining the battery fully charged under these conditions.

The transmitter has been operated for over one year without any more trouble encountered than a burned-out final-amplifier screen-voltage dropping resistor. Once tuned correctly, the rig needs no attention other than an occasional check to determine that vibration has not caused any of the circuits to become mistuned. If the plate and grid currents to the final are normal (plate current, 50 ma. and grid current, 0.75 ma.) it will not be necessary to retune the transmitter. Experience has shown that most troubles result from unnecessary playing with the tuning controls. In operations with the local net (WKAE) the unit will put a reliable signal into the control station from any point in the town. In checks with nets in adjacent towns it has been found that from a reasonably good location, the signal range is upwards of 20 miles. The reliable performance of the transmitter has more than justified the labor involved in the design and construction of the unit. The freedom from worry about frequency stability serves to take the operator's mind off the technical side of WERS and permits complete attention to snappy operating technique.

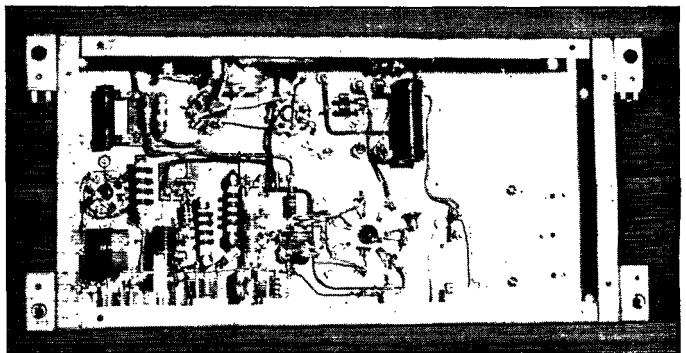

Bottom view of the 112-Mc. crystal-controlled mobile transmitter. Tank circuits for the oscillator and frequency-multiplier stages are assembled in the lower left-hand corner. The brackets are made to fit standard shock mounts.



25 YEARS AGO THIS MONTH

FOR the first time in the history of amateur radio, it would seem from *QST* for July, 1920, we are able to engage in summer work. Traffic is being handled in winter volume. In many sections static seems much less than usual. The average amateur installation is also much superior to what we had before the war. There is an increasing amount of daylight work, which not only evades most summer static but gets around many dead spots. The Fading Tests have also aroused the greatest summer interest we have ever seen in amateur activity — the whole country is agog over them. It is definitely news that we are working through this summer season with great success.

It is also news that the long-heralded transition from spark to c.w. is now in full swing. It is awfully hard to get hold of tubes and it is not cheap, but it is apparent that about 100 watts of c.w. will do as effective work as a full kilowatt of the damped product. It is more than probable that at some time in the future it will become necessary to curtail the latitude allowed spark transmitters. Even T.O.M., after some bad experiences with kick-backs in "Rotten Damped Spark Stuff," threatens to go c.w.

Howard L. Stanley, 2FS and a League director, gives practical advice in "C.W. for the Amateur," reporting his results with three 5-watters in a conductive-coupled circuit. L. C. F. Horle begins the publication of a Radio Club of America paper on "Navy Receiving Equipment," with a description of the SE-143. Our first article by a YL is M. Adaire Garmhausen's amusing personal-experience story, "How to Build a Wireless Station." The British-designed V-24 tube, of such low internal capacity that it is very useful as an r.f. amplifier, and which we very much wish were available in this country, is described by J. O. G. Cann, chief engineer of Canadian Marconi. We describe an interesting receiving loop built at the Naval Radio Station at Otter Cliffs, Bar Harbor, Maine, by Bill Woods of 9LC while stationed there during the war, with funds furnished by Lieutenant Fabbri, the commanding officer. There are two concentric loops, the outer one 22 feet in diameter, the inner one 20 feet, each 4 feet wide, independently revolvable from the operator's booth. This loop was the wonder of the natives, who waited for days to see it revolve like a Ferris wheel.

The leading station description is that of 1AW, President Maxim's home station. Our cover illustration is of the antenna system, a 17-wire slanting fan. The outer ends of the wires, 3 feet apart, are supported on a 50-foot cable slung between two 80-foot masts. A 20-foot trussed spreader supports the lower ends of the wires at a height of 50 feet, after which they are bunched into

a rat-tail cable which runs to the transmitter in the basement. Thordarson and Acme transformers are available. There is a Dubilier mica condenser of 0.01 μ fd. and an oscillation transformer of 2-inch ribbon. The four-point rotary gap is of two solid arms in a cross 15 inches in diameter, on a bronze hub, and is belt-driven at 7000 r.p.m. from a half-horsepower motor, the belt supplying the insulation. Because of the narrow electrodes and very high speed with attendant air blast, it is believed that in this gap quenching is secured far beyond that given by ordinary rotaries, so that tighter coupling is possible with purity of wave maintained. 1AW has been heard in Texas and in Cuba on about 230 meters and performance ranks with the top-liners in the amateur world. A very short anchor gap with large faces is used in the ground lead, and a single wire from the lead-in outside the house runs to the change-over switch at the operating position in the library. The receiver is a Paragon RA6 regenerator, a soft detector, and three stages of audio using VT-1s. The anchor gap eliminates the need for distant-control devices; the gap motor runs continuously and the power line runs direct to the key on the table — as simple an arrangement as could be imagined.

The League has adopted an emblem, a diamond with slightly rounded corners, bearing the letters ARRL and an elementary "hook-up." Pins and buttons are now available for members. By this device we may now recognize true amateur radio when we see it. May it ever stand for the highest in amateur affairs!

Don Mix, ITS, and E. E. House, 8NZ, both report in correspondence that when stations with fairly broad waves fade on one tuner setting, they can be copied by a quick shift to a slightly different tune. A. L. Groves reports that utterly different groups of stations can be copied by shifting the height of his horizontal antenna from 65 feet to 30 feet. . . . With the opening of navigation, Canadian amateurs have been obliged to go from 200 meters back to 50 meters for the summer. . . . British amateurs may not use vacuum-tube receivers without special permission, because of the fear of interference from radiating oscillators.

Another international communications conference is contemplated and the Department of Commerce has begun a study of the proposals, with the help of an advisory committee of the best technical men in the art. One of the members of this committee, representing us, is Charles H. Stewart, 3ZS of St. David's, Pa., member of our Board and assistant manager of our Atlantic Division, an old-time amateur with a great deal of experience in radio legislation as a representative of amateur radio

Calculations for Antenna Orientation

Mathematical Formulas for Azimuth and Distance Calculations

BY W. E. MARQUART,* W9CKT

A PREVIOUS article by the writer¹ described in detail a simple mechanical method of determining the direction and coverage of either a rotating or fixed-direction antenna. That method, while practical and reasonably accurate, may not permit the precision calculations desired in orienting a rhombic or similar long-wire fixed-direction antenna. It is particularly important to aim accurately when constructing an antenna with a narrow pattern, since a fraction of a degree may seriously affect the great-circle path of the center of the beam. It is admitted that the average beam is much broader than might be expected, but this fact does not detract from the importance of orienting accurately the path of coverage for maximum signal strength.

The following method explains how to calculate azimuth and linear distance with an accuracy determined in minutes of arc. It goes without saying that such calculations are ineffective if not followed by precision measurements at the antenna location, using a surveyor's transit and an accurate determination of true North. Most commercial rhombics are laid out with an accuracy of plus or minus 15 minutes ($\frac{1}{4}$ degree) or better, and while the amateur may not need this high order of accuracy, it does become more important at the higher frequencies if the antenna is used on a number of bands.

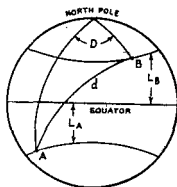

Fig. 1—Angles involved in computing bearings between two points on the Earth's surface. The length of d is the linear distance between the two points.

Perhaps the easiest method for determining a great-circle route is to use Ageton tables where only simple addition and subtraction are involved. However, since these tables are not generally available, a formula method for computing the great-circle course will be presented.

In order to determine the orientation of the antenna, it will be necessary to know the latitude and longitude of the transmitter location and the same for the receiver location. Two bearings then may be calculated, one showing the proper orientation of the transmitting rhombic, or other antenna, with respect to true North, and the other showing the bearing of the signal path at the receiver location.

Fig. 1 shows two locations, A and B, on the surface of the Earth with known latitudes and longitudes. This drawing illustrates the condition

In the April issue of *QST*, W9CKT described a simple mechanical system for determining the bearings between the home station and any point on the surface of the globe. In this article he provides the necessary formulas for doing the job more accurately by means of simple mathematics.

which exists when one location is north of the equator and the other is south of the equator, although calculations may be made regardless of where the stations are located.

In using the formula, it will simplify computations to have B represent the angle of orientation of the antenna at the station with the greater latitude. Final calculations will be shown as bearings east or west of true North as appropriate. When the bearing angle has been determined it will be helpful to check the quadrant in which this angle lies by referring to a globe and visualizing a line connecting the transmitter and receiver locations. This imaginary path of the signals will indicate whether the angle lies east or west of true North, and will be especially helpful when calculating long paths and those running approximately north and south.

In calculating the number of degrees in angles A and B (which are the great-circle bearings for these points), these formulas may be used:

$$(1) \tan 0.5 (B + A) = \frac{\cos 0.5 (L_B - L_A) (\cot 0.5 D)}{\sin 0.5 (L_B + L_A)}$$

$$(2) \tan 0.5 (B - A) = \frac{\sin 0.5 (L_B - L_A) (\cot 0.5 D)}{\cos 0.5 (L_B + L_A)}$$

where A = bearing from station A to station B.
 B = bearing from station B to station A, assuming station B as the one of the greater latitude.

L_A = latitude of station A.
 L_B = latitude of station B.

D = difference in longitudes between stations A and B.

After angles $0.5 (B + A)$ and $0.5 (B - A)$ are determined, angles A and B may be found by addition or subtraction, as follows:

$$(3) B = 0.5 (B + A) + 0.5 (B - A).$$

$$(4) A = 0.5 (B + A) - 0.5 (B - A).$$

In order to simplify the mathematical computations, the logarithms of equations (1) and (2) may be used thusly:

* 2123 26th St., South, Arlington, Va.
¹ Marquart, "Ready! Aim! Fire!", *QST*, April, 1945.

$$(5) \log \tan 0.5 (B_A + A) = \log \cos 0.5 (L_B - L_A) + \log \cot 0.5 D - \log \sin 0.5 (L_B + L_A)$$

$$(6) \log \tan 0.5 (B - A) = \log \sin 0.5 (L_B - L_A) + \log \cot 0.5 D - \log \cos 0.5 (L_B + L_A)$$

The great-circle linear distance between any two stations may be determined by using the following formula:

$$(7) \tan 0.5 d = \frac{[\sin 0.5 (B + A)] [\tan 0.5 (L_B - L_A)]}{\sin 0.5 (B - A)}$$

$$(8) 69.057d = \text{distance in statute miles.}$$

Where d = angular distance in degrees between stations A and B .

Again, the mathematical computations may be simplified by using the logarithmic form of equation (7).

$$(9) \log \tan 0.5 d = \log \sin 0.5 (B + A) + \log \tan 0.5 (L_B - L_A) - \log \sin 0.5 (B - A)$$

Before starting calculations it is to be noted that in using the above formulas, northern latitudes should be taken as *positive* and southern latitudes as *negative*. Thus, if either L_B or L_A is in the Southern Hemisphere the figure will be used as a negative number. Furthermore, in determining the angular difference in longitudes, D , before using the formulas, if both locations are in the same hemisphere, the smaller figure is subtracted from the larger. However, if one is east and the other is west of Greenwich meridian it will be necessary to subtract each figure from 180 degrees and add the resulting values.

If both stations A and B are located south of the equator and the sum of the latitudes ($L_B + L_A$) is negative, computations will be greatly simplified if the bearings are calculated with respect to true South and the bearings converted afterwards to bearings east or west of true North, as appropriate.

Illustration

To illustrate this method of computation, an example will be used in which it is assumed that a transmitting rhombic antenna located at Cross Lake, Minnesota, is to be oriented so that the great-circle path of maximum signal strength will fall on Brisbane, Australia, the receiving location. In this example, the transmitter location will be designated as B since it has the greater latitude,

B — Transmitter — Cross Lake, Minnesota
Latitude (L_B) = $46^{\circ}42' N.$; Longitude = $94^{\circ}7' W.$

A — Receiver — Brisbane, Australia
Latitude (L_A) = $27^{\circ}28' S.$; Longitude = $153^{\circ}2' E.$

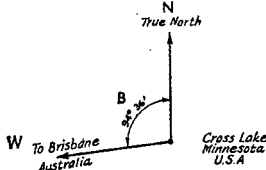

Fig. 2 — Drawing showing great-circle direction of Brisbane, Australia, from Cross Lake, Minnesota.

$$0.5 (L_B - L_A) = 0.5 [(46^{\circ}42') - (-27^{\circ}28')] = 37^{\circ}5'$$

$$0.5 (L_B + L_A) = 0.5 [(46^{\circ}42') + (-27^{\circ}28')] = 9^{\circ}37'$$

$$0.5 D = 0.5 [(180^{\circ} - 94^{\circ}7') + (180^{\circ} - 153^{\circ}2')] = 56^{\circ}25'$$

From formula (5),

$$\log \tan 0.5 (B + A) = \log \cos 37^{\circ}5' + \log \cot 56^{\circ}25' - \log \sin 9^{\circ}37'$$

$$\begin{array}{r} \text{Log } \cos 37^{\circ}5' \\ \text{Add } \log \cot 56^{\circ}25' \end{array} \quad \begin{array}{r} 9.90187 - 10 \\ 9.82215 - 10 \end{array}$$

$$19.72402 - 20$$

$$9.22286 - 10$$

$$10.50116 - 10$$

Subtract $\log \sin 9^{\circ}37'$

$$\log \tan 0.5 (B + A) = 0.50116$$

$$0.5 (B - A) = 72^{\circ}30'$$

From formula (6),

$$\log \tan 0.5 (B - A) = \log \sin 37^{\circ}5' + \log \cot 56^{\circ}25' - \log \cos 9^{\circ}37'$$

$$\begin{array}{r} \text{Log } \sin 37^{\circ}5' \\ \text{Add } \log \cot 56^{\circ}25' \end{array} \quad \begin{array}{r} 9.78030 - 10 \\ 9.82215 - 10 \end{array}$$

$$19.60245 - 20$$

$$9.99385 - 10$$

$$9.60860 - 10$$

Subtract $\log \cos 9^{\circ}37'$

$$\log \tan 0.5 (B - A)$$

$$0.5 (B - A) = 22^{\circ}6'$$

Using formula (3) to find the angular deviation, B , of the great-circle route from North,

$$B = 72^{\circ}30' + 22^{\circ}6' = 94^{\circ}36' \text{ west of North.}$$

The bearing of B from A , though not essential in orienting the transmitting antenna, can easily be determined by using formula (4):

$$A = 72^{\circ}30' - 22^{\circ}6' = 50^{\circ}24' \text{ East of North.}$$

To determine the linear distance along the great-circle route in the above example, formula (9) may be employed as follows:

$$\log \tan 0.5 d = \log \sin 72^{\circ}30' + \log \tan 37^{\circ}5' - \log \sin 22^{\circ}6'$$

$$\begin{array}{r} \text{Log } \sin 72^{\circ}30' \\ \text{Add } \log \tan 37^{\circ}5' \end{array} \quad \begin{array}{r} 9.97942 - 10 \\ 9.87843 - 10 \end{array}$$

$$19.85785 - 20$$

$$9.57545 - 10$$

$$10.28240 - 10$$

Subtract $\log \sin 22^{\circ}6'$

$$\text{Log } \tan 0.5 d = 0.28240$$

$$d = 124^{\circ}53' = 124.88^{\circ}$$

From equation (8),

$$(124.88) (69.057) = 8,624 \text{ statute miles.}$$

In the above example, the axis of the directional transmitting antenna would be laid out at an angle of $94^{\circ}36'$ west of true North at Cross Lake, Minnesota, in order to place the center of the beam on Brisbane, Australia, 8,624 statute miles away. It must be emphasized again, however, that the accuracy obtained by using the above mathematical computations will represent wasted energy unless comparable accuracy is used in determining true North at the antenna location and in transferring the determined deviation to an actual line of stakes on the antenna site.

Hams in Combat



JOHN
ROCKS
W2AGC

In Burma with the AACs

BY T/SGT. JACK HANLEY,* JR.,
W7CDW, SGT. KEN SHANE,*
AND SGT. WILL CHASAN*

PUT a ham down amid a couple of acres of radio equipment and he is apt to start checking his shoulder blades to see if he is sprouting wings. That's a ham's idea of heaven.

If he happens to be in Burma with an Army Airways Communications System unit, some aspects of his heaven may be rather unorthodox. No one, for example, has ever heard of waist-deep mud beyond the pearly gates, and if anyone has ever confused C-ration with manna it is not a matter of record. But a ham who can't overlook minor inconveniences isn't worthy of the name.

Perhaps you have to be a particular kind of radio man to like it here. Anyone who enjoys radio only when he has all the proper parts in a neat, well-equipped workshop would find this slightly less pleasant than purgatory. Lt. Col. Jess Guthrie, our CO, recently told a new group of installations and maintenance men: "In Burma you can't follow the book. If you are at some jungle airfield at the end of a supply line and you can't improvise, you are a dead loss."

Some of us knew what he meant. A couple of weeks before being rushed to a jungle airfield to install a number of radio navigation devices, a series of emergency installations had momentarily emptied our warehouse. There was not a

* Army Airways Communications Service, Burma.

They landed on Myitkyina Airfield in the middle of an air alert and during a driving monsoon rain. Two hours later they had an improvised tower on the air.

single spare part available and the only tools we had were a screwdriver and a monkey wrench. "Borrow, steal, or improvise if you have to," we had been told, "but get it into operation." The next day, having done a little of each, we were on the air.

Another typical example occurred a short time ago. Awakened at midnight, by 4 A.M. we were on a plane headed toward a new Burma airfield. When we arrived we discovered that some of the equipment needed for the particular installations we were to make had been delayed en route. We had been instructed to make a certain deadline, but it began to look as though we were licked. Then someone spotted a cracked-up transport plane at the side of the runway. We salvaged the plane's radio equipment, plus some copper tubing and a number of other parts. These enabled us to install our radio equipment and homing aid and keep them on the air until the remainder of our own equipment came in two days later.

Many of our assignments are the "special and urgent" kind — designed to meet some new tactical situation. Late one night in May a phone rang at the AACs grass-roofed headquarters in northern Assam. The message was brief and vital. Myitkyina Airfield had been taken and General Stillwell's headquarters expected the AACs to be in operation there by the next day. Maybe General Stillwell's headquarters had meant "if possible," but the operators neglected

to mention it. Men were tumbled out of their beds in the middle of the night. Equipment was assembled in the dim lights of a blacked-out warehouse. The next morning a transport plane carrying men and equipment lumbered down the Assam runway and headed toward northern Burma's key airfield.

We'd like to add that the AACS made its deadline, but it didn't. When the transport nosed down into the Irrawaddy River valley, Myitkyina Airfield was under fire. The pilot, after circling and trying twice to land, was forced to turn back to Assam.

The following morning two tower men, T/Sgt. Charles Burke and Sgt. Victor Lundy, with Capt. Robert Moser, an Army Communications Service officer attached to the AACS, managed to get in some equipment. They landed in the middle of an air alert and a driving monsoon rain. Yet two hours later they had an improvised tower on the air and could hear the arriving planes call in: "Fox Hole Tower, Fox Hole Tower, are we clear to land?" While shells and snipers' bullets whistled across the runway they had set up their radio equipment, placing ammunition cases around and a shelter half over it as protection against the rain. "It wasn't strictly orthodox," Capt. Moser acknowledged, "but it worked."

Our main problem in Burma has been keeping equipment in operation — not always easy at advanced units where fuel and every spare part and tool must be either flown in or dropped. At times fuel has been dropped in five gallon cans, and in bad weather even dropping has been difficult. AACS headquarters often has had to rush action on radiograms reading: "Have enough fuel for only eight more hours," or "Going off air tonight unless fuel arrives."

On occasion we have built antenna poles out of bamboo. When no cement was available we have had to fix our diesel engines by sinking heavy logs into the ground and bolting the engines to them. We have had to cut through jungle underbrush to string antenna wires and restring wires knocked down, almost as soon as they were up, by bulldozers pushing back the jungle. Monsoon rains — communication man's special devil in this area — have given us our share of trouble. Wires have been shorted or washed out by the rains and sometimes burned out by lightning. There were times when we were awakened by a great bolt of lightning and knew instinctively that it had knocked something out. There was nothing to do then but go out into the drenching rain and mud and make the necessary repairs.

Usually when we get to an advanced airfield there are no shelters available for equipment. Delicate radio instruments aren't made to withstand rain, and the tarpaulins we throw over them as emergency shelters are rarely proof against the heavy monsoon downpours. Inevitably the rain seeps or pours through, injuring some of the equipment, and maintenance becomes a twenty-four hour a day headache. Many a time crews have worked forty-eight and sixty hours without a break.

Improvisation goes on continually. At one "shop" here, a sprawling grass and bamboo hut, we build tube sockets out of Plexiglass, make our own variable condensers, grind our own crystals and set up our own power plants. In fact, to keep the equipment going we have done everything from cutting up the rubber heels of our GI shoes for insulators to adapting the cockpit of a disabled plane for use as a "tower." And much of this adaptation must be done with tools not prescribed in any manual.

At one time we were short of test equipment and built our own r.f. signal generators and audio oscillators. Anyone who might want to make out a case for the old saying that "necessity is the mother of invention" would find plenty of illustrations at any one of our stations. Several days ago a maintenance man at a jungle airstrip lacked the necessary parts with which to repair several defective circuits in a transmitter. He experimented, cut out certain circuits, transposed parts, and kept the transmitter running. A while back we needed a phono pick-up for a special purpose. There wasn't a regular one within two hundred miles. We built one out of a headphone.

Another major AACS problem in Burma has been transportation. To perform its designated mission some of our radio navigation equipment must be installed in remote places, accessible only by roads which the heavy monsoon rains often make impassable. Once, unable to move our gear by any other means, we induced the natives to supply us with elephants and water buffaloes.

At one field, where an AACS unit marooned by the monsoons stayed on to operate certain navigational aids required for tactical missions in the North Burma area, the men found themselves running out of essential supplies. To repair some defective equipment they trekked to a road several miles distant, where a number of vehicles had been abandoned during General Stillwell's retreat from Burma. By "cannibalizing" the vehicles they got parts needed for repairs.

U. S. War Bonds for Stories of War Service

QST wants reports on the experiences of radio hams in active service on the battlefronts — for immediate publication in this section, where feasible, or to be held confidential where security considerations so require.

Do you have a story of war service to tell — either your own or that of someone you know? Then write us a letter giving full details, including photographs, clippings and other substantiating data where available. If your story is published in *QST*, you will receive a \$25 U. S. War Bond. Please indicate clearly on the report if it is available for publication in its entirety, if names, dates or places should be deleted, or if all information must be held confidential.

The runway, which had been built in the middle of a plain dotted with rice paddies, was under a foot of water. Animals came down to the runway at night to drink, and the men replenished their meager food supply by turning on the tower lights along the runway and firing away. One morning T/Sgt. Gerald Johnson, who had been appointed "Chief Hunter, Fisherman, and Forager" for his unit, shot nine fish on the runway with his sub-machine gun.

When the installation was finally abandoned the men moved out with the aid of quartermaster caterpillars. It took them a full eight days to travel some twenty-odd miles.

The oldest AACCS installation in Burma is at Fort Hertz, where for a long time AACCS men were a substantial fraction of the small handful of Americans in the region. It was an isolated spot, in the middle of a jungle valley, with only an uncertain line of defense between it and the Japs.

The Nips drove us out once. Then, after they, in turn, had been driven back and we returned, they made a practice of sliding a transmitter onto one of our voice frequencies in the middle of particularly dark and stormy nights and saying: "You are surrounded. Come out and surrender!" It was a phase of their notorious jungle war of nerves, but I don't think that we were much affected. Our usual reply began with, "You slant-eyed bastards," and from there on became increasingly unprintable.

They did try to drive us out a second time, but the truck convoy in which their troops were moving north toward us was spotted. We relayed the information to our fighter headquarters and shortly afterward, tuned in on the fighter frequency, we had the pleasure of listening to the convoy being strafed to Kingdom Come.

Our station was an important "check-point" and, we were told, had to be kept on the air "at all costs." There were several days when the cost threatened to be high. One afternoon our air-to-ground station received a message to the effect that a damaged American transport plane, escorted by two fighters, was heading in for an

emergency landing. Four or five of us ran out to the runway, prepared to help in the event of a crash. After a few minutes the transport flew into view. Fire was licking at its fuselage. The fighters were right beside it. As the transport struggled down to the runway the fighters "peeled off," their wings flicking skyward. Bright red on their undersides was the rising sun emblem. We flattened out on the runway like so many clay pigeons as they plunged down at us. They roared down and over us at an altitude of about twenty feet, but without firing a shot. Apparently they had exhausted their ammunition on the transport, which landed in flames.

For a time Jap planes were over us almost every day, but generally our own fighters chased them south before they could do any damage. Once, when they came down and strafed, one of our maintenance men was caught up in a tree stringing an antenna wire. He came down with desperate swiftness — unharmed except for badly splintered hands. After that we called the tree "sucker's roost."

Paradoxical though it may seem, our main complaint was boredom. We were only a handful, with no diversions of any kind, and before long we found ourselves rehashing conversations we'd been through a dozen times. We hunted a bit, partly for food and partly for excitement, but never became jungle-wise enough to catch anything worth while. We livened many an evening by talking of the fresh steaks we could have if we shot a cat or a wild boar; but the next evening, as usual, we dine on C-ration. All of our food came in cans, and often the cans arrived badly battered and without labels. We decided on our menus by tossing a hunting knife into the air and opening the can into which it stuck. Our menus, obviously, tended toward the unorthodox!

There was one day on which no one complained of boredom. Shortly before noon we sighted ten transport planes flying up the valley at a height of about five hundred feet. Our own transports never came by in such numbers; and anyway, so

(Continued on page 86)

We flattened out on the runway like so many clay pigeons as the Jap planes roared down and over us.





STRAYS



An enormous warehouse in Paris has been converted into a Signal Corps salvage and reclamation depot. The depot, the only one of its kind on the Continent, is staffed by 500 Signal Corps officers and men and employs 1000 French civilians. The reclaiming task involves testing, splicing and rewinding the 100,000 miles of wire that was left strung across the battlefields of France, Belgium, Holland and Germany. Other sections rebuild radio equipment, grind crystals for secret communication channels, repair damaged radar units, telephone, teletype and telegraph instruments, and power generators.

The book "Wartime Racketeers," upon which we commented in the May issue of *QST*, was reviewed by Jack Gould in the *New York Times* for April 8th. In line with our own declaration, he says, in part: "Unfortunately, 'Wartime Racketeers' does contain one serious inaccuracy . . . The statement is made that amateur radio operators sold to anxious relatives information on American prisoners which they picked up from German and Japanese shortwave radio. . . . The Federal Communications Commission has stated that no licensed ham has been found guilty of such charges. The offenders were unscrupulous short-wave listeners and not representative of a patriotic group of hobbyists."

The U. S. Army Signal Corps on April 28th set a new record for round-the-world radio transmission in sending a 9-word radioteletype message around the globe in 9½ seconds. Actually, the transmission was almost instantaneous. Just one second after the message tape began moving through a teletypewriter transmitter, a near-by receiving machine started printing the message after it had journeyed around the world. The one second represented the time lag in the electrical transmission, while the other 8½ seconds was the time required to mechanically send the message. The message was transmitted from WAR in Washington through automatic relay stations at San Francisco, Manila, New Delhi and Asmara.

The CAA has undertaken the application of radar to civil aviation, using equipment made available by the Army and Navy. Objectives of the experimental work are the development of a screen to enable an airport control tower operator to visualize the positions of all aircraft within 25 miles, and a collision warning indicator for installation on airplane instrument panels to give a constant visual signal of the proximity of other aircraft within a limited radius.

Gasoline being transferred from one container to another in the vicinity of radar equipment in operative condition represents a serious fire hazard. High-frequency current is induced into the containers and sparks jumping between them can cause an explosion and fire. Any transfer of fuel made in the vicinity of radar sets should be made with the equipment inoperative.

In the period from 1906 to 1942 magnetic storms occurred on 2800 days. A study of these storms made at the Commonwealth Solar Observatory, at Canberra, Australia, revealed that they fall into four groups, divided into twenty-seven periods. Three groups were associated with visible eruptions or with sun spots. These storms took place 1.5 to 2.5 days after the disturbances on the sun's meridian. The fourth group was not accompanied by visible outbreaks of the sun. It is estimated that three days are required for the particles causing these disturbances to travel from the sun to the earth.

When the Italian Island of Sardinia was retaken by the Allies in September, 1943, one of the first shipments from the island to this country was kaolin talc. This is the raw material from which Steatite is made. Steatite is an excellent high-frequency insulating material with which all hams are well acquainted.

According to W1GWP and W1GWI, Al Winchell, W1AIY, former *QST* contributor of articles on microwave research, has undergone too much of a strain from doing similar work in recent months, and submit this photograph as proof.

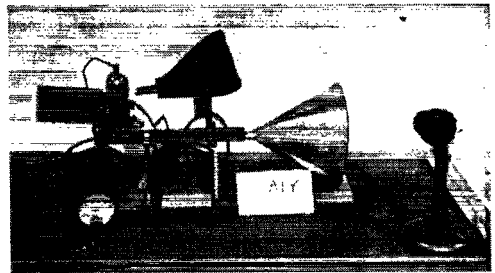

They add that W1AIY apparently is suffering from the hallucination that the equipment depicted represents the latest in supersecret microwave design. The gear, which bears the caution, "be sure to start blower before adjusting to frequency with tuning strut," is tagged: "Dere Bub — Du to shortij of critiele matieiel etc, wer out of cliestonns — can u make this wrk? — Sperry & Barns Rateioscope Co. (Not inc.)"



HINTS AND KINKS FOR THE EXPERIMENTER

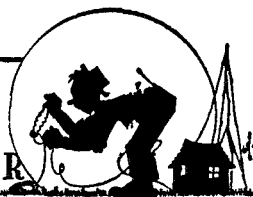

MULTIPURPOSE V.H.F. EQUIPMENT

I RECENTLY made plans for a general-coverage multiple purpose signal generator for v.h.f. Fig. 1 shows what came out of the "radio cupboard" and the OM's imagination (plus a few back issues of *QST*). The choice of tubes is entirely coincidental. I had a 955 built into a tuned circuit providing for plug-in coils, so I built around that. The plug-in part, L_1 and L_2 , consists of contacts out of a moulded octal socket, mounted in a bit of plastic. (Polystyrene would be excellent.) The coil ends slip into these contacts. The second triode provides audio when the unit is used as a monitor or receiver.

When the "peewee" becomes a signal generator (by closing S_1), the audio stage becomes a tone-generator and modulator, by throwing S_2 to the transformer side. A series of plug-in coils of various sizes can be used and calibrated. I used harmonics from the oscillator of the family b.c. receiver, operating on its highest range. The four-turn coil covered the range 108 to 138 Mc. It's surprising how nice a curve a few calibration points will give on a piece of graph paper. A curve is worth while since the miscalculations show up prominently.

I use the "peewee" mostly as a general-coverage v.h.f. receiver, as everything else around the shack covers 110 to 120 Mc. only. In a pinch I believe it would work as a transmitter, too (A2 only). Other tube combinations probably would work satisfactorily. — Harry B. Miller, W9AB, 729 $\frac{1}{2}$ E. Lowell Ave., Mishawaka, Ind.

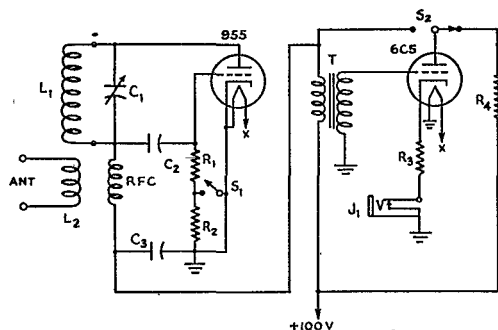

Fig. 1 — Multipurpose v.h.f. signal generator used in the shack of W9AB.

- | | |
|--------------------------------|--|
| C_1 — 8- μ fd. variable. | S_2 — S.p.d.t. switch. |
| C_2 — 50- μ fd. mica. | T — Audio transformer. |
| C_3 — 0.005- μ fd. mica. | J_1 — Closed circuit (key). |
| C_4 — 0.1- μ fd. paper. | J_2 — Open circuit ('phones). |
| R_4 — 100,000 ohms. | L_1 — Spiral coil, 6 or 8 turns. |
| R_3 — 2000 ohms. | L_2 — 4 turns No. 16, $\frac{3}{8}$ inch |
| RFC — V.h.f. choke. | outside diameter to |
| S_1 — S.p.s.t. switch. | cover 112-Mc. band. |

A FULL-WAVE TRANSFORMERLESS LOW-VOLTAGE SUPPLY

THE 117Z6GT, a full-wave rectifier, may be used without a transformer in a low-voltage power supply, as shown in Fig. 2. The output has a 120-cycle ripple, thus reducing the amount of

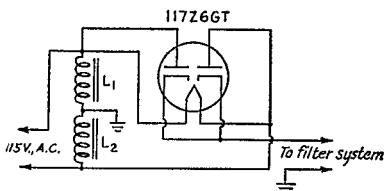

Fig. 2 — Low-voltage power supply requiring no transformer. L_1 and L_2 should be 10 to 20 henries.

filter required. The chokes, L_1 and L_2 , are across the 115-volt line and must also carry the output current. A value of from 10 to 20 henries is suggested for these chokes. — Sgt. W. M. Nunn, jr., USMCR, Quantico, Va.

NOTES ON ELECTRON-COUPLED OSCILLATORS

SINCE the widespread adoption of variable-frequency oscillators by amateurs, the original Dow electron-coupled circuit as described in *QST* for January, 1932, has been subjected to a great deal of mistreatment.

The advantages of the original e.c.o. circuit were considerable, and included:

- 1) Minimized frequency change with supply-voltage fluctuations. An increase (or decrease) in plate and screen voltages produced changes in frequency in opposite directions, so by properly proportioning the two, a ratio of plate/screen voltage could be found which compensated for frequency variations caused by a fluctuating supply voltage.

- 2) Freedom from frequency change due to load variations. The screen grid is at ground potential for r.f. and there is no capacitive coupling between the plate and oscillatory circuits. All coupling is through the electron stream (hence the name "electron coupled") and variations in plate loading have no effect on frequency. Actually, the e.c. oscillator is a Hartley circuit followed by an amplifier, with no capacitive or inductive coupling between the two.

However, in many current versions, these advantages have been almost totally neglected. With the voltage stabilized power supplies now in use, the first advantage mentioned is not as

important as it was originally, but it is still worth consideration. In small, inexpensive transmitters where the same power supply is used to operate the e.c.o. and the other stages, good frequency stability can be obtained without resorting to voltage-regulating tubes. By operating the screen from a voltage divider and adjusting the slider, a point will be reached where minimum frequency variation is caused by supply-voltage changes when keying an amplifier fed from the same power supply. This really works. Try it on your e.c.o. and see.

The second advantage, plate-circuit isolation, is more often disregarded. This is caused mainly by the use of audio pentodes and beam tubes. The original Dow circuit used tetrodes of the 860 or 865 variety. These tubes were fine, since they had low grid-plate capacity and no suppressor grid. After them came the audio pentodes of the 59 and 89 types. These made fair electron-

by the difference in r.f. potential between the cathode and filament. This can be avoided by grounding the cathode, as shown in Fig. 3-A. This puts the screen above ground, but this can be taken care of by placing a small neutralizing condenser between the plate and grid of the tube. A two- or three-plate air-trimmer will do. This circuit retains all of the original features of electron coupling. Another true electron-coupled circuit is shown in Fig. 3-B. A pentagrid converter tube (6A8), is used, with a grounded-cathode Hartley oscillator. No neutralization is required, since the plate is shielded from the anode-grid by the screen, which is at ground r.f. potential. Any pentagrid tube will work in this circuit, such as the 1A7G, 1C7G, 2A7 and 6A7. The 6SA7 should *not* be used, as it has a different element structure. — *Harry R. Hyder, W2LIW.*

— . . . —
CAUTION TO USERS OF WAFER SOCKETS WITH OCTAL-BASE RECTIFIERS

THE procedure described by W. T. Watson in Hints and Kinks in the March, 1945, issue of *QST* (he used a variety of rectifiers in a socket which had pins connected in a universal arrangement), is satisfactory providing the socket is of the molded type. I have found that arcing will take place between the high voltage pins and the grounded pins in some types of wafer sockets. The tube manufacturers spaced the rectifier pins to prevent such arcing. — *Pvt. Walter A. Midcalf, Co. D, 149 Bn., 90th Rgt. IRTC, So. Camp Hood, Texas.*

— . . . —
NO-KINK SCHEME FOR 'PHONE CORDS

HERE is a kink destined to solve that ever-present problem of headphone leads getting in the op's way. Run an extension lead from the receiver up the wall and along the ceiling of the shack. Put a 'phone jack on the ceiling over the operator's position. By inverting the earpieces the cords go right up, completely out of the way. — *Ensign Jack Nelson, USMS, W8FU.*

— . . . —
IMPROVED "HETROFIL" CIRCUIT

AFTER experimenting with various suggested "Hetrofil" circuits, I found that performance was greatly improved by the use of three

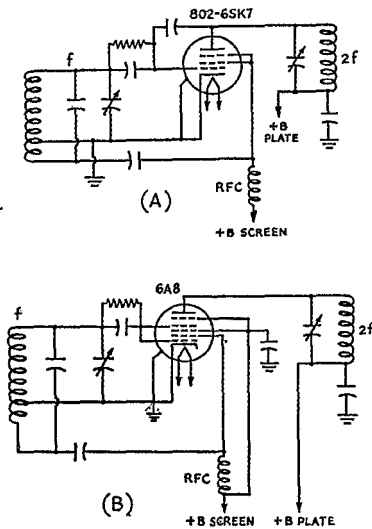

Fig. 3 — Electron-coupled oscillator circuits.

coupled oscillators since the suppressor came to a separate base pin which could be grounded. The grid-plate capacity was greater, however, making them less desirable. The worst tubes for an e.c.o. are the audio pentodes of the 6F6 type, because their suppressors are connected internally to the cathode. The cathode is above ground to r.f., thereby causing undesired coupling between the oscillator and load circuits. Beam power tubes, such as the 6V6, 6L6 and 807, also are poor from this standpoint. While these tubes have no suppressor, their beam-forming plates are internally connected to the cathode. The best tubes for e.c. oscillators appear to be receiving r.f. pentodes (6K7, 6SK7) and transmitting pentodes (802, 837). All of these types have low grid-plate capacity. The suppressor should be tied to the screen at the socket, or grounded, and should *not* be connected to the cathode.

A difficulty which frequently arises with indirectly heated tubes is hum modulation caused

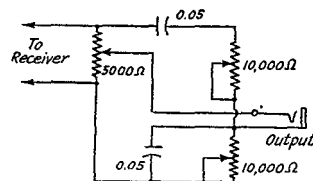
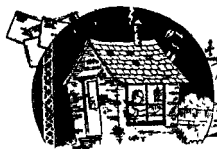

Fig. 4 — Improved "Hetrofil" circuit developed by W7ABF. The three variable controls are not ganged.

variable controls in the circuit shown in Fig. 4. It is suggested that condensers of high quality be used as others will impair the operation. — *Lt. Robert H. Flagler, USNR, W7ABF.*



CORRESPONDENCE FROM MEMBERS

The Publishers of *QST* assume no responsibility for statements made herein by correspondents.

THE CHALLENGE ABOVE 200 MC.

1925 S. Sunnyridge Rd., Dayton, Ohio

Editor, *QST*:

At the conclusion of the war and upon the reopening of the amateur frequencies for ham use, amateur radio and its operators must accept what probably will be the greatest challenge in its history, namely the development of the u.h.f. and s.h.f. spectrum. The announced allocations show very definitely that our Government expects us to accept that challenge.

Let's review briefly how amateur activity was responsible for endless engineering and development on the higher frequencies.

Contrary to general belief, u.h.f. is not the newcomer, but is in fact the oldest branch of amateur experimentation. Marconi made numerous experiments at wavelengths measured in centimeters. However, communications later conducted at lower frequencies overshadowed all former u.h.f. activity so completely that its possibilities were forgotten for a time. About 1922 several American and British amateurs instigated small networks on $2\frac{1}{2}$ meters. These contacts, however, involved only small groups communicating over very limited distances. The foregoing experiments appear to have ceased until about 1935 when several British amateurs heard signals from Europe and North Africa.

In 1936, interest in v.h.f. became apparent with greatly increased activity in all American cities on 5 meters, and by the end of the year there were such amateur stations located throughout the world, all regularly active and performing observation work as well as regular schedules over ever-increasing distances.

Between 1928 and 1935 very few 5-meter DX signals were heard. However, during 1935 British hams heard innumerable European signals, harmonics of powerful transmitters located on the continent, the farthest DX being from Italy and North Africa. American amateurs noticed a greatly improved band condition, and coast to coast QSOs were reported by many stations. By the close of 1937 W sigs were heard in England and vice versa. In 1939 a British ham had a QSO with a ham in Italy, and in this hemisphere a British Columbian worked Japan!

It is, of course, impossible to predict what distances will be covered on our new u.h.f. and s.h.f. frequencies, but it is certain that amateur radio will very definitely accept the challenge and great changes in equipment design will result from our experiments. When the time comes to resume our activity we may find our new frequencies to be the most interesting field yet explored.

— Major John C. Alison, AC, W5JSU

A PHONETIC ALPHABET

920 Alpha St., Inglewood, Calif.

Editor, *QST*:

Regarding your editorial suggesting a universal phonetic alphabet — I believe such an alphabet should be made up of words which would be readily identifiable by the general public, as in the standard Western Union system.

The trouble with the Navy list and also the one you propose in March *QST*, is that they require the users to be familiar with those particular lists. This is because the lists contain "mirage" words which, over the air, may sound exactly like other words and thus provide no identification of the letters we are trying to distinguish between. For instance "dog" could be understood as "bog," "Nan" as "man," "tare" as "pear," and so on. Since "d" sounds like "b," "n" like "m" and "t" like "p," the lists are very confusing when used by the uninitiated.

We should have a universal list by all means, but please adopt one which does not have the above-mentioned fault.

— George Dery, W6HG

Somewhere in Germany

Editor, *QST*:

. . . K.B.W.'s editorial in March *QST* concerning the phonetic alphabet didn't set right. Why pick on the words the Army is using? Especially when K.B.W. stated it didn't make much difference what the words were provided they were technically sound, universally used, etc. You understand many of us are tired of this Army and the way things are done in it. And, anyway, we like individuality — that's one great thing about our ham radio. If we *must* have a uniform phonetic alphabet, please pick other words — words the Army *never* used. Ourselves, we're tired of everything or anything GI.

— Chet Wise, W9JCJ

— Chuck Todd, W9ZYJ

— Andy Anderson, ex-W9CKR

86 Riverside Dr., Saranac Lake, N. Y.

Editor, *QST*:

. . . I want to sound a very loud *no* in reply to the plug for a compulsory phonetic alphabet to be used in 'phone calls. To my mind the repeated and habitual use of this method is just so much "pig Latin"! The telephone companies use it only when a single letter needs to be stressed. In such a case it has a good use, but certainly not as a compulsory amateur call method. If a call cannot be interpreted by our time-honored letter

or personalized call it certainly won't be clear enough otherwise.

I sat in the cockpit of an airliner for years calling and listening to almost every tongue in popular use. The need for phonetics in this vital work has never been seriously considered for the simple reason it is so seldom needed and its habitual use would only clutter up the air. . . .

— *George I. Rhoades, W4HMQ*

Dogpatch, Ark.

Edytor, *QST*:

I see by the 2nd idiotoryl on p. 10 of Mar *QST* tt the edytur tinks the stayt dept wurd list iz the nutz becuz it dont hav no plase naymes. Such ignurunce! I suppoze the edytur nevr herd of such faymus plases az Abell, Md.; Baker, Ark.; Charleroi, Pa.; Dog Creek, Ky.; Eby, Ky.; Fox, Ala.; George, Ark.; Howe, Ida.; Ithan, Pa.; Jiggs, Nev.; King, Tex.; Love, Ky.; Mike Horse, Mont.; Nancy, Ky.; Ono, Calif.; Peters, Calif.; Queen, Pa.; Rogers, Minn.; Sugar, Ida.; Tarry, Ark.; Uncas, Okla.; Victor, Colo.; Williams, Ariz.; Xavier, Kans.; York (like in poke chop), Ala.; Zena, Okla.

The edytur shud not rite such misgided informashun with out lurning hiz jeeogruffy bettr like we do in Dogpatch, Ark.

— *Abner Sokum*

A RIDE FOR "SOURDOUGH"

22 Wilson Ave., Chatham, N. J.

Editor, *QST*:

"Sourdough" should take a ride on the Lexington Avenue line during the rush hour. I'll bet he would rewrite the third paragraph of his article entitled "Flummajimmery" in May *QST*!

— *George A. Diehl, W3FVZ*

RESISTOR VALUE ABBREVIATIONS

APO 417, c/o Postmaster, New York, N. Y.
Editor, *QST*:

After reading the letter from W8OT in Correspondence from Members in March *QST* suggesting the use of the abbreviation "kilo" in place of "000" in resistor values, several observations of German radio equipment come to mind.

In this case, the abbreviations "K Ω " and "M Ω " are used to represent 1000 and 1,000,000 ohms, respectively. This system makes the printed values compact and readable. . . .

— *Pfc. Charles W. Clifford, jr., W6QMY*

APO 758, c/o Postmaster, New York, N. Y.
Editor, *QST*:

. . . I think it would be a great help to have an abbreviated method of writing resistor values and offer the system I have found in common use throughout Italy, France and Germany. This system uses "Q" for ohms, "K" for kilo, and "M" for meg. Values from 100,000 Ω up become fractions of M. Thus 100 ohms is 100 Ω , 1000 ohms is 1 K Ω , 100,000 ohms is 0.1 M Ω , and 1,000,000 ohms is 1 M Ω . This simplifies the marking of values on the very small resistors.

— *Sgt. R. T. McMillan*

RADAR ECHOES

U. S. Naval Training School, Del Monte, Calif.
Editor, *QST*:

. . . I am glad to see *QST* is still on the high plane we all expect of it and you all are to be congratulated on keeping it so. I just finished reading Clint DeSoto's first chapter on radar techniques and it is very good indeed.

In fact, I am damn proud to belong to such a fine organization after seeing for the past three years how its publications occupy such a prominent place in the radio field and the respect with which they are regarded. Every instructor keeps a copy of the *Handbook* for ready reference. The most distinctive part of the *Handbook*, to my mind, is that it is a practical book. There are many books written on different theories of every conceivable phase of radio, but there is only one real *Handbook*. . . .

— *Lt. H. W. Wickenhiser, USNR, W8KWA*

Hotel Foster, Schenectady, N. Y.

Editor, *QST*:

I liked your radar articles — and I wanted you to know it. . . .

— *Lt. Myron Eddy, USN (Ret.)*

35 Standish Rd., Watertown, Mass.

Editor, *QST*:

I like the articles on radar and television because they give you a month to digest each article. This is very helpful to a beginner. By progressing each month, everyone is pleased.

— *Charles Beaudette*

Naval Training Schools, Fort Lauderdale, Fla.
Editor, *QST*:

. . . I am particularly interested in Clinton DeSoto's "Radar Techniques" as I am now instructing at the Fire Controlmans School here. You will be interested to know that his articles have been of great help to me as an instructional aid in my classes, and I eagerly look forward to the remainder of the series. Another score for the League, I'd say! . . .

I can't begin to enumerate the ways in which the education I've obtained in years past from ARRL's various publications has helped me.

— *Bill Bottomley, FC(o)3c, USNR, ex-W1FSE*

SOME INTERESTING QUESTIONS

Hq. Sig. 712 MP Bn., Ft. Niagara, N. Y.
Editor, *QST*:

I have been following the progress of the FCC conferences on frequency allocation and I have been wondering about several things.

One of them is just what are we going to use for tubes on the very much discussed s.h.f.? Yes, I know that great strides have been made in the field of r.f. generators but as to date we haven't even seen a description of any new tubes that might help. What of the klystron? Has anyone

(Continued on page 76)



OPERATING NEWS



CHARLES A. SERVICE, W4IE
Acting Communications Manager

LILLIAN M. SALTER
Asst. Communications Manager

WERS Continued. Last month we notified you of the modification of regulations by FCC to permit the continuation of the War Emergency Radio Service, even though civilian defense offices no longer are in existence. We now look forward to the continuation of existing networks and the licensing of new networks. The possibility of natural disaster is always with us and since there is no amateur radio to participate in emergency communication work we believe it is important that there be a WERS unit in each community ready to perform in any emergency where WERS assistance is required.

Affiliated Club Activity. We have been particularly pleased these past few months to note a considerable increase in club interest and activity. Tabulation of returned year-end survey questionnaires has brought out some interesting facts. Reports were returned from 147 affiliated clubs, of which only nine have been disbanded or are definitely inactive. Although a number of clubs report that they are inactive at the present time because of war conditions, the majority of them are looking forward to holding regular meetings at the earliest opportunity. Lately there have come to our attention instances of clubs becoming extremely active after several years of complete inactivity. ARRL membership in clubs also is holding its own as will be noted by the number of clubs listed in the Honor Roll of affiliated clubs having 100 per cent ARRL membership, shown on this page. As already stated, reports were returned by 147 affiliated clubs, which still leaves over one hundred not yet heard from. Clubs, if your secretary has not yet returned the questionnaire giving us all the facts and figures on your group, please ask him to get this in to us as soon as possible. We do not want to discontinue bulletin mailings to any association that is active or contemplates activity in the near future.

Personal. No sooner had June *QST* gone to press than we received word from Carol Witte that her address had been changed. Carol has been transferred from Pasco, Wash., to New York City for some special training. Mail for her should be directed to: Carol K. Witte, HA1c, Hospital Corps Rehabilitation School, Hunter College, Bronx, New York, N. Y.

General. Until a short time ago we published in each issue of *QST* an Honor Roll of clubs or associations conducting code and/or theory instruction for beginners. For the past several months only one club has seen fit to report on its activities in this connection. Therefore, we have thought it advisable to omit this listing.

However, we would appreciate advice on any groups still holding classes. Occasionally we receive inquiries regarding code and theory training. All information received will be added to our card file and will be made available to persons requesting such information.

Radio Aides. Recently a bulletin was mailed to all radio aides to which was attached a form for use in reporting fully on WERS units. If you have not already done so, we urge that you send in your report form, giving complete information on your licensee, in order that, we may have accurate information concerning the degree of activity of your units.

— L. M. S.

ARRL AFFILIATED CLUB HONOR ROLL

The list below was compiled by analysis of a questionnaire returned in response to a year-end club survey.

All Members of these Clubs are ARRL Members:

Amateur Radio Researchers, Bell, Calif.
Amateur Radio Transmitting Society, Louisville, Ky.
Amateur UHF Club, Jamaica, Long Island, N. Y.
Associated Amateur Radio Operators of Denver, Denver, Colo.
Cahokia Amateur Radio Club, E. St. Louis, Ill.
Charlotte Amateur Radio Club, Charlotte, N. C.
Detroit Amateur Radio Association, Inc., Detroit, Mich.
Garden City Radio Club, Garden City, Long Island, N. Y.
Grumman Amateur Radio Club, Bethpage, Long Island, N. Y.
Hi-Q Radio Club, Lynn, Mass.
Illinois Ham Club, Chicago, Ill.
Inglewood Amateur Radio Club, Inglewood, Calif.
Intercity Radio Club, Mansfield, Ohio
Iowa-Illinois Amateur Radio Club, Burlington, Iowa
Jackson Amateur Radio Association, Jackson, Mich.
Jersey Shore Amateur Radio Association, Monmouth County, N. J.
Main Line Radio Club, Philadelphia, Pa.
M. A. K. Amateur Radio Association, Medford, Mass.
Parkway Radio Association, West Roxbury, Mass.
Pendleton Amateur Radio Club, Pendleton, Ore.
Peoria Amateur Radio Association, Peoria, Ill.
Radio Club of Tacoma, Inc., Tacoma, Wash.
Schenectady Amateur Radio Association, Schenectady, N. Y.
The T-9 Club, Beverly, Mass.
The Winston-Salem Amateur Radio Club, Inc., Winston-Salem, N. C.

BRIEF

Since January 1, 1939, every member of the T-9 Club, of Beverly, Mass., has been an ARRL member — thus the Club is now in its seventh year as a 100 per cent club. The members are also 100 per cent in the services or in war work. Monthly meetings have been held without a single break for eleven years. On April 20th the twelfth annual meeting was held and the following officers were elected: Richard S. Briggs, W1BVL, president; Philip R. Grush, W1GGV, vice-president; Reginald Toof, W1ISX, secretary; and Robert G. Ling, W1IBF, treasurer.

WERS of the Month

Montclair, New Jersey

IMEDIATELY after Pearl Harbor, Robert Siegel, W2AIE, rounded up all the amateurs in Montclair and formed a group whose services were offered to the town officials. As soon as government plans were announced for the reactivation of amateur radio stations for the purpose of aiding in civilian defense activities, the mayor of Montclair applied for permission to reactivate five stations. Meanwhile, Walter E. Rahm, W2GBI, and John I. Stockwell, W2IGX, undertook a program of technical development of transmitters and receivers. On December 31, 1941, the following were reactivated: Robert Siegel, W2AIE; Walter E. Rahm, W2GBI; John I. Stockwell, W2IGX; Herbert M. Warner, W2INX, and Charles K. Atwater, W2JN. Others who were not reactivated, but cooperated, were: William L. Hayes, W2GZA; Walter J. Sickinger, W2GBT, and Robert A. Waters, W2JST.

The reactivated stations were put on the air at once and the first piece of gear built by Rahm and Stockwell was given field tests. In January the government again closed down all amateur radio stations, but the experience acquired in the short time in which the group had functioned was later to form the foundation of a truly outstanding network.

The feeling persisted that eventually some form of radio communication would be required in civilian defense work. Meetings were held at intervals during which progress was reported from those engaged in designing equipment for possible use in defense work. The group elected Charles K. Atwater, W2JN, as its chairman. Rahm and Stockwell designed and built a crystal-controlled transmitter which was to become the control transmitter for the Montclair WERS network.

Within a few months after the formation of the War Emergency Radio Service was announced, application for a license was made and Montclair was granted a license for ten units with the call WKAE on January 1, 1943.

One of the first accomplishments of Atwater, who had been appointed radio aide by Mayne S. Mason, communications officer, was to design a simple 9-watt crystal-controlled transmitter. Its design was influenced by the availability of parts in the junk boxes of the various members of the net and by the stocks of available materials in local jobbers' stores. The luckiest find was a small quantity of 20-meter crystals. The transmitter uses a 7C5 crystal oscillator-quadrupler in a tri-tet circuit, driving a 7A4 doubler which in turn drives a pair of 7A4s as a push-pull, neutralized final amplifier. It operates from a 300 volt, 100 milliamper power supply. The modulator is a 7C5 in a modified Heising circuit. The town provided each unit with a 300-volt vibrator power supply and a six-volt storage battery for auxiliary power. Best results have been obtained with the extended double-Zepp antenna. The antennas are used for both transmitting and receiving by the addition of a simple antenna change-over relay.

After the crystal-controlled units were put into operation it was found that the original plan of fusing the 20-meter crystals in three groups of frequencies was not satisfactory. The control transmitter occupied a frequency of 112.512 Mc. while there were two additional frequency groups, 113.136 to 113.360 Mc. and 113.880 Mc. This plan was intended to require but three receiver settings to receive signals from any unit on the basis that the bandwidth of the superregenerative receivers was great enough to accept these signals within each group. It was decided that an attempt would be made to grind all the crystals to 14235 kc. Atwater was able to grind and calibrate all but one crystal to 14235 kc. and all crystals will zero-beat within 2000 cycles. This made possible spot frequency operation on 113.880 Mc. of all transmitters. The inherent stability of these transmitters has enabled the control station operators to handle over sixty coded catastrophe messages per hour on several occasions during drills conducted with local defense council services.

Montclair's mayor and his council cooperated fully in extending support to WERS. The organizing ability of Mayne Mason, communications officer of the Montclair defense council, resulted in the location of the control transmitter in a room adjacent to defense council control center and in a building only a few yards from fire and police headquarters.

This transmitter, a rack and panel job with an input power of twenty-five watts, was designed and built by Rahm, assisted by Stockwell. It is composed of a 6A6 with one section functioning as a crystal oscillator on 20 meters and the other section as a quadrupler to 56 Mc. This drives a 7C5 doubler which in turn drives an 832 final amplifier. Modulation is furnished by a pair of 7C5 tubes driven by a 7A4 amplifier. The power supply makes use of all paper condensers in the filters in order to insure reliability. The main receiver at control is a superheterodyne with resistance coupled i.f. amplifiers. The receiver is of conventional design and was built by Atwater. All equipment normally operates from commercial power but, in the event of power failure, the station is equipped with a gasoline-driven generator of 300 watts capacity. The operating room is located on the ground floor of a 60-foot building on top of which is mounted a 30-foot guyed mast. An open-wire transmission line of approximately 500 ohms impedance runs from the transmitting position to the roof through a stair well, terminating at a double-pole, double-throw relay. On the mast are mounted two extended double-Zepp antennas, one of which is vertically polarized and the other horizontal. Selection of either of the two antennas is made at the operating position by means of the relay. Considerable interference was at first experienced from other networks, especially those to the east of Montclair. This suggested the subsequent installation of the horizontal antenna which is directional north and south so as to reject interfering signals. This method was feasible since the town is five miles long in a north-south direction and only one and one-half miles wide, and the control center is at the approximate geographic center of the town. The use of the horizontal antenna during periods of extreme interference has made possible consistent communication with all local units. That these steps were necessary can best be realized when it is understood that Montclair is an excellent v.h.f. receiving location and is at the hub of the most active WERS territory in the country. Completing the equipment in use at the control center is a broadcast receiver for monitoring broadcast advisory announcements, and an all-way communications receiver. The location of the transmitter plus the over-all efficiency of the installation has resulted in reports of reception from New London, Conn., and Eastern Long Island. Schedules have been maintained with New Brunswick, N. J.

Several of the 9-watt transmitters have been arranged so that they may be used as portable-mobile units. The antenna that has been favored for mobile use has been the simple "J" mounted in the car window so that the radiating portion extends above the car roof. In the cars, as at fixed locations, use is made of antenna change-over relays so that the same antenna serves for both transmitting and receiving. Thus, the operator is assured that if the control transmitter can be heard at his location, he is in a position to be heard at control. The receivers in the field are super-

Each month under the accompanying heading we shall publish the story of an outstanding WERS organization as an item of general interest to all WERS participants. Contributions are solicited from any radio aide or WERS participant, whether he be an amateur or a WERS permittee. Descriptions of organizations which have already been featured in *QST* articles will not be considered. The story may describe the organization in general, how it came into being, how it was set up and how it operates; or it may describe some particular phase of the organization which makes it unusual or unique. Contributions should be brief (two or three typewritten pages, double-spaced, is maximum) and may include photographs if desired, although only one photograph will be printed with each story. Each story must be released for publication by the radio aide of the licensee, in writing. Address your contribution to the Communications Department, ARRL, and mark it: "For WERS of the Month."

regenerative detectors equipped with r.f. stages to reduce interference between units due to re-radiation.

Interest has been spontaneous, and the net has continued to grow, both from the standpoint of the number of active members and the amount of equipment in use. The number of authorized units has increased to twenty. One of the factors responsible for the maintenance of interest is that there is enough new equipment being designed and built to keep all members striving to attain maximum efficiency. The use of A-2 emission by several of the more experienced operators has spurred others on to thoroughly learn the code. At present there are ten active members, seven of whom hold technical positions in the electronics industry: Charles K. Atwater, W2JN, radio aide; Theodore D. Haubner, ex-W2AIM; William L. Hayes, W2GZA; C. V. Hulse, W2MZS; Robert Kessler, W2EBU; Walter E. Rahm, W2GBI; John I. Stockwell, jr., W2IGX; Benjamin F. Tillson, jr.; Lois Tillson, and Robert A. Waters, W2JST.

—Theodore D. Haubner, ex-W2AIM, and Robert A. Waters, W2JST

Meet the SCMs

ARTHUR RAYMOND GAETH, W9FQB, SCM of Nebraska, first became interested in amateur radio back in 1921 and received his first license in September, 1922, when he was but sixteen years old. Since then he has held the calls of W9DKN and W9FQB. As W9DKN he operated $\frac{1}{4}$ kw. spark and several low-powered tube transmitters, including a WD-11 which covered sixty-five miles on a few trans-



smissions into Lincoln. A native Nebraskan, he attended YMCA Trade School. Before his present employment as inspector for the City of Omaha Fire Department he was photostat and blueprint operator with U.P.R.R. for seven and one-half years. Prior to the war "Art" held appointment as Emergency Coördinator and was a member of all the radio clubs in Omaha. He was instrumental in organizing the recently affiliated Ak-Sar-Ben Club and is a member of the WERS Club; he holds the

office of secretary in both clubs. Also, he is president of the Helmet Club, past-secretary of Firefighters' Local No. 385 and secretary of the Ark (young married couples' club). SCM Gaeth enjoys swimming, golf, softball, skating and fishing; his favorite sports are hockey and football. He was the Old Man in the ritual team which initiated new members into Omaha's first radio club, located in the Woodman of World Bldg. Initiation was for the Order of the Wouff-Hong. For one whole year (every other day, on his regular day off from the fire department) W9FQB was code, procedure and field instructor. That he is greatly interested in the War Emergency Radio Service is proven by the wealth of material on WERS contained in the regular monthly Activities Reports received from him.

BRIEFS

Hamfesters Radio Club of Chicago will hold its 12th annual picnic on Sunday, August 5th, at Dolton Picnic Grove, Dolton, Ill. Games, contests, and demonstrations of WERS equipment will be features of the day. Refreshments will be available for those who do not bring picnic baskets. Dolton may be reached by driving south on Halsted, east on 147th and north on Chicago Road to the picnic grounds. South Suburban Safeway Buses leave the depot at 20 E. Randolph every 40 minutes after 8 A.M. and will stop at the grove on request. All hams, ex-hams, would-be-hams, WERS ops, SWLs and their families are cordially invited.

The first "postwar" hamfest of the North Shore Radio Club will be held in the Community Garden Ballroom, 215-32 Jamaica Ave., Queens Village, N. Y. on Friday evening, August 24th. All are invited. Watch for complete details in August QST.

The Month in Canada

QUEBEC—VE2

From Lt. L. G. Morris, VE2CO:

CONGRATULATIONS to Lt. G. G. Yull, 2GF, who married an English girl last April. The wedding took place in Doncaster, England, and the best man was Capt. R. H. Frissick, ex-2CX. 2CX forwarded this news in an interesting letter, mentioning also that he has been in touch with Ray Thornton, 2AR, who has been overseas as an Army captain for several years. After serving on foreign duty since early in 1941, Flight-Lieut. Sid Chapman, 2LV, is stationed at Clinton, Ont.

ONTARIO—VE3

From L. W. Mitchell, VE3AZ:

Now that V-E day has come and gone, with the Allied score, "two down and one to go," everyone is pulling a little harder to hasten V-J day, and all it means to fair minded and peace-loving peoples the world over. Many of the boys still overseas have already volunteered for Pacific duty, knowing they will have but a short leave at home before proceeding to help eliminate the Nips. To those boys we offer our thanks for past duties nobly performed, and pray for their safety and quick return to all they hold dear.

At this time we also pay tribute to an old member of the ham fraternity who did not live to enjoy the first fruits of our victory. He was Cliff W. Speer, 3BF, CBC war correspondent engineer, who died in a London, England, hospital on May 11th, as the result of a collision between the CBC mobile broadcasting van he was driving and an army truck. Cliff went overseas early in 1944 and served in Britain, Italy and on the Western Front. He is survived by his wife, a daughter, and a son with the Canadian Army. Cliff was 42 years of age, and a real ham.

WAOO News: May 3, 1945, was a red letter day in the history of the Wireless Association of Ontario. Part II of the paper, "Basic Concepts and Performance of a Frequency Modulation System," was covered at the meeting by Morley Patterson, BA, Sc, 3GQ, who reviewed briefly the highlights of the previous meeting. He later dealt in detail with circuits and applications, enlarging his talk with slides showing various forms of amplitude and frequency modulation. Mr. Patterson next explained the circuit and operation of the reactance-tube modulator, the discriminator and limiter circuits. By means of transmitters and oscilloscopes the speaker was able to give practical demonstrations of the various aspects involved. Ray Anthes was in charge of the equipment and assisted materially in making the demonstration so successful. The high spot of the evening was the two way communication system set up in the lecture room, through the courtesy and cooperation of the Toronto Transportation Commission. Mobile f.m. equipment, the property of the Commission, installed and operated by Mr. Sadler, was put in contact with T.T.C. Hillcrest Barn station, and with various cruisers operating in the Toronto area. After a brief question and answer period, Percy Sparks, 3AEX, proposed a hearty vote of thanks to Messrs. Anthes and Patterson for their wonderful presentation, and to Messrs. Cowan and Sadler of the T.T.C. for their kindness in giving their time and talents on behalf of the WAOO.

The meeting was presided over by our new president, Alf Edmunds, member of the ARRL, who introduced the new executive to the meeting. They are: vice-president, Harold Benson, 3HB; sec. treas., Art Potts, 3MT; membership, Wally Hainge, 3IB; news editor, Bill Winter, 3APA. The papers committee consist of: Bob Humphreys, 3ALC; Les Weir, 3AIB; Dave Parks, 3SX, Les Jackson, 3AXW; Art Vivian, 3YY. Ashley Chown, 3IW, also on the new Executive, was unavoidably absent from the meeting. The attendance at our last meeting far exceeded any previously held, being approximately 160, members and visitors, and 21 membership-subscriptions were received at this one meeting alone. We really believe one of the reasons for the great success of the recent WAOO meetings, was the new roles assumed by both speakers. Ray Anthes and Morley Patterson — both became proud poppas recently. Morley's jr. op was born May 1st, and Ray's jr. YL. op. on March 14th.

Durham Blachford, 3AHX, and E. V. Brown, 3AHV, Ft. Lts. in the RCAF, recently returned home from overseas. AHX has been discharged and is now taking a course at U. of T. AHV has been posted to Trenton, Ont., for further duties. Both are experienced on radar. Fred Rogers, 3IQ,

formerly of Weston, is now working in the radio section of Canadian Westinghouse Co. in Hamilton, Ont. Les. Weir, 3AIB, expects to join the ranks of the Benedicts soon. No date has been set as yet. Congrats. 3AEX, Percy Sparks, has decided to return to the WAOO fold after a lengthy absence on hush-hush work. Spence Williams, 3NF, sqdn. ldr. in the RCAF, is reported as being stationed in Scotland at present. Spence was very active on 20 before the War. Bob McIntyre, former WAOO member, has returned to his work at Rogers after 4 years with the RCAF. Bill Winter, 3APA, got quite a thrill on receiving a letter from India written by a fellow ham and friend of long standing, Karl Beckemeyer, W4EVZ-ex-W5JTU-ex-KA1KB. Frequent 40-Mc. skeds were worked in the days before hostilities, but later contact was lost. Then QST for February was received by Beck in India. He saw Bill's QRA and immediately wrote a very entertaining letter which was received 9 days later.

VE OPS News: The Canadian Amateur Radio Operators' Association (VE OPS) held a get-together and banquet at Diana Sweets, Bloor St., Toronto, on Monday, May 14th. The affair was practically international in scope as every Canadian district was represented as well as Great Britain. The attendance was well over 100, of whom all but 15 were licensed hams. Manley Haines, 5MQ, acted as capable MC, assisted by Sam Trainer, 3GT. After the dinner the meeting was thrown open and suggestions were called for, 5 minutes being allotted to each speaker. Several took advantage of the opportunity, among them being Peter Posnikoff, 4ATR; Eric Bartman, 3VD; Len Horstall, 3AOS, and Flt. Sgt. H. C. O'Brien RCAF. The latter gave a very interesting story on the pioneering work done by hams in the early part of the war, about 1200 of whom enlisted almost immediately in Canada, proceeding overseas to act as organizers and instructors in the various sections of the services devoted to radio research and development. Their work has proven of inestimable value, said Flt. Sgt. O'Brien, in the successful prosecution of the war, and the knowledge they have gained will help to raise the standard of ham efficiency during the postwar years. The present Committee of Management of the new Association is as follows: chairman, Sam Trainer, 3GT; secretary, Manley Haines, 5MQ; treasurer, Eric Bartman, 3VD; The committee consists of: J. C. R. Punchard, 2KK; Peter Posnikoff, 4ATR; Ed DeGrey, 2IN; Wally Hainge, 3IB; Dave Parks, 3SX; Fred Heath, 4QX; Mr. Reid, 5IO; John Hooper, 3AHA and Flt. Sgt. H. C. O'Brien. The Association has decided to revive publication of the magazine *Xtal*, which was the official organ of the prewar VE Operators' Association. The following committee was organized for this work: Alf Gillier, 3AZI, chairman; Sam Trainer, 3GT; Peter Posnikoff, 4ATR; Eric Bartman, 3VD; and H. C. O'Brien. The new magazine *Xtal* will, it is hoped, be published every six weeks for the first few issues, and will contain between 28 and 32 pages of feature articles, news items, new circuits, Q & A section, selected advertising, etc. For the present the magazine will be distributed free by a mailing list, and will reach all parts of Canada. The first issue mailed around the end of May ran to 2500 copies. Correspondents should address their letters to S. B. Trainer, General Delivery, Leaside, Toronto 12, Canada.

The Kitchener-Waterloo Radio Amateur Club, the latest newcomer to our ranks, was organized by a group of hams and would-be hams, on Tuesday, Jan. 23, 1945, when a meeting was held at the YMCA in Kitchener. Membership in the organization is open to anyone interested in the advancement and furthering of radio amateur aims and activities, provided the applicant is above 14 years of age. Regular meetings are held the fourth Tuesday of each month at the Kitchener YMCA at 8 o'clock. Anyone interested is welcome to attend the meetings. The officers are: president, Newt Good, ex-spark ex-5FE — ex-VE3CY, of Kitchener, presently employed in Inspection at Dominion Electrohome Ind., Kitchener; vice-president, Ron. Little, also holds the position of Technical Committee Chairman, engineer at Standard Radio Products, Kitchener; sec. treas., Orm. Boetger, employed in the Eng. Dept. of Dominion Electrohome Ind. Ltd., Kitchener. To date the club has held four general meetings and attendance has increased at each meeting. At present two code practice groups are meeting about once a week, and additional instructors are available who can take over any time that new classes are formed. The technical committee promises to have interesting speakers and subjects for discussion at the meetings. The speaker at the April 24th meeting was F. A. O. Banks, manager of the Engineering Dept. of Dominion Electrohome Industries Ltd., Kitchener. Mr. Banks spoke

on the subject of f.m., giving a short résumé of f.m. up to the present and its future as related to the general public and the postwar amateur. The speaker for the May meeting was C. J. Irwin, Chief Engineer of Philco Corp. of Canada. In addition to the president, Newt. Good, the club has these hams as members: Norm Friedmann, ex-3HM; 'phone, code, Kitchener, and Albert Fenske, ex-4AFN, code, Yorkton, Sask. The club would welcome any communications from other similar organizations, suggesting what projects they should pursue in the advancement of the study of amateur radio.

ALBERTA — VE4

From W. W. Butchart, VE4LQ

From 4HM, Chas. Harris of Edmonton, we learn that 5EP, Don Vaughan-Smith of Vancouver is now in Australia with RCCS, and that 5RK, Ross Goodwin of Prince George, B. C., is in India. We are unable to state which service Ross is with, but my guess is RCAF. Rumor has it that 5ADD-ex-4ABH, Stan Jones, is stationed in Edmonton with N.W. Air Command. We'd sure like to hear from him. 4HM saw 4AES, Pere' McGrane of Lac la Biche, on the station platform at Edson a while ago. It appears that 4AES was just returning from the coast, where he had been taking a course in naval instruction. Pere' is O/C of the Sea Cadets at Lac La Biche. Last dope on 4AKK, Bob Lamb of Edmonton and Calgary, informs us that he is still cleaning 201As out of the equipment at CFCN. 4HM now possesses a "frequency record" for test purposes, which gives him an audio response from 10,000 to 50 c.p.s. It should prove very useful to HM who is experimentally inclined. Another Alberta 'phone man showed up in 4BW's joint the other day in the person of 4DC, Frank Wright of Wainwright, Camrose, etc., who until recently has been with the Saskatchewan Power Co. in Que Appelle, Sask. He is with Calgary Power now, and intends to take up residence in Lacombe shortly. During war years the call of 4ID, "Barney" Barnstable of Vegreville, kind of dropped from sight, and only recently have we been able to get a lead on his whereabouts. He was at one of the Empire Air Training Schools at Portage La Prairie, and since the closing of the school he has been with the C.P.R. Technical Maintenance Crew, making his hq. in Calgary.

Albert Potoski of the Lethbridge SARC was an Edmonton visitor in May. We spent an hour or so talking things over, and I managed to make Albert puff during the climb up to the top of the Parliament Buildings dome! The SARC really goes into deep stuff at their meetings, such things as sawtooth oscillators, electronic switches, a.c. vectors, etc. Albert goes to considerable trouble to build up the apparatus that is demonstrated. Looks as if the NARC will have to prevail upon the SARC to make a trip to Edmonton with some of this equipment. 4IZ, Elwood Irwin of Barons, and 4WZ, John Row of Barons, took in the last meeting of the SARC and report having a splendid time. Boyd Clarke, 4SP, of Picture Butte, also attended and returned to Barons with Elwood and John. SP works in the machine shop at the sugar beet factory since receiving his discharge from the RCAF. While in the service he spent quite a bit of time on research work on radar, and promises to give the SARC a lecture on it as soon as the ban on its secrets are lifted. 4AQP, Milson Hodgson of Barons, had to forego the Lethbridge meeting as the plasterers were at work on his new home and he had to be there to mix plaster! By the way, AQP is O/C of the Barons Cadet Corps. 4ADY, Laverne House, was kept busy welding on an important job and also missed the ride, and 4ARC, Aylmer Gloer, was busy trucking. As for his own activity, 4IZ reports that he is building a 2-kw, 110-volt a.c. generator, and has it just about ready to start winding. He hopes to get ADY to build up a ventilating fan for it.

A wedding announcement received from Vancouver broke the news that our Hilda, 4WH, was married to F/O Thomas S. Wright on April 17th. Well, Hilda, the NARC certainly wishes you loads of happiness, and we'll be looking forward to hearing you on the air again soon. The name of Pete Fair, 4YD, was mentioned in one of these reports and since that time Pete has turned up in person. Yes, it's F/O P. A. Fair, of Peace River, and he has just returned to Canada after serving overseas for several years. He phoned the house the day after he arrived in Edmonton, and at that time was holding forth with 4JL, "Jake" Allen, R. I., Edmonton.

(Continued on page 94)

AMATEUR ACTIVITIES

ATLANTIC DIVISION

EASTERN PENNSYLVANIA — SCM, Jerry Mathis, W3BES — A letter from 3HQE to 3HXA states that he is OK and raring to get back for a reunion with all his gang. 3HXA will have a voice-operated relay in his new 'phone rig. 3GET has a new QTH which is pretty well in the open. 3CHH had a miniature hamfest at the Hotel Benj. Franklin. 3ENX, back with us permanently, is on the prowl for a good suburban location. 3HKY writes from India that the Chinese hams are all on 20-meter 'phone and they come in his place R9 plus. 3CZM dropped in for a brief visit from the West Coast where he is stationed in the Navy. 3GHM is somewhere on the Ledo Road and is building a receiver to pick up the States. 3HFD is dabbling in some heavy ECO experiments. 8MTO, a Field Day guest of the Frankford Radio Club, called to say hello to the Club. 3AQN reported again by electrical transcription. 3HRE is buying a place in Easton. 8ECR/3, well-known DXer around Philadelphia a few years back, now is in Lancaster. This dope came from 3FMZ of the same town. According to the published Army "point system" we should see 3GYV one of these days. 3IJJ is working in Galveston. 73, Jerry.

MARYLAND-DELAWARE-DISTRICT OF COLUMBIA — SCM, Hermann E. Hobbs, W3CIZ — The WJDC network plans to send in an article on its organization and work, for possible publication in *QST*. WJDC-28 and WJDC-49 are additions to the District of Columbia gang. WJDC-15 has been off the air for some time because the operators are overseas. The Washington Radio Club code class is just starting practice for beginners; intermediates 7½ w.p.m. and advanced 12 w.p.m. when the transmission is good. Kung Shao-Hsiung, former operator of XU6KL, attended a recent WRC meeting where we managed to ask him a few questions about himself and about ham radio in China. The following addresses were received: Pvt. William Dunne, 104th AACs Sq., Big Bethel Radio Station, Box 683, Langley Field, Va. Lt. Comdr. Robert D. Bass, 4CQG, Naval Academy, 12 Revell St., Annapolis, Md.

SOUTHERN NEW JERSEY — SCM, Ray Tomlinson, W3GCU — Asst. SCM, Ed. G. Raser, W3ZL WERS groups are requested to maintain regular tests and drills during official periods in order to keep this emergency communication network at peak efficiency. On May 19th, the Hamilton Twp. WERS Operators' Association, of the WKPX network, was host to several visiting members of the Hillsboro, Branchburg, and Bridgewater Twp. organizations at a get-together held at the Nottingham Fire Headquarters in Hamilton Twp. Among the visitors were Stan Case, radio aide for Hillsboro Twp., his assistant, Horace Brokaw, and several of their operators, and Paul Todd, control operator for Bridgewater Twp. and a delegation of its operators. Stan reports that the WKXQ network is all set to go in case of any emergency requiring its services. A letter from EED, while at sea, tells us the chief operator on the ship is a ham who never held his own station license because he was in show business traveling the States and Europe doing a tumbling act. 3AFH, Wm. L. Meade, 170 East Washington St., Trenton 10, welcomes visitors and would appreciate any information on the present QTH of 2LGS. We would like information on GDW and GEV. JAG was home on leave recently, as was 3EQF, who has been in Africa for thirty-one months. Ed Beamish is working his top off doing research on amplifiers. EGE recently became affiliated with the Delaware Valley Radio Association. M/Sgt. FBC is home on furlough after three years overseas; The Delaware Valley Radio Association now holds regular meetings on the second Wednesday evening of each month in the Chamber of Commerce Room of the Stacy-Trent Hotel. Sgt. CKY, supervisor of radio for the N. J. State Police radio communications system, was guest speaker at the April meeting of DVRA. Several members of the DVRA were accorded a swell time at a visit to the South Jersey Radio Association on May 17th. CCO copped the big prize on the kitty-draw. 6AAO, of Glendale, Calif., formerly of Wildwood, N. J., has been accepted into DVRA membership. A swell time was had by several members of the DVRA at the

annual get-together held at the home of Director VanNest recently. The DVRA Bond Wagon is perking along in high gear with the blue team still in the driver's seat. The members of the Association wish to thank Sgt. Jimmy Hassal, now overseas, for the \$25.00 he donated toward their building fund. Charles B. Cubberly, of Trenton, was welcomed into membership at the May meeting. EED, of the merchant marine, was in port for a few days and then left for another trip. FBC, on leave after three years in foreign service, tells us that while in England he saw 2PF and HKO; also while in the German fracas his outfit was stationed within a few miles of Maj. 3VE. Eddie Peters (LSPH) was promoted recently to electrician's mate first-class, and is stationed in the Philippines. "BB" Wentzel tells us he got a big surprise recently, while on a "no tell" project, when he was greeted by AIR. QL has been promoted to the rank of full lieutenant. Sgt. HAZ has been transferred to Camp Plauche, La. Bill is learning to be an auto mechanic. ZI is trying to enlarge his collection of early wireless equipment. If anyone has any old-time tubes, keys, or other gear, just address Ed. G. Raser, 315 Beechwood Ave., Trenton. AGZ is operator at WIP, Belmawr. The regular meeting of the SJRA was held at Hotel Walt Whitman on April 19th with a gathering of twenty-five members and ten visitors. Applications were received for five new memberships. First prize of a year's subscription to *QST* was garnered by IZP, editor of *SJRA News*. The twenty-ninth anniversary dinner of the SJRA will be held at the Fireside Inn, Mount Holly, on June 21st. 73 to all. Ray.

WESTERN PENNSYLVANIA — SCM, R. R. Rosenberg, W8NCJ — Members of the EARC have voted to change the name of their club to the Radio Association of Erie. At a recent meeting GU, SLC, BHN, TXZ, AQY, and NOJ were elected directors. Lt. KWA and his XYL, 2MIY, are the proud parents of a YL operator. Wick is at Navy Radar Training School, Del Monte, Calif. TVA, still stationed in Brazil, hears from many old friends, and would like to know the whereabouts of OUH and OSN. TTD writes often from Camp Crowder, where he is teaching radio. TTJ, reported to be within sight of actual fighting on Pacific islands, has seen plenty of beautiful YLs in his travels! TTN says *QST* reaches them in the Northern Solomons after having previously been read and reread. A mighty fine letter was received from UVD, who states he has a nice workbench in his radio room. UHO was last reported to be in France. VNE, who recently returned to the U. S. from Africa in a Navy plane, has completed advanced radio studies at Norfolk. VYU, who is attending Carnegie Tech., works in the transmitter room of WHJB on Saturdays and Sundays. UTT and SNA, both Greensburg hams, have been in the merchant marine for some time. TPI, RMC, spent more than a year in the ETO and was awarded the purple heart as a result of wounds sustained in the invasion of Sicily. IYI submits an FB report from DuBois. NCJ and his XYL hear regularly from K4KD and are looking forward to resumption of schedules on 40 and 20 meters. AOE, who sends in the following news, wishes to thank all of the boys who have written expressing appreciation at seeing Western Pennsylvania again in *QST*. PER writes that he is now Sgt. of the CAP at Vandergrift Airport. He is teaching c.w. to the cadets of 62nd Squadron, CAP. MKO has completed 2½-meter gear and is waiting to have it licensed for the CAP. NDE, St. Marys, is doing a wonderful job as executive director of the St. Marys Boys' Club. He writes he is radio aide for Elk County, WERS, licensed under WMGR. "Doc" says Ridgway, Johnsonburg, St. Marys, and Emporium are represented in the WERS net. Contacts to Emporium, a distance of 22 miles, are made on 2½-meters. NDE, IOI, KXP, HRW, KAV, CUZ, and VMX are the members of the WMGR net. JUR received the surprise of his radio career when he was heard on 2½ by the Mercer County WERS net. Ens. Sanford Shaftz, (no call assigned), in the merchant marine, returned home on furlough and took an active part in the Mercer County WERS net activities. He also acted as official photographer for the WKXV WERS net. KXV reports that he is in New Guinea. TTD writes "April issue of news fine, except for fib someone put in about my challenge." BRJ, what has become of Kane's powerful little 800 watter? Your SCM desires to express his sincere appreciation to those who extended their congratulations upon his recent appointment. Among the many letters received was one from Cmdr. 3QV, Atlantic Division Director, stationed in Washington, D. C. I wish to extend special thanks to TTD, AOE, and TVA who were so active in securing my election. Thanks and very 73, Ray.

CENTRAL DIVISION

ILLINOIS — SCM, David E. Blake, II, W9NUX — Capti TLQ, CAP, was host to Col. Earle L. Johnson, national commander, and Major Frank I. Adams, national communications officer, and officers of Wisconsin, Indiana, Michigan and Minnesota Wings. A demonstration of two-way radio contacts was given by Col. Johnson in a plane and Illinois group stations operating in planes and mobile on the ground. Major Adams was highly pleased with the radio activity shown by the Illinois Wing. Mrs. Lillian Gehrs, Peeters, Mo. (XYL of SCB, who is *jooverseas* as a civilian government technician), last heard from BRD while he was in the Philippines. She says her OM, who worked CGT in the old days, met him in person in Cairo, Egypt, at the Radio Conference last year. CGT's present address is wanted. Lt. ALU, APO 70, c/o Postmaster, San Francisco, Calif., writes that he always reads the Illinois section report first. He met ex-K5AA, Maj. Bellai, and several W2s and W3s in Australia and some W9s in New Guinea and received a long letter from ARN. The 12th Annual Hamfesters Family Picnic and ham get-together will take place Aug. 5th. ABR resigned as sergeant at arms of the Hamfesters because of illness and OFZ was duly elected to replace him. QDA was in Chicago from California for several weeks on business and a honeymoon. With sorrow we learn that JBH's son was killed in action in Germany. Addresses are wanted for Lt. SGC and M/Sgt. VIZ. Following are present addresses of some Illinois hams: Maj. CBI, 15 No. Parkside Ave., Chicago 44, Ill. O/C QPR, 1st Co., OCRU, Fort Benning Ga. Sgt. AEG, 55th Sig. Rep. Co., Camp Bowie, Tex. Pfc. MRK, 18th AAF BU, Motion Picture Unit, Culver City, Calif. S/Sgt. QFG, Co. A., 3rd Bn., 2nd Reg., Percy Jones Conv. Hospital Facility, Battle Creek, Mich. EZG, ACRT, is in England. ODT and the Joliet Club still have get-togethers from time to time. FXB, who is having good luck with new antennas on WERS, is fully underway with his new company, the Art Linick Enterprise. 73, Dane.

INDIANA — SCM, Herbert S. Brier, W9EGQ — WXG visited EGQ before setting out for the Pacific again. CKP and he are exchanging insults via the *Bison*. EHT and FDS both complain that the other does not answer letters. EHT dreams of getting back to Indiana as the Navy moves him farther away. KYQ works in CAP-WERS, WKVY. ARI has a fine radio shop in Muncie, FDS is working on a voice-operated break-in unit for — you guess what. YWE is taking a correspondence course in radio engineering. EBB threatens to send EGQ a 35-pound audio transformer "collect" to shut him up. DHJ listens to low-frequency police c.w. stations, and has a 112-Mc. receiver. KQV is an instructor at Ft. Monmouth. OUI is at Camp Crowder. ILU and KMY are in the Philippines. ILU has had no use for his foxhole on land, but several times at sea, he wished he had one near. YMV reports that "electrical engineers" on his ship repealed Ohm's law long ago, and are not interested in any new legislation. FOS is in the States again. NZZ has repaired a few midgits. ILL sent me some "simple algebra" which I thought was for designing robot bombs, but turns out to be for calculating bandspread. UMK reports that Manila really took a pasting. NXU and others are having some success with carrier-current work. EGV is playing with thyratron tubes. TDX is at the U. of Wisconsin studying radio for the Navy. KBQ is at Scott Field, Ill. waiting to be shipped again. SVH was thrilled that EGV finally said a kind word to him, even if he did have to get sick to hear it. PLW is getting married. Gary WERS, MVZ, radio aide, was on alert for thirteen hours on V-E Day. CTK is in the States after a long hitch in the Pacific with the Navy. ABB is sweating out a leave soon. EDP recently visited SVH. MVZ, DUT and JZA have portable-mobile units for WERS that cover the city of Gary very well. Window "J" antennas seem to work the best. 73, Herb.

KENTUCKY — SCM, Darrell A. Downard, W9ARU — Giles Allen's latest technical problem is how to get WJKK-23 on the air when he can't talk above a whisper. URG must be studying to be a "Quiz Kid." Ed Wallace is the new 2nd district radio aide. Jim Jackson is back from the Army and attended the May ARTS meeting. Ralph Albers, of the merchant marine, also was present. Tom Parrott finally made the meeting. Bill Dover slipped coming out of the "booby trap" at 22 and busted his pet handie-talkie. On April 30th Gates, WJKK-40, participated with WJKK-531 in a demonstration of two mobile units working out a problem with the Coast Guard at Louisville. Tony Ambrose is the proud papa of a new boy. Dave Jarett is busily engaged in preparing for a commercial license. Rev. Joe Colvin who

is now operating WJKK-430 operates a paint brush with one hand and a walkie-talkie with the other. It is amazing how the high school students are absorbing radio technical information and how well qualified they are in the construction of radio units. Stu Gates has been extremely helpful in furnishing spare parts as needed. Chas. Frederick, ARTS member, is their prof. Doc. Mather, control station WJKK-3, has two superhets on 114-Mc. Math, at U. of L., is keeping Whitfield, operator at 31, off the air. The SCM thanks Dover, Cox and Funk for reporting the news.

MICHIGAN — SCM, Harold C. Bird, W8DPE — There are rumors of a Michigan hamfest to be held somewhere in the metropolitan area this fall. 81LP sends us a report on the round-the-table network. Had the pleasure of a visit from NLV, formerly of Holland, originally from Greenville. He attended the last meeting of the DARA along with our old friend, Zeph. 81LP, still on submarine duty, is plugging ham radio and QST, and says radar work is as much fun as ham radio. 8JO is looking for radio operators with 1st- or 2nd-class radiotelegraph licenses. 8MGV occasionally finds a copy of QST to read. 8GQZ is with Michigan State police at WRDH and hopes to see the gang soon. 8TRP is doing a swell job as our bulletin mailman and also in sending out report cards. 8UGR is sending in some dope to Headquarters on rigs he built during the winter. 90NB, M. J. Fujawa, S2c, Brks. 11, Class R40B, N.A. Tech. Tra. Cen., Memphis 15, Tenn., would like to hear from Richard Mick, 8VIV. 9CYC wants to attend club meetings in Grand Rapids. 8CSL wishes someone in his town was able to send code to him so he could practice up a little. He is interested in Jim Gundry's address. 8KNP is spending most of his time rebuilding and modernizing b.c. receivers. 8PVB, in Rogers City, says they could use a couple of operators. Joe would like to hear from 9IIG and 9ZAW, of Kansas, and 8PWI, of Youngstown, Ohio. 8QKK writes that Lt. 81XJ is in Puerto Rico. The SCM has his complete address. 8FWU sends in a lot of good ideas. 9NJB is located in West Dearborn. On May 7th the DARA and the Edison Radio Club held a very interesting joint meeting. On May 10th the DARA held its usual monthly meeting with a nice turnout. The ladies auxiliary raffled off a hooked rug. Don't forget to send in cards with your comments about a hamfest. 73, Hal.

OHIO — SCM, Carl F. Wiehe, W8MFP — RRR, of Toledo, reports that OZX is in the Army in Europe. RBR is stationed on the West Coast after a spell in the Pacific. TIV parked his plane long enough to get married. VDJ is anticipating Army life. SCC is a Navy CRT and was home for a short leave with five battle stars and lots of ribbons acquired in the Pacific. JES, with the CAA, soon will be located in Bowling Green, Ky. SUD and QOV, both Army sergeants are home after thirty months in the Pacific. Lt. EVU is home after thirty months in E.T.O. An FB bulletin from the Toledo Radio Club indicates excellent attendance at their very interesting meetings. PZA, of Cleveland, reports an attendance of sixty-two at the May meeting of CRA. An "Information Please" was conducted with LEX, NV, PWY, and JNF as the "experts." AVH and TMD have brand new jr. operators. AVH says his son was born with a p.a. system already installed. QV thinks that radio had something to do with the naming of AVH's youngster, MIKE KIENER. The National Merit Award for Cuyahoga County Council of Civilian Defense was awarded on May 22nd. This includes meritorious work done by the WJHH WERSmen during the East Ohio Gas Co. fire and disaster. AVH attended the Board meeting at Hartford and he says that the hams can be assured that the Board is doing everything in its power to protect their rights and interest. EFW writes from the Marianas and he would like some letters from the gang. UWT is in the USN convalescent hospital at Beaumont, Calif., after having seen action in many parts of the Pacific. TLQ is now a corporal in Europe. M/Sgt. LZE, somewhere in England, recently was married to an Air WAC. OFF, an operator in the merchant marine, was home between trips recently. KMP, of Akron, reports that the Buckeye Short Wave Radio Club and the WERS crew continue active. They have an m.o.p.a. job at control station WODF-9 on the 28th floor of the First Central Tower, which puts a good signal throughout the area. Best DX to date is mobile WODF-40 (VQI operator) with four watts to Cleveland control center WJHH-156. Distance about thirty-five miles. GCI is operating his own dental lab. CBI, of Dayton, reports club and WERS activity continuing good. MFV is stationed somewhere in the Arctic and claims that being up there isn't too bad. ENH was in Dayton recently on his way to a new station at Chicago. OVL has been on the

West Coast for several months. VAY was home from Ft. Knox on furlough. Ex-ICA, now K6UNO, was in town on vacation with his "bride" to whom he was married four days after Pearl Harbor. QQ, of Columbus, reports that activity there continues good. WERS was on the job helping with traffic at a bad C & O train wreck and did an FB job. 73.

WISCONSIN — SCM, Emil Felber, jr., W9RH — RKP, having been a civilian radio instructor at Truax Field, and Scott Field for the past three years, is back in Milwaukee. OOL, formerly of Des Moines, Iowa, is located in Milwaukee. Travis Baird, of Milwaukee, is connected with the Bureau of Ships and has gone to the West Indies. SNK has a frequency spotter in his ham's paradise shack that has been running for the duration. M/Sgt. UPM was home on a furlough but is now in New Guinea. CID, WERS operator of WMFI-4, and many years in the Milwaukee Police Dept., has been promoted to patrol sgt. T/Sgt. FQO, has been transferred to the Dutch East Indies. M/Sgt. UPM wrote HRM that he is being given overseas training. CRM JWN is at Dearborn, Mich. and states the course is pretty tough. Lt. ANA, USNR, located in the Philippines, wrote that the Islands have been sprayed with DDT and the mosquitoes have been repelled, but the ants are bothersome at night. Capt. JWT, USMCR, sends thanks from Palau Island for all the seeds the boys sent. Reid wants to know what GVL meant by sending asparagus seeds. Lt. Pasquale Eannelli is in France and is lonesome for amateur radio and the Milwaukee Club meetings. Sgt. Don Hayner is in Southern Italy. Ex-KWV is with Allen Bradley in New York and has purchased a house in Scarsdale, N. Y. Ex-BDD is in Washington, D. C., in the Bureau of Supplies and Accounts of the Navy Dept., Contract Termination Branch. ART1c ex-AFW writes from Florida that the only exciting happening there was the arrival of a daughter in March. Comdr. DTK, USNR, has gone to Peleliu, Palau Island, where he is staff communications officer. T/Sgt. OEB, in England, reports that the RSGB is asking for the return of all bands as well as a band between 21-22 Mc. Cpl. John Holmes reports on the swell 50¢ steak dinners they get in Australia. The Army Air Show at Billy Mitchell Field, May 19th and 20th and the participation therein of our WERS set-up WMFI, by request of Sheriff Geo. M. Hanley, brought forth a letter of thanks and appreciation from the sheriff. 73, *Emil*.

DAKOTA DIVISION

SOUTH DAKOTA — SCM, P. H. Schultz, W9QVY — DKJ reports from Bureau of Ships, Electronic Division, with the following dope: PHP is lt. comdr. in the Navy. RSE, brother of PEP, is Washington representative of the Aerion Co. of Kansas City. YEZ is an ensign and is taking advanced radar training. PRX is state's attorney for Brown Co. at Aberdeen. ZWL reports for the Rapid City Club and says that they keep in touch with the gang by sending the minutes of each meeting to all the members wherever they are located. ANW was home on leave after thirty-seven months overseas. ADJ had his headquarters moved to Long Pine, Nebr., but retains his residence at Rapid City. GLA and ZWL are operating for KOTA at Rapid City. ZBU says that BZI, of Wagner, is on a carrier in the Southwest Pacific and has been promoted to aviation chief radio technician. QLE, ex-5EVW, of Watertown, writes from Italy. He is s/sgt. with a fighter squadron. 73, *Phil*.

HUDSON DIVISION

NORTHERN NEW JERSEY — SCM, Winfield G. Beck, W2CQD — Sgt. DPB writes "Let the gang know that DPB, formerly of Rutherford, hopes to be on the air in the near (?) future from Metuchen and he will be out for DX and also AARS nets." Here's Walt's address: 60th Signal Radio Intelligence Co., Vint Hill Farms Station, Warrenton, Va. CTT no longer is with FCC, having reported for duty with the USNR on May 1st. He has been made an ensign. 73, *Win*.

MIDWEST DIVISION

KANSAS — SCM, Alvin B. Unruh, W9AWP — OUU writes from the Marianas Islands, where he is radio operator-gunner on a B-24. He reports he found a copy of QST in the mail upon returning from his 29th bombing mission. BCZ has been ordered to report to the OWI training station in Ohio for a short training period. Ex-BLA is "dickering" for OWI service. 5HHF and QQI are at Wright Field, Ohio, for advanced radar-radio school. They are test

engineers for Boeing-Wichita's Confidential Electronics Shop. ZUY (Mrs. YYW) reports the OM, stationed in the Hawaiian Islands, has been promoted to ART2c by the Navy. YYW and ZUY formerly were with the CAP on the Gulf Coast. HFP, formerly of Kansas City, has been added to the Boeing-Wichita radio-radar group, while DJL supervises the electrical and experimental ground crews. LFB, supervisor of communications at KGPZ, received a German walkie-talkie radio from M/Sgt. 9ABG, with the Signal Corps in Europe. 73, *Abie*.

MISSOURI — SCM, Mrs. Letha A. Dangerfield, W9-0UD — HIC, located at Camp Bowie, Texas, says HCL is in the Los Angeles area with a radio aircraft target control unit; TCR is at a Washington radio station; 6UHY, ex-JWI, is at Camp Crowder; BAU is in England and 5JNK, ex-ULB, is with Braniff in Dallas. YSM, of the old AARS net, has been in the Army since June, 1942, and has been stationed in Louisiana, Mississippi, Texas, Missouri, and back to Texas. He is a technical sergeant and a skilled radio repairman. ZXX had carrier-current rig well on the way to completion before he was confined to the Naval hospital in Chicago with rheumatic fever. 5H2M is in the same barracks and they manage to keep the other boys fairly well confused. KPM, who landed on Okinawa on D-Day, says there are no other hams in his outfit. OUD and BMS are dreaming of a postwar houseboat down on the Grand River, with a portable rig, of course. 73.

NEBRASKA — SCM, Arthur R. Gaeth, W9FQB — KHBW-1, ROE at the mike, with BJR and AFG as visitors, added YDC, KHKN-52, and UEV, KHKN-30, to list of Omaha contacts. ZNI, KHBW-2, is attempting to complete relay into Lincoln, via Omaha, Ashland, Waverly, and Lincoln. UFD, KHKN-31, built m.o.p.a. rig, with an HY75 oscillator capable of 25 grid mills into an 829 final. QXP, KHKN-44, has HY75-815 m.o.p.a. on 2½, and reports that McCook Air Base has a T200 on 2½, and contacts a similar service in North Platte, which uses 829s, with S9 signals both ways. EKK, KHKN-2, is working on a remote control set-up from his store, which is about six miles from the radio shack. Cliff Allwine, KHKN-39, built a very FB 615 rig (unit 23) for CAP. CAP, at Omaha Municipal Airport, has applied for WERS permit for 18 units. SPM, KHKN-20, Plattsmouth, and Tom Jeffery, KHKN-17, have been issued new permits. YDC, KHKN-52, reports that the Council Bluffs gang has applied for WERS permits for 9 units. KHB1, Minnesota wing of CAP, was heard by KHKN-2 and KHKN-33, on April 23rd at 9:41 p.m. VKT, KHKN-9, copied KHBW-1 solid. YMU, KHKN-59, is attending night school radio classes at Omaha U. Mary F. Meyer, KHKN-33, nicknamed the "voice," is a new YL member of KHKN net and a member of CAP. Paul Rasmus, KHKN-15, reports school exams tough, what with competition from WERS operation. ZZG, KHKN-49, lacks iron in system to use body as reflector, as does VKT, KHKN-9. Ex-HZR, K6AMH is with PAA in Maryland, and mentions 9EW and Art Segal. JCK is waiting for WERS permit with a 6V6 oscillator and J antenna ready to go. FQB, KHKN-10, is conducting code drill practice three times a week for KHKN net. RUJ was reported missing in action. RIE is busy wiring houses in the country. BZY has been promoted to captain, and is plans and training officer. 4GFH, "Cellophane," is trying to crack John Hopkins U. GKL has a new home on one of the highest points in town. Pfc. LTL reports via a personal visit. RT2c SHH, was home on furlough, and has eight battle stars. Capt. HTE, somewhere in the Pacific, signed up for a correspondence course in municipal police administration. Anyone knowing the correct address of GAS, please contact this SCM at once. 73, *Art*.

NEW ENGLAND DIVISION

CONNECTICUT — SCM, Edmund R. Fraser, W1KQY — The sympathies of this section are extended to George N. Dunbar (LSPH) on the recent death of his father. At a recent meeting of the IRE held at Hotel Taft, New Haven, the following hams were present: IJ, IYV, JXP, and KQY. JQD reports his student, Joe Chernitch, has acquired a code speed of 12 w.p.m. Club news: IND, KAT, Fred Burkle (LSPH), and Bill Dayton, jr., were voted in as members of GB. Meetings are held Friday nights with attendance increasing. TD reports receiving a letter from Lt. BU, USNR, who has been at sea on various ships participating in several invasions. A letter from JPK, Sgt. R. Almon Bent, Chief Operator, Ships Complement, Casual

(Continued on page 64)



STOP us if you have heard this one before, but the design of a receiver involves personal preference as well as engineering skill. Returns on our question, "What is your idea of an ideal post-war receiver?" are still coming in, and the verdict is anything but a landslide for any one design. In fact, the nominations do not seem to be closed.

* * *

★ ★ ★ Take a detail such as controls. We ask of a receiver that it bring in the signal we want, as loud as we want, and that it bring in nothing else. This requires two controls, one to select the signal and one to adjust the volume. Any controls in addition to these two are necessary only because the set cannot give its best performance without special adjustments by the operator.

Does this mean that the best receiver has the fewest controls? Traffic men are inclined to say "Yes". They are only interested in results, and they want to get them as quickly and easily as possible. Newcomers give an emphatic "No!" They want to learn technique. The more adjustments they have at their fingertips, the better they can acquire the "feel" of a complex circuit. Technical men want controls, too. The set may be giving its best performance, but what fun is that unless it was their skill that accomplished it?

Maybe we should build a special traffic man's receiver, with adjustments as automatic as possible. Whether we do this or not, we shall certainly continue to make receivers with all significant controls brought out to the panel.

There is a school of thought that holds that if ten knobs are good, twenty knobs are better. If ten tubes are good, twenty tubes are far better. Never mind how many are needed.

We do not think that you want this type of design since an extra knob or an extra tube that does not contribute to the performance of the set is simply an added expense and a possible source of trouble. We plan to provide just as many controls as are needed to give the operator complete mastery of his instrument, and no more. We will use the minimum number of tubes to energize the most efficient circuits we can devise. We shall mind our P's and Q's, but mostly our Q's. For you know, if we take care of the Q, Performance pretty nearly takes care of itself.

* * *

We have found your suggestions very helpful. We are doing our best to interpret them intelligently, and follow them honestly and skillfully. Our designs are a composite of your experience and ours. We are sure you will like them.

DICK GENTRY



Post Office, Fort Mason, Calif., states he has two jr. operators, one eighteen months and the other four months old. For the past three years JPK has been sailing as chief operator on transports, and has visited many DX places, such as Saipan, Tinian, and the Marshalls. At the Masonic Temple in Brisbane he met Bob Carter, VK3, as well as other VK hams who were tops. The radio inspector at Brisbane, who checked JPK's gear, was also a VK3 ham. JPK prefers the intermediate to the high frequencies as there is less fading and they are more reliable over their effective range, which is about 5000 miles on 500 kc. with 250 watts to the antenna. While writing the letter 3000 miles from the States the West Coast stations were heard consistently along with one or two East Coast stations. WERS news: Steve Tabor, ex-radio aide, WJLH, West Haven, recently spent six days leave, having completed his boot training at Sampson NTS. Howard Peters, WERS operator from the same town, is also at Sampson. WJLH district radio aide and assistants KQY and FMV, along with Hamden and East Haven radio aides JQK and LTZ, attended a Waterbury radio aides' meeting at the QTH of Carl Weyand, WKWG-70, in Prospect. This location is 950 feet above sea level and is an ideal spot for WERS f.m. and television, as has been demonstrated. EER, IKX and Tuttle were also among those present. Eli Crumb, reporting for Norwich, says their monthly attendance has increased to an average of five units and operators. WJTR-6 has contacted WKWG-70, which makes the fifth district worked. Others are WJZA-5, WKOB-14, WJLE-61, WKNQ-1 and 25. His receiver is working very nicely and he has a new power supply under construction for TR-4. WJTR-5 is building a new receiver. Howard Pott, owner and operator of WKAO-31, passed away April 8, 1945. No. 40 was mobilized on V-E Day. Keeling, No. 44, stood by all day for any emergency. Joe Dietz, control operator at No. 40, is nearly ready and No. 25 should be "on the air" very shortly. Plans are under way, and a committee has been chosen for a WERS hamfest in June. With the closing of civilian defense activities, the Red Cross chapters around the New Haven area are interested in taking over WERS for a source of emergency communication, and plans are well under way. 73, Ed.

MAINE — SCM, G. C. Brown, W1AQL — During the severe storm of May 11th several of the gang from Maine, Massachusetts, and Rhode Island were on duty operating 221B radiotelephone emergency units owned by the New England Telephone and Telegraph Company. CGJ, of Portland, was stationed at Millinocket, forming a two-way link with IKP and AQL at East Millinocket. KGC operated a unit at Turner Village. NIV is in Italy after serving in the African campaign. NHT is power station agent for the Great Northern Paper Company at E. Millinocket. DTY is in the So. Pacific. 8BOQ and 8QGN are with the AACOS at Dow Field, Bangor. KOB, of Boston, recently was transferred from the CAA station at Millinocket to the Bangor station. Ex-CHF, Milton, Mass., was in Bangor, Millinocket and Winter Harbor recently on business for the A.T.&T. Co. JTH has passed the Eddy Test in the Navy, which entitles him to S1c and a course in radar. KEZ and NBK have renewed their EC tickets. Malcolm York, of Presque Isle, is planning to get his ham ticket after the war. George Pierce, a former K6, is making plans to settle down in Houlton. NBK has built a couple of record players and a speech amplifier. 73, "GC."

EASTERN MASSACHUSETTS — SCM, Frank L. Baker, jr., W1ALP — KBM is S1c (RT) in the Navy, and is located at Great Lakes, Ill. 9FFY has been promoted to captain in the Signal Corps and is located at Belmar, N. J. JDO has a new baby. The South Shore Amateur Radio Club held its regular meeting, and elected the following: IHA, pres.; JXU and MMH, vice-pres.; ALP, secy.; and LZW, treas. Those present were: HRF, LAT, CCL, DPI, CPD, DDO, NUP, JXU, MD, FWS, IS, MMH, LZW, IHA, ALP, 5JLO, Dan Hoxie, and the Mugford twins. Throughout the summer meetings will be held on the first Friday of each month at the Quincy YMCA. MTV, who is at N.R.L. in Washington, D. C., spent a few weeks in the hospital. CTR writes that he is busy at the same place. MQE is in combat on a Western Pacific island. LTR is in the Pacific area with the Navy. LVZ lost his bird. AGX went to New York. HWE has a new glass bird-feeder. JFS says he had a visit from MVQ and his XYL. ZZC is in Germany looking over their rigs. NVB is selling radio parts in Salem. 2BR sends 73 to the North Shore gang. EAU and his XYL have a new baby girl. 73, Frank.

WESTERN MASSACHUSETTS — SCM, William J. Barrett, W1JAH — JXE reports from Gardner that he is awaiting release from active duty. Harry has seen service in England, North Africa, Italy, and France as communications officer with the rank of major. Civilian Defense is going on an inactive status with local groups trying to maintain their trained personnel. So far Worcester, Pittsfield, and North Adams have signified their intention of carrying on as usual. Henry Richard reports from Ware that WKHF-54 has special permission to operate from the Quabbin Reservoir, 1250 feet above sea level, as a relay point in the statewide WERS net. MIM/8 says LAH is a radio operator in the merchant marine. LAH and KJO met at a dance in Liverpool. LBR is pounding brass in the merchant marine. LXE reports from "somewhere in Germany." MBL is in the Navy. MIM would like to know the whereabouts of MVN, MSV, EAX, KYI, and the rest of the gang. Dick Atwood reports for the Worcester WERS net, WJBB. The Mayor of Worcester expressed himself as being strongly in favor of continuing the WJBB net on a voluntary basis as long as authorized by FCC. WJBB-3 reports that WKHF-55 puts in a swell signal at Paxton. WJBB-8 uses 112.5 Mc. as calling frequency. Bob Martin, Warner Adams, Dave Sawyer, and Walter Dickson, of WJBB, have joined the armed forces. How about more reports, gang? 73, Bill.

NEW HAMPSHIRE — SCM, Mrs. Dorothy W. Evans, W1FTJ/4 — RM2c NMB reports from the Pacific area that NAZ is now an ART1c and is with an aircraft squadron somewhere in the Pacific area. BFT, who just returned from a trip to the radio-radar school at Corpus Christi, Texas, is substituting for your SCM this month, as she is back in good ole New Hampshire for a few weeks. CMB is at Pearl Harbor and he and LBD get together occasionally. ATE is apparently connected with a Navy radar school on the West Coast, after several years of sea duty. LVG suddenly showed up for a little leave after an extensive tour of duty with the USAAF in Europe. 73, Carl, W1BFT/4.

VERMONT — SCM, Burtis W. Dean, W1NLO — AVP has been promoted to sergeant in the Vermont State Guard and is communications officer for the southern part of the State. Bill also has his WERS operator permit. MUK has been discharged from the service and has settled at 46 Elm Street, Rutland. KUY and LJZ are stationed in the Canal Zone and enjoy their radio work. While home recently KXL dropped in on KJG at his office. KJG and family have moved to their new home in Morrisville. FSV's mother has subscribed to QST and is sending it along to Bob in the So. Pacific. KWB and XYL are the proud parents of a son, Guy Paul Lindsay, born April 11th. KVV is chief engineer at WHEB in Portsmouth, N. H. 73, Burt.

NORTHWESTERN DIVISION

MONTANA — SCM, Rex Roberts, W7CPY — KBM and Verne Spring were given a going-away party by the Butte Club. KBM has moved to Seattle and Verne has joined the Army. BIS, of Helena, was in Butte at just the right time to attend the party. Our sympathy to EMF, whose mother recently passed away. Frank Zubick is a new member of the Butte Club. FLT was in Baker recently and reports things humming on the ranch. KD4HDS is visiting in Baker awaiting assignment. DSS reports on the Great Falls gang: CC spent his leave in the Falls after being in the So. Pacific a couple of years. HEM, from San Pedro, was home on a short leave. EGN, formerly of Boise, Idaho, recently visited his parents in Great Falls; he says he has a radio shop in Fairbanks and will see us after V-J Day on 20-meter 'phone. FGZ, now in Libby, is doing his stuff but misses the old gang. DJR has moved to California. DSS has rebuilt an old battery superhet, putting in a Lamb noise silencer and crystal filter, and says it is a real set. 73, Rex.

OREGON — SCM, Carl Austin, W7GNJ — HAL reports that GOF, now CPO, was in Portland on leave, and that JL is out of the Navy. IEJ, still in Portland with FCC, has an XYL. He mentions that AOL is with the Army at Ft. Lewin, and FEE is in Baker Hospital, Spokane, after about three years in Australia. An FB letter from HBO, ARM1c at Corpus Christi, tells us the following: Met GWN, ART1c, who was high school classmate; GYH, ACRT, is back in the States; GIU, ACRT, is instructor at Ward Island; GVC, brother of HBO, contracted malaria, now is out with a CDD and is finishing college at Whitman. MQ, of Pendleton, says they had a swell hamfest at his shack. Those in attendance included MQ, KR, BKD, BEE, EZ, BDN, DXF, Marvin Eisenback, Bill Barraclough, Jim Bostwick, and Bob Harrell. FXS has been at KOAC for nearly three years as engi-



WHAT DO YOU WANT?

YOU
TELL
US!

WRITE NOW! You've had four years to dream about a new transmitter or a new receiver. Tell us just what you think it should be and what it should do. We've had four additional years of engineering and research during which we have better equipped ourselves to bring you the finest in communications equipment.

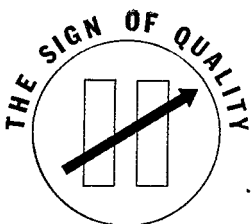

ESTABLISHED 1910

Send your suggestions to "Postwar Development"
DESK 11

HAMMARLUND

THE HAMMARLUND MFG. CO., INC., 460 W. 34TH ST., N. Y. C.
MANUFACTURERS OF PRECISION COMMUNICATIONS EQUIPMENT

meer-operator and possesses a radiotelegraph 2nd-class license. EOY is in Hawaii, in Navy electrical work. GVD is T3 at Indian Head, Md., doing maintenance work. He belongs to Maryland WERS and says they have a swell set-up. He also mentions that GZW is still farming at Aurora. FHB, instructor in radio at Eugene, sends the following: GQ has a bad case of "inertia," but is planning a local party soon; KL is trying to bribe someone to build him a recording amplifier; AGZ spent a short leave in Eugene, and mentioned meeting FJY in Naples; FBO, who is CRM, spent a two-weeks leave with his parents, and said that FHM, also CRM, will be home soon; SO has a snappy new service shop in Albany; Vern Sahnou is very QRL with studio job at KOIN. HLF says the WERS gang at Medford uses c.w. now with h.f. buzzers, and he has started his new rig, using 6L8-807 from ARRL *Handbook*. Power supply and rack are finished. 73, Carl.

WASHINGTON — SCM, O. U. Tatro, W7FWD — Olympia has applied for renewal of its WERS license with modification for the transmitters that have continued active. Miriam Brown (LSPH) reports on KFEY, Skagit County, as follows: KFEY-5 is preparing for 2nd-class telephone exam; No. 4 was recently married; No. 6 is working on code in preparation for amateur exam besides the building of considerable 2½-meter equipment; No. 7, of Anacortes, is heard in Everett; FXD, No. 8, of Sedro Woolly was heard from Clear Lake while mobile by KFNV-16, Mukilto, a distance of 35 miles; DQ, No. 1, is located at the foot of a little mountain; No. 2 is just sixteen years old, and JBH, No. 3, is the radio aide; KFNV continues active. IOQ soon will be using an m.o.p.a. at home and the TR-4 will be used exclusively in the truck; DYD, No. 14, is doing the building; No. 6 will test from a CAP plane; ZL, No. 9, continues as mainstay of the organization; IOQ called on Miriam (LSPH) and she forgot the coffee pot. BG, ARRL Director, has just returned from the Board Meeting. IVE is working at KMO, Tacoma, and is going to school. AHC is back from the So. Pacific and is in Washington, D. C. BTV, CRM, is now in P. I. waters with the Navy. IBM is working for EHQ, who is the sole owner of C&G, Tacoma; EXG, former owner, is trying to regain his health. AW, of Sperry detector car fame, was in Seattle recently but now is honeymooning. AEA, EC, was a recent visitor and passed out cigars because of the arrival on April 9th of Kathryn Ellen, weight 8 lbs. 2 oz. Comdr. KX, USNR, and Lt. EKW, USNR, are at Great Lakes. HWG is batching while his XYL is in the hospital. ERU has just acquired a new 20-watt p.a. system, and FWD, with the assistance of FWR, makes a few recordings, 73, Tate.

PACIFIC DIVISION

EAST BAY — SCM, Horace R. Greer, W6TI — EC, QDE; EC v.h.f., FKQ; Asst. EC v.h.f., OJU; OO v.h.f., ZM. The regular monthly WERS meeting was held May 17th in the Oakland City Hall control room. The subject of discussion was Class C amplifiers by Winsby, KFMV-35. EY returned from the Board Meeting and said that the League is very much on the job. DUB and TT just returned from a several-days fishing trip with reports that fish are as scarce as ham radio operation is at the present time. Saw GEA the other night; he looks FB and is working hard. All the Red Cross girls who took the 3rd-class exam passed and are now awaiting their WERS permits. In the near future a WERS rig will be installed in several Red Cross mobile units. TI and TT announce that they have completed installation of the interoffice and public address system at Red Cross Headquarters to be used in any emergency that may arise. "Another day closer to victory." TI.

SAN FRANCISCO — SCM, William A. Ladley, W6RBQ — Phone Randolph 8340. ECs, DOT, KZP. OO u.h.f., NJW. FYN, of North San Juan, was discharged from the services, went to work for S. P., was injured and now is in S. P. Hospital. He has a Simpson tube checker and a Supreme volt-ohmmeter for sale. LLW of CCN-SFN nets sends in a V-mail letter from Cpl. CLV, now in the Signal Co., who says there are thirty-five hams from all districts in the outfit. CIS is in the Philippines and wants letters from the old San Francisco gang. EAR is in Seattle and expects a furlough soon. Lt. KB6ILT is living in Napa with duty at Skaggs Island. Capt. HJP writes in from the Far Western Pacific stating mosquitoes the size of P3s and plenty of bed bugs are giving him a bad time. Write to the SCM for the addresses of LLW and HJP. PIV is busy monitoring and helping crippled boys at Sacramento Hospital. 9EKY, at Pearl Harbor, advises that Comdr. Glenn Glasscock paid

him a visit before moving west. He heard from Sgt. 9ICN, also moving west with USMC. Dale's wife, 9ILE, now is back home in Alton, Ill. VE4GU, of Australian radio fame, is covering the Peace Conference here for Aussie newspapers and spent an evening with RBQ. NGV and his son visited State Guard WERS control. Hal still is with the WPB. Director 6EY spent his annual vacation attending the Directors' Meeting in Hartford. Mac reports that our frequency situation looks good. Maj. ZF is home for fifteen days, the first time off in over three years. 1st Lt. RH is reported back in town after a long time abroad. State Guard WERS is going strong with increasing interest. Amateurs located in northern California cities and towns that have State Guard units are requested to write the SCM for details concerning State Guard WERS. 73, Bill.

SAN JOAQUIN VALLEY — Acting SCM, Edward H. Noack, W6BXB — 9VSU, ex-GXL, formerly of Turlock, now in Chicago, is assistant inspector for the Navy and part time television engineer for a Chicago organization. RFN is with the Signal Corps somewhere in England. RM1c RFO, of Modesto, is in a Navy hospital somewhere in the Pacific area. The SCM had a lot of visitors from Stockton. NGW, who has just returned from the Aleutian Islands, is stationed in the Ferry Building in San Francisco and is in charge of all radio equipment. HIP, who was warrant officer and instructor in radio at Treasure Island, is on his way to the Pacific area in charge of radio equipment. DTJ, who was instructor in radio at Treasure Island, will leave for the same area soon. Ex-OAV, now a K7, has an honorable discharge after about five years in Alaska and the Aleutian Islands. He now is located in San Diego. PNM was in town recently; Ralph is code instructor in the Army at Tucson, Ariz. JIN is back as auto mechanic at Buick Agency. 73.

ROCKY MOUNTAIN DIVISION

COLORADO — SCM, H. F. Hekel, W9VGC — Bob Perski is in Gulfport, Miss., as radioman in Co. I, 2nd Platoon, NTS. T5 QDC was in Italy on April 10th. His XYL is going after a ticket, and that may put him to doing the housework and looking after the baby. Anyone wishing to write to Harry should get in touch with the SCM for his complete address. EHC went through Denver on a hurry-up trip and took his auto back with him. JBI is reported home on sick leave. CNL is back at his home base at 25 Emerson St., Denver. QYT is away back in the hills on a vacation and (off the record) is looking for a place to do some fishing. YKP found a vacant apartment back East and Donna and the two babies are leaving to join him. FYY is with Western Electric in New York City. WYX and 3JIN have been taught the uses of the twenty-four-inch gauge and the common gavel and are preparing to hie themselves to the top of Squaw Mountain to continue the construction of "The Temple of 30,000 Megacycles" (Crystal-controlled). (?) 73, by Heck.

SOUTHEASTERN DIVISION

EASTERN FLORIDA — SCM, Robert B. Murphy, W4IP — TZ is jumping around out in the Pacific like a hen on a hot griddle. Hunter is doing a Raytheon field engineer's job. COW has been out island-hopping for some time. Bill Meadow, of WFLA, and Johnny Fussel, of Tampa, are in Brooklyn. FYI and AWS are out in that country too. A letter to KK from HJQ says that Webster is back in the Pacific area or somewhere on the West Coast. Red is radio officer in communications set-up with the rank of full lieutenant. 1FAN is going through Raytheon School at Waltham, Mass. and sends his 73 to all the WKDL gang. Jones is getting set to be a field engineer; he met IMIR in N.Y.C. and Witherspoon is now in the merchant marine. EYI, of St. Pete., says DWU, now a lieutenant in the Signal Corps, expects overseas duty. We extend our sympathies to Spence, EC for St. Petersburg, on the passing of his mother. FWZ comes through with an excellent letter of the Jax doings. Hollister, jr. is a lt. col. in the State Guard and from reports from MD, of Miami, and ACZ, of Lake Worth, is doing fine. Col. FWZ is at the Army and from his letter he seems to be there on Monday nights. DU is warrant officer with the CAP. GIL is in France. HRB just returned after thirty-five flights over Germany. JU is with the Signal Co. Labs in Clermont. We understand AOK is there too. AWE still is in Jax and is planning a Calkillywatt. SUBN is with Eastman in Jax. ACZ is in Lake Worth polishing his bottles getting ready to be the first one on the air. MD is holding up the Signal Co. end of the game here in Miami. Hollister has

(Continued on page 68)

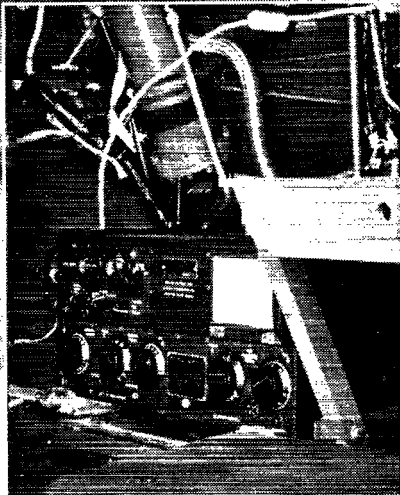
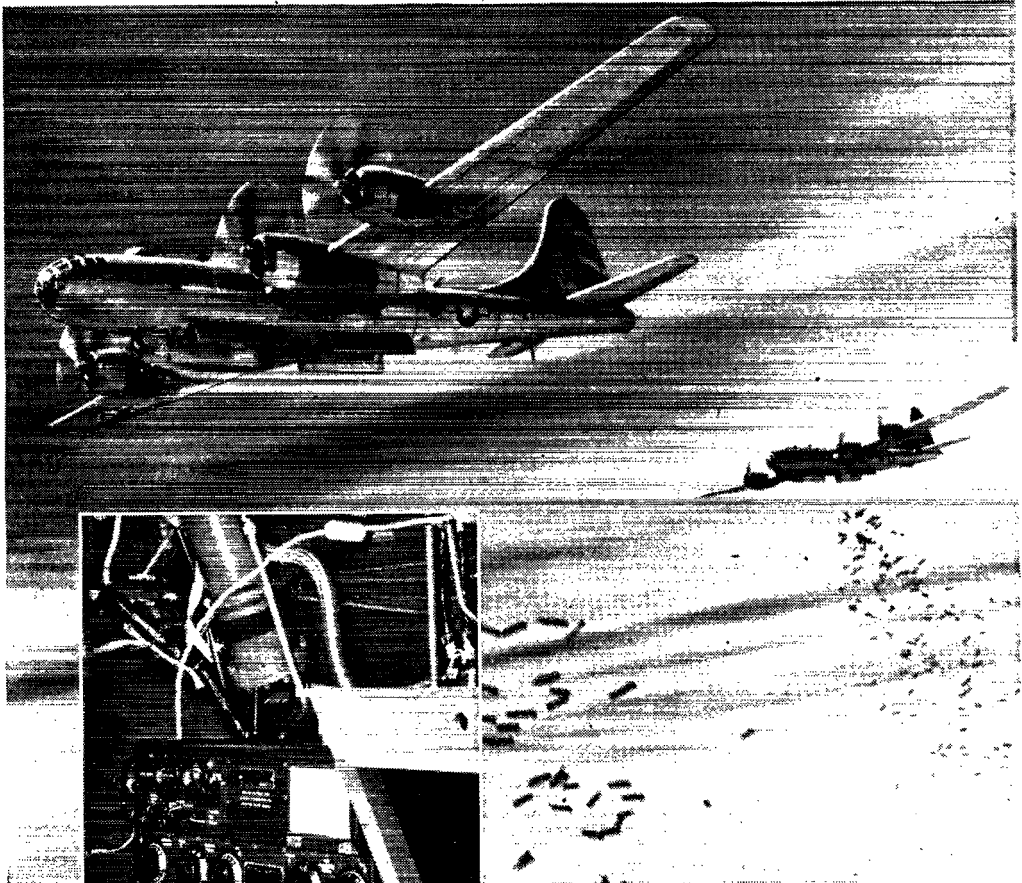

The Collins-designed transmitter as the operator sees it from his station in a Superfortress. Boeing—Wichita Photo.

Superfortresses blast and roast the Japs. Official photo U. S. A. A. F.

In the Boeing B-29 from the first

THE FIRST MESSAGE from the Army's first Boeing Superfortresses over Japan, on the Yawata mission of June 15, 1944, was transmitted by a Collins radio transmitter of the type shown above. From that time on, this transmitter has been standard equipment for all the Superforts, as it is also for the larger Naval aircraft.

As the Army and Navy demand increased, requirements exceeded the capacity of the extensive Collins facilities, and other manufacturers of radio equipment were drawn into the production program, aided by Collins engineers. Total deliveries have been very large.

Collins engineering and production have gained much valuable experience during the war in providing reliable radio communications under all operating conditions in practically every quarter of the globe. This experience will be available to commercial and personal users as soon as military requirements permit. Collins Radio Company, Cedar Rapids, Iowa; 11 West 42nd Street, New York 18, N. Y.



IN RADIO COMMUNICATIONS, IT'S . . .

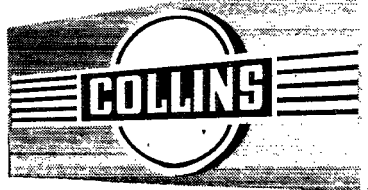

DC from AC

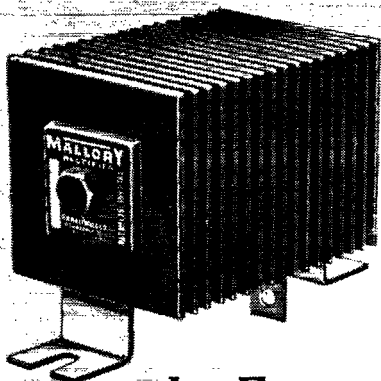

*the Easy,
Economical Way*

For battery charging, electroplating, energizing magnetic chucks, there is no substitute for direct current. There are countless other applications where it does a better job than alternating current. They range from operating train models to powering motion picture arc lights. High gain speech amplifiers, for instance, can be made more hum-free by operating the tube heaters from d.c. Solenoids and electromagnets operate smoothly and without chattering when powered by direct current.

Low voltage, direct current—from a watt to kilowatts—is easy and economical to obtain with Mallory Magnesium-Copper Sulphide Rectifiers. There are 20 years of commercial manufacturing experience behind them. No risks or experiments are involved when you use them.

Full details are incorporated in Form R-615, available without charge from your Mallory distributor or from the factory. Inquiries from manufacturers whose products employ dry disc rectifiers are also invited.

P. R. MALLORY & CO., Inc.
INDIANAPOLIS 6 INDIANA



P. R. MALLORY & CO. Inc.
MALLORY

Amateur Activities

(Continued from page 68)

sixty-four men in the Signal Co. of the State Guard. Wouldn't it be fine if we could tie this gang in with the WKNW WERS net in Miami. We already work one of his men, WKRW-36, in Ft. Lauderdale. AHZ has a fine station atop the Sweet Bldg. FWZ has thirty sets to use on 3655 and will be on the go after the encampment. The local WERS is planning big things. The fellows are so enthusiastic over their sets that they are planning to finance the set-up if Dade County will not. We are planning to get seventy-five stations on the air instead of the present 45. No. 2 received a letter from Togores, of CMI in Havana, that he had been heard down there, with Bowers one-quarter-wave coaxial stub. NB has put up a new antenna, extended Zepp, and hopes to cut down the directional effect. No. 7 and No. 13 are getting some new rigs on with full 25-watt input; No. 8 has a nice signal and is heard all over town; No. 9 has got his set going; No. 10 is having trouble keeping on frequency but puts in a nice signal to control; No. 11 is running portable and fixed with a 1'l'i.c.w. practice on the side; No. 14 has one of the best mobile rigs in the net; worked him recently from control NW of Ojus, about 15 miles DX; No. 16 has now worked in to Ft. Lauderdale; No. 17 works mobile with ease; he also has No. 27 as a fixed station; No. 28 works his rig inside an apartment with no outside antenna; No. 30 still is control and is being manned by ex-hams; No. 31 is really an experimental lab; No. 32 is doing nicely with his mobile and is letting Francis handle No. 31; No. 33, another mobile, is working an Abbott in his car; No. 36 is getting ready to go south for PAA; No. 37 is rebuilding and checking his rig; No. 39 is doing experimental work while on his vacation; No. 41 is putting out a good signal all over town with an Abbott; No. 43 is heard at times being located in Ojus; No. 45 is dividing time with 2 because of a regenerative receiver. This net consists of mechanics from PAA, Navy technicians, both civilian and Navy, youngsters, broadcast engineers, clerks, and radio repairmen. 73, *Merf.*

WESTERN FLORIDA—SCMI, Oscar Cederstrom, W4AXP—Lt. MS, one of the section's outstanding hams, has returned to his old stamping grounds after a long sojourn in the land of W3s. Eddie brought back a set of color movies of hams he met up there. They show 3IV, BES, DE, JPE, FWL, GNA, IOV, JKL, and QV. MS and DAO paid a visit to AXP recently, set up the movie machine and gave us a real glimpse of what some of our over-the-air acquaintances look like. After a nice three-way QSO in person, MS, DAO, and AXP loaded up in MS's car and visited 6PNI, ECT, FJR, and HJA over on Navy Point. HJA was visiting ECT and FJR. AXF, the better half of MS, went through a serious operation but is up and about again. MS will have GBM and 6PNI as office associates for awhile. AXP paid a visit to GBM. GBM rebuilt a radio and it really performs. EJE heard from FUA, an old friend of his in Charlotte, N. C., and FUA is the proud papa of a son. FUA is a 10- and 20-meter fan. AXP has gotten some fine pointers on variable condenser building from MS. 6AXV, USN retired, renewed acquaintance via our column in QST with John Blackman, who was a former shipmate. Sgt. EPT, a radio instructor in the Marine Corps, inquired about EQR and EAD. Yerby, an instructor in the radio department of A and R here at Naval Air Station, passed his exams for the services. One of the newest of Whaley's poems is "Old Sparkie." 9ADI, an old-timer from Milwaukee, Wis., is here. DAO is progressing nicely in the reconstruction of his shack, which is a part of his dwelling. ECT and FJR received a fine letter from EGO giving a lot of dope about the gang down around Panama City. From information we get there are quite a few readers of QST at Tyndall Field, Eglin Field, and some of the Navy fields in Western Florida. EGO is working with the Signal Corps at Tyndall Field, and is getting some swell experience in radio. EGO reports on the following hams at Tyndall and Panama City and vicinity: The captain is ex-9OBI; 4AFJ is a sergeant. He is from Winter Garden and is a c.w. man. Sgt. HVT comes from North Carolina and is an f.m. expert. QZB is getting an ECO ready for the big day when we go back on the air. 5JVE, ex-4JB, is a foreman and hails from Jackson, Tenn. FJM is collecting pictures to put on the walls of his shack after the war. GVH is in business as a groceryman in Millville. GTJ is determined to be on or in the air so since amateur radio is out for duration he has been doing a lot of flying. BJF, an old-timer in c.w. and 'phone and an active member of AARS, has been closely linked up with state radio activities during the war. Besides his other du-



No matter what the Frequency

BE SURE YOU'RE ON IT!

The postwar Browning Frequency Meter, like pre-war and wartime models, will assure you of meeting FCC requirements.

Like its popular predecessors, it will be a boon to amateur, police, aircraft and other mobile services.

Continued, whole-hearted devotion of all Browning resources and facilities to war service demands prevents any "unveiling" of the new Browning Frequency Meter at this time.

When it does come, it will reflect the expressed desires of many who have written us about it. It will be exactly what you want.

You'll be glad you waited for it!



BROWNING

LABORATORIES, INCORPORATED
WINCHESTER, MASSACHUSETTS

PORTABLE POWER PROBLEMS

THIS MONTH—PATHE NEWS RECORDING AMPLIFIER



PORTABLE SOUND EQUIPMENT used by Pathe News' Washington staff must be ready for instant action, rain or shine. To meet all requirements of newsreel work, Pathe News engineers developed a light-weight sound amplifier—powered by a special, flat type 180-volt Burgess Battery—with sufficient output in milliwatts to operate the mirror galvanometer. Burgess engineers worked closely with Pathe sound experts to develop this battery (photo lower right).

UNUSUAL ELECTRONIC APPLICATIONS for battery power are the specialty of Burgess engineers. Ask for their help on your dry battery problem. In addition to developing batteries for specific needs, Burgess engineers have made a line of Industrial Batteries so complete that one of the standard types may be ideal for your special requirement. For further information on Industrial Batteries, see your Burgess distributor.

Burgess Battery Co., Freeport, Ill.

SAVE MORE PAPER—SEND IT TO WARI



BURGESS BATTERIES

(Continued from page 68)

ties, EGO keeps the radio entertainment system perking at the hospital at Tyndall Field. Lt. Comdr. Cooper, executive officer at Corry Field, is amateur radio operator and an old-timer at the game. Bill Langford has been snowed under with radio work. He is looking for television gear. Letters from readers at all the Army and Navy flying fields and Army forts of Western Florida will be greatly appreciated. 73, from "The Old Maestro."

SOUTHWESTERN DIVISION

LOS ANGELES — SCM, H. F. Wood, W6QVV — We recently had the pleasure of getting together with MFJ, who was on leave, and UQL, who was released from the hospital in Washington. SSU has taken a very FB job with an airline company, being associated with FUS. The Valley Radio Club invited us to one of their regular Friday meetings at the home of SRJ and, in addition to SSU and FUS, we were glad to greet JXZ, EFL, QNW, RMZ, KBI, and Bill Tuers. HHJ was home from Navy duty and some very interesting experiences were related by him and others that had seen service. A hamfest is scheduled for May 26th by the Altadena group of the Los Angeles County WERS nets. A fine letter was received from IAH, who says that he is stationed in Navy Radio (NAD), Boston, in charge of the transmitting station, after sea duty with the Seabees. Stan says they have ham transmitter there which was revamped for their frequencies and that it "puts out more juice, watt for watt," than any other transmitter they have. It uses a 6L6 crystal oscillator, driving a Gammy 24 buffer into p.p. Gammy 54s. The blueprints say it was designed by "Kramer." If any of you know him tell him about this and ask him to write to Stan at Communication Office Bldg. 39, Boston Navy Yard. KGIC, Inglewood net, is reported by able Radio Aide Fred Stapp to be functioning very well. Application for modification of the license is now on file and if granted the net will be expanded considerably. Fred reports a lot of work has been done by the fellows on crystal-controlled rigs and super receivers as well as improvements made in antenna systems. Another very successful "incident" drill was held recently and the mobile units showed up very well in the handling of emergency traffic. The KGWE and KGCL nets are both very active on the drill periods. The KGLV net is working out better and better at each drill period and considerable work is being done on new gear. Stan Lambert has done a great deal of work himself, and with others in his area and Don McCoy and Rudy Jenson has done likewise in the Valley. Earl Rau has about the best receiver we have run across in the group and we understand that a number more are being made. GZZ continues to "hold 'em in line" with his constant monitoring of frequencies and now has an assistant or two to help out. Had the extreme pleasure of meeting EPA in the office recently. After a brief chat he coaxed ESX into playing hooky from his desk for the rest of the day and they flew up to Bakersfield on business. It's really a shame that his office and that of AEL are so close together, or maybe that was arranged with malice aforethought as considerable time is spent in discussion of the relative merits of this or that antenna, tube, or what have you. 73, and good luck to all, Ted.

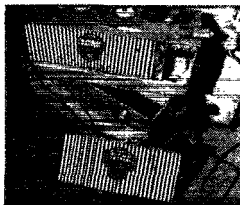

ARIZONA — SCM, Douglas Aitken, W6RWW — Doug still is on the sick list and MLL is writing this report. Doug is improved but not yet out of the hospital. NRP is in the Philippines pounding brass. PDA is back in Phoenix after an eleven-months stay in Santa Fe. FZQ expects to go to officers training school to increase his rank from captain to major. MAE is working at Papago Prisoner of War camp. ROP's gear was auctioned off and NGJ bought his 1/2-kw. rig. TBR has a fine litter of pups. The Tucson Short Wave Club is working on WERS with twelve hams being interested in tickets; WERS gear shown at their last meeting caused great enthusiasm. They are conducting code classes for the Chinese Cadets at the Air Base. S1c LKE is in Washington, D. C., after many war experiences and reports seeing KFC there and PQQ and NGG in the Islands. SCK took the second-class 'phone exam at Phoenix in April. KOL sold his house in Nogales. Frank Amado (LSPH) is in England as a co-pilot on a B-17. Tucson High is offering a class in theory review for the radar exam, classes beginning the last of May. 73, G. C.

SAN DIEGO — SCM, Ralph H. Culbertson, W6CHV — Asst. SCM, Gordon W. Brown, W6APG, Dewight Williams and Red Wyatt of Long Beach were visitors in San Diego recently. Suggestions were made on the frequency operation of WERS of approximately 113.6 and 113.2 Mc. NDD is

It must be made of

Steatite

WHETHER in the field of communication (high and ultra-high frequency) or in the various industrial electronic fields, there is no substitute for Centralab Steatite.

There are no other materials that can be made in as many varied forms and shapes as Steatite. Our engineering and laboratory facilities are at your disposal.

Producers of VARIABLE RESISTORS — SELECTOR SWITCHES — CERAMIC CAPACITORS, FIXED AND VARIABLE — STEATITE INSULATORS — AND BUTTON-TYPE SILVER MICA CAPACITORS.



Centralab

DIVISION of GLOBE-UNION INC., Milwaukee

WANTED

More Raytheon Field Engineers TO SERVE THE NAVY

In the U. S. or Abroad

THE NAVY has asked Raytheon to greatly expand its Field Engineering force to take care of the Raytheon Electronic Equipment now playing a vital part in all naval operations.

Raytheon invites you to join this essential group if you have (1) practical experience in building amateur rigs, (2) extensive experience in installing or maintaining classified military electronic equipment during the war, and (3) are physically fit. The job is supervision and installation of vital radio detection gear at a United States base or Naval activity abroad.

You will serve the Navy, and you will gain experience of inestimable value in any future position in this growing field.

WRITE TO CLARK C. RODIMON, W1SZ, Raytheon Manufacturing Company, Field Engineering Division, Waltham 54, Massachusetts. All hiring will conform to War Manpower Commission regulations.

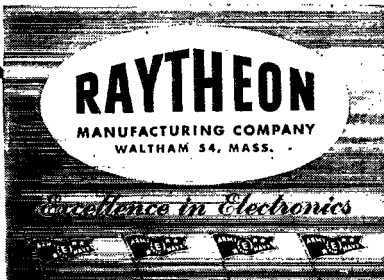

(Continued from page 70)

back at work after an FB vacation. OIN has finished an FB 1 $\frac{1}{2}$ - and 2 $\frac{1}{2}$ -meter four-element horizontal beam, electrically controlled and mounted up on the old familiar pole. LSV, who was around town recently, has returned to the So. Pacific as 1st lieutenant in the Marine Corps. DUP will be in the hospital for a minor operation and LYY is reported as being quite ill in the Naval Hospital. TBI is leaving La Jolla and moving to his new home in Pacific Beach. RPJ has opened a new radio shop in San Diego. FTT is in the So. Pacific with Raytheon. QEZ, in the So. Pacific, has been promoted to radioman 1st class. AYA is reported to be flying for Convair. 73, *Ralph*.

WEST GULF DIVISION

NORTHERN TEXAS — SCM, Jack T. Moore, W5ALA — BAM reports that he is ashore at the Naval Air Station at Daytona Beach, Fla. after thirty-nine months continuous sea duty on carriers as assistant communications and radio officer, with the rank of lieutenant in the Naval Reserve. Gene says 4ASR, a former Texan, is with him and that AUL has completed his third landing, while BKH is in a CVE. BAM would like to know the present QTH of PJ. IZU, an instructor for the last couple of years in the Signal Corps Radio School in Tyler, is instructing in radio code, repair, and maintenance at Tyler Commercial College. Frank sends the following about other Tyler boys: HJJ is a 1st lieutenant in the Signal Corps and is stationed in Hawaii; IBM is supervising the drilling of oil wells for his own company; the last word from KDP was during his training at the Great Lakes Naval Station, at which time he was seaman first class; DAA is with the FCC in El Paso; EME recently joined the teaching staff of the U. of Texas; KJO is in charge of the Tyler police radio and is thrilled over the new f.m. equipment that has just been installed; PH is pushing a pencil for the railroad and is keeping up his interest in photography; HWD is a lieutenant in the Air Corps and IZU thinks HWD is a communications officer stationed in Florida; ASA is kicking around Longview; KHN, EUI, and IYJ were in civil service work when last heard from. GKB has returned to McCamey, where he is doing radio service work. KGE is building a signal tracing unit and is doing a little radio service work on the side. E. M. Gettys, jr. (LSPH) suggests that the ARRL do all it can to help the fellows that have received their licenses since Pearl Harbor to get on the air on opening day. GZZ is RM1c and says that the radio equipment he and 3IOM work with is enough to make any ham's mouth water. VV has been promoted to the rank of colonel. BNQ reports that FIV was home on leave for a few days. ICB is teaching radio to the McKinney CAP. IIA is the only ham left at Slaton and sends the following information on other local hams: INM is an aircraft and radio maintenance engineer and is stationed at Selman Field in Monroe, La., where he flies in C-47s; IBC is chief radarman on a destroyer in the Pacific, and recently finished a three months' advanced course in radar in addition to passing the exam for his Class A amateur ticket. VU is the author of a new textbook on radio. AJG has a new v.h.f. superhet which is really hot. GZH advises that IFY is working for the National Geophysical Company in Dallas. Griff says EQJ has left WFAA to go into business for himself and HQA is working for the telephone company in Hillsboro. DXR wants to sell his NC200 and 80X receivers. APW reports that the post office and drug business is keeping him busy. He sends in the following: GLW is servicing BCL sets in Decatur; CUA is playing with miniature photography; DO sends out "Report for Induction" notices from Jacksboro; IWZ is chief troubleshooter for the telephone company at Frederick; VQ is operating the Ft. Worth Radio Supply. NW reports that he attended the Board of Directors meeting in Hartford. CDU would like to know the QTH of ISD. Joe reports a visit from FDR, who was passing through Dallas on his way to Maryland for some special schooling. FDR was recently awarded the Congressional Medal of Honor. CDU advises that JFF is in charge of the radio range station in Shreveport. GTL is a staff sgt. in the AACS in Alaska, and CJJ is stationed in Corpus Christi. 73, *Jack*.

SOUTHERN TEXAS — SCM, James B. Rives, W5JC — EHM is with the Ground Training Technical Advisory Department at Randolph Field and reports the arrival of a jr. operator. Ex-IW is in the Navy and is stationed at Corpus Christi. 6IPA, ex-7BB, is teaching code at San Antonio Aviation Cadet Center. BI suffered a heart attack and is in the hospital. R. C. and L. F. Hall report that there are thirty WERS units in Houston and about ten more in



Skilled fingers check every connection before this Meissner electronic equipment leaves Mt. Carmel Ill., its destination—"Somewhere with the Armed Forces." This "precisioneering" may make the difference between a successful military operation or a defeat, and Meissner's "precision-el" are working for victory.

THIS IS PRECISIONEERING by Mt. Carmel's famed "Precision-el"

Precisioneering isn't just another word for precision quality. It means that pride and skilled craftsmanship are represented in every product. To the men and women of Meissner, precisioneering means that they are maintaining the same high standards of workmanship that earned them the name "precision-el"—highest standard of an exacting industry.

To you, the users of Meissner precision-built electronic equipment, it means that these precisioneered products give you added quality, greater dependability.



Precision testing in Meissner Laboratories proves the precision quality of the work of Meissner "precision-el." It means new highs in performance when you specify Meissner precision-built electronic equipment for your product.



Concentration on the production of finer electronic equipment is characteristic of the men and women of Meissner. This devotion to quality production makes "precisioneering" out of even the most routine jobs—gives even greater skill to technicians like these.



"Step Up" Old Receivers!

These Meissner Ferrocart I. F. input and output transformers are getting top results in stepping up performance of old worn receivers. Special powdered iron core permits higher "Q" with a resultant increase in selectivity and gain, now available for frequency range 127-206. Ask for numbers 16-5728 input, 16-5730 output. List \$2.20 each.



MEISSNER

MANUFACTURING COMPANY • MT. CARMEL, ILL.

ADVANCED ELECTRONIC RESEARCH AND MANUFACTURE
Export Division: 25 Warren St., New York; Cable: Simontrice

COMPLETE EQUIPMENT FOR THE RADIO LAB



No matter what you need for your radio laboratory . . . amateur . . . industrial . . . or experimental . . . you can get it quickly and easily at one of NEWARK radio stores. Test equipment, small tools, complete supplies of parts. Order everything you need from the NEWARK store nearest you. We ship every possible item right from stock, and promptly advise you probable delivery on any unfilled part of your order.

WESTERN ELECTRIC MICRO-AMMETERS

\$7.50

150-0-150. Bakelite case, fits 3 3/4" hole. Radium dial . . . can be reversed for your own calibration. A perfect production and laboratory test meter. Can be adapted to oscillator, bridge, and crystal circuits. Indicates null, output, and polarity. Immediate shipment on priority L265 or better.

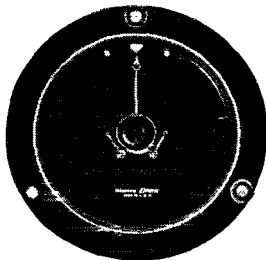

GENERAL ELECTRIC METERS

- 0-500 DC MA 2" round Bakelite case. \$3.50
- 0-8 RF Ammeter 2" round Bakelite case. \$4.00

THORDARSON TRANSFORMERS (Power Transformers and Chokes)

Immediate delivery on Priority L265 or better

- T-45556 or T-92R21 leads out of side. 778 V. C.T. at 200 MA. 115 V. 60 Cycle 6.3 V. C.T. at 5 A. 5 V. at 30 amp. 9 lbs. \$5.29
- T-13C30 8 H. 150 MA. 200 ohm 1600 V. Insulation 2 1/4 lbs. \$1.41
- T-45557 or T-74C29 leads out of side. 15 H. 150 MA. 200 ohm 2000 V. Insulation 5 1/4 lbs. \$2.82

ORDER FROM YOUR NEAREST NEWARK STORE

Newark service is now available both from New York and Chicago. 90% of all amateur and industrial radio labs are now within 24 hours from a Newark store, where your orders and inquiries will receive prompt and technically intelligent handling.

NEWARK ELECTRIC CO.

2 stores



323 W. Madison Street, Chicago, Illinois
115-117 W. 45th St., New York

(Continued from page 72)

the tri-city area around Goose Creek. Recently fourteen units went to the bay shore, some operating as portable units, others as mobile and one unit on top of the San Jacinto Monument. Test messages were handled between the mobile and portable units and the station in the monument, from which point they were relayed to the control station in the Houston Police Headquarters. AMX is servicing motion picture equipment for Inter-State Theaters. We received a nice letter from Division Director NW giving all the information on the annual Board Meeting. 73, Jim. NEW MEXICO — SCM, J. G. Hancock, W5HJF — Harold Wheeler (LSPH) was wounded in Germany. KCW is going round'n'round with a model of the wire recorder which appeared in a recent issue of QST. ISN is so busy with his new metal-turning lathe he is having a hard time keeping his customers' radios repaired. HJF has lost ten pounds from forgetting to eat and just sitting looking up at his new sixty-foot telephone pole antenna masts. 73, Jake.

The Month in Canada

(Continued from page 59)

4EA, Roy Usher of Edmonton, was cameraman for the Edmonton Cine Club Group whose picture took second place in the group picture contest. The picture in which yours truly took part placed third on the list, but we had a lot of fun producing it anyway. Sorry to report that illness is still dogging 4VJ, Ken Angus of Edmonton, and he has been confined to bed again recently. You chaps will possibly wonder what happened to the March-April report from Alberta. Well, I was busy studying to write professional examinations, and just couldn't spare the time to whip up a report. Now that the exams are over (no results yet) I can get back on schedule with the monthly round-up of VE4 news for you, and I'll try not to let you down again! By the way, my rig has been wrapped up in paper for the past five years. A week or so ago I had a phone call from 4BW, Ted Sacker of Edmonton, who was stuck for an O-200 Triplett meter for some equipment that had to go North. Yes, I "unveiled" the rig long enough to remove the meter. It is the first piece of equipment that has been stripped from my rig. I saw 4AHQ, Archie McMullen of Edmonton, a week or two ago, and he is busy flying into the North these days. He sold his rig some time ago.

MANITOBA — VE-1

From A. W. Morley, VE4AAW:

CONGRATULATIONS this month go to 4JN who was presented with the British Empire Medal by the Governor General who was visiting Winnipeg recently. Nice going, Lloyd, and keep up the swell work. Was talking to 4VD on the street and Fred is all keyed up to put a kilowatt on the air as soon as permission to let loose comes through. 4HC of Fisher Branch, according to reports reaching me, is an instructor in the Army and is located in Calgary. Please confirm this, Steve, and drop me some dope while you're at it. Had a letter from 4PA at Dauphin. Lyall says the Dauphin boys are all talking of the things to come. 4TQ has a power supply as big as a trunk that is panting to let loose. 4XP takes out an RK20 and shines it faithfully every week. 4AFF has moved to Flin Flon. Lyall also reports, "Cece Patterson, 4WW, who was really an old-timer at the game is a Silent Key. He was a Tel. on the corvette Windflower and was lost while on leave in Glasgow during an air raid in the spring of '41. No trace of him has ever been found, and his ship was lost shortly after he was reported missing, so it was very difficult to trace him." How about some news from ABE, ALT, and TJ. Remember fellows this is your column.

Allocations Below 25 Mc.

(Continued from page 16)

with plans beginning to form for a world-wide conference by the spring of next year. We should have further news to report on this part of the spectrum in our next issue.

— K. B. W.

A McELROY "Flash"

to communications men
all over the world . . .

WE HERE AT McELROY have been making communications equipment for almost a quarter of a century. Ever since 1939, the Army and Navy have been favoring us with their business for our products. So, you see, we're not a war-born contractor. We know radiotelegraphy from the ground up . . . from Ted McElroy down.

Quietly, and without any fanfare, we've been working on a number of new ideas to still further advance the art of radiotelegraphy. Now, all the development and experimentation are over. We're set. We're tooled up. And our production lines are now turning out . . .

New Tape Perforators

. . . in one unit of great ruggedness and simplicity at an amazingly low price. Small, compact, and ideal for the preparation and despatch of automatic radiotelegraph signals—on land, sea or air.

New Auto-Head Transmitters

. . . of radically improved design and operation. A special feature prevents dirt and glue from entering the mechanism. Operates at speeds from 15 to 525 words per minute. A remarkable development in mechanical auto-head transmitters.

New Recorders

. . . capable of tremendous speeds, but designed basically for speeds up to 500 words per minute, the speed that all radiotelegraphers know is practical.

The coming months' issues of this, and other magazines, will reveal these and other units such as amplifiers, tape pullers, etc., along with their complete story. Watch for them.



McElroy MANUFACTURING CORP.
82 BROOKLINE AVE., BOSTON, MASS.

WORLD'S LARGEST MANUFACTURER OF AUTOMATIC RADIO TELEGRAPH APPARATUS

The little Part

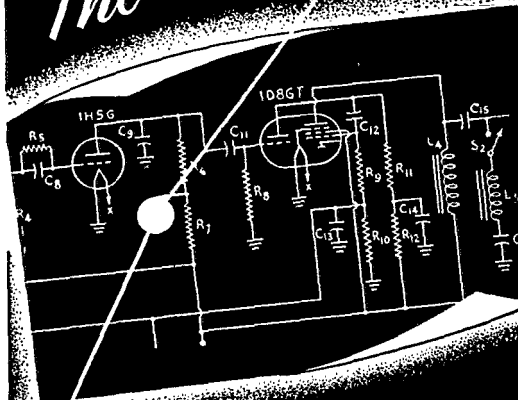

that wasn't there!

Nobody knows why — last minute design changes, delayed shipments, "upped" delivery requirements — but the cry is "Get it now!"

Then it's RADIO SHACK to the rescue. Our comprehensive stocks of electronic parts and instruments, and our super-expeditors "on the ball" with coast-to-coast contacts, produce rapid results in finding critical components.

So, for help in a hurry, call RADIO SHACK first... call CAPitol 7530

P.S. Our new 108-page catalog is free to engineers, purchasing agents, designers, schools and colleges, and government agencies; write, on business letterhead please, for your copy of this useful handbook.

BUY MORE BONDS

The RADIO SHACK
167 WASHINGTON ST.
BOSTON, MASS., U.S.A. ★

Correspondence from Members

(Continued from page 55)

brought out any new models of that jitterbug bottle? And what does a fellow use for L/C on 10 centimeters? If the frequencies get much higher we will have to include a precision micrometer and lathe as standard equipment.

Another question is this: the ARRI was founded for the express purpose of facilitating the handling of traffic. There will be a large number of boys in the service who, when they get their ham tickets, will want to handle DX traffic. How will we find room for them all? Should we limit the low-frequency bands to traffic of a DX nature? Or is there possibility of an automatic u.h.f. relay system?

An automatic relay system, ARS for short, would be the possible answer to DX traffic on the very-highs and ultrahighs. Let us elaborate. In the city of Youngstown, Ohio (my home QTH), we may have a ham population of over two hundred. You can readily see the possibility of a congestion of the lower frequencies even for local work. So why not use the very-high- or ultrahigh-frequency bands to handle traffic? The range is too limited and even if we are able to get a message off, how many stations would be involved, and how would our accuracy and speed suffer on a message to Hartford, for instance?

It all boils down to this. Why not have a club-owned ARS station? This station might be located on a central tower and act as automatic relay for any local or mobile station in a poor QTH. You can see how the little fellow or the fellow in the poor location and the mobile station could contact that station over on the other side of the hill. This would be the ideal solution to the emergency mobile and low power problem. Just think what a hard time a "handie-talkie" has working a station only a couple of blocks away in the canyons of the city. But with an ARS station he can work anywhere in the city or within the range of the ARS station.

Now, what is the layout in an ARS station? Just this: There might be a conventional receiver front-end on 224.5 Mc. and a frequency converter to an i.f. of 22.55 Mc., then a series of frequency multipliers to 225.5 Mc. driving a 50-watt final. Of course only f.m. could be used because of the Class-C action of the final and driving amplifiers. Of course, the technical considerations would be rather stiff because of the proximity of the receiver and transmitter. But there would be no audio troubles and certainly no detector overloading. If the band-width of the circuits was made wide enough the one relay station might accommodate two or even three signals at once, providing they did not spill over on the next station and providing the selectivity of the receiver of the stations on the other end was great enough. That is, an ARS station of 100 kc. band-width would pass three 30-kc. sigs which would allow them each a deviation of three to one and a fidelity of 5000 cycles. This would require an accurate control of frequency by each station,

(Continued on page 78)

You are cordially invited
to help write the "specs"
for this new
Gammatron Tube

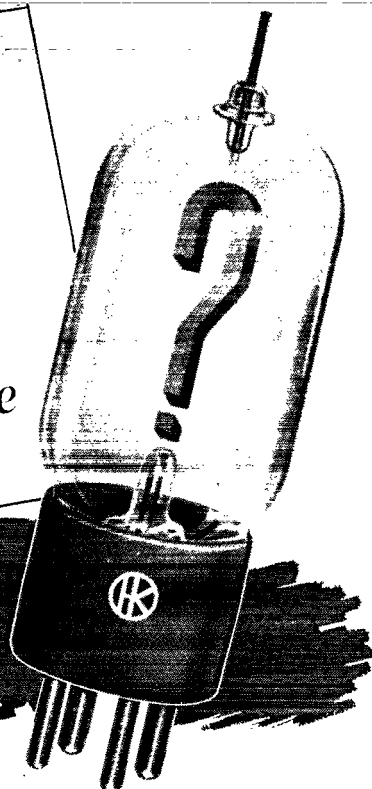

Heintz and Kaufman Ltd. — first to design and produce such popular tube types as the 24, 24G, 54, and 257B — cordially invite you as a designer or manufacturer of electronic equipment to have a hand in the development of a new series of H & K "firsts." ☆ Our engineering staff welcomes your suggestions for additions to the Gammatron line. If you have a requirement not adequately met by existing tubes, please let us know so that our development program may be directed accordingly. ☆ It will be to our mutual benefit if you will take a few minutes now to set forth your suggestions, and thus participate in the designing of outstanding new Gammatrons.

HEINTZ AND KAUFMAN LTD.
SOUTH SAN FRANCISCO • CALIFORNIA

Gammatron Tubes

Export Agents: M. Simons & Son Co., Inc. 25 Warren Street, New York City, N. Y., U. S. A.



BUY WAR
BONDS

SOUND VALUES at TERMINAL RADIO

Now in Stock

MEISSNER SIX-TUBE AC-DC TWO-BAND RADIO KIT

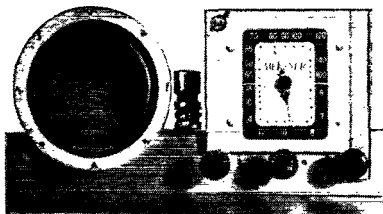

Super-hot
TRF Stage.
Complete
with tubes
and speaker.

\$24.38

NET

F. O. B. N. Y.

For Immediate Delivery

A LARGE STOCK of SOUND and
Inter-Communication EQUIPMENT

- Bogen
- Rauland
- Thordarson
- Stromberg-Carlson

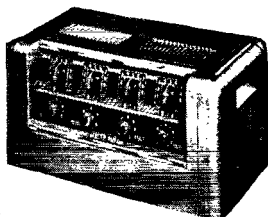

Write Dept. Q7 for Catalog

UTAH WIDE RANGE SPEAKERS

Model F.P. 1220

12-inch. 13 Watts Normal Low
Distortion. Substantially Flat
Response. 60 to 9000 CPS.

\$9.40
NET

F. O. B. N. Y.

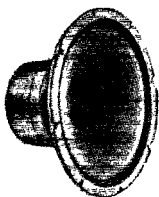

SHURE MICROPHONES

Crystal Mike.
Model 707A.
Fits all stan-
dard stands.

\$7.35
NET

F. O. B. N. Y.

Hand Crystal
Mikes. High Out-
put. Model 717B.

\$5.85
NET

F. O. B. N. Y.



TERMINAL RADIO CORP.

85 CORTLANDT ST., NEW YORK 7, N.Y. Tel. WORth 2-4415

(Continued from page 78)

Now for the DX possibilities. By establishing a series of net frequencies each particular route would be able to tie into any other route. Youngstown might act as an ARS station between Pittsburgh and Cleveland. Now the Pittsburgh side could tie through to Harrisburg by way of a couple of nicely placed ARS stations. On the Cleveland side we would tie in to Chicago. All anyone who was located on this net would have to do would be to shift his transmitter to the frequency of the ARS station nearest his QTH and call CQ to any locality on the route. If the traffic was for another route he would call CQ to the locality on the other route or intermediate route. In this way the amount of actual relaying would be cut to a fraction. Of course, the DX ARS would use different frequencies than the local. Thus a message from Sharon, Pa. (about 20 miles from Youngstown), for a station in St. Louis would go on the local Youngstown ARS and be relayed by voice to the ARS net to Chicago. There it would be received and relayed to the ARS to St. Louis.

It sounds a bit far fetched, I know, but this may be one solution to some of our postwar problems. Of course it will take effort. It certainly isn't a new idea, but as yet I haven't seen anything in *QST* along these lines.

— Paul A. Hudson, T/5, W8SRD

THAT TERM "HAM"

2826 Santa Anna St., So. Gate, Calif.

Editor, *QST*:

Just received May *QST*, and one of the first things I read was K.B.W.'s editorial on "Being an Amateur." In it he traced the meaning of the word *ham*, and I am not able to agree with either the definition of the "Tramp Dictionary," or the version as to its origin from the Cockney diminutive of the word *amateur*.

My father was a railroad telegraph operator. In 1880 I was born in the living quarters of a railroad depot about 15 feet from the clicking of the telegraph instruments and I was 15 years old before we ever lived for more than a few months in anything but a railroad depot.

Naturally, I spent a lot of my time in the telegraph office and at 12 years of age was taking train orders and messages for delivery to the train crews. I know that the word *ham* was used by railroad telegraphers as a designation of an incompetent operator. My parents were members of the Order of Railroad Telegraphers and in their magazine *The Telegrapher*, the word *ham* was used frequently.

Telegraph operators in those days were divided into two classes, railroad and commercial operators. The latter were either Western Union, press or broker operators, and a commercial operator usually made a very poor railroad telegrapher until he learned the numerous duties of keeping station accounts, selling tickets, handling freight and express shipments, etc.

(Continued on page 80)

FOR AMATEUR

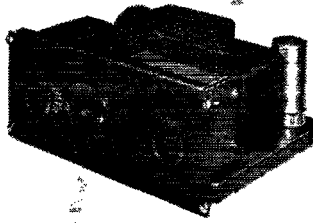

MOBILE USE

A VIBRATOR POWER SUPPLY

Belongs Here

Built to operate the famous portable SCR-300, Walkie Talkie, is the battle proven E-L Vibrator Power Supplies Model 1566. It is designed to provide necessary operating voltages from a battery source, and is typical of the new developments that will soon be available to the amateur. Versatile, and tested in the most rugged combat use, the E-L Vibrator Power Supplies have many applications that will provide superior performance for the amateur who is interested in the best

PORTABLE AND MOBILE APPLICATIONS

First, there are models for mobile and portable applications to allow efficient operation of powerful two-way rigs from your car or any non-fixed source of power. These units, which have stood the test of the most rugged combat use in military services, will be available after the war to provide trouble-free mobile operation both for emergency service and regular use.

BUILT-IN APPLICATIONS

Second, there are E-L power units that can be incorporated as an integral part of your equipment for the operation of short-wave radio from either batteries or 110-volt AC outlets. These units are ideal for providing the plate and grid supply for radio receivers and transmitters, for stationary and mobile or portable applications.

MANY EXCLUSIVE ADVANTAGES

E-L Power Supplies, both for light and heavy-duty use, provide highest efficiency, longest life and greatest economy. In addition, models are available which provide constant output voltage despite wide fluctuations in input voltage, multiple inputs and outputs in one unit, and power outputs up to 1000 watts. When planning your new rig, include E-L Power Supplies in your design.

* * * * *

**E-L Standard Power Supply
Model 1566**

This typical E-L unit, with voltage regulation is used to supply necessary voltages for the Model BC-1000 Walkie Talkie Transmitter-Receiver from 6, 12, or 24 volt storage battery

Input Voltages: 6, 12 and 24 volts DC.

Output Voltages: 140 volts DC at 0 - 55 ma.

90 volts DC at 30 ma.

4.5 volts DC at 250-550 ma.

Regulation: Output voltages are held constant within 5% over the entire range of load changes listed above, as well as over input voltage variations, as for example, 5.7 volts to 7.5 volts.



VIBRATOR POWER SUPPLIES FOR LIGHTING, COMMUNICATIONS, ELECTRIC MOTOR OPERATION, AERIAL, ELECTRONIC AND OTHER EQUIPMENT

Electronic
LABORATORIES INC.
NEW HAVEN, CONNECTICUT

(Continued from page 78)

As I remember it, the commercial operators called their incompetent operators "lids."

In the early days, railroad telegraphers worked a minimum of 12 hours a day 365 days a year, and on numerous roads worked for as little as \$30.00 a month and there was no overtime. Most of the students were young farm boys, who served their apprenticeship as unpaid helpers for the over-worked station agents, who in return taught them telegraphy. As I understood it in my younger days, the word *ham* had a bucolic reference to the farm origin of most of the student railroad telegraphers. I know it was a disgrace to be called a *ham*.

When I broke into the amateur game and heard the fellows proudly calling themselves *hams* I was greatly amused, but soon accepted it as something to be proud of as an amateur radio operator, yet right now if I was working on a railroad and anyone called me a *ham* they would have to lick me before I would take it.

— Roy Wheadon, W6KTY

134 Manor Rd., Douglaston, L. I., N. Y.
Editor, QST:

. . . I think you are out of the groove in your explanation of the term *ham*. I know personally that it was applied to inferior operators in the American wire telegraph service as much as forty years ago.

How about encouraging the amateurs to write in the distinctive style of the old-time op? It has the merit of speed and legibility but is a disappearing art. Did you ever see the book, "Telegraph Operators' Penmanship," by Donald McNicol (published about 1919) when he was editor of *Tel. and Tel. Age*? I can still copy 35 w.p.m. with it. I'm rusty on the mill but have started to practice copying GIK at 40 w.p.m.

Mill or "700" is nearly as old as the typewriter. Don't tell us that came from H'England!

— R. B. Shanck

HINDU ROPE TRICK—GI STYLE

APO 339, c/o PM, New York, N. Y.

Editor, QST:

Just received copies of three issues of good old QST. Each time a copy arrives, it is like seeing an old friend — hi!

. . . You ask for some news. Well, I have an example of ham ingenuity. In the early days of the Normandy invasion I was a radio electrician for a tank company. In the thick of a battle one tank lost its antenna. I was called up to see what was the trouble or what could be done. As luck would have it, no antenna could be obtained at that crucial moment.

In order to keep the tank in action I used my noggin and remembered that a rope, if wet, will conduct energy. It was raining cats and dogs anyway. I found a muddy wet tent rope and tied it securely around the top end of the antenna base, strung it to the rear of the tank, draped it over a



of HARVEY ORDERS

Many of the radio and electronic components now on the critical list can be obtained without delay at HARVEY. In stock, we have an unusually wide assortment of meters, resistors, capacitors, test equipment, transformers, etc. When a specific item is not on our shelves, our trained staff exerts every effort to procure it. Or, if not obtainable quickly, they may suggest an equally effective substitute. Eighteen years of experience have taught us how to handle orders efficiently and assure prompt deliveries.

The proper priority must accompany each order. If you are uncertain as to your priority, we can supply the information you need.

Telephone orders to LOnacre 3-1800





RAYTHEON TYPE 1B48

A HIGH VOLTAGE COLD CATHODE MINIATURE GAS RECTIFIER

• There are many applications in which a high DC voltage, at a relatively low current, must be obtained in a minimum space and with maximum power efficiency.

If tubes necessitating a heater voltage supply are used, the space and weight requirements of a filament transformer insulated to withstand high potentials—and the additional power consumption—are often detrimental factors. Numerous oscilloscope applications are in this category.

Thus there is often a real need for a small modified miniature type cold cathode gas rectifier like the 1B48—which can easily deliver 1000 volts DC at 6 milliamperes average current. Furthermore, several tubes may be operated in series to obtain even higher voltages.

Shown here are the physical and electrical features of the 1B48. The schematic diagram indicates cascade operation in a half wave circuit. Full wave rectification may be accomplished in the conventional manner.

This Raytheon tube represents just one more entry in Raytheon's record of tube development . . . a continuing engineering program that is making possible still finer tubes for *your* postwar products.

CASCADE OPERATION

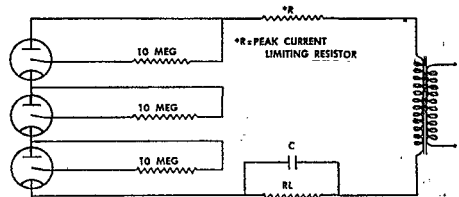

SPECIFICATIONS OF 1B48

PHYSICAL:

Maximum Over-all Length	2-1/4 inches
Maximum Seated Height	1-9/16 inches
Maximum Diameter	3/4 inches

ELECTRICAL:

Maximum Peak Inverse Voltage	2700 volts
Maximum Peak Plate Current	50 ma
Aver. DC Voltage Drop at 6 ma	100 volts
Maximum DC Output Current	6 ma
Minimum Peak AC Start'g Volt.	800 volts
Maximum Starter Anode Current	100 μ a

RAYTHEON

MANUFACTURING COMPANY
RADIO RECEIVING TUBE DIVISION

Newton, Mass. • Los Angeles • New York • Chicago • Atlanta

Listen to
"MEET YOUR NAVY"
Every Saturday Night
AMERICAN BROADCASTING CO.
Coast to Coast
181 Stations



All Four Divisions
Have Been Awarded
Army-Navy "E"
With Stars

DEVOTED TO RESEARCH AND THE MANUFACTURE OF TUBES AND EQUIPMENT FOR THE NEW ERA OF ELECTRONICS

Wanted ENGINEERS

Radio

★ Electrical

Electronic

★ Mechanical

★ Factory Planning

Materials Handling

Manufacturing Planning

Work in connection with the manufacture of a wide variety of new and advanced types of communications equipment and special electronic products.

Apply (or write), giving full qualifications, to:

R.L.D., EMPLOYMENT DEPARTMENT

Western Electric Co.

100 CENTRAL AVENUE, KEARNY, N. J.

★ Also: C.A.L.

Locust Street, Haverhill, Mass.

Applicants must comply with WMC regulations

FIELD SERVICE ENGINEERS

For Domestic and Foreign Service

and

INSTRUCTORS

MUST POSSESS GOOD
KNOWLEDGE OF RADIO

Essential Workers Need Release

HAZELTINE CORPORATION

58-25 Little Neck Parkway
Little Neck · Long Island

(Continued from page 80)

wooden tool handle and weighted the loose end with a rock. In that way the turret could traverse, and the rope would slide and not short to the chassis. By golly, it *did* work beautifully. I returned the final and the tank was kept in action for the remainder of the skirmish. . . .

Although I am not yet a licensed ham, my Dad, W2BMT, and I have been in amateur radio for years. My radio knowledge has been the sole factor in my climb in rank.

— T/Sgt. Donald Hollister

NO DIARIES FOR THE U.S.M.S.

c/o F.P.O., San Francisco, Calif.

Editor, *QST*:

It might be a good idea to warn hams now in the merchant marine not to keep a diary. A friend of mine was found with one. He paid a \$50 fine and had to go before a hearing.

There are notices posted in quite a few places warning merchant marine men about diary keeping, but some men don't seem to read notices.

Perhaps this note in *QST* may save a few hams some money and trouble in this matter.

— Ens. Jack G. Nelson, USMS, W8FU

NO CODE PRACTICE OSCILLATORS ON SHIPBOARD

Casual P.O., Fort Mason, San Francisco, Calif.

Editor, *QST*:

I picked up a recent issue of *QST* (chiseled from an RCA man in transit) and read an item in Hints and Kinks on an audio oscillator.

Not that audio oscillators aren't nice things to have around the shack on terra firma (the more firma, the less terra), but wartime instructions to men on merchant ships frown on their use, saying that while the chance of radiation is negligible, they cannot be too strongly discouraged, and under no circumstances should they be installed in the shack. It ends up by saying that any device must be approved by the chief op. There is some little marine experience in back of the order and therefore we should stick to it. If any salty brother wants to take the trouble, he can look up the paragraph in his instruction book.

So much for that. What do you think of 5000 miles for DX on 500 kc. with 200 watts to the antenna? What has the h.f. band got on that?

— Sgt. R. Almon Bent, W1JPK

DX RECEPTION ON 500 KC.

156 South 4th St., Rogers City, Mich.

Editor, *QST*:

I note W8FU suggested a story of WSL — "the loudest signal heard on 500 kc." I'll back him up on that report. There are only two stations (at night) here at WLC, on the shores of northern Lake Huron, that we can read through WSL. One is VBB at Soo, Ontario, about 100 miles away, and WNO, 35 miles south of here at

(Continued on page 84)

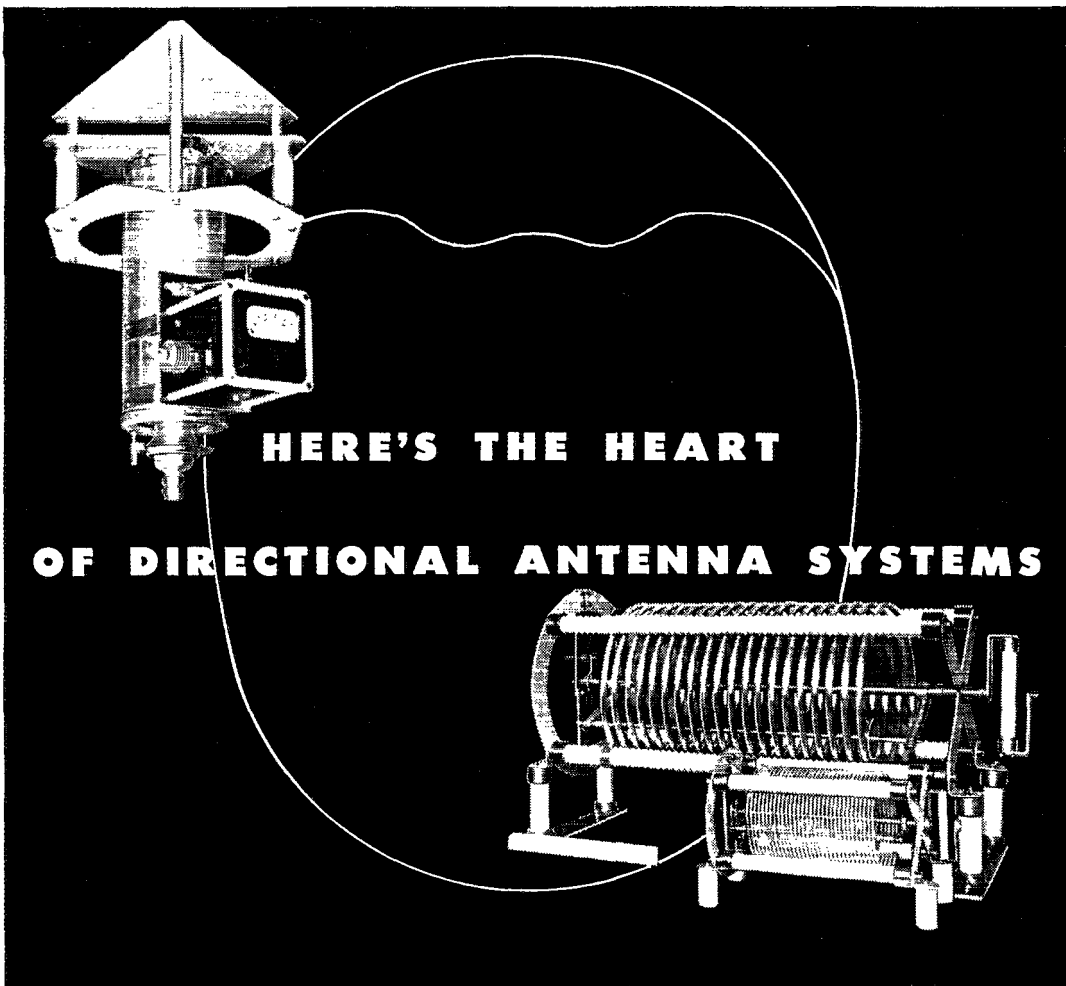

HERE'S THE HEART

OF DIRECTIONAL ANTENNA SYSTEMS

Westinghouse tower tuning and matching components shown above are a variable, gas-filled capacitor (top, left) and a continuously adjustable inductor (below, right).

In these dependable tower tuning and matching components lies the heart of directional broadcasting. They help give Westinghouse phasing and matching equipment the high efficiency, reliability and easy adjustment that meet today's needs.

These qualities stem from many features of Westinghouse phasing equipment. High Q inductors, low-loss capacitors and effective circuit design establish high efficiency. Reliability is assured by using all components well within their ratings.

Operation has been simplified. Current division and phasing adjustment can be made while in operation. Phase adjustments can be made by a single control for each tower.

Westinghouse—working with your consulting engineer—offers its wide facilities

in installing complete directional equipment for every type of coverage from simple cardioid patterns (above) to more complex, intricate ones. Your nearest Westinghouse office will give you information. Westinghouse Electric Corporation, P. O. Box 868, Pittsburgh 30, Pa. J-08109A

XXV RADIO'S 25TH ANNIVERSARY KDKA

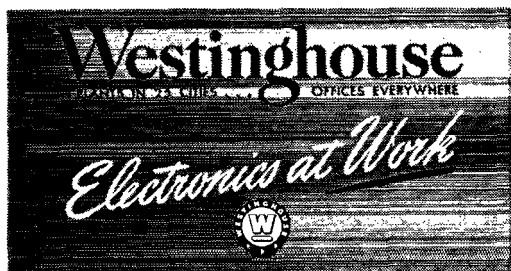

(Continued from page 82)

**FOR YOUR
POSTWAR RIG**

**IRC
SUGGESTS**



**GRW
RESISTORS
(GRADE 1 • CLASS 1)**

Rugged and dependable, IRC Type GRW (Grade 1—Class 1) Resistors readily meet every requirement of Jan-R-26 specs. Made in 7 standard sizes with power ratings from 15 to 140 watts and resistance ranges of 0.1 to 63000 ohms. They're engineered to "take it" far beyond normal requirements.

Write for data bulletin.
Address Dept. 18-G



INTERNATIONAL RESISTANCE CO.

401 N. BROAD ST., PHILADELPHIA 8, PA.

IRC makes more types of resistance units, in more shapes, for more applications, than any other manufacturer in the world.

Phone, Wire or Write

WHOLESALE

**Radio-Electronic Parts
Tubes, Sets and
Equipment**

R. G. SCELİ & CO.

227 Asylum St. Hartford, Conn.

Telephone 2-1144

Alpena, Michigan. When the op at Ammagansett punches the key, all else goes by the board!

With regard to DX on the intermediate frequencies: Regularly at night we hear NBS, Canal Zone; VPO, Barbados Radio; South Americans. PJA, PJC; West Coasters KFS, KOK, KEK, NPG, NPL, and others. Of course, we hear all of the Atlantic coast stations, such as WAG, WSC, WNY, NCR, NMF, NMN, NAM, WMH, WOE; and on the Gulf, WAX and WNU.

I believe the greatest DX heard on 500 in the three years I've been attending watches at WLC are NPU in Samoa, heard late last year when conditions were particularly good, and CWA of Uruguay heard several times this spring.

It might be interesting to note that those fellows out on the Atlantic who hear WLC now and then are listening to a transmitter that has had only minor changes since it was first built back in '24 or '25. The r.f. tubes were changed a few years ago and the current line-up is the 100TH m.o. into parallel 250TH in the p.a. The audio oscillator for m.c.w. is a museum piece UV-211. There are transmitters and transmitters, but this old kilowatt has been on the air every year for more than 20 years, and hasn't given any indication of dying yet — although it has been sick a few times!

Just a word to the new operators: When a shore station is called and answers with "K 700," or "QSY 468," shift your transmitter but leave your receiver on 500 kc. unless the shore station tells you definitely he is shifting his transmitter, too. You'll save time in clearing traffic, and help the shore operator, who, believe it or not, is sometimes very busy, especially if he is standing watch on several frequencies.

If there is an operator or two who likes both 'phone and c.w. operating on frequencies from 165 kc. to almost 40 Mc. and is looking for a new job — drop a line to Radio WLC-WLF, Rogers City, Michigan. The OM will send you further dope pronto. After all, the time is growing nearer all the time when FS and I will want more time to get the old ham stations in tip-top shape and get 'em running again — and believe me, 8PVB needs a lot of revamping!

— Joe Hassett, W8PVB

c/o A. C. A. Marine Local No. 2,
5 Beekman St., New York City

Editor, *QST*:

I want to add a word to W2HNR's letter published in the March issue of *QST*. I, too, saw some of the work done by the merchant marine in the Normandy Campaign as my job in that gigantic movement was as radio operator on the S.S. *William N. Pendleton*, which was given the job of taking the first Army nurses to France.

I also put in a vote to back W8FU's idea of an article about WSL. Incidentally, does anyone know what the DX record of WSL happens to be? On several occasions I have heard it off the southern coast of Sicily — with a readable signal!

— Ensign R. A. Spinks, USMS



Famous Lighthouse Tubes

Disk-seal
parallel-plane
design

●
For use in the
ultra-high-
frequency
spectrum



TYPE 2C40
RECEIVING TUBE

TYPE GL-3C22
TRANSMITTING TUBE

Basic Ratings

TYPE 2C40 (as local oscillator) TYPE GL-3C22 (as power oscillator)

Filament voltage	6.3 v	6.3 v
Filament current	0.75 amp	2 amp
Max plate voltage	500 v	1,000 v
Max plate current	25 ma	150 ma
Max plate dissipation	6.5 w	125 w
Plate power output, typical operation	.075 w	50 w (at 600 mc)

● Developed by G-E engineers, the new Lighthouse Tubes have extended the top frequency limits, making possible outstanding performance in FM broadcasting, television, aviation and marine radio, and other fields. See your nearest G-E office or distributor, or write to *Electronics Dept., General Electric, Schenectady 5, N. Y.*

For complete information on G-E lighthouse tubes and the story of their development, ask for Bulletin ETR-7, "The Lighthouse Tube".

GENERAL ELECTRIC

161-D7-8850

TRANSMITTING, RECEIVING, INDUSTRIAL, SPECIAL PURPOSE TUBES
VACUUM SWITCHES AND CAPACITORS

You
**CAN FIND
 YOUR
 RADIO
 NEEDS**
at
SUN RADIO



**OVER 10,000
 ITEMS IN STOCK
 FOR IMMEDIATE
 DELIVERY!**

★
 America's
 most complete
 Radio
 Electronic Supply House

**RADIO
 PARTS
 TUBES
 ELECTRONIC
 EQUIPMENT**

**FREE
 800 Page
 Buying Guide**

Available solely to
 authorized purchas-
 ing agents and en-
 gineers who write
 to us on company
 letterhead. Address
 Box 7 JQ.

★
**PHONE
 Barclay 7 1840**

**SUN RADIO
 & ELECTRONICS CO.**
 212 Fulton Street, New York 7, N. Y.

**RADIO
 ENGINEERS
 DRAFTSMEN
 WANTED**

For development and design of
 marine radio telephone, tele-
 graph and navigational equip-
 ment. Permanent positions avail-
 able with pioneer company.

write
Mackay Radio and Telegraph Company, Inc.
 MARINE DIVISION
 111 EIGHTH AVE. NEW YORK 11, N. Y.

Hams in Combat

(Continued from page 50)

far as we knew, none were expected. Jap para-
 troopers, we decided.

One of the interesting things about our air-
 strips was that the only line of retreat was by
 air. With a grimness that later seemed amusing,
 we grabbed guns and ammunition, jumped into
 slit trenches, and tensely waited for parachutes
 to blossom. The planes, in perfect formation, flew
 slowly toward us. Finally, after the traditional
 minutes-that-seem-like-hours, we saw their mark-
 ings and squirmed in embarrassment. They were
 our own planes on a special mission, of which we
 had not been informed.

For several weeks after that, any comment on
 the "dullness of our lives" would bring the reply:
 "What we need is another paratroop invasion!"

AACS men at a remote station, fortunately,
 have too much to do to have much time for brood-
 ing. Because of the supply problem, a minimum
 crew is assigned to it. In addition to keeping our
 radio communication, homing and other facilities
 on the air, we do our own cooking, laundry, and
 construction work. We double as a field opera-
 tions crew, and there are numerous unexpected
 details. Occasionally food and mail dropped to us
 lands in the jungle. Once it took us three days to
 retrieve a mailbag.

The men in an AACS group endure the usual
 hardships of soldiers in advanced jungle areas.
 When you are at any advanced base, you are
 plagued by mosquitoes, including the malaria
 anopheles, leeches, and a variety of other insects.
 You eat C-ration for breakfast and dinner, and
 then, for a change, for supper. Your water supply
 is the monsoon. You put empty ammunition tins
 and your helmet outside your tent during the wet
 season. Sometimes the installations are a couple
 of muddy miles from each other and the only
 transportation you have is your GI shoes. It is,
 in the Army phrase, "a rough life," but to a radio
 amateur it represents being a round peg in a
 round hole.

Despite handicaps of terrain, weather, and
 supply, the AACS provides in Burma the com-
 munications services that have helped to make
 "the Hump," once the most dangerous air route
 in the world, a more or less routine flight assign-
 ment. For "bred in the bone" radio amateurs, it
 has been exciting to be part of the outfit that
 handles it.

Strays

For maintaining and operating wire and radio
 systems along the Ledo Road and for installing
 communications in Myitkyina under intense shell
 fire, Company C of the 835th Signal Service
 Battalion has been awarded a Distinguished Unit
 Citation. The company saw prolonged service
 with combat units in Burma, facing monsoon
 and jungle conditions which critically hampered
 its operation.

DUPLICATING A GERMAN VACUUM TUBE IN 3 DAYS

Just behind the battlefront, a telephone system lay dead. The retreating enemy, hoping to return, had not blown it up, but had taken with them its vacuum tubes. To put it back to work, the General ordered 1000 new tubes — spot delivery.

A sample tube was flown back to the United States and brought to Bell Telephone Laboratories. It was of German design, different from any American tube in both dimensions and characteristics. Could it be duplicated soon? The job looked feasible. Within three days, try-out models were on their way to Europe. Three weeks later, Western Electric Company had made and delivered every tube. They were plugged in; vital communications sprang to life.

Vacuum tubes are an old story for Bell Laboratories scientists. Back in 1912 they made the first effective high vacuum tube. Three years later, they demonstrated the practical possibilities of tubes by making the first radio talk across the Atlantic, pointing the way to radio broadcasting. Since then, they have developed and utilized the vacuum tube wherever it promises better telephone communication — there are more than a million in your Bell Telephone System.

Today, Bell Telephone Laboratories is solving many of the toughest tube problems faced by the Armed Forces. When the war is over, it goes back to its regular job — keeping American telephone service the best in the world.



BELL TELEPHONE LABORATORIES

Exploring and inventing, devising and perfecting for our Armed Forces at war, and for continued improvements and economies in telephone service.

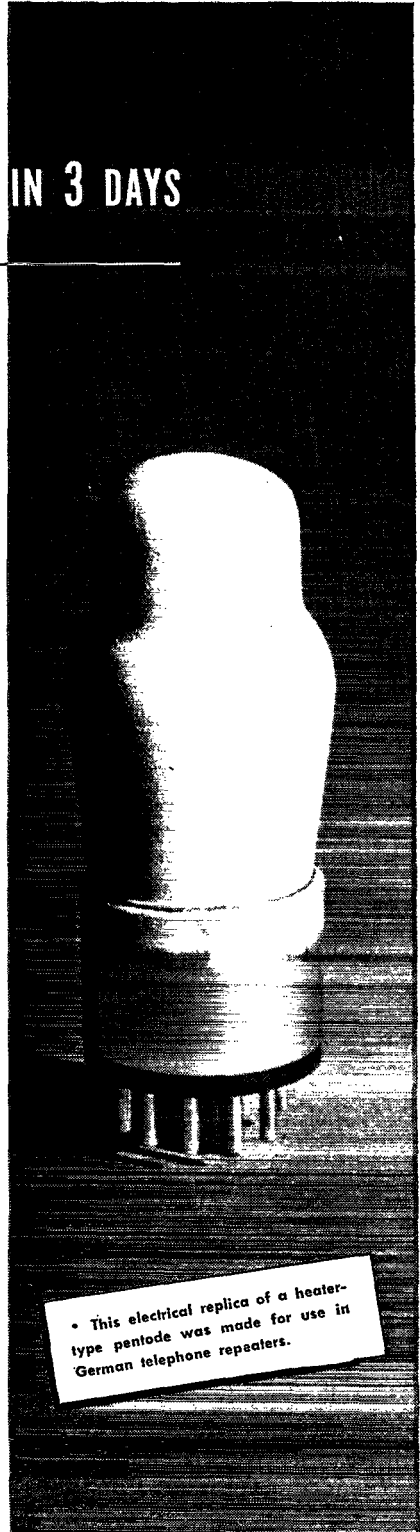

• This electrical replica of a heater-type pentode was made for use in German telephone repeaters.

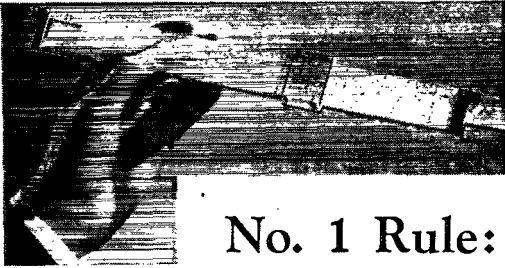

No. 1 Rule:

For a Better Job and Secure Career in Radio-Electronics

It is up to you to decide if you will be a "screw-driver" mechanic or a real technician in a responsible engineering position. CREI home study courses provide you with up-to-date technical training, covering such important subjects as: U. H. F. circuits, cavity resonators, wave guides, Klystrons, Magnetrons and other tubes. U. H. F. as well as all other basic principles of modern, practical radio-electronics engineering are covered in CREI home study courses.

CREI can help you prepare by providing you with a proved program of home study training that will increase your technical ability and equip you to advance to the better-paying radio jobs that offer security and opportunity.

WRITE TODAY! If you are a professional or amateur radioman and want to make more money — let us prove to you we have something you need to qualify for the better job opportunities that can be yours. To help us intelligently answer your inquiry — please state briefly your education, radio experience and present position.

CAPITOL RADIO ENGINEERING INSTITUTE

Dept. Q-7, 3224 16th St. N.W., Washington 10, D. C.

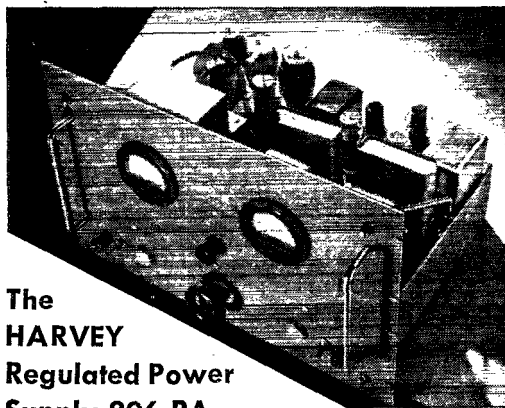

The HARVEY Regulated Power Supply 206 PA

is your best source of laboratory D.C. power between ranges of 500 to 1000 volts. The HARVEY 206 PA operates in two ranges — 500-700 volts at 1/4 amp., 700 to 1000 volts at 1/5 amp. Regulation is 1% or better in both ranges and output remains constant even though line voltage varies between 95 and 130 volts.

The HARVEY 206 PA is designed for safe and convenient operation. It has over-load relay and inter-

locking relay protection at all voltages. Time delay for high voltage circuit applications and pilot lights to indicate unit in use. It is mounted on a standard relay rack panel and all components are easily accessible. Sturdy, precision-built, its dimensions are 12 3/4" x 19" with a depth of 13". Weight but 72 pounds.



For complete information write:

HARVEY RADIO LABORATORY, INC.

451 CONCORD AVENUE • CAMBRIDGE 38, MASS.

Silent Keys

It is with deep regret that we record the passing of these amateurs:

- W1ANK-ex-W1EIM, Kenneth P. Lewis, Lynn, Mass.
 W1BPN, Lt. Malcolm H. Robertson, USNR, Chicopee Falls, Mass.
 W1BZR, Dana H. Bacon, Arlington, Mass.
 W1HPT, Wm. K. Bowers, West Newton, Mass.
 W2GU, Arthur R. Nilson, New York, N. Y.
 W4DPT, George W. Harvard, Jacksonville, Fla.
 W6NNP, Robert Evans, Los Angeles, Calif.
 W8AYQ, D. Earl Cousart, Pittsburgh, Pa.
 Ex-W9KWP, Lt. Col. Cyrus Stafford, AC, Glen Ellyn, Ill.
 VE3BF, C. W. Speer, Islington, Ontario
 VE4AFH, Ron C. Miller, RA4c, RCN, Calgary, Alberta
 G3ZG, W. H. Gooderman, Cleethorpes, Lines, England

Happenings of the Month

(Continued from page 40)

the appropriation for the expenses of the Planning Committee is hereby returned to surplus; and that there is hereby appropriated from the surplus of the League, as of this date, the sum of one thousand dollars (\$1,000) for the expenses of the Planning Committee, any unexpended remainder of same on the date of the next annual meeting of the Board to be restored to surplus.

On motion of Mr. McCargar, unanimously VOTED that the Board, having examined its actions at the 1940 meeting at which it granted the President extraordinary powers to act as a committee of one in all aspects of protecting amateur operation, and in which it made an open authorization of \$10,000 available to him for the defense of amateur frequencies, now reaffirms those actions.

Moved, by Mr. Stedman, that the League inquire of the appropriate government agency whether its bookkeeping practice in the matter of the Secretary's salary is permissible under government regulations. After discussion, moved, by Mr. Kirkman, to amend the motion to provide that present practice in this respect be discontinued until the answer is received. After further discussion, on motion of Mr. Stedman, VOTED that the subject shall lie on the table.

Proceeding now to an examination of matters concerned with the allocation of bands of frequencies to the amateur service, the Board heard a supplemental oral report from the Secretary. On motion of Mr. Norwine, unanimously VOTED, at 10:46 a.m., that the assembly now resolves itself into a Committee of the Whole for the consideration of allocation matters. At 2:29 p.m. the committee arose and the Board resumed its session, with all directors and other persons hereinbefore mentioned in attendance.

[At this point the Board heard certain recommendations of its Committee of the Whole, resulting from a detailed discussion of amateur frequencies over the previous several hours, and in accordance with those recommendations issued appropriate instructions to its officers for their guidance in dealing with amateur frequency matters. While the publication of the details of those instructions at this time would not be in the interests of amateur radio, it is expected that they can be revealed when the whole story of amateur allocations is concluded in the near future.]

(Continued on page 90)

SPECIAL OFFER

DURING

JULY AND AUGUST

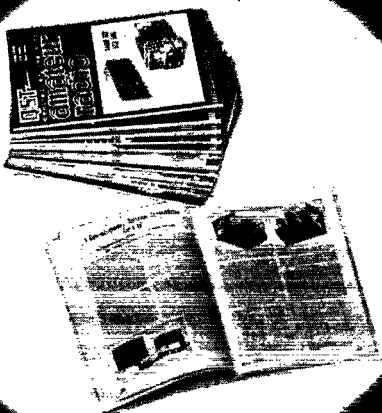
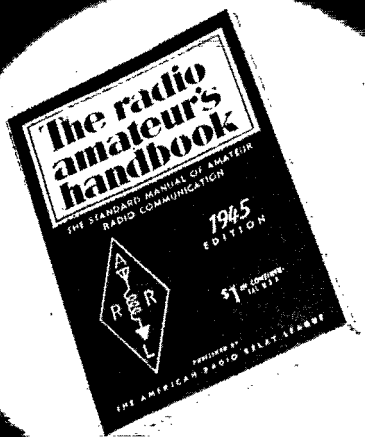

\$3.00

U. S. A. Only

- **ARRL MEMBERSHIP**
for one year, including
- **SUBSCRIPTION TO QST**
(new or renewal or extension)
and the
- **RADIO AMATEUR'S HANDBOOK**

THIS OFFER AVAILABLE ONLY DIRECT FROM

AMERICAN RADIO RELAY LEAGUE, INC.
WEST HARTFORD, CONNECTICUT



Premax Antennas Are Proving Themselves in the Armed Forces

New designs . . . as well as the old . . .
in monel, aluminum, stainless and
steel . . . are with the armed forces
all over the world.

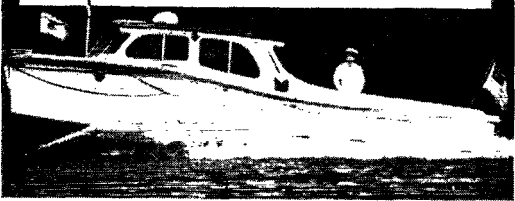

Premax Products

Div. Chisholm-Ryder Co., Inc.
4519 Highland Av., Niagara Falls, N. Y.



IN STOCK  ON PRIORITY

hallicrafters

 . . . the name that makes
news in war and peace . . . 

● Henry Radio Shops are headquarters for Halli-
crafters receivers. Hallicrafters receivers can be
supplied on AA5 or better priority. S20Rs at \$60;
S39s at \$110; SX-25s at \$94.50; SX-28As at \$223;
and PM-23 speakers at \$15 can be supplied at
once. Little longer for other models. Here's hoping
non-priority orders can be filled soon. When that
happens you will get quickest delivery from the
large stocks of Henry Radio. List your name with us
now for preferred delivery. Write for information.

Bob Henry, W9ARA
HENRY RADIO SHOPS
Butler, Missouri, and Los Angeles 25, Calif.
"WORLD'S LARGEST DISTRIBUTOR OF
COMMUNICATIONS RECEIVERS"

(Continued from page 88)

Mr. Kirkman moved the adoption, as a statement of fu-
ture policy after present allocation commitments are ful-
filled, of the following resolution:

Whereas no definition exists of the requirements of the
American public duly licensed as radio amateurs for op-
erating space in the radiation spectrum used for radio
communication; whereas the need for such a definition
exists as a guide during negotiations among the American
Radio Relay League representing the radio amateur, the
Federal Communications Commission as the regulating
authority, and private and commercial users of portions
of the spectrum; and whereas past experience has shown
that frequency bands which constitute approximately a
one-tenth part of the octave in which they are located
provide fair and reasonable operating space in relation to
other services; Be It RESOLVED: that it be henceforth
a basic policy and principle of the American Radio Relay
League and the officers thereof to negotiate and cam-
paign, to the end that a one-tenth part of each octave in
the radio frequency spectrum between 25 megacycles and
the upper frequency limit to which formal allocation may
progress, be assigned to the public for use under licenses,
and rules and regulations, governing the amateur service.
Be It Further RESOLVED: (a) that in order to define
and evaluate a tenth part of the radio frequency spec-
trum octave by octave, each frequency band shall be
weighted logarithmically in such a manner that of two
bands separated by one octave and of equal width in
terms of cycles per second, the higher band shall have a
value of one-half the lower; (b) that in order to provide a
fair distribution of assigned bands throughout the spec-
trum, but nevertheless allow certain reasonable com-
pensations and adjustments to be made where it is im-
possible to provide ideal harmonically related frequency
assignments, it shall be in accordance with the above prin-
ciple if a one-tenth part of any and all portions of the
radio spectrum bounded by frequencies having a ratio of
one to ten shall be assigned to the amateur service, and
provided that the assigned space shall comprise not less
than three distinct bands, or parts of bands; (c) that the
officers of the League shall base all recommendations
concerning amateur frequency assignments upon this ac-
tion of the Board.

On motion of Mr. Martin, unanimously VOTED that the
foregoing resolution is amended to provide that, if it be
adopted, it is committed to the Planning Committee. The
question then being on Mr. Kirkman's motion as thus
amended, the same was REJECTED, 5 votes in favor to 10
opposed.

On the question of representation at the coming inter-
American regional radio conference, after discussion, on mo-
tion of Mr. Norwine, unanimously VOTED that the sum of
five thousand dollars (\$5,000) is hereby appropriated from
the surplus of the League, as of this date, for the expenses of
representation of the League at the coming inter-American
regional radio conference to be held in Rio de Janeiro; and
that the President is authorized to select and appoint the
League representatives thereto.

Moved, by Mr. Kirkman, that the League contribute
\$1,000 to the Institute of Radio Engineers' Building Fund,
and that the sum of one thousand dollars (\$1,000) be
hereby appropriated from the surplus of the League, as of
this date, for this purpose. On motion of Mr. Stedman,
VOTED that the pending motion is amended by inserting
after the word "contribute" the words "in the name of
QST." The question then being on the motion as thus
amended, the same was unanimously ADOPTED.

Moved, by Mr. Noble, that the plan for postwar station
calls presented to directors in Secretary's Letters Nos. 611
and 612 and in maps and charts at this meeting be approved
and accepted by the Board, and that the Secretary be
directed to transmit the same to the Federal Communica-
tions Commission with a request for its adoption. Moved, by
Mr. Kirkman, that the pending proposal be so amended
that no W2 station be moved to W3. But there was no sec-
ond, so the motion was lost. On motion of Mr. Stedman,
VOTED that the pending proposal is amended to place
Colorado in the WØ area. Moved, by Mr. Bickel, and sec-
onded by Mr. McCargar, that the pending proposal be
amended to retain Arizona and Nevada in the W6 area. But
the said motion was rejected. Moved, by Mr. Davis, that the
pending proposal be amended to retain Minnesota, North

(Continued on page 98)

24 HOURS A DAY

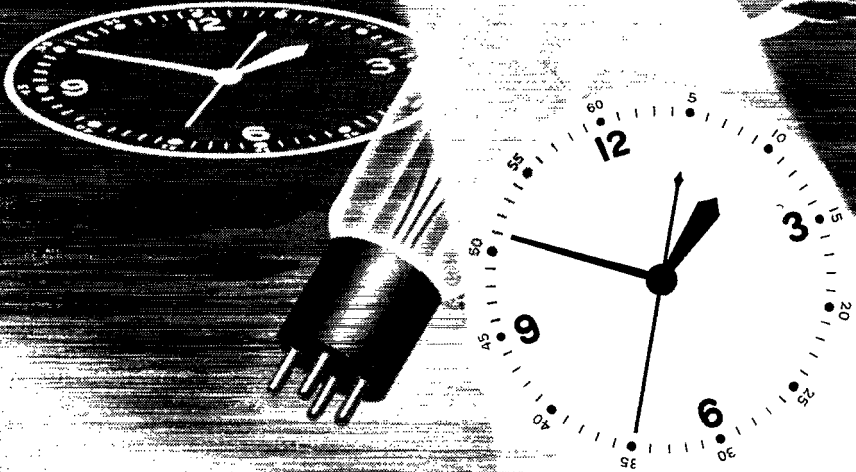

On every fighting front . . . on land, at sea, in the air . . . Delco Radio products aid in the coordination of military operations. Their assignments include communication, detecting and ranging, directional-finding and all the other varied phases of radio and radar activity. It's a full-time job, continuing and continuous, to which Delco Radio products bring an effective combination of engineering vision—manufacturing precision. Delco Radio Division, General Motors Corporation, Kokomo, Indiana.

KEEP BUYING WAR BONDS

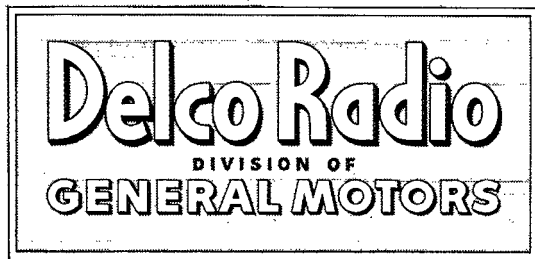

RADIO CHASSIS PUNCH



Saves hours of work cutting clean, accurate holes in radio chassis—for connectors and other receptacles. Simply insert cap screw in hole to be enlarged (drill small hole if necessary), turn with ordinary wrench to force punch through the metal. No reaming or filing—hole is smooth and clean. No distortion—die supports metal. Ten sizes from $\frac{3}{4}$ " to $2\frac{1}{4}$ "; also up to $3\frac{1}{2}$ " for meters. Write for free catalog 33E to Greenlee Tool Co., 1867 Columbia Ave., Rockford, Ill.

Get Ready with Greenlee!



RADIO ENGINEERS Radio, Research and Development Engineers and Draftsmen needed for key positions by manufacturer of diversified line of aircraft accessories, small motors, and aircraft radio who will be in the home radio field postwar. Salaries open. Full compliance with WMC regulations necessary. Confidential inquiries respected. Live in the midst of the best hunting and fishing in Michigan. Our employees know of this ad.

Address Box 132, QST
38 La Salle Road West Hartford 7, Connecticut



Founded in 1909

RADIO TELEPHONY RADIO TELEGRAPHY ANNOUNCING

Courses ranging in length from 3 to 9 months. Dormitory accommodations on campus for men and women students. Advanced students eligible for practical training at KPAC, 1 KW broadcast station owned and operated by Port Arthur College. New students accepted each month during year. If interested, write for details.

PORT ARTHUR COLLEGE PORT ARTHUR TEXAS

(Continued from page 90)

Dakota and South Dakota in the W9 area. But there was no second, so that motion was lost. Moved, by Mr. Kirkman, to amend the pending proposal to place New Jersey in the W2 area with New York. But there was no second, so the motion was lost. Moved, by Mr. Groves, to amend the pending proposal to include New Mexico in the W5 area. But the said motion was rejected. Moved, by Mr. Arledge, to amend the pending proposal to place Tennessee in the W4 area. But the said motion was rejected. The question then being on Mr. Noble's motion as amended, and the yeas and nays being ordered, the said question was decided in the affirmative: Whole number of votes cast, 14; necessary for adoption, 9; yeas, 11; nays, 3. Those who voted in the affirmative are Messrs. Arledge, Caveness, Davis, Groves, Kiener, McCargar, Noble, Norwine, Sides, Stedman and Weingarten. Those who voted opposed are Messrs. Bickel, Kirkman and Martin. The President, Vice-President and Canadian General Manager abstained. So the proposal was adopted, with the amendment that Colorado be in the W0 area. The Chairman thanked Assistant Secretary Service for his labors on this project. (Applause.)

At this point Mr. Reid rendered a report for the Finance Committee, which was accepted by the Chairman on behalf of the Board.

Moved, by Mr. Caveness, that By-Laws 19 and 20 be amended to read respectively as follows:

19. On any date not later than noon of the twentieth day of September of an election year in any division, nominating petitions signed by ten or more Full Members of a division and naming a Full Member of the division as candidate for Director, may be filed with the Secretary. The Board of Directors shall solicit such petitions in the August and September issues of QST in each election year by a notice that will show the names of the incumbents.

20. The Executive Committee shall delete the name of any nominee who may be ineligible to election and the name of any who may withdraw by written communication. The remaining names shall be listed on a ballot, in alphabetical order. If there be but one eligible nominee, the Executive Committee shall declare him elected without balloting by the membership. If there be more than one eligible nominee, then during the first week of October the Secretary shall send by mail to every person who on the twentieth day of September of that year was a Full Member of the League in the divisions in which elections are being held, a ballot listing the candidates for Director in his division, and a return envelope, soliciting a vote for one name. The ballot shall contain a copy of By-Laws 19, 20, 21, 22, 23 and 24. The Executive Committee shall constitute itself a Committee of Tellers; but any member of the League who shall deliver to the Secretary on or before the first day of October of election year a written petition signed by at least ten Full Members of a division, stating their desire that he witness the counting by the Committee of Tellers of the ballots from that division, shall be permitted to do so and shall be accorded every reasonable opportunity to satisfy himself of the correctness of the count reported by the Committee; provided that the aforesaid signatures shall not have appeared on another similar petition. Ballots, to be counted, shall reach the Secretary not later than noon of the twentieth day of November of election year. No outer envelopes marked as containing ballots shall be opened until the meeting of the Committee of Tellers held for the purpose of counting the ballots. The Committee of Tellers shall meet at the headquarters office of the League as soon thereafter as possible and in the presence of each other shall open the envelopes containing ballots and shall count the vote, after first eliminating the ballot of anyone disqualified from voting. They shall forthwith prepare and sign a report of the results of the vote, declaring duly elected as new directors the candidate in each division receiving the greatest number of votes of the League members therein; and they shall turn over all their records and ballots to the Secretary for presentation at the next annual session of the Board of Directors.

The yeas and nays being ordered, the said question was decided in the affirmative: Whole number of votes cast, 15; necessary for adoption, 10; yeas, 15; nays, 0. Every director voted in the affirmative, the President and Vice-President

(Continued on page 94)

Announcing Your Post-War Receiver



The New RME 45



BETTERS PERFORMANCE AND EASE OF OPERATION

Embodying the important advancements brought about by the war, the new RME 45 is now ready for those who want a really fine communications receiver.

The RME 45 is the product of months of painstaking research and laboratory measurements which have collaborated to produce a receiver that betters performance, stability and ease of operation. In designing the receiver, not a single component has been neglected or overlooked. From the indirectly illuminated and non-fatiguing calibrated scale to the new acoustically designed speaker housing—the RME 45 is your post-war receiver!

The indirectly illuminated scale is designed for hours of non-fatiguing operation. Like a vernier, the sharp, hairline calibrated scale—white letters on an optically black background—enable the operator to log the frequency of the incoming signal accurately and effortlessly!

TRUE ELECTRICAL BANDSPREAD

One control activates the bandspread dial and main tuning dial simultaneously—to give you true electrical bandspread!

Regardless of the contemplated shifts in amateur frequency allocations, your RME 45 will not become obsolete because it bandspreads the entire spectrum from 550 KC to 33,000 KC.

In all, you will find the RME 45 a remarkable receiver and definitely worth waiting for.

Now sold on priority to essential services

ADDITIONAL FEATURES

- Streamlined two-tone cabinet. Acoustically designed speaker housing
- Relay rack mounting panel
- Six bands, 550 to 33,000 KC
- Automatic noise limiter
- Relay control and break-in terminals
- Stability—temperature compensating padders and local tubes
- Signal level meter
- Variable crystal filter
- Bandspread—equivalent to 75 linear inches for every 180 degree sweep of main pointer

Literature describing the new RME 45 will be gladly sent you upon request



RME

FINE COMMUNICATIONS EQUIPMENT

RADIO MFG. ENGINEERS, INC.

Provia 6, Illinois U. S. A.

RME
SINCE
1933

RECEIVING SENDING
CODE *Speed* *without strain*

CHAMPIONS ENDORSE CANDLER WAY

Get skill, accuracy, speed with the highly endorsed Candler System. Learn to send and receive by telegraph or radio code. Government service and commerce need thousands of better trained operators. Air commerce, mail, freight, etc., demand expert, reliable operators. Good pay. Get the Candler System, the maker of champions. It teaches you the "knack" of sound sense, alertness, speedy sending and receiving without strain. Adventure—good pay. Learn at home or wherever you are. Rush name today for free book.

FREE! **CANDLER SYSTEM CO.**
Dept. 4.H., Box 928, Denver 1, Colorado, U.S.A.
and at 121 Kingsway, London, W.C. 2, England

▶ TRANSMITTING TUBES RECTIFIERS CATHODE RAY TUBES

We have been appointed a sales agent by Defense Supply Corporation of Government surplus tubes and rectifiers. All are first grade Government tested and inspected tubes—not rejects.

The following types are immediately available:

826 (HF Triode)	Cathode Ray Tubes
VT 127A (HF Triode)	8AP1
304 TL	8BP4
872A M. V. Rectifier	3AP1

WRITE FOR PRICES

LEWIS ELECTRONICS 16 Lyndon Avenue
Los Gatos, California

LEO'S SPECIAL!
 Immediate Delivery on this
Multitester
\$18.75
 WRL 300 Less Leads



Handles AC and DC Voltmeter, DC Milliammeter, High and Low range Ohmmeter. Size 5 1/2 x 8 x 3 1/4. 3" meter with sturdy D'Aronsva movement. Write for priority information today.

PHONO AMPLIFIER KITS
 Complete with tubes, all parts, chassis, diagram, etc. Priority AA-5 or higher. **\$9.50**
 No. 1059.....

We Feature Hallcrafters



Need to Get...
RADIO PARTS
TUBES and CIRCUITS
 Wholesale RADIO LABORATORY

America's outstanding "radio man's radio." Available for immediate delivery on priority. Write for full details today!

These Items - Exclusive at Leo's
 44 Page Radio Parts Flyer. FREE
 Tube and Circuit Book. 10c
 Giant Radio Reference Map. 15c
 Handy Tube-Base Calculator. 25c

Address Leo, Dept. Q-7
 Council Bluffs, Iowa

Wholesale
RADIO LABORATORIES

CRABTREE'S

WHOLESALE RADIO

2608 Ross Ave. Dallas 1, Texas

RADIO AND ELECTRONICS ENGINEER

For research and development in the field of radar, radio communications and electrical test equipment. Good postwar opportunity. Also openings available for Draftsmen and Junior designers.

ALLEN D. CARDWELL MFG. CO.
 81 Prospect Street, Brooklyn, N. Y.

RF Inductors • RF Chokes • IF Transformers
 Condensers • Mica Molded Condensers • Trimmer
 Condensers • Miscellaneous Apparatus

The F. W. Sickles Co., Chicopee, Mass.

SICKLES Electronic Specialties

SPECIAL
OFFER . . . See Page 89

(Continued from page 92)

abstaining as required. So the by-laws were amended as proposed.

On motion of Mr. Davis, unanimously VOTED that the Chairman is directed to appoint a committee to investigate and report to the Board the potentialities and possibilities of recommending to the Federal Communications Commission changes in amateur regulations desirable in the postwar era.

On motion of Mr. Norwine, after discussion, the following resolution was unanimously ADOPTED:

The Board of Directors having last year increased the salary of Secretary K. B. Warner and the Treasury Department not having authorized the present payment of the whole amount of that increase, Be It RESOLVED: that that portion of the increase not authorized to be paid over now shall be entered on the books of the League to the credit of K. B. Warner, to be paid over to him if and when such payment becomes lawful.

Moved, by Mr. Kirkman, that, in view of the doubt expressed by the director of the Hudson Division concerning the wisdom of recommending to the FCC that the State of New Jersey become a part of the third call area instead of a part of the second call area, with particular reference to the numbers of displaced calls, a final decision of the Board in regard to the State of New Jersey be deferred until the statistics can be checked. But there was no second, so the motion was lost.

At this point General Counsel Segal retired from the meeting, at 6 P.M.

In connection with a brief discussion of 'phone frequencies, and reflective of the wishes of several members of the Board, the President, the Board concurring, DIRECTED the Secretary to prepare and submit to the Board a plan that will facilitate the Board's determinations of its recommendations for the assignment of frequencies for 'phone operation in the bands below the 144-148-Mc. band.

Moved, by Mr. Norwine, that the annual meeting of the Board of Directors be called for the second Friday in May of each year, unless in the judgment of the President there are compelling reasons in the League's interests why the meeting should be held on some other date in May. Moved, by Mr. Stedman, to amend the motion to change "second Friday" to "fourth Friday." Moved, by Mr. Caveness, to place the motion on the table; but the said motion was rejected, 5 votes to 10. The question then being on Mr. Stedman's amendment, the same was rejected. Moved, by Mr. Arledge, to amend the pending motion by changing "Friday" to "Wednesday." But the said motion was rejected. The question then being on Mr. Norwine's original motion, the same was thereupon unanimously ADOPTED.

On motion of Mr. Kiener, unanimously VOTED that the Board commends President Bailey and Secretary Warner on their presentation for the amateur service before the Federal Communications Commission last autumn. (Applause.)

Whereupon, on motion of Mr. Caveness, the Board adjourned, sine die, at 6:40 P.M.

K. B. Warner

Secretary

Strays

Director Bickel, W6BKY, and his wife were riding across Indiana on their way to the Board Meeting, accompanied by Vice-President Blalack, W6GG. Johnnie and Charlie were hamming, while Mrs. Bickel looked at the scenery from the train window. Suddenly she remarked, "I never saw so many antennas in my life. Look, Johnnie, that house has five antennas on it!" They turned out to be lightning rods — the answer being that since there is never (well, hardly ever) any lightning on the Pacific Slope, she had never heard of lightning rods!

"Calling Car No. 101"



*Police Desk Sergeant
Uses Astatic Model D-104
Microphone mounted on
Grip-to-Talk Desk Stand*

With installations such as this Police Transceiver, in use at Youngstown, Ohio, Astatic Microphones meet the demand for dependable communications service. With proper priorities such Astatic products are now available.

**"You'll HEAR MORE
from Astatic"**

THE
Astatic
ASTATIC CORPORATION
CONNEAUT, OHIO
IN CANADA, CANADIAN ASTATIC LTD., TORONTO, ONTARIO

Radio Communications Assemblies

TAILORED TO ANY INSTALLATION

Since 1931, Wilcox has manufactured dependable radio communications equipment, to meet the particular needs of various types of installations... including Military requirements during the past war-time years. Today, Wilcox radio communications equipment is becoming available again—subject, of course, to military priorities.



F3 RECEIVER... designed for telephone reception only. Compact, rack-mounting unit, having medium selectivity, high sensitivity, and flat automatic volume control.

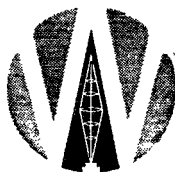

**WILCOX ELECTRIC
COMPANY, INC.**

Manufacturers of Radio Equipment

FOURTEENTH AND CHESTNUT KANSAS CITY, MISSOURI

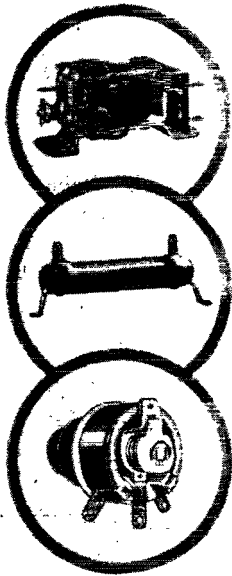

FOR DESIGN

FOR REPAIR

FOR MAINTENANCE

Use Ward Leonard Vitrohm Wire-Wound Resistors and Rheostats—made to conform to the most rigid specifications for use in any transmitter application. Relays, too, are built to the same exacting standard that marks all Ward Leonard products. Write us for our new catalog now being compiled. A copy will be sent you as soon as it is off the press.

WARD LEONARD ELECTRIC CO.

Radio and Electronic Distributor Division
53 WEST JACKSON BLVD., CHICAGO, ILL.



RADIO

RADIO Technician and Radio Communications courses. Register now for new classes starting first MONDAY of each month. Day and Evening Classes.

AMERICAN RADIO INSTITUTE
101 West 63d St. New York 23, N. Y.
Approved under GI Bill of Rights

Choose **AMERICA'S FINEST KEY**

Genuine Semi-Automatic

VIBROPLEX

Reg. Trade Marks: Vibroplex, Lightning Bug, Bug

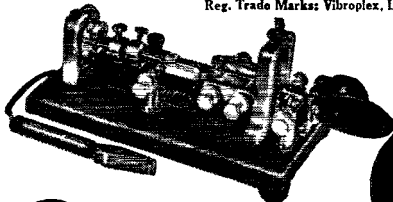

Deluxe MODEL

PATENTED JEWEL MOVEMENT
\$19.50



The "BUG" Trade Mark identifies the Genuine Vibroplex. Accept no substitute.

The aristocrat of all Vibroplexes. Amazing PATENTED JEWEL MOVEMENT. Watch-like precision. Feather-touch action free of tiring effort. Simply press lever—Vibroplex does the rest. Adjustable to touch and speed. New, non-glare Battleship Gray base. Bright machined parts. Colorful red switch knob, finger and thumb piece. DIE CUT contacts and main spring. 3/16" contacts. Cord and wedge. Order yours to-day! Money order or registered mail. Illustrated catalog FREE.

THE VIBROPLEX CO., Inc.
833 BROADWAY • NEW YORK 3, N. Y.

Radio Operating Procedures

(Continued from page 84)

calling station may be omitted, the first method being much the better because it is more positive:

THIS IS CHARLIE DOG TWO. WILCO. OUT.

Single-Call or Link-Sign Calling

In some combat areas a form of calling known variously as the "single-call" or "link-sign" method is used by ground troops.

In this system the net control station does not have a call sign of its own. When it works any subordinate station of the net, it uses the call of that station. Likewise, when a subordinate wishes to call the NCS he uses his own call. From the standpoint of enemy intercept this is very confusing, because the direction of calling cannot be determined. With R/T, in fact, the whole thing sounds like Broadway double talk. For instance, an NCS has a short prearranged code message for a subordinate station whose call is MQ2. He opens:

HELLO MIKE QUEEN TWO. OVER.
MIKE QUEEN TWO. OVER.
MIKE QUEEN TWO. HAM AND EGGS. OVER.
MIKE QUEEN TWO. ROGER. OUT.

If the message is from MQ2 to the NCS, the transmissions are exactly the same!

An additional feature of this single-call method is its brevity. Only one call sign, instead of two, is used.

The effectiveness of this system is based on the fact that in most tactical ground force nets (division and down), practically all traffic is between the NCS and the subordinates. In lateral working between two subordinates the call signs of both stations must be used, but from here on certain complications develop. These are best learned on the spot, as numerous variations have been developed to suit the requirements of particular circumstances of operation.

Not the least interesting feature of link-sign calling is its origin. This operating procedure was developed by the German army and used very successfully in the North African campaigns of 1941-42. The British Army then adopted it,



although many scoffers asked: "How can you expect to fool the Germans with their own procedure?" However, the knife *did* cut both ways; captured enemy documents proved that the Germans were fooled just as the British had been. Finally, the procedure was also adopted by U. S. ground forces in the ETO.

"Tailor-made"

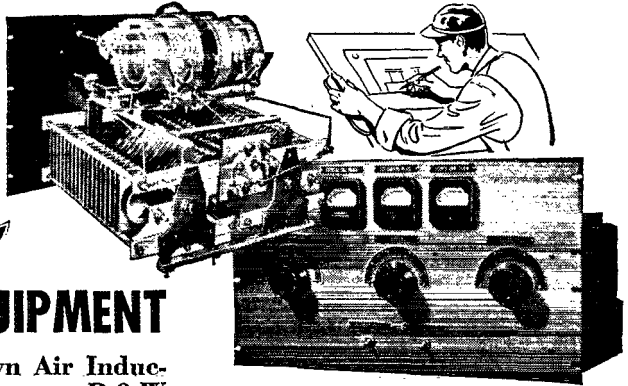

ELECTRONIC EQUIPMENT

In addition to its well-known Air Inductors and Variable Air Condensers, B & W offers a wealth of specialized facilities for the design and production of custom-built electronic equipment. Whatever your need in special transmitters, test equipment, tuning units, high and ultra-high frequency units, high voltage equipment, and similar assemblies, write for details.



**AIR INDUCTORS • VARIABLE
CONDENSERS • ELECTRONIC
EQUIPMENT ASSEMBLIES**

BARKER & WILLIAMSON

DEPT. Q 65, 235 FAIRFIELD AVENUE
UPPER DARBY, PENNSYLVANIA

Export: LINDETEVES, INC., 10 Rockefeller Plaza, New York, N. Y., U. S. A.

ANTENNAS

EST.



1906

For every radio purpose

BRACH ANTENNAS

*since the beginning of radio broadcasting
have been pace-makers in their field*

BRACH Antennas, tested and perfected to meet Army and Navy standards, are doing their part for victory on land, on sea, and in the air.

After the war, BRACH Puratone* Antennas will again resume their established leadership for Home and Auto Radios, Television, Marine, F.M. and other services.

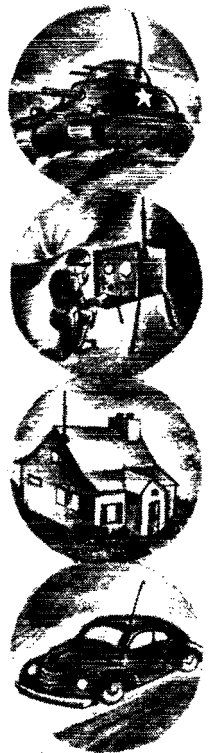

*Reg. Patent Trade Mark

L. S. BRACH MFG. CORP.



NEWARK 4, N. J.

can you fill one of these *good* jobs?

We Need 3 High Grade Men Immediately for:

- **Radio Amateur Sales Engineer.** Great opportunity for licensed ham. Will plan sales literature, handle correspondence and customer contact. Formal electrical education and practical radio experience helpful. Prefer man under 40. Finest kind of postwar opportunity.
- **Public Address Equipment Sales Engineer.** Should be experienced in sound equipment, so as to plan catalogs, handle correspondence and customer contact. Must know amplifier circuits, and be backed with practical experience. Would like man under 40. Excellent postwar opportunity.
- **Industrial Sales Engineer, Electronics.** Should have formal electrical education and practical experience in transformer and electronics field. Will be trained to contact customers personally and by mail, working closely with the engineering dept., preparing transformer specs., samples, etc. Preference given to man under 40.

Above men are wanted for one of America's largest and most aggressive companies operating in these fields.

If interested in any one of these jobs, write immediately, giving full details of experience, salary wanted, etc., and phone number if possible, in first letter. State which job you would like. Address:

Box 130, care of QST

38 La Salle Road West Hartford 7, Connecticut

LEARN RADIO

Pre-Military training for beginners. Catalog on request. We teach all technical branches of radio. Lic. by the Comm. of Mass. Dept. of Education.

MASSACHUSETTS RADIO SCHOOL
18 Boylston Street Boston, Massachusetts



INSTITUTES

Offer thorough training courses in all technical phases of



RADIO and TELEVISION

WEEKLY RATES DAYS—EVENINGS

VETERANS: RCA Institutes is approved under G. I. Bill of Rights

For Free Catalog write Dept. ST-45
RCA INSTITUTES, Inc.
A Radio Corporation of America Service
75 Varick Street, New York 13, N. Y.



65 models, sizes from 350 to 35,000 watts, A.C. types: 115 to 650 volts, 50, 60, 180 cycles, 1 or 3-phase; 400, 500 and 800 cycles, 1-phase. D.C. types: 6 to 4000 volts. A.C.-D.C. combination types available. Write for engineering assistance and literature. Model shown is from ATC lightweight series.

**Over 250,000
Now In Service**

D. W. ONAN & SONS

2626 Royalston Ave., Minneapolis 5

Minnesota

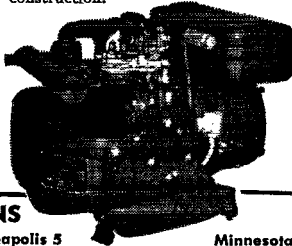

Electricity

FOR RADIO AND ELECTRONIC APPLICATIONS

Onan Electric Generating Plants supply electric service for electronics applications and general uses, mobile, or stationary. Driven by Onan-built, 4-cycle gasoline engines, they are of single-unit, compact design and sturdy construction.

Allocations Above 25 Mc.

(Continued from page 14)

quencies and how completely we shall have to revolutionize our thinking when we go into field techniques. No more do we expect to be using simple dipole antennas, but the ham is frequently best able to visualize frequencies in terms of the length of a half-wave antenna. For the 5-kMc. band such an antenna would be only an inch long.

So you can see, fellows, that we have a lot to learn. There is already a considerable literature of the u.h.f. and s.h.f. art, most of it not accessible to the average amateur or understandable to him. And the bulk of what is new and interesting cannot yet be published, for reasons of military security. But do not despair—the dope will come. We have no reason to think that these frequencies will ever take the place of our lower and heavily populated frequencies. Average ranges will always be short and operating difficulties many. But we also know that when the wartime restrictions are removed and the information can be published, attainable ranges will be found to be much greater than many have believed possible and a fascinating new world opened up to the experimenter. Let's get on with that war!

There has been some grouching over the apparently aimless selection of the location for these amateur bands. They aren't harmonically related, they don't seem related to anything. But there is a sort of method to them: in every case they adjoin bands assigned to the Government. The Government bands themselves in many cases got established where they are by sheer chance. Somebody developed a new gimmick of certain dimensions and this is where it happened to land; or a research group went to work to develop apparatus for a particular purpose that would not exceed certain dimensions and this is what its frequency turned out to be. Then similar gear got built in quantity and the bands got occupied, and they are doing a job in the war. So these locations became standards for the future, and in every one of these Government bands apparatus is actually working today. Then when the Government got to planning for peacetime and estimating how much it could cut down its bands when the war is over, it very wisely spotted the amateur bands alongside the Government ones, so that when we are closed down during a war they will again have widened bands for themselves. Certain advantages flow to us from that system. The military services now have the incentive to protect these amateur assignments and we are assured of powerful support, now that the decisions have been made. Moreover, most of the apparatus working in the Government bands is capable of working also in the adjacent ham bands, something that by no means can be said of all the frequencies above 25 Mc. Much of this gear is not applicable to amateur needs but some of it will be, and in all cases there will be equipment manufacturers who have had experience with these frequencies. We think this factor will be of much help to us in getting our own start in these bands.

—K. B. W.

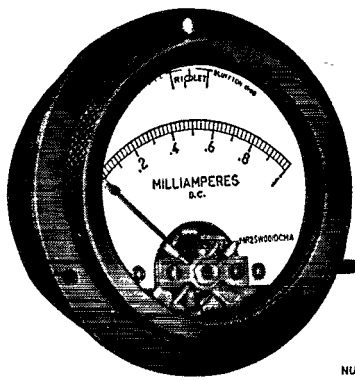

INTRODUCING THE NEW TRIPLETT LINE OF HERMETICALLY SEALED INSTRUMENTS

All the features of standard instruments retained. Withstand submersion tests at 30 feet. Comply with thermal shock, pressure and vibration tests. Resistant to corrosion. Conform to S.C. No. 71-3159 and A.W.S. C-39.2-1944 specifications. 1 1/2", 2 1/2" and 3 1/2" metal cases with 1/16" thick walls, in standard ranges. D.C. moving coil, A.C. moving iron and thermocouple types. Write for circular.

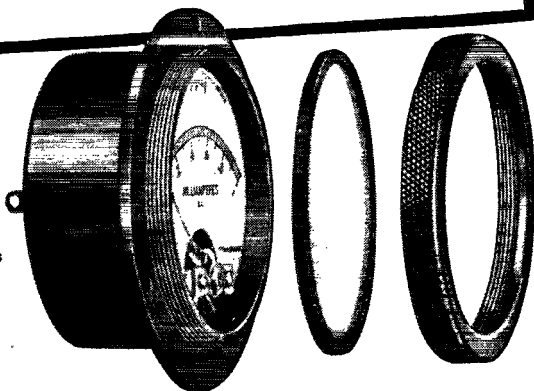
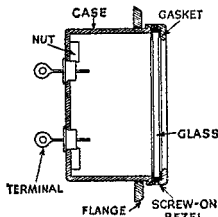

Triplett

ELECTRICAL INSTRUMENT CO. BLUFFTON, OHIO

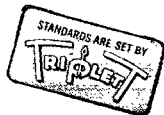

COMPLETE RADIO TRAINING!

All branches of communications, including television and FM courses from 6 to 18 months' duration. HIGH SCHOOL GRADUATES 17 YEARS OF AGE — prepare for radio operating positions in the U. S. Merchant Marine in 6 months. Complete pre-induction radio training in 3 months. Information supplied to Veterans on radio engineering training.

Write for particulars
VALPARAISO TECHNICAL INSTITUTE
Dept. T Valparaiso, Indiana

RADIO-TELEVISION-ELECTRONICS

Prepare now for ever-increasing post-war opportunities. Day and Eve. Sessions. Enroll now for new classes. Consideration given to Veterans eligible for training under the G.I. Bill.

RADIO-TELEVISION INSTITUTE

480 Lexington Avenue, New York 17 (46th Street)
Plaza 3-4585 Licensed by New York State



RADIO Train with professionals. Complete, intensified courses; Repair and Maintenance, Communications, High-speed telegraphy, Slip transcription, FCC exams, etc. High School Students accepted for training as Merchant Marine Radio Officers. Gov't sponsorship available to veterans. "A Radio School managed by radio men." 45 W. 45th St., Dept. Q, New York 19, N. Y.

MELVILLE RADIO INSTITUTE

COMMERCIAL RADIO INSTITUTE

A RADIO TRAINING CENTER FOR 24 YEARS

Resident Courses Only • Pre-Induction, Broadcast, Service, Aeronautical Television, and Marine telegraphy classes now forming for Oct. 1. Literature upon request. Veteran training.

Dept. B, 38 West Biddle Street, Baltimore 1, Maryland

Now—a really
high-powered



RADIO ENGINEERING LIBRARY

- especially selected by radio specialists of McGraw-Hill publications
- to give most complete, dependable coverage of facts needed by all whose fields are grounded on radio fundamentals
- available at a special price and terms

THESE books cover circuit phenomena, tube theory, networks, measurements, and other subjects—give specialized treatments of all fields of practical design and application. They are books of recognized position in the literature — books you will refer to and be referred to often. If you are a practical designer, researcher or engineer in any field based on radio, you want these books for the help they give in hundreds of problems throughout the whole field of radio engineering.

Free Examination • Special Low Price • Easy Terms

McGRAW-HILL BOOK CO., 330 W. 42nd St., New York 18

Send me Radio Engineering Library, 5 vols., for 10 days' examination on approval. In 10 days I will send \$3.00, plus few cents postage, and \$3.00 monthly till \$24.00 is paid, or return books postpaid. (We pay postage on orders accompanied by remittance of first installment.)

Name.....
Address..... Company.....
City and State..... Position..... QST 7-45

5 VOLS.
3319 PAGES,
2289
ILLUSTRATIONS

1. Eastman's Fundamentals of Vacuum Tubes
2. Terman's Radio Engineering
3. Everitt's Communication Engineering
4. Hund's High Frequency Measurements
5. Henney's Radio Engineering Handbook

HAM-ADS

(1) Advertising shall pertain to radio and shall be of nature of interest to radio amateurs or experimenters in their pursuit of the art.

(2) No display of any character will be accepted, nor can any special typographical arrangement, such as all or part capital letters be used which would tend to make one advertisement stand out from the others.

(3) The Ham-Ad rate is 30c per word, except as noted in paragraph (6) below.

(4) Remittance in full must accompany copy. No cash or contract discount or agency commission will be allowed.

(5) Closing date for Ham-Ads is the 25th of the second month preceding publication date.

(6) A special rate of 7c per word will apply to advertising which, in our judgment, is obviously non-commercial in nature and is placed and signed by a member of the American Radio Relay League. Thus, advertising of bona fide surplus equipment owned, used and for sale by an individual or apparatus offered for exchange or advertising inquiring for special equipment, if by a member of the American Radio Relay League takes the 7c rate. An attempt to deal in apparatus in quantity for profit, even if by an individual, is commercial and all advertising by him takes the 30c rate. Provisions of paragraphs (1), (2), (4) and (5) apply to all advertising in this column regardless of which rate may apply.

Having made no investigation of the advertisers in the classified columns, the publishers of *QST* are unable to vouch for their integrity or for the grade or character of the products advertised

QUARTZ — Direct importers from Brazil of best quality pure quartz suitable for making piezo-electric crystals. Diamond Drill Carbon Co., 719 Union Bldg., New York City.

COMMERCIAL radio operators examination questions and answers. One dollar per element. G. C. Waller, W5ATV, 6340 Washington Blvd., Tulsa, Okla.

WHY NOT turn your unused equipment into ready cash which may be applied towards new and better equipment after the war? Leo, W9GFQ, offers you the best cash prices for communications receivers and test equipment. Write today for large illustrated catalog. Wholesale Radio Laboratories, 744 W. Broadway, Council Bluffs, Iowa.

CRYSTALS available — all types, including 100 kc., 465 kc. and 100 kc. Broadcast and Aircraft given prompt attention. Scientific Radio Products, Council Bluffs, Iowa.

CRYSTALS: complete units or blanks. All types. Your specifications and tolerances. One or one million. Refinishing and re-pairing of your present units. Rex Bassett, Incorporated, Ft. Lauderdale, Fla.

RADIO TESTS — Pre-examination Tests for Radio Operators. Tests your knowledge before you appear for commercial radio operator license examinations. Avoids failures. Guides your preparation. Saves your time. Worth investigating at once. Also books for home study. Write for free circulars 5Q. Nilson Radio School, 51 E. 42 St., New York 17, N. Y.

PROMPT Repair Service on meters and electronic instruments. Braden Engineering Co., 3317 Kenmore Ave., Dayton 10, Ohio.

FRITZ for better QSLs after victory! 1213 Briargate, Joliet, Ill.

RK-49 type tubes wanted. Charles J. Bodnar Co., 58 Marbledale Road, Tuckahoe 7, N. Y.

QRR de LSPH: Need Volumes 1, 2 and 3 to complete my file of *QST*. Will pay good price for bound volumes or single copies in good condition. QRU? E.D.C., 38 LaSalle Road, West Hartford 7, Conn.

IMMEDIATE shipment on priority: new SX28As, \$223.00; SX25s, \$94.50; PM23s, \$15.00; 839s, \$110.00; 820Rs, \$60.00. In stock without priority: Trimm No. 100 Featherweight headsets, \$6.00; No. 65 Dependable headsets, \$2.28, meter rectifiers, \$1.95, etc. Instructographs for rent. Write for our parts list. Henry Radio, Butler, Mo., and Los Angeles 25, Calif.

HIGHEST prices paid for used receivers, test equipment, bugs, oscillators. What have you? W9ARA, Butler, Mo.

HEADPHONES: latest type, light weight, finest quality, with plug for tuning in on radio, or intercommunication system. 2000 ohm resistance. Headphones: (no headbands, slightly used) \$1.25; Headphones: (no headbands, new), \$1.75; Headphones: (with leather covered adjustable headbands, slightly used), \$2.50; Headphones: (with adjustable leather-covered headbands, new), \$3.75, plus 25¢ shipping charges. Send check or money order. Quantity limited. Telephone Wire-insulated, used, suitable for radio or home wiring, 50 ft. lengths, \$1.65; 100-ft. lengths, \$2.95; 500 ft. \$12.75, plus 5¢ shipping charges. Send check or money order. Nico Supply Co., 540 North 17th Street, Philadelphia, Pa.

BUILD radio complete with tubes, \$10.95, details. Radio, 9418j Avenue "A", Brooklyn, N. Y.

WANTED: Typewriter in good condition. Prefer portable. Floyd Howard, Jonesboro, La.

DID you know — that in addition to other types, Eidson makes a one cycle coefficient crystal unit of 0.005% tolerance that's a honey? Reasonably priced, excellent delivery. New crystals available throughout the 100-12500 Kc. range. Send for free folder L-5, mention your needs. "Eidson's," Temple, Texas.

WANTED: Sargent Model II TRF communications receiver, "Universal" tuning range, 9.5-20,000 meters (15 kc. to 31.6 Mc.), any operating voltage. Chrysler Corporation, Att. Mr. MacDuff, Engineering Dept., Detroit, Mich.

WHEN amateurs are on the air again there will be a complete line of James Knights Precision Crystals for every amateur activity. The James Knights Company, Sandwich, Ill.

ASTATIC pickups and microphones in stock. Send for price-list and information. Hard-to-get tubes at ceiling prices. Also batteries. List and prices on request. Abbott Appliance & Music Co., 2101 Grand Concourse, New York City.

FABERADIO crystals will be available to amateurs immediately after hostilities cease. Faberadio, Sandwich, Ill.

SELL HRO seven coils, 200 kc. to 30 Mc., power supply. Best offer. Kirchhuber, W2KJY, 629 Avenue L., Brooklyn, N. Y.

WANTED: portable s.w. receiver such as Hallcrafters S-39, Trade or sell Sky Buddy. Don Aufderheide, 4246 Cornelius, Indianapolis 8, Ind.

FOR SALE: Hallcrafters SX-28 and PM-23 speaker, used 3 months. Any offer over \$100 considered. Roy Norvell, W5DFP, Box 904, Dalhart, Texas.

WAR surplus: aircraft instrument type Selyns for locating position of remotely located rotary antenna. Can be used in remote control circuit. Available \$15 pair without priority. Writing instructions included. Discount to dealers. D. O'Connor, 7 Winthrop Terr., East Orange, N. J.

FOR SALE: Siphon tape recorder as described in April 1943 *QST*, less exciter lamp and photo-cell. Best offer. Gilliam, W9SVE, 422 Goshen Ave., Elkhart, Ind.

TUBES and parts, new: two HY866 Jrs., \$1 each; HY61, \$3.50, HY60, \$2.50; Two HY40Z, \$3.50; Two HY25, \$1.50 each; Two 813, \$15 each; 866/866A, \$1.50; 811, \$3.00, 830B, \$7.50; 616, 75¢; matched pair iron core IFs, \$3; Johnson 200ED30 variable condenser, \$5; 160BTL Coto-Coil, \$2.50; Hallcrafters S-20R in original carton, best offer. Used but good: 35TG, \$5; 813, \$10. Send for list of miscellaneous parts including HV mica condensers. Wise, W9YCF, 424 20 N.E., Cedar Rapids, Iowa.

WANTED: modern tube tester, v.o.m. meter, Riders service manuals. C. B. Vogel, 3310 Morrison Ave., Houston 9, Texas.

FOR SALE: Hammarlund HQ-120 communications receiver; oscillator, Meissner signal calibrator with Bliley oven controlled 100 kc. crystal. Excellent condition. Best offer. Stanley Valinet, 1828 Central Ave., Indianapolis, Ind.

SELL National PW-O gear drive with micrometer dial, also Sky Champion receiver. E. Henderson, 2444 Gaylord St., Denver, Colorado.

WANTED: G. L. Automatic tape sender, Model J. Good condition. R. J. Sandvick, Veterans Home, Napa County, Calif.

SALE, best offer: S-20R, three sets of tubes, two new. Martin Croze, 212 Walnut St., Minneapolis 14, Minn.

WANTED: good clean used RME-9D, Breting 12 or Hallcrafters S-9, Vernon E. Conleton, W9DPW, 335 Desha Rd., Lexington, Ky.

WANTED: EC-1. Cash. Lt. Edward M. Hawkins, W4FOX.

WANTED: small compact self-contained cw/phone transmitter, 19" x 8 3/4" panel, 10 or 20-meter band, 25 to 50 watts. Good price for quality job. Immediate shipment. W1BB.

FOR SALE: best offer, three used 204A tubes, good condition. Thomas, W2UK, Box 695, Quogue, N. Y.

FOR TRADE: stamp album worth \$450, received offer of \$300, postage issues from No. 28 U.S. and old U.S. covers. List sent. Want Super-Skyrider and signal generator or Super-Pro. Herbert Hoch, 469 East 52nd St., Brooklyn 3, N. Y.

WANTED: Hallcrafters S-20R, Howard 437-A, (NC-45 Echo-phone 3, less speakers), \$65 maximum cash. Make offer! A. Carlson, Box 601, Lewistown, Montana.

SELL Triplett modulation monitor, new condition, \$30. Deller, W2BRE, 89 Durland Rd., Lynbrook, N. Y.

WANTED: Portable 110 a.c. plant, 750 or 1000 watt. Paul E. Gardner, New England, North Dakota.

SELL: Patterson PR10 and speaker, good condition. \$40. Wiseman, W9FKO, 1416 Loveland Ave., Springfield, Ill.

HRO bc. coil. State price. C. L. Terrel, DeGraff, Ohio.

WANTED: Hallcrafters HT-7 frequency standard. Will pay top price for instrument in first class condition. Quote f.o.b. Boston, price in letter. W. H. Hauser, 112 Warren St., Newton Center, Mass.

RECORD-player with crystal pick-up. Quiet electric motor, beautiful cabinet. Jarden, 7149 Ardleigh St., Philadelphia 19, Pa.

**"YOO HOO, BABY... YOU AND I
AND ECHOPHONE GOTTA DATE
IN THE NEAR FUTURE ON THE
CITIZENS' RADIOPHONE BAND"***

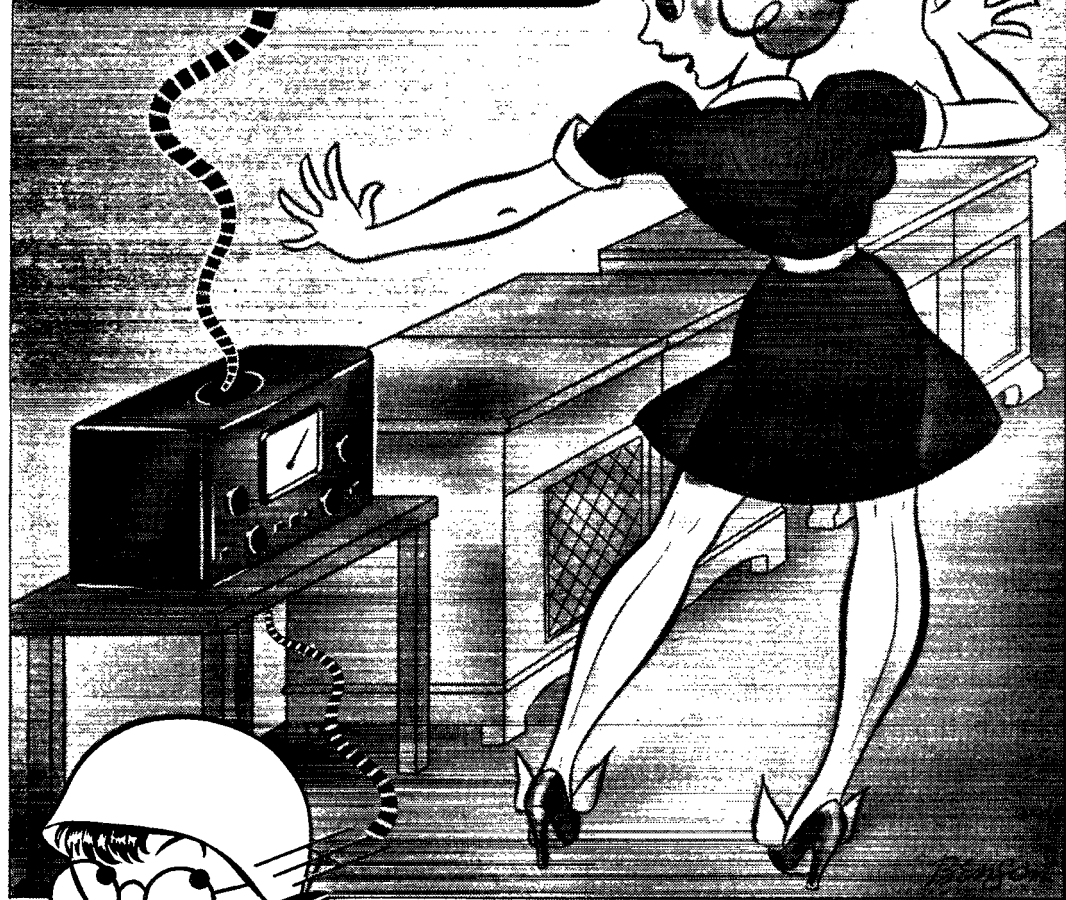

HOGARTH MAKES A DATE

Hogarth's date with the future embraces new possibilities for Echophone. There will be Echophone equipment for use on the citizens' radio communications service band. It is certain to be low in price, high in performance and completely dependable. The present EC-1 covers from 550 kc. to 30 Mc. on three bands . . . electrical bandspread on all bands . . . self-contained speaker . . . 115-125 volts AC or DC.

** Citizens' radio communications service band, 460-470 Mc., recently proposed by the F.C.C.*

ECHOPHONE RADIO CO., 540 NORTH MICHIGAN AVE., CHICAGO 11, ILLINOIS

ECHOPHONE
"The Ears of the World"

Designed for

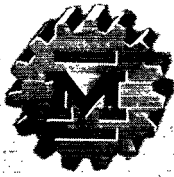

Application

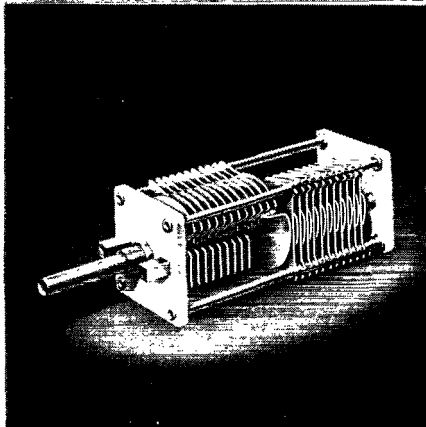

The 28000-29000 Series Variable Air Capacitors

"Designed for Application," double bearings, steatite end plates, cadmium or silver plated brass plates. Single or double section .022" or .066" air gap. End plate size: 1 9/16" x 1 11/16". Rotor plate radius: 3/4". Shaft lock, rear shaft extension, special mounting brackets, etc., to meet your requirements. The 28000 series has semi-circular rotor plate shape. The 29000 series has approximately straight frequency line rotor plate shape.

JAMES MILLEN MFG. CO., INC.

MAIN OFFICE AND FACTORY

MALDEN
MASSACHUSETTS



Index to Advertisers

	Page
Abbott Instrument, Inc.	**
Aerovox Corporation	**
American Lava Corp.	**
American Radio Institute	96
American Tel. & Tel. Corp.	87
Amperex Elec. Products, Inc.	**
Astatic Corporation, The	95
Ayers Automatic Code Machines	**
Barker & Williamson	97
Billie Electric Co.	5
Brach Manufacturing Corp.	97
Browning Laboratories, Inc.	69
Burgess Battery Company	70
Candler System Company	93
Capitol Radio Engineering Institutes	88
Cardwell Mfg. Corp., Allen D.	94
Centralab	71
Clarostat Mfg. Co., Inc.	**
Collins Radio Company	67
Commercial Radio Institute	**
Communications Products Co.	**
Crabtree Wholesale Radio	94
Crystal Products Co.	101
Delco Radio, Div. Gen. Motors	91
DX Crystal Company	**
Echophone Radio Company	101
Fitel-McCullough, Inc.	4
Electro-Voice Mfg. Co.	**
Electronic Laboratories	79
Galvin Mfg. Corp.	**
Gardiner & Company	**
General Ceramics & Steatite Co.	**
General Electric Co.	85
Greenlee Tool Company	93
Hallcrafters Co., The	1, 2
Hammarlund Mfg. Co., The	65
Harco Steel Construction Co.	**
Harrison Radio Company	**
Harvey Radio Company	**
Harvey Radio Laboratories, Inc.	80
Harvey Wells Communications, Inc.	**
Hazeltine Electric Corp.	82
Heintz & Kaufman, Ltd.	77
Henry Radio Shop	90
Hytron Corporation	**
Instructograph Company	**
International Resistance Co.	84
Jensen Radio Mfg. Co.	**
Ken-Rad Tube & Lamp Corp.	**
Kenyon Transformer Co., Inc.	**
Knights Company, James	**
Lewis Electronics Co., Inc.	93
Mackay Radio & Tel. Co.	86
Maedel Publishing House	**
Mallory & Co., P. R.	68
Massachusetts Radio School	98
McElroy Mfg. Corp.	75
McGraw-Hill Book Co., Inc.	99
Meck Industries, John	**
Meissner Mfg. Co.	73
Melville Radio Institute	99
Metropolitan Technical School	**
Milien Mfg. Co., James	102
National Company, Inc.	63, Cov. III
Newark Electric Co.	74
New York YMCA Schools	**
Nilson Radio School	**
Ohmite Manufacturing Co.	**
Ouan Electric Co., W.	98
Oxford-Tartak Radio Corp.	**
Pioneer Gen-E-Motor	**
Port Arthur College	92
Premax Products	98
RCA Institutes, Inc.	98
RCA Manufacturing Co., Inc.	Cov. IV
Radio Manufacturing Engineers	93
Radio Shack Corporation	76
Radio-Television Institute	99
Ramsey Publishing Co.	**
Raytheon Mfg. Co.	72, 81
Sechl & Co., C.	34
Scientific Radio Products Co.	**
Shure Brothers	**
Sickles Co., F. W.	94
Simpson Electric Co.	104
Sperry Gyroscope Co.	**
Sprague Electric Co.	**
Standard Radio Elec. Co.	**
Standard Transformer Co.	**
Sun Radio & Electronics Co.	86
Taylor Tubes, Inc.	**
Telegraph Apparatus Co.	**
Teleplex Company	**
Terminal Radio Corp.	78
Thordarson Elec. Mfg. Co.	**
Triplet Elec. Instrument Co., The	99
Turner Company, The	**
United Transformer Co.	Cov. II
Universal Microphone Co.	**
Valparaiso Technical Institute	99
Vibroplex Company, Inc., The	96
Wallace Co., William	**
Ward Leonard Elec. Co.	96
Western Electric Co.	82
Westinghouse Elec. & Mfg. Co.	83
Wholesale Radio Laboratories	94
Wilcox Electric Co.	95
Yakley (Mallory, P. R.)	68
Zenith Radio Company	**

All of the above advertisers are cooperating with the A.R.R.L. to permit publication of an editorially adequate QST during this period of war rationing of paper. Using less advertising space but at higher rates, they continue their customary support of QST. Some are using smaller space in each issue and some are using space only every second or third issue. Of the latter, those whose advertising does not appear in this particular issue are indicated by the **above.

Crystal UNITS for

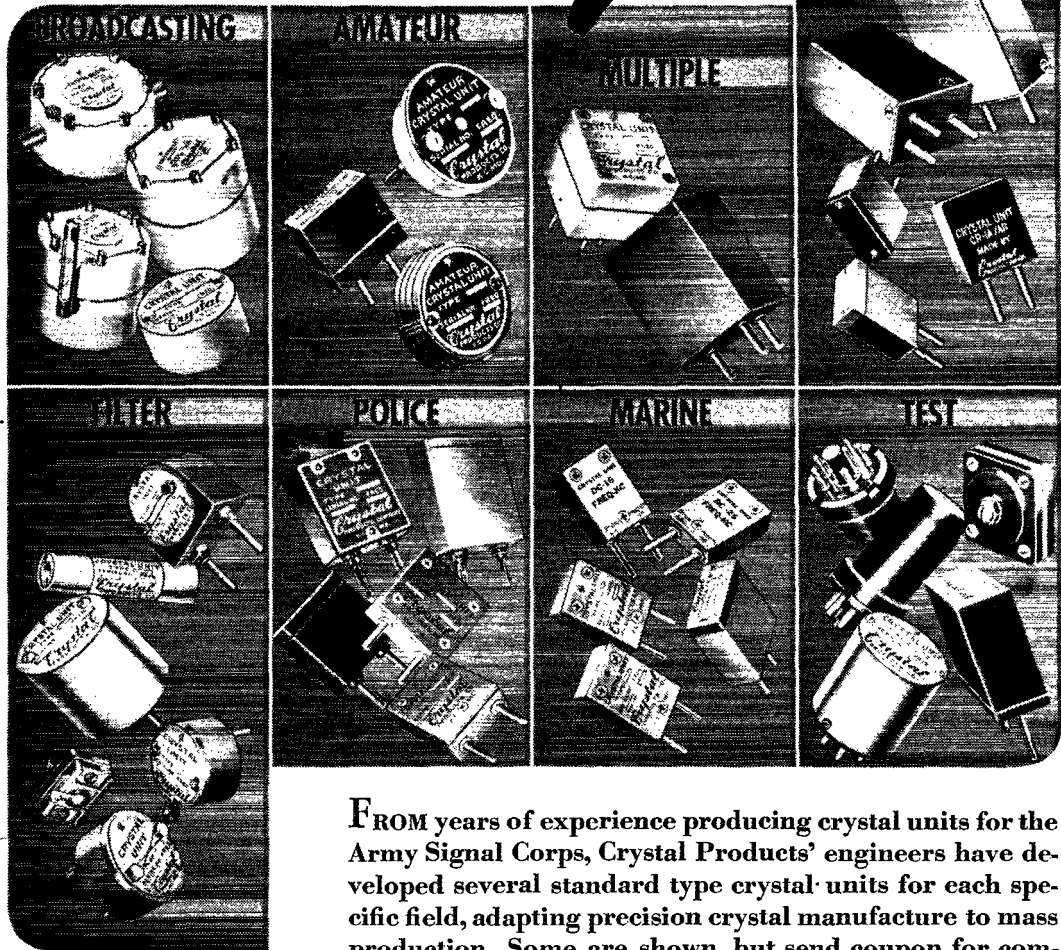

FROM years of experience producing crystal units for the Army Signal Corps, Crystal Products' engineers have developed several standard type crystal units for each specific field, adapting precision crystal manufacture to mass production. Some are shown, but send coupon for complete information about the units best adapted to your particular business.

MAIL THIS COUPON!

CRYSTAL PRODUCTS CO.,
Dept. O, 1519 McGee, Kansas City, Mo.
Gentlemen: I am interested in

NAME

FIRM

ADDRESS

CITY STATE

Crystal

PRODUCTS COMPANY

1519 MCGEE STREET KANSAS CITY, MISSOURI

Producers of Approved

Precision Crystals for Radio Frequency Control



Wondering about tube testers?

*... Here's what Simpson has ready
and waiting for your postwar needs*

Sensational? Yes . . .

1. This new Simpson Mutual Conductance Tube Tester tests tubes with greater accuracy than any commercial tube tester ever designed.
2. Provides greater flexibility for future tubes than any other tester.
3. Tests tubes with voltage applied automatically over the entire operating range.
4. Simplifies as never before the interpretation of tube condition from mutual conductance readings.

SIMPSON ELECTRIC COMPANY
5200-18 Kinzie Street, Chicago 44, Ill.

Simpson

INSTRUMENTS THAT STAY ACCURATE

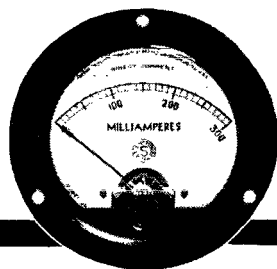

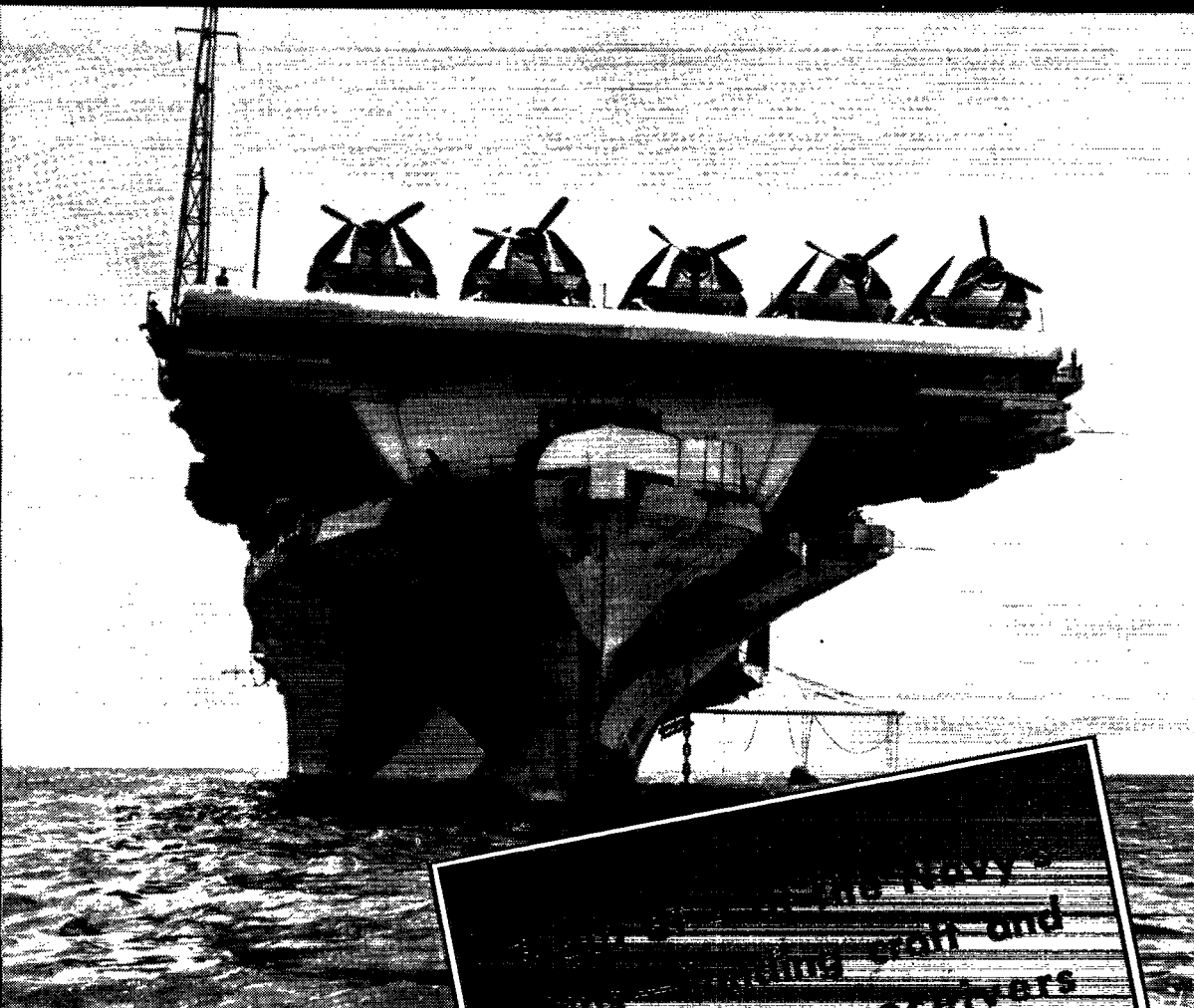

U.S. HORNET OFFICIAL U. S. NAVY PHOTOGRAPH

...of the Navy
...craft and
...receivers
...total.
...place
...anything but the
...radio equipment.

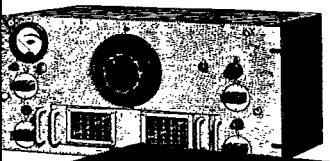

HRO

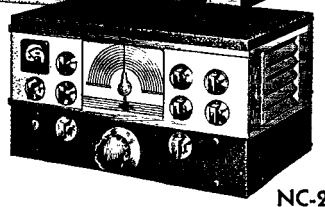

NC-200

NATIONAL COMPANY

MALDEN  MASS, U. S. A.

NATIONAL RECEIVERS ARE IN SERVICE THROUGHOUT THE WORLD

WHY AMATEUR TRANSMITTERS ARE MORE COMPACT AND EFFICIENT WITH RCA BEAM-POWER TUBES

Beam-power tubes provide simple, compact equipment with wide frequency range, high power-sensitivity, as well as excellent over-all efficiency and economy.

THE high power-output and low driving-power of beam-power tubes mean that fewer stages, smaller tubes, and a simpler power supply can do the job you want done—and at lower cost—than is possible with other types of tubes.

Because neutralizing is unnecessary with beam-power tubes, you can have a multi-frequency transmitter capable of quick band-changing without re-neutralizing for each frequency.

Whether used as r-f amplifiers, frequency multipliers, or modulators, beam-power tubes have been the choice of thousands of amateurs for flexibility, compactness, and economy.

Beam-Power Principle Applied to Many RCA Receiving Types

The advantages of the beam-power principle have been applied to such receiving tubes as the 1Q5-GT, 1T5-GT, 3Q5-GT, 6L6, 6V6, 6Y6-G, 25L6, 25L6-GT, 50L6-GT, and many others.

For information on RCA beam-power tubes, see the Radio Amateur's Handbook, which contains ratings, circuits, and socket information.

THE FOUNTAINHEAD OF MODERN TUBE DEVELOPMENT IS RCA

Tube Type No.	Filament Volts	Max. Freq. Mc.	Max. Plate Dissipation Watts	R-F Amplifier Class C Telegraphy			A-F Modulator or Amplifier, Class A, AB ₁ or AB ₂		Amateur Net Price
				Max. Plate Volts	Max. Plate Input, Watts	Grid Drive Watts	Max. Plate Input* Watts	Grid Drive* Watts	
1619	2.5	45	15	400	30	0.4	60 (AB ₂)	0.4	\$ 2.20
1614	6.3	80	21	375	35	0.1	70	0.4	1.65
832A	6.3 12.6	200	15	750	36	0.2	—	—	13.00
1624	2.5	60	25	600	54	0.4	108 (AB ₂)	1.2	2.40
815 #	6.3 12.6	125	25	500	75	0.2	75 (AB ₂)	0.4	4.50
807 #	6.3	60	30	750	75	0.2	180 (AB ₂)	0.2	1.95
829B	6.3 12.6	200	40	750	120	0.8	—	—	17.00
814 #	10.0	30	65	1500	225	1.5	—	—	17.50
828 #	10.0	30	80	1500	270	2.2	540 (AB ₁)	0	14.00
813	10.0	30	100	2000	360	0.5	—	—	18.00

* Values are for two tubes except for push-pull type 815
ICAS Ratings



BUY MORE

WAR BONDS

62-6436-69

RADIO CORPORATION OF AMERICA

RCA VICTOR DIVISION • CAMDEN, N. J.