

QST

march, 1945

25 cents

35c in Canada

devoted entirely to

amateur radio

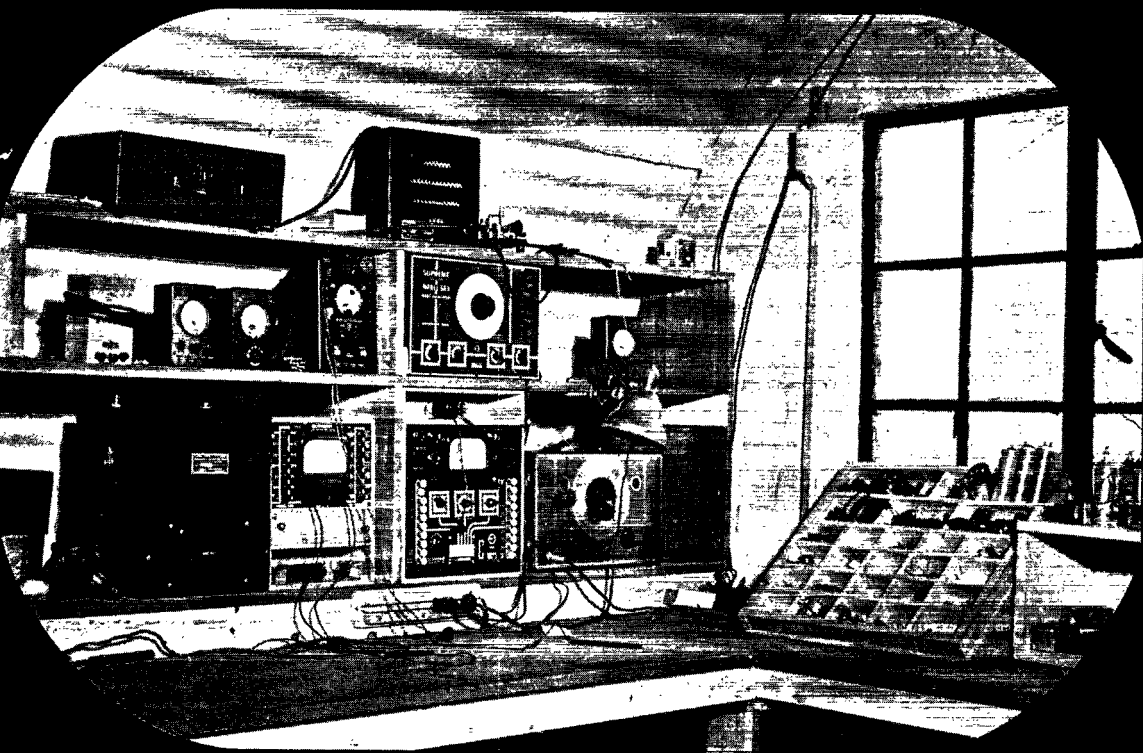

In This Issue:

Principles of Panoramic Reception • Polyphase R.F. Systems • "The Ghost of Guam" — KB6CJX
Radio on Leyte • A Compact V.F.O. With Stable Output • A Transmitter-Receiver for CAP-WERS

EQUALIZERS

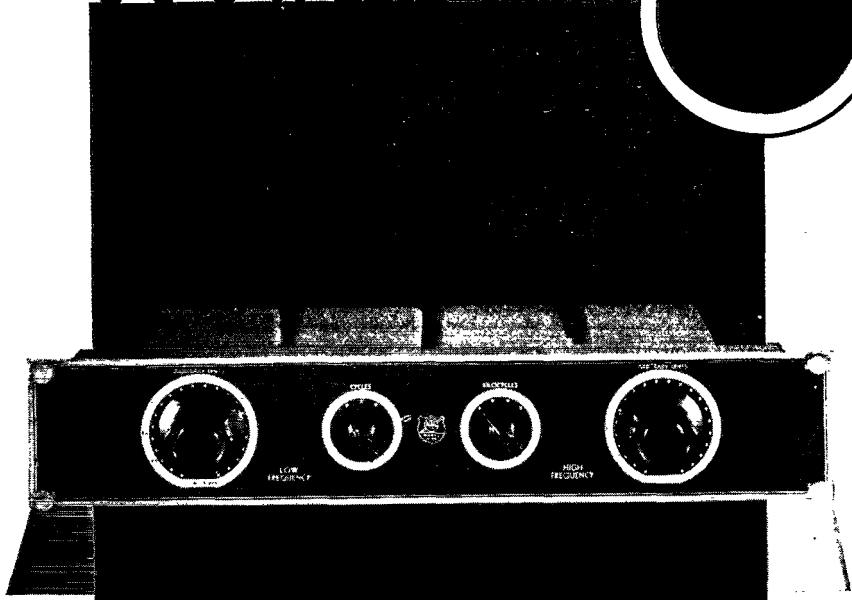
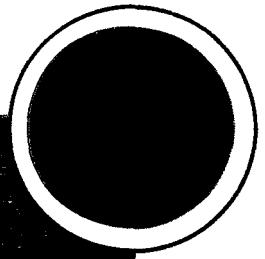

3AX

BROADCAST SERVICE.
 VIDES ADJUST OF 100, 250,
 100 CYCLES F CYCLES ARE
 8000, OR 10,000
 BRATED CONTROL UNIT EMPLOYS
 IZATION AND FREQUENCIES SUFFICIENTLY WIDE
 LOSS EFFECTED BY THE CARE OF ANY
 THROUGH SPECIAL
 IT IS CONSTANT RE
 CHANGE IN TONE COL
 NEGLIGIBLE CHANGE IN VOL

YOU ON DESIGN SAVINGS
 , WAR OR POSTWAR?



United Transformer Co.



COMMUNICATIONS



Land...Sea...Air

Hallicrafters will again assume its position of leadership in the field of peace time communications — with equipment especially designed to give new standards of transmitting and receiving performance on land, at sea or in the air. Communications receivers and transmitters for amateur and commercial use; two way radio telephones for marine and aviation use *plus* the finest kind of new equipment for further experiment and research at very high frequencies will all be included in Hallicrafters postwar production plans.



BUY A WAR
BOND TODAY!

hallicrafters RADIO



THE HALCRAFTERS CO., MANUFACTURERS OF RADIO AND ELECTRONIC EQUIPMENT, CHICAGO 16, U.S.A.

5 YEARS AHEAD OF ITS TIME

FM
AM
CW

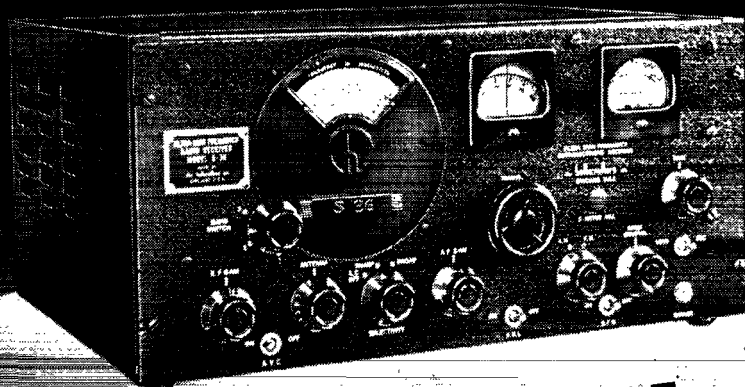

27.8 to 143 Mc

Covers old and new FM bands

hallicrafters Model S-36

EXACTLY five years ago—in 1940—Hallicrafters introduced a very high frequency communications receiver with a range of 27.8 to 143 Mc. This model was clearly five years ahead of its time in its anticipation of new and exciting possibilities for superior performance on the higher frequencies. Today Model S-36 stands by itself as the only commercially built receiver covering this range. It is outstanding for sensitivity, stability, high fidelity. With its extraordinary VHF versatility it is ready for immediate application in the ever widening fields of FM and higher frequency development work. Engineering imagination at Hallicrafters is reaching out beyond the next five years, beyond the present known limits of radio technique so that Hallicrafters equipment will continue to be always ahead of its time, above and beyond your best expectations.



hallicrafters RADIO

THE HALLICTRAFTERS CO., MANUFACTURERS OF RADIO AND ELECTRONIC EQUIPMENT, CHICAGO 16, U.S.A.

MARCH 1945

VOLUME XXIX

NUMBER 3



STAFF

Editorial

KENNETH B. WARNER, W1EH
General Manager of A.R.R.L.
Publications

CLINTON B. DESOTO, W1CBQ
Editor

A. DAVID MIDDLETON, W2OEN
Assistant Editor

GEORGE GRAMMER, W1DF*
Technical Editor

DONALD H. MIX, W1TS
Acting Technical Editor

J. VENABLE FITZBUGH, W5VL
HOLLIS M. FRENCH, W1LJK
BYRON GOODMAN, W1FB*
Assistant Technical Editors

EDWARD P. TILTON, W1HDQ
Contributing Editor, V.H.F.

WALTER E. BRADLEY, W1FWH
VERNON CHAMBERS, W1JEQ*
Technical Information Service

LOUISA B. DRESSER
Editorial Assistant

JAMES J. LAMB, W1AL*
Research Engineer, A.R.R.L.

Advertising

F. CHETNEY BEEKLEY, W1GS
Advertising Manager.

Circulation

DAVID H. HOUGHTON
Circulation Manager

RALPH T. BEAUDIN, W1BAW
Asst. Circulation Manager

*On leave of absence



OFFICES

38 La Salle Road
West Hartford 7, Connecticut

Subscription rate in United States and Possessions, \$2.50 per year, postpaid; all other countries, \$3.00 per year, postpaid. Single copies, 25 cents. Foreign remittances should be by international postal or express money order or bank draft negotiable in the U. S. and for an equivalent amount in U. S. funds.

Entered as second-class matter May 29, 1919, at the post office at Hartford, Connecticut, under the Act of March 3, 1879. Acceptance for mailing at special rate of postage provided for in section 1103, Act of October 3, 1917, authorized September 9, 1922. Additional entry at Concord, N. H., authorized February 21, 1929, under the Act of February 28, 1925. Additional second-class entries to cover sectional editions authorized March 20, 1935.

Copyright 1945 by the American Radio Relay League, Inc. Title registered at U. S. Patent Office.

QST

devoted entirely to

AMATEUR RADIO

PUBLISHED, MONTHLY, AS ITS OFFICIAL ORGAN, BY THE AMERICAN RADIO RELAY LEAGUE, INC., AT WEST HARTFORD, CONN., U. S. A.; OFFICIAL ORGAN OF THE INTERNATIONAL AMATEUR RADIO UNION



CONTENTS

It Seems to Us	9
Polyphase Systems Applied to R.F. <i>S/Sgt. Robert W. Bickmore, W6QDV</i>	11
Happenings of the Month	14
I.R.E. Winter Meeting	17
Panoramic Reception <i>Harvey Pollack, W2HDL</i>	18
A "Handbook" on Leyte <i>Cyrus T. Read, W9AA</i>	22
A Transmitter-Receiver for CAP-WERS Work <i>Capt. Robert E. Lathrop, CAP, ex-W9GOD</i>	24
Splatter	29
In the Services	30
A Compact V.F.O. With Stable Output <i>Arthur H. Lynch, W2DKJ</i>	34
"The Ghost of Guam" — KB6GJX <i>A. David Middleton, W2OEN</i>	38
A Versatile Electronic Key <i>Norman Snyder, W2HRD</i>	42
Attention! — Inventors	44
Citizens Radiocommunication Service	45
An F.M. Receiver for Carrier-Current Communication <i>George M. Guill, jr., W8VAN</i>	46
Hams in Combat Mine Sweeper! <i>Lt.(jg) George Zimmerman, USNR, W2NNZ</i>	48
In QST 25 Years Ago This Month	51
Strays	52
Gold Stars — W7IZV, W8SPK	53
Hints and Kinks <i>A Forward-Reading "S" Meter — Don't Shelve That A.C.-D.C. Set! — Dual-Tone Keying Monitor — Curing Trouble with HY75 Tubes — A Short-Wave Loop Antenna — Universal Output Transformers Used in Modulator — Simplified Method for Calculating LC on the Slide Rule — Adapter for Octal-Base Rectifier Tubes</i>	54
Correspondence from Members	57
Operating News	60
The Month in Canada	64
Amateur Activities	65
Silent Keys	88
WV Schedules	90
World-Wide Advertising via Radiophoto	92
Ham-Ads	108
QST's Index of Advertisers	110

Ⓢ All material appearing in QST conforms with the "Code of Wartime Practices for the American Press" of the U. S. Office of Censorship.
Ⓢ All material involving military security has been reviewed by appropriate military, naval or other competent authority.

RECIPE FOR "PRECISION-EL" (MT. CARMEL STYLE)



Take Mt. Carmel, Illinois, a typical American city, where men and women can work to produce and acquire the better things of life. Add pleasant and congenial working conditions like those you'll find at Meissner, exacting jobs like those you'll find in electronics — wait for the smile that means pride in a precision piece of work well done, and — presto — there you have it — "precision-el."

The men and women whose progress is shown on these pages are typical of Meissner famed "precision-el." Look at them. You'll find them just one more reason why Meissner products, precision built by "precision-el," do your job better.



"Precision-el" at work — still smiling, intent on the job at hand. Now it's a job that will bring victory nearer . . . After victory, it will be a job that makes for better living. Always, it's a better job, thanks to the smile that's always there.

Back to work with a smile — These men and women look forward to their jobs each day. They're Meissner's famed "precision-el." With many of them working to produce vital electronic equipment for the Armed Forces is a "family affair," for a place in this home front army of "precision-el" isn't restricted only to dad — mother, brother and sister contribute to the quality of Meissner products, too.



Splitting thousandths of an inch is all in the days work for this skilled machinist, yet he finds new reason to smile with each job done better. He, and hundreds like him, are responsible for the recognition of Meissner's "precision-el" by an exacting precision industry.



Easy Way To "Step Up" Old Receivers!

Designed primarily as original parts in high-gain receivers, these Meissner Ferrocarril I. F. Input and Output Transformers get top results in stepping up performance of today's well-worn receivers. Their special powdered iron core permits higher "Q" with resultant increase in selectivity and gain. All units double-tuned, with ceramic base, mica dielectric trimmers, thoroughly impregnated Litz wire, and shield with black crackle finish. Frequency range, 360-600. List price, \$2.20 each.



MEISSNER

MANUFACTURING COMPANY • MT. CARMEL, ILL.

ADVANCED ELECTRONIC RESEARCH AND MANUFACTURE
Export Division: 25 Warren St., New York; Cable: Simontrice

MOBILE! COMPACT! SIMPLIFIED!

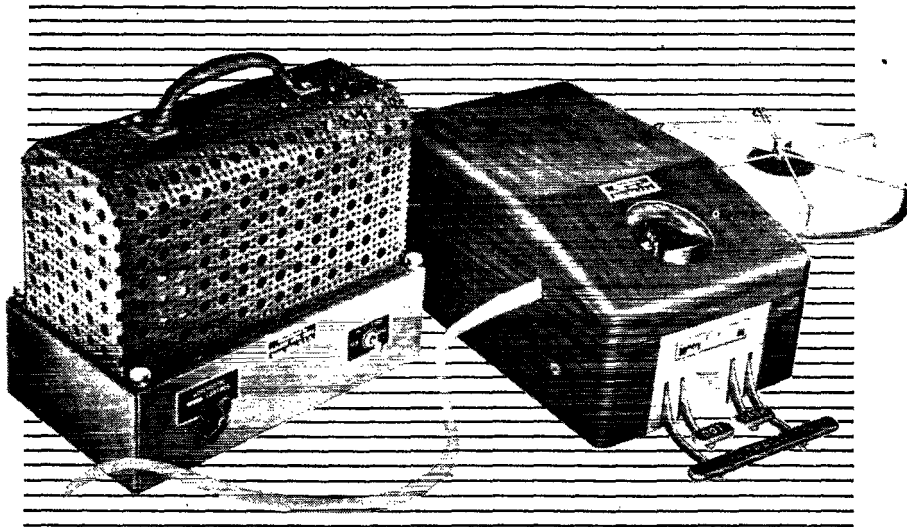

McELROY Wheatstone Code Tape Perforator Model PFR-443-A

Prepares clean and accurate tapes for transmission at speeds up to 300 words per minute on any make of automatic transmitter!

There's nothing bulky or complicated about the Model PFR-443-A. It may be set up instantly—anywhere. It operates perfectly on land or sea—stationary or rolling. It is extremely simple in action, yet experienced operators can easily maintain speeds of between 30 and 40 words per minute in all Morse combinations assigned to the Russian, Turkish, Greek, Arabic and Japanese alphabets and languages. The Model PFR-443-A comprises two units: the Keying Device and the Electronic Drive. Both are lightweight, compact, and self-protected against jolts and jars. Both require minimum attention—no more than you would give an ordinary typewriter. Available for immediate delivery, at the substantially lowered price of \$275.00.

McELROY Wheatstone Code Tape Perforator MODEL PFR-145

Similar in design and mechanical excellence to the PFR-443-A, but minus the electronic unit, this instrument makes possible the mechanization of even the most modest wireless station. \$195.00.

McElroy engineers never copy . . . never imitate. We create, design, build . . . we are never satisfied with mediocrity.

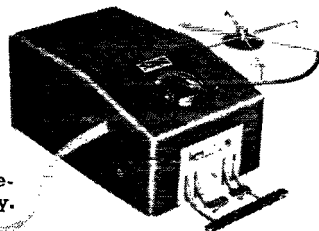

McElroy

MANUFACTURING CORP.
82 BROOKLINE AVE., BOSTON, MASS.

Stand back of the Sisters of Mercy with your dollars . . . Support the Red Cross Drive for funds

Section Communications Managers of the A.R.R.L. Communications Department

Reports Invited. All amateurs, especially League members, are invited to report communications activities, training plans, code classes, theory-discussion groups, civilian-defense building or planning each mid-month (16th of the month for the last 30 days) direct to the SCMI, the administrative official of ARRL elected by members in each Section whose address is given below. Radio Club reports and Emergency Coordinator reports representing community organized work and plans and progress are especially desired by SCMs for inclusion in **QST**. **ARRL Field Organization appointments**, with the exception of the Emergency Coordinator and Emergency Corps posts, are suspended for the present and no new appointments or cancellations, with the exception named, will be made. This is to permit full efforts of all in Emergency Corps plans.

ATLANTIC DIVISION				
Eastern Pennsylvania	W3BES	Jerry Mathis	623 Crescent Ave. 9701 Monroe St. Silver Springs P. O.	Glenside Gardens
Maryland-Delaware-District of Columbia	W3CIZ	Hermann E. Hobbs	623 E. Brown St.	Linden, Maryland
Southern New Jersey	W3GCU	Ray Tomlinson	186 Dorsey Rd.	Trenton 10
Western New York	W8MC	William Bellow	703 Broadway	Rochester
Western Pennsylvania	W8CKO	E. A. Krall		East McKeesport
CENTRAL DIVISION				
Illinois	W9NUX	David E. Blake, II	4501 N. Malden St.	Chicago 40
Indiana	W9EGQ	Herbert S. Brier	385 Johnson St.	Gary
Kentucky	W9ARU	Darrell A. Downard	116 N. Longworth Ave.	Louisville 12
Michigan	W8DPE	Harold C. Bird	R.F.D. 2, Box 235	Pontiac 2
Ohio	W8MFP	Carl E. Wiene	122 St. Albert St.	St. Bernard 17
Wisconsin	W9RH	Emil Felber, Jr.	1625 N. 18th St.	Milwaukee 5
DAKOTA DIVISION				
North Dakota	W9YVF	John W. McBride	620 North Menlo Ave.	Sioux Falls, South Dakota
South Dakota	W9QVY	P. H. Schultz	118 N. Yankton Ave.	Pierre
Northern Minnesota	W9FUZ	Armond D. Brattland	2802 So. Western	Los Angeles 7, Calif.
Southern Minnesota	W9YNQ	Millard L. Bender	608 N. Huron Ave.	Spring Valley
DELTA DIVISION				
Arkansas	W5GED	Ed Beck	2503 Bishop St.	Little Rock
Louisiana	W5DKR	Eugene H. Treadaway	P. O. Box 44	LaPlace
Mississippi	W5HAY	P. W. Clement	524 Santini St.	Box 1
Tennessee	W54SF	James B. Witt	R.F.D. 6, Shady Dell Trail	Knoxville
HUDSON DIVISION				
Eastern New York	W2HZL	Ernest E. George	2044 Lexington Parkway	Schenectady 8
N. Y. C. & Long Island	W2AVZ	E. L. Baunach	102 Central Ave.	Massapequa, L. I.
Northern New Jersey	W2CQD	Winfield G. Beck	617 Spruce St.	Roselle
MIDWEST DIVISION				
Iowa	W9AED	Arthur E. Rydberg	1617 S. Seneca St.	Mitchellville
Kansas	W9AWP	A. B. Unruh	Box 123	Wichita 12
Missouri	W9OUD	Mrs. Letha A. Dangerfield	6105 N. 37 St.	Butler
Nebraska	W9FQB	Arthur R. Gaeth		Omaha 11
NEW ENGLAND DIVISION				
Connecticut	W1KOV	Edmund R. Fraser	37 Willow St.	West Haven 16
Maine	W1AOL	G. C. Brown	179 No. Main St.	Bozox
Eastern Massachusetts	W1ALP	Frank L. Baker, Jr.	91 Atlantic St.	North Quincy 71
Western Massachusetts	W1IAH	William J. Barrett	239 Columbia St.	Adams
New Hampshire	W1FTJ/4	Mrs. Dorothy W. Evans	1435 Snowden Ave.	Memphis 7, Tennessee
Rhode Island	W1HRC	Clayton C. Gordon	70 Columbia Ave., Gaspee	Plateau, Providence 5
Vermont	W1NLO	Burtis W. Dean	P. O. Box 81	Burlington
NORTHWESTERN DIVISION				
Alaska	K7GNN	James G. Sherry		Fomer
Idaho	W7AVP	Don D. Oberbillig	P. O. Box 486	Boise
Montana	W7CPV	Rex Roberts	Box 1088	Glendive
Oregon	W7GNJ	Carl Austin	1137 Federal	Bend
Washington	W7FWD	O. U. Tatro	513 N. Central	Olympia
PACIFIC DIVISION				
Hawaii	K6ETF	Francis T. Blatt	837 16th Ave.	Honolulu
Nevada	W6CW	N. Arthur Sowle	Box 2025	Reno
Santa Clara Valley	W6IUZ	Earl F. Sanderson	600 Acacia Ave.	San Bruno
East Bay	W6GRC	Horace R. Greer	414 Fairmount Ave.	Oakland 11
San Francisco	W6RBO	William A. Ladley	200 Naylor St.	San Francisco 12
Sacramento Valley	W6MDI	Vincent N. Feldhausen	113 South Quincy St.	McCloud
Philippines	KA1GR	George L. Rickard	Box 849	Manila
San Joaquin Valley*	W6NXX	Edward H. Noack	811 West Magnolia St.	Stockton
ROANOKE DIVISION				
North Carolina	W4CVB	W. J. Wortman	P. O. Box 566	Morganton
South Carolina	W4QJ/ANG	Ted Ferguson	3423 Rosewood Drive	Columbia 25
Virginia	W3AKN	Walter G. Walker	217-51 St.	Newport News
West Virginia	W8JRL	Kenneth M. Zinn	P. O. Box 132	Clarksburg
ROCKY MOUNTAIN DIVISION				
Colorado	W9VGC	H. F. Heikel	2743 Julian St.	Denver 11
Utah-Wyoming	W7DIE	John S. Duffy	P.O. Box 293.	Medford, Oregon
SOUTHEASTERN DIVISION				
Alabama	W4GBV	Lawrence J. Smyth	808 Winona Ave.	Montgomery
Eastern Florida	W4IP	Robert B. Murphy	3302 S.W. Grapeland Blvd.	Miami 33
Western Florida	W4ANP	Oscar Cederstrom	408 S. Pine St.	Warrington
Georgia	W4FDJ	Ernest L. Morgan	R.F.D. 1	Lyons
West Indies (Cuba)	CM4DP	Mario de la Torre	Escobar 110 (Altos)	Habana, Cuba
(Puerto Rico-Virgin Islands)	K4KD	Everett Mayer	24 Lindberg St.	Santurce, P. R.
SOUTHWESTERN DIVISION				
Los Angeles	W6QVV	H. F. Wood	429 So. Fairview	Burbank
Arizona	W6RWW	Douglas Aitken	341 S. Mt. Vernon Ave.	Prescott
San Diego	W6CHV	Ralph H. Culbertson	1712 Eads St.	La Jolla
WEST GULF DIVISION				
Northern Texas	W5ALA	Jack T. Moore	5712 Berkshire Lane	Dallas 0
Oklahoma	W5AYL	Ed Oldfield	1141 N.W. 35th St.	Oklahoma City 6
Southern Texas	W5SMN	Horace E. Bidly	1746 Schley Ave.	San Antonio
New Mexico	W5HJF	J. G. Hancock	110 S. E. Nevada St.	Portales
MARITIME DIVISION				
Maritime	VE1DQ	A. M. Crowell	69 Dublin St.	Halifax, N. S.
ONTARIO DIVISION				
Ontario	VE3EF	Wing Commander Donald R. Gunn	c/o Canadian Bank of Commerce	New Toronto, Ont.
QUEBEC DIVISION				
Quebec	VE2CO	Lieutenant L. G. Morris	211 Bolton St.	Ottawa, Ont.
VANALTA DIVISION				
Alberta	VE4GE	C. S. Jamieson	581 W. Riverside Drive	Drumheller, Alta.
British Columbia	VE5DD	C. O. I. Sawyer	2634 West 31st Ave.	Vancouver
PRAIRIE DIVISION				
Manitoba	VE4AAW	A. W. Morley	26 Lennox St.	St. Vital
Saskatchewan	VE4SY	Arthur Chesworth	1084 Redland Ave.	Moose Jaw

*Officials appointed to act temporarily in the absence of a regular official.

A MODERN SYLLOGISM

MAJOR PREMISE:

Bell Telephone System serves the American Public.



MINOR PREMISE:

Bell Telephone Laboratories develop the facilities of the Bell System.

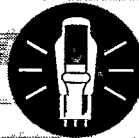

CONCLUSION:

Therefore, Bell Laboratories serve the American Public.



And that is the *raison d'être* of the Laboratories. For the Bell Telephone System, the Laboratories carry on research studies in all the sciences and development work in all the engineering arts that relate to electrical communication.

For the Western Electric Company, the manufacturing unit of the System, the Laboratories

develop equipment, prepare specifications for its construction, and engage in various engineering activities.

For the Armed Forces of the United States, under contracts of the Western Electric, the Laboratories have undertaken more than a thousand development projects — many with spectacular effect upon our enemies.



BELL TELEPHONE LABORATORIES explore and invent, devise and perfect for our Armed Forces at war and for continued improvements and economies in telephone service.

THE AMERICAN RADIO RELAY LEAGUE, INC.,

is a noncommercial association of radio amateurs, bonded for the promotion of interest in amateur radio communication and experimentation, for the relaying of messages by radio, for the advancement of the radio art and of the public welfare, for the representation of the radio amateur in legislative matters, and for the maintenance of fraternalism and a high standard of conduct.

It is an incorporated association without capital stock, chartered under the laws of Connecticut. Its affairs are governed by a Board of Directors, elected every two years by the general membership. The officers are elected or appointed by the Directors. The League is noncommercial and no one commercially engaged in the manufacture, sale or rental of radio apparatus is eligible to membership on its board.

"Of, by and for the amateur," it numbers within its ranks practically every worth-while amateur in the nation and has a history of glorious achievement as the standard-bearer in amateur affairs.

Inquiries regarding membership are solicited. A bona fide interest in amateur radio is the only essential qualification; ownership of a transmitting station and knowledge of the code are not prerequisite, although full voting membership is granted only to licensed amateurs.

All general correspondence should be addressed to the Secretary at the administrative headquarters at West Hartford, Connecticut.



Past Presidents

- HIRAM PERCY MAXIM, W1AW, 1914-1936
EUGENE C. WOODRUFF, W8CMP, 1936-1940

Officers

- President** GEORGE W. BAILEY, W1KH
Washington, D. C.
Vice-President CHARLES E. BLALACK, W6GG
Yuma, Arizona
Secretary KENNETH B. WARNER, W1EH
West Hartford, Connecticut
Communications Manager F. E. HANDY, W1BDI*
Chevy Chase, Maryland
Treasurer DAVID H. HOUGHTON
West Hartford, Connecticut

General Counsel PAUL M. SEGAL
1026 Woodward Building, Washington 5, D. C.

*On leave of absence. Address correspondence to the Acting Communications Manager, Charles A. Service, W4IE, West Hartford 7, Connecticut.

Directors

- President**
GEORGE W. BAILEY W1KH
1530 F St., N.W., Washington 25, D. C.
- Vice-President**
CHARLES E. BLALACK W6GG
Box 108, Yuma, Ariz.
- Canadian General Manager**
ALEX REID VE2BE
240 Logan Ave., St. Lambert, P. Q.
Alternate: Leonard W. Mitchell VE3AZ
78 Raglan Ave., Toronto, Ont.
- Atlantic Division**
WALTER BRADLEY MARTIN W3QV
25 Arbutha Rd., Abington, Pa.
Alternate: Herbert M. Walleze W8BQ
P. O. Box 18, Drums, Pa.
- Central Division**
JOHN A. KIENER W8AVH
1479 Rockway Ave., Lakewood 7, Ohio
Alternate: Earl S. Nelson W8DS
22551 Hadden Rd., Euclid 17, Ohio
- Dakota Division**
TOM E. DAVIS W9VVA
915 W. Becker Ave., Willmar, Minn.
Alternate: Aaron E. Swanberg W9BHY
1487 Breda St., St. Paul 4, Minn.
- Delta Division**
E. RAY ARLEDGE W5SI
340 N.E. 20th Terrace, Apt. 7, Miami 37, Fla.
Alternate: Samuel H. Dowell W5ERV
1057 Mildred St., Shreveport 15, La.
- Hudson Division**
ROBERT AKERIDGE KIRKMAN W2DSY
Werah Pl., R.F.D. No. 1, Box 61, Long Branch, N. J.
Alternate: George Ruffs, Jr. W2CJY
38 Brookwood Drive, Manhasset, L. I., N. Y.
- Midwest Division**
FLOYD E. NORWINE, JR. W9EFC
7405 Hiawatha Ave., Richmond Heights 17, Mo.
Alternate: C. A. Colvin W9VHR
% Omaha & Council Bluffs St. Railway Co.,
Omaha 2, Nebr.
- New England Division**
PERCY C. NOBLE W1BVR
37 Broad St., Westfield, Mass.
Alternate: Clayton C. Gordon W1HRC
70 Columbia Ave., Warwick, R. I.
- Northwestern Division**
KARL W. WEINGARTEN W7BG
3219 N. 24th St., Tacoma 7, Wash.
Alternate: R. Rex Roberts W7CPY
110 W. Brennan St., Glendive, Mont.
- Pacific Division**
J. L. McCARGAR W6EY
66 Hamilton Pl., Oakland 12, Calif.
Alternate: Elbert J. Amarantes W6FBW
1675 Dale Ave., San Jose, Calif.
- Roanoke Division**
H. L. CAVENESS W4DW
2607 Vanderbilt Ave., Raleigh, N. C.
Alternate: J. Frank Key W3ZA
Box 707, Buena Vista, Va.
- Rocky Mountain Division**
C. RAYMOND STEDMAN W9CAA
925 So. Gaylord St., Denver 9, Colo.
Alternate: Howard R. Markwell W9TEF*
355 Monroe St., Denver 6, Colo.
- Southeastern Division**
WILLIAM C. SHELTON W4ASR
527 Revilo Blvd., Daytona Beach, Fla.
Alternate: William P. Sides W4AUP
Fleming Road, Montgomery, Ala.
- Southwestern Division**
JOHN E. BICKEL W6BKY
1834 E. Whittier Blvd., Whittier, Calif.
Alternate: Eldridge E. Wyatt, Jr. W6ARW
P. O. Box 3597, Long Beach 3, Calif.
- West Gulf Division**
WAYLAND M. GROVES W5NW
Box 1314, Seagraves, Texas
Alternate: Jennings R. Poston W5AJ
Box 246, Mabank, Texas

"IT SEEMS TO US—"

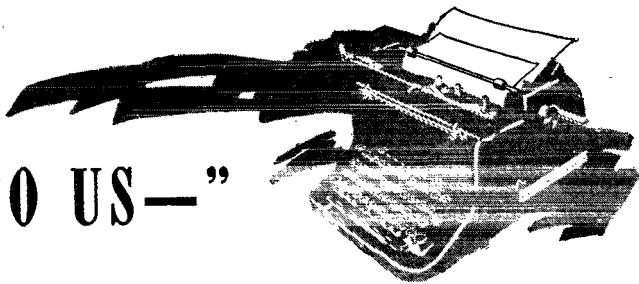

ABOVE 25

THERE is a long, long circuit path to be traced out before postwar allocations become final, with plenty of possibilities for unexpected blocking condensers, accidental grounds, mismatches and reflections. Yet much of the shape of the postwar radio world above twenty-five megacycles is made reliably visible by the Federal Communication Commission's announcement of its intended allocations and the simultaneous embracing of these same allocations by the Interdepartment Radio Advisory Committee, as we report in this issue. It is too early to count one's megacycles, since there is still the possibility of some changes of importance, but the major outline is something that is certain to come into adoption and to endure for years in this country — and, we can reasonably expect, in much of the world.

We find the report, from our own amateur standpoint, something better than moderately good to look upon; and of its honesty, intelligence and general soundness in technical matters there can be no doubt — it is a remarkable job. It dealt with problems of appalling complexity and puts forth a reasoned and skillful answer which impresses us as being, all things considered, as good a job as one could hope for. It is by no means a perfect plan in its amateur provisions, yet we have come closer to realizing our hopes and our demands than have any of the other services except aviation and the Government services; and, with some knowledge of the difficulties that confronted the Commission in finding provisions for all worthy services, we are reasonably content. The amateur is allotted a goodly collection of bands throughout the higher reaches of the spectrum, not as wide as they should be, not as close together as they should be, but sufficient to give us wide opportunities to go forward with the art and assuring us the "happy existence" in this part of the radio world which we so eagerly sought.

Once the allocation is made final it will be our duty to take stock, see precisely what we have, and begin laying plans for the most intelligent employment and development of each band. We hope that we shall be approaching that stage in our postwar thinking in just a month or two. We suggest that League members meanwhile study carefully the prospective amateur bands in the v.h.f., u.h.f. and s.h.f.

ranges, and do what visualizing they can of the problems of organization and employment and technique, to be prepared to participate in the discussions which we hope to inaugurate shortly in our columns.

One of the most interesting of the Commission's provisions, and certainly the most surprising, was that looking to the establishment of what they propose to call the citizens radio service, on 460-470 Mc. So interesting is this proposal that we reprint it, in its entirety, in another part of this issue for your information. Old-time amateurs will recall that there was a time when we spoke of ourselves as Citizen Radio, representing the private citizen's only holdings of frequencies. When this new service is established we shall no longer have that sole honor. But amateurs we are, of course, and the new service will have nothing in common with us, since it is based upon utilitarian considerations and not on love of radio itself or personal interest in its techniques. In fact, we ourself have from time to time proposed very much this same idea in rag-chews with Commission people, suggesting that the assignment of a few frequencies to the general public would relieve amateur radio of the pressure of those who improperly seek to employ its facilities only for utilitarian purposes. Our idea was that the Act might be amended to permit the operation, without licenses of any sort, of approved apparatus made by authorized manufacturers. License the set-maker, in other words, to turn out a foolproof set that would operate only on authorized frequencies, and which might therefore be employed without further formality by anyone who could purchase it. The Commission has chosen to set up the service within the existing Act, with licenses required but with the simplest possible licensing requirements.

What a mad world this band is going to turn out to be! The Commission properly says that its potentialities are limited only by one's imagination. We, now, can imagine all sorts of things. We wouldn't want to be FCC's citizen licensing unit, not with our ability to imagine possibly millions of applicants. We won't want to be an FCC district inspector during the first few years of this service, settling the quarrels over walkie-squawky QRM and the tendencies to chop down each other's masts which are practically certain to disfigure the activities of those who have not had the ama-

teur's experience in coöperative action. We suspect the gentlemen are letting themselves in for something. But we also suspect that they realize it and have gone ahead undaunted, out of the conviction that it is a desirable thing and worth the effort. It is going to mean great things to many chunks of our citizenry, particularly those who employ the apparatus and those who manufacture and sell it. If you see a manufacturer walking around with a certain gleam in his eye, it's probably not f.m. sets he's thinking about: it's citizens rigs, to be sold over the drugstore counter by the bushel. It will be a great little old market.

We figure that this thing will bring both some boons and some headaches to amateur radio. With the commercial employment of this service we have no concern, no interest. The individual "citizen" interests us mildly because his experiences may excite a real interest in radio and cause him to want to become an amateur. We suppose that there will be some "citizens" who attempt to crash our 420-450 band, particularly if manufacturers put out sets that cover both bands with the aim of including us in their market. (They should not, as our requirements are far from the same, but we suspect some of them will.) One thought which appeals to us particularly is that when the good old free-enterprise system gets to chewing on the 460-470 problems, with fat business profits in prospect, it's going to solve most of the apparatus and circuit problems for our near-by band. Inexpensive tubes, for instance. The bigger market will justify their development, and they'll be equally adaptable to 420-450 and the lower bands. Seems to us we can just about scratch the 420 band off our list of postwar development problems — the opening of the citizens service will do it for us. You'll be interested in reading, too, FCC's comparisons with amateur radio and its references to our League by name. That means some problems also, for we'll be looked up to as the model and called in to help in spots, we suppose. And the "citizens" will want to help in communication emergencies and some of them can possibly be welded into the plans of our Emergency Coördinators. A final thought amuses us: some of our XYLs who could never learn the code can at least qualify as citizens. But there is no provision for intercommunication with the amateur service, so we can see a lot of us OMs going for citizen tickets, too, so that some of the more chummy potentialities of this new service may be realized. In any event, we prophesy that the Citizens Radiocommunication Service is going to add a lot of zizz to the American scene.

PHONETICS

IT HAS long been our point of view that there ought to be one uniform phonetic alphabet for use in amateur 'phone operation and that all amateur calls should be pronounced with these "alphabet words" rather

than the letters. We haven't much cared what was in the word list, beyond the positive conviction that it should contain no place names.

In our joyous prewar days, our individualized and home-brewed phonetics gave color to amateur 'phone operation but frequently failed to add understanding. More scientifically constructed lists were used by the telephone, telegraph and radio companies and by the several branches of the military establishment but they differed, none was official except in its own service, and most of them were disfigured by the use of occasional geographical names — which can be almightily confusing in radio communication. On top of that we have, in the English language, both American and British practice — which, incidentally, must have caused a few headaches for CCB during the war. Back around 1938 FCC was toying with the idea of adopting an official list to be used by all amateurs, to facilitate monitoring identification, but nothing ever came of it. There is a word list in the Cairo Regulations but its use is compulsory only in the small-boat telephony service, which is chiefly a European institution. It is mostly of place names, mostly in their French rendering so that there are many of them that an American can't pronounce, and happily the regulation has had no applicability to other services.

At last a movement is on foot to do something about this need. The committees organized by the Department of State to advance proposals for the next world conference have before them a draft proposal suggesting that a word list be prepared in each official language and putting forward a suggested English list. The draft reads:

Whenever, in conversations in the English language, it is necessary to identify individual letters of the alphabet, the following alphabet words shall be used:

A Able	N Nan
B Baker	O Oboe
C Charlie	P Peter
D Dog	Q Queen
E Easy	R Roger
F Fox	S Sugar
G George	T Tare
H How	U Uncle
I Item	V Victor
J Jig	W William
K King	X X-ray
L Love	Y Yoke
M Mike	Z Zebra

There, it seems to us, is a beginning, and a good one, although Heaven only knows what the list will look like after the inevitable compromises with the British. (Or aren't they using it too for combined operations during the war?) But, as we say, we don't care much what is in the list provided it is technically sound; universally used, eschews geography, and escapes indecent accidental combinations. Any sound effort in this direction ought to be applauded by us all as contributing to the certainty of amateur communication.

K. B. W.

Polyphase Systems Applied to R.F.

Some Unique Uses of Two-Phase Driving Circuits

BY S/SGT. ROBERT W. BICKMORE, * W6QDV

POLYPHASE electrical systems have been widely used in many highly important electronic developments. However, their application to radio has been, for the most part, confined to power units and special devices such as the radio compass.

As pointed out in the following paragraphs, many useful applications for multiphase excitation are possible. Since two-phase radio-frequency voltage can be obtained from any r.f. generator very easily, compared with the much more difficult task of obtaining other polyphase voltages, this article will be confined entirely to two-phase systems. The general nature of basic applications and results is about the same as in more complex systems.

Up to the present time, the circuit shown in Fig. 1 has been the most common example of the employment of multiphasing in receivers and transmitters. This circuit is the basic discriminator arrangement, used in f.m. receivers to secure the audio component of the signal and in a.m. transmitters and receivers to correct the frequency drift of self-excited oscillators. Since its operation is explained fully in *The Radio Amateur's Handbook* and elsewhere, no attempt will be made here to go further into its principles of operation.

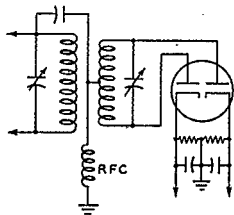

Fig. 1 — Basic discriminator circuit diagram.

Automatic Resonating Circuits

Now consider the circuit of Fig. 2. It shows an oscillator-amplifier combination which appears conventional with the exception that both link coupling and capacity coupling are used simultaneously. With this arrangement the amplifier grids are driven 180 degrees out of phase (push-pull excitation) by virtue of the link coupling, as well as in phase (parallel excitation) by means of the capacity coupling to the center tap of the grid coil, L_1 . As a result there is a difference of 90 degrees between the two components of the driving voltage. However, the phase difference is exactly 90 degrees only when the tuned circuit, L_1C_1 , is precisely in resonance at the excitation frequency. When this circuit is not at resonance the phase difference is not 90 degrees, and, furthermore, the potentials of the two grids are not equal.

This phenomenon may be usefully employed in an automatic resonating device, such as that

* Communications Chief, Hdq. Sqdn., 413th Fighter Group, 138 Naples St., San Francisco 12, Calif.

Multiphase excitation is new in amateur design. This article describes several simple applications which will automatically tune an amplifier stage to resonance or rotate an antenna pattern. The future possibilities of such systems appear to be almost limitless.

shown in Fig. 3. A reversible motor, M , rotates C_1 either clockwise or counter-clockwise (depending upon which side of resonance the circuit happens to be tuned) until the grid voltages are equal, and thereby automatically tunes the circuit to the excitation frequency. Condensers C_2 and C_3 are adjusted simultaneously for good sensitivity with minimum circuit loading and independently for equal cathode voltages on the 6H6 when C_1L_1 is at resonance.

Ry_1 is a sensitive meter-type relay movement featuring magnetic contacts and s.p.d.t. action with a neutral center position. The motor is one of the many small 115-volt a.c. models now obtainable, with an attached gear train giving various shaft speeds. A shaft speed of about one r.p.m. is suitable for most installations.

The plate tank circuit may be tuned by a similar arrangement. Alternatively, one autotransformer can be switched back and forth. In this case each tank circuit still requires its own motor, of course.

To obtain two-phase voltage in a following stage, it will be necessary to use the same dual-coupling method between stages, since one component cancels in the amplifier plate circuit.

Antennas

Now that the transmitter is tuned, what about the antenna? There happen to be a number of ways in which two-phase voltage can be used in the antenna circuit, aside from the autotransformer feature.

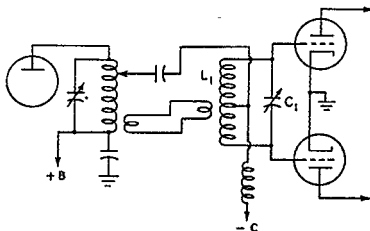

Fig. 2 — Driver-amplifier coupling arrangement which will provide two-phase excitation. From the viewpoint of inductive interstage coupling the grids of the amplifier operate in push-pull, while for the capacitive coupling they are effectively operated in parallel.

Consider an ordinary horizontal half-wave antenna, fed at the center with tuned feeders one-quarter wavelength long, as shown in Fig. 4-A. Operated normally at one-quarter wavelength above ground, an antenna of this type is horizontally polarized and the angle of principle radiation in the vertical plane is close to 90 degrees, as shown in Fig. 4-B.

Now, let us suppose that the system is fed by capacitive coupling as shown in Fig. 5, with no inductive coupling whatsoever. The system then becomes a simple top-loaded vertical radiator, the fields of the horizontal portions canceling each other. This antenna is vertically polarized and the angle of principle radiation in the vertical plane is about 10 degrees, as shown in Fig. 5-B.

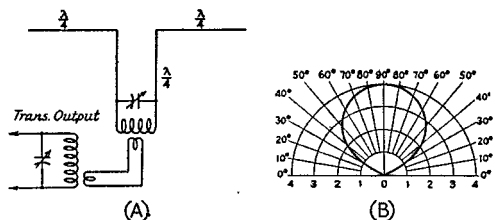

Fig. 4 — A — Half-wave antenna with quarter-wave tuned feeders and simple link coupling to the output stage. B — Pattern of vertical directivity.

shown in Fig. 7. Rather than bring the transmitter to the antenna, a "dog house" is made for the antenna-tuning apparatus which can be fed with any desired type of line. Incidentally, if the antenna tuning condensers are ganged, the auto-resonator described previously will save many a trip to the roof. In this case it would be applied to the auxiliary tuned circuit, C_1L_1 .

Horizontal Coverage

The final circuit to be discussed is interesting in that it appears at first glance that we are getting something for nothing. However, no matter how we figure it we can't beat the power meter, as will be shown later. This circuit, shown in Fig. 8, is a familiar two-element antenna array which can be used for either end-fire or broadside radiation, depending upon how it is fed. As in the case of the Iconoscan, we shall feed it both in phase and 180 degrees out of phase.

Referring to the *Handbook*, we see that with two half-waves fed in phase maximum gain occurs with an element spacing of $\frac{5}{8}$ wavelength, while maximum gain for two half-waves fed 180 degrees out of phase is obtained with an element spacing of $\frac{1}{2}$ wavelength. The curves cross at approximately $\frac{3}{8}$ wavelength, so this spacing is taken as a good compromise.

When two-phase excitation is applied to this system, the lobes of maximum radiation will shift through 90 degrees at a rate equal to twice the carrier frequency. The result is an antenna system giving essentially equal radiation in all directions with a gain of approximately 3 db. over a half-wave dipole.

Tuning and Loading

Since most of us have enough trouble with single-phase systems, it might be well to go into

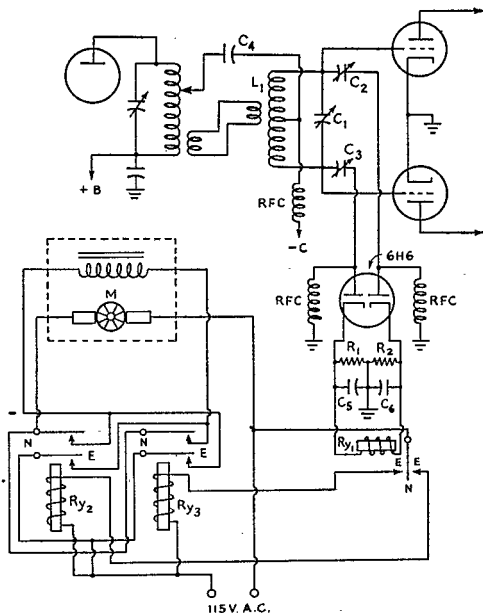

Fig. 3 — An autoresonator system for automatically keeping a grid tank circuit tuned to resonance.

- C_1L_1 — Grid tank circuit.
- C_2, C_3 — 50- μ fd. air trimmer.
- C_4 — 0.001- μ fd. mica.
- C_5, C_6 — 0.001 μ fd., 200 volts.
- R_1, R_2 — 1000 ohms, $\frac{1}{2}$ watt.
- RFC — 2.5-mh. r.f. choke.
- Ry_1 — Sensitive relay (see text).
- Ry_2, Ry_3 — 115-volt relay, d.p.s.t., contacts normally open.
- M — Motor (see text).

Combining the two systems and using both inductive and capacitive coupling, as shown in Fig. 6-A, we have the *Iconoscan* which has a vertical radiation angle which is varying constantly between 10 degrees and 90 degrees at a rate of twice the carrier frequency. This is that answer to high-frequency radiation problems, since it does much toward the elimination of fading caused by varying skip and weak signals which are the result of a critical reflection angle.

A variation of the feeding system which may be more convenient to use where the antenna cannot be located directly above the transmitter is

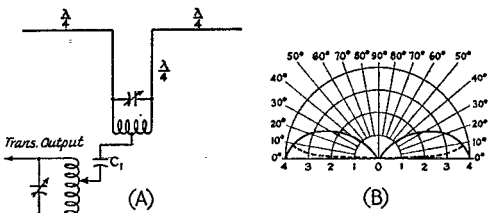

Fig. 5 — A — Same antenna as Fig. 4 with capacitive coupling to the center of the system. This places the two sections effectively in parallel, making the antenna a simple vertical top-loaded antenna having a vertical pattern such as that indicated in B.

the tuning and loading of these circuits. The curves in Fig. 9 show two voltages 90 degrees out of phase and the resultant of these two components. The two components add algebraically and reach a peak at $\pi/4$ and $5\pi/4$. This peak has a value of 1.414 times the maximum value of either of the two components. Consequently,

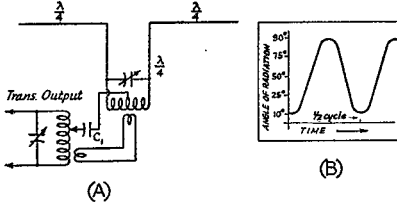

Fig. 6—A—Same antenna as Figs. 4 and 5 with two-phase excitation. The vertical pattern now varies continuously between that of Fig. 4-B and that of Fig. 5-B, as shown here in B.

each coupling is adjusted to 70.7 of its normal value, which gives a resultant of 100 per cent of normal. This reasoning, as applied to the plate current of a stage, can be shown mathematically as follows:

- I_n = normal plate current.
- I_o = instantaneous value of leading component.
- I_l = instantaneous value of lagging component.
- I_r = instantaneous value of resultant current.
- θ = phase angle of leading component.

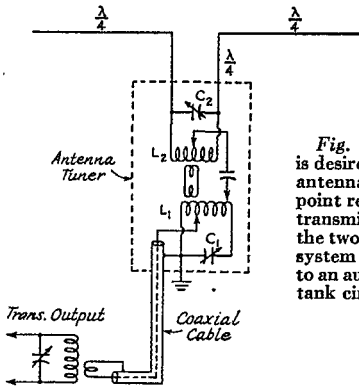

Fig. 7—In case it is desired to locate the antenna of Fig. 6 at a point remote from the transmitting position, the two-phase coupling system can be applied to an auxiliary antenna tank circuit, C_1L_1 .

Assuming that each coupling loads the circuit to 100 per cent of normal,

$$\begin{aligned} I_o &= I_n \sin \theta. \\ I_l &= I_n \sin (\theta + \pi/2). \\ I_r &= I_o + I_l. \\ &= I_n \sin \theta + I_n \sin (\theta + \pi/2). \\ &= I_n \sin \theta + I_n \cos \theta. \end{aligned}$$

Calculating the maximum value of I_r ,

$$\begin{aligned} \frac{dI_r}{d\theta} &= I_n \cos \theta - I_n \sin \theta = 0 \\ \cos \theta &= \sin \theta = 0.707. \\ \theta &= \pi/4 \text{ and } 5\pi/4. \end{aligned}$$

Thus,

$$I_r = 1.414 I_n.$$

In order not to overload the amplifier, the peak current must not exceed the normal current. Therefore I_r must be reduced by a value of $1/1.414$ and consequently must equal 70.7 per cent of its former value, so that

$$0.707 I_r = 0.707 I_o - 0.707 I_l.$$

It can now be seen that each coupling must be adjusted to draw 70.7 per cent of normal plate current and that, with both coupled, the resultant current will be 100 per cent of normal.

The easiest way to load the circuit is to disconnect the coupling condenser, couple the tank loosely with the link, and adjust both tuned circuits to resonance. Then the link should be un-

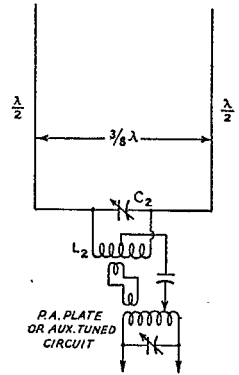

Fig. 8—Two-phase excitation applied to a two-element directive array to rotate the horizontal pattern automatically.

coupled entirely and the condenser tapped on the plate coil of the final amplifier at a point where 70.7 per cent of normal plate current is drawn, always keeping the tank circuit at resonance.

Now the link should be coupled again and the coupling adjusted until the plate current increases to 100 per cent of normal, again keeping the plate circuit tuned to resonance. Finally, the antenna tank circuit, or the grid tank circuit if the input of an amplifier is being considered, should be trimmed up so that there are equal feeder currents in the case of an antenna, or equal grid voltages in the case of an amplifier. This assures exactly 90 degrees phase difference. Removing either coupling should result in a drop in plate current to 70.7 per cent of normal at resonance.

(Continued on page 98)

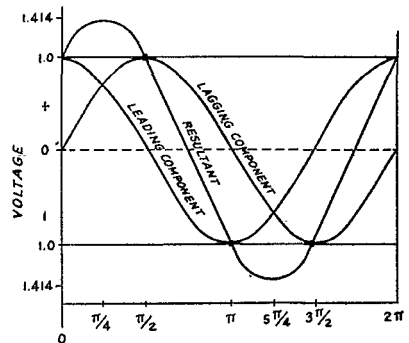

Fig. 9—Graph showing two voltages with a 90-degree phase difference and their resultant.

HAPPENINGS OF THE MONTH



THE F.C.C. REPORT

LAST autumn FCC held a hearing on post-war allocation that lasted six weeks. It heard 231 witnesses in 4200 pages of testimony, plus hundreds of exhibits. There followed some months of intensive staff work, plus a series of conferences with IRAC to reconcile conflicts with Government requirements. On January 15th FCC issued a 265-page document, a report on its proposed allocations above 25 Mc. Objectors will have an opportunity in February to file briefs and argue for changes, following which the Commission is expected, in early March, to confirm the allocation with or without changes. On January 15th IRAC also modified its pending proposal with the Department of State, as concerns the frequencies above 25 Mc., to coincide exactly with the FCC report. Thus there is now only one American plan.

The amateur frequencies, in megacycles, are as follows: 28-30, 50-54, 144-148, 220-225, 420-450, 1125-1225, 2500-2700, 5200-5750, 10,000-10,500, and 21,000-22,000.

A similar FCC report dealing with the longer-distance frequencies below 25 Mc. is not to be expected for from some weeks to some months yet.

The report is one of the most thorough and comprehensive radio documents that we have ever seen. It is in three parts. Part I, in five sections, discusses the preliminary work done by the industry and FCC prior to the hearing, describes the hearing, summarizes the requests of non-Governmental services (which greatly exceeded the available frequencies), states the principles upon which the proposed allocation is based, and gives the table showing the Commission's proposed allocation above 25 Mc. Part II is a discussion of the proposed allocation in nineteen sections, each devoted to a particular radio service, of which amateur radio is Sec. 6. Part III is a discussion by frequencies, in convenient steps beginning at 25 Mc.

As we prophesied, the report bears a marked resemblance, in its major outlines, to the original IRAC proposal. We do not know, of course, what judgment posterity will place upon this allocation and we are not able to judge its provisions for some of the radio services with which we are not too familiar, but it is obviously a masterly and

thoughtful job, a very hard piece of work by many people over many months, and in its essentials technically sound.

Government gets roughly half the frequencies. The report makes comprehensive provision for the usual fixed and mobile public services. International broadcasting is described as "a service of great significance" and although FCC canceled its unused assignment above 25 Mc. it says that it will endeavor to assign it adequate frequencies below 25 Mc. when that portion of the work is reached. F.m. is to be expanded and moved, to 90 channels from 84 to 102 Mc., of which 84-88 will be for noncommercial educational stations. The major provision for television is "upstairs," 480-920 Mc.; but it also retains 12 channels below 225 Mc., being 44-84 minus our band 50-54, plus 180-216 Mc. Facsimile may use the f.m. channels, plus 470-480. Elaborate provision was made for aviation. Police channels in the 30-44 Mc. band were increased from 29 to 56, plus a new band, 152-156 Mc. Facilities of numerous other services were preserved or expanded. Provisions were made for several new services, including railroads. A startling new one is called Citizens Radiocommunications Service, with the assignment of 460-470 Mc. and the promise of minimum licensing requirements — of which we shall make further report in *QST*. Numerous proposals were dismissed by the Commission as unworthy of frequencies and most services received far less than they requested.

The accompanying table gives the major provisions of the proposed allocation, minus innumerable notes relating to special provisions, power, shared use, etc., for services other than amateur.

Sec. 6 of Part II, the section dealing with the amateur radio service, occupies six pages of the report. It praises amateur radio highly; makes frequent reference to the transcript of the hearing (our testimony); describes past amateur allocations; reports our requests at the hearing; lists the proposal of the Commission for the allocation of frequencies to amateurs, above 25 Mc., as listed above; and then comments on the proposed allocation in the following language:

The number of frequency bands allocated to the amateur service and their positions in the frequency spectrum have been established with regard to the needs of governmental services, as well as services administered by the Commission.

The 28-30 Mc. band presently assigned to the amateur service will remain unchanged under the proposed allocation.

The amateur frequencies have been shifted from the 56-60 Mc. band to the 50-54 Mc. band, thereby permitting the Television Channel No. 2 to fall between 54-60 Mc. It is thought that this shift will not interfere with amateur operation other than with respect to the slight advantages of harmonic relationship between amateur bands, and will result in a substantial benefit to television. It will permit the assignment of 4 out of 6 channels instead of 3 out of 6 channels in a highly congested area.

(Continued on page 16)

ARE YOU LICENSED ?

When joining the League or renewing your membership, it is important that you show whether you have an amateur license, either station or operator. Please state your call and/or the class of operator license held, that we may verify your classification.

TABLE OF PROPOSED ALLOCATIONS ABOVE 25 MC.

<i>Megacycles</i>	<i>Proposed International Allocation</i>	<i>Proposed U. S. Allocation</i>
25.015-27.305	Fixed; mobile except aeronautical and maritime	Government and non-Government fixed and mobile
27.305-27.335	Industrial, scientific and medical devices	Industrial, scientific and medical devices
27.335-28.000	Fixed; mobile except aeronautical and maritime	Government and non-Government fixed and mobile
28.000-30.000	Amateur	Amateur
30.000-40.960	Fixed; mobile except aeronautical	(Roughly, alternate megacycles to Government and non-Government, fixed and mobile, per elaborate list.)
40.960-41.000	Industrial, scientific and medical devices	Industrial, scientific and medical devices
41- 42	Fixed, mobile, except aeronautical	Government
42- 44	Fixed; mobile except aeronautical	Non-Government fixed and mobile
44- 50	Broadcasting; fixed; mobile	Television
50- 54	Amateur	Amateur
54- 78	Broadcasting; fixed; mobile	Television; fixed; mobile
78- 84	Broadcasting; fixed; mobile	Television
84- 88	Broadcasting	Educational f.m. broadcasting
88- 102	Broadcasting	Commercial f.m. broadcasting
102- 108	Broadcasting; fixed; mobile	(Non-Government but not yet determined)
108- 112	Air navigation (localizers)	Government (air navigation aids — localizers)
112- 118	Air navigation (ranges)	Government (air navigation aids — ranges)
118- 122	Aeronautical mobile (airport)	Airport control
122- 132	Aeronautical mobile	Aeronautical mobile (primarily non-Government)
132- 144	Aeronautical mobile; fixed	Government
144- 148	Amateur	Amateur
148- 152	Fixed; aeronautical mobile	Government
152- 156	Fixed; mobile except aeronautical	Police
156- 162	Fixed; mobile except aeronautical	Non-Government fixed and mobile
162- 170	Fixed; mobile	Government
170- 180	Navigation aids	Navigation aids
180- 192	Broadcasting; fixed; mobile	Television; Government
192- 216	Broadcasting; fixed; mobile	Television; fixed; mobile
216- 220	Fixed; mobile	Government
220- 225	Amateur	Amateur
225- 400	Fixed; mobile	Government; 75 aeronautical channels for non-Government
400- 420	Fixed; mobile	Government (including radiosonde)
420- 450	Air navigation and amateur	Amateur and air navigation

NOTE. — To be used temporarily for "special" air navigation aids. Band to be exclusively amateur when no longer required for "special" air navigation aids; meanwhile amateur power to be limited to 50 watts.

All non-Government services will be established in the bands above 450 Mc. on an experimental basis pending adequate showing as to need and technical requirements.

450- 460	Air navigation	Temporarily special air navigation aids; thereafter non-Government fixed and mobile
460- 470	Fixed; mobile	Non-Government fixed and mobile
470- 480	Broadcasting	Facsimile broadcasting
480- 508	Broadcasting	Television
508- 524	Air navigation aids	Temporarily air navigation aids; thereafter television
524- 920	Broadcasting	Television
920- 940	Broadcasting	Experimental broadcasting services
960- 1125	Navigation aids	Navigation aids
1125- 1225	Amateur	Amateur
1225- 1325	Fixed; mobile except aeronautical	Television relay
1325- 1450	Fixed; mobile	Government
1450- 1500	Air navigation aids	Air navigation aids
1500- 1550	Meteorological aids	Meteorological aids
1550- 1650	Aeronautical mobile	Aeronautical mobile
1650- 1900	Fixed; mobile	Government
1900- 2300	Fixed; mobile except aeronautical	Non-Government fixed and mobile
2300- 2500	Air navigation aids	Air navigation aids
2500- 2700	Amateur	Amateur
2700- 2800	Meteorological aids	Meteorological aids
2800- 3900	Navigation aids	Navigation aids
3900- 4550	Fixed; mobile except aeronautical	Non-Government fixed and mobile
4550- 5200	Fixed; mobile	Government
5200- 5750	Amateur	Amateur
5750- 7050	Fixed; mobile except aeronautical	Non-Government fixed and mobile
7050-10,000	Fixed; mobile	Government
10,000-10,500	Amateur	Amateur
10,500-13,000	Fixed; mobile except aeronautical	Non-Government fixed and mobile
13,000-16,000	Fixed; mobile	Government
16,000-18,000	Fixed; mobile except aeronautical	Non-Government fixed and mobile
18,000-21,000	Fixed; mobile	Government
21,000-22,000	Amateur	Amateur
22,000-26,000	Fixed; mobile	Government
26,000-30,000	Fixed; mobile except aeronautical	Non-Government fixed and mobile
30,000 up	Experimental	Experimental

The 112-116 Mc. band formerly allocated to the amateur service is presently employed for operation of a large amount of aviation equipment. The proposed allocation contemplates the continued use of the above band for navigation devices. The 4-megacycle band deleted from the amateur service in this portion of the spectrum is restored a little higher up between 144-148 Mc.

The 224-230 Mc. band formerly assigned to the amateur service falls in the 225-420 Mc. band allocated for fixed and mobile services which is to be used in the United States exclusively by governmental radio services. The band 220-225 Mc. is being allocated to the amateur service in lieu of its present 224-230 Mc. band.

The band 400 to 401 Mc. presently assigned to the amateur service was not requested for reassignment. Instead, the American Radio Relay League requested a 32-Mc. band from 448 to 480 Mc. In lieu of this, a 30-Mc. band between 420 and 450 Mc. is being assigned. However, this band is presently used for special air navigation aids and its continued use for that purpose will be necessary for some time to come. The proposed allocation provides for a sharing of this band by these special air navigation aids and low-powered amateur services on a non-interference basis. Ultimately exclusive assignment in the United States of the band to the amateur service is contemplated.

The next band requested for the amateur service was 64 megacycles between 896 and 960 Mc. 200 megacycles between 1792 and 1920 was also requested. The first of these falls in the portion of the spectrum being allocated to experimental broadcast services, and the second falls in a band which in the United States will be allocated primarily for exclusive government use. In lieu of these requests, 100 megacycles is being assigned to the amateur services between 1125 and 1225 Mc.

The next band requested was 3584 to 3840 Mc. This band is being allocated to navigation aids and instead the amateur service is being assigned the band 2500 to 2700 Mc.

The amateur service also requested the band 7168 to 7680 Mc. This band falls in the band being assigned in the United States exclusively to governmental fixed and mobile services. In lieu thereof the amateurs are being assigned a lower band between 5200 and 5750 Mc.

Instead of the requested band 14,336 to 15,360 Mc., which is another exclusive government band, the amateurs are being allocated a 500-Mc. band between 10,000 and 10,500 Mc.

The highest band requested by the amateur services was between 28,672 and 30,720 Mc. This latter band, of course, extends beyond the limits of the spectrum for which allocations are being made at this time. Instead the amateurs are being assigned a 1,000-Mc. band between 21,000 and 22,000 Mc.

Above 30,000 Mc. the band is being designated as available for general experimental use and this will, of course, include experimentation by amateurs.

Throughout the foregoing paragraphs, as they relate to frequencies above 100 Mc., the Commission speaks in terms of our primary request for an upward extension of our *harmonic* family. We ourselves perceived the developing conflicts with many proposed Government assignments, as so frequently mentioned by FCC. For that very reason we incorporated in our presentation an alternative set of frequencies above 100 Mc. which we said would be equally acceptable to us if FCC found it more readily possible to provide. This alternative set of frequencies was substantially the IRAC proposal, which we knew had the right of way. It is substantially this alternative set of frequencies which has now been granted. It would have been somewhat more realistic for FCC to frame its comments in terms of our secondary proposal, rather than our primary one, as it could thereby show that what it gave us was a fairly close approximation of what we asked for. Our alternative request was for 144-149, 218-225, 420-460, 840-900, 1125-1225, 2500-2700, 5200-5750, 10,000-10,500, and 21,000-22,000 Mc.

In Part III of the report, the discussion by frequencies, discussing 25-30 Mc., the Commission observes that "The range 28 to 30 Mc. is presently allocated to the amateur service and the proposed allocation is the same." Discussing 50 to 60 Mc., it says:

This portion of the spectrum is presently divided between television broadcasting and the amateur services, with television from 50 to 58 Mc., and the amateurs from 56 to 60 Mc. The proposed allocation would result in shifting the two bands so that the amateurs would be allocated 50 to 54 Mc. and Television Channel No. 2 would fall between 54 and 60 Mc. This shift will not interfere with amateur operations and it will result in a substantial benefit to television as it will make possible the assignment of 4 out of 6 channels instead of 3 out of 6 in highly-congested areas.

There is a highly-significant comment on the band 144-148 Mc.:

This band is presently allocated to fixed and mobile and assigned in the United States to Government services. The proposal is to allocate it to the amateur services in lieu of the band 112 to 116 Mc. presently assigned to the amateur services. Here it will be noted that this proposed amateur band is adjacent to a proposed Government band. From this point on up to 30,000 megacycles, similar contiguous assignments of Government and amateur bands are made. The reason for this is to locate the amateur bands at points where in time of war or national emergency they may be used for the expansion of essential Governmental radio services. It is felt that this arrangement of contiguous Government and amateur bands is more important than the preservation of strict harmonic relations between the amateur bands.

Well, fellows, there you have it. As concerns the region above 25 Mc., this is what has come out of the months of meetings, testifying, writing, negotiating and arguing. Remembering that this is still a proposal, not yet final, we can still take stock. The 10-meter band, often threatened, is untouched. The 5-meter band, constantly under the most severe pressure and many times cut or cut out and restored and cut out again, has been retained in its customary width of 4 Mc. and its customary position between Television Channels Nos. 1 and 2 but moved downward 6 Mc. — which the Commission says will make a great improvement in the number of television channels that can be employed in a given community. We hear that the friends of amateur radio in the closed sessions had a hard job preserving this band. The proposed shift to 50-54 is in the direction where oscillation is easier to get and will result in a slight increase in the effective width of the band. As to 2½, it has been apparent for a long time that this band would have to go above 144. We don't think the shift in location is important, although to have the same effective width the band ought to be 5 megacycles wide. We gather that our failure to receive, in this band and the next two higher ones, the full widths originally contemplated for us by IRAC was part of the price for the compromise that resulted in saving "5." From the 100-Mc. region upward there is no pretense at harmonic relationship but a strong adherence to the principle of putting amateur bands in juxtaposition to Government ones to permit the wartime expansion of the latter, a scheme which assures us the continued support of the military services in this part of the spectrum.

AMATEUR WAR SERVICE RECORD

Name

Call, present or ex; or
grade of op-license only

Present mailing address

SERVICE

Rank or rating

- Army
- Navy
- Coast Guard
- Marine Corps
- Maritime Service
- Merchant Marine
- Civil Service
- Radio industry,
100% war

Branch or bureau: *Signal Corps, AAF, BuShips, WAVES, etc.*
If civilian industry, give title and company.

Bear in mind that this allocation is not yet final. The ARRL Board of Directors has voted to accept the results as concerns amateurs, feeling that we have here an allocation that will well take care of our needs. Some of the displaced commercial services, notably f.m., are known to be displeased with the proposal and will doubtless protest, with the possibility of continuing pressure on some of our bands. Thus it will not be over until it is over and, although the League does not expect to be filing briefs and appearing in argument, we shall continue on the job of looking after our interests until the allocation is made final. We shall quite possibly be able to report the final results in our next issue.

Meanwhile the FCC-IRAC recommendations to the Department of State become the basis for the United States' preparations for the Rio conference in June, work on which is expected to begin in February.

HAVE YOU REGISTERED?

PARDON us if we keep on talking about that coupon at the top of this page, but if you are an American or Canadian amateur, using your radio knowledge in the war effort, and haven't yet registered the simple facts with us, we want to hear from you.

The reason is that we are compiling at ARRL Hq. a card record of the amateur service in the war — whether in the armed forces, the seagoing services, the Civil Service, or industry which is wholly devoted to the war effort. The information we need is shown on the form and is so simple that you can do the whole job in a minute — or repeat the essentials on a post card if you don't wish to cut your copy of *QST*. But please see that we have the data on you, so that this record for posterity and for the future protection of the amateur may be as nearly complete as possible.

And if you can send us similar data on your associates of amateur background, it will help a lot. TU.

IRE Winter Meeting

TECHNICAL papers covering a wide range of subjects from u.h.f. multiplex radio systems to the performance of quartz-crystal units were presented at the 1945 Winter Technical Meeting of the Institute of Radio Engineers, January 24-27, at the Hotel Commodore in New York.

Klystron amplifier characteristics were compared to those of a conventional triode in a paper given by Coleman Dodd. "Some New Antenna Types and Their Applications" was the subject of a paper by A. G. Kandoian. New miniature tubes, particularly useful for u.h.f. application, were discussed by R. L. Kelly and N. H. Green. Several interesting papers, covering all phases of the radio multiplex system installed between Cape Charles and Norfolk, Va., were given by engineers of the Bell System. The r.f. equipment of this system operates in the vicinity of 160 Mc.

In a paper delivered by representatives of the Signal Corps Ground Signal Agency, the radio-relay communications systems used by the United States Army were described in detail and illustrated with diagrams and photographs showing the application of this equipment in the field. During the early phases of the war, standard police-type frequency-modulation equipment was used with great success during the Tunisian, Sicilian and Italian campaigns, providing simple teletype circuits over distances of several hundred miles using repeater or relay stations. Later, v.h.f. equipment was developed for use with voice-frequency-carrier equipment to provide multichannel voice and teletype circuits over a single radio frequency. This operation met with great success and was a most important factor during the invasion and later in battle of France.

In view of the recently proposed Interdepartment Radio Advisory Committee's allocation table involving the use of frequencies above 25 Mc., a highlight of the meeting was a paper by Capt. E. M. Webster, Vice-Chairman of IRAC.

Panoramic Reception

A Review of Its Principles in Simple Language

BY HARVEY POLLACK,* W2HDL

AT A desolate, lonely post in the heart of the Allied lines in Burma, a Marine radio operator was grimly monitoring the bands used by the Japs for field orders. Before him were several communications receivers, each surmounted by a smaller cabinet containing a cathode-ray tube. His alert glance shifted from one to another of the fluorescent screens while he continually checked the frequency sheet used by the various Allied mobile and fixed transmitters in the area. The constantly shifting pattern of radiance was so familiar to his trained eye that only cursory and occasional corroborations were necessary; he knew almost instinctively that every station on the air was that of a friendly post.

Suddenly, and without warning, a small peak appeared on one of the screens where none had existed before. It stood out like the shoe-button eye of a snow man.

"Japs!" muttered the operator. "And mobile, too. Look at that peak grow! Only thing that could come that fast is a flight of planes."

Just as suddenly the peak winked out and the scene was restored to its former serenity. But the cat was out of the bag. The operator reached for the land-line transmitter and spoke a few clipped words into the mouthpiece.

Almost instantly, at far-flung and widely separated aircraft installations, a sharp alert was sounded as the men took their stations. Long before the Japs came within striking distance, the Allied fighters met them head on.

The Japs never had a chance.

What the Panoramic Receiver Tells Us

The cathode-ray unit which makes such feats and many others possible is the panoramic adaptor which may be added to almost any type

* Engineering Dept., Panoramic Radio Corporation.

The panoramic receiver is not a wartime development, experimental models having been produced just prior to the outbreak of war. However, the many uses to which it has been put have demonstrated that the panoramic idea, particularly in the form of adaptors which may be connected to any receiver, is going to be very important and useful in the ham station of the future. In simple language this article reviews the general principles upon which the panoramic system is based and includes also a picture of the many ways in which it may serve the operator of a postwar amateur station.

of receiver. Technically, panoramic reception is defined as the simultaneous *visual* reception of a multiplicity of radio signals over a *broad band of frequencies*. In addition, panoramic reception provides an indication of the frequency, type and strength of signals picked up by the receiver. Deflections or "peaks" appearing as inverted Vs on the screen of a cathode-ray tube, as shown in Fig. 1, are indicative of the presence of signals. The character of each individual deflection tells its own story. For instance, in Fig. 1, *a* is a signal of constant amplitude indicating a steady carrier, while *b* is a nonvarying signal whose strength is about twice that of *a*. The signal indication at *c* is a peak which appears and disappears so rapidly that the base line appears closed beneath the deflection. This type of trace is produced by a very rapidly keyed c.w. signal. With slower keying the base line would appear open. Incidentally, if the keying is sufficiently slow the code can be read directly from the screen, like a blinker, after a little practice.

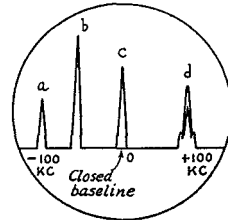

Fig. 1 — Typical signal patterns on the screen of the cathode-ray tube of the panoramic receiver. The peaks *a* and *b* indicate a c.w. signal or unmodulated carrier. The closed baseline of *c* indicates a rapidly keyed signal, while *d*'s irregular shape identifies it as a modulated carrier.

The signal at *d* is composed of separate parts. The smaller peaks are produced by the sidebands of a modulated carrier, while the high center peak is produced by the carrier itself. Hence, this is the picture of a 'phone station. More often the sidebands will not be visible as separate deflections, a 'phone station trace being recognizable rather by a deflection which tends to vary in amplitude between the high center peak and the low center peak.

The various frequencies shown may be compared with reference to each other or to the calibrated dial of the receiver. As an illustration, imagine that the receiver dial reads 5000 kc. Signal *c*, the c.w. signal discussed previously, appears immediately above zero on the scale. This scale reading indicates that the frequency of the signal is that indicated on the dial of the receiver; in other words, 5000 kc. Another way of saying the

same thing is that the frequency difference between the receiver dial reading and the signal appearing over the center of the scale marking is zero. It follows from this that signal *a* is 100 kc. lower than signal *c*, or 4900 kc., while signal *b* is approximately 65 kc. lower than signal *c*, or 4935 kc. Hence, while signal *c* is heard on the receiver's

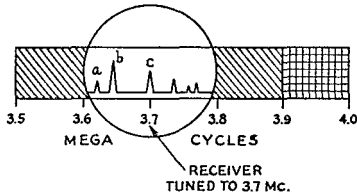

Fig. 2 — Graphic representation of the 3.5-Mc. amateur band with the panoramic adaptor sweeping the 3.6 to 3.8-Mc. section. The receiver is tuned to 3.7 Mc.

normal output circuit, the other signals will be seen distributed as shown in the diagram. They will not be heard in the headphones, however, unless they happen to be close enough to *c* in frequency to be within the receiver's normal band of acceptance.

Application to Amateur Bands

For the sake of clarity, let us choose the 3.5-Mc. amateur band for our discussion. This band extends from 3.5 Mc. to 4.0 Mc. and is shown graphically in Fig. 2. Now let us say that the receiver has been equipped with a panoramic adaptor which covers a maximum band-width of 200 kc. and that the receiver has been tuned to 3.7 Mc. All of the signals between 3.6 and 3.8 Mc. will be visible on the screen of the cathode-ray tube in the adaptor. The signal heard on the headphones will appear at the center of the screen as signal *c*. Now to listen to signal *a*, the receiver would have to be tuned to a lower frequency.

As the receiver tuning is shifted, all of the peaks will move to the right across the screen until signal *a* is heard. At that point, *a* will appear centered on the screen as shown in Fig. 3. Signal *c* now has moved to the right of the screen and is visible but no longer audible in the headphones; *b* has passed through the center of the screen and might have been heard for an instant as it passed the center point of the screen. At the same time, new signals, *d*, *e* and *f*, which were not present previously now have made an appearance at the left side of the screen since the 200-kc. acceptance band has been shifted lower in frequency. Because the signals in this part of the band all are

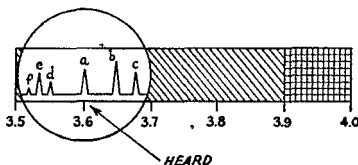

Fig. 3 — This is the same as Fig. 2 except that the receiver is now tuned to 3.6 Mc., the panoramic sweep now covering a range of 3.5 to 3.7 Mc.

c.w., the deflections will appear and disappear in accordance with the keying. Should we now tune to the 'phone band the signals will appear as peaks pulsating in amplitude. This effect, as explained previously, is caused by the modulation.

Sweep Width

Another feature of an adaptor of this type is that the number of kilocycles visible at any time (sweep width) is under the direct control of the operator and may be reduced to any lesser value all the way down to zero if so desired. This control provides the operator with a visual selectivity control of the most flexible variety. As the sweep width is reduced, the resolution constantly improves. The term "resolution" is used here in the same sense as the word "selectivity" is used in discussing the frequency discrimination of receivers. Fig. 4 should help to illustrate this point. Two signals differing in frequency by 3 kc., let us say, will present the appearance shown in Fig. 4-A if the sweep width control is set at its maximum point. Now, as this control is backed off, the signals will appear to separate and at about 20 per cent of maximum they will appear somewhat as presented in Fig. 4-B. This increase in visual selectivity may be carried still further by a

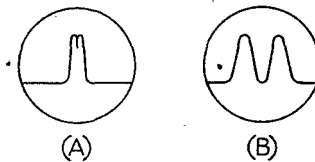

Fig. 4 — Sketches illustrating how "resolution" may be improved by decreasing the sweep width. *A* indicates two signals very close together in frequency with a wide sweepband, while *B* shows how the same two signals are separated when the sweepband is reduced.

greater reduction in sweep width. Not only does this feature permit visual inspection of signals which otherwise might interfere with each other, but also it makes possible the analysis of signals which are heterodyning one another. If we should be in the middle of a QSO when QRM starts to wash it out, a quick reduction in sweep width will disclose the side (high- or low-frequency) where the heterodyne modulation is taking place. A break-in flash to the other end — such as "shift two or three kc. higher" — will suffice to shift the QSO to clearer channels.

In general, then, just as a crystal filter or a variable i.f. control on a receiver is employed when congestion in the band warrants it, the variable sweep-width feature of the adaptor meets the problem of visual interference.

Superheterodyne Fundamentals

For the benefit of those who have permitted themselves to become rusty in elementary superhet-receiver theory, let us first review the principles upon which this type of receiver is based. Let us assume that a radio signal whose frequency is 100 kc. is to be received. Referring to Fig. 5, the 1000-kc. signal is fed into a tuned stage called

the converter. At the same time the h.f. oscillator of the converter feeds a signal of 1400 kc. into the mixer section. When these signals are combined in the mixer, a new frequency representing the difference between the two original frequencies appears in the output. In this case the difference frequency (or intermediate frequency) is 400 kc. Of course, the original frequencies are still present, plus a fourth frequency equal to the sum of the original frequencies, but the tuning of the following i.f. amplifier is so sharp that only the 400-kc. signal is permitted passage. Following the highly selective intermediate-frequency amplifier, the signal is detected or demodulated, the modulation being amplified through the audio amplifier to a sufficiently high level to operate a speaker or headphones.

Thus we have:

Oscillator frequency.....	1400 kc.
Signal frequency.....	1000 kc.
Intermediate frequency.....	400 kc.

Now, should we desire to listen to a station at 1300 kc., we would rotate the tuning-condenser knob to the new position. Since a ganged tuning condenser is usually employed, in so doing we have changed both the frequency to which the converter is tuned and the oscillator frequency and we now have:

Oscillator frequency.....	1700 kc.
Signal frequency.....	1300 kc.
Intermediate frequency.....	400 kc.

It will be noted that the i.f. has not changed because we have maintained a constant difference between the signal frequency and the oscillator frequency. Thus the tuning of the i.f. amplifier may be fixed for all signal frequencies so long as the oscillator frequency "tracks" 400 kc. higher (or lower if desired) in frequency than the frequency of the incoming signal. In this case, the i.f. amplifier is tuned to 400 kc. and left there.

It is obvious that many signals differing quite

widely in frequency are inducing their respective voltages in the antenna. Although the input circuit of the converter stage is tuned, its selectivity is so poor that signals differing by several hundred kilocycles from the one to which the receiver is tuned will appear at the grid of the converter tube, with only slight attenuation below that of the signal to which the receiver is tuned. Thus, with the response characteristic shown in Fig. 5, the amplitudes of signals at 900 and 100 kc. are only slightly below the amplitude of the signal at 1000 kc. to which the receiver is tuned.

Starting with the assumption that several signals of equal strength reach the antenna, the signal to which the converter is tuned will be the strongest, as we have seen, while the others which are off resonance will fall off in relative strength to a degree depending upon the frequency separation from the frequency to which the converter input is tuned. Although it would be impossible to receive these signals simultaneously by the usual aural method without interference, we shall see that this can be done visually by panoramic reception.

The Panoramic Adaptor

A small portion of the voltage developed by each of these input signals is taken from the output of the converter and fed into the r.f. amplifier of the panoramic adaptor which is broadly tuned with the i.f. of the receiver (400 kc.) as its center frequency. It will be noted from Fig. 5 that the input circuit of this stage is designed to have a response characteristic opposite to that of the input circuit of the receiver's converter stage, the ultimate effect being to compensate for the dropping off of signals off resonance in the converter stage, so that all signals of equal strength at the antenna again are essentially equal in strength at the grid of the adaptor r.f. stage.

The signal from the r.f. stage is fed into a converter stage whose input circuit also is broadly

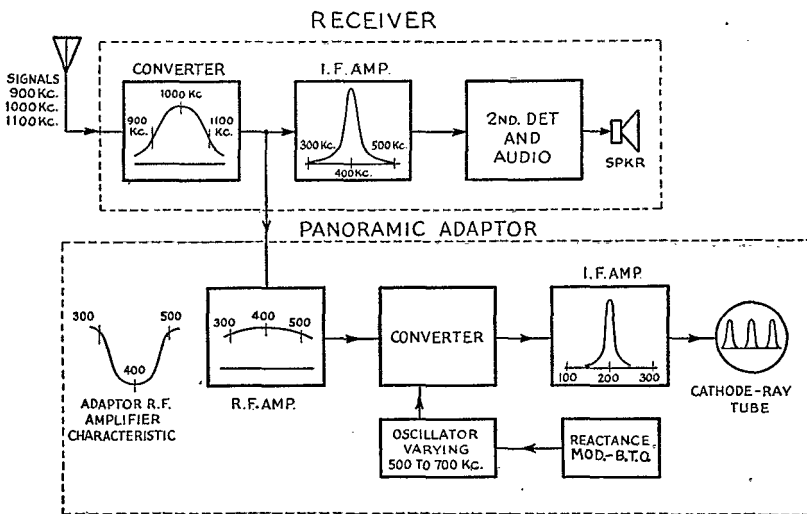

Fig. 5 — Block diagram of the various units comprising a superheterodyne receiver with panoramic adaptor. The accompanying graphs serve to illustrate the tuning characteristics of the principal units of the system.

tuned to accept all signals delivered to it by the r.f. stage with as little attenuation as possible. The local oscillator used in connection with this converter is normally tuned to a frequency 200 kc. higher (or lower) than the center frequency of the band accepted by the converter input circuit to produce an i.f. of 200 kc. However, the frequency to which this oscillator is tuned does not remain constant as it does in the receiver proper. Its tuning continually is varied or swept over a selected range of frequencies so that at some point in its excursion it mixes or beats with each one of the signals appearing at the input of the adaptor converter to produce the required i.f. of 200 kc. Thus when this oscillator's frequency is 500 kc., it beats with the 300-kc. signal to produce an i.f. of 200 kc. to which the following i.f. amplifier is sharply tuned. Similarly, when the oscillator's frequency is at the other end of its range, 700 kc., it beats with a 500-kc. signal again to produce an i.f. of 200 kc.

Cathode-Ray Indicator

The output of the adaptor's i.f. amplifier is rectified and the resulting d.c. voltage is applied to the vertical deflecting plates of the cathode-ray tube. We know that with no voltage on either vertical or horizontal deflecting plates the spot on the screen of the cathode-ray tube normally will be stationary at the center of the screen. If, however, a varying voltage is placed across the vertical deflecting plates, the spot will move in a vertical direction, forming a luminous line if the variations in voltage are sufficiently rapid to create persistence of vision. Therefore, if we were to tune the adaptor's oscillator to beat with one of the signals at the input of the adaptor, the output voltages of the rectifier following the i.f. amplifier would follow a curve similar to the response curve shown for the adaptor's i.f. amplifier in Fig. 5, and if this voltage is applied to the vertical deflecting plates of the cathode-ray tube, the spot will move upward from the center and then back to center as the beat between the oscillator and the signal approaches the i.f. of 200 kc. and then recedes after passing through maximum at 200 kc. If the tuning of the oscillator in this manner is done repeatedly and at a high rate of repetition, a vertical line would appear on the screen of the cathode-ray tube.

Now, if at the same time a smoothly varying voltage is applied to the horizontal plates, the spot will move under the influence of a horizontal as well as a vertical force and the resulting path will resemble the i.f. response curve.

Electronic Tuning

In the panoramic adaptor, the tuning of the oscillator is not done manually, of course, but this is accomplished by a reactance modulator whose characteristics are such as to sweep the frequency of the oscillator back and forth over the proper range at a rate corresponding to the rate of oscillation of a second special oscillator called the *b.t.o.* (blocking-tube oscillator). Voltage from the *b.t.o.* also is fed to the horizontal deflecting plates

of the cathode-ray tube so that the spot when no signal is present at the input of the adaptor is moved back and forth horizontally in synchronism with the sweeping of the adaptor's converter oscillator. If signals are present at the input of the adaptor, they will cause vertical deflections whenever the oscillator's frequency is appropriate to produce the required 200-kc. i.f. and these signals will then be reproduced in succession as indicated in Fig. 5. Normally, the sweeping action is set at a repetition rate of about 30 cycles per second, any rate which will maintain persistence of vision being adequate.

Since the signal to which the receiver is tuned corresponds to the center of the range being swept by the adaptor's oscillator, it follows that any peak appearing in the center of the screen is caused by the signal to which the receiver is tuned. Also, since the amount of vertical deflection for any given signal is proportional to its strength, strong signals will cause high peaks on the screen, while the peaks of weaker signals will be proportionately lower.

Ham Applications

It is not difficult to visualize many ways in which panoramic reception may be applied in postwar ham work. It is, of course, very easy to spot an unoccupied channel on the screen of the cathode-ray tube, and just as easy to watch the e.c.o. of the station's transmitter walk up to the vacant hole as the operator tunes it to the proper frequency. Not only is the lining up of stations in a spot-frequency net facilitated, but if net stations or stations in a "round-table" are operating on scattered frequencies, the control-station operator can keep tabs on all of them without disturbing the setting of his receiver. This sort of visual reception is valuable in many other practical operating tricks.

By the pattern on the screen, it is possible to check percentage of modulation, comparative signal strength, carrier shift and other signal characteristics. With the sweep width reduced to zero, the panoramic receiver becomes an oscilloscope. With a calibrated scale on the screen accurate frequency checks may be made.

While it is not probable that many operators could develop visual code-copying speed comparable with the speeds possible by ear, it should not be difficult for any ham to develop his eye to the point where he readily could recognize such things as the "CQ SS" of a Sweepstakes contest!

Strays

A widely-known manufacturer of radio receivers recently agreed to cease and desist from representing that any receiver it sells contains a designated number of tubes or is of a designated tube capacity, when one or more of the tubes referred to do not perform the recognized and customary functions of radio tubes in the detection, amplification and reception of radio signals.

A "Handbook" on Leyte

The Dramatic Story of a Radio Network Established by Guerrilla Forces in the Philippines

BY CYRUS T. READ,* W9AA

Presented herewith is a true story which we would have hesitated to print as fiction. We have long known that our *Handbook* contains all the information necessary to build and operate a complete radio station, but we never expected anyone to start from scratch and produce a whole radio system out of it while fighting Japs on the side. Former Assistant Secretary Cy Read heard a fragment of this yarn and, recognizing the interest it would hold for all hams, took time out from his regular job to pinch hit as a QST reporter once again. The result is this interview with Lt. Richardson.

LT. ILIFF RICHARDSON, USNR, never was a ham. Indeed, prior to January, 1944, he was completely unacquainted with the technical side of radio. His hobby was gas engines, motorcycles and the like, and, while he didn't say much about it, we got the impression that he really knew his way around in that field. Today, however, he knows his way around in radio equally well — and how he got that experience is one of the most amazing stories we have ever heard.

The chain of circumstances by which Lt. Richardson arrived on Leyte Island in the Philippines is too long to recount here. The full story will be told in the book, "History Island — The story of an American Guerrilla on Leyte," by Ira Wolfert,¹ which is being previewed in the March issue of *The Reader's Digest*. Suffice it to say that Lt. Richardson was executive officer aboard a PT boat, one of the group immortalized in "They Were Expendable," and his boat was among those which did *not* get away. At the time our story opens he was chief of staff of the guerrilla forces on Leyte.

In January, 1944, General MacArthur's headquarters got in touch with the guerrillas. Plans were already under way for the reconquest of the Philippines, and there was important work to be done. The principal assignment, prior to the actual invasion, was the setting up of ship-watching posts and the construction of radio stations to report the movement of Jap convoys. This was a "must," and nothing could be permitted to interfere with it.

Not that there weren't a few slight obstacles to be overcome at the start. First, the place was

infested with Japs — who, presumably, would hardly approve of this ship reporting service, and who were well equipped with radio direction finders. Second, aside from the Jap installations there wasn't a radio transmitter on the island, and none could be sent in. Finally, not a man in the outfit had ever had any real radio experience.

Nevertheless, Lt. Richardson was ordered to get a station on the air without delay.

Assignment: The Impossible

There is a familiar military motto which says: "The difficult we do immediately; the impossible takes a little longer." Something of this sort must have been in Richardson's mind when he started on this apparently "impossible" assignment. The first thing was to determine what assets they possessed, if any, which could be used to offset the all-too-evident liabilities.

He had plenty of money, practically the only item which could be sent in. There were telephone exchanges, telegraph stations and small power houses which contained equipment — some good, some wrecked, but all of which constituted a possible source of raw materials. By diligent inquiry he discovered a young Filipino, Joe Rifereal, who had been interested in radio and was able to read wiring diagrams. Somewhere they acquired an old UV-211 "50-watter" and a mica condenser, capacity unknown. Finally, they found a copy of *The Radio Amateur's Handbook*, 1932 edition, which belonged to a chap who had been a telegraph operator for the Philippine Bureau of Posts. It was dog-eared and mouldy, and had been sampled by white ants; the cover was long since gone and someone had bound it together with wire — but the essential information, every bit of practical knowledge necessary to build and operate a radio station, was still there.

Using the available funds, they started out to buy as many radio sets as could be found. The first haul consisted of one RCA, one Philco, two Airline and one Phillips receiver — the latter a Dutch-built set. The Phillips and one of the Airline jobs seemed to be in the best condition. They were used as the receiver, one functioning as a b.f.o. to permit e.w. reception on the other. The remaining sets were dismantled for parts to make a transmitter. While this was going on, someone came up with a p.a. amplifier which contained a 200-watt transformer. Then someone else brought in the field coils from a wrecked generator, an almost inexhaustible source of No. 28 copper wire.

* 507 W. 62nd St., Chicago, Ill.

¹ To be published by Simon & Schuster.

Improvisation à la Handbook

Some of the details of that first rig are a little hazy, but the lieutenant can quote line and page from the *Handbook* on all the important points! They rewound the p.a. transformer with wire from the generator, insulating the layers with waxed paper which had been used as wrapping for dynamite. They wound six-layer r.f. chokes on glass tubes found in a drug store, using No. 30 d.s.c. taken from a telegraph relay. There was no coil dope available to hold the layers in place, so they used natural gutta percha obtained from the trees on the island. Tank coils were wound from No. 6 telephone wire.

The problem of a socket for the precious 211 was solved in similar rough-and-ready fashion. Old hard-rubber storage-battery jars were cut up for insulating material. The tube was wedged into place in a hole cut in one of the receiver chassis and spring contacts were made out of a brass nameplate taken from one of the telegraph relays. When these proved too flexible, broken hacksaw blades were used to add springiness. A 150-watt transformer from one of the larger BCL receivers was rewound to give a 12-volt filament supply.

When it came to a source of power for all this equipment, Richardson's knowledge of gas engines paid big dividends. A great deal of the electrical equipment on Leyte was designed for 220-volt a.c. operation and a large Fairbanks-Morse gasoline-driven generator for that voltage was located. The engine was beyond repair, but the generator was still good and it didn't take long to hook it up to a 2½-horsepower single-cylinder job, which was salvaged from a local farm. It was of the type with two enormous flywheels, hitting only once in every half-dozen revolutions after it gets up to speed, and had to be started on gasoline. Once under way, however, it performed very well on coconut oil. The main drawback was the lack of a muffler, for the exhaust from that big cylinder could be heard altogether too far for safety. This difficulty, unfortunately, was not covered in the *Handbook*. It was finally solved by burying 30-odd feet of hollow bamboo tubing underground at random angles and running the exhaust through this "pipe."

The finishing touches on this first transmitter included red and green pilot lights from the p.a. system to indicate when plate and filament voltages were on and a white lamp with a pick-up loop to show output. This radiation indicator burned out several times before they got it adjusted correctly, but fortunately there were plenty of spare bulbs.

When the rig first went on the air there was one other difficulty. The key had been inadvertently connected in the high-voltage lead, and they had to operate it with a long plastic-handled screwdriver for a few days until the reason for the "fireworks" was discovered.

No regular antenna wire was available but there was plenty of No. 24 enameled wire from another old field coil and a hand drill was pressed into service to twist together 17 strands of this wire.



Lt. Iliff Richardson, USNR.

Zepp spreaders were cut out of the hard-rubber battery cases and there were plenty of jungle trees to serve as "sky hooks." The antenna was strung about 130 feet above ground and was oriented for maximum signal strength in the direction of Australia.

At about this point in the narrative we interrupted to remark that, of course, Lt. Richardson must at least have known the code before he ever undertook such a job. That turned out to be a bad guess on our part. It seems that the code was on page 30 of the *Handbook* — and it was just something else that had to be learned in between dodging Japs, building radio equipment, and conducting full-scale guerrilla warfare!

On the Air

When they finally got their first transmitter in good running order, it operated with an input of 85 watts. The plate supply was 940 volts of raw a.c. from the rewound transformer, and the note sounded like someone clearing his throat — but it did the trick.

As might be expected, all was not smooth sailing. The transformers were the principal source of trouble. That waxed dynamite-wrapping paper didn't work out very well; it seemed to encourage moisture condensation, and they found that ordinary typewriter paper was better for the purpose. It wasn't long before all hands became expert at detecting incipient burn-outs and doing a rewinding job in a hurry. In fact, they even invented a new "Q" signal to cover the situation:

QAB — My transformer is smoking. Please stand by for an hour.

With the first rig on the air and working successfully, it was time to expand the organization. The search for more broadcast receivers, prefer-

(Continued on page 108)

A Transmitter-Receiver for CAP-WERS Work

112-Mc. Gear for Light Aircraft

BY CAPT. ROBERT E. LATHROP,* CAP, EX-W9G0D

In this article the author describes the construction of a 6-tube transmitter-receiver for CAP-WERS plane-to-ground communication. The 2-tube transmitter is an m.o.p.a. with a linear output tank, while the receiver is a superregenerator with a tuned r.f. stage. The unit is compact and weighs less than 6 pounds.

THE need for a light-weight 112-Mc. transmitter-receiver with good frequency stability and low battery drain has existed ever since CAP was authorized to use WERS frequencies for flight and training missions. The author believes that the unit shown in the photographs not only fills this need but also will be able to carry on after the need for WERS is past. With the replacement of the self-excited oscillator by a crystal oscillator of proper frequency, this transmitter-receiver will be usable in the 130-Mc. band which is scheduled to replace the currently-used frequencies of 278 kc. and 3105 kc. Most large airports already are using v.h.f. equipment for airport-control purposes.

The transmitter-receiver and all accessories, including storage battery, weigh 29.1 lbs. The average light plane is equipped with a storage battery so the net added weight of the equipment will be only 13.2 lbs. A tabulation of individual weights is given here, since the average light plane often

* Wisconsin Wing Communications Officer, 130 Delafield Ave., Waukesha, Wis.

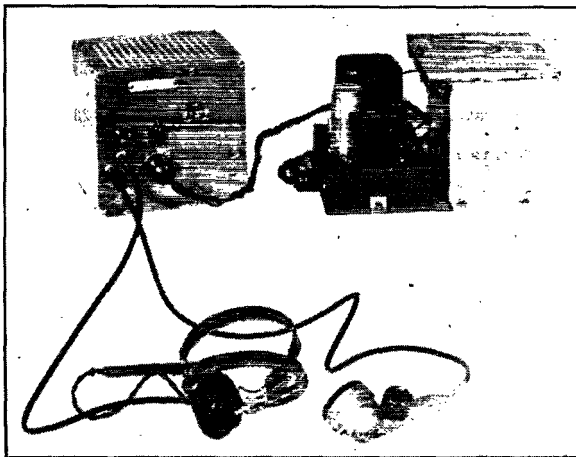

The complete equipment for the CAP-WERS installation consists of the transmitter-receiver unit, vibrator power pack with battery, headphones and microphone.

is allowed less than 50 lbs. for accessories and baggage.

Weight Table	Lbs.
Unit with tubes	5.25
Microphone and cable	0.81
Headphone and cable	0.25
Power supply and cable	6.14
Antenna and lead-in	0.75
	<hr/>
Storage battery and case	13.20
Total	15.90
	<hr/>
	29.1

The total stand-by receiving "A" battery load is 4.1 amperes, increasing to 9.2 amperes while transmitting. With the 22-ampere-hour storage battery used, the equipment will operate satisfactorily for approximately 3½ hours before the battery voltage falls off sufficiently to cause unsatisfactory operation.

Circuit Details

Only two tubes are used in the m.o.p.a. which constitutes the r.f. part of the transmitter. One section of the 6C8G dual triode serves as a self-controlled oscillator operating at 19 Mc., while the other section is used as a frequency tripler to the 56-Mc. band. The output stage with a 7A4 doubles frequency to the 112-Mc. band.

Since there is seldom any need for changing the tuning of either transmitter or receiver, once they have been set to the proper operating frequencies, all tuning adjustments are made by screwdriver. Thus only the knobs for regeneration and gain controls appear on the front panel.

The oscillator circuit is tuned to the proper frequency primarily by C_1 , and also by means of a machine screw in the field of L_1 which serves as a tuning "slug" to alter the inductance of the coil. The transmitter output frequency changes about 60 kc. for each revolution of the screw.

A self-resonant coil is used in the plate circuit of the tripler stage. This circuit is adjusted by squeezing together or spreading out the turns of L_2 . Once the frequency is set for the middle of the band, no further adjustment is required.

A concentric-line tank, L_4 , is switched to serve as the plate tank for the 7A4 when transmitting or for the grid tank of the 9001 r.f. amplifier tube when receiving. Thus it is not necessary to switch the antenna when changing over from transmitting to receiving, the antenna being permanently coupled to the tank by means of the hairpin loop, L_7 .

When the concentric tank is switched over for receiving, the additional tuning

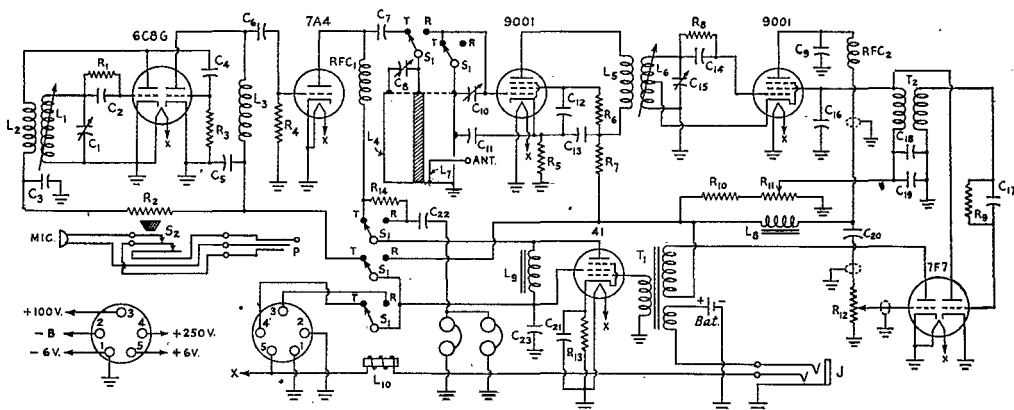

Fig. 1 — Circuit diagram of the CAP-WERS transmitter-receiver.

C_1 — 100- μ fd. midget air variable.
 $C_2, C_4, C_{11}, C_{12}, C_{13}$ — 500- μ fd. mica.
 C_3, C_{17} — 0.005- μ fd. mica.
 C_5, C_7 — 0.002- μ fd. mica.
 C_8, C_{14} — 50- μ fd. mica.
 C_9, C_{10}, C_{15} — 25- μ fd. air variable (Hammarlund APC-25).
 C_0 — 0.003- μ fd. mica.
 C_{16} — 250- μ fd. mica (see text).
 C_{18}, C_{20}, C_{22} — 0.02- μ fd. paper.
 C_{19} — 0.5- μ fd. paper.
 C_{21} — 10- μ fd. 50-volt electrolytic.
 C_{23} — 20- μ fd. 450-volt electrolytic.
 R_1 — 10,000 ohms, $\frac{1}{4}$ watt.
 R_2, R_7 — 5000 ohms, $\frac{1}{4}$ watt.
 R_3, R_9, R_{10} — 50,000 ohms, $\frac{1}{4}$ watt.

R_4, R_6 — 250,000 ohms, $\frac{1}{4}$ watt.
 R_5 — 200 ohms, $\frac{1}{4}$ watt.
 R_8 — 2 megohms, $\frac{1}{4}$ watt.
 R_{11} — 50,000-ohm potentiometer.
 R_{12} — 500,000-ohm potentiometer.
 R_{13} — 700 ohms, $\frac{1}{4}$ watt.
 R_{14} — 100,000 ohms, $\frac{1}{4}$ watt.
 RFC_1, RFC_2 — V.h.f. choke (Ohmite Z-1).
 T_1 — Interstage audio transformer with microphone winding added (see text).
 T_2 — Quench-oscillator coils. (Carron S-565. Also see text).
 L_1 — $8\frac{1}{2}$ turns No. 22 enameled wire, $\frac{1}{2}$ -inch diameter, $\frac{3}{16}$ -inch long.
 L_2 — $5\frac{1}{2}$ turns No. 24 d.s.c. wound

between turns of L_1 at ground end.
 L_3 — 10 turns No. 20, $\frac{3}{8}$ -inch diameter (see text).
 L_4 — Coaxial tank (see text).
 L_5 — $1\frac{1}{2}$ turns No. 24 d.s.c. wound between turns of L_6 at ground end.
 L_6 — $2\frac{1}{2}$ turns No. 14, $\frac{3}{8}$ -inch diameter, $\frac{1}{2}$ -inch long, tapped 1 turn from ground end.
 L_7 — Antenna pick-up (see text).
 L_8 — Interstage audio transformer (primary and secondary connected in series).
 L_9 — Output coupling choke (Thorndarson T-13C26).
 L_{10} — Solenoid winding (see text).

capacity, C_{10} , is connected in parallel with C_3 , which tunes the transmitter output circuit. This added capacity is necessary to compensate for the difference between the output capacity of the 7A4 and the input capacity of the 9001. In addition, in the proposed schedule of frequency allocations for future aircraft communications, ground-station frequencies are lower than frequencies for itinerant aircraft so that the aircraft receiver always must be tuned to a frequency lower than that of the transmitter. Inductive coupling is used between the r.f. stage and the 9001 superregenerative detector. The grid coil, L_6 , also is provided with a tuning "slug" so that its inductance may be adjusted. This "slug" could be eliminated, of course, by substituting instead a smaller tank condenser and a 3-30- μ fd. mica trimmer, although the stability might be impaired somewhat. Several of these receivers have been in use for a period of over two months without retuning and all are still "on the button."

Audio Section

One section of the 7F7 dual triode which follows the detector is used as a separate quenching oscillator, while the other section serves as the first audio amplifier. The separate quenching oscillator results in better stability and a lower hiss level, and the sensitivity of the detector can be made the equal of the usual self-quenching detector if the proper quenching voltage and frequency are chosen. Quenching voltage is introduced in the screen circuit of the detector.

The audio section of the 7F7 is operated at zero bias and is transformer coupled to the 41 output stage. This stage is operated at reduced plate voltage for receiving. Two stages of audio are necessary, since "prop" and engine noises usually are sufficient to cover a lower-level a.f. which may seem to be entirely adequate in the quiet surroundings of a test bench. The output of the 41 is impedance-capacity coupled, by means of L_9 and C_{22} , to two headsets in parallel, one for the pilot and the other for the operator. To provide "side tone" the headphones are not disconnected when transmitting, although the coupling is reduced by switching R_{14} in series. This arrangement permits the pilot to overhear both sides of the conversation between the plane and ground-station operators.

If the contacts of the push-button switch, S_2 , are adjusted properly, slight pressure will close the upper contacts without closing the lower contacts which operate the change-over switch, S_1 . The audio section then may be used as an intercommunicating system between the pilot and the operator. In this case the mike must be passed back and forth, although with two microphones this would not be necessary.

The change-over switch, S_1 , is operated by the solenoid, L_{10} . If electrical operation is not deemed necessary, it may be operated by a push rod from the front of the panel, as shown in the sketch of Fig. 2. The latter arrangement has the disadvantage that two hands are required unless a throat microphone is used.

Construction

The over-all dimensions of the unit are $7\frac{1}{2}$ inches high, $7\frac{1}{4}$ inches wide and $5\frac{3}{4}$ inches deep. For lightness, the case and chassis are made of sheet aluminum. Looking from the rear, the transmitter occupies the left-hand side of the chassis while most of the receiver components are mounted on the right side with a vertical shield separating the two sections. The parts for both are laid out so as to keep all connecting leads as short as possible. With the exception of the grid and plate leads to the master-oscillator tube, none is over $1\frac{1}{2}$ inches long. The oscillator grid and plate coils, L_1 and L_2 , are wound on a piece of half-inch polystyrene rod $\frac{1}{8}$ inch long. L_2 is wound between the spaced turns of L_1 . While other means may be preferred by the individual constructor, in this case it was convenient to mount the coil form on the ceramic base of C_1 . This was done by the use of a brass sleeve or bushing $\frac{3}{4}$ inch long threaded $\frac{1}{4}$ -inch-28 on the outside and 6-32 on the inside. This sleeve was threaded into the "ground" end of the polystyrene rod with sufficient length left protruding so that it could be mounted on the condenser base with a $\frac{1}{4}$ -inch brass nut. A 6-32 brass machine screw threaded into the brass sleeve and fitted with a locknut serves as the tuning slug for tuning the coil. The assembly of condenser and coil is mounted in the lower left-hand corner of the panel where the adjusting screws protrude through clearance holes to the front. The 6C8G is mounted directly behind this assembly, the triode section whose grid connection is made to the cap on top of the tube being used as the oscillator. The self-supporting tripler plate coil, L_3 , is fastened to a strip of polystyrene mounted underneath the chassis alongside the socket of the 6G8G.

The 7A4 output tube can be seen adjacent to the concentric-line tank. The outer conductor or

"can" of this tank consists of a sheet of 0.028-inch copper sheet rolled into the form of a 2-inch cylinder $6\frac{1}{4}$ inches long (with the aid of the junior op's baseball bat). The inner conductor, which may be made from a $6\frac{1}{2}$ -inch length of $\frac{1}{8}$ -inch copper tubing or No. 8 wire, is soldered directly to the stator of C_8 which is mounted on the front panel so that the inner conductor is central in respect to the outer "can." Incidentally, this tank is mounted in a position inverted to that shown in the diagram of Fig. 1, with the high-potential end at the chassis level.

The antenna-coupling loop, L_7 , is a piece of No. 14 insulated hook-up wire $3\frac{3}{4}$ inches long bent in the shape of an L, one end of which is soldered to the top or "ground" end of the cylinder, $\frac{1}{16}$ inch from the center conductor. Two and a half inches of the length is run parallel to the center conductor while the balance is brought out through a $\frac{3}{8}$ -inch clearance hole to the antenna post on the panel.

Those details of construction which cannot be seen clearly in the photographs may be determined from an examination of the sketch of Fig. 2. The 9001 r.f. amplifier-tube socket is mounted with its grid terminal an inch or so from the tank. Ground connections for C_{10} and C_{11} , as well as all other ground connections shown for the 7A4 and 9001 r.f. stages are made directly to the outside conductor of the tank and not to the chassis.

The 9001 superregenerative detector tube is mounted near the right-hand edge of the chassis (rear view). The r.f. transformer consisting of L_5 and L_6 is mounted underneath the sockets of the two 9001 tubes. These two coils are wound on a $1\frac{3}{8}$ -inch length of $\frac{3}{8}$ -inch polystyrene rod which is threaded to take a 6-32 mounting screw at one end and another 6-32 with the head cut off at the other end. This latter serves as a tuning slug which may be turned by a piece of

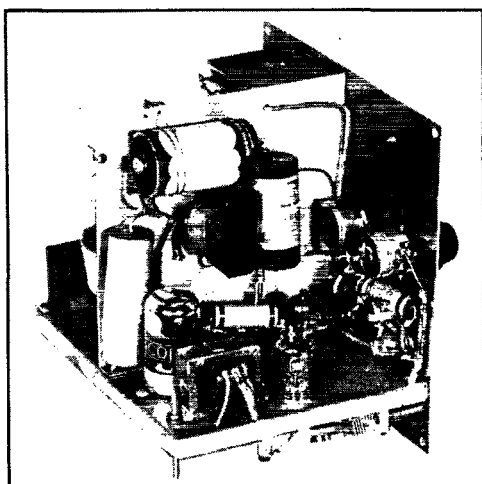
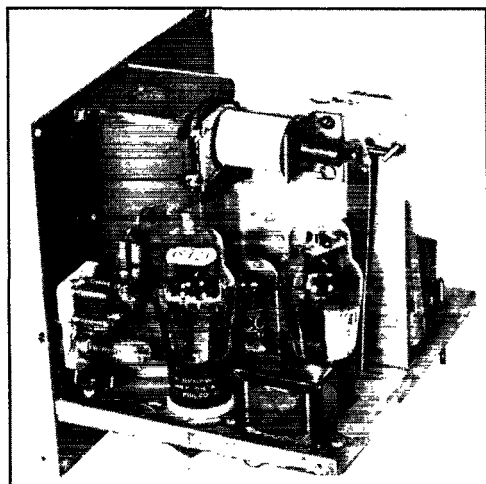

Left — The transmitter end of the chassis, showing the oscillator tank circuit, the 6C8G, 7A4, and 41 tubes, and the output coupling choke, L_9 . The coaxial tank is in the background. The solenoid and lever which operate the change-over switch are mounted against the vertical shield. Right — The receiver end of the chassis, showing the two 9001s and the 7F7. Volume and regeneration controls are mounted on the panel. L_8 is seen in the foreground, on the chassis, while T_1 is mounted on the vertical shield under the single-cell microphone battery.

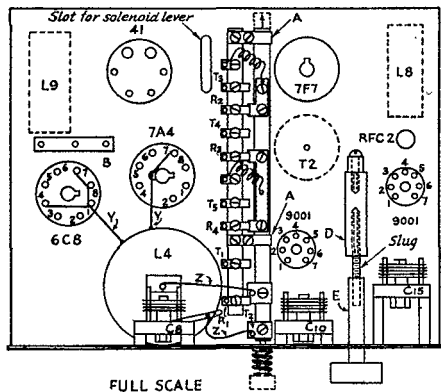

Fig. 2 — Sketch showing details of the change-over switch construction and the chassis arrangement of other important components.

$\frac{1}{4}$ -inch polystyrene rod extending through the front of the panel. The form is fastened in a horizontal position to a brass post which spaces it from the chassis. L_5 is wound between the turns of L_6 and both windings should be given a coat of low-loss coil cement. C_{16} should be mounted as close as possible to the detector tube since it serves not only to control the quench frequency but also as an r.f. by-pass for the detector screen.

The 7F7 is mounted on the receiver side of the vertical shield near the rear edge of the chassis with the audio choke, L_8 , between the 7F7 and the 9001 detector tube. This audio choke actually is a midget interstage transformer with primary and secondary windings connected in series.

The quench coils comprising T_2 may be made, if desired, by turning two slots $\frac{1}{8}$ inch apart in a piece of broomstick. The plate-coil slot should be $\frac{3}{8}$ inch wide and $\frac{1}{4}$ inch deep, while the slot for the grid coil is $\frac{1}{4}$ inch by $\frac{1}{4}$ inch. Both slots should be wound full with No. 34 or No. 36 enameled wire. The windings should be kept even so that the slots will accommodate as many turns as possible.

The combination microphone and audio transformer, T_1 , is mounted on the vertical shield immediately below the microphone battery. This also is a midget interstage transformer with an added microphone winding of 50 to 100 turns of No. 30 d.c.c. wire placed over the original windings. If space is not available, the core may be filed down slightly to provide a space of about $\frac{1}{16}$ inch for the additional winding. After the winding has been completed, the leads should be anchored with two layers of cellulose Scotch tape and the winding given a coat of coil dope.

The output choke, L_9 , and the 41 output tube occupy the rear left-hand corner of the chassis.

Details of the homemade change-over switch may be seen best in the sketch of Fig. 2. It consists principally of two bars of Plexiglass made from 6-inch feeder

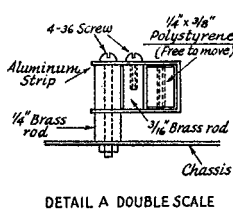

spreaders, on which are mounted jaw-type contacts obtained from a discarded band switch. Contacts of this type are used to escape noise under vibration. One of the bars is mounted in a fixed position while the other is permitted to slide back and forth. The r.f. end of the

switch is adjacent to the coaxial tank, the a.f. contacts are at the rear and the power contacts in the center. The switch is operated by a lever system from a solenoid, L_{10} , located in back of the concentric tank on the transmitter side of the vertical shield. The lever operates through a slot cut in the chassis as indicated in Fig. 2. The solenoid plunger is a piece of $\frac{1}{2}$ -inch soft-iron rod 2 inches long which slides inside a thin-wall brass tube on which 360 turns of No. 22 enameled wire are wound. The coil is $1\frac{1}{4}$ inches long.

The unit is designed so that either dry batteries or a vibrator pack may be used to operate it. If batteries are used, a voltage of 90 to 100 is applied to the receiver and 135 to the transmitting section. When the vibrator pack is used, a 20,000-ohm 10-watt resistor is placed in series with the 100-volt lead. This resistance is installed in the vibrator-pack unit and, in conjunction with C_{23} , serves to provide additional filtering as well as to drop the voltage to the desired value.

Adjustment

In tuning up the transmitter, a test loop consisting of 2 turns of hook-up wire, $\frac{1}{2}$ inch in diameter, with a 2-volt 60-ma. dial lamp in series will be found useful. The oscillator is tuned to one sixth of the desired carrier frequency. If it is working properly, the plate current will be 20 ma. and the lamp in the test loop will light to

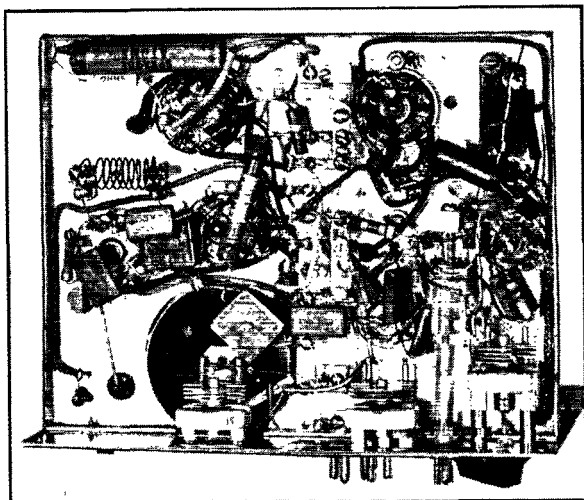

Bottom view of the CAP-WERS transmitter-receiver. The high-potential end of the concentric tank is just to the right of center, near the bottom edge, with C_8 at its center. To the extreme right is C_{15} , with C_{10} between. L_8 is clearly visible at the upper left.

full brilliance with moderate coupling. The tripler plate coil, L_3 , is best adjusted by checking the grid current to the 7A4 with a 0-1 milliammeter connected in series with R_4 at the ground end. When the size of L_3 has been adjusted correctly by changing the spacing between turns, the grid current should be about 350 microamperes and the tripler plate current about 8 ma. The output of the tripler should be checked with an absorption-type frequency meter to make sure that it is tripling.

The final-amplifier tank is then tuned for maximum output, using a 60-ma. dial lamp as a dummy load. The plates of C_3 will be about one-third meshed. The tuning of this circuit is sharp and will not be changed much with antenna loading. With the 7A4 operating at 240 volts, the loaded plate current should be about 8 ma. and the power output approximately $\frac{1}{4}$ watt. With no modulation, the load lamp should light above normal brilliance.

If the transmitter is functioning properly, no trouble should be experienced in obtaining upward modulation with excellent frequency stability and very little carrier shift. The plate efficiency of the final cannot be expected to be remarkable since this stage is doubling frequency, but the signal sounds sweet on a converter-HRO combination and can be held at the same receiver dial setting for a reasonable period of time. However an arrangement of this sort is too selective for practical purposes since temperature variations with altitude cause the frequency of the transmitter to drift somewhat during flight.

No particular difficulty should be experienced in tuning up the receiver. Once the inductance has been adjusted with the tuning slug so that C_{15} covers the desired frequency range, the r.f. stage can be lined up on hiss or signal on the air. It will pay dividends to experiment with somewhat different values for C_{16} in getting smooth superregeneration. It is not advisable to use a value for R_3 greater than 2 megohms because of the danger of self-quenching action in the detector. Less resistance will give better quenching action, but the sensitivity will fall off.

A word about the sensitivity of v.h.f. receivers may be in order at this point. If the sensitivity is good, QRM from the average automobile or unshielded aircraft ignition system will be heard at distances up to 500 feet. If the noise pulses from the ignition system of your own ship are very strong, the superregenerative receiver will automatically decrease its sensitivity and you

may kid yourself that you don't have ignition noise. Under these conditions the sensitivity of the receiver may be reduced to the point where a range of 5 to 10 miles will be maximum.

Antennas

Two types of antennas have been employed with good results. One type consists of a vertical dipole supported by Q bars, fed with a 400-ohm open-wire line. The Q matching section is fastened to a piece of plywood which, in turn, is attached to the jury wing struts. The short open-wire line, made up of No. 16 wire, is run through small holes in the pyralin cabin wall to the antenna. The pyralin should be reinforced with additional pieces cemented in place wherever holes are made. Also the lead-in should be brought in at a point where it will place the least strain on the window.

The second type of antenna, used on metal-covered ships, consists of a quarter- or half-wave vertical antenna fed by a short coaxial line. The half-wave antenna is preferable, since it also may be used on the 200- to 400-kc. aircraft range receiver. Mounting of this antenna on this type of ship must be done by an A and E mechanic, since holes must be made in the skin of the ship.

Installation

WERS installations on aircraft present several problems. CAA requires that any structural alteration or change in weight in an aircraft caused by the installation of radio equipment, including antennas, radio units, batteries, generators, etc., must be done by a licensed A and E mechanic or under his supervision. After this has been done, the aircraft must be inspected and relicensed by a CAA inspector.

However, CAP-WERS stations have been given some leeway in this matter. Antenna systems are made permanent installations and the ship relicensed by compliance with CAA Repair or Alteration Form 337. A temporary radio installation then may be held in the lap of the observer or strapped down in the baggage compartment, during CAP flights and missions or for test flights. Permanent installations of CAP-WERS equipment in aircraft, outside of antennas, are not made since WERS and CAP rules forbid the installation of this type of radio equipment where it is not at all times under the supervision and control of the licensee or his communication officers. Also the CAA rules forbid the removal of radio equipment after it has been installed and the ship relicensed to carry the additional weight of the equipment, unless Form 337 re-inspection rules are complied with. In simple language, CAP-WERS radio equipment is considered as baggage, and so long as the baggage or passenger-weight restrictions are complied with, no trouble will be encountered. As a last word of caution, be sure that cables or microphone and headphone cords do not interfere with the operation of the aircraft controls and throttle, or interfere in any way with

The author and the XYL ready to take off with the CAP-WERS installation.

QST for

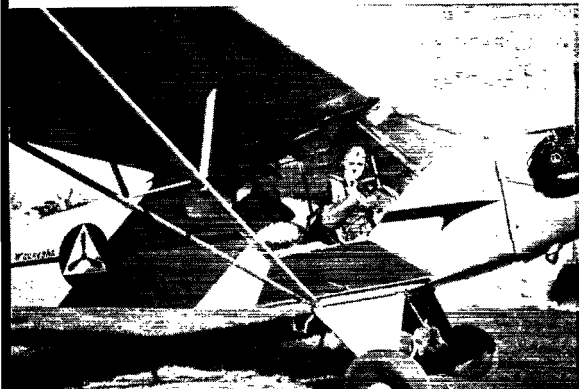

the pilot's vision or operation of the aircraft. Safety is most important.

Performance

Several units built along the lines described have given good results up to 30 or 40 miles under adverse conditions at an altitude of 600 to 1000 feet. At a 3000-foot altitude distances up to 60 miles may be expected. We have heard some Chicago units at a distance of approximately 95 miles while flying at 3500 feet. The CAP ground-station equipment makes use of a coaxial antenna 15 feet above ground. The transmitter is a crystal-controlled 815 job with 15 watts output, while the receiver is a superhet per *QST*, July, 1944, page 15, with 9002 tubes in place of the 955s and a separate quench oscillator added.

Three of these units have been under observation over a period of four months and the maximum frequency deviation observed to date has been under 0.05 per cent. This degree of stability makes it possible for a plane to take off from the home airport and establish communication with another airport ground station, 20 to 30 miles away, as soon as it has reached an altitude of 600 to 1000 feet — without the necessity for long calls or for the ground-station operators to continuously dial across the band.

In Wisconsin all CAP communication is on 115,500 kc. plus or minus 50 kc. Each Group has a home-built frequency meter which is accurate to within 0.01 per cent for normal temperature variations (50 to 90° F.). If abnormal temperatures are experienced, a temperature correction can be made which will bring the net accuracy to within 0.03 per cent.

★ SPLATTER ★

OUR COVER

DEPICTING surroundings in which not a few hams find themselves these days, this is a view of a typical radio assembly and repair bench in a Quonset hut at an overseas U. S. Army depot. The ruggedly built gear procured by the Signal Corps is more often broken up by enemy action than broken down by parts failures, but when replacements or adjustments are in order well-equipped repair shops and skilled maintenance men speedily restore it to service.

... —

FOOTNOTES

THE first of the several new *QST* contributors to be presented in these biographical sketches is S/Sgt. R. Bickmore, W6QDV (p. 11). In response to our plea for pertinent personal data, he writes: "Received my ham license in June, 1938, at the age of 14. . . . Class-A and first class commercial tickets obtained March, 1941. . . . Operated on all bands but spent most of my time on 14

and 112 Mc. . . . While attending University of California — majoring in EE — operated KALW, the net's first f.m. broadcasting station. . . . Entered the U. S. AAF in February, 1943. . . . Became communications inspector and later communications chief of Headquarters Squadron, First Fighter Command. . . . Transferred to present station in October, 1944, as communications chief." Which is a very nice array of data indeed — and to culminate it we call your attention to the fact that W6QDV is now only 21 years old. . . . Each appearance of these notes seems to contain the story of at least one old-time ham dating back to the era of the Wm. J. Duck and E. I. Co. catalogs. The old-timer for this issue is **Robert E. Lathrop ex-9ATX-W9GOD**, (p. 24). His life-story sounds like that of the composite ham. Starting at the age of ten with the gift of a spark coil from a neighbor's attic, Lathrop advanced through the usual Century buzzer era to a Grebe tuner and a quarter-kw. with a rotary gap. By 1923 the spark had given way to c.w., but soon Lathrop was attending Carroll College and was able to operate 9ATX only on week-ends. While at the University of Wisconsin — on a scholarship, incidentally — his license lapsed. Along about 1930 a new call, W9GOD, was acquired and again Lathrop passed through the normal phases of ham radio including membership in ROWH and a Class A ticket. Eventually he wandered off into another fascinating hobby, that of private flying. Now a captain in the CAP and the Wisconsin Wing's communication officer, Lathrop currently manages the time to design and construct radio gear for WERS-CAP installations as well as to fly his own Cub. . . . The radio activities of **Harvey Pollack, W2HDL** (p. 18), appear to have centered mostly around educational work of one form or another. First licensed in 1932, W2HDL started on 80-meter c.w. and stuck to that for two years. Twenty-meter 'phone then claimed — and held — his interest for the next seven years, until the war. For a time Harvey taught physics, also supervising radio clubs and societies in the New York school system. Following this came a period as chief instructor in radio at Melville Aeronautical Radio School. Harvey then joined the engineering staff of the Panoramic Radio Corporation, where he is now in charge of technical literature and specifications. However, just to keep his hand in, he is also teaching evening radio classes at Hunter College. Sometime during the past two years W2HDL somehow found time to get his master's degree in physics at Columbia. Perhaps the strong bond between the educational and radio activities of W2HDL arose when, on graduating from Brooklyn College with A.B. in physics, he took examinations for a teaching post. While awaiting results, he and a friend went on a camping trip in upper New York state. He took along a portable and skeds were arranged with a neighbor-ham at home. On one of these schedules word came from his mother that he was to report at once as an instructor at De Witt Clinton High

(Continued on page 104)



IN THE SERVICES

APOLOGIES to amateurs in Civil Service and 100 per cent war industries, who have sent us their AWSRs and have not yet seen their names listed in these pages. Registrations from men in the armed services, to whom we give preference, continue at a high level, and the available space in *QST* has been insufficient to take care of all other categories promptly. Have patience, fellows. We appreciate your registrations, and every one of you will be listed just as soon as possible.

MARINE CORPS

2LAV, Reigner, T/Sgt., foreign duty
 2NAP, James, Pfc., Walnut Ridge, Ark.
 3HWR, Coale, Sgt., Grove City, Pa.
 4FXV, Kiser, Pvt., Camp Lejeune, N. C.
 4HUP, Parris, Cpl., San Diego, Calif.
 ex-5ADY, Cisler, Capt., foreign duty
 5KPY, Jeffcoat, S/Sgt., Hudson, Wis.
 6LPU, McChesney, Pfc., foreign duty
 6PBI, Veregge, 2nd Lt., Quantico, Va.
 6TDE, Wallin, Pvt., Camp Lejeune, N. C.
 6TPI, Ridderhof, Pvt., Corpus Christi, Texas
 6TRP, McFadzean, Pfc., San Diego, Calif.
 6TZB, Mitchell, Capt., foreign duty
 ex-7FUB, Amsden, Pfc., Grove City, Pa.
 8PPE, Blackschleger, 2nd Lt., Cambridge, Mass.
 8UOQ, Galambos, Cpl., Camp Gordon Johnston, Fla.
 8VJQ, Hager, Lt. Comdr., Staten Island, N. Y.
 9ABW, Holmes, Lt., Corpus Christi, Texas
 9ZVJ, Tevlin, Lt., St. Louis, Mo.

Operator's license only:

Sumberg, MT/Sgt., Brooklyn, N. Y.

ARMY—SIGNAL CORPS

ex-1BLO, Gaumont, Pvt., foreign duty
 KA1CS, Sinkler, Capt., foreign duty
 1DKV, Niland, Capt., Leavenworth, Kans.
 1GAF, Perry, T/Sgt., foreign duty
 1JJT, Conrad, Lt., foreign duty
 1KUY, Mould, Pvt., foreign duty
 1KUZ, O'Brien, T/Sgt., foreign duty
 1NOO, Burdick, T/5, foreign duty
 ex-2AGR, Murray, Capt., foreign duty
 2BJD, Hogenkamp, Major, foreign duty
 2HZZ, Koehler, Lt., foreign duty
 2LQR, Bunnell, Sgt., foreign duty
 2MGT, George, T/5, Camp Kohler, Calif.
 2MTO, Jindela, Pfc., foreign duty
 2OAL, Ellis, 2nd Lt., Baltimore, Md.
 2OLE, Widmann, Cpl., Ft. Jackson, S. C.
 3EPE, Marie, Lt., foreign duty
 3FDF, Hance, T/4, foreign duty
 3FFN, Meyer, Sgt., foreign duty
 4FPD, Logan, Capt., foreign duty
 4FUL, Beeler, Lt., Warrenton, Va.
 4FVI, Reid, T/Sgt., foreign duty
 4GKO, Apple, Pvt., Ft. Monmouth, N. J.
 4HFX, Lay, Sgt., foreign duty
 4IEC, James, Sgt., foreign duty
 5EZE, Busick, Cpl., Long Island City, N. Y.
 5HLR, Glendenning, Lt., foreign duty
 5HPL, Gregory, S/Sgt., foreign duty
 5JQL, Ford, Pvt., Camp Crowder, Mo.
 6BWZ, Strazzarino, Cpl., San Mateo, Calif.
 ex-6JRG, Leonard, Lt., foreign duty
 6PVG, Ferguson, T/Sgt., foreign duty
 6QJ, Weathers, T/5, foreign duty
 6SNX, Mac Millan, Pvt., foreign duty
 7HCS, Minich, T/4, foreign duty
 7HND, Blomness, T/4, Seattle, Wash.
 7HDI, Amsden, T/4, foreign duty
 7KIM, Strong, T/Sgt., Seattle, Wash.
 7KXSS, Arnold, Sgt., foreign duty
 7IAO, Grassier, T/4, foreign duty
 8AAP, Graziano, Cpl., Baltimore, Md.
 8KCV, Crompton, T/4, foreign duty
 8LEL, Ward, T/5, foreign duty
 8QUU, Stewart, T/4, foreign duty
 8RBE, Slater, T/Sgt., La Plata, Md.
 8SXM, Rupert, Cpl., foreign duty
 8TEF, Swink, T/Sgt., foreign duty
 8TMY, Tuma, address unknown
 8TTP, Carrera, S/Sgt., foreign duty
 8UBF, Paniwozik, T/3, foreign duty

8UWE, Sterner, Lt., Cambridge, Mass.
 8VIW, Moody, S/Sgt., foreign duty
 8VUY, Cook, Cpl., foreign duty
 8WGO, Goldfarb, Sgt., foreign duty
 8XP, Amthor, Col., foreign duty
 ex-9BIM, Wesner, Major, foreign duty
 9EEB, Kloepper, 2nd Lt., Long Branch, N. J.
 9GYZ, Brawley, Capt., foreign duty
 9HUK, Kramer, Pvt., foreign duty
 9JCI, Shanks, Lt., foreign duty
 9JEW, Windus, T/5, Camp Crowder, Mo.
 9JVV, Foss, Pvt., foreign duty
 9JXM, Wesley, 2nd Lt., Ft. Monmouth, N. J.
 9KBR, Elder, address unknown
 9MDV, Tipton, Sgt., Chicago, Ill.
 9MNO, Casey, Cpl., foreign duty
 9MTD, Sollenberger, Pvt., foreign duty
 9NQB, Stokes, Cpl., foreign duty
 9ORB, Arne, T/4, foreign duty
 9QVL, Noe, T/4, Ft. Monmouth, N. J.
 9SNO, Padberg, Pvt., Camp Crowder, Mo.
 9TKN, Bodwell, Lt., foreign duty
 9TQD, Quinn, Cpl., Brooklyn, N. Y.
 9WRK, Campbell, Lt., Tuskegee, Ala.
 ex-9YSW, Eckmann, 2nd Lt., foreign duty
 9WVB, Nord, Sgt., Camp Crowder, Mo.
 9YTO, Juring, T/Sgt., foreign duty

Operator's license only:

Brush, Cpl., foreign duty
 Carskaddon, Pvt., Presidio, San Francisco, Calif.

Erpalding, Sgt., foreign duty
 Jevina, S/Sgt., foreign duty
 Levine, T/Sgt., foreign duty
 Levinson, T/5, foreign duty
 Oarlaine, S/Sgt., foreign duty
 Olsen, T/Sgt., foreign duty
 Palm, T/Sgt., foreign duty
 Porter, Lt., Ft. Monmouth, N. J.
 Province, M/Sgt., Ft. Myers, Va.
 Ross, Cpl., Ft. Monmouth, N. J.
 Sullivan, S/Sgt., foreign duty
 Trenbeth, Lt., foreign duty
 Vaughn, Pvt., Ft. Monmouth, N. J.
 Von Wormar, Sgt., foreign duty
 Wallace, T/3, Evanston, Ill.

NAVY—SPECIAL DUTY

1MGW, Hart, Sic, College Station, Texas
 2LIE, Nolan, CRT, Portland, Me.
 2NSU, Nadolski, RT1c, foreign duty
 3ICQ, Kellam, RT1c, address unknown
 3IPX, Schermerhorn, RT3c, Bellevue, D. C.
 3IQO, Redpath, CRT, foreign duty
 4HMV, Ball, RT2c, Houston, Texas
 5CJJ, Pritchett, RT1c, Chicago, Ill.
 5IIU, Sanders, RT1c, address unknown
 5KQB, Hankins, RT3c, Oceanside, Calif.
 5KRC, Andrus, RT2c, Tulsa, Okla.
 6HIR, Gandy, RT1c, foreign duty
 6QUV, Isenberg, RT3c, Chicago, Ill.
 6RGN, Tanner, RT1c, Chicago, Ill.
 6TQP, Reynolds, CRT, foreign duty
 7JDP, Alfred, RT2c, Chicago, Ill.
 8LJX, Bobbitt, RT3c, Chicago, Ill.
 8LVV, Bolvin, RT2c, Chicago, Ill.
 8NYX, Matvay, RT1c, foreign duty
 8PJH, Marshall, RT1c, Chicago, Ill.
 8SYO, Cater, RT3c, Chicago, Ill.
 8UEO, Nauman, Sic, Chicago, Ill.
 8VJO, Narad, RT3c, Chicago, Ill.
 8WOX, Rohlf, RT3c, foreign duty
 8WVA, Dundas, Sic, Great Lakes, Ill.
 9HCJ, Parkin, Sic, Chicago, Ill.
 9NUM, Brinkman, Sic, Stillwater, Okla.
 9NZD, Deno, RT1c, Chicago, Ill.
 9PPA, Leist, RT3c, Chicago, Ill.

Operator's license only:

Bell, Sic, Grove City, Pa.
 Poulin, Sic, Del Monte, Calif.
 Ruetz, RT1c, foreign duty
 Rupert, RM3c, Norfolk, Va.
 Schiermeyer, Sic, Del Monte, Calif.



Many amateurs will remember Capt. Cecil I. Sinkler (right), who operated KA1CS in the Philippines during 1936 and 1937. Called to active duty in 1941, he is now serving as signal officer with a Y-Force liaison team attached to a Chinese division. Y-Force is the American military mission which trained and equipped the Chinese Expeditionary Force for the Salween campaign in Western Yunnan. *Official U. S. Army Signal Corps Photograph.*

ARMY—AIR FORCES

ex-1JD, Tuesday, Lt., foreign duty
ex-1JKP, Bara, Cpl., Olmsted Field, Pa.
1KFA, Kasanof, Lt., Thomasville, Ga.
1LFK, Parmelee, M/Sgt., foreign duty
2BHW, Lindenhayn, Capt., foreign duty
2HLQ, Liljeroos, Pvt., Scott Field, Ill.
2LNH, Craven, 2nd Lt., Cambridge, Mass.
2LTT, Eppard, Lt., foreign duty
3DRJ, O'Connor, Capt., foreign duty
3FSE, Righter, S/Sgt., foreign duty
3ZZZ, Akre, Col., Orlando, Fla.
ex-K5AP, Collins, S/Sgt., foreign duty
ex-3BAG, Crockett, M/Sgt., Denver, Colo.
5CBS, Brock, Lt. Col., Asheville, N. C.
5EQW, Elam, Lt., Boca Raton Field, Fla.
5FTH, McElhany, Sgt., foreign duty
5GWM, Graves, Lt., Boca Raton Field, Fla.
5GZW, Schmidt, A/S, Randolph Field, Texas
5HYD, Clark, Capt., Chanute Field, Ill.
5KEW, Burr, Sgt., foreign duty
5KKN, Dobkins, Pfc., foreign duty
6CWS, Fiedler, S/Sgt., foreign duty
ex-6HYG, DeYoung, Capt., foreign duty
6MLA, Young, Pfc., Ft. Dix, N. J.
6OQD, Schoenfeld, S/Sgt., Camp Polk, La.
6POC, Ufrick, M/Sgt., Esler Field, La.
6SFP, Simpson, P/O, Godman Field, Ky.
6SJV, Perkins, Lt. Col., Bergstrom Field, Texas
7BYS, Dunbar, T/Sgt., Eglin Field, Fla.
7FSL, Lee, Capt., foreign duty
7LXX, Faries, T/Sgt., foreign duty
8FBE, Kirk, Sgt., Malden, Mo.
8FM, White, Capt., foreign duty
8HHD, Watts, Sgt., foreign duty
8OQC, McCarty, 2nd Lt., Ellington Field, Texas
8TFF, Makuta, S/Sgt., foreign duty
9BKL, Rainous, T/Sgt., foreign duty
9EED, Menier, T/Sgt., Millville, N. J.
9EZY, Lepp, S/Sgt., foreign duty
ex-9HTW, Saxon, Pvt., Maria, Texas
9KWQ, Erickson, A/C, Foster Field, Texas
9LAF, Rajajko, S/Sgt., foreign duty
9NMD, Watson, Capt., St. Joseph, Mo.
ex-9NOL, Paris, Capt., Palm Springs, Calif.
9OFJ, Maddox, Capt., foreign duty
9SNH, Ferguson, Sgt., foreign duty
9TDD, Hyde, Capt., Beardstown, Ill.
9TXH, Casswell, Cpl., Sheppard Field, Texas
9USX, Johnson, S/Sgt., Scott Field, Ill.
9UXK, Olson, Cpl., foreign duty
9VAF, Moore, Cpl., Sioux Falls, S. D.
9VPH, DePew, A/C, Hondo, Texas
9YTL, Jasinski, Cpl., Miami, Fla.

Operator's license only:

Brechlin, T/Sgt., foreign duty
Goyman, P/O, Alamogordo, N. M.
Grossman, Pvt., Lowry Field, Colo.
Hall, S/Sgt., foreign duty
Ham, Sioux Falls, S. D.
Hartley, Pvt., Minneapolis, Minn.
Jayner, S/Sgt., foreign duty
Kirshner, Pvt., Sheppard Field, Texas
McClain, Cpl., Camp Kearney, Calif.
Metzmaier, Sgt., Scott Field, Ill.
Neal, Cpl., Malden, Mo.
Osbourne, T/Sgt., Midland, Texas
Parry, T/Sgt., Sherman Field, Kans.
Peters, Lt., foreign duty
Pinheiro, M/Sgt., Eglin Field, Fla.
Rashinsky, Cpl., Pueblo, Colo.
Reiser, Pvt., Midland, Texas
Shoungt, Lt., foreign duty
Silva, Cpl., Boca Raton Field, Fla.
Silvia, Pvt., Drew Field, Fla.
Tater, Cpl., Barksdale Field, La.
Utz, Pvt., Chanute Field, Ill.
Wathen, 2nd Lt., foreign duty
Wiscavage, 2nd Lt., Eglin Field, Fla.
Zorzo, Lt., foreign duty
Zunes, Pvt., Victorville, Calif.

COAST GUARD

1KBO, Jowdy, CRM, Groton, Conn.
2AQH, Jerome, RT2c, Groton, Conn.
2UX, Segerdahl, CRT, Groton, Conn.
3DSK, Baden, RT1c, foreign duty
4HZQ, Calewarts, CRT, foreign duty
7F5H, Ryan, CRM, Seattle, Wash.
9HJP, Glatfelter, ACRT, foreign duty

Operator's license only:

Bush, RM1c, Philadelphia, Pa.

NAVY—AERONAUTICS

3EPC, McConaghy, Lt., Washington, D. C.
5GHP, Schmidt, Ens., Corpus Christi, Texas
5GPL, Meredith, ACRT, foreign duty
5IHF, Adams, ARM1c, Norfolk, Va.
ex-KB6PQB, Jorgenson, Lt. (jg), Bedford, Mass.
6QJL, LeNoir, ART1c, foreign duty
7IOR, Fischer, ACRM, foreign duty
8FZH, Kelly, ACRM, foreign duty
8MRY, Anderson, Lt. (jg), Annapolis, Md.
8RWB, Shoff, Lt. (jg), foreign duty
8TJR, Mannheimer, Sic, Corpus Christi, Texas
8UED, Chuchla, ART3c, foreign duty
9IGY, Kieft, Lt., Atlantic City, N. J.
9IG, Sellers, Lt. (jg), Lake City, Fla.
9JUJ, Matthews, Ens., Corpus Christi, Texas
9KXM, Moerke, ART2c, foreign duty
ex-9LDD, Turpen, ART1c, foreign duty
9RJL, Thompson, ARM2c, Atlanta, Ga.
9WXI, Tuttle, ACRT, Seattle, Wash.
9YDM, Coe, Lt., Patuxent River, Md.
9YLQ, Wagner, Lt., Banana River, Fla.

Operator's license only:

Bienz, Sic, Corpus Christi, Texas
Grant, ART1c, Washington, D. C.
Jensen, ARM1c, foreign duty
Jones, ARM1c, foreign duty
Keyl, Lt., Del Mar, Calif.

ARMY—GENERAL

1FIY, Brady, Pvt., Ft. Knox, Ky.
1INB, MacDonald, S/Sgt., foreign duty
2DYR, Crusier, Lt., Camp Gordon, Ga.
2HNU, Hendrickson, Cpl., Aberdeen Proving Grounds, Md.
3JNY, Blue, Pvt., foreign duty
4EJLN, Pharr, Capt., foreign duty
5GQY, Fiducia, Sgt., foreign duty
5IMY, Jeter, Cpl., Camp Hood, Texas
5MS, Nelson, foreign duty
6IBF, Duford, T/5, Indiantown Gap, Pa.
ex-6IQA, McKim, T/4, foreign duty
K6POF, Kobayashi, T/5, foreign duty
K6SBU, Merritt, CWO, Ft. Monmouth, N. J.
K6TUL, Sugimoto, T/5, foreign duty
ex-7ADP, Greene, S/Sgt., foreign duty
7HLY, Sekijima, Pvt., Hunt, Idaho
7HQJ, Rodgers, Pfc., Oceanside, Calif.
ex-8INM, Hutchin, T/5, foreign duty
8MRG, Wilson, Capt., Ft. Knox, Ky.
8RWS, Wolf, Pvt., Camp Gruber, Okla.
8PFW, Fahnstock, Pfc., Camp Maxey, Texas
9HOD, Cann, Pvt., Ft. Sill, Okla.
9IQP, Clark, M/Sgt., Camp Gruber, Okla.
9KQP, Niedzielak, Pvt., foreign duty
9QCG, Churchill, T/Sgt., St. Joseph, Mo.
9SMY, Lawson, T/4, foreign duty
9TQB, Brienen, Pvt., Ft. Riley, Kans.
9USR, Bain, Pvt., Camp Gruber, Okla.

Operator's license only:

Bailey, Sgt., foreign duty
Byrne, Pvt., Madison, Wis.
Dresler, T/Sgt., foreign duty
Durham, S/Sgt., Camp Maxey, Texas
Ford, T/4, foreign duty
Glidewell, Sgt., Camp Gordon Johnston, Fla.
Hentzen, Pvt., foreign duty
Hollinscad, Pvt., Camp Plauche, La.
Ireland, Pfc., foreign duty
Jemison, S/Sgt., foreign duty
Noto, Sgt., Camp Livingston, La.
Orr, Capt., foreign duty
Plank, Pvt., foreign duty
Shoop, Sgt., foreign duty
Tanguay, Pvt., Ft. Rodman, Mass.
Weaver, T/5, foreign duty

WAC

9ZQI, Graver, Pvt., Asheville, N. C.

WAVES

9WWP, Witte, HA2c, San Diego, Calif.

Operator's license only:

Waggoner, RM3c, Patuxent River, Md.

WASP

6FU, Hayes, Phoenix, Ariz.



Why shouldn't Sgt. Arthur B. Johnson, W2MWA, look pleased? He is receiving the Bronze Star Medal from Major General Keyes, August 26, 1944, somewhere in Italy for "heroic action in direct support of combat operations." Art has had active combat duty with the Signal Corps for two and a half years in Algeria, Tunisia, Sicily and Italy.

NAVY—GENERAL

1AMI, Loisselle, CPO, Seawall, Me.
1FCR, Byrne, CRE, Corpus Christi, Texas
1GNK, Dzubaniuk, RM2c, Port Hueneeme, Calif.
1IWP, Parisi, CRM, McKinley, Me.
1JOF, Fernane, Sic, Great Lakes, Ill.
1KEQ, Atwood, RM1c, foreign duty
1MQU, Burke, RM2c, foreign duty
1MSM, Ames, Lt., foreign duty
1MXJ, Sullivan, A/3, Sampson, N. Y.
1N1S, Anderson, RM2c, address unknown
1NMJ, Wilner, RM1c, foreign duty
1CSW, Hyldahl, RM1c, foreign duty
2FII, Shaw, RM3c, Portland, Me.
2CEJ, Wells, CRE, foreign duty
2GTC, Busse, RM2c, foreign duty
2HTG, McKinley, SM3c, address unknown
2MON, Rosenkrantz, Sic, Los Angeles, Calif.
3CGB, Harrison, Lt. Comdr., Washington, D. C.
3EFP, Grace, Ens., Princeton, N. J.
3HKL, Kuebler, S2c, Miami, Fla.
3JSD, Haberger, Lt., address unknown
3JTD, Barrett, Sic, Grove City, Pa.
3JVI, Cox, Sic, Brooklyn, N. Y.
3JYX, Mills, Lt. Comdr., Washington, D. C.
4EJE, Nisbet, Lt. (jg), Warrington, Fla.
4EJN, Fields, CRM, foreign duty
4FLD, Shelby, CRM, foreign duty
4GPW, Houston, Ens., Washington, D. C.
4HX, Gibbs, Sic, Washington, D. C.
4HXO, Wispm, RM1c, Chicago, Ill.
4IDL, Guess, Sic, Portland, Me.
5FEJ, Brossseau, Ens., Cambridge, Mass.
5VVF, Reynolds, Pfc., Great Lakes, Ill.
5JYF, Beal, RM1c, foreign duty
5KNA, Inks, A/S, Austin, Texas
6CXI, Dippel, CRM, foreign duty
KB6JX, Tread, WO, Washington, D. C.
6HUR, Stewart, Lt. (jg), Panama City, Fla.
6HWH, Winn, RE, Waym, S. C.
6MHW, Brown, RM1c, foreign duty
6NAM, Anderson, Sic, Corpus Christi, Texas
6NGG, Smith, address unknown
6NSP, Stansberry, RM1c, Los Angeles, Calif.
6OKM, Muff, Sic, foreign duty
6OPP, Wilson, RE, foreign duty
6SPA, Williamson, RM1c, Alameda, Calif.
6TLB, Knapton, Sic, Treasure Island, Calif.
6TXR, Anderberg, Sic, Brooklyn, N. Y.

6TZW, Ford, M3c, Norfolk, Va.
 6UDZ, Moore, RM3c, foreign duty
 ex-7DGD, Cross, RE, Washington, D. C.
 7ENW, Hagestad, Lt. (jg), Little Creek, Va.
 7EPY, Adams, Sp1c, Chicago, Ill.
 7GKM, Rothwell, RE, San Diego, Calif.
 7KHBT, Culver, Lt. (jg), foreign duty
 8EW, Wells, Lt. (jg), foreign duty
 8EXI, Trutko, S2c, foreign duty
 ex-8KVE, Stetter, Lt. (jg), Portland, Me.
 8MCG, Royce, CRM, foreign duty
 8OXL, Buyaki, Ens., Bremerton, Wash.
 8QPM, Wade, Chicago, Ill.
 8QVC, Gross, Ens., Brunswick, Me.
 8UWA, Dunn, EM3c, Bainbridge, Md.
 8VJB, Czech, Ens., address unknown
 8VOQ, Ward, CWO, foreign duty
 8VYL, Barber, RM2c, foreign duty
 8WCH, Karawicki, RM3c, address unknown
 8WLN, Brennemann, Sic, Del Monte, Calif.
 9BYR, Young, A/S, Seattle, Wash.
 9CXT, Anderson, Mid., Annapolis, Md.
 9EQH, Miller, Sic, Gulfport, Miss.
 9GAA, Markovich, RM2c, address unknown
 ex-9GRW, Morrison, Lt., Washington, D. C.
 9HCZ, Christenson, Ens., Philadelphia, Pa.
 9HKC, Nance, RM3c, foreign duty
 9IBP, Witte, Ens., Sioux Falls, S. D.
 9ICE, Mason, Sic, Chicago, Ill.
 9JAN, Epstein, RM3c, foreign duty
 9JGW, DeHaven, CRM, foreign duty
 9KFB, Fitzwilliam, CRE, foreign duty
 9KTG, Motley, RM1c, Jacksonville, Fla.
 9KTL, Smithwick, Lt. (jg), Chicago, Ill.
 9MJJ, Woodfill, Sic, Chicago, Ill.
 9OTY, Stoddert, Lt., Philadelphia, Pa.
 9PPF, Hobart, CRM, foreign duty
 9PGD, Jenkins, Sic, Takoma Park, Md.
 9RKY, Larkin, Lt. (jg), Sioux City, Ia.
 9SXC, Gainer, Lt. Comdr., address unknown
 9TDC, Baughman, RM3c, address unknown
 9TFC, Stienstra, EM3c, foreign duty
 ex-9UGB, Gulbranson, Ens., Quonset Pt., R. I.
 9VGG, Schrot, Ens., Brunswick, Me.
 9YMM, Currier, RM3c, foreign duty

Operator's license only:

Camenares, RM3c, foreign duty
 Campanelli, RM2c, foreign duty
 Ernest, Sic, New London, Conn.
 Herman, Lt., Oak Harbor, Wash.
 Mickel, Sic, Great Lakes, Ill.
 Monaco, S2c, Norfolk, Va.
 Moore, A/S, Ithaca, N. Y.
 Perkins, A/S, Pasadena, Calif.
 Sasmeth, Sic, foreign duty
 Schwantes, Sic, Chicago, Ill.
 Shern, Sic, College Station, Texas
 Thomas, RM3c, Port Blakely, Wash.
 Williston, Ens., Union, N. J.
 Woodington, S2c, San Diego, Calif.

MERCHANT MARINE AND MARITIME SERVICE

Do you hams in the MM and MS want each listing to be one line, giving call, name and steamship company? For reasons of security your vessel cannot be named, but we'll be glad to use the alternative form if you will send us the information. Of eighty-one men listed this month, only fourteen gave the name of the steamship company, the remainder the name of the vessel, home address or no address. Send us full information and we will do the rest.

11JX, Marston; 11OS, Cooper; 11PI, Saunders; 11LM, Liard; 11PZ, Simard; 11QJ, Ricker; 11LJ, Couture; 11SK, Martineau; 2APU, Hoffman; 2CB8, Tucker; 2CZO, Sepeasy; 2HNR, Flung; 2IDW, Rodman; 2JON, Labowitz; 2KXR, Fried; 2NZF, Phelps; 3EPD, Eckersley; 3GAL, Hillers; 3IKV, Dickinson; 4FOK, Farrior; 4HSU, Cunningham; 4IEW, Seigler; 5DG, Curry; 5FGZ, Gray; 5HHA, Hickman; 5IGM, Spencer; 5JOH, Clark; K6AFF, Chung; 6BP, Babize; K6DHW, Calley; 6NLZ, Chambers; 6OBH, Smith; 6OKL, Ross; 6OUD, Viljoen; ex-6RO, Neifer; 6RYV, Porter; 6SGW, Wickstrom; 6TBB, Shand; 6UTE, Shaphran; 7DJJ, Mundt; 7EIA, Olson; 7FZA, Schoepflin; 7GBW, Wise; ex-7GCU, Allgrunn; 7GRD, Anderson; K7GSU, Arthurs; 8COT, Morgan; ex-8DJR, Javinsky; 8GZM, Collins; 8HNN, Metz; 8OCA, Fleming; 8OFF, Griesfelder; 8UTC, Gustafson; 8UWZ, Harrison; 8UXS, Dearman; 8DPA, Dietz; 9HWI, Neprud; 9HNN, Pendl; 9JPR, Keen; ex-9OLU, Kozel; 9TGF, Knapp; 9WPW, Suska, and 9YBW, Krause, Adams, Anolik, Battensby, Burgher, Caughey, Goodspeed, Graessner, Kilburn, Kitchener, Kudian, Moody, Moore, Sibert, Sykes, Thomas, Uzel, Weinberger and Young hold operator's license only.

CIVIL SERVICE

2DIB, Stafford, Navy Dept., inspector, Dumont, N. J.
 2JBC, Malas, Navy Dept., Norfolk, Va.
 2LNY, Gaetz, CAA, Laguardia Field, N. Y.
 2MSL, Kalisty, Navy Dept., Foughkeepsie, N. Y.
 2NWT, Burn, Navy Dept., inspector, Rutherford, N. J.
 2OCG, Milton, SC, insp., Chicago, Ill.
 2OFT, Nagle, War Dept., Washington, D. C.
 ex-3AVZ, Meyer, SC, radio instructor, Philadelphia, Pa.
 3CGE, Dows, Aberdeen, Md.
 3GPO, Hirsch, War Dept., electronics repairman, Philadelphia, Pa.
 3JWU, Greenfield, SC, insp., Chicago, Ill.
 3WU, Downs, War Dept., Washington, D. C.
 4ABT, Hage, Navy Dept., Norfolk, Va.
 4AHP, Coley, Navy Dept., Norfolk, Va.
 4AII, Guerrant, AAF, radio mechanic, Harrisburg, Pa.
 4AIQ, Stanley, SC, insp., Sioux City, Ia.
 4APC, Carter, engineer, Camp Tyson, Tenn.
 4ARW, Hudson, FCC, monitoring officer
 4AUL, Ellis, CAA, aircraft communicator, Key West, Fla.
 4AXP, Cederstrom, Navy Dept., communication inst., Pensacola, Fla.

Lt. (jg) George Zimmerman, USNR, W2NNZ, is a member of the "splinter fleet." His ship was one of the few U. S. minesweepers detailed to clear mines from the approaches to the French invasion coast. Dodging shells from Nazi shore batteries, his vessel and its complement had a grandstand seat for the main show. Read his "Hams in Combat" story on page 48 in this issue for a swell yarn.

4BAQ, Meyborn, CAA, aircraft communicator, Memphis, Tenn.
 4BDB, Stuart, AAF, Marietta, Ga.
 4BLU, Roberson, Navy Dept., Norfolk, Va.
 4BTY, Faw, Navy Dept., Norfolk, Va.
 4BVS, Barrier, Navy Dept., Norfolk, Va.
 4CEI, Murray, SC, radio repairman, Columbia, S. C.
 4CRO, Tolman, CAA, maintenance inspector, Hopville, Ga.
 4CWN, Rogers, Navy Dept., Norfolk, Va.
 4DFM, Caldwell, AAF, radio mechanic, Morrison Field, Fla.
 4DLI, Hooser, SC, inspector, Dayton, Ohio
 4DNU, Lenkerd, FCC, radio inspector, Atlanta, Ga.
 4DQA, Smith, CAA, foreign duty
 4DXD, Caldwell, SC, equipment supervisor, Schenectady, N. Y.
 4EAI, Squires, SC, insp., Kansas City, Mo.
 4EEZ, Aaron, Navy Dept., radio mechanic, Jacksonville, Fla.
 4EGK, Batchelor, SC, radio engineer, Tallahassee, Fla.
 4EYF, Shaw, AAF, aircraft radio mechanic, Charlotte, N. C.
 4FKY, Stuart, Navy Dept., Norfolk, Va.
 4FME, Cline, FCC, radio insp., Atlanta, Ga.
 ex-4FOL, Floyd, Navy Dept., foreign duty
 4FTL, Palmer, Navy Dept., Charleston, S. C.
 4FVF, Hines, SC, radio engineer, Ft. Monmouth, N. J.
 4GHY, Young, radio mechanic, Mebane, N. C.
 4GLX, Turner, foreman ground electronic, Natick, Mass.
 4GMT, Harmon, OWI, radio engineer, foreign duty
 4GTI, Hurt, War Dept., Washington, D. C.
 4HCM, Brinson, SC, radio mechanic, West Palm Beach, Fla.
 4HII, Hatcher, Navy Dept., Norfolk, Va.
 4IFA, Dove, CAA, aircraft communicator, Pensacola, Fla.
 4IJJ, Housholder, AAF, Racine, Wis.
 ex-4NK, Tate, Vallejo, Calif.
 4RN, Holliday, FCC, monitoring officer
 4UZ, Prosser, AAF, aircraft radio electrician, foreign duty
 5ADL, Scott, SC, inspector, Chicago, Ill.
 5AQQ, Henderson, Navy Dept., radio technician, Corpus Christi, Texas
 5BIE, Latimer, Navy Dept., radio mechanic, McAlester, Okla.
 5BTL, Baker, Vts. Adm., Wood, Wis.
 5CHU, Bowden, War Dept., radio insp., Ft. Worth, Texas
 ex-5CQE, Stell, SC, foreman, Camp Gruber, Okla.
 5DET, Teitzel, AAF, instructor, Enid, Okla.
 5DFZ, Harrison, Navy Dept., radio technician, Key West, Fla.
 5EEY, White, Navy Dept., supervisor, Corpus Christi, Texas
 5EGG, Davidson, Navy Dept., Norfolk, Va.
 5EUT, Mundhenk, CAA, radio electrician, Ft. Worth, Texas
 5FJP, Dobbs, War Dept., foreman, Oklahoma City, Okla.
 5FVY, Hannett, Navy Dept., instructor, Albuquerque, N. M.
 5FWI, Hecht, CAA, aircraft communicator, Wink, Texas
 5GAM, Roark, SC, radio mechanic, Olympia, Wash.
 5GD, Carmichael, SC, insp., Milwaukee, Wis.
 5GFR, Dalton, SC, electronics inspector, foreign duty
 5GOA, Craig, AAF, Blytheville, Ark.
 5GUA, Hoisington, SC, radio engineer, Dayton, Ohio
 ex-5GUH, Burke, FCC, monitoring officer
 5GXL, Schultz, engineer, Las Vegas, N. M.
 5GYN, Patterson, SC, insp., Kansas City, Mo.
 5GYW, Bettis, CAA, aircraft communicator, Wichita Falls, Texas
 5GZN, Terrell, radio mechanic, Camp Gruber, Okla.
 ex-5HIV, Warner, CAA, maintenance insp., Ft. Worth, Texas

100 PER CENT WAR WORK—INDUSTRY

General Electric Co.
 1E0D, Janulis, Bridgeport, Conn.
 1E0D, Webb, Holyoke, Mass.
 1I1Y, Dome, Bridgeport, Conn.
 1I0E, Allen, Bridgeport, Conn.

QST for



IISX, Toof, address unknown
1ITJ, Smith, address unknown
1IWK, Gurley, Bridgeport, Conn.
1JUU, Coolidge, Schenectady, N. Y.
1JXS, Noble, Bridgeport, Conn.
1KPN, Fox, Bridgeport, Conn.
1KWV, Fay, Bridgeport, Conn.
1KXA, Campbell, Schenectady, N. Y.
1LRY, Bischoff, Bridgeport, Conn.
1MMF, Sinclair, Schenectady, N. Y.
1MXJ, Sullivan, Lynn, Mass.
1NFI, Wintle, Bridgeport, Conn.
1NNL, Takach, Bridgeport, Conn.
1NPI, Farrell, Dover, N. H.
1NSY, Sturtevant, Schenectady, N. Y.
1VB, Glover, Bridgeport, Conn.
2ACB, Peer, Ft. Lauderdale, Fla.
2ALI, Seymour, Schenectady, N. Y.
2BKW, Harvey, Schenectady, N. Y.
2BVR, Conti, address unknown
2BXC, Russell, Schenectady, N. Y.
2CBO, Lash, Schenectady, N. Y.
2CJP, Kanzelmeyer, Schenectady, N. Y.
2CNP, Pagel, Schenectady, N. Y.
2CSN, Williams, Schenectady, N. Y.
2CVZ, Crawford, Schenectady, N. Y.
2CVW, Heffner, Albany, N. Y.
2CZN, Gorski, Schenectady, N. Y.
2DC, Fritschel, Schenectady, N. Y.
2DFX, Redman, Schenectady, N. Y.
2DYC, Mischler, Schenectady, N. Y.
2EBG, Sauter, Schenectady, N. Y.
2FTE, Valdran, Bridgeport, Conn.
2GYV, Jeffrey, Schenectady, N. Y.
2HBQ, Fabel, Bridgeport, Conn.
2HII, McMurray, Schenectady, N. Y.
2HUG, Reich, New York, N. Y.
2IWW, Salerno, Bridgeport, Conn.
2JED, Watroski, Schenectady, N. Y.
2JKF, Edinger, Schenectady, N. Y.
2JUW, Fein, Bridgeport, Conn.
2KIO, Bruntil, Bridgeport, Conn.
2KPB, Johnson, Schenectady, N. Y.
2KZY, Broland, Schenectady, N. Y.
2LAQ, Jones, Schenectady, N. Y.
2LBH, Simpson, Schenectady, N. Y.
2LDU, Hagen, Bridgeport, Conn.
2LPX, Albee, Schenectady, N. Y.
2LWQ, Hanrahan, Schenectady, N. Y.
2MHW, Eidel, Schenectady, N. Y.
2MKB, Buechner, Bridgeport, Conn.
2NHS, Sabourin, Schenectady, N. Y.
2NLO, Alexander, Schenectady, N. Y.
2NWB, Goodhines, Schenectady, N. Y.
2OBZ, Burkhardt, Bridgeport, Conn.
2OGM, Smith, Schenectady, N. Y.
2OMV, Buchan, Schenectady, N. Y.
2OOR, Hogg, Schenectady, N. Y.
3ENX, Waitkenus, Schenectady, N. Y.
3GSZ, McFall, Bridgeport, Conn.
4DDW, Locke, Schenectady, N. Y.
4GJK, Holder, Scotia, N. Y.
5CZH, Black, Schenectady, N. Y.
5FPY, Hardgrave, Schenectady, N. Y.
5GOS, Taylor, Bridgeport, Conn.
5GSH, Peach, Schenectady, N. Y.
6EZ, Hiehle, Schenectady, N. Y.
6IOP, Newman, Schenectady, N. Y.
6NUX, Burkhard, Bridgeport, Conn.
6OJK, Floyd, Schenectady, N. Y.
6OQO, Knight, Schenectady, N. Y.
6SA, Hayes, Schenectady, N. Y.
7BBI, Taylor, Schenectady, N. Y.
7BGM, Mills, Schenectady, N. Y.
7FOG, McClure, Bridgeport, Conn.
7HDL, Zaloudek, Bridgeport, Conn.
7VG, Lehnhoff, Schenectady, N. Y.
8BBQ, Sitterly, address unknown
ex-8BLY, Roggen, Schenectady, N. Y.
8CCO, Fagerholm, Cleveland Heights, Ohio
ex-8CSX, Dodds, Schenectady, N. Y.
ex-8CUW, Brown, foreign duty
8DWJ, Graves, Syracuse, N. Y.
8EDD, Stratton, Schenectady, N. Y.
8FU, Nelson, Schenectady, N. Y.
8GKA, Geisman, Chardon, Ohio
8HAU, Chamberlain, Schenectady, N. Y.
ex-8HDY, Van Epps, Schenectady, N. Y.
8HQR, Smith, Cortland, N. Y.
8HYZ, Church, Cleveland, Ohio
8IV, Richards, Schenectady, N. Y.
8LWD, Wells, Schenectady, N. Y.
8MRJ, Frederick, Schenectady, N. Y.
8OEI, Weitzel, Schenectady, N. Y.
8ONN, Gardner, Adams, N. Y.
8OSD, Bismack, Bridgeport, Conn.
8FUS, Grupe, Schenectady, N. Y.
8PYF, Whitney, Bridgeport, Conn.

8QLV, Hubbard, Schenectady, N. Y.
8SPD, Sussdorff, Schenectady, N. Y.
8SFE, Teeter, Schenectady, N. Y.
8SSH, Blackmore, Bridgeport, Conn.
8SYD, Taylor, Schenectady, N. Y.
8THF, Read, Schenectady, N. Y.
8UDS, Modica, South Euclid, Ohio
8URP, Starka, Schenectady, N. Y.
8UY, Columbe, Schenectady, N. Y.
8VEF, Miles, Schenectady, N. Y.
8WQW, Frank, Schenectady, N. Y.
8WRO, Montanyo, Schenectady, N. Y.
9DGE, Olson, Schenectady, N. Y.
9ERB, Anderson, Schenectady, N. Y.
9FQE, Nielsen, Bridgeport, Conn.
9LTR, Evans, Ft. Wayne, Ind.
9OKB, Reynolds, Schenectady, N. Y.
9PMG, Verberg, Bridgeport, Conn.
9SVA, Roberts, Schenectady, N. Y.
9UMR, Shaw, Bridgeport, Conn.
9USU, Frits, Ft. Wayne, Ind.
9WCL, Kovacs, Syracuse, N. Y.
9WHM, Koch, Schenectady, N. Y.
9YTW, Reagan, Schenectady, N. Y.

Operator's license only:
 Graubard, Greenwich, Conn.



RMic Norma Schall, WINHN, well-known member of the **YLRL** (Young Ladies Radio League, to you underprivileged OMs) received her first class rating January 1, 1945, the first YL to earn this distinction in the **WAVES**. She enlisted November 1942, took boot training at Hunter College and further instruction at the University of Wisconsin, and is now stationed at Treasure Island, Calif. Her brother, **WJLL**, is employed by Submarine Signal Co. and her fiancé, **W7IBC**, **RMic**, works for the Navy.

CANADA

OMs: we're giving you our all from Canada this month. The list is awfully small but we can't invent registrations to pad your section of the **ITS** column. Won't you make it a matter of personal pride to send us calls, names, ranks or grades, military or civilian addresses and branch of the service or war industry of yourself and your buddies? Your government will want to know Canadian amateur participation in the war effort when postwar frequencies are handed out and the value of ham radio to your country is under consideration.

CAA-CA(B)

21Z, Piche, S/Sgt., Hull, Que.
3WC, Jones, Sgt. Major, Ottawa, Ont.

4AIN, O'Connor, Sgt. Major, foreign duty
4ALP, Wilson, S/Sgt., Val Tetreau, P. Q.
4IH, Lake, Col., Ottawa, Ont.
5PU, Carpenter, Major, Ottawa, Ont.

RCAF

3AYJ, Patterson, F/L, Gander Field, Newfoundland
ex-3FI, Stevens, F/Sgt., Yarmouth, N. S.
3IR, Rennie, Forbes, Ont.
4AEP, Read, Glenwoodville, Alberta
4RQ, Hallott, F/O, Patricia Bay, B. C.

RAF

2IL, McMullen, R/O, foreign duty
3AXP, Postelz, R/O, Dorval, Que.

RCCS

3AIM, Dingle, 2nd Lt., Ottawa, Ont.
3AOX, Bramfit, Capt., foreign duty
3ATC, Cooper, Sgt., Ottawa, Ont.
3KB, Harrison, QMS, Britannia Hts., Ont.
3MQ, Cooke, Lt., Woodroffe, Ont.
4AAD, Freeman, Capt., Calgary, Alberta
ex-4AJQ, Kopulos, Sigm., Windsor, N. S.
4GH, Nowell, Sgt., Winnipeg, Manitoba
ex-5DL, Watson, Lt., Ottawa, Ont.
8TVL, Richardson, 2nd Lt., Barriefield, Ont.

RCN

3AYB, Collins, W/O, St. Johns, Newfoundland
3EX, Williams, CTO, Ottawa, Ont.
4ADW, Goodridge, Ord. Seaman, St. John, N. B.
4AIS, Hertz, Tel/S.O., Chelsea, Que.
4ALP, Huska, Ord. Seaman, St. John, N. B.

Operator's license only:

Jones, Tel., St. Johns, Newfoundland

WRCNS

Operator's license only:
Ramsay, Ottawa, Ont.

MERCHANT MARINE

5AEX, Warren, CRO, address unknown
4MD, Wood, R/O, address unknown

CIVIL SERVICE

1AS, Cunningham, Ottawa, Ont.
1XP, Sigston, address unknown
3BAQ, Brunel, Ottawa, Ont.
5AEL, Brokenshire, Vancouver, B. C.
5GC, Pattinson, Ottawa, Ont.
5KF, Cushing, Ottawa, Ont.
5LX, Harker, Vancouver, B. C.

100 PER CENT WAR WORK—INDUSTRY

3AKG, Ravenscroft, Ottawa, Ont.
5BII, Hings, Ottawa, Ont.



Now two and a half years overseas, **William H. Stull, W3GTS**, was recently promoted to major, **AAF**, on the long road from private to general. He doesn't like the weather where he is (who does, regardless where?) and misses ham radio, but claims he still can flick a bug at 50 per.

A Compact V.F.O. With Stable Output

Sturdy Construction Makes the Typical Exciter Unit Useful in the Laboratory or Shop

BY ARTHUR H. LYNCH,* W2DKJ, AND THOMAS GOODWIN,** W2JTK

ONE of these days, hams will be back on the air. If the old rig needs only a little dusting off before firing it up, well and good. If a little rebuilding is required, however, here is a variable-frequency oscillator with design and constructional features which may help the prospective builder to plan a unit to fit his particular requirements.

In pre-Pearl Harbor days, variable-frequency oscillators were gaining rapidly in popularity because of their complete and rapid frequency coverage. Crystal oscillators, however stable, are tied to fixed locations in the spectrum. This is a drawback in amateur operating, since stations are not assigned specific frequencies. The rumored cheapness of crystals after the war may serve to alter this trend somewhat, but it is still questionable whether a large number of crystals and a selector switch make the operating problem much easier for the operator, compared to the turning of one dial of a v.f.o. to any desired spot in a given frequency band.

The rig here described has enough punch to excite the final stages of any average ham transmitter, and with proper adjustment its stability can, for all practical purposes, be made to approach that of crystal control. While we wait for the good old days to return, an outfit of this type is a big help around the lab or shop in connection with alignment or calibration jobs and various kinds of experiments.

* New York Manager, National Company.

** Erco Radio Laboratories, Hempstead, N. Y.

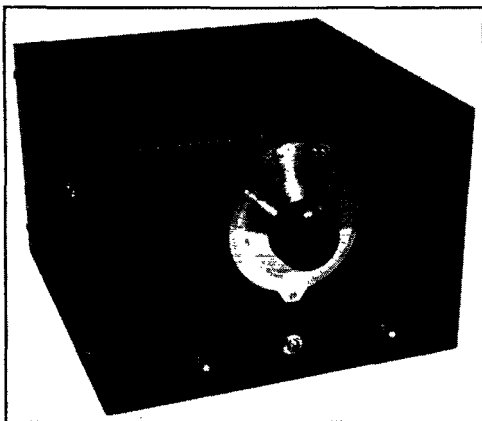

Front view of the v.f.o. unit showing the vernier tuning dial, with the jack for a key or milliammeter underneath, and power-supply control switches on either side. Photographs by Stanley P. McMinn, W2FD.

Pre-Pearl Harbor hams will recall many discussions over the air about v.f.o. rigs in which crystal oscillators were given a run for their money. The talking is over, but the memory lingers on. This article is written not merely to stir up memories but to present a description of one piece of ham gear which has definite usefulness in the war effort, around the lab or shop, and similarly in the ham station when the good old days return. It may well be used now to keep WERS stations within band limits as well as on spot frequencies.

The Circuit

In order that the advantages of a v.f.o. may be realized, the circuit for this rig, shown in Fig. 1, is designed mainly to give convenience of operation and stability of output. In this particular outfit, the author was contented with output in the 3.5-Mc. band, so the plug-in feature was not exploited. The oscillator "perks" in the 1.75-Mc. band, is amplified at the same frequency by the 6J7 buffer, and doubling into the 3.5-Mc. band is done in the 6V6G stage.

Only one dial and two switches are shown in the front-view photograph. The dial controls C_{17} and C_{23} simultaneously through a cable-driven system which is visible in the top-view photograph. One of the toggle switches, S_1 , controls the 115-volt a.c. current, while the other, S_2 , allows the plate and screen voltages to be turned on or off without turning off the tube heaters. The jack, J , is located underneath the dial, and is connected in series with the 6V6G final-amplifier cathode either for keying or metering purposes. The unit, therefore, is single-dial controlled, with all other controls only incidental to its operation, so that convenience of operation is assured. Condensers C_{16} and C_{23} are trimmers across the main tuning condensers, but once they are set, they need not again be adjusted.

The oscillator of this rig is designed for stability through the use of a 6A8 tube in the modified e.c.o. circuit described in detail by Metcalf in *QST* for May, 1941.¹ This circuit eliminates the cathode tap from the tuning inductance and thereby removes the changing cathode-to-heater capacitance from across part of the coil. Frequency stability thus is improved and, at the same time, there is no critical tap adjustment to bother with.

¹ Metcalf, "An Improved Electron-Coupled Oscillator," *QST*, May, 1941, p. 14.

The possibility of hum or roughness in note which often is experienced with the conventional e.c.o. circuit, also is removed by placing the cathode at ground potential. In so doing, the variable condenser, C_1 , is made "hot," so far as d.c. is concerned, but this objection is overcome easily by the use of stand-off insulators and an insulated flexible shaft coupling. Temperature changes affect stability, but compensation for these effects are made with C_3 , which is a negative-coefficient pigtail-type condenser of a few microfarads capacity. High capacity in the tank circuit is achieved by adding the 500- $\mu\text{fd.}$ mica condenser, C_2 , in parallel with C_1 and C_3 .

Isolation of the oscillator from the final load is important to stability, and this feature is provided, along with some boost of the oscillator output, by the 6J7 buffer stage. Choke-input coupling is used, as shown in Fig. 1.

The 6V6G final-amplifier grid and plate circuits are gang-tuned. C_{15} is an odd value of capacitance, 175 $\mu\text{fd.}$, and is made up of three low-

drift condensers with values of 25, 50 and 100 $\mu\text{fd.}$, all in parallel.

Plenty of output signal is provided with inductive coupling between L_4 and the plate tank coil, L_3 ; and the signal may be led to a desired point through a flexible low-impedance coaxial line screwed onto the connector indicated in Fig. 1.

The power supply is included in the unit. The two voltage-regulator tubes, V_1 and V_2 , are connected as shown, in order to stabilize the plate and screen voltages. R_9 is the usual dropping resistor for the VR tubes. Screen voltage is tapped off between V_1 and V_2 . As a further-measure toward r.f. isolation, each side of the 115-volt a.c. line is by-passed, and one side of the 6.3-volt heater winding is grounded.

Some very good ideas for the mechanical design of this unit were gleaned from articles by Perrine² and Brown³ in past issues of *QST*.

² Perrine, "An Answer to the E.C.O. Problem," *QST*, September, 1939, p. 14.

³ Brown, "A Stabilized Variable-Frequency Oscillator," *QST*, July, 1940, p. 13.

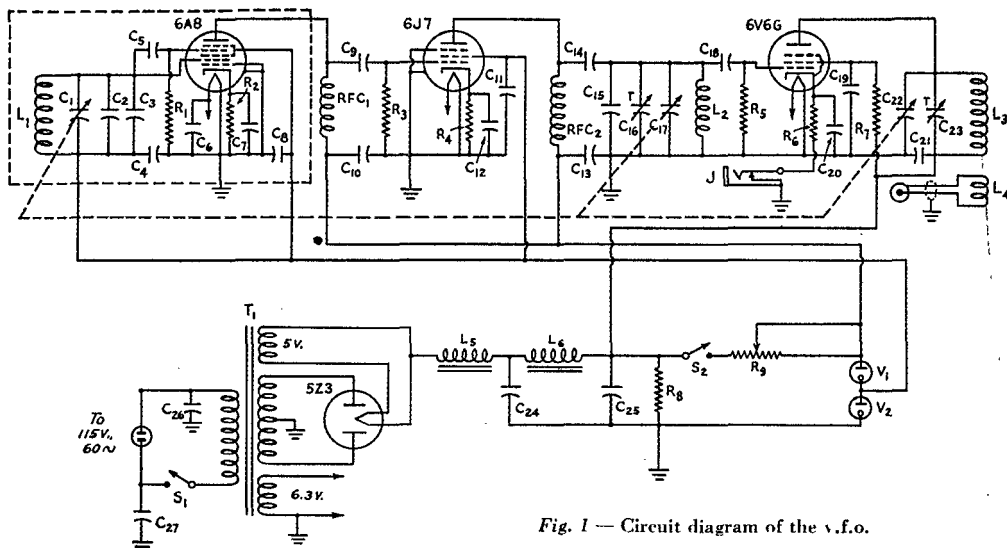

Fig. 1 — Circuit diagram of the v.f.o.

- C_1 — 200- $\mu\text{fd.}$ variable (National SEH-200).
- C_2 — 500- $\mu\text{fd.}$ fixed mica.
- C_3 — Centralab Type 924 or 933, low-capacity, negative temperature-coefficient pigtail-type condenser.
- C_4, C_6, C_8, C_{10} — 0.01- $\mu\text{fd.}$ mica.
- C_5, C_9 — 250- $\mu\text{fd.}$ mica.
- $C_7, C_{11}, C_{12}, C_{13}$ — 0.01- $\mu\text{fd.}$ 600-volt paper.
- C_{14} — 100- $\mu\text{fd.}$ mica.
- C_{15} — 175 $\mu\text{fd.}$, composed of three mica condensers in parallel: 25 50 and 100 $\mu\text{fd.}$ each, low-drift type.
- C_{16} — 25- $\mu\text{fd.}$ variable (National Type US-25).
- C_{17} — 100- $\mu\text{fd.}$ variable (National SE-100).
- C_{18} — 500- $\mu\text{fd.}$ mica.
- C_{19}, C_{20}, C_{21} — 0.005- $\mu\text{fd.}$ mica.
- C_{22} — 25- $\mu\text{fd.}$ variable (National SEU-25).

- C_{23} — 100- $\mu\text{fd.}$ trimmer (National UM-100).
- C_{24}, C_{25} — 10- $\mu\text{fd.}$ 450-volt electrolytic.
- C_{26}, C_{27} — 0.02- $\mu\text{fd.}$ 450-volt paper.
- R_1 — 0.25 megohm, $\frac{1}{2}$ watt.
- R_2, R_4 — 500 ohms, 1 watt.
- R_3, R_5 — 100,000 ohms, $\frac{1}{2}$ watt.
- R_6 — 200 ohms, 1 watt.
- R_7 — 20,000 ohms, 1 watt.
- R_8 — 50,000 ohms, 10 watts (bleeder).
- R_9 — 2500 ohms, wire-wound with slider, 25 watts.
- L_1 — 23 turns No. 22 enameled wire on 1-inch-diameter form, $\frac{3}{4}$ inch long.
- L_2 — 30 turns No. 22 cotenameled wire on $1\frac{1}{4}$ -inch-diameter form, 1 inch long.
- L_3 — 30 turns No. 20 enameled wire on $1\frac{1}{2}$ -inch-diameter form, 1 inch long.
- L_4 — 2 turns of spaghetti-insulated

- No. 20 bare wire wound directly under L_3 on the lower end of the form for L_3 .
- L_5 — Filter choke, 10 to 20 henries, 100 ma.
- L_6 — Filter choke, 30 henries, 100 ma.
- RFC_1, RFC_2 — National R-100 r.f. chokes, 2.5 mh., 125 ma.
- S_1, S_2 — Panel-type d.p.s.t. switch (used as s.p.s.t.).
- V_1 — VR150-30 voltage-regulator tube.
- V_2 — VR105-30 voltage-regulator tube.
- J — Closed-circuit jack.
- P — Screw-type plug for shielded or coaxial cable.
- T_1 — Power transformer. Primary: 115 volts, 60 cycles. Filament windings: 6.3 and 5 volts. H.v. secondary: 350 volts each side of center tap, 100 ma.

The whole outfit is set in a National Type C-FB7 wrinkle-finished sheet-iron cabinet which is 12 inches wide, 12 inches long, and 8 inches high, and which includes a metal subpanel. Parts for each of the circuits are grouped around their respective tube sockets. The tubes themselves are mounted above the base, and the fixed condensers, resistors, r.f. chokes, etc., are arranged underneath. The top- and bottom-view photographs show these arrangements. It is apparent that the oscillator, in the aluminum box at the center of the cabinet, is isolated thoroughly from the 6J7 buffer stage at the left and the 6V6G final-amplifier stage at the right. The coils of the 6V6G input and output circuits are on opposite sides of the mounting base, and are placed with their axes at right angles to each other.

The power-supply components are lined up along the back side of the cabinet, and the transformer shields help to eliminate any possible hum modulation by stray inductive coupling between the 60-cycle and r.f. circuits. One thing that makes possible this arrangement is the approximately two inches of mounting space which is allowed in the main cabinet between the chassis and the cabinet bottom. This same feature is used in the oscillator box, except that the depth of the sub-base area is only approximately one inch.

From the top view of the rig, it is seen that the oscillator variable condenser, C_1 , is set in the middle of the box and coupled to the tuning dial by means of an extension shaft, flexible coupling unit, and the pulley with its additional shaft. Two holes of about one-inch diameter are cut directly underneath the condenser to allow two stand-off insulators to pass through the sub-base to the bottom of the box where they are fastened. The condenser is mounted on these insulators and

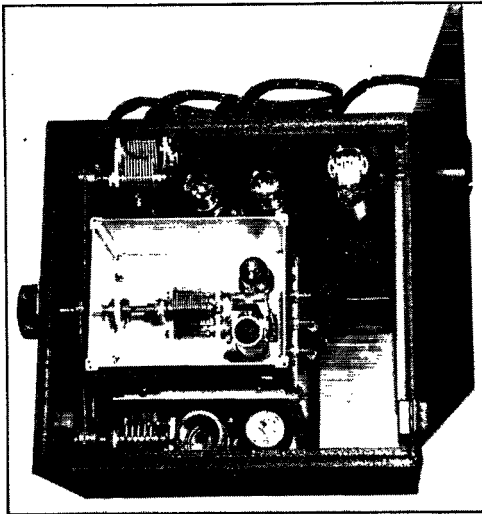

Top view of the v.f.o. unit. The inside box, with lid off, contains the oscillator components. The buffer amplifier is in the upper left-hand corner in the photograph, next to two voltage-regulator tubes at the right. Other power-supply components are along the back side of the cabinet. The 3.5-Mc. final-amplifier stage is shown along the bottom edge of the photograph.

in this way it is kept "above ground." The coil form mounted vertically behind the condenser would seem to be excessively long for the mere 23 turns of No. 22 enameled wire in L_1 , but the additional length allows the winding to be placed over an inch above the metal base, with the same clearance from the top lid, and ample space also exists inside of the top end of the form for mounting the fixed condensers, C_2 and C_3 . The translucent dowel which seems to be hanging between the coil form and tube is a piece of polystyrene rod which is threaded in each end to form a mounting brace for C_4 , C_5 , and R_1 , and also a separator for bus-bar wiring which helps to make the oscillator circuit mechanically rigid. Polystyrene feed-through bushings may be seen at the rear of the oscillator box, and they are used where needed inside the box to allow connections to go to parts underneath the base. This construction places the frequency-determining elements of the oscillator circuit in the upper part of the aluminum box, where some degree of stable temperature may be attained during any reasonably long period of operation.

The aluminum box for the oscillator is set up from grooved corner pieces and with plates cut from $\frac{1}{8}$ -inch stock (General Radio material). Dimensions are $5\frac{1}{2}$ inches wide by $6\frac{1}{2}$ inches long by $5\frac{3}{4}$ inches deep. It could be designed to be plugged into banana jacks as a complete unit, in order to allow different frequency ranges to be covered. The box is set on rubber grommets at its four corners with one corner grounded to the main cabinet, as shown in the bottom view.

Several types of condenser-drive systems were tried out before the pulley-and-cable set-up was installed. A 1929-model Colonial broadcast receiver furnished the brass pulleys. The photograph shows approximately three turns of the cable around each of the pulleys. It is not hard to connect the pulleys if the condensers are set at either minimum or maximum to begin with and the cable is wrapped around each successive pulley, beginning with one on either end. The cable ends then are soldered down to the first pulley.

The National Type N dial permits readings down to one-tenth of one scale division. The dial covers 270 degrees, and the calibration of dial readings against frequency is approximately a straight line. This feature, in addition to the smoothness of operation, is a big help in resetting the rig to a given frequency, and some form of vernier scale is a necessity if calibration work is to be done with the v.f.o. Other condenser dials, such as those using gear-boxes, also should work provided they are designed for 270-degree rotation.

In the power-supply section, the bottom view shows one of the filter chokes mounted against the base. It is of the unshielded variety, and so in this position, hum pick-up by the r.f. circuits above-base is prevented. The wire-wound resistor shown at the right of this choke is R_9 . Its location on the underside of the base indicates that, once the proper setting is decided upon, the tap need not be reset. Leads to the jack and switches on the front panel are laced together, and then laid down the middle of the base, well

away from the tube sockets on either side. Any hum pick-up thereby is prevented. The bus-bar wire running at right angles to the laced wires goes between the grid coil, L_2 , and the coupling condenser, C_{18} . In the top view, trimmer C_{16} is mounted between the two voltage-regulator tubes shown just behind variable condenser, C_{17} . The rotor of this trimmer is grounded, and no r.f. coil is near by, which means that adjustment of the trimmer with a metal screwdriver will not affect the circuit operation. On the other side of the cabinet, both the rotor and stator plates of the trimmer, C_{23} , are "hot" so far as d.c. voltage is concerned. It is mounted between L_3 and the 6V6G tube. Adjustment of C_{23} affects the strength of the output signal, although no effect on frequency should be evident at this point.

No back-view photograph is shown, but this is hardly necessary since only two cables are connected at the rear. One of these is the 115-volt a.c. line which is plugged into a female receptacle shown in Fig. 1, while the other is a flexible shielded coaxial line on a screw-type connector which fits a corresponding plug adjacent to the a.c. inlet. These detachable cables make it convenient to carry the unit about without the necessity of having cords and plugs dangling around to be tripped on or to snag on something.

Operation

For tests of the v.f.o. signal, the first thing to do is to turn on S_1 , located at the right of the tuning dial, and then allow the tubes to heat for several minutes. With uniform heat inside the cabinet, S_2 may be thrown on, to put the circuits in full operation. A lavender-colored glow on both of the voltage-regulator tubes indicates that the power-supply circuit is functioning. This glow may change in intensity when the condenser plates are either nearly all in or out, because of varying amounts of current drawn by the circuits. A milliammeter of suitable range inserted into the circuit through the jack below the tuning dial will indicate these changes. If a key is substituted for the milliammeter through this same jack, a check-up on stability of the signal under keying conditions may be made.

At this point, trimmer condensers C_{16} and C_{23} may be adjusted for best results. Their purpose is to level off the tracking. An insulated screwdriver is best to use here; and by all means, don't get in bodily contact with this trimmer and the chassis while the power is on!

A communications receiver or monitor with a b.f.o. is necessary in order to hear the signal. Of course if a stable oscillator such as one used as a secondary frequency standard is to be had, it may be substituted for the b.f.o., and then some tests may be made on the frequency drift of the outfit. However, this calls for more apparatus, namely, a calibrated audio oscillator, so that the amount of drift away from a given beat note, which is taken as the starting point, may be measured. Without the audio signal generator, one may get an idea of what is happening by observing generally the change in tone of the beat

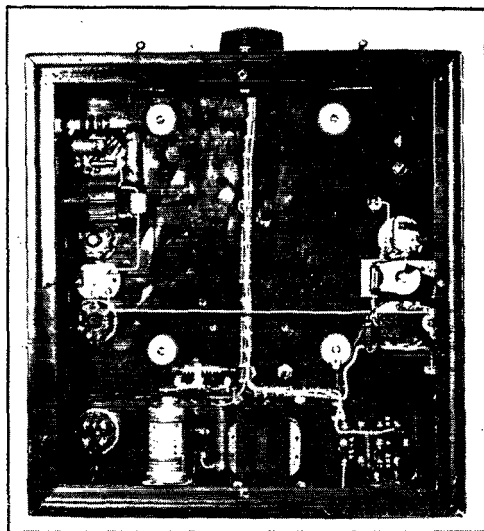

Bottom view of the v.f.o. rig. Grouping of parts in each circuit is shown. Power-supply components are at the top, the 6V6G doubler stage is at the left, and the 6J7 buffer is at the right. The four rubber grommets are at the corners of the oscillator box. A bottom cover is provided for the cabinet.

note which occurs when the stable oscillator output and v.f.o. signals are mixed after, say, five-minute intervals with the v.f.o. on and then off. Measurements which are made with an r.f. signal generator and an audio oscillator, both of which were stable and calibrated, showed that drift is almost nonexistent after a reasonable warm-up period.

The construction is rugged, compact and light enough in weight to be useful in alignment, calibration, test, and experimental jobs of various kinds. It weighs only 25 pounds, which is not too much to carry by hand in the lab, unless the more convenient method is applied of mounting it in a carriage on wheels. Either way, its normal, stable operation is not affected.

Strays

Browder J. Thompson, associate research director of RCA Laboratories, was killed on a Mediterranean flight in an Army plane on July 4, 1944. Serving as a consultant in the Office of the Secretary of War, he was on a special mission "of direct and vital importance to the war."

A former W7, Mr. Thompson was one of America's foremost radio research engineers, making notable contributions in connection with screen-grid tubes, power pentodes and beam tubes. One of the first to appreciate the effects of electron transit time, he was responsible for the development of the "acorn" tube and guided important research on tubes for television and for power generation at u.h.f. In 1936 he was awarded the Morris Liebmann Memorial Prize by the IRE for his contributions to the u.h.f. field.



“The Ghost of Guam” — KB6GJX

An Interview With W/O George Ray Tweed, USN

BY A. DAVID MIDDLETON,* W2OEN

One of the most inspiring true stories to come out of this or any other war is that of Warrant Officer George Ray Tweed, USN, KB6GJX. Tweed has already told many of the details of his activities in various popular magazine articles and in his forthcoming book, “Robinson Crusoe, USN,” to be published this coming March by Whittlesey House. Here we present, for the first time, the hitherto untold radio side of his amazing adventure as a fugitive from the Japs.

WARRANT OFFICER George Ray Tweed, USN, is known to millions of radio listeners, newspaper and magazine readers as the “Ghost of Guam” — but to us he will always be KB6GJX. Tweed’s story is one of the most thrilling examples of the theory that the ham has what it takes, even if it means eluding the treacherous Japs for thirty-one months on the tiny island of Guam.

Mr. Tweed had just finished his talk before a packed house at a recent Army-Navy Work Incentive rally in Hartford, when the writer came up and handed him his QSL card. Tweed’s face lit up as he smiled and said, “You’re a ham, too? Did you know I am KB6GJX?”

“Sure, we know that,” and we explained that we wanted his story for *QST*.

Tweed did not hesitate. “Say — am I pleased to be talking to a ham again!”

And he really meant it. For W/O George Ray Tweed, USN, KB6GJX, is a regular dyed-in-the-wool ham. Enlisting in the regular Navy in 1922, Tweed served in various sections of Navy Communications. But, since 1932, Tweed always found time to build and operate his ham station. Before that he was also a radio man — but strictly Navy.

KB6GJX is a pleasant guy with whom to talk. He spins a good yarn and his ready wit and friendly manner made it easy to get this first-hand account of his radio activity during his hazardous life on Guam.

At first glance Tweed did not look like a man who had eluded and outwitted hundreds of Japanese killers for nearly three long and dangerous years. He did not look like a man who once had a price on his head — a price that multiplied in proportion to the amount of “face” he cost the Japs, until finally they declared him officially dead. Even then, however, the Japs did not cease their relentless search.

But as we talked there appeared behind Tweed’s calm, easy manner the strength of character and determination that helped him survive — to become the only American to escape capture or death at the hands of the Japanese on Guam. By his courage and by his very presence on the

Island, Tweed became, to the native Chamorros, the symbol of the America they revered.

Tweed had made a promise to himself and to his native supporters, that he would not surrender — or die — until the Americans came back to Guam. He kept that promise. That is George Ray Tweed, KB6GJX.

“Most of the story of my life has been pretty well covered in the newspapers and magazines,” said Tweed, “so I’ll begin with the time I started in ham radio. In 1931, while stationed in San Diego, I met a group of boys who were very much interested in radio. In fact, they were so enthusiastic about it I asked them why. Their reply was simple: ‘We are hams — radio amateurs!’ I’d been in the Navy for about nine years and in radio work all of that time, but never had given the ham game much thought. This chance meeting with these fellows convinced me that the ham game must be fun.

“Another Navy man, W6BMP, helped me get started,” Tweed said. “It was a big day in 1932 when I got my license and went on the air as W6GJX in San Diego.”

“What was your first rig?” we inquired.

“A pair of 210s in a TNT, and I was so sure I was going to like 40 meters that I soldered the coils in place. It worked pretty good. My first QSO was with W6ISI in Santa Barbara. I guess I went through the usual experiences as a ham, including 160-meter ‘phone,” Tweed continued. “After working some time on this rig, and getting it on the air, I found that 160 lacked, for me, any DX possibilities, so I went back on 40 c.w. to stay, or at least that is what I thought.”

Asked about his hamming on Guam, Tweed said ruefully, “That didn’t last very long. In August, 1939, I arrived in Guam for a two-year tour of duty and, of course, I took my gear along. Early in 1940 I came on the air on 40 and 20 c.w. and had a fine time, working fellows in the other islands of the Pacific and in the States. Guam is 6000 miles west of San Francisco so now I was DX myself! It was hard to believe!”

“How about U. S. contacts?” we interrupted.

“I had frequent skeds with W6IOX, W5AAN, W5DWW, W5HIP, W6DH, KA1HQ and

* Assistant Editor, *QST*.

W5DXR," Tweed went on. "There were others, but those are the calls I remember well.

"Before leaving California for Guam I had arranged with a parts store to ship things I would order when out on the Island. However, when I placed an order for equipment to get on 20-meter 'phone, I waited and waited for the parts which never did come. Then in desperation I sent through W6IOX to Offenbach in San Francisco, and they shipped out the needed parts in a hurry. I picked out complete assemblies from the ARRL *Handbook* and told them to ship all the components needed to make that unit, giving them changes and exceptions I wanted.

"They shipped just the things I needed, and I went on 20-meter 'phone early in 1941 and worked stations as far east as Minnesota. My 'phone rig ended in a pair of 812s modulated by a pair of HY51Zs in Class-B. I used a 20-meter full-wave Zepp antenna."

"Why and when did you close down KB6GJX?" we queried.

"On June 10, 1941, when censorship was started on the Island, the Navy officially closed down all amateur activity on Guam. We were ordered to suspend operation, pack and crate all our transmitting equipment. It was then taken to the Communication Office where it was sealed and stored for delivery to the rightful owner at some future time."

"Do you think your stuff is still on Guam?" we asked Tweed.

"No, I guess I'll have to go to Tokyo for my transmitter," Tweed replied. "When the Japs took over the Island, they confiscated all that stored equipment.

"After June 10th I could not, of course, do any hamming, except to listen in. We were permitted to keep our receivers. It didn't do *me* much good, however, for one of the first bombs to hit Guam on December 8th lit on my house right on my ham shack, and most of the gear left there was blown up."

"Were there any other amateurs located on Guam at that time?"

"Yes, there were two other stations, besides KB6GJX," Tweed explained. "One was Roy Henning, KB6CBN, of the Pacific Cable Company, and there was also a ham station owned and operated by U. S. Marines. A Marine named Anderson, a newcomer to Guam, did most of the operating at KB6OCL."

"What happened to those other amateurs?"

"Henning was captured by the Japanese and presumably was taken to one of their prison camps somewhere. Anderson was at KB6OCL when a bomb, dropped in one of the first air-raids, made a direct hit on the station. Anderson suffered a fractured skull and died the next day."

"Did you take any radio equipment with you when you took off for the hills to escape capture by the Japs?"

"No, I did not," Tweed stated. "I had prepared some boxes of food and supplies for a tentative flight, but I delayed leaving until the last possible moment. Finally, I decided that if I was

going I'd better leave — fast! I made it with about a minute or so to spare. It was night and the Japs were already in the vicinity. There was considerable shooting but not until we were actually on the move did the Japs start shooting at us. Then a machine gun started firing at the car as we drove away, but I had no lights on and they missed us and the tires, luckily.

"At that time I did not realize how useful a radio set would be," he admitted, with a grin.

"George, the news stories reported that you were accompanied by another man on your escape to the hills. Was this other fellow a radio man?"

Tweed answered, "He was a radio man all right, but not a ham. He was Alfred J. Tyson, Navy radioman first class. We separated some time later on. Several months after that Tyson was killed by the Japs."

"What kind of a place did you live in when you were in the hills?"

"I had various hideouts, but spent most of the time in a cave, formed by a huge overhanging rock and had fixed up a place under there. It was roomy and I had a shelf made out of rocks on which I built a work-table from crates."

"When did you get the idea of using a radio set in the hills?"

"By the spring of 1942 I was anxious to know what was going on in the outside world. I knew that the Japs had been moving fast but there was no authentic news. Immediately after the invasion my friends, the native Chamorros, told me that the Japs had issued orders that all radio equipment must be turned over to them at once. Anyone caught with radio gear of any kind would be put to death.

"The natives kept asking me what I wanted," Tweed continued, "so I told them I wanted a radio receiver. They promised to get me one. The



"At that time I did not realize how useful a radio set would be," Tweed admitted with a grin.

George Tweed has asked QST to print the following message:

"Many hundreds of letters have been received from the relatives and friends of men I knew on Guam. I am answering these letters as quickly as my limited free time will permit.

"To the amateurs who have written me, many thanks! I'll write to you just as soon as I have answered the letters regarding my former mates."

Chamorros more than kept their promise. They brought me a Super Skyrider 16 almost at once — stolen from the store of equipment confiscated by the Japs! For a power supply, they brought me a vibrator-pack and storage batteries. These batteries came from wrecked cars on the island. I'd use up a battery, then the natives would take it to town and charge it on Jap juice and return it! At one time I had a stock of six storage batteries, so I could listen plenty.

"Then I heard about a native priest who had held onto his equipment after the Japs ordered it turned in. He was beginning to get plenty scared, and at last turned it over to one of the natives to dispose of for him. This man in turn brought it to me, so from this unexpected source I obtained another receiver identical to the one I already had! Only, the trouble was, it was inoperative because it had been stored carelessly and the dampness had got to it.

"I stripped parts from it to fix up the first receiver. By the time I had to abandon my radio receiver, most of its parts had been replaced. That dampness was terrifically hard on transformers and any type of fixed condenser. The receivers were not tropicalized and if I had not had the second one for parts, I would have been out of business long before I was."

"What else did the natives bring you?"

"Well, they brought me some tools; a screwdriver, a pair of pliers — and a 110-volt electric soldering iron."

"What use could you make of the iron? Did you have your hideaway wired for power?"

Tweed laughed. "Sure I did! The natives brought me a gasoline engine driven 110-volt 60-cycle generator outfit. It had an output of about 100 watts a.c. as well as a d.c. output for charging storage batteries."

"What about gas?" we asked. "Or did you have a C book?"

"Oh, that's almost a yarn in itself!" Tweed remarked. "When the Japs took over there were lots of private cars on the Island. These they confiscated and put to their own use. Since the Japs did not know how to drive, they wrapped most of the cars around trees. Then, instead of repairing them, the Japs would let the cars lie. The natives would swipe gas and batteries from these wrecks. I even got gas from wrecked Jap military vehicles.

"I used that gas engine a lot when I first had it, but later when the Jap patrols started closing in I could not run it because of the noise.

"One day a native brought me a test meter, and was that a happy event for me, as I had begun to have trouble with the receiver! By-pass condensers had started to pop like firecrackers and I sure needed that meter. It was a small Triplett volt-ohmmeter, complete with a pair of test leads. Those Chamorros thought of everything but they couldn't find me a circuit diagram of that receiver."

"What about spare parts, tubes and the like?" we asked. "Or did you have the use of a regular junk box by then?"

"The natives brought me all the things they could find. Those fellers brought me wire and bulbs and I fixed up my own electric light system. But I could run only one thing at a time; it was a choice between the iron, the lights or the radio receiver."

"What kind of an antenna did you use, and what results did you have in picking up signals from the States?"

"I used an ordinary L-type antenna, insulated with transposition blocks, suspended between trees. It brought in KGEI, San Francisco, fine so I listened to that station most of the time. Whenever KGEI shifted to another channel or changed the times of transmission it threw me off until I found them again. I listened most for the news as I was starved for news of the progress of the war.

"The first news story I picked up told me about the battle of the Philippines, and the last news I heard was a report that the Solomon Islands invasion had started.

"After I got the receiver going I began to give the natives bits of news to repay them for their help. In turn, they would bring me other things such as additional gasoline and food. Since word-of-mouth news is apt to be distorted I got the idea of writing out the news. I wrote the news in pencil for some time. Then one of the natives, an ex-Navy employee, brought me an old battered Underwood. He managed to rustle some paper and carbon paper and then was reborn *The Guam Eagle*. I took this name as it was the name of a local paper published before the Jap invasion. The *Eagle's* circulation reached the record number of five copies! Later I swapped the old mill for another of the same kind, only this one was in better shape."

"What happened to your newspaper?"

"It was circulated among the Chamorros until the characters were no longer legible. Finally I stopped publication because the natives got to talking too much about the news. Even if they had not seen a copy of the *Eagle* themselves, they would brag about it to others. It got to be dangerous, so I quit printing it. I'm sorry that no copies of the *Eagle* are still in existence. When the natives hid my stuff, once when I was on the move, the dampness ruined all my papers and books."

"Did you have any kind of radio publications with you?" asked the writer.

"My native friends brought me a copy of the 1940 ARRL *Handbook*. They also brought me some copies of lesson books from CREI that I had been studying. There were several of these

that the Japs had thrown away and the natives had recovered from the refuse heap at my home. Unfortunately, I found that the book of mathematics tables and formulae was missing."

"Well, why didn't you send a native back after it?" the writer asked.

"I did!" replied Tweed with a grin. "I even made them a sketch showing the color and style of that missing math book — but they couldn't find it. I guess the Japs must have needed it! Anyway, it was gone."

"The news stories here in the U. S. stated that you tried to build a transmitter. Is that correct?"

"Yes, I did try," KB6GJX said thoughtfully. "I gathered parts to make a simple transmitter of about 30 watts output. I had the usual collection of junk from old sets and I worked on it for a time. Then one day a native, who had been a ham before the regulations prohibiting non-citizen activity, came to me. He offered to take the parts to town where there were more tools and it would be easier to assemble the equipment. I never saw this man or the equipment again."

"Perhaps he got cold feet?"

"Well — one way or another," Tweed acknowledged. "The Japs were killing anyone found with any kind of radio equipment. Anyway, I did not get my transmitter back and never got enough parts together to build another."

"What were you going to do with the transmitter when you got it working?"

Tweed continued. "I had two plans. For the first, I had worked out a code which, although it could not be readily decoded, could be solved by Navy cryptographers. I planned to put my transmitter on one of the frequencies used at Pearl Harbor, and send 'blind.' I figured our cryptographers could decipher the coded messages quicker than the Japs, and that would give the Navy the edge if they wanted to take any action on the information I could give them."

"If that plan failed I intended to get somewhere in the old 20-meter ham band and send 'blind' in the hope that some ham in the States would pick up my messages. These would be addressed in plain language with the text in cypher. However, since I never did get the rig on the air, neither plan was put into effect."

"You know, my radio training and knowledge raised the price on my head," Tweed stated. "Those Japs offered only 50 yen for my capture at first. Then after they found out that I was a radio man they must have figured I would try to communicate with the Navy and forward information. So they raised the price to 1000 yen. Almost as soon as I got the receiver going, they put on a more intensive search for me, for rumors were circulated that 'the American radioman had established contact with the States.' This was not true, of course, although I did receive numerous news broadcasts."

"How long did you continue your radio work?"

"About five months," Tweed explained. "In August of '42, I had to make a quick jump to a new hiding place and I gave all my gear to a native to hide for me. He did his job too well!"

Tweed said ruefully. "He practically buried it in another cave, and when we went to get it later the equipment was damaged beyond repair by water and dampness."

"That is about all there is to the story on Guam," Tweed concluded. "How about reversing our situation and let me ask you a question? What about ham radio since I went off the air in June of '41?"

"Well, George," we answered, "of course there have been many changes in equipment and technique, particularly in the u.h.f. region, mostly in military and naval communications but, unfortunately, the rest of us hams have been off the air almost as long as you have. So you haven't so much to catch up on in ham radio."

We had brought Tweed several back issues of *QST* and other ARRL publications and as he looked them over he remarked — "These sure look good to me. You know, I owe a lot of thanks to *QST* and the League. My ham background and experience was a big help to me when I went up for my examination for a rating as chief radioman. I'm glad the ARRL has kept up *QST*. I know all their efforts on behalf of the hams will be of benefit to us in the postwar period."

"Are you planning a postwar rig?"

"You bet I am," replied Tweed. "The Navy held my pay for me while I was away, you know, and some of that money is going into another swell layout after the war."

"That's a promise! How about a sked?"

"Sure thing — right on the low end of 40 meters," Tweed smiled and answered.

Which just goes to prove — once a ham, always a ham. Not even 31 months of near-death dodging the Japs will change a fellow like George Ray Tweed, KB6GJX.

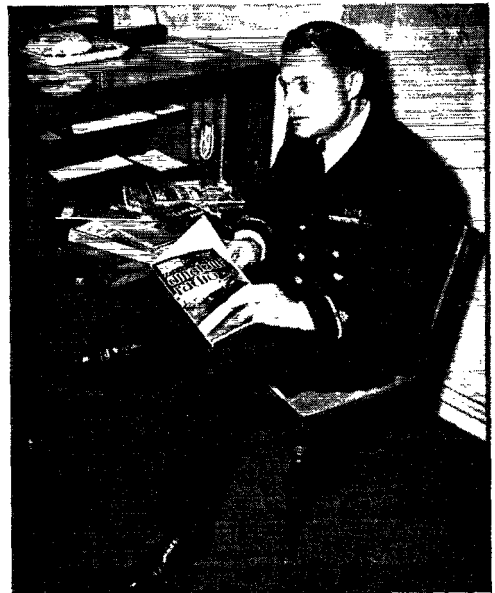

"These sure look good to me. You know, I owe a lot of thanks to *QST* and the League. . . ."

A Versatile Electronic Key

A Compact Unit with Built-in Keying Monitor

BY NORMAN SNYDER,* W3HRD

WITH the addition of a few parts, the simplified electronic key described by Wiley in *QST* for July, 1944,¹ may be made into a unit which is portable and useful in several ways that are not possible in a more simple lay-out. One worthy addition is a built-in monitor-oscillator which may be operated by itself or along with transmitter keying. Then there are times when straight keying is desired instead of automatically-formed dots and dashes. The circuit described in this article shows how this may be done. Flexibility is incorporated in the circuit through independent controls over such factors as the tone and volume of the audio oscillator and lengths of dots and dashes. In addition, it is possible to substitute other types of tubes for those suggested in the circuit diagram of Fig. 1.

Compactness and portability of the improved keyer are illustrated in the photographs. Use is made of all available space inside the cabinet, and some parts are mounted, to advantage, on the outside panels. The entire unit may be held in one hand, since its base is no larger than that of a Vibroplex key, and its height is only six inches.

*656 E. Jamestown St., Roxborough, Philadelphia 28, Pa.

¹Wiley, "Simplifying the Electronic Key," *QST*, July, 1944, p. 40.

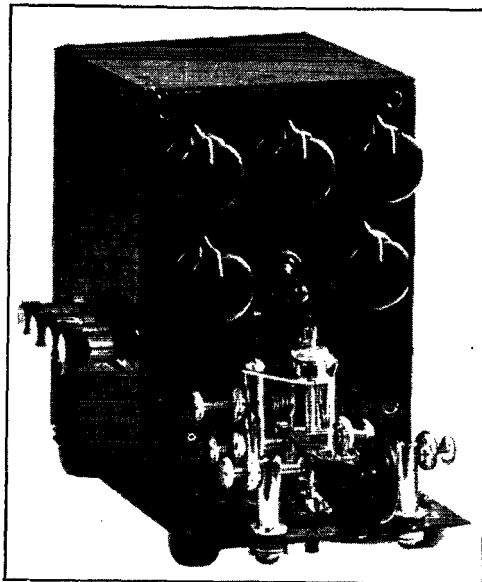

Front view of the compact electronic key. The five knobs control speed, length of dots and dashes, tone and volume. Binding posts on the left-hand side are for external-circuit connections. The key in the foreground is the lever and contact portion of a Vibroplex Champion.

Gone are the days of the "glass arm" for the code operator who follows the modern trend in keyers. Where the all-automatic method with tape machines is not practicable, semi-automatic transmissions with an electronic keyer allow the "op" to ease up on the manual side of the job. In the accompanying article, the author describes a keyer which is a step or two in advance of a simpler design given a few months ago in *QST*. In one small unit it includes an audio-oscillator keying monitor and provision for automatic dots and dashes, automatic dots and manual dashes, and manual operation with a straight key.

Some Modifications

Fundamentally, the electronic key here described is built around the simplified circuit described by Wiley. One modification is the insertion of a one-megohm resistor, R_1 , in series with R_2 and R_3 , for the purpose of lengthening the electronic dash, so that the action of the dash contact of a mechanical bug may be simulated. With R_1 in the circuit, there is a continuous contact for approximately the same length of time necessary to send six or seven dashes by hand. Therefore, with this resistor in the circuit, the key performs as an electronic bug. With R_1 shorted, it becomes completely an electronic key in which both dots and dashes are made automatically.

Another modification shown in Fig. 1 is the installation of a switch which combines S_2 and S_4 —a three-position switch with left, right, and middle-neutral positions. Two independent s.p.d.t. toggle switches, shown in Fig. 1, will serve the same purpose, if you so desire, or if the type of switch mentioned above is not available. S_2 and S_4 working together will make a good combination.

One section of the switch, S_2 , shorts R_1 when thrown to the proper side, and the other section, S_4 , connects the "C" + to the cathode or "B"—, thereby canceling the opening and closing effect upon the relay by the RC network. Thus, an ordinary hand key can be utilized to close the "C"— connection to the grids of the 6N7 tube, whereupon the plate current is cut off, and the relay is released so that it makes contact with an external circuit and the keying monitor. The neutral position of the switch permits R_1 to perform its purpose in the circuit.

I am using four "penlite" cells in series for the "C" battery. Three volts seemed to make my particular unit perform rather well when the 6N7 was used, so I got this voltage from a second cell

in series. I discovered that it was necessary to use the $4\frac{1}{2}$ -volt tap (third cell in series) for clean keying when using an external hand key. An important reason for using the six-volt tap is that by using this amount of voltage instead of three volts, either a 6J5 or 6C5 may be substituted for the 6N7 without any changes whatsoever in socket connections. Another advantage of using the 6J5 or the 6C5 instead of the 6N7 is that a line-cord resistor may be used in place of a filament transformer, because the filament drain in this case is only 0.3 ampere. This arrangement also will help to save cabinet space, not to mention wear and tear on the builder who may have some trouble in finding this particular type of filament transformer.

Monitor and Relay

The 117L7 tube serves a dual purpose. The diode section rectifies the line voltage, and the filter is composed of R_5 , C_4 , and C_5 in a π formation. The tetrode section, working as a triode, operates as a conventional Hartley oscillator.

The output transformer serves as the oscillation transformer. R_6 is used as a pitch control, and R_7 is a volume control. If the value of C_1 is changed, a different pitch will be produced. Therefore, the value of C_1 may be changed to provide the tone control, if R_6 is replaced by a fixed resistor with a value of approximately 25,000 ohms. If this method is used, the large value of C_1 makes it feasible to adjust the tone in steps by means of a tap-switch arrangement. The volume from the midget speaker is sufficient for comfortable copying in the average room.

The relay used is a sensitive type which operates at approximately 4 ma., and is essentially the same as the one used by Mr. Wiley, except that my relay has an extra set of contacts which key the monitor. Both sets of contacts, the external keying and the monitor-keying contacts, are closed when the relay is open. I suggest that the builder connect the two sets of keying con-

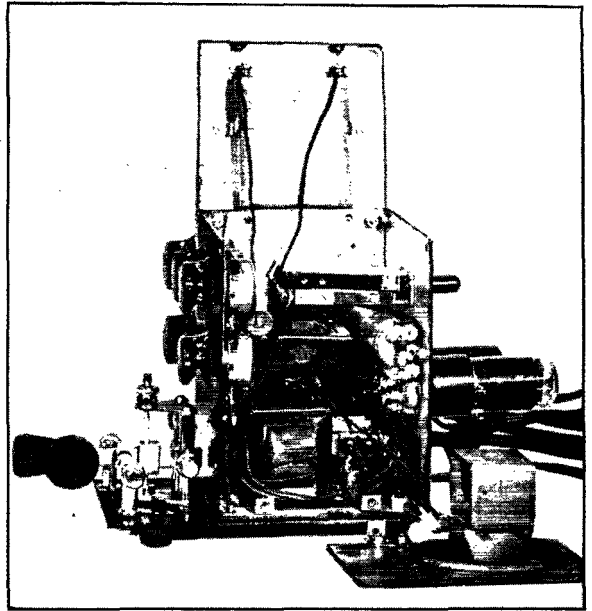

Inside view of the electronic keyer. The controls are shown on the panels at the left and right. The two transformers used in the circuit are mounted at right angles to each other. Mounted on the top lid of the cabinet is the grid-bias battery. The p.m. dynamic speaker fits behind the side of the cabinet shown in the foreground. The relay and smaller parts are fitted into the space under the horizontally-mounted toggle switch shown at the upper right.

tacts to the audio oscillator and then make the proper adjustments of relay-contact spacing so that keying of the external circuit, namely a transmitter, will "track" with the keying monitor before wiring the contacts permanently to the terminal board.

In this particular model, S_1 and S_3 were combined in a single d.p.s.t. toggle switch. However, it would be an advantage to have separate s.p.s.t. units since keying adjustments could then be made with the aid of the monitor, without keying the rig as well, when S_1 is closed and S_3 is open. S_1 controls the a.c. circuit while S_3 serves the purpose of opening the external keyed circuit so that if the keyer is turned off before the rig, the carrier will not be thrown on.

Fig. 1 — Circuit diagram of the compact electronic key.

- C_1 — 4 μ f., 50 volts.
- C_2 — 0.01 μ f., 50 volts.
- C_3 — 0.01 μ f., 200 volts.
- C_4 , C_5 — 20- μ f., 150-volt electrolytic.
- C_6 — 0.05 μ f., 150 volts.
- R_1 — 1 megohm, $\frac{1}{2}$ watt.
- R_2 , R_3 , R_4 — 100,000-ohm potentiometer.
- R_5 — 10,000 ohms, $\frac{1}{2}$ watt.
- R_6 — 50,000- to 100,000-ohm potentiometer. (May be replaced by 25,000-ohm fixed resistor under certain conditions; see text.)
- R_7 — 500-ohm potentiometer.
- R_y — Sensitive relay (4 or 5 ma. coil current).
- B — 4 penlite cells (see text).
- S_1 , S_2 , S_3 , S_4 — S.p.s.t. toggle switch (see text).
- SPKR — 3-inch p.m. speaker.
- T_1 — Midget filament transformer, 115-volt primary, 6.3-volt secondary.
- T_2 — Midget push-pull output transformer.

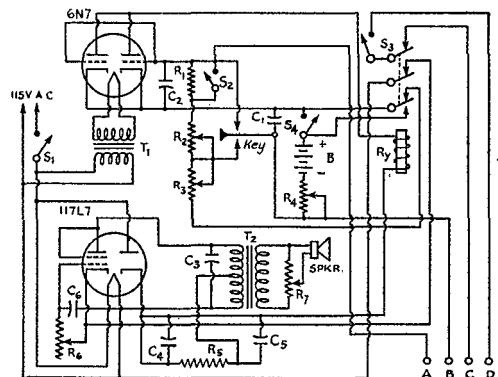

Constructional Details

Dimensions of the cabinet of this particular unit are $6\frac{1}{4} \times 4$ inches at the base, with a height of six inches. The front-view photograph reveals that there are five controls. The three at the top are, from left to right, for control of dashes, dots and speed. S_1 is between the monitor volume control on the left and tone control on the right.

On the left side of the cabinet is a four-conductor terminal strip mounted for convenient tying-in of leads from the external hand key (A and B) and transmitter key circuit (C and D).

Protruding from the back panel, as seen in the rear-view photograph, are the tubes and the d.p.d.t. toggle switch S_2-S_4 . This system of having the tubes outside has its advantages. There is no worry about ventilation in the cabinet, and therefore nothing gets overheated. The cabinet space saved also is a worthy asset, along with the fact that a pilot light is unnecessary, because one glance at the glass tube will tell whether or not the a.c. line circuit is turned on.

On the right-hand side of the cabinet is the speaker. A number of $\frac{1}{8}$ -inch holes are drilled into the cabinet panel to form a grille.

The key lever in this unit is the complete key mechanism from a Vibroplex Champion. (May its remains rest in peace!) I thought for quite some time before performing the agonizing task of disassembling the "bug" which had helped to give me so much enjoyment in handling traffic, in operating contests, and in general rag-chewing in the days of old. However, upon completion of the keyer, I realized that there was nothing to regret, because I still have the bug, but now it is of more modern design.

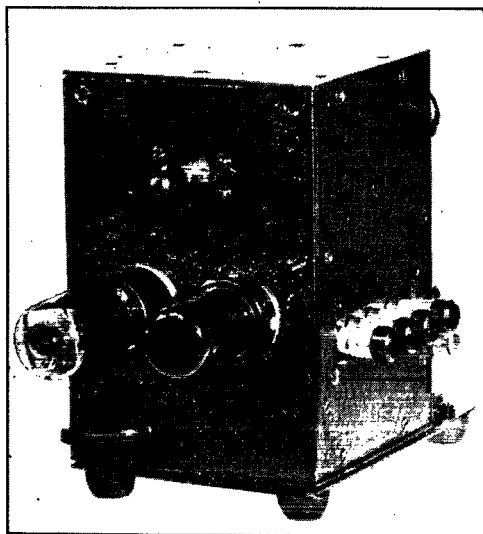

Rear view of the compact electronic keyer. The two tubes are mounted outside the cabinet to eliminate heat from the other components of the circuit. The filament of the 117L7 glass tube serves also as a pilot light. Above them is a toggle switch for change-over to manual operation. Binding posts for connections to external circuits are shown at the right.

Attention!—Inventors

The following presents several inventive problems for which the Navy Department is seeking solutions and which they have turned over to the National Inventors Council for appropriate action. These problems offer an excellent opportunity for ham ingenuity.

1) Waterproof Jack:

Applications: Microphone, headphone and key jacks for telephone equipment.

Characteristics: Should prevent water or moisture vapor from penetrating equipment, even when immersed to a depth of ten feet; should be capable of being cleaned and dried without tools; should accommodate standard plugs.

2) Field-strength meter:

A small portable unit about the size and weight of a walkie-talkie for rapid checking of radio field intensities in the vicinity of radio transmitting stations. The instrument must be simple to use and accurate within plus or minus 10 per cent. Frequency range desired is 100 kc. to 20,000 kc. The range of field intensities desired is from 10 to 1000 millivolts per meter.

3) Radio antennas:

Antennas up to 300 feet in height that can be set up by unskilled ground crews. The efficiency of radio devices is often limited by the extreme difficulty of obtaining reasonable antenna heights quickly in the field. Very light alloys and special rigs for rapid erection by a ground crew without climbing are desired, in addition to ability to dismantle or collapse into packages not exceeding 20 feet in length. Insulated-base vertical antennas are preferable but grounded-base type could be used if the device had enough other advantages in the way of ease of erection and ruggedness.

4) Twin-triode vacuum tube:

A precision twin-triode vacuum tube with general characteristics of the current 6SN7 type having the following additional precision features:

a) After a fifteen minute warm-up, the gm of the two sides shall be equal over the normal operating range to within ± 1 per cent.

b) The tube shall be completely nonmicrophonic.

c) The above characteristics to be maintained over an ambient temperature range $+ 80^{\circ} \text{C.}$ to $- 40^{\circ} \text{C.}$

It must be possible to produce this tube, by mass production methods, with not more than 10 per cent rejects.

(Tubes presently available in production permit excessive variation in grid-plate conductance in the separate halves of the tube.)

5) Time-interval switch:

An expendable, compact, lightweight, rugged, mechanical device to permit successive closures of up to eight electrical circuits with a time interval between closures of about 0.2 to 0.3 seconds.

(Continued on page 98)

The Citizens Radiocommunication Service

Commission Proposes Walkie-Talkies for General Citizenry

OUTSIDE of the amateur allocations, the most interesting feature to us in the Federal Communication Commission's report on its proposed postwar allocations above 25 Mc. was its announcement of its intention to create a new Citizens Radiocommunication Service for the use of the general public under minimum licensing requirements.

We comment on this topic on this month's editorial page and our purpose here is simply to present the Commission's own language from its report, which tells the tale very well indeed:

"The development of light-weight portable short-range radiocommunications equipment of the 'walkie-talkie' type has opened the door to a large variety of new private applications of radio. The success of such communications on the battlefield has been followed by many suggestions for peacetime use of low-power portable transceivers in the cities, on the highways, and in rural areas. To make possible the fullest practicable development of private radiocommunications within the limits set by other demands for assignments in the spectrum, the Commission on its own motion proposes to allocate the band from 460 to 470 Mc. to a new 'Citizens Radiocommunication Service.'

"The possible uses of this service are as broad as the imagination of the public and the ingenuity of equipment manufacturers can devise. The citizens radiocommunications band can be used, for example, to establish a physicians' calling service, through which a central physicians' exchange in each city can reach doctors while they are en route in their cars or otherwise not available by telephone. Department stores, dairies, laundries and other business organizations can use this service in communicating to and from their delivery vehicles. Similarly, it can be used in communicating to and from the trucks, tractors, and other mobile units operating in and around large industrial plants and construction projects — many of which spread over a number of square miles. It can be used on farms and ranches for communications to and from men in the fields; on board harbor and river craft; in mountain and swamp areas, etc. Sportsmen and explorers can use it to maintain contact with camps and to decrease the hazards of hunting, fishing, boating, and mountain climbing. Citizens generally will benefit from the convenience of this service by utilizing two-way portable radio equipment for short-range private service between points where regular communication facilities are not available. During emergencies when wire facilities are disrupted as a result of hurricane, flood, earthquake, or other disaster, the service, as has been demonstrated by the amateur service, will be of inestimable value.

"Separate allocations are being made for urban and for rural transit radio communications, which will be available for communicating with city or intercity buses, trucks, taxicabs, etc. These services may develop on a common carrier or private basis on the frequencies set aside for those purposes. In either event, the citizens radiocommunication band will be open to taxicabs, delivery vehicles, or other mobile units, as well as for incidental communication between fixed points.

"Common carrier operation in the Citizens Radiocommunication band will not be permitted, and no charge can be made for the transmission of messages or use of the licensed facilities. The service will thus be for the private use of the licensee who will be responsible for the use of the facilities under the regulations to be promulgated by the Commission.

"The 460-470-Mc. band which the Commission proposes to allocate for this service is essentially adapted to short-range communications, and as such, is admirably suited to the uses proposed. The rules will permit the use of 'booster' or automatic relay installations where necessary. It is anticipated that most transmitters on this band will be of low power and will not utilize extreme antenna heights. Higher power may be permitted in rural areas where no interference will result.

"The design of equipment for use in the citizens radiocommunication band should challenge the ingenuity of radio designers and engineers. A combination transmitter and receiver of reasonable weight can no doubt be mounted in a suitcase; a broadcast receiver, an alarm system,

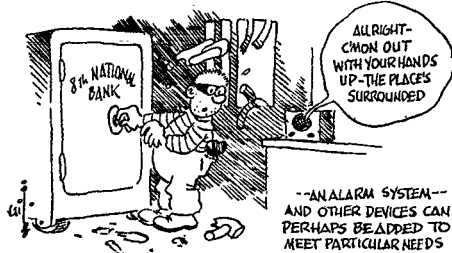

remote control systems, and other devices can perhaps be added to meet particular needs. By keeping the rules and regulations to a minimum, the Commission hopes to encourage ingenuity in design and in utilization.

"As in the case of the amateur service, the Commission proposes to assign no channels within the band. It is reasonable to suppose that most equipment will utilize a channel of 150 kc. more or less, making possible some 60 or 70 channels; but,

(Continued on page 100)

An F.M. Receiver for Carrier-Current Communication

Eight Tubes in a Narrow-Band Unit for Power-Line Work

BY GEORGE M. GULL, JR.* W8VAN

In the December, 1941, issue, the author described a narrow-band f.m. transmitter suitable for use in carrier-current communication. In this article he gives the details of a companion f.m. receiver designed to operate in conjunction with that transmitter.

IN ANY radio communication system the receiver is the most important link in the chain. The receiver to be described can easily be adapted to amateur carrier-current communication for operation in fixed, single-frequency nets.

The narrow-band f.m. carrier-current receiver, shown in Fig. 1, was built as a companion unit for the f.m. carrier-current transmitter which was described in a recent issue of *QST*.¹ Conventional f.m. circuits are used with values suitable for low-frequency operation. With the values shown, results on the test frequency of 69 kc. have been very satisfactory. The tube line-up consists of two 6K7 r.f. stages, a 6J7 and a 6SJ7 limiter stage, 6H6 demodulator, 6SL7GT first audio and squelch, 6H6 squelch diode, and a 6F6 second-audio stage.

Transformers

Since r.f. transformers were not readily available for operation on 69 kc., r.f. chokes were used for coils and were tuned with mica compression-type condensers. The primary and secondary coils were coupled as closely as possible and, together with the tuning condensers and loading resistors, were assembled in shield cans two inches square and four inches high. Resistors R_1 , R_2 and R_3 were necessary to broaden the selectivity curve to prevent excessive sideband cutting and to insure limiter saturation on weak signals. The r.f. gain control is adjusted so normal line noises just saturate the limiter stages. In reasonably quiet locations it is usually run wide open and, under these circumstances, may be eliminated if desired. The neon bulb, N , protects T_1 against high-voltage surges and excessive r.f. voltages when they are encountered. For amateur operation, between 160 and 200 kc., T_1 , T_2 and T_3 may be standard 175-kc. i.f. transformers, eliminating the need for the loading resistors.

*R.F.D. 1, Box 281, Poca, W. Va.

¹Gull, "F.M. for Carrier-Current Communication," *QST*, December, 1944, p. 29.

Limiter Stages

The two limiter stages are conventional and somewhat similar to the circuit of Fig. 732-B of the 1944 edition of *The Radio Amateur's Handbook*. Limiter grid-circuit time constants of about 4 and 6 micro-seconds, respectively, have been found satisfactory on all noise encountered so far. On the 44,000-volt power-line system, where all the tests were made, normal noise levels are more than sufficient to saturate the limiter stages.

The discriminator transformer, T_4 , was constructed in a can similar to the r.f. transformers, using r.f. chokes for coils. L_8 and L_9 are spaced equal distances on opposite sides of L_7 , and at such a distance that the resonant peaks of C_3L_8 and C_9L_9 are on 64 and 74 kc., respectively. Close separation of peaks result in maximum audio output voltage from the demodulator. With these peaks, the operating range, 66 to 72 kc. (for a 3-kc. deviation), is over the straight section of the discriminator characteristic curve. Of course, C_7L_7 is tuned to the center frequency of 69 kc. For amateur operation, T_4 can be constructed from any suitable parts in the junk box or the discriminator circuit can be changed to one similar to Fig. 733-A of the *Handbook*, thus permitting the use of a standard 175-kc. i.f. transformer with a center-tapped secondary. In this case, coupling between primary and secondary coils should be adjusted for a straight discriminator curve over the operating range consistent with maximum audio output and both primary and secondary circuits are adjusted to resonance in the center of the i.f. pass band. For the theory and adjustment of limiter and discriminator operation see Chapter Seven of the *Handbook*.

Noise Squelch

The resistor-condenser filter, R_{21} and C_{23} , attenuates frequencies above about 3000 cycles, the result of which is further to increase the desired signal-to-noise ratio.

When no carrier is being received the output of the receiver is noisy, unless some form of silencing squelch circuit is used. The 6SL7GT performs the function of first audio and squelch and, along with the 6H6 squelch diode, results in an effective silencing circuit. Without a signal, the plate current of the second section of the 6SL7GT is maximum, because the tube operates without bias since the drop across R_{12} is zero. When this maximum plate current flows, the negative voltage developed across R_{23} blocks the grid of the

first section of the 6SL7GT, thus reducing the output of the stage to zero. When a carrier is received, the voltage developed across R_{12} will bias the second section of the 6SL7GT to cut off, thereby putting the first section of the tube into operation. Without the voltage across R_{23} , the first section operates as any normal amplifier stage with its grid-bias voltage obtained from the voltage drop across R_{24} . R_{12} is adjusted so that the average noise voltage developed will not put the audio stage into operation. To prevent operation of the squelch by high-intensity noise peaks of short duration, which may be many times the average noise level, a time-delay circuit, consisting of R_{30} and C_{26} , is introduced in the grid circuit of the squelch triode. Therefore, the bias on the squelch grid increases slowly under an impulse of noise, and as a result the noise pulse has passed on before the grid is blocked. The purpose of the 6H6 across R_{30} is to discharge C_{26} rapidly through R_{13} and R_{12} . A somewhat similar squelch circuit is used in some a.m. commercial carrier sets. Switch S can be used to cut the squelch on or off, as desired.

The same care in lay-out and wiring should be used in the f.m. receiver as one would exercise when constructing any superheterodyne i.f. and audio stages.

The f.m. receiver is located in a power plant and under normal noise conditions the received f.m. signal has excellent speech quality and compares favorably with the power-plant's p.a. system. There is just a small amount of noise, contributed by phase flutter, audible in the background when the audio gain is wide open. A reserve of audio output is available for the average-size room. Without carrier, the receiver is quiet. On one noise test, when noise was produced by an arc to reduce the signal-to-noise ratio to about 1.7 (first-limiter grid-current ratio) the receiver, without carrier, remained perfectly quiet without any change in the squelch control, R_{12} . Under these conditions the f.m. signal was understandable but the noise present was terrific.

The writer will be very much interested in hearing about the results obtained by anyone who has experience in using carrier-current f.m. on low-voltage distribution power lines.

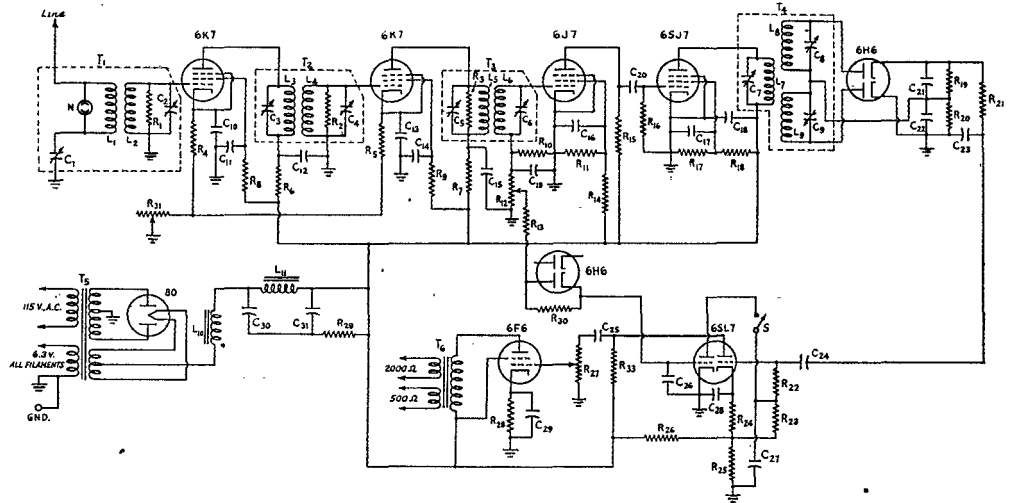

Fig. 1 — Circuit diagram of the carrier-current f.m. receiver.

- C1, C2, C3, C4, C5, C6, C7 — 160-500- μ fd. mica padder.
- C8, C9 — 225-650- μ fd. mica padder.
- C10, C11, C12, C13, C14, C15, C16, C17, C18 — 0.1- μ d., 600-volt paper.
- C19 — 100- μ fd. mica.
- C20 — 250- μ fd. mica.
- C21, C22 — 0.001- μ d. mica.
- C23 — 500- μ fd. mica.
- C24, C25 — 0.002- μ d. paper.
- C26 — 0.05- μ d. Dykanol or mica.
- C27 — 0.05- μ d. paper.
- C28, C29 — 10- μ d. 50-volt electrolytic.
- C30 — 8- μ d. 450-volt electrolytic.
- C31 — 16- μ d. 450-volt electrolytic.
- R1, R3, R19, R20, R21 — 100,000 ohms, $\frac{1}{2}$ watt.
- R2, R10 — 50,000 ohms, $\frac{1}{2}$ watt.
- R4, R5 — 500 ohms, 1 watt.
- R6, R7, R11 — 2000 ohms, 1 watt.

- R8, R9, R23 — 100,000 ohms, 1 watt.
- R12 — 250,000-ohm potentiometer.
- R13, R16, R23 — 250,000 ohms, $\frac{1}{2}$ watt.
- R14, R18 — 50,000 ohms, 1 watt.
- R15 — 4000 ohms, 1 watt.
- R17 — 5000 ohms, 1 watt.
- R22 — 500,000 ohms, $\frac{1}{2}$ watt.
- R24 — 800 ohms, 1 watt.
- R25 — 25,000 ohms, 1 watt.
- R26 — 150,000 ohms, 1 watt.
- R27 — 500,000-ohm potentiometer.
- R28 — 400 ohms, 10 watts.
- R29 — 25,000 ohms, 10 watts.
- R30 — 5 megohms, $\frac{1}{2}$ watt.
- R31 — 20,000-ohm wire-wound potentiometer.
- L1, L2, L3, L4, L5, L6, L7 — 16-mh. r.f. choke (Meissner Type 19-1995).
- L8, L9 — 10-mh. iron-core r.f. chokes (Miller 956).

- L10, L11 — 8-h., 120-ma. filter choke, broadcast-receiver replacement type.
- T1 — See L1, L2 for 69 kc.; standard 175-kc. i.f. transformer for 170-kc. operation.
- T2 — See L3, L4 for 69 kc.; standard 175-kc. i.f. transformer for 170-kc. operation.
- T3 — See L5, L6 for 69 kc.; standard 175-kc. i.f. transformer for 170-kc. operation.
- T4 — See L7, L8, L9 for 69 kc.; see text for 170-kc. operation.
- T5 — Power transformer, broadcast-replacement type for 10- to 12-tube receiver (Stancor P-6013).
- T6 — Output transformer, 6F6 to voice coil or line as required.
- N — $\frac{1}{4}$ -watt neon bulb without base resistor.
- S — S.p.s.t. toggle.

Hams in Combat

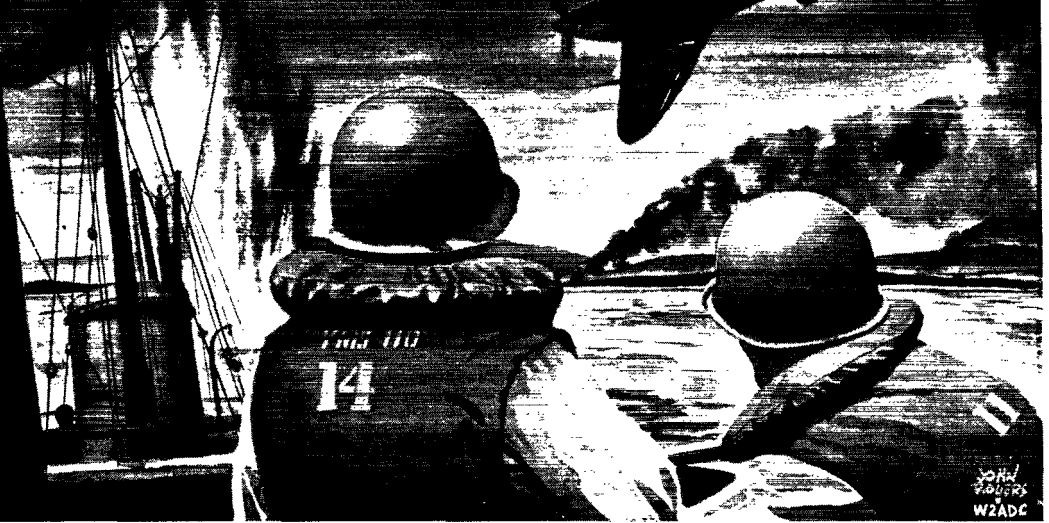

Mine Sweeper!

BY LT. CGD GEORGE ZIMMERMAN,
USNR, * W2NNZ

THIS is a story about that part of the U. S. Navy affectionately known as the "splinter fleet" (so named because the ships composing it are made entirely of wood) and the men who man these ships in the mine-sweeper service.

In March of 1944 special secret orders came to a small number of YMS (motor mine sweeper) type ships to report for overseas duty. From the different sweep ports of the United States, these toilers of the sea assembled at an outfitting yard and were made ready to brave the challenge of the mighty Atlantic.

On the cold/misty morning of April 3rd at 0500, we said good-bye to our homeland, and were on our way. We formed up as part of a huge convoy and settled down to the familiar watch routine. It took us twenty-two days to make the trip. Some of the newer seamen carved a spot for themselves on the lee rail, but for the most part it was a smooth crossing. We put in at Falmouth, England, and the next day the newspapers of that town carried a story of the "wooden wonders" which had challenged the ocean and won the fight.

We lay at anchor in that old English harbor and wondered what was to come next, for our orders were so secret that no one seemed to know why we were there. It wasn't long before several high-ranking Naval officers arrived and gave us the lowdown — we had been ordered from America to make the initial sweep of the scheduled U.S.A. beachhead for the invasion of France.

*c/o FPO, New York, N. Y.

Another Spitfire roared in to finish the job, his smoke screen completely enveloping us.

From that day on we practiced in formation, ironing out all the kinks in our sweep procedure — doing the same things over and over again until we could keep station with our eyes closed. Near the end of May we upped anchor and went to the port from which we were to leave on our trip to France. There, at Plymouth, we saw our first German air raid. Excitedly, we watched the brilliant searchlights pick out their targets and saw the sheets of "ack-ack" reach out to pluck the raiders from the sky.

We were put on a literary diet from the minute of our arrival as all the details and plans for D-day had to be studied. As we poured over the precise plans, we wondered and were amazed at the stupendous undertaking. Those beaches were miniature arsenals! We didn't like the looks of the photos of those ugly-looking guns which we would have to face, but there was cheerful comment to the effect that most of these death-dealing weapons would probably be bombed out by our air force. This proved to be largely true. Thank God for those brave men in the sky who did such a wonderful job that day!

June 3rd arrived — cloudy, and with a mean-looking barometer. We started out, passing through the sea-gate on schedule. The sea was in an angry mood and we were tossed around as if in punishment for invading her sanctity. Hour after hour went by. For the first leg of our journey we were at a semi-general quarters; i.e., with all stations manned, but only half the crew on watch. We were the first ships in the convoy, and as our journey progressed we could look aft and see a line of vessels that reached all the way to the visible horizon. In the air we could see Allied

planes giving us coverage, and their familiar white and black striped markings gave us quite a thrill.

On board our ship there was cool quiet. We knew what our job was to be, and we felt ready for it. We would be the first ships in, and so would make our run right under the muzzles of the giant shore batteries. This had a distinctly sobering influence on us, but we didn't worry too much about it. This was the day which we had been so eagerly awaiting — the day we could start the Nazis on their final road to defeat. Or was this to be the day? The sea which had been beating us so mercilessly was getting worse. Even seasoned men were becoming seasick. What would happen to the landlubber infantrymen? We soon learned the answer, for just after we had pointed our bow on the last leg of the trip orders came to return to England. Nerves taut under the strain of an invasion sweep relaxed. Although it meant a reprieve from the rain of fire which we expected, everyone on board was disappointed.

Still at semi-general quarters, we sailed back to Plymouth. Then, just as we were about to enter the harbor, orders came to turn around and start back to France. Sleepy-eyed men crawled out of their warm sacks and once more we were on our way. Although the sea let up a bit, it still seemed too rough to attempt the invasion. But this time there was no turning back.

All day we steamed ahead, intent on the job we had to do, taking time out only to grab something to eat and to snatch a few minutes of sleep. As we started on the leg of the course which led to France, we came to general quarters. With all stations fully manned and everyone in readiness, we doubled our vigilant watchfulness. The night was as black as a burned-out filament, and station-keeping was difficult. Minutes ticked by.

Finally, down the line of mine sweepers came a weak red signal. This was it! Out went the gear in record time made possible only by those long weeks of practice. We went down the first channel — "buoying" as we swept — with eyes peeled for anything and everything. Again came that weak red signal: "Change course — change sweep formation — prepare to sweep parallel to the beach." Even in the Stygian blackness we could see the outline of the French coast.

Sixty minutes before H-hour! Now it seemed as though all hell had broken loose. Intent as we

were on our job, it was impossible not to see the terrific pasting the Germans were taking. Mighty reverberations shook the ship as the bombers hit the bull's-eye of their targets on land. Flares of every color imaginable lit up the surrounding coast, and much to our dismay they lit us up also. We were like sitting ducks on a pond, awaiting slaughter! Our ship presented a beautifully outlined silhouette only 1000 yards from the enemy gun emplacements, but we kept on sweeping and praying. Dawn was approaching fast and we could even see the shore guns now. Our task was almost over; just a little farther to go. We had been alone only a short while before, but now several cruisers had followed our swept channel and had dropped anchor awaiting H-hour. We finally completed our sweep, and still no enemy fire had reached us.

Then — *wheecough! baroomph!* We weren't out of it yet. That first shell had landed 50 yards on our beam, and the spray was a little too wet for comfort. *Wheecough! Baroomph!* This time 50 yards on our other beam. We had been bracketed with the first two shots. All engines ahead standard! Let's get the hell out of here! We weren't supposed to play David and Goliath with the shore batteries. That's what the big boys had followed us in for, and that is just what they were doing. Our two cruisers now traded shots with the 280-mm. guns that had started the fireworks.

Shells were still splashing around us when a Spitfire came zooming in, about 200 feet off the water, and started laying a smoke screen. That gallant ally paid with his life as an enemy shell scored a direct hit and the plane disintegrated in mid-air. Another Spitfire roared in to finish the job, his smoke screen completely enveloping us.

We eased off, recovered our gear; and then, for the first time since we had started in, radio silence was broken. We heard our squadron leader report to the Flag that Operation One had been completed, 98 per cent successful! The tension was broken as cheers rang out into the brisk Normandy air, and soon all one could hear was, "What have you got to eat, Cookie?" Fifty-two hours with little or no sleep had proved to be too much; after setting a small watch, the rest of us dropped where we were. Although the din of guns was terrific we slept peacefully, thankful that we had been able to do a good job.

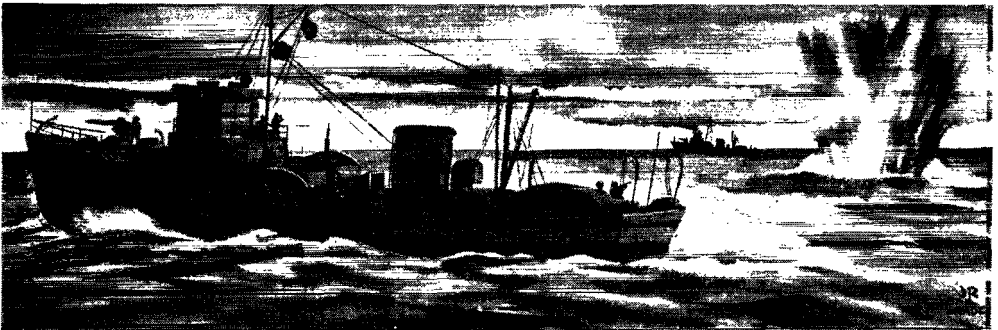

We exploded mine after mine that surely would have sunk one of our other ships.

After a brief but much-needed rest we took a look around, and saw a sight never before seen by man. Barrage balloons spotted the sky for miles and at the bottom of each balloon was an Allied ship. Above the balloons was an endless stream of aircraft — and they were all ours. For days on end they came — dive-bombers, fighters, medium and heavy bombers, and, the most impressive sight of all, the C-47s with their precious cargoes of paratroopers. Right into the most blistering flak ever encountered they flew undaunted, and soon the blue of the sky disappeared as it was covered by a blanket of billowy white with the opening chutes. Thousands of these intrepid fighters dropped from the sky, only to be followed by thousands more. Then came the men in towed gliders. From the sky and from the sea came our fighting men, Americans every one, each doing the task expected of him. They secured that stretch of Normandy coast, overcoming obstacles about which the public still hasn't been told.

We stayed at our beachhead, and swept the sea continually. At night, enemy aircraft would fly overhead and drop mines and bombs. The first week was a hot one, a week of night alerts and of German planes overhead. Daylight would find us clearing the channels again and opening new anchorage areas for our supply ships. We were in popular demand, and were looked on with respect as we exploded mine after mine that would surely have sunk one of our other ships. We ran up quite a score of mines off Normandy, and made a lot of friends doing it.

As our boys on land made good progress in knocking the enemy out, we were following them up. Harbor after harbor was captured, and as they came into Allied possession, we cleared them of enemy mines. Sometimes we worked together with British mine sweepers, but most of the time we were on our own.

We weren't always as lucky as we had been on D-day, and some of our boys are no longer with us. They paid the full price for that mine no

sweep-man ever wants to meet — that is, the mine which is swept not by the gear but by the ship.

But the rest of us are still here, sweeping and clearing enemy obstacles to our shipping. As long as the enemy is able to lay mines, we will be here to remove them.

When I started this story, I thought it might not be of interest to those hams who think of nothing but tubes and circuits, but after getting the story on paper, I've changed my mind. An amateur is a man who is ready and willing to serve his country. If he can do so with his radio experience, so much the better. But no matter what the job to which he is assigned, he does it to the best of his ability. The amateurs in this war are proving their worth in every branch and division of the services, and they have shown they have what it takes.

Strays

Keeping pace with the march of American armed might across the Pacific, the Office of War Information recently intensified its psychological warfare barrage against the Japanese by beaming to the Far East, for the first time, messages and programs from six new 50,000-watt transmitters on the West Coast.

These combined facilities almost double the hours of broadcasting to the Japanese and carry the Voice of America deeper and more completely into Japan, China, the Philippines and the entire Far East.

The new transmitters include four operated for OWI by NBC in the Sacramento Valley at Dixon, and two operated by CBS in the San Joaquin Valley at Delano. At both locations, dual transmitters have been built so that the same program may be beamed simultaneously on different frequencies to different areas.

Programs will originate in OWI's new studios in San Francisco and will include news, commentary, and especially designed radio features in many different languages and dialects.

Psychological warfare programs until recently had been broadcast over the Pacific area from four short-wave stations in and near San Francisco operated for OWI by the Associated Broadcasters and the General Electric Company.

This growing network of facilities, which carries on what the Japanese, in their dislike, term "thought warfare," was strengthened on December 26th when a new 100,000-watt short-wave station was opened in Honolulu and a 50,000-watt medium-wave station was opened on the island of Saipan. The Honolulu station relays programs from the American mainland — in addition to broadcasting programs it originates — on to the Saipan station, which in turn beams them into Japan. The six new transmitters will help to increase the volume of this relay system.

Medium-wave broadcasting can be heard on ordinary civilian receivers, and FCC monitors have reported that Radio Tokyo is attempting various means to prevent and discourage listening.

U. S. War Bonds for Stories of War Service

QST wants reports on the experiences of radio hams in active service on the battlefronts — for immediate publication in this section, where feasible, or to be held confidential where security considerations so require.

• Do you have a story of war service to tell — either your own or that of someone you know? Then write us a letter giving full details, including photographs, clippings and other substantiating data where available. If your story is published in **QST**, you will receive a \$25 U. S. War Bond. Please indicate clearly on the report if it is available for publication in its entirety, if names, dates or places should be deleted, or if all information must be held confidential.



25 YEARS AGO THIS MONTH

MARCH, 1920, was the month when we decided we were as well known and important as *The Saturday Evening Post* and permitted our cover illustration to all but obliterate the letters *QST* — to the untold confusion of news dealers, who couldn't tell a customer whether they had a copy of *QST* or not. After all, it's our biggest issue since the war — 80 pages.

The League places great stress on local radio clubs to coördinate local relaying activity and particularly to control QRM. Thus the leading article in the issue is on "Radio Club Organization" and maintenance, by F. H. Schnell and R. H. G. Mathews. "Minimizing QRM" is the major problem of the day, under which title the editor discusses the acceptor-rejector circuit of the British Navy, known as the Red Plug. Amazing selectivity is claimed for this system, signals differing from the desired ones by but 1 per cent being reported eliminated, as is considerable static. Considering our desperate need for a QRM minimizer, this circuit offers possibilities. A. L. Groves, of Brooke, Va., with a prewar reputation for long-wave reception in the days of towering loading coils, renders the first of his many reports "On the Use of Honey-Comb Coils," thereby giving those coils their first real impetus. Wm. F. Diehl, of A. H. Grebe & Co., describes the CR-3, "A New Regenerative Receiver for Relay Wave Lengths." The Old Man is heard from on the subject of "Rotten House," sitting up all night handling traffic. He sings that sad refrain, "Why Do I Do It?" Dr. Greenleaf W. Pickard, of Wireless Specialty Apparatus Co., is reported to be able to make a crystal detector oscillate by the application of 9 volts in series with it, controlled by a potentiometer. Traffic Manager J. O. Smith, in "A Little Journey," entertainingly describes his visits to relay stations in twenty states.

A Board of Direction has just been elected for two years. For the most part the names are the same but there are a few new ones. Pursuant to a recent amendment to the Constitution providing that persons engaged in the manufacture or sale of apparatus are ineligible, we have lost the services of Clarence Tuska, of the C. D. Tuska Co., and R. H. G. Mathews, of the Chicago Radio Laboratory. Filling these places and two other vacancies are four new men: John M. Clayton, 5ZL, assistant manager of the East Gulf Division; Francis F. Hamilton, 9ZJ, district superintendent for the Indianapolis region; A. E. Bessey, of the coal-burner at 6BR, and M. B. West, prewar 8AEZ. We look forward to a meeting at which all the members of our Board can be present. . . . *QST* is no longer available on subscription to nonmembers of the League. Effective next issue the newsstand price goes from 15 to 20 cents.

The nominal restriction of Canadian amateurs to a maximum wavelength of 50 meters has been lifted from December 30th until the opening of navigation on April 15th, during which time they may use 200 meters. The administration indicates that, if the results of this experiment are satisfactory, they are prepared to consider making the 200-meter wave a permanent assignment. A. H. Keith Russell has been named manager of the new Ontario Division, A. J. Lorimer for the St. Lawrence Division. The opening of traffic routes in Canada having been successful, the League announces now the formation of its Alaskan Division.

But there are plenty of relay troubles. Traffic Manager Smith reports that "the plain fact is that we cannot handle traffic with any certainty of promptness or regularity. . . . There is only one way to successfully handle traffic and that is in short relays. . . . There are many station owners, members of the League, good fellows, and of sound mind apparently, but who will not, for some reason, be content to be part of a successful system of relaying in short jumps — it must be 1000 miles or bust. And frequently they bust. . . . The policy of monopolizing traffic on the part of a few stations is wrong and is hereby condemned. . . . The unnecessary QRM caused by continual attempts at long-distance work is one of the greatest handicaps of amateur radio," he asserts.

The Home-To-Lunch Club, H-T-L, is announced. All you have to do is send out a CQ for traffic between 12:30 and 1:30 any midday. "Is the Sixth District backward?" an editorial wants to know. Numerous good traffic handlers in the Ninth District are weeping bitter tears because they hear sixes but can get no response to their calls. We think we know the answer: we are advised that one- and two-stage amplifiers are just coming into adoption on the Pacific Slope. We call upon West Coast amateurs to fix up their amplifiers so that we can get through to them.

KO, on shipboard near Cuba, has worked 3BZ, 1275 miles, 1AW at 1600, 9ZN at 1775. 5AC has heard a 300-meter signal at 2800 miles. 3AI has caused QRM in Peoria, 950 miles, while using a Ford coil with 45 watts input, his antenna 100 feet high. Clarence F. Bates, of Milwaukee, has been heard in Topeka, distant 400 miles, on a 2-inch spark coil.

Gear is in short supply because nobody could visualize the immense market when amateurs were reopened, only a few months back. VT-2s are available at \$18 but only for laboratory use, not for transmission or reception. . . . The Audiotron has now been licensed by DeForest but only for audio use. . . . The Magnavox "Tele-megafone" loudspeaker is now available, at \$75.



STRAYS



It is a familiar story in the traditions of ARRL that HPM got the idea of a national organization of relayers when reflecting one morning upon his experiences the evening before in trying to get a message through to Springfield, Mass. The purpose of the message was to get in touch with an amateur up that way who was reputed to be making vacuum tubes; HPM wanted one. The name of that amateur was R. T. St. James, 1IZ.

On December 29th last, at Moody Field, Ga., Robert T. St. James, now W1LGI of Pittsfield and a real old-timer, received the War Department Emblem For Meritorious Civilian Service at a ceremony attended by the entire post. The presentation was made by Major Charles N. DeRose, W1CND, deputy commandant. The citation commended Bob as "co-inventor of the present composite panel-switchboard-type code and blinker combination classroom method of instruction" as well as for his "ingenuity in devising a temporary system of instruction pending arrival of regular Army equipment" and for "exemplary performance of assigned tasks." The other co-inventor was similarly honored.

The photo below shows the OM and his Rube Goldberg—six tape machines putting code signals to 100 students' positions at speeds from six to fourteen w.p.m. The Super-Pro provides on-the-air traffic to an advanced group.

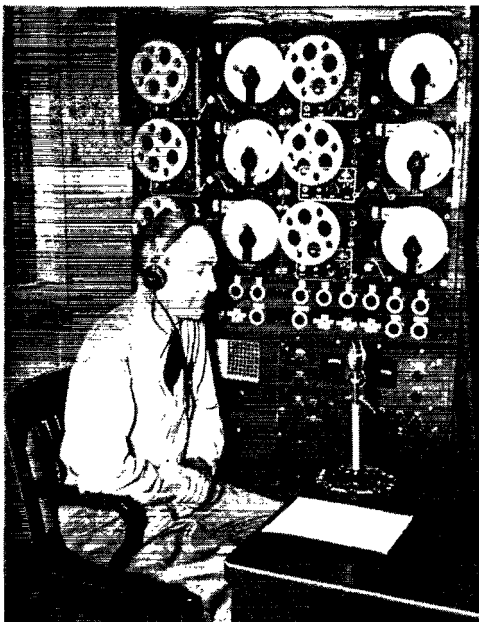

R. T. St. James, W1LGI-ex-1IZ, with the Rube Goldberg for which he and its co-inventor received the War Department Emblem for Meritorious Civilian Service.

Among the 513 prisoners snatched from a POW camp twenty-five miles behind the Japanese lines on Luzon, on January 30th, was Lt. William D. Gibson, SC, ex-W1DXZ. Gibson, technical engineer with the original Voice of Freedom station on Corregidor, went to the Philippines seven years ago to become associated with a radio firm. When the Japanese invaded the Islands he was commissioned in the Signal Corps. While imprisoned, W1DXZ with the help of another prisoner Lt. Frank Burgess, built a one-tube receiver of miscellaneous scrap. Typical of their improvisation was the use of tooth-paste tubes packed with acids for batteries. News picked up on the set was typed out and circulated about the camp. Gibson and Burgess were actually listening to the receiver at the moment the Rangers stormed the camp.

A recent cover of *Broadcasting* bears a photograph of a WLS mike being held up to a giraffe. We've always been told that the giraffe is the one animal incapable of making a sound!

W9CAA advises that the Canadian nickel is not the only well-known medium of exchange bearing an inscription in code. According to W9CAA, the pay-checks issued by the American Telephone & Telegraph Co. are printed on paper which is covered by the words "Bell System," spelled out, over and over, in Continental code.

W2IOP recently forwarded a list of ham calls gathered on his Short Shorter bill saying, "Just in case it ever becomes a contest, please file the following for reference: W1CAZ, W1FAP, W1FPD, W1GTF, W1ISQ, W2FKD, W2GQM, W2HXI, W2HYC, W2HZS, W2ISV, W2KAQ, W2KSB, W2KUS, W2KVY, W2NJO, W2NMA, W2NOB, W2NOV, W2NVG, W2NXM, W2OAH, W2WE, W3ELM, W3JSA, W3SA, ex-W4CP, W4HZC, W6CAA, W6CIO, W6COW, W6HWR, W6OLL, W7ENW, W7GMY, W7HWJ, W8PAG, W8WCG, W8WGZ, ex-W9PNO, W9QDZ, W9YAM, VE3PT, VE5JT, VP9L, VP9X, CT2BP, EI2M, G4RX, GI5QK, K4KD, K7EST and K7FGT."

W6NNF had just completed the installation of a low-frequency loading coil on a merchant ship when he was surprised to receive an invitation to a swell feed in the dining saloon. The sea-going sparks, delighted at having at last gained the use of his low-frequency rig, also pressed a tip onto W6NNF, reports W6NJQ who adds — "Take it from me, that tip is 'one for the book.' Usually we have to back off a ship fighting everyone from the captain on down!"

Among the numerous Christmas greetings received at ARRL Hq. appeared one containing a new and original ham abbreviation, as well as an appropriate military scene. Sgt. Joseph H. Kadlec, W9UIN, sent us a hand-drawn greeting card showing a red-nosed GI standing guard on the Siegfried Line. In the background is shown a pill-box from which projects a long gun barrel. W9UIN wrote: "The gadget sticking out of the pill-box is not a u.h.f. antenna or anything related to radio. It is an 88 and, in this case, that is *not* to be interpreted as 'love and kisses.' . . . My wife and I have concocted a new ham abbreviation — '38,' meaning 'I love you' — 3 little words and 8 little letters!" How do you like it, gang?

— — — — —

The many friends of XU3MA, Dr. William Malcolm, of Chefoo, China, will be happy to know that he is safely back in the U. S. A. after 52 years in China, 21 of them as port health officer at Chefoo, ending when the Japanese took over. Because of his advanced years the Japanese exempted him from internment and he was repatriated to Canada on the *Gripsholm*. He now resides at 956 Fifth Ave., New York.

— — — — —

Copies of the second edition of the useful and informative bulletin, "Difficulties Encountered with Electronic Equipment in Humid Climates," may be obtained upon request by writing to D. P. Carleton, Humble Oil and Refining Co., Houston, Texas. The booklet deals not only with experiences with various types of equipment in humid climates but also with suggested remedies.

— — — — —

A new slide rule, by which it is possible to determine mechanically the position of the decimal point in involved expressions up to 19 places, is announced by Picket & Eckel, 53 W. Jackson Blvd., Chicago 4, Ill. In addition, 30-inch accuracy for cube roots and 20-inch accuracy for square roots is claimed for this 11-inch rule.

— — — — —

A simple device for the testing of wire insulation has been developed by S/Sgt Pasquale L. Wamil for the War Department. Test voltage is applied between the wire and a tubular electrode through which the wire is fed. If the insulation breaks down at any point as the wire passes through the electrode, a relay is actuated which rings a bell. Thus it is possible to determine instantly the point at which the insulation breaks down so that the defective section may be cut out of the reel.

— — — — —

A model "airport radio-service shop" was recently opened at the Grand Rapids (Michigan) Municipal Airport. The shop occupies the ground floor of a building about 20 × 50 feet. Two screen-rooms have been set up. One is designed especially for the servicing of all types of automatic direction finders, and the other for the testing of aircraft receivers and transmitters. This field radio-service shop was set up by Lear, Inc.

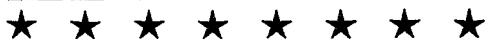

Gold Stars

DONALD D. KRUSE, RT1c, USNR, W7IZV, 23, of Camas, Wash., was killed by a bullet fired by a Japanese sniper on September 28, 1944, while he was on a reconnaissance mission on Peleliu Island in the Pacific.



Don received his amateur license in September, 1941, and therefore did not have much chance to operate before Pearl Harbor. He enlisted in the Navy on February 1, 1942, and completed basic training at Bremerton. This was followed by radio schooling at Stillwater, Okla., and six months' duty at Treasure Island, Calif. In July of 1943 he

was sent to the Southwest Pacific, seeing his first action at Bougainville and thereafter serving sixteen months as a radio technician in that area. He had gone ashore at Peleliu when our amphibious forces landed there in the middle of September.

Following W7IZV's death, his commanding officer wrote: "Only a few days before Don was killed he had saved the life of a shipmate who had fallen overboard between two vessels lying so close together their sides were almost scraping. Don climbed down a ladder and, without regard for his own safety, dove into the water and rescued his shipmate."

LEEO MASON, T/5, W8SPK, 35, of Detroit, Mich., was killed in combat on Saipan on June 27, 1944. He and two other soldiers were on guard duty, covering a road being used for bringing up supplies. They were surrounded by the Japs at 5:30 in the morning, and in the cross fire Leo was fatally wounded. His captain later declared that, had it not been for Leo's warning shots, the entire battery would have been wiped out.

W8SPK entered the Army on August 24, 1942, and completed the enlisted men's radio mechanics course at Fort Sill in November of that year. The following January he was sent to the Hawaiian Islands and was advanced to the rank of radio technician 5th grade. He participated in attacks on several of the islands in the Pacific theater, the last being Saipan.





HINTS AND KINKS FOR THE EXPERIMENTER



A FORWARD-READING "S" METER

HAMS who build their own receivers often desire to include a carrier-level or "S" meter in their sets. Unless one has a special meter whose normal needle position is at the right for zero current indication, however, the meter will read backwards. This means that maximum deflection with signal applied will be to the left. In order to have the meter read to the right at maximum signal it is necessary to invert the instrument. This often spoils the finished appearance of the set.

The circuit shown in Fig. 1 overcomes this difficulty. It consists of a v.t.v.m. with a modified Wheatstone bridge in the plate circuit. Values of components may, of course, have to be altered to adapt the circuit to conditions encountered in different receivers. With the values shown the circuit will function correctly with a 250-volt d.c. plate supply and an a.v.c. system developing up to 10 volts.

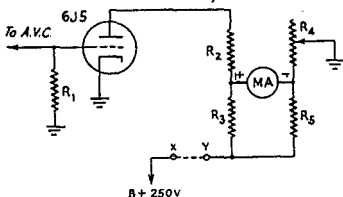

Fig. 1 — Bridge-type forward-reading "S" meter.

- R₁ — 1 megohm, ½ watt.
- R₂ — 20,000 ohms, ½ watt.
- R₃, R₅ — 50,000 ohms, ½ watt.
- R₄ — 100,000-ohm potentiometer.
- MA — 0-1 d.c. milliammeter.

To adjust the range initially, ground the receiver a.v.c. circuit and set R₄ for zero meter reading. Then remove the ground and tune in a strong signal. Note the point of maximum deflection, which should be at nearly full scale on the meter. If it is not, the value of R₃ and R₅ may be changed. Both resistors must be changed an equal amount to sustain balance in the bridge. Increase the resistance if the meter reads too high; decrease it if the reading is too low. A second method of adjustment is to insert a variable resistor between points X and Y. This may be a wire-wound resistor with a slider or a wire-wound potentiometer or rheostat. The first method eliminates the extra control, and thus is preferable.

A higher-range meter may be used, but the full-scale value should not exceed the maximum rated plate current drawn by the tube with zero grid-bias. — *Kenneth M. Miller, W9NQT.*

DON'T SHELVE THAT A.C.-D.C. SET!

HAVING spent many years at this hospital, I have been adopted into the family of nurses — and also into their families.

One of my inheritances, naturally, is the radio problems of the entire hospital. I don't claim to be a serviceman but seldom a day goes by that one or more sets do not come to me for servicing, and that involves the ever-present problem — a.c.-d.c. tubes and the lack of them. It twists my heart to have to tell a nurse to try and find a 12SA7 or a 50L6 — which is only an easier way of saying: "Shelve it." After one such set was shelved for months I figured out a plan for using 6-volt tubes requiring only a few easy changes.

This set had a burned-out 12SK7. I removed the leads from its socket in the set and connected two ordinary electric-light sockets and bulbs as shown in Fig. 2. A shows the original connections to the set while B shows the modified circuit.

Some of the changes that can readily be made are: 12SK7 to 6SK7 or 6SJ7; 12SA7 to 6SA7; 12SQ7 or 12SR7 to 6SQ7 or 6SR7; 12K7 or 12J7 to 6K7 or 6J7; 25L6, 35L6 or 50L6 to 6F6, 6V6, 6U6, 6L6, etc.

It is inadvisable to use outside adapters in r.f. and i.f. stages because of the possibility of unbalance in the circuits which might cause birdies. However, an adapter can readily be used in the a.f. section. Do not forget that a higher-wattage bulb will be needed because of the higher current of the power tube. Start with a 40-watt bulb and gradually increase wattage until proper voltage is applied. — *Harold Ramsey, W8TGU.*

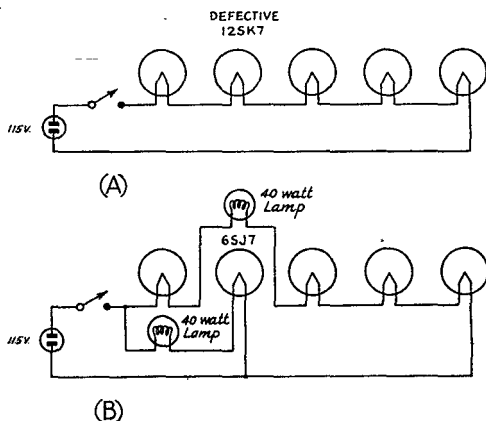

Fig. 2 — (A) A.c.-d.c. broadcast-band receiver before modification to permit use of a 6-volt tube to replace a defective 12SK7. (B) Circuit showing modification and addition of standard lamp bulbs as dropping resistors.

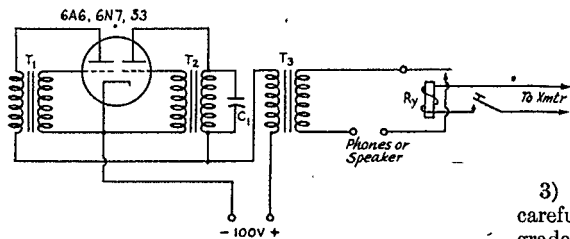

Fig. 3 — Dual-tone audio-oscillator keying monitor.

C_1 — 0.0005 μ fd.

T_1, T_2 — 3:1 audio transformers.

T_3 — Coupling transformer, 1:1, or may be same as others.

R_y — Normally open type s.p.s.t. relay to carry keying-circuit current through field coil.

DUAL-TONE KEYING MONITOR

DURING a lonely watch aboard ship an idea for a unique type of audio keying monitor came to mind. Instead of a pure 500-cycle or 1000-cycle note, this dual oscillator will produce a complex tone that brings joy to the heart of the brasspounder.

The idea, shown in Fig. 3, is simply to use the sections of a dual triode as separate audio oscillators, beating with each other. Their output is combined in a coupling transformer connected to 'phones or speaker. The tone is keyed by an open-type relay in series with the transmitter keying circuit. The field coil of the relay should be capable of carrying the normal load of the transmitter keying circuit.

It may not be necessary to use C_1 , as most audio transformer windings differ sufficiently to tune the separate oscillators to slightly differing frequencies thus producing a complex tone. — Jack C. Nelson, W8FU, WSUK.

CURING TROUBLE WITH HY75 TUBES

THIS information may be of interest to WERS nets using HY75 tubes. In the Worcester WERS, we have chiefly Abbott TR-4s and almost every station has had to shut down at some time due to HY75 tube failures. Few spare tubes are available so it meant that the station was off the air because of the difficulty in getting another tube. The transmitter also had to be recalibrated for each new tube.

A simple procedure has proved to work 100 per cent for the Worcester WERS when some of the following symptoms were observed:

- 1) Erratic or intermittent oscillation.
- 2) Red-hot anode.
- 3) Slightly blue color between plate and filament.
- 4) Plate current abnormal.
- 5) Tube ran hot.
- 6) Tube refused to oscillate except when whistling into mike.
- 7) No grid current flowing.
- 8) Better oscillation of tube when cooled by forced draft.

Of course, one of these symptoms is not a certain indication; but if two or three appear, try the following:

- 1) Heat tube without plate voltage.
- 2) Remove while warm. Do not displace tube caps any more than is necessary.
- 3) Apply a hot tinned iron immediately and carefully to both grid and plate caps. (Use a good grade of solder, if any is needed.)
- 4) Replace tube and clips when the caps have cooled.

The transmitter should function normally with no change in frequency if care has been taken in removing and replacing tube.

The apparent reason for the tube failure is the crystallization of solder connecting the grid-lead wire to the cap. This, so far as the oscillator is concerned, forms an open circuit, with a resulting open grid. The plate current jumps, and may exceed the tube rating if there is enough power available.

This procedure is not new, but I have not seen it described in *QST* before in connection with WERS gear. — Richard F. Atwood, WFBB-4/WFBB-12.

A SHORT-WAVE LOOP ANTENNA

IN AN attempt to receive DX broadcasts originating in the U.S.A. and in London, I have been experimenting with antennas of various types in an effort to minimize interference from undesired stations operating on the same frequency. Since the local set-up makes it impossible to string up a terminated rhombic antenna, I now use the old familiar loop, tuned to the desired short-wave band and rotated until one of the nulls is placed on the interfering station. While the performance of the loop does not compare with that of a rhombic, it does a better job of reducing interference than any other type of antenna for which space is available.

The frame consists of a wooden cross, 19 inches across by 25 inches high, on which are wound three turns of insulated No. 14 wire. The ends of the antenna are tied to the stator plates of a 35- μ fd. split-stator condenser. The condenser rotor and the center tap of the antenna are grounded to reduce hand capacity (and consequent change of tuning) to a minimum.

For coupling the antenna to the receiver I first tried a single turn, inductively coupled to the three-turn loop. When this turn was connected to the 600-ohm input of the receiver, the antenna tuning was affected by the tuning of the receiver. This was tried on the 9.5-11.75 Mc. short-wave broadcast band.

Next I removed the coupling loop and substituted a low-impedance match, tapping the antenna, 14 inches from the center tap on each side, and hooking the low-impedance leads to the receiver input. The loop was connected to about 4 feet of twisted line and mounted adjacent to the receiver.

The antenna tuning sharpened greatly and the signal strength came up to a level only one "S" point less than with a 75-foot outside antenna.

The results with this arrangement were startling. Tuning to London each evening on the 11.75- and 15.0-Mc. bands, I was able to keep them tuned in fine, and placing the null on German interference cut it down two or three "S" points on the receiver's meter. — Lt. Henry B. Plant, SC, APO 512, c/o Postmaster, New York, N. Y.

UNIVERSAL OUTPUT TRANSFORMERS USED IN MODULATOR

ABOUT the most common, and yet one of the more inefficient methods of plate modulating an oscillator or power amplifier, is the Heising or choke-modulation system. Many WERS constructors seem to have overlooked the possibilities of transformer modulation utilizing replacement-type output transformers.

Fig. 4 — (A) Transformer modulation using a conventional modulation transformer, (B) Transformer modulation using a replacement-type push-pull output transformer.

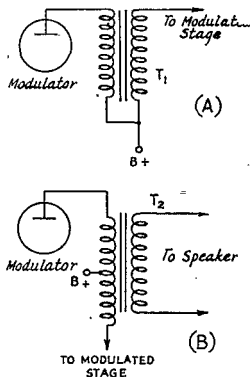

The usual circuit for transformer modulation of an oscillator or amplifier, when both r.f. and a.f. tubes are supplied from the same power source, is shown in Fig. 4. Here, T_1 is equivalent to an auto-transformer of the proper ratio, with the plate voltage fed in at the tap and the modulator and amplifier plates taken off at opposite ends.

For low-power use, advantage can be taken of universal replacement push-pull output transformers, which will satisfactorily handle the low power involved in WERS sets and which are at the same time satisfactory in transceivers or transmitter-receivers, since a speaker winding is also supplied. Thus one transformer, by a judicious choice of values, can be made to take the place of two with greater output efficiency.

For example, consider a 12-watt oscillator, say a 6V6, modulated by a single Class-A 6V6, with a plate-supply voltage of 300 in a circuit as shown in Fig. 4. The plate current of the oscillator will be $I = W/E = 12/300 = 0.04$ ampere (40 ma.) and the equivalent resistance of the Class-C circuit will be $R = E/I = 300/0.04 = 7500$ ohms. The recommended load impedance of the 6V6 modulator for 300-volt operation is 8500 ohms. This mismatch is permissible. However, in tube combinations where a 2:1 or 3:1 mismatch occurs, a

compromise must be made since the most generally available transformers have symmetrical primaries. It is preferable to put the higher load resistance across the modulator, which will give less distortion than the lower value, and accept slightly less audio-power transfer to the load, since this will help guard against over-modulation. — Alan Sobel, 80-02 82nd Avenue, Jackson Heights, N. Y.

SIMPLIFIED METHOD FOR CALCULATING L AND C ON THE SLIDE RULE

AFTER reading the hint "LC on Your Slide Rule" in November *QST*, I developed an alternative method requiring only one setting of the slide.

The formulas used are as follows:

$$f \text{ in cycles} = \frac{1}{2\pi\sqrt{LC}} \text{ when } L \text{ is in henries, } C \text{ in farads.}$$

$$f \text{ in kc.} = \frac{159}{\sqrt{LC}} \text{ when } L \text{ is in } \mu\text{h., } C \text{ in } \mu\text{fd.}$$

Therefore, $f\sqrt{LC} = 159$; $LC = \left(\frac{159}{f}\right)^2$, when f is in kc.

To find LC for, say, 7300 kc. on the slide rule, first set 7300 on scale C above 159 on scale D . Then read the LC value on scale A — in this case 475.

If L is given, C may be found by setting its value on scale B under the LC value. The reading appearing on scale A over the index (1) on scale B will be the value of C .

This method may be used for cycles, kilocycles or megacycles, farads, microfarads or micromicrofarads, henries or microhenries, when the correct placing of the decimal point is mentally calculated. — Murray MacKenzie, 520 Euclid Ave., Toronto, Ont.

ADAPTER FOR OCTAL-BASE RECTIFIER TUBES

HERE'S a handy idea in these days of hard-to-get rectifier tubes. Add a few jumpers to the

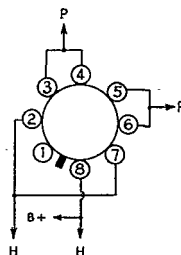

Fig. 5 — Jumpers added to an octal tube socket to permit use of various types of 5-volt rectifiers.

socket, as shown in Fig. 5, and any 5-volt octal-base rectifier tube (such as 5T4, 5U4G, 5V4G, 5W4, 5X4G, 5Y3G, 5Y4G or 5Z4) will operate. — W. T. Watson, RT1/c, USCG Training Station, Groton, Conn.



CORRESPONDENCE FROM MEMBERS

The Publishers of *QST* assume no responsibility for statements made herein by correspondents.

SABOTAGE, SABOTEURS—AND THE HANDBOOK

APO 493, c/o Postmaster, New York, N. Y.
Editor, *QST*:

. . . Our highest commendation for that most digestible manual, *The Radio Amateur's Handbook*. Well written, excellently illustrated, a model of technical instruction, it was deservedly regarded as an important component of our files—until a recent catastrophe. . . .

Two nights ago, when a suspiciously nibbled edge was observed . . . the matter was lightly dismissed. The *Handbook* was replaced in the files and the incident forgotten. This morning, unfortunately, our carelessness bore bitter fruit—for caught and killed in the middle of his breakfast was the culprit, a large India rat. He was eating—you have guessed it—our *Handbook*.

It is true there was some measure of satisfaction in the revenge afforded by the violence of the rodent's death; nevertheless, it is also true that prior to his end he had digested the book, thoroughly, up to page 79—Chapter Four, Section 3-9, on the oscilloscope! Need I say ours was a grievous loss?

It is our humble suggestion that a copy of the *Handbook* be forwarded to a competent biochemist, to discover, if possible, the palatable qualities of the paper which members of the rodent class find so stimulating. Experimentation in this field may eventually lead to a more substantial overseas' product—making disasters such as ours bad dreams of the past.

— *M/Sgt. Julius J. Owsik, W2DYO*

105 E. Washington St., O'Fallon, Ill.
Editor, *QST*:

I was sitting peacefully in a movie theater, watching a newsreel of the captured German saboteurs who recently landed off the coast of Maine, when on the screen flashed pictures of their radio equipment. I almost jumped out of my seat, because next to the German's transmitter lay a copy of the ARRL *Handbook*.

I have always realized how much the *Handbook* has meant to my brother, W9ZIF, and myself, but now that the enemy knows how essential it is . . . I suppose it is no longer a military secret that we call it the "ham's bible."

— *Thomas T. Gordon, LSPH*

165 Church St., Milton 86, Mass.
Editor, *QST*:

Just noticed a scene in the latest Fox Movie-tone News (No. 37). It is part of the sequence on

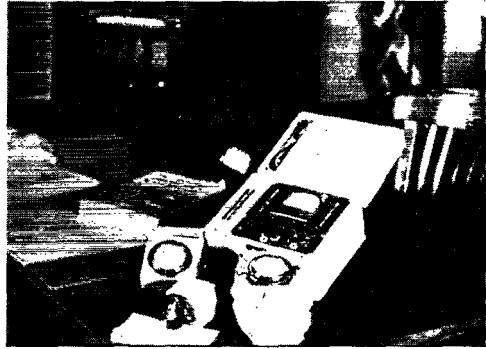

the two Nazi spies that the boy in Maine tipped off to the FBI. Frankly, I think the radio apparatus itself was a "prop"; if it isn't just a voltohmmeter plus a couple of milliammeters, I'm blind. But even spies apparently need a copy of the *Handbook*!

— *H. J. Lydon*

V.H.F. UNDER FIRE

Somewhere at Sea

Editor, *QST*:

. . . You've been asking the boys to report on their experiences on the battlefronts. I was serving aboard the SS *George E. Pickett* as chief radio operator when the allies invaded Normandy. Our ship was one of the first large cargo vessels to appear off the invasion beachhead on D plus one.

It was our job to man the v.h.f. equipment in the shack and also take care of operating the walkie-talkie on the flying bridge during enemy air attacks, passing on fire-control instructions to the gunnery officer. It was tough enough being cooped up in the shack while the firing was taking place, but being up on the flying bridge taking care of the walkie-talkie and dodging all sorts of lead and steel being fired at you was quite another thing. To say the least, it really felt good to take off our boots for a change when we returned to England a week after D-day.

I might add that during the next six months, while I was aboard ship getting supplies over from England to France, I ran into quite a number of operators from the other ships that took part in the invasion. . . . I'm mighty glad to pass the information on to you that a good percentage of those operators are or were at one time or another hams. . . . Wherever there's a good scrap going on, you're sure to find the amateurs right in the middle of it.

— *Ensign Max Plung, USMS, W2HNR*

BOOKS IN COMBAT

109 Powell Ave., Ottawa, Canada

Editor, *QST*:

I have just returned from Europe after four years in the combat areas, where I found the various ARRL publications of great value for reference and instruction. Grammer's little book, *A Course in Radio Fundamentals*, worked wonders in bringing my technicians to a higher standard of knowledge.

In fact, these books were so valuable that I did not have the heart to bring them back with me and thereby rob twenty men for the benefit of one flight lieutenant.

— *F/Lt. W. M. Marshall*

NO BETTER READING

c/o Postmaster, New York, N. Y.

Editor, *QST*:

. . . Thank you for your prompt action on my request for the back issues of *QST*. Here in the hospital there is little besides reading to do, and for a ham there is no better reading than *QST*. I haven't as yet met any of the local amateurs, but I get to town now and then and I'm going to see if I can locate some of the gang.

I was very much interested in some of the items mentioning postwar allocation of frequencies for the amateur radio fiends. It's nice to know we have someone at home to insure a fine future for the best hobby in the world. You will have a new member one of these days; the XYL is boning up so she will have her ticket by the time I get home. . . .

— *Sam W. Ekom, W7IGO/W6UOA*

PRE-WI/KA

Somewhere in the Philippines

Editor, *QST*:

. . . I'm out here as engineer on a Press Wireless unit similar to the one in Europe about which no doubt you have heard. I have been in the Pacific theater for some months. We came out as far as New Guinea by air and thence in a convoy, arriving on the beach in the Philippine Islands in the early part of November. We set up operations and established the first commercial communication circuit from the Philippines to the U. S. since the Japs took over on December 31, 1941. Contact was made on November 14th, after we'd been on the air but twenty minutes.

Our transmitter is a 400-watt job feeding a rhombic antenna. We have worked as high as 425 words per minute, and during a portion of every day we've had a high-speed tape signal direct to Los Angeles. Our business is all press — about everything you've read in the papers from here the past few months has been handled on our circuit.

The set-up here would do far more justice to a typical ham installation than to a point-to-point commercial job, but it's a case of making

out with what you have to work with. There isn't any radio store a few blocks away.

From the standpoint of "pioneering," I think the job we did was typical of the ham spirit. And from an engineering point of view a description of the set-up might be of interest. We set up the station and made our first contact without so much as a pair of pliers. We had a screwdriver which I had brought with me and a few mechanic's tools which came with our gas-engine generator set. We had troubles aplenty with the high humidity, rain, evening air activity and other things which will have to await the telling. We were even delayed more than twenty-four hours by a bombing which destroyed our transmitting antenna.

During the first few weeks on the air we had a single light bulb to illuminate our rather dark operations point. We were located in a corner of a big concrete building with few windows. Repairs on equipment were often made by flashlight or lantern light.

The receiving installation uses Hammarlund Super-Pros, modified slightly to meet our special requirements. The receiving-antenna arrangement has varied; most of the time, however, we've used a Vee. At times this has been put out of commission, and then we've fallen back on the familiar doublet.

As if we didn't have enough grief, a swarm of ants got into our keying oscillator unit, choosing a shielded variable condenser as an assembly place. The unit had to be torn completely down, sprayed with bug killer, cleaned and re-assembled.

But, to date, we haven't been off the air except for routine maintenance since our initial contact of November 14th.

The unit is under the direction of H. E. Stovall. Ed was formerly manager of Mackay Radio in Manila and since the Fall of 1941 has been with Press Wireless at Los Angeles. Our chief engineer is George Luekey.

My job is associated with the receiving and terminal equipment (keying apparatus, perforators, etc.). I also handle any voice transmissions made via our facilities. It seems odd to be talking with the engineers in Los Angeles and yet realize how darned far away home actually is.

All in all it has been a real adventure, and we all feel that a good job has been done thus far. But there's still much to be done and it may be a long time before I get back to the States.

— *T/O Forrest A. Bartlett, W6OWP*

WANTED: A STORY ON WSL

c/o Fleet Post Office, New York, N. Y.

Editor, *QST*:

I think that an article giving information about and the history of WSL, the loudest station heard on 500 kc., would be very interesting to all hams in the Navy and merchant marine, especially those normally in the Atlantic. I surely would like to read about it.

— *Jack C. Nelson, W8FU-WSUK*

ECHOES OF AN HISTORIC QSO

Loudon, N. H.

Editor, *QST*:

Among the many interesting things appearing in the magazine every month, one of the most intriguing is the section recalling "25 Years Ago This Month."

In the January issue, on page 41, there is a line that is of particular interest to me — ". . . and a New York ham is reported to have worked Ohio on voice on 10 watts." I wish to say that the report was correct, although no one knows how much grief was necessary before it took place. I happen to be the fellow that actually did it, but the transmitter was assembled by a Navy CPO named Daniels. (Shortly afterward he worked on the gear which first made possible the complete operation of a battleship by remote control.) The transmitter used W.E. "E" tubes. Our station call was 2ARA. The call of the Ohio station I cannot remember; unless I am mistaken, however, the town was Oberlin.

At present I am not very actively connected with radio. Instead of working on the stuff described in *QST* I now help to print it. My job is that of pressroom foreman at the Rumford Press in Concord. The only radio work is with the Fire Department set-up here in the state, operating on 39,420 kc., a.m., under the call WLOM

Thanks for recalling "the good old days."

— J. Westly Robinson

HOW AN AIR-WAC LEARNED THE CODE

73 Middle St., Wiscasset, Maine

Editor, *QST*:

One evening not so long ago, as I sat toying with the dust-covered key and dreaming of the good old days, a YL friend of mine burst into the shack. Said she, breathlessly: "I joined the Air-WAC today and they told me that there was a good chance that I could get into radio communication if I knew the code, and I have a three-week furlough before reporting for active duty, so how about teaching me the code?"

I gazed at her dubiously for a moment and then, glancing at my trusty key, felt the challenge to a true ham. "Okay, toots," I said, with my fingers well crossed. "Here's a copy of the ARRL *Handbook*. Take it home and study the code table, and report tomorrow night for practice."

Much to my surprise, she appeared promptly the next evening. We set to work with a buzzer loaned by my good neighbor, W1GXY. She had learned all the characters, including the numbers, from the book, and had them down pat by the dit-dah method.

Three weeks later to the day her code speed was fourteen words per minute, solid, on either straight or code group copy as per the standard FCC five minute test. . . . If that is not a record then my seventeen years of hamming have failed me.

She left for her basic training in the WAC, happy in the thought that she would be a radio

operator. However, she is now doing clerical work at Fort Oglethorpe. Ah me, the Army . . .

— Bernard Seamon, W1AFT

KILOHMS?

3001 Cypress Ave., Cleveland 9, Ohio
Editor, *QST*:

For some time I have been using several abbreviations relative to resistor and condenser values, and find them much more easily handled than a series of zeros. I believe they warrant adoption by the field.

For instance, a resistor of 5000 ohms can be read 5 ko., meaning, "five kilohms"; one of 15,000 ohms, 15 ko., etc.; and a resistor of 600,000 could be designated 6 cko., meaning "six hundred thousand ohms."

I like the abbreviation "kilo" in lieu of "000," and believe it rightfully deserves to be used.

— George R. E. Kepler, W8OT

QST ARTICLES

375 E. 205th St., New York 67, N. Y.

Editor, *QST*:

. . . The choice of articles in *QST* is swell. Are articles about microwave technique out for the duration? Yes or no, keep up the good work. . . .

— Alexander Jaffe

A RADIOMAN'S NIGHTMARE

Gary, Indiana

Editor, *QST*:

The following poem was written by S. W. Scott of Los Angeles. It is intended to be sung to the tune of "Mairzy Doats" — if you haven't forgotten that one by now:

A.c. volts
And d.c. volts
And little ohms and amperes.
A little inductance, too,
Wouldn't Q.

With micromhos
And e.c.o.'s
And little microfarads,
I'm more than a little nuts.
Aren't you?

If these terms sound queer
And screwy to your ear,
A bit off resonance and freaky,
Say LCR and a.v.c.,
I think my condenser is leaky.

Ohmzy's Laws
And Kirchoff's bores —
This is a little crazy.
Radio's crazy, too.
Aren't μ ?

— Anton Varga, jr. RM1c, W9W1B



OPERATING NEWS



CHARLES A. SERVICE, W4IE
Acting Communications Manager

LILLIAN M. SALTER
Asst. Communications Manager

Ham Help for Ex-Service Men. In Op News in the January issue of *QST*, we suggested that amateurs and clubs give some thought to helping blinded vets toward an understanding and appreciation of amateur radio in the hope that the social contacts over the air would be a genuine contribution to rehabilitation. Certainly we can think of no more splendid project on the part of any individual or group. Some of you have been privileged to meet personally sightless amateurs in prewar days and know the great boon ham radio has been to our less fortunate brethren, who might otherwise live a lonely existence apart from the physically normal world. The time is at hand when war casualties are returning from the battlefronts in growing numbers and our aid to the blinded and disabled servicemen must start now, if at all.

We are in receipt of a letter from an Atlanta amateur, who has put this idea into practice so beautifully we are quoting his letter in full. His work goes beyond the confines of amateur radio and embraces ideas which can be put into execution, with minor variations to suit local needs, by all hams or clubs in a position to undertake such a program. It merits your careful study.

Communications Dept., ARRL:

"You might be interested in knowing that for the past two months I have been conducting radio classes at Lawson General Hospital near Atlanta. These classes are under the sponsorship of the Red Cross and were started after a conference with Captain A. Reiger who heads the occupational therapy department at Lawson.

"I spend each Monday night in the occupational therapy shop conducting classes in radio construction and repair. All the receivers are in kit form so the patients can continue the work without an instructor during the rest of the week. I am also giving theory during the shop period. A teleplex code practice set is available at any time.

"On Wednesday afternoon I spend a half hour in the shop giving any help I can with the kits or repair work and then go to the various wards to work with the bed patients. As most of these men are taking the USAFA course in radio, I spend some individual time with each, explaining any theory that is not understandable and giving instruction in the assembling and wiring of kits.

"Tools and soldering irons are brought to each patient and as many are in traction the assembling of a receiver is a great help to those fellows who are amputees. As standard kits are difficult to buy, all the drilling of holes on the chassis is done by the radio classes at Tech. High School for the bed patients. The ambulatory cases that come

into the shop are given a 'hunk of tin' and a handful of parts and told to 'make it play.'

"I can advise anyone who attempts to interest men of the type that are at Lawson, that selling them on the idea of learning radio is one of the most difficult jobs I have ever had, in spite of the fact that I have taught high school and trade classes for twenty years. The most gratifying part of the job is to see the men gradually change their views of life when they find that, in spite of their amputations, they can still do everything a normal man can. Some of the fellows who have had their right arms amputated really do a masterful job of left-hand soldering.

"I treat all the men as though they were normal, although some find it necessary to create their own ways of doing things. The best method is to expect from them the same results as if they were entirely normal. In our high school classes we are taking care of the 400-odd radio receivers at the hospital but we are gradually bringing them into the O.T. shop so that the amputees can receive actual repair experience.

"The cost of the kit parts is divided between the Red Cross and the local Elks lodge.

"I am sure anyone who starts classes such as we have at Lawson will have the satisfaction of knowing he is really contributing to the morale of these wounded men. To see a man with very little desire to live take an interest in radio and then begin to talk about going to radio school when he is discharged, is well worth the effort spent in organizing the work.

"I would be glad to advise anyone who wishes to start a class in a government hospital or rehabilitation center, if he will drop me a line."

— C. H. Krueger, W4YC-W4BCR,
Radio Instructor
Technological High School
Atlanta, Georgia

So, fellows, there you have it. W4BCR has done the spade work and has gotten results; he is willing to pass on his experience to others who have the time and inclination to help where help is needed. We can think of no other project which will bring more lasting happiness to a disabled veteran coupled with more personal satisfaction to the amateur. Let the CD know what you do.

Amateurs Operating. To those of you who think ham radio is completely shut down around this war-ridden earth, it will be welcome news that a few, a very few, amateurs are still operating in a very few places.

Information reaches us from OA4D in Miraflores, Peru, via Robert Hoiermann, Alliance, Ohio, that he, OA4E, and one other Peruvian

Ohio CAP Field Day

THE communications sections of the Ohio Wing, Civil Air Patrol, assembled November 12, 1944, with radio equipment for a day of activity at Ohio State University's Don Scott Airport, the official airport of the Ohio CAP Wing.

Inasmuch as it was the first display of CAP 112-Mc. equipment in Ohio, the general public, and especially members of WERS units in central Ohio, attended the meet.

Also present were high CAP officials, including Major Frank A. Adams, USAAF, National Communications Officer of the CAP; Lt. Col. George A. Stone, CAP, Ohio Wing Commander, and Major Kent H. Smith, CAP, Wing Operations Officer.

Army officers included Capt. T. S. Stein, Signal Supply Officer of Fort Hayes, and Lt. J. L. Deets, Communications Officer of the near-by Lockbourne Army Air Base. These officers acted as judges aided by Professor Robert C. Higgy of Ohio State University.

Army radio equipment was offered as prizes in addition to the equipment donated by local jobbers. Awards were made to the squadrons represented by the winning contestants. Army prize awards included three complete compass units with motor-driven loop antennas, receivers, dynamotor power supplies and azimuth and compass meters. A complete ferry-command set, including a two-band crystal-controlled transmitter, two receivers and power supplies, all neatly installed in a large leather carrying case made up another prize as did a high-powered transmitter like those installed in the Flying Fortress.

Eighty-one enlisted CAP members registered for the meet and about twenty-five airplanes had been flown in earlier to participate.

The first event was the code speed contest conducted by Army operators from the Lockbourne Army Air Base, under the direction of Lt. Deets.

First place was won by Lt. Paul R. Wagner of Toledo. Wagner, using Army code procedure, received two minutes of straight copy at a speed of eighteen words per minute without an error. Second prize was won by Sgt. Frank Hackman of the Lima squadron. Lt. Paul Crowell of Springfield placed third. All copying was done by hand.

Lt. Wagner, who incidentally stole the show by winning first place in two other events, was issued a radio compass unit for the Toledo squadron for his efforts in winning the code speed event.

In the afternoon engineers from the University's station, WOSU, arrived with portable equipment to broadcast the events.

Then began a general inspection of the equipment on display in the hangar. The gear was judged for engineering, neatness and performance. Specifically, the judges were called upon to select the best transmitter, receiver, transceiver, smallest transceiver and best portable v.h.f. antenna.

The transmitter award was made to the Cleveland squadron; receiver, Canton squadron; transceiver, Toledo squadron; portable v.h.f. antenna, Toledo squadron. The smallest transceiver prize went to "Tiny Tim," a unit so small that

amateur have permission to operate, but OA4D is the only one who really works at it to any extent. He has a sked every Saturday at 4 p.m. Peruvian time (2100 GMT) with CX3CN in Montevideo, the only Uruguayan ham permitted to operate in his country. The latter is a bed-ridden cripple and, as radio is his only diversion, his government granted him this privilege. These stations operate on the low end of 20 meters.

Hams in Paraguay are permitted to operate, but we have no information on frequency or type of transmission. However, as many South American countries allowed prewar civilian 'phone operation without technical proficiency or code requirements as we know them and no amateur in the States has reported hearing c.w. ham sigs from the south, we infer it is not the sort of operation to intrigue the ham.

The Chinese amateurs have been consistently active in spite of years of war in their land, and the China Amateur Radio League manages to hold a convention annually. President Bailey and Secretary Warner of the ARRL have sent congratulatory messages via short wave broadcast to these meetings, which have been rebroadcast to other members of the CARL in China unable to attend. No Chinese amateurs have been heard in the United States since our shut-down, so we presume they use v.h.f.

Last — and by all odds least — we learn that what passes for amateur operation exists in Germany, of all places! One of our GIs in Belgium swears on a stack of *Handbooks* he heard a whole flock of Ds working each other on about 6800 kc., calling CQ in the approved fashion, exchanging RST reports and signing off with 73. We believe the GI but we smell a rodent elsewhere. Anybody confirm this?

ARRL Makes WAVE. This heading appeared on a recent news release from OCD, on the occasion of Carol Witte, W9WWP, former acting communications manager, joining the Navy. Carol is now cooking on the front burner, as she has finished boot training at Hunter College, been transferred to duty at the Naval Hospital, San Diego, and is an HA2c. — C. A. S.



Left — Lt. Carl M. Lang, Cleveland Group Communications Officer, shows "Tiny Tim," to Capt. E. G. Enderle, W8MDX, Ohio Wing Communications Officer. This transceiver, which is so small it can be held in the palm of one's hand, has been used for two-way communications out to six miles. Right — Two WACs from the Toledo Squadron, CAP, examine one of the three automatic compass receivers which were awarded as prizes at the state-wide communications meet of the CAP in Ohio.

it can be held in the palm of the hand. It was built by W/O George Youncker of Cleveland, who, incidentally, also built the winning transmitter. Youncker was unable to attend the meet, being confined to a hospital because of a serious illness, but his equipment was entered by Lt. Carl Lang, Cleveland Group Communications Officer.

After the judges had announced their decisions, the DX contests began. Plans were altered to terminate the contests as quickly as possible in order to permit those who flew to the meet to take off in time to reach their base airports before dark.

Inasmuch as some pilots were ready to leave, the contests were consolidated with the take-offs.

Capt. John Koch took off with Lt. H. K. Miller as operator in the official contest plane. Ships entering the DX contest then took off. The contesting ships flew in formation and were called one at a time by Miller, who flew at a distance of about fifty miles from the contestants and picked the winner by comparison of signal strengths. The event was won by the Lima squadron. The contesting planes then continued on their way homeward.

The official plane remained in the air calling each of the ground contestants in turn, and recorded the various signal strengths. This event was won by the Cleveland squadron, with the Lima ground radio crew running a close second.

After the competitive events, contestants were assembled and awarded the equipment prizes. Major Adams, in addressing the group, promised continued aid in the developing of the equipment. He also revealed that this was the first such event ever held by the CAP, and stated that he was very pleased with the work being done by communications personnel in Ohio.

— Capt. Edward G. Enderle, W8MDX,
Communications Officer, Ohio Wing, CAP

Hidden Transmitter Hunts for WERS

ALTHOUGH no illegal 112-Mc. transmitter operation has ever been reported in the Cincinnati area, members of the Queen City Emergency Net feel that they are now in a position to run down any such stations quickly and efficiently. They have about fifteen mobile units equipped with various types of 112-Mc. directional antennas, as well as several battery receivers so equipped. As for experience, they have five "illegal transmitter hunts" under their belts, with more to come.

In May of 1944 it was decided that the development of direction-finding equipment for WERS use might prove helpful, not only in running down illegal transmitters, but also in discouraging their appearance. The matter was discussed by QCEN officials and the area radio aide for WKHO stations, J. H. Thornell, who gave his approval. The first hunt was scheduled for July, 1944, and the QCEN members started construction on directional equipment.

The transmitter was hidden at a point in a fifty-square-mile area in the suburbs of Cincinnati. The boundaries of

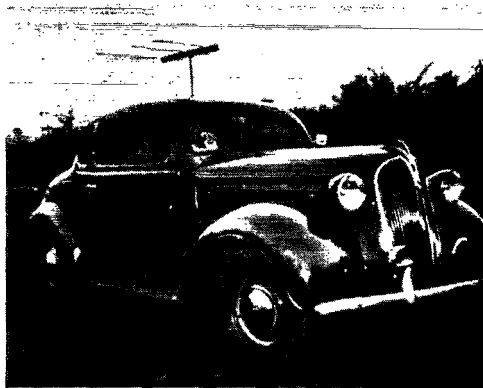

This three-element horizontal beam, mounted on W8PNQ's car, won first place in the only hidden transmitter hunt in which it participated. The "J" antenna at the rear is not associated with the directional beam.

this area were published in *The Listening Post*, official organ of the QCEN, along with rules of the contest. United Radio, of Cincinnati, volunteered to donate about \$12.00 worth of prizes for the first three "finders."

An Abbott TR-4 was used as the hidden transmitter and was continuously modulated by a c.w. oscillator except for voice announcements every five minutes.

Four of the ten contestants found the hidden transmitter within the allotted two-hour WERS test period.

Four more similar hunts were held during successive months. Each time the transmitter was hidden by a different group in a different part of Hamilton County and Northern Kentucky. As the "hunters" became more experienced, the "hidlers" became more tricky. The transmitters were hidden beside cliffs, among hills, etc., to cause numerous reflections, and in the November hunt a three-element directional beam was used on the hidden transmitter, and the signal bounced up a valley. Also, the announced area in which the transmitter was hidden was increased to seventy-four square miles. In spite of this, the transmitter hidden in the November event was found first in twenty-three minutes, and second in fifty-six minutes.

Now a word about the various antennas used. For purposes of comparison, a point system of scoring has been adopted. Each first place won by an antenna scored 5 points, each second place 4 points, each third place 3 points and each fourth place 2 points. In the five hunts that were held, the points per type of antenna stack up as follows:

Three-element vertical beam	22 points
Three-element horizontal beam	16 points
Single-element horizontal	6 points
Quarter-wave vertical loop	4 points
Body-shield method	3 points
Miscellaneous and special antennas	11 points

Thus we see that the three-element beam (utilizing a $\frac{1}{2}$ -wave driven element, with one director and one reflector) is well in the lead. Used vertically, it has given better results than horizontally, probably because vertical polarization was used by all the hidden transmitters.

The users of the three-element vertical beam found that at a distance, the maximum point could best be worked, while close to the transmitter, the null point off the back of the beam proved the most effective. The beam-type antenna proved more accurate than the loop type because of the fact that loop antennas are bidirectional, and also because 180° displacement of the two maximas could only be obtained when the loop was physically tuned to the exact frequency of the received wave.

No matter what type of antenna was used, in order to get good results while close to the hidden transmitter, it was necessary (1) to have a well-shielded transmission line, and (2) to decouple and *detune* the strong signal so that it was being received only weakly.

Reflections from hills and along power lines caused quite a bit of confusion when not properly interpreted. Thus readings had to be taken from the high points where possible, and away from power lines.

There were varied methods of using the different types of antennas. The horizontal beams generally were mounted on the tops of the cars and controlled from the inside, either by means of a shaft through the car roof or remotely by means of electric motors. The vertical beams could not be worked in this manner due to tree interference while in motion. It was generally necessary to stop for readings, and either to get out and raise the beam, or to raise it alongside the car from the open car window.

There are several different methods of starting these hunts. Each person may be allowed to start where he wishes, all may be required to start from a certain point, or a certain area may be set aside as the starting area. We have found that letting each person pick his own starting place, either in or out of the announced area, is the most satisfactory. Receiver interference is practically eliminated by this method. Also, we have found that the person starting farthest from the hidden transmitter is just as likely to find it first as the person starting close by.

Besides being good training these "illegal transmitter hunts" are quite exciting, as anyone who has ever participated in one will realize. We have found that it is an excellent way to encourage more WERS activity, and strongly recommend such hunts to any radio club that finds interest lagging.

— William D. Montgomery, W8PNQ

Ham Yarns

What is the most unusual experience you have ever had in connection with ham radio? Have you ever had a QSO that took place under peculiar circumstances, or that resulted in an exciting adventure? Have you ever been surprised, terrified, or highly amused at some incident that occurred during the good old days when you were operating your ham rig?

CD invites you to submit your story of the most unusual ham yarn you know of, whether experienced by yourself or a fellow amateur, for possible publication in *Operating News*. All stories should contain approximately 500 words, must be true, and must center about the subject of ham radio.

Each winning "Ham Yarn" will be published in this department, and the author may select a bound *Handbook* (Defense or regular edition), *QST* binder and League Emblem, Lightning Calculators, or any other combination of ARRL supplies of equivalent value (\$2.00), as his prize.

All entries should be marked "Ham Yarns" and addressed to the Communications Dept., ARRL, West Hartford 7, Conn.

Ham Yarn No. 5

BY WILLET E. BATCHELDOR,*
WSUMT

IN ALL innocence we bring things upon ourselves. For example, let's take the evening I explained loop modulation to France Paulis. France was the kid who, in 1923, lived just behind my shack in Akron, Ohio, and who pestered me, after the manner of kids, as to how this part and that part of 8HN worked.

Thus one summer night I explained vaguely, "Loop modulation is very simple. That coil of wire sitting in the oscillator tank is in series with that carbon mike. The coil absorbs more or less current from the tank according to the way the resistance of the mike is changed by your voice or other noise. That makes variations in the wave put out by the transmitter and those variations appear as voice in the 'phones of whoever happens to be listening."

No mention of carrier shift, frequency modulation or anything like that. Those were the carefree, if not the good old, days.

France left the shack, his round blue eyes bulging as they always did after watching the meters of my 50-watt Hartley twist and twirl with the peaks and depressions of loop modulation.

During the next few days I watched a fifty-foot pole go up in the Paulis' back yard and an inverted L and counterpoise similar to my own aerial system shape up.

Beyond thinking, "Oh, oh, that means QRM soon!" I wasn't much interested. I was engaged in building a new electrolytic rectifier. Anyone who thinks slop jars can't engage you never built a 50-pint borax job.

Paulis' aerial and my rectifier wound up at about the same time.

A proponent of direct action and too lazy to rig a dummy load, one morning I cut the raw rectifier into the transmitter and, after a few diddledaddles, threw on the power.

Eventually the house wiring quit jumping, the wattmeter settled down to a pleasant howl and I punched the key. Having nothing better to do, I kept the key down and watched the aluminum form into beautiful sparkling oblongs as the amps went into the air.

Fifteen minutes passed. Time to get a person-to-person report on the new juice-jars I judged. On went the regenerative, out went the loop modulation in a wideband CQ.

* 731 Hillsdale, Akron 3, Ohio.

Back came a 14-mile distant reply from a ham in Wadsworth, 8ZZZ. His first remark was —

"Boy, has your modulation come up? Lot louder now, Old Man."

How he argued when I said I hadn't modulated all morning. He insisted, in fact, that he had talked to me all the time I had watched the sparklers. I insisted he was nuts. If I had done any talking, it has been to myself, I snorted.

We signed off, each estimating the other an idiot.

After a period of silent meditation on the mystery, I went about trying to get that extra tenth amp into the aerial as all did in that Marconi-infested period.

I hadn't been at that long when into the shack burst Paulis, kneepants, pajama tops, bare feet and blue eyes all excitedly askew.

"I did it! I did it!" he shrilled. "Oh, boy! Oh, boy! My first QSO. Oh, boy!"

"Your what?" I screamed. I had brought him up in holy fear of bootlegging although I suspected he slipped a bit at times.

"Yup, my first QSO," he chortled.

"That wouldn't have anything to do with a guy in Wadsworth, would it?" A grim thought was surging through my head.

"Yup."

"You're crazy."

"I'm not. I pulled my new aerial off my receiver when you started testing and it put out an awful spark when I touched it to the ground post. I could still hear 8ZZZ and that gave me an idea. I connected my mike from the aerial to a ground and called him. We talked all the time you were testing. Boy, was your note rough at first! Boy, oh, boy, my first QSO!" Paulis lay down on the cot and practically dissolved in a transport of joy.

Gradually the thing seeped into my head. I caused current in his aerial. He varied that absorbed current with his Ohio Bell mike. His new aerial sucked more or less current from my own. That modulated my wave. Bootlegging by proxy.

Such a genius should have stayed in radio instead of being perverted into the grocery super-salesman which he became.



M. E. "Bud" Dahl, a WERS op at WKIB in Philadelphia, Pa., and a future ham, decided to combine his two interests of motorcycle riding and radio, and this picture shows the result. His unit, WKIB-153 is shown here after being removed from a saddle bag and set up in a matter of minutes. Features of note are the reflector, which produces an improvement in strength of signals received, and the handset, in which both ends are utilized during operation.

20-Year Club

Hams is an up-to-date list of amateurs who are members of the 20-Year Club. If you hold an amateur operator license now and have held one for twenty or more consecutive years, you are eligible for membership in this club. If you meet the requirements, please send a brief chronology of your ham career to this department. Include the date you started in amateur radio, the call and date on your first amateur license and any other calls you have held up to the present time. If you qualify, your call will appear in the next published roll of 20-Year Club members.

W1ACV AHI AHY AJ ALP APA AR AZW BB BDI
BNL BPN BSN BVR BXC BYG CJA DMF DMP EAO
EH ES FA FJE FKS FMP FMV FOI GDY GS HGX HXQ
JFN LZ MD MLT NF PG QR RP TP UP WR ZL W2ADW
AOS AOT APJ AX BO BS BYW CJJ CJX CMX DI DIH
DYT DZA EG ELN EMV EY GC GVU GVZ HCO HTU
IMF JP IZ IF JRG KU MIL OEN PF PL W3ABF
ACX ALE AVJ BEI BO BYR BZ CA DRO EUY FLH GJ
GLH GPA GQL HWO JL KT QJ RR WS WU VT ZI
W4BZ CNZ DIN IE RM WD /5FSI W5AJG AQQ CVQ
DZA EOW ERJ NT NW W6AM ANM /GVU AVC AWN
BAW BUK BVM CAN CFN /CVC CIS EA EY GM GS IT
IWU IX KA KMA KTQ LM MMB MSN NPD OCH OQZ
OJY OVK PKX QKI QOJ SIG SN TS VU W7AZX BG
COH DVE EMT ER GCO QP W8AL AMS APD AQ AYS
BCA BKM BOA BXY BWP CBN /SG CHU CMH CNX
DOX FRY GU GYR IGT IO JDV KGH ND OA OFO
OXH QAN RN SDR SIX SQE SQW TGX TO UGR VZ
WGE ZS ZY W9AA AB AED AWP BEN BRX CA CAA
CCD CCE CDE CS CSZ CVU CX DAX DDF DGM DHJ
DSM DI DZG EL ESA EVG EV FRC GTR KWY NZZ
OQG RRC RWF SJ VFW VS VW WIN WTE WZE YNQ
K4KD K6ONM QYI VE3RB UX VE4BM VE5GA.

Meet the SCMs

JACK T. MOORE, W5ALA, pictured here, is the newly elected SCM for Northern Texas.

He was born in McKinney, Texas, on July 2, 1907. Upon graduating from high school, he entered Southern Methodist University, from which institution he received a B.S. Degree in Commerce.

Amateur radio claimed his interest in 1920 and two years later he acquired his first license. Since then he has held the calls W5JY and W5ALA. Prior to his election as SCM he was an emergency coordinator, and at the present time is a member of the original Dallas Radio Club. Shortly after war was declared he sold all of his equipment to the Army. In addition to amateur radio, his hobbies are boating and photography. He is currently employed by the Lockheed Aircraft Corporation as chief radio operator, and previously was engaged in the oil business. For recreation he indulges in golf, tennis and boating, but modestly says he has no particular skill in any.

Since his election to the office of SCM on October 15, 1944, those excellent Northern Texas reports have been appearing in the Amateur Activities column regularly.



BRIEFS

An association known as the Hamilton Township WERS Radio Operators Association was formed at a gathering called by H. Dallas Fogg, Hamilton Township, N. J., Radio Aide. Meetings will be held the third Wednesday of every month at 8 P.M. in the township administration building. The following officers have been elected: William H. Fry, jr., president; Frederick W. Muhs, vice-president, and Charles H. Frank, secretary-treasurer.

The Month in Canada

ONTARIO—VE1

From L. W. Mitchell, VE3AZ:

THE Wireless Association of Ontario had hoped to hold a meeting in January, but due to the unavailability of a suitable speaker, it had to be postponed. However, the February meeting is all lined up, and as the nominations for officers for the coming season will be tabled, a large turn-out is expected. The past season has been very successful, with a number of new members enrolling. Hams in the Toronto area are keeping very busy these days, most of them preparing equipment for the long awaited days when the ether will be filled with CQs, when happy contacts are once more made, and old friendships renewed. 3RH, Bob Haslett, has really acquired the recording bug, having completed a Presto recording outfit which he is using in conjunction with a new amplifier using p.p. 6L6s. He delights in taking recordings of dance bands and orchestras off the air, and sending the plate to the band leader concerned. Bob has received some very complimentary letters in reply and seems very happy about the whole thing. Wally Hainge, 3IB, our old friend and counselor, is still active. In the good old days, Wally used to handle and distribute most of the QSL cards for the boys around Toronto, and how they used to prick up their ears when he called out his long list. 3APA remembers late in 1937 he contacted 8BMF and had a nice QSO for about 30 minutes. He got a report of RST 448 and a promise of a QSL. Nothing more was heard of it until about 18 months later when good old IB handed it over. It sure had been around! And what a thrill! With the receiver repair business at a low ebb due to the lack of trained technicians and the gasoline shortage, some of the boys are doing quite well using their knowledge and also keeping their hand in by repairing friends' and neighbors' sets. Tubes are a problem but usually a little ingenuity and adapting of substitutes works out very nicely for all concerned. 3ADR, Harvey Reid, is still in Muskoka Hospital and would be glad to hear from any of the gang.

QUEBEC—VE2

From Lt. L. G. Morris, VE2CO:

COLIN DUMBRILLE, 2BK, returned to Montreal for a thirty-day furlough, bringing his English bride with him. "BK" has been overseas with RCOS for several years and was recently promoted to the rank of major. Gordon Southam, 2AX, has taken up home recording in a big way and is building up a collection of records of history-making broadcasts, communiques, etc. Bill Bannister, 2FG, has returned to civilian life and now has his own radio business in Lachine. Bill saw several years of foreign duty as an officer in the RCAF. Another RCAF officer back in Canada is Sid Chapman, 2LV. VE2CO visited W1CLN, on a trip to Washington. D. C. Harry Ashdown, 2IO, who has been with the RCAF in England, recently returned for a short stay in Canada. F/O Geoff. Field, who has not been heard of for some time, was reported to be serving in Italy. Bob Prisiwick, ex-2CX, is engaged in that tough job of apartment hunting in Ottawa. Joe Kelly, 2DE, has been promoted to the rank of acting electrical lieutenant-commander, RCNVR.

ALBERTA—VE4

From W. W. Butchart, VE4LQ:

CPL. FRANK WILLAN, RCMP, 4ANS, of Ft. Smith, N.W.T., blew into Edmonton during the Xmas holidays in the process of "bringing out" a mental patient, and he paid us a visit a couple of times. Since hearing from Frank two years ago when he was at Coppermine Detachment, N.W.T., he has been transferred to Ft. Smith, which he tells us has a population of about 300 — 250 of them being Indians! He used to spend a great part of his time with 4YD, Percy "Pete" Fair, of Peace River, back in the days when we were on the air. He has become somewhat of an amateur photographer in recent years, and while here he had one of his pictures published in the *Edmonton Journal*. Frank told us that after we gave him a bit of a write-up two years ago in this column, noting his QTH, etc., he received quite a few fan letters from hams all over the world!

A really newsy letter from 4AAD, Capt. J. T. Freeman, DSO, MD 13, Calgary, gives us the dope on several of the Calgary and Edmonton boys whose calls have been missing from this column for some time. The following gives the gist

(Continued on page 84)



ATLANTIC DIVISION

EASTERN PENNSYLVANIA — SCM, Jerry Mathis, W3BES — A nice long letter from 3IGS states that he is radio operator on a merchant vessel somewhere in the Pacific. He is dreaming of his postwar rig and preparing himself for a return to hamming. 3HFD, 3CHH, 3FLH and 3BES have been communicating with 3FRY via home-recording discs. 3FRY is recuperating slowly. 3DVC is to entertain the Frankford Radio Club at its next meeting. Foster Reynolds (LSPH) is a V-12 at Lawrence, Kans., and writes that he is disposing of his Sky Buddy as his postwar plans call for something far better. 3DMQ shipped out as a merchant marine radio operator. Bob Stevens (LSPH) was in Philadelphia briefly and told of being in Antwerp where the buzz bombs fly thick and fast. Dick Hanak (LSPH) and 3ISS, also ship operators, related many choice yarns. 5AJ, assistant director of the West Gulf Division, dropped in to say hello. We also were paid a swell visit by 8GWZ, from Rome, N. Y. He is employed at the Philco crystal labs, and may take out a W3 call here when the war is won. 3IJN now boasts of a baby daughter. A Christmas card, mailed Dec. 20th via air mail by 3GTS, arrived Jan. 19th. The Lower Merion WERS gang did a fine job in stopping some unauthorized v.h.f. transmission. 3GYY is just back from the So. Pacific, where he has seen some action. 3KT was in Philly Jan. 20th. Please keep the reports coming in. 73, Jerry.

MARYLAND-DELAWARE-DISTRICT OF COLUMBIA — SCM, Hermann E. Hobbs, W3CIZ — There is a rumor that our old friend, Bob Caviness, may be released from the Navy soon. Bob used to operate at WMDD-1. It is understood that QV is back in Washington. DQN is reported being seen around town lately. Mr. Phippeny is now a full-fledged commander, and Tom Pendleton recently received his ham ticket and is planning his postwar rig. Ed Roccati is attending night law school. Thanks from the WERS gang are due Mr. & Mrs. Ralph Stewart for providing a meeting place in their home for our past meetings and to Mr. Stewart for the FB mike stands he recently turned out. About a dozen members of the WERS gang attended the hamfest recently held in Baltimore. It seemed like a regular old-time gathering, but with many strange faces in the crowd. The WERS gang is patting itself on the back. The net actually handled a message during the recent telephone strike, transmitting it and relaying the answer back within a couple of hours. On Dec. 3rd WJDC had thirteen stations on the air and now all of them work on one frequency, 115 Mc. Drop a line to 7GYB, Roy J. Myklebust, S1c, Class 1-45-A, USNTS College of Ozarks, Clarksville, Ark., if you can. 4GPW now is an ensign. The WRC has been meeting for some time in the classrooms of CREI, and wishes to thank the CREI for this favor. The club meets at 7:30 p.m. for code practice. CDQ is the professor-in-charge and the meetings are held the second and fourth Saturdays of each month. It is understood that the code classes meet every Saturday night at 7:30 p.m. for code practice. IBS is located in Ogden, Utah.

SOUTHERN NEW JERSEY — SCM, Ray Tomlinson, W3GCU — Regional EC for So. N. J., Technical Radio Advisor for N. J. State Defense Council, N. J. State Radio Aide for WERS and Radio Aide for Hamilton Twp. WERS, ASQ; EC for Somerville and vicinity including South Branch, and Radio Aide for Hillsboro/Branchburg Twps. WERS, ABS; Assistant Radio Aide for Hillsboro/Branchburg Twps. WERS, ACC. WERS throughout the state is still in high gear as per reports submitted by State Radio Aide ASQ. The second monthly meeting of the Hamilton Twp. WERS Operators' Association was held at the Twp. Municipal Bldg. on Jan. 17th, at which time several urgent matters were attended to, and the following acting committees were appointed by President Wm. Fry: Administrative, ASQ; technical consultant, GSP, ITS, AXU; technical maintenance, ITS, AXU, HTJ; technical construction, GCU, C. Allen, Twp. Police Radio Technician, and E. Ely; antenna construction, maintenance and installation, E. Van Horn, W. Fry. Other committees were appointed but information on appointees has not yet been received by this

office. Although the attendance at this meeting was not as high as anticipated because of hazardous driving conditions, the number present was very gratifying and proves beyond any doubt that interest and activity among our WERS personnel is running high. Thirty-two operators were accounted for, out of a total of about fifty operators. The efficiency of the WKPX network was responsible during a recent drill period for stopping a speeding train on which a blaze was seen by the operator of mobile No. 3 as the train sped past. The disastrous consequences, had the blaze not been discovered, were shown in the prompt action of railroad employees in flagging the train down. Much credit in this incident is also due the Hamilton Twp. police and the members of the Volunteer Fire Co. at location No. 14. Radio Aide ABS, Hillsboro/Branchburg Twps., reports the following line-up of active operators and the respective units to which they have been assigned: WKXQ control, Alma Shively, net secy/stenographer, and Bob Clawson; mobile No. 2, Clem Clawson; mobile No. 3, Radio Aide ABS; mobile No. 4, Irving Connet; mobile No. 5, ABS and Mrs. Mikula; mobile No. 6, Mr. and Mrs. James VanDerveer; fixed relay and sub-dispatch No. 7, also mobile No. 8, Asst. Radio Aide Horace Brokaw; mobile No. 9, Paul Todd. Two additional operators, Geo. Space and Carl Blaufuss, also have been assigned to mobile No. 6, pending construction of additional units. Mr. Valentine and Mr. McCoe have been assigned to reserve duty. The radio aide for Bridge-water Twp. reports another new operator-member of the WJMN network. Routine test and drills are being carried on by WKXQ and WJMN and both organizations are ready for action in case of an emergency. Preliminary matters have been attended to toward the organizing of a new WERS net in Phillipsburg. JBU is very anxious to get going in that territory, but at this writing, no further information has been forthcoming from Sam. State Aide ASQ has some excellent photos of the WJUB field and control station equipment, which has been in active operation under that call since July 1942. HWO's YM, Bob, jr., is stationed at Two-Rock Ranch in Petaluma, Calif., as radio operator. JOL is taking a turn at local broadcast station, WTTM. It has been rumored that ETX, somewhere in England, has gotten "hitched" to an English lass. There have been some promotions as well as transfers in our servicemen's listings: 3FMU has been promoted to 1st lt. ARN has been promoted to chief radio technician, Naval Research Labs. Eddie Peters (LSPH) has been promoted to EM2c, USN, So. Pacific. QL was transferred to duty at New Orleans. The DVRA War Bond Drive has been meeting with a great deal of success; the drive is now in its fourth series and going strong. Proceeds from this venture will be utilized for building a club house of its own. CCO is working at a local radio repair shop. JNO and his Four Hot Spots of Rhythm are playing at a local night-spot. Aaron and his orchestra have long been recognized in local musical circles. ITU is occupying his time as a salesman for a local tobacco concern. More reports would mean more news, so, watsa fellas! 73, Ray.

WESTERN NEW YORK — SCM, William Bellow, W8MC — PK has built a new 112-Mc. superhet on which he copies WERS signals in his home town of East Bloomfield, which is 16 miles away from Rochester. The Buffalo WERS unit should be licensed by now but we have no report of activity. We have located the addresses of two Rochester LSPH that have been asked for: — Burton C. Johns, RM2c, APO 550, c/o Postmaster, San Francisco. Elbert Zuber, RO, and Ben Lecky, CRO, both with the merchant marine, can be reached o/o Fleet Post Office, New York City. Ben recently was home on a short visit while in port. The Rochester WERS (WHNH) gang went into action officially on Dec. 12th when a big snowstorm had traffic and communications pretty well sewed up. The group was ordered into activity by the sheriff and did a great job, and was later commended by city and utility officials. Let's hear more from you fellows, especially the boys in far-away places. We like to hear from you and we know you like to hear of each other. Cordial 73. Bill.

CENTRAL DIVISION

ILLINOIS — SCM, David E. Blake, II, W9NUX — I Service News: T-4 BIX is somewhere in Normandy. T/Sgt. GRB has been in C. Africa for twenty-six months and says it is too hot for comfort. S/Sgt. QFG, Ward 82, Vaughan General Hospital, Hines, Ill., was flown clear across the Pacific, where he was hospitalized in a New Guinea Hospital, and then all the way to Illinois to finish

his recovery at Hines, Lt. DFD, 9th MAW-FMF-USMCAS, Cherry Point, N. C., is finding radar very interesting. RM2c ZZU, c/o Fleet Post Office, San Francisco, Calif. has been moved aboard a submarine tender and is standing radio watches which keeps the old c.w. in mind. Following are some addresses: Lt. SGC, 4518 W. Othello St., Seattle, Wash. S/Sgt. TXV, APO 758, c/o Postmaster, New York. T/Sgt. NQZ, APO 920, c/o Postmaster, San Francisco. Major EDS, Box 151, Scott Field, Ill. S/Sgt. VTL, APO 448, c/o Postmaster, New York. S/Sgt. MOL, Co. C., 1299 Engr. C Ba., Camp Bowie, Tex. RT3c YWF, Amphibious Communications School, Camp Pendleton, Ocean-side, Calif. Comdr. R. H. G. Mathews — somewhere in Australia. His home address is: Brendonwood, R. R. 15, Indianapolis, Ind. Lt. (jg) JSL, c/o Fleet Post Office, San Francisco, Calif. PSP, Fleet Post Office 121, N. Y. Y1X, lt. col. USA (ret.). has been retired from the Army after nearly four years of active duty. He is back at his old stand in the editorial department of the *Chicago Tribune*. LXD — what's the latest? CGT has been moved from Egypt to Greece. Write the SCM for complete addresses of servicemen mentioned in this column. CD-WERS: WKDQ, Downers Grove, is working into the Chicago WHHI networks with very good success. KBO, WHHI Chicago, has given out the information that he now has a new network comprising only crystal-controlled rigs in this south area network. FXB is trying out different types of antennas with WHHI-40. EAL is incorporating frequency equipment with WHHI-102. ITA is building very good remote control equipment, known as WHHI-183. PTS, at the main control of WHHI, is having receiver trouble from f.m. b.c. stations but otherwise is getting out better. WIF, WHHI-70, is planning a mobile program for the Chicago north area. CTN, WHHI-22 of Homewood, is heard with a good signal on Chicago's far north side. CAP-WERS: Capt. TLQ, WAFH, is CAP Illinois Wing Communications Officer. Much experimenting with antennas is holding the limelight. End-fire pitchforks and coaxial types are getting a good workout. The CAP is having an extensive program of training which includes code instruction, microphone procedure and radio theory. AARS: What's the news of the Illinois Army Amateur Radio System? Let's hear from all of you! *Suggestions*: If you are in Chicago's loop on Mondays, drop in at Harding's Restaurant, 7th floor of the Fair Store, and have lunch with a grand bunch of hams. You will hear everything from Einstein's theory to FWV's jokes. Also drop in at 643 N. Michigan Avenue, any day. It's the "Ham Shack" on the Boulevard. I'm sure you will do some high-powered wishing when you see 9WZE's Hallcrafters display of postwar rigs. 73, *Dave*.

INDIANA — SCM, Herbert S. Brier, W9EGQ — WKMR, Gary, had its operation approved for another year by the city authorities, along with continued financial support. PUB, ARM1c, was home on leave, sporting an Air Medal and other stars and ribbons. VML passed away a short time ago. He was working as a technician in a war plant at the time of his death, even though he had been a semi-invalid since childhood. PQL in the So. Pacific, thinks it is a dirty trick that YWE waited until so many of the boys were away before announcing his marriage. KBL and ILL were married recently. ABB still services aircraft on a Pacific Island. NLS saw YMV's ship while on the way to the Philippines. He found out too late that he was on the same island as KMY. ZYJ has been looking for native hams in France, Holland and Belgium. YMV speculates on 2½-meter activity after the war. IFU, a Naval ensign, is going to M.I.T. to study secret radio gear. UCT is the very proud father of a daughter. His company at Camp Campbell has an assortment of hams in it; a "2", "6", "8", "9". EHT reports that he kept on a pretty even keel during the holidays, "mostly because I couldn't get the stuff." WNG has been stationed in Chicago as the skipper of a 75-ft. YP boat filled with radio equipment. WIB asks if "resistance coupling" is a shotgun wedding. MKM is back at the Oakland airport after a furlough in Indianapolis. FFM spent a leave in Garrett after three years in the Aleutians with the Navy. SVH reports that AB sent him a set of blocks for Christmas — without including the instructions. UGH is still making tools and dies in Franklin and hoping. The only radio activity for him is tuning up induction heaters once in a while. IUM is around again after a time in bed as the result of injuring his back in a fall. EGV is disgusted at all the service he has been getting from his thermometer lately. EOC put all his DX cards and pictures in albums. He says, "They represent a lot of lost sleep, so I value them

highly." He has four transmitters ready to go — if things don't start to go fast when he applies the voltage. ZNC now is in France. UMK is in New Guinea and has been on many other Pacific Islands, including Leyte. MTL and WKN are offering \$10.00 as a prize for the best letter on which receiver you want after the war. Write to me for details. (Contest letters must be postmarked before May first.) YGH has visited EGQ several times lately. HUV repaired a cream separator, and then to show his faith in his work he ordered a new part. UZW is in the States after 36 months in the Pacific, fighting in almost every major battle beginning with Guadalcanal! He got married recently. AB reports that Selective Service is sniping at his WERS crew. How about a report from you? 73, *Herb*.

KENTUCKY — SCM, Darrell A. Downard, W9ARU — So many members of ARTS attended the last meeting it appeared that someone may have spread the dope that a country ham would be a monthly prize. Nope, that was YXF's Christmas prize to the club at the previous meeting. Naturally, the attendance of our new YL members couldn't have had anything to do with it! CNE suggested one meeting a year to praise the president (BAZ). That still gives us a lot of meetings to get in his hair! It's been even too cold for the "YL Observation Committee" to function. Joe Colvin laughed when the police picked him up for operating a radio transmitter on top of Jacob's Park Hill — they didn't know he had a WERS license. Two-way radio — WERS and the police — cracked the "case." After a heart-to-heart talk by ARU, DFW is studying for a Class A ticket. We want to know what system URG used to get that policeman's night stick in France, and was the cop on the other end at the time? Wallace, at 22, is working on a steam-heated 'phone headband for bald-headed hams. TXC was "sound effects" man, blending in the music for the color movies shown by Frank Richter at the last meeting. Allen, Wheeler and a few more anticipate taking a crack at the "A" exams.

MICHIGAN — SCM, Harold C. Bird, W8DPE — 8UGR wrote us a nice letter; he also renewed his EC appointment. Paul is working on some new gadgets for the boys. A letter was received from Russ Sakkers, our QSL printer, who now is a little farther up the line with Mac-Arthur's boys. 8UXS, from Lansing, wrote a very swell letter from the East Coast, giving us the low-down on his activities in the M.M. service. He says he is chief and is getting plenty of practice. Our friend, Johnnie, wrote us that he is in the Navy and had a card from 8TUO, who is somewhere in Russia. He also said that UES, of Ypsilanti, is with him and has made CRT. 8FWU sent us a fine letter and report just a bit late to make last month's column. Barney said it was just 25 years ago that he got his first ham ticket and he has been licensed ever since. The Detroit Edison secretary wrote us a nice letter inviting the gang to its meetings. The club has very good speakers whose talks are of an educational nature. The officers of the club are as follows: 8AW, pres.; NXB, vice-pres.; Gene Youngblood, activities manager, and I. Runnells, sec. and treas. The DARA held its last meeting at the home of NXT but because of poor driving conditions the attendance was rather low. The code classes are still being held and some post-war plans are in the making. The WERS gang of Pontiac completed its 10-weeks course in electronics recently with a final examination. An excellent demonstration on a cathode ray oscilloscope was given by Mr. Robert Ellerby, who designs and builds various types of these 'scopes. The demonstration gave the average layman a good idea of how the electron flow can be controlled. The group is now planning to take an advanced course or to take extra money and establish a laboratory for experimental work along the lines which they have studied. May we have reports on WERS from Lansing, Grand Rapids, Flint, Center Line and Detroit, please? Well, fellows, I sure would appreciate hearing from clubs and individuals. I know that you must be planning something so why not let us in on it? It would make very good reading for those boys in the fox holes. How about it? Until next time, best of luck and 73, *Hal*.

OHIO — SCM, Carl F. Wiehe, W8MFP — AVH wishes to thank the Ohio Section and all the amateurs in the Central Division for their support in his election as director. John says, "Let's have more of that support so that we can do everything in our power to aid the amateur cause." AVH would like to have a list of officers and time and place of meeting of all Ohio amateur clubs. So would MFP. Please drop us a card. Lt. General William Haskell, national

(Continued on page 83)



This is another page in our series about high-quality reproduction. Our page in December *QST* mentioned in passing that "the output transformer in particular was a husky affair having lots of iron and copper." With a whole page to write it, we can say lots more about it than that.

Output transformers are apt to be on the skimpy side. They handle the power all right, but the core is run at such a high flux density that there is third-harmonic distortion. This probably does not make much difference in most applications, but in a

high-fidelity job you have to guard against introducing distortion anywhere.

Also, the efficiency of the smaller transformers is not too good. We have never made accurate measurements, but the increase in available power is often quite noticeable when a well-designed transformer is substituted for a cheap one.

A transformer may have to handle only a few watts of signal, yet it has more of a job to do than the power rating would indicate. For instance, suppose a pair of 2A3's supply 7 watts to a $2\frac{1}{2}$ -ohm voice coil. The primary must handle 60 ma. of DC plate current plus about 44 ma. of AC signal current, making a total of about 74 ma. Secondary current is about 1.6 amperes. The a.c. voltage on the primary is about 160 volts r.m.s., plate to plate. This current requires more copper and this voltage needs more core than you will usually find in transformers of 7-watts rating.

As a matter of fact, the output transformer should be almost as large as the power transformer in a self-contained amplifier.

The obvious solution to this is to buy a good transformer. This is an excellent solution — if you can find any these days. However, your junk box may be able to help you even if your dealer cannot. A power transformer makes an excellent output-coupling device, so good that we often used them before the war when dealers' shelves had what you wanted.

The power transformer is run "backwards." The high-voltage winding is connected to the push-pull plates with the center tap becoming the "B+" connection. The low-voltage winding becomes the output winding. Filament windings connected in series will often provide the proper impedance for voice coils, or the 115-volt winding may be used to couple to a line. It is easy to figure the various combinations if you remember that the impedance ratios are the square of the voltage ratios.

In using power transformers for outputs, we usually removed the primary and all of the filament windings, leaving the high-voltage winding intact. We then wound on a new secondary of heavy wire with just the right impedance. Voice coils have such low impedance that only a few turns are required. Be sure to count the turns in the old primary as you remove it. This will enable you to figure how many turns you will need in the new winding.

Perhaps an example will help. Suppose your transformer has a 115-volt primary and a 750-volt center-tapped secondary, and suppose that you find the transformer has a 690-turn primary. From the ratio of voltages you know that there are 6.52 secondary turns for each primary turn, so there must be 4500 secondary turns. To couple push-pull 2A3's (5000 ohms plate-to-plate) to a 1.25-ohm voice coil, the impedance must be in the ratio of 5000 to 1.25, or 4000 to 1. The turns ratio must be the square root of this or 63.2 to 1. We found the secondary had 4500 turns, so the new secondary should have 4500 divided by 63.2, or 71 turns.

Modern tubes have largely made obsolete the power transformers having combination $2\frac{1}{2}$ -, 5-, and $7\frac{1}{2}$ -volt filaments. Many dealers still have such transformers in stock and are offering them at attractive prices and without priority. They are worth consideration as output transformers.

WILLIAM A. READY



(Continued from page 66)

director of the Office of Civilian Defense, Washington, D. C., wrote AVH, chief radio aide of WJH, praising the Cuyahoga County WERS operators on their meritorious service rendered during the East Ohio Gas fire disaster. The Ohio State Council of Defense has recommended that a national award of merit be given to the Cuyahoga County WERS organization. PZA reports that LZE is a m/sgt. in Europe; WV, now a capt. in the Navy, passed through Dayton; GD is in the Navy in the Pacific; OFF joined the merchant marine; FFK is in England; OTT is recuperating after a long illness; the CRA is sponsoring classes for prospective hams. UPB reports that the Cincinnati Chamber of Commerce requested of CAU, a professor at the University of Cincinnati, a survey to determine the amount of QRM that would be caused by several near-by high-power high-frequency broadcast transmitters to airport radio activity at the site of a proposed gigantic airport. CAU contacted the WKHO WERS unit which furnished the essential equipment and operators and successfully conducted and completed the survey, which covered frequencies up to the eighth harmonic of the highest broadcast frequency. TQS reports plans are being formulated to conduct radio classes for prospective hams at the AAF Convalescent Hospital at Ft. Thomas, Ky. Lectures on ham radio background are to be given and transportation facilities are being sought by WKHO, of which TQS is radio aide, to bring able patients to QCEN meetings. NXJ reports that Canton WERS activity increased with the addition of several new operators and two new mobile rigs. CBI, on a vacation in December and marooned at home by snowdrifts, says that Dayton WERS continues active with some walkie-talkie experimentation. RHH reports signals from Troy and Hamilton are heard frequently by WJTW operators. QQ, confined to a hospital, writes that Columbus WERS units were handicapped by the illness of several key operators. Transmitter hunts are being contemplated to stimulate activity in the future. Columbus auxiliary police cooperation is satisfactory to WERS. City council and county commissioners are expected to continue WERS operation within auxiliary police service. Also from Columbus comes news that CAP state-wide and river networks are planned. Permission has been obtained to hold both state-wide and local CAP transmitter hunts early next spring. EQN reports that Springfield WERS is working to eliminate receiver radiation. PGO is home, having been discharged from the Army because of injuries received in several plane crashes. OG hopes for good receiving conditions at his new south-side home. TAD reports Youngstown WERS unit is ready for any emergency. Lt. Comdr. Hoffman, ex-FRY, has been given a medical discharge from the Navy and is back at his police radio job. 73.

WISCONSIN — SCM, Emil Felber, jr., W9RH — From France comes a letter from S/Sgt. Jesse Wheaton, secy. of the Northern Wisc. Wireless Assn., with news from the Superior area. The club was disbanded shortly after Jesse entered the services, but he has been in communication with local boys there and they are planning a monthly hamfest, to be preceded by small "Dutch Treat" suppers and gab sessions, where stories could be swapped as the old gang starts to drift into its old haunts. He also reports that ONI is still taking the bugs out of the BCL sets at home. MRE is doing broadcast work. PQY is chasing the electron for the Electric Co. KYN is beating brass in the Maritime Service along with Joe Quinn. Ernie Luick is a "louie" in the Signal Corps, overseas, and is fooling around with high power. Thanks, sgt., for taking time out to report on the activities of your local area. Wish some of those upstate boys at home would write us some news for this column. T/Sgt. G. H. McClaine wrote from England and reports getting his QST regularly. He sends regards to all the boys. T. C. Kercher, RE, USN, sends greetings to all his friends from near England, where he is on the staff of a Navy radio station. Capt. Reid Burrows, USMCR, sent us a drawn Christmas picture accompanied by a piece of wing fabric from a Jap Zero and several pages from a Japanese electrical text book. From Paris, Technical Observer Wendell Ciganek writes that he expects to return to the States soon for a new assignment. On Dec. 5th the Milwaukee Radio Amateurs' Club had its 25th anniversary of affiliation with the ARRL. The club claims to be the oldest amateur radio club of continuous operation in the world. On Nov. 30th Comdr. DTK, USNR, our visiting member, gave a fine talk on Alaska from where he has just returned. Cpl. Frank Detzek, who was home on a furlough, attended the Dec. 14th club

meeting. Lt. ANA, USNR, somewhere in New Guinea, has been promoted to a full lieutenantcy. Lt. KFB is in England. Paul Leser, ARM1c, passed an exam for chief RM. GQO, at Watertown, Mass., had to have a delicate eye operation, which involved the use of r.f. Cpl. Curtis Schultz is in India. Cpl. CRK is now in Italy. Lt. (jg) Geo. Pfister, USNR, is stationed in Texas. Capt. FY is in New Guinea. RM1c ZUX sends greetings to all the boys. VD showed colored slides of quite a few of our members and ACM showed some 8-mm. movies at our Dec. 28th meeting. VDY was a visitor, accompanied by HFJ. The club's bulletin, which is mailed to members out of the city, now totals ninety copies. Ensign Papke visited the club on Jan. 11th. He is chief radio operator on a U. S. Merchant Marine oil tanker. Pfc. John Deisinger was present on Jan. 18th. S/Sgt. DJC is in New Delhi, India. Ray Charney, RT3c, met up with Dan Gellerup of WTMJ (local b.c. station) in the Southwest Pacific. Dan is down there as an RCA technical engineer. Lt. VKC is still at Agra, India. Greetings were received by HRM, bulletin editor, from ACMR JFS, RKP, GQO, Lt. (jg) Bill Black, USNR, and RM2c ZLE. Sgt. Gil Rink V-mailed from the vicinity of Paris. RM1c JWN sends regards from the Southwest Pacific. Ed. T. Howell, ex-CVI, an old-timer, is doing war work in Wilmington, Del. Dr. L. S. H. Baird, ex-HO, another old-timer, is located in Los Angeles. Cpl. John Rashinsky is in Kansas getting ready for overseas duty. Sgt. James Fischer is now in France. Comdr. SO, USNR, is now a full commander and is located in the California area. The WMFI (Milwaukee) WERS radio net has twenty-seven units in complete operation every Wednesday drill night. The Jan. 25th drill was reviewed by a local news reporter and a story is forthcoming in the *Milwaukee Journal*. NY, the radio aide, said that the net will continue its drills and operation until the last day of the war. 73, Emil.

DAKOTA DIVISION

SOUTH DAKOTA — SCM, P. H. Schultz, W9QVY — FOQ, formerly of Redfield, sends in the only report for this month. He has been teaching at Sioux Falls Army Radio School for the past 2½ years. He says he sees a few of the old gang occasionally and asks me to pass on his 73 to all the gang. Press release states that WOD had some interesting experiences as a dental officer on board ship during the Philippine campaign. No direct news from Doc for quite some time. Another former SCM, SEB, recently dropped over to see me. Although he lives in town, I seldom see him as he has been busy doing electrical work and running the projectors in the local cinema. More news, please. 73, Phil.

HUDSON DIVISION

NORTHERN NEW JERSEY — SCM, Winfield G. Beck, W2CQD — LMB sends his usual nice report from the Jersey Shore Amateur Radio Association. The Dec. meeting was held at the home of CZP. The Jan. meeting will be held at the home of the secretary, LMB, NUB has been promoted from captain to major in the Signal Corps. The club heard from AER, who is in overseas radio service as a civilian engineer. Word from some of our other former members now overseas would be welcome. A nice letter was received from Nick Camenares, RM3c, who now is going to radar school with SWTG, heard in the good ole days on 40 and 80. NWA writes that MAX is now a 2nd lt. in the Signal Corps. OAE is a sgt. in New Guinea in field artillery radio. JSE is S1c (RT) at Gulfport, Miss. MAX is working with Press Wireless at Hicksville, N. Y. MRZ is f.m. instructor at Fort Monmouth. NWA is somewhere out there on a destroyer. He now holds Class A, 1st-class radiotelephone and 2nd-class radiotelegraph licenses. He went to school with MTI who is now on an LST. He would like to hear from NAL, LMO and HWJ. His address is: T. E. Tajkowski, RT2c, c/o Fleet Post Office, San Francisco, Calif. LPV sends a V-mail letter as follows: "After glancing through several of the late issues of QST I noticed that the No. Jersey column is being sadly neglected by the gang, and it is really to be deplored. I think if some of us fellows who are overseas would write in once in awhile we might scare some initiative into the fellows back home, because we certainly would like to hear about them. Quite busy but here's some dope on a few of the ole Paterson gang I've been corresponding with: LHB is a lt. JG is giving his all somewhere on the Atlantic for the Navy. JIS is a hard-working t/sgt. for the Signal Corps in the So. Pacific. KCQ is stationed in the Middle East and is round-

(Continued on page 70)

Over three million Hammarlund

variable condensers

are taking part in the toughest kind of warfare—

each is designed and built to do a specific job—

with plenty of margin

for the unexpected.

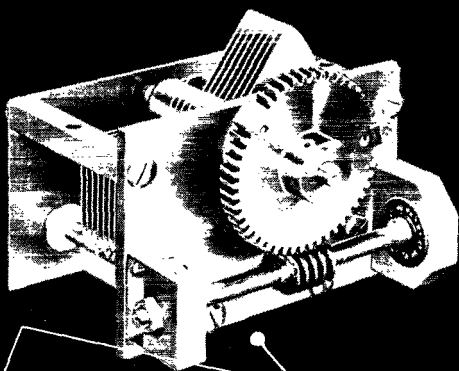

**SPECIAL
DELIVERY**

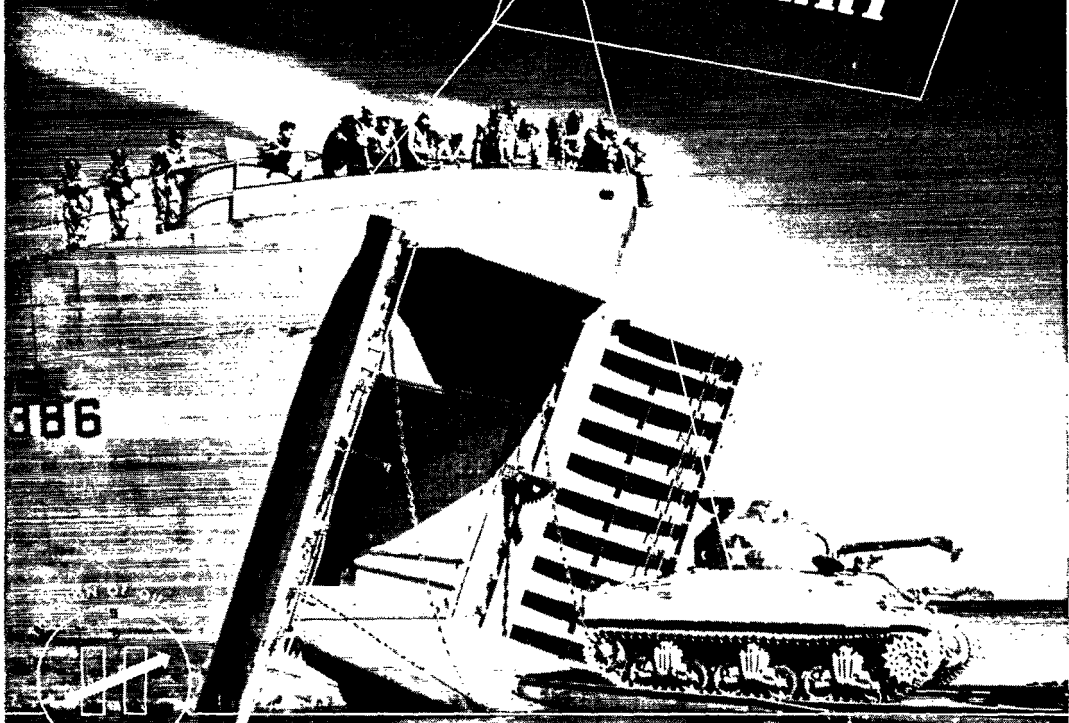

ESTABLISHED 1910

THE HAMMARLUND MFG. CO., INC., 460 W. 34TH ST., N.Y.C.
MANUFACTURERS OF PRECISION COMMUNICATIONS EQUIPMENT

OFFICIAL U.S. NAVY PHOTO

(Continued from page 68) *

ing out his fourth year as 1/sgt. IMG, after seeing service overseas, is back in the states and is going to OCS at Fort Monmouth. HRW is a civilian instructor employed by the Army. I hear from the Alfano brothers occasionally. NHZ and NIW are both in the services. The former was going to RM school down in Maryland and the latter is a commissioned officer in the Army at a Florida camp." Here's Freddy's address: F. V. Sprick, RT3c c/o Fleet Post Office, San Francisco, Calif. Keep the dope coming. 73, Win.

MIDWEST DIVISION

IOWA — SCM, Arthur E. Rydberg, W9AED — JIH, radio aide for KGJL, Cedar Rapids WERS, reports that they have been very busy testing, drilling, etc. They now have three mobile units besides eighteen portable rigs. Other units are being made mobile. They have about twenty operators. Twenty club transmitters and several private enterprise transmitters will be ready for licensing in the near future. They are preparing for a big demonstration to find out definitely whether they can cover the city. The mayor and other city and civilian defense officials will be invited to sit in on a drill to see what the net can do. URK, radio aide for KFHR, Des Moines and Polk County WERS, says things are about the same as last month. One congested area in northeast Des Moines has developed and receivers with r.f. stages and other methods are being used to cut down receiver radiation. A get-together in the form of a meeting at West High School was held recently. Log keeping, WERS regulations and frequencies were discussed. SEJ, net control, is still experimenting with receivers. KFHR-4 is leaving Des Moines for Denver. URK lost his 829. OLY, asst. radio aide, will be on soon. UOP soon will be ready for drill with an 815 in final. For the first time in years AUL has no news for this column. OCG, back from the war, has bought a home and is busy setting it up; as soon as that is finished he will prepare for WERS. HD, who was wounded in France, is home on a furlough and expects to go back to the hospital for further treatment. TIO is in the b.c. repair business. VRT, who works for CAA, gets to Des Moines occasionally. 73, Art.

KANSAS — SCM, Alvin B. Unruh, W9AWP — TJS sends greetings from a New York APO address. KCS received the carrier assignment he was expecting and his address now is c/o Postmaster, San Francisco. KUU is working in Wichita. TVF reports he picked up some Jap radio gear on Saipan, and compares it with our 1935 stuff. It was well constructed mechanically, and plenty of rubber was used. LCC is assistant foreman in Boeing final assembly. FET, on leave from his duties as chief operator at KFBI, is stationed in England with OWI. Glenn sent home some recordings of the Eton College Chapel Christmas services for local broadcast. Bob Whitmer, ex-BFP in Wichita, and later holder of a "W9T" call in Kansas City, has been promoted to director of cargo sales for the entire Transcontinental and Western Airlines. Bob has been with TWA sixteen years, and will be remembered by the Kansas gang for his lectures on aeronautical radio developments at several Wichita conventions. Another ex-Wichitan, McGaha, ex-BJP, has been appointed district manager for TWA at Albuquerque. ESL finished his appointment as instructor at Notre Dame and at the time of this writing was filling a parish at Delia. He also was fixing a few radios for the farmers, and expects another project soon. MFH has been promoted to lt. comdr. USNR, and is with the Navy's Office of Patents and Inventions, New York branch. He was stationed at Pearl Harbor on "that day." Prior to active service, he was a Wichita patent attorney. 73, Abie.

MISSOURI — SCM, Mrs. Letha A. Dangerfield, W9OUD — SZN arrived in Normandy on D-Day plus a few, and passed through many of the towns we were reading about in the news at that time. His work is in meteorology, but he recently made a b.c. set of salvaged parts of various foreign equipment — and it works. GHD made his first trip to Anchorage after 18 months in the Aleutians and declared it was wonderful to see a town and go shopping, and have a drink of milk, which he had not tasted since his arrival. VWW/6UUA is in charge of maintenance on the fixed instrument landing system on a field up in Washington State after having been blown up in a mine field in the Pacific. He joins the list of fellows wanting the addresses of IDK and DDX. ZWK is in Hawaii. TGN would prefer the Pacific to the Atlantic, but likes the ship he has been on for over three years — that 15-day leave was not nearly long enough. KIK wrote us the following dope: PYQ took

over the WERS net from VVX and says they have some sixty members, with over half of them turning out each drill period. BCK is an engineer at a local b.c. station and is thinking of joining WERS. UAB is with KRHO in Hawaii. OUD has a new permanent and a new ribbon for the mill — both much needed. BMS says nothing to report. Lots of luck and 73.

NEBRASKA — SCM, Arthur R. Gaeth, W9FQB — YDC, radio aide for Douglas County, has been confined to the hospital since Dec. 20th as a result of an electrical shock at the KOWH transmitter. I am glad to report that he is on the mend and expects to be back on the job shortly. Ex-FNY was also involved but suffered no serious results. GKL had to officiate at the arrival of five pups born to YDC's pedigreed cocker the day of the accident. JFF (KHKN-25) is building a new 829 rig and a 955-954-6C5-6V6 receiver for 2½. Sounds like some real competition for the 12J5 at KHKN-48. EKK (KHKN-2) now has a pair of HK54s in the final of a crystal rig on 2½, and ran afoul of a city ordinance covering the erection of radio antennas when he erected a 65-foot tower for 2½. The City of Omaha has passed an ordinance covering the erection of any and all antennas, which requires a permit and inspection and involves a small fee. KAAJ, Lincoln, was heard with weak signals by KHKN-2 on Jan. 14th. KHBW-1 and KHBW-2 were heard with 8 and 7 signals respectively by KHKN-39 (Chiff Allwine) on the same date. I would suggest that some i.c.w. be used on signatures so that some of the weaker carriers observed could be identified. ZPZ's OW now holds a restricted radiotelephone ticket and operates KHKN-33 as second operator. ZPZ visited with the KHRW gang at Sioux City, Iowa in Jan. Sgt. FLA reports via a swell V-mail Christmas card from across the drink. Lt. H. L. Hinkle, ex-K6TSS, in Italy, still inquires of MUK. How about some help on this, gang? Capt. HTE reports from a new APO in the Pacific, and says he is looking forward to the time when he can sit down with a stack of QSTs for dessert. FWW now is back in the radio service game at home, after having served three years in the Pacific area with the Navy, where he installed radio and radar equipment until he landed in a hospital for ten months. He still has his ACR175. He received his medical discharge in May 1944. A letter of congrats was received from Cellophane, YL operator No. 1 at 4GFH. She now holds Class A and 2nd-class commercial tickets, and is a member of WERS in New York, where she is employed on a defense job. She operated from W4, passed exams in W2 and reports to W9. Shades of ten meters, remember? FQB is trying out FSR's frequency-meter monitor with thoughts of band-edge operation with a Signal Shifter after the war. The AK-SAR-BEN Radio Club, which meets on the last Mon. of each month, added four new members last month. Moving pictures, furnished by the Signal Corps Repair Depot gang, will be shown at the next club meeting. Also, application for affiliation with the ARRL will be made soon. WWP, this section hopes that your log will be full of smooth sailing in the WAVES. Orchids for some swell reporting, gang. 73, Art.

NEW ENGLAND DIVISION

CONNECTICUT — SCM, Edmund R. Fraser, W1KQY — SG-WERS: IJ, Madison, 1st lt. in the State Guard, reports that five units in Madison, Guilford, Clinton and Westbrook operate weekly on Mondays from 7:30 to 8:30 p.m. Occasional drills are held Thurs. nights with Middletown. CD-WERS: Eli Crumb, ex-BIJ, Norwich, reports three units on consistently, all using 4- or 5-element rotary beams. WJTR-6 is building a new receiver with the hope of picking up more of the out-of-district units. CTI, who operates WJQA-16 in Norwalk, writes that WJQA-31 contacted WKWG-70 on Jan. 15th. This makes all Conn. districts contacted by the latter unit. LIG, formerly of Bridgeport, reports that he has been operating the main WERS control station WKIB-1 of Philadelphia as fourth member of the main control staff. He has been in Philadelphia WERS for a year and a half where he has been attending Temple University and expects to graduate in June. Six prospective WERS operators were given their restricted radiotelephone examination by KQY, and all of them passed. Jean Terrill, ex-WAVE, is now a WERS operator in the WJLH district, as is Ann Cadari, ex-WAC. Both are studying for amateur licenses. The Hamden WERS operators gave a farewell party to Mary Creaven, who entered the WAVES Dec. 28th. Mary will be greatly

(Continued on page 78)

A L L C L E A R !

"All clear" is a welcome greeting

when returning from a sortie.

As one of our DFC boys puts it:

"Going on twenty-five missions is a tough job—

but it's getting *back* to the base that counts."

... Super-Pros are on the job every minute with the AACs.

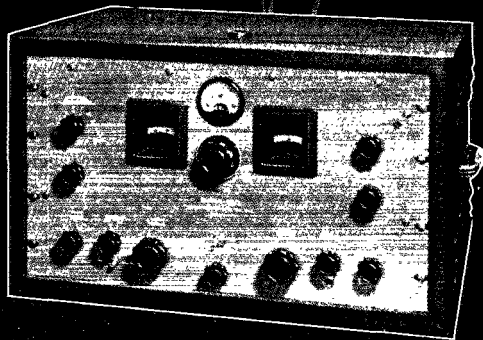

ESTABLISHED 1910

THE HAMMARLUND MFG. CO., INC., 460 W. 34TH ST., N.Y.C.
MANUFACTURERS OF PRECISION COMMUNICATIONS EQUIPMENT

(Continued from page 70)

missed as she was very consistent in attending drills. MVE has nearly completed his superhet receiver for 112 Mc. MVH expects to be transferred to New York for five months, where he will be working on telephone "K" carrier circuits. Steve Taber, West Haven radio aide, is doing a swell job in getting units going again. Jack Naughton writes from Albany that ex-2MIY/3JSH is in California with her second harmonic. JHN, CBM, USCG, has left Bridgeport and is enroute to K6 area. DDX, CRT USN, has left Baltimore for K5 area. Jim Wilcox, GB member, has just returned to Philadelphia after a two-weeks furlough in New Haven. Jim is now RT2c USN. Francis Baron of Branford, Edwin Collins, TD and AGT of West Haven, all WJLH operators, are now working part time for broadcasting station WNHC in New Haven. Many thanks to BDI and UE for their nice letters. We are sorry to learn that Carol Keating Witte, 9WVW, has left Headquarters. Best of luck and success in the WAVES, Carol, and we will continue our support to your successor. GB has hung a poster made by MEF in the local U.S.O. center inviting hams in the services to visit the NHARA while in town. Also, to prepare for postwar activities, servicemen and women from around New Haven, who are engaged in radio, are being sent notices inviting them to drop in at the club on Friday nights if they are interested in amateur activities. It is hoped that this will increase the membership after the war. Gang, please send in news of yourself or other Connecticut hams each month for this column. 73, Ed.

MAINE — SCM, G. C. Brown, W1AQL — CBU is working for the FCC. BXE is on the staff at WNAC. CRU is a broadcast engineer at WHN in Portland. Ex-BFZ has returned to Bangor after a hitch with the AACs. We are very sorry to learn of the passing of BLF's mother, and our sympathy goes out to John in his bereavement. LEV is a lieutenant in the armed forces. Prof. Crabtree, U. of M., is conducting classes in electronics and radio twice weekly in the Bangor High School building. GKJ sends in a fine letter this month with the following news items: KYT is a lieutenant in the Navy and is in the Pacific area. He expects to become a W5 after the war. NKM is RM3c in the Navy. HWY is a sgt. in the AACs and is somewhere in the Caribbean. LNI is in civil service at the Portland Naval Base and also is doing his bit in the CAP. MBR is a 2nd lieutenant in the Signal Corps and has been studying at M.I.T. MFG is a t/sgt. with the AAF in Calif. "Si" Simon, second operator at GKJ, is a m/sgt. in the Signal Corps in Belgium, and says he has met a few ON4s. SUBF and BLO are in the same outfit. AI, ex-AKT, DEO, DFC, GKJ, LEJ, AWT and MQJ are working at the So. Portland shipyard. Thanks a lot, OM, for the news. If the rest of the gang would send in a few items now and then we could make this an FB report. 73, "G.C."

EASTERN MASSACHUSETTS — SCM, Frank L. Baker, jr., W1ALP — IHL is now EC for Wakefield. JGQ says that the Sunday WERS drills in Lynn are starting again. LRD is working at M.I.T. LTC tells me that LEU got married, is now a capt. in the Army and is located at Rochester, N. Y. Sorry to hear that HM's wife passed away. On Jan. 5th the South Shore Amateur Radio Club held its regular meeting at Jim Eng's (KBM) restaurant. The following hams were present: JXU, LZW, CT, IS, MMU, FWS, CIC, IHA, IYU, HRF, MD, ex-UG, BNU, FJN, AKY, CCL, FKV, HCL, KJD, LAT, JXZ, MMH, MPT, EKG, WK, CPD, ALP, R. MacAlpin, Dan Hoxie and Robert and Russell Mugford. IYU now is living in Scituate. Very sorry to have to report the deaths of KM and ZQ. LRQ is working at G.E. in Lynn. Don Jameson (LSPH), of Lowell, is going into the Navy. LFD told me that LEM was home on furlough from Calif.; he is now in the Navy. IID writes from Berkeley, Calif.; he is now a capt. and passes his regards to all the 2½-meter boys. 4HRW, ex-9UTN, is a sgt. in the Air Corps and was at M.I.T. for awhile. He is stationed at Wright Field, and recently passed his 1st-class telephone exam in Boston. EKG says that he is going to go to school for a few weeks in New York. Morton Bardfield, of Dorchester, is going to help out in WERS. NHN writes from California and says that she recently became engaged to 7IBC. William L. Peters (LSPH), from Hull, writes from Miami, Fla., where he is stationed at the Army Air Base. JFS sends in more news. The following boys send New Year's greeting to the North Shore gang: KON and MQE from Hawaii; JNK from New Guinea. KMQ is planning a postwar rig. Ex-AFF is

sking in New York and talks of working 2¼ and 1¼ as a W2 after the war. LVZ made a record player. LTS and LTR have APO addresses. KBS has moved back to Wollaston. LID has an APO, c/o Postmaster, San Francisco address and is probably out in the Pacific by now. I want to thank each one of the 435 members of this Division who voted for me in the recent election for director. As you all know a special election is being held at this time. DJK's mother writes that DJK is in the AACs and is in Surinam, Dutch Guiana. He has been away for 26 months and expects to have a 30-day furlough. 2NFY is working at M.I.T. 73 until next time, Frank.

WESTERN MASSACHUSETTS — SCM, William J. Barrett, W1JAH — AZW reports from home, where he is recuperating after a long siege in the hospital. Prent wishes to thank all who wrote or visited him, and especially BKG, IZN, LUD and LKO, who donated blood for him. JLT is moving to a new location in Pittsfield. IZN is teaching code to CAP members two nights a week. MPU is moving to Florida for his health. DTO is a proud papa again. LKO bought a new home with ideal antenna conditions. LUD and AZW were visited by HPC of Newton and hashed over happenings of the last state-wide WERS test. MKR now a t/sgt., is home on furlough after three years radio operating in the South Pacific. MWE is back on furlough from New Guinea. BKG built the superhet described in QST and is wondering if it will work. How about each radio aide delegating a reporter for this column so we can get some news from the whole section? 73.

NEW HAMPSHIRE — SCM, Mrs. Dorothy W. Evans, W1FTJ/4 — JCA reports that he is now on a tanker in the Pacific. He tells us of an addition to his family, Charles David. We hear that JBA has been decorated by Admiral Nimitz. How about giving us the lowdown, Lee, so that we can pass the news on to the other boys? AXL is back in Claremont, where he is the local CAP communications officer. Ex-ATJ is on duty with the CAP in Bedford, Mass. IJB received a commendation from his commanding general for meritorious service in the North Solomons campaign. 3MY now is overseas with the Army. LBD is in Pearl Harbor; one of his recent visitors was AWU. BFT recently was decorated with the Bronze Star Medal for communication duties prior to and during the Normandy invasion.

RHODE ISLAND — SCM, Clayton C. Gordon, W1HRC — The annual election meeting of the PRA was held the first Tues. in Jan. with ten members present: KKE, HJB, JP, JEZ, FUB, NLF, DTZ, ex-BTV, Ashley Atherton and Harry Nicholson. There were coffee, doughnuts and free movies. The results of the election were: Nicholas Abbenante, pres.; NLF, vice-pres., sec., house committee, and any other duties not specifically assigned; KKE, treas.; HJB and JP, board of directors. Cpl. Ted Samatis is back after two years in the Aleutians where, because he is interested in ham radio and a member of the PRA and all that sort of stuff, he has been a hospital cook. S2c Eddie Lyons is on a coast patrol boat and is building up his code speed. NLEH, chief radio operator and ensign, is on his fourth trip somewhere in the Pacific on a merchant marine ship. JP regularly hears from LYE, who now is a sgt. KCS now is a chief petty officer. The PRA received a Christmas card from ACRM LWA. Milton Cohen was on furlough from Eglin Field, Fla. and called on the SCM the last day before leaving. IXT has joined the PRA. For the benefit of you folks away from home, NLF has promised to write the doings of the PRA every month. Ted's new address is Theodore Davis, 52 Staniford St., Providence 5, in case anybody wants to send any dope to him.

VERMONT — SCM, Burtis W. Dean, W1NLO — BD, communications officer for the VSG, on Dec. 30th was promoted from captain to major. Roy has been doing a bang-up job in getting WERS going in the various 8G units around the State. A good example is Co. E in Barre. Roy has several capable operators who will make good hams after the war. Recently they have been experimenting with J antennas on 113 Mc. MMV attended an REA convention in Texas recently. GAE has been in Chicago taking special training in teletype machine maintenance and has returned to Billings, Mont. Your SCM visited BD in Barre and KJG in Montpelier. GNF was in Montpelier on business and had a rag-chew with KJG and NLO. Al is taking a special course at Dartmouth College. 73. Burt.

(Continued on page 74)

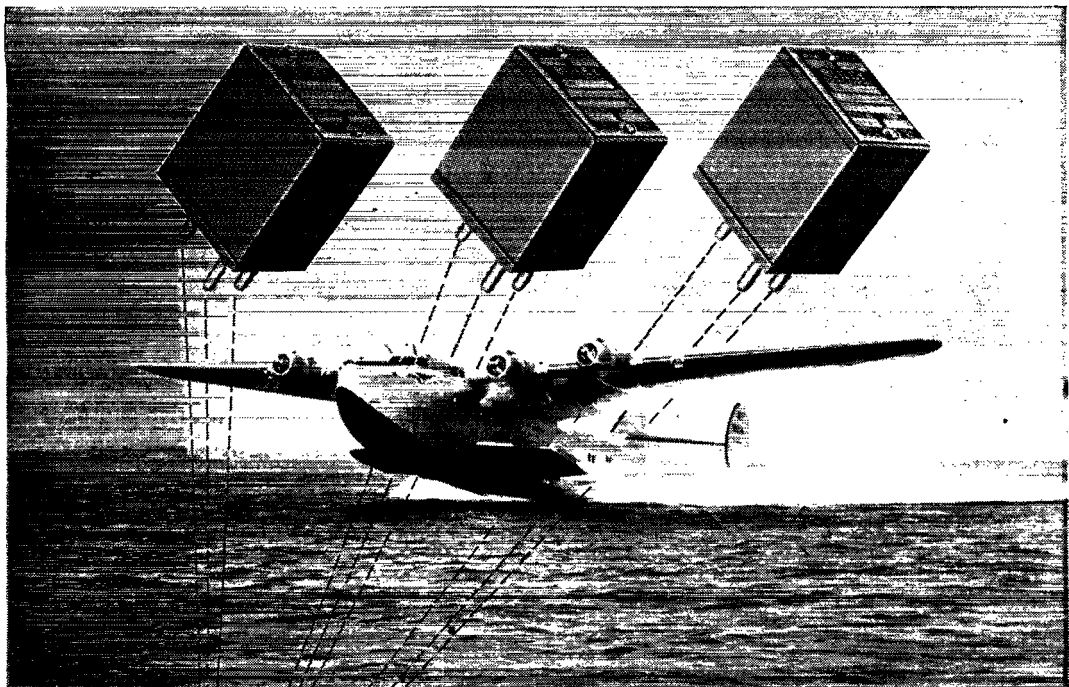

BLILEY CRYSTALS, of course, fly with Pan American



Do more than before . . .
buy extra War Bonds



A new star has been added

Bliley

CRYSTALS

Bliley *acid etched** crystals persistently show up wherever there is an important communications job to be done, such as the combination two-way telephone and telegraph and range finder systems of Pan American World Airways. In peace and in war Bliley crystals have flown millions of world-wide miles with their famous Clippers.

Bliley crystals are pre-conditioned for just such rugged assignments. In the Bliley Electric Company plant there

is a large section where Bliley *acid etched** crystals receive their pedigree. Here each crystal gets "the works". Its activity and frequency are *proved* under tough laboratory created service conditions of altitude, humidity, temperature, immersion, shock and vibration.

But licking tough assignments is a tradition with Bliley engineers and craftsmen. This background of research and skill has been responsible for the distinguished record of Bliley Crystals in every field of radio communication. Whatever your crystal problem may be—specify Bliley.

+

**Acid etching quartz crystals to frequency is a patented Bliley process.
United States Patent No. 2,364,501*

BLILEY ELECTRIC COMPANY • UNION STATION BUILDING • ERIE • PENNSYLVANIA

(Continued from page 72)

NORTHWESTERN DIVISION

MONTANA — SCM, Rex Roberts, W7CPY — Over the holidays several of the old gang were heard from. FL, CRE, U. S. Navy, reports from "somewhere" while on active duty and says he recently met ex-BST, on another ship. A nice card was received from CT, who recently was moved from Miami to Rhode Island. BCE, now in Fort Lewis, visited his old home town, Miles City. DXQ, BCE and AYG recently met in Miles City. DCZ is back in the States after working in England since before Pearl Harbor. CBY has moved to Havre and hopes to be permanently located. The Butte Amateur Radio Club held its annual meeting in January and elected the following officers for 1945: EQM, pres.; EMF, vice-pres.; Jack Picard, Class B operator, secy.-treas. and L. Blewett, C. Smith and J. Harrington on the executive board. They report two new members. EQC announced that he soon would take unto himself an XYL — Dorothy Stankey, who is also an operator for Northwest. BWH is home in Livingston again and reports that only he and FGB of the gang are left there. 73, Rex.

OREGON — SCM, Carl Austin, W7GNJ — This month's report would be very flat if it were not for the following from GVC: S/Sgt. HOQ is back at a redistribution center after 34 months in the infantry in the Southwest Pacific. GVV has received 2nd lieutenant bars at an OTS in Australia, and is serving as a communications officer. FUA has moved from Milton to Walla Walla, where he is running a radio repair shop. AIG is busy as a florist, and is rebuilding the rig in his spare time. FMJ is doing his bit by keeping the farmer's pumps in condition in the Free-water area. GYH still is in the So. Pacific, but is due home soon, on the rotation plan. Pat mentions little about himself except that he was given a disability discharge after four years service and is now attending Whitman College under the G.I. bill. DAA still is with the State Forest Service; he recently made a trip to Washington in connection with new frequency allocations. HVX is trying to figure out a wave guide for 160-meter beam. IIK is now chief ART, still explaining the mysteries of radar and radio at Corpus Christi. Roy Mickel (LSPH) is instructing a code class for Hood River CAP. 73, Carl.

WASHINGTON — SCM, O. U. Tatro, W7FWD — HCE, of Naches, has been appointed EC for Yakima and vicinity. His interest in amateur radio and his activity will insure proper representation for this district, which has been known for its amateur activity. CWN has been doing a little hunting. Lt. HNS now is at Inglewood, Calif. RT3c ILC, at Treasure Island, is reported getting enviable grades. HMJ gave FWR a lift in putting up a 20-meter horizontal; her 65-foot vertical tower was bringing in too much "man made" static. AEA, EC, reports that all is dormant around Tacoma. HCE, EC, writes his report at 3 A.M. while "the turbines try to sing me to sleep." ARF will have to be watched when we get back on the air because he may try to put a huge G.E. carrier rig on 80 meters. AUP reports that all is well in Eureka and he hopes to get his old two-letter W6 call reinstated. FCZ is going to miss 160 meters if we lose it. LV reveals that "Robby" sees at first hand some of the DX spots AYO used to work. It is rumored that ETX is now in the land that made the 4-coil Mervy circuit famous. GMC was at Treasure Island recently. HCE is tempted to tinker with a portable transmitter built long ago. Careful, LAI To the newly-appointed emergency coordinators, good luck and please have your report in by the 15th. 73, Tate.

PACIFIC DIVISION

EAST BAY — SCM, Horace R. Greer, W6TI — EC, QDE; EC v.h.f., FKQ; Asst. EC v.h.f., OJU; OO v.h.f., ZM. Jan. 18th saw another WERS meeting at the Oakland City Hall. Charles Haist was guest speaker and some short movies were shown. Remember the third Thursday of each month. These meetings are held for your enjoyment, so plan to be present. TI and TT are installing a public address system and also an inter-office communications system at the Oakland Chapter of the American Red Cross. In case of disaster, instructions can be given and persons can be called throughout the building. The amplifier and mike are located near KFMV-4, WERS Red Cross station. It's kinda hard to pass on all the news by yourself, so how about those letters and postal cards with all the latest dope about what you are doing in the service or out of the

service? I know many of the old gang would like to know what's doing. "Another day closer to victory." TI.

SAN FRANCISCO — SCM, William A. Ladley, W6RBQ — ECs, DOT and KZP; OO v.h.f., NJW. Radio Officer BP has visited Australia. CIS still is in the Admiralty Islands; he has been promoted and is now chief warrant officer. KB6ILT is busy at Skaggs Island and has purchased a new home at Eldridge, Sonoma County, Calif. RAH is moving to San Diego for Raytheon. NKE visited RBQ along with RXV, ex-YNIGJ; both are in the Navy and are located at Mare Island. I erroneously stated that NKE was in the Marine Corps and was injured in Europe. He was injured while on the East Coast but is well now. My apologies to Lt. HJP in having listed his call as HLP. Art advises he is living amongst grass shacks down on the Atoll of Tarawa. Season's greetings are acknowledged from Lt. OCZ, USNR. Pinky De Lasaux is home for a short visit and has been advanced in rank to Lt. comdr. 9LLH and husband, 91CN, still are in San Diego. RBQ has a new SX28A and is installing a V antenna for recording foreign transmissions on the new Prestar recorder. NJW bought a home with an eye to postwar rhombic antennas. MVG joined the Navy as S1c and is taking a radio technician course at T.I. 9BPN, of St. Louis, visited RBQ. 9EKY wrote in from Pearl Harbor. NKE wrote from Mare Island, where he has met the following amateurs: RXV/YNIGJ, TQE, 9PUG, 5HAT, 5FZA, CDO, 9CAX, 7ENH, 8TIC, 1LEM and R. D. Penny, operator license only. Capt. 7JEA, ex-PPO, who suffered a leg injury, is back at sea. A letter from RM1c 7IBC tells of his engagement to WAVE 1NEN, RM2c. They plan to be married after the war. Norma said she would marry only a ham. She picked a good one, and Bert sure has a swell girl. 73, Bill.

SAN JOAQUIN VALLEY — Acting SCM, Edward H. Noack, W6BXB — Wish some of you hams would take a little interest and send the Acting SCM some news. Have heard nothing from the Fresno section. Had quite a lot of news from QDT, formerly of Modesto, now in Sacramento. HIP, from Treasure Island, called on the SCM a few days ago, and says his class in radio is doing fine. DTJ, at the same place, gave me a call recently. BEW, an ensign in the Navy, also is at Treasure Island. JIN has been honorably discharged from the Navy. He had charge of Diesel engines on crash boats. Brownie, as he is called, is a very good ham. QUE, OYF and the SCM are trying to get going on c.c. So, gang, please send in some dope of any of the boys you know of.

ROCKY MOUNTAIN DIVISION

COLORADO — SCM, H. F. Hekel, W9VGC — Carl Drumeller is back on his job in Washington, D. C. after a two-month stay in the hospital. He sends his best regards to the gang. K. B. Warner's son, Pvt. Richard M. Warner, is stationed at Lowry Field taking a course in gunnery. Mr. Jensen and Mr. Harris of the FCC went through Denver Jan. 12th. The Electron Club and WERS shipped more re-enforcements to the Navy via Great Lakes, Ill. Jan. 26th. That was the day that Bob Perske (LSPH and KFND-22) started his trip to Tokyo. We still have his side-kick, Jim Lindsey (LSPH and KFND-35) and if things get too tough for Bob we can send Jimmie to help him. The Radio Widows whooped it up Feb. 1st with a big blowout and a dinner to celebrate their 100th meeting. Their first idea was to celebrate the occasion with a big clambake but after scouting up and down the Platte River as far as a couple of gallons of gas would take them without finding any clams, they decided to change their plans. Everything worked out for the best, as they found out later that baking a clam is not the same as baking a cake. FA was in Denver visiting his family and friends. He now holds the rank of commander, USNR. AAROD held its annual election of officers. The new line-up is: CNL, pres.; 3JIN, ex-9VTK, vice-pres.; CAA, secy. JBI attended the AAROD meeting as a guest. He spends most of his time on the Atlantic with the Navy. CNL joined forces with Weiker Storage & Trf. Co. BQO reports he has forty WERS operators and plans to have one of the best WERS nets in this part of the country before warm weather sets in again. By that time he expects to have several of the adjoining counties lined up with Denver County making portable DX tests and Field Days a part of WERS activities. 3JIN is designing the new frequency-standard equipment for the laboratory on Squaw Mountain. CAA was re-elected director for the Rocky Mountain Division and TFP was elected alternate. Howard does have his moments with a shotgun during "Stubble Duck" season. He says he has no

(Continued on page 76)

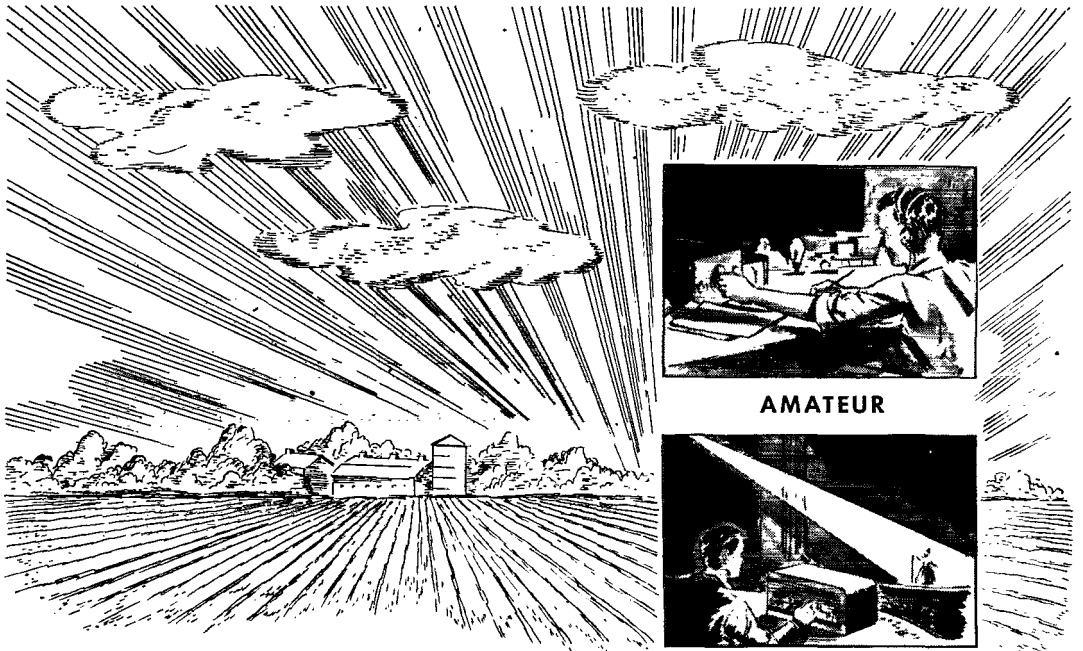

FIELDS OF TOMORROW

**will be developed more efficiently
because of Thordarson Transformers
being designed TODAY!**

Our 50 years of general experience, plus the many new results of war-time research are a guarantee that Thordarson will have the right transformer for every need, when civilian orders may again be accepted.



AMATEUR

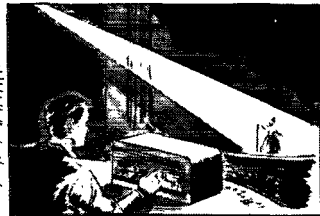

SOUND AMPLIFIER

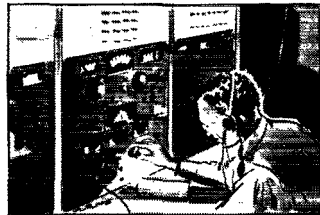

COMMUNICATIONS



EXPERIMENTAL



INDUSTRIAL



THORDARSON

TRANSFORMER DIVISION
THORDARSON ELECTRIC MFG. CO.
500 WEST HURON STREET, CHICAGO, ILL.

Transformer Specialists Since 1895
.. ORIGINATORS OF TRU-FIDELITY AMPLIFIERS

**War Product
That's Here
to Stay**

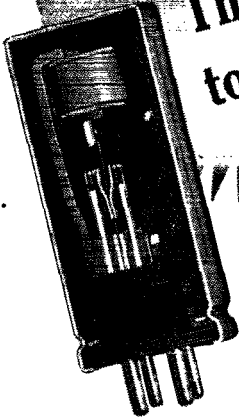

Mallory Hermetically Sealed Vibrators work at high altitudes and at sub-zero temperatures. They can be stored in jungle warehouses, and give rugged service in aircraft, boats and combat vehicles. With many improved features for war service, they're naturally better for civilian applications too—especially where tough conditions exist!

Individually tested against leakage with 20 pounds of applied air pressure, Mallory Hermetic Sealed Vibrators carry their own atmosphere. The seal never admits life-robbing fumes or moisture, never permits ionization breakdowns.

If you have vibrator-powered equipment operating under unusual conditions of humidity, altitude or corrosion, Mallory Hermetic Sealed Vibrators are the answer to your replacement problem. Just tell us the type number of your present vibrator, and the model number of your present equipment, and we will recommend the proper hermetically sealed unit. Stock types are available to replace nearly all standard types where a can size of 1½" diameter and 3¼" length (seated height) is permissible.

See your Authorized Mallory Distributor, or write our Engineering Application Section.

P. R. MALLORY & CO., Inc.
INDIANAPOLIS 6 INDIANA



P. R. MALLORY & CO., Inc.
MALLORY

Amateur Activities

(Continued from page 74)

trouble shooting the birds, his big trouble is in getting the dern things home after he shoots them. 7IV, formerly of Missoula, Mont., is on the staff of KFEL in Denver. The Western Slope Radio Club came up for air and GDC got the sheriffs along that side of the Continental Divide to scare the club membership out of hiding. MGX was elected president, FQT, vice-president and GLT, secretary. BVZ left Denver and reported for re-assignment and, we hope, a promotion in the Navy. His present rank is lt. commander, USNR. 73, by Heck.

SOUTHEASTERN DIVISION

ALABAMA — SCM Lawrence J. Smyth, W4GBV — APJ writes that he lacks only two states to make WAS in person. He is now stationed in the Hawaiian Islands. GYJ still is with Radio Intelligence Division of the FCC. S/Sgt. HAN is home from overseas for 21 days and has an XYL. He will be stationed for a while in Fla. EBD is stationed in Texas and has just been released from the hospital after a short illness. GPW is an ensign in the U. S. Naval Reserve. He is stationed at the Naval Research Lab. in Washington, D. C. He now is editor of the newly-created newspaper of the Washington Radio Club, and WERS operator for the local net, WJDC. He would like to see any of the gang who pass through Washington. DVJ writes a newsy letter from India. Plenty of cigarettes and American beer! ECF was home on leave after two years in the Pacific. He will be stationed in Asheville, N. C., for awhile. GOX recently finished his course at the American Telephone and Telegraph School in New York. 73, Larry.

EASTERN FLORIDA — SCM, Robert B. Murphy, W4IP — WERS activity is on the up and up here in Miami. Although confined to a sick bed, BYF is working very closely with the local boys. 1KVB is working with Mac and it seems as though we are to expect much activity. Among the newcomers to the organization are: NB, Salmon, Ettheier, Powers, Shepherd and others. We are very glad to see such activity. There are about twenty-five active stations at WKNW. Jerguson, a member of this group, is on a traveling job for PAA and is now at Port of Spain. No doubt he will be setting up some 2½-meter equipment to work back to the Miami net. Our new communications superintendent, Mr. Hugh M. Johnston of Pan-American World Airways, who comes to us from Brownsville, Tex., is a dyed-in-the-wool amateur, dating back sometime previous to 1919. Mr. Johnston is taking the place of Mr. H. C. Carroll, now resigned. ASR sends a Christmas card from Daytona Beach and says that ELA was home for a month's furlough. ELA is now a warrant officer. He was in Oran, Sicily and the invasion of southern France. Emmons is now stationed in Boston. ASR still is working hard to keep up the b.c. end of Daytona radio. BYR is plugging ALP as his relief for EC. I need fellows from the various parts of the State to get reports on amateur activity in their sections. Tell me what the fellows away from home and those at home are doing. This column depends on this reporting. You will notice that it is getting smaller each month and contains mostly Miami activity reports. That is because I can get to a telephone and get news individually from each key man in my own town. Now what I want is the same reporting from Jacksonville, Orlando, Lake City, Tampa and Sanford. See if you can get something to write about. STYH called me from CAA station WBR and promised a report from the 75 operators there. 73, Merf.

WESTERN FLORIDA — SCM, Oscar Cederstrom, W4AXP — War veterans' stories are coming to the front since some of the men who have seen service have returned home. One unusual yarn was told to the OM by G. D. Staheli, ACRM. He was in Hawaii and had planned to take the exams on a certain day and even had a transmitter built ready to go. Late the previous day they received orders to go on emergency patrol. After being out for several weeks, they arrived back at the base late on Dec. 6th. The Jap attack came the next morning, so he was out of luck again. Staheli plans to take exams next time the RI comes here. He is at Sqdn. 7, where Blackman and Watson are teaching communication. Watson came in from Corry and is now at Mainside with Blackman. 6BRG has been on leave here. The OM visited ECT, FJR, and 6PNI and a nice rag-chew was enjoyed. Lt. R. W. Bond, USN, a radio experimenter from Relay, Md., visited AXP on the communications shop. He

(Continued on page 78)

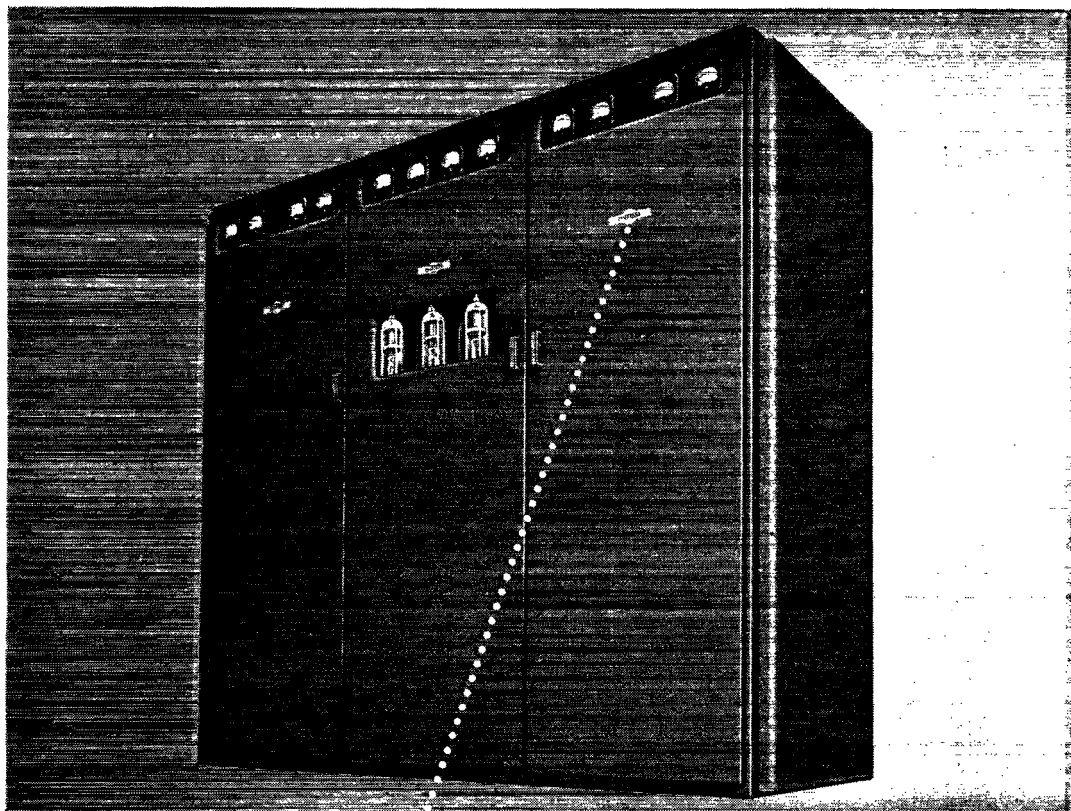

Collins 1000-C Multi-channel Transmitter

Smart engineering design halves the cost per channel

IN THIS 2500 watt, Collins engineering has struck an ingenious balance of quality, efficiency, and economy.

The right hand cabinet contains two vertical rf sections. Through application of the principles of quick shift (less than 2 seconds) each section can be used interchangeably on two channels, such as may be called for by day and night transmission. These channels are not limited to the pass band of the rf circuits but may be located anywhere within the tuning range of the equipment—2 to 20 mc.

The cost per section is comparable to that of conventional single channel sections. The actual cost per channel is thus cut approximately in half.

In addition, relays permit selection of three crystals per channel (six per vertical section) spaced within 2% of the nominal center frequency. Twelve frequencies are therefore available in a single cabinet, arranged as needed within the four channels.

In the equipment illustrated above, the left hand cabinet contains the af and modulator sections. The power supply cabinet is in the center. All sections are of highly advanced design, and are of the vertical chassis type.

We shall be glad to discuss applications of this rugged, versatile equipment to suit your operating requirements. Collins Radio Company, Cedar Rapids, Iowa.



Available: Additional af-modulator and rf multi-channel sections . . . Supplemental Collins Autotune rf section . . . Frequency shift keying . . . Complete remote control, built to your requirements.

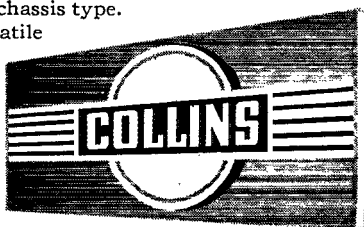

• IN RADIO COMMUNICATIONS, IT'S ...

PORTABLE POWER PROBLEMS

THIS MONTH—COMMERCIAL SOLVENTS CORP. PENICILLIN TEST

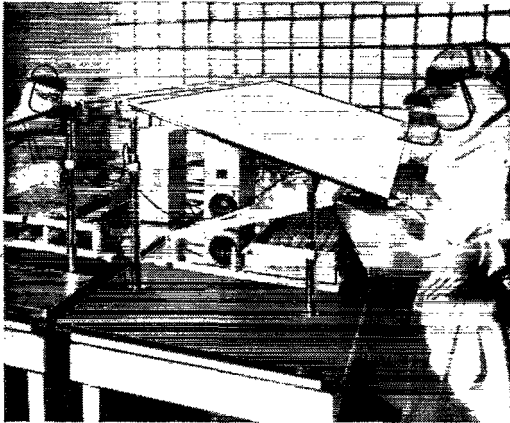

LIFE-SAVING PENICILLIN salt solution is carefully tested by battery-powered pH meters before it is placed in vials by white-clad technicians at the modern Commercial Solvents Corporation plant. Throughout the entire manufacturing process, rigid pH checks against excess acidity and alkalinity must be maintained while the penicillin is in solution.

FOUR pH METERS, powered by Burgess Industrial Batteries, are employed by Commercial Solvents Corporation on a 24-hour a day basis to assure necessary, uniform product control. Burgess Industrial Batteries are built to meet specific requirements of test and control instruments. Whatever your portable power problem may be, Burgess engineers are equipped to find the answer. Write us today about your needs, or request free, 80-page Engineering Manual on characteristics of dry batteries.

Dept. Q-7, Burgess Battery Company,
Freeport, Illinois.



BURGESS BATTERIES

(Continued from page 76)

has been working with radio for many years. His dad is a radio ham. HIZ, ex-W6, has been taking exams for commercial tickets. Our good friend and ex-ham, Comdr. G. R. Smith, USNR, is leaving this station in the near future. His home town is Ozark, Ala. We will miss his cheery smile and so will the boys in his ward at the hospital. DNA is over at Mobile. He has been a bit under the weather with rheumatism. He was up north for awhile, but was glad to get back to the "Sunny South." We had a letter from Hope Plummer, a YL ham formerly of Florida, requesting a copy of Horton Whaley's "The Song of a Radioman." A copy was autographed by the author and sent. Hope used to put her voice on the air over GFH in Palm Beach. Another letter arrived from ARM1c Herbert M. Chaney, USN, who works a radio in a plane here and yonder over the Pacific Ocean. He is OK and sends 73 to all the gang. Chaney enjoys the news from over this way which appears in *QST*. "Red" Flowers sends his greeting to all from Fort Riley. He keeps up with the doings in the section via *QST*, which he enjoys very much. He is a tech. sgt. and teaches radio at his camp. DAO has a beautiful rack and panel job going up and it really looks swell. He is getting set for the curtain to go up on ham activities when the last shot is fired. Bill Langford got his commercial ticket recently and a grade high enough to give him the higher grade ham ticket. He already holds a Class C. All he needs to do now is to pass on the laws of ham radio. He is experimenting with amplifiers and has built a receiver which works very well indeed. Joe Hicks and Seale, from Ellyson and Whiting Fields, have come into the shop on business and for ham chats with the OM. Let's hear from you boys in the eastern part of the section and down Panama City way. 73 to all from *The Old Maestro*.

GEORGIA — SCM, Ernest L. Morgan, W4FDJ — AGI, our former well-known and efficient SCM, now a major in the Marines, has an assignment in the States which will let him become acquainted with his two boys. GFF is in Navy school at St. Louis. GIA is in Navy school at Chicago. GQD was home on furlough. ERS will be in the Naval Hospital until March. Warren H. McQueen, Camp Wheeler, has a new operator license, DNY, home from the Mediterranean and England, is happy with a bride and an assignment with one terminus in the United States for a considerable length of time. FCW is seeing plenty of activity on the Western Front. DIZ has been moving from one school to another so often we can't keep up with him. Sgt. Moss still has a Seattle APO address. We would like more news of the AARS and the 160-meter gangs for this column. 73, *Pop*.

SOUTHWESTERN DIVISION

LOS ANGELES — SCM, H. F. Wood, W6QVV — Fred Stapp, of Inglewood, advises that KGIC has been as active as ever making tests and checks on their recently-activated mobile units. Most of this work is done on Sundays, while the regular drill is held on Monday nights. Stapp also reports that most of the operators are "hams" and that considerable work is being done on new gear; several 112-Mc. superhet receivers are in the process of being built. Applications still are being filed with FCC for additional operator licenses. While we didn't get reports from KGWE and KGCL this month, we know that they are as active as ever for we have heard them on each test period from our very poor location. KGLV is working out at each period, too; several units now are crystal-controlled and some "super" receivers are in operation. Had the pleasure of going over the one built by PTR and Earl Rau, who sure did a fine job. Prints are being made up and pictures taken so it, as well as the small crystal-controlled transmitter and receiver that GZZ had a hand in, may appear in *QST* soon. It is very suitable for mobile as well as fixed station operation. Even our "chief," Walt Matney, is building, I hear. Had the pleasure of meeting GWD, of Northern California and more recently with Submarine Signal Co. of Boston, who was here in town on business for a few days. Took him out to see his old friends Seymore Johnson and Curtis Mason of KFI and a good rag-chew ensued. UQL writes that he expects to be home from the Aleutians in the very near future. SSU seems to be getting farther and farther away. Dick writes that he likes the life of a sailor and his duties as operator on board ship but that the ship doesn't make port often enough. If you want to see more news in YOUR column, send it in to me, please. *Ted*.

ARIZONA — SCM, Douglas Aitken, W6RWW — First of all, I want to thank MLL for taking over this column

(Continued on page 80)



Centralab

Lever Action SWITCHES

THESE low-capacity space-saving switches are used singly and in groups.

In shops and laboratories, by experimenters and by manufacturers these Centralab switches are becoming increasingly popular.

They are particularly adapted to broadcasting, receiving, public address, test instruments and individual uses.

These Centralab switches are available in ten different combinations including positive and spring return action types with either shorting or non-shorting contacts.

Be sure to specify "CENTRALAB" when ordering Lever Action Switches.



Centralab

Division of GLOBE-UNION INC., Milwaukee

PRODUCERS of Variable Resistors;
Selector Switches; Ceramic Capacitors,
Fixed and Variable; Steatite Insulators
and Silver Mica Capacitors.



Consult our Engineers

Into the Stancor units of today are assembled
only those engineering improvements which
gruelling field and combat service have stamped
with unconditional approval . . .

May we suggest that in your projected plans, you
consider Stancor . . . Our engineers, while largely
assigned to the war effort, may be available to
discuss the adaptability of Stancor transformers
to your current and future needs . . . Your inquiry
will receive our best attention within the limits, of
course, of the imperative demands upon all of us.

STANDARD TRANSFORMER CORPORATION
1500 N. HALSTED ST., CHICAGO 22, ILLINOIS

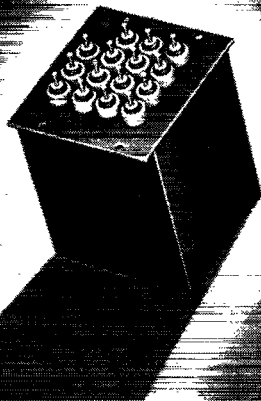

(Continued from page 78)

last month while your SCM had a session in the hospital. I am very sorry to have to report that MLL himself is having another setback—here's hoping you snap out of it quick, Glad! While in the hospital, I had the pleasure of meeting OAS and TBR personally. Wish I might have met more of the Phoenix gang, but circumstances prevented. A swell letter was received from ARTIC QJL, who is in the Pacific area; he wants to say hello to all the gang. UKB sends a wedding announcement. HBR still is instructor down Texas way and now rates RM1c. REJ is over on the other side of the globe now; he thinks it is a swell place and gets a chance to do a little fishing now and then. NRP also is in that area. QWG made a trip to sea again, a short one this time, and was able to be home for awhile with that new XYL of his! RXQ is somewhere in the Pacific area on a destroyer. The Tucson Short Wave Assn. keeps up its activities. A club within a club has been formed, "25 Division," being a section that leans heavily to the liquid refreshments! Officers are: GS, pres.; C.R. Salter, vice-pres.; Jack Pofford, secy.; Louis Haraway, treas. TCQ dropped over from Willcox and acted as temporary chairman. QAP seems to be having a swell time in South America, though he is passing up shrunken heads as decorations for that postwar shack. JRK now is stationed at Davis-Monthon Field. OZM keeps busy with the police, sheriff and Consolidated equipment. Another informative and interesting letter was received from ex-KFC. He writes that he was home over the holidays and got to see a demonstration of the Salt River Valley WERS set-up. He reports that PFL, a capt. in ATC, also was home over Christmas; IUQ is in KA-land; FZQ has been promoted to captain in AACs; KTJ has his 1st-class telephone and commercial flying tickets and is teaching at Junior College; LKK is teaching at Phoenix Union High. Didn't get a chance to wish the whole gang the "Best of the Season," so here it is, although belated. May we all be back on the air again, and soon! 73, Doug.

SAN DIEGO — SCM, Ralph H. Culbertson, W6CHV — Asst. SCM, Gordon W. Brown, W6APG — OIN and NDD met with Red Wyatt of Long Beach recently and formulated further plans for the WERS organization here. Application for operator license will be mailed to anyone desiring it. If interested, please call NDD or OIN. Let's go, gang. GCT is back on the job after a long illness. FTT has returned to Raytheon after a short vacation. LYF reports a promotion; he and ROZ are anxious to get going on WERS. SVB says hello and is going strong with his job at the Gas Co. TQR is plenty busy with dots and dashes and playing with carrier current. MXK is back and has opened his radio shop and laboratory in El Cajon. CAV, of Grosmount, is very busy with his radio shop and duties as postmaster. MKW was a visitor in San Diego. A nice letter was received from Ensign Evan Stover, USMS, who was an SWL but now has his own license, issued after Pearl Harbor. Stover and RTQ are in the Far East. IIRL now is located in San Diego, working as an engineer at Convair. DUP still is delivering mail for Uncle Sam and is a member of VPSF in his spare time. DUP is going to start a code and theory class in February. The class will be held at his home every Friday night. Anyone interested, please get in touch with DUP. RPJ is working for the Navy at Chollis Heights. DNW is back in the radio shop at North Island. 73, Ralph.

WEST GULF DIVISION

NORTHERN TEXAS — SCM, Jack T. Moore, W5ALA — ILJ reports from Brookley Field that HTH now has a San Francisco APO number. Joe wants the address of FCL IJC, who is in the Navy, will be listed in the 1944-1945 issue of "Who's Who in American Universities and Colleges." Batty received his B.S. degree in electrical engineering from the University of Oklahoma in Oct. GLD is now working for KWBU and has obtained both telephone and telegraph 2nd-class licenses. Frank says that although KWBU's studio is located in Dallas and the transmitter in Corpus Christi (better than a couple of hundred miles apart) everything seems to work out nicely. AAN is an ensign in the Maritime Service and advises that he has been pounding brass on merchant ships for the past eighteen months. Trav has been to England, Scotland, North Africa, Italy, Cuba and Panama and is taking a new Liberty ship to the So. Pacific. He advises that he took a cargo of bombs onto the beach the day after D-day in Normandy. He sends his regards to the gang and says he may have something to report later. The SCM thinks that Trav's report on activity up to now is something.

(Continued on page 82)

ONE OF A SERIES OF ELECTRO-VOICE ADVERTISEMENTS EXPLAINING IN DETAIL THE APPLICATIONS AND SPECIFICATIONS OF ELECTRO-VOICE MICROPHONES

Electro-Voice MODEL 205-S

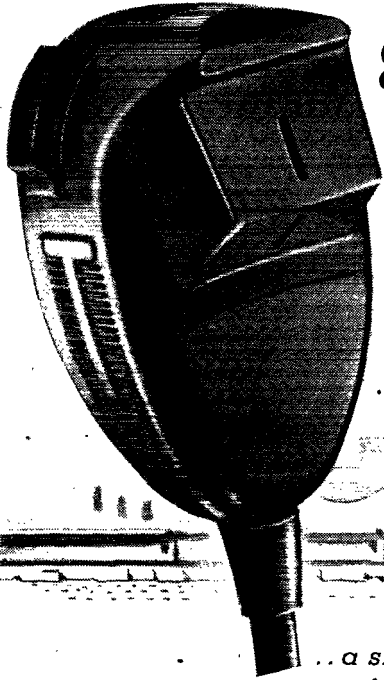

For
RAILROAD
MARINE
AIRCRAFT
POLICE
EMERGENCY
INDUSTRIAL CALL SYSTEMS
IN NOISY LOCATIONS
... and many other applications

... a single button, hand-held, carbon DIFFERENTIAL microphone, designed for maximum intelligibility under extreme noise

Ambient noise is fed into dual apertures, shown in photograph, in correct phase relationship to provide almost complete cancellation of the entire noise spectrum. Speech that originates close to one of these apertures is faithfully reproduced. Articulation percentage is at least 97% under quiet conditions, and 88% under a 115 db noise field. The Model 205-S is unusually versatile . . . can be used, indoors or outdoors, for all speech transmission in any noisy, windy, wet or extremely hot or cold location.

Because the 205-S is a noise-cancelling microphone, it must be used in a manner different from any other type. The microphone should be held so that the lip-rest will touch lightly against the upper lip. This brings the mouth and instrument into the correct position for proper transmission. As with all Electro-Voice microphones, the Model 205-S is guaranteed to be free from defect in material and workmanship — for life.

SPECIFICATIONS OF THE MODEL 205-S

OUTPUT LEVEL: Power rating: 27 db below 6 milliwatts for 10 bar pressure. Voltage rating: 10 db above .001 volt/bar, open circuit. Voltage developed by normal speech (100 bars): .32 volt.

FREQUENCY RESPONSE: substantially flat from 100-4000 c.p.s.

ARTICULATION: at least 97% articulation under quiet conditions; 88% under 115 db of ambient noise.

AVERAGE BACKGROUND NOISE REDUCTION: 20 db and higher, depending on distance from noise source.

WEIGHT: less than eight ounces.

INPUT: standard single button input is required.

CURRENT: 10-50 milliampere button current.

HOUSING: molded, high impact phenolic housing; minimum wall thickness, 5/32"; vinylite carbon retainer.

TEMPERATURE RANGE: from -40° to +185°F.

PRESS-TO-TALK SWITCH: available with or without hold-down lock. Double pole double throw contacts provide an optional wide assortment of switch circuits.

STANDARD SWITCH CIRCUIT: provides closing of button circuit and relay simultaneously.

THERMAL NOISE: less than 1 millivolt with 50 milliamperes through button.

STURDY CONSTRUCTION: capable of withstanding impact of more than 10,000 6" drops to hard surface.

POSITIONAL RESPONSE: plus or minus of 5 db of horizontal.

CONDUCTOR CABLE: 5 feet of two conductor and shielded cable, overall synthetic rubber jacketed.

Model 205-S, List Price \$25.00

Model 205-S, with switch lock, List Price \$26.50

Electro-Voice MICROPHONES

ELECTRO-VOICE CORPORATION • 1239 SOUTH BEND AVENUE • SOUTH BEND 24, INDIANA

Export Division: 13 East 40th Street, New York 16, N. Y., U. S. A. Cables: Arlab



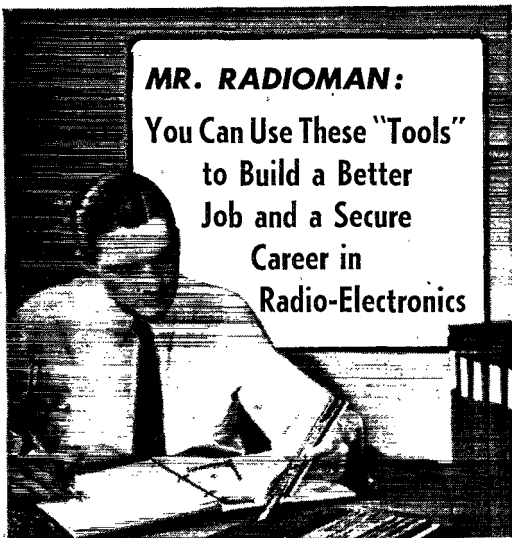

CREI Home Study Training in Practical Radio Electronics Engineering Combined With Your Own Experience Assures You of Post-War Security and an Interesting, Profitable Career.

After the war, it will be "the survival of the fittest." Employers will once again be "choosey." Only the best qualified men will be selected for the best jobs.

NOW is the time to take the time to prepare yourself for these important, career jobs in radio-electronics engineering. CREI can show you the way by providing you with the "tools" to build a firm foundation of ability based on a planned program of technical training.

In our proved home study course, you learn not only *how . . . but why!* Easy-to-read-and-understand lessons are provided you well in advance, and each student has his personal instructor who corrects, criticizes and offers suggestions on each lesson examination. This is the successful CREI method of training for which thousands of professional radiomen have enrolled since 1927.

Investigate now the CREI home-study course best suited to your needs, and prepare for security and happiness in the coming New World of Electronics! *Write for all the facts now.*

● WRITE FOR FREE 36-PAGE BOOKLET

If you have had professional or amateur radio experience and want to make more money—let us prove to you we have something you need to qualify for a better radio job. To help us intelligently answer your inquiry—please state briefly your background of experience, education and present position.



Capitol Radio Engineering Institute

Home Study Courses in Practical Radio-Electronics Engineering for Professional Self-Improvement

Dept. Q-3, 3224 16th St. N. W., Washington 10, D. C.
Contractors to the U. S. Navy, U. S. Coast Guard and Canadian Broadcasting Corporation

Producers of Well-trained Technical Radiomen for Industry.

(Continued from page 80)

How about it, gang? GSZ is keeping the old rig in working order so that when that certain day comes he can get back on the air plenty quick. Cecil says that he is keeping up his subscription to *QST* so that he can follow every detail of the good work that the League is doing toward the restoration of the ham frequencies. He thinks every ham should do likewise, in order to back up the only organization that is fighting for us. SN reports from India that JM is a 1st lt. now, and is stationed on Saipan. Jim says that TR is a 1st lt. comdr. in the Navy and is located in Hawaii. SN would like to know what has become of BAM, as the last report he had, Gene was an ensign on a carrier. JJF and some of the other fellows in El Paso are working on carrier-current rigs and will advise results later. Luther says the following other hams are doing civilian radio work at Fort Bliss: Ex-AKY, ex-BEB, IAF, IXS and KEV; also ENP has been transferred to Lexington Signal Depot while FLJ has been transferred to Camp Barkley. GDH is in the Air Corps Radio Maintenance at Biggs Field and promises news on the other hams stationed there. BNQ wants to use Class B audio in a Class B final in his postwar rig, and if he can figure out a way to reduce the distortion by about four hundred per cent, he will really have something — a transmitter with AVC! NW is due congratulations on his re-election as ARRL director. Soupy reports that he will soon be Hartford-bound to attend a meeting on the discussion of ham frequencies. DLP returns to this section as Philco warplant representative for North American and Lockheed at Dallas and Consolidated in Ft. Worth. IJR is working at Lockheed again. ALA is still looking for an SX-24. 73, Jack.

OKLAHOMA — SCM, Ed Oldfield, W5AYL — Enid's amateur club is functioning regularly although mostly in a social manner. HGN furnished considerable information in that respect. He's doing certified public accountant work in Enid, and as a side-line is continuing his frequency checking of broadcast and police stations. He has a real outfit and is adding some General Radio equipment. "Russ" Battern is at his old job with Pillsbury Flour Mills and is quite busy teaching radio courses sponsored by Oklahoma University. CPC is working for "Failing Supply Co." HGN reports that the Enid club assists the C.A.P. with its radio problems even though not actively coordinating with it. Several of the old club members are still at home and others are overseas with the Army. Will have more dope from the Enid club next month. Regards, Ed.

BRIEFS

Our congratulations this month go to the members of the Milwaukee Radio Amateurs' Club, Inc. of Milwaukee, Wis., who are celebrating their 25th anniversary of affiliation with ARRL, and who are beginning their 28th year of existence as a radio club group. To our knowledge, the MRAC is the oldest, continuously-existent radio amateurs' club in the world. The club has met and still meets every Thursday evening in the Milwaukee Public Library and Museum, the building in which it first began.

The MRAC has always been an extremely active club, and its members have taken great pride in having excellent lecturers procured for club meetings; in holding the annual QSO parties, which have averaged an attendance of from 300 to 500 persons, with some guests coming great distances; in sponsoring other events, such as the 1940 Central Division convention, and in having members on the planning committee of the 1938 National Convention of ARRL in Chicago. In addition, the MRAC has been affiliated with the Chicago Area Radio Club Council for over five years.

Even though the member ranks are greatly depleted now, the old-timers are carrying on "until the boys get back" by maintaining an active WERS set-up, and by issuing a monthly bulletin on club activities which also contains news of members at home and abroad. This bulletin is mailed out to 85 people, and since its inception, the bulletin has been acknowledged in letters from 76 individuals from all parts of the world.

Long live the MRAC!

The Rochester Amateur Radio Association of Rochester, New York, has been holding some fine club meetings attended by about thirty members per meeting. The gang is looking forward to a combination banquet and hamfest to be held in March.

RAYTHEON 6AK5

for Broad-Band Amplifiers

in the high and ultra-high frequency regions

For several years Raytheon has been producing for the government a miniature pentode tube so compact and so outstanding in performance that it should be carefully considered by engineers designing future FM, television and amateur equipment.

Interelectrode spacings and element size have been so greatly reduced that the 6AK5 combines the desirable features of low input and output capacitance with high transconductance, reduced lead inductances and lower transit time losses.

It is obvious that "split-hair precision" is required to manufacture the 6AK5, for the distance between the control grid and the cathode is .0035 in.—and the grid is wound with tungsten wire whose diameter is a fraction of that of a human hair.

The 6AK5 is just one example of Raytheon's outstanding ability to build fine tubes for important military use—ability that will be equally evident in the postwar products of the radio and electronics industry.

Specifications of 6AK5

Maximum Diameter		3/4 inches
Maximum Seated Height		1 3/4 inches
Filament Voltage	6.3	6.3 volts
Filament Current	0.175	0.175 amperes
Plate Voltage	180	120 volts
Screen Voltage	120	120 volts
Control Grid Bias	-2	-2 volts
Plate Current	7.7	7.5 ma
Screen Current	2.4	2.5 ma
Transconductance	5100	5000 umhos
Control Grid to Plate Capacitance*		0.01 μμf
Input Capacitance*		4.0 μμf
Output Capacitance*		2.8 μμf

*Using RMA Miniature Shield.

All Four Divisions
Have Been Awarded
Army-Navy "E"
with Stars



Listen to
"MEET YOUR NAVY"
Every Saturday Night
ENTIRE BLUE NETWORK
Coast-to-Coast
181 Stations

RAYTHEON

RADIO RECEIVING TUBE DIVISION
Boston, Mass. • Los Angeles • New York • Chicago • Atlanta

DEVOTED TO RESEARCH AND THE MANUFACTURE OF TUBES AND EQUIPMENT FOR THE NEW ERA OF ELECTRONICS

HARVEY

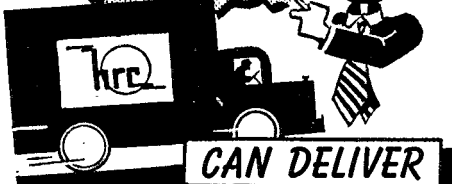

...urgently needed
Radio and Electronic
Components and Equipment
from America's leading manufacturers!

CAPACITORS • RESISTORS
TRANSFORMERS • RELAYS
TUBES • TEST EQUIPMENT
... and 1001 others!

Now, more than ever, HARVEY stands ready to supply you with what you need to help win this war, and to get it to you as fast as possible. We specialize in locating hard-to-find items. We can advise as to the effectiveness of substitutes. We can discuss technical and priority problems with you. HARVEY, with 18 years experience in the field, is now, as always, your safe bet.

Telephone Orders to Longacre 3-1800

HARVEY

RADIO COMPANY

HARVEY

103 WEST 43rd ST., NEW YORK 18, N. Y.

The Month in Canada

(Continued from page 84)

of the report: 4AID, H. O. Grinsrud of Calgary, is in the Army, still fooling around with radio equipment which is reputedly still on the "secret list." 4AOX, A. S. Tulloch of Calgary, is overseas with the Army. 4CW, Ben Cool of Calgary, is doing quite a bit of movie work, especially in the line of home processing. 4FU, R. F. Bonnett, formerly of Edmonton, is a radio supervisor at one of the air schools in Winnipeg, looking after the installation of radio equipment in planes. He will be remembered by many of the Edmonton boys as the chap who ran the Jas. Richardson Co. station out on 143rd Street years ago. Jack says he hasn't lost any weight! 4HQ, Bill Stunden, R. I. of Calgary, is still laid up in his home after the serious auto accident he suffered last Fall. 4HY, Tommy Hyde of Edmonton, is with RCCS overseas. 4IH, R. McLeod of Calgary, is a major with RCCS, and until recently was in Eastern Canada. 4JA, J. A. Argue of Calgary, was DSO in Winnipeg, but recently moved down East. Of 4JL, Jake Allan, R. I., Edmonton, Jack says he usually manages to see him when in Edmonton. 4OV, F. Reesor of Calgary, is doing a good job somewhere overseas. When last heard of he was a signal officer (not with RCCS) with some unit over there: 4UJ, E. H. Heavens of Calgary, is with the RCCS as a "senior op." 4XA, Jack Gillette of Edmonton, is a captain with RCCS overseas, address unknown. 4ZZ, A. W. Morris of Calgary, is an "op" with RCCS. 4TF, Fred Newcombe of Vegreville and Red Deer, is adjutant at the Camrose Basic Training Centre. Thanks a million for all the dope, Jack; it sure helps out immensely.

A letter from Harvey Runnalls, whose brother is overseas with RCEME, tells me that 4AJV, Harvey Milne of Calgary, is a sergeant in his outfit. I'm sorry to report that 4VJ, Ken Angus of Edmonton, is still on the convalescent list, and not feeling himself at all. Let's hope that things brighten up a bit for him in the very near future.

4ZL, Elwood Irwin of Barons, came across with a few notes on the doings of the Southern gang. 4PZ, Vic. Row of Calgary, RCAF, and his XYL are celebrating the arrival of a junior op. 4ADY, Laverne House of Barons, announced the arrival of a daughter on December 15th. A clipping from the Lethbridge Herald attached to Irwin's report indicates that both 4EO, Bill Savage of Lethbridge, and his XYL have been doing some very good shooting in the Canadian Small Bore Rifle Association matches. Their individual scores, which placed them in third and seventh places respectively in the "B" Class competition, were 393-19X and 390-13X. 4AQP, Milson Hodgson of Barons, finally received the windows for his new house, but it will be an awfully chilly job putting them in during the winter. 4ARC, Aylmer Gloer of Barons, is busy trucking wheat and 4WZ, John Row of Barons, is occasionally seen on Barons' streets.

The arrival of long-awaited "wireless" equipment for the Signal Platoon of the 2nd Battalion Edmonton Fusiliers finally arrived and 4LQ, Bill Butchart of Edmonton, has been busy instructing NCOs in its care and use. The equipment included walkie-talkie sets, which prove very interesting. 4XE, Dick Bannard, W.O. 1, of Edmonton, has gone East for a course at Kingston and will not be back until early February. 4ATH, Stan Mitchell of Edmonton, who is now working out at the transmitter at CFRN, has in all probability had more than just a little hand in the construction of that station's new stand-by rig. 5FG, Doc. Hocking of Prince George, B.C., is stationed in Vancouver and according to 4HM, Chas. Harris of Edmonton, he is in charge of a dental clinic. It might be well to note that Doc. is a captain in the Canadian Army Dental Corps. 4AHY, Harvey Runnalls of Edmonton, now with the RCCS in Ottawa, was married early in December.

MANITOBA—VE4

From Art Morley, VE4AAW:

It's been ages since you have seen anything in this section, fellows, but things beyond my control prevented my sending the news down to Headquarters. So please have mercy on me this time. Some of this may be old stuff to you by now but others may not have heard of it. 4VG was posted to Winnipeg a couple of months ago and is working (?) hard. 4AJJ has left the RCAF and is back in civilian life. 4HP also received his discharge and at last report was going back to

(Continued on page 86)

Take a look at the size of the "BATTERY OF TOMORROW"

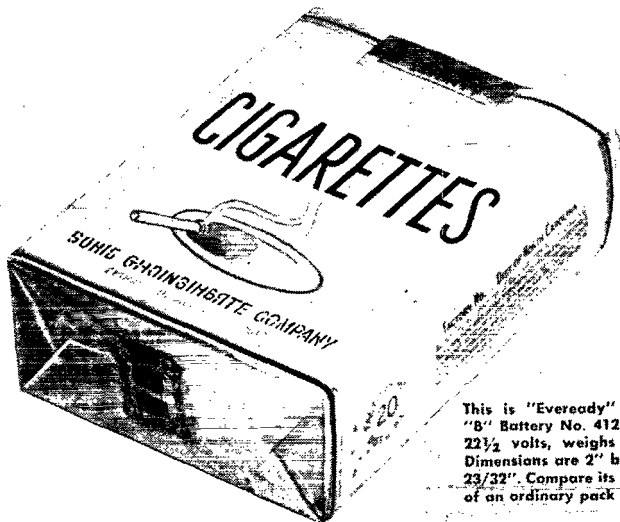

This is "Eveready" "Mini-Max" "B" Battery No. 412. It furnishes 22½ volts, weighs 2½ ounces. Dimensions are 2" by 1 1/32" by 23/32". Compare its size with that of an ordinary pack of cigarettes.

No. 412

"EVEREADY" "MINI-MAX" "B" BATTERY (22½ VOLT)

HERE IT IS—the midget battery that opens up new fields of opportunity in postwar radio and electronics. 22½ volts crammed into a space so small that it staggers the imagination!

"Eveready's" exclusive "Mini-Max" construction makes all this possible. Actually it has proved a vital factor in improved communication equipment for this mobile war. By the same token this revolutionary "Mini-Max" construction will make possible radically new portable radio sets and other electronic devices after the war—sets for the personal use of an individual. Sets so small they will fit in a man's vest pocket or a woman's handbag. The portable radio business, just coming into its own before the war, promises to return with an even brighter future—aided by this midget battery. You can look forward to a new line of merchandise on your shelves—new customers—new business.

Actually, the baby "Mini-Max" "B" Battery in itself is an invitation to creative men to de-

velop new devices to keep pace with it. We urge engineers and designers to consult us—discuss their ideas and problems with our engineers, who are ready and willing to cooperate in every way. The laboratories and technical staff of National Carbon Company are at your disposal.

"EVEREADY"

MINI-MAX
TRADE-MARK

RADIO "B" BATTERIES

NATIONAL CARBON COMPANY, INC.
Unit of Union Carbide and Carbon Corporation

INC.

General Offices: NEW YORK, N. Y.

The trade-marks "Eveready" and "Mini-Max" distinguish products of National Carbon Company, Inc.

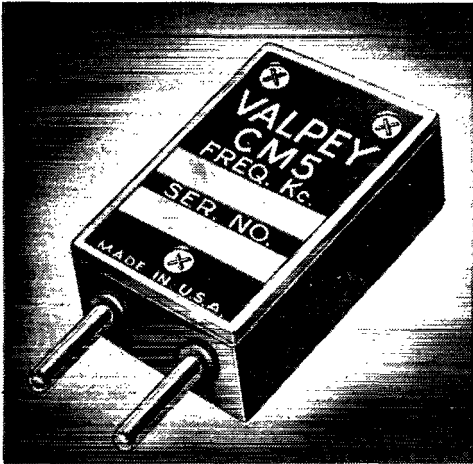

Fidelity

Precision ground by crystal craftsmen. Valpey Crystals may be relied upon for high fidelity and perfect service under all conditions of operation.

Tested in the crucible of war from the Arctic to the Tropics, they have earned their right to prominence in the bright world of tomorrow. Your inquiries are cordially invited.

NOW READY—the first of a series of Valpey Bulletins with Binder—FREE ON REQUEST.

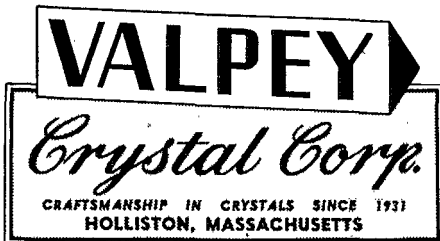

railroading. 4GC was seen in Winnipeg on leave a few days ago. How about a line with some Navy stuff, Regt 4SS is with the RCAF and is now located in Calgary. Was told that 4BG had received his discharge from the Army and was back in the Peg. 4AEE was seen in Dauphin with an RCAF uniform on. 4CZ is to be congratulated on the birth of a jr. op. last week. 4EI is back with CKY. 4FS on last report has been promoted to the rank of Squadron Leader. 4QG was last heard of in Edmonton. Also heard Bill got married. Had a letter from 4AAV, who is overseas with the RCAF. 4ACP was posted to Souris and promoted to Flight Lieutenant. 4FV has left Winnipeg and gone back to the Ferry Command, this time as a pilot. 4AMT is working as a civilian in the radio section of the RCAF station at Portage. 4ARM is with the Army stationed here in the Peg. 4VA, who is in the RCAF, is now in Brandon. 4AFK was presented with a pair of jr. ops. a short time ago. Congrats, Wilf, and sorry I didn't see you when I was in Brandon last. 4ABN is with the RCAF at Portage. 4APQ, who returned from overseas some time ago, is now stationed in Winnipeg. 4MF, who was at Yorkton, is now at Gimli. 4EN was last seen at Brandon. 4PZ is at Dauphin. 4AKO recently received his wings at Gimli and is now a full-fledged pilot. 4ARX was discharged some time ago. 4LV was another one discharged from the RCAF, but understand he is now with the Army. 2BS was posted to Winnipeg a short while ago. 3AZP, who was one of the signal officers at RCAF Hq., left the Peg to go on a special course. Chuck received his promotion to Flight Lieutenant just before leaving. 4XG, who is with the Navy, was married when on leave. 4JN was posted overseas with the RCAF. 4AJC with the RCNVR was promoted to Lieutenant. Harry is on loan to the Fleet Air Arm of the Royal Navy and was in on some of the *Tirpitz* action. Had a letter from 4AEB, who was with the Aussie Navy but has been discharged after seeing much of the world. He is now working for U. S. Transportation Group and is way down in New Guinea. That's all for now, fellows, and don't forget this is your column. 4AAW is no longer with the RCAF so send your stuff along as I've got the time for it now. The address is 26 Lennox St., St. Vital, Man.

MAILBAG

Fred A. Greene, VE2EP, home again after having served in the RCCS, brings us up to date on the doings of the hams of St. Lambert, Quebec: "All the boys of the Hot-Wire Ammeter Club of St. Lambert are now on active service. Three of the members—2KB, 2PC and 2QW—have given their lives. 2KY is doing a fine job with the Navy after five years at sea and is now an instructor. 2LR, 2PW and I are furthering instruction for Army officers and NCOs. 2XXM at present is in the wilds of the Northwest Territories."

L. J. Fader, VE1FQ, a former reporter for the VE1 district, writes from his latest QTH in England:

"I finally made it and am now stationed in England. We sailed from an American port and were well taken care of by the American Red Cross while waiting to go aboard the ship. We were treated with candy, coffee, and doughnuts and they also had a band from the U. S. Army play to us to boost our morale.

"I spent Armistice Day week-end in Montreal and while there called in to see Alex Reid, the Canadian general manager and also saw 2BV, Fred George, who is a big gun in the RCA plant there. Alex gave me a copy of the plans and proposals for amateur radio, as presented before the FCC. I also was able to take in a tour of the RCA plant and while there I met a couple of other hams who are on the staff. Their calls were VE2LJ and VE3PI. I also met WIII, from the Camden, N. J., plant, who was visiting the Montreal plant at the time.

After arriving here, I wrote to Capt. Ben Wallich, G6BW, of Churchill, Somerset, and received a reply a couple of days ago. I learned that he since has been promoted to the rank of Wing Commander and is now doing special lecturing work for the RAF. He had been on active service up until recently when his health gave out and he was retired. He wishes to be remembered to all the gang and mentions meeting W9USI, who, I take it, is in the Air Forces, as G6BW mentions playing on the gramophone in the officer's mess a couple of recordings that he made over the air of W9USI . . .

"Possibly some of the old gang might care to drop me a line." *

* Address mail in care of ARRL Hq. for forwarding.

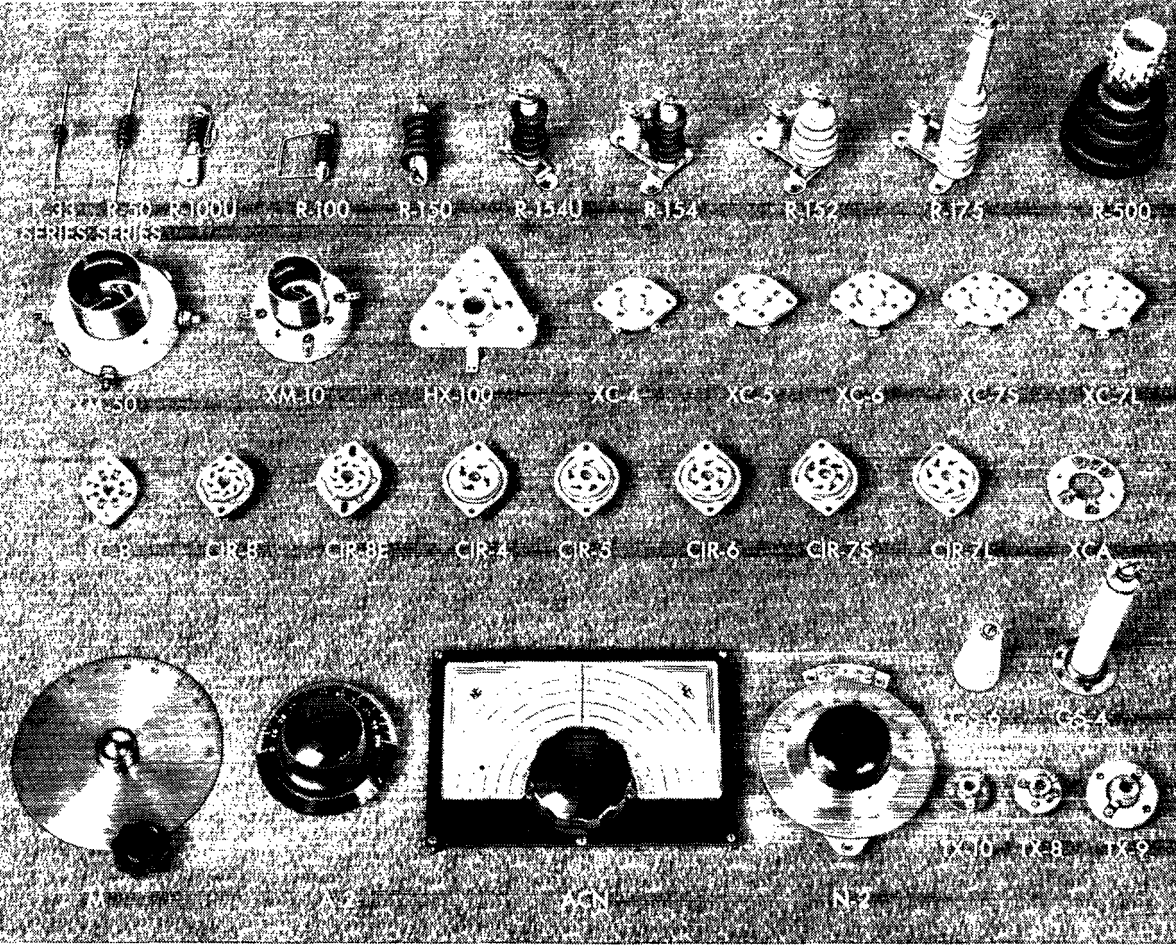

OLD FRIENDS AND NEW ARRIVALS

Many of the parts shown above are old friends that have served communications faithfully for many years. One has passed its 21st birthday, others are new as a kitten. The triangular HX-100 socket is a newcomer, specially designed for such tubes as Eimac 4-250As, 803s and RK-28s. Chokes are available in a variety of inductances, with values up to 10 mh available in the R-100 type. The big R-500 illustrated above has 218 mh, and is provided with taps to make it suitable for use as a timing inductance for frequencies as low as 15kc.



OHMITE RESISTORS and CHOKES

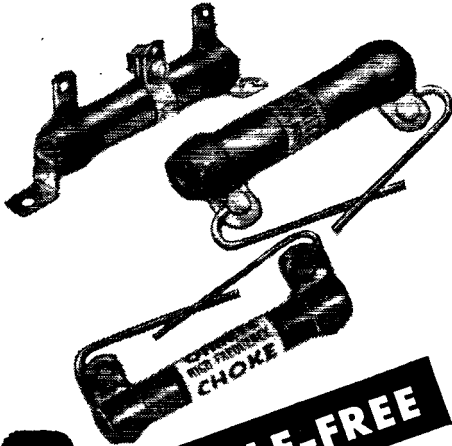

TROUBLE-FREE Control

IN EVERY FIELD OF ACTION

• The Ohmite Resistors and R. F. Chokes so widely used in radio communications equipment before war came are serving today in vital military and industrial equipment. Their time-proved quality assures dependable control... always. Wide range of types and sizes.

Authorized Distributors Everywhere

OHM'S LAW CALCULATOR

Solves any Ohm's Law problem with one setting of the slide. Send only 10c in coin for yours.

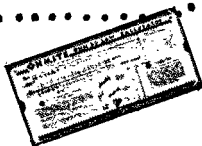

OHMITE MANUFACTURING CO.
4864 FLOURNOY ST. • CHICAGO 44, U. S. A.

Be Right with **OHMITE**
RHEOSTATS • RESISTORS • TAP SWITCHES

Silent Keys

It is with deep regret that we record the passing of these amateurs:

- W1KM, Herbert O. Worthley, Malden, Mass.
 W1ZQ, Harry C. Pierce, Lynnfield, Mass.
 W2NXV, Lt. Paul E. Bowen, Pelham, N. Y.
 W4HHD, Oscar L. Olsen, Miami, Fla.
 W6PIH, Paul L. Clark, Pasadena, Calif.
 ex-W7—, Browder J. Thompson, Princeton, N. J.
 W8OVN, Lt. George Tarr, AC, Toronto, Ohio
 W9CGG, Kenneth Jahnig, Wheaton, Minn.
 W9YVJ, Stephen J. Weber, St. Paul, Minn.
 S. Weir Lewis, III, Philadelphia, Pa.
 G2FR, 1st Rad. Off. G. Hargreaves, N. M.
 GM2TQ, Capt. A. Cattanach, Grantown-on-Spey, Morayshire, Scotland
 G4AS, Major J. E. Holding, R. Signals, Kirby, Cheshire, England
 GM6ND, F/O R. Millar, RAF, Denny, Stirlingshire, Scotland
 G6XX, Air Comdr. Viscount Carlow, RAF, London, England
 G8IX, F/Sgt. R. W. Rider, RAF, Old Woking, Surrey, England
 G8SS, L.A.C. J. G. Stokes, RAF, Sheppey, Kent, England

Strays

In case anyone complains about the lack of an available telephone for his home, you may remind them of the following figures, which include only one small part of the telephone requirements of our armed forces:

Type of Vessel	No. of Telephones	Feet of Cable
BB (battleship) Iowa class	1,556	155,600
CV (aircraft carrier) Essex class	1,358	135,800
CL (cruiser) Cleveland class	902	90,200
DD (destroyer) Fletcher class	230	23,000
DE (destroyer escort)	169	16,900
APA (auxiliary transport) Haskell class	200	20,000
LST (landing ship tank)	63	6,300
LSM (landing ship medium)	32	3,200
LCI (landing craft infantry)	11	1,100
PT	10	1,000

Leaving the mess hall after a ham bull session K7FTM pointed out a passing man to his companion, W7IJY, saying, "That is the guy who works at the North Pole." W7IJY still dreaming of DX replied — "What's his call?"

(P.S. — The North Pole is the local bakery in that town).

QSO

Dear OM:

When you dust off the old rig for midnight sorties into the ether . . . we're afraid that you're going to find it as outdated as a loose coupler or a rotary gap! The wizardry of war-developed advances in radio communication, once unleashed from necessary censorship, will make most prewar equipment obsolete for postwar use.

When that day—V-day—arrives, and you issue a general call for the newest in transmitter equipment, we'll be standing by. Special antennae, high frequency switches, co-axial cable and fittings and other equipment now being made for the armed service is going to be earmarked for the American ham. Put us on your list for a call!

'73's

J.L. Beaul Sr (W2CQF)

Communication PRODUCTS COMPANY, INC.
346 BERGEN AVENUE, JERSEY CITY 5, NEW JERSEY

Time Tested... Time Proven

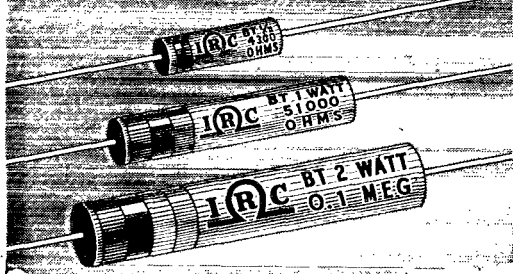

IRC METALLIZED TYPE BT RESISTORS

Unexcelled in such essential characteristics as stability, low noise level, low voltage coefficient, mechanical strength, humidity protection, and insulation—IRC type BT resistors have a proven record of performance in millions of applications. Today, after more than a decade of use, these small, sturdy units are recognized as standard around the world. Available in all wanted ratings.



INTERNATIONAL RESISTANCE CO.

401 N. BROAD ST., PHILADELPHIA 8, PA.

IRC makes more types of resistance units, in more shapes, for more applications, than any other manufacturer in the world.



Founded in 1909

RADIO TELEPHONY RADIO TELEGRAPHY PRE-INDUCTION RADIO

Courses ranging in length from 3 to 9 months. Dormitory accommodations on campus for men and women students. Approved by Texas Department of Education with authority to issue a maximum of 60 semester credits for complete training. *If interested, write for details.*

PORT ARTHUR COLLEGE PORT ARTHUR TEXAS

WWV Schedules

STANDARD-FREQUENCY transmissions are made available as a public service by the National Bureau of Standards over its standard-frequency station, WWV, on the following schedules and frequencies:

2.5 Mc. — 7:00 P.M. to 9:00 A.M. EWT (2300 to 1300 GMT).

5.0 Mc. — Continuously, day and night.

10.0 Mc. — Continuously, day and night.

15.0 Mc. — 7:00 A.M. to 7:00 P.M. EWT (1100 to 2300 GMT).

Each of these radio frequencies is modulated simultaneously at accurate audio frequencies of 440 cycles and 4000 cycles, excepting 2.5 Mc. which carries only the 440-cycle modulation. In addition, there is a 0.005-second pulse, heard as a faint tick, every second, except the 59th second of each minute. These pulses may be used for accurate time signals, and their one-second spacing provides an accurate time interval for physical measurements.

The audio frequencies are interrupted precisely on the hour and each five minutes thereafter, resuming after an interval of precisely one minute. This one-minute interval is provided to give the station announcement and to afford an interval for the checking of radio-frequency measurements free from the presence of the audio frequencies. The announcement is the station call (WWV) sent in code, except at the hour and half hour, when it is given by voice.

The accuracy of all the frequencies, radio and audio, as transmitted, is better than a part in 10,000,000. Transmission effects in the medium may result in slight fluctuations in the audio frequencies as received at a particular place; the average frequency received, however, is as accurate as that transmitted. The time interval marked by the pulse every second is accurate to 0.00001 second. The 1-minute, 4-minute and 5-minute intervals, synchronized with the second pulses and marked by the beginning and ending of the periods when the audio frequencies are off, are accurate to a part in 10,000,000. The beginnings of the periods when the audio frequencies are off are so synchronized with the basic time service of the U. S. Naval Observatory that they mark accurately the hour and the successive 5-minute periods.

Of the frequencies mentioned above, the lowest provides service to short distances and the highest to great distances. In general, reliable reception is possible at all times throughout the United States and the North Atlantic Ocean, and fair reception over most of the world.

Information on how to receive and utilize the service is given in the Bureau's Letter Circular, "Methods of Using Standard Frequencies Broadcast by Radio," obtainable on request. The Bureau welcomes reports of difficulties, methods of use, or special applications of the service. Correspondence should be addressed to the Director, National Bureau of Standards, Washington, D. C.

**OUR
2,000,000th
ANNIVERSARY**

**... CELEBRATING THE PRODUCTION
OF OUR TWO MILLIONTH CRYSTAL!**



More than just a number, the production of our two millionth crystal is the symbol of long years of work...the product of an experienced organization...the result of technical research in the manufacture of precision crystals. All this, plus adequate facilities, are at the service of the radio industry today. A limited number of inquiries is invited.

Crystal
PRODUCTS COMPANY

1519 McGEE STREET, KANSAS CITY, MO.

Producers of Approved Precision Crystals for Radio Frequency Control

Here's your copy of the most informative catalog of crystal unit design and specifications—just

MAIL THIS COUPON!

CRYSTAL PRODUCTS CO.,
Dept. O, 1519 McGee, Kansas City, Mo.
Gentlemen: I would appreciate a copy of your new catalog. I am interested in

.....
NAME

FIRM

ADDRESS

CITY STATE

Wanted **ENGINEERS**

- Radio
- * Electrical
- Electronic
- * Mechanical
- Metallurgical
- * Factory Planning
- Materials Handling
- Manufacturing Planning

Work in connection with the manufacture of a wide variety of new and advanced types of communications equipment and special electronic products.

Apply (or write), giving full qualifications, to:

R. L. D., EMPLOYMENT DEPARTMENT

Western Electric Co.

100 CENTRAL AVENUE, KEARNY, N. J.

*Also: C. A. L.
Locust St., Haverhill, Mass.

Applicants must comply with WMC regulations

TECHNICAL WRITERS

For Instruction Manuals
on Involved
Electronic Equipment

Will Consider **AMATEURS**
Especially Interested
in Circuit Theory

**HAZELTINE
ELECTRONICS CORPORATION**
58-25 Little Neck Parkway
Little Neck, Long Island, N. Y.

World-Wide Advertising via Radiophoto

A postwar program of global advertising which would utilize radiophoto transmission to flash copy and layout for simultaneous release to publications throughout the world has been announced by the Radio Corporation of America.

This new plan for speedy world-wide advertisements will rely upon the transmission of copy by RCA Radiophoto to world capitals which are equipped with this type of communication. From these radiophoto centers, advertisements will then travel by airmail to an additional network of far-flung cities.

This service was demonstrated twice during the past year. The most recent use of radiophoto advertisement transmission occurred during the observance of RCA's twenty-fifth anniversary, when an advertisement describing the company's pioneering contributions in the field of radio and electronics was speeded to publications in Europe, Australia, Africa, India and the Middle East.

The copy was radioed to the Eastern Hemisphere by RCA Communications offices at New York and San Francisco as the first stage of transmission. As soon as the copy was received in London, Cairo, Stockholm, and Sydney, RCA arranged for publication in these centers and rushed copy to other large cities by airmail.

From London the radioed copy was airmailed to Lisbon, Madrid, and Cape Town for distribution to Spanish, Portuguese, and South African publications. From Cairo the radiophoto was flown to Istanbul and Bombay for publications in North Africa, the Middle East, and India. Copy received at Stockholm was dispatched to Swedish publishing houses. Sent from San Francisco to Sydney, the radiophoto advertisement was airmailed on to other cities in Australia and New Zealand.

By the combined use of radiophoto and rapid airmail delivery, the RCA anniversary advertisement was made available to 12,500,000 persons in 47 countries in a matter of hours and days instead of the weeks and months ordinarily required for this type of coverage. Transmitted in English, the advertisement was translated at the point of receipt and appeared in a total of 274 newspapers and magazines published in 18 different languages and dialects: Afrikaana, Arabic, Dutch, English, French, Portuguese, Spanish, Swedish, Turkish and nine Hindu dialects.

Early in 1944 RCA used radiophoto transmission for an advertising campaign in connection with Motion Picture Academy Awards. The day after the awards were announced in Hollywood, an RCA advertisement, carrying the names of the winning motion pictures and their principals, was transmitted by radiophoto to London, Cairo, Sydney, and Buenos Aires for use in publications there and for relay by airmail to publications in other countries.

**Here's an
OPPORTUNITY
FOR HAMS
to become
RAYTHEON
Technical Writers**

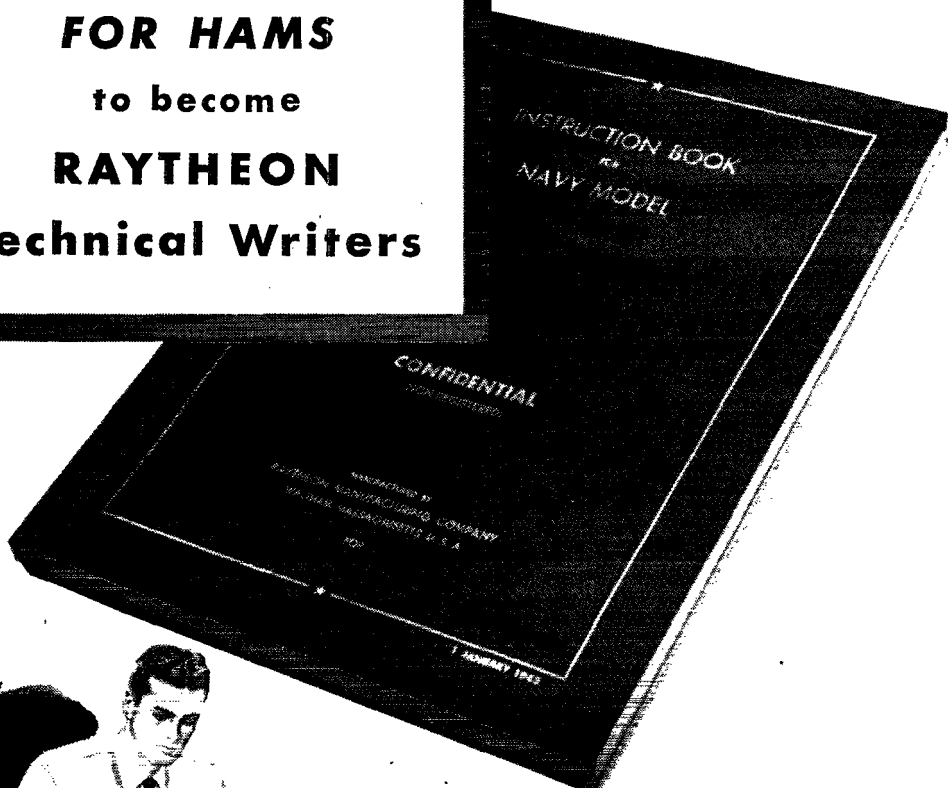

The Navy must have instruction books which show its personnel how to install, operate, maintain and repair vital electronic equipment. If you are familiar with radio and electrical terms and symbols . . . can study pre-production models . . . and then put the essential facts and material into written form—Raytheon has a place for you as a technical writer.

WRITE TO:

Lee A. Ellis, W 3HSB, Raytheon Manufacturing Company, Field Engineering Division, Waltham 54, Massachusetts.

We'll teach you all you need to know about our products—show you how to gather and assemble the facts and build them into book form. Bring yourself up-to-date in this fascinating, highly promising field of electronics. The opportunities for personal development and advancement are practically unlimited.

In addition to serving your country in a most essential industry, you will be preparing for a brilliant future in the post-war electronic field. Write for full details, today.



All hiring will conform to War Manpower Commission Regulations.

Devoted to Research and Manufacture of Electronic Tubes and Complete Electronic Apparatus and Systems

Send Only 10c For This Handy TUBE AND CIRCUIT REFERENCE BOOK

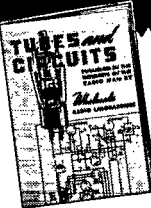

OUR NEWEST GET-ACQUAINTED OFFER

Here's a handy reference book that meets the demand for simple, easy-to-understand data on substitution of radio tubes. Contains a special section devoted to valuable technical information on tubes and circuits. It's a guide you'll refer

to time and again. You can't afford to be without it. Send for your copy today! Only 10c postpaid.

HALLICRAFTERS

For many years we have been one of the country's largest distributors of Hallicrafter equipment. We have Hallicrafters available for immediate delivery on priority. For full particulars, write.

SEND FOR MY LATEST FLYER ON HARD-TO-GET
RADIO PARTS

LEO-W9GFQ

WHOLESALE RADIO LABORATORIES

744 W. Broadway, Dept. Q-1, Council Bluffs, Iowa

Now—a really
high-powered



RADIO ENGINEERING LIBRARY

- especially selected by radio specialists of McGraw-Hill publications
- to give most complete, dependable coverage of facts needed by all whose fields are grounded on radio fundamentals
- available at a special price and terms

THESE books cover circuit phenomena, tube theory, networks, measurements, and other subjects—give specialized treatments of all fields of practical design and application. They are books of recognized position in the literature—books you will refer to and be referred to often. If you are a practical designer, researcher or engineer in any field based on radio, you want these books for the help they give in hundreds of problems throughout the whole field of radio engineering.

Free Examination • Special Low Price • Easy Terms

McGraw-Hill Book Co., 330 W. 42nd St., New York 18

Send me Radio Engineering Library, 5 vols., for 10 days' examination on approval. In 10 days I will send \$3.00, plus few cents postage, and \$3.00 monthly till \$24.00 is paid, or return books postpaid. (We pay postage on orders accompanied by remittance of first installment.)

Name.....
Address..... Position.....
City and State..... Company..... QST-3-45

5 VOLS.
3319 PAGES,
2289

ILLUSTRATIONS

1. Eastman's Fundamentals of Vacuum Tubes
2. Terman's Radio Engineering
3. Everitt's Communication Engineering
4. Hund's High Frequency Measurements
5. Henney's Radio Engineering Handbook

Strays

The Signal Corps has brought the use of homing pigeons to new peaks of service in the science of military communications but it has not yet solved the mystery of the strange instinct that drives these birds with such certainty to their proper destination.

The mystery is deepened by the apparent, though not conclusive, proof that pigeon-instinct is directly affected by radio waves. A recent series of tests by the Signal Corps supports the belief that radio transmission confuses the birds and retards them in fulfilling their flying missions.

Three successive tests, with three different groups of birds, were recently made and all brought virtually identical results. Each group consisted of ten birds, and was subdivided into two smaller groups of five birds each. All were held in a radio station just ten miles from their home loft. While this radio station was transmitting, the first five were released; and about 15 minutes later, with the radio station silenced, the second five were liberated.

These birds released while the station was transmitting seemed completely bewildered. They circled erratically, very close to the station, for 15 or 20 minutes, then took off uncertainly for their lofts, requiring a total of 42 to 52 minutes to complete the ten-mile flight. The birds that were released while the station was silent made the usual brief circling, then took off promptly for the home loft with no confusion whatever, covering the total distance in 18 to 21 minutes. There was very little difference in the results of the three tests. In every case the birds that were hampered by radio transmission bungled their tasks. In every case where there was no transmission the birds performed with the easy confidence which pigeoneers have learned to expect. All the birds were of similar type and training. All flew under practically identical conditions of wind and weather. Not a single bird upset the theory of flying noticeably better or worse than his mates under the same handicaps or advantages.

As the Signal Corps is slow to accept any theory on the basis of a few tests, there will be many more before the connection of radio with the homing instinct is conclusively established.

Many times during the pursuit of the Nazis toward Germany, when wire could not keep immediate pace with fast-moving armored columns, the Signal Corps met the need by introducing a system of v.h.f. radio relays.

This radio-relay system consists of stations 25 to 100 miles apart, each beamed on the next. The military possibilities of this system were developed in America and England after it was first tried out in North Africa.

Police-car radio equipment had been procured for expected police communications requirements in North Africa. This equipment was found admirably suited to provide communications for

(Continued on page 98)

You Are Going to Want
**BROWNING
 SIGNAL
 SYSTEMS**

*How will
 you have
 them?*

YOUR OWN USE of the Browning Signal System may be quite different from the job it has performed so successfully since before Pearl Harbor: detection of intruders.

If you will read the illustrated folder which describes this unique application of a balanced electronic circuit, you will be stimulated to visualizing other uses to which you can put it.

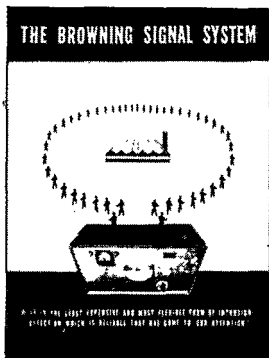

While we are spending every man-hour available on war production, we have jotted down in our lab notebooks certain interesting improvements we want to make in the Signal System. We'd like to add to those notes whatever thoughts you have on the subject. Your own application may call for entirely different design plans, and we want to be able to offer exactly what you will want in the Browning Signal System. Get the booklet today, or, if you already have it, tell us now what you want in this System.

Browning Laboratories, Inc.
 750 Main Street
 Winchester, Mass.

Gentlemen:

I already have your folder. Here are the new uses to which I might put Browning Signal Systems, together with notes on what I would like to see built into them:

NAME _____

TITLE _____

COMPANY _____

ADDRESS _____

Browning Laboratories, Inc.
 750 Main Street
 Winchester, Mass.
 Gentlemen:

I want to learn more about your Signal System as it exists today. Please send your folder to:

NAME _____

ADDRESS _____

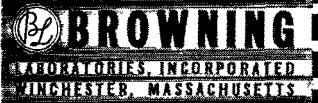



NEW D-20 SERIES . . .

This UNIVERSAL dynamic will be the first new microphone made and distributed by UNIVERSAL since Pearl Harbor. It will meet present and postwar needs for amateur use, as well as other purposes. UNIVERSAL will continue to manufacture microphones and electronic voice communication components for the Army Signal Corps. The D-20 will be available to the armed forces and for essential home front needs. Bulletin 1458 describes the new model.

UNIVERSAL MICROPHONE COMPANY
Inglewood, California

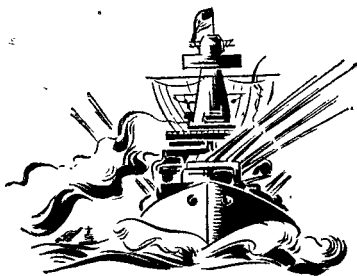

On the "Battle Wagons . . .

It's Premax Antennas

• The favorite Antennas of the amateurs are now doing outstanding service on vessels of the Allied Fleets. When Victory comes, they will be back, tested in war and ready for peace.

Premax Products

Division Chisholm-Ryder Co., Inc.

4819 Highland Avenue • Niagara Falls, N. Y.

(Continued from page 94)

the rapid advance. As a result of this successful experiment and concurrent British groundwork, the amazing radio-relay link equipment in use today was developed in the U. S. and in England, and was made to provide four teleprinter circuits plus three radiotelephone circuits as compared with one teleprinter circuit of the experimental models in Africa.

For communication with the United States a high-powered, multi-channel, 40-kw. Army transmitter was installed by the Signal Corps in France. Packed into 1000 boxes in which it had been shipped across the channel, it required 45 soldier-technicians to reassemble the equipment. Because of its complexity a minimum of a month was believed required to install the transmitter. However, in 25 days, the American station was sending and receiving trans-Atlantic messages.

Major General George L. Van Deusen (Commanding General of ESCTC at Fort Monmouth since 1942) is now Chief of Engineering and Technical Service in the office of the Chief Signal Officer, succeeding Major General Roger B. Colton, who is now Air Communications Officer in the Air Forces Technical Service Command in charge of radio communication activities at Wright Field, including Aircraft Radio Laboratories.

Brig. General Frank E. Stoner, Chief of Army Communications Service, was recently nominated for Major General.

Dr. Frederick E. Terman was recently appointed Dean of the Stanford University School of Engineering. He will assume his new duties upon release from his present position as the head of the Radio Research Laboratory at Cambridge, Mass., where he is in charge of the wartime development of radar.

In 1941, Dr. Terman served as president of the Institute of Radio Engineers, being the first man to be chosen for that position from west of the Atlantic seaboard.

Dr. Terman is the author of five well-known texts on radio engineering.

TO THE XYL

(Dedicated to all XYLs having a husband overseas.)

If you'd ask me to be your beau,
My answer would be WILCO;
And if you'd only want a stand-by,
I'd always be willing to comply.
If you'd only send your 88s,
I'd be happier than all my mates.
But should you send only 73s,
I'd be much happier overseas.
If just once in a while you'd QST,
You'd never know what it would mean to me.
I'd answer your little billet dou,
And say my heart belongs to you.

— Frank D. Atwood, RM1c, W1KEQ

NEW NEWARK'S NEW YORK



*I*N ORDER to give our Eastern customers better, faster service, we have opened a *big new store* at 115-117 W. 45th Street in New York City. Effective immediately, the entire combined stocks of our New York and Chicago stores are BOTH at your command. In New York, the Newark store will be under the personal management of *Adolph Gross*, well known in eastern territory. The new facilities are large, well located, and expertly staffed. As in our Chicago store, the sales policy will conform to Newark's reputation for prompt and courteous service.

SCHOOLS, COLLEGES, BROADCAST STATIONS, INDUSTRIALS

As distributors for all the well known manufacturers in this industry, we solicit your priority business on all types of radio, radar, communications and sound equipment. Send your order to your *nearest NEWARK* store for ALL the things you need RIGHT now. We ship on short notice, direct from our own stocks whenever possible, and *promptly* advise probable delivery on balance of order. You will be amazed how efficient real SERVICE can be under present day conditions.

SPECIAL OFFER of Oil Filled, Oil Impregnated FILTER CONDENSERS

To celebrate the opening of NEWARK in New York, we feature this brand new offer of quality filter condensers. Guaranteed at rated voltage. No Priority Required.



Mfd.	DC	Size	Weight	Price
1	1000 V	5 x 3 3/4 x 1 1/2	10 oz.	\$.59
2	2000 V	4 3/8 x 3 3/8 x 1 1/4	2 1/2 lb.	1.50
6	1000 V	4 3/4 x 2 1/2 rnd. can	12 oz.	1.00

2 MFD and 4 MFD in one can
600 V 4 3/4 x 2 1/2 x 1 1/4
1 1/4 oz. \$.80

THORDARSON TRANSFORMERS (Power Transformers and Chokes)

Immediate delivery on Priority L265 or Better

T-70R61	770 V. C.T. at 70 MA. 115 V. 60 Cycle 6.3 V. C.T. at 2.5 A; 5 V. at 2 A. 4 3/4 lbs.	\$3.36
T-70R62	700 V. C.T. at 145 MA. 115 V. 60 Cycle 6.3 V. at 4.5 A; 5 V at 3 A. 8 1/2 lbs.	4.41
T-45556 or T-92R21	leads out of side. 778 V. C.T. at 200 M.A. 115 V. 60 Cycle 6.3 V. C.T. at 5 A. 5 V. at 30 amp. 9 lbs.	5.29
T-13C27	10 H. 40 M.A. 475 ohm 1600 V. Insulation 3/4 lbs.	.76
T-13C30	8 H. 150 M.A. 200 ohm. 1600 V. Insulation 2 1/4 lbs.	1.41
T-45557 or T-74C29	leads out of side. 15 N. 150 M.A. 200 ohm 2000 V. Insulation. 5 1/4 lbs.	2.82

ELECTRIC CO.

CHICAGO ★ NEW YORK
323 W. Madison St. 115-117 W. 45th St.
DEArborn 0083 BRYant 9-4735

Newark

RADIO CHASSIS PUNCH



Saves hours of work cutting clean, accurate holes in radio chassis—for connectors and other receptacles. Simply insert cap screw in hole to be enlarged (drill small hole if necessary), turn with ordinary wrench to force punch through the metal. No reaming or filing—hole is smooth and clean. No distortion—die supports metal. Ten sizes from $\frac{3}{4}$ " to $2\frac{1}{4}$ "; also up to $3\frac{1}{2}$ " for meters. Write for free catalog 33E to Greenlee Tool Co., 1863 Columbia Ave., Rockford, Ill.



CODE SENDING-RECEIVING SPEED

Get Skill, Accuracy Quickly

Learn to send and receive Radio Code at home or in camp, or prepare for higher proficiency and rating through same easy practical system used in training radio-telegraph specialists.

Our world famous system teaches you code by developing in you a "knack" of sound sense and sound consciousness that is the secret of speedy sending and receiving. Thousands of operators needed. Good pay, adventure. Learn at home quickly. Big opportunities now and peacetime possibilities appear equally promising.

FREE 52-PAGE BOOK explains complete training method and shows how to become a "crack" operator. Rush name for it today. It's absolutely FREE.

CANDLER SYSTEM CO.

P. O. Box 928, Dept. 4-C, Denver, Colo., U. S. A. and at 121 Kingsway, London, W. C. 2, Eng.



65 models, sizes from 350 to 35,000 watts. A.C. types: 115 to 660 volts, 50, 60, 180 cycles, 1 or 3-phase; 400, 500 and 800 cycles, 1-phase. D.C. types: 6 to 4000 volts. A.C.-D.C. combination types available. Write for engineering assistance and literature. Model shown is from OTC lightweight series.

Over 250,000 Now In Service

D. W. ONAN & SONS
2621 Royalston Ave., Minneapolis 5

Electricity FOR RADIO AND ELECTRONIC APPLICATIONS

Onan Electric Generating Plants supply electric service for electronics applications and general uses, mobile, or stationary. Driven by Onan-built, 4-cycle gasoline engines, they are of single-unit, compact design and sturdy construction.

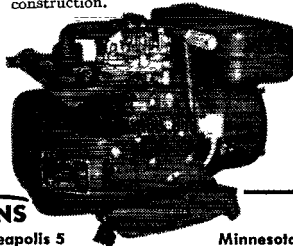

Minnesota

Polyphase Systems Applied to R.F.

(Continued from page 13)

Power Considerations

A word about power input and output might be in order. Since each coupling is adjusted to draw 70.7 per cent of the available transmitter output, it might be thought that the power in the plate circuit becomes greater when both couplings are in use. This is not the case, however, since neither the d.c. plate power input nor the r.f. power output has increased. In the case of the antenna shown in Fig. 8, we are not getting a gain of 3 db. in all directions simultaneously. The fact is that the lobes are rotating at a supersonic rate, thus giving the same effect as a mechanically-rotated system which is revolving at the same speed.

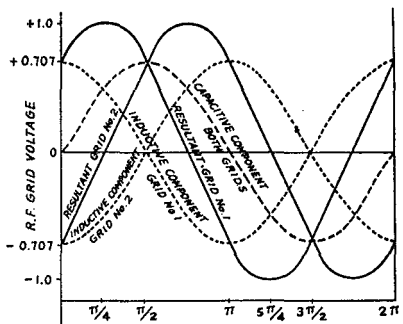

Fig. 10—Curves showing grid-voltage components and their resultants.

The curves of Fig. 10 show the grid voltages and their components and from these it can be seen how the plate and antenna currents flow.

In conclusion we might state that while this article illustrates only a few possibilities, the future should provide many interesting extensions and variations of the idea.

Attention!—Inventors

(Continued from page 44)

6) Double-action solenoid:

A small, fast-acting double-action solenoid to operate on 28 volts d.c., with a stroke of about 0.5 inches, with a 20 pound pull (or push) at condition of maximum air gap. The plunger should "seat" at each end of travel and would very probably have to be an electromagnet whose polarity would reverse at each end of travel.

Suggested solutions to these problems should be prepared in sketch and description form and sent to the National Inventors Council, Department of Commerce, Washington, D. C., for consideration and report.

Please do not send your suggestions or solutions direct to the ARRL.



Coordinating military movement . . .

land, sea, air

Radio and electronic products built by Delco Radio are serving in every theater of war . . . helping to coordinate the action of all units of the armed forces. Good performance is essential. Dependability must be insured under extreme conditions of service. These characteristics are attained through Delco Radio's effective combination of engineering vision, manufacturing precision. Delco Radio Division, General Motors Corporation, Kokomo, Indiana.

KEEP BUYING WAR BONDS

Delco Radio
DIVISION OF
GENERAL MOTORS

SOUND EQUIPMENT

for
INDUSTRIAL · GOVT. · SCHOOL USE
Available Now!

- **AMPLIFIERS and SOUND SYSTEMS**
Bogen · Masco · Stromberg-Carlson · Talk-A-Phone
Thordarson · Webster · Racine
- **MICROPHONES and PICK-UPS**
Amperite · Astatic · American · Brush · Electro-Voice
Shure · Turner · Universal
- **LOUDSPEAKERS and PROJECTORS**
Altec-Lansing · Atlas · Cinaudagraph · Jensen
Kainer · Stromberg-Carlson (Utah) · University · Wright
- **RECORDERS and RECORD PLAYERS**

Also
RADIO PARTS · RADIO TUBES
INDUSTRIAL ELECTRONIC EQUIPMENT

TELEPHONE Barclay 7-1840

*With proper priority or L-265 certification.

SUN RADIO & ELECTRONICS CO.

212 Fulton Street, New York 7, N. Y.

LEARN RADIO

Pre-Military training for beginners. Catalog on request. We teach all technical branches of radio. Lic. by the Comm. of Mass. Dept. of Education.

MASS. RADIO SCHOOL

18 Boylston Street

Boston, Massachusetts

Pre-Induction RADIO COURSES

for Civilians and those entering Military Service
New classes now starting for men and women

- Radio Operating • Code
- Radio Servicing — Electronics

NEW YORK YMCA SCHOOLS

4 West 63rd Street, New York City

COMPLETE RADIO TRAINING!

All branches of communications, including television and FM courses from 6 to 18 months' duration. HIGH SCHOOL GRADUATES 17 YEARS OF AGE — prepare for radio operating positions in the U. S. Merchant Marine in 6 months. Complete pre-induction radio training in 3 months. Information supplied to Veterans on radio engineering training.

Write for particulars

VALPARAISO TECHNICAL INSTITUTE

Dept. T

Valparaiso, Indiana

COMMERCIAL RADIO INSTITUTE

A RADIO TRAINING CENTER FOR 24 YEARS

Resident Courses Only • Pre-Induction, Broadcast, Service, Aeronautical Television, and Marine telegraphy classes now forming for April 16th. Literature upon request. Veteran training.

Dept. B., 38 West Biddle Street, Baltimore 1, Maryland

100

Radiocommunication Service

(Continued from page 46)

as in the amateur band, these matters will not be determined by rule or regulation. It should be possible by the use of comparatively simple circuits already known to provide both transmitters and receivers tunable over all or most of the 460-470-Mc. range and emitting signals sharp enough to minimize interference.

"The bands both above and below 460-470 Mc. are assigned to other services; but the allocation is such that if the utility and requirements of citizens radiocommunications warrant, the band can at some future time be expanded. Alternatively, if a demand for assignments in this band does not arise, the band can be reassigned to another service at a later date.

"The essence of this new service is that it will be widely available. Accordingly, only the minimum requirements of the Communications Act plus a few minimum traffic rules will be set up. Operator licenses will be granted only to citizens of the United States. To procure such a license, an applicant need only show familiarity with the relevant portions of the Communications Act and of the simple regulations governing this service. No technical knowledge will be required. It is hoped that the license can be in the form of a small card, with the operator's license on one side and the station license on the other, and that these will remain in force for five years with simple renewal provisions. Station licenses will be limited to point-to-point, fixed point-to-mobile, mobile-to-mobile, and multiple-address communications; broadcasting is not contemplated.

"A concomitant of the widest possible availability is that particular licensees are not accorded protection from interference. A license in this service does not guarantee the right to a channel; it affords rather an opportunity to share with others the use of a band. The success of this arrangement in the amateur bands gives every reason to believe that it will be equally successful in the citizens radiocommunications band. In the event that intolerable abuses arise, the Commission will of course take steps to eliminate them. The 10,000 kc. width of the band will no doubt be sufficient, however, to make possible simultaneous and efficient use of the limited-range service for many purposes, with serious interference limited to few if any parts of the country.

"In any areas where serious interference is experienced, it is the expectation of the Commission that various users of the band in a particular community will jointly seek, perhaps through local organizations similar to the American Radio Relay League in the amateur field, cooperatively to solve local problems of interference and to ensure maximum utilization. The new service is essentially a local service; the problems will differ widely in an urban and rural area, in the mountainous West and the flat Middle West, etc. The Commission is prepared to cooperate with local groups which may be formed in the working out of cooperative arrangements and it will resort to limiting regulations only in the event that an imperative need is shown."

To build BIG tubes takes BIG experience

G-E "know-how" is your safeguard when buying heavy-duty, high-power amplifiers

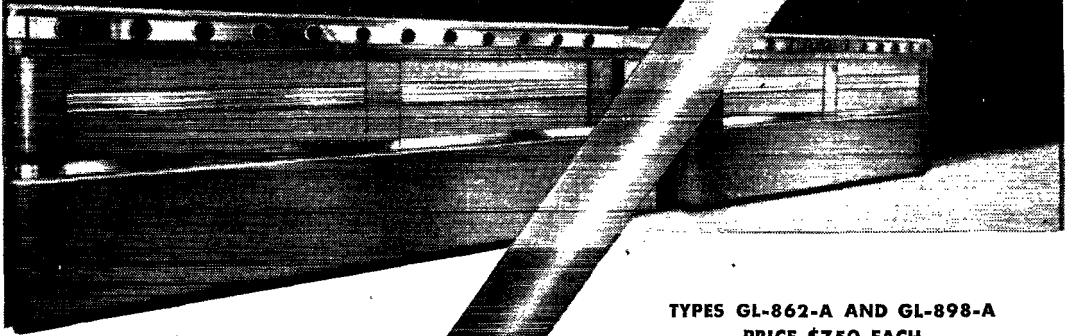

The modern 50-kw broadcast station requires powerful tubes like the water-cooled husky at the right. These large triodes represent a substantial investment—must be dependable, fully efficient.



**TYPES GL-862-A AND GL-898-A
PRICE \$750 EACH**

These 3-electrode, water-cooled power tubes, for use as radio-frequency amplifiers, oscillators, or Class B modulators, also are widely employed industrially in high-frequency heating. They will dissipate 50 to 100 kw, depending on the type of service. Filament voltage for both tubes is 33 v; current is 207 amp for 862-A, and 70 amp for each of the three filament sections of 898-A. Maximum plate ratings for both tubes in Class C service are 20,000 v and 10 amp. Frequency at maximum ratings, 1.6 megacycles.

The water-cooled transmitting tube with tungsten filament and copper anode was pioneered by General Electric in 1919. Since that time the record has been one of continuous development and progress. At one time 500 to 1,000 hours was the average life of a high-power transmitting tube. Today this term is but a fraction of what may be expected in period of service.

Numerous technical improvements have punctuated the years since these large tubes were developed. Some

of the most significant apply to the current models GL-862-A and GL-898-A as against their predecessors. One such important advancement is the self-supporting filament and grid structure, which obviates the need of internal insulators, as well as helps do away with the problem of "transients" such as temporary over-voltage.

New G-E production methods and equipment made possible by large demand have brought about substantial cost savings. The price of these tubes recently has been

lowered from \$1,650 to \$750—a drop of more than one-half!

Prices, ratings, performance charts, and other descriptive data will be furnished on request. Write to *Electronics Department, General Electric, Schenectady 5, New York.*

Hear the G-E radio programs: "The World Today" news, Monday through Friday, 6:45 p. m., EWT, CBS. "The G-E All-Girl Orchestra," Sunday 10 p. m., EWT, NBC. "The G-E House Party," Monday through Friday, 4 p. m., EWT, CBS.

GENERAL  ELECTRIC

161-D3-6850



Easy to Erect

**MASTS
AND
TOWERS**

Catalog will be sent to engineers and executives writing on their business letterhead.
Address Dept. AH

HARCO
STEEL
CONSTRUCTION CO.
Elizabeth 4, N. J.

RADIO ENGINEERS At least two years' design and development experience with Radio Communications Equipment manufacturer on items subsequently satisfactorily produced in quantity. Knowledge and experience in two-way mobile equipment, low power transmitters, receivers, and control equipment essential. Permanent position. West Coast Manufacturer. Will pay expenses to coast for interview if qualifications satisfactory. Write, giving complete past experience, employment record, salary received, and technical references.
BOX NO. 126 • Care of QST

Phone, Wire or Write

WHOLESALE

**Radio-Electronic Parts
Tubes, Sets and
Equipment**

•

R. G. SCELİ & CO.

227 Asylum St. Hartford, Conn.
Telephone 2-1144

A "Handbook" on Leyte

(Continued from page 23)

ably with 6L6 or 6F6 output stages, was continued. Eventually a five-station network was in operation, every station in the net being capable of working Australia. The calls were varied occasionally to fool the Jap eavesdroppers. The most popular transmitters used had two 6L6s in push-pull driven by two 6F6s. A four-tube push-pull-parallel arrangement was tried, but it did not prove practical. Personnel of the radio net finally numbered 60, of whom 15 were former Bureau of Posts operators. Some of these already knew the Continental code; those who didn't learned it from the still-indispensable *Handbook*.

Having been successful with self-excited rigs, Lt. Richardson and his crew, quite in the amateur tradition, wanted to branch out and try something more ambitious. Someone located a portable police rig, about the size of a walkie-talkie, which had been sent to Leyte before the war and never used. It was far too small for the kind of work they were doing, but it did have crystal control. The crystal's frequency was too low, but turning again to "that wonderful book" they found a doubler circuit. After considerable difficulty, eventually they got on the air with a T9 crystal note.

Their triumph did not last long, however. Within an hour or so the elements in their only 5Z3 shorted, and the smaller rectifier tubes from the BCL sets could not stand up under the load.

Jap-Dodging Brasspounders

Never imagine that any of this equipment building, code learning, and station operating was done under ideal conditions of peace and quiet. The Japs were plenty active, and they had good direction finders. Many other clandestine stations throughout the Philippines were located and captured, but Lt. Richardson lost only one station — and even then his men all escaped. He attributes this success in eluding the Japs to the fact that he changed the station locations every two or three weeks. Because of the strength of the guerrilla forces, the Japs could not move quickly to suppress the American stations by using small patrols. Instead, after determining the exact location of a station, they had to organize a heavily armed expedition. By the time they got ready to strike, Richardson and his crew would be somewhere else.

Lt. Richardson is safely back in the United States today, his career as a "home-grown" radio engineer ended — at least for the present. Navy authorities state that his work on Leyte was of tremendous value, that the information he sent over his homemade transmitters played a vital part in the successful invasion of the Philippines, undoubtedly saving thousands of American lives.

In view of the way he accomplished these results, we ARRL members can justly take pride in our *Handbook*. If no other copy than that one dog-eared 1932 volume had ever been printed, all of the time, money and hard work that have gone to make *The Radio Amateur's Handbook* the best practical radio text on earth still would have been well invested.

A BASICALLY NEW IDEA IN FM TRANSMITTERS...

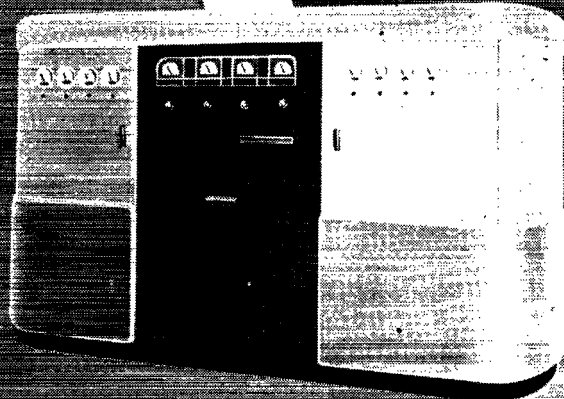

PLUS ALL THE EXTRAS OF SPECIAL WESTINGHOUSE RESEARCH FOR FM

* For harmonics up to 30 kc/s at ± 75 kc/s swing, distortion is less than 1.5% rms for modulating frequencies between 50 and 15,000 cps.

Here in a smartly-styled package is a basically new approach to FM transmitter design . . . combined with all the performance extras of special Westinghouse research for frequency modulation.

Built in 1, 3, 10 and 50 kw ratings, this new design provides direct generation of the modulated carrier by a simple and straightforward circuit. Frequency corrections are independent of critical tuning. Distortion is low.*

Metal-plate rectifiers—first introduced by Westinghouse for high-voltage, high-current AM applications—virtually eliminate outages caused by rectifier (tube) failures. Space and cooling requirements are reduced, operating costs are lowered.

Your nearest Westinghouse office has complete details of this new triumph in FM transmitter design in booklet B-3529. Or write Westinghouse Electric & Manufacturing Company, Radio Division, Baltimore, Maryland.

J-08103-A



Westinghouse
YEARS IN 25 CITIES . . . OFFICES EVERYWHERE

Electronics at Work

XXV - RADIO'S 25TH ANNIVERSARY - KDKA

NEW
1945
EDITION
*The Radio
Amateur's*
HANDBOOK

PAVING THE WAY for postwar amateur development, particularly on the ultra-highs (microwaves) and other prospective new techniques, the 1945 Edition of the "Radio Amateur's Handbook" includes diversified material new to its scope, while still retaining its time-proved treatment of the orthodox theory and practice of amateur radio—refined, modernized, reorganized for maximum convenience whether used as text, reference or constructional manual. This Edition of the "Handbook" contains more pages and more information per page than any "Handbook" yet published. . . . Every subject encountered in practical radio communication is covered, arranged for maximum convenience to the reader, sectionalized by topics with abundant cross-referencing and fully indexed. . . . More than ever the ideal reference work, the 1945 edition also contains practical constructional information on tested and proved gear—always the outstanding feature of the "Handbook." . . .

\$1 Postpaid in
Continental U. S. A.

\$1.50 Postpaid Elsewhere

Buckram Bound \$2.00

**AMERICAN RADIO
RELAY LEAGUE, INC.**
West Hartford 7, Conn., U. S. A.

Splatter

(Continued from page 29)

School. Had it not been for ham radio the valued opportunity might have by-passed him—and jobs were scarce, those days. . . . The newest ham in this month's array of first offenders is **Norman J. Snyder, W3HRD** (p. 42). Norman didn't start until 1938, but he certainly made up for lost time after receiving his license. Although his ham activities reduced his scholastic record to approximately zero, somehow he graduated from high school despite that fact. W3HRD was an avid participant in most every ARRL contest, and was also an active ORS, AARS, and a member of the famed RCC. Holder of a code proficiency award with a 25-w.p.m. sticker, Norman now is a radio technician at RCA. In his spare (?) time he has been experimenting with television, f.m. and electronic keys—or so he claims. . . .

Repeaters again with us this month are **George M. Guill, W8VAN** (Splatter, December, 1944, p. 8), and **Arthur H. Lynch, W2DKJ** (Splatter, January, 1943, p. 16).

Although this column has not so far recorded the life and times of **John Rogers, W2ADC**, his exciting drawings have been highlighting the "Hams in Combat" yarns for several months. That fact alone would merit space for a Rogers write-up in these pages, but we have an even better reason. In digging through old *QST*'s recently we came across one of W2ADC's earliest *QST* efforts—a cartoon appearing in the March, 1926, issue. To show the difference 18 years has made in his technique, we offer a comparison between the 1926 cartoon (reproduced herewith) and the realistic wash drawings on p. 48.

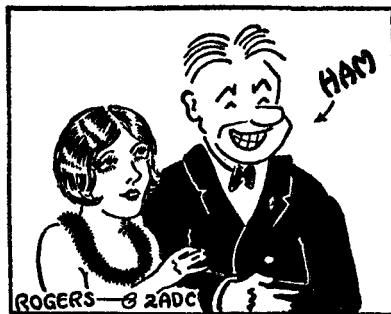

She: "Oh, John, I wish you'd quit this amateur game and turn 'pre.' See how much money Red Grange made."

Queried about his ham activities in that period, he informs us: "I have held 2ADC since 1923. Only 16 when I received my ticket, 2ADC cut quite a swath with those two five-watters on 200 meters! After graduating from high school I attended the Art Students League in New York City. Rushing home from classes early in the afternoon, I handled some of the traffic so plentiful in those days. In the years since then I have been off the air for long periods and must have forgotten most of what I knew about the technical side of radio.

(Continued on page 100)

SOUND VALUES at TERMINAL RADIO

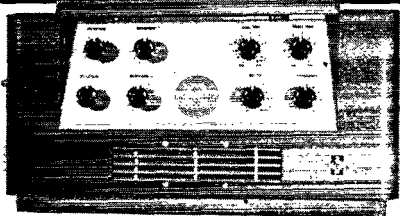

Deluxe 30 watt power amplifier
Six input channels — 4 microphone; 2 phonograph
Controls — 4 microphone gain; 1 dual phono gain;
1 master gain; 1 treble cut & boost; 1 bass cut &
boost
Double tone control for finest equalization
Wide range, hum and distortion free response
4 — 8 ohm speaker sockets with switch to select speak-
ers and proper impedances simultaneously
500 ohm terminal strip for multiple speaker systems
Gray wrinkle steel case with handles and hinged top
Size 20 x 10 $\frac{3}{8}$ x 10 $\frac{1}{2}$, for 105-125V 60 cycles AC.
Tubes — 6-6SQ7; 1-6SJ7; 2-6L6G; 1-5Z3
MODEL 6729 — PRICE, \$57.15 NET WITH TUBES.
F.O.B. NEW YORK

TERMINAL HAS MICROPHONES IN STOCK!

Shure 55C Unidyne — Acclaimed as the best
Price, \$29.10 — F.O.B. New York

Shure 717B Crystal Economy Hand Microphone
Price, \$5.85 — F.O.B. New York

Turner BX Crystal Economy Microphone
Fits all stands
Price, \$5.85 — F.O.B. New York

Electro-Voice V-1 Velocity Ribbon Microphone
Finest of its type.
Price \$16.17 — F.O.B. New York

Large Selection of Other Types By All Manufacturers In Stock!

IN STOCK — Utah Public Address Speakers

Model	Size	Voice Coil Impedance	Normal Power	Peak Power	Magnet Weight	Price F.O.B.N.Y.
8P	8"	6-8	7	11	5 oz.	\$ 3.38
10P	10"	6-8	9	14	12 oz.	\$ 5.44
E12P	12"	6-8	13	20	12 oz.	\$ 9.41
G12P	12"	8	17	26	46 oz.	\$14.26

● Priority Requirements Change Daily

● Write For Catalogue on Terminal Sound Specials

● Write Us For Up-To-Date Information On The Items You Need

TERMINAL RADIO CORP.

85 CORTLANDT ST., NEW YORK 7, N.Y. Tel. WOrth 2-4415

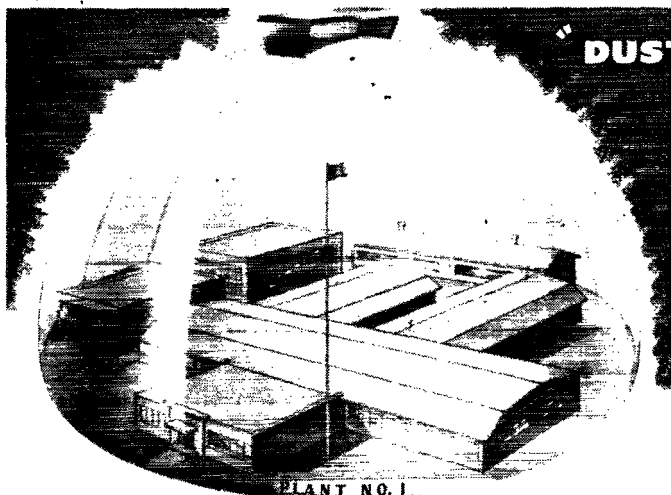

"DUSTLESSTOWN, OHIO"

It's the little things that loom biggest in the manufacture of delicate electrical measuring instruments. Little things like specks of dust or breath condensation can play havoc with accuracy. That's why Triplett Instruments are made in spotless manufacturing departments; why the air is washed clean, de-humidified and temperature controlled; why every step in their mass production is protected. As a result Triplett Instruments perform better, last longer and render greater service value.

Extra Care in our work
puts Extra Value in
your Triplett Instru-
ment.

Precision first
...to last



STANDARDS ARE SET BY
TRIPLETT

Triplett

ELECTRICAL INSTRUMENT CO. BLUFFTON, OHIO

ARRL PUBLICATIONS SERVE THE MEN WHO SERVE THE NATION

Title	Price
QST.....	\$2.50 per year*
The Radio Amateur's Handbook	
a. Standard Edition.....	\$1.00**
b. Special Defense Edition.....	\$1.00
A Course in Radio Fundamentals.....	50c
How to Become a Radio Amateur.....	25c
Learning the Radiotelegraph Code.....	25c
The Radio Amateur's License Manual.....	25c
A.R.R.L. Antenna Book.....	50c
Hints & Kinks for the Radio Amateur.....	50c
Two Hundred Meters and Down:	
The Story of Amateur Radio.....	\$1.00
Lightning Calculators:	
a. Radio (Type A).....	\$1.00
b. Ohm's Law (Type B)..	\$1.00

* In the United States and Possessions — other Countries \$3.00 per year.

** Postpaid in Continental U. S. A. — \$1.50, postpaid, elsewhere.

(No stamps, please)

THE AMERICAN RADIO
RELAY LEAGUE, INC.
West Hartford 7, Connecticut

(Continued from page 104)

But the thrill of a DX QSO and general all-around operating has never left me. My ham rig still stands in my studio, very near my drawing table, waiting for that day! . . ." A newspaper and advertising artist since 1926, W2ADC at present is on the staff of the New York daily, *PM*. Awaiting the return of ham radio, these days all his spare time goes into his work with water colors — at which, he reports, "some progress has been made, as I was awarded the American Water Color Society Medal in 1944."

FEEDBACK

IN QST for December, 1944, on p. 25 (third paragraph), the first sentence should refer to *high*-frequency response instead of to low-frequency response.

In the January, 1945 issue, p. 39, the upper portion of switch *S* in Fig. 1, between the detector and the modulated oscillator, should be reversed; when properly connected, the right-hand connection is made to the 7A4 and the left-hand connection is made to the 7C5. The movable switch arm remains grounded.

In Fig. 1 of the article, "A Homemade Radio-Range Receiver," in the February issue, the rotor of *C*₂ should be grounded, and *C*₅ should be inserted between the bottom of *L*₁ and ground.

Straits

W2LXY advises that cards have been received from F3RA and ON4VU that they are safe and would like to hear from friends over here.

Following a meeting of its directors on January 18th, The Radio Club of America, Inc., the oldest radio organization in continuous existence, announced the reelection for the 1945 term of the same officers who served the previous years, as follows: president, F. A. Klingenschmitt; vice-president, O. James Morelock; treasurer, Joseph Stanley; corresponding secretary, M. B. Sleeper; recording secretary, John H. Bose; publicity chairman, Austin C. Lescarboursa.

While many hams bemoaned the lack of the "Happy New Year" greetings formerly exchanged over the air, Lt. D. D. Duva, WINEA, was having a fine time with his toy-horn QSOs in a Sacramento night club. His log includes W6HUB, W8FRW, and an assortment of operators from the various services. This is an old hamfest trick, of course, but WINEA gave it a new twist — with good results.

RF Inductors • RF Chokes • IF Transformers
Condensers • Mica Molded Condensers • Trimmer
Condensers • Miscellaneous Apparatus

The F. W. Sickles Co., Chicopee, Mass.



SICKLES Electronic Specialties

PERFORMANCE TESTS

Insure Operating Efficiency

THE DEMAND for and ready acceptance of Astatic sound detection, pickup and reproducing products, is due to their dependable performance and high standards of operating efficiency. Assembly line workers are under constant supervision and every Astatic Microphone, Pickup, Cartridge or Recording Head is subjected to exacting tests before stocked for delivery. You'll HEAR MORE from Astatic products.



THE *Astatic* CORPORATION
 CONNEAUT, OHIO
 IN CANADA: CANADIAN ASTATIC LTD., TORONTO, ONTARIO



MRI

RADIO—ELECTRONICS
 Co-educational training in Airliner, Merchant Marine, Press Communications, Electronics, Television. FREE booklet. Address Registrar. Ex-Servicemen: Request FREE copy, G.I. Bill of rights
 "A Radio School managed by radio men."
 45 West 45th Street, New York 19, N. Y.

MELVILLE RADIO INSTITUTE

RADIO

Courses Qualifying for Service Technician • Laboratory Technician • (Electronic Television) • Communications Operator • Register Now for New Classes Starting First Monday of each month — Day-Eve. Classes

AMERICAN RADIO INSTITUTE
 101 West 63d Street New York 23, N. Y.

RADIO-TELEVISION-ELECTRONICS
 Prepare now for ever-increasing post-war opportunities. Day and Eve. Sessions. Enroll now for new classes. Consideration given to Veterans eligible for training under the G.I. Bill.

RADIO-TELEVISION INSTITUTE
 480 Lexington Avenue, New York 17 (46th Street)
 Plaza 3-4585 Licensed by New York State

RCA INSTITUTES

Offer thorough training courses in all technical phases of

RADIO and TELEVISION

WEEKLY RATES DAYS—EVENINGS

VETERANS: RCA Institutes is approved under G. I. Bill of Rights
 For Free Catalog write Dept. ST-45
RCA INSTITUTES, Inc.
 A Radio Corporation of America Service
 75 Varick Street, New York 13, N. Y.

DeLuxe
SPEED KEY

Model CP 810

Amateur Net Price \$9.75

One of the finest commercial or amateur bugs available. Chrome finished base and superstructure. Springs made of selected blue spring steel for uniform performance in all keys. Nine points of adjustment to suit the most critical touch. Fully adjustable. Silver contacts 3/16" diameter.

MODEL CP 510 SPEED KEY • Similar to above except the base is Battleship gray wrinkle finish. Amateur Net Price \$6.75

TELEGRAPH Apparatus Co.
 325 WEST MURON STREET • CHICAGO 10, ILL.

HAM-ADS

(1) Advertising shall pertain to radio and shall be of nature of interest to radio amateurs or experimenters in their pursuit of the art.

(2) No display of any character will be accepted, nor can any special typographical arrangements, such as all or part capital letters be used which would tend to make one advertisement stand out from the others.

(3) The Ham-Ad rate is 30c per word, except as noted in paragraph (6) below.

(4) Remittance in full must accompany copy. No cash or contract discount or agency commission will be allowed.

(5) Closing date for Ham-Ads is the 25th of the second month preceding publication date.

(6) A special rate of 7c per word will apply to advertising which, in our judgment, is obviously non-commercial in nature and is placed and signed by a member of the American Radio Relay League. Thus, advertising of bona fide surplus equipment owned, used and for sale by an individual or apparatus offered for exchange or advertising inquiring for special equipment, if by a member of the American Radio Relay League takes the 7c rate. An attempt to deal in apparatus in quantity for profit, even if by an individual, is commercial and all advertising by him takes the 30c rate. Provisions of paragraphs (1), (2), (4) and (5), apply to all advertising in this column regardless of which rate may apply.

Having made no investigation of the advertisers in the classified columns, the publishers of *QST* are unable to vouch for their integrity or for the grade or character of the products advertised

QUARTZ — Direct importers from Brazil of best quality pure quartz suitable for making piezo-electric crystals. Diamond Drill Carbon Co., 719 World Bldg., New York City. **COMMERCIAL** radio operators examination questions and answers. One dollar per element. G. C. Waller, W5ATV, 6540 Washington Blvd., Tulsa, Okla.

WHY NOT turn your unused equipment into ready cash which may be applied towards new and better equipment after the war? Leo, W9GFG, offers you the best cash prices for communications receivers and test equipment. Write today for large illustrated catalog. Wholesale Radio Laboratories, 744 W. Broadway, Council Bluffs, Iowa.

CRYSTALS available — all types, including 100 kc., 465 kc. and 100 kc. Broadcast and Aircraft given prompt attention. Scientific Radio Products, Council Bluffs, Iowa.

IMMEDIATE shipment on priority: new SX28As, \$223.00; SX25s, \$94.50; PM23s, \$15.00. In stock without priority: Trimm #65, Dependable headsets, \$2.28; #100 Featherweight \$6.00; meter rectifiers, \$1.95; coils, transformers, etc. Instructographs for rent. Write for our catalog. Henry Radio Shop, Butler, Mo.

HIGHEST prices paid for used receivers, test equipment, bugs, oscillators. What have you? W9ARA, Butler, Mo.

BUILD a radio, complete kit with tubes, \$9.95. Details. Radio, 9418 Avenue "A", Brooklyn, N. Y.

FABERADIO crystals will be available to amateurs immediately after hostilities cease. Faberadio, Sandwich, Ill.

CRYSTALS: complete units or blanks. All types. Your specifications and tolerances. One or one million. Refinishing and repairing of your present units. Rex Bassett, Incorporated, Ft. Lauderdale, Fla.

CALIF. kilowatt of special designed equipment, including tubes. For list, write Davis, 4306 W. 60th St., Los Angeles, 43, Calif.

RADIO TESTS — Pre-examination Tests for Radio Operators. Tests your knowledge before you appear for commercial radio operator license examinations. Avoids failures. Guides your preparation. Saves your time. Worth investigating at once. Also books for home study. Write for free circulars 5Q. Nilson Radio School, 51 E. 42 St., New York 17, N. Y.

NEED Dec. 1915 and May 1916 issues *QST*. Pay any price. Also want old Call Books and Handbooks. W. L. Holst, W9MD, 2553 Winnemac Ave., Chicago, Ill.

MICA condensers, 0.0001-3000V — \$1.50; 0.0012-5000V — \$2.50. Van Sickle Radio, Indianapolis 6, Ind.

IRE Proceedings wanted. July, August, October, December 1936. Issues before 1930. Hoisington, 48-02 Browvale, Little Neck, N. Y.

SALE: Delco 6 volt gas engine generator, direct coupled self-cranking, or trade for SW receiver or 20 gauge Remington Sportsman. W9GPP, I. N. Johnson, Luverne, Minn.

SELL or swap: HK-54, 809, RK-28, 35-T, RK-20, RK-39, 866 type tubes. Rotary converters 85 v.d.c. to 110 v.a.c., 1 k.w. with auto starter. 85 v.d.c. to 110 v.a.c. 3 k.w. 1200 v.d.c. Power Supply, 500 amp. Wanted: HK-254 tubes, good camera. Leo Vachow, Mackinaw City, Mich.

WANTED: Presto recorder. W. Read, 2101 Harrison Ave., Wilmington #278, Delaware.

SELL: Abbott TR4, comb. power supply, table mike, all like new, \$62.50. 300 v. power supply, \$8.50. W. Gardner, 1821 Chouteau Ave., St. Louis 3, Mo.

FOR SALE: Best offer, pair RCA 813, 803, 575A. Never used. Guaranteed. J. Middleton, W2MKV.

TRADE U. S. stamps, covers, mints, for radio equipment. Exchange lists. R. Peck, 2538 S. Robinson St., Philadelphia 42, Pa.

WANTED: 80, 40, and 20 meter coils for 1941 Meissner signal shifter. Fred Kost, W3HPO, 24 Green Lane, Green Ridge, Penn.

WANTED: Triplett Model 221 meter 100 ma. W1BB.

NEED: 100 k.c. secondary frequency standard crystal with holder. Prefer Bliley SOC-100. Cash or will trade 22 LR standard velocity ammunition. Carroll Swain, Box 440, Anchorage, Alaska.

WANTED: Sky Buddy or Champion receiver. Sgt. Wm. Holt, Jr. Post Signal Office, Ft. Huachuca, Ariz.

SELL: Superpro. New, no b.c. band. W3QP.

TUBES for sale: list on request. Abbott Appliance & Music Co., 2101 Grand Concourse, New York City.

WANTED: Hallicrafters SX-25 or SX-28. M. Roberts, 1836 Seabrook, Topeka, Kansas.

CHANGING frequency? Immediate delivery of Eidson fine crystals; low drift types available throughout the 100-12,000 k.c. range. Also repair and regrinding, and crystals fitted to your holders. Ten years of satisfaction and fast service. Send for folder L-5, mentioning needs. "Eidson's," Temple, Texas.

WANTED: Printing press and equipment in exchange for radio parts. What do you need? Fuller, 6 Sunrise, Cocoa, Fla.

WANTED for cash: two 9001 and two 9002 tubes. Willard Hall, Rural Route #5, Creve Coeur, Ill.

WANTED: Receiver that covers 200-400 kc.c. band. Set super-heterodyne coils for same band. Larry Kleber, Belvidere, Ill.

TRADE Winchester Model 65, lever action, 25-20 repeating rifle, micrometer rear sight, with shells, Ideal 25-20 reloading tools, outfit like new inside and out; for best offer of Meissner Deluxe signal shifter. Chester Robison, 1359 Blair Avenue, Tyrone, Penn.

RESISTOR, wire wound, nationally known make. 3000 ohms, 7½ watts. Remove wire to make any desired value. For making servicing equipment, shunts, multipliers, experimenting, etc. Five for \$1.00. Radioco, 1110 T Marshall Bldg., Cleveland, Ohio.

WANTED: Set of 10 meter coils for Hallicrafters HT-6 transmitter. W5ALA, Moore, 5712 Berkshire, Dallas 9, Texas.

TURNTABLE with motor for 78 r.p.m. wanted. Please describe. J. V. Fitzhugh, A.R.R.L. Hdqtrs., 38 La Salle Rd., West Hartford 7, Conn.

FIELD SERVICE ENGINEERS

for

Domestic and Foreign Service

MUST POSSESS GOOD KNOWLEDGE OF RADIO

Essential Workers Need Release

HAZELTINE CORPORATION

58-25 Little Neck Parkway
Little Neck • Long Island

"HOGARTH, I HAVE A FEELING WE'RE NOT ALONE. MAYBE YOUR FRIENDS WILL GO AWAY IF YOU TURN OFF YOUR ECHOPHONE EC-1"



ECHOPHONE MODEL EC-1

(Illustrated) a compact communications receiver with every necessary feature for good reception. Covers from 550 kc. to 30 mc. on 3 bands. Electrical bandspread on all bands. Six tubes. Self-contained speaker. 115-125 volts AC or DC.

ECHOPHONE
"The Ears of the World"

Designed for.

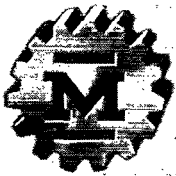

Application

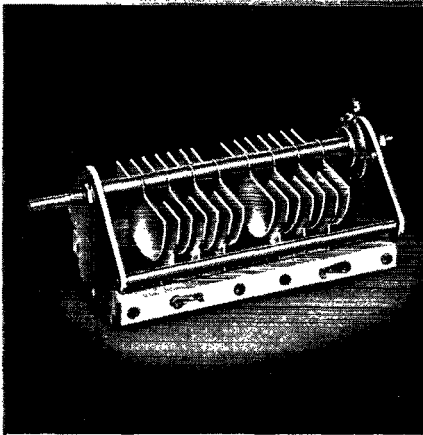

16000 Series

Transmitting Condensers

A new member of the "Designed for Application" series of transmitting variable air capacitors is the 16000 series with peak voltage ratings of 3000, 6000, and 9000 volts. Sturdy construction, thick, rounded, polished aluminum plates with 1 3/4" radius. Constant impedance, heavy current, multiple finger rotor contactor of new design. Available in all normal capacities in single and double sections.

**JAMES MILLEN
MFG. CO., INC.**

MAIN OFFICE AND FACTORY
**MALDEN
MASSACHUSETTS**



Index to Advertisers

	Page
Abbott Instrument, Inc.	**
Aerovox Corporation	**
American Lava Corp.	**
American Radio Institute	107
American Tel. & Tel. Corp.	7
Amperex Elec. Products, Inc.	**
Astatic Corporation, The	107
Ayers Automatic Code Machines	**
Barker & Williamson	**
Biley Electric Co.	73
Brach Manufacturing Corp.	**
Browning Laboratories, Inc.	95
Burgess Battery Company	78
Candler System Company	98
Capitol Radio Engineering Institute	82
Cardwell Mfg. Corp., Allen D.	**
Centralab	79
Clarostat Mfg. Co., Inc.	**
Collins Radio Company	77
Commercial Radio Institute	100
Communications Products Co.	89
Crystal Products Co.	91
Delco Radio, Div. Gen. Motors	92
DX Crystal Company	**
Echophone Radio Co.	109
Eitel-McCullough, Inc.	112
Electro-Voice Mfg. Co.	81
Electronic Laboratories	**
Galvin Mfg. Corp.	**
Gardiner & Company	**
General Ceramics & Steatite Co.	**
General Electric Co.	101
Greenlee Tool Company	**
Hallcrafters Co., The	1, 2
Hammarlund Mfg. Co., The	69, 71
Harco Steel Construction Co.	102
Harrison Radio Company	**
Harvey Radio Co.	84
Harvey Radio Laboratories, Inc.	**
Harvey-Wells Communications, Inc.	**
Hazeltine Electric Corp.	92, 108
Heintz & Kaufman, Ltd.	**
Henry Radio Shop	**
Hytron Corporation	**
Instructograph Company	**
International Resistance Co.	90
Jensen Radio Mfg. Co.	111
Ken-Rad Tube & Lamp Corp.	**
Kenyon Transformer Co., Inc.	**
Knights Co., James	**
Maedel Publishing House	**
Mallory & Co., P. R.	76
Massachusetts Radio School	100
McElroy Mfg. Corp.	5
McGraw-Hill Book Co., Inc.	94
Meck Industries, John	**
Meissner Mfg. Co.	4
Melville Radio Institute	107
Metropolitan Technical School	**
Millen Mfg. Co., James	110
National Carbon Co., Inc.	85
National Company, Inc.	67, 87, Cov. IV
Newark Electric Co.	97
New York YMCA Schools	100
Nilson Radio School	**
Ohmite Manufacturing Co.	88
Onan Electric Co., D. W.	98
Philco Corporation	**
Pioneer Gen-E-Motor	**
Port Arthur College	90
Premax Products	96
RCA Institutes, Inc.	107
RCA Manufacturing Co.	Cov. IV
Radio Manufacturing Engineers	**
Radio Shack Corporation	**
Radio-Television Institute	107
Ramsey Publishing Co.	**
Raytheon Mfg. Co.	83, 95
Scoll, R. G. & Co.	102
Scientific Radio Products Co.	**
Shure Brothers	**
Sickles Co., F. W.	106
Simpson Electric Co.	**
Sperry Gyroscope Co.	**
Sprague Electric Co.	**
Standard Radio Electronics Co.	**
Standard Transformer Co.	80
Sun Radio & Electronics Co.	100
Taylor Tubes, Inc.	**
Telegraph Apparatus Co.	107
Teleplex Corporation	**
Terminal Radio Corp.	105
Thordarson Elec. Mfg. Co.	75
Triplett Elec. Instrument Co., The	105
Turner Company, The	**
United Transformer Co.	Cov. IV
Universal Microphone Co.	86
Valparaiso Technical Institute	100
Valpey Crystals	86
Vibroplex Company, Inc., The	**
Wallace Co., William	**
Western Electric Co.	92
Westinghouse Elec. & Mfg. Co.	103
Wholesale Radio Laboratories	94
Wilcox Electric Co.	**
Yaxley (Mallory, P. R.)	76
Zenith Radio Company	**

All of the above advertisers are cooperating with the A.R.R.L. to permit publication of an editorially adequate QST during this period of war-rationing of paper. Using less advertising space but at higher rates, they continue their customary support of QST. Some are using smaller space in each issue and some are using space only every second or third issue. Of the latter, those whose advertising does not appear in this particular issue are indicated by the ** above.

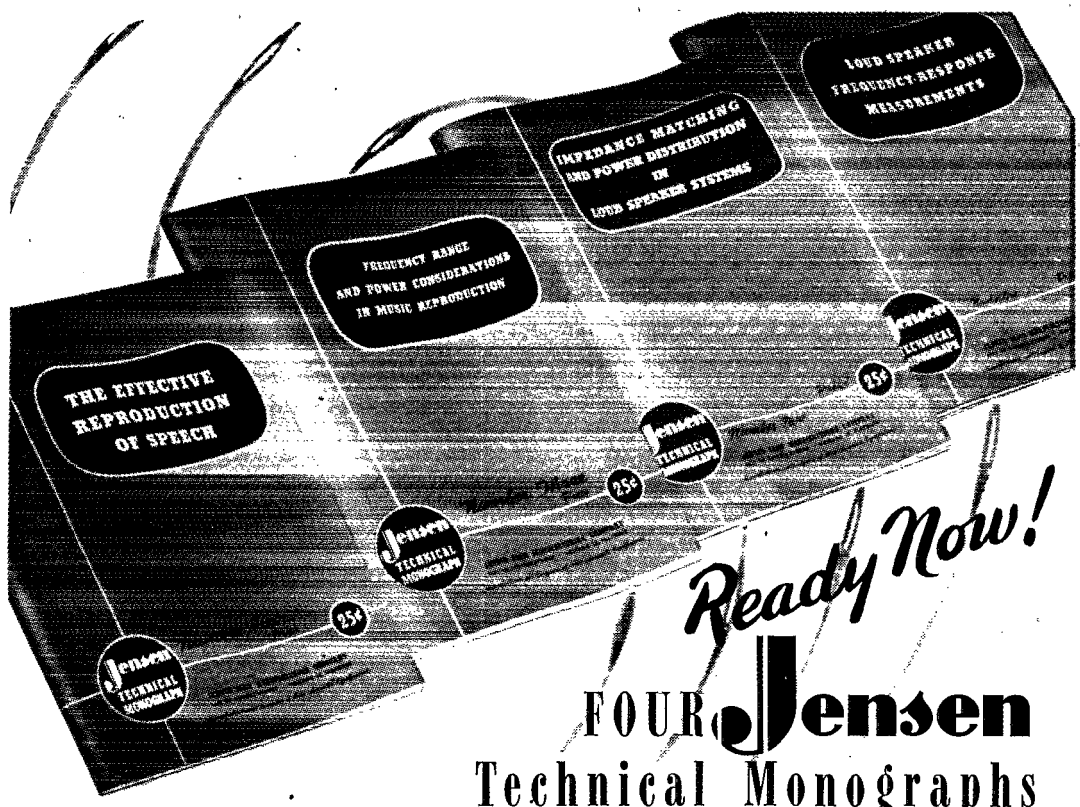

Ready Now!

FOUR Jensen Technical Monographs

EVERYONE interested in the reproduction of sound — engineer, tradesman, instructor, student or layman — should own these four Monographs. Published by the Jensen Technical Service Department in the interest of improved sound reproduction, they are the first four numbers of a series. Up-to-date in factual information, replete with useful charts, graphs and tables, they supply a world of data, heretofore unobtainable, to guide in the selection, installation and operation of loud speakers. You will want not only these four numbers but the rest of the series as announced from time to time.

MONOGRAPH No. 1: "Loud Speaker Frequency-Response Measurements." Deals with one of the most interesting and controversial subjects in the field of acoustics. Discusses, among other topics, frequency response of the human ear, the influence of environment on frequency response, the practical aspects of frequency response measurements. Amply illustrated with charts and graphs.

MONOGRAPH No. 2: "Impedance Matching and Power Distribution." Discusses such subjects as multiple speaker connection, volume control, design of efficient transmission lines, and conversion of volume levels to power and voltage. The text is supported by

twenty-eight drawings and tables. More than a score of questions are described, illustrated and solved, including a comprehensive sound system for a military installation.

MONOGRAPH No. 3: "Frequency Range in Music Reproduction." What frequency range is needed for high fidelity reproduction? What are the maximum, useful audio frequency ranges under actual listening conditions? What are the practical limitations on high fidelity reproduction even if perfect transmission, reception and reproduction were possible? How much change in high frequency cut-off is required to be just noticeable to the listener? All these and many more questions are answered in this Jensen Monograph.

MONOGRAPH No. 4: "The Effective Reproduction of Speech." Explains why faithful speech reproduction requires a frequency band almost as wide as for music, while amplified speech for strictly communication purposes may be reproduced satisfactorily within a narrower band because in this case the principal emphasis is on such things as articulation, loudness, masking, and power requirements. Presents useful conclusions and practical information for everyone interested in speech reproduction.

Get any or all of these Monographs today from your Jensen jobber or dealer. Fill in the coupon and send with it 25c for each copy desired, or clip a dollar bill to the coupon and get all four.



FREE to men in the Armed Services, and to Colleges, Technical Schools and Libraries.

JENSEN RADIO MANUFACTURING COMPANY
 6611 South Laramie Avenue, Chicago 38, Illinois

Send me:

- Loud Speaker Frequency-Response Measurements
- Impedance Matching and Power Distribution
- Frequency Range in Music Reproduction
- The Effective Reproduction of Speech

(Check one or more. Send 25c for each book ordered.)

NAME _____
 ADDRESS _____
 CITY _____ ZONE _____ STATE _____

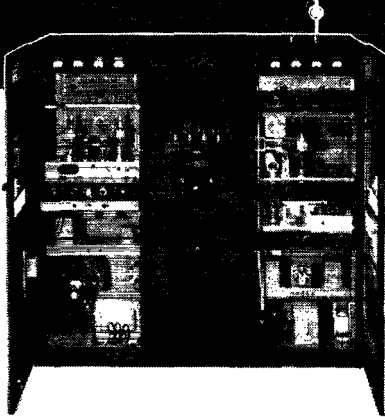

Output CW—5 KW; Output 'Phone—3 KW 100% modulated with a pair of Eimac 450TL tubes in class "B" audio; continuous coverage from 2 MC to 18.1 MC with 11 preset channels in that range and complete manual coverage throughout whole range. Capable of completely unattended remote control operation and of A1, A2 and A3 type emission. Audio characteristics: plus or minus three DB from 150 to 3,500 cycles. Total harmonic distortion less than 10%. The transmitter can be terminated into a 50 to 1,200 pure resistive load at zero degrees phase angle. 70 to 850 ohm load at plus or minus 45 degrees and 100 to 600 ohms at plus or minus 60 degrees.

Write for your copy of Electronic Telesis—a 64 page booklet fully illustrated—covering the fundamentals of Electronics and many of its important applications. In layman's language.

COLLINS ENGINEERING AND EIMAC TUBES *achieve outstanding results*

This Collins type 231D-11 (Navy TDH) radio transmitter is an outstanding demonstration of the value of capable engineering coupled with the intelligent choice and use of vacuum tubes.

It is the latest of a series of Collins Autotune, quick shift transmitters which were originally introduced in 1939, and which use Eimac tubes in the important sockets. In the 231D-11, two Eimac 750TL tubes in parallel make up the power amplifier, while a pair of Eimac 450TL tubes in class "B" are used as modulators for voice and MCW emission.

Mr. F. M. Davis, General Manager of the Collins Engineering Division, says: "Eimac tubes have been found to be reliable, rugged and capable of withstanding the severe overloads encountered during equipment tests, without damage." Statements like this, coming from such men as Mr. Davis, offer proof that Eimac tubes are first choice of leading engineers throughout the world.

Follow the leaders to
Eimac
REG. U. S. PAT. OFF.
TUBES

EITEL-McCULLOUGH, Inc., 956 San Mateo Ave., San Bruno, Calif.
Plants located at: San Bruno, California and Salt Lake City, Utah

Export Agents: Frazer & Hansen, 301 Clay Street, San Francisco 11, California, U. S. A.

NATIONAL RECEIVERS ARE THE EARS OF THE FLEET

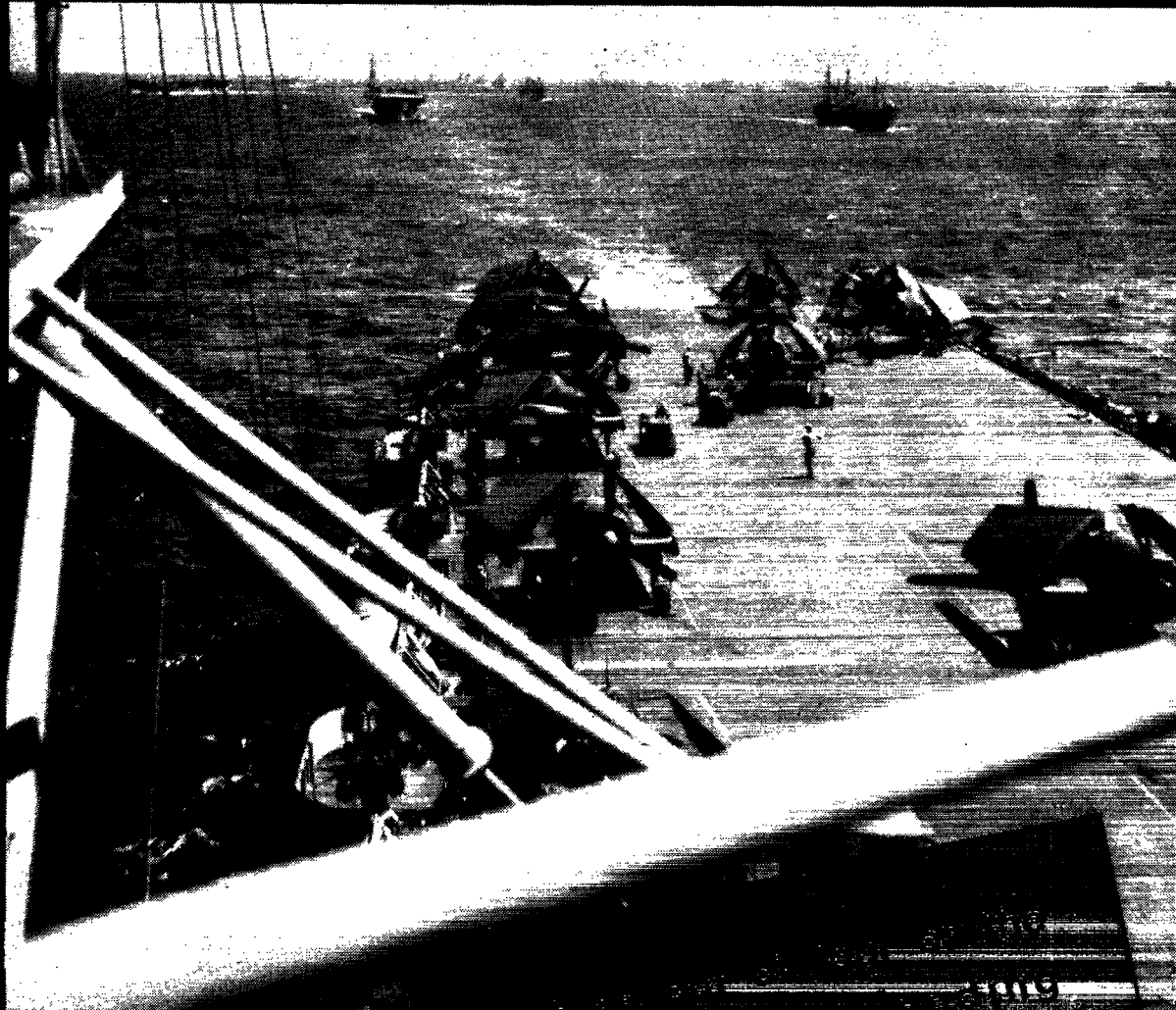

OFFICIAL U. S. NAVY PHOTOGRAPH

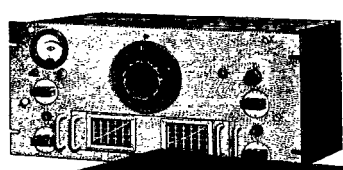
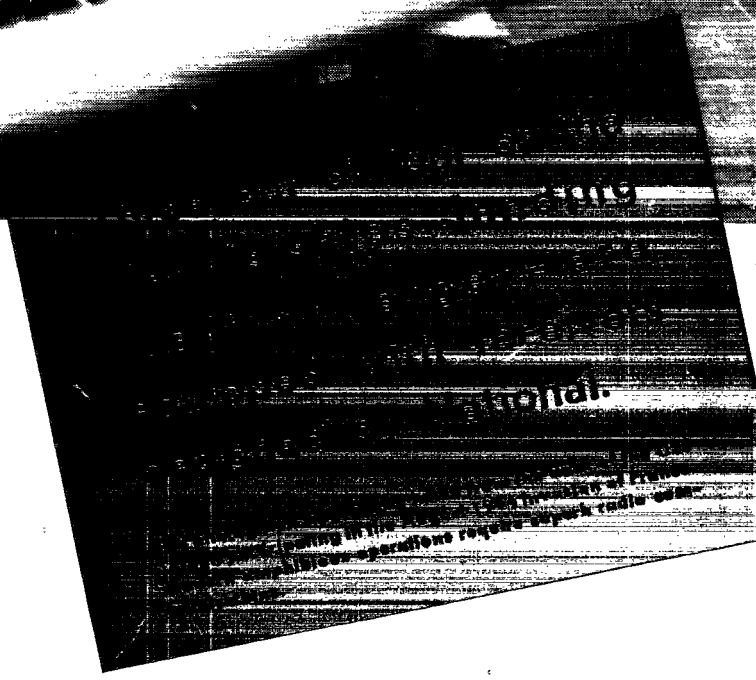

HRO

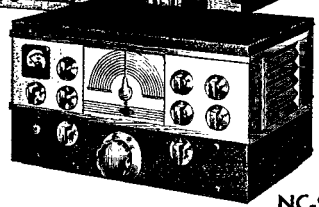

NC-200

NATIONAL COMPANY
MALDEN  **MASS., U. S. A.**

NATIONAL RECEIVERS ARE IN SERVICE THROUGHOUT THE WORLD

RCA HIGH-VALUE RECTIFIERS?



RCA-816
 HALF-WAVE
 MERCURY-VAPOR
 RECTIFIER
 125 Ma @ 1750
 volts RMS input
\$1⁰⁰



RCA-5R4-GY
 FULL-WAVE
 HIGH-VACUUM
 RECTIFIER
 250 Ma @ 700
 volts RMS input
 per plate
\$1⁰⁰

TECHNICAL DATA

	5R4-GY	816
Fil. Volts (A. C.)	5.0	2.5
Fil. Amp.	2.0	2.0
Max. Overall Length, inches	5-5/16	4-11/16
Base	Micanol; Med. Shell Octal, 5-pin	Small 4-pin
Cap Mounting: Vertical	Yes	Small Yes — base down only
Horizontal	With pins 1 and 4 in vertical plane	No

MAXIMUM RATINGS (Design Center Values)

	5R4-GY	816
Peak Inverse Volts	2800	5000
Peak Plate Milliamperes	650 per plate	500
Average Plate Milliamperes		125
For Condenser-input Filter	250 max. @ 1400 volts* 150 " @ 1800 " *	
For Choke-input Filter	250 " @ 1500 " * 175 " @ 1900 " *	
Warm-up Time, Seconds	10	10

*RMS plate-to-plate input value

For power supplies for low- and medium-power stages of transmitters, and for other electronic apparatus, these two RCA rectifiers fill a real need. Both are sturdily built to give dependable, low-cost service.

THE FOUNTAIN-HEAD OF MODERN TUBE DEVELOPMENT IS RCA



62-6436-43



RADIO CORPORATION OF AMERICA

RCA VICTOR DIVISION • CAMDEN, N. J.