

QST

february, 1945

25 cents

35c in Canada

devoted entirely to

amateur radio

In This Issue:

WERS and the Red Cross

A Wide-Range R/C Audio Oscillator

A WERS Master-Control Transmitter

A Sensitive Bridge-Type Vacuum-Tube Volt-Ohmmeter

Band-Width Requirements for Pulse-Type Transmissions

RS

AMERICAN RED CROSS

Why

AMPEREX

WATER AND AIR COOLED TRANSMITTING AND RECTIFYING TUB

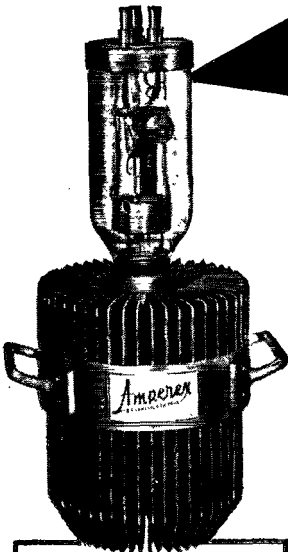
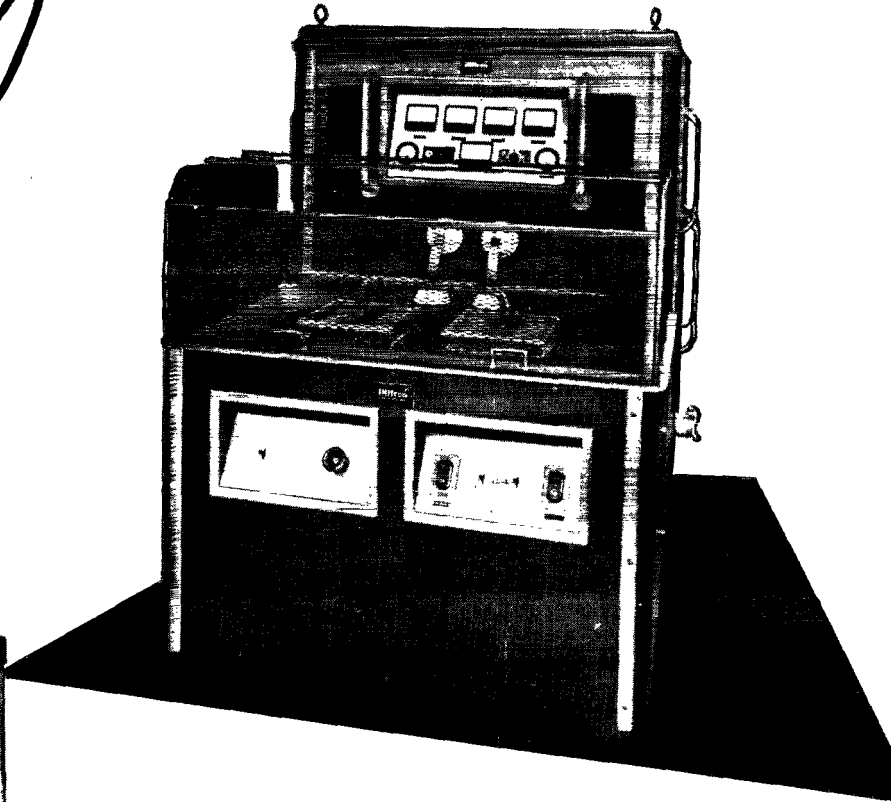

AMPEREX

... the high performance tube



The ILLINOIS TOOL WORKS has made tremendous strides in the design and development of dielectric heating equipment for such applications as moulding bakelite, heating pre-forms, joining thermoplastics, etc. AMPEREX tubes are used in all such equipment produced by this well-known concern.

With the ILLINOIS TOOL WORKS, as with many other leading concerns working with electronic tubes, it's the "Amperextra" of longer life and low-cost efficiency that has made our products a first and exclusive choice. AMPEREX pioneered in the field of tubes for industrial applications. We are familiar with the needs of industry, and we have the tubes to meet all requirements. Consult AMPEREX for assistance with your present or postwar problems.

IMPORTANT! AMPEREX tubes are now available through leading radio equipment distributors. This new arrangement may save valuable time for busy engineers by enabling them to obtain many of our standard tube types from their local supply sources.

AMPEREX ELECTRONIC CORPORATION

79 WASHINGTON STREET • • • • • BROOKLYN 1, N. Y.

Export Division: 13 E. 40th St., New York 16, N. Y., Cables: "Arlab"

THE WAR ISN'T OVER YET...BUY AND HOLD MORE WAR BONDS

new directions in radio . . .

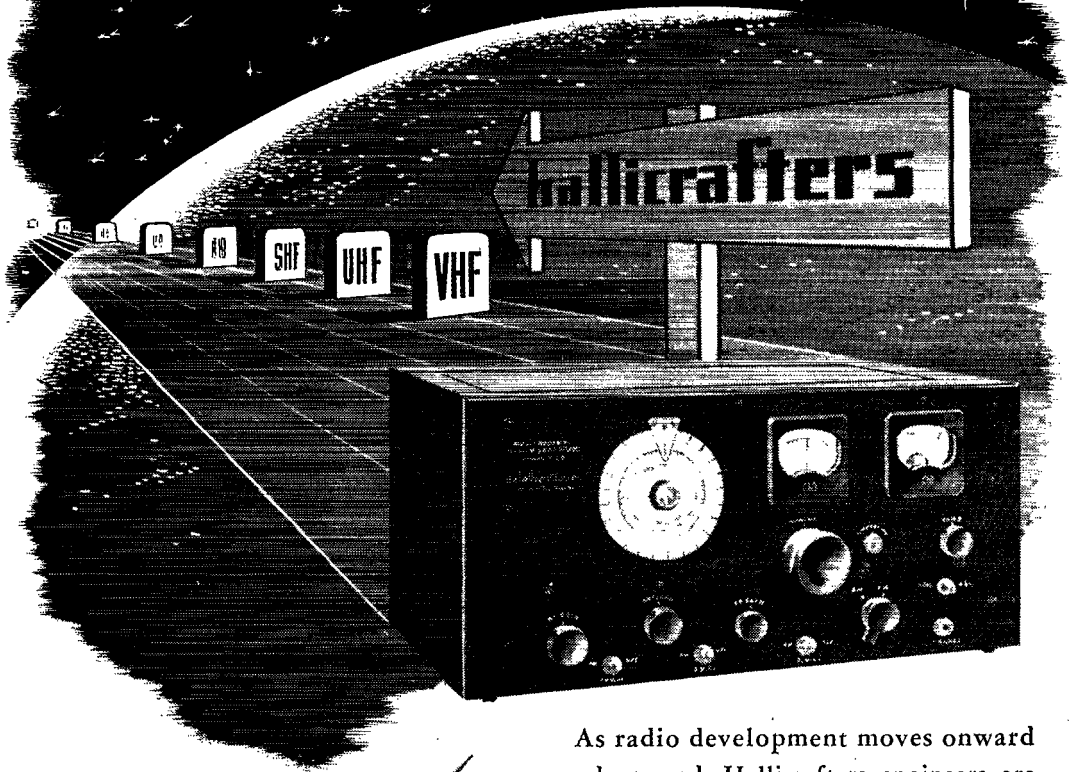

*New directions
in radio will
be charted by
Hallicrafters*

As radio development moves onward and upward, Hallicrafters engineers are setting the pace, pushing back the horizons in the exciting fields of very high frequency, ultra high frequency, and super high frequency development work. The range of the Model S-37 illustrated here covers higher frequencies than any other continuous tuning commercial type receiver. It is becoming a prime instrument of experiment and research in marking out the new directions that all radio will take.



hallicrafters RADIO

Buy a War Bond Today!



THE HALLCRAFTERS CO., MANUFACTURERS OF RADIO AND ELECTRONIC EQUIPMENT, CHICAGO 16, U. S. A.

how high is very high?

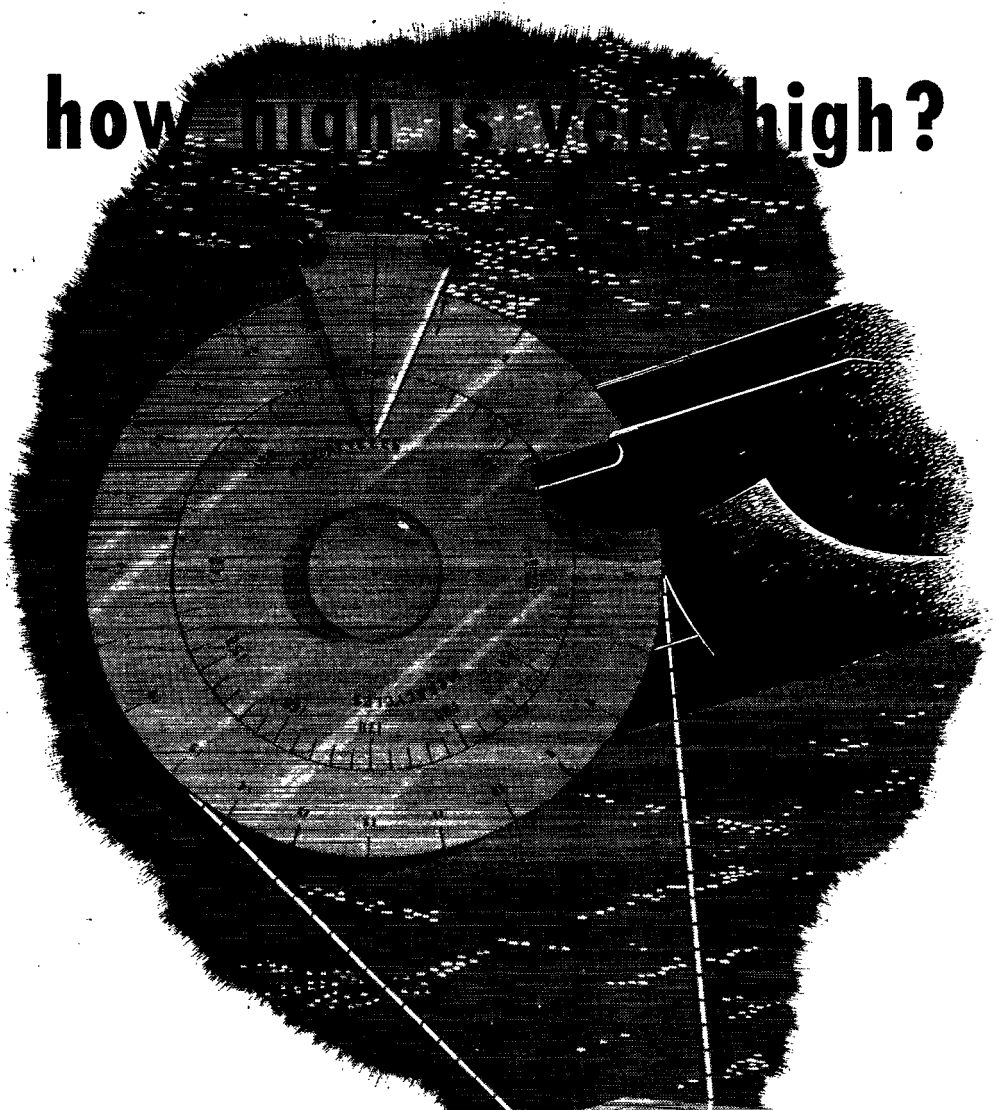

★ Engineers at Hallicrafters are continually striving for new heights of perfection in high frequency development work. The Model S-37 is one example of the progress they have made. This is the first and only set of its kind—covering both AM and FM and operating in the range of 130 to 210 Mc. Two r.f. stages are used and in conjunction with an intermediate frequency of 18 Mc., assure an amazingly high ratio of image rejection. It is becoming a valuable instrument in the hands of all exploring the upper reaches of the high frequency ranges.

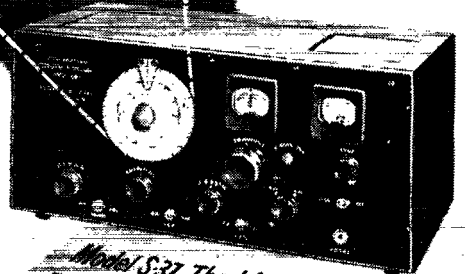

Model S-37. The highest frequency range of any continuous tuning commercial type receiver.

hallicrafters RADIO

THE HALLICRAFTERS CO., MANUFACTURERS OF RADIO AND ELECTRONIC EQUIPMENT, CHICAGO 16, U. S. A.



Buy a
War Bond
Today!



FEBRUARY 1945

VOLUME XXIX

NUMBER 2



STAFF

Editorial

KENNETH B. WARNER, W1EH
General Manager of A.R.R.L.
Publications

CLINTON B. DESOTO, W1CBD
Editor

A. DAVID MIDDLETON, W2OEN
Assistant Editor

GEORGE GRAMMER, W1DF*
Technical Editor

DONALD H. MIX, W1TS
Acting Technical Editor

J. VENABLE FITZHUGH, W5VL
HOLLIS M. FRENCH, W1JLK
BYRON GOODMAN, W1JE*
Assistant Technical Editors

EDWARD P. TILTON, W1HDQ
Contributing Editor, V.H.F.

WALTER E. BRADLEY, W1FWH
VERNON CHAMBERS, W1JE*
Technical Information Service

LOUISA B. DRESSER
Editorial Assistant

JAMES J. LAMB, W1AL*
Research Engineer, A.R.R.L.

Advertising

F. CHEYNEY BEEKLEY, W1GS
Advertising Manager

Circulation

DAVID H. HOUGHTON
Circulation Manager

RALPH T. BEAUDIN, W1BAW
Asst. Circulation Manager

*On leave of absence



OFFICES

38 La Salle Road
West Hartford 7, Connecticut

Subscription rate in United States and Possessions, \$2.50 per year, postpaid; all other countries, \$3.00 per year, postpaid. Single copies, 25 cents. Foreign remittances should be by international postal or express money order or bank draft negotiable in the U. S. and for an equivalent amount in U. S. funds.

Entered as second-class matter May 29, 1919, at the post office at Hartford, Connecticut, under the Act of March 3, 1879. Acceptance for mailing at special rate of postage provided for in section 1103, Act of October 3, 1917, authorized September 9, 1922. Additional entry at Concord, N. H., authorized February 21, 1929, under the Act of February 28, 1925. Additional second-class entries to cover sectional editions authorized March 20, 1935.

Copyright 1945 by the American Radio Relay League, Inc. Title registered at U. S. Patent Office.

QST

devoted entirely to

AMATEUR RADIO

PUBLISHED MONTHLY, AS ITS OFFICIAL ORGAN, BY THE AMERICAN RADIO RELAY LEAGUE, INC., AT WEST HARTFORD, CONN., U. S. A.; OFFICIAL ORGAN OF THE INTERNATIONAL AMATEUR RADIO UNION



CONTENTS

It Seems to Us	9
Splatter	10
Band-Width Requirements for Pulse-Type Transmissions W. W. Hansen	11
Transmission Requirements and Bell System Facilities for Video and Music	13
A Red Cross Mobile Disaster Headquarters — WERS Equipped Houston W. Hendrix, W3DOU	14
A Homemade Radio-Range Receiver Alexander Browdy, W6UKP-ex-W2NSS	17
Building an RAAF B.C. Station Ralph Turner, VK5TR	19
In the Services	20
An Extended-Range Audio Oscillator Charles J. Leipert, W6ROA	24
A WERS Master-Control Transmitter Philip S. Rand, W1DBM	27
Happenings of the Month	33
Increasing Vacuum-Tube Volt-Ohmmeter Sensitivity Hardy Glenn, W5BRX	35
In QST 25 Years Ago This Month	39
Practical Applications of Simple Math — Part X Edward M. Noll, ex-W3FQJ	40
Gold Stars — W8MAD, W8UFO, W2KCD	41
Hans in Combat Radio Saves Life of Aleutian Outpost Commander Cpl. Bill Granberg	42
Hints and Kinks Drive for Home-Recording Cutter Head — Electronic Bug Movement — Using One Receiver to Check I.F. of Another — Testing Receiver Power-Transformer Primaries	44
Correspondence from Members	46
Operating News	49
Amateur Activities	53
The Month in Canada	64
Missing in Action	68
Prisoners of War	68
Silent Keys	68
WVW Schedules	70
Ham-Ads	92
QST's Index of Advertisers	94

☞ All material appearing in QST conforms with the "Code of Wartime Practices for the American Press" of the U. S. Office of Censorship.

☞ All material involving military security has been reviewed by appropriate military, naval or other competent authority.

Section Communications Managers of the A. R. R. L. Communications Department

Reports Invited. All amateurs, especially League members, are invited to report communications activities, training plans, code classes, theory-discussion groups, civilian-defense building or planning each mid-month (16th of the month for the last 30 days) direct to the SCM, the administrative official of ARRL elected by members in each Section whose address is given below. Radio Club reports and Emergency Coordinator reports representing community organized work and plans and progress are especially desired by SCMs for inclusion in QST. ARRL Field Organization appointments, with the exception of the Emergency Coordinator and Emergency Corps posts, are suspended for the present and no new appointments or cancellations, with the exception named, will be made. This is to permit full efforts of all in Emergency Corps plans.

ATLANTIC DIVISION				
Eastern Pennsylvania	W3BES	Jerry Mathis	623 Crescent Ave., 9701 Monroe St. Silver Springs P. O.	Glenside Gardens
Maryland-Delaware-District of Columbia	W3CIZ	Hermann E. Hobbs	623 E. Brown St.	Linden, Maryland
Southern New Jersey	W3GCU	Ray Tomlinson	186 Dorsey Rd.	Trenton 10
Western New York	W8MC	William Bellow	703 Broadway	Rochester
Western Pennsylvania	W8CKO	E. A. Krall		East McKeesport
CENTRAL DIVISION				
Illinois	W9NUX	David E. Blake, II	4501 N. Malden St.	Chicago 40
Indiana	W9CQO	Herbert S. Brier	385 Johnson St.	Gary
Kentucky	W9AR0	Darrell A. Downard	116 N. Longworth Ave.	Louisville 12
Michigan	W8DPE	Harold C. Bird	R.F.D. 2, Box 223	Pontiac 2
Ohio	W8MFP	Carl F. Wiehe	122 St. Albert St.	St. Bernard 17
Wisconsin	W9RH	Emil Felber, Jr.	1625 N. 18th St.	Milwaukee 5
DAKOTA DIVISION				
North Dakota	W9YVF	John W. McBride	620 North Menlo Ave.	Sioux Falls, South Dakota
South Dakota	W9QVY	P. H. Schultz	118 N. Yankton Ave.	Pierre
Northern Minnesota	W9WRT	Armond D. Brattland	2802 So. Western	Los Angeles 7, Calif.
Southern Minnesota	W9YNQ	Millard L. Bender	608 N. Huron Ave.	Spring Valley
DELTA DIVISION				
Arkansas	W5GED	Ed Beck	2503 Bishop St.	Little Rock
Louisiana	W5DKR	Eugene H. Treadaway	P. O. Box 44	LaPlace
Mississippi	W5HAV	P. W. Clement	524 Santini St.	Biloxi
Tennessee	W4SP	James B. Witt	R.F.D. 6, Shady Dell Trail	Knoxville
HUDSON DIVISION				
Eastern New York	W2HZL	Ernest E. George	2044 Lexington Parkway	Schenectady 8
N. Y. C. & Long Island	W2AZV	E. L. Baunach	102 Central Ave.	Maspeth, L. I.
Northern New Jersey	W2CQD	Winfield G. Beck	617 Spruce St.	Roselle
MIDWEST DIVISION				
Iowa	W9AED	Arthur E. Rydberg	1617 S. Seneca St.	Mitchellville
Kansas	W9AWP	A. B. Unruh	Box 123	Wichita 11
Missouri	W9QFD	Mrs. Leta A. Dangerfield	6105 N. 37 St.	Butler
Nebraska	W9FOB	Arthur R. Gaeth		Omaha 11
NEW ENGLAND DIVISION				
Connecticut	W1KOY	Edmund R. Fraser	48 Willow St.	West Haven 16
Maine	W1AOL	G. C. Brown	379 No. Main St.	Brewer
Eastern Massachusetts	W1ALP	Frank L. Baker, Jr.	91 Atlantic St.	North Quincy 71
Western Massachusetts	W1JAH	William J. Barrett	239 Columbia St.	Adams
New Hampshire	W1FTJ	Mrs. Dorothy W. Evans	1435 Snowden Ave.	Memphis 7, Tennessee
Rhode Island	W1ERC	Clayton C. Gordon	70 Columbia Ave., Gaspee	Plataau, Providence 5
Vermont	W1NLO	Burtis W. Dean	P. O. Box 81	Burlington
NORTHWESTERN DIVISION				
Alaska	K7GNN	James G. Sherry		Homer
Idaho	W7AVP	Don D. Oberbillig	P. O. Box 486	Boise
Montana	W7CPY	Rex Roberts	Box 1088	Glendive
Oregon	W7GNJ	Carl Austin	1137 Federal	Bend
Washington	W7PWD	O. U. Tatro	513 N. Central	Olympia
PACIFIC DIVISION				
Hawaii	K6ETF	Francis T. Blatt	837 16th Ave.	Honolulu
Nevada	W6CW	N. Arthur Sowle	Box 2025	Reno
Santa Clara Valley	W6IUZ	Earl F. Sanderson	600 Acacia Ave.	San Bruno
East Bay	W6TI	Horace R. Greer	414 Fairmount Ave.	Oakland 11
San Francisco	W6REO	William A. Ladley	200 Naylor St.	San Francisco 12
Sacramento Valley	W6MDI	Vincent N. Feldhausen	113 South Quincy St.	McCloud
Philippines	K4GR	George L. Rickard	Box 849	Manila
San Joaquin Valley*	W6XB	Edward H. Noack	811 West Magnolia St.	Stockton
ROANOKE DIVISION				
North Carolina	W4CYB	W. J. Wortman	P. O. Box 566	Morganton
South Carolina	W4BOE/ANG	Ted Ferguson	3422 Rosewood Drive	Columbia 25
Virginia	W3AKN	Walter G. Walker	217-51 St.	Newport News
West Virginia	W3JRL	Kenneth M. Zinn	P. O. Box 132	Clarksburg
ROCKY MOUNTAIN DIVISION				
Colorado	W9VCC	H. F. Heikel	2743 Julian St.	Denver 11
Utah-Wyoming	W7DIE	John S. Duffy	938 "D" St.	Rock Springs, Wyo.
SOUTHEASTERN DIVISION				
Alabama	W4GBV	Lawrence J. Smyth	808 Winona Ave.	Montgomery
Eastern Florida	W4IP	Robert B. Murphy	3302 S.W. Grapeland Blvd.	Miami 33
Western Florida	W4XP	Oscar Cederstrom	408 S. Pine St.	San Antonio
Georgia	W4FDJ	Ernest L. Morgan	R.F.D. 4	Lyons
West Indies (Cuba)	CM2OP	Mario de la Torre	Escobar 110 (Altos)	Habana, Cuba
(Puerto Rico-Virgin Islands)	K4KD	Everett Mayer	24 Lindberg St.	Santurce, P. R.
SOUTHWESTERN DIVISION				
Los Angeles	W6QVV	H. F. Wood	429 So. Fairview	Burbank
Arizona	W6RWW	Douglas Aitken	341 S. Mt. Vernon Ave.	Prescott
San Diego	W6CHV	Ralph H. Culbertson	7172 Eads St.	La Jolla
WEST GULF DIVISION				
Northern Texas	WSALA	Jack T. Moore	5712 Berkshire Lane	Dallas 9
Oklahoma	WSAYL	Ed Oldfield	2141 N.W. 35th St.	Oklahoma City 6
Southern Texas	WS3MN	Horace E. Biddy	1746 Seley Ave.	San Antonio
New Mexico	W5HJF	J. G. Hancock	110 S. E. Nevada St.	Portales
MARITIME DIVISION				
Maritime	VE1DQ	A. M. Crowell	69 Dublin St.	Halifax, N. S.
ONTARIO DIVISION				
Ontario	VE3EF	Wing Commander Donald R. Gunn	c/o Canadian Bank of Commerce	New Toronto, Ont.
QUEBEC DIVISION				
Quebec	VE2CO	Lieutenant L. G. Morris	211 Bolton St.	Ottawa, Ont.
VANALTA DIVISION				
Alberta	VE4GE	C. S. Jamieson	581 W. Riverside Drive	Drumheller, Alta.
British Columbia	VE5DD	C. O. I. Sawyer	2634 West 31st Ave.	Vancouver
PRAIRIE DIVISION				
Manitoba	VE4AAW	A. W. Morley	932 Dorchester Ave.	Winnipeg
Saskatchewan	VE4SY	Arthur Chesworth	1084 Redland Ave.	Moose Jaw

*Officials appointed to act temporarily in the absence of a regular official.

McELROY

CONTINUES TO FURTHER THE ART OF RADIOTELEGRAPHY!

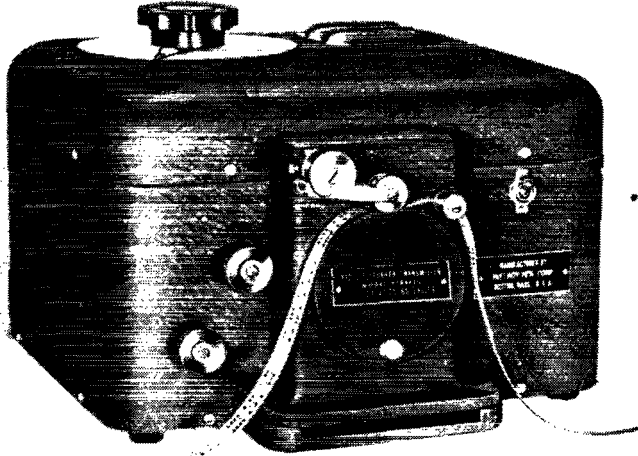

New **MODEL XTR-442-G AUTOMATIC TRANSMITTER**

- For keying the intermediate relay of a radiotelegraph station, or an audio oscillator for training radiotelegraph operators.
- New type auto head, with the most modern ball-bearings, including a new plastic bearing and tool steel bell cranks.
- Speed range on first set of gears is from 10 to 60 words per minute . . . for speeds from 50 to 300 words per minute, you simply shift the gear.
- Provides accurate calibration of words per minute, and the speed remains constant, unaffected by temperature rises or voltage fluctuations.
- New microswitch is operated by lever extending throughout front panel—longer life of the power mechanism and parts are assured because of this unique arrangement.
- The XTR-442-G opens and closes any keying circuit to form mechanically precise signal elements in response to Wheatstone perforated tape. Available for immediate delivery at \$490.00.

Additional information supplied upon request

McElroy engineers never copy . . . never imitate. We create design . . . build. We are never satisfied with mediocrity.

McElroy

MANUFACTURING CORP.
82 BROOKLINE AVE., BOSTON, MASS.

SHARE YOUR BLOOD WITH A WOUNDED SOLDIER...DONATE A PINT TO THE RED CROSS



War shortages crop up in strange materials. Mica, for instance. Once seen principally in the windows of stoves, and in small boys' pockets, it is now used extensively as electrical insulation. In some war products, it is virtually indispensable: capacitors for radio, spark-plugs for airplane engines, insulators in electronic tubes.

With demand mounting, manufacturers were desperate.

A four-man technical mission flew to London to help ration the world's supply between the United States and Great Britain. The shortage was serious.

The War Production Board, convinced that much mica was classified too low when judged by appearance alone, asked Bell Telephone Laboratories to develop a new method of electrical tests. The Laboratories were able to do this quickly because

of their basic knowledge and experience in this field.

The new tests were made available to manufacturers in this country and abroad—the supply of usable mica was increased 60%—and a difficult situation relieved.

Skill to do this and other war jobs is at hand in Bell Laboratories because, year after year, the Laboratories have been at work for the Bell System.



BELL TELEPHONE LABORATORIES *Exploring and inventing, devising and perfecting for our Armed Forces at war and for continued improvements and economies in telephone service.*

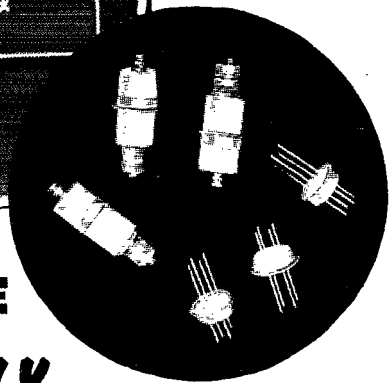
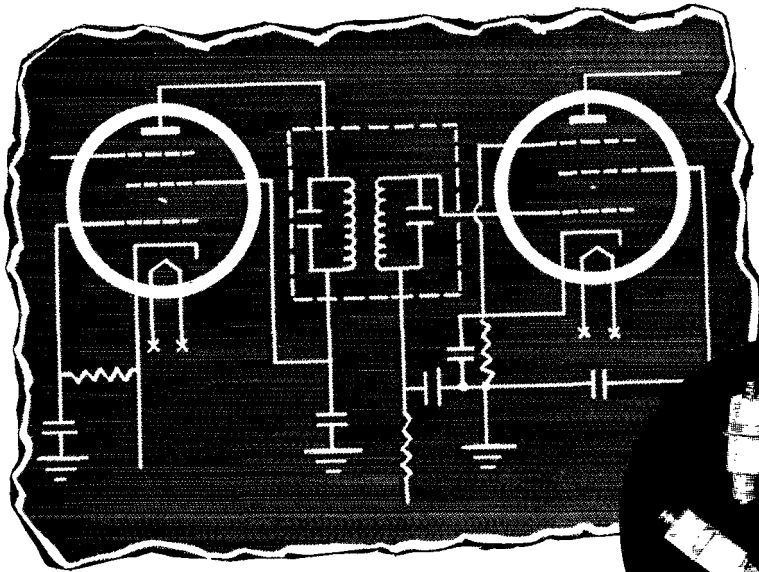

STEEL and STEATITE bonded *PERMANENTLY*

The high mechanical strength of steel and the excellent, permanent insulation qualities of STEATITE have been combined by General Ceramics through its development of a new method of hermetically sealing and permanently bonding together STEATITE and metals in various combinations.

These SEALEX combinations successfully withstand the most severe temperature changes, and show no vibration fatigue. The metal parts are tinned to facilitate soldering where desired.

The General Ceramics method of fusing steatite and steel solves the problems of hermetically sealing and permanently protecting equipment against moisture.

For long-life, dependable, efficient service specify "Steatite" and "Sealex" Combinations.



General Ceramics

AND STEATITE CORP.

GENERAL
STEATITE

KEASBEY
NEW JERSEY

THE AMERICAN RADIO RELAY LEAGUE, INC.,

is a noncommercial association of radio amateurs, bonded for the promotion of interest in amateur radio communication and experimentation, for the relaying of messages by radio, for the advancement of the radio art and of the public welfare, for the representation of the radio amateur in legislative matters, and for the maintenance of fraternalism and a high standard of conduct.

It is an incorporated association without capital stock, chartered under the laws of Connecticut. Its affairs are governed by a Board of Directors, elected every two years by the general membership. The officers are elected or appointed by the Directors. The League is noncommercial and no one commercially engaged in the manufacture, sale or rental of radio apparatus is eligible to membership on its board.

"Of, by and for the amateur," it numbers within its ranks practically every worth-while amateur in the nation and has a history of glorious achievement as the standard-bearer in amateur affairs.

Inquiries regarding membership are solicited. A bona fide interest in amateur radio is the only essential qualification; ownership of a transmitting station and knowledge of the code are not prerequisite, although full voting membership is granted only to licensed amateurs.

All general correspondence should be addressed to the Secretary at the administrative headquarters at West Hartford, Connecticut.



Past Presidents

HIRAM PERCY MAXIM, W1AW, 1914-1936
EUGENE C. WOODRUFF, W8CMP, 1936-1940

Officers

President.....GEORGE W. BAILEY, W1KH
Washington, D. C.
Vice-President.....CHARLES E. BLALACK, W6GG
Yuma, Arizona
Secretary.....KENNETH B. WARNER, W1EH
West Hartford, Connecticut
Communications Manager.....F. E. HANDY, W1BDI*
Chevy Chase, Maryland
Treasurer.....DAVID H. HOUGHTON
West Hartford, Connecticut
General Counsel.....PAUL M. SEGAL
1026 Woodward Building, Washington 5, D. C.

*On leave of absence. Address correspondence to the Acting Communications Manager, Carol K. Witte, West Hartford 7, Connecticut.

Directors

President
GEORGE W. BAILEY.....W1KH
1530 P St., N.W., Washington 25, D. C.

Vice-President
CHARLES E. BLALACK.....W6GG
Box 108, Yuma, Ariz.

Canadian General Manager
ALEX REID.....VE2BE
240 Logan Ave., St. Lambert, P. Q.
Alternate: Leonard W. Mitchell.....VE3AZ
78 Raglan Ave., Toronto, Ont.

Atlantic Division
WALTER BRADLEY MARTIN.....W3QV
25 Arbuta Rd., Abington, Pa.
Alternate: Herbert M. Walleze.....W8BQ
P. O. Box 18, Drums, Pa.

Central Division
JOHN A. KIENER.....W8AVII
1479 Rockway Ave., Lakewood 7, Ohio
Alternate: Earl S. Nelson.....W8DS
22551 Hadden Rd., Euclid 17, Ohio

Dakota Division
TOM E. DAVIS.....W9VVA
915 W. Becker Ave., Willmar, Minn.
Alternate: Aaron E. Swanberg.....W9BHY
1487 Breda St., St. Paul 4, Minn.

Delta Division
E. RAY ARLEDGE.....W5SI
340 N.E. 20th Terrace, Apt. 7, Miami 37, Fla.
Alternate: Samuel H. Dowell.....W5ERV
1057 Mildred St., Shreveport 15, La.

Hudson Division
ROBERT AKERIDGE KIRKMAN.....W2DSY
Werah Pl., R.F.D. No. 1, Box 61, Long Branch, N. J.
Alternate: George Ruffus, jr.....W2CJY
38 Brookwood Drive, Manhasset, L. I., N. Y.

Midwest Division
FLOYD E. NORWINE, JR.....W9EFC
7405 Hlawatha Ave., Richmond Heights 17, Mo.
Alternate: C. A. Colvin.....W9VHR
%, Omaha & Council Bluffs St. Railway Co.,
Omaha 2, Nebr.

New England Division
PERCY C. NOBLE.....W1BVR
37 Broad St., Westfield, Mass.
Alternate: Clayton C. Gordon.....W1HRC
70 Columbia Ave., Warwick, R. I.

Northwestern Division
KARL W. WEINGARTEN.....W7BG
3219 N. 24th St., Tacoma 7, Wash.
Alternate: R. Rex Roberts.....W7CPY
110 W. Brennan St., Glendive, Mont.

Pacific Division
J. L. McCARGAR.....W6EY
66 Hamilton Pl., Oakland 12, Calif.
Alternate: Elbert J. Amarantes.....W6FBW
1675 Dale Ave., San Jose, Calif.

Roanoke Division
H. L. CAVENESS.....W4DW
2607 Vanderbilt Ave., Raleigh, N. C.
Alternate: J. Frank Key.....W3ZA
Box 707, Buena Vista, Va.

Rocky Mountain Division
C. RAYMOND STEDMAN.....W9CAA
925 So. Gaylord St., Denver 9, Colo.
Alternate: Howard R. Markwell.....W9TFP
355 Monroe St., Denver 6, Colo.

Southeastern Division
WILLIAM C. SHELTON.....W4ASR
527 Revilo Blvd., Daytona Beach, Fla.
Alternate: William P. Slides.....W4AUP
Fleming Road, Montgomery, Ala.

Southeastern Division
JOHN E. BICKEL.....W6BKY
1834 E. Whittier Blvd., Whittier, Calif.
Alternate: Eldridge E. Wyatt, jr.....W6ARW
P. O. Box 3597, Long Beach 3, Calif.

West Gulf Division
WAYLAND M. GROVES.....W5NW
Box 1314, Seagraves, Texas
Alternate: Jennings E. Poston.....W5AJ
Box 246, Mabank, Texas

"IT SEEMS TO US —"

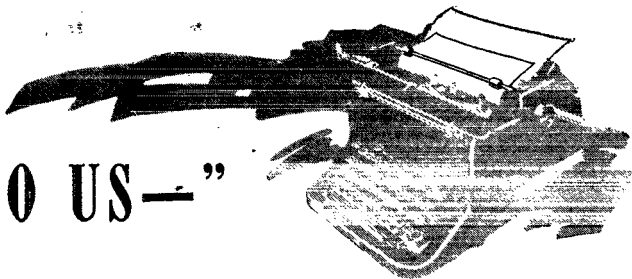

THEM THAR HAMBANDS

A FEW short years ago the broadcast listener could only listen to what is called standard wave broadcasting. From a look at the trade magazines, it can be seen that after this war he is going to have standard broadcasting, f.m., international short-wave, television and facsimile—alone or in combination, with or without phonographs, recorders, portable bars and laundry tubs.

Make you envious? It need not. For in post-war amateur radio we are confronted by such an infinitude of possibilities that the mind is almost made weary by their contemplation and it seems sheer impossibility for one to become the master of all the offerings of this most lively art. Without going in for plexiglass domes and engines-in-the-rear, we have a richness of possibilities that makes an uncontrollable itching to get going.

Of course we'll have our usual telegraphy on all bands, probably making the 5- and 2½-meter bands carry a heavy load of pure c.w. and using A-2 on the higher-frequency bands. We'll have voice communication on both DX and domestic frequencies, and of course on the short ranges of the ultrahighs; and not only by the conventional amplitude modulation but with an opportunity for f.m. in some of our higher frequencies. For both telegraphy and voice operation we may expect the rapid evolution of new "procedures" that will make for snappier or more pleasurable operating. It seems to us to be quite reasonable to expect that in some OM-XYL stations the two modes of voice and c.w. will go on simultaneously by some adaptation of carrier-shift telegraphy, as you can hear today on some of OWI's broadcasting stations.

We think of A-1, A-2 and A-3, employed in direct communication, as our "fundamental modes." But we'll have other things on top of them, including direction finding, remote control, the radio control of models, and automatic relaying, that will keep us busy for years. And we expect beautiful new auxiliary gear to add new zest to doing the old things: instantaneous and accurate frequency shift and antenna changes with selsyns and servos, panoramic receivers, built-in crystal bars in receivers, and the most gorgeous sort of measuring gear for easy adjustment and reliable monitoring.

Above 200 Mc. a new world awaits. Frequent-generation itself will offer a field of

work for the next generation of amateurs, what with cavities and lines, new tubes and Klystrons and maggies, horns and paraboloids and waveguides. Here we have opportunity not only for telegraphy and voice but for television and facsimile, both a.m. and f.m., and with the fax running all the way from strip printers to circuit diagrams and true pictures. And, although we're not at all keen about the possibilities of pulse transmission as we see them now, we have some possibility of the useful employment in amateur radio of visual reception as well as aural. Maybe we're talking plexiglass fantasies now but if there is virtue in pulse transmission it might well be because it would make possible visual reception on a cathode-ray tube in which you can see the dots and dashes slowly chase each other off the left-hand side of the screen in much the manner that the news of the day can be read in electric lights in Times Square.

We could get a little feverish and start heaping it on, compounding some of these possibilities into fanciful combinations. But we'll leave that to come about naturally in the future, knowing that we have only begun to sketch the possibilities and that there is no limit to what will happen when America's amateurs return to the air. No field is richer in its postwar possibilities than amateur radio, for the whole gamut of the radio art lies waiting in the amateur bands for that happy day.

STATION CALLS

THE Cairo regulations prescribe that the call of an amateur station shall consist of not more than two letters to identify the country, a single digit, and not more than three additional letters. When war broke out and amateur-station licensing was discontinued, with something less than 60,000 stations in the country, we were perilously close to running out of station calls compounded in the traditional W manner. In the ninth call area, for example, the bottom of the barrel had been reached and it was necessary for FCC to go frequently over the list of abandoned calls and pick out and reassign all those that had been idle for five years—the later being an FCC practice intended to prevent confusion with listings in call books still in use. Some of the other call areas were almost as bad off.

Without question there will be great increase in the number of amateurs after the war. The

League estimates 185,000 in three years, a quarter of a million in five years. Obviously something will have to be done about calls, not mere expedients but a new plan that, within international provisions, yields a greatly-increased number to take care of many years of growth.

The first thing that it occurs to one to do is to set up a 0, or zero, call area. The use of the numeral 0 is permitted by the international regulations and indeed is employed in amateur calls in the Netherlands. The present ninth call area is much the largest, so it would be logical to set up the new call area, in principle, as a subdivision of the ninth, thereby giving us ten areas.

But there is nothing sacred about these call-area boundaries and in fact they have been changed occasionally; and they need another going over. In olden days, when FCC's predecessors had only nine radio inspectors, there were nine radio districts and each inspector assigned the calls to the amateurs in his district. Now there are twenty-three districts, generally with no coincidence with call areas, and the latter exist in the FCC scheme of things exclusively as arbitrary areas for the assignment of amateur calls, a hangover from the long ago. The number of calls issued in each area varied widely, some areas approaching the end of their resources and others being but halfway through the alphabet. It is obvious, we believe, that to do the job with anything like engineering efficiency the call-area boundaries ought to be shifted so that each area embraces about one-tenth of the population of the country and therefore about a tenth of the expected number of amateurs, thus equalizing the load. Such reapportionment, plus the zero area, would put us in much better shape than before the war, but would still leave our eventual needs unsatisfied.

The next step, after these two, would seem to be a rearrangement of the calls themselves. We don't want to add any more characters to our calls (and indeed that is forbidden) but it

will be noted that the language of the regulation provides one very interesting possibility in its reference to the use of either one or two letters to indicate the nationality: we can move the digit. For example, after we have gone from W9AAA to W9ZZZ, we can shift the 9 over one column and have amateur calls from WA9AA to WZ9ZZ, equal in number to all that have gone before, with no more characters, and still complying with the regulations. That would seem an obvious thing to do after the plain-W calls are exhausted, doubling the number and, in combination with the zero area and the evening-up of the load in each area, promising to take care of us for a very long while. And if that still didn't suffice, we might move to get the international regulation amended to permit moving the digit still another column, providing such calls as WAA9A to WZZ9Z, or another fifty per cent on everything that had gone before.

Any of these things means that *some* of our prewar calls will be changed, and to propose that is about the most unpopular thing in amateur radio circles. We know that and we can just hear you fellows unlimbering your sledge hammers. But if anybody can suggest a plan that will really take care of our needs for five to ten years to come and not involve anyone's prewar call, we'd certainly like to hear about it. We think that all hands will agree with us that if any such changes have to be made at any time within the next few years, it is much better that they take effect upon the very resumption of operation than at any later time. With the war having interrupted the "reputation" we built up under our calls, and changes of address having invalidated our stationery, and with many newcomers who never heard of us under our old calls anyway, the inconveniences would be much less extensive than if we accepted such changes any time after we got going again. Yes?

We'd like to hear from members on this subject.

K. B. W.

★ SPLATTER ★

OUR COVER

Like the outstretched hands of that angel of mercy, the Red Cross nurse, the slender rod of the "J" antenna reaches out to lend its strength to that splendid organization, the American Red Cross. That uplifted antenna symbolizes the true amateur spirit of cooperation without which there could not have been the mobile headquarters communication unit on which this antenna rests and from whence will radiate messages of appeal and succor in time of great need.

FOOTNOTES

Five new names are being written on the roster of *QST* authors this month as we present (1) a radio test crew-chief, (2) an instrument designer for an oil company, (3) a learned professor of physics, (4) a combustion engineer, and (5) a monitoring officer from the RID — by name, alphabetically:

Alex. Browdy, W6UKP (p. 17), who states that the gift of a loudspeaker started him in radio at the tender (?) age of 14. Three years later he was elected president of the James Monroe (NYC) High School Radio Club and operated at W2AAY. He admits there was a gap in his ham activity until about 1940, when he came back on the air as

(Continued on page 88)

Band-Width Requirements for Pulse-Type Transmissions

A Discussion of Wave Shape as a Guide in Frequency Allocations

BY W. W. HANSEN*

IN MAKING suggestions as to suitable allocations of wave bands in the microwave region for the future, due caution should be exercised in considering any proposed system which uses grossly more band-width than the minimum required by the information communicated.

It may be that wave bands can be allotted more liberally in the microwave region than in the long-wave region, simply because there is so much band space available that it is difficult to see at present how all of it can be used. Nevertheless, the history of the spark transmitter suggests that caution is in order; at least serious thought should be given before systems using excessive spectrum space are permitted. It is the object of this article to present some information relative to one family of such systems and to make some suggestions as to possible regulations which might usefully be imposed on such types of transmissions.

Modulating Systems

The type of systems we have in mind perhaps may be illustrated by means of an example. Suppose the information we wish to transmit has frequencies up to 10 kc. Then assume that we choose some higher frequency, say 20 kc. as a "subcarrier." The transmitter then is turned on and off at a 20-kc. rate. This is called discontinuous modulation. When the signal input voltage is zero, the transmitter is on half the time and off half the time. In other words, the microwave modulation envelope is a 20-kc. square wave with equal "on" and "off" periods. Then to modulate upward, one increases the time the transmitter is on and decreases the time it is off, 100 per cent modulation occurring when the transmitter is on continuously. To modulate downward, one decreases the fraction of the time the transmitter is on. More

*Research Engineer, Sperry Gyroscope Co., Inc., Garden City, N. Y.

generally, the unmodulated condition can correspond to the transmitter being on less (or more) than half the time. For example, one-microsecond pulses at a rate of 1000 pulses per second might correspond to no modulation and two-microsecond pulses to 100 per cent upward modulation. Another possible system is one having all pulses of the same duration but varying in the number per second in accordance with the information-bearing modulation. Still another method would be to vary the phase of the pulses in accordance with the signal modulation.

The advantage of such systems is that they will work with power sources that cannot be modulated linearly in a continuous manner. Another point is that a great deal of suitable technique is available as a result of war-inspired research. Incidentally, one of these systems was used in the early microwave link across the English channel developed by I.T.T. about ten years ago.

Pulse Shapes

Let us now inquire into the frequency spectrum required by such a system. Fundamental to the problem is the frequency spectrum corresponding to a single typical pulse. This depends, of course, upon the shape of the pulse. We shall give results for two pulse shapes which, it would seem, constitute a sort of upper and lower boundary for pulses which may be realized in practice.

Consider first, then, a simple flat-topped pulse of duration t_0 . The frequency spectrum corresponding to this pulse is $\frac{\sin \omega t_0/2}{\omega t_0/2}$ and the distance

between 71-per-cent points on a frequency scale is easily found to be $0.88/t_0$. While the distance between 71-per-cent points is a good measure of the frequency interval containing most of the energy, it should be noted that the above function

Pulse technique in which the carrier is broken up at regular intervals before modulation probably is one of the most important radio developments since the beginning of the war. Its possible applications still are far from being fully explored. While it is apparent that greater band-widths are required for transmissions of this type, certain advantages may be gained if it is possible to operate under conditions where band-width is not of too great importance. This, of course, points to applications which make use of much higher frequencies than those heretofore employed by amateurs. Among the advantages claimed for pulse-type transmissions are a considerable improvement in signal-to-noise ratio and the simplification of equipment. Since there may be ways in which this technique can be used to advantage in amateur work of the future, this discussion of pulse shape in relation to spectrum economy should be of unusual interest.

drops off rather slowly with ω so that considerable intensity exists at high values of ω . Specifically the envelope of the function is $1/\pi f t_0$ so that, for example, when f is 10 times the value corresponding to the 71-per-cent point, the amplitude is down only about fourteen times near one of the peaks of $\frac{\sin \omega t_0/2}{\omega t_0/2}$. In this matter of a

rather slow decrease of amplitude with increasing ω , the flat-topped pulse is the worst function likely to be encountered in practice.

Consider next a pulse in the form $e^{-1.39(t/t_0)^2}$, the numerical factor being so chosen that the time between 71-per-cent points is t_0 . Then one finds the frequency spectrum to be of the form $e^{-0.18(\omega t_0)^2}$ and from this we find the separation of the 71-per-cent points on frequency to be $0.44/t_0$. Also, at a frequency ten times the frequency at the 71-per-cent point the function is down by about 15 powers of ten or 300 decibels in power. This is to be compared with 26 decibels for the square pulse.

Actual pulse forms which may be used will fall between the above two limits. The frequency spectrum cannot fall off as slowly as that first considered, because the start and finish of the pulse cannot be perfectly abrupt, as assumed. On the other hand, a pulse as smooth as the Gauss-error type discussed above is not likely in practice.

Pulse Modulation

Next, what happens if a series of pulses is used to modulate a carrier? If they are evenly spaced and of uniform intensity, as we shall assume for a moment, then the frequency spectrum is as illustrated qualitatively in the graph of Fig. 1 which is drawn for the Gauss-error-curve type of pulse.

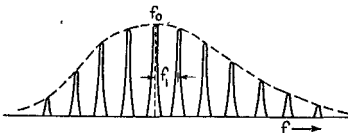

Fig. 1 — Graph of modulation envelope with pulse-type transmission.

Here the origin corresponds to the carrier frequency and the various peaks are spaced f_1 apart, where f_1 is the subcarrier frequency. The dotted line, which is the envelope, has the same shape as the spectrum of a single pulse. Strictly speaking, the various peaks, which have been drawn with a small but finite width, should be infinitely narrow and infinitely high but with a finite area corresponding to the dotted-envelope curve.

If, finally, we vary the height of the various pulses according to some signal voltage, each peak spreads out to a width corresponding to the frequencies contained in the signal voltage. We will call the highest frequency contained in the signal voltage f_2 .

Band-Width Requirements

Actually, the modulation is not done by varying the height, but the width or the frequency or

the phase of the pulses. This complicates the analysis too much for discussion here but one point, and it is the essential one, remains unchanged. Namely, the frequency spectrum follows roughly the spectrum corresponding to a single pulse; or, stated more exactly, the envelope of the frequency spectrum follows the spectrum of a single pulse.

From the above we see that the amount of spectrum used is of the order of $1/t_0$, whereas one could transmit the information with a band $2f_2$ (or f_2 , if a single-sideband transmission were used). Thus, one uses roughly $1/f_2 t_0$ times as much spectrum as need be.

How big is this factor?

If one makes the subcarrier, f , only slightly greater than f_2 and makes $t_0 = 1/2f_1$ (i.e. uses a square wave as an unmodulated signal), then the factor $1/f_2 t_0$ is not significantly different from two, and there is little, if any, waste of frequency spectrum. (This statement will be subject to some qualification later.) If, on the other hand, for some reason t_0 is made quite small, say, for example 10^{-6} seconds, while f_2 is, say 10^4 cycles per second, then one uses about 100 times more spectrum than necessary.

In some cases some of this waste can be recovered while still using the same general scheme of modulation. For example, a number of stations can be assigned the same carrier frequency provided they are assigned different subcarriers. Then a band-pass filter in the receiver will separate the signals from various transmitters.

Interference Capability

In the above we have considered the band used as that between the 71-per-cent points. But, although most of the energy usually will lie in this region, this is not the whole story when it comes to interference. What we want to know is over how wide a band will there be enough energy to cause interference. Plainly, this is a question which is difficult to answer quantitatively. Besides the obvious arbitrariness involved in deciding how much energy will cause interference, etc., there is the very important matter of pulse shape. Indeed, as the calculations above show, this is probably the most important single factor. Thus, whereas a smooth pulse of Gauss-error form of about one microsecond duration will cause no appreciable interference outside a band a megacycle or two wide, a flat-topped pulse with perfectly square corners would cause interference that would probably be called important over 20 Mc. or more.

What conclusions are to be drawn from the above? There follow certain suggestions and opinions of the author which may form a partial answer to this question.

If the subcarrier frequency is not much higher than the highest information frequency and the average pulse length not much shorter than a half cycle of the subcarrier frequency, there is no essential waste of frequency spectrum. But to avoid interference because of tails of the frequency spectrum, the regulations should call for

some means of reducing the harmonics of the sub-carrier frequency; in other words, rounding the corners of the pulses. Some ideas on this point will be suggested later.

If the pulse length is markedly short compared to the reciprocal of the highest information frequency, necessarily there is a waste of frequency spectrum, unless the purpose is multiplex transmission, and it should be considered carefully whether this is warranted. For example, with one-microsecond pulses, there would be room for rather less than 300 stations between 9 cm. and 10 cm. In the author's opinion, probably there are enough available frequencies to allow such waste, provided certain conditions are imposed.

Use of Filters

Some means must be provided to round the corners of the transmitted pulses, as mentioned before, so avoiding an additional wastage of frequency spectrum by a factor which may amount to ten or more. Rounding the corners of the d.c. voltage pulse will not be permissible in some cases, since many of the tubes on which this system will be used have a strong tendency toward frequency modulation. Besides, this defeats the main purpose of discontinuous modulation. The simplest and best method would appear to be the requirement of a filter in the antenna line. This appears to be a thoroughly practical scheme. For example, with one-microsecond pulses one could use one or more resonators with band-widths of about one megacycle between the transmitter and the antenna. How many stages of filter should be required is a question to be answered by the conditions prevailing in each case. The author would suggest that two would be sufficient in most cases.

Conclusions

Use of the modulation system suggested should be confined to certain restricted bands, leaving other bands where more normal systems will be free from what might perhaps be styled "super monkey chatter." This should present no difficulty since advocates of this system will no doubt claim that it does not cause undue interference. They should, therefore, be quite pleased to have various interference-free regions of the spectrum to themselves.

Finally, the author would like to add that almost all the above applies to pulsed radar systems, except that in this case the use of short pulses is often a real necessity, not a matter of real or fancied convenience. In the author's opinion much trouble would be avoided if all pulse systems were put in a segregated band, and if output filters to cut off the frequency tails were required. As to the first, there is certainly no reason to burden television and other communications services using continuous modulation with the difficult problem of putting up with pulse interference caused by discontinuous modulation. As to the second, such filters need not interfere with the performance of a system. They are cheap and easy to apply, and will greatly reduce interference potentialities.

Transmission Requirements and Bell System Facilities for Video and Music

Harold S. Osborne, chief engineer of the American Telephone and Telegraph Company, in a recent address before the Society of Motion Picture Engineers outlined the requirements for the faithful transmission of video, music and other frequencies outside the speech range and stated the facilities offered by the telephone companies, as well as contemplated developments.

The requirements for television band-width are roughly expressed as equivalent to sending an electrical impulse for each point of a halftone picture and transmitting sufficient pictures per second to avoid undue flicker. The present standard 525-line television with 30 pictures per second requires a frequency band of approximately 400 kc., which is about one thousand times the width of a telephone circuit.

When the coaxial cable system is used for television transmission the available band-width is somewhat greater than when the same conductors are used for multiplex telephone transmission. This is because the requirements for avoiding interaction between various parts of the band are less severe when the transmission is a single broad band rather than one split into many separate transmissions. In the latter case a very minute amount of interaction may cause interference between transmissions.

A television band of 2.7 Mc. can be transmitted with the coaxial cable equipment now used. Development work expected to be concluded shortly after the close of the war includes improved equipment capable of transmitting a band of 7 Mc. With this system it will be possible to transmit a 4000-kc. band for television plus 480 telephone channels simultaneously over the same conductors, or, if future television standards require it, to transmit a broader television band.

Whether the coaxial cable system will be used with broader bands of frequencies will be a question of economics rather than one of inherent limitation of the cable. The spacing of repeaters is set by the top frequency transmitted over the cable. It is 5.3 miles with the present system and will be about 3.5 miles with the 7-Mc. system.

Extensive coaxial cable networks now exist, with others under construction, forming an excellent beginning for the development of nationwide television transmission networks. Additional conductors are provided in the cables to provide for future growth. It is therefore possible to establish a limited number of television circuits in the cables initially without interfering with telephone requirements.

Alternatives to the coaxial cable system are the applications of ultrahigh-frequency radio to relay repeater stations and to wave-guide conductors. The Bell System has secured FCC approval for the construction and experimental operation of a radio system between New York and Boston to use about eight intermediate relay repeater

(Continued on page 80)

A Red Cross Mobile Disaster Headquarters — WERS Equipped

Red Cross Combines with WERS to Equip and Man a Mobile Unit with Complete Communication Equipment

BY HOUSTON W. HENDRIX, * W3DOU

THE American Red Cross has always had great respect for the American radio amateur and his assistance in civilian disasters. A few local disasters had clearly indicated the necessity for closer coordination between the amateur and Red Cross in the Philadelphia area. For example — some months ago a crack train was wrecked just within the city limits of Philadelphia. This accident presented almost insurmountable problems of relaying information to and from hospitals and in communication with other activities at the locale of the accident, which occurred in an almost inaccessible location. This tragic event emphasized the need for a mobile disaster headquarters with a communication system that could arrive and function quickly at the scene of a civic disaster.

Shortly thereafter, a donation was made by the Frankford Arsenal (Coöperative Committee of Employees) to the Red Cross. This contribution, consisting of several thousand dollars, was to be

*Chairman of Radio, Southeastern Pa. Chapter, ARC. Radio Aide, Township of Lower Merion.



The WERS-equipped mobile disaster unit with its Onan 2-kw. gas-driven 110-volt 60-cycle generator. Note the external connection on the vehicle for the 110-volt power cable.

Is interest in WERS slackening off in your area? Those in charge of WERS in the Philadelphia area did not wait for activity to die out. They coöperated with the Red Cross in their vicinity to provide a vital link in the chain of disaster relief — that of a complete mobile communication system equipped for swift movement to the scene of any disaster. This is the first such unit reported. Why not coöperate with the Red Cross in your community in planning a similar unit?

used by the Red Cross in any way deemed advantageous.

The idea of a mobile disaster unit to act as a control and communications center was immediately evolved by our Philadelphia Disaster Committee. A mobile office and living quarters vehicle was secured from National Headquarters, which had previously constructed a number in preparation for any possible bombing disaster in this country. These vehicles were equipped with sleeping and cooking facilities plus office space so that the workers could be self-sustaining for periods of several days while on duty. This body and chassis construction appeared to meet our requirements.

The Problem

In considering the use that might be made of this vehicle, the committee had the following situation in mind — The Southeastern Pennsylvania Red Cross Chapter embraces not only the city and county of Philadelphia, but also the surrounding counties of Bucks, Chester, Delaware and Montgomery. In this large geographical area with its variety and sizes of communities and industrial districts, our disaster hazards run the gamut of major disasters — e.g., floods, fires, windstorms, transportation wrecks, explosions and especially industrial accidents. The Committee also recognized that in this area disasters often occur very quickly where the first warning is received from an eye witness rather than being received in advance of some impending disaster. Therefore, it was necessary to have a disaster unit that could immediately roll to the scene of the catastrophe, set up headquarters and establish communication with the least possible delay. With this idea in mind a search was made for a suitable operating arrangement.

Unfortunately, the Red Cross has no specific radio channels on which they may operate. It is also understood that FCC will grant no channel to any service, unless a *number* of units are in operation; therefore, this unit (plus its headquarters station) would not be considered sufficient for a special license and channel allocation. However, we did have a WERS program in the area.

The Solution — Red Cross Plus WERS

We all know that WERS was originally organized under civilian defense. As this need gradually lessened it was obviously more difficult for civilian defense units to keep the interest of their volunteers and to secure general response to drill duty. WERS on the other hand, although recognized as part of the defense program, has a dual and grave responsibility, that of serving civilian defense, and of aiding any organization active in time of civic disaster.

We therefore combined the need for communication on the part of the Red Cross with the availability of WERS personnel and channels.

With the basic ideas in mind the actual planning started. This mobile unit was to be painted in the traditional gray, with large red crosses on a white background, so that it could be seen for long distances and could be picked out immediately as the Red Cross Disaster Headquarters. Workers arriving at the scene of a disaster would then know where to report without time-wasting inquiry and confusion.

The mobile unit must contain complete equipment for operation by radio, telephone and over a public address system. The unit must be completely self-contained with facilities for operation from 110-volt 60-cycle power lines, a 110-volt 60-cycle gas driven generator, or from the truck battery. Extended periods of operation in isolated areas must be anticipated.

Communication and Power Equipment

With these specifications to be met, the vehicle was equipped as follows:

The mobile unit is provided with two telephones in the office compartment. Terminal boxes on the side of the vehicle permit connection by a lineman to any near-by telephone line.

Two loudspeakers mounted on the roof of the vehicle are connected to an amplifier located on the radio operating desk. The p.a. microphone is located in a compartment situated in the forward part of the vehicle permitting announcements to be made without pick-up by the radio microphone and without cross-talk from the radio speaker into the microphone of the p.a. system.

An operating desk in the main compartment provides a firm platform on which is mounted the p.a. amplifier, the radio transmitter-receiver, and an automobile-type broadcast-band receiver.

It was naturally hoped that this mobile unit could be equipped with a stabilized 112-Mc. transmitter and a selective receiver for use on the present WERS frequencies. But this called for a complicated lot of hard-to-get equipment and it was decided that the simple gear was best for the

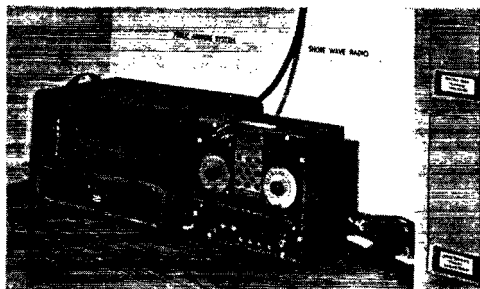

Operating desk showing the TR-4 transmitter-receiver and the p.a. amplifier equipment. Sockets for 110-volt 60-cycle and 6-volt d.c. are visible at the rear of the desk.

duration. Plans were made for the postwar installation of higher power equipment to be operated on whatever emergency service bands are then available.

The simplest and most dependable equipment with which we were experienced was the Abbott TR-4 112-Mc. transmitter-receiver which was, fortunately, generally available. This transmitter-receiver is connected to a concentric-line which passes up through a capped hole in the roof to a collapsible "J" antenna. It was obvious that any antenna would have to be designed so that it could be folded down when the vehicle was in motion and still not be shorted, so that reception and short-range transmissions would be possible.

The "J" antenna was chosen, first for its effectiveness, and second for its ease of adjustment and construction. The antenna is firmly fastened to stand-off insulators mounted on a 4 × 8 inch steel plate. This plate is fastened to a railing around the top of the vehicle so that one bolt serves as a pivot and the other bolt holds the antenna vertical when in a fixed location. When the vehicle is to be moved, the operator climbs the readily accessible ladder on the side of the vehicle and removes the bottom bolt, dropping the antenna to a horizontal position. He then places this bolt into another hole on the angle bracket to hold the antenna firmly in the horizontal position. The concentric line feeder permits the free movement of this antenna through the 90-degree arc. This arrangement would have been extremely difficult with an open-line feeder.

The TR-4 can obtain its required voltages from either of two power supplies:

a) A vibrator power supply (Mallory OZ4) operating directly from the vehicular storage battery.

b) A 110-volt 60-cycle a.c. power supply. (On the same chassis with the vibrator power supply is a power transformer with an 80 rectifier tube, feeding into the vibrator power supply filter.)

A multiple switch on the power supply, readily accessible to the operator, connects the TR-4 to the d.c. or a.c. power supplies. Failure of either source will not interrupt communication for over ten seconds. In a third position of this switch the TR-4 is completely disconnected from either power supply.

Two sources of a.c. power are anticipated. The mobile unit carries 150 feet of heavy flexible line terminating at one end in a plug, fitting into a socket on the outside of the vehicle body, while the other end of the cable is equipped with heavy clips for attachment to any 110-volt line. Where the disaster unit is near a house or power line having 110-volt a.c. available, the mobile unit may be operated from the line.

If the unit is in an isolated area or where no power is available, full dependence is placed on an Onan 2-kw. gasoline-driven generating unit carried in its own cubby-hole in the left front section of the vehicle. The generator, mounted on a small dolly, may operate several feet away from the vehicle. Noise and exhaust fumes will then be at a minimum and will not interfere with conversation or communication within the operating compartments.

In addition to the above communication features, the disaster unit is equipped with spot and search lights, which may be operated from the available 110-volt a.c. source. The p.a. system is likewise operated from the 110-volt a.c. supply.

The vehicular dome and desk lights operate from 6 to 8 volts a.c. or d.c. A completely fused switch compartment is provided permitting connection of these lights either to the vehicular storage battery or to the a.c. source in use.

The Operational Plan

The full responsibility for the operation of the Red Cross mobile unit lies with WERS. The transmitters, both in the mobile unit and at the Red Cross Headquarters on North Broad St., in Philadelphia, are WERS licensed stations — WKIB-136 and WKIB-110, respectively — and all operation must be by WERS operators.

The area covered by the Southeastern Chapter consists of five counties: Philadelphia, Bucks,



Left to right — Joseph R. Rollins, Chairman Disaster Committee; Motor Corps driver; George Hautenchild, W3KD, Radio Aide, Philadelphia (WKIB), and H. W. Hendrix, W3DOU, Chairman Radio, Red Cross Disaster Committee.

Chester, Montgomery and Delaware, for a distance of approximately 50 miles in an 180-degree arc with Philadelphia as the focal point.

It is obvious that a single transmitter operating on the 112-Mc. band at the scene of a disaster might be inadequate, but it should not be overlooked that it is backed up by operators and stations from the following additional areas: Philadelphia, Lower Merion Township, Haverford Township, Reading, Pa., Allentown, Pa., and Easton, Pa. There are other outlying points to which transmissions could be directed and any one of the above-mentioned areas could have stations on the air for relay purposes. It must not be overlooked that the disaster unit is a *central communications system* at the scene of the disaster, operating outwardly in the most advantageous directions. The surrounding territories would be called in to aid and support this operation.

The six above-mentioned WERS areas have over 200 station licenses, fixed, portable-mobile or walkie-talkies; therefore, it is obvious that a group of operators is available with all kinds of equipment to coordinate activities with the Red Cross mobile unit. The mobile unit must be operated under the supervision or direction of the radio aide under which it is licensed (Philadelphia), but it will undoubtedly be under the actual control of the licensee nearest to the scene of the disaster.

It is also expected, for example, that if the disaster occurred in Montgomery County, near Reading, that assistance would be obtained from Reading, for both operators and Red Cross workers. Tests have already been run between Philadelphia and Reading and two-way communication has been established within this fifty mile radius without relays.

Since there are other licensees in New Jersey, and in other directions which might be closer to a point of disaster, they would be called upon to assist in maintaining a communication network. The organization of the Red Cross mobile unit and the fixed station at the Chapter Headquarters is, therefore, WERS, but it is so tied in as to be available for any natural disaster, on which the Red Cross may function.

We feel that this area is now well equipped with a mobile disaster unit, independent of outside facilities. It can readily handle the communications problem of the Red Cross in any location within the five-county area, covered by this Chapter.

DX Tests Possible

Several months ago correspondence with the Federal Communications Commission resulted in authorized operation of the mobile unit anywhere in this five-county area for test transmissions, providing that the radio equipment is operated by and under WERS rules and regulations. This will allow operation outside of our own back yards and provides the possibility of working a little DX, yet doing so in a constructive way, preparing for possibilities where vital aid may be given rather than just for pleasure.

A Homemade Radio-Range Receiver

A Simple T.R.F. Set for Light Aircraft

BY ALEXANDER BROWDY,* W6UKP-EX-W2NSS

In this article the author describes a three-tube receiver for radio-range work in light aircraft of the type which many civilians, including hams, will be flying in the post war era. A simple range-signal filter for voice reception is included in the circuit.

IT SEEMS quite obvious that many hams are going to be found in the ranks of civilian fliers when the chocks are removed from private-airplane operation after the war. Numerous hams have acquired an active interest in aviation through their close contact with CAP work at home, while countless others are now serving as pilots, navigators and bombardiers as well as radio operators aboard fighting aircraft. It is needless to say also that any ham who takes up private flying soon will begin to think about radio gear for his plane, not only because of his natural interest in this direction but also because any civilian pilot will want to take advantage of the hundreds of new radio ranges which have been installed throughout the country by CAA since the beginning of the war. In so doing it will be possible to make comparatively long flights with all the assurance and safety which airways radio systems provide.

While most hams doubtless would like to have both transmitting and receiving gear aboard, the weight and cost of a transmitter of suitable power output makes its installation in small aircraft a rather doubtful practical proposition. Light planes of the type which most civilians own or will own, with engine powers of 100 h.p. or less, have a maximum baggage allowance of 20 to 25 pounds. The weight of any additional equipment must come out of this unless gasoline capacity is to be sacrificed. Speaking from experience, I would prefer to have the extra gasoline along rather than the minimum amount of transmitting equipment necessary to sustain reliable two-way communication, especially since a receiver alone will cover most of the essential requirements.

With the receiver, it is not only possible to follow the numerous radio ranges which direct intercity and cross-country air traffic, but also to take advantage of weather reports, flying-condition predictions, landing and take-off instructions and other information which is issued by radio from the stations at larger airports.

At present, small aircraft with receivers only are able to obtain clearance by "buzzing" the

control tower (flying low in sight of the control-tower operator). Upon seeing the aircraft, the tower operator transmits to the ship, "Aircraft flying over traffic control, if you read the tower rock your wings." Thereupon the aircraft receives landing instructions after complying with the tower operator's request. (Of course, we always have the wise-cracking pilot with a transmitter in his ship who comes back to the most surprised traffic-control operator with these words, "Traffic control, I read you O.K.; if you read me rock the tower!")

Most of the CAA radio ranges operate on frequencies between 200 and 400 kc. and the majority of CAA airports have a traffic-control frequency of 278 kc. A satisfactory receiver for this band need not be expensive nor complicated. The one shown in the photographs can be built without difficulty by the average ham constructor. It weighs less than five pounds complete with power supply. Including batteries and headset, the cost for parts was less than twenty dollars.

The circuit is shown in the diagram of Fig. 1. I chose a t.r.f. arrangement for its simplicity in wiring, its stability at the low operating frequencies of 200 to 400 kc. and the availability of parts lying about the average ham shack. The r.f. amplifier is a simple arrangement with tuned input and output circuits. C_4 , connected across the antenna coil is for the purpose of eliminating broadcast-band signals which sometimes force their way into the receiver if the plane happens to be flying in the immediate vicinity of a high-power b.c. station. R_2 is the r.f. gain control. The plate current of all tubes flows through this resistor resulting in a voltage drop, a variable portion of which is applied as bias to the grid of the 1N5G.

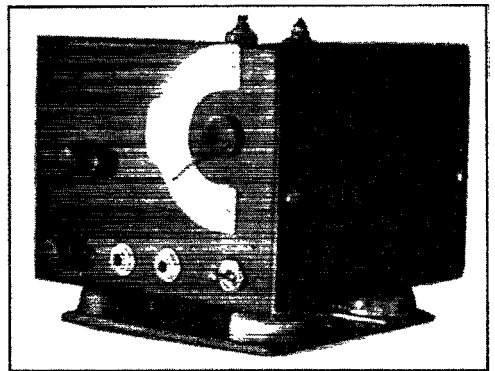

Front view of the range receiver. The cabinet is set on shock absorbers to reduce tube vibration.

*1962 South Stearns Dr., Los Angeles, Calif.

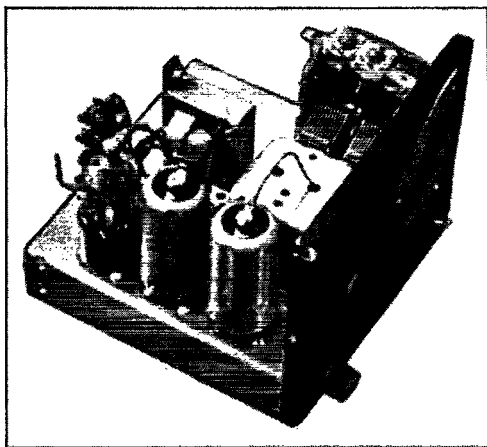

Interior view of the radio-range aircraft receiver.

Simple capacitive coupling is used between the r.f. amplifier and the 1H5G grid-leak detector. The detector is followed by two stages of resistance-coupled audio amplification using the triode and pentode sections of a 1D8GT. This gives plenty of audio for two headsets. The output of the pentode section is impedance-coupled to the headphones to remove any possibility of shock from the "B" battery, and to permit the use of crystal headphones if desired. The arrangement also simplifies construction somewhat since the frame of the 'phone jack may be grounded.

A little explanation is in order in regard to the series filter made up of L_4 and C_{16} . As many readers probably are aware, the range signal consists of a steady carrier and a keyed carrier, the difference between the frequencies of the two carriers being 1020 cycles. Therefore the range signal appears as a 1020-cycle tone in the audio output of the receiver. Voice transmissions are made by modulating the steady carrier which means that unless measures are taken to prevent it, the voice must be copied through the 1020-cycle tone.

Therefore the purpose of L_4 and C_{16} is to filter out the tone while voice transmissions are being made. While the 1020-cycle filters supplied with manufactured range receivers are much more elaborate, the simple arrangement shown serves the purpose to a surprising degree. However, since it is not a highly selective device, there is some loss in voice frequencies either side of 1020 cycles when the filter is switched in, but this loss may be compensated for to a certain degree by turning up the gain for voice transmissions.

Construction

The chassis for the receiver can be made out of almost any sheet metal although, of course, aluminum is preferable because it is lighter. Small metal boxes can be bought for about a dollar. One measuring 6 inches on a side is about right for the job. Referring to the view of the open receiver, the three tubes are lined up along the left-hand end of the chassis with the r.f. amplifier in front, the 1H5G detector tube in the center and the dual audio tube at the rear. The coils, L_1 and L_2 , are placed in a small shield can directly behind the row of tubes, while L_3 is mounted underneath the chassis thus shielding the coils from each other. The tuning condenser (C_1 and C_2 in Fig. 1) is a dual-section unit with adjustable mica trimmers. It is of the type used in inexpensive broadcast receivers and is mounted at the right-hand end of the chassis by means of an L-shaped metal bracket.

The output coupling impedance, L_4 , and a terminal strip are mounted on brackets at the rear. Space for the remainder of the components was found underneath the chassis. A shock mounting for the receiver is advisable to eliminate excessive vibration to which the tubes with their low-current filaments are quite susceptible.

In a row along the bottom of the panel are the gain control, R_2 , two headphone jacks connected in parallel, and the filter switch, S_2 .

The rotor of the tuning condenser is operated by the small knob at the left on the panel by

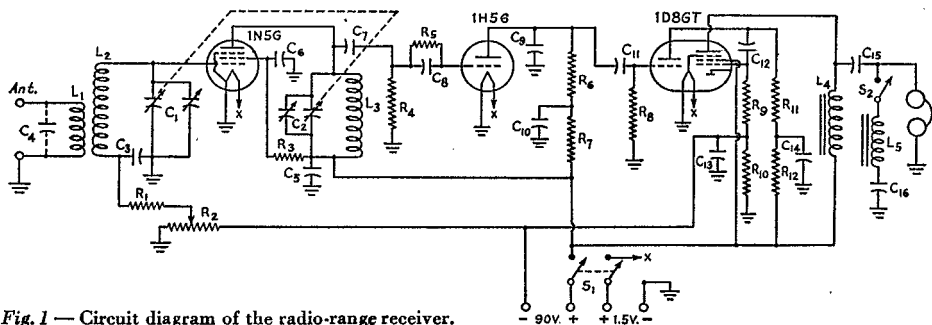

Fig. 1 — Circuit diagram of the radio-range receiver.

- C_1, C_2 — Section of dual-gang tuning condenser with trimmer, 365 to 400 $\mu\text{fd.}$ maximum.
- C_3, C_{10}, C_{14} — 0.05 $\mu\text{fd.}$
- C_4, C_7 — 500- $\mu\text{fd.}$ mica.
- C_5 — 8- $\mu\text{fd.}$, 150-volt electrolytic.
- C_6 — 0.25 $\mu\text{fd.}$
- C_8, C_9 — 250- $\mu\text{fd.}$ mica.

- C_{11}, C_{12}, C_{15} — 0.01 $\mu\text{fd.}$
- C_{13} — 25- $\mu\text{fd.}$, 25-volt electrolytic.
- C_{16} — 0.1 $\mu\text{fd.}$
- R_1, R_7, R_{11} — 100,000 ohms.
- R_2 — 10,000-ohm volume control with S_1 attached.
- R_3 — 5000 ohms.
- R_4 — 1 megohm.
- R_5 — 2 to 5 megohms.

- R_6 — 1.5 megohms.
- R_8, R_9 — 500,000 ohms.
- R_{10} , 1000 ohms.
- R_{12} — 50,000 ohms.
- L_1, L_2, L_3 — See text.
- L_4 — 200-h. audio choke.
- L_5 — 200-mh. audio choke.
- S_1 — D.p.s.t. switch attached to R_2 .
- S_2 — S.p.s.t. toggle.

means of a pulley arrangement which provides a vernier reduction. The pointer was cut from a piece of scrap copper, although any metal will do, of course. A ¼-inch grid clip soldered to the center axis of the pointer permits the pointer to slip snugly over the ¼-inch shaft of the condenser which was cut off flush with the panel.

The dial also was made from a scrap sheet of metal. When the receiver was calibrated with a signal generator, the dial was etched with a scriber, following through with a heavier cutting tool. The numbers were stamped in by hand and all indentations were filled in with red paint. After drying, the dial was rubbed, face downward, on a sheet of fine emery paper to which a little oil had been applied. This not only removed the excess paint but also gave the scale a satin finish.

Coils

In accumulating parts for the receiver, I found that it was impossible to purchase aircraft-receiver coils of standard manufacture without a high priority, so I had to search around for some suitable substitute. The inductance required to tune to the 200-400 kc. range with the 350- μ fd. condenser is between 1.5 and 2 millihenries. After experimenting with a few i.f. transformer coils, it was apparent that a 175-kc. transformer would work fine by disconnecting the trimmers and using the primary for the antenna coil and secondary for the grid coil. For those who cannot obtain the 175-kc. transformer, a simple standard 2.5-millihenry r.f. choke can be used with comparable efficiency at much less cost and work. Chokes of this type usually are wound in four pies. One of these should be disconnected from the others to serve as L_1 , while the other three in series will give just about the right inductance for L_2 . A coil similar to either of the above also may be used for L_3 . In this case, only one of the i.f. coils is used, while one of the pies of the r.f. choke is unused.

Depending upon the antenna system used, it may be necessary to alter the size of C_4 to get best reduction in interference from broadcast stations in the immediate vicinity of the plane.

The receiver is operated from dry batteries, using flashlight cells for the 1.5-volt filament supply and two small 45-volt "B" batteries for plate supply.

Building an RAAF B.C. Station

BY RALPH TURNER,* VK5TR

WHILE serving with the Royal Australian Air Force at Milne Bay, New Guinea, S/Ldr. Harry Shirley, an ex-commercial radio man, and the writer decided that a broadcast station was required to serve the many receivers used by the men of the Allied Services in the district.

Owing to the extreme humidity, normal commercial receivers were almost useless, since a few weeks' operation in this area decreased their sensitivity to well below a workable value. Some idea of the conditions may be gathered from the

following example: A five-tube vibrator-type receiver was tested and found to have a sensitivity of 12 microvolts for normal output. This set was then allowed to operate under normal conditions for seven days. At the end of this time the receiver was again tested, and it was found that the sensitivity had dropped to 20 microvolts. This set was a typical commercial receiver, not treated for tropical conditions, and was an example of the type made available to service men.

Only a good solid signal of local origin seemed likely to provide radio entertainment, so it was decided to produce a transmitter. Overtures to various sources of supply failed to produce anything in the form of a suitable transmitter, and we decided that the only thing to do was to build one ourselves. Plenty of bits and pieces for a c.w. transmitter were available, but the necessary gear for 'phone operation appeared extremely difficult to obtain.

Transmitter

The whole job was built along ham lines and the U. S. Signal Corps, U. S. Navy and the Australian Army Signals materially assisted in supplying parts.

A conventional three-stage transmitter (250 watts output) was decided on, and of the tubes available, the following were selected: 6V6 e.c. oscillator, 807 buffer and a pair of 813s push-pull final amplifier. A pair of 805s were used in Class-B modulation.



Having decided on plate modulation, it was necessary to produce the required transformers. One of the transformer cores was obtained from a half-kw. power transformer, and the other from a receiver.

The winding of these transformers improved our vocabulary to some extent. An improvised winding machine, with an old automobile speedometer as a turns-counter, provided all the difficulties necessary to transform a normally sane bloke into a raving lunatic. Matters were not helped by well-meaning visitors to the workshop making all sorts of impractical suggestions, usually resulting in their being consigned to the nether regions.

Interruption in transformer production was caused by a downpour of rain — some 26 inches in

(Continued on page 86)

*Directorate of Radio Services (Signals), Section S. 6, RAAF Hq., Victoria Barracks, Melbourne, Australia.

IN THE SERVICES

WHERE do all the ITS names come from which fill 24 file drawers with 3 × 5 cards and keep this column at its usual 4-page size every month? When will the supply slack off? Are amateurs in the service and defense industries inexhaustible? Will the bottom of the barrel be reached?

Not for a long time, apparently. The AWSR form appearing in each issue of *QST* continues to be our best bet, but we would starve to death if we depended on that alone. Every Hq. department cooperates in relaying information to ITS and in addition, one girl spends her entire time ferreting out and cataloging names from every conceivable source. Membership applications, renewals and changes of address from the Circulation Department, SCM reports, ham club publications, general correspondence, letters from families and friends of men in the service, Bureau of Public Relations news releases, return addresses on envelopes, lists sent by war industries employing hams, Xmas cards, ballot envelopes for division director elections, visiting amateurs

at Hq., newspaper clippings and a few more leads are all grist for the ITS mill.

Two years ago we guessed there were about twenty thousand amateurs in the armed forces, twenty thousand in defense industries and the remaining twenty thousand were too young, too old or too 4-F to be among those present. As time goes on and our roster grows steadily we think our original estimate of amateur participation was pitched too low. We hope you will help us prove that we were wrong, that amateur Q in the war is even greater than we had boasted. Please take a minute to mail in that form on page 34.

ARMY—AIR FORCES

1LID, Melanson, Pvt., Kearns, Utah
 1MZF, Hill, M/Sgt., foreign duty
 1NOH, Arnold, Lt., Egin Fld., Fla.
 ex-2KDR, Tavetian, Pfc., Sheppard Fld., Texas
 2OMJ, Davis, Pfc., Napier Fld., Ala.
 3JUT, Fustfeld, Pvt., Keesler Fld., Miss.
 3JVZ, Wiebel, M/Sgt., foreign duty
 4FYN, Hammond, Pvt., foreign duty
 4HMU, Davis, Lt., Chanute Fld., Ill.
 5GBH, Hamilton, Lt., foreign duty
 5IFD, Miller, Sgt., foreign duty
 5JHU, Bates, Cpl., foreign duty
 5JHW, Hawkins, address unknown
 ex-8CAW, Schwab, Cpl., Boca Raton, Fla.
 6MEV, Praun, Capt., Egin Fld., Fla.
 6SLZ, Hollenbach, Pfc., Kirtland Fld., N. M.

6UPZ, Scrivner, CWO, Ft. Sumner, N. M.
 7FYX, Arnuquist, A/C, Frederick, Okla.
 7IQP, Boelens, A/C, Santa Ana, Calif.
 7KJAT, Wolters, Major, foreign duty
 ex-8GHR, Brown, Capt., Warrensburg, Mo.
 8GZW, Pepper, Sgt., foreign duty
 8KXC, Ambrose, S/Sgt., foreign duty
 8PJG, Logan, Pvt., Lowry Fld., Colo.
 8POU, Macke, Cpl., Sioux Falls, S. D.
 8THA, Werntges, Cpl., Boca Raton, Fla.
 8VVL, Outcall, Col., Washington, D. C.
 8WML, Loveland, address unknown
 9BTH, Beutner, Cpl., foreign duty
 ex-8EZX, Krott, Lt., Brookley Fld., Ala.
 9FTD, Resch, Sgt., foreign duty
 9GFE, Franz, 2nd Lt., Dalhart, Tex.
 9KXN, Lane, Pvt., Scott Fld., Ill.
 9LXI, McGregor, T/Sgt., foreign duty

Operator's license only:

Arnold, Sgt., Mitchel Fld., N. Y.
 Ausman, Pfc., Sioux Falls, S. D.
 Bagdon, Lt., Marianna, Fla.
 Gonzales, T/Sgt., Sheppard Fld., Texas
 Kaiser, T/Sgt., foreign duty
 Miles, Sgt., foreign duty
 Murphy, Lt., foreign duty
 Penska, T/Sgt., foreign duty
 Watson, T/Sgt., Long Beach, Calif.

ARMY—SIGNAL CORPS

1KHQ, Targonski, Major, foreign duty
 ex-2ALY, Houser, 2nd Lt., Perth Amboy, N. J.
 2FPY, MacLennan, Major, foreign duty
 ex-2GLE, Meekoloichuck, Sgt., foreign duty
 ex-2GRW, Lippencott, Lt., foreign duty
 2LOW, Kane, T/4, Ft. Monmouth, N. J.
 3CPJ, Papp, 2nd Lt., Ft. Monmouth, N. J.
 3GQR, Reisch, Lt., Ft. Monmouth, N. J.
 3HQQ, Kriz, 2nd Lt., Baltimore, Md.
 ex-4DKP, Yingling, Lt. Wright Fld., Ohio
 4HDE, Barnhill, Pvt., Camp Robinson, Ark.
 5BII, Cobb, S/Sgt., West Point, N. Y.
 ex-5CFS, Lindsey, T/3, foreign duty
 ex-5GNF, Dundee, Lt., foreign duty
 5EMH, Freeland, 2nd Lt., Ft. Monmouth N. J.
 5FVD, Digby, Lt., Robins Fld., Ga.
 5HKZ, Morrell, W/O(G), foreign duty
 5KHT, Clement, Camp Crowder, Mo.

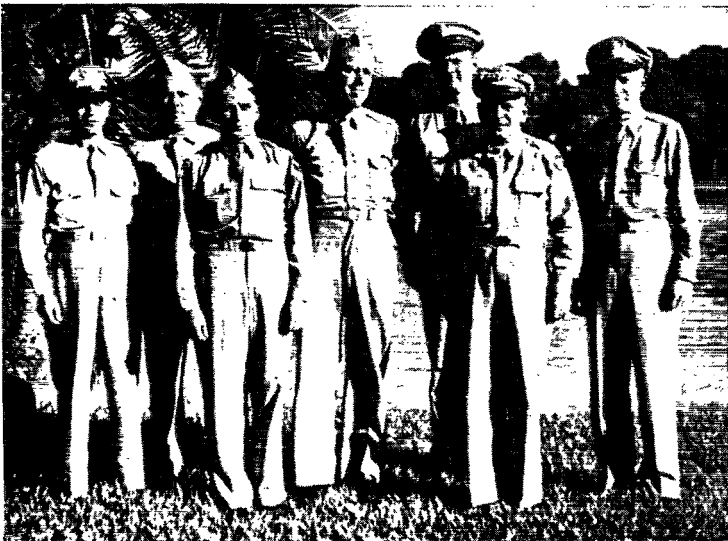

Although slightly hoary, (it was taken last July), this photo reached us from Lt. Col. Handy, ARRL communications manager on leave of absence, in time to have much interest value. Shown are a group of officers, all radio amateurs, who attended the Senior Communications Officers' Course, AAF School of Applied Tactics, Orlando, Fla. *Left to right:* Lt. Spitz, W6FZQ; Major Haymans, ex-W4AQL; Capt. Kurz, W9JWX; Lt. Col. Handy, W1BDI; Major Jacks, W7DJIA; Capt. Honeywell, W6ANT; and Capt. Vickery, W9ISQ. Amateurs not pictured but attending the school were Capt. Jones, W9FHT; Capt. Ditto, W5NF; and Major Bird, W5FZL. Several of these officers were returned from overseas to attend the course.

ex-6BN, Elder, Pfc., Camp Chaffee, Ark.
 7BUX, LeDuke, T/4, foreign duty
 7BLE, Hall, Cpl., foreign duty
 7GQX, Williams, 2nd Lt., Ft. Monmouth, N. J.
 7HFC, Swapp, T/Sgt., foreign duty
 7HFS, Litan, Cpl., foreign duty
 7K7NG, Paulley, T/4, foreign duty
 7YHPY, Wassor, S/Sgt., foreign duty
 7HPZ, Score, T/4, foreign duty
 7IAT, Cross, T/4, foreign duty
 8AJJ, McKone, W/O (jg), foreign duty
 8DRW, Clark, T/4, foreign duty
 8HHW, Hopkins, Capt., foreign duty
 8NRV, Johnson, Pfc., foreign duty
 8PLD, Isaac, T/5, Erie Proving Ground, Ohio
 8QDF, Popovich, Capt., foreign duty
 8QDR, Blasingame, Capt., foreign duty
 8YKE, Baczynski, T/4, Ft. Dix, N. J.
 9BNQ, Rubin, Lt., Robins Flt., Ga.
 9BBD, Full, Cpl., foreign duty
 9CXY, Brewer, Capt., foreign duty
 9KHA, Ritts, 2nd Lt., Chicago, Ill.
 9LKY, Rector, Lt., Washington, D. C.
 9MHY, Friedman, T/Sgt., foreign duty
 9NUO, Glanckenbeard, T/5, foreign duty
 9OEM, Robbins, Capt., foreign duty
 9QCA, Kern, Sgt., foreign duty
 9QCI, Horritt, 2nd Lt., Ft. Monmouth, N. J.
 9QOS, McFarland, T/Sgt., foreign duty
 9RGY, Walker, 2nd Lt., Ft. Monmouth, N. J.
 9SPJ, White, Pfc., Camp Crowder, Mo.
 9TOV, Willrodt, T/Sgt., Menlo Park, Calif.
 9VYO, Kapfer, Pvt., foreign duty
 9WKC, Dodson, Lt., foreign duty
 9YNY, Kature, Sgt., foreign duty
 9YTI, Feik, Lt., foreign duty
 9ZIP, Neu, T/5, foreign duty

Operator's license only:

Fuchs, Cpl., Ft. Monmouth, N. J.
 Kear, Sgt., foreign duty
 Leary, Pfc., Bridgeport, Conn.
 McGuire, Pfc., foreign duty
 Povrznik, Lt., foreign duty
 Shenk, Major, foreign duty
 Wagner, M/Sgt., foreign duty

NAVY—SPECIAL DUTY

ex-1BKR, Chace, Lt.(jg), Cambridge, Mass.
 1DOO, Rhodes, S2c, Methuen, Mass.
 ex-1IAP, Combellaek, Ens., Cambridge, Mass.
 ex-1JMD, Sparks, Ens., Cambridge, Mass.
 1JYJ, Elyosius, Ens., Cambridge, Mass.
 1LKN, Edmunds, Ens., Cambridge, Mass.
 1LZN, Gaskell, Ens., Cambridge, Mass.
 1MQC, French, Ens., Cambridge, Mass.
 1MZM, Supryniewicz, RT1c, foreign duty
 1NGW, Clark, Ens., Cambridge, Mass.
 2IBI, Straehl, Ens., Cambridge, Mass.
 2IGG, Kozma, RT3c, Brunswick, Me.
 2ITR, Hyland, Ens., Cambridge, Mass.
 2IYB, Obriet, RT3c, Jamaica, N. Y.
 2KYG, Lapidge, Ens., Cambridge, Mass.
 2LDS, Chapman, CRT, foreign duty
 2LMQ, Keiran, Ens., Cambridge, Mass.
 2LND, Bower, Ens., Cambridge, Mass.
 2LWU, Slawsky, Ens., Cambridge, Mass.
 2NFM, Lynn, Lt.(jg), Cambridge, Mass.
 2NQT, Trompeter, Ens., Cambridge, Mass.
 3EAN, Reynolds, Ens., Cambridge, Mass.
 3EQI, Ayres, Lt.(jg), Cambridge, Mass.
 3EWW, Neill, Ens., foreign duty
 3FBM, Nosek, Sic, Stillwater, Okla.
 3FFE, Greenwood, Ens., Cambridge, Mass.
 3FKY, Ball, Lt. Comdr., Cambridge, Mass.
 3FRX, Heritage, Ens., Cambridge, Mass.
 3FZL, Moore, Ens., Cambridge, Mass.
 3GHI, Wagner, Sic, Chicago, Ill.
 3GKC, Wien, RT1c, Chicago, Ill.
 3HVV, Cottrell, Ens., Cambridge, Mass.
 3HVV, Hartman, RT3c, Ft. Pierce, Fla.
 3JAD, Fowler, Ens., Cambridge, Mass.
 3JBG, Robinson, RT1c, foreign duty
 3JWQ, Krapf, Lt. Comdr., Cambridge, Mass.
 ex-3AAJ, Balch, Ens., Cambridge, Mass.
 4BMC, Sinclair, Ens., Cambridge, Mass.
 4CJN, Reid, Ens., Cambridge, Mass.
 ex-4CPY, Hair, RT3c, Washington, D. C.
 4DCW, Kanoy, RT3c, Washington, D. C.
 4FOB, Woodyard, CRT, foreign duty
 4GJA, Hatley, Ens., Cambridge, Mass.
 4KTI, Gould, Lt., Cambridge, Mass.
 ex-4UT, Love, Ens., Cambridge, Mass.
 5BOE, Ossenbeck, Ens., Cambridge, Mass.
 ex-5BYE, Long, Ens., Cambridge, Mass.
 ex-5EDZ, Smith, Ens., Cambridge, Mass.
 5FLI, Hill, RT1c, Dallas, Texas



Brigadier General Edmund C. Lynch, AC, W3HWJ, recently promoted from the rank of colonel, is well known to Virginia tidewater amateurs in the Norfolk section. He was formerly president of the Peninsular Amateur Radio Club of Newport News, took a very active part in the Roanoke Division Convention in 1940, and was a candidate for director in that division in 1942. His graduation from West Point in 1922 marked the beginning of extensive military experience in radio and aviation duties and studies. We believe he is the first radio amateur to achieve the rank of brigadier general. Hearty congratulations!

5FRY, Witt, RT1c, Oklahoma City, Okla.
 5FZU, Prickett, Lt.(jg), Cambridge, Mass.
 5GBC, Conner, Ens., Cambridge, Mass.
 5GXS, Hooker, Lt.(jg), Cambridge, Mass.
 5HEH, Morrison, RT1c, foreign duty
 5HGG, Anderson, RT1c, foreign duty
 5HGU, Swafford, Ens., Cambridge, Mass.
 5HKI, Deming, Sic, Brooklyn, N. Y.
 5HZZ, Sparks, RT1c, Bremerton, Wash.
 5IKO, Baird, Ens., Cambridge, Mass.
 5JDA, Haviland, Ens., Cambridge, Mass.
 5KLE, Bobbitt, RT1c, foreign duty
 5KMI, Hanan, RT1c, foreign duty
 6DDX, Patterson, Ens., Cambridge, Mass.
 6DYF, Clarke, RT2c, Sacramento, Calif.
 6EAB, Mariscal, Lt., Cambridge, Mass.
 6FDE, Van Orstrand, Ens., Cambridge, Mass.

ex-6FNI, Obert, Lt.(jg), Cambridge, Mass.
 ex-6GPO, Riley, Ens., Cambridge, Mass.
 6IFK, Fray, Lt.(jg), Cambridge, Mass.
 6JFU, Boutz, Lt.(jg), Cambridge, Mass.
 6KFC, Camp, Lt.(jg), Cambridge, Mass.
 6LBS, Diehl, RT1c, Jackson Hts., N. Y.
 ex-6LWQ, Rose, CRT, foreign duty
 6MQQ, Davis, RT1c, foreign duty
 6MQX, Klein, Ens., Cambridge, Mass.
 6NNC, Holser, Lt.(jg), Cambridge, Mass.
 6NPO, Denham, RT1c, Farragut, Idaho
 ex-6NSH, Noonan, RT1c, foreign duty
 6PDU, Tlapa, RT1c, Washington, D. C.
 6PFB, Taschner, Lt.(jg), Cambridge, Mass.
 6QAN, Nelson, RT2c, Washington, D. C.
 ex-6ANE, Serez, Lt., Cambridge, Mass.
 6SUX, Hale, A/S, Berkeley, Calif.
 6TFL, Cask, RT2c, foreign duty
 6THB, Fuch, Sic, Chicago, Ill.
 6TUK, Gally, Ens., Cambridge, Mass.
 6UFG, Farwell, RT1c, foreign duty
 6UOV, Hutherland, Sic, Great Lakes, Ill.
 7DPK, Campbell, RT3c, Washington, D. C.
 7DYC, Glenn, RM3c, Port Blakely, Wash.
 7FKT, Berquist, Ens., Cambridge, Mass.
 7GIS, Graham, Ens., foreign duty
 7GQF, Keller, CRT, Chicago, Ill.
 7HBM, Phinney, CRT, foreign duty
 7HDC, Eck, Sic, Treasure Island, Calif.
 7JCO, Jones, Sic, Chicago, Ill.
 ex-7GBE, Ames, Lt.(jg), Cambridge, Mass.
 7YG, Seares, Ens., Cambridge, Mass.
 ex-8ASQ, McNulty, Lt., Cambridge, Mass.
 ex-8HTT, Olson, CRT, foreign duty
 ex-8JXO, Harbeson, CRT, Quonset Point, R. I.

8KDB, Easterbrook, Lt.(jg), Cambridge Mass.
 8LIX, Vember, RT3c, Chicago, Ill.
 8NDU, Russ, RT1c, foreign duty
 8ODY, Siu, Ens., Cambridge, Mass.
 8OIG, Winters, Ens., Cambridge, Mass.
 8OXT, Kaufman, Ens., Cambridge, Mass.
 8REU, Cummings, Ens., Cambridge, Mass.
 8TPD, Smith, Ens., Cambridge, Mass.
 8IWT, Kildoo, RT1c, foreign duty
 8UAG, Elder, RT1c, Norfolk, Va.
 8VKR, Raupp, Sic, Brooklyn, N. Y.
 8WNY, Bennett, RT2c, foreign duty
 8WPV, Griffiths, Sic, Chicago, Ill.
 9AAX, Honer, Ens., Cambridge, Mass.
 9AON, Wiley, CRT, foreign duty
 ex-9BAY, Parry, Lt.(jg), Cambridge, Mass.
 9EOH, Heller, Sic, College Station, Texas
 9EVL, Asmus, Lt.(jg), Cambridge, Mass.
 ex-9FGK, Bowman, Ens., Cambridge, Mass.
 9FSL, Hazen, Ens., Cambridge, Mass.
 9LAG, Clarke, Ens., Cambridge, Mass.
 ex-9LEI, Hutson, Ens., Cambridge, Mass.
 9LSE, Patton, RT1c, Rockford, Ill.
 9MYD, Zobel, Sic, Clarksville, Ark.
 9NJM, Bennett, Ens., Cambridge, Mass.
 9OQN, Wright, Ens., Cambridge, Mass.
 9OPQ, Sayland, Ens., Cambridge, Mass.
 9PBM, Balfour, RT1c, foreign duty
 9PVY, Witnah, RT3c, Treasure Island, Calif.
 9QHY, Hausenbauer, Ens., Cambridge, Mass.
 9QIP, Eichenauer, Lt.(jg), Boston, Mass.
 9RTG, Spors, Ens., Cambridge, Mass.
 9SPT, Hansen, RT3c, Chicago, Ill.
 ex-9SY, Lindsay, Lt.(jg), Cambridge, Mass.
 ex-9TED, Haverland, CRT, foreign duty
 9UDE, Gots, Ens., Cambridge, Mass.
 9VET, Stinger, Ens., Cambridge, Mass.
 9WKQ, Hale, Ens., Cambridge, Mass.
 9YFF, Hursh, Ens., Cambridge, Mass.
 9YST, Riggs, Ens., Cambridge, Mass.
 9ZAC, Hanna, Ens., Cambridge, Mass.
 9ZDT, Cleary, Ens., Cambridge, Mass.
 9ZVM, Cortinovic, CRT, St. Louis, Mo.

Operator's license only:

David, Sic, Chicago, Ill.
 Dibble, CRT, foreign duty
 Gillingente, RT3c, Treasure Island, Calif.
 Groff, CRT, foreign duty
 Harris, RT1c, Deer Lodge, Mont.
 Kinney, Sic, Chicago, Ill.
 Lyford, Sic, Great Lakes, Ill.
 McParren, Sic, foreign duty
 Miller, Sic, Great Lakes, Ill.



M/Sgt. Roland B. Hunt, W9STI (left), is shown receiving the Legion of Merit award. The citation reads in part: "For exceptionally meritorious conduct in the performance of outstanding services as communications chief. . . The skill, leadership and devotion to duty displayed by M/Sgt. Hunt has inspired his entire communications detail to an exceptional degree of efficiency."

NAVY—AERONAUTICS

1MOG, McLellan, ACRM, Miami, Fla.
 ex-2HBS, Voorhees, Lt. Comdr., Brooklyn, N. Y.
 2IPR, Kokinchak, ART1c, foreign duty
 ex-2KKW, Sarbello, ART2c, Norfolk, Va.
 2KXU, Carfagno, ART1c, Charleston, W. Va.
 ex-2MPT, Gordon, S2c, Patuxent River, Md.
 3GKT, Sigler, Lt., Glynco, Ga.
 3IMF, Hedrick, ART1c, Norfolk, Va.
 3JQV, Mooers, Ens., foreign duty
 4GEG, Caldwell, ACRM, foreign duty
 4GZF, Warbington, RM3c, Jacksonville, Fla.
 4ERY, Ray, ART1c, Patuxent River, Md.
 4ICS, Littlefield, Sic, Corpus Christi, Texas
 4IQ, Boyd, Ens., foreign duty
 4PI, Waldo, Lt., Patuxent River, Md.
 5EQP, McClenney, Lt., Norfolk, Va.
 5GKT, Harkley, ART2c, Norfolk, Va.
 5HZO, Simmons, Lt., Patuxent River, Md.
 6BHM, Bowles, RE, Albany, Calif.
 ex-6CNQ, Foster, ART1c, Beaumont, Calif.
 ex-6EOH, Smith, RE, Norfolk, Va.
 6PQQ, Griffith, ACRT, foreign duty
 6SQO, Addington, ART1c, Norfolk, Va.
 6UDG, Atkeson, ACRT, Hutchinson, Kan.
 7KA, Warner, CRT, Venice, Calif.
 7GOI, Leisy, Sic, Corpus Christi, Texas
 7HBR, Wood, ARM3c, Whidbey Island, Wash.
 8HPD, Lutz, ART3c, Corpus Christi, Texas
 8LBI, Prostinak, ACRT, Patuxent River, Md.
 8PYB, Ring, ARM1c, foreign duty
 8QJK, Keirnan, ACRT, foreign duty
 8SSL, Barber, ACRT, foreign duty
 8WFO, Dout, ACRT, Norfolk, Va.
 8WUZ, Caswell, ART1c, Miami, Fla.
 9BEN, Williams, ART1c, Squantum, Mass.
 9BER, Berker, Sic, Corpus Christi, Texas
 9EXG, Hale, S2c, Jacksonville, Fla.
 ex-9FYK, Ertz, ART1c, Norfolk, Va.
 9IBO, Hofkes, Lt., Patuxent River, Md.
 ex-9KKB, Hjeltn, ARM1c, Corpus Christi
 9NVB, Knutson, ARM1c, foreign duty
 9RLL, Hanson, Lt., Norfolk, Va.
 ex-9RTQ, Caves, ACRT, Norfolk, Va.
 9SAN, Shinable, Lt., Norfolk, Va.
 9VDW, Ragsdale, Lt., Patuxent River, Md.

Operator's license only:

Beekage, ART1c, Norfolk, Va.
 Collier, ART1c, Norfolk, Va.
 Dennis, ARM2c, Lakehurst, N. J.
 Douglass, ACRM, New York, N. Y.
 Hanson, ARM1c, Astoria, Ore.
 Hess, ART1c, Washington, D. C.
 Hunter, ART3c, Fountain Head, Tenn.
 Kaiser, Sic, Memphis, Tenn.
 McKamey, ACRM, foreign duty
 Meyer, S2c, Corpus Christi, Texas
 Mitchell, ARM2c, Hutchinson, Kan.
 Olsen, ART2c, Cambridge, Mass.
 Platt, Lt., Traverse City, Mich.
 Reese, ACRT, Boca Chica, Fla.
 Sherrill, Lt., Corpus Christi, Texas
 Soto, ART2c, Norfolk, Va.
 Van Patten, Sic, Corpus Christi, Texas

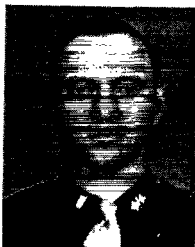

Holder of the coveted DX Century Club certificate in prewar days, Lt. Albert H. Hix, W8PQQ, is now radio plant officer for a communications division of the Signal Corps operating in the E.T.O. His duties have brought him in contact with much German, Russian and Italian radio gear and with other American amateurs. Hams and radio gear can always be found in close proximity, regardless of the nationality.



ACRT(R) Hobart Burkhamer, W8KWI, has seen duty in the North and South Atlantic during the past several years after graduating from the Naval Air Training School, Corpus Christi, Texas. Licensed since 1933, he was active on all bands from 160 to 2 1/2 meters, and took part in DX and SS contests, WAS and had verifications from 104 countries worked before the shutdown.

ARMY—GENERAL

1AMR, Bailey, Pvt., North Camp Hood, Texas
 1EKU, Hook, Pvt., Pine Camp, N. Y.
 1IVM, Payson, 2nd Lt., Aberdeen Proving Ground, Md.
 1IZZ, Lawrence, T/Sgt., Ft. Bragg, N. C.
 1NAS, Ciccarella, T/Sgt., foreign duty
 1NHS, Suhie, M/Sgt., foreign duty
 ex-2CDB, Hudson, Pvt., South Camp Hood, Texas
 2DBU, Baumach, 2nd Lt., Ft. George G. Meade, Md.
 2GCB, Canning, T/4, foreign duty
 2TTO, Swider, S/Sgt., foreign duty
 2KLI, Baker, Lt., Camp Swift, Texas
 2KIG, Reineke, M/Sgt., foreign duty
 2LMZ, Perkins, S/Sgt., foreign duty
 2MHL, Boiko, Cpl., Ft. Bragg, N. C.
 2NCC, Vdoviak, Pvt., New York, N. Y.
 2NEY, Burriak, Cpl., Washington, D. C.
 ex-2VP, Schwalbe, Major, Minneapolis, Minn.
 3EXY, Dillon, Lt., Baltimore, Md.
 3GRN, Shirey, Pfc., foreign duty
 3HIU, Brown, T/3, foreign duty
 3HL, Lynch, Pvt., Los Angeles, Calif.
 3HOL, Markowitz, T/4, Ft. Bragg, N. C.
 3HQU, Lybrand, M/Sgt., foreign duty
 3HPV, Raymond, Col., foreign duty
 3ITK, Austin, T/Sgt., Camp Gruber, Okla.
 4GAK, Hames, Pvt., Camp Robinson, Ark.
 4GKH, Williams, Sgt., Ft. Jackson, S. C.
 4GWA, Carman, T/4, Camp Rucker, Ala.
 4HPL, Ludtke, Pvt., Fowlerville, Mich.
 4HVV, Wright, Pvt., foreign duty
 5TBE, Landress, Pfc., Dallas, Texas
 5JBT, Koerner, T/Egt., foreign duty
 6FGY, Breen, Major, San Jose, Calif.
 6QKP, Aaronian, O/C, Ft. Belvoir, Md.
 6RUE, Speyers, 2nd Lt., Glendale, Calif.
 6TGE, Amendt, Pvt., Ft. Riley, Kan.
 7TDE, Schoesler, foreign duty
 7DXB, Brown, Lt., foreign duty
 8LZD, Tuckerman, Capt., foreign duty
 8OKY, Ramsay, Major, foreign duty
 8QGR, Baker, Cpl., Santa Fe, N. M.
 8QKA, Horvath, Cpl., Camp Maxey, Texas
 8TKB, Pawlik, Cpl., address unknown
 8UAF, Troppman, Pvt., foreign duty
 8WAD, Feyes, Sgt., foreign duty
 9DAM, Harris, Cpl., Washington, D. C.
 9DNO, Klintworth, Pvt., Camp Wolters, Texas
 9ECC, Gumm, Sgt., foreign duty
 9EQT, McKee, Pvt., foreign duty
 9FMQ, Olgeirson, T/4, foreign duty
 9GEX, Lebeson, Pvt., foreign duty
 9GHB, Joyce, Pfc., foreign duty
 9HCV, Koye, Cpl., Madison, Ind.
 9HJW, Stefucza, 2nd Lt., Granite City, Ill.
 9HMZ, Frost, Pvt., Camp Blanding, Fla.
 9JUV, Kellogg, Lt., Kearns, Utah
 9KMU, Stasek, T/4, Ft. Benning, Ga.
 9KUL, Warking, Pvt., Camp Chaffee, Ark.
 9LGL, Setles, T/Sgt., Camp Polk, La.
 9LMM, Boot, Pvt., Ft. Knox, Ky.
 9NAC, Buffinger, T/5, foreign duty
 ex-9NFK, Burroughs, S/Sgt., foreign duty

9PDR, Willeford, Sgt., foreign duty
 9QGT, Heuser, Pfc., Ft. Benning, Ga.
 9RHK, Ferguson, Sgt., foreign duty
 9UEQ, Komarek, Pvt., Ft. Riley, Kan.
 9UMI, Baker, S/Sgt., Sioux Falls, S. D.
 9VEX, Berner, Capt., Mommouth, Ill.
 9VVE, Tisdale, T/4, foreign duty
 9WDD, Kinnaman, Sgt., foreign duty
 9WGB, Weilage, T/5, foreign duty
 9WGI, Harris, T/Sgt., foreign duty
 9YFG, Spangler, Pvt., Camp Chaffee, Ark.
 9YME, Tyson, Pfc., Camp Campbell, Ky.
 9YTE, Hankins, Cpl., Sturgis, S. D.
 9YUH, Holloway, Pvt., Ft. George G. Meade, Md.
 9ZCH, Beatty, Sgt., foreign duty

Operator's license only:

Colclausre, S/Sgt., foreign duty
 Colson, T/4, Camp Cooke, Calif.
 Di Blasi, Pvt., Quantico, Va.
 Gifford, Pvt., foreign duty
 Glazier, Sgt., foreign duty
 Groton, T/5, Ft. Monroe, Va.
 Grubbs, Cpl., Camp Gruber, Okla.
 Hankins, Cpl., Sturgis, S. D.
 Hyland, T/4, foreign duty
 Margolis, Pfc., foreign duty
 Middleton, T/Sgt., foreign duty
 Nygard, M/Sgt., Camp Gordon, Ga.
 Thompson, S/Sgt., foreign duty

COAST GUARD

1CEG, McKean, RT1c, Groton, Conn.
 1KRO, Medary, Lt.(jg), Washington, D. C.
 1LFB, Buckley, RT1c, foreign duty
 1LVQ, Huntoon, CRM, Washington, D. C.
 2OCB, Kyser, CRM, foreign duty
 3BTV, Mowery, Sic, Lancaster, Pa.
 5IBZ, Timmons, CRM, foreign duty
 6LZU, McDowell, Lt. Comdr., Long Beach, Calif.
 6MWS, Hoyt, Lt.(jg), foreign duty
 7AAK, Gulletad, RT1c, Port Angeles, Wash.
 7FVW, Byerley, RM1c, foreign duty
 7HTC, Slattery, RM3c, Empire, Ore.
 ex-7LJ, York, S2c, Tacoma, Wash.
 ex-9BSA, Schofield, RM2c, foreign duty
 9KOO, Neering, CRM, Miami, Fla.
 ex-9PZG, Miller, RM1c, San Diego, Calif.
 9ZVM, Cortinovis, CRT, St. Louis, Mo.

Operator's license only:

Dean, ARM3c, Port Angeles, Wash.
 Smith, RE, Curms Bay Md.

NAVY—GENERAL

1AAT, Rizoli, F1c, Salem, Mass.
 ex-1BMS, Hall, CRE, Friendship, Me.
 1ENN, MacArthur, Y3c, New Bedford, Mass.
 1FXH, Lavalette, RM1c, Newport, R. I.
 1HEK, Williams, BM1c, Deer Isle, Me.
 1HUI, Davis, Sic, Clarksville, Ark.
 1HVE, Lyman, Lt. Comdr., San Diego, Calif.
 1HBG, Bennett, RM2c, foreign duty
 1KNV, Harner, Ens., Norfolk, Va.
 1KON, Morrison, Lt.(jg), foreign duty
 1KPT, Young, EM3c, foreign duty
 1KZA, Reed, RM3c, foreign duty
 1LAG, Rogers, RM1c, foreign duty
 1LVN, Walden, Sic, Gulfport, Miss.
 1MVF, Faats, RM3c, Manteo, N. C.
 1MVV, Roberts, Sic, Clarksville, Ark.
 2GAC, Sullivan, RM1c, Bronx, N. Y.
 2GEB, Robertson, Lt. Comdr., Anacostia, D. C.
 2GVA, Denning, Lt., foreign duty
 2IVP, Krichick, CRM, foreign duty
 2LBB, Yodis, S2c, foreign duty
 2NNZ, Zimmerman, Lt.(jg), foreign duty
 2OCO, Walsh, Sic, Madison, Wis.
 2OEH, Cunniff, Sic, Great Lakes, Ill.
 3AOA, Faries, Lt. Comdr., foreign duty
 3CTG, Gallery, Lt. Comdr., foreign duty
 3DMF, Dallison, Sic, Madison, Wis.
 3EON, Augenblick, PhM1c, foreign duty
 3EQZ, Weeks, CRM, foreign duty
 3EST, Gondaker, Sic, Madison, Wis.
 3GYH, Clark, Ens., Washington, D. C.
 ex-3HRS, Hogan, Lt. Comdr., Alexandria, Va.
 3HTF, Lukoff, Sic, Chicago, Ill.
 3IUC, Busenkell, Lt. Comdr., Philadelphia, Pa.
 3JBB, Newcomb, Ens., Camp Bradford, Va.
 4APY, Geegan, RM2c, North St. Petersburg, Fla.

4DHD, Griffith, S2c, Camp Peary, Va.
 ex-4DKR, Dill, S1c, Clarksville, Ark.
 4EDL, Whitted, Ens., Durham, N. C.
 4FJX, Lowrey, Lt., Los Angeles, Calif.
 4FKK, Elliott, CRM, foreign duty
 4GFF, Ellis, F2c, St. Louis, Mo.
 5BXC, Turner, CM1c, Astoria, Ore.
 5DSX, Cross, RM3c, foreign duty
 5FTC, Fulton, RM1c, foreign duty
 5IIE, Palmer, Ens., Cambridge, Mass.
 5IIN, Cloer, F2c, Inyokern, Calif.
 5ILR, Davidson, Ens., Oak Ridge, Tenn.
 5IRP, Kurth, S2c, San Diego, Calif.
 5IXM, Geiser, S2c, Great Lakes, Ill.
 5I2J, Powell, Lt., Galveston, Texas
 5JLL, Garon, Lt. (jg), foreign duty
 5JVJ, Baum, S1c, Corpus Christi, Texas
 5KLC, Martin, S1c, College Station, Texas
 5KQT, Chamberlain, A/S, Great Lakes, Ill.
 5PF, Bible, S1c, Great Lakes, Ill.
 6ANU, Harris, Ens., La Mesa, Calif.
 ex-6BRG, Ludwig, Lt. (jg), Warrington, Fla.
 ex-6DTD, Spilmer, CRE, foreign duty
 6GWP, Baller, CRM, foreign duty
 6HXD, Adams, Lt. Comdr., Oceanside, Calif.
 6KIA, Ashe, Ens., Phoenix, Ariz.
 6MZL, Sherlock, S1c, Clarksville, Ark.
 6NEY, Rietzke, CRE, foreign duty
 6NSK, Blakey, Ens., foreign duty
 6NTK, Storey, S1c, Chicago, Ill.
 6OEI, Powell, CRM, foreign duty
 6OTY, Kebby, Ens., San Jose, Calif.
 6PJD, Kessler, SAD2c, Montara, Calif.
 6PZI, Hatch, S1c, Treasure Island, Calif.
 6QL, Wells, Lt., Colton, Calif.
 6QYO, Olson, Ens., Miami, Fla.
 6RTG, McWilliams, RM1c, foreign duty
 6RXP, Osborn, A/S, Lawrence, Kan.
 6TGB, Sandoval, S1c, Stillwater, Okla.
 6TKT, Sargent, S1c, Treasure Island, Calif.
 6UNQ, Meuron, S1c, Chicago, Ill.
 6UQR, Engleman, Comdr., Washington, D. C.
 7AYO, Klahn, Lt., Washington, D. C.
 7BKB, Hanson, S1c, Stillwater, Okla.
 7DTF, Blackburn, RE, Clinton, Okla.
 7FOZ, Randall, Ens., Solomons, Md.
 7GTJ, Elaeson, CE, foreign duty
 7HCD, Blakey, RM1c, Skaggs Island, Calif.
 7ILZ, Williams, A/S, Berkeley, Calif.
 8DXM, Blakeslee, Lt., San Diego, Calif.
 8LSS, Frank, Lt., Washington, D. C.
 8LYW, Kalmus, CRM, foreign duty
 8MBP, Klass, RM3c, foreign duty
 8NCA, Urbanski, RM3c, Amapago, Tenn.
 8NWZ, Brown, Ens., Oak Ridge, Tenn.
 8OHG, Lynch, S1c, foreign duty
 8TEC, Koth, S1c, Oakland, Calif.
 8UKC, Weiss, Ens., Raleigh, N. C.
 8UWY, Brown, A/S, Notre Dame, Ind.
 8VNE, Stafford, RM1c, foreign duty
 8VSB, Koella, S1c, College Station, Texas
 9ANA, Wollaefer, Lt., foreign duty
 ex-9BTM, Beck, RM3c, San Diego, Calif.
 9CJK, Baker, Lt. Comdr., foreign duty
 ex-9CYM, Liscum, Lt., Fredericksburg, Va.
 9DKC, Moudy, RE, Waldron Fld., Texas
 9EAC, Shatavsky, Ens., Washington, D. C.
 9FFLD, Raean, RM1c, Chicago, Ill.
 9FFH, Arber, EM2c, foreign duty
 9FLH, Craig, S1c, Great Lakes, Ill.
 9HVV, Gibbons, Lt. (jg), foreign duty
 9IER, Starner, CEM, Treasure Island, Calif.
 9IFU, Costas, address unknown
 9ITS, Markland, SC3c, La Jolla, Calif.
 9KNI, Jameson, A/S, Cambridge, Mass.
 9KXB, Lee, Y1c, Hutchinson, Kan.
 9MMJ, Wilson, CRM, foreign duty
 ex-9MSI, Jones, S1c, Chicago, Ill.
 ex-9MSJ, Buch, EM1c, Camp Endicott, R. I.
 9NZL, Anderson, S1c, Del Monte, Calif.
 9RMV, Whittier, CRM, Port Blakely, Wash.
 9RPN, Brown, Ens., Peoria, Ill.
 9SGS, Olson, Ens., Cambridge, Mass.
 9SQZ, Sucker, S1c, Chicago, Ill.
 9STH, Vernon, Lt. (jg), address unknown
 9TKM, Bracken, Lt., Arlington, Mass.
 9TWW, Perl, A/S, Urbana, Ill.
 9WMP, Kihlmeier, RM2c, Ft. Madison, Ia.
 9WOK, Landeck, Ens., Washington, D. C.
 9WPW, Suska, R/O, foreign duty
 9WYV, Kaspar, A/S, Ames, Ia.
 9YWY, Torreano, RM3c, foreign duty
 9ZDE, Raudonis, S1c, Great Lakes, Ill.
 9ZIE, Mahoney, RM2c, address unknown

Operator's license only:
 Austin, S1c, College Station, Texas
 Baird, foreign duty

Bastian, S1c, Great Lakes, Ill.
 Bates, S2c, Camp Peary, Va.
 Bohn, S1c, Chicago, Ill.
 Day, A/S, Lawrence, Kan.
 Egler, RM1c, foreign duty
 Endres, A/S, Dallas, Texas
 Focuse, A/S, Atlanta, Ga.
 Frazier, RM2c, Washington, D. C.
 Germer, RM2c, San Francisco, Calif.
 Gibbs, RM2c, Indianapolis, Ind.
 Goulston, S1c, Great Lakes, Ill.
 Grice, RM3c, foreign duty
 Hill, CRM, foreign duty
 Hiller, S2c, Little Creek, Va.
 Hupphod, EM2c, foreign duty
 Kaiser, RM3c, Port Blakely, Wash.
 Kerr, S1c, Michigan City, Ind.
 LaBato, RM3c, foreign duty
 Lamb, S1c, Great Lakes, Ill.
 Mills, SoM2c, foreign duty
 Palatt, S2c, Bainbridge, Md.
 Papineau, S1c, foreign duty

HAM HOSPITALITY

Now that many of our fellows are overseas and discovering for the first time what it means to be lonesome while on leave thousands of miles from home, the friendly hospitality extended by amateur clubs and individuals in other lands fills a great need. Like music, ham language is universal and any American or Canadian who finds himself at loose ends for companionship and conversation is overlooking a good bet if he doesn't take advantage of the invitations appearing in this column from time to time.

Three invitations were received from England for this month's column. T. Chat Bryant, G3SB, of Beaconfield, Pemswell Road, Minehead, Somerset, writes he would be glad to welcome any amateurs who might be in his district in the evening. His telephone number is Minehead 17.

P. Roberts, G2COR, 65 Mossom Lane, Norbeck, Blackpool, would similarly enjoy a visit from any amateurs from the States or Canada.

Eddy H. Browell, G2HKU, 27 Unity St., Sheerness, Isle of Sheppey, Kent, says he has not yet had the pleasure of meeting any American hams and wishes to extend a welcoming hand. He also would like to meet any W or VE hams in London, since he is frequently in that section.

These hams, all with the rating of RM1c in the Coast Guard, are *left to right*, Williams, W6SGN; Byrley, W7FJW, and Weber, W6JOH. On duty in the Pacific, they find their work interesting and give credit to previous ham experience for their success. They also favor returning the islands to the Polynesians, but perhaps they haven't met their people yet — if any.

Two issues ago in this column we gave a list of Australian and New Zealand amateurs and organizations who would be glad to see visiting amateurs. To this we wish to add the names of A. J. Hilkie, ZL2QT, whose home address is 58 N. Park Ave., Lower Hutt, Wellington, and R. McLeod, ex-ZL1KN, 25 Greenwood St., Frankton, Waikato, N. Z.

Letters from South Africa send us the names and addresses of clubs and amateurs who have entertained or are anxious to meet fellow hams from across the Atlantic and we list them below:

B. Coleridge, ZS6CH, 17 Rebecca St., Florida, Transvaal;
 L. W. Ensor, ZS6BJ, Hon. Sec'y, Radio Amateurs Society (S. A.), P. O. Box 2327, 107 Grand Nat'l Bldg., Rissik St., Johannesburg;

Rev. C. R. Jenkins, ZS5CI, Methodist Manse, Vryheid, Natal;

S. W. v. d. Merwe, ZS2Y, Hon. Sec'y, Port Elizabeth Radio Assn., care Hubert Davies & Co., No. 1 Shed, Port Elizabeth Harbor; or alternatively, R. Bosman, ZS2X, care General Motors Frigidaire Dept., Telephone 8181, Port Elizabeth (Meetings 1st Friday of month at members' houses);

V. Plumridge, ZS1BG, Box 2994, Capetown;

C. A. W. Rieder, ZS1T, Ham Club of Capetown, Ocean View Dr., Greenpoint (Club meetings 1st Thursday each month at Randall House, 73 Loop St., Capetown);

D. J. Robinson, G3IF, care Engineer-in-Chief's Office, Posts & Telegraphs Dept., Lagos, Nigeria.



An Extended-Range Audio Oscillator

A Practical Ham Instrument With Some Novel Uses

BY CHARLES J. LEIPERT,* W6ROA

AN AUDIO oscillator which covers more than the normal audio-frequency range has many uses around the laboratory or service shop. Audio systems of receivers, p.a. amplifiers, speech amplifiers, and modulators may be tested with such an oscillator. In an f.m. system, the oscillator is useful in testing band-pass and fidelity of the audio system, off-resonance response of the r.f. tuned circuits, and sideband width in transmitters, including carrier-current outfits. To a certain extent, video amplifiers may be checked similarly, but the range of the test oscillator here described is not great enough, because video circuits respond normally up to approximately four megacycles. However, if the oscillator range is extended by means of doubler stages, the entire video spectrum may be covered. Another possibility along this line is the use of an R-C audio oscillator to control a ham transmitter on a low-frequency band. Since the stability of R-C oscillators is very good, something close to crystal-control performance possibly may be achieved, along with the flexibility of an e.c.o. Here is a quality which also makes the outfit ideal for use as an interpolation oscillator with which frequency measurements may be made.¹ Frequency stability of the unit here described is enhanced by the use of a temperature-controlled box, the construction of which is simple and quite inexpensive. Also in other parts of the circuit, easy-to-get components are used, and this is a relief, since priorities are becoming harder to obtain.

*1721 North Baker Street, Santa Ana, Calif.

¹Clapp and Crawford, "Frequency Standardization," *QST*, March, 1930, p. 9; Chinn, "Standard Frequency Station W1XP," *QST*, Jan., 1931, p. 27.

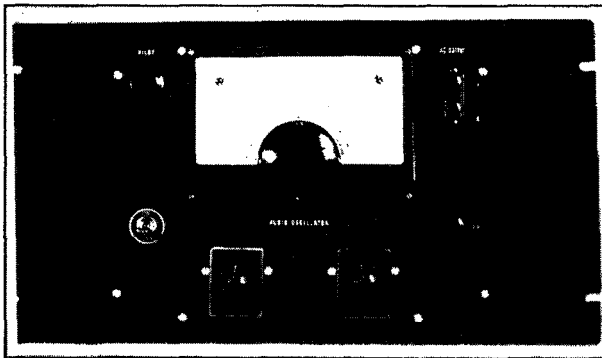

Front view of the R-C tuned audio oscillator. At the left are the heat-indicator pilot light and on-off switch for controlling part of the heater resistance. Output binding posts are shown at the right of the dial, with the common grounded terminal in the right-center of the panel. The two bottom controls are for frequency-range selection and low-impedance output attenuation.

The ordinary audio oscillator is doing well enough to put out a signal of constant level from 15 to 15,000 cycles. This range is good for most test work. With f.m. and video circuits coming into the picture, however, an instrument of this type must have a range well into the lower end of the r.f. spectrum, and with uniform volume level. Then some really modern testing can be done. Not only that, but the author hints that the unit here described may rival the crystal oscillator for stability, and may replace it on the low-frequency ham bands.

Circuit Design

In Fig. 1, the R-C elements are shown to be two identical groups of resistors, R_1-R_4 and R_5-R_8 , along with condensers, C_1 and C_2 . The ganged switch, S , allows resistors of equal value from both groups to be selected simultaneously, and it is by this method that a desired frequency range is chosen. The spectrum from 16 to 85,000 cycles is covered in the following steps: 16-150, 150-1500, 1500-10,000, and 10,000-85,000 cycles. A frequency ratio of approximately 10-to-1 exists for each setting of the switch, and these figures represent the end calibration points, with no gaps over the full range.

Condenser C_1 is a broadcast-type four-gang unit, and not four separate single sections, as it may appear from the diagram. The usual leaf-type mica trimmers are mounted on each section, but are not shown in Fig. 1. Two of the sections

connected in parallel are used to tune across the upper set of resistors (R_1-R_4), while the other two tune across the R_5-R_8 group. C_2 is a very low-capacity, low-drift, fixed mica condenser which makes up for the added capacity of the two lower sections of C_1 with respect to the chassis. By this means, the capacity element of the R-C tuned circuit is kept in balance.

Oscillation is maintained by feedback from the plate circuit of the second tube in the line-up to the cathode-suppressor connection on the first tube. A 6SJ7 tube is in the R-C tuned circuit, followed by a 6V6GT which, in turn, is followed by another 6V6GT as a final amplifier. Feedback energy is coupled through the common cathode-return path and

resistor R_9 . Degenerative voltage is developed across the two lamps, RL_1 and RL_2 , in series. The positive resistance-temperature characteristic of these lamps causes the voltage across them to rise more rapidly than does the increase in current through them. Degenerative voltage therefore appears on the 6SJ7 control grid simultaneously with the regenerative feed-back voltage through R_9 , so that oscillations are better stabilized.

If the load is hooked right onto the oscillator output, frequency variations are bound to occur, and this is *not* what is wanted. An easy way out of this little difficulty is to use a stage or two of amplification following the oscillator, so that the oscillator frequency is not affected by changes in load impedance. This is done in the unit here described. Either high- or low-impedance loads may be connected to the output of the second 6V6GT tube in the circuit from terminals on the front panel. The isolating amplifier circuit is built around the middle 6V6GT tube. Across the high-impedance terminals, the audio voltage reading is 19 volts. Across the low-impedance binding posts, the voltage averages about 1.25 volts, with a slight taper at 25,000 cycles. These figures represent maximum readings. A 1,000-ohm attenuator is used across the low-impedance terminals, but there is none across the high-impedance side. It is believed that adjustment of the volume level may be made more conveniently at the load circuit in the case of high-impedance output.

The power supply is not made a part of the oscillator unit because in that position it has been found to affect the stability of the oscillator. Power for the rig therefore is "piped" in through a cable and plug.

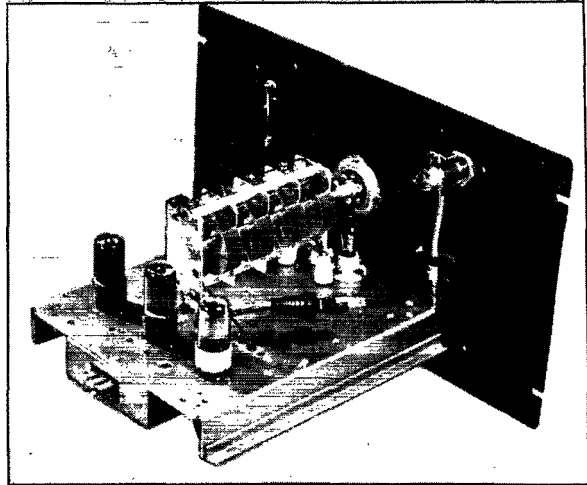

Top view of the R-C tuned audio oscillator. The four-gang main tuning condenser is set on stand-off insulators at the center. The three tubes are shown at the rear. A two-prong male plug shown at the right of the gang condenser carries current for a thermostatically-controlled heater element in a temperature-controlled box.

Metal tubes are preferable because they are shielded, but essentially the same results may be achieved with glass tubes and shields connected to the cathode pins. The 6V6GT tubes are so constructed internally, and are so placed in the circuit, that they could be left unshielded, but complete elimination of hum pick-up and of unwanted feed-back makes it preferable that tube shields be used.

Construction Details

Salvaged metal is used in several parts of the lay-out. A rusty $\frac{1}{8}$ -inch steel plate with 82 holes in it, for example, was converted into the front panel shown in the accompanying photograph. A welding torch was used to fill in the holes, after

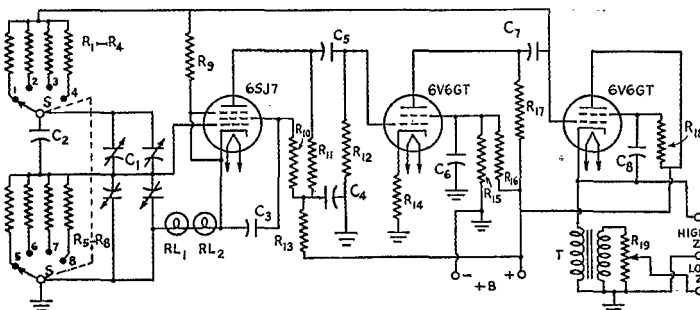

Fig. 1 — Circuit diagram of the R-C audio oscillator.

- C_1 — 4-gang broadcast-type variable, 365 μ fd.
- C_2 — 75- μ fd. midget mica, low-drift.
- C_3, C_5 — 1- μ fd., 450-volt paper.
- C_4, C_6, C_7, C_8 — 8- μ fd., 450-volt electrolytic.
- R_1, R_5 — 10 megohms, $\frac{1}{2}$ watt.
- R_2, R_6 — 1.25 megohms, $\frac{1}{2}$ watt.
- R_8, R_7 — 150,000 ohms, $\frac{1}{2}$ watt.

- R_4, R_8 — 20,000 ohms, $\frac{1}{2}$ watt.
- R_9 — 2,500 ohms, 1 watt.
- R_{10}, R_{12} — 0.5 megohm, $\frac{1}{2}$ watt.
- R_{11}, R_{13} — 100,000 ohms, $\frac{1}{2}$ watt.
- R_{14} — 200 ohms, 10 watts.
- R_{15} — 40,000 ohms, 1 watt.
- R_{16} — 50,000 ohms, 1 watt.
- R_{17} — 10,000 ohms, 10 watts.
- R_{18} — 25,000 ohms, 10 watts.

- R_{19} — 1,000-ohm potentiometer, carbon volume-control type.
- RL_1, RL_2 — 120-volt, 6-watt lamps (G. E. Mazda type S6). The same type is used for the heat-indicator pilot light.
- S — Ganged 2-section, 4-point wafar-type switch.
- T — Universal output-to-voice-coil type transformer.

which the plate was ground, sanded, and given a wrinkle-finish paint job. Actually, the family cook-oven was appropriated for the baking part of the paint job (while the family kindly evacuated for the time being), and the finished product hardly resembles the old rusty plate from the junk pile.

The chassis is a hole-ridden relic, also from the junk pile, which was finished up and pressed into service. It is an odd-shaped affair of $\frac{1}{8}$ -inch brass with the following dimensions: $9\frac{1}{2}$ inches across the forward edge, $11\frac{1}{4}$ inches deep, $10\frac{1}{4}$ inches across the back edge, and a clearance underneath of two inches for the mounting of parts. Some of the large holes in the chassis are entirely too big for the tube sockets, but the required diameter is obtained by mounting socket washers on top of the chassis instead of underneath. Other smaller holes are not filled up because they serve to ventilate the components when the unit is mounted inside the temperature-controlled box.

The main oscillator gear is enclosed fully by the temperature-controlled box except that, as previously mentioned, the power supply is an independent external unit. Another junk-box item made of $\frac{1}{8}$ -inch iron forms the temperature-controlled box and it has the following dimensions: $12\frac{1}{4}$ inches wide, 12 inches deep, $9\frac{1}{2}$ inches high, with a flat flange made so that the box may be screwed flush with the main rack.

For a thermostat, one which is designed for use in chicken incubators does very well. Even though a thermostat of this type is somewhat large, it is not hard to find a way to mount it inside the temperature box. A more scientific model virtually is impossible to obtain because of priority restrictions. The one used cost approximately two dollars, and it works well enough to keep the temperature within plus or minus one degree. The accuracy of the circuit components themselves with respect to temperature is no greater

than this. For further heat insulation, an outside covering of $\frac{1}{2}$ -inch Celotex is used around the box. The Celotex is cut to size and given three coats of black paint. Black is chosen because of its heat-retentive properties. If any trouble is experienced in making the Celotex joints tight, linoleum glue is recommended for the purpose.

Almost any type of thermometer will do. In the original gear, a bathroom-type for measuring water temperature was obtainable, and it served well enough, since a scientific model was not to be had. If the glass tubular type with graduations etched on the stem is used, a single hole drilled into the box is good enough for holding it. Another hole of appropriate size is needed in a convenient spot on the box for mounting the fuse base. A screw-type fuse is used. "Heat On" is indicated by the illumination of a 120-volt, 6-watt Mazda lamp behind a one-inch jewel. Beneath the jewel is an on-off switch for controlling that portion of the heater resistance which is connected through the thermostat.

The grounded, or common, binding post for the audio output is shown at the middle right in the front-view photograph. Above it, on a two-terminal strip, the low-impedance post is at the bottom, and the high-impedance post is at the top.

The main tuning condenser, C_1 , is mounted on stand-off insulators, and connections are brought to it through the chassis, as shown in the top-view photograph. The author fortunately was able to obtain the National vernier dial from a supply house.

The two lamps, RL_1 and RL_2 , which control the amount of degeneration, are mounted between the main tuning condenser and the back of the front panel. They are of the 120-volt, 6-watt variety. Both of them are mounted in ceramic sockets, and their connections are brought to the cathode of the first 6SJ7 tube.

The audio transformer is a universal output-to-voice-coil type in a shielded case. In order to exclude the outside atmosphere and any inside moisture in this particular component the transformer was heated and then the case was filled with hot beeswax.

The terminal strip shown diagonally across the bottom of the chassis carries most of the resistance components for the circuit. The smaller strip, which lies alongside the larger one, is filled mostly with cathode resistors. Several half-value resistors are connected in series to provide the proper resistance, since the correct values in individual units were not obtainable. Metal sleeves, such as short pieces of tubing of equal length, serve as stand-off supports for each of these strips. The resistors, by this arrangement, are easily ventilated. They are accessible readily in case of trouble, and all leads to and from them are shielded thoroughly.

(Continued on page 84)

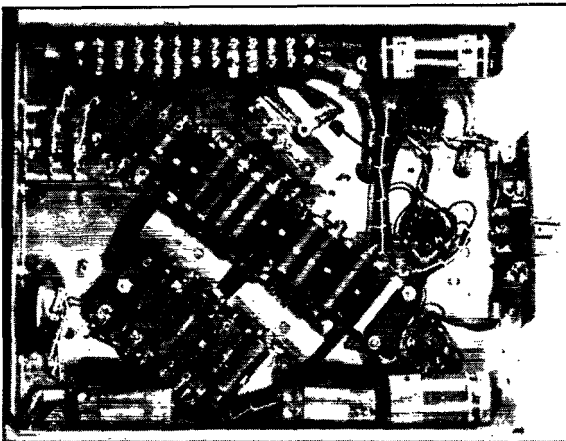

Bottom view of the audio oscillator. Resistors are shown on the two diagonally-mounted terminal strips. Condensers are held solidly to the chassis by metal straps. Leads from the external power supply come in at the Jones male plug shown at the right. On the left, the ganged wafer-type frequency-range switch is at the end of the long resistor strip. Above it is the 1,000-ohm attenuator.

A WERS Master-Control Transmitter

A Multi-Stage Rig with Stabilized Frequency Control for 112-Mc.

BY PHILIP S. RAND,* WIDBM

The transmitter described in this article is the result of considerable experimenting on the part of the author for the purpose of arriving at an arrangement for a WERS master-control transmitter having as many desirable features as possible without unnecessary complications. It is constructed chiefly from parts salvaged from prewar ham rigs and the design is such that it can be adjusted by inexperienced operators if necessary.

IN DESIGNING equipment to be used in the master-control station of a WERS network several factors must be kept in mind. Ordinarily the amateur designer does not have to worry too much about the total power consumed by the transmitter, since to him an added stage or two means only a few more cents on the power bill at the end of the month.

On the other hand, if WERS is to function as intended, all equipment must be capable of operating economically from battery power when the a.c. lines fail, since very few communities are fortunate enough to possess prewar gasoline-driven equipment.

In sparsely settled areas high transmitter-frequency stability may not be of great practical importance, but in the heavily industrialized sections it becomes a prime requirement if the many networks within range of each other are to operate without serious interference. For the same reason, experience has shown that the frequency of a master-control station should be easily adjustable to any desired spot in the allotted band. Since often it may be necessary for inexperienced personnel to operate the equipment, it is important also that it be reliable in performance and as simple and straightforward as possible in adjustment.

Design Considerations

In developing satisfactory gear for the control station for the Middletown, Conn., Warning Area, many 112-Mc. transmitters were built and tested under actual operating conditions before the final model shown in the photographs was completed. The original transmitter at WKNO-1 consisted

of a 6V6 crystal oscillator operating in the 3.5-Mc. band followed by doubler stages and an 829 final amplifier plate modulated by a pair of 6L6s. This arrangement fell down badly in a number of respects. In the first place the disadvantage of crystal control was recognized after the district frequency had been changed several times in an attempt to avoid interference with other neighboring nets. The District Radio Aide discovered that he could build two e.c. oscillators in the length of time it had taken him to grind a crystal for each of the changes, not to mention the crystals which had to be discarded because they had been ground down too far. Also it was found that the heavy plate-current drain imposed by the numerous doubler stages precluded satisfactory operation from emergency supply. As an added difficulty, the 112-Mc. doubler had to be pushed so hard to obtain sufficient excitation for the final amplifier that it was necessary to replace the tube frequently. This transmitter had been designed starting at the crystal oscillator using an existing power supply which originally supplied a ham transmitter.

After analyzing the problem, it was decided to reverse the procedure and design the transmitter from the output stage back to the oscillator, basing the design upon the available emergency battery-operated supplies and later adjusting the a.c. supply to deliver the same output voltages.

The first decision was to keep the 829 as a final amplifier because of its low driving-power requirements and unlimited life at an input of 25 watts.

Frequency Multipliers

A lot of experimenting was done to determine the most suitable tube or tubes for the final frequency multiplier to 112 Mc. which usually is the most difficult stage of all to get operating prop-

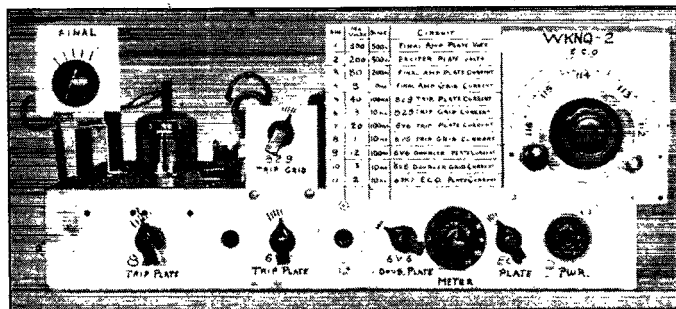

Front view of the WERS master-control transmitter. The various adjustment controls may be identified by the labels. The chart applies to the metering switch.

*Electronic Division, Remington Rand, Inc., Middletown, Conn.

erly. Various combinations were tried for doubling frequency from 56 to 112 Mc. Although beam tetrodes require little driving power, they do not work very efficiently as doublers at the higher frequencies because of their high output capacities which necessitate the use of very small tank inductances. Triodes are not so handicapped in this respect but, of course, they require much greater driving power. The push-pull tripler shown in the diagram of Fig. 1 proved to do a better job of driving the final than any of the doublers tried. With this arrangement the capacities of the two tubes are in series with a resultant capacity of only half that of the single tetrode of a doubler stage. Thus a tank coil of reasonable size can be used while still keeping the low driving-power feature of the beam tube. Combinations of 6V6s in push-pull, an 815, an 832 and an 829 were tested and it was found that the 829 gave the best over-all tripling efficiency. Greater final grid current with less driver plate current was obtained with this tube than with any of the others.

In considering the driver for the 829 tripler, another tetrode was indicated so a 6V6 was tried. In this stage we had the choice of doubling or tripling frequency. A few trials showed that with proper bias the 6V6 tripled frequency from 12.4 to 37.3 Mc. very nearly as well as it doubled from 18.6 Mc. Inasmuch as it was considered important to obtain the required frequency multiplication with as few stages as possible, it was decided that this stage also would be operated as a tripler.

The E.C.O.

At this point tests were made to determine if the 6V6 tripler could be driven directly by the e.c.o. However, it was found that it took more power to drive this tripler efficiently than a simple e.c.o. was capable of putting out while still maintaining satisfactory frequency stability. Therefore another 6V6 was used as a combined doubler and isolating stage between the 6SK7 e.c.o. and the 6V6 tripler.

To obtain sufficient power from the e.c.o. it was necessary to tune its output circuit. Attempts at tuning this circuit to the oscillating-circuit frequency resulted in instability, despite very thorough shielding between these circuits. Tuning the oscillating circuit to half the frequency of the output circuit eliminated this trouble, so the oscillating section now operates at a frequency in the neighborhood of 3.15 Mc.

To obtain the desired stability considerable capacity is used in the grid circuit of the 6SK7. Most of this is contributed by the zero-drift fixed condenser, C_1 . Additional capacity is furnished by the air band-setting condenser, C_3 . C_2 is a negative-temperature coefficient condenser to prevent appreciable drift in frequency with a change in temperature. C_4 is the main tuning condenser. It has a capacity range which is appropriate for spreading the 112-Mc. band over the dial when connected across the total fixed capacity.

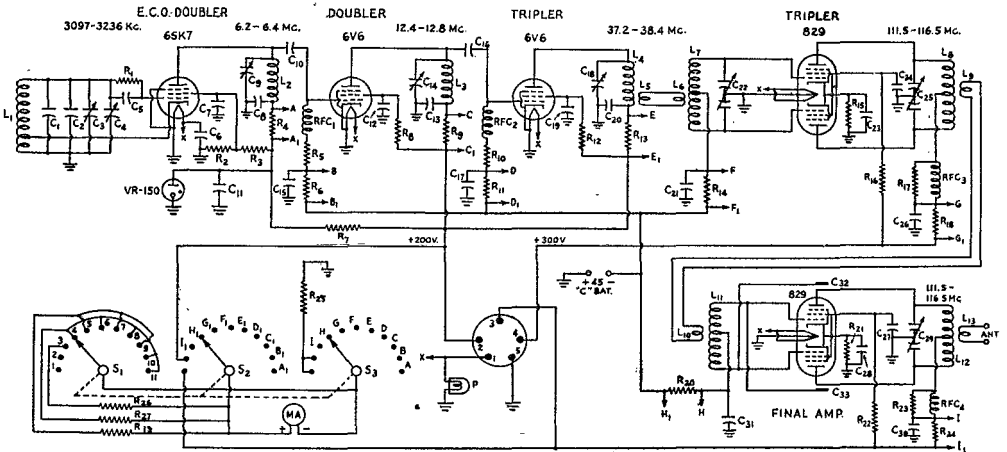

Fig. 1 — Circuit diagram of the WERS master-control transmitter.

- C_1 — 250- μ fd. zero-drift ceramic.
- C_2 — 25- μ fd. negative temperature-coefficient condenser.
- C_3 — 150- μ fd. variable air padding condenser.
- C_4 — 35- μ fd. variable, double plate spacing.
- C_5 — 100- μ fd. zero-drift mica.
- C_6, C_7, C_8 — 0.01- μ fd. mica.
- C_9 — 50- μ fd. variable.
- C_{10}, C_{16} — 100- μ fd. mica.
- C_{11} — 16- μ fd. 500-volt electrolytic.
- $C_{12}, C_{13}, C_{15}, C_{17}, C_{23}, C_{24}, C_{27}, C_{28}$ — 0.005- μ fd. mica
- C_{14}, C_{18} — 35- μ fd. variable.
- $C_{19}, C_{20}, C_{21}, C_{26}, C_{30}, C_{31}$ — 0.002- μ fd. mica.
- C_{22}, C_{25}, C_{29} — 35 μ fd. per section.
- C_{32}, C_{33} — Neutralizing condenser (see text).
- R_1 — 100,000 ohms, 1 watt.
- R_2 — 50,000 ohms, 5 watts.
- R_3 — 20,000 ohms, 5 watts.
- $R_4, R_6, R_9, R_{11}, R_{13}, R_{14}, R_{18}, R_{20}, R_{24}$ — 50 ohms, $\frac{1}{2}$ watt.
- R_8, R_{10} — 100,000 ohms, $\frac{1}{2}$ watt.
- R_7 — 2500 ohms, 10 watts.
- R_5, R_{12} — 50,000 ohms, 1 watt.
- R_{15} — 1000 ohms, 10 watts.
- R_{16} — 30,000 ohms, 10 watts.
- R_{17}, R_{23} — 2000 ohms, 1 watt.
- R_{19} — 0.55 ohm (see text).
- R_{21} — 250 ohms, 10 watts.
- R_{22} — 20,000 ohms, 10 watts.
- R_{25} — 500,000 ohms, 1 watt (see text).
- R_{20} — 0.27 ohm (see text).
- R_{27} — 7.1 ohms (see text).
- RFC1, RFC2 — 2.5-mh. r.f. choke.
- RFC3, RFC4 — V.h.f. choke (Ohmite Z-1).
- S_1, S_2, S_3 — Sections of triple-gang, 11-point rotary switch.
- MA — 0-1 milliammeter.
- P — Pilot lamp.

Oscillator plate voltage is held constant within close limits by a VR150 voltage-regulator tube. Screen voltage is taken from the voltage divider, R_2R_3 , across the regulated supply. Both L_1 and L_2 are well shielded.

Exciter Circuits

Capacity coupling is used in the first two multiplier stages. In spite of the unusually high grid-leak resistance values, which were chosen carefully for best doubling and tripling, the use of r.f. chokes in series with the resistors increased materially the efficiency of these two stages. A value of 50,000 ohms for the screen voltage-dropping resistors gave best output with least input. For constructional convenience, the rotors of the tank condensers are grounded with the blocking condensers, C_8 , C_{13} and C_{20} completing the three tank circuits.

In the higher-frequency stages link coupling proved to be superior. While a tuning condenser, C_{22} , is used in the grid circuit of the 829 tripler, a self-resonant grid coil, L_{11} , is adequate in covering the band in the output stage. Neutralization of the final amplifier is necessary, at least in this instance, to prevent instability. The resistors R_{17} and R_{23} shunting the v.h.f. chokes are required to eliminate parasitic oscillations. No grid leaks are used in the last two stages, operating bias being obtained from the drop across the cathode resistors, R_{15} and R_{21} , plus the 45-volt battery.

Metering System

The oscillator, of course, operates at 150 volts, while the plate voltage of the first two multiplier stages is 200 and the last two stages operate at 300 volts. A fixed bias of 45 volts is applied to all stages except the oscillator to limit the plate current to the tubes while tuning up or during an accidental loss of excitation.

A metering system also is included as indicated in Fig. 1. Experience has shown that it is a very worth-while addition. The current-multiplying shunts, R_{19} , R_{26} and R_{27} , are adjusted to provide current-reading ranges of 200 ma., 100 ma. and 10 ma., and the circuit is such that the shunt for the proper current range in each case is connected automatically across the 1-ma. meter when switched to any plate or grid circuit. The values shown for the shunt resistors under Fig. 1 are suitable for the Beede meter we used which has an internal resistance of 56 ohms. Copper-wire shunts for meters with other values of internal resistance may be made experimentally by following the procedure outlined in the *A.R.R.L. Handbook*. When the meter switch is turned to either of the first two positions, the resistor, R_{25} , converts the milliammeter to a voltmeter with a 500-volt range for checking the two supply voltages.

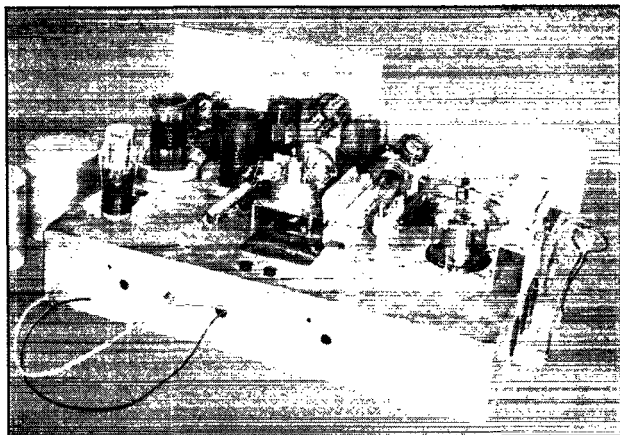

Rear view of the transmitter used at the control station of the WKNQ WERS net. The socket of the inverted 829 frequency tripler is slightly to the left of the center of the chassis. The tube in the rear left-hand corner is the voltage-regulator tube while the final amplifier tube is to the right. Other components are identified in the text.

Construction

Junk-box parts were relied upon rather heavily in constructing this unit. It is quite apparent from the photographs that the chassis is one which has seen better days. While it may seem rather large for the purpose, we have found that it does no harm to use good spacing between the individual stages. When viewed from the rear, the e.c.o. is at the left with the grid and plate coils, L_1 and L_2 , in separate shield cans. The 6SK7 is mounted just forward and between the coils. The bandspread tuning condenser, C_4 , is mounted on the panel at the extreme left, with the temperature-compensating condenser, C_2 , connected across its rear terminals. The pigtail leads of C_2 are left sufficiently long to permit the condenser to be suspended within an inch or so of the 6SK7 where it will come under the influence of the heat developed by the tube. The ceramic padder, C_1 , is soldered directly to the coil-socket terminals underneath the chassis, while the air padder, C_3 , is mounted inside the coil form. C_9 is mounted on the front edge of the chassis with the control shaft extending to a knob. C_5 and R_1 should be mounted rigidly and all connecting leads in the oscillator circuit should be short and heavy to avoid any possibility of vibration.

The two 6V6s are placed near the front of the chassis with L_3 between and L_4 to the right. The two multiplier-stage tuning condensers, C_{14} and C_{18} , are fastened to the chassis directly under their respective coils.

Components for the 829 tripler stage are grouped near the center of the chassis. The tube is mounted in an inverted position with the socket terminals above the chassis to permit short connections between the grid terminals and the input tank circuit made up of L_7 and C_{22} . For the same reason and to provide shielding between input and output circuits, the plate tank-circuit components for the tripler and the self-resonant grid coil, L_{11} , are placed underneath the chassis. So that

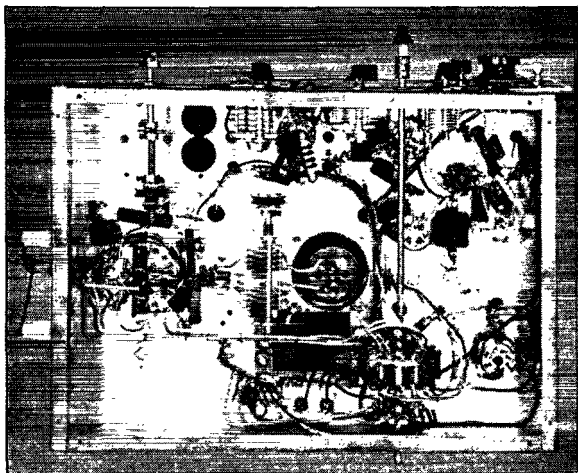

Bottom view of the WERS control-station transmitter.

C_{25} may be placed in proper position between the two tubes, this condenser is controlled by a separate shaft and pulley arrangement.

Although the final-amplifier tube is mounted in an upright position, its socket is spaced below the chassis, a little more than half of the tube projecting above through a clearance hole. The output-amplifier plate tank-circuit condenser and coil are mounted at the extreme right-hand end. The neutralizing condensers, C_{32} and C_{33} , consist of lengths of No. 12 wire protruding through small Millen isolantite feed-through bushings set in the chassis an inch or so on either side of the tube. In each case the wire is connected to a grid terminal, crossing to the opposite side before passing up through the bushing.

The metering switch is mounted underneath near the back of the chassis and is controlled by a long shaft. The multiplier resistances, R_{19} , R_{26} and R_{27} are made of small-size copper wire and are mounted on the terminal strip to the left of the switch in the bottom-view photograph. The voltmeter series resistor, R_{25} , was selected for accuracy from a batch of several resistors on hand. Pin jacks near the rear of the chassis are provided for making connections to the meter.

Since any one of several individuals may be called upon to tune or check the transmitter it is especially important to have all controls plainly marked. Directly over the meter-switch control is placed a chart which identifies each switch position and lists the correct readings which should be obtained as well as the full-scale meter reading for each position. The appropriate values are given later in tabulated form.

Modulator and Power Supplies

The circuit diagram of the plate modulator used with the transmitter is shown in Fig. 2. It consists of a high-gain input stage using a 6SJ7 pentode, a 6J5 driver and Class-AB 6A3s. Because the filaments of all tubes in the installation are operated from a common power source, it is necessary to use battery bias for the 6A3s. The use of slightly higher than normal bias reduces the no-signal plate current.

The microphone used with this modulator is a crystal-headphone unit wrapped in copper screening which is grounded to the shield of the mike cable and covered with rubber tape. This type of microphone has worked out very well in a number of installations in the WKNQ net.

Three units furnish power for the transmitter. The speech amplifier in the audio unit and all but the last two stages of the transmitter are operated from the combination vibrator and a.c. supply whose circuit appears in Fig. 3. It is of the same type used throughout our net to furnish power for TR4s of which we have several. The station receiver also is operated from this supply which is switched back and forth by the send-receive change-over switch. Should the power lines fail, the 6A3s in the modulator and the last two stages of the transmitter may be operated from a dynamotor delivering 300 volts. Otherwise, the a.c. supply diagrammed in Fig. 4 is used. The several 7.5-volt windings of T_1 are connected so as to buck the line voltage to the primary of T_2 to reduce the output voltage to match that of the dynamotor. The filter is arranged so that it serves for both a.c. and emergency supplies. Fig. 5 shows the wiring of the junction and control panel through which proper connections between the power-supply units and the radio equipment are made. S_1 makes all of

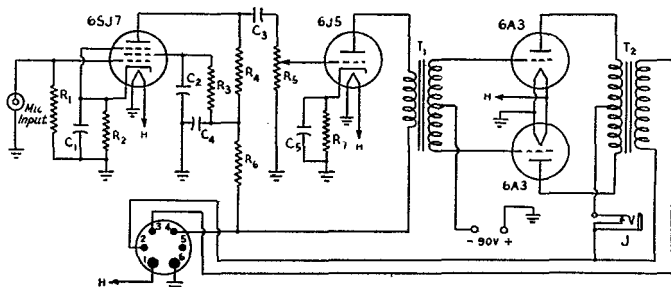
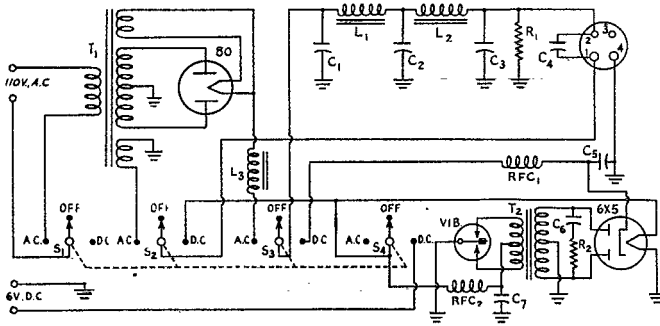

Fig. 2 — Circuit diagram of the modulator used with the WERS control-station transmitter.

C_1, C_5 — 25- μ fd., 25-volt electrolytic by-pass condenser.
 C_2 — 0.25 μ fd., 600 volts.
 C_3 — 0.1 μ fd., 600 volts.
 C_4 — 3- μ fd., 450-volt electrolytic.
 R_1 — 5 megohms, $\frac{1}{2}$ watt.
 R_2 — 1200 ohms, $\frac{1}{2}$ watt.
 R_3 — 2 megohms, $\frac{1}{2}$ watt.

R_4 — 500,000 ohms, $\frac{1}{2}$ watt.
 R_5 — 1-megohm potentiometer.
 R_6 — 50,000 ohms, 1 watt.
 R_7 — 2000 ohms, 1 watt.
 T_1 — Interstage transformer.
 T_2 — Output transformer, p.p. 6A3s to 4000-ohm load.
 J — Closed-circuit jack.

Fig. 3 — Circuit diagram of the combination a.c. and vibrator power supply for receiver, speech-amplifier and exciter stages.



- C₁, C₂ — 8- μ fd., 450-volt electrolytic.
- C₃ — 16- μ fd., 450-volt electrolytic.
- C₄ — 100- μ fd. mica.
- C₅ — 0.01 μ fd., 600 volts.
- C₆ — 0.015 μ fd., 1600 volts.
- C₇ — 0.5 μ fd.
- R₁ — 50,000 ohms, 10 watts.
- R₂ — 5000 ohms, 1 watt.
- RFC₁ — 2.5-mh. r.f. choke.
- RFC₂ — 55 turns No. 12 enam., 1-inch diam., close-wound.
- L₁, L₂ — 10-12 h., 100-ma. filter choke.
- L₃ — 10-h. filter choke (use only to drop voltage if excessive).
- S₁, S₂, S₃, S₄ — Poles of 4-pole, 3-position rotary switch.
- VIB — Radiart No. 3320 vibrator.

the necessary changes in shifting instantly from a.c. to emergency plate power, S₂ is the send-receive change-over switch, while S₃ is for the purpose of shifting filament supply from a.c. to battery.

One problem which presented some difficulty was that of arriving at some arrangement whereby the antenna relay could be actuated by the send-receive switch while the transmitter was operating from emergency supply, since the storage battery does not provide sufficient voltage. The solution finally was found by operating the relay from a voltage divider connected across the dynamotor output.

In making the control panel and connecting cables it is advisable to use good heavy leads from the storage battery all the way up through the relay contacts to the dynamotor and to parallel several wires in the cables for filament voltage. A filament transformer may deliver enough voltage to spare some drop in the cables, but a storage battery won't.

Adjustment

Since frequency is doubled twice and tripled twice in the exciter, the total frequency multiplication between the e.c.o. grid circuit and the input circuit of the final amplifier is 36. Therefore, if an output frequency range of 111.5 to 116.5 Mc. is desired, the oscillating circuit must operate over a range of approximately 3097 to 3236 kc. The oscillator frequency range can be given a preliminary check with a calibrated all-wave receiver or by any other convenient method. The air padder, C₃, should be adjusted until the band-spread tuning condenser, C₄, covers the proper range. If the correct range cannot be obtained, it may be necessary to alter the number of turns on L₁ slightly.

The corresponding tuning ranges of the other stages are indicated in Fig. 1. After obtaining the customary plate-current dip and grid-current peak indicating resonance, the tuning of each circuit should be checked with an absorption-type

frequency meter to make sure that all are operating at the correct harmonic. There is not too much difference between outputs at the second, third, fourth and fifth harmonics, so that the chances are good that the final output frequency will not be found in the 112-Mc. band unless care is used in checking the frequency of each stage. If possible, the coils should be adjusted so that adjacent harmonics fall just outside the tuning ranges of the condensers.

With a plate voltage of 200 on the first three stages and 300 on the last two, average plate- and grid-current readings should be close to the values given in the following tabulation.

E.c.o. plate current	2 ma.
Doubler grid current	0.3 ma.
Doubler plate current	12 ma.
First tripler grid current	1 ma.
First tripler plate current	20 ma.
Second tripler grid current	3 ma.
Second tripler plate current	40 ma.
Final grid current	8 ma.
Final plate current	80 ma.

Some interaction may be noticed between the tuning of the 829 tripler grid circuit and that of the 6V6 tripler plate circuit. If this appears to be

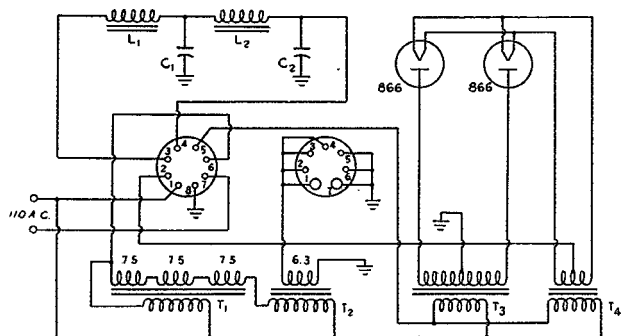

Fig. 4 — Circuit diagram of the a.c. supply for the modulator and last two transmitter stages of the WERS control transmitter.

- C₁, C₂ — 16- μ fd., 450-volt electrolytic.
- L₁ — 10-h., 200-ma. input filter choke.
- L₂ — 10-h. 200-ma. smoothing choke.
- T₁ — Filament transformer with three 7.5-volt windings.
- T₂ — Plate-voltage transformer, 500 volts each side of center tap.
- T₃ — Filament transformer for 866s.
- T₄ — 6.3-volt filament transformer, 10 amp.

COIL TABLE

Coil	Turns	Wire Size	Diam. Inches	Length
L ₁	25 tapped 8 turns from ground	18	1½	Close-wound
L ₂	25	18	1½	Close-wound
L ₃	14	18	1	Spaced turns (National 20-E)
L ₄	6	14	¾	1 inch
L ₅	2	16	¾	Close-wound
L ₆	3	16	1	¼ inch
L ₇	6	18	1	1 inch (National 10-C)
L ₈	2	14	½	½ inch
L ₉	2	16	½	Close-wound
L ₁₀	1	16	½	
L ₁₁	4	14	½	1 inch
L ₁₂	2	12	1	½ inch
L ₁₃	1	14	1	

excessive, it may be reduced somewhat by an adjustment of the links. However, in any case, the two circuits should be tuned simultaneously, one with each hand, for maximum grid current.

Neutralizing the Final

As mentioned previously, we found it necessary to neutralize the final amplifier. This should be done before applying any power to the stage. The wires of the homemade low-capacity neutralizing condensers should be made so that they extend up from the chassis the full length of the tube plates. In neutralizing the final amplifier, they should be clipped off, about a sixteenth of an inch at a time, until no change in grid current is observed when the plate tank circuit is tuned through resonance. This should be done, of course, with excitation but no plate or screen voltage applied to the output stage. If it is found that slightly too much has been clipped off, the neutralizing capacity may be increased again by bending the wires toward the tube.

In testing the final amplifier for output, a 10-watt lamp may be used as a dummy load. It may be noticed that maximum lamp brilliance and minimum plate current do not occur simultaneously when tuning the output tank circuit. This is characteristic of screen-grid tubes when operated with a series screen voltage-dropping resistor.

After the transmitter is working properly, it may be desirable to make a more accurate calibration for the e.c.o. dial. At WKNQ we used a Browning frequency meter which has a built-in 1000 kc. oscillator which gave us a marker every megacycle. Since the main dial of this instrument is calibrated directly for the 56-Mc. band, the dial readings had only to be multiplied by two to arrive at intermediate calibration points. Rather tight coupling is necessary between the 829 and the frequency meter to obtain a usable signal. Needless to say the equipment should be warmed up thoroughly before attempting the calibration.

The frequency meter can be used also for checking frequency drift as the transmitter warms up from a cold start. If any serious drift is apparent, the compensating condenser, C₂, should be moved nearer to or farther away from the 6SK7 to increase or decrease its compensating action, depending, of course, upon the direction of drift observed.

Antenna

The antenna to be used depends upon several factors, such as the space available, amount of gain necessary to overcome the effects of unfavorable terrain, directions of the stations most difficult to work, etc. Here in Middletown no two of our net stations are in the same direction from the control and the intervening terrain is unfavorable. For these reasons a rotatable beam antenna or several fixed arrays would be dis-

(Continued on page 88)

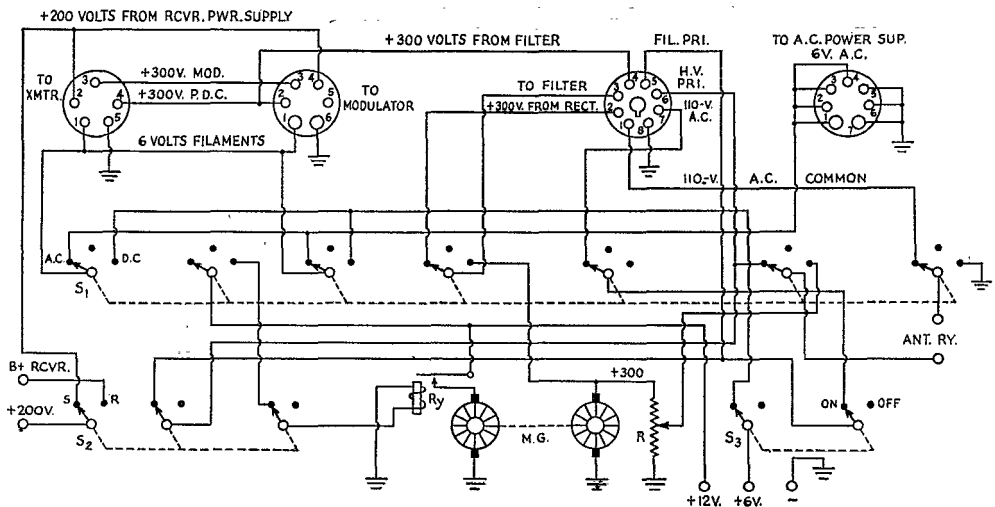

Fig. 5 — Circuit diagram of the control and junction panel used with the WERS control transmitter.

Ry — 12-volt relay.

S₁ — 7-pole, 3-position rotary switch.

S₂ — 3-pole, double-throw switch.

S₃ — D.p.d.t.

HAPPENINGS OF THE MONTH

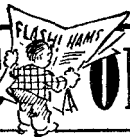

ELECTION RESULTS

ONE new ARRL director and one new alternate director took office January 1st as a result of the balloting which was canvassed by the Executive Committee in late December, two incumbent directors were returned to office, and in one division there was a tie vote, necessitating a rerun of the election.

The new director is John A. Kiener, W8AVH, representing the Central Division. The old director, Lt. Comdr. G. L. Dosland, is overseas and was not a candidate for reelection. The balloting figures:

Mr. Kiener	779 votes
George B. Ashton, W9PNV	456 "
George Keith, jr., W9QLZ	371 "

Mr. Kiener is vice-president and general manager of Kiener Coal, Inc., dealers in coal and coke at Cleveland, and is trustee and treasurer of the Retail Coal Board of Cuyahoga County. He has had an active amateur radio career in the Cleveland area, being a director of the Cuyahoga Radio Association and a former director of the Westlake Amateur Radio Association. He is chief radio aide for WERS in Cuyahoga County (WJH) and has been ARRL Emergency Coördinator for the Greater Cleveland area since the inception of AEC; and he is also a member of the Disaster Relief Committee of the Red Cross' Cleveland chapter.

The Rocky Mountain Division returned C. Raymond Stedman, W9CAA, as director for two additional years, he winning handily over Franklin K. Matejka, W9ZNN, 120 votes to 54. In the balloting for alternate director, Howard R. Markwell, W9TFP, was victor over W. Robertson White, W9PDA, 105 votes to 68. The previous incumbent, W9BQO, withdrew his name because he was entering the commercial radio field. Mr. Markwell is a switchman for the Mountain States Telephone & Telegraph Company at Lowry Field, Denver, on equipment maintenance. He has been a ham since 1934 and is vice-president of the Associated Amateur Radio Operators of Denver and a past-president of the Bell Radio Amateurs.

In the West Gulf Division, Wayland M. ("Soupy") Groves, W5NW, was reelected for two more years, scoring 231 votes to 157 for George W. Smith, jr., W5HIP.

For the first time in ARRL history, there was an absolute tie in an election for director. In the New England Division Percy C. Noble, W1BVR, and Frank L. Baker, jr., W1ALP, each received 435 votes. A second balloting between the same two candidates is now taking place in this division, the results to be determined in late February and the new director to assume office as soon as the answer is known.

ALLOCATION PROGRESS

AT THE moment of writing, FCC and IRAC are reported near the end of a series of joint meetings, held behind locked doors, to reconcile the differences between civilian and military thinking in matters of postwar allocation. Shortly FCC is expected to announce its postwar ladder.

The whole work can now be seen in better perspective. At one end was RTPB and the FCC public hearings, feeding civilian allocation requests to FCC. At the other end stands the Department of State, waiting to receive the agreed American allocation desires, to put them forward as American proposals for international conferences, one for the American region to open at Rio de Janeiro on June 2nd and one for the world, not yet set. Between these two ends of the mechanism are FCC, the allocation authority for civilian radio services, and IRAC, its similar for Government services. The present joint IRAC-FCC meetings promise harmonious joint decisions that will then possess great strength. Announcements concerning the civilian radio services are of course to be expected only from FCC.

Where the new ladder will deal with frequencies of purely domestic range (above, say, 30 Mc.) it is generally expected that FCC will put the allocations into early effect by means of a public notice or amendment of its regulations. Where the frequency decisions involve changes from the Cairo or Santiago treaties, it is expected that they will take the form of recommendations from FCC to the Department of State, since they cannot take effect until they are enacted by future international conferences. IRAC may also commend the new proposals to the State Department, thereby modifying the pending IRAC proposal. The State Department study committees, recently mostly QRX, can then be expected to become preparatory committees for the next conferences, and thus work will begin on one more hurdle in the complex course of postwar planning.

Stand by for an FCC announcement soon.

WAIVER OF PROOF OF USE

SINCE the war, FCC, by its Order 77 and successive extensions, has been waiving its rule that licenses will not be renewed without a proof

ARE YOU LICENSED?

When joining the League or renewing your membership, it is important that you show whether you have an amateur license, either station or operator. Please state your call and/or the class of operator license held, that we may verify your classification.

of use. A further extension, adopted on December 27th under the Order No. 77-D, extends this waiver another year under the following language:

IT IS ORDERED, That Sections 12.26 and 12.66 of the Rules Governing Amateur Radio Stations and Operators, and Section 13.28 of the Rules Governing Commercial Radio Operators, insofar as the required showing of service or use of license is concerned, BE, AND THEY ARE HEREBY, SUSPENDED until further order of the Commission, but in no event beyond January 1, 1946.

CANADIAN PLANNING

To Canadian amateurs, from Canadian General Manager Alexander Reid, VE2BE:

Following up my note in December QST, I have now to tell you that the Canadian Radio Technical Planning Board has been formally set up and that the Canadian Section of ARRL is one of its contributing sponsors. Others include Canadian Assoc. of Broadcasters, C.B.C., Canadian Electrical Manufacturers Assoc., I.R.E., R.M.A. of Canada, The Railway Assoc. of Canada and The Telephone Assoc. of Canada. The form of organization closely parallels that of RTPB in the United States, although somewhat simplified for our purposes.

Six panels are being set up. Panel A, on spectrum utilization and frequency allocation, will probably be the one of greatest interest to amateurs, and it is expected that this will be chairmanned by Mr. L. S. Payne. Panel B deals with a.m. broadcasting; C with the communication services; D with f.m., television and the other forms of broadcasting; E with aviation and navigational aids, and F with industrial and medical radio. Mr. Reginald M. Brophy, general manager of the Canadian Marconi Co., has been elected as general chairman, and Mr. W. W. Richardson as secretary-treasurer. Mr. Brophy is an old-time VE2 amateur whom I have counted as a friend for 20 years. I represent our Canadian Section on the CRTPB Administrative Committee, with Lt. Comdr. Noel Wright, VE2DU, as my alternate. I expect to announce very soon the appointment of selected Canadian amateurs as our representa-

tives on the various panels, each chosen for qualities best suited to his particular task. At this writing, we are about to proceed with the various panel meetings, and I shall endeavor to keep you informed from time to time of our progress through the columns of QST.

YOUR WAR SERVICE RECORD?

You ought to see the war service records coming into Hq. on the card forms we printed in our September issue! We get a handful every day from fellows on distant fronts, proving that, despite the two years' work the Hq. gals have done on our roster, it is very far from complete. They sit here waiting to enter *your* record, for the League is trying to compile the story on what every U. S. and Canadian amateur has done in the employment of his amateur radio know-how during the war. We need only a very little data, easy for you to fill out in the form on the bottom of this page (or which you may reproduce on a post card if you prefer). Won't you do amateur radio and ARRL the favor of seeing that your service record is on file? Just address ARRL, West Hartford, Conn.

THANKS, FELLERS

THE Hq. Gang wants to say its thanks for all the Christmas and New Year's cards received at Hq. from amateurs in and out of the services. The woman's touch of some of the Hq. girls made a very pretty display of them in our lobby, hung on wires stretched along the wall near our office Christmas tree. In addition to cards from amateurs at home we had them in even greater number, we believe, from hams in the fighting forces all over the world, particularly France, the Pacific, Italy, India and Burma—and very interesting art they are. We appreciate them greatly.

PERSONAL MENTIONS

NOTES on four USNR hams:
Comdr. W. Bradley Martin, W3QV, director of the Atlantic Division, has returned from a

(Continued on page 82)

AMATEUR WAR SERVICE RECORD

Name

Present mailing address

Rank or rating

Branch or bureau: Signal Corps, AAF, BuShips, WAVES, etc.
If civilian industry, give title and company.

Call, present or ex; or
grade of op-license only

SERVICE

- Army
- Navy
- Coast Guard
- Marine Corps
- Maritime Service
- Merchant Marine
- Civil Service
- Radio industry,
100% war

Increasing Vacuum-Tube Volt-Ohmmeter Sensitivity

A Balanced-Bridge Circuit for 1-Ma. Meters

BY HARDY GLENN,* W5BRX

By using vacuum tubes in all four legs of the Wheatstone bridge circuit employed in this electronic volt-ohmmeter, a sensitivity of less than one volt is obtained for an instrument using a milliammeter with a scale of one milliampere. This compares with a sensitivity of 1.5 volts or more which is the usual maximum for electronic voltmeters employing the more sensitive 200-microampere current indicator.

A VACUUM-TUBE voltmeter is a device which permits measuring voltages without appreciably disturbing the circuit under test, thereby enabling many measurements otherwise impossible. The capabilities of such an instrument are especially appreciated by those who are accustomed to its use. There are several types of vacuum-tube voltmeters of which the most suitable for general use is the balanced push-pull direct-reading type. Such a voltmeter has been described in an earlier article in *QST*.¹ The popular RCA "Voltohmyst Jr." employs a circuit of this type.

The advantages provided by the circuit shown in Fig. 1 include increased sensitivity and a more rugged, less expensive meter. All previous designs of this type of voltmeter have employed 200-microampere meter movements of which few are to be found around the average ham shack. However, the standard "one-mil" meter is not so rare, whether it be so marked or whether it be any voltmeter bearing the inscription "1000 ohms per volt." The junk box here contained a 200-volt meter bearing the 1000 ohms-per-volt inscription, from which the internal resistance coil was removed, thus providing a 1-ma. movement for beginning the design of a v.t.v.m.

Maximum Sensitivity

It was determined that with the use of a single pair of triodes or pentodes in the Wheatstone bridge circuit, a sensitivity of about 1.5 volts was maximum. This was ob-

*Research Engineer, Stanolind Oil and Gas Co., Tulsa Okla.

¹DeSoto, "A Modern V.T.V.M. for D.C., A.C. and R.F. Measurements," *QST*, Dec. 1941, p. 40.

tainable only with fairly high grid currents which return to cathode through the measuring circuit. For most purposes this was not objectionable, but for certain others it was prohibitive. Two more triodes were substituted for the two upper legs of the bridge, and their grids arranged so that any unbalance in the two lower tubes would be amplified. It was found that reducing the current through the entire bridge (by increasing the bias on the upper tubes) maintained the high sensitivity and at the same time lowered the input grid current. The maximum sensitivity of such a design was found to be 0.32 volt at full scale and the grid current was measured at 0.0008 microampere.

This more than satisfied the requirements, so a final model of the voltmeter was built, reducing the sensitivity to one volt for the most sensitive range, with the resistance, R_{24} , connected in series with the meter. A seven-position attenuator was included to provide range selections of 1, 3, 10, 30, 100, 300 and 1000 volts.

A.C. Measurements

To the final model also was added a diode rectifier for measuring a.c. voltages and a resistance-measuring circuit. The diode rectifier serves to convert a.c. voltages to d.c. potentials which may be measured by the voltmeter. The indicated potential will depend upon the nature and magnitude of the applied a.c. voltage. For sine waves the indicated potential will be substantially the peak value of the sine wave (1.4 times the r.m.s. value). For complex waveshapes the indicated potential will be somewhat less than the peak

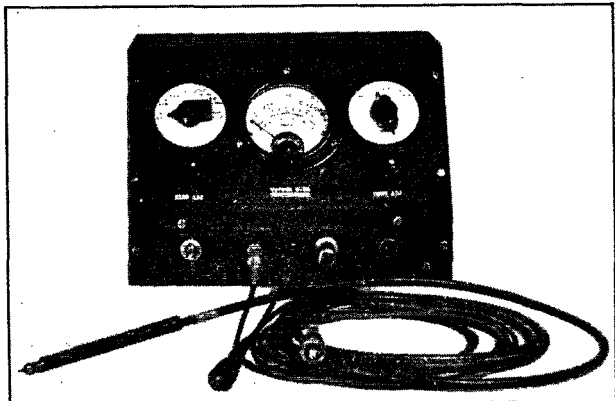

Panel view of the electronic volt-ohmmeter.

value. However, comparisons may be made between different magnitudes of like waveshapes. A contact potential of approximately one volt is developed in the diode rectifier, which is balanced out by a bucking circuit including a penlight cell and the semi-variable potentiometer, R_3 . A filter, R_2C_2 , smooths out the d.c. developed across the diode before application to the voltmeter.

Resistance Measurement

The resistance-measuring circuit employs a single 1.5-volt size "C" flashlight cell which permits measurements from 0.1 ohm to 1000 megohms. The meter series resistance, R_{25} , serves to reduce the full-scale sensitivity of the voltmeter to equal the battery voltage. The battery voltage is supplied to the voltmeter through resistors in such a manner that the resistance being measured forms a part of a potential divider. The potential appearing across the resistance under measurement is applied to the voltmeter. The resistance scale is direct reading. To accommodate the increasing internal resistance of the battery with age, the first series resistor, R_{11} , is variable. This is adjusted first by turning R_{25} to maximum meter deflection. A precision 10-ohm resistor then is measured on the $R \times 1$ scale and the series resistor, R_{11} , adjusted to make the meter read 10 ohms. This adjustment needs checking only occasionally, and as this resistor adjustment

approaches zero, it serves as a warning that the battery is growing weak.

The $R \times 1$ scale was calculated according to the formula:

$$\text{Meter-deflection percentage} = \frac{(R) (100)}{R + 10}$$

Experimental checking of the accuracy of the entire ohmmeter by means of precision resistors has shown that the indicated resistance values do not vary more than 3 per cent from the actual resistance values.

The volt-ohmmeter was checked for operation under conditions of varying line voltage with a Varitran. For line voltages between 110 and 120 the indicated potentials or resistances did not vary more than ± 2 per cent nor more than ± 5 per cent between line voltages of 105 and 125. For continuous operation in any one line-voltage region, the meter can be adjusted to be correct. The instrument draws 18 watts at 117 volts.

The 6F8G was chosen over the 6SN7 or 7N7 for the lower triodes because one grid is well insulated by being brought out through the top of the tube. Another 6F8G was chosen for the upper triodes to reduce the number of tube types required and to facilitate the selection of tubes having nearly identical characteristics. The 6H6GT was chosen for both rectifying positions because of the low plate-power requirements and

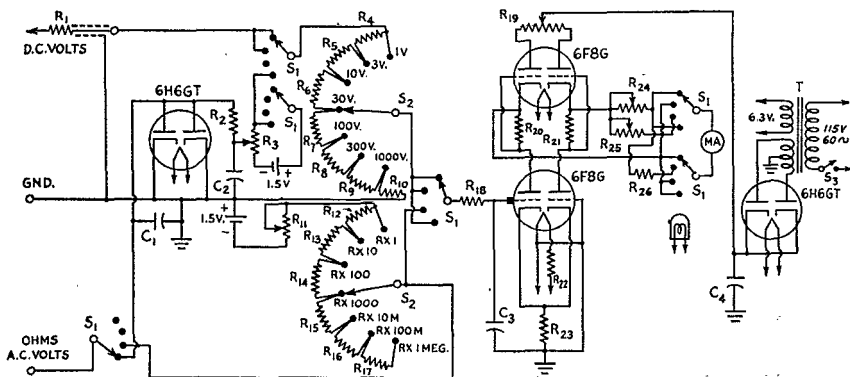

Fig. 1 — Circuit diagram of electronic volt-ohmmeter.

- | | | |
|--|---|--|
| C_1 — 0.02- μ fd. mica or 1000-volt paper. | R_9 — 20,000 ohms, $\frac{1}{2}$ watt precision (see text). | R_{20} — 10,000 ohms, $\frac{1}{2}$ watt. |
| C_2 — 0.05- μ fd. mica or 1000-volt paper. | R_{10} — 10,000 ohms, $\frac{1}{2}$ watt precision (see text). | R_{21} — 10,000 ohms, $\frac{1}{2}$ watt. |
| C_3 — 0.005- μ fd. mica or 1000-volt paper. | R_{11} — 10-ohm, wire-wound potentiometer. | R_{22} — 5 ohms, 5 watts. |
| C_4 — 10- μ fd., 450-volt electrolytic. | R_{12} — 90 ohms, $\frac{1}{2}$ watt precision (see text). | R_{23} — 500 ohms, $\frac{1}{2}$ watt. |
| R_1 — 1 megohm, $\frac{1}{2}$ watt. | R_{13} — 900 ohms, $\frac{1}{2}$ watt precision (see text). | R_{24} — 10,000-ohm wire-wound potentiometer. |
| R_2 — 1 megohm, $\frac{1}{2}$ watt. | R_{14} — 9000 ohms, $\frac{1}{2}$ watt precision (see text). | R_{25} — 15,000-ohm wire-wound potentiometer. |
| R_3 — 25,000-ohm semivariable potentiometer. | R_{15} — 90,000 ohms, $\frac{1}{2}$ watt precision (see text). | R_{26} — 500 ohms, $\frac{1}{2}$ watt. |
| R_4 — 7 megohms, $\frac{1}{2}$ watt precision (see text). | R_{16} — 900,000 ohms, $\frac{1}{2}$ watt precision (see text). | S_1 — Pole of 6-pole, 4-position rotary switch (shorting type preferable). |
| R_5 — 2 megohms, $\frac{1}{2}$ watt precision (see text). | R_{17} — 9 megohms, $\frac{1}{2}$ watt precision (see text). | S_2 — Pole of 2-pole, 7-position rotary switch (shorting type preferable). |
| R_6 — 700,000 ohms, $\frac{1}{2}$ watt precision (see text). | R_{18} — 20 megohms, $\frac{1}{2}$ watt. | S_3 — S.p.s.t. toggle. |
| R_7 — 200,000 ohms, $\frac{1}{2}$ watt precision (see text). | R_{19} — 10,000-ohm wire-wound potentiometer. | T — Power transformer; 500 volts, c.t., 10 ma.; 6.3 volts, 2 amp. |
| R_8 — 70,000 ohms, $\frac{1}{2}$ watt precision (see text). | | MA — D.C. milliammeter with 0 1-ma. scale. Pilot light connected to filament supply. |

to reduce the number of tube types required. This also permits the use of a power transformer having only one filament winding.

The power-supply requirements are not critical. Only three milliamperes at about 300 volts are required. A single 10-microfarad, 450-volt condenser filters adequately.

Reduced filament voltage is used on the 6F8G forming the two lower legs of the bridge. This serves to reduce the grid current flowing through the measuring circuit.

Construction

The junk box was drawn upon heavily in the construction of the instrument. In addition to meter, tubes, sockets, switches, transformer, and other hardware, the junk box provided a sloping-front 7 × 9 inch cabinet which had been saved especially for some kind of test equipment such as this.

The three photographs show the general layout. The front view shows the 3-inch meter in the center of the inclined part of the front panel. On the left of the meter is the range switch, S_2 , with the zero-adjustment potentiometer, R_{19} , immediately below. To the right of the meter is the selector switch, S_1 , with the resistance-adjustment resistor, R_{25} , underneath. From left to right on the vertical section of the front panel are mounted the off-on switch, S_3 , a.c. volts-ohms jack, ground jack, d.c. volts jack, and pilot light.

The switch plates and meter scale were drawn with India ink on "Bristol" board by a draftsman friend. The lettering was accomplished with the smallest LeRoy lettering guide, size 80. The meter scale was cemented over the old meter face with paper cement, sometimes called "frisket" cement. The switch plates were similarly cemented onto

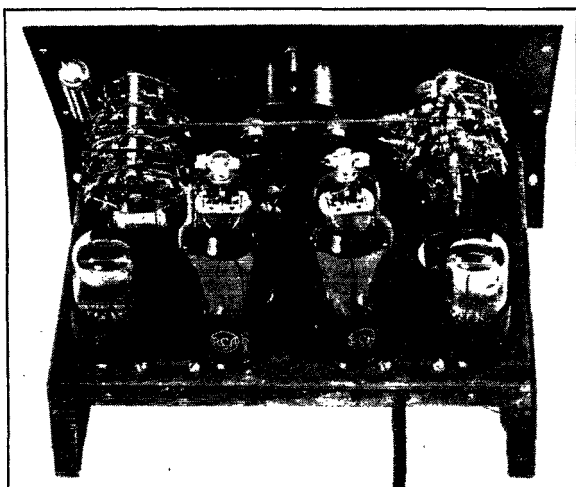

The interior of the vacuum-tube volt-ohmmeter, showing the four tubes, the milliammeter and the rotary switches.

thin metal discs two inches in diameter having a three-eighths-inch diameter concentric hole. A light coat of clear lacquer was sprayed on to provide protection against fingerprints. The lettering on the panel represents the writer's first attempts at using the panel lettering system described in the August, 1944, issue of *QST*.²

The rear view shows the four tubes equally spaced across the rear edge of the chassis. The tubes, from left to right, are the 6H6GT plate-power rectifier, the 6F8G lower dual triode, the 6F8G upper dual triode, and 6H6GT a.c.-measurement rectifier. The power transformer is mounted with little room to spare between the 6F8Gs and the meter.

The bottom view shows the two variable resistors, R_{24} and R_{25} , mounted with their shafts pointing downward from metal "L" brackets from the side of the chassis. Their shafts were cut to about three sixteenths of an inch in length and provided with screwdriver slots to enable adjustment through quarter-inch diameter holes in the bottom of the cabinet. It is well to lay out the holes in the bottom of the cabinet and drill pilot holes not larger than one-eighth inch. The hole then may be filed to one-quarter inch with a rattail file, meanwhile filing the hole in the proper location. The writer found that the original one-quarter-inch holes had to be "moved," since it proved to be almost impossible to measure and lay out the adjustment holes with sufficient accuracy (and luck) to obtain proper alignment.

The battery for resistance measurements is held in place against the corner of the chassis by a spring made from a length of hacksaw blade. The proper

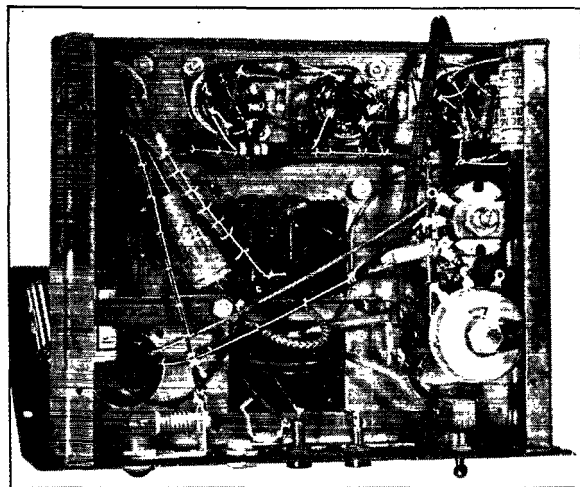

Bottom view of the electronic volt-ohmmeter. The chassis and cabinet were salvaged from a previous job.

² Foot, "A Hand-Screening Process for Amateur Instrument Panels," *QST*, Aug., 1944, p. 38.

length was determined and the blade snapped in two by bending sharply. The broken end was ground smooth, the corners rounded and the teeth ground off on an emery wheel. The hole in the end of the blade was used to mount the spring on one of the transformer mounting screws.

Wiring and Leads

All leads were cabled with Irish linen cord (or shoemaker's thread) with the exception of the leads in the range and selection circuits leading from the jacks on the front panel to the grid of the 6F8G. It is important that these leads be isolated one from another and from ground to avoid erratic operation produced by varying leakage resistance and varying contact potentials.

The d.c. voltage test lead and prod were constructed of shielded single-conductor microphone cable terminating in a one-megohm resistor contained within the prod handle. The shield extends inside the prod handle to within one-half inch of the joint between the conductor and the resistor. Small wooden wedges, cut from matchsticks and toothpicks, were driven into the end of the test prod around the braided shield so as to prevent movement of the prod with respect to the cable.

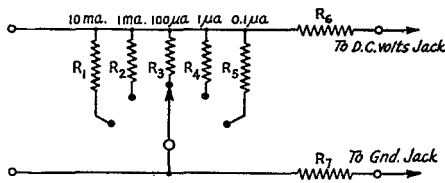

Fig. 2 — Shunt resistance arrangement for current measurements with the electronic volt-ohmmeter.

- | | |
|----------------------|--------------------------|
| R_1 — 300 ohms. | R_4 — 300,000 ohms. |
| R_2 — 3000 ohms. | R_5 — 3 megohms. |
| R_3 — 30,000 ohms. | R_6, R_7 — 10 megohms. |

Such movement would pull or twist off the leads to the resistor. The end of the cable's outer rubber covering was stretched over the end of the test prod. This makes a neat looking joint between the cable and the prod. To prevent the covering from being pulled off the prod, the cable was wrapped tightly with about twenty-five turns of Irish linen cord. Both ends of the cord were pulled under the wrapping by beginning the wrap with a long loop. The turns were wrapped over the loop, and finally the finish end of the cord was threaded through the exposed remainder of the loop. The beginning end of the cord forming the loop then was pulled until the finish end of the cord was pulled under the wrap to the middle. The two ends were then cut at the edge of the wrap, and care was exercised to prevent cutting into the rubber covering of the cable.

Calibration

The precision resistors needed for the voltage and resistance ranges probably will not be found in many junk boxes. The writer prepared suitable resistors by selecting resistors either correct in value or somewhat below the proper resistance value. Where correct resistors could not be lo-

cated, those slightly lower than correct resistance were chosen and carefully notched with a triangular file sufficiently deep to bring the resistance up to the proper value. This should be done very carefully, since it is easy to file too deeply and spoil a resistor. The resistance values may be measured with a precision resistance bridge or with an accurate ohmmeter. While preparing the resistors, it is well to keep in mind that the accuracy of the finished instrument will be limited by the accuracy of the resistance values.

Resistances R_{20} and R_{21} should be as nearly matched as possible. The potentiometer, R_{19} , serves to balance the bridge. If balance cannot be obtained within the range of adjustment of R_{19} several other 6F8Gs should be tried in both positions to obtain a pair with more nearly identical characteristics.

Measurements of r.f. voltages by the a.c. portion of the instrument can be made by constructing a probe and cable of the type described by DeSoto in the December, 1941, issue of *QST*. This can be designed to replace the 6H6GT a.c. measurement rectifier tube.

The measurement of currents from 10 milliamperes to 0.1 microampere full scale will be possible by the construction of a shunt resistance box and the use of the 1-volt scale of the instrument. The circuit for such a shunt resistance box is shown in Fig. 2. In using the instrument to measure current it should be remembered that the chassis and cabinet are included in the circuit, and any potentials developed at the measuring point with respect to ground will be present at the cabinet. The two ten-megohm resistors, R_6 and R_7 , serve to lessen the danger to the operator should accidental contact be made with the cabinet at high voltage.

Straits

Radio communication might have been impaired and the work of producing quartz crystals materially increased had not an accidental fracture of a crystal revealed the usefulness of small size crystals. A South African amateur, after dropping his precious "rock," reported his accident to the American crystal manufacturer when ordering a replacement, stating that his crystal was now in tiny fragments but that they still worked!

From this chance remark grew the design changes that produced millions of military crystals at an enormous saving in quartz and expense. The former one-inch square crystals were replaced by tiny bits of quartz averaging less than three-tenths of a square inch in area. The thickness of the new crystals runs from fifteen to eighteen thousandths of an inch. Reduction in crystal size resulted in the production of more plates per pound of raw quartz and also in the use of quartz of a size and quality formerly considered non-adaptable to radio use. The saving in quartz is estimated at 1200 tons.



IN
QST

25 YEARS AGO THIS MONTH

THE cover illustration for our February, 1920, issue is the first of a series by 8UX, inventor of the QSL card and long-known as "QST's cartoonist." The leading technical article is one of the classics of amateur literature, being "A New Method for the Reception of Weak Signals at Short Wave Lengths," by Edwin H. Armstrong, president of the Radio Club of America, and delivered as a paper before that club — the first publication of the new wartime invention, the superheterodyne. "Spark Coil Transmitter Design" is the subject of an article by Sumner B. Young, 1AE, who shows that it is possible to get good reliable communication out of a spark-coil rig when it is properly tuned up; and who gives an arrangement for switching in series antenna condensers to provide operation on 100 and 150 meters as well as on 200. H. E. Rawson contributes the first QST notes on "Round's Round Ground," the ground system developed by Captain H. W. Round, chief engineer of Marconi, Ltd. Guy Entwistle authors a plea for 500-cycle sets; we have the quenched gaps on the amateur market now — all we need is the alternator and we amateurs ought to be able to evolve a cheap low-power one that would serve us.

2PL is the subject of this month's Station Description. A novel feature is the location of the transmitter in a doghouse outside the house, so that the ground lead is but three feet long and the rig feeds directly into a vertical fan antenna seventy-five feet high. The fan is suspended from a cable stretched over but not attached to the tops of two ninety-foot oak trees. The trees can sway in the wind and slide under the cable without breaking it.

We have become conscious of freak transmission phenomena. For a period of two weeks in December no one in New England could hear an amateur signal farther than a hundred miles, and Midwestern stations monotonously report "No Eastern stuff." It is known that there were cosmic disturbances — in fact, the end of the world had been prophesied for December 17th. For reasons that we don't understand, our long-distance communication was completely blanketed for days on end, justifying our Operating Department's policy of striving for relay stations not over 50 miles apart. The editor also notices temporary dead spots, with signals apparently going over our heads and close-in stations unheard, although we know they are on and going because we can hear their more-distant correspondents.

Traffic Manager Smith publishes the "Traffic Rules & Regulations of the ARRL," adopted by our Operating Department. ARRL is sponsoring a 9 P.M. curfew on local small-talk and the official hours for relay work are from 9 to 12 P.M. The interference problem is very severe. Various

plans are being created in the bigger cities to cope with it. Philadelphia amateurs have a system whereunder any amateur desiring to open up will first transmit a series of Morse Cs (IE), and any busy ama-

teur desiring him to wait a few moments will respond with the wait signal (AS). Representatives of all the major clubs in the Boston area have met in a convention, under the chairmanship of Guy Entwistle, to seek improvements in the QRM situation. It is recommended that a control station be set up in each community to preserve order and assign the right to transmit, that offending amateurs who fail to cooperate or who deliberately interfere shall be tried by their peers and, if guilty, blacklisted in QST; and that for repeated offenses they be turned over to the Radio Inspector, since malicious interference is a federal offense. It is hoped that vacuum-tube transmission will solve most of these difficulties, as the few c.w. stations in operation are experiencing very interesting results and the signal is much sharper. The traffic manager warns that if unlicensed operation and the use of false calls and profane language does not cease, ARRL will act against the offenders.

What is believed to be the first amateur communication with a plane in flight has occurred, in recent flights of the NC4 of transatlantic fame. On recent recruiting flights, 9BR was in constant touch over the St. Louis-Hannibal stretch, while 5AC similarly supplied communication over the New Orleans-Galveston flight at distances up to 200 miles, both handling traffic for their cities.

Irving Vermilya, 1ZE, and Jimmy Rau, 3AEP, are the subjects for this month's "Who's Who." In a letter, VN also reports the dismantling of the Marconi Company's old WCC by the Navy. Every article of equipment was taken away and the wooden towers are down. "Many of the operators of today learned copying old WCC. 'Old Reliable' was sure the name for it. The idea was to start at 10:15 or die in the attempt. It never died while Marconi had it."

Louis G. Pacent, well-known manager of the wireless department of Manhattan Electric Supply Company, has left the Mesco stores and launched into business for himself under the name of Pacent Electric Company, with offices at 150 Nassau Street, New York. . . . Western Electric VT-1s are available at \$10, but only for uses other than the transmission or reception of messages. RCA and Marconi join in an advertisement warning amateurs and dealers against violation of the recently-upheld Fleming patent. The genuine Marconi V.T. at \$7 is the only authorized tube. The Audiotron is not licensed, and users will be prosecuted. . . . A California company offers to repair burned-out receiving tubes at prices ranging from \$4 to \$6.50, guaranteeing them to operate as well as when new. R. U. Clark, 3rd, advertises his "Radio Buyer's & Builder's Handbook," "describing and simplifying many new radio inventions and improvements."

Practical Applications of Simple Math

Part X—Determining Operating Points for Tetrodes and Pentodes

BY EDWARD M. NOLL,* EX-W3FQJ

THE proper operating point of a pentode is more difficult to find than that of the triodes discussed in previous installments because the screen current must be taken into consideration as well as the fact that all points must be carefully located to insure accuracy. The latter precaution is necessary because there is little change in plate current over the linear portions of the bias lines.

Operating Point for Tetrode Output Stage

One of the easiest points to find is demonstrated in Fig. 1 and Fig. 2. In this example the 5000-ohm load line for the 6V6 already is drawn on the curve and all that remains to be done is to locate the plate-voltage point on the load line. Since transformer output is used, the reflected load is 5000 ohms but the d.c. resistance of the primary winding is only 300 ohms. Thus a 300-ohm d.c. load line is drawn from the supply-voltage point toward the plate load line with a slope of 300 ohms. The intersection of this line, *AOB*, with the load line (point *O*) is the operating point. Having found the load line it is an easy matter to determine a value of cathode resistance which will produce the required 12 volts of bias when a voltage of 250 is applied to the plate and screen circuits. The screen voltage is exactly 250 volts, while the plate voltage is slightly less because of the drop through the primary of the plate transformer. The plate current at the operating point is approximately 50 ma. and the screen current for the 6V6 is approximately 10 per cent of this value, or 5 ma. Therefore, the total current

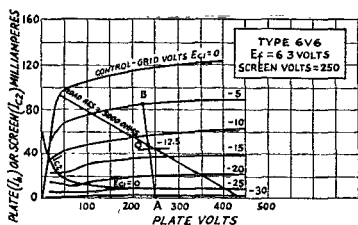

Fig. 1—Average plate characteristics for a type 6V6 tetrode.

through the cathode resistor is 55 ma. and the value of the cathode resistor is

$$R_k = \frac{12}{0.055} = 218 \text{ ohms.}$$

If the exact ratio of plate to screen currents is not known, the ratio can be approximated by assuming a value for the screen current of 20 to 25 per cent of the plate current for pentodes and 7 to 10 per cent for beam tetrodes.

* 300 Fifth Ave., Asbury Park, N. J.

Operating Point for R-C Pentode

The following procedure is used to locate the operating point of a resistance-coupled amplifier which uses a 6C6 pentode. The characteristic curves for this tube are shown in Fig. 3 while the diagram appears in Fig. 4.

1) Construct the 100,000-ohm load line from the supply-voltage point on the plate-voltage coordinate.

2) Assume two values of bias voltage along the load line. These are points *A* and *B* at 2.5 and 4 volts respectively along load line *XY* shown in Fig. 3.

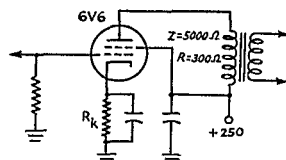

Fig. 2—Typical output-stage circuit with transformer coupling.

3) Find the value of plate current which would flow through the cathode circuit at the bias values given above when using a 1500-ohm cathode resistor.

At this point it is necessary to consider the effect of screen current flowing in the cathode resistor. In the case of the 6C6 this current is 25 per cent of the plate current as shown by the screen-current scale in Fig. 3. Thus, in order to anticipate the true operating point on the plate current-plate voltage characteristics, the effective cathode resistance must be found by increasing the value of the cathode resistor by the same percentage as that by which screen current increases the total cathode current. Consequently, in drawing the bias line the slope of the line is determined by

$$(1500) (0.25) = 375$$

$$\text{Effective } R_k = 1500 + 375 = 1875$$

4) Find the effective plate currents flowing for points *A* and *B*.

$$\text{Point A: } I_p = \frac{2.5}{1875} = 0.00133 \text{ amp., or 1.33 ma.}$$

$$\text{Point B: } I_p = \frac{4}{1875} = 0.00214 \text{ amp. or 2.14 ma.}$$

5) Locate these plate-current points on the same plate-voltage coordinates. These points are *A'* and *B'*. A line drawn through these points will intersect the load line at the operating point, *O*.

6) The plate current shown at this point is 1.7 ma., the plate voltage 130, and grid bias -3.19 volts.

7) These points can be checked using the same procedure outlined in the last previous installment of this series.

Grid bias = $(0.0017) (1875) = -3.19$ volts.
 Plate voltage = $300 - [(0.0017) (100,000)] = 130$ volts.

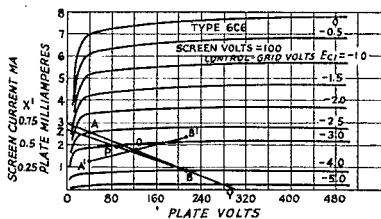

Fig. 3 — Average plate characteristics for a type 6C6 tetrode.

8) As a final check the actual resistance in the cathode circuit and the current flowing through it are considered. Thus the bias due to plate-current flow is

$$E_c = I_p R_k = (0.0017) (1500) = -2.55 \text{ volts.}$$

The bias due to screen current is

$$E_c = I_{s0} R_k = (0.000425) (1500) = -0.637 \text{ volts.}$$

Therefore the total grid bias is

$(-2.55) + (-0.637) = -3.19$ volts proving that the operating point as determined previously is correct.

9) It is possible also to draw a screen load line on a characteristic curve as demonstrated by line YZ in Fig. 3. One point of the screen load line is of course at the supply-potential point on the plate-voltage coordinate. A second point is point P which is the screen voltage and grid-bias point. In this case the screen voltage is 100 and the grid bias -3.187 volts.

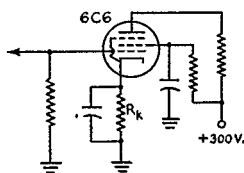

Fig. 4 — Typical resistance-coupled pentode amplifier circuit. $R_k = 1500$ ohms. $R_p = 100,000$ ohms.

10) Draw line YZ through these points. The slope of this line is the value of the required screen resistor or

$$R_{s0} = \frac{300}{0.00064} = 470,000$$

11) This value can be checked since we know that the screen resistor must drop the supply voltage by 200 volts and the value of the screen current is 0.000425 amp. or

$$R_{s0} = \frac{200}{0.000425} = 470,000 \text{ ohms.}$$

★ ★ ★ ★ ★ ★ ★ ★

Gold Stars

SECOND LIUT. DON F. HARRINGTON, AC, WSMAD, 32, was killed October 17, 1944, in the crash of two Army gliders near Malden, Mo.

Lt. Harrington attended Clinton (N. Y.) High School. Enlisting on Dec. 15, 1941, he became an aviation cadet in September, 1942, and was commissioned Jan. 7, 1943. WSMAD spent six months in the New Hebrides as the co-pilot of a C-47 evacuating wounded from the Bougainville area. On returning to the States he became a glider instructor.



WSMAD started his ham career in 1934 and was active on the 1.75-, 3.5- and 14-Mc. bands.



STAFF/SGT. CLARENCE R. HENDRICK, WSUFO, 21, was killed April 19, 1944, when the Army plane in which he was a radio mechanic crashed at Nashville, Ill.

Following his enlistment in July, 1941, "Bud" Hendrick had been stationed at Scott Field, first for training and then as an instructor and radio main-

tenance man for the school. He was on a routine flight at the time of his death.

WSUFO was interested mainly in 1.75-Mc. and lacked only two states for his 1.75-Mc. WAS.

LOUIS BIGOTTO, W2KCD, an American Airlines flight radio officer, was killed in Scotland, August 26, 1944, when his plane, making an instrument landing in a fog, crashed into a building, killing all on board.

W2KCD was an ardent amateur and a competent broadcast engineer. Although active on the 14- and 7-Mc. bands, Louis always had time to assist in emergency traffic handling and to participate in the local ham doings.

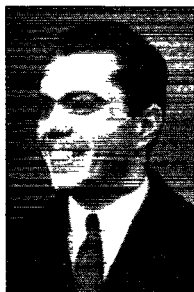

Louis Bigotto was a native New Yorker and a graduate of RCA Institute. Although only 24, he had become one of the most beloved radio men in the New York area.

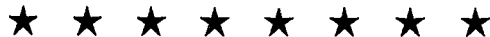

Hams in Combat



Radio Saves Life of Aleutian Outpost Commander

BY CPL. BILL GRANBERG*

WIND rocked and buffeted the radio hut clinging to the mountainside. The raging blizzard drove the snow until buildings were no more than little white mounds. It was one of winter's worst storms on this Aleutian island—an island which, for sake of military security, must remain nameless.

In the radio hut, operators of the Signal Aircraft Warning Company were struggling to maintain communication with their outposts. QRN and QRM always offer a headache to the brass-pounders in this area, but this stormy night it was worse than ever. The receivers had to be coaxed and babied before they would pull in signals strong enough to be read through the static.

Suddenly the station's call was heard, followed by the call letters of one of the most inaccessible outposts—and then the Q signal for a priority message. "Priority" at 7:30 at night could mean only one thing—trouble! The message was short and to the point. Decoded, it read:

SEND DOCTOR AT ONCE MAN RESCUED AFTER BEING BURIED TWO HOURS IN SNOWSLIDE.

The message-center runner fought his way down the mountain to the company medical officer's hut. Capt. Hyman Marcus donned his parka and boots and struggled back up to the radio shack. Reach that outpost tonight? Impossible! The trip could only be made by boat, and no boat could live in that storm!

*Somewhere in the Aleutians.

Capt. Marcus regained the microphone and spoke grimly: "Give the patient blood plasma immediately . . ."

But a man's life was at stake. . . . Capt. Marcus asked the operator if he could get through to the outpost on 'phone, so that he might talk with the men there. The operator was dubious, but said he would try. He transmitted the Q signal for "listen out for voice." A test call was made, voice contact was established between the two stations and held—although the interference was terrific. Capt. Marcus picked up the microphone. He exchanged questions and answers with a first-aid man, Cpl. Antony LaTorrey, at the outpost.

Quickly, Capt. Marcus added up the information. Obviously the patient was suffering from severe shock. His condition was critical. Capt. Marcus regained the microphone and spoke grimly:

"Give the patient blood plasma immediately. Slowly and carefully. Put nothing in his mouth." Then he added: "I'll stay by this station. Keep me advised of every step, and of the patient's progress. Understood?"

The answer came back. "Understood, sir. Anything else?"

"By the way, who is the patient?" asked Capt. Marcus.

The reply came slowly, and the voice seemed to break. "It's the outpost commander, sir."

The outpost commander! That meant Lt. Thurman McCoy, one of the best-liked officers in the outfit. The kind who might best be described as a gentleman and a grand guy.

We later learned the story of how Lt. McCoy came to be buried in the snowslide. That afternoon Lt. McCoy, accompanied by an enlisted

man, had set out from the outpost for a point a mile away, where a barge had been wrecked on the beach by a storm. Their plan was to salvage certain valuable equipment from the barge before it was broken up by the sea.

Along the beach, at the foot of a 300-foot cliff, the two men fought their way against the blizzard. Suddenly the snow above gave way and a huge avalanche hurled its weight at the men. Lt. McCoy was buried completely by the slide, while the enlisted man was caught up to his hips. Carefully the soldier dug himself free and struggled back to camp for help. With blankets, litter and shovels, the men of the outpost hurried to the site.

They worked swiftly and carefully. On one side was the sea, pounding against the beach and drenching them with spray. On the other was the cliff with its hazard of more slides. Six men, swept off their feet by the waves, almost lost their lives before companions pulled them back to comparative safety.

After two hours of hazardous work Lt. McCoy's unconscious form was laid on the litter, covered with blankets, and lashed down. Working in relays of four men, the unconscious officer was carried to his hut, where he was stripped to the skin and warmed. Cpl. LaTorrey directed first-aid efforts until he went to the radio hut to attempt contact with Headquarters.

After he had received his radioed instructions, Cpl. LaTorrey administered blood plasma for about three hours. The plasma brought immediate improvement. Within an hour Lt. McCoy became rational and his pulse, respiration, and temperature improved. Cpl. LaTorrey relayed word of his patient's condition to Sgt. Little, the outpost radio operator, who passed it on to the Headquarters station. There Capt. Marcus kept his vigil until after midnight, giving advice and encouragement. During the night, progress was reported by c.w.

In a subsequent statement to the writer, Capt. Marcus credited radio communications with having saved the life of Lt. McCoy, declaring that tragedy could not have been averted had it not been for the radio contact with the outpost. Much credit should also go, of course, to the men who rescued Lt. McCoy from the snowslide, to the medic who directed the first-aid work and administered the plasma, and to the radio operators.

Capt. Marcus had more work to do. The following day an Army crash boat carried him to the distant outpost, where he went ashore in a dory to move Lt. McCoy into a boat anchored off shore, to bring him in for hospitalization. The first two attempts to move the injured officer resulted in near disaster. Once that day and again the following day heavy seas capsized the dory before it could reach the crash boat. Lt. McCoy was spilled into the sea and rescued by his companions. The third day, in calmer seas, the trip was successful and the outpost commander was finally brought in for hospital care.

That's the way the war is being fought in the Aleutians — against hazards of the worst weather in the world. And that, too, is the way it is being

U. S. War Bonds for Stories of War Service

QST wants reports on the experiences of radio hams in active service on the battlefronts — for immediate publication in this section, where feasible, or to be held confidential where security considerations so require.

Do you have a story of war service to tell — either your own or that of someone you know? Then write us a letter giving full details, including photographs, clippings and other substantiating data where available. If your story is published in *QST*, you will receive a \$25 U. S. War Bond. Please indicate clearly on the report if it is available for publication in its entirety, if names, dates or places should be deleted, or if all information must be held confidential.

won by men unafraid, by men trained to do an efficient job — whether they be radio operators, medical officers or first-aid men.

It was with pardonable pride that we saw our radio team click this night, when they got all the messages through in the old ham tradition to save a man's life.

Strays

Study of captured radiosonde equipment now allows comparison with that used by our country. The German and Japanese use techniques and measuring elements similar to ours but differing in the type of elements and in the method of transmitting the information. The Germans use two general types of radiosondes. One employs wet and dry bulb mercury-in-glass thermometers for temperature and relative humidity measurements, and a mercury-filled glass manometer for pressure measurement. Two transmitters and antennas and two radio frequencies are required. The Germans also use chronometric radiosondes employing bimetallic elements for temperature and hair hygrometers for humidity measurements. Japanese radiosondes are very similar to those of the Germans.

American radiosondes operate with one transmitter, audio modulated, and one radio frequency. The variation in modulation can be translated into meteorological data and recorded graphically on a chart at the receiver.

Both our radiosondes and those of the enemy have batteries for their power source. The enemy uses vibrator power supplies while our equipment operates solely from tapped batteries.

German and Japanese radiosondes are well designed and constructed and are smaller in size and lighter in weight than our equipment. However, our radiosondes are the only ones designed for mass production. In addition, our radiosondes give a greater number and consequently more accurate readings than those of the enemy.



HINTS AND KINKS FOR THE EXPERIMENTER



DRIVE FOR HOME-RECORDING CUTTER HEAD

As one of the many hams who have sought a wartime outlet for some of their peculiar talents in constructing audio gear — amplifiers, speaker baffles, phono-pick-ups and recording equipment, I found that I got too late a start in the recording game. No turntables, no motors, no pick-ups, and especially no drive mechanisms for recording heads, are generally available at the beginning of 1945.

Even the pregrooved blanks which were widely used in the early days of home recording are no longer stocked by dealers. Their use never produced satisfactory fidelity in the finished recording, while the lowered costs and increased production of driven recording units in the prewar period decreased the demand for such blanks.

I found a GI synchronous self-starting motor at a sale of Army-salvage goods. The 12-inch turntable from a worn-out Victrola was mounted on the motor after a tricky job of filing the proper taper inside a short length of copper tubing to make an adapter to fit the motor spindle. Fortunately I had acquired a crystal pick-up some years ago. A flyer from a mail-order house led me to the purchase of an unmounted magnetic cutter head. The job of making a straight metal arm, with adjustable counterweight and pivot-and-swivel bearings was fairly easy.

The big problem was how to drive that cutter head across a recording disc at the proper pitch and speed, under modulation. The sort of finely threaded lead screw and half nut that would best do the job is definitely off the market. I have no lathe, and even if I had I am not enough of a machinist to cut a decent lead screw, harden it properly and make well-fitted bearings for it. I did try to adapt a fan-shaped gear with spiral-gear drive for the purpose, but the cut was far

too coarse and there was too much play in the gears.

New Year's Day was coming up fast, and our family at home had hearts set on the completion of the recorder by that time. We hoped to send voice greetings to my son in the Army Air Corps, away from home at Christmas for the first time in his eighteen years. I found a way to cut that record, without gears or lead screws.

A professional recording studio cut a 12-inch master disc for me with a silent track — just the spiral groove, with no modulation applied. I obtained a supply of 6½-inch paper-base acetate discs, and superimposed one of them upon the master disc on the turntable. A removable drive pin had been threaded into the top of the turntable at the proper distance from the spindle to engage the off-center hole in the recording discs, one of which was used as a template for the drilling. In this position, about 2½ inches of the diameter of the pregrooved master is exposed beyond the outer edge of the blank recording disc.

As shown in Fig. 1, a 2-inch length of ¼-inch rod was mounted on the side of the cutter arm, at a right angle, opposite the position of the cutting needle. A small binding post which held an ordinary playback needle, was fitted into the outer end of the rod, with a short shank, held by a set screw which allowed for the adjustment of the angle of the tracking needle which travels in the silent groove of the master record, and drives the cutting head across the blank disc. This adjustment is necessary because, combined with the adjustment of a counterbalance on the cutter arm, it will determine the depth of the cut. Too deep a cut will narrow the bridge between the lines on the recording, which may then break down under heavy modulation. Too light a cut will result in imperfect reproduction.

It is absolutely necessary when attempting to use this method of drive that the turntable should run true and level. Otherwise the cutting needle will skip some points in the revolution of the disc.

A speaker output transformer was substituted for the modulation transformer on the 30-watt amplifier formerly used to modulate the 'phone rig at W1JLK, and the leads from the cutting head plugged into the 8-ohm output of the transformer. Using the Brush crystal headphone which had given excellent results as a microphone in the earlier use of the modulator, speech was recorded very satisfactorily on the 6½-inch recording blanks, and the family holiday greetings will go through, to be heard by our boy in some company dayroom at a far-distant air field. — *Hollis M. French, W1JLK*

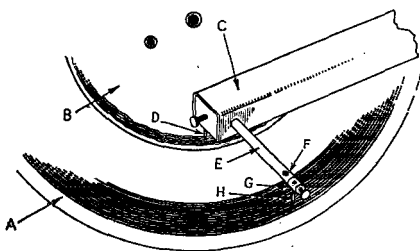

Fig. 1 — Device for driving a cutter head for home recordings. (A) Master pregrooved 12-inch blank. (B) Recording disc, 6½-inch diameter. (C) Cutter head and arm. (D) Cutting needle. (E) Drive bar. (F) Set screw. (G) Binding-post chuck. (H) Tracking needle.

USING ONE RECEIVER TO CHECK I.F. OF ANOTHER

WHEN a signal generator is not available, this simple means of lining up a receiver's i.f. amplifier may help.

The idea is to use a second receiver whose i.f. amplifier already is tuned to the desired i.f. The second receiver, used as a signal generator, is tuned to a station. The output signal then is taken from one of the i.f. stages and fed through a mica condenser to the i.f. amplifier of the first receiver. The first i.f. amplifier then can be lined up on this signal.—*Kenneth S. Digre, Marion St., at Polk, Tampa 2, Fla.*

— . . . —

ELECTRONIC BUG MOVEMENT

THE dash lever of many homemade bugs is imperfectly fitted to the pivot spindle so that there is appreciable vertical play apparent at the thumb paddle. Further, the dash lever is forced against the pivot spindle when at rest or when making dashes, but away from the pivot spindle when making dots, resulting in a certain amount of lateral play.

Builders of electronic bugs can take advantage of the absence of the dot mechanism to eliminate this vertical and lateral play. This is done by mounting dot and dash contact points, the knob and the thumb paddle all on a single lever, *C*, as shown in the photograph. Lever *C* is attached to the pivot spindle *B*, as shown in Fig. 2. An examination of the photograph makes it apparent that the lever *A* is being forced against the pivot spindle at all times, whether making dots, making dashes or resting. After making dashes the thumb paddle will return to the same rest position as after making dots and there is no lateral play. If careful adjustment of the pivot points is made there need be no vertical play apparent at the thumb paddle.

The dot spring *D* and the dash spring *E* are both compression springs. The dash spring assembly is constructed in a conventional manner

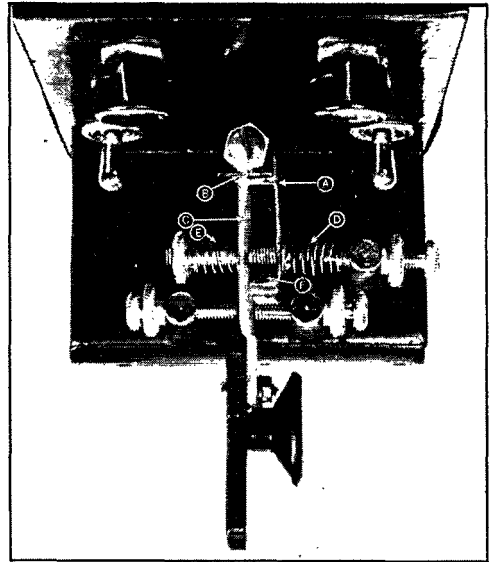

Electronic key movement made by W9SOC. (A) Equivalent to dash lever on a standard bug key. (B) Pivot spindle. (C) Keying lever. (D) Dot spring. (E) Dash spring. (F) Dot stop.

excepting that it protrudes to the left instead of the right. The dot spring could be placed anywhere along lever *A*, the position opposite the dash spring being chosen for symmetrical appearance. The dot stop *F* is a rod projecting upward from the key base.

Lever *A* may be made of very light material, since the only strain it must bear is that of the pressure of the springs. One-sixteenth-inch sheet iron was used in the model shown in the photograph for lever *A*, and one-eighth-inch brass for lever *C*. The pivot support was made of one-eighth-inch iron bar. The contact posts and screws are standard Vibroplex parts.

This movement is easy to build, compact, rugged, and free from lost motion from either vertical or lateral play. — *John R. Bass, W9SOC.*

— . . . —

TESTING RECEIVER POWER-TRANSFORMER PRIMARIES

MY BIGGEST headache comes from putting a receiver with a supposedly good power transformer across the line, then having to replace a blown fuse. I don't like to blow fuses. It makes me nervous.

The only way to check a transformer primary for shorts is through the use of a.c. I built up a small test panel for this purpose. The circuit consists simply of the combination of an a.c. voltmeter paralleled by a 40-ohm resistor and a s.p.s.t. switch, the whole in series with one side of the line. The switch is left open and the receiver to be tested is plugged in. If the transformer is

(Continued on page 80)

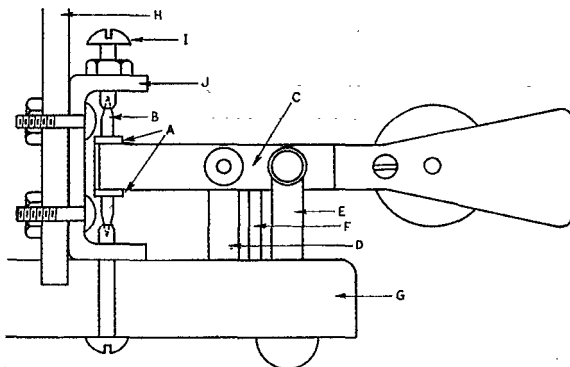

Fig. 2—Side view of electronic key movement, illustrating bearings and supports of moving parts. (A) Ears on lever *A* (see photograph) (B) Pivot spindle. (C) Keying lever. (D) Dot spring post. (E) Dash contact post. (F) Dot stop. (G) Key base. (H) Control panel. (I) Pivot screw. (J) Pivot support.



CORRESPONDENCE FROM MEMBERS

The Publishers of *QST* assume no responsibility for statements made herein by correspondents.

FUTURE GROWTH OF AMATEUR RADIO

St. Raphael's Church, Dubois, Ind.

Editor, *QST*:

I have read President Bailey's testimony in December *QST* and it seems to me his predictions about the future growth of amateur radio are entirely reasonable in the light of its growth in the past and in consideration of the present circumstances he has so ably described.

... I heartily agree with our League president in all the statements he has made concerning the merits and advisability of amateur radio as an American institution. All his statements are one hundred per cent true, and anyone who has followed amateur radio as long as I, is compelled to admit that his statements are entirely correct. I am glad to know we have in the amateur such men as Mr. Bailey and others who can and do present the facts of our institution in such clear and unmistakable language.

— Rev. Joseph A. Terstege, W9LQE

SEPARATE SPOTS FOR DX AND LOCALS

Inglewood, Calif.

Editor, *QST*:

Sitting here musing upon the probability of a great deal of postwar DX activity it occurred to me that it might not be a bad idea to segregate the American and foreign stations within our bands on a purely voluntary basis, as a mutual aid in working DX.

In the pre-1927 days when foreign amateurs occupied a nice slice of ether in the vicinity of our present day 36-meter marine band and the Yankee rigs were on 37.5 to 42.8 meters, it was nice to tune around in the DX band with no QRM from domestic stations!

If this idea meets with general approval, the ARRL could give it publicity and I am sure it would be given the same cooperation as other ARRL sponsored plans.

If we are given the same bands when we return to the air, perhaps the U. S. hams would confine their activity to 7000-7200 kc. on 40 and leave 7200-7300 for the DX brethren. That would permit foreign stations using crystal control to make the move by simply grinding down their present rocks, or perhaps it might be preferable to give them the low-frequency end of the band so they could use the same crystal for doubling.

I am not suggesting that our bands be made narrower, but think that a gentlemen's agreement would make DX work even more fun. We now have plenty of time to work out the details!

— George Dery, W6HG

SOP FOR AMATEURS?

c/o Postmaster, New York, N. Y.

Editor, *QST*:

The following letter represents the ideas of several of us, with regard to the return to normal operating. . . .

Sitting here in the shack the other day, while copying a 'phone circuit, the following idea struck us as being one of the things that should make postwar amateur radio just a bit better, and a bit more along the efficient lines of our present military set-up.

We should standardize the method used in calling and carrying on our 'phone contacts. Some of our prewar 'phone transmissions left a lot to be desired, in regard to efficiency and accuracy. The League has always advocated a regular procedure for calling and carrying on an intelligent 'phone contact, but we all will admit that little has actually been done about employing these fine rules set forth by the League. I am not advocating that our 'phone contacts of the future have the same rigid set-up as our military outfits now use, but we could benefit greatly by borrowing some of the snappy operating practices used. In postwar times, John Q. Citizen, with his new "all-wave" radio receiver is going to be hearing a lot of us guys, and I for one don't think the old-time "hi-diddly-bump-de-bump" chatter is going to cement those ever-strained ties between the ham and his self-inflicted public, the b.c. listener.

How about employing a standard "phonetic alphabet," as we do in the Navy, and use these names for our letters that are used in calls? Our alphabet in the Navy is derived from the names of the flags used for international signaling. The same system could be used in amateur radio. For instance, I think it would be a lot easier to read that "S-2" boy who is signing a call like "W3CDE" if he transmitted that same call — "W3 cast-dog-easy." There is not one chance of the guy on the other end getting confused on that call. I know there will be a lot of the gang that insist that the old system of having your own pet words for your call, like the author's "This is the voice of 'Harry-Jimmie and Eddie'" will serve the same purpose. Maybe so, but I think that using a standard system would be better for those foreign contacts, where the op might not savvy some of the "Yankee slang" that is used in the old system. I think it would bring ham radio one step up the ladder of modernization, a bit further out of the old "school-boy-in-the-attic" category and make it more efficient.

— Eddie B. Frye, RM1c, W2HJE

LESS QRM?

c/o Fleet Post Office, New York, N Y.
Editor, *QST*:

It has been commercial practice for many years to use one frequency for calling, and others for working. Would this system be of help to us amateurs?

The commercials use 500 kc. as their calling frequency, and other frequencies for traffic.

Hams could use this idea on, say, the 3500-4000 kc. band. Let's say 3600 kc. Whenever they call CQ, stations would listen on 3600 kc. for CQs and answer on the same frequency.

Here is how it might work out:

CQ CQ CQ DE W8XXX AR
W8XXX W8XXX DE W2XXX K
W2XXX DE W8XXX 3650 KC. K
W8XXX DE W2XXX 3675 KC. K

This exchange would take place on 3600 and then these two hams would continue their QSO on 3650 and 3675 kc. if they were both crystal controlled. If they both had v.f.o. rigs they could both go to the same frequency, say 3675 kc. Thus the calling frequency would again be clear.

Advantages: 1) A ham can set his receiver to the calling frequency and be sure to hear anybody's CQ without tuning up and down the band.

2) C.w. calls can be very short, because the receivers are tuned on the CQ calling frequency.

Objections: 1) Hams with only crystal control will object to buying any new crystals. 2) It will be said that the calling frequency will be crowded too much, making it impossible for any CQs or calls to get through.

— Jack C. Nelson, W8FU

IDO—AN INTERNATIONAL LANGUAGE

San Jose, Calif.

Editor, *QST*:

In November *QST* W7DZZ wrote about the need for an international language. This would be an immense help, not only in the cause of peace, but in all scientific and social relations. Apart from radio, telephone and telegraph transmission there is a tremendous lot of work being wasted in printing the scientific abstracts such as chemical, engineering, biological, botanical, etc., in all of the leading languages. These might be replaced by one abstract in an *international language* until such time as scientific papers are originally published in this international language.

W7DZZ seems to overlook the fact that we already have an international language—IDO.

In 1629, the French philosopher, Descartes, defined various systems that might be followed. Of the several dozens that were proposed, tried and forgotten, only two reached prominence. Volaptuck in 1887 at one time claimed over a million followers but it was so difficult and complicated it was abandoned. Esperanto started in 1887 and has grown to have many followers but it still is too difficult. It is being gradually replaced by IDO which is a greatly simplified form of Esperanto.

IDO was started in 1900 at the Paris Exposition when a movement was started with the object of creating a language that:

a) Would meet the requirements of ordinary social life as well as those of commerce, science and philosophy.

b) Would be acceptable to people having an ordinary elementary education and especially by the peoples of Europe.

c) Would not be an existing national language.

By 1907 this delegation had received the endorsement of 310 societies from all countries, and the approval of 1250 members of universities. Taking Esperanto as a base, they created IDO which has suppressed all accented letters and may be written with an ordinary typewriting machine and printed with ordinary type. It has few grammatical rules which have neither exceptions nor irregularities. IDO is truly international since its root-words are selected by taking root-words understood by the most people.

The International Auxiliary Language Association (IALA) has its headquarters in New York. Leading American commercial, industrial and banking firms as well as diplomatic and scientific personnel belong to IALA. However, instead of accepting IDO and having an academy to improve it as the years went by, they started from the beginning, apparently not realizing that IDO represents the effort of a group of outstanding experts of many nationalities.

An effort should be made to have IALA make a start with IDO.

Since many organizations have committees in the IALA, might it not be possible for the ARRL to have representation in that organization?

— E. H. Twilight, ex-K4JA

W2PL ATTENDS ANGLO-AMERICAN HAMFEST

Somewhere in Germany

Editor, *QST*:

I very much enjoyed dropping in on a little hamfest in London while visiting that city in October. Am glad to report that every call area of the continental U. S. was represented. I was very happy to see an old friend there—Lt. Col. "Dave" Talley, W2PF. Also met a very interesting British YL and, believe it or not, her call was G2YL. Altogether it was a grand afternoon.

In looking through October, 1944, *QST* I note with great respect the claim of W2JA and W2RB (page 57). I doubt if I have the right to challenge that claim since my active participation in ham radio had not been unbroken through the years. However, I was on the air with a one-inch spark coil in 1911, got my first "ticket" December 30, 1912, and received the call 2PL in early 1913. Served as a radio man in World War I with the Signal Corps from October 9, 1917, to July 23, 1919. Feeling sure that we would again be involved in war I was glad to act on the suggestion made to me by W9GGG and W2LSD that I join up with the F.T.S. net and encourage more traffic handling among the boys on "40." I feel sure that

the efforts of F.T.S. and the ARRL in the matter of traffic nets did much to get many a future Army or Navy operator started. 1940 found me a fairly regular member of B.P.L. under the old call, W2PL.

My job over here is not exactly radio but I am happy that I can again be of use to the Signal Corps in World War II. My ham activity, however, is certainly responsible for my being here.

I am sure the future of ham radio is the greatest present concern of ARRL and I know that the fate of our beloved hobby is in good hands. You are all to be congratulated on the fine work you are doing in keeping up interest, in continuing publication of *QST* and in assembling a formidable mass of evidence of the national value of the ham. Keep up the good work!

— T. O. Daniel E. Lindsay, W2PL

TNX DE ZL

Frankton, Waikato, 25 Greenwood St.,
New Zealand

Editor, *QST*:

I have recently returned from duty in the Pacific Islands where it was my privilege to come in contact with many American radio amateurs to whom I wish to pay tribute.

Those same hams, like many others, have done and are still doing a marvelous spot of duty for their country in every theater of war. Their country owes a great debt to them.

I have met them in every phase of war duty and they are all carrying it out with great efficiency. Wherever I've met an American ham there has always been that true fellowship and understanding which is so often lacking between peoples of many nations today, and is still the greatest asset, the world over, between individuals and nations.

During the past months I have met the following hams: W9JHF, W1LHD, W2NAQ, W9SMP of the Marines; W9JGL, W5GGC, W4GYA, W5JMV, W2HXW, W3BUH, W4ANN, W9TWY, W3DBJ, of the Army; and W7JBD, VE4AMK, W5JOX, W6MND, W9CYC, W8FGI, W4HJJ (W5QL's 2nd op), Chief Lee K. Bell of the Navy.

I have the privilege of looking back on quite memorable occasions when several of us would gather around on board ship or under cocoanut trees and discuss what is, to us all, the world's greatest hobby.

Many thanks to those who assisted me in renewing my subscription to the ARRL for several years. I owe much to W6MND, W1LHD and W2NAQ for being able to listen and enjoy the world news and happenings.

I extend to any of the above hams a real welcome should they travel to this part of the world and I trust it is not so very long before we are all returned to our normal way of life when we can renew our wartime acquaintances by the medium of amateur radio.

The very best of luck to you all.

— R. "Mac" McLeod, ex-ZL1KN

DUNGAREE NET ACTIVE

c/o Fleet Post Office, New York

Editor, *QST*:

I have just received the November issue of good old *QST* and, as always, I was very glad to get the latest news of the amateur radio world.

I have noticed several articles from time to time in regard to identifying yourself as a ham although in uniform. I have my call painted just above my pockets on my dungarees, and have had the good fortune of meeting several fellow hams who noticed the ham call at once. Of course this does not apply to any dress uniform, but a sailor meets a lot of fellow sailors while in the blue dungaree uniform.

Mr. Milgram in his "Letter to the Editor" states that a land-line operator is so fast that press copying would put him to sleep. I would like to see some of these "wizards" sit down and copy WCX for an hour without slowing up. I doubt that he would be able to take the slightest nap.

Since Mr. Milgram doesn't sign an amateur call, he wouldn't understand how an amateur feels about the "ham" in amateur radio. I think every amateur who holds any ticket always will like the word "ham." I wonder how Mr. Milgram could handle a QSO on 40 meters with a reasonable amount of QRM. Since his land-line circuits are static free, I feel that he would have a wonderful time trying to pull the sigs through for a fairly good QSO. Maybe when he gets a ticket and a few QSOs under his hat, he will understand a little more of what the "ham" is, what he has done, and what he is going to do in the future.

Good luck and good listening.

— S/Zc F. J. Yandle, W4ITK

COMMENTS ON CARBON MIKES

Plainville, Conn.

Editor, *QST*:

Yesterday one of the hams here told me he read my article "Why Low Level Microphones" in December *QST*; that it sounded convincing but he still didn't believe it. Today "Sourdough" wrote in the opposite vein.

I think reasonably good reading of my article would indicate that I have dealt very briefly with points "Sourdough" raises — though he has put them in considerably more succinct form.

— McMurdo Silver

"Sourdough" comments:

... By golly, that there article in the December *QST* about carbon mikes is right down-to-earth-common-horse-sense. Young feller — you missed a coupla points, though.

Here the telephone people spent years fussing and fiddling about to get the best *speech* characteristic on the line. They built it into their mikes — cavity resonance, etc., and these tarnation young squirts is so blinded by chromium plating and "streamlining," they ain't got enough sense to use what's waiting under their noses for a coupla bucks.

(Continued on page 72)

OPERATING NEWS

CHARLES A. SERVICE, JR. W4TE
Acting Communications Manager

LILLIAN M. SALTER
Asst. Communications Manager

Postwar Prospects. A review of the past twelve issues of *QST* shows Operating News has devoted its space almost exclusively to WERS activities and has said very little about strictly ham doings. This was as it should be. WERS is not amateur radio but is largely powered by amateurs who have contributed generously of their time, knowledge and facilities to an important civilian wartime measure and have found the nearest possible approach to peacetime transmitter construction and communication.

Granted the work was of vital importance as an auxiliary defense measure in the early phases of the war and latterly was indispensable in natural disaster emergencies, it now seems more attention should be given in this column to items of purely amateur interest. Compared with thousands of licensed and prospective hams in the armed services, in Civil Service and in war industries, amateur participants in WERS are a handful and WERS activities are of secondary importance to amateurs sweating it out in foxholes in the South Pacific or Quonset huts in Iceland.

They are thinking, these men in the service, of that postwar rig, of plans for reducing u.h.f. military technique to amateur practice, of coming QSOs with buddies met in far places, of DX contests and WIAW qualifying runs uninterrupted by air-raid alerts. To them this month, therefore, we devote Operating News and the future prospects of the best of all hobbies, asking the WERS group to QRX until our hooks are cleared with the men in the service.

First and foremost in amateur thinking these days is the subject of postwar frequencies. Will we get our old bands back? What provision will be made for our use of frequencies above 300 Mc.? How can we accommodate thousands of postwar

hams on overburdened prewar frequencies? Should FCC license regulations be stiffened to keep our numbers within reasonable limits and prevent intolerable QRM? What is the League doing in Washington? Will foreign governments grant their amateurs corresponding privileges? These questions come to ARRL Headquarters from amateurs all over the world and the present increase and urgency of such inquiries is a good indication the spirit of ham radio burns brightly in spite of a three-year shut-down. If any good can be said to come of war, from our standpoint it is a realization of the high value we now place on the institution of amateur radio and our vital concern for its future.

The Communications Department cannot enter into a detailed discussion of these questions as they are primarily the concern of the Secretarial Department and have been dealt with at length in recent issues of *QST*, but we *would* like to talk briefly about certain aspects of your relationship with the League and its work in your behalf at Washington. Current correspondence from members relative to League policy falls into two clearly defined categories: the first kind of letter says, "You're doing a swell job, fellows, keep it up," and the second cries, "Treason! You're selling amateur radio down the river." Fortunately, for our peace of mind, the "treason" type numbers only one in a hundred — and we've got the correspondence to prove it! Strangely enough the most ardent League-baiters are fellows back home in civilian jobs with axes to grind in their spare time; men in the trenches, on battle wagons and in the skies are the orchid-senders and we are grateful for their loyalty and support.

The axe-grinders seem to be under the impression League policy is directed by whim or decision

Here are the currently active members of one of Chicago's oldest ham clubs, the Chicago Suburban Radio Association. Left to right, seated: W8LVV, W9LIP, W9RIY, W9FCN and W9YXQ. Standing: W9PMJ, W9YQC (sec'y), W9VSJ, W9DZJ, W9MAT (pres.), W9PNV (vice pres.), W9PK, W9RLM and W9MZW. All members shown hold WERS operator permits, and also are busy with regular club meetings which have been held throughout the war. We know that the 26 returning members will be deeply grateful that the club fires have been kept burning!



of League Headquarters and we again stress a fact stated many times during the past twenty years since League affairs went democratic and our present constitution was adopted; to wit, your Board of Directors and not Headquarters shapes League policy. You, the licensed members of the League, elect a director from your division. He represents your views at Board meetings and, in conjunction with sixteen other directors, determines League policy for the coming year. Headquarters gets its instructions from the Board, carries them out to the letter, makes few decisions of its own and is subject at all times to review by the Board. Consequently when a member takes pot-shots at Headquarters over something which doesn't happen to suit him, his aim is badly misdirected. Your director solicits your suggestions, weighs them carefully, determines League policies on the basis of the greatest good for the greatest number and orders them carried out by the Headquarters officers.

Our representation of amateur interests at RTPB meetings and at the recent FCC hearing followed instructions by the Board, which met last May and decided that we should ask for the return of prewar amateur frequencies without alteration, plus additional slices in the high frequency portion of the spectrum. The Board was faced with this situation. Either it could try and figure future needs of all services and tailor its demands for frequencies accordingly, or it could stand pat for prewar frequencies and let other services prove a greater necessity if they could. Obviously the latter choice placed us in the stronger position and your Board of Directors wisely decided on that course. President Bailey and Secretary Warner carried out the Board's directions at the FCC hearing as reported in the November and December, 1944, issues of *QST*.

The radio art has gone far under the impetus of war, new devices have come into being which will have later civilian application and the demand for frequencies by all interests far exceeds the supply. It was evident from the start many other radio services were presenting conflicting claims for portions of our bands, and divergent needs would have to be reconciled by FCC, representing civilian interests on the one hand and IRAC, representing government requirements, on the other.

Now that our needs have been presented to FCC, what are the chances of our getting back our prewar bands intact? Let's face the facts. Today many more government departments and commercial interests are in need of frequencies than before the war. Some of these are definitely "phonies" and can be disregarded, but some represent powerful financial institutions serving millions of people, some are concerned with safety devices for the preservation of life and property on land, sea and air, and still others have more restricted but nevertheless valid claims for production of peacetime goods and services looking toward a higher standard of living. We cannot disregard the fact these concerns represent an investment of millions of dollars

which must yield a return and, but for the fact the amateur is an essential part of the radio world, they would not hesitate to relieve us of our frequencies if it meant more dividends for stockholders. That is business, and competition in the radio field is becoming keener every year.

Amateur radio does not exist because we are free citizens and should have the right to pursue our hobby unmolested, or because we had the frequencies first, or because we are taxpayers, or because we are strongly organized to repel nasty commercials. We exist solely because we are a national asset, which has proved its worth magnificently in war and peace and as such we are entitled to our place in the radio structure. No amateur need ever apologize for his avocation or seek to justify his existence, but let him never forget he exists because he gives his country as much as he receives and renders a special service to the public and to the nation which cannot be replaced by any military or industrial activity.

This fact is certain: amateur radio is far stronger today than it was after the last war and, at the same time, it must face more powerful competition. Other services have valid claims to frequencies and must be accommodated. Somewhere along the line there must be a compromise. Before some of you fellows get excited at that word "compromise" and beat your breasts in despair over the future of amateur radio, take heart in the knowledge other interests must likewise compromise and if some of our frequencies are lost or shifted, additional ones will be assigned in compensation.

Amateur interests are not served by thumping FCC desks and haranguing senators, demanding our rights and the hell with everyone else, as recommended by some of our members. Delegations by the carload go to Washington every year and try that method but they never make the headlines nor the grade. Our future will be settled around the conference table by competent government officials who have heard the testimony for the amateur, who will weigh the needs of all radio services on their relative merits and will finally decide where each of us belongs in the radio spectrum. Some compromise may be inevitable but the amateur has demonstrated his worth to his country, for a job well done he is respected by government and industry alike, and whatever changes lie in store he will not find himself up the creek without oars.

— C. A. S.

BRIEFS

The Washington Radio Club invites ham-aspirants to join a class in code instruction which is being held every Saturday evening from 7:30 P.M. to 8 P.M. Anyone interested is invited to join the class now, or to drop in later when the speed reaches his level. (Code speed will start from scratch and continue up to 13 w.p.m. and over, depending on the requirements of those participating.) For further information, contact one of the following recently elected officers of the club: *Pres.*: Elizabeth M. Zandonini, W3CDQ, 4430 Garrison St., N.W., Wash. 16, D.C.; *Vice-Pres.*: Oscar Reed, W8FPQ, 10702 Lorain Ave., Silver Springs, Md.; *Secy.*: Barbara Peck, 230 34th St., N.E., Wash. 19, D.C.; or *Treas.*: George Sugar, 1909 2nd St., N.E., Wash., D.C.



Mike Holbrook, WERS licensee, operating mobile unit WKBS-21 during the storm at Syracuse, N. Y., on Nov. 30-Dec. 1, 1944.

WKBS and the Syracuse Snow Storm

On December 1, 1944, a limited number of WERS stations (WKBS) were called into service at the request of an operating official of the Central New York Power Corporation. The occasion was one of the worst snow storms (30 inches) in the history of Syracuse.

At about 1 A.M. Friday, December 1st, a telephone call was received from the local superintendent of the Lighting Company, who said that there was an extreme need for WERS services. A high-tension transmission line had broken somewhere between Baldwinsville and Phoenix, also Phoenix and its area had had no service since 5 P.M. Thursday. There were many instances elsewhere of disruption of service, not only of light and power but also of street lighting.

Because the work to be done involved a technical understanding of electric distribution lines, only certain Lighting Company employees (also WERS members) were called out. One exception was made in order to secure a particularly powerful mobile unit for relay purposes. This policy proved very practical and resulted in the forwarding of accurate and dependable information from the field to the Company's operating headquarters. The activated units included two fixed stations and five mobile units. Two of the latter were used for relay purposes only. The other three were employed in checking the cause and location of wire breaks and reporting on road conditions.

The first task was to try to reach the men who were patrolling the line for breaks between Baldwinsville and Phoenix. Two WERS units were sent north, but failed to get very far beyond Liverpool because of clogged highways. These units then returned to the city and, with the addition of one other, were assigned to other work.

This work was quite important. It consisted of sending a WERS mobile unit into a near-by area to find and to radio back the location of the line break or whatever caused the disruption of service, also to report road conditions, stating the best route for the line repair crews to reach the source of the trouble. Because the origin of the interruption could be a case of fallen wires, blown high-tension sectionalizing fuses on poles, twisted low-tension or house service wires, the job required WERS personnel who had a knowledge of electric distribution fundamentals. This was particularly so in the case of observing from the ground blown line fuses at the top of a pole and the ability to determine whether they supplied a line or a transformer.

Many messages were handled, the control station log showing a total of 175 contacts. The information collected and radioed back by WERS cars was invaluable in enabling the repair crews to be sent directly to the source of the trouble. Because of WERS assistance, war industries and homes of war workers had electric service much sooner than would otherwise have been the case.

This was the first time that WKBS units had participated in a real emergency. The experience gained by the participants seemed well worth their efforts.

—W3STD

Ham Yarn No. 4

BY HARRY L. ROSCOE, * W9UCN

A RATHER amusing episode took place one day several years ago on 160-meter phone. W9UCN and W9SVY had a schedule for a rag-chew every day at noon. On that particular day they perpetrated a dastardly plot that managed to backfire, much to the chagrin of one of the conspirators.

Even in those days good maids were as rare as precious jewels. UCN's wife had just engaged one. Her name was Dina, short for Dynamite, no doubt, for she was a two-hundred-pound tornado when armed with a broom.

It was her first day and the XYL was showing her around the house. Finally they arrived at the shack. The transmitter was on. UCN was at the mike but remained silent. Dina peered around at the stacks of radio magazines, the wires, tools, condensers, resistors and such, which cluttered up all available space. Suddenly she got that mad house-cleaner's gleam in her eye, pushed up her sleeves, and said purposefully, "Iff'n you-all don' mind, ah'll start in cleanin' right here, firs' thing in the maw'nin'! Sho' looks like this place needs organizin'." A devilish leer came over UCN's face. He remained ominously quiet and furtively flipped a concealed switch. SVY came blasting in, "Dina, don't you dare touch a thing in this room. You just do your organizing and cleaning elsewhere. And see that your cooking improves. And don't eat so much, you're getting too hefty. Now you behave yourself because we have our eye on you. Incidentally, that blue and white apron is very becoming."

Dina's natural chocolate-brown complexion changed to gray, her eyes rolled wildly. She threw her apron over her head and, in spite of her size, simply flew down the stairs. When UCN and his XYL finally caught up with her she was pulling on her coat and muttering, "That musta been the poleece. Ah ain't nebbber had no trouble wif dem. If'n it warn't dem, den dis place am haunted and ah ain't hesitatin' here no more!" It took plenty of explaining and pleading and the promise of a two-dollar raise to change Dina's mind. But she maintained that the radio must be a "deevce of the debil" or else how did it know she had on a blue and white apron. She couldn't be convinced otherwise. Needless to say she never stepped foot in the shack again and UCN reigned happily thereafter amid his squalor.

* 2658 E. 77 St., Chicago 49, Ill.

Ham Yarns

What is the most unusual experience you have ever had in connection with ham radio? Have you ever had a QSO that took place under peculiar circumstances, or that resulted in an exciting adventure? Have you ever been surprised, terrified, or highly amused at some incident that occurred during the good old days when you were operating your ham rig?

CD invites you to submit your story of the most unusual ham yarn you know of, whether experienced by yourself or a fellow amateur, for possible publication in *Operating News*. All stories should contain approximately 500 words, must be true, and must center about the subject of ham radio.

Each winning "Ham Yarn" will be published in this department, and the author may select a bound *Handbook* (Defense or regular edition), *QST* binder and League Emblem, Lightning Calculators, or any other combination of ARRL supplies of equivalent value (\$2.00), as his prize.

All entries should be marked "Ham Yarns" and addressed to the Communications Dept., ARRL, West Hartford 7, Conn.

BRIEFS

John Zorzy, W3JIM, furnishes the following new information on 35 w.p.m. press transmissions:

Station	Freq.	Time (EWT)	Origin
WEC.	8930 kc.	8-10:30 P.M.	New York
WQW2	5270 kc.	8-10:30 P.M.	New York

Also, Dawson W. Bearden informs us that KFS has started broadcasting news for the Army at 0830 immediately following the 0605 KFS/KNA6 transmission on the same frequencies and at the same speed. WHD, on about 8350 kc., sends the New York Times news summaries starting at 0500 at about 16 w.p.m. He further reports that there is some good copy from KROX (OWI in San Francisco) on 5985 kc. beginning at about 0900/1100, 30/35 w.p.m.

When a survey was made recently to determine how many hams were included among the personnel of the U.S. Navy Underwater Sound Laboratory at New London, Connecticut, and of the laboratories of the Columbia University Division of War Research, which are a part of this Navy activity, it was found that there were more than fifty, representing practically every section of the U. S. It naturally followed that a hamfest was planned.

This was held in December at the Lighthouse Inn, out on the ocean front at New London, with an attendance of forty-five. A cheering talk on the ham's place in the postwar radio spectrum was given by Cy Read, assistant secretary of the League. Another guest speaker was Commander J. B. Hoag of the U. S. Coast Guard Academy at New London. Lt. Commander J. B. Knight, W2JJ, related some humorous experiences he had when he was one of the NBC engineers helping to establish television atop the Empire State Building. Several movies were shown, including the new Hallicrafters war picture "The Voice of Victory." Then came the distribution of door prizes. Even in these lean days of radio parts and equipment it was possible to scrape up seven of these prizes.

The parting shot was a "Perfect Copy Code Contest." The winner was Aleck Sienkowski, ex-W1HV.

Among the hams engaged in this war activity, which is credited with being an important contributor not only to the success of our warfare against the U boat but to the tremendous successes of our own submarines in the Pacific, are: W1CJN, W1CLI (ex-W2BV/W4WH/W8BFS/W1G BU), W1DCM, W1FNY, W1FOZ, W1HNW, W1HRN, ex-W1HV, W1IOH, W1IOW, W1KRB, W1KYV, W1KZQ, W1LVI, W1QV, W2FHR, W2HO, W2HTF, W2JCR (ex-W2OF), W2JJ (ex-W2ALU), W3AMD, W3EC, ex-W5EQV, ex-W6ARE, W6HL, W6IZU, W6RCY, W6UBT, ex-W8BEL, W8BNC, W8CKM, W8IPU, W8JUG, W8LNM, W8LOM, W8MAP, W8PEY, W9AWL, ex-W9BCZ, W9BNI, ex-W9BNC, W9DBG, W9DGP, W9DIT, W9HEK, W9IFM, ex-W9IR, W9JMR, W9KEY, W9SAG (ex-W2KHA), W9UZI, W9VQD and W9WRA.

— S. Gordon Taylor



During the hamfest held recently by hams of the U. S. Navy Underwater Sound Laboratory at New London, Conn., these amateurs took part in the "Perfect Copy Code Contest," which was won by ex-W1HV. Left to right, front row: W8PEY and ex-W1HV. Back row: W6HL, ex-W9IR, a guest, W9AA, W2JJ, W1QV and W6IZU.

ELECTION NOTICES

To all ARRL Members residing in the Sections listed below:

The list gives the Sections, closing date for receipt of nominating petitions for Section Manager, the name of the present incumbent and the date of expiration of his term of office. This notice supersedes previous notices.

In cases where no valid nominating petitions have been received from ARRL full members residing in the different Sections in response to our previous notices, the closing dates for receipt of nominating petitions are set ahead to the dates given herewith. In the absence of nominating petitions from full Members of a Section, the incumbent continues to hold his official position and carry on the work of the Section subject, of course, to the filing of proper nominating petitions and the holding of an election by ballot or as may be necessary. Petitions must be in West Hartford on or before noon on the dates specified.

Due to resignations in the San Joaquin Valley and Utah-Wyoming Sections, nominating petitions are hereby solicited for the office of Section Communications Manager in these Sections, and the closing date for receipt of nominations at ARRL Headquarters is herewith specified as noon, Thurs., Feb. 15, 1945.

Section	Closing Date	Present SCM	Present Term of Office Ends
W. New York	Feb. 1, 1945	William Bellor	Feb. 15, 1945
San Joaquin Valley	Feb. 15, 1945	Antone J. Silva (resigned)
Utah-Wyoming	Feb. 15, 1945	John S. Duffy (resigned)
Hawaii	Feb. 15, 1945	Francis T. Blatt	Feb. 28, 1941
Sacramento Valley	Feb. 15, 1945	Vincent N. Feldhausen	June 15, 1941
Alaska	Feb. 15, 1945	James G. Sherry	June 14, 1942
Southern Minn.	Feb. 15, 1945	Millard L. Bender	Aug. 22, 1942
New Hampshire	Feb. 15, 1945	Mrs. D. W. Evans	Sept. 1, 1942
West Indies	Feb. 15, 1945	Maria de la Torre	Dec. 16, 1942
Western Fla.	Feb. 15, 1945	Oscar Cederstrom	Oct. 1, 1943
Idaho	Feb. 15, 1945	Don D. Oberbillig	April 15, 1944
South Dakota	Feb. 15, 1945	P. H. Schultz	May 18, 1944
Alabama	Feb. 15, 1945	Lawrence Smyth	May 22, 1944
Iowa	Feb. 15, 1945	Arthur E. Rydberg	May 26, 1944
Los Angeles	Feb. 15, 1945	H. F. Wood	July 1, 1944
Arkansas	Feb. 15, 1945	Edgar Beck	Aug. 17, 1944
North Dakota	Feb. 15, 1945	John McBride	Aug. 17, 1944
Virginia	Feb. 15, 1945	Walter G. Walker	Oct. 15, 1944
New Mexico	Feb. 15, 1945	J. G. Hancock	Oct. 15, 1944
Santa Clara Valley	Feb. 15, 1945	Earl F. Sanderson	Oct. 15, 1944
Tennessee	Feb. 15, 1945	James B. Witt	Nov. 15, 1944
Georgia	Feb. 15, 1945	Ernest L. Morgan	Nov. 29, 1944
Southern Texas	Feb. 15, 1945	Horace Biddy	Dec. 15, 1944
Kentucky	Feb. 15, 1945	Darrell A. Downard	Dec. 15, 1944
Western Penna.	Mar. 15, 1945	E. A. Krall	April 1, 1945
Mississippi	Mar. 15, 1945	P. W. Clement	April 1, 1945
Rhode Island	Apr. 2, 1945	Clayton C. Gordon	April 15, 1945

1. You are hereby notified that an election for an ARRL Section Communications Manager for the next two-year term of office is about to be held in each of these Sections in accordance with the provisions of the By-Laws.

2. The elections will take place in the different Sections immediately after the closing date for receipt of nominating petitions as given opposite the different Sections. The Ballots mailed from Headquarters will list in alphabetical sequence the names of all eligible candidates nominated for the position by ARRL full members residing in the Sections concerned. Ballots will be mailed to full members as of the closing dates specified above, for receipt of nominating petitions.

3. Nominating petitions from the Sections named are hereby solicited. Five or more ARRL full members residing in any Section may nominate any full member of the League as candidate for Section Manager. The following form for nomination is suggested:

Communications Manager, ARRL (Place and date)
 38 La Salle Road, West Hartford, Conn.
 We, the undersigned full members of the ARRL residing in the..... Section of the..... Division hereby nominate..... as candidate for Section Communications Manager for this Section for the next two-year term of office.

(Five or more signatures of ARRL full members are required) The candidates for five or more sections of the League full members in good standing or the petition will be thrown out as invalid. Each candidate must have been a licensed amateur operator for at least two years and similarly, a full member of the League for at least one continuous year, immediately prior to his nomination or the petition will likewise be invalidated. The complete name, address, and station call of the candidate should be included. All such petitions must be filed at the headquarters office of the League in West Hartford, Conn., by noon of the closing date given for receipt of nominating petitions. There is no limit to the number of petitions that may be filed, but no member shall sign more than one.

4. Members are urged to take initiative immediately, filing petitions for the officials of each Section listed above. This is your opportunity to put the man of your choice in office to carry on the work of the organization in your Section.

— Charles A. Service, Jr., Acting Communications Manager

ELECTION RESULTS

Valid petitions nominating a single candidate as Section Manager were filed in a number of Sections, as provided in our Constitution and By-Laws, electing the following officials, the term of office starting on the date given.
 Oregon Carl Austin, W7GNJ Nov. 22, 1944



ATLANTIC DIVISION

EASTERN PENNSYLVANIA — SCM, Jerry Mathis, W3BES — 3CHH is back in Philadelphia, working for B&W for a short time. 3GUV paid us a visit and stated that he and 3DZR still are in Washington in the Signal Corps. 3QV is just finishing a 30-day leave from the So. Pacific. He said that 3GRF and 9VKF asked about us. The York Road Club held a well-attended meeting at 3HFE's place. Service members attending were 3CXU and 3QV. HFE himself is in the Navy, stationed locally. They played an interesting home-recording which was made of the gang the week before Pearl Harbor. Harry Spitzkopf, WKIB-38, and Bud Wahl, WKIB-153, passed their ham exams. 3IKW was in to say hello to all the Frankford Club gang while on a short leave from the So. Pacific. 3HYT, now RM1c, is OK, according to a recent letter. 3RR writes that he is following events through QST and sends 73 from Denver. 3QV allowed us to make copies of a recording made in April, 1941, of the Red Cross test at Rayburn Plaza, Philadelphia. On that day one of the Frankford Radio Club portables relayed a message from 3DPV/3 at Red Cross Headquarters to the National Headquarters at Washington, via 3CDQ. 3AKB was at the key of 3BES/3. Records don't lie! 3BES/3 had a gosh-awful chirp and 3AKB left out dots here and there. Copies will be supplied to interested parties at the cost of the disc and, if mailed, the postage. 3FED is now technical director of KYW. FB. 3AQN sent us a swell photo of his new shack full of recording equipment. Recording is for the duration only and he will be back running the E. Pa. net soon, we hope. 1LIG is in Philadelphia operating WKIB. Many thanks for the reports. Keep them coming. 73, Jerry.

MARYLAND-DELAWARE-DISTRICT OF COLUMBIA — SCM, Hermann E. Hobbs, W3CIZ — The new Washington Radio Club publication is called *D.C. Notes*. 4GBW was commissioned an ensign in the USNR. GKP taught his 5-year-old junior operator how to solder! CAB entertained the Washington Radio Club at his home. EEN has just been promoted to captain in the USNR. EZN works for BuShips. CQS now works in Washington. HZ rides a bicycle to work regardless of the WX. About 25 of the WJDC gang attended a WERS meeting in Baltimore and met the governor of Maryland. ZD moved to New Jersey. HMX is master of ceremonies for the "mosquito network" in New Caledonia. There are more hams in Washington than ever before. All districts are represented. Let's have a postal or telephone call from you to let us know what is doing. We can't write this column without news. ETT is a Navy lieutenant. EJB is a teletype repair expert! GZQ has been promoted to lt. comdr. CDQ had the Washington Radio Club gang up for a party. Let's keep this column alive. We want to hear from any of the hams in this area. 73.

SOUTHERN NEW JERSEY — SCM, Ray Tomlinson, W3GCU; Regional EC for So. N. J., Technical Radio Advisor for N. J. State Defense Council, N. J. State Radio Aide for WERS and Radio Aide for Hamilton Twp. WERS, ASQ; EC for Somerville and vicinity, including South-branch, and Radio Aide for Hillsboro/Branchburg Twps. WERS, ABS; Assistant Radio Aide for Hillsboro/Branchburg Twps. WERS, ACC. ASQ reports having been in attendance at a meeting recently of several high national officials of WERS and civilian defense, as well as some of the FCC officials in Baltimore, Md., at which several items were discussed at length. The only portion of the discussion which can be reported is the fact that FCC has flatly stated that all WERS stations must adhere strictly to rules and regulations of operation on drills or tests, and that "ham-chewing" absolutely must be eliminated. The radio aide for Hamilton Twp. reports that additional WERS operator permits have been received recently, and other applications are now ready for FCC action. Reconstruction of emergency control unit Nr. 31 into an m.o.p.a. is under consideration by ITS. A new unit has replaced the temporary operation of a DK2 at Nr. 4. A new unit has been built for operation on a.c./battery or Vibrapack and has given a swell account of itself under test, as fixed, portable, and portable-mobile.

Construction on new units including t.r.f. stages has been slow due to lack of good components. A general meeting of the WKPX personnel was held Dec. 17th at the location of Nr. 18. The purpose of the meeting was to discuss some of the present problems of the net, also plans for more efficient operation and placement of personnel in case of emergency. An organization of this group was formed which will be known as the "Hamilton Township WERS Operators' Association." Bill Fry, operator of Nr. 21 was elected pres.; Karl Frank, operator at Nr. 18, secy./treas., and Fred Muhs, relief operator at Nr. 18, vice-pres. There were twenty operators of the WKPX net present, and it was decided that the organization will hold regular meetings in the Hamilton Twp. Municipal Building on each third Wed. evening at 8 p.m. Action on several committees to be appointed as well as other business was held over until the January meeting. It was also decided, with the permission of Radio Aide ASQ, that the Dec. 20th and Dec. 27th drills will be dispensed with due to the holiday activity, although all were given to understand that everyone is to stand ready for operation at a moment's notice in case of emergency. Regular drills will be resumed on the first official period following the 27th. ABS reports his net and personnel are ready to go at a moment's notice should emergency need arise. Two of the recent five 3rd-class applicants have received their WERS operator permits and three still are waiting. ABS reports for his organization only routine tests and drills to maintain high efficiency and operation in his organization. Ray Cassell, Bridgewater Twp. radio aide, reports the following units and operators ready for momentary emergency notice: Nr. 1, control, operator, Paul Todd; Nr. 2, fixed, operator, Merrill Kilby; Nr. 3, fixed, operator to be determined; Nr. 4, mobile, Ray Cassell, radio aide, operator; Nr. 5, mobile, operator, Bill Auld; Nr. 6, mobile, operator, Paul Neuman; Nr. 7, walkie-talkie, operator, Wilma Stevens; Nr. 8, mobile, operator, L. E. Chittender. Ray also reports that the municipal officials of Bridgewater Twp. are expected to pay a visit to witness the efficiency of the WJMN network and its personnel. A recent letter from JBU, Phillipsburg, states that in reply to requests for information from that locality, efforts were made by some amateurs a couple of years ago to get a WERS organization started which met with a complete let-down by the city fathers. Since that time three of the boys have entered the armed services, and the others have been unable to get anything going. JBU, at the request of the radio aide for Northampton Twp., Pa., WLOA, applied for and received an operator permit last August and has taken an active part in the operation of control center for that network. Karl is (or was) also an air raid warden. Thanks for the dope, Karl. For the benefit of the boys in the services who may want Karl's QTH, he may be addressed as follows: Karl S. Morris, W3JBU, 367 Bates St., Phillipsburg, N. J. Our boys in the merchant marine have changed berths again: JAG has shipped out again after a 30-day leave and is now CPO first class; GRW is with Atlantic Refining Co.; ISY, who also was recently home on leave, has returned to duty. The addresses of these boys may be obtained by contacting your SCM, address in QST. HAZ, now t/sgt., has been transferred from the high speed school at Ft. Monmouth to an Army transport. CCC may also be reached by contacting this office for complete QTH. Ed now is on duty as CRM in Puerto Rico. He is also a brand-new grandpoo as of Dec. 3rd. 3AID now is NOT the only "3rd," eh! ATF, recently home from the So. Pacific on furlough, has been assigned to Special School, Ft. Monmouth. FTU is teaching power transmission at Ft. Monmouth, and sends his 73 to the gang. FBM, formerly of Ringoes, was affiliated with the Associated Press in White Plains, N. Y., since the call for operators became acute, and, until June '44, did an excellent job. Ferd entered the armed forces in June and took boot training at Sampson, then was transferred to pre-radio in Chicago, after which he was transferred to Oklahoma A. & M., Stillwater, Okla., where he is going through primary school for RT. He may be reached as follows: Ferd. E. Nosek, S1c, 403 Cordell Hall, Stillwater, Okla. EEQ has been transferred from N. Y. IBM Labs to foreign service for that organization. His address is Russell Snedaker, jr., APO 4305, c/o Postmaster, San Francisco. Bob Crozer, former DVRA member has been promoted to t/sgt.; Bob is with a bomber group in Corsica. JOL and JAG are now listed among the ranks of CPO, 1st class. HW has recently received his 2nd-class 'phone ticket. ZI has just recently renewed his telegraph 1st class, completing a cool twenty years as commercial 1st class. EGE has advised us that the new quarters of the Griffith Electric Supply Co. were open

for public inspection on Dec. 22nd. Bill is to be commended on his excellent progress in the commercial electrical supply field, which he started under severe handicap only a few years back. Vince Wagner, ex-8BRJ, has been appointed vice-pres. of the Delaware Valley Radio Association, filling the vacancy left by the resignation of GCU. Ex-ATX is now in charge of the radio department at Fineburgs, Trenton's Philco distributor. Brother Weeast, an excellent radio technician was obliged to abandon amateur radio some years back at the insistence of his family physician — too many "early" skeds, we hear! The Delaware Valley Radio Association held their annual Christmas Party on Dec. 20th. The Annual "Old Timers" night was held by that organization at the Bromley Inn on Nov. 17th. '73 'til next month.

WESTERN NEW YORK — SCM, William Bellor, W8MC — Our mention of that, now famous, noontime 160-meter round table of TEP, RCJ, SZB, LLZ and QOT has stirred many pleasant memories, as indicated by our mail of late. BXY, now located at Kamp Kill Kare, Raquette Lake, New York, wants to let the gang know he is still alive. He has a swell rig up there and is waiting to get going. Last month we asked for dope on NVK and lo and behold we were pleasantly surprised to get a letter from his brother, TKY. Don is assigned to an attack transport and expects to see plenty of action. All we can gather from Don's letter is that NVK is commanding officer of an aircraft carrier somewhere in the Atlantic. The County of Monroe WERS, WHNH, swung into action as a result of a severe snow storm on Dec. 12th that tied up transportation and communications. Among those operating units were DFN, JIC, MC (both operators), RDX and several LSPH. The highest praise was given by public officials for the aid in facilitating the speedy location of wires that were down and of open routes for utilities crews to follow. After the initial alert call all units were asked to stand by and were still on the job, standing by 100 per cent, three hours later when checked around by control station. Ben Lecky, now a radio officer in the merchant marine, dropped in on us during a shore leave and asked us to pass on his best to all the gang. PK reports hearing WHNH-1 in Buffalo, 70 miles away. We hear that Buffalo WERS is getting under way and hope to hear more from those boys from now on. 73, Bill.

CENTRAL DIVISION

INDIANA — SCM, Herbert S. Brier, W9EGQ — WEU lives in New Buffalo, Mich. EGV and his Austin tangled with an inebriated Ford. John got a black eye; the Austin painful bruises. UZW changed his address from USMC, Fleet Post Office, San Francisco to Covington, Ind. MTL and WKN met "CPD," Chicago Police Department, by parking in a restricted zone! EHT is an artist. He sent me a hand-drawn picture of a pinup cutie as a Christmas greeting. ABB, "on the road to Tokio," has been building himself a receiver, but the parts blow up as fast as he wires them in. WIB was in the Leyte Gulf battle. His group shot down some Nip planes. CTC is back at Purdue after a hitch in the Army. BPX is putting the finishing touches to his ASTP training. He wants to know whose cow HUV was loading in a truck after dark. "Do people ship their own cattle after dark?" FDS gives blood regularly, recently giving his seventh pint. He took a commando course at Ft. Dix. KMY, in New Guinea, has lots of spare time. He is going to investigate the new b.c. station on the hill. YDA and DDH, old friends in a dance band years ago, got together through QST and the BISON. YDA has done much experimenting with 112 Mc. He says the trick in making a 6J5 take 300 volts is in using a 15,000-ohm grid leak. DGA is chief operator of an M.P. radio station in Egypt, "and we don't use 'phone." He built an emergency receiver for the station using "junk" and reclaimed parts. He wants information on QLU and RZM. The last heard of EHU was when he was in Corsica. VCO is in Missouri. IFU is in the Navy, address unknown. MBM has finished three high-voltage supplies for his transmitter. The largest one delivers 2,000 volts at 500 ma. UKN and VMW found, through the BISON, that they were stationed close to each other. Result: a couple of fine rag chews. KVE is captain of the Evansville police radio. CRZ, a captain in the Signal Corps, has been wandering around the Pacific for over thirty months and is ready to come home. MYP is in the same general vicinity. AB visited an airport and examined its five v.h.f. antennas very closely. He reports that his WERS gang thinks his 815 crystal-controlled unit is OK, but what they really like is an oscil-

lator modulated 500 per cent. HJJ has been trading for parts for a new transmitter. He reports: "LTV moved to Columbus, Ohio; ARI advertises in the paper that he can fix radios; HOG twists wires in Kokomo; JDW gave up his radio shop; OMD still peddles aspirin in the Army; FFN is trying to couple his tractor to his transmitter for remote control; DOK bought a new lot. The Mrs. thinks it is for a garden." HUV is building a record player using a magnetic cutting head as a pickup. PLW built one using the case from an old acoustic type. He got parts from here, there and everywhere. ZNC is somewhere in Europe. NXU continues his study of Grammer's course, and is arguing with HUV about the "Q" of resonant circuits. DLI paid me his annual visit and subscribed to the BISON. YGH is trying to get CWO to have his picture taken for a WERS license. YMV is in the Pacific enjoying "ideal (?) winter weather." He speculates as to WERS effect on future 2½-meter activity. KYQ plans to handle traffic six or seven hours a day when he gets back on the air. PUB was home on a thirty-five day leave from the Pacific. He was surprised at the strange customs of the natives of the States. They wear clothes and cook their food! KBL and ILL are married — not to each other. MVZ, WKMR radio aide, made a recording off the air of all WKMR units and two WHHI units. Results were very fine. 73, Herb.

KENTUCKY — SCM, Darrell A. Downard, W9ARU — ALR tells us he wondered why the natives of a certain Southern town finally "opened up" to him until he realized that the new blue-gray uniform made him look like a Civil War general. While thawing out, after operating station WJKK-22, the boys get in a few licks at code practice. What him, now in the armed forces, refers to DFW as a 5-watt wolf? He says, to be exact, it's 5.37 watts. URG reports from England that copying code through QRM 12 hours a day is making a 'phone man out of him. Practically all of the WERS stations in the second district work both code and 'phone. At the last meeting GOM was elected to the Board of Directors of ARTS. A real country ham was donated by YXF as a prize and was won by T. E. Jones, while the rest of the gang sat around drooling. Universal Radio donated some tubes and handbooks.

MICHIGAN — SCM, Harold C. Bird, W8DPE — 8FLA sends us a card and asks how we liked the pictures of RID in a recent issue of QST. SGP was a little late with his card but reports that he is back at fixing radios again for a few hours a day. He reports that 8DOV, of Clawson, now is a 1st Lt. in the AACA somewhere overseas. Sgt. 9YNY says that he got the DARA QMN Bulletin and thanks us for same. He is copying press in parts unknown. Cpl. 8MV writes us a nice letter and renews his QST membership-subscription at the same time. He reports that he is working nights for Uncle Sam and is doing maintenance work. If any of you fellows in QMN would like to contact him, his address is as follows: Cpl. Frank J. Beecher, 1918 10th Road, So., Arlington, Va. At a recent DARA meeting, the election of a new Board of Directors was held. After the directors were installed the club elected new officers with Ralph Thetreau drawing the secy.-treas. job. After the meeting the usual QMN round robin was held, and then lunch was served. The Ladies Auxiliary put on a box social recently to raise some money for their club. It was held at the home of Mr. and Mrs. Mike Stalmach. Dancing and movies served as entertainment after the boxes were auctioned off and everyone had enjoyed a very fine lunch. Those present seemed to have had a very wonderful time. To sum it all up, it was a huge success. The City of Pontiac WERS gang is still going to electronic school and from reports of the exam taken lately most of the members are doing OK. The course has a few weeks to run yet and then big things are being planned for WERS station activity. The Flint gang still is very active and we understand that Lansing is carrying on although the local OCD has folded up. Centerline WERS reports that they may have to discontinue their activity because of lack of personnel, and an insufficient number of interested people to warrant training of new personnel. Your reporter would be glad to hear from any other active WERS groups in the section. We believe that it is a very wise move on the part of amateurs interested in WERS to carry on as it may be of benefit to them in the near future. No cards were mailed with the QMN Bulletin last time. It is planned, however, to mail out all the cards we have each time the bulletin is sent out so you boys can get the dope to your reporter. Remember, the emergency is not over and we are not on the air as yet, and if we do not support the gang over there we may not be on the air for some time to come. So let's forget our own interests

for now and really show those fellows we want them back with us. Best of luck. 73, Hal.

OHIO — SCM, Carl F. Wiehe, W8MFP — A card from IBNL says that he now is living in Cincy and working at WSAI for Crosley, after having spent fifteen years at WTAG. RBX reports that he is working at Air Way Electric along with JOE, who is a Navy inspector, PVM, who is fresh out of service with a medical discharge, and ex-80H, who is asking about antennas (flat tops he calls 'em). They are making code oscillators for some young squirts to save the OM's flashlight batteries. RBX wants the APO address of 2JYM. AVH sends a summary of the activities of Cuyahoga County WERS during the East Ohio Gas Company's fire on Oct. 20th. It is wonderful reading. John's vest is still popping buttons over the way his crew performed. Ham radio is proud of that job too. Twenty-five mobile units, six walkie-talkies, several report center stations and ninety-five operators were on the job promptly. Who can beat that? NXJ reports that WERS continues good at Canton. UTL, who is a CRM in aviation, was home on a 30-day leave. He was the first president of the Canton Amateur Radio Club. LYZ, also a CRM, was home for a short stay. UYL is now in the Navy, after passing the Eddy test in high school as RT. QA is out of the Army after two years as a lieutenant. Canton club activities continue good. CBI sends a page of the Sunday Journal-Herald Spotlight of Dayton featuring the Dayton and Montgomery County WJTW WERS outfit. The display includes pictures of three fixed stations and more than thirteen mobile units together with the personnel. The WJTW outfit fairly radiates quality, efficiency and an abundance of energy. Their signals are heard consistently in Cincinnati fifty miles away. VUS is a radio technician at the W. Va. Ordnance Works and reports considerable success with carrier-current on 150 kc. The Pomeroy WERS group has been indulging in considerable code practice. VWW writes regularly from France. PNJ reports that he has heard from MFV on Baffin Island. VUV writes that he has been promoted to pfc. and that he will never forget his Thanksgiving dinner, which only the American Army furnishes its men. VMA reports that the QCEN, which has as its motto "Amateur Radio Communication in Any Emergency," has presented to thirteen of its members awards for meritorious service in WERS. PNQ reports that the Cincinnati gang, under the direction of Radio Aide TQS, is indulging in extensive code practice in an effort to make hams of its restricted radiotelephone ticket holders.

DAKOTA DIVISION

NORTH DAKOTA — SCM, John W. McBride, W9YVF — Received a nice letter from UNU. Ralph is now a granddad and is the proud UNV reports that his son, Don, is in the Navy. PQW spent two weeks at home and he and YOO visited at Crete with ENM and had no trouble getting their limit of pheasants. Paul has returned to the Aleutians again. IHS is with the Airways at St. Paul. NCL is now in West Fargo; his son, Herb, is in a radio shop in Fargo. ZVE is on the West Coast; Art and his XYL are in the jewelry business. RPJ announces the arrival of a YL — no mention was made of her code speed. BMR is still reading post cards at Wahpeton. Lt. Comdr. MLE underwent a serious operation in the Naval Hospital at Bremerton; his XYL teaches school in Bremerton. K6PLZ is back in Honolulu after spending a year in Minneapolis. KZK is still the assessor. KOY says that news is quite scarce, and that's not new to us either. Drop us a line wherever you are. 73, John.

SOUTH DAKOTA — SCM, P. H. Schultz, W9QVY — MBA is CRM in the Navy and is an instructor at Camp Simpson. Recently he acquired an XYL. YFR was with FCC for a time but at present is in the U. S. Navy as a radio operator on board ship. He has been in quite a few war zones and has visited several countries. ILL reports that he and IQD are the only hams left in Huron, and that with three others and his XYL, who has a Class B ticket, they have a WERS net going. FLO was at Provo, So. Dak. KYZ is in Pierre with the telephone company. BAE has been teaching in a radio school (Navy) on the West Coast. When last heard from GYG was on the West Coast. VQC is the possessor of another jr. operator. HKX was in So. Carolina but now is overseas. WYG, formerly of Wolsey acquired an XYL, left N. W. Airlines and is now helping Uncle Sam. IQD has been tinkering with a welding outfit on v.h.f. antennas. ILL has a 2nd-class 'phone ticket and is radio operator for Western Airlines besides doing maintenance and installation work. DZD, a sgt. in a signal outfit, was last

reported somewhere in Germany. It is deep regret that we report that DZD's brother, Sgt. FSX was killed in action on Leyte, Oct. 29, 1944. 73, Phil.

HUDSON DIVISION

EASTERN NEW YORK — SCM, Ernest E. George, W2HZL — The Schenectady Amateur Radio Association elected your SCM president for 1945, as well as KLM, vice pres.; Harry Schwarze (LSPH) secy. and BKW, treas. Directors are AMM, BRS and OOT. Ex-SCM LU has been transferred to the West Coast. KUG is now an "inspector in charge" in the Signal Corps. A long letter received from Nicholas Camenares, RM3c, reports that a copy of QST got on his ship by mistake! While on his last leave he built a flea power rig and is anxious to try it out. He reports that NBJ is in the Infantry despite all of his radio licenses. KUD still is working in Washington, D. C. The Schenectady gang painted their 5-kw. power supply fire engine red, loaded it up with flood lights, both portable and fixed, and have arranged to help the neighboring fire department at night fires. This is a new use for emergency equipment when it is not needed for radio service.

NORTHERN NEW JERSEY — SCM, Winfield G. Beck, W2CQD — Ole standby, LMB, sends the following report on the Jersey Shore Amateur Radio Association: "The JSARA is meeting regularly every month. The November meeting was held at the home of the president, GMR. OMS, who took unto himself a wife recently, has just returned from overseas duty. AER, who is now overseas on civil service duty, is growing a pair of handle bars on his upper lip." LMB also adds that out of the present thirty members, six are now serving in the armed forces and thirteen are in civil service as radio engineers, technicians or operators. LXI sends a post card reporting that Sgt. JSF is in Italy after having taken an active part in the No. Africa campaign. Maj. JUU was in Italy; he is now in the Pacific area. JMC still is at Wright Aero and is all set for reactivation except for his antenna. Wally likes the new frequency recommendations, too, and has a kilowatt — which isn't built up! 3GIT, formerly of 75-meter 'phone in Schillington, Pa., is QRÄing in Newark, N. J., and is inspecting Navy parts for Pollack Mfg. Co. IZC still is at Western Electric and is discussing new ham frequencies with CQV. JJE is romancing at Babcock & Wilcox. RM3c LSX writes that he would like to see news of more of the No. N. J. gang in this column. How about sending in reports, fellows? 73, Win.

MIDWEST DIVISION

IOWA — SCM, Arthur E. Rydberg, W9AED — Polk County WERS station KFHR activity has increased immensely. Last month six active stations were reported, this time twelve stations are on and the number is increasing with each drill period. With more stations the superregenerative interference problem has cropped up and r.f. stages, superhets and other receiver improvements are taking place. The actual operation of transmitters has shown up some defects and much work is being done to correct them. It's a little chilly for antenna work on icy housetops, nevertheless antenna work is being done. AED, at Mitchellville, some fifteen to seventeen miles from Des Moines has been able to hear almost all of the Des Moines stations, but is not able to read all of them. SEJ and WHG put in the best signals. URK has a new 829 which he will put to work on 112 Mc. UOP has a new hilltop location and is busy preparing a WERS station. KGIL, Cedar Rapids WERS, has its first mobile unit in operation and WQQ is having a lot of fun driving up in front of fixed-station locations on drill nights. JIE finally got his 815 going with a 2C22 oscillator driving it. He tells us not to believe all we hear about an 815 being easy to drive on 112 Mc. EMS plays piano in his spare time. OCG is helping AUL repair b.c. sets. UAD was quarantined at Purdue over Christmas. PNK of the Navy, whose family recently moved to Denver, was there on his last leave and visited a former Iowa ham, FKQ. PNK is now on the East Coast awaiting assignment to a ship. OJD sent a nice V-mail Christmas card from Italy. OLY is very happy to have his son of the Navy, a wearer of the Purple Heart, home on leave in time for Christmas. 73, Art.

KANSAS — SCM, Alvin B. Unruh, W9AWP — CKV is working at the Dodge City AAF radio repair shop as a senior radio mechanic. "Baldy" says he is picking up some v.h.f. pointers. JOY and SIL are stationed at NATTC, Corpus Christi, Tex. They have been together through boot training at Great Lakes, then pre-radio at Chicago, and Stillwater,

Okla. for primary. QZT advises his friends, especially those in Coffeyville, of his advancement to technical sergeant, and says that he might drop around his old haunts soon. TYV (Navy flight control) is in the Admiralty Islands, and is meeting lots of Aussies, whom he describes as "good boys." He doesn't think their radio gear is the equal of ours, however. KCS is waiting for a carrier and expects to go out soon. He wants a reservation on 3663 kc. for the postwar Kansas net. NMT and 5GAN have joined the Boeing-Wichita confidential-electronics group. 73, *Abie*.

MISSOURI — SCM, Mrs. Letha A. Dangerfield, W9OUD — Two letters reached us this month. One was from AEJ — which the censor got hold of before we did. Wm. had a ten-day leave some time ago and left (place deleted) to fly home for a visit, and is now in Hawaii, assigned to the USS (deleted) to which he is awaiting transportation. He sends his regards to the gang and has all of our best wishes. KPM wrote the other letter. Gene is in the communications section of an artillery battery somewhere in the So. Pacific; he is tired of jungles and eager to do some regular hamming. Aren't we all. We made a mistake in the last issue of *QST*. The receiver for which BMS built the squelch is an SX-24 instead of 23. We must either invest in a crystal ball or have more letters from which to gather news. OUD is practically caught up on her correspondence and is very desirous of getting behind again, so how about aiding her by sending in some letters? Remember, she can still write poetry in this column, so be warned. The best of luck and 73 to you all.

NEBRASKA — SCM, Arthur R. Gaeth, W9FQB — The AK-SAR-BEN Radio Club is sponsoring a new HY75 transmitter for WERS control center, which was built by UFD, and a new antenna built and erected by ZPZ, ZZG and FQB. KHKN-2 (EKK) and KAAJ (Lincoln) have a schedule for the first Monday night in the new year. By the time you read this no doubt they will have had several additional schedules completed. We will advise you of the results in our next report. Don't forget to inform your SCM of reception of either of these stations outside of their immediate vicinity. A display of Army radio equipment by the gang from the repair depot at Fort Omaha was enjoyed by the AK-SAR-BEN Radio Club at their Nov. meeting. Personnel at the depot includes FSR, YMU, AYC, 5ABI, H. L. Petersen (KHKN-43) and Herman Hoosinz (ex-W9) from So. Dak. KPA was listed as DPA in last month's report in error. YOP returned from his second tour of duty in Alaska and is installing transmitter equipment for CAA. His QTH is c/o CAA, Section 99, Anchorage, Alaska. His family recently left to join him. S/Sgt. GXO, after service in Africa, Sicily and Italy, has returned to the States. He has now been reassigned c/o Fleet Post Office, New York. S/Sgt. LXI is on leave from the CAA for war service and is on Bora Bora Island. POB, when not handling the mail, is at his radio service bench, and says that he would like to turn it all over to some qualified man who has been released from military service. I have just learned of the death, some time last spring, of HNG. HNG was both a 'phone and c.w. man and was considered one of the dependables of the ARRS net for several years. LTL reports, via a personal visit with your SCM, that he is an instructor of the Net Operation Branch at the Army Air Base in Sioux Falls. He holds aeronautical code endorsement on his 'phone ticket and works for Mid-Continent Air Lines during his time off. KYP is an instructor in EFB at the same base. OUC, 2nd lt. in the Signal Corps, is working for Press Wireless, Inc., Hicksville, N. Y. NYU is doing radio maintenance work in Italy. LPA moved his family to Maxwell, Iowa, and bought a theater there. EUT is now an operator at the WOW transmitter and reports that GTC, a super at the same station, is confined to the hospital with rheumatic fever. EW received a promotion to electrical inspection engineer with Western Electric at Lincoln. NZ is applying his talents toward building midget t.r.f. receivers that are really hot stuff. EXZ had a piece of high priority steel taken out of his hand at the hospital, but now is back throwing parts into autos and radios. CCR is an engineer at KFAB. FQB signed up twelve new members for the ARRL, nine of which were brand-new. HAT is manufacturing electronic apparatus, with UEW and Holmer Schulz assisting. VIC and 7GQO are at the Radio Engineering Service Co., in Omaha. JFJ is an engineer at KOIL. RUH still is running a filling station, repairing radios and has an HY75 on 2½ meters. I received three reports this month. If the rest of the gang would just send me a crumb, it would look like a banquet. HZC, formerly of Lincoln, is now located at 1722 Strand, Apt. 5, Hermosa Beach, Calif., and would like to hear from the gang. 73, *Art*.

NEW ENGLAND DIVISION

MAINE — SCM, G. C. Brown, W1AQL — CBV is wearing the bars of a 2nd lt. in the CAP and is conducting code classes every Tues. evening at the Bangor High School. UP and his son and CRI have received their permits to operate the CAP rig, and the station license is expected in the near future. The write-up about K4FAY on page 23 of Dec. '44 should bring back the old days when K4FAY was a frequent visitor to the Queen City Radio Club. The Maine gang is pleased to note that two of the Maine boys were present at the hamfest in England last Sept., namely DTS of Oldtown and DUJ of Warren. BNZ is in Italy, after having spent several months with the merchant marine in New York. AWY was a recent visitor; he is employed in the shipyard in Portland. WABI has another 264-foot steel tower and DLC, chief operator, has been busy taking field strength tests. PQ has returned to the States after a long tour of duty in Africa with the O.W.I. Word has been received that AKR is on the move again after having spent nearly two years in Africa. QH writes that he is in the thick of affairs in the Pacific. The *Telephone Topics* carried a fine picture of Lt. Col. FQ. Ex-BHS is handling a trick at WABI. 73, and a Happy New Year. "G.C."

EASTERN MASSACHUSETTS — SCM, Frank L. Baker, jr., W1ALP — WERS news: On Dec. 10th another state-wide test was held in an attempt to tie in with the western part of the State into Boston and GAG sends in a general outline. We hope JAH won't mind if we include the whole report under this section report. Adams and North Adams were not heard. WKHW had some difficulty in getting his message through to WKHF, but WKKW-7, although not received in Pittsfield, got most of its message and forwarded it to WKHF-2. WKKW-2 received the signals of WJBB-12 very well, but did not contact him. WKKW also heard WLSO-26 and 1, as well as many of the WMAC stations in Hartford. WKHF-53 handled the Springfield relay (Ware) very well for the western area into WJBB-4-12 for the Worcester leg. WJBB-12 was in direct contact with WJQH-4 in Newton, who relayed to WKXH-1. At this point, I would like to say that Springfield stations have heard New York (Bronx, I believe) stations so well, that it seems possible to contact them. Inasmuch as this transcends the lines of C.D. and reverts to ham DX, it has not been tried. WLSO did not complete its contact with WJQH-4, but instead, WLDC-14 received WLSO's message and forwarded it to WKXH-1. WLDC-14 passed along messages for WKNM, in Haverhill, and its own, to WKXH-1. WJID was heard. WJRG, Lowell, reported direct to WKXH-1. As noted by WJYM-7, Quincy, WKNM's signals were heard although he did not say how well. Haverhill to Quincy is a good haul. WKKL reported in through WLDM-WJQH-4 to WKXH-1. WKAZ reported direct to WKXH-1. WKRN had two operators, one station. WJPY units were on, as well as WJYM. ALP and EAU were at WJYM-1, HHU and Jack Donnelly at WJYM-7 and JXZ at WJYM-29, with most of region 5 handling its message through WJQH-4. WJSU, Fall River, was isolated because none of the units in the Brockton area were in operation. GAG had a Christmas card from MQO in Kwajeilin Atoll, who claims the coral fungus has caught up with him. The South Shore Amateur Radio Club held its regular meeting with the following hams present: EKG, MMH, JXZ, IS, MMU, FKV, AKY, FWS, AUG, JXU, CPD and ALP. LSD is very busy working at Raytheon by day and servicing sets by night; he also tried some radio teaching. LUW has a new job at Polaroid. JCE is building a new preselector and is doing some SWLING. LNX now is living in Newton. NDA now is an ensign in the Naval Air Corps and was home for a few days. BPK now is CRM. JOV is living in Amherst but still is at M.I.T. 7BOG is a lt. in the Navy and now is at M.I.T. LID was home for a few days and now is on his way to the West Coast. FI, a lt. comdr. in the Navy, is home after sixteen months in the Pacific area and says he visited some hams in VK-land and met hams everywhere he went. KQN and Chas. W. Tittle (LSPH), Class A from Texas now living in Canton, sent in their WERS operator licenses. MIH visited ALP one night. ALP met MNH one night. MNH still is living in Orleans and working in Boston. GWK bought a house in Scituate. John J. Marshall of Dorchester is going to help out in WERS; he says he operates a monitoring station and went to Mass. Radio School. MIH says he visited MIV (ex-2ABQ) in West Brookfield. MPT finally got home to see his new son. More stations heard in Quincy in the State test are: WJPY-19, 3, 27, 13, 22, WLDM-1, 4, WKVL-4, WKYG-1, WKXH-

38, 39, WJIE-5, WJQH-2, 3, WKXH-67, 10, WJPY-25, 26, WKKL-1, WKAZ-10, 5, 14, 4, WKND-1. KBS has moved back to Quincy. JBY is not with the FBI, as stated in last month's report. He is in the Navy, stationed in Virginia, and was home for Christmas. To all of you, thanks very much for the many Christmas cards and hope you will be home before next Christmas. *Frank*.

WESTERN MASSACHUSETTS — SCM, William J. Barrett, W1JAH — The Pittsfield Radio Club recently elected the following officers for the coming year: IZN, pres.; BKG vice-pres.; Geraldine Sheehan, secy.; Janet Barton, treas. Committee chairman; LKO, technical; Janet Barton, social; BKG, educational, and Geraldine Sheehan, publicity. On Dec. 12th the club held its annual Christmas party under the direction of Janet Barton, WKHW-5, aided by Mrs. IZN and Jack Fitzpatrick, WKHW-21. The team captained by AMS won the question bee. In the state-wide WERS relay test held Dec. 10th, WKHW had nine stations on the air. WKHW-16, mobile on Washington Mt., got through to WKHF-2 in Springfield. We sincerely hope that AZW will have finished his long siege in the hospital by the time this reaches you. LPP has returned to the Berkshires and is living in Lenox. Meetings of the Pittsfield Radio Club are held every other Tuesday evening in the old police station on School St. Anyone in the vicinity is cordially invited to attend. February meetings will be held on the 6th and 20th. WJPG had three stations on for the state-wide WERS test of Dec. 10th. JLM is a radio officer in the merchant marine. WKKW stations active in the WERS test reported hearing stations in the following WERS nets: WKHW, WKHF, WJJB and WMAC. How about some news from Fitchburg, Gardner, Worcester and Springfield? 73.

NEW HAMPSHIRE — SCM, Mrs. Dorothy W. Evans, W1FTJ — Your SCM has taken a powder and moved to Memphis, Tenn. BFT, after three years of sea duty in the Atlantic and in the Mediterranean, finally received orders for shore duty at the Naval Air Technical Training Center in Memphis, where he is associated with airborne electronic training. Therefore, FTJ has shifted her QTH. The time has definitely come for a new SCM, so get busy and send in your nominations to ARRL. FTJ will continue to fill in until you elect a new SCM. Indirectly, we hear that Portsmouth has a nice WERS set-up now: WJSP, with 5 units, 4 transceivers and one transmitter-receiver. CUZ, KWB, and several LSPH are the operators. Received a nice letter from MMG, who is RM2c on a new cruiser in the Pacific. Recently BFT spent a few days in Washington and managed to look up the following W1s: BDI, HJI, JFN, KH and UE. Swell rag-chews were held with all of them.

RHODE ISLAND — SCM, Clayton C. Gordon, W1HRC — For the benefit of the fellows who are away from home we report that on Dec. 19th we had our first big snowstorm of the season, so if you are down in the So. Pacific you can think of home as having had a "White Christmas." We received a V-Mail Christmas card from ILWA in the Marshall Islands, and also a nice Christmas card from Lt. Norm Gertz, Doings at the P.R.A. this month included four reels of movies projected by KKE in the little room at the other end of "Conduit Hall," and the usual coffee and doughnuts. FUB stated that he had been working over his frequency meter and HRC had been doing something about a v.t.v.m., which resulted in some further work on his frequency meter. Ted Davis, NLF, lost his wife just prior to the first meeting of the month. In spite of this, Ted managed to find time to send out the monthly notices, which shows what kind of a chap he is. We all sympathize with him in his loss. Perhaps some of you fellows that are away would like to drop Ted a line after reading this. Harry Nicholson refused the honor of acting as Santa Claus this year, so the club passed up having a Christmas party. We are saving it for the time when the boys are all home again, and then we are going to do it up right. In the meantime, we all wish you all just the best there is, and a much happier New Year.

VERMONT — SCM, Burtis W. Dean, W1NLO — BD has returned to Barre to work for MMV as cashier in the REA office in Barre. Roy has been a member of the faculty at Dartmouth College for the past seven months. AND has resumed radio classes with Co. E VSG. A card from KJG reports that he and the XYL have purchased a home with good facilities for ham radio. KXL is now with the merchant marine and when last heard from was somewhere in the Mediterranean. MCQ has been busy building woodworking equipment. JRU has started an electrical contracting

business in Suffield, Conn. GNF has been honorably discharged from the Marine Corps because of a shoulder injury. He is now living at 43 Lebanon St., Hanover, N. H. AHN was home on a furlough recently. MIH spent the holidays in Vt. and visited friends in Burlington. CBW is working in Bedford, Mass. EKV is stationed at Pine Camp, N. Y. KXP has given up flying and is working at the East Boston Airport. "Rog" and his mother spent Christmas with IQG and family. 73, *Burt*.

NORTHWESTERN DIVISION

MONTANA — SCM, Rex Roberts, W7CPY — The Butte Amateur Radio Club reports 9DZB, in the Navy V-12, has been transferred to U. of W. at Seattle. 9DZB and BKM took exams for Class A tickets in Oct. Harry Baker is in California taking RT training. EQM and BDP still are giving code lessons. A swell Halloween party was held with 30 in attendance. Byron Roberts was guest at one of the meetings; he is now permanently located in Havre. The following are new BARC members: Sam Rafferty and Dorothy Stankey, operators for Airlines, Leonard Smith and Robert Daly. Tom Hood, vice president of the club, has moved to Missoula. BKA passed the Class A exam OK. Gang, please note from the various reports from the hams overseas, how much they appreciate the squibs about the old gang at home, and send me news on what you or others are doing. Can any of you send me the addresses of DZB and Tom Hendrix of the Butte Club? Long time no reports from the Livingston and Great Falls clubs! The SCM hopes that you have finished a happy and prosperous 1944. May 1945 be even better and may we meet on the air before the next year rolls around, 73. *Rex*.

OREGON — SCM, Carl Austin, W7GNJ — ARZ, on his first vacation in a year and a half, had to return a couple of days early to straighten out a frequency instability at KBND. During his trip, he called on BVV and reports that the latter is engaged in the design of some kind of voltage-current regulator — when the tail wags, the mouth barks and, conversely, when the mouth barks, the tail wags. HLF reports that the gang at Medford is starting a class to make hams out of some WERS operators and any others interested. Dwight also met AGT, who says her son is still somewhere in the States. She complains that her ham gear is getting obsolete. FYF, being in sheet metal work, is very busy with priorities, etc. A Christmas card from HXG and his XYL carries a Nome, Alaska postmark, so evidently the pair are now regular operators up there. BVV says that AGZ is somewhere in Italy. A card from his XYL tells us that IDJ is now a chief ART, and is quite pleased to be able to wear the new grey and green Navy uniforms. They are still at New Brunswick. CZJ sends us another letter from FTA and ITZ, who are CAA radio operators. From our snooping we find that with barges becoming lost, harbor freezing, planes going through the ice, crashes, etc., to be reported and handled via radio, they have an interesting time of it. IHK says that now that IHJ is back, they may return to Portland. AUH and his XYL, EIU, are radio operators at Tanana, and like the work FB. They report that it is kinda cold up there! Many of the Oregon gang will be interested in learning that "Cardboard" Harry is a Lt., and has been in England and France for several months. The annual report from GUP tells about his 10-acre ranch all stocked and right near the city limits, with plenty of room for antennas. He also reports that FYL, now a major, was home on furlough from Iceland, and was then sent to Florida. Also that 6MDI has his radio gear at Ashland, and hopes to be a W7, after the war. AOY still is inspecting equipment for the Navy. 73, *Carl*.

WASHINGTON — SCM, O. U. Tatro, W7FWD — IOQ has consented to take over the EC job for Everett and vicinity. Leo will be a stimulating influence as he is very active. JBH, DYD, and IOQ, representing KFEY-3, KFEY-5 and KFNV-14, met to plan a test from the San Juan Islands to Everett and Mt. Vernon. Miriam Brown (LSPH), a member of the KFVW net, is active and more will be heard from that "bluff" near Mukilteo. AEA, EC, reports that LB now is leadman electrician at Tacoma's Todd Ship Yards. AC, 1st Lt. and communications officer with the air forces, is back from Australia and has recovered from an eye infection picked up in the So. Pacific. FEZ, Lt. comdr., is a communications officer with the Navy. HAY was on Saipan. NS is with the Bonneville Aluminum Plant, and the Tacoma club is going to be active again. HCE reports that Warrant Officer Orville Bishop,

a W7, of Toppenish, held the Yakima club spellbound for hours with permissible war stories and stated that ham experience is invaluable in Navy radio maintenance. "Bish" spent several years in the So. Pacific. ETX is on a long boat ride. ALH has moved his gear to the basement. LV is disturbing the Japs. HCE expects a new soldering iron from Santa. IVC is at Camp Crowder. IHJ and IHK are at Santa Barbara, Calif. HMJ, now attached to C.U.B. unit, is home for the holidays on a 21-day leave. JCS will be at Camp Crowder, where his family expects to join him. FWR has spent the past five weeks nursing the OM back to health. 73, *Tate*.

PACIFIC DIVISION

EAST BAY — SCM, Horace R. Greer, W6TI — EC, QDE; EC v.h.f., FKQ; Asst. EC v.h.f., OJU; OO v.h.f., ZM. OJW reports he has resigned from the Signal Corps Labs to accept a position with the National Broadcasting Co. as transmitter engineer for the new Office of War Information station at Dixon, Calif. It is an international broadcasting station with four 50-kw. rigs and directional antennas. Just a small ham rig. HI. The regular WERS meeting was held Dec. 21st at the Oakland City Hall. Morrison, Nr. 35, gave an FB talk on h.f. oscillators and equipment for 224-Mc. From our good friend, O CZ, somewhere in the Pacific, I received the following special V-mail Christmas card with an appropriate picture: "With the Eclipse of the rising sun Merry Xmas to you and all my ham friends in Oakland through you. 'The Bugles of Battle will sound the Marches of Peace, East, West, North and South, the long fight will cease; Then we'll sing the Song of Great Joy that the Angels bring, We'll sing of Glory to God and of Good Will to man.'" Lt. Sidney F. Glasson, USNR. Another day closer to victory, *TI*.

SAN FRANCISCO — SCM, William A. Ladley, W6RBQ — ECs, DOT and KZP; OO v.h.f., NJW. CIS still is in the Admiralty Islands. 9FA is back in Pearl for a new assignment. 1NMB visited with PGB before leaving for the So. Pacific, and says that "ham" hospitality is tops here. 9ICN and 9ILH now are residing in San Diego, Calif. NKE, U. S. Marines, returns from active service in Europe, where he was severely wounded; he is recovering in good shape and now is at Mare Island Navy Yard. IPH still is in Italy. LLW at Salinas advises that the Finn, ex-NLL, now is in the So. Pacific area and his address is T/Sgt. H. E. Bergman, APO 711, c/o Fleet Post Office, San Francisco, Calif. Both of RBQ's sons are serving in the Pacific area aboard carriers and have participated in four major battles to date. EAR reports in from Seattle. HLP, a 1st Lt. in the AACs, reports in from Pearl Harbor after many months in the Western Pacific. As noted in last month's report, WERS in San Francisco may do some work for the State Guard. At this writing we are negotiating with this organization and if present plans mature our WERS group will take on the most important phase of message handling yet attempted here. Civilian defense, locally, has undergone severe changes and consolidations, which has made it important that we of the WERS look elsewhere for a sponsor. QDN is doing his share in Alaska. His address is Sgt. George E. Goranson, Alaska Communication System, Box 219, Anchorage, Alaska. George advises that he is now a married man and sends his best to all AARS and CON/SFN members. 9BRD writes in from the So. Pacific. S/Sgt. RFF writes in. His address is Jettie B. Hill, RT3c, Class 545B, College of The Ozarks, Clarksville, Ark. RTP is now with the O.W.I., Terminal Island. CIS reports in from the So. Pacific to the effect that he is spending much time in the air. Our negotiations with the State Guard have just been completed with the following amateurs now enrolled: Ed Fichtner, Geo. Muelendyk, Manuel Solorzano, Carl Sorensen, Ralph Stoddard, Earle Tucker, Sam Van Lieu and John Damonte. Clerical assistance in this newly-formed State Guard Signal Corps will be given by Miss Frances Jessen, Miss Frances Drake and Miss Theresa Bonzani. More detailed information on this will be given next month. More cards from section members will be appreciated. 73, *Bill*.

ROCKY MOUNTAIN DIVISION

COLORADO — SCM, H. F. Hekel, W9VGC — EHC sent his regular report from Washington, D. C. He is back on the job after a month in the hospital. The Radio Widows, in addition to their other duties, have scheduled a number of showers for some new mammas. These include Donna Goff, her sister, Erna May Scott, and Lea Holcomb.

The Christmas party was held Dec. 28th with Margaret Swanlund as hostess, which meant that WYX was permitted to stay out until midnight 12/28/44. Jaque Hawley was hostess for the New Year's Eve party, another occasion when the OMs were permitted to attend, providing they behaved themselves. Lt. Comdr. BVZ arrived back in Denver Dec. 12th, on a 30-day leave, after a tour of duty that took him from one end of the Pacific to the other and through five major engagements, the last being the battle of the Philippines and the landing on the Island of Leyte. At the expiration of his leave he will go to Chicago, Ill., for reassignment. That seems to be all this month and I may have to let a few cats out of the bag to keep this column going. Remember what happened to Webber? I still have one about the person who took his wife out hunting "Stubble Ducks" and . . . See what I mean, Howard? 73, *by Heck*.

SOUTHEASTERN DIVISION

EASTERN FLORIDA — SCM, Robert B. Murphy, W4IP — WERS is playing an active part in the Florida State Guard, as shown in their bulletin Nr. 12. Great credit is due Hollister, Hazelton and Litschauer, ACZ. These men, all dyed-in-the-wool amateurs, are pushing this organization. BYF is pushing the Miami WERS net. 1KVB is going to be his right hand man. There will be a little reorganization, then things will begin to function. KVB is a real technical man, being employed in the overhaul shop of PAA as a crew chief. I am sure he will go places with this new arrangement. Lloyd Moore, chief operator on a ship, wants to get in touch with HFQ and 2NKQ. He went to Tech High with my jr. operator. BYR is a very busy man these days, in Tampa and about the State — so busy that he has asked to have his EC appointment canceled. Sure hate to do it. AXY, my namesake, is chief here in Miami and says he is working on gear that makes 56 Mc. look like low frequency. GAJ, communications chief, seems to be in the thick of it and sends 73 to GEE and BYR. TZ has left us for the So. Pacific; his wife has remained in Frisco. ES, who, with his YF, has returned from the North, is delving into the social and civic whirl, according to the pictures in the daily paper. CNZ has sold his RME to GGL and Kin-sell, the latter having prospects of being a good amateur after this fracas. He is starting out by getting this good receiver and copying code for practice. EYI, one of my best reporters, comes through with some very nice pictures of his 20-meter rig and reports the following: FOD has a new jr. operator; FHX has been transferred to the Pacific; DBA is home for the holidays; ANH has taken up flying; IGQ is out of the hospital after a battle with the flu; FJG, who was an instructor for CAA, now has a radio shop; JZ is busy looking after his orange grove. In reading AXP's write-up for the Western Florida section I notice that ECT and FJR are the proud parents of a brand-new 1944 model YL. FJR will be remembered as the YL operator in St. Augustine and various other places. She really could beat the tar out of a bug. From the above, I would suggest that you read Oscar's column. Some of the old gang may be in that section now. HKJ visited me and promised that he will be my reporter for the Africa and Orient ATC, Pan-American World Airways. Here are a few of the old 10-meter fellows working out of Miami: VV is a flight engineer for A&O. HMQ is a captain with PAA, Latin-Amer. Div. HKJ is a flight operator with A&O. SA, who was K4SA on San Juan, is a captain in the Army, located at Coral Gables, a "suburb" of Miami. 9KBG is with Pan-Am in Miami. 6PNL, from Orrinda, Calif., is a captain with A&O. HKJ is planning, between trips across the pond, to join the local WERS net; he has some fine suggestions for a new antenna. KK has been very busy the past month. A little item on a government post card fires me up with something to write about. Who knows, some of the boys on one side of the world or the other might enjoy reading about you. Drop me a line and don't be so stingy. HI. 73, *Merf*.

WESTERN FLORIDA — SCM, Oscar Cederstrom, W4AXP — Bob Purdy, one of our radio instructors at Saufley Field and an old-timer in the ham game, had two occasions to celebrate this month. Rodger Cullen Purdy, 7½ pounds of boy, arrived and Bob passed his telephone 1st-class and Class A amateur examinations. 9ZVJ is at Saufley Field now and saw Bob's call, VR, on his car, so VR will have a visitor soon. Perry Lovelace, jr., who was a former operator at Postal Telegraph and a member of the NCR gang here, has been in the thick of it in the So. Pacific.

(Continued on page 60)



OUR STORY in December *QST* on high quality reproduction has resulted in a number of inquiries from amateurs who want to know how to build it. In these days of material shortages, the choice of components depends more on what is available than on what one would like to use. So instead of giving just a diagram and a list of parts, we are going to write a series of pages, discussing some features of high-quality amplifier design. The diagram will come later.

As a start, consider the item from the fifth paragraph of our story which read "... and with the speaker adequately damped." If a sudden, brief impulse is applied to the grids of a pair of 6L6's whose plates drive a loud speaker, the voltage on the voice coil of the speaker will not be a similar impulse. It will be a damped wave which may pass through half a dozen cycles before it dies out. This gives the same effect to the ear as holding down the sounding pedal of a piano, and generally slurs over musical passages. Reproduction is "muddy."

It can be minimized by damping the speaker by means of a shunt resistor across the voice coil. Of course, if an actual resistor is wired across the terminals, it will waste too much power to be tolerated, but fortunately, the plate resistance of the tube can be used for this purpose. The 6L6's mentioned above, being pentodes, have very high plate resistance and, consequently, little damping. Degeneration has the effect of reducing plate resistance, and this is very effective in damping the speaker. In fact, this is the greatest virtue of degeneration in our experience. In using degeneration, bear in mind that only voltage controlled feed back reduces plate resistance. Current-controlled feed back, such as from an unbiased cathode resistor, *increases* plate resistance.

For the best possible reproduction, we feel that the old-fashioned push-pull Class A triode output stage has no superior. It has low plate resistance and low distortion. It can be driven from a high impedance stage and does not require good regulation in the power supply. It has the disadvantage of relatively small power output, which has caused it to fall in disfavor.

Triodes have low plate resistance, which provides the damping for the speaker. However, there is a great difference between tube types, and a type should be selected which has a low plate resistance compared to its load resistance. The output transformer which steps up the voice coil impedance to match the tube is going to step down the plate resistance in the same ratio, so only the ratio of the two resistances count. Using Type 50 tubes, the plate resistance would appear as a 4 ohm shunt resistance across a 10 ohm voice coil. 45 tubes give a slightly lower shunt resistance, but 2A3's, running Class A, give less than a third of an ohm. However, these same 2A3's, running Class AB₁, have a resistance of 11½ ohms, which is not so good.

By way of comparison, 6L6's give 78 ohms and 6F6's give 111 ohms when pentode connected.

There is an old rule that says that if you want 4 watts of high quality audio power, make an oversized amplifier of 10 or 20 watts. This rule was fine when everything was Class A. However, a 30 watt Class B or a 15 watt Class AB amplifier does *not* sound as well as a 4 watt Class A amplifier, provided 4 watts is all you want. Not to our ear anyway.

WILLIAM A. READY



the **INSIDE STORY** tells the **DIFFERENCE**

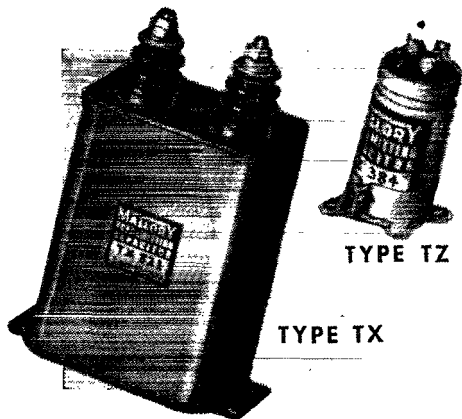

TYPE TZ

TYPE TX

Inner specifications that make the difference between long life or early failure cannot be judged by the outside appearance of a transmitter condenser. Good condensers have an extra margin of safety, as reflected by the generous use of insulation and special care in manufacture.

That is why long time users are so enthusiastic about Mallory transmitter condensers. They have an unexcelled record for long life and for functioning unflinchingly when needed.

Mallory transmitter condensers are made in 28 sizes, in working voltages from 600 to 6000, and in capacities from $\frac{1}{2}$ to 4 mfd. They are made in economical round can units and in standard square can construction.

Don't risk going off the air when you need your rig most. Condenser failure may cost you dearly in damage to associated components such as rectifier tubes and transformers. Specify Mallory and be safe! Available through your Authorized Mallory Distributor.

P. R. MALLORY & CO., Inc.
INDIANAPOLIS 6 INDIANA



P.R.MALLORY & CO. Inc.
MALLORY

Amateur Activities

(Continued from page 68)

He is a CPO and a first-rate radio operator. He is well known here, especially in ham circles, and everyone was glad to hear from him. 8SUZ dropped over for a personal ragchew. He has 1st-class commercial telephone and 2nd-class telegraph and Class A amateur ham tickets. He has worked all bands but seems to be a 40-meter c.w. ham. His home is in Greenville, Ohio, but he now is in the Navy and is at the Naval Air Station here in the radio department. 6OHN, of Hollywood, Calif., dropped in at the communications training shop for a nice chat. He and his dad, 6ELR, worked all bands but 40-meter c.w. was his real love. Lt. 6PNI has moved to Navy Point. His new QTH will be 279 Sunset Ave. A nice cherry card arrived from our old friend, AXY. He is a chief radio technician in the USCG, in the radio repair shop in Miami. Doc had some real nice ham gear in operation before the war. Lt. (jg) A. P. Ludwig has been transferred to Corpus Christi and will be missed by his many friends here. He was 6BRG and a real old-timer in the radio game. He was communications officer here and a firm advocate of mass training of radio operators for war work. With the assistance of Chas. Slattery, ARM1c, Tex, RM3c, our radio WAVE, and Rodgers, a civilian instructor, he compiled a pocket communications handbook that has been a boon to the Navy men. His latest contribution to radio training is a synthetic arm to show the exact movement of the arm in sending. It should be of real value in radio training, especially to wrist-weary teachers. Lt. (jg) Ludwig's successor is Lt. (jg) Joe Ellis who came up from the ranks and has seen real service in the So. Pacific. Joe is not a stranger to this air base for he was here in the capacity of CPO. He knows radio communication from A to Z and is well-liked by all. He is married, has three children and lives at Navy Point. A nice card was received from Sgt. GAJ, of the Army. He dreams of the day when he will be home and can put a rig back on air. A nice letter and Christmas card arrived from Red Flowers, formerly of our instructor staff, but now a m/sgt. in the U. S. Army. Red reads *QST* regularly and in that way keeps up with the section doings. Bill Langford made his Class C and may have a Class B soon. Bill has bought a National receiver and is having lots of fun with it. L. J. N. Dutreil, X-5DUFCC inspector, gave exams here recently. The OM had a nice personal chat with him while exams were going on. AXP put in for a restricted 'phone license and got it. Hi. John Blackman, a veteran operator, took the exam for a special license and got it. More news from the boys in the services and stories of adventure will be greatly appreciated. 73 to all. *The Old Maestro*.

SOUTHWESTERN DIVISION

LOS ANGELES — SCM, H. F. Wood, W6QVV — A nice letter was received from Capt. 3WVY, ex-6TEY, who has been laid up in the AAF regional hospital at Santa Ana. He states that he has been keeping up with the gang through *QST* and that while he has been there it has been a great help to him. Yes, Jack, those planes do "bump pretty hard." We're all glad that it wasn't "too hard" for you, though, and will be mighty glad to see you when you get out. Also Rus Sakkers, who used to print those QSL cards in Holland, Michigan, sent a nice letter. Rus is also in a hospital. You "8s" back there around Holland had better write to him; he'd like to hear from you. His address is APO 322 c/o Postmaster, San Francisco. UQL has been moved and may now be reached through APO 726, c/o Postmaster, San Francisco. Frankie reports that the WX is terrible. He says that he thoroughly enjoys *QST* and the new ARRL *Handbook* that Santa sent. SSU has shipped out with the merchant marine and may be addressed c/o Postmaster, San Francisco. We heard from him indirectly through his XYL and are glad to learn that he was able to contact Jim Rollins at his first stop. Fred Stapp writes that KGIC activity for the Inglewood area is progressing in fine style. They have switched their regular weekly drill periods to Monday nights and have been very busy activating new units. The technical committee has been working on a new and improved receiver design as well as on beam antennas and frequency-measuring equipment. Early results are fine and they hope to have their whole net equipped soon with the newer ideas. Several new operator applications are being sent in and they really are going to town. AM writes that KGWE stations are very active on their

(Continued on page 68)

NEVER ALONE

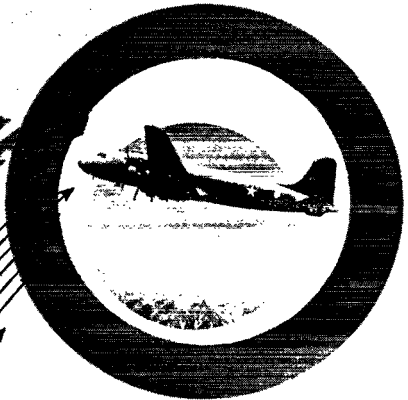

Many thousands of Hammarlund
"Super-Pro" radio receivers
assist the Army Airways Communications System
in providing flight information
for Allied planes
in the skies everywhere...

Below we see a battery of
"Super-Pros" in action
Somewhere in the Pacific.

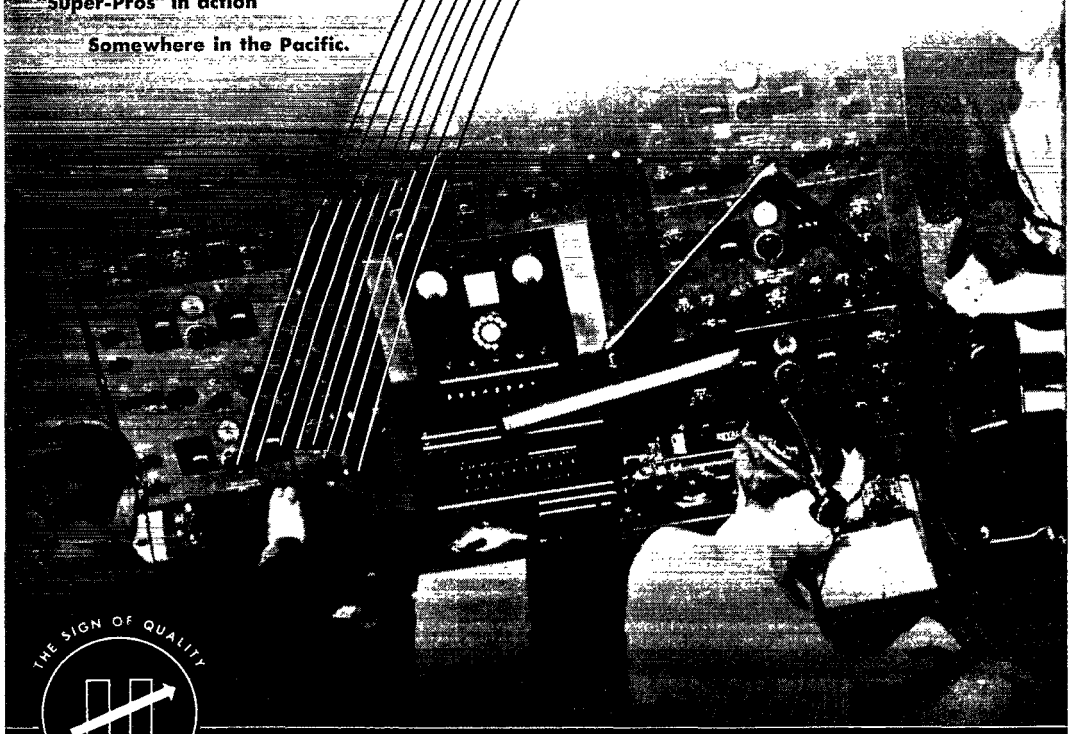

ESTABLISHED 1910

THE HAMMARLUND MFG. CO., INC., 460 W. 34TH ST., N.Y.C.
MANUFACTURERS OF PRECISION COMMUNICATIONS EQUIPMENT

OHMITE RHEOSTATS

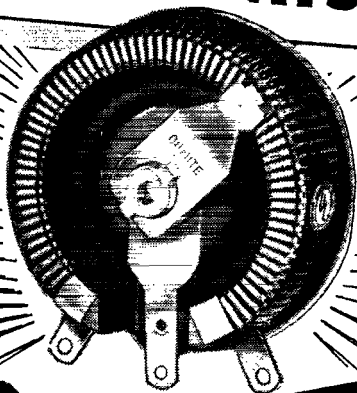

SMOOTH • CLOSE • ACCURATE

Control

• Design engineers everywhere rely on Ohmite Rheostats for smooth, close, accurate control of electronic tubes and devices. The many time-proved features of these control units insure trouble-free operation under toughest service conditions. That's why Ohmite Rheostats are so widely used today in vital military and industrial equipment. Ten sizes ... from 25 to 1000 watts.

Authorized Distributors Everywhere

Send for Ohm's Law Calculator

Solves any Ohm's Law problem with one setting of the slide. Send only 10c in coin for yours.



OHMITE MANUFACTURING CO.
4863 Flournoy St. • Chicago 44, U. S. A.

Be Right with **OHMITE**
RHEOSTATS • RESISTORS • TAP SWITCHES

(Continued from page 60)

drill periods, that the majority of them now are crystal-controlled and they are using superhet receivers. A great deal of their time is being spent in experimenting. KGLV is working out on all drill periods allowed and the new tactical drills are proving of interest to all. Willy, as unit Nr. 31, is still very much on the job, guiding the boys to their proper frequencies, etc. Operating conditions at unit Nr. 1, as well as at many other points, are being greatly improved and soon the whole network will be as efficient in operation as Walt Matney had it on paper. Ora Martin reports the passing of that excellent ham, PIH. Paul had been bedridden for over twenty years, as many of you know, and his great courage in carrying on under such a handicap had won him great admiration from all who knew him. 73, Ted.

ARIZONA — SCM, Douglas Aitken, W6RWW — RWW has gone to the hospital and I (MLL) am sending in a few notes for him. Everyone wishes you the best of luck, Doug, and hopes that you soon will be home again. NRP, RM2c is in New Guinea, slinging mail for the Navy. OZM held open house Dec. 23rd. KOL still is at the Naval Aircraft factory in Philadelphia. His request for active duty has been turned down repeatedly. R. Rouzard (LSPH), now stationed in Hawaii, has built a receiver from Jap equipment he captured on Saipan. He built a guitar pick-up from a Jap magnetic mine and a car coil. RWW has plans under way for starting a State organization. He says a united voice in Arizona will help ARRL more than a few weak cries here and there. R. Quen (LSPH) is going overseas as a radioman on a C-47. MLL's radio class members are building carrier-current rigs. I wish to take this opportunity to extend to all of you the best wishes for a Happy New Year from Doug and myself. 73, G. C.

SAN DIEGO — SCM, Ralph H. Culbertson, W6GHV — Asst. SCM, Gordon W. Brown, W6APG — The entire gang is waiting patiently for WERS to materialize. It is hoped that by the next report NDD's confirmation as radio aide will have been approved by FCC. He then will be able to start certifying amateurs for WERS. All those interested are urged to contact NDD or CHV as soon as possible. 73, Ralph.

WEST GULF DIVISION

NORTHERN TEXAS — SCM, Jack T. Moore, W5ALA — ELC reports that he is still "working on the railroad" for Ft. Worth & Denver and sends a swell report on the Ft. Worth boys: BYO is a major and is communications officer for the Caribbean area. CKG is working for Consolidated Vultee Aircraft and is teaching an ESMWT radio class at T.C.U. ALK supervises the installation of transcontinental cables for Southwestern Telephone and occasionally takes time off to skipper his sailboat on Lake Worth. CF is general manager of a Purina plant. GKA has moved to Chicago and is working for Swift. HHU is a captain in the Air Forces. RJ has done a lot of traveling for CAA, making range and other installations. CVW is a major in the Air Forces and has spent a lot of time in India, but at the present time, Bill is running a world-wide air-taxi service out of Washington. CVA is with Aeme News Picture Service. GEC and FJV, the well-known "Collup Twins" recently were graduated from Oklahoma U. with degrees in communication engineering and are now in Washington working in the Navy Research Lab. GCR is chief radioman in the Navy and has had three years experience. BGW is with the FCC in Dallas. JO is in charge of the radio test lab. at Consolidated. BNG is a captain in the Army. AGQ is a captain in the Air Forces, somewhere in the Pacific. DFU (Dad's Flannel Underwear) is head of the American Airlines radio department in Ft. Worth. FOA is an engineering aide with the CAA in Washington. The widow of DNE would like to sell his FB7 with PSK. ISM has given up his carrier-current rig because of lack of activity. IF is in Washington per CDU. Joe says he keeps in practice by copying press. VV, commanding officer in the AACs, moved to Dallas from Chicago. Lt. Col. Wilmer Allison will be located at Love Field attached to a ferrying group. 9SAY, 9TGJ, and 9YFB have moved to Dallas and are working at North American Aviation. EXFFI, who is an engineer at WKRC, says that reading about the fellows he used to work back in the good old days is almost like a letter from home. IZL sends in a nice report. Ruth says she has been recruiting WAC instead of working WAC since the war and that her younger son, Bert Allen, is a C-47 pilot in England. Ruth also advises that she

(Continued on page 64)

SEARCH AND RE-SEARCH

Years of engineering research are responsible for

the many well known Hammarlund marine type

variable condensers, which are now playing such

a vital role in the search for

enemy ships over the seven seas.

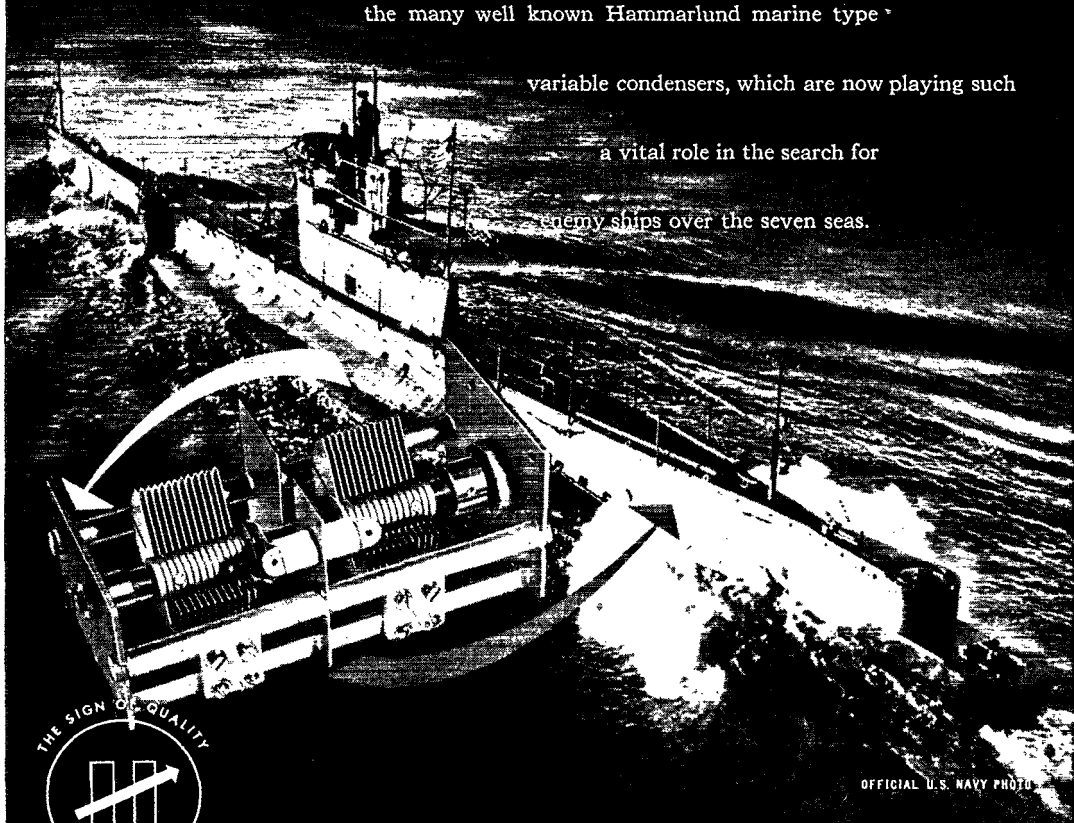

OFFICIAL U.S. NAVY PHOTO



ESTABLISHED 1910

THE HAMMARLUND MFG. CO., INC., 460 W. 34TH ST., N.Y.C.
MANUFACTURERS OF PRECISION COMMUNICATIONS EQUIPMENT



... Here's How You Can Qualify for a BETTER RADIO JOB

... CREI technical training is preparing others for good paying radio jobs —
WHY NOT YOU?

Are you finding yourself in a routine job — a job that any other man can handle just as well as you? Today, radio jobs are many — but radio careers are few!

Now, is the time for you to prepare and equip yourself with the necessary technical training to qualify for an important engineering position with a sound future.

In the proved CREI course of home-study training you learn not only *how*... but *why!* Easy-to-read-and-understand lessons are provided you well in advance, and each student has his personal instructor who corrects, criticizes and offers suggestions on each lesson examination. This is the successful CREI training for which more than 10,000 professional radiomen have enrolled since 1927.

Now when industry needs men, is the time for you to investigate radio career training. Your radio experience backed by modern CREI technical training will equip you to share in the good-paying jobs that await trained men... and to make good in the important positions that lead to post-war careers with security and happiness!

● WRITE FOR FREE 36-PAGE BOOKLET

If you have had professional or amateur radio experience and want to make more money—let us prove to you we have something you need to qualify for a better radio job. To help us intelligently answer your inquiry—please state briefly your background of experience, education and present position.



Capitol Radio Engineering Institute

Home Study Courses in Practical Radio-Electronics Engineering for Professional Self-Improvement

Dept. Q-2, 3224 16th St. N. W., Washington 10, D. C.
Contractors to the U. S. Navy, U. S. Coast Guard and Canadian Broadcasting Corporation
Producers of Well-trained Technical Radiomen for Industry

(Continued from page 82)

visited the 6TNZs the past summer. FYZ is with the Texas Co. in Louisiana as a recorder. How about you fellows who used to work GWO on 40 meters dropping him a line addressed as follows: Lt. J. F. Kennedy, Det. of Patients, Ward 7, Brooke Hospital, Ft. Sam Houston, Tex. GWO got his navigator wings about a year ago and went to England. On June 20th, over Paris, flak came through the bottom of his Fortress and got him in the left arm and leg. He was in a hospital in England for several months before being sent to Brooke Hospital, where he has a date for another operation as soon as he is able. IIB is a 1st Lt. stationed at Ft. Monmouth. GWX is a 1st Lt. in the USMC and has been in some of the toughest Pacific battles. IEB is now at Camp Livingston, La., after spending many months in the Aleutians. Fellows, in an effort to get you to send in some news, I am going to give a copy of the new *Handbook* to whoever turns in the best report for next month. How about sending in yours right now? 73, Jack.

OKLAHOMA — SCM, Ed Oldfield, W5AYL — With Christmas past and the New Year started may I wish you all a Happy New Year. Really missed the ham gear usually received for Christmas and the opportunity to use it. Received a good letter from FIY who now is working and traveling for RCA. The Oklahoma City club had a small, but none-the-less mighty, turnout on Dec. 7th. We enjoyed a long picture show at AYL's place. How about reports from the other clubs in the State? Information is scarce here and we must have your letters. Regards, Ed.

NEW MEXICO — SCM, J. G. Hancock, W5HJF — JWA is enjoying a 30-day furlough at home after losing his ship. Jack has a busted ear drum to remind him of the sinking. JVV is an old member of ARRL, just returned after making the mistake of playing the SCM a game of chess by mail. He said he had tried to forget radio. The SCM has also found an enthusiast in St. Louis, Mo. through the medium of correspondence chess, and is trying to keep him on the right track. Won't some of you St. Louis fellows contact Chester Lestmann, 3337 Minnesota Street, Zone 18, and help both of us. Chess is a swell fellow and will make a fine addition to the QRM Masters. 73, Jack.

The Month in Canada

ONTARIO — VE3



From L. W. Mitchell, VE3AZ:

The Secretary of the WAOO reports that most of the OMs and YLs have been busy Christmas shopping for the junior ops. One of the gang was seen lugging home a Christmas tree which was big enough to support a 20-meter beam. Some of the boys are lighting up their decorations with r.f. this year just to make sure parts of the old rig are perking. Plans are now going ahead for the holding of a conference of the members of the Wireless Association of Ontario and the gang at R.E.L. Further information as to date and time will be announced in this column soon. Plans have been made to hold the next regular meeting of the WAOO in Room 21, Electrical Bldg., University of Toronto, on Thursday February 15, 1945, at 8 p.m. The guest speaker will be T. S. Farley, who will present a paper on the problems of r.f. coil design. Anyone desiring information on WAOO activities is invited to get in touch with the secretary, Bill Winter, VE3APA, 66 Gormley Ave., Toronto, HY. 2279, or President Bob Humphreys, VE3ALC, 218 Havelock St., Toronto, LO. 7375.

All members of the WAOO wish to express their gratitude to ARRL, and to Canadian General Manager Alex Reid, for their efforts on behalf of Canadian hams, on the Canadian Radio Technical Planning Board.

3IM, Flight-Lieutenant C. W. Boughner, OBE, has returned from overseas and is now stationed at the RCAF repair depot at Winnipeg. 3FB, Flight-Lieutenant Bob Sangster, who recently completed a course as a signals officer and was in charge of the RCAF radio laboratories at Winnipeg, is now completing a v.h.f. course at No. 1 Wireless School, Hamilton. Wing Commander Al Walmsley, a former VE5, is now in charge of Signals Training Air Force Hq. at Ottawa. 3EF, Wing Commander Donald Gunn, is now second in command of Signals at Air Force Hq. at Ottawa. 1MW, Wing Commander Don Campbell is Chief Signals Officer, No. 1 Training Command at Toronto. 1BO,

(Continued on page 86)



**In meeting
the challenge of the future,
Western Electric
equipment leads the way**

War's end will bring a challenge to everyone. To those identified with communications and transportation, faster, better interchange of ideas and goods will be the order of the day.

We at Western Electric—with our 75-years heritage of leadership in communications equipment—believe we are peculiarly qualified to accept this challenge.

In world-wide telephony, broadcasting, aviation, marine and mobile radio—in every field where sound-transmission apparatus plays a part—Western Electric has led and will continue to lead the way. In these fields as well as in television, Western Electric will play a dominant part in the future.

To speed Victory, buy more War Bonds—and keep them!

 **Western Electric** 
ARSENAL OF COMMUNICATIONS EQUIPMENT

 Distributed by
Graybar
ELECTRIC COMPANY

Fresh

OFF THE
GRIDDLE

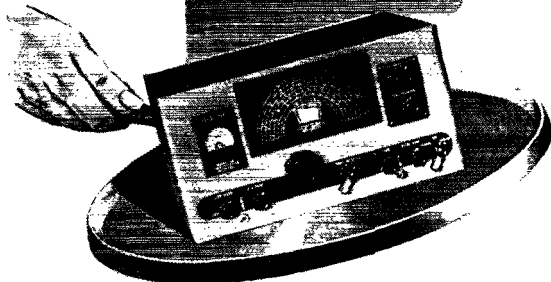

EVERYTHING THAT'S NEW IN RADIO DESIGN

RME

FIRST THINGS FIRST

R. M. E. keeps ahead of the field with the new things in radio — first. Our engineering staff has tomorrow's R. M. E. equipment ready for you — available as soon as military demands are fulfilled. Again R. M. E. has taken long strides in introducing new fea-

tures of design which will set the pace. Again we offer the new things first. Since 1933 R. M. E. radio communications equipment has developed such outstanding radio firsts as the calibrated DB signal strength meter, the modulation monitor, the split-stator tuning system and the phase adjusted crystal filter unit.

In scores of other radio advancements, R. M. E. has been a leading pioneer and will be among the first to offer new design when it's new.

We will be glad to send you details on the R. M. E. series receivers as they are announced. Write us a card today asking for facts on R. M. E. equipment.

"R. M. E.—Since 1933"

R M E



FINE COMMUNICATIONS EQUIPMENT
RADIO MFG. ENGINEERS, INC.

Provia 6, Illinois U. S. A.

(Continued from page 64)

Wing Commander Kenneth Patrick, is Officer Commanding No. 5 Radio School, Clinton. 3BC, Captain Bruce Carveth, who is with the RCCS in France, recently married a girl in England who was a ground wireless operator in the WAAF. Congrats OM!

ALBERTA—VE4

From W. W. Butchart, VE4LQ:

A newsy letter arrived recently from 4NU, Gordie Sadler, of Edmonton and Grande Prairie, who is now chief operator at CFGP, Grande Prairie in which he says that he follows the doings of the VE4 gang through this column every month. He notes absence of the call of ADW, Jack Gooderidge, of Edmonton and Saskatoon from the column. Jack is in the RCNVR stationed at Saskatoon for the time being, where his YF is working in a jewelry store. Gordie also passes along some dope re CFGP which will interest you chaps. The station is operated by the Northern Broadcasting Company, is powered at 1000 watts and operates on 1350 kc. Their slogan is "The Voice of the Mighty Peace," and in justifying that name Gordie says that it gives good coverage throughout the Peace River Block and into the Northland. Reason for Edmontonians very seldom picking up the station is the fact that superhets in Edmonton listening to CJCA radiate a goodly sized "hash" (heterodyne to those more technically minded) right smack on 1350 kc. Gordie adds hopefully, though, that if you are interested in hearing CFGP, "listen in sometime when CJCA has a particularly stinky program on, when fewer supers in the city will be tuned in to it, and consequently the hash will be less at 1350, and CFGP might be able to poke in a signal!" Gordie has been looking around the north country in the vicinity of Grande Prairie for a few hams with thoughts of forming a northern branch of the NARC or possibly the nucleus of a brand new organization! Thanks a million for the letter Gordie, and we'll be seeing you on the air one of these days.

4AOZ, Slim Marsden, of Milo, tells us that 5DO, Art Muskett, of the B.C. Provincial Police, Port Alice, B.C., is celebrating the arrival of a jr. op., James Lindley Muskett, as of November 22nd. 4EA, Roy Usher, of Edmonton, had a visit from K7HMS, Pierre St. Amand of Fairbanks, Alaska, the other day. He is with the U. S. AAF, and stationed in Edmonton temporarily. At the time of writing up our last report, 4VJ, Ken Angus of Edmonton, was reported as being on the sick list. Ken went back to work, but it has been a bit too heavy for him, with the result that the Doc has ordered a further lay-off for Ken. And by the way, 4ATH, Stan Mitchell of Edmonton, has joined the staff of CFRN in Edmonton, after spending a year or more in the laboratory over at the U. of A. Last report in on 4AKK, Bob Lamb of Edmonton and Calgary, shows that he is still very much alive and is still "modernizing" the studio equipment at CFRCN, Calgary.

From time to time in this column we mention Paul Johnson of Edmonton, member of the NARC, without a call, who has been overseas with the CBC Overseas Recording Unit. Paul returned to Canada a few months ago and recently visited his home here in Edmonton. As recording engineer with the unit he has seen service in Sicily, Italy, England, and also I believe, in France. He has seen and heard plenty in his travels which have placed sounds and descriptions of modern warfare on "the platter."

4HM, Chas. Harris of Edmonton, has been busy making photographic Xmas greeting cards. 4BW, Ted Sacker of Edmonton, one of Edmonton's foremost prestidigitators made a buying trip down through the States, and he managed to pick up a pile of new tricks. He has been busy of late practicing up on them, and we understand that his services are much in demand. Saw 4EY, Bill Careless of Edmonton, in BW's joint the other day, buying sundry radio articles, amongst which appeared two identical speakers. We asked him what sort of receiver he was building that would require two speakers! He is building up a "talk-back" system for inter-office work at the CN telegraph!

A letter from 4AAD, Jack Freeman of Edmonton and Calgary, brings news that he will in all probability be making Edmonton his hq. for postwar activity. Dot Fitts, 4VO, of Calgary, who is a member of Jack's staff in the District Signal Officer's office at Calgary is a corporal (CWAC). By the way, Dot, how about a nice newsy letter?

Would appreciate hearing from you chaps who can pass along news of interest to the VE4s.



The Greeks gave us a word for it . . . now we give it to you

WHEN Sperry first developed its velocity-modulated, ultra-high-frequency tube, the word "KLYSTRON" was registered as the name of the new device.

This name—from the Greek, as coined by scientists of Stanford University—is an apt description of the bunching of electrons between spaced grids within the tube.

"Klystron" is a good name. So good, that it has come into widespread use as the handy way to designate any tube of its general type, whether a Sperry product

or made by another manufacturer.

This is perfectly understandable. For the technical description of a Klystron-type tube is unwieldy, whether in written specifications, in conversation, or in instructing members of the Armed Forces in the operation of devices employing such tubes.

These conditions have prompted many requests from standardization agencies—including those of the Army and Navy—for unrestricted use of the name Klystron. In the public interest, Sperry has

been glad to comply with these requests . . .

From now on, the name KLYSTRON belongs to the public, and may be used by anyone as the designation for velocity-modulated tubes of any manufacture.

Sperry will, of course, continue to make the many types of Klystrons it now produces, and to develop new ones.

On request, information about Klystrons will be sent, subject to military restrictions.

SPERRY GYROSCOPE COMPANY, INC. GREAT NECK, N. Y.

Division of the Sperry Corporation

★
LOS ANGELES • SAN FRANCISCO • NEW ORLEANS
HONOLULU • CLEVELAND • SEATTLE

GYROSCOPICS • ELECTRONICS • RADAR • AUTOMATIC COMPUTATION • SERVO-MECHANISMS

"Gadgeteering"

better CARDWELLS

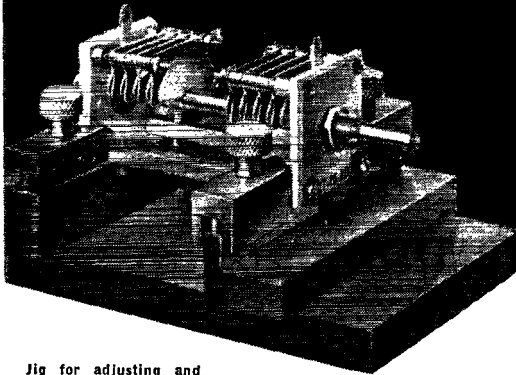

Jig for adjusting and checking parallelism of tie-bars on dual Trim-air condensers.



Special tools, jigs and fixtures are, in the final analysis, the key to improved quality for even the simplest devices.

Sometimes a good customer may design a fixture to improve a troublesome detail encountered in production use of one of our devices. RCA "gadgeteered" this assembly jig which insures parallel and co-planar tie-bars and dual Trim-air condensers.

We appreciate such cooperation because we are doing plenty of "gadgeteering" on our own hook—some of it very complicated—and the obvious is sometimes overlooked.

Whether it is an automatic "gadget" such as Cardwell developed to electronically calibrate, and mechanically print, more than 3000 points on each of the thousands of Cardwell Frequency Meters (used by our Armed Forces), or the relatively simple device shown here, Cardwell products reflect, in improved quality, the application of intelligent "gadgeteering." This is passed on to all users of

CARDWELL QUALITY PRODUCTS

STANDARD OF COMPARISON
CARDWELL  **CONDENSERS**

THE ALLEN D. CARDWELL MANUFACTURING CORPORATION
81 PROSPECT STREET BROOKLYN 1, N. Y.

Missing in Action

T/Sgt. James A. Sisney, W6TNG, has been reported missing in action since April 22, 1944, when his plane failed to return from a mission in the Southwest Pacific.

Prisoners of War

S/Sgt. Wheeler Whelchel, W5EOJ, and S/Sgt. Albert Senter, W5GUZ, are reported to be prisoners of war of the Japanese, having been captured on Bataan or Corregidor in 1942.

Silent Keys

It is with deep regret that we record the passing of these amateurs:

W1BGF, Perry O. Briggs, Wakefield, R. I.
W2NDG, John F. Shaughnessy, Hollis, L. I., N. Y.

W3HDP, Francher L. Turner, Roanoke, Va.

W5GVD, John E. Madden, Ft. Worth, Texas

W6JZN, E. C. Cockrell, Lancaster, Calif.

W6PIH, Paul L. Clark, Pasadena, Calif.

W6SDP, James P. Seargeant, Los Angeles, Calif.

W8ACW, George Gurnea, Flint, Mich.

W8BSK, Herbert Halverstadt, Kent, Ohio

W8EVK, Frank A. Teach, Columbus, Ohio

W8GJI, Louis A. Marien, Davison, Mich.

W8PTB, John D. Witmer, Rochester, N. Y.

W8SYT, Alex C. Boulter, Mason, Mich.

W9AFF, William W. Bingham, Fox Lake, Ill.

W9FSX, Sgt. Faris B. Davison, Huron, S. D.

W9HNG, Bernard V. Rose, Madrid, Nebr.

W9ONR, Charles J. Uher, Oak Park, Ill.

W9WZW, George Masing, Muncie, Ind.

Strays

In the period from 1906 to 1942 magnetic storms occurred on 2800 days. A study of these storms made at the Commonwealth Solar Observatory, at Canberra, Australia, revealed that they fall into four groups, divided into twenty-seven periods. Three groups were associated with visible eruptions or with sun spots. These storms took place 1.5 to 2.5 days after the disturbances on the sun's meridian. The fourth group, was not accompanied by visible outbreaks of the sun. It is estimated that three days are required for the particles causing these disturbances to travel from the sun to the earth.



Westinghouse

Doolittle
RADIO, INC.

Signal Corps

Federal Telephone and Radio Corporation

SPERRY
GYROSCOPE COMPANY, Inc.

GENERAL ELECTRIC

GROSLEY

WILCOX ELECTRIC
COMPANY

WEBSTER ELECTRIC

RAYTHEON MANUFACTURING COMPANY

Western Electric



THE BEST KNOWN NAMES ON THE WAR PRODUCTION FRONT DEPEND ON THORDARSON QUALITY

Throughout the trying periods encompassed by 3 wars . . . and in all the intervening years of peace since 1895 . . . Thordarson leadership has been accentuated by its association with the most outstanding concerns in America.

Especially on the present world-wide war fronts . . . where the marvels of research laboratories and the handwork of production geniuses may be seen in action . . . there also will be found the results of Thordarson experience and Thordarson engineering ability.

Thordarson Transformers and Amplifiers are "good right hands" to a host of America's leading organizations who are concentrating on winning the war as quickly as possible.

Thordarson products are helping to do everything from making communications easier and more accurate to conducting

fatigue tests which insure more dependable airplane propellers. All

of these services and experiences, now devoted to war, will enable

us to serve you better when peacetime needs are again paramount.



THORDARSON

TRANSFORMER DIVISION
THORDARSON ELECTRIC MFG. CO.
500 WEST HURON STREET, CHICAGO, ILL.

Transformer Specialists Since 1895
ORIGINATORS OF TRU-FIDELITY AMPLIFIERS

PORTABLE POWER PROBLEMS

THIS MONTH—BRISTOL PYROMASTER

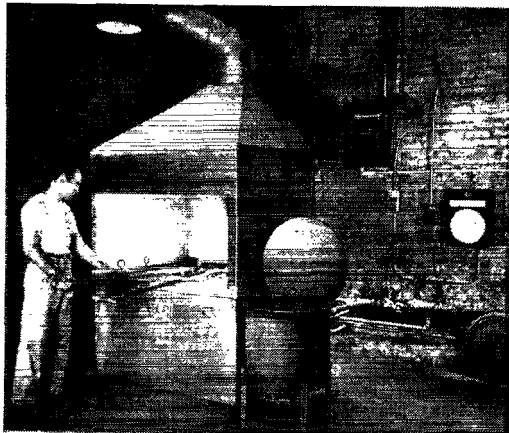

INDUSTRIAL PROCESSES are accurately recorded, indicated and controlled by the Bristol Pyromaster Self-Balancing Potentiometer. In the illustration above, a Pyromaster maintains temperature control of a gas-fired furnace, used for case hardening steel parts.

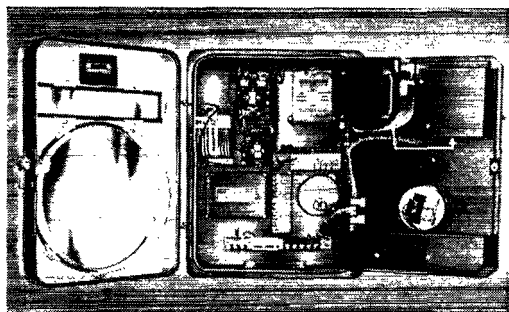

DIRECT MARKING pen moves instantly and continuously at the rate required to follow temperature variations. A 1½ volt Burgess Battery supplies constant current to the potentiometer circuit. Burgess Industrial Batteries are designed to meet the exacting specifications of special instruments. Write today about your specific needs. Free 80-page Engineering Manual on characteristics of dry batteries. Write Dept. Q-6, Burgess Battery Company, Freeport, Illinois.



BURGESS BATTERIES

WWV Schedules

STANDARD-FREQUENCY transmissions are made available as a public service by the National Bureau of Standards over its standard-frequency station, WWV, on the following schedules and frequencies:

2.5 Mc. — 7:00 P.M. to 9:00 A.M. EWT (2300 to 1300 GMT).

5.0 Mc. — Continuously, day and night.

10.0 Mc. — Continuously, day and night.

15.0 Mc. — 7:00 A.M. to 7:00 P.M. EWT (1100 to 2300 GMT).

Each of these radio frequencies is modulated simultaneously at accurate audio frequencies of 440 cycles and 4000 cycles, excepting 2.5 Mc. which carries only the 440-cycle modulation. In addition, there is a 0.005-second pulse, heard as a faint tick, every second, except the 59th second of each minute. These pulses may be used for accurate time signals, and their one-second spacing provides an accurate time interval for physical measurements.

The audio frequencies are interrupted precisely on the hour and each five minutes thereafter, resuming after an interval of precisely one minute. This one-minute interval is provided to give the station announcement and to afford an interval for the checking of radio-frequency measurements free from the presence of the audio frequencies. The announcement is the station call (WWV) sent in code, except at the hour and half hour, when it is given by voice.

The accuracy of all the frequencies, radio and audio, as transmitted, is better than a part in 10,000,000. Transmission effects in the medium may result in slight fluctuations in the audio frequencies as received at a particular place; the average frequency received, however, is as accurate as that transmitted. The time interval marked by the pulse every second is accurate to 0.00001 second. The 1-minute, 4-minute and 5-minute intervals, synchronized with the second pulses and marked by the beginning and ending of the periods when the audio frequencies are off, are accurate to a part in 10,000,000. The beginnings of the periods when the audio frequencies are off are so synchronized with the basic time service of the U. S. Naval Observatory that they mark accurately the hour and the successive 5-minute periods.

Of the frequencies mentioned above, the lowest provides service to short distances and the highest to great distances. In general, reliable reception is possible at all times throughout the United States and the North Atlantic Ocean, and fair reception over most of the world.

Information on how to receive and utilize the service is given in the Bureau's Letter Circular, "Methods of Using Standard Frequencies Broadcast by Radio," obtainable on request. The Bureau welcomes reports of difficulties, methods of use, or special applications of the service. Correspondence should be addressed to the Director, National Bureau of Standards, Washington, D. C.

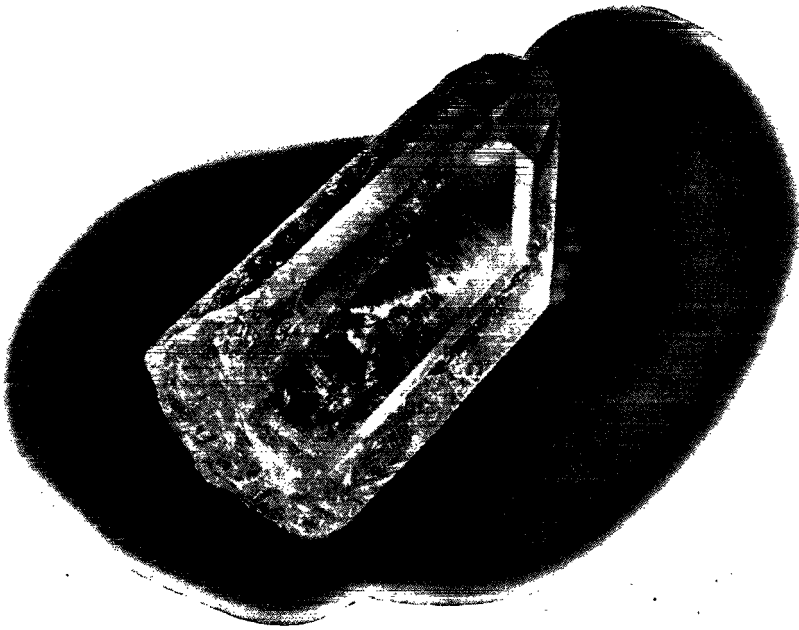

Here all similarity ends...

from this point on, it's craftsmanship!

In one important respect there is a striking similarity between the millions of Bliley crystals which we now produce and the mere handful of custom made units that constituted our annual production when radio was still young.

In those early days of radio, when each quartz crystal was painstakingly cut and ground by hand, a tradition was born. It was a tradition of craftsmanship that has grown with the years—a tradition that Bliley engineers have successfully translated into the more intricate techniques of volume production.

Etched crystals are an outstanding discovery and development of Bliley research engineers. This technique, by means of which crystals are finished to frequency by acid action rather than abrasive action, was an established part of Bliley production long before Pearl Harbor. It has since proven to be an essential element in the manufacture of crystals that have the dependable characteristics necessary for military communication in global warfare.

We have been called upon to

solve some knotty problems. But that is nothing new at Bliley. It has been our habit to parallel new developments in radio with the right crystal for each application.

Things will be different soon. Peacetime projects will again come first. But our engineers and craftsmen will be ready, as always, with the right answer to your requirements. Don't fail to include Bliley crystals in the component specifications for your peacetime equipment.

Do more than before...

buy extra War Bonds

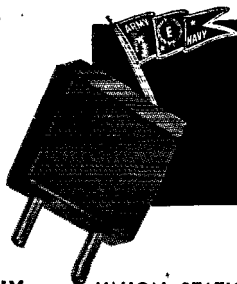

Bliley
CRYSTALS

BLILEY ELECTRIC COMPANY

UNION STATION BUILDING • ERIE, PENN.



Shriving the distances that separate us but can never divide us, amateur radio exerts its mighty force in true democracy, without regard to speech, creed, or color — united by our love of radio, we hams are truly "Americans All."

For our small part in forging this bond of knowledge and friendship among radio amateurs, we are grateful — and we pledge our continuing readiness to serve you in war as in peace.

The RADIO SHACK
 ★ 167 WASHINGTON ST. ★
 BOSTON, MASS., U.S.A.

Correspondence from Members

(Continued from page 48)

The thing you ain't mentioned — 'though 'course you know all about it — is the muddle-headed dumbness of pumping out stuff from 30 cycles up to 200 or 300 cycles and from 3500 cycles and up. Don't nobody hear it, 'cause communication receivers don't take it in. All it does is subsidize the power company and overwork the modulation. Worst of all, on the top side it makes a wider sideband. If every ham had a maximum 4000 instead of 9000 cycles top then you got 5 kc. less crowding per station.

You keep plugging carbon mikes — you're dead right.

— "Sourdough"

Box 95, South Harwich, Mass.

Editor, QST:

Thank you, on behalf of all the hams on Cape Cod, for the swell job ARRL is doing in Washington. With such capable spokesmen, I am sure that the hams will come in for their share of the radio spectrum.

Also, thank you for your article by McMurdo Silver on microphones. This is a problem that has long been facing the ham, and which needs much more in the way of solution. I am a broadcast engineer (WOCB) and I fully realize the requirements of a high-fidelity speech system, but have always contended that this is not for amateurs. We are primarily interested in communications, not the reproduction of music, and for that reason, we should design our equipment for communication purposes. Designing a speech system for high-fidelity brings in all the problems of high-gain stages, with their attendant troubles, such as hum pick-up, r.f. feed-back, etc. If we build our systems to reproduce a range of say, 100 to 3000 cycles, we have eliminated the 60-cycle hum problem entirely. Using a modern carbon microphone and eliminating high-gain stages, we eliminate the r.f. problem to a great extent. I find the hiss level of a carbon microphone to be negligible if the voltage is kept low. I have always used the F-1 carbon mike, and those who have worked me have never noticed any hiss level at all. I cannot read any on the VU meter on the output of my speech amplifier. In any event, it seems to me that the mixer noise on any superhet far exceeds any thermal noises that may be in the received signal. I have always campaigned for carbon microphones, have talked many of my ham friends into using them, and hope that you will publish more material concerning them. They will eliminate any and all amplifier troubles such as feed-back, etc., and will make it possible for the new ham to put a 'phone signal on the air that will be far better than if he tried to use a high-gain amplifier. . . .

The average ham is not highly skilled in engineering, especially during the first few years. I know I wasn't, and were it not for the ARRL Handbook and a lot of advice from older hams, I

(Continued on page 74)

FOR DEPENDABILITY IN TIME OF EMERGENCY COUNT ON E-L POWER SUPPLIES



IN EVERY natural catastrophe that has struck this country—in time of flood, of storm, of forest fire—the radio ham has played a vital role in maintaining necessary communications and helping to direct rescue operations. In many instances, the ham was the only means of making contact in inundated and isolated areas.

Today, the hams are barred from the air by government order, but they will be back one of these days looking for new equipment to improve their shortwave rigs—equipment that is more efficient, more serviceable, more dependable.

Among the newest developments for the amateur are the Electronic Laboratories Vibrator Power Supplies for mobile and

portable applications. These power supplies have stood the test of the most rugged combat use in military service. Efficient and dependable, E-L units will be available just as soon as war conditions permit.

E-L are pioneers in the field of vibrator conversion of current. Many exclusive developments in this method of power adaptation have led to such advantages as constant output voltage despite wide fluctuations of input voltage, power outputs up to 1,000 watts, and any wave form, including pure sine wave.

For your postwar rig, plan for E-L Vibrator Power Supplies. Give your name to your dealer now for early supply after the war.

E-L STANDARD POWER SUPPLY
Model 601 E-L converter is ideal for providing the plate and grid supply of radio receivers and transmitters, for stationary, mobile or portable applications from a 6 volt storage battery.
INPUT: 6 volts DC.
OUTPUT: 225 volts DC at 50 ma.; 250 volts DC at 65 ma.; 275 volts DC at 80 ma.; 300 volts DC at 100 ma.
OUTPUT POWER: 30 watts.
FILTERING: Full RF filtering provided.
SIZE: 4½x4x6 in. WEIGHT: 6 pounds.

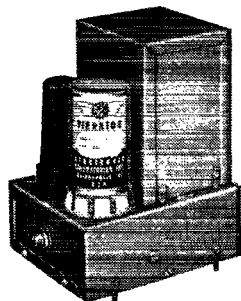

Electronic

LABORATORIES INC.

INDIANAPOLIS

VIBRATOR POWER SUPPLIES FOR LIGHTING, COMMUNICATIONS AND ELECTRIC MOTOR OPERATION - ELECTRIC, ELECTRONIC AND OTHER EQUIPMENT

Gammatron
**MATCHED
 PERFORMANCE**

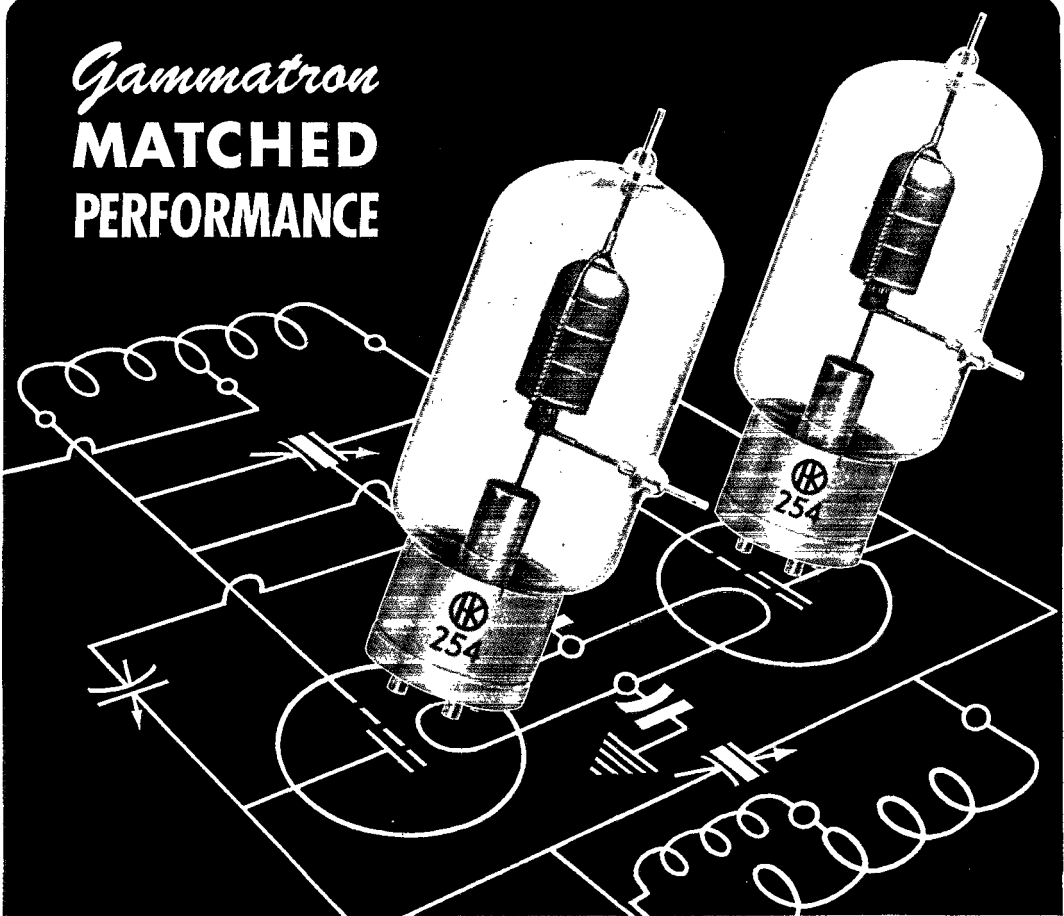

Gammatron **UNIFORMITY
 MEANS LONGER TUBE LIFE**

Heintz and Kaufman engineers have continually developed closer electrical and physical tolerances for Gammatron tubes over the past 16 years, knowing that matched characteristics result in better operation and longer tube life.

Today the importance of tube uniformity, especially in the very high frequencies, is widely recognized; and many of the peacetime standards we have established for Gammatrons are now contained in the wartime specifications for all tubes of the Gammatron type... When you design a transmitter around a pair—or even a dozen—Gammatrons, you will get the full benefit of our years of experience in pioneering constantly higher standards of transmitting tube performance.

HEINTZ AND KAUFMAN LTD.
 SOUTH SAN FRANCISCO • CALIFORNIA

Gammatron Tubes

**H K-254 Matched
 CHARACTERISTICS**

MAXIMUM RATINGS

Power Output	500 Watts
Plate Dissipation	100 Watts
Amplification Factor	25
DC Plate Voltage	4000 Volts
DC Plate Current	225 M. A.
DC Grid Current	40 M. A.
Max. Frequency	175 Mc

INTER-ELECTRODE CAP.:

C grid-plate	3.6 uuf
C grid-filament	3.3 uuf
C plate-filament	1.0 uuf

Filament Voltage	5 Volts
Filament Current	7.5 Amps.



**KEEP IT UP
 BUY WAR BONDS**

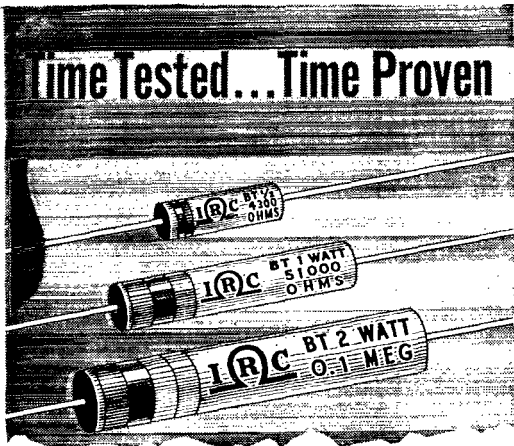

IRC METALLIZED TYPE BT RESISTORS

Unexcelled in such essential characteristics as stability, low noise level, low voltage coefficient, mechanical strength, humidity protection, and insulation—IRC type BT resistors have a proven record of performance in millions of applications. Today, after more than a decade of use, these small, sturdy units are recognized as standard around the world. Available in all wanted ratings.



INTERNATIONAL RESISTANCE CO.

401 N. BROAD ST., PHILADELPHIA 8, PA.

IRC makes more types of resistance units, in more shapes, for more applications, than any other manufacturer in the world.

Phone, Wire or Write

WHOLESALE

Radio-Electronic Parts
Tubes and Equipment

R. G. SCELİ & CO.

227 Asylum St. Hartford, Conn.

Telephone 2-1144

(Continued from page 74)

First, the League is doing a bang-up, unlimited, topside job and although most of the fellows don't write, they are all behind the ARRL 100 per cent.

Second, regardless of the postwar privileges, the American ham will continue to make the most, for the best, with the least.

— Wesley J. Lott, W9GIY

REBUTTAL FROM THE A.C.S.

Somewhere in Alaska

Editor, *QST*:

Regarding your article by Major James W. Hunt, in the December *QST*, I wish to argue the point where the Major says, "Truly, a ham is as near heaven as he ever expects to be when he is in the AACs."

We of the ACS (Alaska Communication System) are otherwise known as the — Signal Service Company, and prior to December of 1942 were listed as the 1st Signal Service Company. It is the Western Union of Alaska. In 1900, this organization set up communications in Alaska. When the war expansion program came upon Alaskan Territory, the ACS was given the task of supplying Alaska with communications between every village and hamlet. We have accomplished this through hard work and ingenuity. For example, we had to lay a land line between two certain villages in Alaska, and a very mountainous country lay in the path of this line. One of the officers in our engineering crews got the brilliant idea of flying the spools of wire by airplane and dropping them at regular intervals along the path of the line. Our crews then came along on the ground and recovered these spools and only one was lost. The line was completed in record time and communications set up.

Ours is the job to supply all signal outfits with all the communication equipment necessary to equip an up-to-date station. It is also our job to install this equipment. The men that do this installation work are highly skilled men — more so than in any other branch of the service.

We also have to hold a twenty-four hour contact with all stations. We accomplished this several years ago. The men stationed in our smaller stations, which are located in the isolated regions, handle these stations with all the excitement, thrills and problems with which any ham can be confronted. The only difference is they are ham stations elaborately equipped, and on a commercial and War Department basis of operation.

I insist that the *Alaska Communication System* is "truly as near to heaven as any ham can possibly get"!

The equipment here in Alaska that the AACs has, to make the "hams to drool at the mouth and get wild looks in their eyes," is installed and furnished by our organization. We have been in communication work long before the AACs was ever thought of. The Major speaks of radio-teletype circuits "that gargle away and send more traffic than has any right to be sent even on

(Continued on page 78)

PAVING THE WAY for postwar amateur development, particularly on the ultrahighs (microwaves) and other prospective new techniques, the 1945 Edition of the "Radio Amateur's Handbook" includes diversified material new to its scope, while still retaining its time-proved treatment of the orthodox theory and

practice of amateur radio — refined, modernized, reorganized for maximum convenience whether used as text, reference or constructional manual. This Edition of the "Handbook" contains more pages and more information per page than any "Handbook" yet published. . . . Every subject encountered in practical radio communication is covered, arranged for maximum convenience to the reader, sectionalized by topics with abundant cross-referencing and fully indexed. . . . More than ever the ideal reference work, the 1945 edition also contains practical constructional information on tested and proved gear — always the outstanding feature of the "Handbook." . . .

NEW 1945 EDITION

The Radio Amateur's Handbook

\$1 *Postpaid in Continental U. S. A.*

\$1.50 Postpaid Elsewhere . . . Buckram Bound \$2.00

American Radio Relay League, Inc., West Hartford 7, Conn., U. S. A.

Wanted ENGINEERS

- Radio
- * Electrical
- Electronic
- * Mechanical
- Metallurgical
- * Factory Planning
- Materials Handling
- Manufacturing Planning

Work in connection with the manufacture of a wide variety of new and advanced types of communications equipment and special electronic products.

Apply (or write), giving full qualifications, to:

R. L. D., EMPLOYMENT DEPARTMENT

Western Electric Co.

100 CENTRAL AVENUE, KEARNY, N. J.

*Also: C. A. L.

Locust St., Haverhill, Mass.

Applicants must comply with WMC regulations

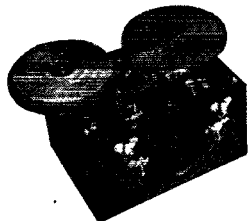

**MASTER
THE CODE**

with

Master Teleplex

"The Choice of Those Who Know"

ALL AC OPERATED. The only all-in-one instrument that will record your own sending and repeat it back to you. Records signals from the air and repeats back at any speed. The perfect instructor for both sending and receiving.

A postcard will bring Booklet N-12 giving full details of ten day FREE TRIAL

TELEPLEX CO. 107 Hudson Street
Jersey City 2, N. J.

(Continued from page 76)

good equipment." Our equipment is constantly in top condition and ready for any and all emergencies. The AACS technicians for teletypes here are constantly calling upon ACS technicians for aid in repairing their equipment. I must admit, however, that this battle has continued in Alaska ever since the AACS first came up here. We had men up here for fifteen and twenty-five years standing on the welcome mat waiting for the AACS men that were to come up here to do marvels with communications — yes, marvels that were already old stuff to our System.

We continue (our engineer boys) through the whole winter installing new equipment and antennas in temperatures that are unbelievable. . . . Our men, our equipment, our work, our skill — but AACS gets the glory! But the Chief Signal Office in Washington, D. C., knows who does this work, and we get our just credit from there.

*

RADIO/RADAR MAINTENANCE AND THE HAM

c/o FPO, San Francisco, Calif.

Editor, *QST*:

Although I'm not at present working at radio/radar maintenance, being also a naval aviator, I have spent a large part of my naval career at it — and of course my ham experience has been of inestimable value.

In the past I've had a good many technicians working for me and those who were hams, without exception, were definitely superior.

I enjoy my copies of *QST* a great deal — keep up the good work.

— Lt. J. A. Fulmer, USNR, W4HAV

IT WAS A "TRAVELER" NOT AN EC-1

c/o Postmaster, New York, N. Y.

Editor, *QST*:

Just got my September issue of *QST*. On page 21 is the remark to the effect that the receiver being worked on is an EC-1. However, I believe closer examination will reveal it to be a Hallcrafters' Sky Traveler.

QST and the *Handbook* sure are a blessing way out here in Burma. A good tie with the "good old days" and the best way to keep from getting rusty. We're doing lots of postwar antenna planning.

— Sgt. John Holmbeck, W9KZO

GIVES THANKS FOR AMATEURS

APO 942, c/o Postmaster, Seattle, Wash.

Editor, *QST*:

Let me add my thanks for the amateurs.

I entered this theater about four years ago as an enlisted man. The need for aircraft radio repair facilities was soon felt. By rounding up a couple of other hams, using my test gear and

* Name withheld by request.

¹ Not all the glory goes to AACS. See, "The Alaska Communications System," *QST*, April, 1944, p. 9 — Ed.

Endorsed from coast to coast

FOR AM COMMUNICATION AND POLICE RADIO WORK



Types GL-159 and GL-169. Price \$60 each.
Medium power high-vacuum triodes for
Class B and C service.

These G-E tubes are strong links in your chain of equipment for dependable transmission

The tantalum anodes used in the GL-159 and GL-169—three-electrode tubes with medium frequency and power ratings—are more durable than other types at high temperatures, and permit greater dissipation per unit of area. This is one of many advancements in the design and construction of these popular amplifiers, enabling them to render the kind of efficient service on which you can rely.

Types GL-159 and GL-169 are exceptionally easy to mount. Another advantage is their medium size and ratings, the two tubes being similar in their characteristics except for the

amplification factor, which is 20 for the GL-159, 85 for the GL-169. Filament voltage and current are 10 v and 9.60 amp. The GL-159 is principally employed in Class C service, with maximum plate ratings of 2,000 v and 0.4 amp—plate input 800 w, dissipation 250 w. Highest frequency at maximum plate input is 15 megacycles; at 50 percent input, 35 megacycles.

The GL-169 is designed primarily for Class B audio-frequency service, with an output for two tubes up to 900 w. For such service the maximum ratings per tube are: d-c plate voltage 2,000 v, signal current

0.4 amp; d-c signal plate input 750 w, dissipation 250 w.

Thus these tubes meet ideally the needs of communication, police radio, or other work employing AM equipment. A price of \$60 made possible by large-scale production in the world's most modern tube factory, spells high dollar-value. Consult your nearest G-E office or distributor for full information on these or other transmitting tubes in G-E's complete line. Or write direct to *Electronics Department, General Electric, Schenectady 5, N. Y.*

Hear the G-E radio programs: "The World Today" news, Monday through Friday, 6:45 p. m., EWT, CBS. "The G-E All-Girl Orchestra," Sunday 10 p. m.; EWT, NBC. "The G-E Houseparty," Monday through Friday, 4 p. m., EWT, CBS.

GENERAL ELECTRIC

161-D2-8850

(Continued from page 78)

● QST YEARLY BINDERS

ARE WE RIGHT?

You should have at least two of them—one for your complete 1944 file of copies, and one for each 1945 issue as published.

With each binder is furnished sheet of gold and black gummed labels for years 1926 through 1946. The proper one can be cut from the sheet and pasted in the space provided for it on the back of binder.

Price \$1.50 postpaid

Available only in United States and Possessions

THE AMERICAN RADIO RELAY LEAGUE
West Hartford 7, Connecticut

some miscellaneous spare parts from my rig, we got going.

Many changes have been effected since then. I was commissioned, my original partners were transferred out, others were found and lost and beginners were trained. Radar repair and installation also fell in our lap.

In the course of time I have had twenty-two amateurs work for me. Without them it would have been tough going since the men we were getting from school had very little training and no practical experience. Under the amateurs some mighty fine repairmen and installation men were developed in from four to six months.

But, in addition to the various arms of the service being thankful for the amateurs, I believe the amateurs should also be grateful to the service. Some mighty fine training and practical experience has been given to the amateurs that many would never have had a chance to get. I think the fine equipment they have had to work on and use will also be reflected in future rigs. More perfection and refinements will be incorporated in our post-war rigs.

So keep up the battle to get our channels back, because there will be need for all the old and probably many new ones.

— Major D. E. Wolters, AC, K7JAT

Hints and Kinks

(Continued from page 46)

shorted, the voltage across the resistor, as shown by the voltmeter, will rise to full line value. If this does not occur, the switch may be closed, putting full power on the receiver transformer.

An even simpler arrangement is similar with a 115-volt lamp of any convenient size substituted for the voltmeter and shunting resistor. The lamp, of course, will light to full brilliance if the transformer primary is shorted.

This kink saves time and nerves on many a rush job. — Charles D. Vaughn, RT1c, USNR, c/o Fleet P.O., N. Y.

Bell System Facilities

(Continued from page 18)

points. Work will proceed as soon as the relaxation of war demands makes it possible. Experiments will be conducted at frequencies of about 2000 Mc., 4000 Mc. and 12,000 Mc. Bandwidths up to about 10 Mc. are contemplated.

If the radio beams are found to have undesirable characteristics, ultrahigh-frequency transmissions conducted through wave guides may be used. Wave guides are simply hollow pipes which serve to isolate a small section of space and thus guide the transmission of extremely high-frequency waves while protecting them from outside interference. Such guides are now extensively used for short distances.

Now—a really high-powered



RADIO ENGINEERING LIBRARY

- especially selected by radio specialists of McGraw-Hill publications
- to give most complete, dependable coverage of facts needed by all whose fields are grounded on radio fundamentals
- available at a special price and terms

5 VOLS.
3319 PAGES,
2289
ILLUSTRATIONS

1. Eastman's Fundamentals of Vacuum Tubes
2. Terman's Radio Engineering
3. Everitt's Communication Engineering
4. Hund's High Frequency Measurements
5. Henney's Radio Engineering Handbook

THESE books cover circuit phenomena, tube theory, networks, measurements, and other subjects—give specialized treatments of all fields of practical design and application. They are books of recognized position in the literature—books you will refer to and be referred to often. If you are a practical designer, researcher or engineer in any field based on radio, you want these books for the help they give in hundreds of problems throughout the whole field of radio engineering.

Free Examination • Special Low Price • Easy Terms

McGraw-Hill Book Co., 330 W. 42nd St., New York 18

Send me Radio Engineering Library, 5 vols., for 10 days' examination on approval. In 10 days I will send \$3.00, plus few cents postage, and \$3.00 monthly till \$24.00 is paid, or return books postpaid. (We pay postage on orders accompanied by remittance of first installment.)

Name.....
Address..... Position.....
City and State..... Company..... QST-2-45

Announcing Two Highly Developed Collins Autotune* Transmitters

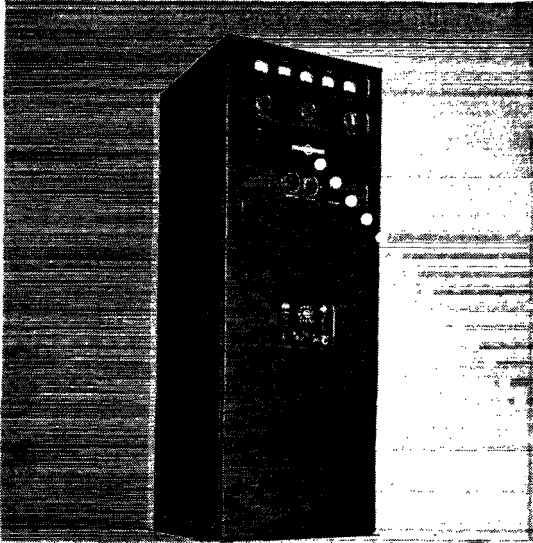

Collins 16F-9—Nominal power output: 300 watts phone; 500 watts CW. Frequency range: 2 to 18 mc. Ten quick-shift frequencies.

Collins 231D-13—Nominal power output: 3000 watts phone; 5000 watts CW. Frequency range: 2 to 18 mc. Ten quick-shift frequencies.

IN DESIGN and construction, these transmitters reflect intense engineering endeavor and hard won experience in meeting the requirements of war. The most advanced laboratory refinements are combined with military ruggedness on a production-line basis!

The lessons learned since Pearl Harbor have increased the already high reset accuracy and dependability of the Collins Autotune. Any one of ten frequencies is reliably, precisely available at the flip of a dial, from a remote point. The standard models are crystal controlled, and special models are available with tunable master oscillator control.

The physical size of these transmitters has been increased, and components specially Collins re-designed, to increase safety factors throughout.

The renowned Collins pi network matches into a wide variety of single wire or vertical antennas. The 231D-13 also matches into a 600 ohm balanced transmission line from 4 to 18 mc.

Frequency-shift keying is available, making it possible to use these transmitters in printing telegraph circuits.

We will welcome inquiries and an opportunity to make recommendations for your particular application. Collins Radio Company, Cedar Rapids, Iowa.

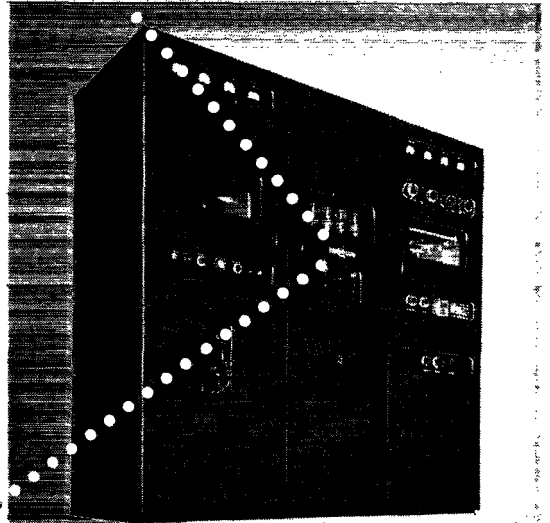

*The Collins Autotune is a repositioning mechanism which quick-shifts all tuning controls simultaneously and with extreme precision to any one of a number of pre-selected frequencies. Patents issued and pending in the U. S. A. and other countries.

• IN RADIO COMMUNICATIONS, IT'S ...

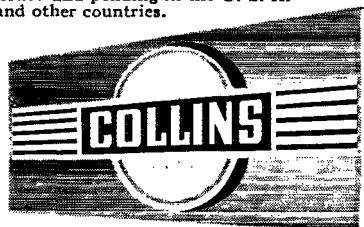



READY NOW . . .

UNIVERSAL'S Pictorial Portfolio, with descriptive text, contains more than a dozen illustrations depicting the History of Communications. They are of size suitable to frame for office, den or hobby room. Get yours now by writing direct to the factory. There is no charge, of course. The Portfolio will be an interesting addition to the library of all ham ops. If you are now in the service and prefer the copy mailed to the home address we'll be glad to do so.

UNIVERSAL MICROPHONE COMPANY
Inglewood, California



65 models, sizes from 350 to 35,000 watts, A.C. types: 115 to 660 volts, 30, 60, 180 cycles, 1 or 3-phase; 400, 500 and 800 cycles, 1-phase, D.C. types: 6 to 4000 volts, A.C.-D.C. combination types available. Write for engineering assistance and literature. Model shown is from OTC lightweight series.

Over 250,000
Now In Service

D. W. ONAN & SONS

2621 Royalston Ave., Minneapolis 5

Minnesota

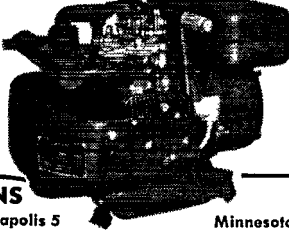

Electricity

FOR RADIO AND ELECTRONIC APPLICATIONS

Onan Electric Generating Plants supply electric service for electronics applications and general uses, mobile, or stationary. Driven by Onan-built, 4-cycle gasoline engines, they are of single-unit, compact design and sturdy construction.

LEARN CODE

Improve Your Sending
G. C. Automatic
"KEYER"

Will Teach You Code—
Speed Up Your
Receiving

TYPE "A" \$25

New, Different, Efficient. Adjustable speed, silent induction type A.C. Motor. In small walnut finished case with carrying handle. Complete with 10 rolls of selected double perforated tape. A wide variety of other tapes available at 50c per roll.

If Your Dealer Can Not Supply You, Write Us

GARDINER & COMPANY Box 56, Stratford
New Jersey, U. S. A.

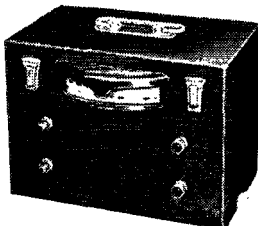

WERS Master-Control Transmitter

(Continued from page 38)

tinctly advantageous. However, since space for antennas is limited, we decided on a vertical collinear array and started out with two half waves in phase, one above the other, their centers spaced $\frac{1}{4}$ wave. One of these was installed at WKNQ-1 and one at WKNQ-2. After some trouble in getting a good match between a 600-ohm line and the quarter-wave section which phases the two half waves, we tried connecting a pair of "Q" bars between the 600-ohm line and the shorting-bar point after removing the shorting bar. This idea was described in Oct. *QST* in the *Hints and Kinks Section*. The results obtained with these antennas have improved coverage by both master control stations on transmitting as well as receiving. At present we have a similar type of antenna under construction for WKNQ-1 using four half waves stacked vertically. The advantages of this type of antenna are increased gain with good horizontal coverage and a minimum of wind resistance.

Happenings of the Month

(Continued from page 34)

couple of years of communications duty in the Pacific and is now assigned to duty in the Office of the Director of Naval Communications at Washington. He resumes the reins as Atlantic Division director.

Capt. William Justice Lee, W4XE, Assistant Director of Naval Communications, has been retired from the naval service for medical reasons and is serving as the military liaison representative of the American Red Cross at its national headquarters in Washington.

Comdr. Paul M. Segal, W3EEA, has returned to Washington from duty as a communications officer at various odd-named islands in the Pacific and has temporarily returned to inactive status. He has resumed his duties as the ARRL General Counsel.

Capt. Fred H. Schnell, W9UZ, late of K6, has returned to the States for medical observation and is on temporary duty in the Office of the Industrial Manager at Chicago, with the probability of a Washington assignment coming up.

IGNITION INTERFERENCE

THERE is pleasing indication of the likelihood that all postwar automobile production will be equipped at the factory to suppress ignition interference. A joint committee of the radio and automobile industries has worked intermittently on this problem for years, James Lamb representing us, and they are now active again with postwar planning. The police have suffered severely from ignition interference, as well as ourselves; but the real push comes from the imminence of f.m. reception in automobiles, for which suppression is a necessity. Now is the time, of course, while production is at a standstill and before all of America wants new cars.

CHECK on this "QUICK-CHECK" Feature of the Solar Capacitor Analyzer . . .



THE SOLAR MODEL CE Capacitor Examiner speedily locates common defects in capacitors without disconnecting condensers—often eliminating further tests. This saving of time and labor is accomplished by the unique Solar "QUICK-CHECK" feature.

In this *single* instrument are combined the simplest, most convenient methods for examining the true condition of every capacitor in ordinary use . . . shorts, opens, intermittents, high R.F. impedance and high power factor.

Catalog IN-1 illustrates and describes features of all models. Send for your copy today.



ANOTHER HELPFUL SOLAR SERVICE

SOLAR CAPACITOR SALES CORP.
285 Madison Avenue, New York 17, N. Y.

Please send me a copy of Catalog IN-1 on Solar CAPACITOR ANALYZERS.

Name _____

Title _____

Company Name _____

Street Address _____

City _____ State _____

SEND THIS COUPON IN TODAY

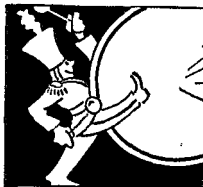

MAKE "NEWARK" YOUR
**HEADQUARTERS
 FOR RADIO
 AND RADAR
 PARTS**

Transformers, resistors, rectifiers, rheostats, condensers, filters, wire, etc., SUPPLIED FROM STOCK on short notice, on properly rated orders.

FILTER CONDENSERS

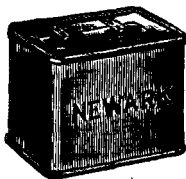

NO PRIORITY REQUIRED!
 Oil-Filled Oil-impregnated

Mfd.	D.C.	Size	Price
1	1000 v.	5 x 3 3/4 x 1 1/2	\$.59
2	2000 v.	4 7/8 x 3 1/2 x 1 3/4	1.50
4	3000 v.	5 x 3 3/4 x 3 3/4	3.75

Listen to Newark's Radio Program Every Tuesday 9-9:30 A.M. Station WJJD — Chicago

BUY ANOTHER WAR BOND
 Earn \$6.25 on an \$18.75 Investment!

NEWARK ELECTRIC CO.
 323 W. Madison St. Chicago, Ill.

RADIO TECHNICIAN COURSE

735 HOURS

RADIO COMMUNICATION COURSE

480 HOURS

DAY AND EVENING CLASSES

AMERICAN RADIO INSTITUTE 88 Columbus Ave.
 New York 23, N. Y.
 TRafalgar 4-2591

COMMERCIAL RADIO INSTITUTE

A RADIO TRAINING CENTER FOR 24 YEARS

Resident Courses Only • Pre-Induction, Broadcast, Service, Aeronautical Television, and Marine telegraphy classes now forming for mid-year term Feb. 5th.

Literature upon request.

Dept. B., 38 West Biddle Street, Baltimore 1, Maryland

COMPLETE RADIO TRAINING!

All branches of communications, including television and FM courses from 6 to 18 months' duration. HIGH SCHOOL GRADUATES 17 YEARS OF AGE — prepare for radio operating positions in the U. S. Merchant Marine in 6 months. Complete pre-induction radio training in 3 months. Information supplied to Veterans on radio engineering training.

Write for particulars

VALPARAISO TECHNICAL INSTITUTE
 Dept. T Valparaiso, Indiana



INSTITUTES

Offer thorough training courses in all technical phases of

Radio and Television

WEEKLY RATES DAYS—EVENINGS

VETERANS: RCA Institutes is approved under G. I. Bill of Rights

For Free Catalog write Dept. ST-45

RCA INSTITUTES, Inc.

A Radio Corporation of America Service
 75 Varick Street, New York 13, N. Y.



An Extended-Range Audio Oscillator

(Continued from page 86)

The range-setting gang switch is mounted on the left-hand side of the chassis, as seen in the bottom view. Above it, on the same side, is the 1,000-ohm potentiometer with which the low-impedance output level is varied.

Six fixed condensers are used in the layout. Four of these are of the 8- μ fd., 450-volt dry electrolytic cartridge variety, two of which are mounted with copper straps to the side of the chassis. The other two are wrapped in empire cloth and mounted between the two resistor blocks. Two condensers of 1- μ fd., 450-volt rating also are mounted on the inside of the chassis with copper straps.

Leads from the external power supply to the chassis come in to a Jones six-connection male plug which is mounted on a stand-off metal strip in such a way that it protrudes through a hole in the heater panel.

Calibration

There are several means by which the oscillator may be calibrated. The zero-beat method is the simplest and perhaps the most familiar because the average ham knows how to bring a local oscillator to zero beat with a given carrier or standard-frequency signal. The visual method of calibration requires the use of an oscilloscope. With it, the 60-cycle power-line frequency may be used as a basic "standard," since this frequency is kept fairly constant. Voltages at harmonic frequencies of 60 cycles then may be mixed with the unknown audio oscillator signal and then identified through a knowledge of certain geometrical patterns which appear on the screen.² These patterns are known commonly as Lissajous figures. Their interpretation is simple because, when they are brought to a standstill on the screen, they represent a simple ratio between the two frequencies which appear simultaneously on the vertical and horizontal plates.

Conclusions

Sometimes an audio system which is designed for general use by the public need not have a frequency range anywhere near to that of the test oscillator here described. The average human ear can not respond above approximately 15,000 cycles. Broadcast modulation is limited to 5 kc. plus and minus the carrier frequency — a band width of only 10 kc. Just where a wide-band audio oscillator such as this one finds its usefulness may not at once be apparent. It has been pointed out in this article, however, that certain of the newer developments in radio circuits, more particularly in the field of f.m. and video, require wide-band circuits for special purposes, so that the width of the audio spectrum with relation to the human ear is beside the point. If such circuits are to be tested, a wide-range oscillator such as the one described in this article is required.

² Rider, "The Cathode Ray Tube at Work."



Engineering Vision . . . Manufacturing Precision



In ships at sea, in fighter and bomber planes, at command posts and in tanks and vehicles . . . Delco Radio products are carrying out vital assignments for the fighting forces. They represent the application of radio and electronic science to varied requirements of communication, detection and protection. They represent, too, the effective combination of engineering vision and manufacturing precision that safeguards the performance of all Delco Radio equipment, wherever it serves and whatever its purpose. Delco Radio Division, General Motors Corporation, Kokomo, Indiana.

Delco Radio
DIVISION OF
GENERAL MOTORS

**Make Your Dollars Fight
BUY MORE WAR BONDS**

PREMAX

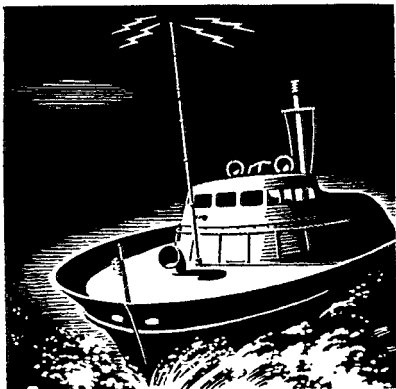

Premax Antennas

- Tested in War
- Ready for Peace

Premax Products

Division Chisholm-Ryder Co., Inc.
4519 Highland Avenue Niagara Falls, N. Y.

LEARN RADIO

Pre-Military training for beginners. Catalog on request. We teach all technical branches of radio. Lic. by the Comm. of Mass. Dept. of Education.

MASS. RADIO SCHOOL
18 Boylston Street Boston, Massachusetts

FIELD SERVICE ENGINEERS

for

Domestic and Foreign Service

MUST POSSESS GOOD KNOWLEDGE OF RADIO

Essential Workers Need Release

HAZELTINE CORPORATION

**58-25 Little Neck Parkway
Little Neck · Long Island**

Building an RAAF B. C. Station

(Continued from page 18)

24 hours. This flooded the whole place and reels of wire and like equipment had to be salvaged from the mud and dried before construction could proceed. After a few mishaps such as this, the transformers were eventually finished, and surprisingly enough, they worked!

Control and Mixer Amplifier

Unfortunately, Harry Shirley had been associated with broadcast stations only in an administrative capacity and the technical difficulties involved in making a mixer unit, like the RCA job, never occurred to him. First, it was thought that two pick-ups and a microphone input would suffice, but no — Harry must have a receiver input for the news broadcast. Then he wanted a second mike input from the mixer to operate the local camp amplifier system. There were so many knobs and switches on that mixer, it looked like a Fortress bomb selector switchboard, but it did a fine job with Harry at the controls.

Land Lines

A land line was installed as the transmitter was located some two miles from the studio. Twisted-pair telephone cable was run through the jungle and coconut palms.

It is surprising just how many scatter-brains there are, with a surplus ammunition, who can't find a better target to snipe at than an inoffensive land line. Bulldozers also seem to delight in tearing down trees on which the Signal Corps have attached lines. You have no idea how exhilarating it is to plough through a mile of dense undergrowth to locate a broken line, particularly when the outfit responsible for the line-break rings the studio to know why the station isn't on the air.

A humorous interlude was provided one evening when the studio land line shorted across an adjacent telephone line. A voice crashed out over the air — "When in the blankety blank are you going to change that frequency on 'A' watch?" The studio line had apparently crossed the 'phone line from the local signals office.

Studio

The studio set-up consisted of two Presto turntables (supplied by the Australian Comforts Fund) plus two dynamic microphones, the mixer unit and a short-wave receiver for relaying short-wave news broadcasts.

The entire staff was drawn from surrounding units and all volunteered to assist on their own time. Several commercial announcers were found and were very pleased to get back into the old business. Three Australian news sessions and the San Francisco news were broadcast daily.

Programs were supplied by the Australian Broadcasting Commission — 2UW, Sydney — and the U. S. Special Services Division, and the programs have provided news entertainment to thousands of men and women of the Allied Fighting Services.

TOUGH AND VERSATILE TURNER 22X or 22D

CHOICE OF VETERAN HAMS

Here's the Mike you'll want for clean, sharp transmission of voice, music or any sound without harmonics or distortion— for unfailing performance under all acoustic and climatic conditions.

22X CYRSTAL has built-in wind-gag permitting outdoor operation. Crystal impregnated against moisture. Automatic barometric compensator. 90° tilting head and removable cable set. Satin chrome finish. Range 30-7,000 cycles. High level — 52DB.

22D DYNAMIC has same smart styling as 22X but has high level dynamic cartridge. Reproduces smoothly at all frequencies. Dependable indoors or out. Range 30-8,000 cycles. Output — 54DB. Available in 30-50, 200 or 500 ohms or high impedance.

WRITE Today for Your Free Copy of Illustrated Turner Microphone Catalog

The **TURNER Company**
917 17th St., N.E. • Cedar Rapids, Iowa, U.S.A.

Crystals Licensed Under Patents of the Brush Development Co.

TURNER

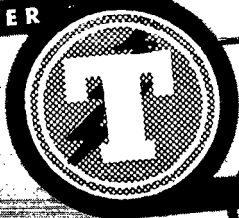

TURNER

Pioneers in the communications field

Microphones

RADIO RESEARCH DEVELOPMENT

(Post-War Opportunity)

Expanding national organization has three openings on its Research-Development Field Staff. These positions entail some travel with full expenses and allowances paid by the company. Knowledge of radio set construction or definite mechanical ability essential. The positions are permanent and offer an exceptionally fine post-war future. Starting salary \$172.50-\$200.00 per month depending upon ability. Periodic increases based on merit. If you are interested in joining an expanding and progressive company, please give us (in confidence) full details about yourself for a personal interview.

BOX 124 • QST

CODE SENDING SPEED RECEIVING SPEED



Have Skill, Accuracy

Be a "key" man. Learn how to send and receive messages in code by telegraph and radio. Army, Navy and Commerce need thousands of men. Expansion of air commerce and freight after war should create an even bigger peacetime demand for operators. The famous Candler System, maker of world's champions, teaches you the "knack" of sound sense and sound consciousness that is the secret of speedy sending and receiving. Good pay, adventure. Learn at home quickly.

FREE 52-PAGE BOOK explains extra course of training. Rush name for it today. It's absolutely free.

CANDLER SYSTEM CO.

Dept. 4-B, P.O. Box 928, Denver 1, Colo., U. S. A.
and at 121 Kingsway, London, W. C. 2, Eng.

HARVEY REGULATED POWER SUPPLY

for use with CONSTANT FREQUENCY OSCILLATORS
AMPLIFIERS, PULSE GENERATORS, MEASUREMENT EQUIPMENT

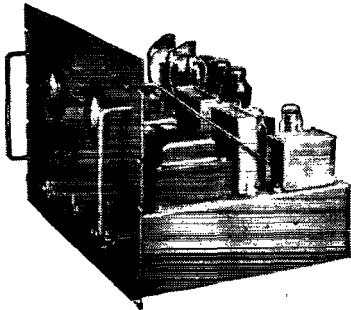

500
to
1000
Volts

The HARVEY Regulated Power Supply 206 PA

This new HARVEY OF CAMBRIDGE development is designed for use with equipment requiring a constant D.C. voltage source in the 500-1000 volt range. It operates in two ranges — 500 to 700 at $\frac{1}{4}$ of an ampere; 700 to 1000 volts at .2 of an ampere. The voltage change is less than one per cent in both ranges. Write for complete specifications.



HARVEY RADIO LABORATORIES, INC.

451 CONCORD AVENUE CAMBRIDGE 38, MASS.

DRAFTSMEN WANTED

- MECHANICAL DESIGNERS
- CHECKERS FOR LAYOUTS
- DETAILING AND CHECKING

Radio and Electronic Equipment
War Plant with Postwar Future . . .

HAMILTON RADIO CORP.

510 Sixth Avenue

New York, N. Y.



Founded in 1909

RADIO TELEPHONY RADIO TELEGRAPHY PRE-INDUCTION RADIO

Courses ranging in length from 3 to 9 months. Dormitory accommodations on campus for men and women students. Approved by Texas Department of Education with authority to issue a maximum of 60 semester credits for complete training. *If interested, write for details.*

PORT ARTHUR COLLEGE PORT ARTHUR
TEXAS

Splatter

(Continued from page 10)

W2NSS. In that same year he joined the Lockheed radio testing section; now he is directing the work of a radio flight test crew, checking out the radio gear aboard Lockheed-made B-17s. The present activity at W6UKP represents no less than a complete rebuilding of the station into a deluxe postwar layout — even to a new tower for the rotary beam. . . . Maybe that radio range receiver W6UKP wrote about will come in handy for **Hardy Glenn, W5BRX** (p. 35), who, in addition to being a private flyer, also knows his way around the v.t.v.m. circuit because he is an electronic and instrument engineer for Stanolind Oil and Gas at Tulsa. W5BRX has been a ham for 12 years and has held a Class A ticket since 1936. He has two widely separated interests — equipment design and construction, and flying! Hardy has held a private pilot's license since 1940. He wrote us: "The writing of this article has been an effort of such magnitude as to astound me. Now, as never before, I can really appreciate the work of the contributors and editors of *QST* and other technical magazines." Now that's the kind of honest unprejudiced opinion we like. Most folks seem to think that a writer just says to himself, "I'm going to write a swell article about something or other. I'll put a piece of paper in my old mill, and then I think I'll go out to lunch. When I return — the article will be all finished — and off it'll go to *QST*!" But we know better, don't we, Hardy? . . .

Then along comes another feller and it appears that to some writers it just comes natural-like at that. We can take, for example, no less a figure than **Dr. William W. Hansen** (p. 11). During his wide scientific and engineering experience Dr. Hansen has probably prepared enough technical material to fill an encyclopedia. After receiving his A.B. in physics at Stanford University in 1929, he remained there as an instructor while preparing for his Ph.D., also in physics. From 1933 to 1935, Hansen was a National Research Fellow at MIT. Then he returned to Stanford as assistant professor in X-rays and electromagnetic theory for four years, advancing to associate professor in 1939 and then to professor in 1940. It was in that period that he introduced the world to such theretofore uncivilized specimens of electromagnetic phenomena as the cavity resonator, — not to mention the taming of the Klystron. Not long after, he joined the Sperry Gyroscope Company as research engineer. Dr. Hansen admits that in 1923 he coerced an indulgent RI into giving him a passing grade on his efforts to guess that last word in the 10 w.p.m. code test and soon thereafter was licensed 6CSY. Once having obtained the license, he appointed himself "chief operator" and designated several more competent (?) lads to do the actual brasspounding. . . . Meanwhile **H. W. "Tex" Hendrix, W3DOU**, had started in the ham game as 5SF back in '21. Later at Texas University "Tex" was chief op of 5YW. A short spell of 5QF was followed by a move to Philadelphia and W3DOU. A c.w. man until

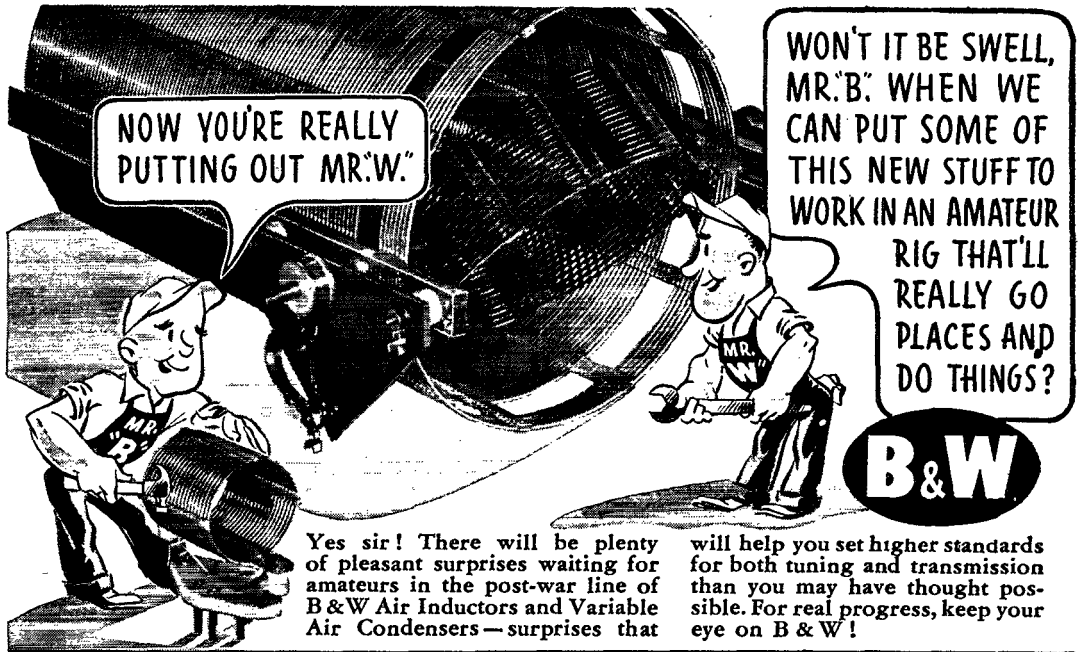

Yes sir! There will be plenty of pleasant surprises waiting for amateurs in the post-war line of B & W Air Inductors and Variable Air Condensers—surprises that

will help you set higher standards for both tuning and transmission than you may have thought possible. For real progress, keep your eye on B & W!

BARKER & WILLIAMSON

Dept. Q-25, 235 FAIRFIELD AVE., UPPER DARBY, PA.

Exclusive Export Representatives: Lindeteves, Inc., 10 Rockefeller Plaza, New York, N. Y., U. S. A.

Quiz in Q Code

Here are two questions often asked us by amateurs . . . and these are our answers:

QRL Like all other American firms, we are working for victory, producing as fast as we can the finest in communications equipment for use by the Armed Forces.

QRU No, not at the present time. But you can be certain that the products you receive from Harvey-Wells in the postwar period will incorporate the tremendous strides we have made in perfecting excellent radio equipment.



Harvey-WELLS

ELECTRONICS
SOUTHBRIDGE, MASSACHUSETTS

SETTING THE PACE FOR PROGRESS IN COMMUNICATIONS

DeLuxe SPEED KEY

Model
CP 180

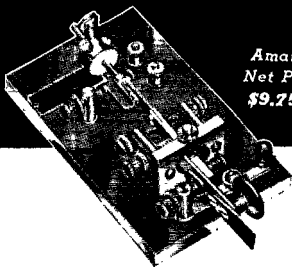

Amateur
Net Price
\$9.75

Finest commercial or amateur bug available. Chrome finished base and superstructure. Springs made of selected blue spring steel for uniform performance in all keys. Nine points of adjustment to suit the most critical touch. Fully adjustable. Silver contacts 3/16" diameter.

MODEL CP 510 SPEED KEY • Similar to above but in battleship gray wrinkle finish. Amateur Net Price.....\$6.75

TELEGRAPH Apparatus Co.

325 WEST AURON STREET • CHICAGO 10, ILL.

RF Inductors • RF Chokes • IF Transformers
Condensers • Mica Molded Condensers • Trimmer
Condensers • Miscellaneous Apparatus
The F. W. Sickles Co., Chicopee, Mass.

SICKLES Electronic Specialties

WANTED By Midwestern manufacturer radio transmitters and associated equipment — several junior project engineers qualified to supervise or assist development of transmitters, speech input systems, control apparatus, and similar items. Salary average \$2500 per year. Give full details first letter. Reply to W. F. SICKMUND, 305 Homer Building, Washington 5, D. C.



RADIO-ELECTRONICS

Co-educational training in Airline, Merchant Marine, Press Communications, Electronics, Television. FREE booklet. Address Registrar. Ex-Servicemen: Request FREE copy, G.I. bill of rights
"A Radio School managed by radio men."
45 West 45th Street, New York 19, N. Y.

MELVILLE RADIO INSTITUTE

RADIO-TELEVISION-ELECTRONICS

Prepare now for ever-increasing post-war opportunities. Day and Eve. Sessions. Enroll now for new classes. Consideration given to Veterans eligible for training under the G.I. Bill.

RADIO-TELEVISION INSTITUTE

480 Lexington Avenue, New York 17 (46th Street)
PLaza 3-4585 Licensed by New York State

(Continued from page 88)

1936, he succumbed to the wiles of 28-Mc. 'phone and remained on that band until Pearl Harbor. In the letter accompanying his article on the mobile disaster unit (p. 14) "Tex" said: "When WERS became a reality, as radio aide for Lower Merion Township I obtained one of the first WERS licenses in this area. . . . My main business is combustion engineering, but radio is just one of those lifetime hobbies that I cannot seem to shake off." From the active ham life of W3DOU, it would appear that any attempted "shaking" was none too vigorously done. . . . From a combustion engineer with radio as a hobby we move to a man who has lived a full-time radio career with a typical background and plenty of extras thrown in. Charles J. Leipert, W6ROA, said, "I started in wireless in 1910 and finally was licensed 2DF. The bug had bitten hard so I entered RCA Institute in NYC. World War I came along and I enlisted in the Radio Division, U. S. Navy. After the war I liked the looks of those 'Seven Wonders of the World,' so I spent the next ten years as a sea-going op. Somehow, they let me off the ship one day and I found myself working as an engineer at Mutual in NYC. After several years of broadcasting, my next move was to California and in 1940, a job with FCC in the RID."

Charles did not add that he is also a member of that thrill-packed organization, the VWOA, or that he has been awarded a scroll in recognition of "Meritorious Services Performed at Sea."

In addition to these five new authors, two familiar names reappear when Edward M. Noll, ex-W3FQJ (Splatter, October, 1943, p. 8), adds another chapter to his excellent series on mathematics (p. 40) and Philip S. Rand, WIDBM (Splatter, November, 1942, p. 12), tells how to operate a WERS net more efficiently through the use of a stabilized master-control transmitter (p. 27).

FEEDBACK

On page 18 of *QST* for December, 1944, a plus sign was omitted from the equation (6) which should read,

$$e_o = \left(\frac{\mu R_k}{R_k + r_p} \right) (e_i - e_o)$$

In the same article, on page 19, an error appears in the example for gain without load. Corrected it reads,

$$\frac{e_o}{e_i} = \frac{(20)(2500)}{10,000 + 2500(20 + 1)} = 0.8$$

In the circuit diagram of the f.m. carrier-current transmitter on page 29 of the December issue, C_{15} should have a value of 50 μfd . and L_3 an inductance of 0.4 mh. for 170-kc. operation. The connection between the top of R_1 and C_1 should be omitted.

On page 36 in the same issue the decimal point was misplaced in the result from the substitution of values in the expression for C_2 . The answer should, of course, be 0.013 μfd .



ASTATIC'S NEW PLANT AT CONNEAUT, OHIO

On the Assembly Line

Here, hundreds of workers, fighting against time, are engaged daily in the production of Astatic Microphones, Pickups, Cartridges and important unmentionables, urgently needed in furthering the war effort. These same assembly lines, at the proper time, can be converted almost overnight to the production of Astatic products for radio and phonograph manufacturers and parts jobbers.

THE **Astatic**
CORPORATION
CONNEAUT, OHIO
IN CANADA: CANADIAN ASTATIC LTD., TORONTO, ONTARIO



COIL SPECIALISTS SINCE 1917

It is three long years since COTO-COIL made equipment for radio amateurs. Since that time we have been working night and day building electrical components for our armed forces.

Coils by COTO are in action in every land, sea and air battle. We fervently hope that 1945 will herald the return of the fraternal radio days we all used to enjoy.

COTO-COIL CO., INC.

65 PAVILION AVENUE

PROVIDENCE 5, R. I.

HAM-ADS

(1) Advertising shall pertain to radio and shall be of nature of interest to radio amateurs or experimenters in their pursuit of the art.

(2) No display of any character will be accepted, nor can any special typographical arrangements, such as all or part capital letters be used which would tend to make one advertisement stand out from the others.

(3) The Ham-Ad rate is 30c per word, except as noted in paragraph (6) below.

(4) Remittance in full must accompany copy. No cash or contract discount or agency commission will be allowed.

(5) Closing date for Ham-Ads is the 25th of the second month preceding publication date.

(6) A special rate of 7c per word will apply to advertising which, in our judgment, is obviously non-commercial in nature and is placed and signed by a member of the American Radio Relay League. Thus, advertising of bona fide surplus equipment owned, used and for sale by an individual or apparatus offered for exchange or advertising inquiring for special equipment, if by a member of the American Radio Relay League takes the 7c rate. An attempt to deal in apparatus in quantity for profit, even if by an individual, is commercial and all advertising by him takes the 30c rate. Provisions of paragraphs (1), (2), (4) and (5), apply to all advertising in this column regardless of which rate may apply.

Having made no investigation of the advertisers in the classified columns, the publishers of *QST* are unable to vouch for their integrity or for the grade or character of the products advertised

QUARTZ — Direct importers from Brazil of best quality pure quartz suitable for making piezo-electric crystals. Diamond Drill Carbon Co., 719 World Bldg., New York City. **COMMERCIAL** radio operators examination questions and answers. One dollar per element. G. C. Waller, W5ATV, 6540 Washington Blvd., Tulsa, Okla.

WHY NOT turn your unused equipment into ready cash which may be applied towards new and better equipment after the war? Leo, W9GFQ, offers you the best cash prices for communications receivers and test equipment. Write today for large illustrated catalog. Wholesale Radio Laboratories, 744 W. Broadway, Council Bluffs, Iowa.

CRYSTALS available — all types, including 100 kc., 465 kc. and 100 kc. Broadcast and Aircraft given prompt attention. Scientific Radio Products, Council Bluffs, Iowa.

PREPARE NOW for tremendous opportunities in new fields of radio after the war. Training for Federal licenses. Write for particulars. Radio code classes, all speeds. American Radio Institute, 44 East 23rd Street, New York 10, N. Y.

IMMEDIATE shipment on priority: new SX28As, \$223.00; SX25s, \$94.50; PM23s, \$15.00. In stock without priority: Trimm #65, Dependable headsets, \$2.28; #100 Featherweight \$6.00; meter rectifiers, \$1.95; coils, transformers, etc. Instructographs for rent. Write for our catalog. Henry Radio Shop, Butler, Mo.

HIGHEST prices paid for used receivers, test equipment, bugs, oscillators. What have you? W9ARA, Butler, Mo.

WANTED: radio operators for merchant marine. Commercial license. Must join union. Wagos \$300 to \$375 monthly. Radio Officers Union, 1440 Broadway, New York.

BUILD a radio, complete kit with tubes, \$9.95. Details. Radio, 9418 Avenue "A", Brooklyn, N. Y.

WANTED to buy: a used Collins 30FXB or 30FXC transmitter. Will be used in conjunction with army tests. Your chance to convert old model into cash for purchase of new post-war design. Capt. Harold B. Churchill, Little Silver, New Jersey.

FABERADIO crystals will be available to amateurs immediately after hostilities cease. Faberadio, Sandwich, Ill.

GET set for V-Day: 1000 v.a. transformers, 1100-2200-4400 v. each side. CT \$13.50 each. Guaranteed. F. G. Dawson, 5740 Woodward Street, Detroit 10, Mich.

CRYSTALS: complete units or blanks. All types. Your specifications and tolerances. One or one million. Refinishing and re-pairing of your present units. Rex Bassett, Incorporated, Ft. Lauderdale, Fla.

FOR SALE: two 3-phase, 230 v. power transformers, output voltage 5500, 4000, 2750, or 2000, maximum d.c. secondary current, 1 amp per leg. Send bid to Max M. Knight, 855 35th St., N. E., Cedar Rapids, Iowa.

RADIO TESTS — Pre-examination Tests for Radio Operators. Tests your knowledge before you appear for commercial radio operator license examinations. Avoids failures. Guides your preparation. Saves your time. Worth investigating at once. Also books for home study. Write for free circulars 5Q. Nilson Radio School, 51 E. 42 St., New York 17, N. Y.

WANTED: Hallcrafters Sky Buddy or Sky Champion. Good condition. Reasonable price. S/Sgt. L. I. Dobrowolski, 93rd Fighter Control Squadron, Bradley Field, Conn.

WANTED: By man overseas, Hallcrafters S-29, Sky Traveler. Cash. E. G. Parmenter, S 1/C, C.B.M.U. 566, c/o F.P.O., NYC, N. Y.

WANTED: 6v. telegraph sounder and box, A1 condition. W1BB.

RADIO Hams! Broaden your scientific background and gain contacts with amateurs in other fields through the Amateur Scientists' Magazine. Sample 15c. Memphis, Tenn.

HALLCRAFTERS SX-24 and speaker. Make an offer. Write: C. Horn, 325 E. 163 Street, New York 56, N. Y.

CALIF. kilowatt of special designed equipment, including tubes. For list, write Davis, 4306 W. 60th St., Los Angeles, 43, Calif.

1 KW. composite phone and c.w. transmitter, perfect. \$835. Described in March 1938 *QST*. W9AXH, Stuart, 5207 No. Ill., St. Indianapolis, 8, Ind.

FOR SALE: 500 w. transmitter, 6' high, 18" deep, 19" wide. Standard relay rack, 6½ sections, all steel panel, aluminum chassis on castors. Operates on 8-40-20-10 meters with e.c.o. b.w. coils for all bands and full tube complement. Final T55 to T240 to 809 to 6L6G or e.c.o. c.w. only. Heavy power supplies well filtered and choked, all Thordarson and U.T.C. transformers. Marton speed-key with custom-built electronic keyer, variable speed 16 — 65 w.p.m. — all for \$400. Robert A. Demers, 19 Percy Street, Chicopee Falls, Mass.

FINAL clean-up of W9UFD's 2¼ to 160 m. transmitters, 2¼ m. receivers, parts at your own price. J. F. Leeder, 3176 South 13th St., Omaha, Nebraska.

WANTED: Transmitter, 500 watt or larger, will pay cash or trade ham equipment. Send details. Bob Easley, 295 Garfield Place, Brooklyn, N. Y.

URGENTLY wanted: Modern tube tester. Describe fully, mention price. Mabon Kingsley, Chestertown, Maryland.

WANTED: Echophone EC-1 receiver. Will pay cash. R. L. Hamman, Alcatraz, Calif.

CRYSTALS: Immediate delivery of Eidson Fine Crystals; many types available throughout the 100-12,000 k.c. range for transmitters, fixed frequency receivers, etc. Also repair and regrounding service. Ten years of satisfaction and fast service. Send for free folder L-5, mentioning your needs. "Eidson's," Temple, Texas.

WANTED: 500 mil swinging choke, 1-2500 or 3000 volt transformer, 1 amp or more. D. E. Illian, 142 Alger Road, Oak Ridge, Tenn.

WANTED: EC-1 or equivalent. W1LIG/3, #520X, YMCA, 1421 Arch Street, Philadelphia 2, Pa.

FOR SALE: Coastal radio station WLO. Write P.O. Box 1322, Mobile, Alabama.

UP to date complete radio testing equipment, Riders, chanalyst, or what have you, for a repairman. Cash. Fred W. Rudolph, W8WSC, 350 East Beecher St., Adrian, Michigan.

ELECTRONIC tube and radio development engineers and technicians wanted. War projects, electronic devices. Plan your future in television, ultra-high frequency. Write qualifications. Electronic Tube Corporation, 1200 E. Mermaid Ave., Philadelphia 18, Pa.

WANTED: Enclosed "six foot" relay rack. Give description. W8EDD, 1972 Eastern Parkway, Schenectady 8, N. Y.

FOR SALE: 1 Hammarlund HQ120X communications receiver. Excellent condition. Best offer. Stanley Valinet, 1828 Central Avenue, Indianapolis, Ind.

RESISTOR, wire wound, nationally known make, 3000 ohms, 7½ watts. Remove wire to make any desired value. For making servicing equipment, shunts, multipliers, experimenting, etc. Five for \$1.00. Radioco, 1110T Marshall Building, Cleveland, Ohio.

IMPORTANT ANNOUNCEMENT!

In the operation of an important airline under extremely difficult conditions, we need experienced aircraft radio service men to maintain our large fleet of aircraft and extensive ground installations in India and China. Extensive previous practical experience necessary. Single men preferred.

CHINA NATIONAL AVIATION CORP.
Chrysler Building • New York City

**"DON'T WORRY-IF SHE'S A SPY,
SHE'S WASTING HER TIME-
HOGARTH ONLY TALKS ABOUT
HIS ECHOPHONE EC-1!"**

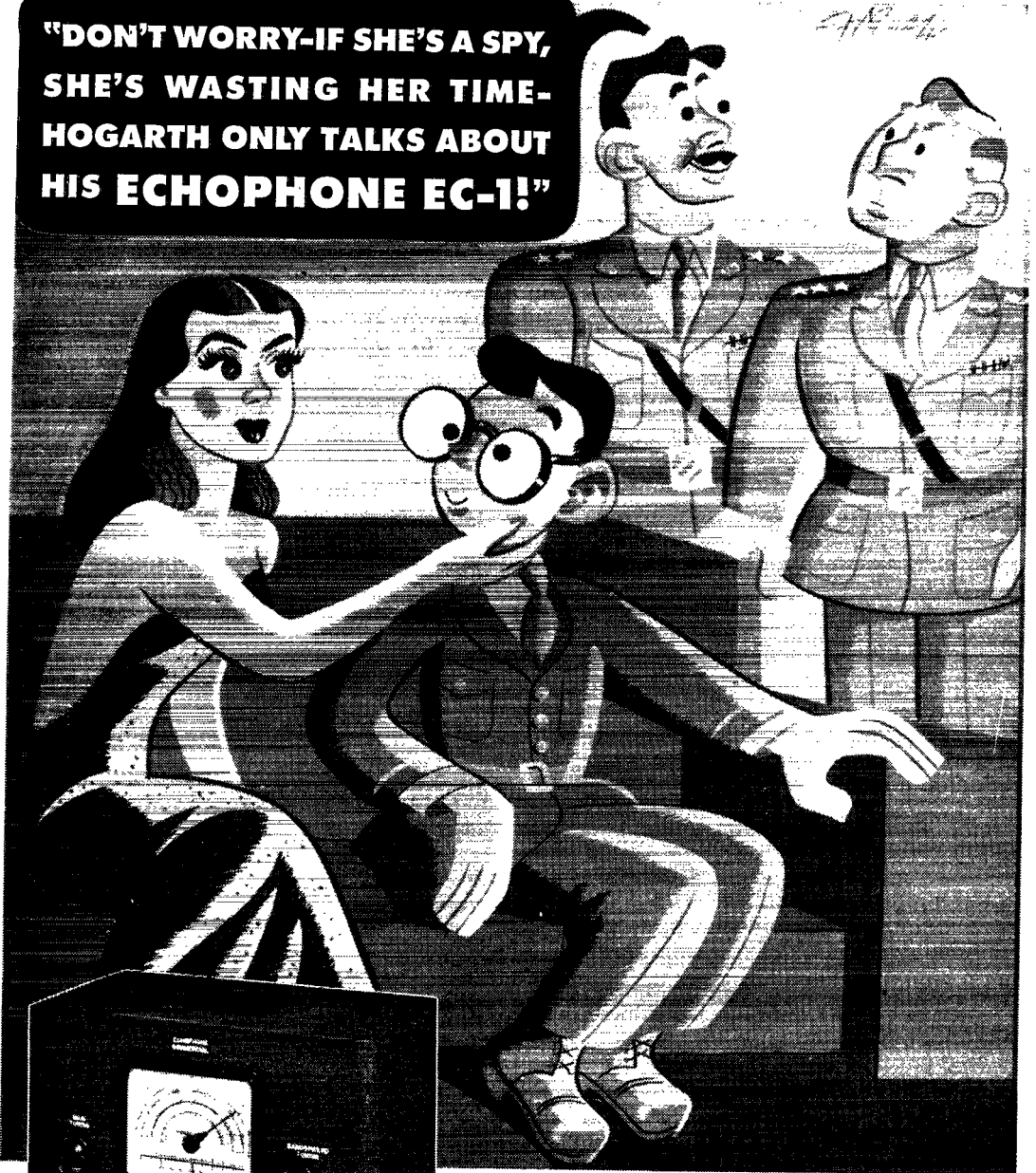

ECHOPHONE MODEL EC-1

(Illustrated) a compact communications receiver with every necessary feature for good reception. Covers from 550 kc. to 30 mc. on 3 bands. Electrical bandspread on all bands. Six tubes. Self-contained speaker. 115-125 volts AC or DC.

ECHOPHONE
"The Ears of the World"

ECHOPHONE RADIO CO., 540 NORTH MICHIGAN AVE., CHICAGO 11, ILLINOIS

Designed for



Application

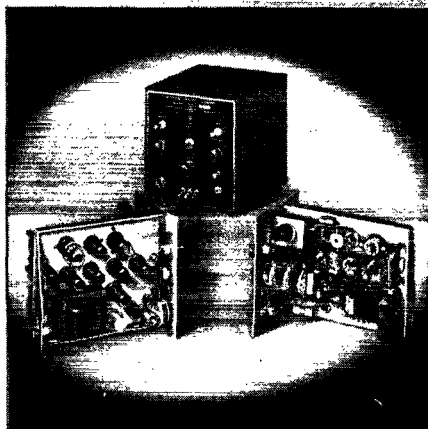

THE No. 9050

SECONDARY FREQUENCY STANDARD

A Precision Frequency Standard for both Laboratory and production uses. Designed around the GE crystal, having a frequency temperature coefficient of less than 1 cycle/Mc/C°. The crystal is sealed in a standard metal tube envelope. Adjustable output provided at intervals of 10, 25, 100, and 1000 KC with magnitude useful to 50 MC. Harmonic amplifier with tuned plate circuit and panel range switch. 800 cycle modulator, with panel control switch. Panel plate supply control switch. In addition to Oscillators, Multi-vibrators, Modulators, and Amplifiers, a built-in Detector with phone jack and gain control on the panel is incorporated. Self-contained AC power supply with VR 150-30 voltage regulator. Cabinet size 9" x 9 5/8" x 10 1/2", weight 20 lbs.

**JAMES MILLEN
MFG. CO., INC.**

MAIN OFFICE AND FACTORY

MALDEN

MASSACHUSETTS



Index to Advertisers

	Page
Abbott Instrument, Inc.	**
Aerovox Corporation	**
American Lava Corp.	**
American Radio Institute	84
American Tel. & Tel. Corp.	4
Amperec Elec. Products, Inc.	Cov. 11
Astatic Corporation, The	91
Ayers Automatic Code Machines	**
Barker & Williamson	89
Billey Electric Co.	71
Brach Manufacturing Corp.	**
Browning Laboratories, Inc.	**
Burgess Battery Company	70
Candler System Company	87
Capitol Radio Engineering Institute	64
Cardwell Mfg. Corp., Allen D.	68
Centralab	**
Claroat Mfg. Co., Inc.	**
Collins Radio Company	81
Commercial Radio Institute	84
Communications Products Co.	**
Coto-Coil Co., Inc.	91
Crystal Products Co.	**
Delco Radio Div. Gen. Motors	85
DX Crystal Company	**
Echophone Radio Co.	93
Eitel-McCullough, Inc.	96
Electro-Voice Mfg. Co.	**
Electronic Laboratories	73
Galvin Mfg. Corp.	**
Gardiner & Company	82
General Ceramics & Steatite Co.	7
General Electric Co.	79
Greenlee Tool Company	**
Hilcrafters Co., The	2
Hammarslund Mfg. Co., The	61, 63
Harco Steel Construction Co.	**
Harrison Radio Company	**
Harvey Radio Co.	**
Harvey Radio Laboratories, Inc.	88
Harvey-Wells Communications, Inc.	89
Hazeltine Electric Corp.	86
Heintz & Kaufman, Ltd.	75
Henry Radio Shop	**
Hytron Corporation	**
Instructograph Company	**
International Resistance Co.	76
Jensen Radio Mfg. Co.	**
Ken-Rad Tube & Lamp Corp.	**
Kenyon Transformer Co., Inc.	**
Knights Co., James	**
Maedel Publishing House	**
Mallory & Co., P. R.	60
Massachusetts Radio School	86
McElroy Mfg. Corp.	5
McGraw-Hill Book Co., Inc.	80
Meck Industries, John	**
Meissner Mfg. Co.	**
Melville Radio Institute	90
Metropolitan Technical School	**
Millen Mfg. Co., James	94
National Company, Inc.	59, Cov. 111
Newark Electric Co.	84
New York YMCA Schools	**
Nilson Radio School	**
Ohmite Manufacturing Co.	62
Onan Electric Co., D. W.	82
Oxford-Tartak Radio Corp.	**
Palco Corporation	**
Pioneer Gen-E-Motor	**
Port Arthur College	88
Premax Products	86
RCA Institutes, Inc.	84
RCA Manufacturing Co., Inc.	Cov. 66
Radio Manufacturing Engineers	72
Radio Shack Corporation	90
Radio-Television Institute	**
Ramsey Publishing Co.	**
Raytheon Mfg. Co.	76
Seal, R. C. & Co.	**
Scientific Radio Products Co.	**
Shure Brothers	90
Sickles Co., F. W.	**
Simpson Electric Co.	83
Solar Cap. Sales Corp.	67
Sperry Gyroscope Co.	95
Sprague Electric Co.	**
Standard Radio Electronics Co.	**
Standard Transformer Co.	**
Sun Radio & Electronics Co.	**
Taylor Tubes, Taylor	**
Telegraph Apparatus Co.	90
Telex Company	78
Terminal Radio Corp.	74
Thordarson Elec. Mfg. Co.	69
Triplet Elec. Instrument Co., The	87
Turner Company, The	**
United Transformer Co.	82
Universal Microphone Co.	84
Valparaiso Technical Institute	**
Vibroplex Company, Inc.	**
Wallace Co., William	65, 78
Western Electric Co.	**
Westinghouse Elec. & Mfg. Co.	**
Wholesale Radio Laboratories	**
Wilcox Electric Co.	**
Yaxley (Mallory, P. R.)	60
Zenith Radio Company	**

All of the above advertisers are cooperating with the A.R.R.L. to permit publication of an editorially adequate QST during this period of war-rationing of paper. Using less advertising space but at higher rates, they continue their customary support of QST. Some are using smaller space in each issue and some are using space only every second or third issue. Of the latter, those whose advertising does not appear in this particular issue are indicated by the ** above.

SPRAGUE VITAMIN-Q*



A BIG STEP FORWARD . . . in Capacitors for High Temperature, High Voltage Applications

Vitamin Q impregnant, pioneered and perfected by Sprague, has resulted in capacitor developments of far-reaching importance for high temperature, high voltage applications. Although extremely compact, Sprague Type 25P Capacitors, for instance, operate satisfactorily at thousands of volts at ambient temperatures as high as 105° C. Moreover, their leakage resistance at room temperature is 20,000 megohms X microfarads—or at least five times higher than that of previous types.

Sprague Vitamin Q impregnated Capac-

itors retain all of the virtues of conventional oil-impregnated capacitors throughout the extreme range of +105° C. to -40° C. Used where high temperature is not a factor, they result in materially higher ratings for a given size.

Standard types include hermetically sealed rectangular metal container units in styles for 95° C. and 105° C. continuous operation, and in d-c rated voltages from 1000 to 16000 V. Other types include Type 45P hermetically sealed in glass shells with metal end caps.

SPRAGUE ELECTRIC COMPANY, North Adams, Mass.

(Formerly Sprague Specialties Co.)

*TRADEMARK REG. U. S. PAT. OFF.

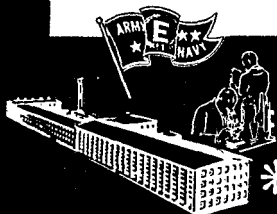

* SPRAGUE CAPACITORS * KOOLOHM RESISTORS

PAN AMERICAN USES EIMAC TUBES



Pan American World Airways, which has done so much to advance the war-time goals of the nation, has just announced a plan for a new service to South America. Employing a fleet of stratosphere planes, carrying 108 passengers, flying at more than three hundred miles an hour, Pan American proposes to take travelers from New York to Rio de Janeiro in less than twenty hours instead of the present sixty-six hours, charging \$175 for the trip, as against the current rate of \$491.

Pan American Airways and all its associated and affiliated companies, which comprise the P. A. A. World System, have been using Eimac tubes in the key sockets of all ground stations for a number of years.

Because of the extensive operations of Pan American World Airways, these tubes have been subjected to about every test possible—altitudes; ground level; extremely cold climates and high temperatures found at the equator; conditions of high and low humidity; and in some instances, when new bases are being built, perhaps somewhat trying power conditions. The high regard which P. A. A. engineers have for Eimac tubes is clearly evidenced by their continued and more extensive use, as the years roll by.

The fact that Eimac tubes are the number one favorite of the commercial airlines is important evidence to substantiate the oft repeated statement that "Eimac tubes are first choice of leading electronic engineers throughout the world."

Follow the leaders to

Eimac
REG. U. S. PAT. OFF.
TUBES



EITEL-McCULLOUGH, INC., 947 San Mateo Ave., SAN BRUNO, CALIF.
PLANTS LOCATED AT: SAN BRUNO, CALIFORNIA AND SALT LAKE CITY, UTAH

Export Agents: **FRAZAR & HANSEN, 301 Clay Street, San Francisco, California, U. S. A.**

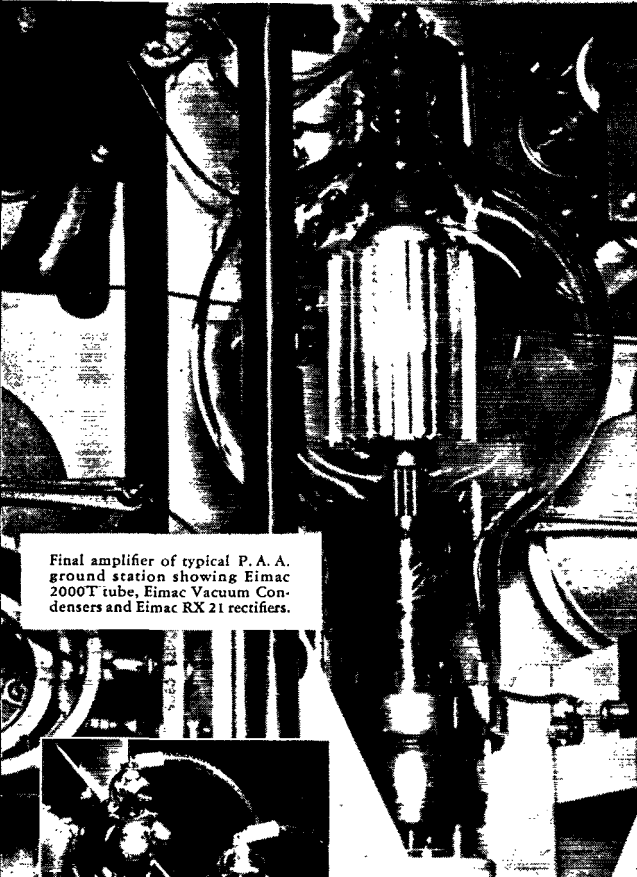

Final amplifier of typical P. A. A. ground station showing Eimac 2000T tube, Eimac Vacuum Condensers and Eimac RX 21 rectifiers.



Write for your copy of Electronic Telesis—a 64 page booklet fully illustrated—covering fundamentals of Electronics and many of its important applications. Written in layman's language.

NATIONAL RECEIVERS ARE THE EARS OF THE FLEET



OFFICIAL U. S. NAVY PHOTOGRAPH

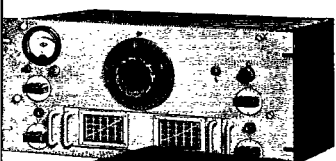

HRO

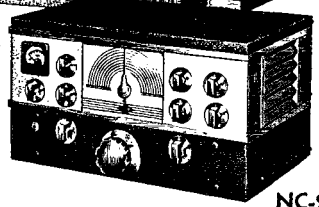

NC-200

NATIONAL COMPANY

MALDEN  MASS, U. S. A.

NATIONAL RECEIVERS ARE IN SERVICE THROUGHOUT THE WORLD

FREE!

HELPFUL DATA ON 22 RCA MINIATURES

BUY MORE WAR BONDS

RADIO CORPORATION OF AMERICA
RCA VICTOR DIVISION • CAMDEN, N. J.

THIS condensed story on the complete line of RCA miniatures . . . giving application data and suggested uses for each type . . . is yours on request.

Miniatures were an RCA development back in 1940, when that famous quartet, the 1R5, 1S4, 1S5 and 1T4, put "personal" portables on the map. War demands have speeded the development of miniatures so that today 22 RCA types are available. 17 out of the 22 are on the Army/Navy Preferred List of Vacuum Tubes; 21 out of the 22 were developed by RCA!

As plans for postwar equipment begin to unfold, the future importance of miniatures . . . and of RCA'S leadership in miniatures . . . becomes more

and more apparent. That's why we believe you will be interested in this condensed picture of the RCA line, which brings together for your convenience important information on each type, in a two-color, 7" by 10" chart. For your copy, fill out coupon below and mail it to RCA, Commercial Engineering Section, Dept. 62-64, Harrison, N. J.

The fountain-head of modern Tube development is RCA.

RCA, Commercial Engineering Section, Dept. 62-64
Harrison, New Jersey

Please send me (without charge) a copy of the QUICK-REFERENCE CHART ON RCA MINIATURE TUBES. Mail to:

Name _____

Address _____

City _____ State _____

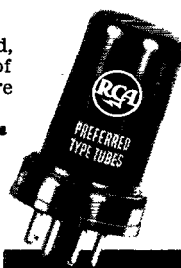

62-6436-64

RADIO CORPORATION OF AMERICA

RCA VICTOR DIVISION • CAMDEN, NEW JERSEY