

QST

July, 1944
25 cents
35c in Canada

devoted entirely to

amateur radio

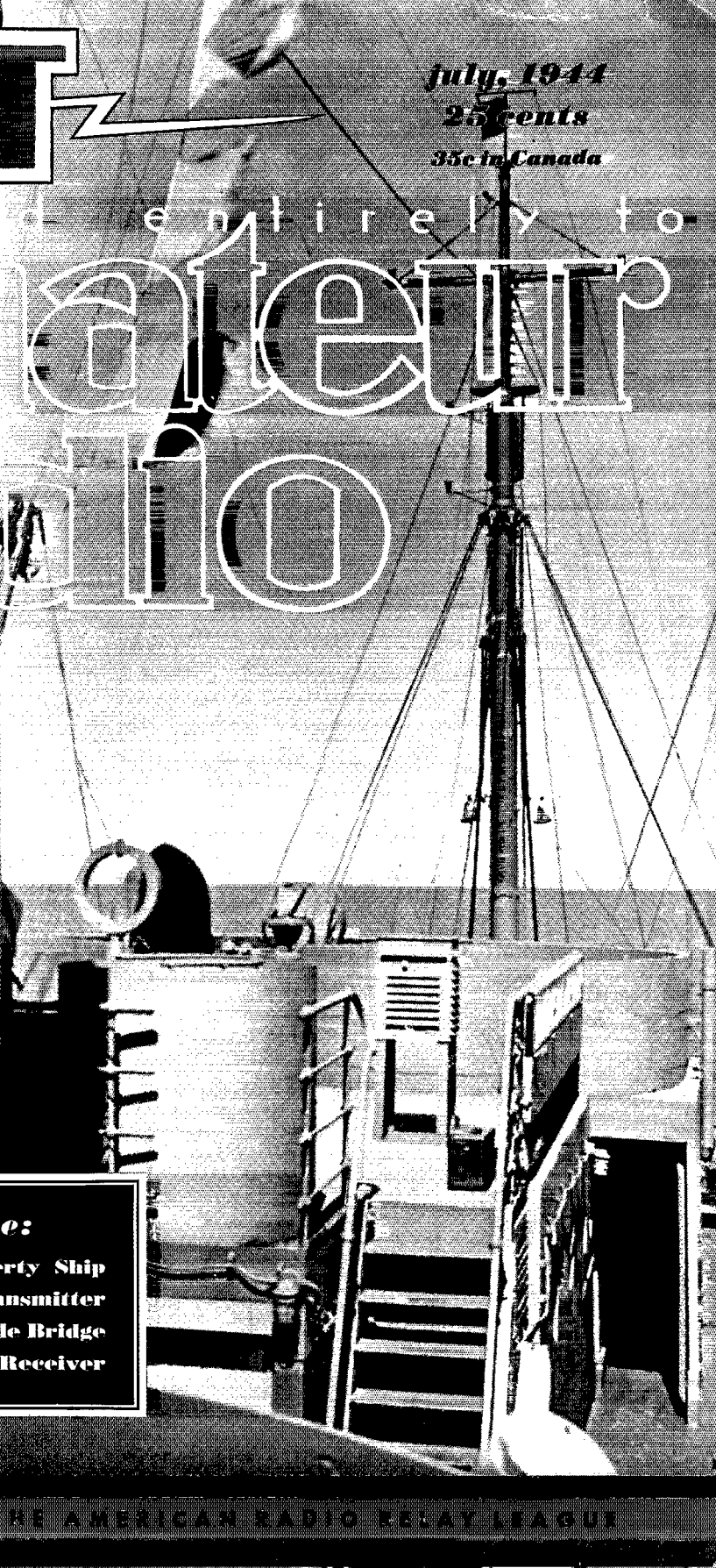
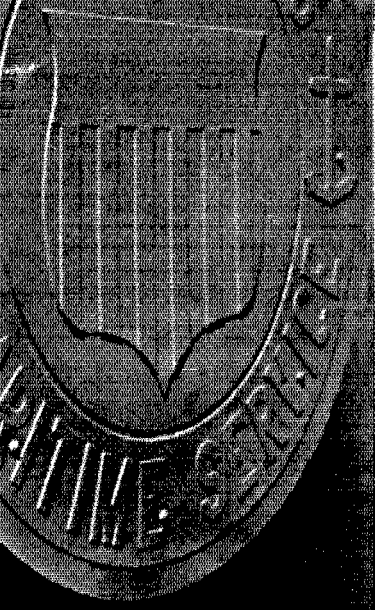

In This Issue:

- QST Cruises on a Liberty Ship**
- A Midget A.C.-D.C. Transmitter**
- The Iconoscope • A Simple Bridge**
- WERS Control-Station Receiver**

INTERSTAGE FILTERS BY

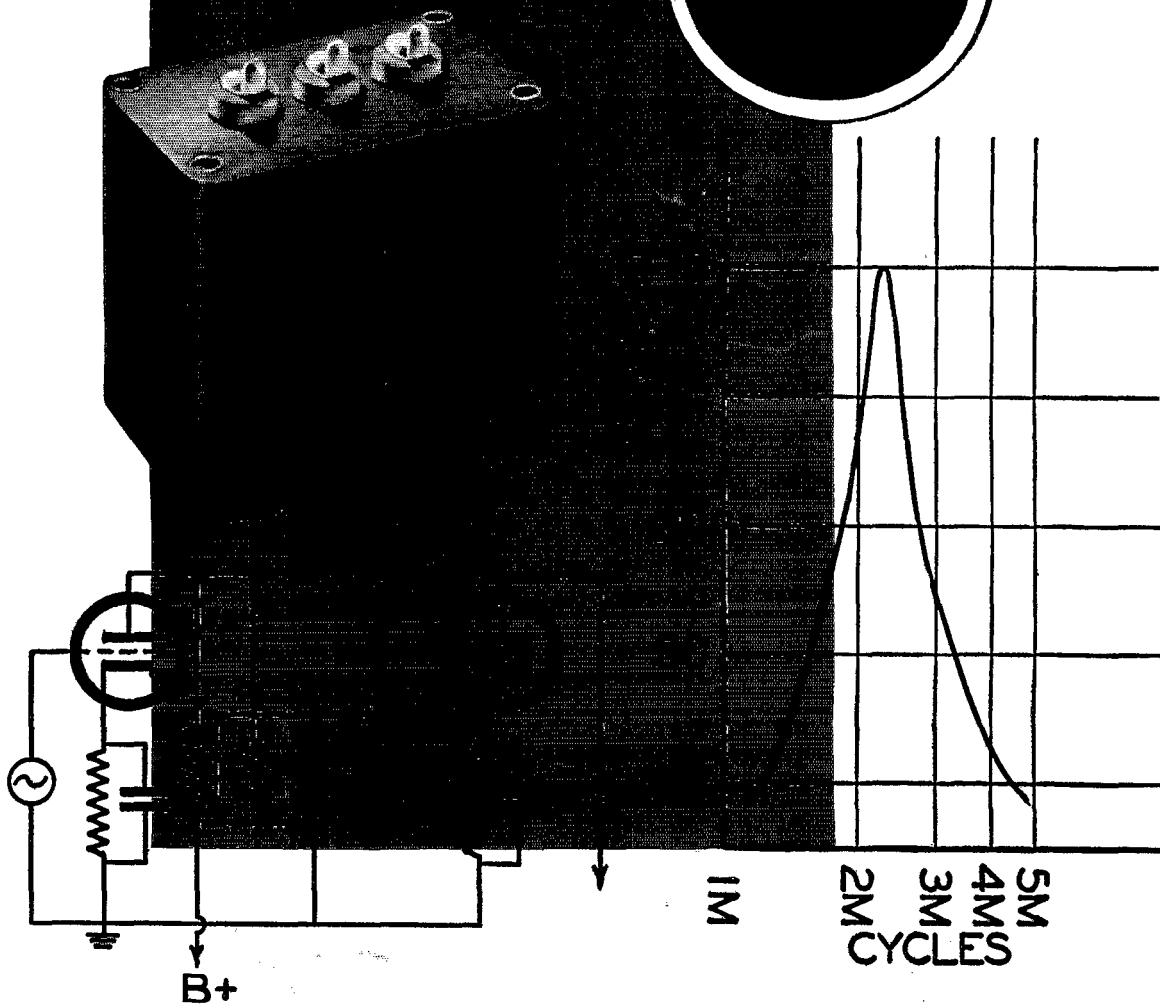

Interstage filters lend themselves to effecting gain simultaneously with their frequency discrimination. The unit illustrated is a band pass unit which provides a 2:1 step-up ratio, with band pass attenuation of 40 DB per octave. This unit employs a dual alloy magnetic shield which reduces inductive pick-up to 150 Mv. per gauss. The dimensions in its hermetically sealed case are $1\frac{1}{2} \times 2\frac{1}{2} \times 2\frac{1}{2}$. Filters of this type can be supplied for any band pass frequency from 200 to 10,000 cycles.

May we cooperate with you on design savings for your application . . . war or postwar?

150 VARICK STREET

An aerial black and white photograph of a beachhead during a military operation. In the foreground, soldiers are seen on the beach, some near a tank. The middle ground shows a large landing vehicle, possibly an LVT, with a soldier visible inside. The background features the ocean and several aircraft flying in the sky.

FIRST on the NORMANDY COAST

The Army's SCR-299's went ashore with the wave of Allied assault troops that split the 2nd front wide open. These mobile radio units rolled up on the beachhead early in the battle to serve as vitally important front line communications weapons to coordinate and direct the striking power of the land, sea and air forces.

In truck or duck, the Hallicrafters-built SCR-299's go anywhere and are sturdy enough to withstand front line action. Highly dependable and powerful, they "get the message through."

hallicrafters RADIO

THE HALLICRAFTERS CO., MANUFACTURERS OF RADIO
AND ELECTRONIC EQUIPMENT, CHICAGO 16, U. S. A.



BUY A WAR
BOND TODAY!



THE FOURTH REASON

The men and women of Hallicrafters Company are proud to receive the Fourth Army-Navy Production Award. It is a Fourth Reason, a Fourth Incentive, to continue to produce the most and the best that those at the fighting fronts all over the world shall not have "too little, too late." With deep humility and with the realization that to produce is the least that can be done for those who fight, the people of Hallicrafters accept this award.

BUY A WAR BOND TODAY!

hallicrafters RADIO

THE HALCRAFTERS COMPANY, CHICAGO 16, U. S. A.

THE 1ST EXCLUSIVE RADIO MANUFACTURER TO RECEIVE THE "E" AWARD FOR THE 4TH CONSECUTIVE TIME

JULY 1944

VOLUME XXVIII

NUMBER 7



STAFF

Editorial

KENNETH B. WARNER, W1EH
General Manager of A.R.R.L.
Publications

CLINTON B. DESOTO, W1CBD
Editor

GEORGE GRAMMER, W1DF*
Technical Editor

DONALD H. MIX, W1TS
Acting Technical Editor

HOLLIS M. FRENCH, W1JEM
BYRON GOODMAN, W1LPE*
Assistant Technical Editors

EDWARD P. TILTON, W1HDQ
Contributing Editor, V.H.F.

WALTER E. BRADLEY, W1FWH
VERNON CHAMBERS, W1JEQ*
Technical Information Service

LOUISA B. DRESSER
Editorial Assistant

JAMES J. LAMB, W1AL*
Research Engineer, A.R.R.L.

Advertising

F. CHEYNEY BEEKLEY, W1GS
Advertising Manager

Circulation

DAVID H. HOUGHTON
Circulation Manager

RALPH T. BEAUDIN, W1BAW
Asst. Circulation Manager

*On leave of absence



OFFICES

38 La Salle Road
West Hartford 7, Connecticut

Subscription rate in United States and Possessions, \$2.50 per year, postpaid; all other countries, \$3.00 per year, postpaid. Single copies, 25 cents. Foreign remittances should be by international postal or express money order or bank draft negotiable in the U. S. and for an equivalent amount in U. S. funds.

Entered as second-class matter May 29, 1919, at the post office at Hartford, Connecticut, under the Act of March 3, 1879. Acceptance for mailing at special rate of postage provided for in section 1103, Act of October 3, 1917, authorized September 9, 1922. Additional entry at Concord, N. H., authorized February 21, 1929, under the Act of February 28, 1925. Additional second-class entries to cover sectional editions authorized March 20, 1935.

Copyright 1944 by the American Radio Relay League, Inc. Title registered at United States Patent Office.

QST

devoted entirely to

AMATEUR RADIO

PUBLISHED MONTHLY, AS ITS OFFICIAL ORGAN, BY THE AMERICAN RADIO RELAY LEAGUE, INC., AT WEST HARTFORD, CONN., U. S. A.; OFFICIAL ORGAN OF THE INTERNATIONAL AMATEUR RADIO UNION



CONTENTS

It Seems to Us	7
Splatter	8
QST Cruises with the Maritime Service	
Clinton B. DeSoto, W1CBD	9
A WERS Control Station Receiver	15
Frank Heubner	
OPA Revises Ceiling Prices	18
A Simple M.O.P.A. for WERS Service	
Henry O. Pattison, jr., W2MYH, and Donald H. Mix, W1TS	19
Happenings of the Month	22
Missing in Action	25
Silent Keys	25
The Iconoscope	26
B. W. Southwell, W60JW/2	
In the Services	28
An Inexpensive Impedance Bridge	32
Athan Cosmas	
In QST 25 Years Ago This Month	37
Them Wuz the Good Old Days	38
"Sourdough"	
Simplifying the Electronic Key	
W/O Lawrence G. Wiley, ex-W9YDA	40
On the Very Highs	42
E. P. Tilton, W1HDQ	
Practical Applications of Simple Math — Part III	
Edward M. Noll, ex-W3FQJ	46
Gold Stars — W9FJH, W5HGE	49
Hams in Combat	
One Life to Give	50
A Lady of Mercy — Part II	
S/Sgt. John F. Wojtkiewicz, W3GJY-W4GQJ	53
A "OSL"-Type Transmitter with Transformerless Power Supply	56
Paul J. Palmer, W8UGR	
New Tube — RCA-6J4	58
Hints and Kinks	
Installation and Calibration of a Loop Direction Finder — A WERS Transmitter-Receiver Unit Using 2.5-Volt Tubes — A Homemade Gas Soldering Torch Constructed From Scrap Copper Tubing — Substituting a 1H4G Tube for the 1G4G in the Handbook Code-Practice Set	59
Strays	62
Chicago "Hamboree"	63
Look Before You Leap	64
Walter E. Bradley, W1FWH	
Correspondence from Members	65
Operating News	68
Honor Roll	68
ARRL Affiliated Club Honor Roll	69
Press Schedules	71
The Month in Canada	72
Amateur Activities	73
Ham-Ads	108
QST's Index of Advertisers	110

Section Communications Managers of the A.R.R.L. Communications Department

Reports Invited. All amateurs, especially League members, are invited to report communications activities, training plans, code classes, theory-discussion groups, civilian-defense building or planning each mid-month (16th of the month for the last 30 days) direct to the SCM, the administrative official of ARRL elected by members in each Section whose address is given below. Radio Club reports and Emergency Coordinator reports representing community organized work and plans and progress are especially desired by SCMs for inclusion in QST. ARRL Field Organization appointments, with the exception of the Emergency Coordinator and Emergency Corps posts, are suspended for the present and no new appointments or cancellations, with the exception named, will be made. This is to permit full efforts of all in Emergency Corps plans.

ATLANTIC DIVISION				
Eastern Pennsylvania Maryland-Delaware-District of Columbia Southern New Jersey Western New York Western Pennsylvania	W3BES W3CIZ W3GCU W8MC W8CKO	Jerry Mathis Hermann E. Hobbs Ray Tomlinson William Bellor E. A. Krall	6208 Master St. 9701 Monroe St. Silver Spring P. O. 623 E. Brown St. 186 Dorsey Rd. 703 Broadway	Philadelphia 31 Laden, Maryland Trenton 10 Rochester East McKeesport
CENTRAL DIVISION				
Illinois* Indiana Kentucky Michigan Ohio Wisconsin	W9QLZ W9EGQ W9ABU W8DPE W8CBI W9RH	George Keith, Jr. Herbert S. Brier Darrell A. Downard Harold C. Bird D. C. McCoy Emil Felber, Jr.	Box 22-A, R.F.D. 2 385 Johnson St. 116 N. Longworth Ave. R.F.D. 2, Box 228 Normandy Lane, R. R. 7 1625 N. 18th St.	Utica Gary Louisville 12 Pontiac 2 Dayton Milwaukee 5
DAKOTA DIVISION				
North Dakota South Dakota Northern Minnesota Southern Minnesota	W9YVF W9QVV W9FUZ W9VNG	John W. McBride P. H. Schultz Armond D. Brattland Millard L. Bender	420 West 12th St. 118 N. Yankton Ave. 2802 So. Western 608 N. Huron Ave.	Sioux Falls, South Dakota Pierre Los Angeles 7, Calif. Spring Valley
DELTA DIVISION				
Arkansas Louisiana Mississippi Tennessee	W5CED W5DKR W5HAV W4SP	Ed Beck Eugene H. Treadaway P. W. Clement James B. Witt	2503 Bishop St. P. O. Box 44 524 Santini St. R.F.D. 6, Shady Dell Trail	Little Rock LaPlace Biloxi Knoxville
HUDSON DIVISION				
Eastern New York* N. Y. C. & Long Island Northern New Jersey	W2HZL W2AZV W2CQD	Ernest E. George E. L. Baunach Winfield G. Beck	2044 Lexington Parkway 102 Central Ave. 617 Spruce St.	Schenectady 8 Massapequa, L. I. Roselle
MIDWEST DIVISION				
Iowa Kansas Missouri Nebraska	W9AED W9AWP W9QUD W9POB	Arthur E. Rydberg A. B. Unruh Mrs. Leola A. Dangerfield Roy E. Olmsted	1617 S. Seneca St. Box 123 101 Arikari Ave.	Mitchellville Wichita Berkeley Wauneta
NEW ENGLAND DIVISION				
Connecticut Maine* Eastern Massachusetts Western Massachusetts New Hampshire Rhode Island Vermont	W1KQY W1AQL W1ALP W1JAH W1EFT W1ERC W1NLO	Edmund R. Fraser G. C. Brown Frank L. Baker, Jr. William J. Barrett Mrs. Dorothy W. Evans Clayton C. Gordon Burtis W. Dean	48 Willow St. 379 No. Main St. 91 Atlantic St. 239 Columbia St. P. O. Box 312 70 Columbia Ave., Gaspee P. O. Box 81	West Haven 16 Brewer North Quincy 71 Adams Concord Providence 5 Burlington
NORTHWESTERN DIVISION				
Alaska Idaho Montana Oregon Washington	K7GNN W7AVP W7CPY W7GNJ W7FWD	James G. Sherry Don D. Oberbillig Rex Roberts Carl Austin O. U. Tatro	P. O. Box 486 Box 1088 1137 Federal 513 N. Central	Homer Boise Glendive Bend Olympia
PACIFIC DIVISION				
Hawaii Nevada* Santa Clara Valley East Bay San Francisco Sacramento Valley Philippines San Joaquin Valley*	K6ETF W6BVZ W6IUZ W6TI W6RBO W6MDI K6LGR W6M1W	Francis T. Blatt Carrroll Short, Jr. Earl F. Sanderson Horace R. Greer William A. Ladley Vincent N. Feldhausen George L. Rickard Ralph C. Lowry	837 16th Ave. 1608 Arizona St. 600 Acacia Ave. 414 Fairmount Ave. 200 Naylor St. 113 South Quincy St. Box 849 315 Santa Barbara	Honolulu Boulder City San Bruno Oakland 11 San Francisco McCloud Modesto Modesto
ROANOKE DIVISION				
North Carolina South Carolina Virginia West Virginia	W4CYB W4BOE/ANG W3AKN W8JRL	W. J. Wortman Ted Ferguson Walter G. Walker Kenneth M. Zinn	P. O. Box 566 1213 College St. 217-51 St. P. O. Box 132	Montganton Columbia Newport News Clarksburg
ROCKY MOUNTAIN DIVISION				
Colorado Utah-Wyoming	W9VGC W7DIE	H. F. Heikel John S. Duffey	2743 Julian St. 938 "D" St.	Denver 11 Rock Springs, Wyo.
SOUTHEASTERN DIVISION				
Alabama Eastern Florida Western Florida Georgia West Indies (Cuba) (Puerto Rico-Virgin Islands)	W4GBV W4IP W4AXP W4FDJ CM2OP K4KD	Lawrence J. Smyth Robert B. Murphy Oscar Cederstrom Ernest L. Morgan Mario de la Torre Everett Mayer	808 Winona Ave. 3302 S. W. Grapeland Blvd. 408 S. Pine St. R.F.D. 4 Escobar 110 (Altos) 24 Lindberg St.	Montgomery Miami 33 Warrington Lyons Habana, Cuba Santurce, P. R.
SOUTHWESTERN DIVISION				
Los Angeles Arizona San Diego	W6QVV W6RWV W6CHV	H. F. Wood Douglas Aitken Ralph H. Culbertson	429 So. Fairview 341 S. Mt. Vernon Ave. 7172 Eads St.	Burbank Prescott La Jolla
WEST GULF DIVISION				
Northern Texas Oklahoma* Southern Texas New Mexico	W5IAU W5AYL W5SMN W5HJF	N. R. Collins, Jr. Ed Oldfield Horace E. Biddy J. G. Hancock	2230 W. Amherst 2141 N. W. 35th St. 1746 Schley Ave. 110 S. E. Nevada St.	Dallas Oklahoma City 6 San Antonio Portales
MARITIME DIVISION				
Maritime	VE1DQ	A. M. Crowell	69 Dublin St.	Halifax, N. S.
ONTARIO DIVISION				
Ontario	VE3EF	Flying Officer Donald R. Gunn c/o Canadian Bank of Commerce		New Toronto, Ont.
QUEBEC DIVISION				
Quebec	VE2CO	Lieutenant L. G. Morris	211 Bolton St.	Ottawa, Ont.
VANALTA DIVISION				
Alberta British Columbia	VE4GE VE5DD	C. S. Jamieson C. O. I. Sawyer	581 W. Riverside Drive 2634 West 31st Ave.	Drumheller, Alta. Vancouver
PRAIRIE DIVISION				
Manitoba Saskatchewan	VE4AAW VE45Y	A. W. Morley Arthur Chesworth	932 Rochester Ave. 1084 Redland Ave.	Winnipeg Moose Jaw

*Officials appointed to act temporarily in the absence of a regular official.

Eimac Vacuum Pump

To create the nearly perfect vacuum within Eimac tubes and put vacuum pumping on a mass production basis, Eimac Engineers developed a whole new vacuum technique and much special equipment.

One of the devices resulting from these years of research and development is the Eimac HV-1 Diffusion Pump together with the special vaporizing oil which it requires.

Today this pump is being made available to manufacturers and research laboratories throughout the world. You can obtain full information and technical data without cost or obligation by writing direct to the San Bruno plant address below.

This Eimac HV-1 pump is one good reason why Eimac tubes are unconditionally guaranteed against premature failures which are caused by gas released internally. This reason plus outstanding performance, great stamina and others have made Eimac tubes first choice of leading Engineers throughout the world.

Follow the leaders to

Eimac
TUBES

PART NUMBER	ITEM
D-1	2 1/2" BRONZE STEEL CAPSCREW
D-2	3
D-3	BRONZE GASKET - COUPLER
D-4	BRONZE GASKET - COUPLER
D-5	BRONZE GASKET - COUPLER
D-6	BRONZE GASKET - COUPLER
D-7	BRONZE GASKET - COUPLER
D-8	BRONZE GASKET - COUPLER
D-9	BRONZE GASKET - COUPLER
D-10	BRONZE GASKET - COUPLER
D-11	BRONZE GASKET - COUPLER
D-12	BRONZE GASKET - COUPLER
D-13	BRONZE GASKET - COUPLER
D-14	BRONZE GASKET - COUPLER
D-15	BRONZE GASKET - COUPLER
D-16	BRONZE GASKET - COUPLER
D-17	BRONZE GASKET - COUPLER
D-18	BRONZE GASKET - COUPLER
D-19	BRONZE GASKET - COUPLER
D-20	BRONZE GASKET - COUPLER
D-21	BRONZE GASKET - COUPLER
D-22	BRONZE GASKET - COUPLER
D-23	BRONZE GASKET - COUPLER
D-24	BRONZE GASKET - COUPLER
D-25	BRONZE GASKET - COUPLER
D-26	BRONZE GASKET - COUPLER
D-27	BRONZE GASKET - COUPLER
D-28	BRONZE GASKET - COUPLER
D-29	BRONZE GASKET - COUPLER
D-30	BRONZE GASKET - COUPLER
D-31	BRONZE GASKET - COUPLER
D-32	BRONZE GASKET - COUPLER
D-33	BRONZE GASKET - COUPLER
D-34	BRONZE GASKET - COUPLER
D-35	BRONZE GASKET - COUPLER
D-36	BRONZE GASKET - COUPLER
D-37	BRONZE GASKET - COUPLER
D-38	BRONZE GASKET - COUPLER
D-39	BRONZE GASKET - COUPLER
D-40	BRONZE GASKET - COUPLER
D-41	BRONZE GASKET - COUPLER
D-42	BRONZE GASKET - COUPLER
D-43	BRONZE GASKET - COUPLER
D-44	BRONZE GASKET - COUPLER
D-45	BRONZE GASKET - COUPLER
D-46	BRONZE GASKET - COUPLER
D-47	BRONZE GASKET - COUPLER
D-48	BRONZE GASKET - COUPLER
D-49	BRONZE GASKET - COUPLER
D-50	BRONZE GASKET - COUPLER
D-51	BRONZE GASKET - COUPLER
D-52	BRONZE GASKET - COUPLER
D-53	BRONZE GASKET - COUPLER
D-54	BRONZE GASKET - COUPLER
D-55	BRONZE GASKET - COUPLER
D-56	BRONZE GASKET - COUPLER
D-57	BRONZE GASKET - COUPLER
D-58	BRONZE GASKET - COUPLER
D-59	BRONZE GASKET - COUPLER
D-60	BRONZE GASKET - COUPLER
D-61	BRONZE GASKET - COUPLER
D-62	BRONZE GASKET - COUPLER
D-63	BRONZE GASKET - COUPLER
D-64	BRONZE GASKET - COUPLER
D-65	BRONZE GASKET - COUPLER
D-66	BRONZE GASKET - COUPLER
D-67	BRONZE GASKET - COUPLER
D-68	BRONZE GASKET - COUPLER
D-69	BRONZE GASKET - COUPLER
D-70	BRONZE GASKET - COUPLER
D-71	BRONZE GASKET - COUPLER
D-72	BRONZE GASKET - COUPLER
D-73	BRONZE GASKET - COUPLER
D-74	BRONZE GASKET - COUPLER
D-75	BRONZE GASKET - COUPLER
D-76	BRONZE GASKET - COUPLER
D-77	BRONZE GASKET - COUPLER
D-78	BRONZE GASKET - COUPLER
D-79	BRONZE GASKET - COUPLER
D-80	BRONZE GASKET - COUPLER
D-81	BRONZE GASKET - COUPLER
D-82	BRONZE GASKET - COUPLER
D-83	BRONZE GASKET - COUPLER
D-84	BRONZE GASKET - COUPLER
D-85	BRONZE GASKET - COUPLER
D-86	BRONZE GASKET - COUPLER
D-87	BRONZE GASKET - COUPLER
D-88	BRONZE GASKET - COUPLER
D-89	BRONZE GASKET - COUPLER
D-90	BRONZE GASKET - COUPLER
D-91	BRONZE GASKET - COUPLER
D-92	BRONZE GASKET - COUPLER
D-93	BRONZE GASKET - COUPLER
D-94	BRONZE GASKET - COUPLER
D-95	BRONZE GASKET - COUPLER
D-96	BRONZE GASKET - COUPLER
D-97	BRONZE GASKET - COUPLER
D-98	BRONZE GASKET - COUPLER
D-99	BRONZE GASKET - COUPLER
D-100	BRONZE GASKET - COUPLER

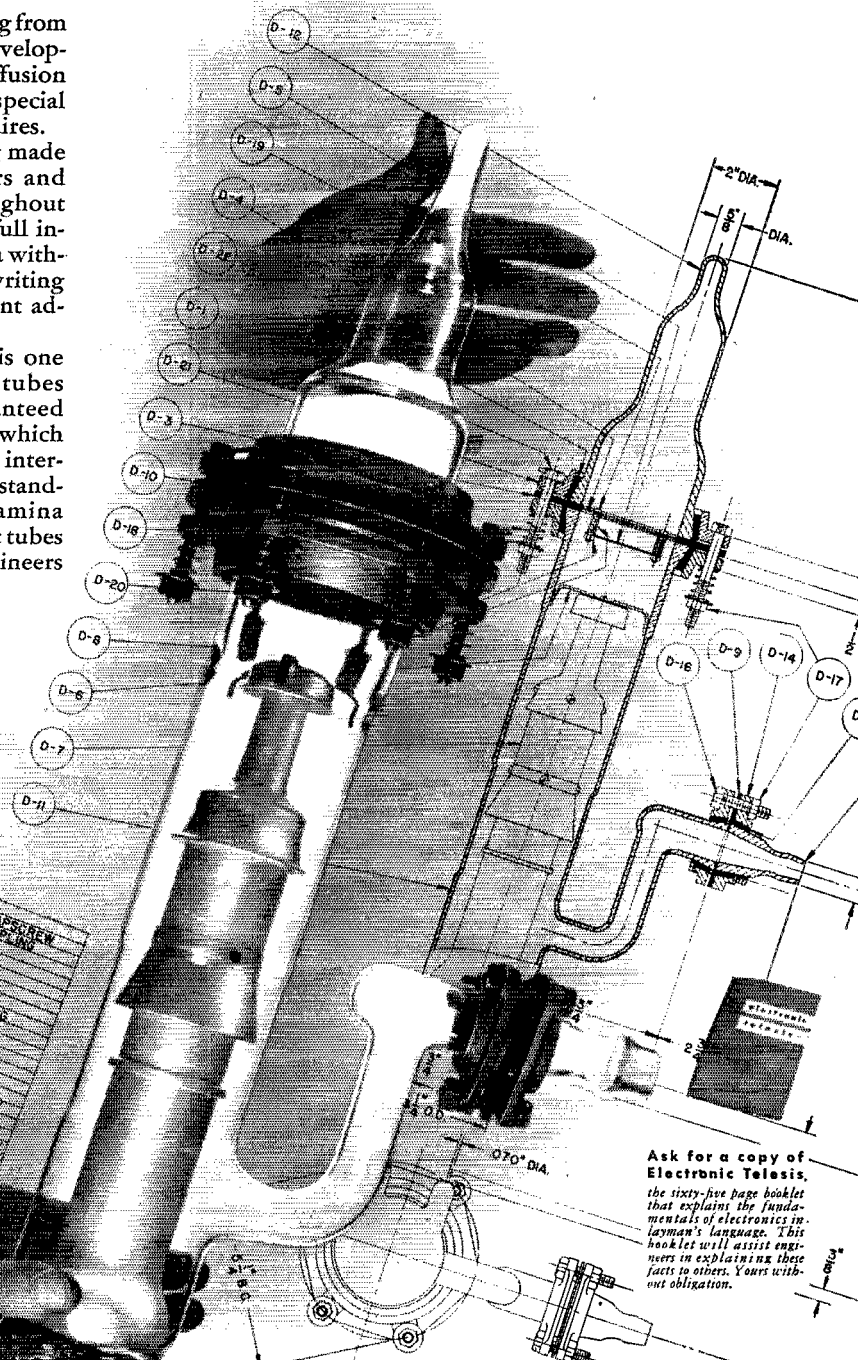

Ask for a copy of **Electronic Telesis**, the sixty-five page booklet that explains the fundamentals of electronics in layman's language. This booklet will assist engineers in explaining these facts to others. Yours without obligation.

EITEL-McCULLOUGH, INC., 816 San Mateo Avenue, SAN BRUNO, CALIFORNIA
Plants located at: San Bruno, California and Salt Lake City, Utah

Export Agents: **FRAZAR & HANSEN, 301 Clay Street, San Francisco, California, U. S. A.**

THE AMERICAN RADIO RELAY LEAGUE, INC.,

is a noncommercial association of radio amateurs, bonded for the promotion of interest in amateur radio communication and experimentation, for the relaying of messages by radio, for the advancement of the radio art and of the public welfare, for the representation of the radio amateur in legislative matters, and for the maintenance of fraternity and a high standard of conduct.

It is an incorporated association without capital stock, chartered under the laws of Connecticut. Its affairs are governed by a Board of Directors, elected every two years by the general membership. The officers are elected or appointed by the Directors. The League is noncommercial and no one commercially engaged in the manufacture, sale or rental of radio apparatus is eligible to membership on its board.

"Of, by and for the amateur," it numbers within its ranks practically every worth-while amateur in the nation and has a history of glorious achievement as the standard-bearer in amateur affairs.

Inquiries regarding membership are solicited. A bona fide interest in amateur radio is the only essential qualification; ownership of a transmitting station and knowledge of the code are not prerequisite, although full voting membership is granted only to licensed amateurs.

All general correspondence should be addressed to the Secretary at the administrative headquarters at West Hartford, Connecticut.



Past Presidents

HIRAM PERCY MAXIM, W1AW, 1914-1936
EUGENE C. WOODRUFF, W8CMP, 1936-1940

Officers

President.....GEORGE W. BAILEY, W1KH
Washington, D. C.
Vice-President.....CHARLES E. BLALACK, W6GG
Yuma, Arizona
Secretary.....KENNETH B. WARNER, W1EH
West Hartford, Connecticut
Communications Manager.....F. E. HANDY, W1BD1*
Chevy Chase, Maryland
Treasurer.....DAVID H. HOUGHTON
West Hartford, Connecticut
General Counsel.....PAUL M. SEGAL
1026 Woodward Building, Washington 5, D. C.

*On leave of absence. Address correspondence to the Acting Communications Manager, Carol K. Witte, West Hartford 7, Connecticut.

Directors

President
GEORGE W. BAILEY.....W1KH
1530 P St., N.W., Washington 25, D. C.

Vice-President
CHARLES E. BLALACK.....W6GG
Box 108, Yuma, Ariz.

Canadian General Manager
ALEX REID.....VE2BE
240 Logan Ave., St. Lambert, P. Q.
Alternate: Leonard W. Mitchell.....VE3AZ
78 Raglan Ave., Toronto, Ont.

Atlantic Division
WALTER BRADLEY MARTIN.....W3QV
Address correspondence to the Acting Director:
HERBERT M. WALLEZE.....W8BQ
P. O. Box 18, Drums, Pa.

Central Division
GOODWIN L. DOSLAND.....W9TSN
11831 Longwood Drive, Chicago, Ill.
Alternate: Everett H. Gibbs.....W8AQ
405 Broad St., Wadsworth, Ohio

Dakota Division
TOM E. DAVIS.....W9VVA
915 W. Becker Ave., Willmar, Minn.
Alternate: Aaron E. Swanberg.....W9BHY
1487 Breda St., St. Paul 4, Minn.

Delta Division
E. RAY ARLEDGE.....W5SI
340 N. E. 20th Terrace, Apt. 7, Miami 37, Fla.
Alternate: Samuel H. Dowell.....W5ERV
1057 Mildred St., Shreveport 15, La.

Hudson Division
ROBERT AKERIDGE KIRKMAN...W2DSY
248 Albert Place, Elberon, N. J.
Alternate: George Rulfs, Jr.....W2CJY
87-01 Clover Hill Rd., Hollis 7, L. I., N. Y.

Midwest Division
FLOYD E. NORWINE, JR.....W9EFC
7405 Hlawatha Ave., Richmond Heights 17, Mo.

New England Division
PERCY C. NOBLE.....W1BVR
37 Broad St., Westfield, Mass.
Alternate: Clayton C. Gordon.....W1HRC
70 Columbia Ave., Warwick, R. I.

Northwestern Division
KARL W. WEINGARTEN.....W7BG
3219 N. 24th St., Tacoma 7, Wash.
Alternate: R. Rex Roberts.....W7CFY
110 W. Brennan St., Glendive, Mont.

Pacific Division
J. L. McCARGAR.....W6EY
66 Hamilton Pl., Oakland 12, Calif.
Alternate: Elbert J. Amarantes.....W6FBW
1675 Dale Ave., San Jose, Calif.

Roanoke Division
H. L. CAVENESS.....W4DW
2607 Vanderbilt Ave., Raleigh, N. C.
Alternate: J. Frank Key.....W3ZA
Box 707, Buena Vista, Va.

Rocky Mountain Division
C. RAYMOND STEDMAN.....W9CAA
925 So. Gaylord St., Denver 9, Colo.
Alternate: Willard C. Wright.....W9BQO
2641 S. Race St., Denver 10, Colo.

Southeastern Division
WILLIAM C. SHELTON.....W4ASR
327 Revillo Blvd., Daytona Beach, Fla.
Alternate: William P. Sides.....W4AUP
Fleming Road, Montgomery, Ala.

Southwestern Division
JOHN E. BICKEL.....W6BKY
1834 E. Whittier Blvd., Whittier, Calif.
Alternate: Eldridge E. Wyatt, Jr.....W6ARW
P. O. Box 3597, Long Beach 3, Calif.

West Gulf Division
WAYLAND M. GROVES.....W6NW
Box 1314, Seagraves, Texas
Alternate: Jennings R. Poston.....W5AJ
Box 246, Mabank, Texas

"IT SEEMS TO US—"

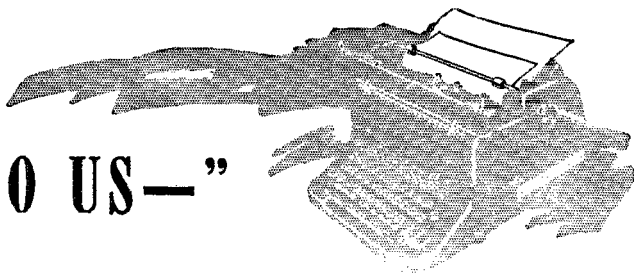

A SHINING EXAMPLE

THE death of C. Stuart Ballantine a few weeks ago has deprived the radio art of one of its most brilliant minds and of a uniquely colorful personality. Beginning as a Philadelphia amateur in 1908, at the age of ten, he is probably best known to older amateurs as the author of the famous 1922 textbook, "Radio Telephony for Amateurs." He was much more than that, however: he was a pioneer amateur who became a radio engineer, physicist and scholar, who made many notable contributions to our art, and whose abilities were recognized and honored by numerous learned societies with fellowships and gold medals. He was a shining example of what amateur experience can mean in our science. As he was in some ways the product of the last war, so we may expect that other amateurs, coming out of this one, will follow his footsteps and similarly enrich the art.

The radio world is filled with Ballantine anecdote. Among his other characteristics, he was a mathematical fireball. We remember an engineering conference of government departments which we attended at the Bureau of Standards one winter night during the last war as an observer for the Air Corps. The subject was loop antennas or radio compasses, a field in which Ballantine had done considerable work as a civilian expert for the Navy. To most of us it was still a fairly mysterious subject. One of the speakers in the course of his remarks derived on the blackboard a simple formula for the voltage induced in a coil aerial, showing it to be proportional to the number of turns and inversely proportional to the wavelength. When discussion was called for, Ballantine arose and said that that was interesting enough as a first approximation but that one might as well be accurate about it and that there were several other factors that ought to be taken into consideration. For instance, there was that bogey, "antenna effect." He explained it and, grabbing chalk, added a term to the formula to account for it. (Indeed, he invented a device to eliminate it.) Then there was the little matter of so-and-so, and the additional question of this-and-that, and the problem of thus-and-so. As fast as he could talk and write he made additions to that formula, until it stretched halfway across the room and its own grandmother couldn't have recognized it. He

did it all out of sheer understanding of the problem, without reference to notes, and was done and back in his chair in two minutes. The effect was slightly devastating. There was no one qualified to argue with the twenty-year-old mathematical physicist and the only sound we can remember was the noise of furious scribbling in many notebooks. But for months to come that awe-inspiring demonstration of ease with difficult mathematics was to be enviously spoken of by those who had witnessed it.

We have before us, as we write, an old exchange of correspondence with Ballantine twenty-five years ago, after we had become the editor of *QST* and he was in private practice as a communication engineer. We wrote him asking that he be good enough to suggest how many turns we should put on our eight-foot loop in order to be able to receive NAA. To make his answer easy we enclosed a memorandum reply in which he had only to insert the magic figure. Instead, he wrote us a three-page letter in which he derived eight numbered formulas and to which he attached a family of curves containing twenty-five calculated datum points. Pure Ballantine!

He realized one of his ambitions when he brought out his textbook for amateurs in 1922. It was a practical book and, despite his flair for math, it contained no formulas beyond some simple algebra in its chapter on principles. It was a "how-many-turns" book, and so far as we can now recall it was the first text for amateurs that had been published since the war. Although it seems naïve and even occasionally inaccurate upon inspection today, it was hailed as a very potent help in those days and many amateurs accomplished their transition from spark to c.w. with its aid. Those were 200-meter days, remember, and every amateur used a Marconi or grounded antenna and strove for the greatest possible antenna current. One of the things which Ballantine emphasized heavily was the desirability of working the antenna at its fundamental wavelength or even less, regardless of the effect on antenna current. "In a well-designed antenna," he said, "the undesirable losses remain practically constant from the fundamental wavelength to a wavelength two or three times this and the ratio of the useful loss (radiation) to the total power supplied is greatest at the fundamental wavelength.

Hence this is the wavelength at which best radiation takes place, and should be selected for transmitting. It will usually be necessary to insert in the antenna a load coil for the purpose of coupling the power circuit to it, but this should be kept as small as possible and its effect in raising the wavelength above the fundamental may be compensated for by inserting a series condenser having low losses. The fundamental wavelength is not the wavelength at which maximum current will be secured, but at which maximum I^2R_a (R_a = radiation resistance) is obtained. The operator is warned therefore not to be deceived by the antenna ammeter reading in estimating how well his station is radiating; this tells only a part of the story." Driving home that lesson was, we think, Ballantine's greatest contribution to amateur technique.

Any amateur who was actively practising at that time will have particularly vivid memories of the period. The previous winter, Phelps and Conrad and Ramsey had started three-cornered experiments in which they dropped their wavelengths in steps from 200 meters to 100 and obtained progressively better results. It was suspected that there was something about the shorter wavelength that made it get out better. Yet here was Ballantine telling us, quite correctly, that if we would get away from loaded antennas at 220 meters and drop to the fundamental or below, we would radiate better because of the improved radiation resistance. Radiation resistance or superior inherent characteristic — which was it? It was a confused period and it was to be quite a while before we knew much of the answer. Indeed, by the time the answer was apparent we had gone to Hertzian antennas and stopped worrying about how to jack up radiation resistance. But then it was of tremendous importance, and he was the first to show the way.

Stuart Ballantine was an amateur who grew up during the last war. The tremendous stimulus which our whole art experienced because of military needs gave him the chance both to contribute and to learn more. He is gone now but the same mechanism is at work again. Out of the laboratories of this war there are certain to come innumerable young amateurs who, contributing much, have also learned more, and who have that spark that will surely result in rich additions to our art in the next few years to come. We move into new fields of knowledge, new techniques on higher frequencies that inescapably introduce new and puzzling phenomena. These will be the world of the young Ballantines of the near future, the amateurs of enriched wartime experience who will be our technical leaders, tomorrow. We may be confident that, as surely as there are questions and problems, they will have the answers and solutions and will again be able to point the way to an expanding realization of radio's endless potentialities.

PUBLICITY

DESPITE the old saying, to our mind there are two kinds of publicity about amateur radio. At Headquarters we are more or less succeeding in the affirmative job of planting favorable publicity for the amateur around the country. The other kind crops up occasionally here and there through some mischance, frequently as a misquote of a public official by a green wartime reporter. It requires a quick application of rotenone dust or bordeaux mixture before it spreads. While we keep the dust gun filled and the sprayer pumped up, you can help amateur radio by bringing such cases to our attention — fast, so that we can start combating them without delay. And thanks for your assistance.

K. B. W.

★ SPLATTER ★

OUR COVER

SOMBER now under its achromatic coat of blue-gray war paint, the shield of the U. S. Maritime Service yet rides proudly on the main stack as the Liberty ship it adorns sails in serene majesty over a placid sea.

This Liberty ship is, of course, the *American Mariner* — the USMS training vessel further pictured and otherwise described in the following pages. Apart from the Maritime Service shield, visible in this starboard view of the flying bridge are the radio d/f loop, an elevated cabinet containing meteorological instruments (with lattice front), gun platforms, signal flags flying on their halyard, and the foremast with the lookout's crow's-nest just under the "u" in "amateur."

FOOTNOTES

THAT off our chests, we now present the five new authors making their initial *QST* appearance in this issue — simultaneously revealing their carefully edited and expurgated personal histories, as taken from the voluminous *dossiers* collected by our own G-2.

Athán Cosmas (p. 32) has been a licensed ham operator for two years, beginning in 1926. No, that's not a misprint. He got his first ham operator ticket in 1926, allowed it to lapse after a year, and didn't get another until 1943. Most of the intervening years were spent traveling around the world as a commercial brasspounder. He recalls, nostalgically, an early contact with the marvels of high-frequency radio on the China Coast when a couple of Dollar Line hams established the first — and perhaps the last — five-meter-cigar-box-battery-powered-two-way *jinrikisha* communication system. Now on the engineering

(Continued on page 104)



QST Cruises with the Maritime Service

Life Aboard a Liberty Ship

BY CLINTON B. DESOTO,* WICBD

ARE you between 16 and 17½ or between 26 and 35 and not in uniform? Are you 1-C or mildly 4-F or otherwise ineligible for military service? Are you interested in a radio operating job in direct support of the war effort?

Then there's a place for you in the U. S. Maritime Service. If you hold a commercial radiotelegraph second or higher-grade license, so much the better. But you don't need a ticket to start with; in fact, you don't need any previous radio training whatsoever. The Maritime Service will train you. It will make a proficient merchant marine radio operator out of you at one of the nation's finest operator schools — *with pay!* 

This is an opportunity described several times before in *QST*. It is time now for the story to be told again. For today the merchant marine is in greater need of men — and particularly of radiomen — than ever before.

You may have read recently that U. S. production of merchant shipping is being raised to new highs, with ever-increasing numbers of new bottoms leaving the ways daily. These ships are needed to carry the gargantuan cargoes of global warfare.

But ships alone don't move cargoes; it takes men to make the ships move — seamen, carpenters, oilers, cooks, enginemen, machinists and, particularly, radiomen.

Yes — particularly radiomen. Effective July 1st, new regulations require practically every merchant vessel sailing the seas to carry not less than three qualified radio operators. Up to now, such ships had only one or two operators aboard. This requirement alone has more than doubled the number of civilian radio operators needed to man the merchant fleets. Coupled with the increasing number of ships being commissioned and the usual quota of replacements, the demand for new operators is tremendous.

*Editor, *QST*.

So tremendous, in fact, that right now there simply aren't enough qualified men available to meet it. Even by lowering the license requirements — even by taking men out of the training schools before they have completed their courses and sending them to sea, letting them acquire the remainder of their training by apprentice methods — still the WSA manning offices are having difficulty keeping the operator berths filled.

The Maritime Service, although a highly essential part of the nation's war machine, obtains its manpower not from selective service quotas but through direct recruiting. Merchant mariners aren't drafted; they are volunteers.

Right now, therefore, the War Shipping Administration is asking for more volunteers. But it isn't the usual kind of arduous and difficult volunteering assignment they offer — not unless taking one of the country's finest radio training courses under ideal conditions and being paid while in training is difficult, or unless living and working on shipboard at \$180 a month or more and all found is arduous!

Earlier issues of *QST* have presented a picture of the kind of radio operator training given by the U. S. Maritime Service.¹ There's no need to repeat the details of that side of it here. The purpose of this story is to show, as viewed through landlubberly eyes, the other side of the picture — the kind of life that is led on shipboard. It's the side of the story that comes after the fledgling radio operator has finished his training at the shore station and, crisp new ticket in hand, steps over the rail into his first seagoing berth.

¹ Rodimon, "QST, Visits Gallups Island," *QST*, June, 1941, p. 9. DeSoto, "QST Returns to Gallups Island," *QST*, May, 1943, p. 14.

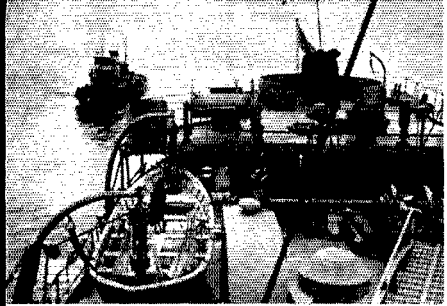

Shown on this page are miscellaneous views aboard the *American Mariner* as recorded by W9AA's persistently snapping "minnie" camera.

Above — Looking out over the stern, the first of two tugboats which haul the big and, at close quarters, unwieldy freighter into the channel is seen puffing up to Pier 73 through the river mist.



Left — As the tug comes alongside the deck crew prepares to cast off, hauls aboard the mooring lines. *Above* — Framed in the mechanistic circle of the d/f loop, the receding Empire State building appears as a lonely vestige of shore life.

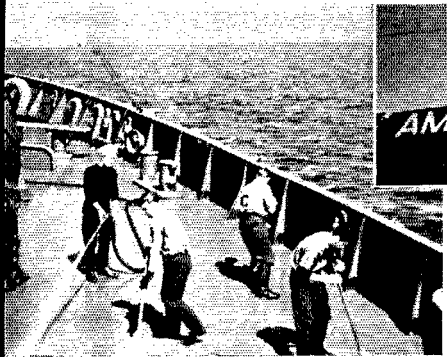

Left — The signal flags flying from their halyard and the ship's name emblazoned on the main cabin both mean the same thing — identification. The signal flags display the assigned code identification of the ship for the benefit of harbor and coastal patrols.

Left — This picture illustrates the kind of work that a radio operator on shipboard does not do. But swabbing isn't bad duty, at that! *Right* — This view from the stern, looking forward on the main deck, suggests the complexity of the gear and fittings which are required aboard a 10,000-ton freighter.

Right — Here again, looking aft on the main deck from the bow, the elaborate multiplicity of detail is apparent. Behind the row of windows is the wheelhouse on the bridge deck, with the boat deck below and the flying bridge above. Hooded objects in this and in other views are guns.

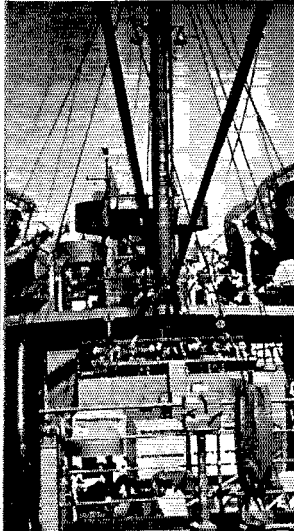
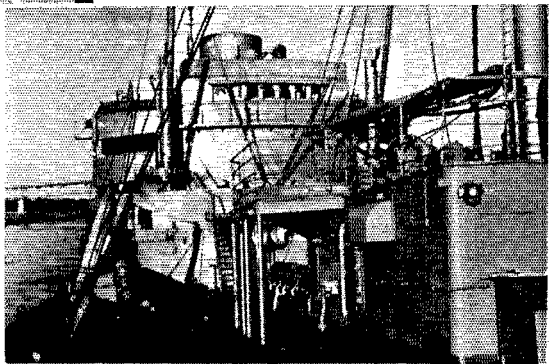

**Left* — From his vantage point under the ship's bell a "talker" keeps a sharp early-morning look out passing through the Cape Cod ship canal. *Below* — A trainee takes a pelorus reading on a distant landmark on shore. Partially concealed behind him is the radio d/f loop. *Right* — Pictorial shot of a ventilator, lifeboat davits, a gun platform, the main stack, and the open sea.

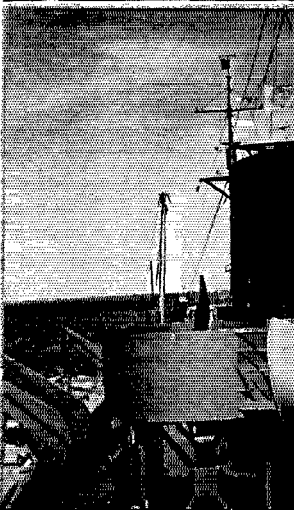
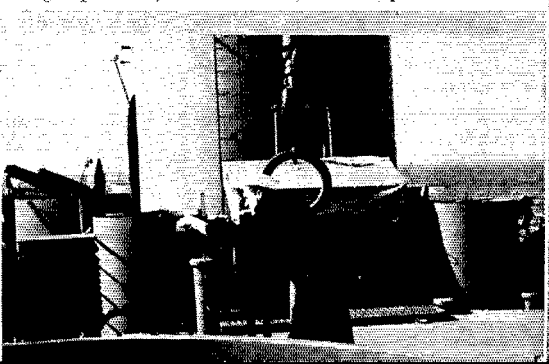

That story is told here at first hand — from actual, if brief, personal experience. At the invitation of the War Shipping Administration, Cy Read, W9AA, and the writer shipped on the USMS training ship *American Mariner* out of New York in middle May. Aboard her we lived the life of the regular crew — sleeping in the triple-decker bunks of the seamen, standing in the chow line in the crew's mess.

The *American Mariner* is a Liberty ship — a 10,000-ton 440-foot freighter of the kind now cruising the sea lanes of the world by the hundreds. Instead of munitions or GI provisions, however, her usual cargo is men. Aboard her trainees from Sheepshead Bay and from Gallups Island and the other USMS training stations make training voyages as a preview of life at sea — the culminating phase of their training.

For this purpose her superstructure has been somewhat modified and the cargo holds have been converted into classrooms, additional quarters and messrooms for the trainees. While the normal crew on a Liberty ship numbers 68, the *American Mariner* has a permanent complement of 138 men. On the shakedown cruises as many as 400 trainees can be accommodated aboard — quartered, fed, and given a thorough dose of actual shipboard experience.

Embarkation

The early morning air was clammy and chill along the New York waterfront when we embarked, presaging an unseasonal late-May frost that was to blacken New England Victory gardens. Mist lay low and gray over the East River as the armed guard passed us through the iron-barred gate to Pier 73.

We clambered up the sharply slanted gang-plank to the deck. There the master-at-arms checked our credentials, logged us aboard, and handed us a key ring with two keys and a numbered metal tag. Then, trailing a petty officer assigned as our guide, we filed down a complicated series of companionways into what seemed the bowels of the ship — an intricate maze that resolved itself into a memorizable pattern only hours later.

That, in fact, was the most striking initial impression of the interior of the ship. So complex is its arrangement — with every foot of space utilized, the whole divided into innumerable interlocking compartments any one or all of

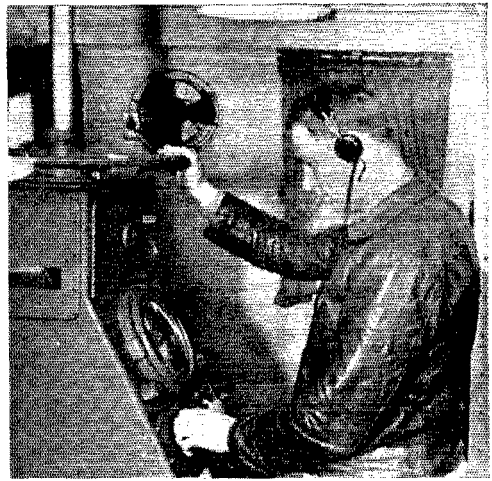

The navigating officer takes a directional bearing on the radio direction-finder. One hand operates the hand-wheel controlling the rotatable d/f loop above the deck while the other adjusts the magnetic balance control.

which can be isolated by "W.T." (watertight) doors — that learning one's way around is an habituating process resembling orienting oneself in a strange community.

Arriving at the trainee's quarters, we were assigned lockers and given our choice of bunks — "sacks" or "bags" on shipboard. There was ample space, we found, for all wardrobe and personal effects in the 6-foot lockers, which include a separate locked compartment for stowage of valuables.

Our gear stowed, we traced our way back up to the main deck. The deck crew was making preparations for shoving off. Near the stern, booms and winches transferred boxes of supplies from the dock to the dry-cargo hold. Trainees dressed in work dungarees which evidenced the toil their wearers already had performed at the training stations scurried around the ship — stowing cargo, coiling lines, arranging gear, and carrying assorted buckets of white and red and the ubiquitous blue-gray paint which covers all of the visible exterior of the ship.

Industrious though they were, some of the trainees were not unwilling to pause for a moment's rag-chew. Many had never been to sea before. To most of them, we learned, the ship was

Inside the radio room aboard the Liberty ship. Both side-by-side operating positions are shown in these two views. At the left end of the operating table is the high-frequency transmitter, with the low-frequency transmitter and the emergency set (visible only in the right-hand view) beside it. The auto alarm is on the bulkhead beside the telephone.

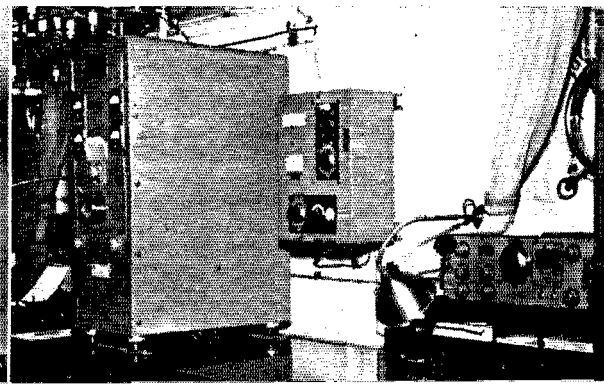

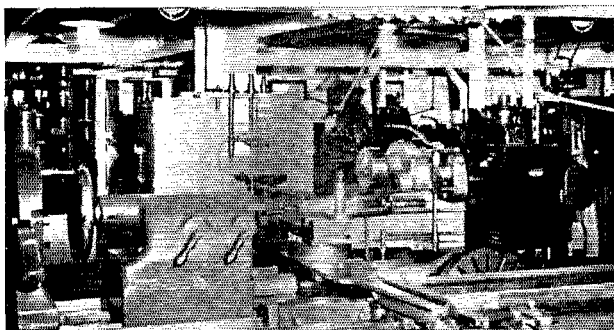

Deep below-decks is a large and magnificently equipped machine shop capable of producing any repair part required on shipboard.

an unexplored novelty. Some of them had never before been aboard an ocean-going vessel of any kind, much less a Liberty ship. The majority — as we already knew from recruiting statistics — were dry-land recruits having their first taste of salt water.

To them this was the Great Adventure — or the first leg of it, at least. There was the red-checked railroad fireman from Ohio, filled with pride at the edge his shore trade gave him over his mates in the engine room — a pride undimmed by a subsequent slight seasickness. There was the filling-station attendant from New Jersey whose erstwhile ambition to be a garage mechanic had faded in the light of a new love — a 20-mm. antiaircraft gun. There was the well-bred, likeable lad from Pennsylvania who was wholly content in the menial rôle of wardroom attendant. And there was the tough kid from South Chicago who wrestled cargo all the more vigorously while growling about how hard he had to sweat.

Sailing Time

Overhead the sky began to lighten. Gradually the mist rolled back along the river. By two bells (0900) there was enough light for a Weston reading of 25 on W9AA's light meter. From then on the day brightened rapidly — a full stop every few minutes.

At 0950 a rope ladder was lowered and the harbor pilot climbed aboard. Soon a tugboat came puffing down the harbor. It veered sharply and pulled alongside near our bow, and a weighted line called a "heaving line" was tossed aboard. This line was bent to a heavy hawser. The deck crew pulled up the hawser and made its huge eye fast to a deck bitt. A few minutes later a second tugboat, churning up from the lower harbor, plowed over to Pier 73 at the head of an iridescent path of wake.

The next twenty minutes were filled with the mysterious maneuverings characteristic of tugboats and harbor pilots, always inexplicable to the landsman. Finally, as though all the preliminary false starts, shifting of hook-ups and backings and fillings had been only to kill time, the tugs eased the big ship out into the channel and headed her upstream. The engine-room telegraph clanged cheerily; the big triple-expansion steam engine

engaged the 200-foot propeller drive shaft located in the shaft alley deep down near the keel, and we got under way.

One tugboat scuttled off to another job. The other, captained by a one-armed salt with Popeye cap and pipe, convoyed us up the river, chugging along near our stern like a happy puppy at heel. Farther up the river, where the channel narrows, the tug came up amidships on the port side and a hawser again was fed up to our main deck. Thereafter the tug, its own propeller idle, caught a free ride snuggled against our hull — serving as a sea anchor against the

pull of the outgoing tide until we had passed through the Narrows.

A Seagoing Community

It was time now to get acquainted with our temporary new home afloat. We explored the ship from stem to stern — a proceeding occupying the remainder of the day.

By comparison with shore-borne structures, the ship could be described as a combination warehouse and office building seven stories high. The main deck is, of course, the largest; those below become narrower and shorter with the taper of the ship's hull, while those above are stepped back like the upper stories of a skyscraper.

Under the main deck are several huge cargo compartments, the fuel and fresh-water tanks, engine room, canteen, trainees' quarters, mess-rooms, kitchens, etc. Above the main deck rise, in order, the boat deck, the bridge deck, and the flying bridge — the "roof" of the ship.

Distributed throughout the enclosed portions of these upper decks are the quarters and mess-rooms for the officers and permanent crew. There are four classifications of quarters on the ship — apart, of course, from those of the captain, who occupies private quarters. The officers have individual private rooms, the CPOs (chief petty officers) have smaller single rooms, the ratings (specialists 1st, 2nd and 3rd class) are quartered in groups of two to four to a room, and the seamen — ordinary and AB (able-bodied) — occupy triple-tier bunks stacked two wide and three deep. These bunks are basically iron-tube frames from which flat springs and mattresses are slung.

Members of the radio crew aboard a Liberty ship, incidentally, have private quarters of their own. The chief ordinarily has a room adjacent to the radio shack up on the boat deck — just down the passageway from the captain's quarters, in fact. The other two operators usually share a comfortable room in the section assigned to "ratings."

Housed on the main deck is the varied miscellany of other establishments required in a self-sufficient seagoing community. There is a row of general offices for the extensive administrative and paper work required — including a separate mimeograph room. There are the sick bay, the



Above — "Abandon ship!" As the ship's whistle screams the danger signal in shrill urgency, all hands instantly drop work and run to their lifeboat stations.

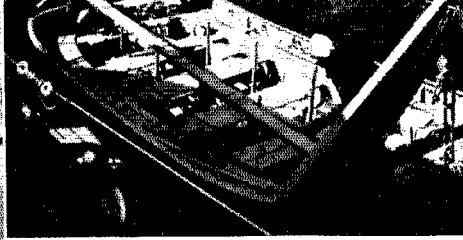

Left — Following a carefully organized plan, two men remove the covering from their boat while it is still in davits. *Right* — Working swiftly, they clear the boat for action.

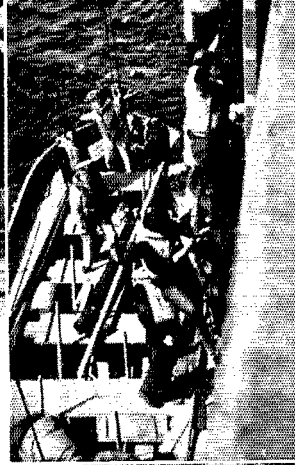

Above, left — Meanwhile their shipmates all have assembled at their respective lifeboat stations. The officer in charge calls the roll to make certain that no one gets left behind. *Above, center* — Hoistmen lower the boat from its davits until it is almost in the water. Bulky in their life preservers, the men go over the side. *Right* — Leather-lunged officers hurrying them on, the trainees swarm down the scramble nets into the boat.

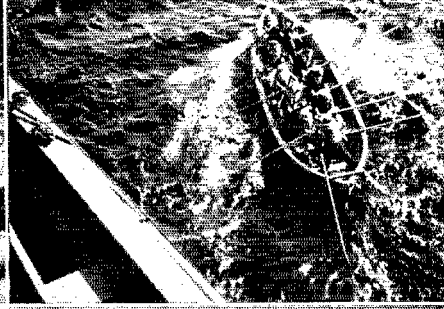
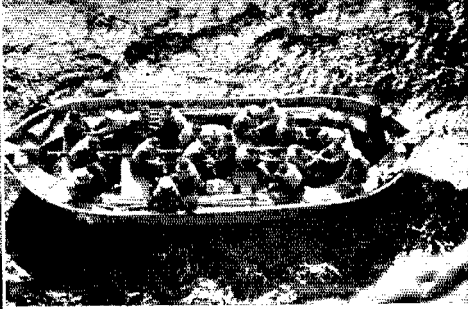
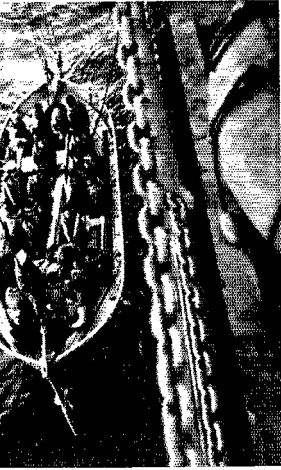

Left — The lifeboat remains suspended with its keel just above the waves until all are aboard. *Above* — In the Lundeen boat, the scamen vigorously pump the handles which drive the screw propeller. *Right, above* — With equal vigor, their mates in an older type of boat pull their oars.

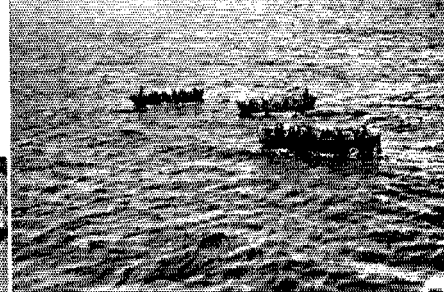

Below — It was only a practice drill, after all. At the "Return to Ship" signal the boats head for the ship. *Right* — The boat is hoisted level with the main deck and grinning trainees disembark.

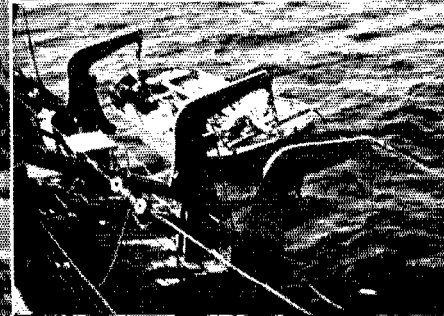
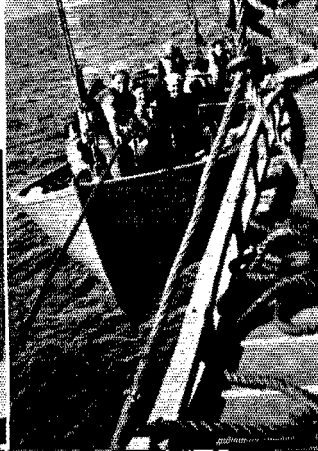

doctor's and dentist's offices and laboratories, a photographic darkroom, a barber shop (haircuts 25 cents), a tailor shop and a cobbler's shop (no shines!). There is even a spacious auditorium where recreational activities are centered — feature-length movies being shown every night. Also in the line of recreation, space for athletic sports activities is provided in the hold for pingpong tables, a boxing arena and even a basketball court.

Forward on the bridge deck is the wheel house, with its large windows, windshield-wiper equipped, facing toward the bow. There the wheelsman on watch manipulates a large central steering wheel which, through a hydraulic system, controls the main steering engine — a small reversible steam engine in the stern whose spider-leg connecting rods actuate the huge spring-balanced quadrant gear on the rudder post through step-down gears. Alongside the wheelsman, a standby helmsman is also on watch at a smaller auxiliary wheel. This wheel controls an electric motor which can replace the hydraulic control. While this auxiliary system may be used manually if the hydraulic system fails, the electric rudder drive also connects to the "iron mike" or automatic pilot. In conjunction with the indicating gyrocompass it can be used to steer the ship fully automatically, keeping her headed exactly on any predetermined course.

The instrumentation on a Liberty ship is elaborate and comprehensive. Apart from the gyrocompass and the usual magnetic compasses, peloruses and other devices commonly associated with maritime navigation, there are ink-graphic recorders maintaining continuous records of data ranging from engine r.p.m. to depth soundings. Even the ocean temperature is recorded, and a complete outfit of meteorological instruments is provided in a cabinet on the flying bridge.

In the wheelhouse a large pigeon-holed rack holds a complete set of international signaling flags, all neatly rolled and ticketed. In addition to the helmsman and his alternate, this room normally is occupied by a petty officer in charge of the wheel detail and, of course, the ship's officer on watch. Also present is a "talker" — a seaman

equipped with headphones and breast-mike connected to an interphone circuit which links the bridge, the crow's nest, and all gun positions. There are talkers constantly on duty at each of these positions while the ship is under way.

In addition to the interphone system, two other methods of intra-shipboard communication are provided. One is a regular magneto-ringing wall-type telephone circuit, with "subscriber's" positions liberally distributed throughout the ship including several convenient points on deck. The other is a general loudspeaker call system used to announce general orders, ship's time, mess calls, watch changes and the like. Speakers attached to this system infest the ship from the holds to the flying bridge, including the wardroom and all messrooms, ensuring that no hand aboard can fail to hear an order.

Directly aft of the wheelhouse is the navigator's domain. Here the radiocompass installation is located, its d/f loop projecting up into the open overhead on the flying bridge. In this room also are additional recording instruments and the control board for the degaussing system. A large switch- and meter-panel is required for the degaussing apparatus alone. In a smaller adjacent room is located the fire-protection control equipment — an intricate arrangement incorporating two complete thermally operated automatic systems and the associated manual controls.

The protective equipment provided is impressive in its scope and comprehensiveness. Coupled with the extensive compartmentation, the fire-protection systems make it possible for a ship to suffer incredible damage and still remain afloat. Tales are told of freighters which have suffered two or three direct torpedo hits, with holes below the waterline big enough to drive a car through, and yet have sailed back across the Atlantic under their own power.

Further aft, still other separate rooms are used for specialized functions — among them the chart-storage room, the hydro room and, of course, the radio room.

The Radio Shack

The most notable impression on an initial viewing of the radio shack is one of neatness, convenience and comfort. Compactly arranged, as is everything aboard a Liberty ship, all units —

(Continued on page 94)



If the smiling faces above seem incongruous in view of the evident fact that there's morning chow on the table, the explanation lies in the excellent fare served aboard all merchant craft. *Right* — Service is cafeteria style, direct from cooking utensil to plate, around the rim of the clean and efficiently arranged galley.



A WERS Control Station Receiver

A Simple Superhet of Medium Selectivity

BY FRANK HEUBNER*

In large cities and in other localities where communities are closely grouped, often considerable difficulty is experienced from interference with reception of stations in the local net by signals from stations in neighboring nets whose assigned frequencies are close to the local frequency. Under such circumstances the usual type of superregenerative receiver falls down badly. In this article the author describes a simple superheterodyne receiver which has sufficient selectivity to eliminate most troubles of this nature, yet which does not discriminate too greatly against signals from simple modulated-oscillator transmitters.

SINCE the start of WERS in the Manhattan section of New York City, our control station has experienced various types of trouble in reception. Strange as it may seem, the basic difficulty was caused neither by equipment failure nor by the lack of experienced operators. Much of it was attributable to our favorable location (18 stories above ground), which is so excellent that signals from stations in other nets throughout adjoining localities often are stronger than those from some of our own local net stations. Under these conditions a superregenerative receiver proved to be almost useless as a control-station receiver, not only because of its poor inherent selectivity but also because of the tendency of a receiver of this type to shift frequency and lock in with a strong adjacent-channel signal.

In an attempt to improve the situation, a resistance-coupled superheterodyne using a 954 r.f. stage and a 954 autodyne converter was first tried. This receiver proved to be a little more selective than the superregen, but the particular model used required two tuning controls. In addition, adjustment of the regeneration control changed the calibration so much that frequency checks could not be made unless an experienced operator were handling the receiver. Noise from ignition and local motors also was high.

Goodman's superheterodyne¹ using an 1852 mixer was built next. While it was more selective, it did not seem to be so sensitive to weak signals as some of its predecessors. A 7A4 mixer, similar

to that described by Grammer,² was found to be even less sensitive than the 1852. Hull's original superinfragenerator receiver, described in *QST* for November, 1935,³ was studied, but it was felt that the selectivity would be too great for satisfactory reception of signals from most of our stations which employ modulated oscillators. In reviewing the material on receivers for v.h.f. which has appeared during the past ten years, finally we ran across the description of a converter circuit in the July, 1940, issue of *QST*⁴ which looked good. By stealing a few features here and there from the other receivers mentioned and adding a high-gain i.f. stage, the receiver shown in the photograph below was developed.

Our tests indicate that this receiver is more sensitive and selective than any we have tried to date. Any appreciable additional increase in selectivity would make it unsatisfactory for the reception of signals from modulated oscillators. There is no noticeable radiation from the receiver at 112 Mc., and the single-dial tuning control is a great advantage. After the receiver has been in operation for 15 minutes the calibration holds remarkably constant. Other state nets still cause some QRM when they are exactly on our frequency, but they do not take control of the receiver out of the operator's hands. This receiver also takes the kick out of badly overmodulated signals. They do not sound half so powerful as on a superregenerative receiver and therefore cause much less trouble. Our own stations have become accustomed to the fact that they can get

² Grammer, "More Selectivity in WERS Reception," *QST*, September, 1943, p. 17.

³ Hull, "A New Receiving System for the Ultra-High Frequencies," *QST*, November, 1935, p. 10.

⁴ Rehm, "An Acorn-Tube 112-Mc. Converter," *QST*, July, 1940, p. 41.

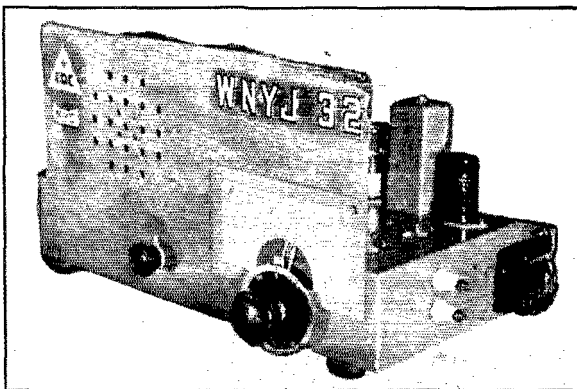

Panel view of the 112-Mc. superheterodyne receiver for WERS use, showing the calibrated tuning dial and audio volume control.

* 10 Park Terrace East, New York, N. Y.

¹ Goodman, "Receivers for 112-Mc. Emergency Work," *QST*, January, 1942, p. 18.

through to the control station in fine shape with less modulation.

The final circuit arrangement is shown in Fig. 1. The 955 mixer tunes from 112 to 116 Mc., while the h.f. oscillator, in which a second 955 is used, tunes from 91 to 95 Mc. The tuning condensers of these two circuits are ganged. The 1852 i.f. amplifier and the 6J5 superregenerative detector are tuned to 21 Mc. Transformer coupling is used between the detector and the 6J5 first audio stage. The output tube which feeds the speaker is resistance coupled to the preceding stage. The power supply is a simple choke-input affair with a VR-105-30 regulator tube controlling the plate voltage of the h.f. oscillator and mixer stages. R_9 is the detector superregeneration control, and R_{11} is the audio volume control.

Construction

This receiver is not difficult to build and get into operation. Most of the constructional details are apparent from the photographs. The chassis

measures $3 \times 7 \times 15$ inches. All components of the v.h.f. circuits, including the tubes, are mounted underneath the chassis. In the bottom-view photograph, the double-section tuning condenser, C_1C_2 , is mounted near the top. Each section of the original condenser consisted of two rotor plates and one stator, giving a maximum capacity of $10 \mu\text{fd.}$ per section. By removing one rotor plate in each section and double-spacing the stator, sufficient reduction in tuning rate was obtained to spread the 112- to 116-Mc. band over 110 degrees on the dial. If this much bandsread is not desired, the stator plates need not be double-spaced.

Immediately above the tuning condensers are the two acorn tubes, with the oscillator tube nearer the panel. The self-supporting mixer and oscillator coils, L_2 and L_3 , are mounted at right angles to each other and soldered to their respective condenser terminals.

The 1852 i.f. tube is mounted on top of the chassis in the rear right-hand corner. The first

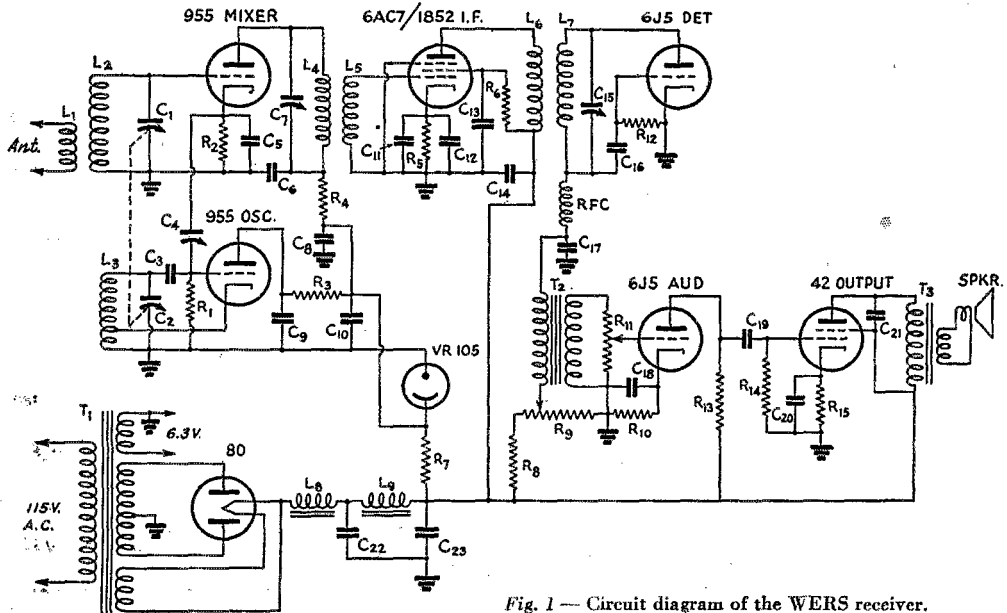

Fig. 1 — Circuit diagram of the WERS receiver.

C_1, C_2 — $10\text{-}\mu\text{fd.}$ modified midget variable (see text).
 C_3, C_6, C_{16} — $100\text{-}\mu\text{fd.}$ midget mica.
 C_4, C_7, C_{15} — $3\text{-}30\text{-}\mu\text{fd.}$ trimmer.
 C_5 — $50\text{-}\mu\text{fd.}$ midget mica.
 C_8, C_{10}, C_{17} — $0.001\text{-}\mu\text{fd.}$ midget mica.
 C_9 — $500\text{-}\mu\text{fd.}$ midget mica.
 C_{11} — $0.002\text{-}\mu\text{fd.}$ midget mica.
 C_{12}, C_{13}, C_{14} — $0.01\text{-}\mu\text{fd.}$ 400-volt paper.
 C_{18}, C_{20} — $25\text{-}\mu\text{fd.}$ 25-volt electrolytic.
 C_{19} — $0.05\text{-}\mu\text{fd.}$ 400-volt paper.
 C_{21} — $0.002\text{-}\mu\text{fd.}$ 400-volt paper.
 C_{22}, C_{23} — $3\text{-}\mu\text{fd.}$ 450-volt electrolytic.
 R_1 — $20,000$ ohms, $\frac{1}{2}$ watt.
 R_2, R_3, R_4 — $10,000$ ohms, $\frac{1}{2}$ watt.

R_5 — 200 ohms, $\frac{1}{2}$ watt.
 R_6 — $60,000$ ohms, $\frac{1}{2}$ watt.
 R_7 — 7000 ohms, 10 watts.
 R_8 — $250,000$ ohms, 1 watt.
 R_9 — $75,000\text{-ohm}$ wire-wound potentiometer.
 R_{10} — 2000 ohms, 1 watt.
 R_{11} — 0.5-megohm volume control.
 R_{12} — 2 megohms, $\frac{1}{2}$ watt.
 R_{13} — $50,000$ ohms, 1 watt.
 R_{14} — 0.5 megohm, $\frac{1}{2}$ watt.
 R_{15} — 500 ohms, 1 watt.
 L_1 — 4 turns No. 20 hook-up wire, $\frac{1}{2}$ -inch diameter.
 L_2 — 8 turns No. 12, $\frac{1}{2}$ -inch diameter, $1\frac{1}{4}$ inches long.
 L_3 — 5 turns No. 12, $\frac{1}{2}$ -inch diameter, $\frac{5}{8}$ inch long, tapped 2 turns above ground.

L_4 — 12 turns No. 18, $\frac{3}{4}$ -inch diameter, close-wound.
 L_5 — Same as L_4 , spaced $3/16$ inch away from L_4 on same polystyrene form.
 L_6 — 10 turns No. 18, $\frac{3}{4}$ -inch diameter, close-wound.
 L_7 — 15 turns No. 18, $\frac{3}{4}$ -inch diameter, close-wound, spaced $\frac{1}{2}$ inch away from L_5 on same polystyrene form.
 L_8, L_9 — 20-henry filter choke.
 T_1 — Power transformer, 700 volts, c.t., at 60 ma., with 5-volt rectifier-filament and 6.3-volt heater windings.
 T_2 — Interstage audio transformer.
 T_3 — Pentode output-matching transformer.
RFC — 2.5-mh. r.f. choke.

i.f. transformer is composed of two coils, L_4L_5 in Fig. 1, wound on a polystyrene form $\frac{3}{4}$ inch in diameter. It is placed underneath the chassis as close as possible to the submounted 1852 socket and at right angles to L_2 and L_3 . No shielding of these windings, other than that provided by the chassis, is necessary.

The second i.f. transformer, L_6L_7 , is made in a similar manner and is mounted in the shield can on top of the chassis to the left of the 1852. The i.f. tuning condenser, C_{15} , also is mounted inside the shield in such a position that it can be adjusted by means of a screwdriver inserted in a hole in the top of the can. The plate lead of the 1852 should be as short as possible and well shielded to prevent regeneration in this stage. All r.f. ground connections for the i.f. amplifier are brought to a single point on the metal ring by which the socket is fastened to the chassis. Particular care also should be exercised in grounding the can shielding the second i.f. transformer.

The 6J5 superregenerative detector is placed to the left of the second i.f. transformer. The two audio tubes are in line in front of the detector tube. The audio transformer, T_2 , had to be mounted outside the chassis at the right-hand end because it picked up hum in any other position. If a shielded transformer had been available, it is probable that this trouble would not have been encountered.

The regeneration control, R_9 , is fastened underneath the chassis, since it does not require attention once it has been adjusted for proper operation of the detector. The audio volume control, R_{11} , is the only control aside from the tuning dial which appears on the panel.

Power-supply components are placed at the left-hand end of the chassis, both above deck and below. The speaker is mounted at the left-hand end of the panel where a screen of $\frac{3}{8}$ -inch holes has been drilled. A pair of feed-through insulators at the right-hand end of the chassis serves as the antenna terminals. Half-inch rubber feet are fastened to the bottom edges of the chassis to raise it slightly to provide clearance for the tuning knob.

When the receiver was first placed in operation the grid of the 1852 was tapped down four turns on L_5 , which was tuned with a trimmer condenser. L_4 and L_5 were spaced $\frac{3}{4}$ inch apart. While crystal-controlled signals came through perfectly with this arrangement, the selectivity was too great for satisfactory reception from modulated-oscillator transmitters. As a result, the tuning condenser across L_5 was removed, the grid of the 1852 was moved to the top of the coil, and the distance between L_4 and L_5 was reduced. These changes provided some increase in gain as well as the desired reduction in selectivity.

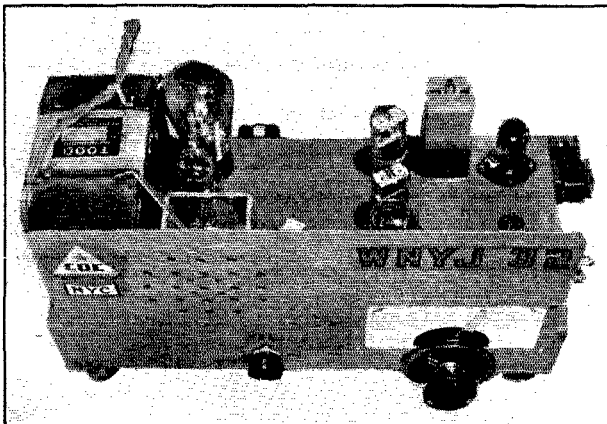

Top view of the control-station receiver. The i.f. amplifier tube and output transformer are in the rear right-hand corner. The other tubes in line to the right are the detector and audio tubes. Power-supply components and loudspeaker are at the left-hand end of the chassis.

Alignment

The receiver may be lined up with the aid of an all-wave receiver or anything else which will serve as a signal generator at the required frequencies.

The first part of the job consists of tuning up the i.f. amplifier and adjusting the superregenerative detector. To do this, the 955 oscillator tube should be removed from its socket and a two-foot length of wire attached to the plate lead of the mixer tube where it connects to the top of L_4 , the wire serving as an antenna. The regeneration control, R_9 , should then be advanced until the 6J5 detector goes into the usual hiss associated with superregeneration. If an all-wave receiver is used as the test-signal source, it should be tuned slowly between 20 and 30 Mc. with its antenna attached. At some point between these limits the signal from the oscillator in the all-wave receiver should block the detector. The all-wave receiver should then be tuned to approximately 21 Mc. and the detector adjusted to this frequency by listening for the dead spot as C_{15} is turned through its range. The detector tuning can be made more accurate after this initial adjustment by moving the all-wave receiver some distance away, disconnecting its antenna and readjusting C_{15} on the weaker signal. At the same time the input circuit of the i.f. amplifier may be tuned up by adjusting C_7 . R_9 should then be given a final adjustment to give maximum blocking and greatest reduction in hiss when the test signal is tuned in.

With the detector and i.f. amplifier lined up, the next step is to put the 955 oscillator tube back in its socket and remove the antenna from L_4 . If frequency-measuring apparatus for putting the oscillator on 91 to 95 Mc. is not available, either a very low-power 112-Mc. oscillator or a harmonic from the oscillator in the all-wave receiver may be used to produce a test signal at the operating frequency. In our particular case, the third harmonic of the oscillator in a Meissner

f.m. receiver tuned to 41.6 Mc. was used. If the signal cannot be heard at some point on the dial as C_3 is turned, the inductance of the oscillator coil may have to be adjusted by squeezing together or spreading slightly the turns of L_3 . The coupling condenser, C_4 , should be set at about three-quarters of its maximum capacity at the beginning and then adjusted for maximum mixer response as indicated by the amount of silencing when the test signal is tuned in. C_2 must be readjusted each time the capacity of C_4 is changed. When the right amount of injection has been determined, the spacing of the turns of L_3 should be adjusted so that a 114-Mc. signal is heard when C_2 is set at half its maximum capacity. Then C_7 and R_9 should again be readjusted slightly for maximum signal response consistent with good quality. Optimum operation will be obtained with a detector plate voltage of about 20.

As a final adjustment, the mixer should be checked for resonance. By squeezing or spreading the turns of L_2 very slightly while tuning in signals at 112 and 116 Mc. alternately, it should be possible to determine if more or less capacity is required to peak the signal. By bending one end of the rotor plate of C_1 slightly, the mixer can be adjusted to resonate over the entire band.

Best results were obtained with the antenna coil, L_1 , inserted about half-way inside L_2 at the

grounded end. The particular antenna used with this receiver is a delta-matched dipole with a two-wire transmission line having a conductor spacing of two inches, although other antenna arrangements should work satisfactorily.

While this receiver may not be the ultimate for WERS control-station use, it is the best by far that we have found to date. Its use has solved one of the most annoying problems we have encountered by eliminating the interference previously experienced from stations outside our net operating on adjacent frequencies.

OPA Revises Ceiling Prices

SPECIFIC wholesale and retail ceiling prices for new standard radio replacement tubes for civilian radio receivers and phonographs have been announced by the Office of Price Administration, in Amendment No. 134 to Revised Supplementary Regulation No. 14 to the General Maximum Price Regulation. The new prices became effective May 20, 1944.

The following are retail ceiling prices for some of the most commonly used standard tubes for portable, table, console and auto radio sets:

Type	Price	Type	Price
1A5GT.....	\$1.10	50L6GT.....	\$1.10
1A7GT.....	1.30	5Y3G.....	.70
1H5GT.....	1.10	6F6G.....	.90
1N5GT.....	1.30	6SA7GT.....	1.10
12SA7GT.....	1.30	6SK7GT.....	1.10
12SQ7GT.....	1.00	6V6GT.....	1.10
25L6GT.....	1.10	4Z.....	.85
35Z5GT.....	.85	80.....	.70

The amendment requires those retailers who in March, 1942, purchased radio receiver tubes from a manufacturer, to sell at no more than their highest March, 1942, prices for the particular brand, provided that the prices do not exceed the specific prices now set for that tube.

Dollars-and-cents prices which retailers will pay to wholesalers are computed on the basis of discounts off the retail price list and are graduated according to the quantity sold. Wholesalers must make out and retain complete records of all sales to retailers.

OPA's action also specifies maximum service charges for testing radio receiver tubes. No charge may be made by a dealer or repairman for testing tubes when they are brought to his shop by a customer. However, when a customer brings a portable or table model radio or phonograph to a dealer's or repairman's shop for tubes to be tested or replaced, a maximum charge of 50 cents may be made for testing all of the tubes in the set. If the radio or phonograph mechanism has to be removed in order to test and replace the tube, a maximum charge of \$1.00 may be made for testing all of the tubes.

The amendment reaffirms the customary 90-day guarantee given by the industry against defects in material or workmanship. In addition it calls for posting of ceiling price lists in the dealer's or repairman's place of business.

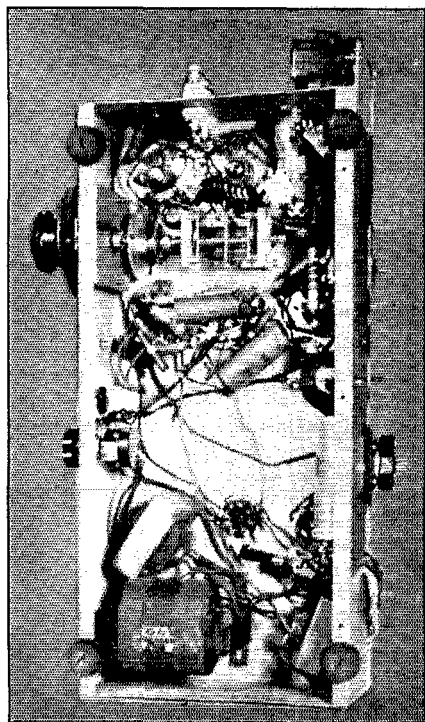

Bottom view of the WERS control-station receiver. The two acorn tubes in the h.f. circuits are visible above the tuning condenser, near the top end of the chassis. Power-supply components occupy the lower portion.

A Simple M.O.P.A. for WERS Service

A 112-Mc. Transmitter with Improved Frequency Stability

BY HENRY O. PATTISON, JR.,* W2MYH, AND
DONALD H. MIX,** W1TS

As the author of this article points out, more selective receivers (such as that described in the preceding pages in this issue) are of little use in coping with QRM between adjacent WERS stations unless the increased selectivity is accompanied by a corresponding improvement in the frequency stability of the transmitters employed. The unit shown in the photographs is a neat but simple example of a stable m.o.p.a. transmitter for 112 Mc. which gives markedly improved performance over the usual modulated-oscillator type of transmitter.

WHILE much has been written on the subject of frequency stability in amateur equipment, there are still many who do not recognize the fact that it has always had an important bearing upon the practical existence of amateur radio. Many try to solve the problem of interference, which limits band occupancy, by searching for more selective receivers, failing at the same time to remember that a highly selective receiver is of no use unless a corresponding improvement is made in transmitter frequency stability. It is obvious that such a receiver will accept only unintelligible pieces of an unstable signal as, under modulation, it slides back and forth across the narrow opening which the selective receiver's band of acceptance provides. As a matter of fact, good frequency stability is the first requirement in any attempt aimed toward making more effective use of our bands, because reduction of the width of the channel occupied by the transmitted signal will in itself provide for a greater number of readable signals within a given band, even though the inherent selectivity of the receiver is not increased.

These principles are usually taken for granted by those who have populated our lower-frequency bands in the more recent years before the outbreak of war. However, because of the relatively light occupancy of the bands above 60 Mc. by prewar amateurs in most localities, only those amateurs situated in metropolitan areas were beginning to encounter the problem of serious interference at these higher frequencies just prior to the outbreak of war.

Stability in WERS

The inauguration of WERS has multiplied the former amateur occupancy of the 112-Mc. band

* 81 Hillcrest Ave., Summit, N. J.

** Acting Technical Editor, *QST*.

several times. Even small communities which formerly could boast of only two or three active hams on "21 $\frac{1}{2}$ " now may have networks of a dozen or more WERS units. To make matters worse, restriction of operating hours and the nature of the work to which these stations are devoted necessitates almost simultaneous operation of most of them. In many parts of the country these small communities are well within the interference range of one another, and the problem of satisfactory channel allotments for interference-free service therefore becomes a difficult one.

The fact that certain types of WERS gear must be as simple and light in weight as possible does not preclude the practicability of the use of better gear in the majority of applications. To secure a profitable improvement in frequency stability over that of the average type of equipment found in WERS installations does not require the use of multi-stage crystal-controlled affairs. A high-C oscillator alone will contribute much toward a higher order of stability. However, many of the disadvantages of a modulated oscillator cannot be eliminated by this simple means, and the improved stability is obtained only at the expense of appreciable reduction in power output.

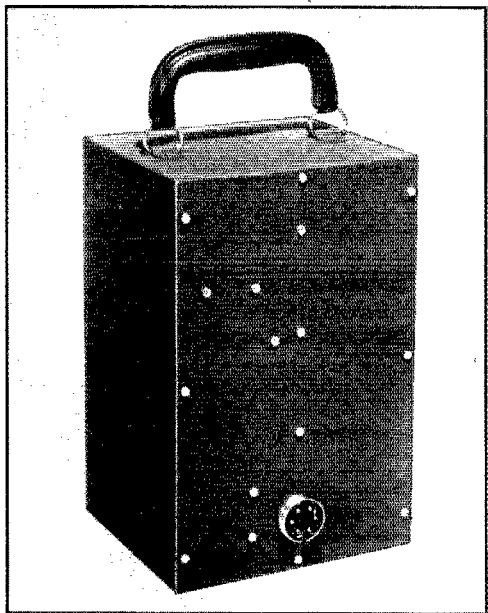

The 112-Mc. m.o.p.a. transmitter for WERS is entirely enclosed within its standard metal carrying case. The male-plug receptacle near the bottom is for power-supply connections. Tuning adjustments are made by screwdriver through holes in the rear of the case.

Fig. 1 — Circuit diagram of the 112-Mc. m.o.p.a.

- C_1 — 100 $\mu\text{fd.}$ per section variable (Hammarlund MCD-100-S).
- C_2 — 3-30- $\mu\text{fd.}$ mica trimmer (National M-30).
- C_3 — 25 $\mu\text{fd.}$ per section variable (Hammarlund HFD-30-X).
- C_4 — 15 $\mu\text{fd.}$ per section variable (Cardwell ET-15-AD).

- C_5, C_7, C_8 — 250- $\mu\text{fd.}$ midget mica.
- C_6 — 50- $\mu\text{fd.}$ midget mica.
- R_1 — 15,000 ohms, $\frac{1}{2}$ watt.
- R_2 — 15,000 ohms, 1 watt.
- R_3 — 10,000 ohms, 10 watts, for plate voltage of 300; 15,000 ohms for plate voltage of 400.

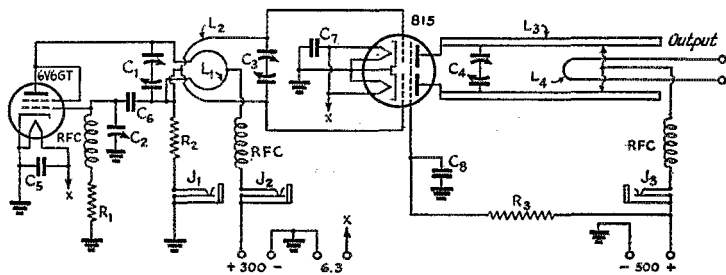

RFC — $1\frac{1}{4}$ -inch winding of No. 28 d.s.c. wire on rod, $\frac{1}{4}$ -inch close-wound, or Ohmite Z-1 v.h.f. r.f. choke.

L_1, L_2, L_3, L_4 — See text.
 J_1, J_2, J_3 — Closed-circuit jack.

The simple m.o.p.a. shown in the photographs has proved to be a satisfactory solution. Not only does it provide for all the input power the regulations will allow, but it permits removal of modulation from the frequency-determining stage. From the practical operating standpoint, perhaps an even more important feature of such an arrangement is that it provides an effective measure of isolation between the antenna and the oscillator so that changes in position or length of the antenna do not drag the frequency all over the band. This is an advantage which will be readily recognized by those who have attempted to operate spot-frequency WERS nets with simple modulated-oscillator transmitters and inexperienced operators.

The entire transmitter shown, as well as a modulator of sufficient power, may be operated economically from a dual vibrator-type power pack in emergency service with a carrier output of 15 watts. At maximum rating, for postwar amateur operation the power output may be boosted to 40 or 50 watts.

The circuit diagram is shown in Fig. 1. The oscillator is similar to the high- C arrangement described by Grammer in a previous issue of *QST*,¹ in which a triode-connected 6V6GT is used. Excitation can be adjusted for best output and stability by means of C_2 . An 815 dual pentode

¹ Grammer, "A 112-Mc. Emergency Transmitter," *QST*, December, 1941, p. 14.

is used as a push-pull amplifier. The two stages are coupled inductively, since experience has proved this method to be superior to link coupling. The output tank is of the linear type. Jacks are provided so that milliammeters may be plugged in to read oscillator plate current and amplifier grid and plate currents.

Mechanical Arrangement

A special effort has been made to keep the mechanical arrangement neat. The unit is built on the panel of a standard steel carrying case for portability. The outside dimensions of the case are $12 \times 7 \times 6$ inches, the panel measuring 12×7 inches. The chassis is cut from a piece of aluminum sheet 15 inches long and 5 inches wide. A $\frac{3}{4}$ -inch edge is bent down at each end of the sheet, the sheet then being bent into the form of a step at one end with a 3-inch "riser" and a $2\frac{1}{2}$ -inch "tread."

A separate inverted L-shaped mounting, also made of sheet aluminum, is provided for the oscillator components, as shown in the bottom-view photograph. It consists of a 4×5 -inch piece of sheet metal bent at right angles at the center of the 5-inch dimension, each half then measuring $4 \times 2\frac{1}{2}$ inches.

The oscillator tank inductance, L_1 , is a piece of 1/16-inch aluminum sheet cut to the shape of a U, 2 inches wide and $2\frac{1}{2}$ inches long over-all. A half-inch slot $1\frac{3}{4}$ inches long in the center makes the conductor $\frac{3}{4}$ -inch wide at all points. To provide good surface contact between the inductance and the stators of the tank condenser, C_1 , slots $\frac{1}{4}$ -inch wide and $\frac{3}{4}$ -inch long are cut in the ends of the legs of the U, spaced so that they will slide under the stator sections when the mounting screws of the latter are loosened up. Washers may be used to raise the rotor sections a

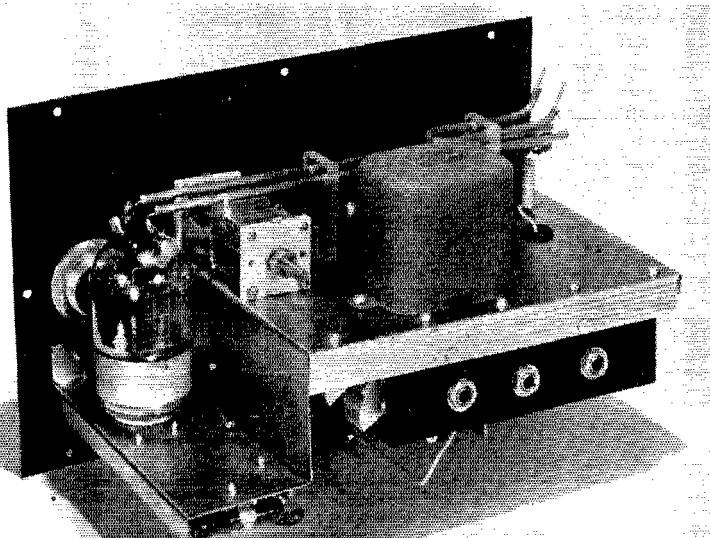

Top view of the 112-Mc. m.o.p.a., showing the 815 amplifier tube and its linear plate tank circuit. The modulation transformer is mounted toward the rear of the chassis and the meter jacks are suspended beneath on the bakelite strip.

corresponding amount. This assembly is then fastened to the under side of the horizontal part of the inverted-l mounting.

All tank condensers are mounted with their control shafts facing toward the rear, from where they may be adjusted with a screw-driver. The oscillator-tube socket is mounted on the vertical part of the l mounting, so that its terminals are close to the condenser stators, with the tube in a horizontal position. After the oscillator unit is assembled and wired, it is fastened to the panel by means of aluminum angle pieces and self-tapping screws.

The amplifier grid-circuit components are mounted underneath the "tread" portion of the step at one end of the chassis. The grid tuning condenser, C_3 , is placed at the inner edge of the "tread," leaving sufficient space alongside it for the 815 socket. The grid inductance, L_2 , is a U-shaped piece of 3/16-inch copper tubing approximately 2 inches long and 1½ inches wide. The ends of the tubing are soldered to the stator terminals of C_3 . The grid tuning condenser should be mounted so that L_2 is centered over L_1 , with a separation of about 1 inch between the two inductances.

At the rear of the chassis an 8-inch length of angle stock provides a mounting for a bakelite strip which carries the three metering jacks.

The components of the linear output circuit for the 815 and the modulation transformer are placed on the top side of the chassis. The line consists of a pair of ¼-inch copper tubes 9 inches long, spaced 1 inch center to center. They are supported on two pieces of polystyrene ½-inch thick, each of which has been tapped at the bottom edge so that it may be fastened to the chassis by a machine screw from underneath. The sections of tubing are passed through holes drilled in the polystyrene at such a height that the tubing sections almost touch the condenser stator terminals as they pass over C_4 to the plate terminals of the 815. The piece supporting the outer ends of the tubes is made somewhat longer than the other so that an extra pair of holes may be provided at the top for mounting the "hair-pin" antenna-coupling loop above the tubing sections. The loop is a piece of No. 12 wire covered with "spaghetti" and then bent to shape. The high-voltage lead to the amplifier passes up through a rubber grommet in the chassis to the r.f. choke, $R'F'C$, which is soldered to the sliding shorting bar which tunes the line.

The amplifier chassis is fastened to the panel by sections of angle stock. Plate and heater voltage are fed to the unit through a plug and receptacle near one end of the panel.

Bottom view of the WERS m.o.p.a. transmitter. The amplifier grid-circuit components are grouped near the 815 tube socket at the right, while the oscillator section is built up as a separate unit on the l-shaped bracket at the upper left.

Tuning

In tuning the transmitter the oscillator is first set to the correct frequency by adjusting L_1 . This is done by sliding it backward or forward under the stators of C_1 until it is possible to tune to the center of the 112-Mc. band with C_1 set near maximum capacity. With the oscillator running the grid circuit of the amplifier should be tuned for resonance, which will be indicated by maximum amplifier grid current. C_2 should now be turned toward maximum capacity until the grid current starts to fall off and then backed off slightly to restore normal grid current. Maximum stability will be obtained when C_2 is set as close to its maximum capacity setting as it can be without impairing appreciably the output of the oscillator.

The oscillator does a good job of driving the 815 amplifier. When the oscillator is adjusted correctly and the grid circuit of the amplifier is tuned to resonance, there should be no difficulty in obtaining a grid-current reading of 6 or 7 ma. It may be necessary to vary the coupling between the two circuits to obtain a maximum grid-current reading. When the oscillator is loaded, its plate current should run about 50 ma.

Amplifier plate and screen voltages may now be applied and the plate circuit tuned to resonance. Adjustment of the shorting bar may be necessary to bring the band within the range of C_4 . Plate voltage should be applied for only short intervals until the resonance point has been found. No neutralization has been found necessary, probably because the arrangement employed provides good isolation between the input and output circuits.

With the antenna attached, the amplifier may be loaded by increasing the coupling until the plate current at resonance increases to about 150 ma. The plate voltage should be limited to 400 if the amplifier is to be plate modulated. Under load conditions, the grid current will drop to 3 or 4 ma. For WERS work, the unit should be operated at reduced input to comply with the regulations; which limit the permissible power input to 25 watts. With a 300-volt vibrator-pack supply the plate current to the amplifier should be adjusted to a maximum of about 80 ma.

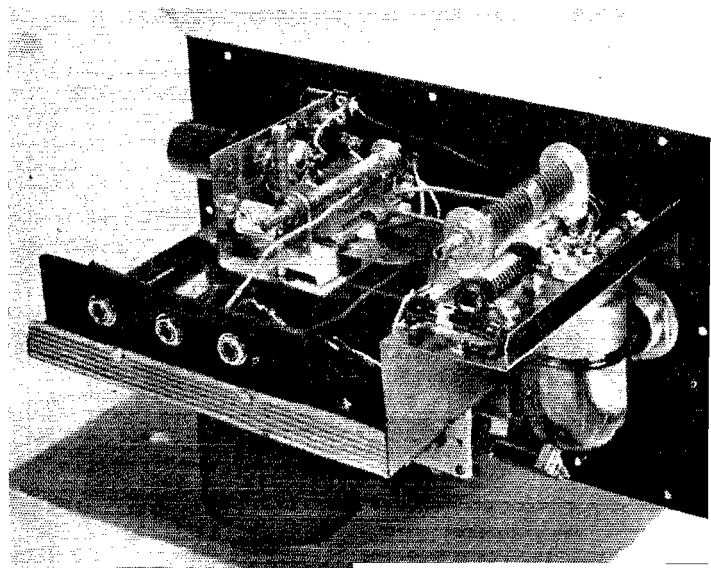

HAPPENINGS OF THE MONTH



SCIENTIFIC PERSONNEL NEEDED

THE nation's need for scientific personnel continues unreduced. There are new scientific developments constantly, new projects being started. They require not only research workers but experienced people capable of supplying technical leadership and direction. The need, we understand, is particularly great for radio physicists and radio engineers. Qualified and experienced men and women interested in a more active participation in important war projects are invited to correspond in confidence with the president of the League, George W. Bailey, Chief of Scientific Personnel, Office of Scientific Research & Development, 1530 P Street, N. W., Washington 25, D. C.

HAMS NOT RACKETEERS

UNDER some such heading as "FCC Broke Hams' Racket," many newspapers recently carried an AP dispatch reporting that the Government had blocked a "devilish sort of black market" in the commercial sale to relatives of enemy-broadcast information concerning war prisoners. Malcolm S. Hensley, chief of wire services of FCC's Foreign Broadcast Intelligence Service, was quoted as telling a House investigating committee that some radio amateurs for a time succeeded in beating the Government's delivery of POW messages to next of kin — for a price.

Mr. Hensley said no such thing. We have a copy of his testimony. In it he reports and condemns the racket, which arouses the hatred of every amateur, but he makes no reference to radio amateurs. The press association merely put that unwarranted interpretation on it. Mr. Hensley writes ARRL:

"... I simply was endeavoring to distinguish notification by private individuals from notification by a Government agency. I certainly did not intend to infer that licensed amateur radio operators were involved in any way. I am indeed sorry that my testimony was incorrectly interpreted in a manner which might injure in the slightest the high reputation of the licensed radio amateurs who . . . have provided such a valuable pool of experience from which our country is able to draw during this war. . . . [As to] whether any licensed amateur operators were ever reported to us as being guilty of attempting to collect money for forwarding messages, our records reveal no instance of such."

Based on the above information, the Associated Press has willingly sent out a correction of the story, at the request of ARRL Hq. The incident illustrates the kind of inadvertency in which, on this month's editorial page, we ask the assistance of the membership.

ELECTION NOTICE

To All Full Members of the American Radio Relay League residing in the Midwest Division:

You are hereby notified that a special election is about to be held in your division to elect an alternate director for the unexpired remainder of the 1944-1945 term of the late Capt. William H. Graham, W9BNC. Your attention is invited to the applicable portions of the Constitution & By-Laws of the League, a copy of which will be mailed any member upon request.

The nomination of candidates is by petition. Nominating petitions are hereby solicited. Ten or more Full Members residing in the Midwest Division may join in nominating any eligible Full Member residing in that division as a candidate for this office. The following form is suggested:

Executive Committee

The American Radio Relay League
West Hartford, Conn.

We, the undersigned Full Members of the ARRL residing in the Midwest Division, hereby nominate of as a candidate for Alternate Director from this division for the unexpired remainder of the 1944-1945 term.

(Signatures and addresses)

The signers must be Full Members in good standing. The nominee must be a Full Member and must have been both a member of the League and a licensed radio amateur operator for a continuous term of at least four years immediately preceding receipt by the Secretary of his position of nomination, except that a lapse of not to exceed ninety days in the renewal of the operator's license and a lapse of not to exceed thirty days in the renewal of membership in the League, at any expiration of either during the four-year period, will not disqualify the candidate; provided that if a candidate's membership has been interrupted by reason of service in the armed forces of the United States, he shall not be deemed to be disqualified so far as concerns continuity of membership if he has, since May 7, 1943, renewed his ARRL membership within ninety days of discharge from the military service. He must be without commercial radio connections: he may not be commercially engaged in the manufacture, selling or renting of radio apparatus normally capable of being used in radio communication or experimentation, nor commercially engaged in the publication of radio literature intended for consumption by licensed radio amateurs. Further details concerning eligibility are given in By-Law 12. His complete name and address should be stated. All such petitions must be filed at the headquarters office of the League in West Hartford, Conn., by noon EWT of the 20th day of July, 1944. No member shall append his signature to more than one such petition. To be valid, a petition must have the signatures of at least ten Full Members in good standing, in execution of a single document. A member holding a certificate of Associate Membership is not eligible to join in a nomination or to stand as a candidate.

If only one eligible candidate for this office is named, he will be declared elected without membership balloting. If more than one is named, voting will take place between July 20 and August 20, 1944, on ballots that will be mailed from the headquarters office to each Full Member of the Midwest Division. The balloting will be canvassed on August 20, 1944, and the new alternate director will take office immediately.

For the Board of Directors:

K. B. WARNER,
Secretary

April 20, 1944.

EXECUTIVE COMMITTEE MEETINGS

THE following is an abstract of the actions of the Executive Committee of the League during the past year between Board meetings, as ratified by the Board at its recent meeting, here published for your information by order of the Board:

Meeting No. 180, Nov. 1, 1943. Examined nominations in regular autumn elections, determined eligibility of candidates. In cases where there was only one eligible candidate, declared him elected without balloting. Where there was no eligible candidate, ordered further solicitation of nominations.

Meeting No. 181, Jan. 24, 1944. Examined nominations in delayed election in Midwest Division, determined eligibility of the renominated incumbents as the only candidates, declared them elected without balloting.

YOUR WAR SERVICE RECORD

WE INTEND to keep right on publishing the now-familiar form that you find at the bottom of this page and pestering you every month until you have registered with ARRL headquarters the simple but essential facts of your wartime radio service. We are endeavoring to compile at headquarters a complete record of the service of radio amateurs in this war.

If you are, or if you ever have been, a licensed amateur, of either the United States or Canada, holding either amateur station or amateur operator license, and are engaged in any aspect of electronics where radio know-how counts, we ask you to register with us — either by clipping the form below or by reproducing its essentials on a post card. We desire such a record whether your service is in uniform in the armed forces, or in the Civil Service, or in any other branch of government work of a nature essential to the war effort, or in those portions of the radio manufacturing industry which are 100 per cent devoted to the war effort. It will take you only a minute to fill out the form and it will be a big help to amateur radio.

And if you have a few additional minutes to spare, we would much appreciate similar data on your co-workers of amateur background. TU vy.

ARE YOU LICENSED?

When joining the League or renewing your membership, it is important that you show whether you have an amateur license, either station or operator. Please state your call and/or the class of operator license held, that we may verify your classification.

NOTICE TO MEMBERS DISCHARGED FROM THE MILITARY SERVICES

ARRL by-laws have long provided that an amateur must be continuously a member of the League for at least the last four years to be an eligible candidate for director or alternate, and at least one year for SCM. They also normally provide that if a member becomes in arrears in his dues for more than thirty days, his continuity of membership is broken. Your attention is directed to the fact that the by-laws have now been amended on behalf of members serving in the armed forces of (only) the United States. It is now provided that such a member, who becomes in arrears, will not make himself ineligible to hold League office, insofar as concerns a discontinuity of his membership while he was in uniform, if he resumes his membership within ninety days after release from active military duty.

While this action will have its greatest usefulness after the war is won, there are already some members being discharged from the military services for physical reasons, etc. All such persons are advised that, if they will renew ARRL membership within ninety days following discharge, they will be deemed to have had continuous membership during the period of their military service, so far as the requirement of continuity for office eligibility is concerned. Those desirous of taking advantage of this arrangement are asked to claim the right when renewing membership, stating the beginning and ending dates for their military service.

AMATEUR WAR SERVICE RECORD

Name

Present mailing address

Rank or rating

Branch or bureau: Signal Corps, AAF, Buships, WAVES, etc.
If civilian industry, give title and company.

Call, present or ex; or
grade of op-license only

SERVICE

- Army
- Navy
- Coast Guard
- Marine Corps
- Maritime Service
- Merchant Marine
- Civil Service
- Radio industry,
100% war

BOARD MEETING

LAST month, by the skin of our teeth, we succeeded in giving you a brief report of the annual meeting of the Board of Directors of ARRL, held at Hartford on May 5th. Here, for full details, are the minutes of that meeting:

MINUTES OF 1944 ANNUAL MEETING OF THE BOARD OF DIRECTORS, AMERICAN RADIO RELAY LEAGUE

May 5, 1944

Pursuant to due notice and the requirements of the by-laws, the Board of Directors of the American Radio Relay League, Inc., met in regular annual session at The Hartford Club, Hartford, Conn., on May 5, 1944. The meeting was called to order at 9:07 A.M., Eastern War Time, with President George W. Bailey in the chair and the following other directors present:

- Charles E. Blalack, Vice-President
- Alexander Reid, Canadian General Manager
- E. Ray Arledge, Delta Division
- John E. Bickel, Southwestern Division
- Hugh L. Caveness, Roanoke Division
- Everett H. Gibbs, Central Division (alternate, acting)
- Robert A. Kirkman, Hudson Division
- J. Lincoln McCargar, Pacific Division
- Percy E. Noble, New England Division
- Floyd E. Norwine, jr., Midwest Division
- Jennings R. Poston, West Gulf Division (alternate, acting)
- William P. Sides, Southeastern Division (alternate, acting)
- C. Raymond Stedman, Rocky Mountain Division
- Aaron E. Swanberg, Dakota Division (alternate, acting)
- Karl W. Weingarten, Northwestern Division

Absent, Acting Director Herbert M. Wallez, Atlantic Division. There were also present Acting General Counsel Philip J. Hennessey, jr., Treasurer D. H. Houghton, Assistant Secretary C. T. Read, Assistant Secretary C. A. Service, jr., Secretary & General Manager K. B. Warner, and Acting Communications Manager Carol K. Witte. Also in attendance, at the invitation of the Board, as a nonparticipating observer, was Communications Manager (on leave from ARRL) F. E. Handy.

The meeting first stood with bowed heads in silent tribute to the memory of the League's former president, the late Dr. Eugene C. Woodruff, W3CMP. The assembly was then welcomed and briefly addressed by President Bailey.

On motion of Mr. Arledge, unanimously VOTED that the minutes of the 1943 annual meeting of the Board of Directors are approved in the form in which they were issued by the Secretary.

On motion of Mr. Norwine, unanimously VOTED that the annual reports of the officers to the Board of Directors are accepted and the same placed on file.

On motion of Mr. McCargar, VOTED that all acts performed and all things done by the Executive Committee since the last meeting of the Board, and by it reported to the Board, are ratified and confirmed by the Board as the actions of the Board. Mr. Kirkman requested to be recorded as voting opposed.

* At Mr. Reid's request, without objection, the rendering of the report of the Finance Committee was ORDERED put over until the afternoon session.

Mr. Blalack, chairman of the Planning Committee, read a report on behalf of that committee. During the reading Alternate Director George Rulfs, jr., Hudson Division, joined the meeting as a nonparticipating observer, at the invitation of the Board, at 9:22 A.M.; and at 9:25 A.M. Technical Adviser George Grammer joined the meeting. On motion of Mr. Blalack, unanimously VOTED that the 1944 report of the Planning Committee is accepted and the same placed on file.

On motion of Mr. Weingarten, unanimously VOTED that the annual reports of the directors to the Board of Directors are accepted and the same placed on file.

On motion of Mr. Weingarten, and by unanimous VOTE, affiliation was granted the Livic Radio Club, Livingston, Montana.

On motion of Mr. Caveness, unanimously VOTED that there is hereby appropriated from the surplus of the League, as of this date, the sum of three thousand five hundred dollars (\$3,500), for the purpose of defraying the expenses of holding this meeting of the Board of Directors, any unexpended remainder of same to be restored to surplus.

On motion of Mr. Bickel, after discussion, unanimously VOTED that the sum of three thousand one hundred dollars (\$3,100) is hereby appropriated from the surplus of the League, as of January 1, 1945, for the legitimate administrative expenses of the directors in the calendar year 1945, said amount allocated as follows:

Canadian General Manager	\$ 150
Atlantic Division Director	200
Central Division Director	400
Dakota Division Director	200
Delta Division Director	150
Hudson Division Director	300
Midwest Division Director	225
New England Division Director	150
Northwestern Division Director	200
Pacific Division Director	200
Roanoke Division Director	100
Rocky Mountain Division Director	200
Southeastern Division Director	125
Southwestern Division Director	200
West Gulf Division Director	300

\$3,100

any unexpended remainders of these funds at the end of the year 1945 to be restored to surplus.

At this point the Board heard supplemental oral reports from the President, Secretary, Treasurer and Acting Communications Manager. The Board was in recess from 11:29 A.M. to 11:46 A.M.

On motion of Mr. Stedman, after discussion, unanimously VOTED, at 11:50 A.M., that the assembly now resolves itself into a Committee of the Whole for the consideration of postwar plans and related matters. At 3 p.m. the committee arose and the Board resumed its session, with all directors and other persons hereinbefore mentioned in attendance.

Moved, by Mr. Blalack, that Section 2 of Article IV of the Constitution be amended, as had been duly proposed, by causing the last sentence thereof to read as follows: "Directors shall serve without compensation from the League, except that the President may be compensated for special assignments for such periods and in such amounts as may be authorized by the Board of Directors." The yeas and nays being ordered, the said question was decided in the affirmative: Whole number of votes cast, 14; necessary for adoption, 10; yeas, 14; nays, 0. Every director present voted in the affirmative, the President and Vice-President abstaining as required. So the amendment was adopted.

Mr. Bailey, as chairman of the Committee of the Whole, presented to the Board certain recommendations of the Committee of the Whole, from which the following actions resulted:

a) Moved, by Mr. Caveness, that the Board of Directors open a Washington office, at a time, and for a duration, to be determined by the Board of Directors, at a cost not to exceed \$1,000 per month including the temporary remuneration of the President, the expenses of same to be charged to the League's reserve for postwar rehabilitation expenses. Moved, by Mr. Kirkman, that the motion be amended to provide for the immediate opening of the Washington office. But, after discussion, the proposal for amendment was rejected, Messrs. Kirkman and Stedman requesting to be recorded as voting in favor. The question being on the original motion, the same was then unanimously ADOPTED.

OFFICERS' REPORTS AVAILABLE TO MEMBERS

In April of each year, the officers of the League make comprehensive written reports to the directors. The Board of Directors has made these reports available to the membership of the League. Interested members may obtain copies post-paid at the cost price of 50¢ per copy. Address the Secretary at West Hartford.

b) On motion of Mr. McCargar, unanimously VOTED that the membership of the Planning Committee is increased to five members, the additional two members to be appointed by the President.

c) On motion of Mr. McCargar, unanimously VOTED that the Board, having examined its actions at the 1940 meeting at which it granted the President extraordinary powers to act as a committee of one in all aspects of protecting amateur operation, and in which it made an open authorization of \$10,000 available to him for the defense of amateur frequencies, now reaffirms those actions.

d) On motion of Mr. Arledge, unanimously VOTED that the membership of the Finance Committee is increased to five members, the additional two members to be appointed by the President.

e) Moved, by Mr. Reid, that the salary of Secretary K. B. Warner be increased to \$15,000 per year, effective January 1, 1944. After discussion, the yeas and nays being ordered, the said question was decided in the affirmative: Whole number of votes cast, 15; necessary for adoption, 8; yeas, 11; nays, 4. Those who voted in the affirmative are Messrs. Arledge, Gibbs, Noble, Norwine, Poston, Reid, Sides, Stedman, Swanberg, Weingarten and Blalack. Those who voted opposed are Messrs. Bickel, Caveness, Kirkman and McCargar. So the salary was increased.

f) Moved, by Mr. Poston, that the salary of D. H. Houghton, as Treasurer, be increased to \$625 per year, effective January 1, 1944. On motion of Mr. Bickel, VOTED, 10 to 3, to amend the amount in the pending motion to \$1,000; Mr. Stedman requesting to be recorded as voting opposed. The question then being on the adoption of the original motion as thus amended, the same was ADOPTED without dissent, Messrs. Kirkman and Stedman requesting to be recorded as not voting.

The Secretary and Treasurer spoke briefly in appreciation, pledging the continuance of their best efforts.

On the request of the Secretary for instructions on certain matters concerning the League's invention agreement with employees, after discussion, on motion of Mr. Blalack, VOTED that in all contracts with employees pertaining to inventions, the payments to the League henceforth be reduced from 33 $\frac{1}{3}$ % of the net profits, revenues and royalties realized from the sale or exploitation of such inventions, to 15%.

On motion of Mr. Reid, unanimously VOTED that the sum of seven hundred and fifty dollars (\$750) is hereby appropriated from the surplus of the League as of this date for the expenses of the Finance Committee, any unexpended remainder of same on the date of the next annual meeting of the Board to be returned to surplus.

On motion of Mr. Blalack, unanimously VOTED that the unexpended remainder existing this date in the appropriation for the expenses of the Planning Committee is this date restored to surplus; and that the sum of one thousand dollars (\$1,000) is hereby appropriated from the surplus of the League as of this date to defray the further expenses of this committee, any unexpended remainder of same to be returned to surplus.

At this point Mr. Reid rendered a report for the Finance Committee. On motion of Mr. Sides, unanimously VOTED to accept the report.

On motion of Mr. Reid the following resolution was unanimously ADOPTED:

Whereas, on April 26, 1944, Kenneth Bryant Warner completed twenty-five years of continuous service as Secretary and General Manager of the American Radio Relay League, his term in office having covered almost the entire span of organized amateur radio activities, be it

RESOLVED: That the Board of Directors, meeting at Hartford, Conn., May 5, 1944, in recognition of K. B. Warner's untiring efforts on behalf of the League, does hereby express its deep appreciation of his loyalty, fidelity and intelligent devotion to the best interests of the institution of amateur radio.

On motion of Mr. Kirkman, after discussion, unanimously **RESOLVED** that it is the sense of this Board that the interests of the United States and of the United States radio amateur require the return of all previously-assigned frequency bands with no net loss of channels, plus the acquisition of all frequency bands in harmonic relationship to the 224 to 230 megacycle band to as high as formal assignment may progress; and that the officers and employees of the League are instructed to act in furtherance of the

above ends, that they may be brought about at the earliest possible moment after the conclusion of the present wars in which the United States is engaged.

Moved, by Mr. Stedman, that it is the policy of the Board that the directors, the President and the Vice-President shall serve without compensation, and the temporary compensation of President Bailey in connection with the operation of the Washington office in no way changes this policy. Ruled, by the Chair, that the said motion was out of order.

Proceeding to the election of President and Vice-President, on motion of Mr. McCargar, two-thirds concurring, Special Rule A was suspended. The Chair appointed Messrs. Handy, Grammer and Read as Tellers.

Nominations for President being in order, those nominated were Messrs. Bailey and Blalack. Mr. Blalack withdrew his name and, on his motion, the Secretary was unanimously **ORDERED** to cast one ballot for the unanimous election of Mr. Bailey. Which done, Mr. Bailey was declared re-elected for a two-year term.

Nominations for Vice-President being in order, those nominated were Messrs. Blalack and Caveness. Mr. Caveness withdrew his name and, on his motion, the Secretary was unanimously **ORDERED** to cast one ballot for the unanimous election of Mr. Blalack. Which done, Mr. Blalack was declared re-elected for a two-year term.

Whereupon, on motion of Mr. Norwine, the Board adjourned, *sine die*, at 5:31 P.M.

Secretary

Missing in Action

W4FRS, RM1c, Jack G. Ehlerding, USN, of Pensacola, Fla., has been reported missing following action in the performance of duty.

W5JMK, Munzio Di Paola, of Winnsboro, La., has been reported missing in action over Germany.

Silent Keys

It is with deep regret that we record the passing of these amateurs:

W1JQQ, T/Sgt. Thomas J. Harrigan, Scituate, Mass.

W4HON, Leon H. Nicholson, Asheville, N. C.

W5BLG, M/Sgt. Glenn Bricker, North Little Rock, Ark.

W8ASI, Dr. J. P. Jones, Buckhannon, W. Va.

W9AOL, Chester J. Gehrke, Blue Island, Ill.

W9KAM, James E. Stephens, Neodesha, Kans.

W9RMM, John G. de Bey, Orange City, Iowa

W9RYZ, H. L. Hewell, Hope, N. D.
C. Stuart Ballantine, Boonton, N. J.

Edward R. Dirling, W8WMQ, of Larimer, Pa., whose name appeared in Silent Keys in June *QST*, is reported by his family to be alive and well and stationed in England with the AAF. Although regretting the error, we are happy to make this correction.

The Iconoscope

A Brief Résumé of Its Principles of Operation

BY B. W. SOUTHWELL,* W6OJW/2

Most amateurs have the urge to experiment with new developments in the field of radio. There are those who will wish to explore the possibilities in the use of television on the amateur bands after the war is over. Since there are large parts of the country not covered by commercial television signals, it will often be necessary for the amateur experimenter to build his own television transmitter as well as a picture receiver. *QST* has published articles on the construction of a video camera and transmitter using a Type 1847 pick-up tube for operation in the 112-Mc. band.¹

In this article an attempt will be made to give the amateur experimenter a clear understanding of what happens within the iconoscope tube. The word "iconoscope" comes from a combination of two Greek words—*ikon*, meaning "image," and *skopcin*, meaning "to observe." Various types of iconoscope tubes have been manufactured. Fig. 1 shows a sketch of a typical tube of this type.

Mosaic

The essential element in the evacuated tube is the *mosaic*. The base of the mosaic is a flat mica plate which is used because of its high electrical insulation, good surface and its uniform thickness. The thickness of the mosaic plate is on the order of about 1 mil (0.001 inch). One side of the plate is coated with a thin, finely sifted coating of

silver-oxide powder. After the mica has been coated it is baked in an oven, which reduces the silver oxide to pure silver. The silver congeals in the form of extremely minute globules less than 0.001 inch in diameter. Each globule is separated and insulated from its neighbors by the mica.

The silver globules are then made photosensitive by the admission of caesium vapor to the tube and by passing a glow discharge through the tube in an atmosphere of oxygen.

Before it is placed in the tube, the reverse side of the mosaic is coated with a thin *signal coat* of colloidal graphite. This coating serves as the electrode through which the signal is transferred to the external circuits during the process of scanning. Silver plating sometimes replaces the colloidal graphite as the signal coat.

The mosaic is mounted in the iconoscope in such a position that the electron beam strikes the photosensitized side at an angle of 30 degrees from the normal, and the optical image to be transmitted is projected normal to the surface on the same side. The scene to be transmitted is focused through an optical lens onto the mosaic, as if the latter were the film of an ordinary photographic camera.

The mosaic may be thought of as a great number of minute photocells, each of which is coupled by an electrical condenser to a common signal lead, as shown in Fig. 1. When the mosaic is illuminated these condensers are positively charged, as a result of the emission of photoelectrons from its surface. The fundamental action of photoelectricity is in this way performed, and the optical image is thus translated into an electrical image.

Electron Gun

There now remains the task of dissecting the electrical image obtained on the mosaic into an orderly series of horizontal lines. This is accomplished by means of an *electron gun*, which is also contained within the iconoscope tube. The electron gun produces a very narrow stream of cathode rays which serve as a commutator for the tiny photocells on the mosaic. The gun may be thought of as an electron projector which concentrates the electrons emitted from the cathode of the gun in a very small spot on the mosaic. The electron optical system consists of two electron lenses formed by the cylindrically symmetrical electrostatic fields between the elements of the gun, as shown in Fig. 2.

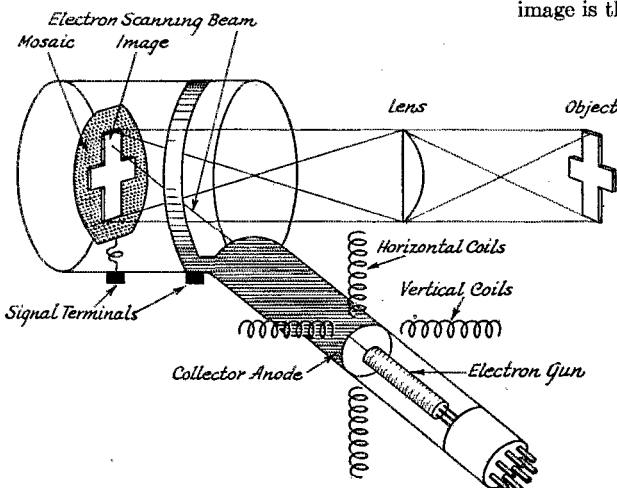

Fig. 1 — Sketch showing the basic construction of the iconoscope and how an image of the object being viewed is focused on the mosaic plate.

* 37 Holly Rd., Belmar, N. J.

¹ Lamb, "Television Camera-Modulator for Practical Amateur Operation," *QST*, October, 1940, p. 11.

Details of the gun construction are of considerable interest. The cathode is indirectly heated with its emitting area at the tip of the cathode cylinder, which is mounted with the emitting area a few thousandths of an inch in front of an aperture in the control grid. A long cylinder with

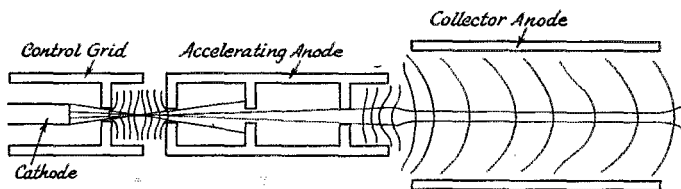

Fig. 2 — Sketch showing the principal points of the "electron gun."

three defining apertures, whose axes coincide with that of the cathode and control grid, serves to give the electrons their initial acceleration. This cylinder is known as the *first anode*, or the *accelerating anode*. A second cylinder, of somewhat greater diameter than the first and mounted along the same axis, serves as a *second anode* which gives the electrons their final velocity. The second anode generally is formed by applying a metal coating to the neck of the iconoscope bulb.

Scanning

The electron beam is aimed initially at the extreme upper left-hand corner of the image and is then moved horizontally, from left to right, across the upper edge of the picture, to trace out the first scanning line. As it passes over each silver globule of this line the beam contributes electrons to each globule in succession, thereby cancelling the positive charge created by illumination and restoring for an instant the charge to the value it possessed before illumination — the *equilibrium charge*. This change in charge results in the generation of a minute voltage across the small capacity between the globule and the signal plate. This voltage is then transferred to the signal terminals and amplified to the necessary degree for modulation. As each charge is restored the image plate potential changes, resulting in the potential of the plate assuming a rapid succession of different values, each value depending upon the amount of charge restored at that particular instant. The deflection of the electron beam for scanning the mosaic is accomplished by means of deflection coils arranged in the form of a yoke which slips over the neck of the iconoscope.

As the electron beam completes its motion across the first scanning line, it is blanked out and instantaneously returned to the left-hand edge of the picture. During the scanning and return motions the beam is moved vertically downward at a comparatively slow rate, so that its position is somewhat below the initial starting position of the previous line. The beam then traces out a new scanning line across the mosaic, parallel to the preceding one but separated from it by the width of one line. The beam therefore scans the mosaic in a *succession of alternate lines*. The empty space between lines is later filled in by a second interlacing field.

Interlacing

When the beam reaches the bottom of the mosaic, the slow vertical motion is stopped. The beam is then extinguished and returned while in that state to the top of the picture. Here the

beam again begins its scanning motion, but this time it is positioned to scan the spaces between the lines previously scanned, thus filling in the gaps in an interlacing fashion. When the beam again reaches the bottom of the picture it has covered every point on the mosaic in two series of alternate lines.

The picture mosaic is scanned at the rate of thirty complete pictures per second. There are various methods of scanning, but the interlaced method just described has been adopted as standard in the United States.

A picture element has a height equal to the distance between centers of adjacent scanning lines. The number of picture elements depends upon the number of lines by which a complete picture is scanned. The greater the number of lines, the greater the number of picture elements, and hence the higher degree of definition obtainable.

In the Type 1847 iconoscope the inner signal electrode (the conductive film on the mosaic) is a band of conductive material on the inner surface of the tube. Another band of conductive material is placed on the external surface of the tube, directly over the internal band. The capacitance between the two bands, in series with the capacitance between the signal electrode and mosaic, provides the coupling between the signal-electrode terminal and the mosaic.

Storage vs. Non-Storage Types

Image pick-up tubes may be divided into two groups; namely, storage pick-ups and non-storage pick-ups. In the storage type, which is the one described in this article, the photoelectric current from an element of the picture charges an individual condenser for a period of time equal to the scanning time of one complete picture. This condenser is discharged once during the scanning time of a complete picture, the time of discharge being only the time of scanning of one picture element. In the non-storage pick-up the current from the photoelectric cell flows only during the time of scanning, does not charge a condenser, and therefore no storage of the charge caused by the photoelectric effect takes place.

Widespread use of television promises to be one of the earlier postwar developments. The experimentally inclined ham therefore should have more than ordinary interest in this explanatory discussion of the "eye" of the television transmitter — the iconoscope.



IN THE SERVICES

THIS is the month for fireworks, and that makes it an appropriate time for us to light the fuse of a bomb we've been holding back for weeks. We've contained ourselves just as long as we can and now must give vent to our irritation. The reason is that four out of five recent visitors at Hq., when queried about their registration in the service roster, nonchalantly admitted that they just haven't taken the time to give us the data we need on their contribution in the war effort. How many of you others have been doing the same thing? We have been making excuses for you—"we know you're all busy, working long hours, etc., etc."—but now we're telling you that we'll never attain that 100 per cent goal of every amateur on record if you and you and you continue to procrastinate. It takes only a brief time to fill in the convenient form on page 23, and we can assure you that in years to come it will prove to have been time well spent—so do it today!

The stay-at-home amateurs who are supporting the boys on the fighting fronts by their employment in 100 per cent war radio industry are again represented in this issue. Though the groups are widely varied each is doing a mighty vital job, and their place in our roster is an important one.

Somehow we got our wires crossed in the April issue. The amateurs listed under "Harvard Radio Research Lab" actually are employed at Harvard's Underwater Sound Lab. Sorry, OMs.

ARMY—AIR FORCES

- 1AUB, Hirsh, T/Sgt., foreign duty.
- 1GPL, Toye, Sgt., Stuttgart Field, Ark.
- 2KHI, Mau, foreign duty.
- 2NGY, Schneider, 2nd Lt., New Haven, Conn.
- 4HTN, Johnson, foreign duty.
- 5DAV, Clark, foreign duty.
- 5DVA, Cravens, M/Sgt., foreign duty.
- 5KNY, Winans, 2nd Lt., Boca Raton Field, Fla.
- 6RCI, Vatcher, S/Sgt., Las Vegas Field, Nev.
- 6SSS, Hess, Kelly Field, Tex.
- 8CLA, Welsh, Sgt., foreign duty.
- 8GAV, Steele, Lt., foreign duty.
- 8KSH, Smith, Cpl., foreign duty.
- 8MAD, Harrington, Lt., Warrensburg Field, Mo.
- 8OMD, Spragge, Sgt., foreign duty.
- 8RQL, Hilton, Pvt., Lawson Field, Ga.
- 8SUF, Bove, S/Sgt., foreign duty.
- 8UXJ, Tomesek, Pvt., Atlanta, Ga.
- 8VRG, Rowe, Cpl., foreign duty.

- 8WCJ, Miller, Cpl., foreign duty.
- 9GWY, Brower, Sgt., foreign duty.
- 9HJF, Algoe, T/Sgt., Atlanta, Ga.
- 9IKG, Nichols, S/Sgt., Baer Field, Ind.
- 9MOV, Peterson, 2nd Lt., Dayton, Ohio.
- 9SCK, Smith, T/Sgt., Peterson Field, Colo.
- 9WCR, Green, Cpl., foreign duty.
- 9WFO, Neste, 2nd Lt., New Haven, Conn.

Operator's license only:

- Adams, D., Lt., foreign duty.
- Adams, S., Lt., foreign duty.
- Arnold, Pfc., address unknown.
- Bates, Cpl., San Bernardino, Calif.
- Baughan, Lt., Gowen Field, Idaho.
- Broc, Lt. Col., foreign duty.
- Brook, Pfc., address unknown.
- Collins, Pvt., Sioux Falls, S. D.
- Deisinger, Pfc., Eglin Field, Fla.
- Hearfield, Cpl., Waco Field, Tex.
- Krocker, Cpl., address unknown.
- Lincoln, Pfc., Liberal, Kans.
- Lind, Cpl., Yuma Field, Ariz.
- Prestigiacomo, Sgt., Maxwell Field, Ala.
- Smalshaf, Pfc., foreign duty.

MARINE CORPS

- 2MOU, Poracky, address unknown.
- 3YI, Ramsey, Lt. Col., foreign duty.
- 3JEX, Wilcox, Cpl., foreign duty.
- 4GZ, Smith, Maj., foreign duty.
- 4GZ, Aaron, 2nd Lt., Quantico, Va.
- 5GGL, Schroeder, 2nd Lt., foreign duty.
- 5HGL, Reid, S/Sgt., San Diego, Calif.
- 6HTM, Huthabaugh, Pfc., foreign duty.
- 6KBY, Radom, 2nd Lt., Quantico, Va.
- 6RDR, Rypinski, S/Sgt., foreign duty.
- 6RDT, Black, Capt., San Diego, Calif.
- 7GJC, Maki, Pvt., address unknown.
- 9HLP, Liverett, MT/Sgt., San Francisco, Calif.
- 9JRI, Chapman, S/Sgt., foreign duty.
- ex-9ZME, Bottolfsen, MT/Sgt., Santa Barbara, Calif.
- 9ZZT, White, Lt., address unknown.

Operator's license only:

- Kahan, S/Sgt., foreign duty.
- Watkins, Pfc., foreign duty.
- Wilson, Cpl., foreign duty.

NAVY—SPECIAL DUTY

- 2JIB, Schober, RT, address unknown.
- 2NVR, Neuman, RT1c, foreign duty.
- 3FXN, Scully, RT3c, Bellevue, D. C.
- 3JIA, Versace, RT3c, Bellevue, D. C.
- 4EEX, Inock, Lt. (jg), foreign duty.
- 5FBI, Howell, RT1c, foreign duty.
- 5HZM, Scharath, RT3c, address unknown.
- 5KHY, Kafoury, RT1c, foreign duty.
- 5ERM, Collett, Ens., Treasure Island, Calif.
- 6KMM, Hull, CRT, foreign duty.
- 6QEI, Spiekerman, RT1c, foreign duty.
- 7ITL, Taylor, RT1c, foreign duty.
- 8VGU, Ferraro, RT, foreign duty.
- 9BXH, Wright, RT1c, Washington, D. C.
- 9HGN, Hedin, RT3c, Farragut, Idaho.
- 9THI, Stockberger, RT3c, Bellevue, D. C.
- 9WIK, Diehl, RdM2c, foreign duty.
- 9YXL, Clay, RT3c, Little Creek, Va.

Operator's license only:

- Nelson, RT1c, foreign duty.
- Stoddart, RT2c, foreign duty.

NAVY—AERONAUTICS

- ex-1JBR, Storrs, ART1c, foreign duty.
- 4FZL, Hudson, ART1c, foreign duty.
- 7IET, Smith, ARM1c, address unknown.
- 8IDJ, Moore, ACRM, Banana River, Fla.
- 8OAN, Paul, ART2c, foreign duty.
- 8QFJ, Kostir, Ens., Philadelphia, Pa.
- 8WNW, Kohler, A/C, Northfield, Minn.
- 9RXX, Lanyon, RM1c, Olathe, Kans.
- 9TPY, Victor, ART1c, Clinton, Okla.



Though widely separated now, at the time of this picture these OMs were among the amateurs in a Signal Corps platoon in North Africa awaiting the invasion of Sicily. L. to r.: Lt. Robert Crynack, W8RTQ; M/Sgt. J. A. Stippick, W9BLB; T/Sgt. A. J. Kovcs, W8RCX; Cpl. Arthur Johnson, W2MWA, and T/Sgt. C. M. Duer, W5KLS.

ARMY—SIGNAL CORPS

WE UNDERSTAND we have no cause to worry about the distribution problem once *QST* reaches "W9-Mad-Hungry-Boisterous" over in Italy. Lt. Mills tells us his copy is regularly stolen from him within 48 hours after delivery. Might be a bunch of hams in his unit—what?

1CUC, Wade, Lt., foreign duty.
 1KQR, Gaynos, Lt., Camp Finedale, Calif.
 1MEZ, Frazier, Camp Crowder, Mo.
 1NMK, James, Sgt., foreign duty.
 2AJX, Marcus, Pfc., Camp Crowder, Mo.
 2BPWF, Silverman, Pvt., Camp Crowder, Mo.
 2FGD, Flessel, W/O (jg), foreign duty.
 2IBY, Dillon, Camp Crowder, Mo.
 2IPP, Green, 2nd Lt., Ft. Monmouth, N. J.
 2JOF, Webb, Cpl., Camp Crowder, Mo.
 2LFP, Stecker, Lt., foreign duty.
 2MCR, Weinberg, Ft. Monmouth, N. J.
 2MLM, Lindemann, 2nd Lt., Ft. Monmouth, N. J.
 2MGP, Nicolini, Maj., Boston, Mass.
 2NCG, Golyznik, Pvt., Camp Crowder, Mo.
 2NLW, Kiesling, Camp Crowder, Mo.
 2NGV, Kenigson, Lt., foreign duty.
 2OBJ, Vignali, Pfc., Ft. Monmouth, N. J.
 ex-3AGE, Chromy, Capt., Washington, D. C.
 3ICU, Paul, 2nd Lt., Ft. Monmouth, N. J.
 3JFR, Duvall, Camp Crowder, Mo.
 3RT, Knight, Capt., Ft. Monmouth, N. J.
 4HZA, Madden, Pfc., Norfolk, Va.
 ex-5C9P, Cooper, 2nd Lt., foreign duty.
 5FFJ, Vestal, foreign duty.
 5FYJ, Culmer, 2nd Lt., Ft. Monmouth, N. J.
 6DAN, Ritter, Lt., Kelly Field, Tex.
 6HRB, Breeding, Lt. Col., Lynwood, Calif.
 6KLO, Mellin, S/Sgt., Ft. Monroe, Va.
 6NCS, Tesche, 2nd Lt., Ft. Monmouth, N. J.
 6REB, Lawrence, M/Sgt., foreign duty.
 6REK, Helf, foreign duty.
 6RPZ, Ketchum, Pfc., Davis, Calif.
 6RXW, Badger, Pvt., Camp Butler, N. C.
 6THH, Harrington, 2nd Lt., Ft. Monmouth, N. J.
 K6TMM, Letendre, M/Sgt., foreign duty.
 7AXE, Hofstatter, S/Sgt., foreign duty.
 7EYJ, Ains, T/3, foreign duty.
 7FC, Carlson, Pvt., Camp Crowder, Mo.
 8EJK, Evans, Lt., foreign duty.
 8EYU, Beal, Capt., foreign duty.
 8RET, Masters, Camp Crowder, Mo.
 8HR, Anderson, Pvt., Camp Crowder, Mo.
 8JNL, Stringer, Camp Crowder, Mo.
 8MAW, Hagen, Camp Crowder, Mo.
 8MOG, Haines, Lt., foreign duty.
 8MQX, Wagner, T/Sgt., foreign duty.
 8NGO, Vogt, S/Sgt., foreign duty.
 8OGN, Hallack, T/4, Camp Campbell, Ky.
 8OQN, Lipscomb, T/3, foreign duty.
 8PZL, Ziniuk, Pfc., Camp Crowder, Mo.
 8RMR, Shurtleff, Pvt., Camp Crowder, Mo.
 8SBY, Brown, 2nd Lt., Ft. Monmouth, N. J.
 8SNE, Wozniak, Lt., Ft. Benning, Ga.
 8TYV, Falzalar, Pvt., Camp Crowder, Mo.
 8VLX, Sweeney, Pvt., Ft. Monmouth, N. J.
 9AQH, Hansen, Lt., Robins Field, Ga.
 9GDD, Simmons, Cpl., foreign duty.
 9DMD, Wilke, M/Sgt., Nashville, Tenn.
 9ELZ, Jackson, Camp Crowder, Mo.
 9FFO, Green, Cpl., Petaluma, Calif.
 ex-9FFY, Kerns, Lt., Cambridge, Mass.
 9FMP, Dawson, Lt., foreign duty.
 9GZU, Rensch, Camp Crowder, Mo.
 9HHE, Lorenz, Camp Crowder, Mo.
 9JUE, Stachura, Capt., Upper Darby, Pa.
 9JZI, Jones, Camp Crowder, Mo.
 9LDZ, Kash, Cpl., foreign duty.
 9NSS, Johnson, Sgt., foreign duty.
 9NTU, Simmons, Sgt., Camp Fickett, Va.
 9QAG, Lutz, T/3, foreign duty.
 9QPT, Kwietniewski, S/Sgt., Camp Campbell, Ky.
 9QQN, Rodgers, Camp Crowder, Mo.
 ex-9QZS, Daley, T/5, address unknown.
 9SBF, Meisel, Sgt., foreign duty.
 9SEK, Hammers, Pvt., Camp Roberts, Calif.
 9TWC, Kennedy, Capt., foreign duty.
 9TXV, Settles, Lt., foreign duty.
 9VLR, Anderson, T/4, foreign duty.
 9VRP, Roeker, T/3, address unknown.

9WOB, Snider, T/Sgt., Davis, Calif.
 9ZBY, Palmer, T/Sgt., foreign duty.
 Operator's license only:
 Cole, Pvt., Ft. Monmouth, N. J.
 Deeg, Cpl., foreign duty.
 Fucile, T/5, foreign duty.
 Harman, Pvt., Ft. Monmouth, N. J.
 Kennedy, Sgt., foreign duty.
 Levine, Cpl., foreign duty.
 Malvern, Pvt., Camp Crowder, Mo.
 Mooney, Pvt., Camp Crowder, Mo.
 Rheinfrank, Sgt., foreign duty.
 Smith, Sgt., Camp Adair, Ore.
 Tedesch, T/4, foreign duty.

NAVY—GENERAL

1COM, Ashton, S2c, Sampson, N. Y.
 1GPF, Read, Lt., Cambridge, Mass.
 1LIV, Bowen, RM1c, foreign duty.
 1LZX, Neilson, S1c, Great Lakes, Ill.
 1NDR, Sienko, A/S, Sampson, N. Y.
 1NNG, Arnfield, S1c, address unknown.
 2FYQ, Lindstrom, EM1c, foreign duty.
 2KCK, Vriesenga, A/S, Sampson, N. Y.
 2OAC, Earnshaw, S2c, Camp Endicott, R. I.
 3CRB, Kirk, EM3c, foreign duty.
 3CZM, Welsh, RM3c, address unknown.
 ex-3FEF, Patterson, Comdr., foreign duty.
 3HCQ, Hall, Lt., Corpus Christi, Tex.
 3HLY, Blair, RM3c, Bainbridge, Md.
 3HYT, Kass, RM2c, foreign duty.
 5GEL, Douglas, S1c, Great Lakes, Ill.
 5HOX, Robison, A/S, San Diego, Calif.
 5ICW, Taylor, RE, foreign duty.
 6ANH, Crystal, RM1c, San Pedro, Calif.
 ex-6HJO, Young, CEM, foreign duty.
 6NRH, Myers, RM1c, foreign duty.
 ex-6PLL, Calder, RM1c, foreign duty.
 6QAE, Vincent, EM1c, foreign duty.
 6QXC, Cazin, RM1c, foreign duty.
 6RCT, Dickerson, S2c, Port Hueneme, Calif.
 6TBB, Schinnerer, SoM2c, foreign duty.
 6TTG, Townsley, W/O, address unknown.
 K7CPK, Cameron, EM1c, Port Hueneme, Calif.
 8BHE, Gearhart, Lt. (jg), address unknown.
 8DRE, Irwin, Lt., foreign duty.
 8QYV, Connell, RM1c, foreign duty.
 8SOZ, O'Connor, A/S, Sampson, N. Y.
 8SUX, Hayler, Lt. (jg), foreign duty.
 8UNU, Pease, Ens., Ft. Schuyler, N. Y.
 9COX, Bullen, Lt. (jg), Brunswick, Me.
 ex-9ELV, Elliott, S1c, Great Lakes, Ill.
 9IML, Gugler, Lt. (jg), Mare Island, Calif.
 9MRJ, Kusnetz, S2c, address unknown.
 9NMA, Wight, S1c, Great Lakes, Ill.
 9OLE, Hausske, S1c, Del Monte, Calif.

Operator's license only:

Carbee, RM1c, Boston, Mass.
 Hilton, S1c, Chicago, Ill.
 Lees, SM1c, Miami, Fla.
 Mogg, RM3c, Brooklyn, N. Y.
 Opitz, RM2c, address unknown.
 Philactos, S1c, foreign duty.
 Sharpe, A/S, Ann Arbor, Mich.
 Tagger, address unknown.
 Trautwein, A/S, Ithaca, N. Y.
 Wells, A/S, Durham, N. C.
 Wolk, S2c, foreign duty.

ARMY—GENERAL

THOSE convenient little amateur war service forms, printed under "Happenings of the Month" in each issue, are wending their way back to us after being routed out of the oddest places. One such came from S/Sgt. J. H. Bottomley, W4DLI, who found the November, 1943, copy in a maze of magazines in Portuguese print somewhere in Brazil.

1DLZ, Cilicus, S/Sgt., Ft. Knox, Ky.
 1JY, Darchik, S/Sgt., Camp Stewart, Ga.
 2BRN, Bogart, Pvt., foreign duty.
 2GT, Hopper, Capt., foreign duty.
 2MKJ, Bors, Sgt., foreign duty.
 3CPS, Klecha, Pvt., Ft. George Meade, Md.
 4HJT, Jacobs, Capt., Ft. Benning, Ga.
 5LRE, Whitehouse, Capt., Ft. Riley, Kans.
 5KQX, Parsons, T/5, foreign duty.
 6QYL, Westervelt, Col., foreign duty.
 6TRT, Ibarra, T/4, Camp San Luis Obispo, Calif.
 ex-7DOP, Molver, S/Sgt., Ft. Stevens, Ore.
 7GHT, Smith, Lt., foreign duty.
 7GZQ, Kingshott, T/4, foreign duty.
 8BYS, Taylor, Lt. Col., foreign duty.
 8HY, Chop, Sgt., Camp Stewart, Ga.
 8QER, Monath, Pvt., Ft. Knox, Ky.
 8TPQ, Bartlow, Sgt., Ft. Leonard Wood, Mo.
 8VUV, Kane, Pvt., Camp Davis, N. C.
 8WLQ, Mitchell, Pvt., Camp Davis, N. C.
 8WVD, Maruna, Pvt., Camp Walters, Tex.
 9BDD, Swarts, S/Sgt., Camp Polk, La.
 9DKS, Sharp, Sgt., foreign duty.



Members of the 45th "Thunderbird" Division Signal Company, these hams are maintaining communications for the Fifth Army in Italy. *Kneeling, l. to r.:* Sgt. J. G. Dube, W2HVC; T/Sgt. T. R. McLean, OPLO; and Sgt. W. W. Harr, W2GEZ. *Standing, l. to r.:* Cpl. E. Cook, OPLO; Cpl. W. Potts, W7FJY; Sgt. A. Foster, W8OSH; and Sgt. G. F. Huether, W2HO. See Correspondence from Members, p. 64 in this issue for further details.

9FJN, Wolpe, Pvt., Camp Edwards, Mass.
 9GRB, Schreurs, T/Sgt., foreign duty.
 ex-9IOX, Nash, Pvt., foreign duty.
 ex-9IRA, Moore, Pvt., Ft. Leonard Wood, Mo.
 9IWT, Stolberg, Pvt., foreign duty
 9TDO, Schalett, Pvt., foreign duty
 9VNT, Smith, Pfc., Camp Gruber, Okla.
 9ZHX, Gerth, Pvt., Ft. Riley, Kans.

COAST GUARD

It seems the register the hams have set up for themselves in a well-known Waikiki restaurant has become very famous since our write-up in this column in April. The following calls have joined the thirteen previously published: W1AZT, W1EBO, W2HPA, W3ARD, W3DIA, W3DNP, W3FYK, W4CXE, W6BIP, W7CEY, W7CLH, W7CZ, W7DBM, W7INK, W8MHY, W8SWV, W8TIG and W9WGH.

1AUI, Cox, RT1c, Groton, Conn.
 1DEC, Anderson, CRT, foreign duty.
 ex-1LLC, Alley, RT2c, Groton, Conn.
 2CST, Dolan, CRT, St. George, N. Y.
 2ILV, Wright, RM1c, foreign duty.
 ex-3BGX, Blake, Lt., Norfolk, Va.
 3HGV, Covington, Brooklyn, N. Y.
 5KTO, Lyon, S2c, Silver Spring, Md.
 6OXM, Ribarich, Lt. (jg), Miami, Fla.
 6PCK, McCulloch, Lt. (jg), Long Beach, Calif.
 6PFQ, Dudley, CBM, San Diego, Calif.
 6RUF, Strauss, RM1c, foreign duty.
 8SEU, Castor, RT2c, foreign duty.
 ex-6SPG, Duffen, CRM, foreign duty.
 8SQS, Schmidt, PhM3c, New London, Conn.
 6SWB, Stephens, RM3c, foreign duty.
 8TTR, Yeagley, RM3c, Atlantic City, N. J.
 8UAB, Johnston, S2c, Atlantic City, N. J.
 9HYU, Risvold, ARM1c, Lindbergh Field, Calif.
 9JQK, Seielstad, Lt. Comdr., Long Beach, Calif.
 9QVS, Hebson, RT2c, Groton, Conn.
 9SEH, Jones, RT2c, foreign duty.

Operator's license only:

Ciszek, CRM, Manhattan Beach, N. Y.
 Perciach, ARM1c, Elizabeth City, N. C.
 Zink, ARM2c, Elizabeth City, N. C.



Obviously enough, Charles S. Howard, W2MQS, is a photographer's mate first class in the Navy and here he is in his working togs, ready for action. In pre-Pearl Harbor days he worked for the New York Times and held a basic AEC certificate.

100 PER CENT WAR WORK—INDUSTRY

Bath Iron Works:

IAPR, White, T. P., Portland, Me.
 IATA, LeBourdais, J. E., Lewiston, Me.
 IAXT, Black, C., Bath, Me.
 IAZS, Rittall, W., Bath, Me.
 IBEW, Giroux, D., Waterville, Me.
 I8HI, Mailhot, L., Lewiston, Me.
 I8VK, Beattie, R., Farmingdale, Me.
 I8WO, Fisher, G., Bar Harbor, Me.
 ex-ICGF, Robbins, M. H., Bath, Me.
 I1DH, Grimes, C. C., Gardiner, Me.
 I1JS, Ripley, F., Rockland, Me.
 I1CH, Dodge, H., Bath, Me.
 I1CJ, Crooker, L., Bath, Me.
 I1ZW, Daley, V., Rockland, Me.
 I1GP, Lee, A. W., Auburn, Me.
 I1GX, Pomeroy, J. E., Bath, Me.
 I1HS, Haley, C. E., Woolwich, Me.
 I1XR, Shaw, C. W., Bath, Me.
 I1FF, Bateese, R. I., Damariscotta, Me.
 I1IE, Castner, H. W., Damariscotta, Me.
 I1RD, Duncan, J. R., East Brunswick, Me.
 I1CM, Dupont, L., Bath, Me.
 I1HX, Rachliff, C. L., Gardiner, Me.
 I1MM, Haines, J., Waterville, Me.
 I1WX, Marquois, R., Hallowell, Me.
 I1AP, Dupont, D. F., Farmingdale, Me.
 I1FU, Littlefield, R. D., Monroe, Me.
 I1ML, McGown, C., East Boothbay, Me.
 I1DC, Ward, R., Augusta, Me.
 I1NJ, McPhee, F. L., Boothbay Harbor, Me.
 I1NQ, Peters, J., Pittston, Me.
 I1NR, Carles, R. C., Bath, Me.

Stromberg-Carlson:

1JJM, Kempton, K., Newport, N. Y.
 1MJU, Clarke, D., Rochester, N. Y.
 ex-3II, Suplee, D., jr., Philadelphia, N. Y.
 5IAH, Thompson, W., Rochester, N. Y.
 7IGC, Sharp, A., Rochester, N. Y.
 8AVF, Skiff, D. C., Rochester, N. Y.
 8BCL, Waterbury, A., Rochester, N. Y.
 8DZL, Robinson, H., Rochester, N. Y.
 SDFN, Jobs, R., Rochester, N. Y.
 ex-8DIM, Ling, W., Rochester, N. Y.
 8DKN, Reynolds, F. L., Rochester, N. Y.
 ex-8DMY, Jaffesen, A., Rochester, N. Y.
 ex-8DOH, Barlow, W., Rochester, N. Y.
 ex-8DRC, Mulcahey, J., Lyons, N. Y.
 ex-8EHI, Caputo, S., Rochester, N. Y.
 ex-8GFW, Maichle, R., Rochester, N. Y.
 ex-8ILQ, Langworthy, W., Rochester, N. Y.
 8JDB, Maine, H., Ithaca, N. Y.
 8JKJ, Litzenberger, R., Rochester, N. Y.
 8JPF, Ideman, G., Rochester, N. Y.
 8JPJ, Lawson, M., Rochester, N. Y.
 8JPT, Punch, E., Rochester, N. Y.
 8JQV, Talpey, D., Rochester, N. Y.
 8JSR, McMahon, W., Rochester, N. Y.
 8JXU, Ackley, K., Rochester, N. Y.
 8KAU, Kryszewski, F., Rochester, N. Y.
 8KSW, Halpin, L., Rochester, N. Y.
 8MNV, Wheeler, W., E. Bloomfield, N. Y.
 8MND, Wyman, B., Rochester, N. Y.
 8MTD, Smith, J., Rochester, N. Y.
 8MZU, Freeland, K., Rochester, N. Y.
 8OQD, Merle, C., Rochester, N. Y.
 ex-8PLX, Welch, P., Rochester, N. Y.
 8RTB, Young, R., Rochester, N. Y.
 8RWG, Glavign, F., Rochester, N. Y.
 8SQT, Schmidt, P., Rochester, N. Y.
 8SYO, Cater, B., Brockport, N. Y.
 8TEX, Bauer, O., Rochester, N. Y.
 8TQV, Rutherford, A., Ogdensburg, N. Y.
 8TRC, Goldberg, L., Rochester, N. Y.
 8TXB, Ketz, A., Rochester, N. Y.
 8UBT, Hartman, C., Rochester, N. Y.
 8UIB, Laughton, R., Rochester, N. Y.
 8VGN, Williamson, C. B., Rochester, N. Y.
 ex-8VR, O'Connor, D., Rochester, N. Y.
 8WVT, Langalov, J., Rochester, N. Y.
 8WCD, Vanderbilt, A., Williamson, N. Y.
 8WII, Parmele, E., Rochester, N. Y.
 8WQV, Holtz, E., Newark, N. Y.
 ex-9AWV, Haskins, F., Rochester, N. Y.
 ex-9JCP, DeMers, E., Rochester, N. Y.
 9KRA, Robinson, J., Rochester, N. Y.
 9PPB, Pederson, E., Rochester, N. Y.
 9TYG, Jacobson, R., Rochester, N. Y.

Operator's license only:

Kane, A., Rochester, N. Y.
 Patenall, B., Rochester, N. Y.
 Paterchak, J., Rochester, N. Y.
 Portella, E., Rochester, N. Y.

CIVIL SERVICE

1AUG, Clafin, SC, radio technician, Boston, Mass.
 1AU9, Izart, radio engineer, Greiner Field, N. H.
 1BVN, Colby, CAA, radio engineer, Washington, D. C.
 1CDT, Harmon, CAA, Knoxville, Tenn.
 ex-1JJD, Shea, Navy Dept., radio engineer, Kensington, Md.
 ex-2DQQ, May, SC, radio operator, Washington, D. C.
 2GTS, Angostat, War Dept., radio engineer, foreign duty.
 2LQ, Elliott, OWI, foreign duty.
 2MNS, Obermiller, FCC, Washington, D. C.
 2OOJ, Estes, CAA, radio engineer, Washington, D. C.
 2PS, Caggiano, SC, radio technician, Brooklyn, N. Y.
 3CSZ, Smith, CAA, radio engineer, Washington, D. C.
 3DWA, Brassington, SC, inspector, Cincinnati, Ohio.
 3PHD, Uphoff, Cambridge, Mass.
 3HL, Gilbert, CAA, Washington, D. C.
 31NR, Williams, CAA, radio engineer, Washington, D. C.
 3IUL, Graham, Navy Dept., radio mechanic, San Bruno, Calif.
 3JOA, Pickard, CAA, radio engineer, Washington, D. C.
 4AAK, Mann, War Dept., Fayetteville, N. C.
 4BZA, Thomas, CAA, foreign duty.



Another ham whose motto is "Semper Paratus." This time it's RT1c Harry W. Blochle, W2CVO, who has been in the Coast Guard since 1942 and an amateur since 1930. Harry has been overseas for many months now and took an active part in the invasion of Sicily and Salerno.

4DYX, Cagle, CAA, foreign duty.
 4IHH, Lindsey, CAA, foreign duty.
 4HO, Taylor, Tulsa, Okla.
 ex-5DZB, Fritts, Sacramento, Calif.
 5FGX, Peay, CAA, radio engineer, Washington, D. C.
 5FKY, DeLacerda, SC, Lexington, Ky.
 5ROA, McClellan, CAA, radio engineer, Washington, D. C.
 5HZP, Martin, AAF, radio mechanic, Columbus, Miss.
 5IRJ, Dansby, instr., Kelly Field, Tex.
 5PO, Ousley, SC, radio mechanic, Camp Mazy, Tex.
 ex-5ZAK, Patchin, SC, inspector, Hollywood, Calif.
 6BGF, Wenz, SC, radio engineer, Arlington, Va.
 6COV, Conn, radio mechanic, Patterson Field, Ohio.
 ex-6CQY, Rogers, Navy Dept., address unknown.
 6BKQ, Edises, radio inspector, Alameda, Calif.
 ex-6CIV, Triplett, CAA, radio engineer, Washington, D. C.
 6GWD, Demey, AAF, instructor, Hancock Field, Calif.
 6KGM, Kemp, AAF, Camp Kearns, Utah.
 6MKX, Anderson, Sacramento, Calif.
 6RIG, Westlake, CAA, Washington, D. C.
 6TYQ, Christian, CAA, aircraft communicator, Elko, Nev.
 ex-7AEC, Simson, CAA, Washington, D. C.
 7DBZ, Johnson, CAA, aircraft communicator, Medford, Ore.



T/Sgt. R. E. Wheaton, W9EUJ, is serving with the Marines and putting his ham experience to good use. Though our last military address for him was Corpus Christi, Tex., we know that his home town is Hobart, Ind. W9EUJ has been an active ARRL member since 1938.

- 7DEZ, Richardson, CAA, radio electrician, Toledo, Wash.
 7DYK, Mears, CAA, aircraft communicator, foreign duty.
 7FFJ, Aschoff, AAF, Portland, Ore.
 7FFP, Swarm, CAA, radio engineer, Washington, D. C.
 7FOJ, Parish, CAA, aircraft communicator, Medford, Ore.
 7FSP, Tysdal, CAA, aircraft communicator, Medford, Ore.
 7HGO, Unger, Sacramento, Calif.
 ex-7IS, Mattmueller, CAA, Washington, D. C.
 8CFT, Mehring, CAA, Washington, D. C.
 8CXG, Jordan, CAA, radio engineer, Washington, D. C.
 ex-8DEE, Kugler, CAA, Washington, D. C.
 8EH, Jefferson, FCC, jr. monitoring officer.
 8FRC, Coleman, OWI, foreign duty.
 8MTD, Smith, Navy Dept., radio inspector, Rochester, N. Y.
 8NF, Blair, CAA, radio engineer, Washington, D. C.
 8NVC, Uryniak, FCC, jr. monitoring officer.
 8QLP, Breetz, NRL, Washington, D. C.
 8SQJ, Beaver, CAA, aircraft communicator, Brookfield, Ohio.
 9GMM, Hoffer, CAA, radio engineer, Washington, D. C.
 9KPL, Albert, AAF, radio mechanic, Mobile, Ala.
 9QED, Ebert, NRL, Washington, D. C.
 9RSL, Miedke, NRL, Washington, D. C.
 9SML, Zaander, NRL, Washington, D. C.
 9SVB, Poutinen, SC, radio mechanic, McClellan Field, Calif.
 9SXX, Anderson, FCC, jr. monitoring officer.
 9THQ, Ainslie, CAA, Ft. Worth, Tex.
 9TXE, Hendricks, AAF, instructor, Delray Beach, Fla.
 9TYO, Halstrom, NRL, Washington, D. C.
 9UIP, Craig, NRL, Washington, D. C.
 9ULQ, Whitaker, CAA, Ft. Worth, Tex.
 9UTD, Krausbaar, SC, radio mechanic, McClellan Field, Calif.
 9UTS, Thomas, Navy Dept., Philadelphia, Pa.
 9VDF, Young, NRL, Washington, D. C.
 9VUH, Chalk, AAF, instructor, Chanute Field, Ill.
 9WKX, Young, NRL, Washington, D. C.
 9WLB, Roberts, NRL, Washington, D. C.
 9WTC, Wuerfel, NRL, Washington, D. C.
 9YSG, Lauder, NRL, Washington, D. C.
 9YUE, Fry, NRL, Washington, D. C.
 9YUQ, Simpson, NRL, Washington, D. C.
 9ZC, Gielhaus, NRL, Washington, D. C.
 9ZDD, Shifflett, NRL, Washington, D. C.
 9ZEW, Oras, NRL, Washington, D. C.
 9ZJP, Rice, NRL, Washington, D. C.
 9ZXD, Hockfield, NRL, Washington, D. C.

Operator's license only:

- Alford, NRL, Washington, D. C.
 Bly, Navy Dept., inspector, Sunbury, Pa.
 Boswell, NRL, Washington, D. C.
 Corbett, NRL, Washington, D. C.
 Davis, NRL, Washington, D. C.
 Daitzer, CAA, aircraft communicator, Houlton, Me.

- Fuchs, AAF, instructor, Truax Field, Wis.
 Good, SC, radio engineer, San Francisco, Calif.
 Keller, AAF, instructor, Scott Field, Ill.
 Krishke, SC, radio mechanic, Moore Field, Tex.
 Lilienfeld, instructor, Truax Field, Wis.
 Matyjewicz, FCC, jr. monitoring officer.
 McQueen, SC, radio mechanic, McClellan Field, Calif.
 Mills, NRL, Washington, D. C.
 Newcomb, FCC, jr. monitoring officer.
 Palmer, NRL, Washington, D. C.
 Pappila, AAF, Scott Field, Ill.
 Pugh, NRL, Washington, D. C.
 Strother, Navy Dept., inspector, Trenton, N. J.
 Taylor, NRL, Washington, D. C.

MERCHANT MARINE

- 5AAM, Wong, address unknown.
 5DC, Holthy, address unknown.
 5FQ, Clarkson, address unknown.

100 PER CENT WAR WORK—INDUSTRY

- 1JT, Taylor, F.
 2GT, Deeks, R.
 2HF, Ward, L.
 2IN, deGray, E. H.
 3AAF, Miller, H. R.
 3AAP, English, H.
 3ACL, Nixon, I.
 3ADF, Callahan, R.
 3AEW, Millen, T.
 3AFQ, Thornhill, J. R.
 3AGP, Law, N. K.
 3AIB, Weir, J. L.
 3AJD, Ward, R. F.
 3AJT, Perrin, G. C.
 3ALC, Richards, G. A.
 3AIS, Macdonald, M. C.
 3AMK, Saville, D.
 3AOJ, Cates, G.
 3AOS, Horsfall, L.
 3APU, Kunhyr, S.
 3ASC, Bamford, D.
 3ATT, Gray, R.
 3AUS, Phillips, C. P.
 3AVG, Webster, E.
 3AXZ, Bottomley, G. A.
 3AZC, Stewardson, F. E.
 3BAO, Hogg, W. E.
 3BH, Forbes, D.
 3CS, Allard, E.
 3DN, Harvey, D.
 3EWP, Clark, W. B.
 3GD, Heald, N.
 3GH, Birchard, J. H.
 3GM, Snellgrove, C.
 3GT, Trainer, S. B.
 3HE, Ryan, H. D.
 3LF, Petch, A.
 3ME, Warner, K.
 3NB, Crossman, G. W.
 3QL, Cartmill, L.
 3QS, Organ, P.
 3QT, Cross, M.
 3TO, Potter, R.
 3UQ, Reeve, J. H.
 3UU, Murray, G.
 3VD, Bartman, E.
 3VK, Alsop, F.
 3ZS, Booth, H. K.
 4AAI, Parnley, A.
 4ATR, Posnikoff, P. W.
 4BO, Macdonald, M. A.
 4GM, Davidson, J.
 4HV, Davis, A. P.
 4RS, Sheppard, R. S. B.
 4SD, Bennett, H. J.
 ex-4UB, Hayward, V. A.
 5IO, Reade, M.
 5MQ, Haines, M.

CANADA

THE list of Canadian amateurs serving in uniform is decidedly dwarfed this month by the publication of an FB list of hams working in one of Canada's great industries. We are indeed grateful to VE3ANZ for his effort in compiling this record for us. From an individual amateur war service record sent in by an OM included on the list, we have deduced that the concern undoubtedly is Research Enterprises, Ltd., of Toronto, Ont. We're proud of this list and you should be too—but what of the boys in the armed forces? You wouldn't want this section to lapse into oblivion two months from now, would you? Then how about scaring up some service data on the OMs you know and sending it along to us at once—and pictures also!

At the time we received the poem "The Radar Man" which appeared in this department in the May issue of *QST*, we thought that, because it was sent in by A. C. Jebb, VE4TJ, he was the author. It now turns out that he was merely relaying it to us and that actually the verse was written by Roy Curd, a civil service employee working in 100 per cent war work in California. The error was called to our attention by B. F. Davidson, W6RWO, who states that the poem was written by Mr. Curd nearly two years ago, and adds: "It is interesting to note how far this classic has traveled and that it still retains the original wording."

RCAF

- IDT, Bateman, LAC, foreign duty.
 1JX, Isley, LAC, Moncton, N. B.
 2AJA, Hart, P/O, address unknown.
 2HS, Pooney, P/O, Clinton, Ont.
 3EP, Holden, F/Lt., Trenton, Ont.
 3IT, Staples, F/O, Bagotville, Que.
 4NT, Claydon, F/Lt., foreign duty.
 5AGR, Fuller, Sig. Officer, address unknown.

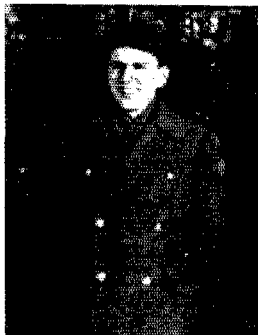

Enlisting in October, 1911, Lt. R. J. Hesler, VEIKS, served with the Royal Canadian Artillery (Medium) for one year, and then was transferred to the Ordnance Corps. He is now in charge of all Army Wireless Maintenance in the Atlantic Command.

An Inexpensive Impedance Bridge

The Principles and Construction of a Laboratory-Type Instrument for C, L and R Measurements

BY ATHAN COSMAS*

INTO the life of every ham there comes a time when the exact measurement of some value of C , L or R is required. It may be of a resistor which is to be used with a delicate relay, a coil for some type of filter, or perhaps a condenser which is needed in a special circuit. What to do? If there is no school laboratory handy, or if there are no friends who happen to own an expensive instrument such as the General Radio Type 650-A Impedance Bridge, the best "out" is to build an impedance bridge which will do the work.

The bridge shown in the accompanying photographs will enable the making of all the measurements which usually are required in ham work. It has many of the fine features of the G-R bridge which it emulates. It will, of course, lack several of the fine points which contribute to the nicety and high accuracy of the expensive laboratory instrument; but it may be made from inexpensive parts, most of which the average ham has on

*73-50 Kessel St., Forest Hills, L. I., N. Y.

Many amateurs who have gone into advanced radio work, either in the armed forces or as civilians in industry, are becoming acquainted with the usefulness of laboratory-type precision measuring equipment. It is safe to say that the post-war ham will be far more "instrument-conscious" than he was in prewar days. He will consider an inexpensive but accurate impedance bridge, such as the one described in these pages, an almost indispensable item of station equipment.

hand, and it will have high enough accuracy for the average type of amateur measurements. The only hard-to-get item is the galvanometer.

Range

The complete circuit diagram of the instrument is given in Fig. 1. It includes a switching arrangement whereby any of the basic bridge circuits shown in Fig. 2 may be obtained.

In Fig. 1, when selector switch S_2 is in the position marked R , the circuit is that of the Wheatstone bridge, shown in Fig. 2-A. With this arrangement any resistance value from 0.01 ohm to 1 megohm can be measured when it is connected across the terminals at the right marked R .

When the switch is turned to either of the positions marked CD or CDQ , the circuit is that of the capacity bridge shown in Fig. 2-B. Any capacity between 100 $\mu\text{fd.}$ and 10 $\mu\text{fd.}$ connected across the C - L terminals can be measured with either of these arrangements. This circuit also provides for two ranges of power factor, 0 to 0.1 with S_2 in the CD position and 0 to 1 with S_2 in the CDQ position.

With the switch thrown to the LDQ position, the circuit is that of the Maxwell bridge shown in Fig. 2-C. This circuit is used to measure the inductance of coils having values of Q up to 10. In the LQ position, the circuit is changed to that of the Hay inductance bridge shown in Fig. 2-D. With it, coils having values of Q up to 1000

Panel view of the impedance bridge. The large dial in the center is the CRL dial, which controls R_{10} . In the upper corners are the knobs for (left) the selector switch, S_2 , and (right) the multiplier switch, S_1 . In the bottom row from left to right are the Q dial controlling R_{12} , the DQ dial controlling R_{11} and the D dial controlling R_{13} . The generator or battery input terminals are located at the bottom, and the detector terminals at the top. The R terminals, to which unknown resistances are connected, are at the left, and the C - L terminals, to which unknown capacities or inductances are connected, are at the right.

Photos by Robert E. Cobaugh, W2DTE

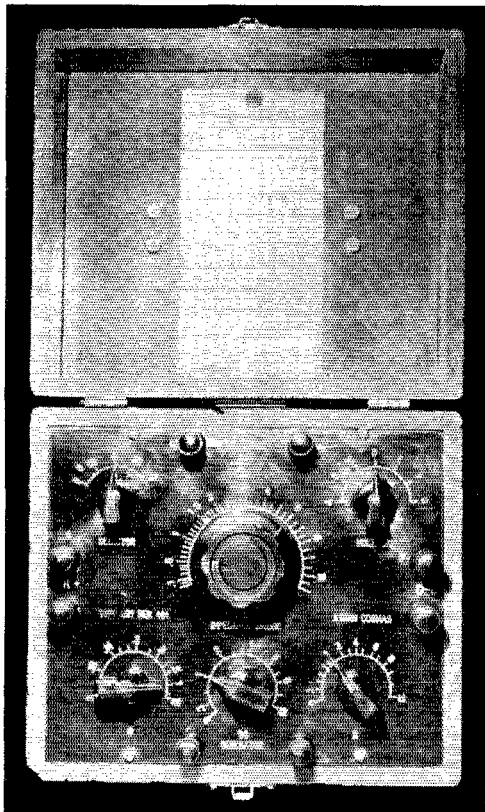

can be measured. The inductance range is from 10 microhenries to 100 henries with either circuit.

For the benefit of those who have not had occasion to work with bridge circuits of this sort in the past, a brief explanation of the operating principles will be given.

Resistance Measurement

Referring to Fig. 2-A, the fundamental bridge circuit consists of four resistance arms. Two of these arms, R_a and R_b , are made up of fixed resistance values which are selected by a dual tap switch, S_1 . The third arm, R_v , consists of a calibrated variable resistor (in this case the resultant of R_9 and R_{10} in parallel, because a variable unit of proper taper could not be obtained), while the fourth arm is composed of the unknown resistance, R_u . G is a d.c. galvanometer which, in effect, indicates the voltage differential between the midpoints of the upper and lower branches.

The object in adjusting the bridge is to arrive at a balanced condition where no current flows through G . In order that no current shall flow through G , it is obvious that its terminals must be at the same voltage. For this to be true, the galvanometer must have each of its terminals connected at the same percentage of the total resistance in each arm. For instance, if R_b has three times the resistance of R_a , then the unknown resistance, R_u , must have three times the resistance of the variable resistor, R_v , when the latter is set for zero galvanometer current. Since R_v is calibrated, it is a simple matter to determine the value of the unknown resistance.

From this reasoning we can set down the following proportion for the condition of zero current through the galvanometer:

$$\frac{R_a}{R_b} = \frac{R_v}{R_u}$$

From this we obtain

$$R_u = \frac{R_a R_v}{R_b} = R_v \left(\frac{R_b}{R_a} \right)$$

It is apparent that the unknown resistance, R_u , must always be equal to the value of resistance at which the variable resistor, R_v , is set, times a multiplying factor represented by the ratio R_b/R_a . If some fixed value is selected for R_a , then a change in R_b alone will change the multiplying factor. Thus, the several resistances (R_3 , etc.) represented by R_b may be considered as multipliers for the range of R_v .

As an illustration, in the instrument shown in the photographs R_a is 10,000 ohms, R_b is also 10,000 ohms (except for the highest resistance range, G in Fig. 1), while the tap switch, S_1 , changes R_b in steps of 10 to 1; i.e., 1 ohm, 10 ohms, 100 ohms, etc., up to 100,000 ohms. The multiplying factors which can be applied to the resistance setting of R_v are, therefore,

$$\frac{R_b}{R_a} = \frac{1}{10,000}, \frac{10}{10,000}, \frac{100}{10,000}, \text{ etc.}$$

or, in decimal equivalents, 0.0001, 0.001, 0.01, etc. Since the useful range of R_v is assumed to be

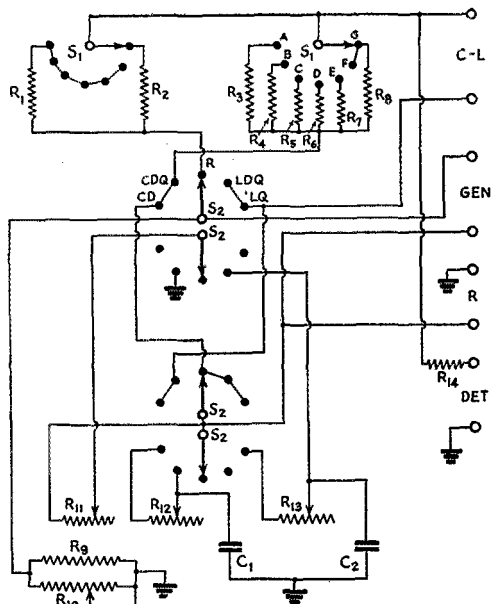

Fig. 1 -- Circuit diagram of the impedance bridge.

C_1 — 0.1- μ fd. mica (see text).

C_2 — 0.01- μ fd. mica.

R_1, R_7 — 10,000 ohms, wire wound.

R_2, R_6 — 1000 ohms, wire wound.

R_3 — 1 ohm, wire wound.

R_4 — 10 ohms, wire wound.

R_5 — 100 ohms, wire wound.

R_8 — 100,000 ohms, wire wound.

R_9 — 41,000 ohms, wire wound.

R_{10} — 15,000-ohm, wire-wound potentiometer.

R_{11} — 16,000-ohm, wire-wound potentiometer.

R_{12} — 165-ohm, wire-wound potentiometer.

R_{13} — 1600-ohm, wire-wound potentiometer.

R_{14} — 70 ohms.

(Note: Odd-size resistance values may be composed

of two or more standard-value resistors in series.)

S_1 — Sections of 2-gang, 7-position rotary switch.

S_2 — Sections of 2-gang, 4-circuit, 5-position rotary switch (Centralab 2515).

from 100 to 10,000 ohms, the successive ranges of resistance measurements which can be made by the bridge are from $100 \times 0.0001 = 0.01$ ohm to $10,000 \times 0.0001 = 1$ ohm when $R_b = 1$ ohm; from $100 \times 0.001 = 0.1$ ohm to $10,000 \times 0.001 = 10$ ohms when $R_b = 10$ ohms; from $100 \times 0.01 = 1$ ohm to $10,000 \times 0.01 = 100$ ohms when $R_b = 100$ ohms etc. Therefore, with the particular values selected for this bridge, the *maximum* resistance measurable in each range is equal to the value of R_b selected by the tap switch, S_1 .

In the wiring diagram of Fig. 1, R_1 and R_2 are the resistors represented by R_a , while R_3 to R_8 are the resistors represented by R_b . R_v represents the resultant of R_9 and R_{10} in parallel. When S_1 is turned to the last tap (G), R_a is changed from R_1 (10,000 ohms) to R_2 (1000 ohms). In this position, R_b (which represents R_8) has a value of 100,000 ohms. The multiplying factor for this range is, therefore,

$$\frac{R_b}{R_a} = \frac{100,000}{1000} = 100.$$

As R_v is varied from 100 to 10,000 ohms, the re-

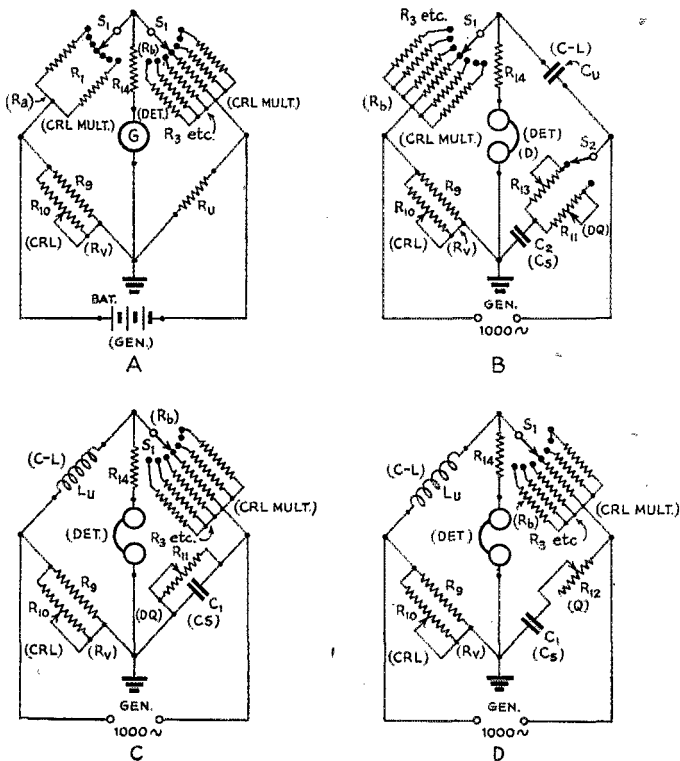

Fig. 2—Basic bridge circuits. A—Wheatstone bridge used for resistance measurements. B—Capacity bridge for measuring capacity and power factor. C—Maxwell inductance bridge. D—Hay inductance bridge.

Labels on components refer to similar components and labels in Fig. 1 and to designations in the text. The respective dials controlling each variable unit also are indicated. In A, a DeJur student galvanometer or its equivalent is suitable for G. The galvanometer is strictly necessary only for low-resistance measurements. The 1000-cycle a.c. source and headphones may be used for measuring the higher resistance values as well as for inductance and capacity.

sistance-measuring range runs from $100 \times 100 = 10,000$ ohms to $10,000 \times 100 = 1,000,000$ ohms = 1 megohm.

In use, the unknown resistance is connected to the terminals marked *R*, the *CRL* multiplier switch, *S*₁, is turned to the approximate value and the *CRL dial*, controlling *R*₁₀, is adjusted for zero galvanometer current. The *CRL dial* reading is taken and the multiplying factor indicated by the position of *S*₁, as shown in Table I, is applied to the *CRL dial* reading to obtain the value of the unknown resistance.

If the bridge is very far off balance when the battery voltage is applied, excessive current may flow through the galvanometer. While *R*₁₄ serves to limit this current, a push-button switch may also be incorporated in series with the galvanometer so that the battery voltage may be applied only momentarily until the arms are adjusted for an approximate balance.

Capacity Measurement

When selector switch *S*₂ is in the *CD* position, the circuit becomes that of the capacity bridge shown in Fig. 2-B. This arrangement is similar to the Wheatstone bridge circuit used

for resistance measurements except that two of the arms contain capacities—one the unknown capacity, *C*_u, and opposite it a known capacity, *C*_s. The principle of obtaining a balance is much the same as that described for the Wheatstone bridge. In order to obtain voltage drops across the condensers, it is obvious that an a.c. source must be used instead of a battery. This is provided by a 1000-cycle generator. In place of the galvanometer a pair of headphones is used as an indicator, and the bridge is balanced when the arms are adjusted to give minimum response in the headphones.

Since the impedance of a condenser is in inverse proportion to its capacity, the expression for a balance becomes

$$\frac{R_b}{C_u} = \frac{R_s}{C_s} \text{ or } \frac{R_v}{C_u} = \frac{R_b}{C_s}$$

From this we obtain

$$C_u = \left(\frac{R_v}{R_b} \right) (C_s)$$

From the above, we see that the ratio *R*_v/*R*_b is the multiplying factor to be applied to the standard capacity to obtain the unknown value, *C*_u. The highest capacity range is made available when *R*_b is set at one ohm. The multiplying factor then

becomes $\frac{R_v}{R_b} = \frac{100}{1} = 100$ when *R*_v = 100 ohms,

and $\frac{10,000}{1} = 10,000$ when *R*_v = 10,000. At

the other end of the range, when *R*_b is set at 100,000 ohms the multiplying factor

is reduced to $\frac{R_v}{R_b} = \frac{100}{100,000} = 0.001$ when *R*_v =

100 ohms and $\frac{10,000}{100,000} = 0.1$ when *R*_v = 10,000

ohms. The standard represented by *C*_s is *C*₂ in Fig. 1. It has a value of 0.01 μfd., to which the above multiplying factors are applied when determining the value of the unknown capacity. The total capacity range varies from 100 μfd.

when $\frac{R_v}{R_b} = 10,000$ to 0.00001 μfd. = 10 μμfd.

when $\frac{R_v}{R_b} = 0.001$. Table I shows the factor by

which the *CRL dial* reading should be multiplied to obtain the capacity in μfd. for each of the ranges set by *S*₁.

Power Factor

When making capacity measurements with the bridge it will be found impossible to obtain a complete balance unless the power factor of the condenser under measurement happens to be the same as that of the standard condenser, because of the difference in phase shifts. A condenser with a power factor greater than zero may be represented by a pure capacity (a condenser without losses) in series with a resistance. Therefore, if the losses of the condenser used as a standard are negligible, the power factor of the arm containing the standard may be made the same as the power factor of the arm containing the unknown capacity by adding resistance (R_{11} or R_{13} in Fig. 2-B) until the circuit is in balance. The setting of the series resistance for balance thus serves as a means for measuring the power factor.

A close approximation of the power factor of a condenser is given by the ratio R/X , which is known as the dissipation factor. Here R is the equivalent series resistance and X the reactance of the condenser. The latter is equal to $\frac{1}{2\pi fC}$ where f is the frequency of the applied voltage in cycles and C the capacity of the condenser in farads. Therefore, in Fig. 2-B,

$$p.f. = \frac{R_s}{\frac{1}{2\pi fC}} = (R_s) (2\pi fC)$$

As an example, we know that the frequency is 1000 cycles and the capacity $0.01 \mu\text{fd.} = (0.01) (10^{-6})$ farads. Substituting these values, we obtain

$$\begin{aligned} p.f. &= (R_s) (6.28) (1000) (0.01) (10^{-6}) \\ &= (R_s) (0.0000628) \end{aligned}$$

R_s represents either of the variable resistances, R_{11} or R_{13} , in the standard arm in Fig. 2-B. R_{11} is in the circuit when S_2 is in the CDQ position. It has a maximum resistance of 16,000 ohms and is controlled by the dial marked DQ . At full scale the power factor of the standard arm is $(16,000) (0.0000628) = 1$. When S_2 is in the CD position the circuit is the same except that R_{13} , with a maximum resistance of 1600 ohms, is substituted for R_{11} . R_{13} is controlled by the dial marked D . When R_{13} is set at maximum the power factor indicated is 0.1. If the DQ dial is marked 0 to 10, its readings should be multiplied by 0.1 to obtain the correct power factor. (See Table III.) Similarly, the D dial reading should be multiplied by 0.01.

In practice, S_1 is first set to the appropriate range for the capacity to be measured. The CRL dial controlling R_{10} is then varied for minimum

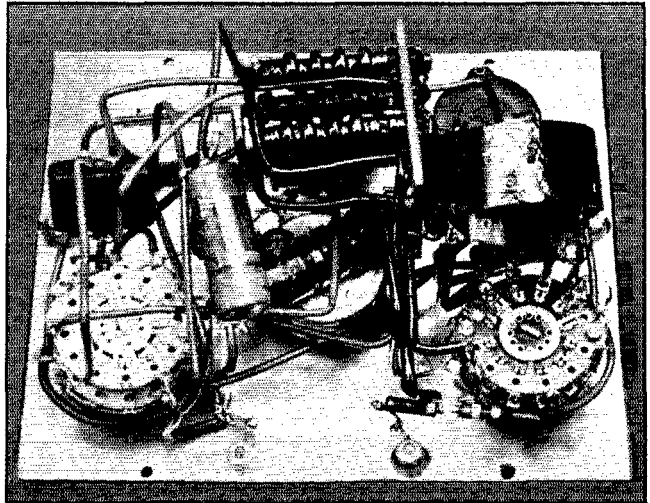

Behind the panel of the impedance bridge. This view shows the multi-tap switches, the fixed standards and the four variable-resistance units.

response in the headphones. Finally, the D or DQ dials and the CRL dial must be carefully juggled back and forth for minimum response. When the positions giving the lowest possible response are found, dial readings of capacity and power factor can be made.

Inductance Measurement

When selector switch S_2 is turned to the LDQ position, the circuit becomes that of the Maxwell inductance bridge shown in Fig. 2-C. The Hay inductance bridge of Fig. 2-D is obtained with S_2 in the position marked LQ . The circuits are the same insofar as the measurement of inductance is concerned; they differ only in the ranges of Q which may be measured.

Since the impedance of a coil is proportional to its inductance while that of a condenser is in

TABLE I

This table shows the multiplying factors which must be applied to the readings of the dial calibrations given in Tables II and III.

Depending upon the position of the multiplier switch, S_1 in Fig. 1, CRL dial readings should be multiplied by the factors shown below to give the correct values in the units indicated.

S_1	For C	For R	For L
A.....	10 $\mu\text{fd.}$	0.1 ohms	100 $\mu\text{h.}$
B.....	1 "	1 "	1 mh.
C.....	0.1 "	10 "	10 "
D.....	0.01 "	100 "	100 "
E.....	0.001 "	1,000 "	1 h.
F.....	0.0001 "	10,000 "	10 h.
G.....	—	100,000 "	—

When making $p.f.$ measurements on the D dial, multiply the dial reading by 0.01.

When making $p.f.$ measurements on the DQ dial, multiply the dial reading by 0.1.

When making Q measurements on the DQ dial, multiply the dial reading by 1.

When making Q measurements on the Q dial, multiply the dial reading by 100.

TABLE II

This table shows how the *CRL* dial controlling R_{10} should be marked to be direct reading for various resistance settings. For example, when the parallel combination of R_9 and R_{10} in Fig. 2 is adjusted to a resistance of 1500 ohms, the *CRL* dial scale should be marked 1.5.

<i>CRL</i> Dial	Resistance in Ohms	<i>CRL</i> Dial	Resistance in Ohms
0.....	0	2.2.....	2,200
0.05.....	50	2.4.....	2,400
0.1.....	100	2.6.....	2,600
0.2.....	200	2.8.....	2,800
0.3.....	300	3.0.....	3,000
0.4.....	400	3.5.....	3,500
0.5.....	500	4.0.....	4,000
0.6.....	600	4.5.....	4,500
0.7.....	700	5.0.....	5,000
0.8.....	800	5.5.....	5,500
0.9.....	900	6.0.....	6,000
1.0.....	1,000	6.5.....	6,500
1.1.....	1,100	7.0.....	7,000
1.2.....	1,200	7.5.....	7,500
1.3.....	1,300	8.0.....	8,000
1.4.....	1,400	8.5.....	8,500
1.5.....	1,500	9.0.....	9,000
1.6.....	1,600	9.5.....	9,500
1.7.....	1,700	10.0.....	10,000
1.8.....	1,800	10.5.....	10,500
1.9.....	1,900	11.0.....	11,000
2.0.....	2,000		

inverse proportion to its capacity, the condition for balance in the circuits of Fig. 2-C and 2-D is given by

$$\frac{L_u}{R_b} = \frac{R_v}{\frac{1}{C_s}} = R_v C_s$$

$$L_u = R_b R_v C_s$$

From this we see that the product of $R_b R_v$ is the factor by which the numerical value of C_s must be multiplied to obtain the value of the unknown inductance. Both inductance and capacity are expressed in units of similar order; i.e., in henries and farads. In the circuits of Figs. 2-C and 2-D, C_s represents C_1 , which has a capacity of 0.1 μ f., while R_v may be varied from 100 ohms to 10,000 ohms and R_b from 1 ohm to 100,000 ohms, as before.

The smallest multiplying factor is obtained when R_v and R_b are at their minimums of 100 ohms and 1 ohm respectively. Then the factor becomes 100 and $L_u = (100) (0.1) = 10 \mu$ h. (μ h. because C_s is expressed in μ f.). The largest multiplying factor is obtained with the maximum values of resistance for both R_v and R_b , which are 10,000 ohms and 100,000 ohms, respectively. The factor at this end of the range is (10,000) (100,000) = 10^9 and $L_u = (10^9) (0.1) = 10^8 \mu$ h. = 10^2 h. = 100 h. Therefore, the range of the instrument on inductance measurements is from 10 μ h. to 100 h.

As in the case of capacity measurements, it will be found necessary to balance resistive components as well as reactive components in the nonresistive arms. The amount of resistance which must be added in the capacitive arm to obtain minimum response in the headphones may

be used as a measure of the Q (or X/R) of the coil. Since the reactance of the standard condenser,

$$C_s, \text{ is given by } X = \frac{1}{2\pi f C_s}$$

$$Q = \frac{1}{\frac{2\pi f C}{R}} = \frac{1}{2\pi f C R}$$

When selector switch S_2 in Fig. 1 is in the *LDQ* position for the Maxwell bridge circuit of Fig. 2-C, $C_s = C_1 = 0.1 \mu$ f. and $R = R_{11}$, which is the variable resistor controlled by the *DQ* dial and which has a useful range of 160 to 16,000 ohms. The frequency is, of course, 1000 cycles, as before. Substituting these values in the above equation,

$$Q = \frac{1}{(6.28) (1000) (0.1) (10^{-6}) (16,000)} = \frac{1}{10} = 0.1$$

(the factor 10^{-6} in the above denominator being necessary in converting to farads). At the other end of the range of R_{11} ,

$$Q = \frac{1}{(6.28) (1000) (0.1) (10^{-6}) (160)} = \frac{1}{0.1} = 10.$$

Thus the range of this circuit in measuring Q is from 0.1 to 10.

When S_2 is in the *LQ* position to give the Hay bridge circuit of Fig. 2-D the procedure is the same, except that R_{12} , which has a useful range of 16.5 to 165 ohms, is substituted for R_{11} . This gives a range of Q from 10 to 1000.

Constructing Resistance Standards

Most of the constructional details may be observed from the photographs. If the case is made

(Continued on page 86)

TABLE III

This table shows how the *D*, *DQ* and *Q* dials should be marked to be direct reading for each resistance setting of R_{12} , R_{11} and R_{12} (Fig. 2), respectively.

<i>D</i> (R_{12})		<i>DQ</i> (R_{11})		<i>Q</i> (R_{12})	
Dial Reading	Resistance in Ohms	Dial Reading	Resistance in Ohms	Dial Reading	Resistance in Ohms
0.....	0	0.....	0	0.10.....	165
0.1.....	16	0.1.....	160	0.12.....	138
0.2.....	32	1.5.....	800	0.14.....	113
0.4.....	64	1.0.....	1,600	0.16.....	103
0.6.....	96	1.5.....	2,400	0.18.....	92.5
0.8.....	128	2.0.....	3,200	0.20.....	83
1.0.....	160	3.0.....	4,800	0.25.....	66.3
2.0.....	320	4.0.....	6,400	0.30.....	54.3
3.0.....	480	5.0.....	8,000	0.35.....	46.6
4.0.....	640	6.0.....	9,600	0.40.....	40.3
5.0.....	800	7.0.....	11,200	0.45.....	35.6
6.0.....	960	8.0.....	12,800	0.50.....	32.0
7.0.....	1,120	9.0.....	14,400	0.60.....	26.8
8.0.....	1,280	10.0.....	16,000	0.70.....	23.0
9.0.....	1,440			0.80.....	20.1
9.5.....	1,520			0.90.....	17.7
10.0.....	1,600			1.0.....	16.1
				1.5.....	10.8
				2.0.....	8.1
				3.0.....	5.95
				4.0.....	4.1
				5.0.....	3.27
				10.0.....	1.7



IN **QST** 25 YEARS AGO THIS MONTH

THE Darr cover on *QST* for July, 1919, shows a gub sitting idle before his battleship receiver and daydreaming about his amateur shack back home. Seems familiar — only in July of 1919 the war had been won, demilitarization was underway, reception was again permitted, and we were looking ahead to the resumption of transmitting “just as soon as those German persons sign the peace treaty that has been pushed to them.”

The reorganization of the Operating (communications) Department is proceeding gratifyingly. Division managers and district superintendents are hard at work, activity everywhere is at white heat, and we are confident of having a strong and efficient traffic body by the time the restrictions on transmitting are removed. Many vacancies still exist and members desirous of having an active part in the traffic work are invited to communicate. The Treasurer reports that the bond issue by which the League is financing its postwar reorganization is over half subscribed; and *QST*, devoting two pages to a further call for loans, hopes that the job can be finished this month so that the magazine space will be available for technical articles. The new editor introduces himself and there is a photograph, right on the editorial page, complete with Army uniform and choker collar.

Only reception so far is permitted. There is considerable interest in long-wave c.w. reception and The Old Man reports his adventures with it in one of his most famous tales, “Rotten Undamped.” A list of the calls and wavelengths of such stations is contributed by Ensign Charles A. Service, jr., 3ZA, manager of the ARRL Atlantic Division.

The vacuum tube situation isn't too rosy. The round deForest has disappeared. The Marconi W/T Co. of America, “sole distributors for deForest Radio Tel. & Tel. Co.,” advertises the Marconi V.T. — “the only vacuum tube which amateurs can use,” “practically the same electrical constants as the tube used by the Allied armies and navies throughout the war in c.w. transmission and reception,” terminals brought out to a four-prong base. The price is \$7, socket \$1.50 additional. Despite the warning, the Audio-Tron is advertised on the next page. DeForest, however, offers only such things as honeycombs, “units” and a two-step amplifier. Tuska has gone into business for himself, the C. D. Tuska Co., “to sell good but inexpensive apparatus,” and displays a breadboard-style hot-wire ammeter at \$1.50, a wavemeter for \$7, a variable condenser.

A new receiving idea is the use of “Loop Aerials,” under which title the subject is presented to *QST* readers for the first time by “Dr. Radio.” The chief interest, however, lies in preparation

for the resumption of transmitting and there are several technical articles of general advice on that question. It is the editor's opinion that any station that expects to do relaying should use a vacuum-tube detector, because it is reliable and constant and supersensitive. Besides, it is essential with a regenerative receiver, which remains the last word in efficient short-wave reception. Multistage V.T. amplifiers are also entirely practicable. But the main question is the type of transmitter to use. The new editor jumps boldly into this question with a recommendation of c.w. transmission, opening the issue with an article on “Essentials of V.T. Transmitters.” It is the beginning of the *QST* campaign to change amateur radio from spark to c.w. C.w. has the great advantage that the energy is concentrated on one wavelength; the writer has personally seen a distance of 37 miles worked with a small one-tube set with a portable antenna twenty feet high, in daylight, with only three watts of antenna power. On the other hand, it has never been tried in amateur radio and the editor can't be entirely sure how it will work out:

“As undamped transmission becomes general we may experience many new difficulties. It is admittedly very difficult to tune to c.w. at the extremely high frequencies we will be using. We may have a hard time eliminating howls when two near-by transmitters beat upon each other when the ether becomes crowded with amateur c.w. all concentrated on 200 meters. We believe all these difficulties will be solved, but it may be so hard that we will prefer to stick to our sparks. . . . The efficient c.w. offers a possible solution of the interference problem, . . . but who is so bold as to say that the limit has been reached in the improvement of spark sets and that the interference problem may not be unexpectedly solved by some practical method of tuning to spark notes, or to varying decrements, or by some means we don't even dream of now? One thing we can predict: we're all going to see some immensely interesting progress in amateur radio in the immediate future.”

Strays

Joseph Hunter, W3WB, on duty in the Holabird (Md.) Signal Depot Post Office, recently hung out some “bait” to catch migratory hams at the Depot. Getting one of his QSL cards out of moth-balls, he fastened it to the iron grille just outside the window where he dispenses stamps and postal information, hoping that it will bring forth QSOs on the topics cherished by all hams.

Them Wuz the Good Old Days . . .

. . . Or Wuz They?

BY SOURDOUGH

ED THIDDLESBUG lives up at the head of Catfish Pond. He's an old guy and we don't never see him except when he comes down to sell his syrup after the sugarin' season. He come down this year same as ever. While we wuz settin' around waiting for the grading to get finished, Ed had his annual say. Every year he gets off about the same story as last year and the year before on the topic of "Them Wuz the Good Old Days." We ain't got the heart to douse the old fool, and so we just let him maunder on till he runs dry. After all, it's only once a year, and I guess it's about the only fun Ed gets outta life.

Reason Ed comes into this story is because after he left Martha and me began talking over them old days, too. Far as Martha is concerned, she reckons that the only good thing about 'em is that they are gone. That's easy to figger out, what with modern washing machines and all making life easier for the wimmen folk. As for me, guess I'm old enough to remember the early days of ham radio but young enough so I don't live in 'em.

After reading back through my file of *QST*'s (bless the day Martha bullied me into having 'em bound each year) and getting out some of the old log books, I come to the conclusion that them was the good old days *at the time*, but that they look kinda sad in the light of what we know today — and didn't know then. Looking back sorta puts a haze over the things that weren't too good and makes the good times stick out clear.

You take that sync spark transmitter we had up here about twenty years ago. It sure was impressive. By golly, that old blast furnace would reach out as much as 800 miles on a good night! It

TO HOLD A
SIGNAL YOU
HAD TO HOLD
YOUR BREATH

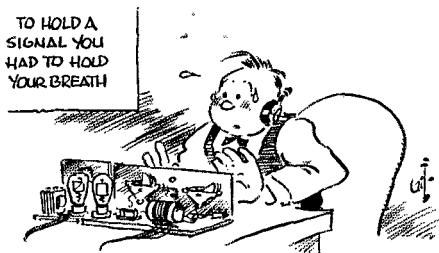

put out a strong smell of ozone and shoved a solid 14 amperes into the aerial. Brahms never wrote a rhapsody as sweet as the music of that gap. Them things I remember clear.

But now let's dig around in the haze a bit. When I used that rig the Polecat County Electric Company used to blame me every time there wuz a surge back up the line. The neighbors weren't rightly interested in my QSOs and they took a nasty view of flickering lights. And when the

power bills came in at the end of the month — whew! Them sure wuz good days *at the time*, but I'd ruther have that prewar 250-watt rig and no ozone. Come the end of the war we'll sure have a better one, too.

'Course, there wuz some things about them early days where there warn't nothing down in the haze — it was all good. When there was only a few fellers on the air we were so glad to see each other that every one was real nice to every one else. Messages got slapped through best a feller could do. There warn't so much of fellers shouldering each other outa the way and riding the next guy down just to make a DX QSO.

Competition is a fine thing but, like most fine things, it can be carried too far. A DX contest is really a high-power radio Olympic Championship contest. Every feller should play as hard as he knows how without beating the rules. Seems like a lot of fellers was running a permanent DX contest in the last couple years before the war. They used to use ECO swooshing as a spearhead attack and their heavy artillery was an oversize kilowatt. When they got all through they'd blasted some little guy handy to them with their ground wave and ruined the tempers of a dozen other guys around the country. The result wuz a single QSO with a DX station and a card later — mebbe. Ain't nothing against high power s'long as it's used decent-like, but it ain't right to abuse it.

Farmers is supposed to be pretty saving folk, but just the same it reminds me of the feller who used his .375 express rifle on rabbits. It sure stopped the rabbit but all he could find was the tip of one ear and some fluff from its tail. Every man to his own fishing pole, but I reckon that a quarter kilowatt works out about right for me from a money as well as from an operating point of view. . . .

One of the brightest moments wuz the first time I stoked up the Reinartz receiver. Before then we used a perambulating tickler coil. My set had a whole raft of Meccano parts to make a reduction gear (about 2000 to 1), but no matter how a feller strained and grunted the doggone thing would go *plop* into oscillation just at the time when the signal was crawling up outa the hash. That job of Johnny Reinartz's we copied religious-like outa *QST*. Seems silly today, but all it amounted to was reaction control with a variable condenser instead of a rotating tickler coil. Didn't seem silly when I first switched it on, though. As the feed-back condenser eased around the set slid smooth into oscillation with a gentle rushing noise. You could build her up right to a knife edge of oscillation and just a lectle past — and out come signals like you never heard before.

The Reinartz receiver *then* was like stepping out of a Model T Ford into a Rolls Royce, but it sure would look sick today. For instance, if another station opened up within a megacycle or so of the one you were listening to that detector bottle got a snob complex and pulled itself over to the stronger of the two. On a very weak DX signal you had to hold your breath and keep your



I GOT MY ALUMINUM FROM THE BODY OF AN OLD CAR

nose from twitching; otherwise the body capacity would change the tuning and lose it for you. Bet TOM's cat got spat on for that more'n any other reason! You young fellers who never knew nothing about the old detector-one-step rigs don't know how well off you are. And I reckon it's safe to assume that after the war we'll have better receivers than ever before, too.

Some of you old-timers will be interested in what I heard t'other day. Young city slicker up from Washington told me that the original John Reinartz has got three stripes on his sleeve and scrambled eggs on his hat now and is in the Radio Division at the Naval Research Laboratory. Reckon *that* guy ain't changed much. Didja ever notice that fellers who have been doing ham radio for a long time don't seem to change much? They get older, sure — but they don't get stodgy and sot in their ideas. Reckon that planning that next rig what's always going to be better than the one you have now kinda keeps a feller young.

Guess the durndest, fussiest, dirtiest, most divorce-making invention of Satan that the old-timers used was them chemical rectifiers. Right at the first we used just the raw a.c. on the plates and signals sounded like a cross between a bad-tempered hog at feeding time and a slow-speed hand saw. Then along came the chemical rectifiers. To begin with you needed a truck to get the stuff together. Four or five dozen quart Mason jars was the minimum. Then you get some borax (I allus held that 20 Mule Team was the best — no advertisement intended). 'Bout twenty-five pounds wuz enough to start with. Next item was sheet aluminum and sheet lead. The lead you could come by pretty easy. In the early '20s aluminum was rare stuff and the pure kind rarer. I got mine from the body of a junked foreign car a feller smashed up when he hit a tree down the road one time. The trimmings needed added up to a gross of nuts and bolts and a 2 × 4 frame — not to mention a bath tub! Had to be a bath tub that was enameled, too; a tin wash tub wuz supposed to be poison.

Well, you lined all the Mason jars up on the rack — no lids on 'em, of course. Then you got a pair of tin snips and grew a crop of blisters cutting out strips of aluminum and lead, one strip of each for each jar. Then you connected 'em all up, aluminum to lead, like a battery. Next, them jars had to be filled. You got a lot of boiling water and made a strong solution of borax in the bath tub and then laded some out into each Mason jar pretty near to the top. If you wuz real fancy you floated a little oil on top of the soup in the jars to keep it from evaporating and creeping. (It never worked!) If all went well you ended up with a bridge rectifier just like the copper-oxide rectifiers we have today.

After making sure your life insurance wuz paid up, you connected the transformer secondary across one side of the bridge and hooked a lamp in series in the primary circuit to reduce the volts and save the fuses. Then you switched it on for a while. This was called "forming" the cells and was unpredictable as a six-month-old colt. Sometimes she blew up; sometimes she boiled over. If luck wuz with you the plates "formed" and you had a rectifier. It wuz a swell rectifier *then*; why, the d.c. didn't have more'n about 40 per cent ripple! Them jars looked right pretty in the dark, too. They blowed — I mean glowed, but they did both — a nice, eerie blue light and there wuz little sparkles of light in 'em like some of you fellers seen in tropical waters. Swell — if only they hadn't crept. That's where the divorces come in. That dadgummed stuff would crawl outa them jars and go creeping around the house, crystallizing here and soaking there. You married fellers know the rest!

Mebbe that sounds kinda glamorous — but it wasn't. Now today you take a couple of little old bottles not much bigger than a receiving tube and shove 'em into a neat, clean, dry little power supply and out comes husky, fat, pure d.c., enough and to spare — and, by golly, you get the blue glow thrown in free!

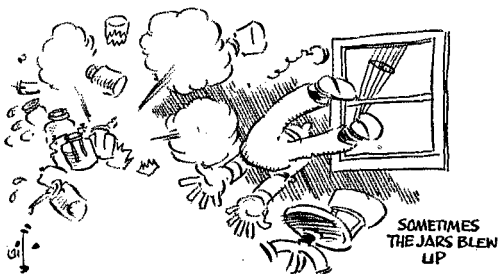

SOMETIMES THE JARS BLEW UP

No! a thousand times *no!* Them wuz swell days then. Wouldn't have missed 'em for anything. But as the feller sez on the radio, "Time Marches On," and the guy who don't march with it is either dumb or ornery. Ed Thiddleslug can look back over his shoulder all he wants to, but you and me — we automatic-like look ahead to doing it better and neater. If we hadn't, ham radio would of dried up and blown away long ago.

Simplifying the Electronic Key

A Single-Tube Arrangement for Automatic Dots and Dashes

BY W/O LAWRENCE G. WILEY,* EX-W9YDA

This article presents still another version of the electronic key. While it may lack some of the refinements of other units of this type described in previous issues of *QST*, none of the essentials of a satisfactory automatic key for dots and dashes has been sacrificed. Yet it is much simpler to build and also less expensive than most of its predecessors.

THE idea of a bug which will make dashes as well as dots automatically has always been fascinating to contemplate. The original electronic key, as described in *QST* by W2ILE,¹ was very ingenious and left little to be desired in the manner in which it performed. Nevertheless, it was felt that something small enough to place on the operating table and still leave room for the receiver would be an improvement. While the simplified version, as described by George Grammer,² met this requirement, it introduced constructional difficulties in the form of a key lever of complicated construction. Inasmuch as neither

* Staff and Faculty, Cavalry School, Dept. of Communications, Ft. Riley, Kansas.

¹ Beecher, "Electronic Keying," *QST*, April, 1940, p. 9.

² Grammer, "An Inexpensive Electronic Key," *QST*, May, 1940, p. 12.

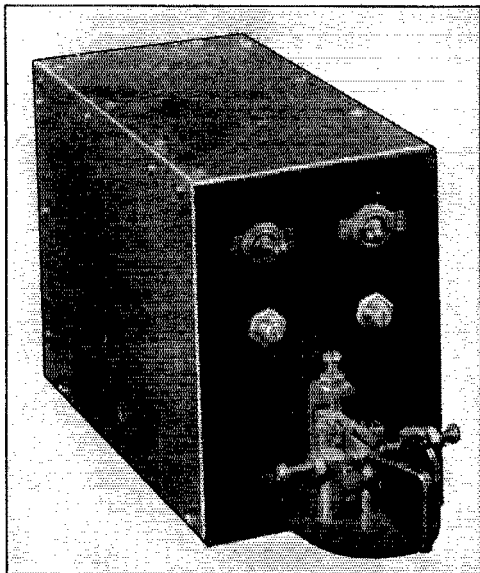

Front or panel view of the electronic key, showing the control lever, speed-adjusting controls and switches.

key seemed to meet the requirements of small size and ease of construction, an effort was made to design one which would.³

It happens sometimes that those who possess a profound knowledge of radio will overlook a simple means of performing a function, while those who are not so clever, such as the writer of this article, will stumble upon some simple method. This is not so surprising when it is considered that those of us who are not so clever are unable to understand anything *other* than that which is simple and straightforward. For that reason, we should not be content merely to follow along behind but, instead, should be constantly trying to simplify the ideas which have been pointed out by the few people who are really clever. Along this line, let us consider for a moment what can be done in the case of the electronic key.

When a voltage is applied to a condenser and resistor in series the condenser does not instantly become charged but consumes an interval of time in doing so, the amount of time being proportional to the values of resistance and capacity in the circuit. Conversely, the same is true when a condenser discharges through a resistor. With the above in mind it was reasoned that, if a condenser were connected to the grid of a vacuum tube and alternately charged and discharged through a resistor, the varying amount of voltage present on the condenser would regulate the amount of current flowing in the plate circuit of the tube. Thus it should be possible to operate a sensitive relay in the plate circuit, the length of time the relay remained open or closed depending upon the value of capacity and resistance in the charge and discharge circuits.

The first problem to be overcome is the need for some method of switching the condenser from discharge to charge. After considerable scratching around with a pencil, it was decided that the plate relay could be used for this job as well as for the actual keying. The practical circuit finally evolved is given in Fig. 1.

Dots

The principle of operation is quite simple. Referring to Fig. 1, when plate and filament voltages are applied to the tube plate current will flow, since the grid is floating with the key open. This plate current operates the relay, opening the keying circuit and applying voltage from the battery to C_1 in series with R_1 , thus charging C_1 . When the key is shifted to the dot position the voltage

³ Another type of electronic key has been described more recently in the article, "New Electronic-Key Circuits," by Gardiner and Page in the March, 1944, issue of *QST*, p. 15.

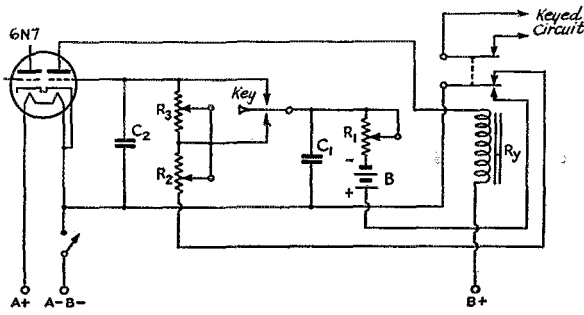

Fig. 1 — Circuit diagram of the simple electronic key.
 C_1 — 2 μ fd. B — 3-volt battery.
 C_2 — 0.01 μ fd. R_y — Sensitive-type relay.
 R_1, R_2, R_3 — 100,000-ohm potentiometer.

present on C_1 is applied to the grid of the tube, cutting off the flow of plate current and thus causing the relay to open. This closes the keying circuit and removes the battery from C_1 , and C_1 begins to discharge through R_2 which is now in the circuit. As soon as C_1 is sufficiently discharged, plate current again starts to flow. This causes the relay again to operate, opening the keying circuit, connecting the battery to C_1 in series with R_1 , and disconnecting R_2 from the circuit. As soon as C_1 becomes charged the relay opens as before and the same cycle of events is repeated. The opening and closing of the relay will continue as long as the key remains in the dot position. If R_1 is made of such size that C_1 charges in the length of time required for a space and R_2 is of such size that C_1 discharges in the length of time required for a dot, then a perfect train of dots will be made.

Dashes

Exactly the same action takes place when the key is operated to the dash position, except that C_1 now discharges through R_2 and R_3 in series. R_3 is made such a size that C_1 discharges in the length of time required for a dash. Since C_1 is still charging through R_1 , which was adjusted for

a proper space, a perfect train of dashes will be made. Opening the key will immediately stop the train of characters, since it disconnects C_1 from the grid of the tube.

The whole idea is so simple that the only surprising thing about it is that someone didn't think of it before. Only a very simple key lever is required and the small number of parts allows the unit to be constructed in a minimum of space.

Construction

The actual construction of the unit is quite simple. The length of leads has no effect on the operation, and the parts can be arranged to suit the artistic taste of the constructor.

The model shown in the photographs uses the circuit of Fig. 1. Condenser C_2 is for the purpose of eliminating a slight chatter in the relay. This chatter is probably caused by an R/C oscillation. C_2 may or may not be needed in other units.

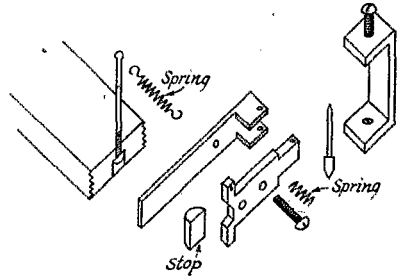
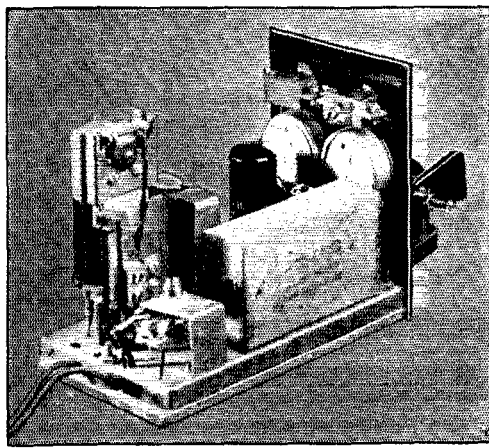
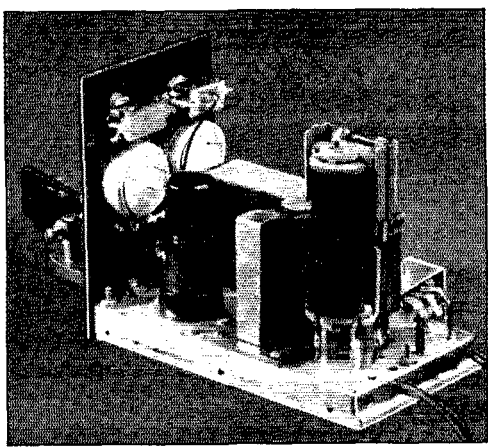

Fig. 2 — Detail sketch of the working parts of the key lever, as discussed in the text.

Since the keying circuit is closed when the relay is open, a switch should be incorporated to open the keyed circuit when plate voltage is removed from the tube. The switch in the 6N7 common lead is the "on-off" switch.

(Continued on page 98)



Left — Right-side view of the electronic key. The 6N7 tube is seen near the panel and the sensitive relay is at the rear. Right — Left-side view of the key assembly. The space-control potentiometer, R_1 , is in the rear corner.



ON THE VERY HIGHS



CONDUCTED BY E. P. TILTON,* W1HDQ

SHORTLY after the outbreak of war we proposed, in these pages, a study of aerology as a substitute for amateur operating activity. The response we received indicated a considerable interest in the subject, but this was at the time when the submarine menace along our coasts was at its height and, as a result, we were scarcely permitted even to print the word "weather," much less to go into a discussion of the means by which weather may be foretold by observation of v.h.f. and u.h.f. signal variation. Our first complete column devoted to the subject, presenting material similar to that which follows, was withheld from publication at that time in compliance with censorship.

Now, with wartime radio developments accentuating the rôle that the v.h.f. and u.h.f. portions of the spectrum are destined to play in the future of all forms of radio activity, it behooves us to learn as much as we can about the effects of weather on propagation at these frequencies. So, if the experienced weathermen in the audience will find something else to do for a few minutes, we shall attempt a sketchy review of some of the points where observing amateurs in both aerology and radio meet on common ground.

Like all sciences, aerology can become very involved in mathematics if one goes into it deeply enough; but, unlike most scientific pursuits, it also affords many opportunities for interesting work for anyone who is equipped with nothing more pretentious than a barometer, a thermometer and a pair of good eyes. If the person so equipped happens to be a ham who is casting about for something to do to while away a spare hour now and then, he will do well to get hold of a receiver which is capable of tuning the frequencies above 30 Mc. With nothing to be

* Contributing Editor, QST.

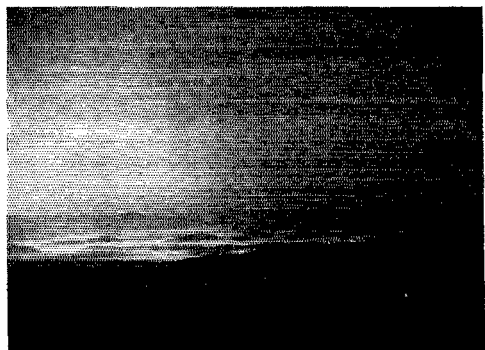

Early morning radiation fog, as it appears here filling the valleys in Vermont's Green Mountains, indicates a mild temperature inversion of the local type, with fair weather and moderate v.h.f. bending in prospect.

heard on Five, and with the probable reception on 112-Mc. limited to the WERS test periods, the f.m. broadcast band now offers undoubtedly the best opportunity for observation of variations in v.h.f. conditions.

By the end of 1941 most of us had already become used to regarding strong v.h.f. signals from beyond visual distances as an advance warning of a storm on the way, but many were content to let the matter rest there. Perhaps there would have been more interest in daily operation on 56 and 112 Mc. in the dear, dead days prior to December 7th if more of us had taken the correlation between radio and weather a little further.

Temperature Inversions

As most extensions of the normal operating range of v.h.f. stations result from a temperature inversion of one sort or another, we should first understand what this term means in order to recognize the visible and audible effects associated with it. We all know that air temperature normally drops with an increase in altitude. The year-round average rate of decrease for the world's atmosphere is about 3° F. for each 1000 feet of altitude. Whenever the rate of decrease (commonly called *lapse rate*) is less than this figure an inversion may be said to exist, even though the air aloft may not actually be warmer than that at ground level. Under certain conditions, to be outlined later, the temperature up to several thousand feet may be several degrees higher than the ground reading.

Bending of v.h.f. waves arises from the fact that the top of the radiated wave hits the warmer and rarer medium first, and thus is accelerated. As the warm air seldom is at any great height the bending usually serves merely to keep the wave traveling more or less parallel to the earth's surface, although in rare instances something approximating a skip zone is noticed. A pronounced inversion at low altitude, a common occurrence in warm weather, may increase the strength of a signal coming from the other side of town; while the maximum distance at which atmospheric bending, uncomplicated by other factors, has resulted in two-way work on 56 Mc. is somewhere between 350 and 400 miles. It is at distances between 75 and 200 miles that the effect of temperature inversions seems to be most pronounced, and the degree of variation in signal strength from night to night is greater with increasing frequency.

Temperature inversions may be said to fall into two general classifications: those resulting from air-mass movement which may be continental in character, and the more limited type resulting from localized atmospheric convection. This is not the place to go into an involved dis-

cession of air-mass analysis¹ other than to say that a temperature inversion results when a mass of warm moist air (such as those originating in the Gulf of Mexico or out over the Pacific) overruns a mass of cool dry air of polar origin. This type of inversion can develop almost anywhere in the United States, at almost any time of the year. As warm moist air is of low density, it overruns the heavier cold air whenever the two types come in contact. The sloping "discontinuity" thus produced means interesting times for the v.h.f. enthusiast.



The familiar fair-weather cumulus, appearing at mid-day or in the early afternoon as the result of warm air rising at a moderate rate, will dissipate in late afternoon. Prediction: fair weather and moderate v.h.f. bending.

Continental Air-Mass Inversions

A typical weather cycle may consist of a period of cool clear weather, with high barometer and good visibility for two or three days; followed by gradually increasing cloudiness and warmer weather until the advent of a storm. Toward the end of the fair stage the strength of v.h.f. signal from points beyond the visual horizon will show a gradual improvement, increasing until about the time that the storm breaks, wiping out the inversion condition. Almost everyone knows from what direction storms come in his own locality. By watching the clouds² and listening for variations in strength of stations in that general direction, the approach of a change in the weather may often be foretold as much as several days in advance.

If one is fortunately situated as to altitude of the receiving location this correlation is particularly striking. An example is the prewar location of W1HDQ, which was several hundred feet above the surrounding country with a clear

¹ "Weather And the Ocean of Air," by Major W. H. Wenstrom (Houghton-Mifflin Co.), provides the most readable discussion of air-mass theory we have yet found. More strictly technical, but still understandable, is the paper, "An Introduction to the Study of Air Mass Analysis," by Jerome Namias and others, contained in the *Bulletin* of the American Meteorological Society, Vol. 17, Nos. 6 and 7.

² The accompanying photographs show the appearance of typical formations. Scenes (1) and (2) were taken from the summit of Glastenbury Mountain, near Bennington, Vermont; the others at various points around Springfield, Massachusetts.

path of 50 miles or more toward the southwest. Here the signal-weather relationship showed up beautifully on 56 and 112 Mc. and, to a certain extent, on 28 Mc. also.

During the evening following a clear day in spring, for instance, 56-Mc. signals might be heard from points as far southwest as Washington, D. C. — more than 300 miles away. Stations all along the line up to Philadelphia, about 200 miles in the same direction, would also be very strong, but signals from the New York area, 125 miles away, would be only slightly above normal. This would place the maximum inversion area below New York.

By the following evening we would have lost the stations below Philadelphia as rain moved up from the southwest, wiping out the inversion as it came toward us. By this time the amateurs in Springfield and Hartford would be working into the New York metropolitan area, with ordinary low-elevation locations at both ends of the 100-150-mile path.

Around this time we would be noticing an increase in the strength of signals from the Boston area and up into New Hampshire, some 90 miles to the northeast. If our period of observation was continuous we would note a sudden drop in the strength of the New York signals, coinciding almost exactly with the arrival of rain in that area. Just preceding this some of the New York stations would have been working up into the Boston area. Cloudiness would have become general over Western New England by this time, and Boston-area signals would be very strong, even though 1200-foot elevations intervene along the path. Until the storm broke signals from the east and northeast would remain strong, though it would have become impossible to hear any but the very strongest stations to the southwest.

Thus far we have been dealing only with the continental air-mass type of inversion, the idealized case described above occurring most frequently during the late spring or early fall. In winter we find the air-mass inversion in a practically pure state, although the extremes of bending are not so great as in warmer weather. In mid-



The rapidly billowing wind-blown cumulus pictured here indicates turbulent conditions aloft. Thunderstorms may follow in warm weather, accompanied by high noise levels and generally poor radio conditions. V.h.f. hams should watch for DX openings in early summer, however.



Cirrus "mare's tails," tell-tale vanguard of an advancing cold front, presage a change from fair to stormy weather and may possibly portend strong v.h.f. bending.

summer the picture can be complicated by so many factors that it took us several months of operation from our Wilbraham Mountain location before we could resolve any very reliable system for predicting weather by radio conditions, or vice versa.

With certain variations, which each observer will have to learn for his own locality, the appearance of the clouds and the movements of the barometer furnish quite reliable warnings of the approach of good v.h.f. weather. With the exception of midsummer a rising barometer means increasing signal strength, while a falling or low barometer indicates lower signal levels. The appearance of cirrus clouds, those beautiful wispy "mare's tails" high in an otherwise clear blue sky, often gives advance warning of the approach of a storm by as much as 36 hours. The old saying about "mackerel scales and mare's tails" is useful for v.h.f. enthusiasts as well as for mariners. A hazy ring around the moon, evidence of warm, moist air aloft, has been recognized as a good sign by five-meter men since the earliest days of work on that band; and the periods around both full moon and new moon invariably are times of improved signal strength. "New moon, full moon, and over thirty on the barometer" is a good rule-of-thumb basis for predicting good times on the very-highs.

Localized Convection Inversions

We come now to the more localized convection type of inversion, a product of hot weather, which gives the boys fortunate enough to be located along our sea coasts, or near the Great Lakes or other large bodies of water or even adjacent to heavily forested areas, some of their most exciting moments.

We all know that heated air rises; when it does, other air must come from somewhere to take its place. Cool air is heavier (at higher pressure) and therefore will tend to flow in to replace air which has risen as the result of heating by direct radiation from the sun or reradiation from the earth. Thus, when we have a clear hot day along the seacoast, by noon there is a fresh cooling breeze coming in from over the ocean, the air inland having

been heated sufficiently to cause it to rise. The heated air, in turn, flows out over the ocean at high levels, creating an inversion condition which holds until well into the evening of practically every fair summer day.

V.h.f. men who operate from points remote from the ocean know that mid-afternoon is the time during which the lowest signal strength of the whole day occurs, but the enthusiast located on Cape Cod, Long Island or the California Coast will find things interesting practically all day long in summer time.

For the man located farther inland, the two hours around sunset will show strong signal peaks any sunny day in warm weather. As the earth cools more rapidly than the air above it, an inversion develops close to the ground shortly after sunset in almost any locality. The chilly spots frequently encountered when riding through open country at dusk after a hot day constitute a familiar example. The effects of the seacoast inversion described above may show up at points as much as 100 miles or more inland as the evening wears on; and when this sort of thing is combined with an inversion resulting from the approach of a tropical air mass, v.h.f. enthusiasts experience an evening which goes down in the history of "big nights."

The coastal inversion is a phenomenon well known to occupants of the 112-Mc. band along the California coast. The tremendous updraft of warm air from the superheated desert country far inland moving out over the relatively cold Pacific produces a degree of bending of 112-Mc. signals seldom equaled elsewhere in the United States. So pronounced is the bending that flea-powered pack sets operating in the hills near Los Angeles frequently worked into San Diego, more than 100 miles away, and two-way work between home stations in San Diego and Los Angeles, using nothing more than simple receiving-tube rigs and half-wave antennas, was a common occurrence during the peak of the inversion season.

The coast of Northern New England is blessed with very cold water, as Maine vacationists will testify. Although the country inland is not heated to the extent that prevails in California, the "inversion by subsidence" is a daily affair in mid-summer. A rare combination of subsidence and air-mass inversions prevailed on that now-famous date of August 21, 1941, when W2MPY made the long climb to the summit of Mt. Katahdin in the heart of Maine, arriving on the scene at the peak of the bending. The result is now history: a dozen or more contacts beyond the former 255-mile record for 112-Mc. work, and a 335-mile QSO with WJFF at Newport, R. I. — a record which will take *some* breaking when we get back to such things again.

In describing his Katahdin experiences, W2MPY reported that on this trip, and on many others when he has worked long distances from high elevations, he was actually able to "see the inversion," a phenomenon also observed by your conductor in his mountain-climbing days. It took

an aerology textbook³ to give us the answer to this one. In practice, its appearance has turned out to be one of the most reliable visual warnings of the existence of both subsidence and air-mass inversions.

Smoke and Dust Layers

During hot weather, particularly after a dry spell, the rising heated air carries aloft a considerable amount of dust. When this dust strikes an overrunning layer of moist tropical air it can rise no further, with the result that it spreads out at the bottom of the warm layer, clearly marking the height at which v.h.f. signals are bent. In industrial areas smoke in the air serves the same purpose, with the added advantage that the smoke generally rises whether there is any appreciable warming of the earth's surface or not. We have observed the occurrence of this brownish-gray smoke/dust layer on many occasions, both in winter and in summer, and it has never yet failed as a warning of a storm on the way. Its appearance may give 36 hours or more warning of a change in the weather (from fair to stormy) in the summer, when air-mass movement is slower, and 12 to 24 hours in winter. It should be an equally good harbinger of periods of strong v.h.f. signals.

The foregoing is just a meager glimpse of the vistas which will be open to the v.h.f.-minded amateur after the war, but it will serve to show that operation on the very-highs can be a whole lot more than a nightly round of friendly chats with the gang in our own locality, important though these contacts loom in our picture of amateur radio as a source of relaxation and enjoyment.

The events of December 7, 1941, interrupted ten years of continuous operation on the v.h.f. bands on our part, but we've found this weather business a splendid antidote for that empty feeling we used to get when we looked across the

³ "Weather and the Ocean of Air," Chapter VII.

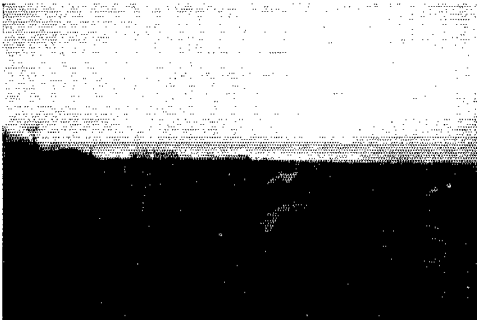

Nature's best but least-known visual warning of the presence of a temperature inversion resulting from an overrunning tropical air mass is the clearly defined smoke or dust layer marking the base of the warm moist mass. Look for it before sunrise or at dusk in clear calm weather, at any season. When you see it, rain is 36 to 48 hours away in summer; rain or snow 12 to 24 hours away in winter. Excellent radio conditions with strong v.h.f. signals may be expected at any time of the year.



A thickening alto-stratus haze veiling the sun, as shown above, is the result of warm, moist air aloft. This is the stage following that pictured at the bottom of this page, occurring immediately preceding precipitation.

Connecticut River Valley to that tower of ours high up on Wilbraham Mountain.

Cloud Stalking

Most of the time during our six-month sojourn in Key West, now concluded, we kept an eye peeled for interesting cloud formations, trying all the while to imagine what operation on 56 and 112 Mc. would have been like down there. There, as elsewhere in open flat country, the general trends were much easier to discern than in rugged country like our native New England; and therein lies the beauty of cloud chasing as a hobby. If one takes the trouble to learn a little about aerology (and he need not get to the calculus-and-slide-rule stage) he will still have to figure out conditions for his own locality himself when it comes to tying weather and radio "signs" together.

Since Pearl Harbor we've been finding an ever-increasing interest in books dealing with the weather, and we've been stalking clouds with a camera whenever we could get the necessary film. We find this a most enlightening pursuit, especially when carried on in conjunction with a daily log of radio and weather observations, even though the latter may include nothing more than an occasional glance at the barometer and a check on the gyrations of the weather cock on the steeple of the town hall. Operation on the very-highs is going to be a source of even greater pleasure and satisfaction, as a result of this enforced interlude, when the current unpleasantness is over.

Before this material appears in print we shall have returned to Boston, where we will remain for a short period, following which we expect to be off on another assignment afield, this time outside the continental limits of the United States.

We shall continue to submit copy whenever time and conditions permit, and we will especially appreciate hearing from any of the amateur fraternity who care to write. For the time being, the mailing address had better be: % ARRL, 38 LaSalle Road, West Hartford 7, Conn.

Practical Applications of Simple Math

Part III—Resistance-Coupled Amplifier Calculations

BY EDWARD M. NOLL,* EX-W3FQJ

THE design of a resistance-coupled amplifier is a relatively simple operation involving considerably less formula juggling and mental exertion than computing all the deductions subtracted from your pay check these days. The information given in previous installments of this series, plus some added information on the practical use of vacuum-tube characteristic curves, will permit the ready calculation of all required design values for the resistance-coupled amplifier shown in Fig. 1.

The characteristic curves for the type 6J5 tube are shown in Fig. 2. The B_p/I_p curves, the most common in general use, show the variations in plate current with changes in plate voltage for various fixed values of grid bias, the complete set of curves forming a "family" of characteristics for the particular tube under consideration. These curves represent static variations in tube potentials and currents when the tube circuit is not loaded.

When a load is applied, such as the plate resistor of a resistance-coupled amplifier, an additional line called the *load line* must be drawn to represent the dynamic variations in tube potentials and currents. It is apparent that the plate-current variations through the load resistance cause a varying voltage drop across the plate resistance, which is actually a change in plate voltage. Thus, a change in grid potential with the applied signal does not change the plate current without changing the plate voltage. In fact, the resultant change in plate voltage, caused by the variations of plate current through the load resistance, represents the useful output of the amplifier. Therefore, a load line representing the plate load resistance (total resistance between plate and cathode) is drawn on the characteristic curves to show the actual dynamic changes in tube operation.

Many excellent articles have been written on the theory of characteristic curves and load lines. Since this article is aimed at illustrating the practical application of the curves, theoretical considerations will be brought into the discussion only when necessary.

Constructing the Load Line

In constructing the load line on the characteristic curves, the actual resistance of the load depends upon the circumstances under which the amplifier is to be operated. Each set of conditions may require a slightly different value of load resistance for optimum performance. Optimum values may be chosen, for instance, for

maximum possible undistorted voltage output with a given value of input signal, or for maximum possible undistorted voltage output with a definite amount of plate supply voltage. Each of these requirements may necessitate the use of different values.

As an illustration of the method used in arriving at the first of these objectives, let us assume that the maximum peak-to-peak signal delivered to the grid of the amplifier of Fig. 1 from the preceding stage is 8 volts. It is necessary to place the load line on the curves in such a position as to permit the signal to swing over the linear portion of the characteristic curves. Therefore the signal must not swing into the curved portions at low plate-current values, nor must it swing into the positive grid distortion region. In the case of the 6J5 triode curves the least value of bias that can

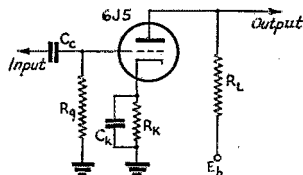

Fig. 1—Triode resistance-coupled amplifier circuit.

be employed with an 8-volt signal is -4 volts, permitting the signal to swing between 0 and -8 volts. Bias in excess of -4 volts should not be used because it would result in an undesirable reduction in gain. As a result, the load line must be drawn to permit the grid signal to swing over the linear region, between the 0- and -8 -volt bias curves.

The actual load line might be drawn at any one of a number of different slopes and in each case the plate voltage swing each side of the mean value would be equal and therefore distortionless. However, we are interested in obtaining a maximum plate-voltage swing with a low value of average plate current and a minimum variation in plate current. From this consideration, it is evident that the load line should appear practically horizontal and well down on the characteristic curves. Since a load line which approaches a horizontal position represents a high value of resistance (large change in plate voltage with a small change in plate current) the resistance-coupled voltage amplifier has a high value of plate resistance in comparison to a power amplifier, where we are interested in a large plate-current variation to develop power. Thus we find our 6J5 load line for an 8-volt signal well down on the curve; in fact, point B on the -8 -volt

* 117 S. Woodlawn Ave., Clifton Heights, Pa.

curve was chosen as far down as possible without moving into the region of distortion as indicated by excessive curvature.

Using the point on the -8-volt curve as one point of the load line, a straightedge is moved about this point as a pivot until an equal plate voltage is set off by the swing of the signal on each side of the average bias value set on the -4-volt curve. When this position is found, a line is drawn along the straightedge which represents the value of plate resistance which permits maximum nondistorted voltage output. The value of this resistance is readily calculated by extending the load line until it crosses the plate-voltage and plate-current coordinates, as shown in Fig. 2. The slope of the load line, or the resistance represented by the load line, is equal to the change in plate voltage divided by the change in plate current.

Maximum Voltage Gain

We are now ready to consider some typical problems.

1) What should the total plate load resistance, R_p , be for maximum undistorted voltage gain in the amplifier of Fig. 1, using the characteristics shown in Fig. 2?

From Fig. 2 we find that the slope of the load line is

$$R_p = \frac{E_p}{I_p} = \frac{270}{0.0035} = 77,000 \text{ ohms.}$$

2) Find the plate power-supply voltage, E_b , required.

Since the maximum plate voltage is applied to the plate only when no plate current flows through the load, the plate voltage indicated at zero plate current is the power-supply voltage. The position at which the load line crosses the zero plate-current axis is point C, representing 270 volts. Therefore, $E_b = 270$ volts.

3) Calculate the required value of the cathode resistor, R_k .

Examination of the curve shows that the average plate current at our operating bias, point O, is equal to 2.1 ma. Therefore, the resistance required to develop this amount of bias across the cathode resistor is

$$R_k = E_c / I_p = \frac{4}{0.0021} = 1905 \text{ ohms.}$$

4) Calculate the required value of the plate load resistor, R_L .

Since the total plate resistance includes the cathode-biasing resistance, the actual value required for the plate resistor is the total plate resistance minus the value of the cathode resistor, or

$$R_L = R_p - R_k = 77,000 - 1900 = 75,100 \text{ ohms.}$$

5) Determine the value of the grid resistor, R_g .

The value of the grid resistor should be at least four times greater than the plate load re-

sistor of the previous stage, but should not exceed the maximum value set by the tube manufacturer for safe operation of the tube. In the case of the 6J5, the maximum value set by the manufacturers when using cathode bias is 1 megohm. In most cases the value used is in the vicinity of 500,000 ohms.

6) Determine the value of the cathode by-pass condenser, C_k .

The capacity of the cathode by-pass condenser is set at a value which will pass the lowest frequency to be amplified with a gain equal to 70.7 per cent of the gain over the middle range of frequencies. (The calculation of capacity values will be elaborated upon in the next installment. However, it is a basic rule that, if the reactance of the condenser at the lowest frequency is equal to the resistor value, the amplifier response will be down 70.7 per cent at this frequency.) Since R_k is equal to 1900 ohms, the reactance of C_k for a minimum frequency of 60 cycles should be 1905 ohms. The minimum capacity for C_k may then be determined as follows:

$$X_C = \frac{1}{2\pi fC} = 1905 = \frac{1}{(6.28)(60)(C)} \text{ and } C_k = 1.4 \text{ } \mu\text{fd.}$$

7) Determine the value of the coupling condenser, C_c .

The coupling condenser, which also causes a loss of low frequencies because of its reactance, is calculated in like manner with respect to the grid resistor, or

$$X_{C_c} = \frac{1}{2\pi fC} = 500,000 = \frac{1}{(6.28)(60)(C)} C_c = 0.0053 \text{ } \mu\text{fd.}$$

8) Determine the peak plate-voltage and plate-current variations.

By dropping perpendicular lines to the coordinates from the points A, O, and B in Fig. 2, which represent the average bias and the extremities of grid-signal swing, the peak-to-peak plate voltage and current can be determined by simple subtraction.

Peak-to-peak plate voltage = $175 - 40 = 135$

Peak-to-peak plate current = $3 - 1.25 = 1.75$ ma.

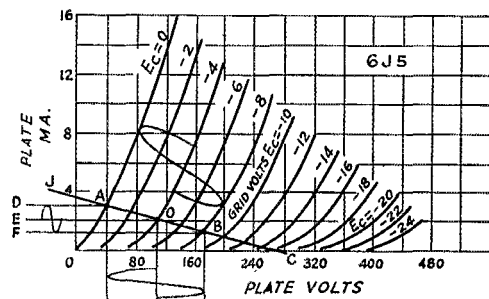

Fig. 2 — Family of plate-voltage vs. plate-current characteristic curves for the Type 6J5 triode tube.

9) Determine the peak-to-peak voltage output of the tube.

Since the plate-voltage swing represents the variations in potential between plate and cathode, the portion of the variation across the cathode resistor is lost. The actual voltage output, E_o , of the stage is

$$\frac{75,000}{77,000} = \frac{E_o}{135}$$

$$E_o = 131 \text{ volts}$$

10) Determine the voltage gain of the amplifier stage.

Voltage gain is equal to the output voltage divided by the input voltage.

$$\text{Gain} = \frac{E_o}{E_{in}} = \frac{131}{8} = 16.3$$

Maximum Power Output

Let us consider now the case where it is desired to obtain maximum possible undistorted output

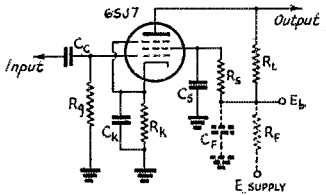

Fig. 3 — Pentode resistance-coupled amplifier circuit.

for a selected plate-supply voltage. As an example, in the circuit of Fig. 3 a supply voltage of 200 (E_b) is assumed. Since the maximum value of 200 volts is applied to the 6SJ7 plate only when no plate current flows, one point on our load line is certain to be at point A, shown in Fig. 4, where the plate current is zero and the plate voltage 200. From point A, load lines of various slopes may originate; the lower the plate load resistance, the steeper the slope. Since, as in the previous example, we are only interested in obtaining a large plate-voltage variation with a minimum variation in plate current, the slope of our load line should be as far down on the curves as possible and still accommodate the complete grid swing without running into the distortion region. Therefore, two typical load lines were drawn on the curves shown in Fig. 4. The load line AB represents a load resistance of 13,000 ohms which provides for a 5-volt grid signal without distortion, while load line AC represents a load of 110,000 ohms which provides for a 1-volt signal. Load-line AC would be the most common, since the 6SJ7 is a high-gain pentode which is designed to amplify small input signals to a much higher level.

Inspection of the curve shows that we are operating the tube at a negative bias of $4\frac{1}{2}$ volts and that the negative peak of the grid signal reaches -4 volts. In the case of a triode, such an amplifier would not be operating under optimum condi-

tions. However, the presence of the screen and suppressor in the pentode permits the plate voltage and plate current to swing to very low values without distorting even on the higher-bias curves. Thus we can obtain a large plate-voltage variation at reasonable efficiency if we do not permit the signal to approach zero on its positive peaks.

From the information available we may now proceed to calculate suitable circuit values and some of the operating conditions:

1) Find the total plate resistance represented by the load line, AC.

$$R_p = \frac{E_p}{I_p} = \frac{200}{1.8 \text{ ma.}} = 110,000 \text{ ohms.}$$

2) Find the proper value for the cathode resistor, R_k .

Since the bias point, midway between points D and E which represent the extremities of permissible grid swing without distortion, is at $-4\frac{1}{2}$ volts, the average plate-current flow is 1 ma. and our average plate voltage is 80 volts. The screen current is approximately 25 per cent of the average plate current and, therefore, the total current passing through R_k is 1.25 ma. In order to secure a $4\frac{1}{2}$ volt drop, the value of R_k is

$$R_k = \frac{E_c}{I_k} = \frac{4.5}{0.00125} = 3600 \text{ ohms.}$$

3) What should be the value of the plate resistor, R_L ?

$$R_L = R_p - R_k = 110,000 - 3600 = 106,400 \text{ ohms.}$$

4) Determine the value of the cathode condenser, C_k .

$$R_k = X_{C_k} = \frac{1}{2\pi f C_k} = 3600 = \frac{1}{(6.28)(60)(C_k)}$$

$$C_k = 0.73 \text{ }\mu\text{fd.}$$

5) What should be the value of the coupling condenser, C_c , when using a 1-megohm grid resistor, R_g ?

$$R_g = X_{C_c} = \frac{1}{2\pi f C_c} = 1,000,000 = \frac{1}{(6.28)(60)(C_c)}$$

$$C_c = 0.0026 \text{ }\mu\text{fd.}$$

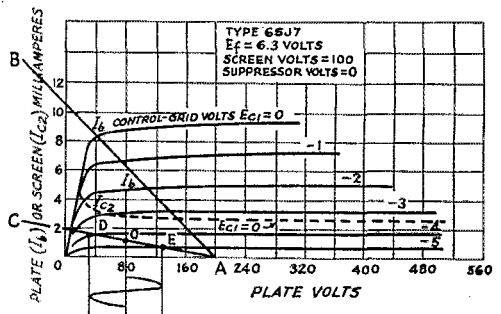

Fig. 4 — Plate-voltage vs. plate-current characteristic curves for the Type 6SJ7 pentode tube.

6) The value of the screen-dropping resistor, R_s , is readily calculated if the screen voltage and screen current are known. The screen potential must be 100 volts to meet the requirements of the characteristic curves, which are drawn for a screen potential of 100 volts. Therefore, the voltage drop required across the series screen resistor is $200 - 100 = 100$ volts.

$$R_s = \frac{E_s}{I_s} = \frac{100}{0.00025} = 400,000 \text{ ohms.}$$

7) In order to by-pass the screen-dropping resistor adequately, the reactance of the by-pass condenser, C_s , should be not more than 1/10th the resistance of the screen-resistor at the lowest frequency.

$$X_{C_s} = \frac{R_s}{10} = 40,000 \text{ and } 40,000 = \frac{1}{2\pi f C_s}$$

$$C_s = \frac{1}{(40,000)(60)(6.28)} = 0.067 \text{ } \mu\text{fd.}$$

8) If the resistance-coupled amplifier is employed in an audio system which has three or more stages, it may be necessary to employ a decoupling network, $R_f C_f$, to prevent feed-back through the common plate impedance. In this case, the power supply voltage must be increased by an amount sufficient to compensate for the voltage drop across R_f . The value of R_f often employed is 1/10 of the value of R_L .

$$R_f = (0.1)(106,400) = 10,600 \text{ ohms.}$$

9) The condenser C_f , by-passing R_f , should have a reactance, at the lowest frequency to be passed, of not more than 10 per cent of the resistance of R_f .

$$X_{C_f} = \frac{10,600}{10} = \frac{1}{2\pi f C_f} = 1060$$

$$C_f = 2.5 \text{ } \mu\text{fd.}$$

10) The new supply voltage would, of necessity, be 200 volts plus the voltage drop across R_f .

$$E = 200 + (I_s + I_p) R_f$$

$$= 200 + (0.00025 + 0.001)(10,600)$$

11) The total plate-voltage swing as determined by the perpendiculars of Fig. 4 is 130-30 = 150 volts. From the ratio, $\frac{106,400}{110,000}$, we know that 97 per cent of the output voltage or 97 volts peak-to-peak appears across the plate resistor. Since a 1-volt peak-to-peak signal is applied at the grid, the stage gain is $\frac{97}{1} = 97$.

If a different screen voltage were selected the curves would change somewhat, calling for alterations in the values.

In the next installment, covering the design of a two-stage audio amplifier, an approximate method will be outlined to convert the curves to a lower screen potential.

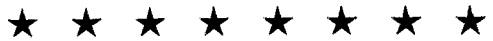

Gold Stars

PFC. ALEX. C. RULES, W9FJH, was killed December 30, 1943, while serving in Italy with an armored unit. No details have as yet been officially released concerning the action which resulted in his death. Pfc. Rules enlisted in the



Army in May, 1941, and received his basic training at Fort Knox, Ky. From there he was transferred to Fort Dix, N. J., and in the spring of 1942 he went to Northern Ireland with the American Expeditionary Forces. He participated in the invasion of North Africa, and as our forces pushed forward he moved on to the battlefield in Italy.

W9FJH built his own station, operating it exclusively on 160-meter 'phone. He attended Coyne Electrical School of Engineering and operated a radio repair shop in conjunction with his electrical installation business. An earnest student of radio, all of his spare time was spent either in study or operating his rig.

HENRY L. BROCK, W5HGE, 21, was killed May 13, 1942, when the merchant ship on which he was radio operator was torpedoed and sank in the Gulf of Mexico a short time after it had left Corpus Christi, Texas.

W5HGE began studying and experimenting with radio while still a youngster in grade school, receiving his Class C license during his second year in high school. His first transmitter was a 5-watt rig, followed by a

succession of new circuits and gear built mostly out of parts salvaged from old b.c. sets. Two weeks after graduating from high school he received his radiotelephone first and radiotelegraph second-class licenses and went to work as a c.w. operator in a government point-to-point station. His next position was as an engineer at b.c. station WPAD in Paducah, Ky. In his spare time on this job he built up a c.w. and 'phone rig for 3.5, 7 and 14 Mc., completing it on that fateful day of December 7, 1941. Shortly thereafter he moved to Little Rock, Ark., to become radio technician for Pulaski County. He resigned from that post in April, 1942, to join the merchant marine.



★ ★ ★ ★ ★ ★ ★

Hams in Combat

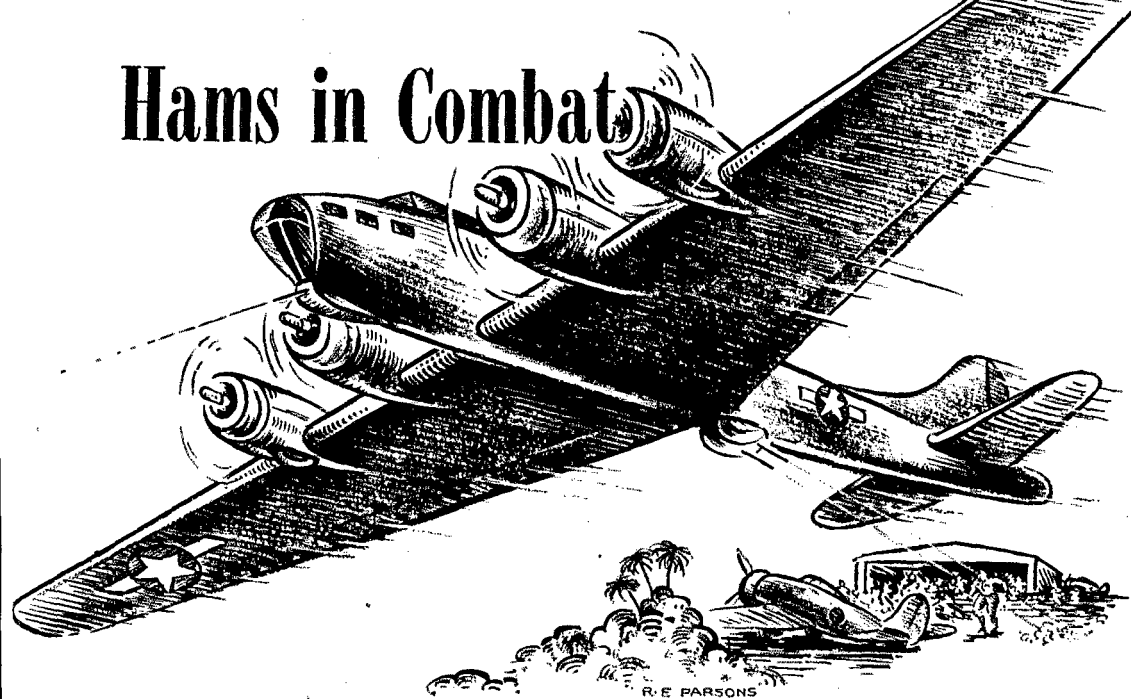

"We strafed hell out of the place . . . slugging it out at tree-top level with the Nips."

One Life to Give...

Had this story been written by the man who should have written it — Capt. William H. Graham, W9BNC — it would have been one of the greatest "Hams in Combat" yarns ever told in these pages.

But Bill Graham never got around to writing his story. He was too intensely occupied with the living of it — too keenly aware of the new paragraph that was the moment, too eager to learn what was on the next page.

And then, on March 20th, in the dark jungles of New Guinea, he came to a page that bore the words: "The End."

FOR twenty-five years Bill Graham was an ace newspaperman — one of the best in the game. He was a reporter. He wasn't a news analyst or a commentator or a columnist. He was the kind of newspaperman who digs out the facts — the exact facts, all the facts and nothing but the facts — and writes them up in straightforward, understandable language.

That kind of talent — the ability to collect, analyze and interpret information accurately and cogently — is precisely the kind required in military intelligence work. By training and experience, therefore, Capt. Graham was exceptionally qualified for his Army duty: he was a combat intelligence officer. It was in the performance of that duty that he met his death.

Bill Graham was also a ham — a devoted and proficient ham. That, of course, is why his story belongs in *QST*. As told here, it is based in part

on bits of the letters he sent back home and on fragments from the pieces he wrote for his paper. The rest of the story comes from the record.

In Bill Graham's case that record is both a full and distinguished one.

Bill was born a Kentuckian, with all the fire and chivalry indigenous to his breed. Beattyville, Ky., was his birthplace, but he was still in his teens when he left there, drawn by the lure of a roving newspaperman's life.

He started his journalistic career as a sports reporter on a Nashville, Tenn., paper. He was a bright-eyed cub, hardworking and friendly. His versatility and zeal attracted the attention of the local Nashville AP bureau. Soon he was offered a better job with the Associated Press.

The AP packed Bill off to South Dakota to serve his novitiate as correspondent at Sioux Falls. It wasn't long before he proved himself capable of a bigger assignment. In 1921 he was sent to Omaha, Neb., as a vacation relief man in the AP office there.

Omaha seemed to Bill a pretty good place in which to forsake the roving life and settle down. In the fall, when his summer relief job was ended, he left the AP to join the Omaha *World-Herald* as an assignment reporter.

Omaha and the *World-Herald* became home to Bill Graham. He liked them and they liked him — liked his refreshing personality, his energy and drive, his uncompromising fearlessness and his equally relentless tenacity in digging out the truth. Above all, they liked him because he was a conscientious and competent reporter.

Bill occupied just about every desk on the paper at one time or another. He was state editor

for several years. As an assignment reporter he covered many of the biggest news stories in Omaha and in the state at large. His reporting of the Nebraska state legislature won him laurels among newsmen.

It was in covering the Douglas County courthouse beat that he did his most notable work, however. A journalistic Jeremiah, he was the bane of chiseling politicians. Single-handed he wrecked a powerful but corrupt machine. In his obituary write-up the *World-Herald* said: "He was the journalistic broom which swept out a number of commissioners, and brought about numerous reforms. It was there that his courage and tenacity were best exemplified. . . ."

Bill Graham's introduction to radio came as an offshoot of his journalistic enterprise. In 1923, at Omaha's WOW, then just beginning to build its subsequent nationwide reputation as a pioneer broadcaster, the revolutionary idea was conceived of broadcasting news summaries as interludes between the recordings and home-talent artists. Bill did the broadcasting, and thus became one of the country's pioneer newscasters.

Bill's insatiable curiosity about everything under the sun soon led him to explore the technical aspects of broadcasting. That, inevitably, brought him into contact with the hams who were running WOW's transmitter.

Five years passed before that first tentative contact culminated in the issuance of the license for W9BNC. Actually, they were years of preparation. When Bill Graham went into anything he first equipped himself painstakingly, and that was true of ham radio.

W9BNC soon became well known on all bands, 'phone and c.w. Bill participated actively in every phase of the game. He worked DX, handled traffic, and was always willing to chew the rag. Working WAC and WAS was a commonplace achievement to him.

Unlike many another competent and active operator, however, his vision extended beyond the knobs on the panel. He had a thorough technical grounding and the restless, questing spirit of the true experimenter. He was not a "tinkerer" — he was an inveterate experimenter and a competent researcher.

On the organizational side of amateur radio, as might be expected, Bill was equally active. He took an active interest in both local and divisional affairs and served as a valued advisor to each successive Midwest Division director.

In 1938, under the traditional system of rotating divisional conventions, it was Omaha's turn to sponsor the Midwest Division ARRL Convention. At the time, however, there was no active amateur club in Omaha to run the affair. To Bill Graham that was a challenge. He got together the leading hams in Omaha and Council Bluffs and organized them into a convention committee. They retaliated by electing him general chairman. He threw himself into the job with all his abundant energy and turned out one of the most successful ham conventions ever held in the Midwest.

For several years he served as assistant division director for Nebraska, and in 1941 he was elected alternate director for the Midwest Division. When his first two-year term ended he was far off in the wilds of New Guinea.

The fact that Bill hadn't been in touch with his constituents for over a year didn't affect their support. He was reelected without opposition.

In New Guinea, some three months after the event, he received official word from ARRL Hq. of his reelection. In reply he wrote:

"Thanks for your notification upon my 'reelection' as alternate director, which came via Omaha and Mrs. Graham. I must confess I feel pretty helpless to serve from this vast jungle-land!" And he went on: "Some of my constituents write me that they hope the ARRL will keep on its toes and see that we don't lose any frequencies when peace comes and the airways are opened again. I pass this word along, knowing that the Headquarters gang is doing and will do all possible to guard our interests in all directions."

That letter was dated March 19th. On March 20th Bill Graham was killed in an airplane crash while on a reconnaissance mission.

He need not have been concerned about his ability to be of service. He and the scores of other hams in this war who have given their lives for their country — and for amateur radio — are its surest guarantee for the future.

Bill hadn't been in uniform in World War I. For that reason he felt that he had to get into this one. And so, immediately after Pearl Harbor, he volunteered in the Air Corps. In May, 1942, he was commissioned a first lieutenant.

He was given training at the Harrisburg (Pa.) AAF school, majoring in combat intelligence. In July, 1942, he was sent to the South Pacific to join MacArthur's command. When he arrived down under he was assigned to the 43rd Bombardment Group (Heavy). He was stationed at Fifth Air Force headquarters in Australia, a member of the headquarters squadron. For nearly a year he served on detached duty with the Aussies and later the Dutch.

In March, 1943, he was transferred to New Guinea. In his own words: "I came back with our forces — Yanks, as they call us, much to the consternation of the boys below the Mason-Dixon line. We are pretty deep in the New Guinea wilds. Near enough that the Japs pester us nearly every night with nuisance raids. They only make us climb out of bed at all hours and lose some sleep, though. Actually, their bombing is impotent."

About his new assignment he wrote: "For security reasons I cannot tell you exactly the kind of work I am engaged in, except to say that it has its exciting moments. I've had nearly 100 hours of combat flying in heavy bombers and have been lucky enough to get in on three of our major landings on Jap strongholds." The three major actions to which he referred included the Allied landings at Lae and Cape Gloucester.

When Los Negros Island in the Admiralty group was seized he was official observer for the

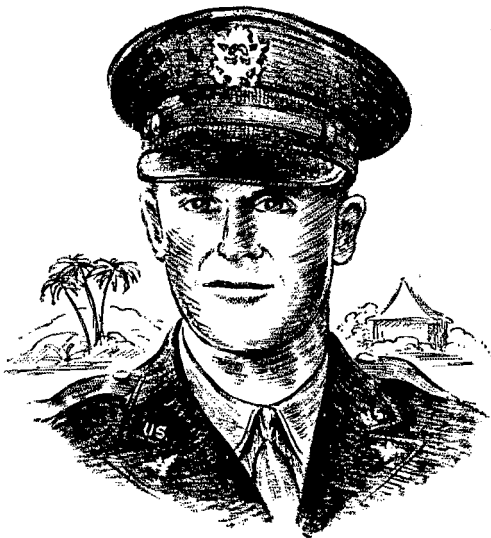

Capt. William H. Graham, W9BNC.

AAF and witnessed the entire action from a bleacher seat in a combat plane.

Preceding the Los Negros invasion Bill played an impromptu supporting role in the softening-up bombing operations. As he described it:

"Over Momote, the Japs' fine airport on Los Negros Island, I had a hell of a lot of fun. The heavy bombers were scheduled to go in first and bomb the harbor shore where our land forces were to go in. Then we were to be followed by the mediums, and finally the strafers. But the weather was foul and few of the lighter boys got through that morning. So we took this big, lumbering bomber down to strafing level and decided to do the job ourselves. Inasmuch as I had replaced a gunner, it was up to me to man a couple of machine guns. So we strafed hell out of the place and I shot away nearly one thousand rounds of ammunition. I don't know how much damage, if any, my lead caused. It must have looked funny to the amphibious forces to see that bomber slugging it out at tree-top level with the Nips."

It was in New Guinea that Bill Graham saw most of his active combat experience. About his ham encounters down under he wrote:

"Most of my foreign service (nearly two years now!) has been in the New Guinea wilds and as you know there aren't many Fuzzy Wuzzy hams here. I did meet some of the lads down in Australia, chiefly Wal Ryan, VK2TI, of Sydney. . . . When he heard I was in town for a day he used up his entire month's gas ration — taking me to his home for the day, showing me some sights, then to the airport in the evening, etc. He wouldn't have it any other way. He had quite a bunch of the Sydney amateurs in for the evening, too, and honestly, Ken, I never saw such hospitality. They made me feel like the great white warrior come from America to save their country single-handed! I was prouder, I believe, than at any time in my life that I was an amateur."

Underlying the tales he sent back from that theater, even when describing hardships, always was a characteristic lightness of touch:

"Here where I am located, deep in the New Guinea wilds, we don't even try to cope with the abundance of bug and insect life. The 'krud' is the name we have given to some three thousand jungle itches that bother us here.

"A tentmate of mine got up the other morning to get his mess kit, hanging on a tent pole. It was covered with big yellowish green ants. As fast as he'd flick off one ant two others would crawl back on, rearing on their hind legs and literally leering at him. Finally, in a pathetic tone, he addressed the ants: 'Please, boys, let me have my mess kit!' That tickled my funny bone all day."

This account of a native celebration is excerpted from a *World-Herald* Sunday feature — the last piece he wrote for his paper:

"For many days we had noticed great numbers of Fuzzy Wuzzies trooping in from miles around. . . . We learned they were trekking here for some kind of ceremonial. . . . The ceremonial turned out to be a photographer's paradise. . . .

"We could hear the drums pounding away long before we reached the ceremonial ground in our jeep. . . . There were big Fuzzies, fat ones, slim ones, dwarfish ones, albinos and the usual droves of native youngsters, stark naked. . . . They were beating their drums, howling and stamping their feet up and down Indian fashion, only not so fast. . . . I snapped pictures, fully expecting my head to be chopped off or a spear impale me. But nothing happened. They went right on dancing, not noticing me at all. . . . A lass of perhaps 17 . . . even flashed me a smile as she pranced past. She wasn't half as embarrassed in her semi-nude state as I snapping her picture.

"An Aussie captain, noting my American technique, approached and offered to wager I couldn't get a photo of a particularly attractive (to another Fuzzy) girl of 18 who was standing near by watching the dancers. He'd been trying to photograph her for half an hour. And in that time three or four others had failed, he said. Remembering some tricks of the *World-Herald* photos, I said: 'Look, buddy!'

"I focused my 35-mm. camera on a blade of kuai grass at right angles and about the same distance as the girl from me. The girl eyed me over her shoulder, her back to me — a pose, incidentally in which no self-respecting Yank photographer would ever take a native girl. Finally she turned away from me, satisfied I wasn't interested in her. . . . I pointed the camera at the girl. . . .

"'Now yell at the top of your voice,' I told the Aussie. He was embarrassed and wouldn't. Then I asked him to whistle as loudly as he could and he let loose a blast that could be heard at Blup Blup. The girl, of course, turned to see what the commotion was and I snapped. She may have a surprised look when the negatives come out.

"'Uncanny blokes, you Yanks,' the Aussie commented as I wound the film for the next shot. . . ."

At the last Bill was getting homesick. For two years he had seen only one member of his family — who was, singularly enough, a stranger! His daughter Marilyn had married an Army lieutenant after Bill left the U. S. The new son-in-law himself subsequently was shipped to Australia, and the two met there. Bill had a son, too — Roger. On the very day — March 29th — that the Graham family was notified of Bill's death, Roger was to have left for duty in the Navy.

In January Bill wrote to a fellow *World-Herald* staff member: "This leaves me disgustingly healthy, and as happy as a fellow could be who has been away from his family for darn near two years. Good gosh, I just happened to think. I'm now eligible to wear four service chevrons. . . . It doesn't seem two years since I last visited the old gang. I wonder what changes there will be when I return? I'd give four front teeth to be able to sit in on a party with you all tonight — even if you only served ice-water! . . . I'm expecting to get home later this year. Feel as though. . . ."

And then, just before his death, he wrote: "I hope that before the end of the year I will get leave back to the States. Unfortunately, in my line of work, the longer I am here the more valuable I can be. They never figure we, too, can get war-weary."

It was the next day he set out on the mission from which he did not return.

How he met his death we do not know. The official report states only that "Capt. Graham was killed in an airplane crash in New Guinea on 20 March 1944." That's all the War Department will say about it. The Public Relations Branch, the Press Branch, the War Branch, the Casualty Branch — each is silent about the details.

There is a reason for their silence, of course. We have learned, informally, that the mishap was not classified as a "combat" crash. That indicates that it occurred on a reconnaissance mission. And reconnaissance was Bill Graham's job — or a part of it, at least. It wasn't coincidence that, in the past, he happened to be around a number of Jap bases not long before things suddenly started to get hot for the Sons of Heaven.

If the Army doesn't want to say how or where Bill came to his last landing, therefore, we don't propose to speculate about it in print. We know only that, however or wherever it happened, he was doing his duty per orders — doing it with unflinching courage and unswerving determination.

Before he made his final unanticipated rendezvous with the Master Pilot, Bill Graham left a prophetic legacy to the game he loved. In the final paragraph of that letter dated March 19th — the day before his death — he wrote:

"In nearly every one of my missions there has been a ham at the bomber's radio — a mighty important fellow on the crew of a bomber. No, after this is over, the amateur will have no excuses to offer for his part in this three-dimensional war. He has functioned to the everlasting glory of us all."

— C. B. D.

U. S. War Bonds for Stories of War Service

QST wants reports on the experiences of radio hams in active service on the battlefronts — for immediate publication in this section, where feasible, or to be held confidential where security considerations so require.

Do you have a story of war service to tell — either your own or that of someone you know? Then write us a letter giving full details, including photographs, clippings and other substantiating data where available. If your story is published in *QST*, you will receive a \$25 U. S. War Bond. Please indicate clearly on the report if it is available for publication in its entirety, if names, dates or places should be deleted, or if all information must be held confidential.

A Lady of Mercy

BY S/SGT. JOHN F. WOJKIEWICZ,*
W3GJY-W4GQJ

(Continued from the June issue of *QST*)

A FEW DAYS after the bombing raid on Violet we were on our way back to Carnation. There was constant air activity. Allied planes of all types moved in endless patterns across the Mediterranean to Rose. Every now and then an Allied fighter would swoop low over us and dip his wings in salute. Something about those fast, devastating fighters commanded respect. But it couldn't compare to the feeling I had when we passed a fleet of American warships traveling in a single, majestic line. They had just come back from pasting a port in Rose and seemed to possess an air of quiet satisfaction. I helped dip the *Lady Luck's* flag in salute to the fleet, experiencing a feeling of complete reverence as I did so.

Ashore in Carnation the following afternoon I found there was strict curfew and no one was supposed to be in the city unless on official business. Not wanting to stay in the outskirts of the city I hailed a Navy truck hauling supplies and gave the driver a long, sad tale about friends I had to see in Carnation. Being a sympathetic soul he told me to climb in with the supplies and smuggled me through the military police. The MPs must have figured I was on official business, for once I was inside no one bothered me.

I reached a section of the city where row after row of buildings lay in ruins. A small boy who spoke a little English appointed himself my guide. As we walked along he pointed to this and that building, telling me which had been bombed by the RAF and which by the Americans.

When we reached Café Roma I gave the boy some chewing gum and thanked him for the tour. Seating myself at a corner table, I ordered a bottle of wine. A few minutes later two of the mates

* 434 Glenwood Drive, Ambridge, Pa.

from the *Lady Luck* entered the café and, needless to say, they joined me in a series of toasts. I say "series of toasts" because that's the seamen's way of excusing the system of multiple drinking they employ.

Before long the world suddenly seemed very wonderful. The people of Carnation were wonderful. We were wonderful. One of the mates could speak the language of the people fairly well and soon we were surrounded by a crowd of them, three deep. Through the mate's interpretation we exchanged viewpoints on the war, the wines, the customs, the cigarettes and the future.

It was now six o'clock and we had orders to be back at the ship by eight. We bade the people good-by and started off in search of a ride. We were in luck; within five minutes a jeep picked us up and deposited us right in front of the dock gates. We presented our papers and started for the boat which was to take us to the *Lady Luck*.

Suddenly the three of us halted in our tracks. There, dead ahead, was the *Lady Luck's* tall stack moving out to sea. We stared dumbly. It couldn't be. We still had an hour and a half of liberty time. I made a feeble joke about being left behind in Carnation, but the response was even weaker. No matter how much of an adventurer one is at heart, it is no fun to be stranded in a foreign port in wartime without proper papers.

Then one of the mates went into action. Rushing up to the skipper of an LCI boat, he told of our plight. Now, a mate carries quite a bit of authority, but an LCI doesn't chase fleeing ships just to deliver a few stragglers. I waited for the skipper's polite refusal. But, unaccountably, it was a deal — the LCI would take us.

The LCI's engines roared and away we went after the *Lady Luck*, now a good six miles ahead of us. It was exhilarating to feel the power of those engines under the thin steel deck. The propellers churned up a mountainous peak of water as they bore along under full throttle and I felt (with the help of a couple of bottles of wine) like the hero in a movie thriller.

A half hour went by and the lights of the *Lady Luck* seemed no nearer. An hour passed and still we seemed no closer. It didn't make sense. The *Lady Luck* can only do sixteen and a half knots

wide open and there would be no reason for her to be going full blast. The LCI should do better than eighteen knots and we were wide open. Still, the fact remained that it would take three or four hours to catch her at the rate we were going. We tried blinking her down, but there was no answering light. The LCI's skipper was very nice — but enough was enough. He had patrol duty that night, so we had to turn back.

There was nothing to do but go on patrol duty with the LCI. Personally, I was quite in the mood for it by then, for the wine was having its full effect. I took one last look at the fleeing *Lady Luck* and then settled down to enjoy whatever might come.

It was a very dark night with everything blacked out. Suddenly a huge, black hull loomed up. With all guns trained on the LCI it challenged us. We all tensed until the LCI established its identity, for one shot from the cruiser's lightest gun would have blown us to very small bits.

In spite of anticipated action I slept peacefully the night through, awakening the next morning to see Carnation bathed in warm, peaceful sunshine. Looking out on the bay I saw, of all things, the *Lady Luck*. I couldn't believe my eyes. Why would she be back in Carnation after racing out to sea like a scared rabbit the night before? I woke up the mates from the *Lady Luck* and asked them if I was seeing things. They assured me I was not. Thanking the skipper of the LCI, we made our way back to our ship. Never has anything seemed so good as the moment I planted my feet on the *Lady Luck's* deck.

It turned out that the captain had been told to anchor a safe distance outside Carnation to escape the expected air raid. Naturally the ship couldn't wait for us, so it just went ahead according to orders. During the night a German Focke-Wolf flew over the *Lady Luck* and circled as though picking the best place to drop its bombs. While the raider was circling the *Lady Luck* it spotted a destroyer about a mile away. After gaining altitude for a moment, it dove on the destroyer, releasing its bombs — all of which, however, fell wide.

The destroyer in the meantime had signaled a near-by airfield that the *Lady Luck* was being attacked. In no time American night fighters were overhead and the German raider was brought down in flames.

We took on casualties that afternoon. For the first time I learned that the constant sound of rifles we had been hearing in the outskirts of the city was the firing of snipers. After that, whenever I heard the crack of a rifle I felt sure that the sniper had me singled out for a pot shot.

Not far out of Carnation I went below to the administration office of the *Lady Luck*. There, lying on the floor on stretchers, were badly wounded men, many of them in agony. Yet every one of them returned smile for smile as I passed by, as much as to say: "Don't worry about me; I'm okay." It made me wonder, seeing those men as

The LCI's engines roared and away we went under full throttle.

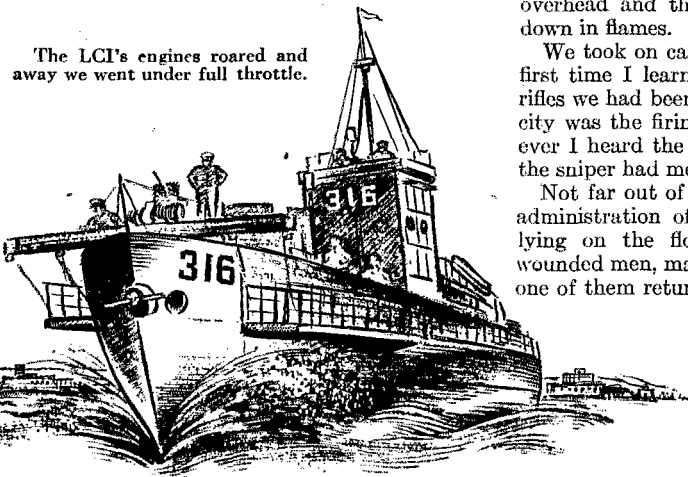

QST for

they were then, what right anyone has to complain about rationing, taxes, no cars or little gasoline. . . .

When I reported back to the bridge a few minutes later the captain looked worried. I soon discovered why. We had, by deft maneuvering, just missed a floating mine. Not one of the small or medium-sized kind, but a big one. It would have blown the *Lady Luck* in half had we struck it. I looked astern through the field glasses and, sure enough, big as life the mine was floating in our wake. The horns standing out on the surface of the mine (its contact points) looked more wicked and diabolic than those of the devil himself at that moment.

There was nothing the *Lady Luck* could do about the mine. We had no guns to set it off. Yet it was a crime to let it float around to blow another ship to bits. At that moment a plane appeared overhead. When it turned out to be an Allied plane we signaled a message reporting the mine and its location.

This time we took the casualties to Orange Blossom instead of Violet. The harbor of Orange Blossom is strictly man-made. A long sea wall runs almost parallel with the shore, and at a glance one can see why it is such an important Allied base.

The next morning I went ashore into the city of Orange Blossom. There I got the full impact of the food shortage when I saw a group of poorly dressed natives standing around begging, not for money but for any small particle of food we could give them.

When I arrived back at the ship there was great excitement aboard. A rumor was circulating that we were going back to the States. It seemed too good to be true, but when the captain came aboard he confirmed it. We were heading back to the States that very day.

While we were taking on fuel in the afternoon all hell broke loose in the hills behind Orange Blossom. Big guns started blasting and the din was terrific. We all looked heavenward to see what enemy craft had been spotted, but no planes were in sight. It turned out that the Army was trying out some big guns. I don't know the value of those guns as weapons, but if they won't hit the enemy they surely will scare him to death.

Late that night we were on our way to get our clearance papers. I could fairly hear an official coming aboard and saying: "Sorry, but your orders have been changed." But no — the *Lady Luck* was cleared within a matter of minutes, and soon we were on our way out into the open sea.

For days after we left there was a stiff headwind, but the weather was clear and the sea steady. The night of August 25th brought hurricane warnings from Nova Scotia. According to the reports a full gale was offshore, heading toward Nova Scotia, and would probably hit the following night. The next day the wind got stiffer, but it was nothing to worry about and most of us figured we would probably escape the main blast. But that night all hell broke loose around the *Lady Luck*.



Sure enough —
big as life the mine
was floating in our
wake.

The sea seemed to come to a boil. Odd pieces of equipment broke loose on deck, and even good sailors were getting that telltale look symptomatic of seasickness. I thought of the casualties below and the misery such a sea would bring them. But soon I forgot everything except the *Lady Luck* herself. I wondered if she would break in two as she spanked down on the sea after sticking her bow sickeningly upward over the combers that drove in at us. The gale was terrific now and the sea was being whipped into a white lather. The captain issued orders for all ship's personnel except those on watch to stay below, and for everyone to stay away from windows. Some thought the last was a foolish order since the glass in the *Lady Luck* was half an inch thick — surely enough to withstand any sea.

By now the blow was at its worst. The doctors, nurses and enlisted men's crews all were suffering violently from seasickness. They could barely hold their heads up, yet there was so much that had to be done for the casualties.

Accidents began to multiply. Men and women were being thrown headlong down ladders, against walls and into furniture. The captain's warning to stay away from windows was forgotten and a group of enlisted men clustered about a porthole to look out. Then — *crash!* — a huge sea smashed into the glass, shattering it to fragments. Many were cut. One man would have died on the spot if a quick-thinking sergeant hadn't clamped his thumb on the man's severed jugular vein. Beside sewing up this man's throat, the doctors took seventeen stitches in his face and eleven in his leg. Yes, the captain had known what he was talking about!

The sea and wind were now doing their best to tear the lifeboats away and deck crews worked constantly to keep them securely lashed. I found out later the deck engineers were out in that storm off and on all night lashing those boats.

Electricians were constantly on the move, taking care of frayed wires and short circuits. A fire broke out, but was brought under control.

(Continued on page 90)

A "QSL"-Type Transmitter with Transformerless Power Supply

A Midget Self-Contained 15-Watt Rig

BY PAUL J. PALMER,* W8UGR

"Hi, there, fellers," said Tuffy 6L6G. "Dis punk 8UGR sez that Fred, W8QBW-QDK, wuda got 'round t'builidin' a lil rig like dis fer youse guys if'n he cuda stay'd wid us longer. It's a rig de small fry kin make outa de pop allowance 'n' de junk box. Ya kin lug it 'round in de overcoat pocket, jist like his odder til QSL rigs. It's fedderrweight 'n' totes its own power house. Me 25Z5 pals'll push enuf millies over t'gilcha 'bout twenty watts into it, 'n' ya kin use me er me buddies 6V6, 6V6GT, 6L6 or 6F6. Boy, I kin hardly keep me shoit on 'til us boids kin git on d'air again 'n' WAC 'll mean sumpin else 'sides 'Fightin' Gals' — 88 t'em. Well, pals, 30 fer now 'n' 73. BCNU. . . Oh, yeah — dis tilewad, 8UGR, sez sum o' youse guys fergot t' come across wid a stamp when writin' 'bout dat rotary oscillotor, else y'da got a anser. Don' tell de piker I tole ya — de imatashun Scotchman!"

HERE is another rig built as a memorial to that grand ham, Fred Sutter, W8QBW-QDK, who left us for the land of "Silent Keys" over three years ago. It is similar to his "Portable Five"¹ and "Runt 60"² in the style of chassis, arrangement of parts, light weight and low cost.

* 868 Whittier Blvd., Grosse Pointe Park, Detroit, Mich.

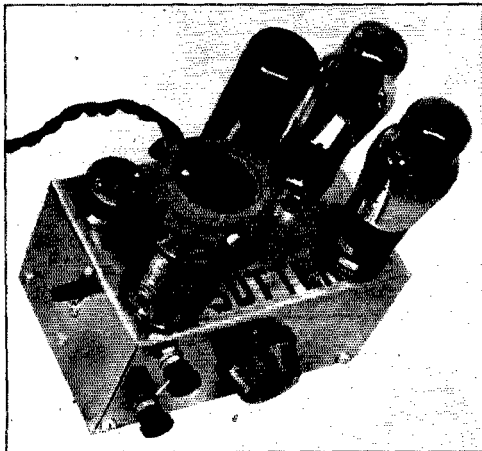

Top view of the 15-watt midget rig. The two tubes at the right are the rectifier tubes for the voltage-quadrupling transformerless supply. The 6L6 oscillator tube is behind the coil in the foreground and the crystal occupies the rear left-hand corner of the chassis. The plate-tank tuning knob and key terminals are mounted on the front. On the left edge is the band-change switch.

The little rig shown in the photographs is designed to get along with as few parts as possible. It contains a complete 15-watt transmitter and power supply on one chassis. The circuit diagram, including power supply, is shown in Fig. 1.

Circuit

The r.f. circuit is the familiar simple tetrode-oscillator type. It is the same as that used so successfully by Sutter in all of his "QSL" series of small transmitters. Grid bias is obtained from the cathode resistor alone, and the circuit is keyed by opening the connection between cathode and negative high voltage. Screen voltage is obtained from the adjustable voltage divider, R_2 .

The plate tank coil, L_2 , is designed for a fundamental frequency of 3.5 Mc., but a switch, S_1 , is provided to short-circuit a portion of the turns at the ground end in case it is desired to operate at 7 Mc. either with a 7-Mc. crystal or by doubling frequency from a 3.5-Mc. rock. L_1 is the antenna-coupling coil and the small air variable condenser, C_{10} , is provided to tune the feeders. The flashlight bulb, B , serves as a resonance indicator. A similar bulb might be used in series with the crystal to indicate crystal current, but the power is relatively low and this precaution is not strictly necessary.

The heaters of the rectifier tubes and the oscillator tube and a dropping resistor, R_3 , are connected in series across the 115-volt a.c. line. The dropping resistor may be a line-cord resistor, a 10-watt wire-wound unit, or a ballast tube. It should drop the line voltage to 56.3 volts across the series of heaters. Any one of several tube types may be used, such as the 6L6, 6L6G, 6V6, 6V6G, 6V6GT, 6F6 or others.

Two 25Z5 full-wave rectifier tubes in a voltage-quadrupling arrangement are used in the power-supply section. This circuit was described in the 1939 edition of *The Radio Amateur's Handbook*. It will deliver about 400 volts under a load of 40 ma. This will provide for an input of about 15 watts to the transmitter. Type 25Z6 rectifiers may be substituted, if desired, by providing the octal sockets which these tubes fit, instead of the six-prong type required for the 25Z5s.

Chassis

The drawing of Fig. 2 shows the lay-out plan for the chassis. It is cut from a $9\frac{1}{2} \times 11$ -inch

¹ Sutter, "The 'Portable Five,'" *QST*, December, 1939, p. 32.

² Sutter, "The 'Runt Sixty' and the 'QSL Sixty,'" *QST*, September, 1939, p. 50.

sheet of light-gauge aluminum or other sheet metal. When completed, the chassis measures $3\frac{1}{2}$ inches wide, $5\frac{1}{2}$ inches long and 3 inches deep. These dimensions are the same as those for the chassis of W8QBW's "QSL 60,"² but in this case the power supply is included.

All holes should be cut before the chassis is bent. The socket holes may be made by scribing circles to fit the sockets at the proper points on the chassis and drilling a number of $\frac{3}{16}$ -inch holes inside the scribed lines. The center may then be broken out with a pair of long-nose pliers. The rough edges remaining can be easily removed with a half-round file.

If two pieces of hardwood about $\frac{3}{4}$ -inch thick and the same width and length as the inside dimensions of the chassis are made up, the aluminum can be clamped between them and the sides bent up very easily. The corners of the chassis are held together at the bottom edges by means of small aluminum angles, bent from scraps of the chassis stock, and self-tapping screws. It may be easier to mount some of the parts and to do the wiring if the corners are not fastened together until after this part of the job has been done.

Construction

The five socket holes are placed so that the two rectifier tubes are located at the right, the oscillator-tube socket in the center at the rear, and the

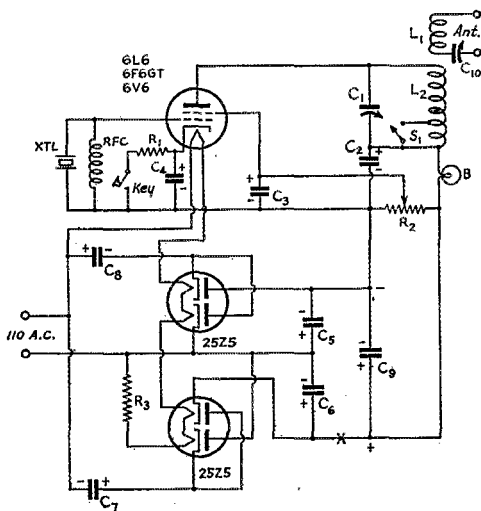

Fig. 1 — Circuit diagram of the midget transmitter.

- C₁ — 100- μ fd. midget variable (Hammarlund Star).
- C₂, C₃, C₄ — 0.01- μ fd. 600-volt tubular paper.
- C₅, C₆, C₇, C₈ — 8- μ fd. 450-volt electrolytic (Blue Beaver or equivalent).
- C₉ — 16- to 20- μ fd. 450-volt electrolytic (Blue Beaver or equivalent).
- C₁₀ — 100- μ fd. micro-type variable in coil form for antenna tuning.
- R₁ — 400 ohms, 10 watts.
- R₂ — 25,000 ohms, 25 watts (Ohmite with slider).
- R₃ — 200 ohms, 10 watts (see text).
- L₁ — 9 turns No. 18 enameled wire, close-wound.
- L₂ — 25 turns No. 18 enameled wire, tapped at 20th turn from plate end.
- B — 60-ma. flashlight bulb (pink head).

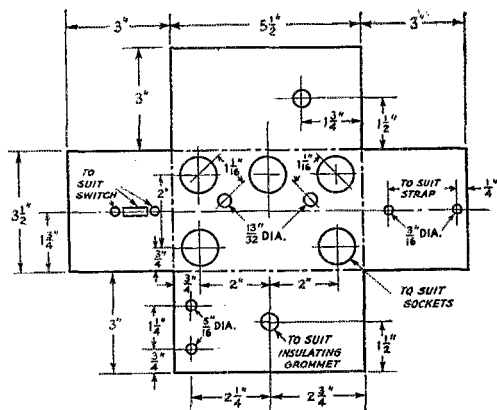

Fig. 2 — Sketch showing all important chassis dimensions and the locations and sizes of the mounting holes.

crystal and coil sockets along the left-hand edge of the chassis. This arrangement permits short leads between the various components in the r.f. portion of the circuit. The tank-condenser shaft must be well insulated from the chassis. Fiber washers will serve the purpose, since no r.f. insulation is required. The tuning knob should be of the type with a deep set-screw hole so as to avoid any danger of shock. The band-change switch, S₁, is an automobile dome-light switch. It is mounted on the left-hand edge of the chassis with its terminals close to the coil socket.

The two terminals for the key are mounted on the front edge of the chassis at the left. Both terminals must be insulated from the chassis; in fact, power-supply and r.f. circuits are not connected to the chassis at any point, to preclude any possibility of line voltage between the chassis and ground. The power cord enters the chassis at the rear through a rubber grommet.

The small chassis space requires the use of midget-type filter condensers. Several manufacturers make 8- μ fd. condensers which measure only $\frac{3}{4}$ -inch in diameter. The new "Victory" type will be satisfactory if the older kinds are not available. The four filter condensers, C₅, C₆, C₇ and C₈, are grouped together and held in place underneath the chassis at the right-hand end by means of a metal strap, as shown in the bottom-view photograph. The outside surface of this strap may be covered with a piece of rubber tape if there appears to be any danger of the strap coming in contact with the base of the plate-circuit indicator-lamp socket, which would short-circuit the high-voltage supply. A similar strap serves to hold C₉ in place against the left-hand end of the chassis.

The tank coil, L₂, is wound on a standard $1\frac{1}{2}$ -inch diameter plug-in form. The 7-Mc. tap is brought out to one of the pins which is not otherwise used, while the corresponding socket prong is connected to one side of the short-circuiting switch, S₁. Because this would make coupling to the antenna difficult, were the coupling coil wound in the usual manner at the "ground" end

of L_2 , L_1 is placed at the top end of the form about $\frac{1}{4}$ -inch away from the plate end of L_2 . The antenna terminals are mounted directly on the top of the plug-in coil form so that the feeder connections need not pass through the chassis, while the antenna tuning condenser, C_{10} , is mounted inside the form.

Tuning

When power is first applied and the key closed, the plate-circuit indicator lamp, B , should light up brightly. As C_1 is adjusted through its range, a point should be found where the filament of the bulb dips to a dull glow or goes out entirely. The light will increase in brightness either side of this point. C_1 should be set at the center of the minimum point. As C_{10} is adjusted, B should become brighter again. C_1 should then be readjusted for minimum brilliance, but this time the minimum will be brighter than before. The adjustments of C_1 and C_{10} should be juggled back and forth until a point is reached where the lamp will grow dimmer whenever C_{10} is moved to either side of the correct point and brighter as C_1 is moved either side of the correct point.

For the 3.5-Mc. band a Zepp-type antenna 134 feet long with 67-foot feeders is recommended when it becomes possible to use the transmitter on the air.

Because of the transformerless supply, in some cases the carrier may not be quite as clean with the power plug inserted in the wall receptacle in one direction as it will in the opposite direction.

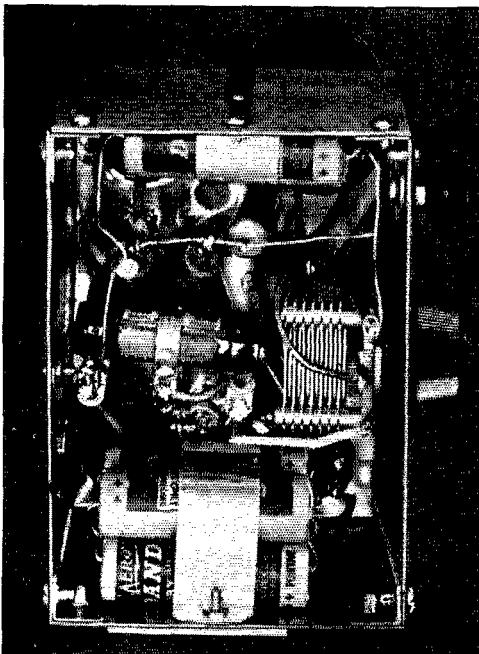

Bottom view of the "QSL"-type transmitter. The tank condenser at the right must be insulated from the chassis. The filter condensers may be seen held against the top and bottom sides by means of metal straps.

The plug should be tried both ways and then both the plug and receptacle marked so that it will be easy thereafter to determine the correct plug polarization.

The total cost of the unit, including the tubes, should not run over six or seven dollars. Basing the performance upon that obtained by W8QBW with his "Portable Five," this little one should get out to your heart's desire when we go "on" again since it has triple the output of that pee-wee outfit. This little rig also could be used very readily in QRR work, for it is light in weight and readily transportable.

New Tube — RCA-6J4

RCA has recently made available to equipment manufacturers, against WPB rated orders, a new member of the family of miniature "button-base" tubes, the 6J4. When obtainable, it should be of considerable interest to amateurs.

The 6J4 is a triode intended for use as a grounded-grid v.h.f. or u.h.f. amplifier at frequencies up to about 500 Mc. It has an amplification factor of 55 combined with the extremely high transconductance of 12,000 micromhos. Used in the "grounded-grid" or inverted-amplifier circuit, it aids in securing a high signal-to-noise ratio. The 6J4 may also be used in conventional triode circuits with ungrounded grid.

In grounded-grid service the grid of the 6J4 functions as a shield between cathode and plate, and the input signal is applied to the cathode. The input circuit therefore is between cathode and the grounded grid; the output circuit is between plate and the grounded grid. Internal shielding connected to the grid aids in reducing undesirable feed-back effects by keeping the capacitance low between cathode and plate.

The heater is rated at 6.3 volts, 0.4 ampere. Maximum plate voltage is 150 volts; rated plate dissipation is 2.25 watts maximum. The maximum permissible d.c. heater-cathode potential difference is 90 volts.

Strays

John A. Blackman, a radio code instructor at Pensacola Naval Air Station and an amateur since 1923, has patented a simple and unique keying device as an aid to learning the code without trained assistance. The keying device, which may be used to operate a buzzer or audio oscillator, consists essentially of embossed metal characters corresponding to the code equivalents of letters of the alphabet which are set in grooves in an insulated mounting. By running a metal contactor at the end of a flexible cord along the groove by hand, the external circuit, which includes the buzzer or oscillator, is keyed as the circuit is closed by the moving contactor when it makes connection with the embossed characters.



HINTS AND KINKS FOR THE EXPERIMENTER

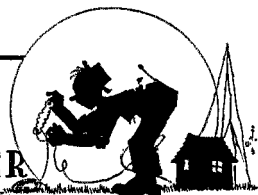

THE INSTALLATION AND CALIBRATION OF A LOOP DIRECTION FINDER

AN INTERESTING interim project for amateurs is the construction and installation of a loop direction finder. Data on the construction of suitable loop antennas will be found in *The ARRL Antenna Book*.

The optimum site for a direction-finder set-up is one free from any local obstructions which would introduce error in the readings. Careful calibration, however, will enable the operator to take into account and compensate for such errors, as well as for those which may be inherent in the instrument itself.

The loop mounting should be equipped with a pointer which moves over a 360-degree azimuth scale. Divisions may be limited to 5-degree intervals, although it is preferable to have 360 divisions at 1-degree intervals.

The scale is orientated by aligning 0 degrees and 180 degrees with true North and true South. True North is found by adding to the magnetic north or compass reading the number of degrees of magnetic declination for the location, applying the principle "east is least and west is best." The figure for the magnetic declination may be obtained from a topographical survey map of the region.

Concentric with the loop location, a large circle should be laid out having a radius of one half-wavelength for the lowest frequency at which the loop is to be used. A smaller radius may be used if limited space makes it necessary.

On this circle a stake is placed at true North, another at true South, and still others at 10-degree intervals around its circumference. A surveyor's transit facilitates the placing of the stakes; if such an instrument is not available,

compass bearings, corrected as in the case of true North, may be taken to establish points on the circumference at true East and true West.

The quadrants between the stakes at the four cardinal points should be subdivided into nine equal divisions each. The distance to be laid off for each division on the circumference may be found by calculating the length of the circumference ($3.1416 \times$ the diameter) and dividing that figure by 36. This interval should be laid off carefully along the circumference, starting from the stakes at the cardinal points and working both ways to avoid the cumulation of small errors. The stakes are then placed at each 10-degree division.

When the circle has been divided the calibration of the loop commences. A low-powered oscillator, such as a battery-operated signal generator, is placed on the 0° stake (north). The loop is rotated until a null is observed in its receiver output and the resulting reading on the azimuth scale is recorded. The loop is then rotated approximately 180 degrees to the reciprocal null point and the bearing checked. This should be the same bearing if the oscillator has not been moved.

The process of checking for nulls and logging the results is repeated for each of the stake-marked points on the circumference in turn. When the oscillator is moved to a stake 180 degrees from one already checked, the bearing will not necessarily check as a 180-degree difference from that observed on the reciprocal stake, since re-radiation from surrounding objects may affect the readings. Each bearing should be logged as observed, however, the reading on the azimuth scale appearing opposite the true bearing of the stake on which the oscillator is located.

After loop bearings have been taken for the entire circle a calibration curve can be drawn

◆
Fig. 1 — A typical calibration curve for a direction-finder loop. The true bearings are plotted against the observed bearings, which are scaled on the base line.
◆

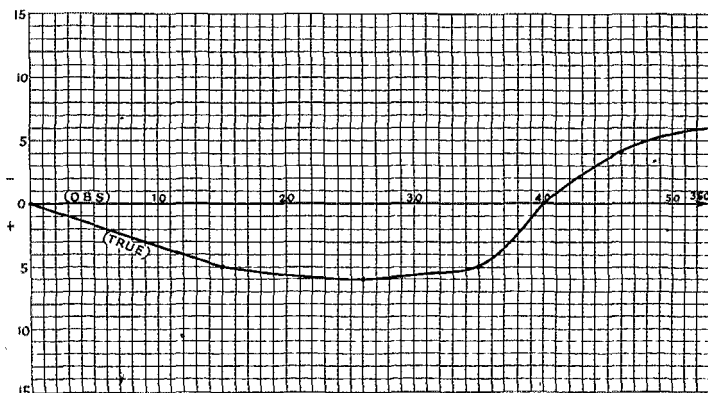

from the readings. This may be done either by using the true positions of the stakes as a reference axis and plotting the deviation of the bearings against it, or by using the observed readings as the reference axis and plotting the true bearings against that axis. Either method is satisfactory. The second method was used in plotting the sample curve shown in Fig. 1.

With the oscillator at the true North stake (0 degrees on the circumference), the loop azimuth reading was 0 degrees; i.e., the observed bearing was the same as the true. The second reading, taken with the oscillator on the 10-degree stake, was observed as 15 degrees on the azimuth scale, so the log reads: "True: 10°; observed: 15°." In plotting the reading, as shown in Fig. 1, 5 degrees were counted beyond the 10-degree point on the axis and 5 degrees down from the axis, to mark the point of the reading. This process will be better understood if it is remembered that a reversal appears, since the observed readings were made the basis of the reference axis.

In all cases where the observed reading is less than the true bearing, the reading is plotted by counting back from the true bearing point on the axis the number of degrees of the deviation, and, conversely, upward from the axis the same number of degrees. For example, when the oscillator is on the 50-degree stake, the azimuth reading observed is 46 degrees. Therefore the plotting point is placed four degrees above the 46-degree point on the axis.

The final step is the making of a list of correction readings for each degree of the azimuth readings. This is done by reference to the calibration curve. For example, with the curve shown in Fig. 1, where the observed and true

bearings are the same at 0 degrees, the curve falls 1 degree below the axis at 2 degrees on the axis line. Thus, 1 degree must be subtracted from the 2 degrees, to give a true reading of 1 degree. For an observed bearing of 5 degrees the curve is found 2 degrees below the line. It is necessary, therefore, to subtract 2 degrees from 5, to give a true reading of 3 degrees.

Wherever the curve runs above the axis, the difference must be added to the observed bearing. If, for example, 43 degrees is observed and it is found that the curve is 2 degrees above the line, it is necessary only to add 2 to 43 and derive a true reading of 45 degrees.

Corrections should be made for the entire tuning range of the loop, preferably at frequency intervals of 500 kc., although a 1000-kc. interval provides a fair coverage.

The method described is but one of several. However, while there is no universally standard method of calibrating a direction finder, the procedure described will accomplish the job and, moreover, will provide an interesting experiment to help fill the gap in transmitting activities. — *S/Sgt. J. H. Hearne, AACIS, APO 953, c/o Postmaster, San Francisco, Calif.*

A W.E.R.S. TRANSMITTER-RECEIVER UNIT USING 2.5-VOLT TUBES

A COMPACT transmitter-receiver unit which employs 2.5-volt tubes and a minimum of hard-to-get parts has been adopted as standard equipment for WERS stations in the WKPX net, Hamilton Township, N. J.

The circuit diagram is shown in Fig. 2. Improvement in the high-frequency response obtain-

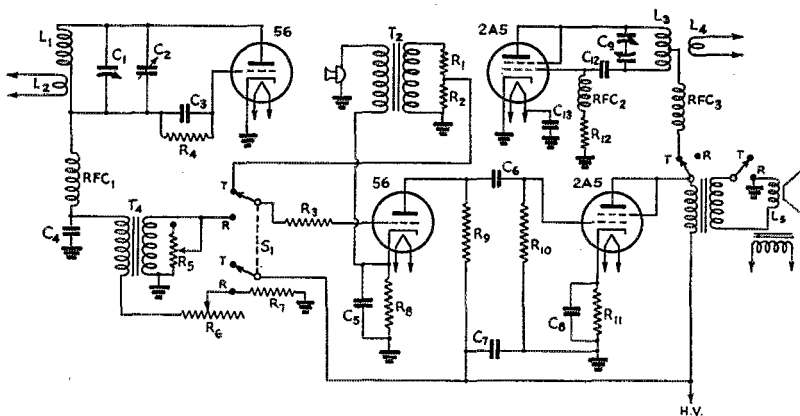

Fig. 2 — Circuit diagram of the WERS transmitter-receiver unit employing 2.5-volt tubes.

- | | | |
|--|--|--|
| C ₁ — 2-plate midget variable. | R ₃ — 5000 ohms, 1 watt. | T ₃ — Pentode output transformer. |
| C ₂ — 3-30- μ fd. mica trimmer. | R ₄ , R ₁₀ — 0.5 megohm, 1 watt. | T ₄ — 3:1 audio transformer. |
| C ₃ , C ₁₂ — 50- μ fd. mica. | R ₅ — 0.5-megohm potentiometer. | L ₁ — 3 turns No. 14, $\frac{1}{2}$ -inch diam-eter. |
| C ₄ — 0.001- to 0.006- μ fd. mica. | R ₆ — 50,000-ohm potentiometer. | L ₂ — 1 turn No. 11, $\frac{1}{2}$ -inch diam-eter. |
| C ₅ — 50- μ fd. electrolytic, 50 volts. | R ₇ — 50,000 ohms, 1 watt. | L ₃ — 2 turns No. 14, $\frac{1}{2}$ -inch di-iameter, $\frac{5}{8}$ -inch long. |
| C ₆ — 0.01- μ fd. paper. | R ₈ , R ₁₁ — 2500 ohms, 1 watt. | L ₄ — 2 turns No. 14, $\frac{1}{2}$ -inch diam-eter. |
| C ₇ — 0.05- μ fd. paper. | R ₉ — 0.1 megohm, 1 watt. | L ₅ — Voice coil on loudspeaker. |
| C ₈ — 10- μ fd. electrolytic, 50 volts. | R ₁₂ — 15,000 ohms, 1 watt. | S ₁ — 4-p.d.t. rotary switch. |
| C ₉ — See text. | RFC — V.h.f. r.f. choke (Ohmite Z-1). | |
| C ₁₃ — 250- μ fd. mica. | T ₂ — Single-button microphone transformer. | |
| R ₁ , R ₂ — 0.25 megohm, 1 watt. | | |

able with the microphones available was secured by the inclusion of R_3 . In some of the rigs it was necessary to use a lower value of resistance than that given in the parts list for R_3 . This was because of the reduced plate voltage available for the Type 56 audio tube.

All the transmitter-receiver units were built on chassis salvaged from old midget a.c.-d.c. receivers. Transmitting components are mounted on the chassis top, with the receiver parts located below so as to isolate the circuits insofar as possible.

The tuning condensers used for C_9 are dual 23-plate variable b.c.-type units, with each rotor section cut down to two plates and the original trimmers removed. The condensers are mounted on plexiglass to insulate them from the chassis. L_3 is mounted directly on the stator lugs of the tuning condenser, C_9 .

The loudspeaker output transformer is mounted directly on the chassis in order to reduce the length of the plate leads and the modulator lead, but the speaker itself is kept separate from both the power-supply unit and the transmitter-receiver chassis.

The power supply, which is on a separate chassis, is not included in the circuit diagram. It is built around a b.c. replacement-type transformer and a Type 80 rectifier tube. Input and output condensers in the filter circuit are 16- μ fd. 450-volt electrolytics. The speaker field coil is used as a filter choke in the power-supply filter circuit. The power-supply unit delivers between 250 and 275 volts to the plates of the transmitting tubes.

Excellent results have been obtained with receivers using the Type 56 as a superregenerative detector, working over distances of from 4 to 11 miles airline. — *W. Ray Tomlinson, W3GCU.*

— . . . —

A HOMEMADE GAS SOLDERING TORCH CONSTRUCTED FROM SCRAP COPPER TUBING

A HOMEMADE gas soldering torch which I have been using for a number of years is shown in Fig. 3. Such a torch is useful for jobs which are too large to be heated with an ordinary soldering iron. The torch may be made in any required size. All of the materials used are readily obtained and probably can be found by most hams in the junk box.

A piece of $\frac{1}{4}$ -inch copper tubing is cut to the desired length and given a 30-degree bend at a point 3 or 4 inches from one end. At the bend a $\frac{1}{8}$ -inch hole is drilled through one wall, on a line with the axis of the short section. Next, a piece of $\frac{1}{8}$ -inch copper tubing is inserted through the drilled hole to a point approximately $\frac{1}{16}$ inch inside the end of the short section of the $\frac{1}{4}$ -inch tubing. The external length of the $\frac{1}{8}$ -inch tubing

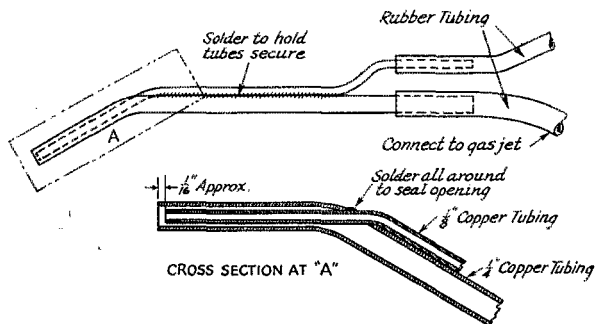

Fig. 3—Constructional details of the homemade soldering torch.

is bent down to lie along the longer or shank section of the $\frac{1}{4}$ -inch tubing. It is then soldered in place all along the adjoining length of the $\frac{1}{4}$ -inch tube from a point an inch or so from the open ends of the shank sections. The joint at the drilled hole is also soldered, in order to make an airtight connection.

A length of automobile windshield wiper rubber tubing is slipped over the open shank end of the $\frac{1}{8}$ -inch copper tube, and a piece of rubber gas tubing is attached to the shank end of the $\frac{1}{4}$ -inch copper tube.

The large tube is connected to a gas jet and the flame lighted at the mouth of the torch. The open end of the small rubber tube is placed in the mouth, and the breath is blown through it. The result is a cone-shaped flame of intense heating capacity.

By increasing the gas flame to a length of 18 inches or so and delivering air from a compressor at 25 or 50 pounds-pressure through the small tube, enough heat can be obtained to melt aluminum. By this means I have made successful aluminum castings in plaster forms, using the homemade torch. — *J. Hengel, Route 10, North Kansas City 16, Mo.*

— . . . —

SUBSTITUTING A 1H4G FOR THE 1G4G TUBE IN THE HANDBOOK CODE-PRACTICE SET

I BUILT the simple battery-operated audio oscillator for code-practice use as described on page 16 of the 1944 edition of the *Handbook*. The 1G4G tube specified for use in this set worked satisfactorily, but when it was broken I was unable to replace it.

I am now using a 1H4G in place of the 1G4G and find that it gives even better results in respect to tone. The 1H4G is rated at 2 volts for the filament and from 90 volts to a maximum of 180 volts on the plate. However, I operate it in this oscillator with 1.5 volts on the filament and 67.5 volts on the plate, with excellent results. The only change I needed to make was the increase of 45 volts on the plate.

I have found that the 1H4G tubes seem to be relatively easy to obtain in comparison to other types. — *Philip Slipkoff, 3312 Louisiana Parkway, New Orleans 15, La.*

On American Samoa in the South Pacific is a tiny broadcasting station operated by three enterprising Navy men, one of whom is RM1c Stanley T. Dixon, W6NJK. Called "Rock Radio" after the Marines' name for that island paradise, the station is described as operating on 2½ watts' worth of "tired tubes, broken bed springs and stripped jeep gears."

— . . . —

A new wood treatment process developed by Du Pont makes wood harder and stronger and prevents swelling or warping under changes in humidity, thereby increasing the uses of ordinary wood and making possible the commercial use of soft wood formerly rejected as unsuitable. The process consists of impregnating the wood structure with methyloleurea, a compound of resin-forming chemicals capable of reacting with the wood cellulose. In addition to being harder, stronger and resistant to moisture, "transmuted" wood can be more smoothly worked and its tendency to shred or splinter during working or later use is greatly reduced. It can be highly polished without further surface treatment and, since the finish is infused throughout the entire thickness of the wood, scratches can be removed by sanding and repolishing without refinishing entire surfaces. Color can be introduced in the process, resulting in wood that is colored throughout its structure. Treated woods require slower rates of cutting and turning, different tool settings and harder tools. More power is needed for drilling or for inserting screws, but the holding power of screws or nails seems to be improved.

— . . . —

Production of fixed and variable resistors for electronic equipment increased more than 20 per cent in April over the average production in February and March, according to a War Production Board report.

— . . . —

Optimistic note: W5MN is reported as having recently installed new ropes in his antenna system.

— . . . —

Tuning one of the communications receivers in the studio of VU2ZY, the new U. S. Armed Forces radio station at New Delhi, India, is Pvt. Eskil E. Holt, W6NNE, chief engineer for the 50-watt station. Operated by and for servicemen of the United Nations stationed in the China-Burma-India theater of war, VU2ZY presents transcribed programs of all the major broadcasts heard in the States as well as news reports and local talent on shows planned and produced with G1 performers. Set up by the Armed Forces Radio Service of the Morale Services Division of the War Department, the station is immensely popular. Two weeks after VU2ZY went on the air local radio dealers reported a complete sell-out of all available receivers. To keep reception at its best, W6NNE in his spare time has taken on the job of G1 radio repairman and runs a miniature repair shop in the studio to which the men can bring their sets. Because of the wartime scarcity of parts, many of these free jobs boast a spliced cable or a makeshift connection — and leave it to a ham to know how to do that!

Official U. S. Signal Corps Photograph

Chicago "Hamboree"

The first big amateur get-together in the Middle West since Pearl Harbor was held May 13th in Chicago's Sherman Hotel under the auspices of the Chicago Area Radio Club Council. Anticipating a large attendance of service men, the Council financed the meeting through donations from local dealers and manufacturers and admission was free.

The doors opened at 5 P.M. Early comers greeted old friends and viewed the display of Army radio equipment furnished by the Signal Corps. By the time the program got under way at 8 P.M. nearly 500 hams, ex-hams and would-be hams were present. Every call area was represented.

The program, arranged by Warren Clark, secretary of the CARCC, consisted of moving pictures and talks on amateur subjects. Three pictures were shown: "Voice of Victory," a Hallierafters film about the SCR-299 mobile radio communications unit; "Patrolling the Ether," described in May, 1944, *QST*, and "Attack Signal," a Signal Corps training film showing the use of walkie-talkies in landing operations. Speakers were Cmdr. J. E. Parrott, W7KX, communications officer for the Ninth Naval District, Cyrus T. Read, W9AA, assistant secretary of ARRL, and Kenneth Porter, foreign correspondent for *Radio News*. Clifton Bryne, acting regional representative of the War Shipping Administration, spoke briefly on the necessity for more operators in the merchant marine. George Ashton, W9PNV, chairman of the Council, acted as master of ceremonies.

Warren Clark came in for some good-natured "ribbing" over the invitation he had sent to Commander Parrott. Not knowing that the commander was a veteran amateur, he had described in great detail just what amateur radio was and why the communications officer for the Ninth Naval District should speak at a ham gathering. His feelings when he received an acceptance signed by W7KX can be imagined!



Look Before You Leap

A Survey of Power-Supply Systems Encountered by American Troops Serving Abroad

BY WALTER E. BRADLEY,* W1FVH

IN VIEW of the fact that many of the boys provide themselves with American-made receivers for personal use while on foreign duty, we have received a number of requests for information concerning the power-supply sources available in the different countries. Unfortunately, the 115-volt a.c. to which we are accustomed is not so prevalent elsewhere as it is in the U.S.A.

In England, 230-volt 50-cycle power mains are now the national standard, although anywhere from 220- to 240-volt d.c. or a.c. (at 25, 40 or 50 cycles) may be encountered in some areas.

Italy is terrible! They use anything from 110-volt d.c. and a.c. to 250-volt d.c. and 260-volt a.c. (50, 45 or 42 cycles), with many different voltages in between.

Australian power is pretty well standardized, but it depends where you land. New South Wales offers 240-volt d.c. or a.c. (50 cycles only). Victoria has 230-volt d.c. or a.c. (50 cycles only). Queensland has 220- or 240-volt d.c. and 240-volt 50-cycle a.c. South Australia uses 200-, 230- and 220-volt d.c. as well as 200-, 230- and 240-volt 50-cycle a.c. West Australia is a bit different, offering 220-, 110- and 230-volt d.c. and only 250-volt 50-cycle a.c.

Tasmania uses 240-volt 50-cycle a.c. mostly, but 230-volt d.c. is also available.

New Zealand's power lines are standardized but all you get is either 230-volt d.c. or a.c. (50 cycles).

In Africa, Tunisia is the best place to go; there 110-volt 50-cycle a.c. is used exclusively. Egypt isn't too bad; 110-, 200- or 220-volt a.c. (50 or 40 cycles) and 220-volt d.c. are available. French Morocco gives you 110- and 115-volt 50-cycle a.c. or 110-volt d.c.

China has 110-volt a.c. (50, 60 or 25 cycles) for the most part, but you're apt to find 200 or 220 volts as well. D.c. voltages of 220 and 110 also are used.

India's variety in voltages almost equals that of Italy. D.c. mains supply may be either 110, 220, 225, 230 or 250 volts; a.c. mains (50 or 25 cycles) supply is at 110, 220, 230 and other voltages.

Hawaii isn't bad. 110- and 220-volt 60- and 25-cycle juice is available.

Alaska has 110- and 220-volt 60-cycle a.c., of course.

Iceland uses 220-volt 50-cycle current in its power lines.

Bermuda offers 110-volt 60-cycle a.c. — just like home.

So much for the countries where American troops are stationed at present. Turning now to the enemy and enemy-occupied countries where many GI Joes may expect to find themselves in the not-too-distant future:

In Belgium the power lines supply 220-, 120- or 110-volt d.c., and 220-, 127-, 110-, 115- or 135-volt a.c. at 50 or 40 cycles. The Netherlands offers d.c. at 220 volts and 50-cycle a.c. at 220, 120 or 127 volts. In France the d.c. mains furnish 110, 220, 120 or 125 volts, while a.c. is supplied at 50 and 25 cycles in voltages ranging from 110 (the most prevalent) to 230. Denmark uses 220- or 110-volt d.c. and 50-cycle a.c. at 220, 120 or 127 volts. In Germany — your destination in Europe — you will find d.c. at 220, 110, 120, or 250 volts and a.c. at 220, 127, 120 or 110 volts (50 or 25 cycles).

In the Pacific theatre, the Philippine Islands use 220-volt 60-cycle a.c. Japan, when you get there (and we hope it will be soon!), will have both 110-volt d.c. and 100- and 110-volt a.c. at 50 and 60 cycles. The 110-volt a.c. supply is the most common.

In our own camps in the U. S. and in military installations overseas, according to the Signal Corps, the generators produce 110 volts for lighting, radio equipment, etc., and 220 volts for power, both at 60 cycles a.c.

American-manufactured receivers for domestic consumption are designed for "110-volt" operation — which means an operating range of 105-130 volts, based on a mean line voltage of 117 — at 60 cycles a.c. Power transformers in such receivers will operate safely on 110- to 120-volt 50-cycle a.c., but 40- or 25-cycle a.c. power lines may cause them to burn up. The a.c.-d.c. variety of receiver will operate on "110-volt" a.c. power regardless of its frequency, as well as on 110-volt d.c. power.

By inserting a resistor of proper value in series with one side of the power cord, any 115-volt a.c. or a.c.-d.c. receiver may be operated on higher voltages. The value of resistance necessary to operate a 115-volt a.c. or a.c.-d.c. receiver on a 220- or 230-volt a.c. or d.c. line may be found by the following formula:

$$R = \frac{12,100}{W}$$

where R is the value in ohms of the required series resistor and W is the power in watts consumed by the receiver (usually given on the metal license-notice plate on the chassis). The resistor must have a wattage rating equal to that consumed by the receiver.

* Technical Information Service, ARRL.



CORRESPONDENCE FROM MEMBERS

The Publishers of *QST* assume no responsibility for statements made herein by correspondents.

VITAL LINK

Somewhere in New Guinea

Editor, *QST*:

. . . I am in the Army Air Forces doing signal work in connection with the Aircraft Warning System. During my Army career I've been fortunate enough to have been on duty in England, in the United States, and now in the Southwest Pacific area.

The role that has been played by the radio amateur since the beginning of this war is outstanding. It makes me shudder to think what would have happened if our country had been unable to draw from a reserve of well-trained radio men. Everywhere I've been there were amateurs filling important positions in communications systems and aircraft warning systems in all branches of the Army. This is true also in the Allied armies with which I've worked. Amateurs basically seem to be the same the world over.

This war has proved that the radio amateur is a vital link in the security of our country. He must not be forgotten when frequencies are re-assigned after the cessation of hostilities.

Hams are lucky indeed to have an organization like the ARRL to fight for them. Keep up the good work.

— Capt. Ross H. Reynolds, W4BRT

QSO

Somewhere in the South Pacific

Editor, *QST*:

The following incident in which two hams got together overseas may interest readers of *QST*.

The Signal Corps recently built a broadcast station on one of the South Pacific Islands, where I was stationed at the time, for the entertainment of all the armed forces in that area. One evening while listening on my receiver I heard an announcer's voice which suddenly made me imagine I was back in Chicago sitting before my SX-25! I almost expected him to say, "W9JGL over to W9DTY."

The next morning I made my way down to the station and asked the name of the announcer on the four o'clock program. Sure enough, I had been right. He was W9JGL, "Spence" Allen, with whom I used to have rag-chews on ten-meter 'phone nearly every night. We lived only a few blocks apart in Chicago, but we had never met personally. We finally made it over 8000 miles away from home, after being off the air nearly two and a half years!

Our meeting prompted Capt. Allen, who is in complete charge of that American Expeditionary Station [see *QST*, June, 1944, p. 56 — Ed.], to

put out a CQ for other hams to come in and make themselves known. Several hams from other parts of the U. S. showed up. A hamfest and some pictures for *QST* were being planned, but, unfortunately, I was shipped out.

Incidentally, the receiver I'm using down here in the jungle is the one-tube regenerative job described in the *Handbook*, which I managed to build out of junk parts. My short-wave reception covers the world, and I don't think any ham ever received more pleasure out of that 6C8G circuit than I have.

The copies of *QST* received in the mail are really a treat down here. We all appreciate the work you're doing for the hams' future. . . .

— Cpl. Jack Walker, W9DTY

HE MADE WAC IN PERSON

211 Cobourg St., Ottawa, Canada

Editor, *QST*:

The log book has six years of dust on it, but it still says VE3AU made WAC several times over on 20 meters with the li'l 'ole RK20. Well, I did it in person in the last six months. No kidding! North America, Australia, Asia, Africa, South America and Europe — count 'em.

I spent two months in Australia and a month in New Guinea this past winter. Add a few weeks in Ceylon and India for some of that Oriental touch. . . . In passing, it is interesting to note that the trip from Perth, Australia, to Ceylon was made in a Catalina — 3600 miles in 26 hours non-stop continuous flight! That's the world's longest regular air route. Quantas Empire Airways gives you a rare and coveted certificate for that trip which is worth a thousand Short Snorters. It's called the Secret Order of the Double Sunrise.

From India I took the regular ATC run across Africa to South America and up to Florida. Three days and nights in a C-54, with no seats! It was a C-87 across the Pacific. I also managed to wangle a quick one to England.

Flew every inch of the way, in all kinds of planes. Hardest part of the trip: three-hour argument at Montreal to get on a plane for Ottawa on last lap. Easiest part: five-minute talk at New Delhi to arrange the trip to the U. S. A. . . .

— Don McKinley, VE3AU

HAMS ON THE ANZIO BEACHHEAD

With The Fifth Army, Italy

Editor, *QST*:

The famous 45th "Thunderbird" Division, now fighting the Nazis on the Allied Fifth Army's Anzio beachhead in Italy, has at least ten hams

on its roster. Eight of these are actually engaged in radio work of one sort or another, while two are in the Medical Corps. [See photograph on page 29 in this issue. — Ed.]

Operating radio sets in the division signal company are the following veterans: Sgt. Archie Foster, W8OSH, of Ogdensburg, N. Y.; Cpl. William Potts, W7FJY, of Albany, Ore.; Sgt. Wilbard W. Harr, W2GEZ, of Baltimore, Md.; Cpl. Everett Cook (op. lic. only), of Boston, Mass.; T/Sgt. Thomas R. McLean (op. lic. only), of Royal Oak, Mich.

Working in the radio repair section of the division signal company are Sgt. Joseph G. Dube, W2HVC, of Worcester, Mass., and Sgt. George F. Huether, W2IHO, of Bronx, N. Y. . . .

Capt. Jessie Langford, W5GVV, of Enid, Okla. is communications officer with a 45th Division artillery outfit.

The two medicos are Capt. A. A. Messe, W2DRG, of Far Rockaway, N. Y., serving with the medical detachment of an infantry regiment, and Maj. John F. Daly, W5GVP, of Pawhuska, Okla., a regimental surgeon.

All ten of these "Thunderbird" hams have been through the Sicilian campaign, fought from Salerno to Venafro in Italy and now are doing their jobs on the Fifth Army's battle-torn bridgehead south of Rome.

— Sgt. Wilbard W. Harr, W2GEZ

LITTLE BUT GOOD

APO 706, c/o Postmaster, San Francisco, Calif.
Editor, *QST*:

. . . I noted with interest S/Sgt. John L. Mohn's gripe in the March issue of *QST* regarding the much-publicized Signal Corps.

They do a good job and a big one, but they're not the only ones who man the equipment. Look down the line to the communication sections of the artillery, infantry, and numerous other branches of the services. They're little, but they also have a big job.

There are five men in my section who do all the work of keeping the lines in and standing watch on our transmitter. We're not Signal Corps men; we're artillery men. So how about a little credit for the small sections? We also get the message through. . . .

— Sgt. I. S. Staimbrook

On the Anzio Beachhead

Editor, *QST*:

. . . I get *QST* regularly, although it comes about one month late, and all of us enjoy reading it. . . .

The letter in the March issue, by S/Sgt. J. L. Mohn is 100 per cent correct, I can tell you. In this infantry division, the "Fighting 45th," the radio sets are operated 95 per cent by artillery and infantry men.

— Sgt. George F. Huether, W2IHO

HE MADE A RING

RFD 1, Ambler, Pa.

Editor, *QST*:

The letter entitled "He Wants A Ring" in May *QST* caught my eye, and I am offering a solution to the problem. . . .

If you have a signet ring of reasonable size, just send fifty cents cash or money order ("no stamps, please") to the ARRL and tell them you want an ARRL pin. . . .

Now carefully remove the pin mounting and catch from the back of the pin, place the pin on a wet cloth (a turkish towel will do if it is not a good one), and tin the back of the pin. The wet towel will prevent the enamel from softening. Then tin the ring and place the pin in a central position. If obtainable, some jewelers' liquid solder would serve the purpose nicely.

If you obtain a pin with a screw type fastening, the process is much simpler. Just drill the ring and insert the threaded stud through the ring. Cut the stud off flush, tin the end and solder it securely in place.

I have done this with other ornaments and it works very well. Care is the key to a neat job. . . . The same idea may be applied to a cigarette case or lighter, a lady's locket, or a watch charm.

— Wesley W. Brogan, W3ARM

Picton, Ontario, Canada

Editor, *QST*:

W2MXW may be interested in the solution of the identity problem employed by former members of the Boy Scouts now in the services. The wearing of a personal identity tag on the wrist is not objected to, so the Scouts use a strap, like a watch strap, to which is pinned a metal emblem on the reverse of which is engraved the normal identification material. The emblem is obvious to anyone shaking hands with the wearer.

Now a question. Why do some fellows have all the luck in ham hunting? For a whole year I exhibited the RSGB emblem (in the form of a mounted windshield sticker) whenever I took sick parade. My ham bag was nil. Maybe hams are too fit to come my way!

— F/Lt. H. G. Fenn, RAF, BRS2515

DURATION DXERS MEET AGAIN

APO 885, c/o Postmaster, New York, N. Y.

Editor, *QST*:

Your letter of February 17th received, and we are glad to note your interest in our little organization. I read your missive to the last meeting of Duration DXers, and everyone here sends regards to you and the rest of the American hams.

Yes, Major Wilson, W3DQ, is here. Don't know how he got left out of first meeting; could be he was out of town at that time. . . .

. . . Our organization embraces fellows from both SEAC and CBI and the British Services in this vicinity.

The third meeting of Duration DXers was held March 15th in a tent on the grounds of the Church of the Redemption at New Delhi, India. Twenty hams were present: W1XTY, W4GBN, W9JPD, W6NNE, W6NIP, W9ZHE, W6WAK, W4LK, W4BRF, G2LC, G6GD, 2FQR, W3FYD, W9-EYE, W9NQQ and BR54405. . . .

The meeting program consisted of a discussion of directional antennas by F/Lt. Hobday of the RAF, followed by a discussion of crystals and crystal-grinding methods by Lt. Lynch of the USAF. Coffee and cakes were served.

A proposal for our next meeting was an inspection trip to the All-India Radio plant, provided necessary consent could be obtained.

— Lt. M. C. Davie, jr., W4GBN

“VALUABLE CREATURE”

Box 82, Pinchi Lake, B. C., Canada
Editor, *QST*:

Enclosed is a little sketch of one of the Kee Birds we have trained to go out and run or fly down stray bursts of northern QRN, etc. These birds abound in this district and, if a little caution is used, can be trained to do lots of odd jobs usually distasteful to operators in general, such as digging counterpoise wires out of snow, chopping icicles off the eaves, and eating ice worms — which, I might say, cause us no end of trouble by chewing down aerial masts, wind socks, etc.

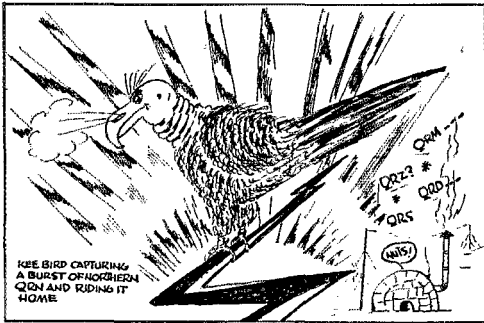

You will notice his neck, particularly its telescopic structure. This comes in handy if an aerial should come down and we find it difficult to coax a high rigger to go up the pole when it is 40° below zero and a gale is blowing. All we have to do then is call “Kay Bee.” He very kindly grasps the insulator in his beak and, stretching his neck out, does duty for a pole until the weather abates a bit. In fact, when Kay Bee has had a good meal of back-dated messages and worn carbon paper he can stretch his neck fifty or sixty feet.

We call our little pet — well, several names, all of which I am sorry to say are more or less unprintable.

In conclusion, I would be glad to explain the training schedule of Kay Bee to anyone who cares to obtain a Kee Bird and wants it trained. You must act quickly, however, as the Army is seriously considering putting a ban on the capture

of these valuable creatures, except for its own use

I have thought of offering my services as a hunter and trainer, but you know what Thought did.

— W. H. Sharp, VE5DB

“POP” KEEPS US POSTED

c/o Evening Outlook, Santa Monica, Calif.
Editor, *QST*:

. . . I note your request for items from the kid. As his “pop,” I will say that the kid writes some darn interesting stuff. He is John Phillip Linden, W6UCX, an RM3c in the Armed Guard (Pacific).

He has some real tales with lots of action. Speaks casually of Tarawa, Espiranto Santo, etc. Got a laugh out of an ammunition dump blowing up. Kids about the mosquitoes.

He acts as a radio technician and keeps the rigs going, although he is not rated as a radio technician. He also keeps the electrical depth “doohickies” working and acts as signalman, though not rated for it. He is the “braids” yeoman, although not rated for that, either. He also has a gun station. In his spare time he is typing a book on navigation for the second mate and acts as typist for the captain. He had a signal lamp go up in smoke with a destroyer roaring down at him and yelling for identification — what a spot for a ham! Says it’s “good duty.” . . .

He says that ships’ personnel all think every merchant ship should have a ham on board to keep her perking. He meets plenty of hams — says they are by far the best operators because they are also technicians. He hopes when the war is over the government will remember the work the hams have done. . . .

— E. T. Linden

AN OLD TIMER REMINISCES

Editor, *QST*:

QST arrived yesterday and now, 24 hours later, it’s been read from “kiver to kiver,” including the ads. . . .

I notice some men in the armed services give us as many details as is possible and still stay within military censorship. That’s fine — I surely enjoy their stories.

Since I am an old-timer (ham and soldier); perhaps my experience in Army radio would be interesting to some of the boys.

I went to the post radio school on Corregidor Island in the Philippines in 1920. The qualifications for graduating were to be able to draw the diagram of a simple spark transmitter and a crystal detector and explain their operation, and to copy 20 w.p.m. How different it is today!

After graduating as a wireless operator I was assigned to small battalion spark stations, which consisted of overgrown buzzers powered from storage batteries. We couldn’t use a ground because of QRN, so a counterpoise was used. From

(Continued on page 104)



OPERATING NEWS



CAROL K. WITTE, W9WVP
Acting Communications Manager

LILLIAN M. SALTER
Communications Assistant

Intermunicipal Agreements. Of late we have been receiving inquiries from a number of WERS licensees concerning the procedure for expanding area coverage under the original license. They want to know how to negotiate intracounty and intermunicipal agreements, and how to bring adjacent communities within the scope of operations.

Any licensee can include an adjacent town or city in its license by means of an intermunicipal agreement with that community. An application for a new license is not required, but an application for a *modification* of the existing license is then required as the next step.

To begin, the applicant should secure sworn copies of the agreement made with the adjacent community. A sample form of the type of agreement to be signed appears on page 20 of *A Manual for the War Emergency Radio Service*. In brief, the agreement must show that the equipment to be used in the adjacent community shall be under the direction and control of the applicant, that the adjacent community will not request individual authority, and that the agreement can be terminated at any time by either party, provided that notification of such action be sent to the FCC sixty days before the termination of the agreement. A sworn copy of this agreement should then be sent to the FCC, along with the application for modification of the existing license on Form 455.

In filling out FCC Form 455 for modification purposes, it should be remembered that Items 1 and 2 refer to the name of the community licensed, and that the address given should be the location of the municipality's executive offices, and not merely the address of the radio aide. Item 3 must be filled out also, giving the call

letters and file number of the existing license. Under Items 5, 6, 7 and 8, it is not necessary to recopy all the information on station units which appeared previously in the original application. Only the descriptions of the new units should be given here, with a note made to the effect that they are additions to or changes from the original list. Under Item 9, it is necessary to include a new map of the entire district to be covered by the licensee under the modification, plus a map of the community to be added, showing the numbers and locations of the new units. The supplementary statements may be treated in the same manner as Items 5, 6, 7, and 8, with reference made to the original application.

Most unlicensed communities are glad to be covered by WERS operation because of the protective advantages offered, but have not previously been organized for it because of the lack of initiative leadership, proper facilities, etc. Through intermunicipal agreements it is possible to bring WERS to these communities, and the FCC readily approves such modifications of existing licenses.

Summer Activities. In the summer, a young ham's (older one's, too) fancy lightly turns to thoughts of outdoor hamfests, radio picnics, etc. Since these years of war have depleted the clubs of active ham and SWL membership, in most instances, it might be advisable to conduct WERS-fests, or hold combined WERS-and-hamfests. Many of the present WERS operators are potential hams, and certainly an outdoor hamfest is one of the pleasant phases of the hobby to which they should be introduced. If the affair is conducted on a Sunday afternoon, in the area covered by the local licensee, the regular WERS testing period may be used to conduct a "hidden transmitter" or "hidden receiver" hunt. Although only licensed portable and portable-mobile units can be used to track down the signals from the hidden unit, and only WERS operators may actively participate, groups or teams can be formed of both operators and onlookers to add to the competitive spirit of the occasion. Most of the games and contests sponsored at hamfests in the old days are still good, even though it is not possible generally to furnish radio equipment as prizes. War stamps and bonds, books and pamphlets on radio theory and practice, etc., are practical and useful substitutes, since they will be used in preparation for the happy days of active amateur radio operating to come.

Writing to Hams in the Services. We agree with the Hamfesters' Radio Club that one of their members really had a five-star idea when he conceived the unique plan of getting the members

Honor Roll

**The American Radio Relay League
War Training Program**

Listing in this column depends on an initial report of the scope of training plans plus submission of reports each mid-month stating progress of the group and the continuance of code and/or theory classes. All radio clubs engaged in a program of war radio training are eligible for the Honor Roll. An asterisk indicates that both code and theory are taught. Others conduct only code classes.

- Butte (Montana) Amateur Radio Club
- Cuyahoga Radio Association, Cleveland, Ohio
- *Dade County, Florida WERS licensee WKNW
- Tucson (Arizona) Short Wave Association

of the club to write to their fellow members in the services by having a card shuffle at each meeting. A new round of names is dealt out each time, thus keeping letters varied and consistent. Replies received are published in the club bulletin, and since this bulletin is sent to all members — at home and away — it enables everyone in the club to keep up with the activities of their former club pals and friends. Fellows in the services already indicate their enthusiastic reception of the new plan, and they urge its continuance. Letters from ham friends are particularly welcome to other hams in the services, because such correspondence enables them to “QSO” about activities in the good old days, to talk over local ham activities, and to hash over ideas for postwar rigs, operating, etc. This is something that most amateurs cannot do in letters to relatives, so they usually welcome correspondence of this nature.

We'd also like to encourage, among the clubs, the sending of letters to ham prisoners of war. These are perhaps the most unfortunate of our fighting brethren, and a letter received from one of the local gang would certainly be a morale builder. Special airmail letter cards for POW mail are now available, free of charge, at all local post offices. Regular airmail stamps can be used, but any stamps with a “Win the War” slogan, or a “V for Victory” emblazonment are not acceptable. This also applies to the 1940 National Defense issue which carries the slogan “For Defense,” the 1943 two-cent “United Nations” commemorative, and the one-cent “Four Freedoms” commemorative stamp. It seems that the Axis powers, masters of propaganda themselves, have realized the propaganda value of such slogans on stamps on letters received by Allied prisoners, and have banned these stamps as a result. To insure delivery of POW mail, therefore, use the new airmail letter cards. Be sure not to use stamps with slogans offensive to the enemy.

Change Sheets. Reprints of the “Changes in Typical Element One Answers,” which appeared in this department on page 58 of May *QST*, are now available, free of charge, to all who would like to add them to their copies of *A Manual for the War Emergency Radio Service and Training Auxiliary Operators for WERS*.

— C. K. W.

BRIEFS

Planning it along the lines of a good old-fashioned ham-fest, the WERS gang of WMHC, Hartford, Conn., will hold the first “Werspree” in the area on Sunday, July 16th. All WMHC ops and interested hams and their families in the vicinity are invited, as are any local hams in the services who may be around at the time. In addition to being a get-together for the local WERS ops, giving them an opportunity to meet face-to-face, the “Werspree” will afford the opportunity for plenty of rag-chewing. Featured in the afternoon will be games and contests, and a “hidden receiver hunt” during the regular WERS drill period from 5 to 7 p.m., in which the portable and portable-mobile units of WMHC will be used. Names of those who plan to attend, together with a fee of twenty-five cents for each adult, to defray expense of prize awards, should be sent to the registration chairman, Carroll E. Drysdale, 83 Farmington Ave., Plainville, Conn.

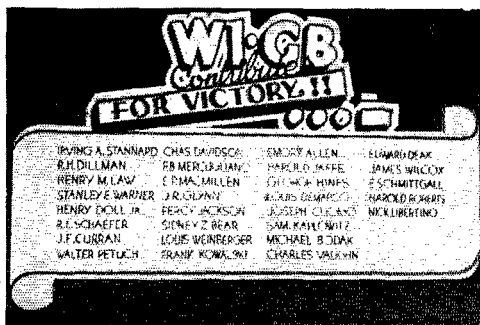

W1KQY of the New Haven Amateur Radio Association had the idea of making an honor roll of members in the armed forces. W1MEF turned the idea into reality, and W1ATH photographed it for *QST*.

ARRL Affiliated Club Honor Roll

The list below was compiled by analysis of questionnaires returned in response to a year-end club survey.

All Members of these Clubs are ARRL Members:

Amateur Radio Club of Seattle, Wash.
 Amateur Radio Transmitting Society, Louisville, Ky.
 Amateur UHF Club, Jamaica, L. I., N. Y.
 Associated Amateur Radio Operators of Denver, Colo.
 Binghamton Amateur Radio Assoc., Binghamton, N. Y.
 Butte Amateur Radio Club, Montana
 Charlotte Amateur Radio Club, N. C.
 Columbus Amateur Radio Association, Ohio
 Dayton Amateur Radio Association, Ohio
 Dells Region Radio Club, Wisconsin Dells, Wis.
 Huron Radio Club, Huron, S. D.
 Illinois Ham Club, Chicago, Ill.
 Inglewood Amateur Radio Club, Calif.
 Inter-City Radio Club, Gallion, Ohio
 Iowa-Illinois Amateur Radio Club, Burlington, Iowa
 Jackson Amateur Radio Association, Mich.
 M.A.K. Amateur Radio Association, Boston, Mass.
 Northeastern Indiana Radio Club, Kendallville, Ind.
 Parkway Radio Association, West Roxbury, Mass.
 Short Wave Amateur Club of America, New Orleans, La.
 Spokane Amateur Radio Association, Wash.
 The Winston-Salem Amateur Radio Club, Inc., N. C.
 Yakima Amateur Radio Club, Wash.

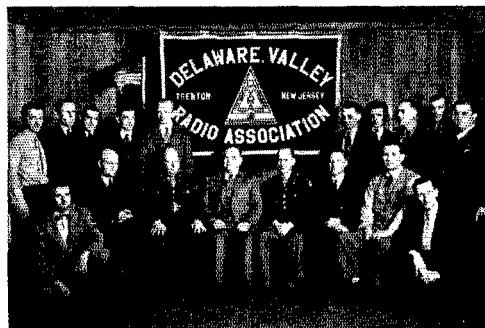

Here are some of the gang who attended the twelfth annual DVRA get-together and open house meeting on April 12th in Trenton. *L. to r., seated:* E. W. Pullen, W3ISZ; Ed Raser, W3ZI, secretary; Cpl. D. Nabutovsky, W3ITU; A. D. Middleton, W2OEN/W7GLH; Lt. L. H. Allen, W3CCO; H. L. Yoder, W3EED, treasurer; L. R. Yoder, W3EED, president, and C. A. Moore. *Standing:* W. A. Bluml, W3JOL; M. R. Lawshe, ex-W3UQ; H. J. Arnts; V. S. Wagner, ex-W8BRJ; W. A. Burroughs, W3ADD; Ray Tomlinson, W3CGU, vice-president; P. Williams, W3JAG; S. Kramer, G. N. Brindley, and W. A. Gaskill.

WERS of the Month

Prince George's County, Md.

CONTRARY to the reports of dwindling interest among members of various other WERS nets, we of WJWM are proud to say that the morale of our group is at a high peak, and seems to be increasing. In the beginning, we had only 18 people who were interested in WERS. None of them knew each other then, and they were working as strangers. Then, one Sunday night after test hours, a get-together meeting, complete with refreshments as an added inducement, was held at the home of the assistant radio aide. It turned out so successfully, that it was determined then and there to make the weekly meeting, after test hours, a regular event. The net grew, of course, and it was not possible to include all the members at these meetings, so it was decided to limit it to the basic group who were originally responsible for the success of the network. The radio aide, assistant radio aide and engineer made it their policy to make regular visits to all the stations, however, to help solve the difficulties in local operation and to keep in close touch with the operating personnel. This has proved a very effective means of building morale and keeping interest alive among the net operators.

At the present time there are 14 members of WJWM who hold a license higher than third class radiotelephone; 8 of these are amateurs, and 6 of these hold other commercial licenses. The balance of 96 operators have been trained by the 14 holding the higher-grade licenses. As has been noted in other cases, the 96 who had never been on the air before proved to be the best operators; the former amateurs were the most difficult to control in eliminating "hamming" practices from net operation.

Unauthorized operations of any sort have been strictly banned within the WJWM net. Only two operators have violated the rules. They were first warned to discontinue the particular practices, and when they persisted in continuing them, their licenses were suspended, by the radio aide, for a period of 90 days. This cured the violators of their bad habits, and did much to strengthen the good operating practices of the rest of the net.

The WJWM network has been very fortunate in having the splendid cooperation of the County officials. Very little financial support has been accepted, however. The County officials were kind enough to rent a banquet room and furnish food and refreshments recently for a group of 123 people who were on hand to celebrate WJWM's birthday.

Although there is activity in construction of new equipment, the number of stations, which at present is 33, is not being increased. All efforts are now concerned with improv-

ing the station units already in existence. Superregenerative receivers are being replaced with superheterodynes, and transmitters are being improved for frequency stability and modulation quality.

At present we are exchanging messages with the Washington, D. C., net, WJDC; the Montgomery County net, WMDD; and the State control station, WJGS-70, in Baltimore, or Pikeville, Md., as the location is now — which is also the headquarters of the Maryland State Police. The distance between Prince George's County control station and the Maryland State control station at Pikeville is approximately 40 miles. This now ties the chain among Baltimore, Prince George's County, Montgomery County and Washington, D. C., WERS.

A tri-net meeting every three months is being planned for the WMDD, WJDC and WJWM networks. We hope to continue to build the morale of all the operators in these nets in this fashion.

BRIEFS

On May 7th one of the largest fire demonstrations ever held in the Washington, D. C., area was staged by civilian defense units at Alexandria, Va., for training purposes. Houses were bombed and fired as though the actual incident had occurred, and the only means of communication were the units of the War Emergency Radio Service, WJDC.

Approximately ten portable and portable-mobile units were used in the dispatching of messages to bomb and rescue squads; the activities of the relay water units of the Fairfax County Fire Departments were also directed in this manner. The bomb squad, attended by one of the portable units, kept fire headquarters advised as to burning buildings, so that Fire Chief James Duncan could dispatch fire apparatus at the critical moments. The conditions which would exist in an actual emergency were simulated as accurately as possible.

Civilian defense officials who supervised the exhibition, Radio Aide George Bailey and Controller of Communications Friede were pleased with the performance of the WERS personnel of WJDC in this demonstration, and were lavish in their praise of the participants. Some of those who took part were: WIDEI, W1MUK, W3AKB, W3BWT, W3FGR, W3GGX, W3IUN, W5FYE, W8LIW and Broughall, Stites, Ejerpe, Sugar and Wilson.

The members of WKBS, the WERS net of Syracuse, N. Y., are busy arranging for an exhibit of WERS equipment on the ground floor of the Central New York Power Corporation's building at Franklin and Erie Blvd W., in Syracuse. In this manner, the hundreds of people who enter and leave the building each week will gain a better idea of the activities of their local WERS organization. Besides photographs of the units, there will be representative pieces of fixed mobile and portable types of equipment, field strength meters, frequency meters, antennas, log-books, etc., on display. Many of the local citizens, familiar in a vague way with WERS, will thus get their first look at the actual equipment used in net operations.

Each month under the above heading we shall publish the story of an outstanding WERS organization as an item of general interest to all WERS participants. Contributions are solicited from any radio aide or WERS participant, whether he be an amateur or a WERS permittee. Descriptions of organizations which have already been featured in QST articles will not be considered. The story may describe the organization in general, how it came into being, how it was set up and how it operates; or it may describe some particular phase of the organization which makes it unusual or unique. Contributions should be brief (two or three typewritten pages, double-spaced, is maximum) and may include photographs if desired, although only one photograph will be printed with each story. Each story must be released for publication by the radio aide of the license, in writing. Address your contribution to the Communications Department, ARRL, and mark it: "For WERS of the Month."

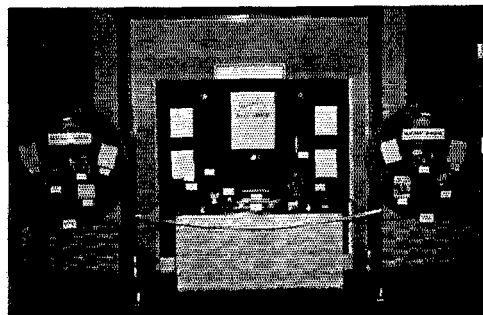

This photograph shows the neat and attractive WERS exhibit of the Syracuse net, WKBS, which has been attracting the attention of visitors to the Central New York Power Corporation building in that city.

Meet The SCMS



Although the appointment as SCM of Colorado is a recent one for Henry Hekel, W9VGC, he has been performing a very creditable job as Acting SCM for this Section for quite a few months.

Since his birth in Waterloo, Iowa, on November 16, 1889, the new SCM has led a busy life. After spending the usual number of years in attendance at grade school, high school and the Waterloo Business College, W9VGC answered the call to adventure and joined the 6th Infantry Group of the U. S. Army in 1914, and remained in service until 1926. During this time, he served with the Group on the Mexican Border and with the Mexican Expedition into Old Mexico, until 1917. Then, as a first sergeant, he served with the 54th Infantry in France during the last World War, and returned to the United States in 1919.

In 1921 Hekel found a Texas girl who agreed to "overlook his horseplay, tolerate his nonsense, and take him for better or for worse." "So far," "Heck" says, "she has been getting the worst of it." In 1926, after receiving his honorable discharge from the Army, Hekel settled down to the "hum-drum life of an honest, upright, decent, respectable, law-abiding citizen of Colorado and surrounding territory."

Amateur radio had fascinated "Heck" since 1923, but it wasn't until 1935 that he obtained his first ticket. He has participated in Sweepstakes Contests, and holds the WAS certificate. His ARRL appointments include AEC and OPS. He was the first president of the Electron Club of Denver, Colo., and has since served as chairman of its organization committee.

W9VGC's jobs have included press-feeding and motion picture projection work, but he has always managed to find time for his hobbies of trout fishing and small-bore rifle shooting (when he isn't operating his amateur rig, of course).

The rig at W9VGC will be ready to operate again on all bands, after the war, and more particularly, on 160, 20 and 10 meters. Until then, W9VGC will endeavor to keep the Colorado gang happy by continuing to submit those FB Amateur Activities reports — "by Heck!"

BRIEFS

From *Station News*, a publication for the employees of Maguire Industries, Inc., we learn that W2CRQ recently had a run-in with John Law. While operating his portable-mobile WERS unit in a car on top of a hill in Port Chester, N. Y., someone called a local cop to investigate "that drunk up there in a car talking to himself." As luck would have it the policeman knew W2CRQ, so a good laugh all around was the only result.

— . . . —

Don Park, communications coordinator for the Ohio State Council of Defense, did such a fine job of promoting WERS and the cause of amateur radio in the State, that Ohio amateurs presented him with a mahogany plaque on the occasion of his recent retirement from the Council. On the plaque is a stainless steel plate engraved as follows: "Presented to Don Park by the amateurs of Ohio in appreciation of his services to WERS and amateur radio — March 31, 1944."

Press Schedules

We are indebted to Marine Corps Sergeant Norman Gert W1KYK, for the following list of press schedules, which we are publishing as a supplement to the list which appeared in January, 1944, *QST*. Sergeant Gertz found that he "was able to get plenty of news (and code practice) from these stations" while his outfit was down in the South Pacific. All the stations listed are on at the stated times, most of them transmitting daily, with the exception of a few which do not transmit on Sundays. None of the material copied from these schedules must be divulged except to the addressee; use these transmissions only for code practice.

Time (GCT)	Call	Frequency (kc.)	Origin	Speed
0000 to 0300	KUN	17300	Los Angeles	30
0005	WSL	109/5555/11115	New York	20
0015	NSS	113/4390/9425/12630	Wash., D. C.	25
0030	WCX/WJS	7850/15700	New York	35
0500	WCX/WJP	7850/8810	New York	35
0605	KFS/KNA6	97.5/8270/12550	San Francisco	22
1430	WCX/WJS	7850/15700	New York	35
1515	KJEB/KHF4	7350	San Francisco	35-40
1615	WCX/WJS	7850/15700	New York	35
1800	KJE9	15625	—	35
1900	KHF4	15650	Los Angeles	35-40
2000	KCI5	15825	Los Angeles	25
2100	WCX/WJS	7850/15700	New York	35
2200	WCX/WJS	7850/15700	New York	35
2315	KCI5	15825	Los Angeles	25
2330	WCX/WJS	7850/15700	New York	35

BRIEFS

Those who enjoy hearing various slants of the daily raw news may be interested in tuning in on the following stations, which have been logged by George E. Hengy, jr., of San Antonio, Texas: Leopoldville, Belgian Congo, Africa, news in English at 2415 GMT, 9,785 kc.; Brazzaville, French Africa, news in English at 6:45 P.M. CWT, 11,970 kc.; Tokyo, JZI, news in English at 8, 9, 10 and 11 A.M. CWT, 9,535 kc.; and Tokyo, JZH4, news in English at 8, 9, 10 and 11 A.M. CWT, 6,130 kc.



Staff members of WHHI, Chicago, broadcast a WERS roundtable on the Newark Electric Co.'s ham promotion program heard at 7:30, Saturday mornings, over WJJD. *Left to right, seated* — Miss Bessie Lawler, secretary of WERS in the Chicago metropolitan area, and Col. A. D. Patterson, in charge of coordination of CD activities for sixteen states in the Middle West. *Standing* — David Blake, W9NUX, assistant director of radio communications, and F. D. Wyatt, director of radio communications for Chicago metropolitan area.

The Month in Canada

ALBERTA—VE4

From W. W. Butchart, VE4LQ:

MEMBERS of the NARC visited the University of Alberta Observatory early in March, at the invitation of Dr. Campbell of the University staff, and the gang really enjoyed themselves. They viewed Saturn, Jupiter and the moon. Cyril Waites of the Royal Astronomical Society was on hand to explain various points of interest. Among those present were: Ken Angus, 4VJ; Bert Stollery, 4EJ, and his YF; Ted Sacker, 4BW; Bill Careless, 4EY; Pat Sullivan, 4XF, and his YF and junior op.; Gordie Sadler, 4NU, and YF; Hilda Hughs, 4WH; Chas. Harris, 4HM; Bert Fowler, 4KK, and his YF, Reg. Mainwood, 4BV; Stan Mitchell, 4ATH; Ron Matthews and Jack Peters.

4AM, Sqdn. Leader Jack Charles, of Lashburn, Sask., was an Edmonton visitor during April, coming here to address a meeting. Jack, you will remember, is the chap who, along with a Free French pilot, knocked over the 1000th Nazi plane in his fighter sector over in England, winning a nice cash bonus for doing so. Since last reporting on Jack's decorations we find that he has "collected" several more! His list now includes: D.S.O., D.F.C. (two bars), and U. S. Silver Star. He has over 300 operations piled up, has shot down 15½ enemy planes, and has been shot down into the English Channel twice himself, surviving both ordeals in good shape. Jack also has a brother Bill with NWSR.

We bumped into 4NU and 4AKK along with their respective YFs at a recent Ciné Club screening, and Bob, 4AKK, was able to give me all the above dope on 4AM. He also revealed that 4ALO, Spencer Addeman, had transferred to the Ferry Command and is stationed down East somewhere. 4AKK saw 4VO, Dot Fitts, and 4GD, Jim Smalley, down in Calgary a few weeks ago. Bob says they look FB. 4ATH, Stan Mitchell, of Edmonton, and his mother also attended the Ciné Club show. 4EA, Roy Usher, of Edmonton, was responsible for the musical score accompanying the screening of the films, and did his usual fine job at the controls.

4NU, Gordie Sadler, of Edmonton, has left CATL to go to work for CFGP up at Grande Prairie. He will be in Edmonton for the next few weeks working on some equipment which is being assembled for the station. Gladys, of 4AFT, was home on leave from Halifax a month or so ago. Jim, 4AFT himself, is L/Tel. operating aboard ship. A brother, Jack, is a WAG with the RCAF. 4EA has been doing a spot of carpentry work on his shack. Now that Roy has taken down his tall sticks and revamped the face of the shack, visitors will have to look twice to find the home of EA in its new guise! 4BW keeps active in magicians' circles, and he puts on quite a few displays for various organizations in the city. By the way, gang, Ted has moved the location

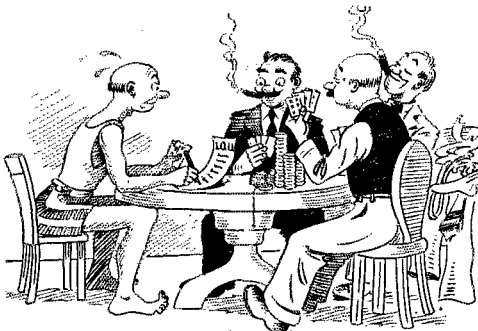

QRI
IS MY NOTE GOOD?

OT TAWA
MONITORING
STATION

The above is one of a series of cartoons entitled "Q Signals as They Might be Used," sent to us at the suggestion of Lt. L. G. Morris, VE2CO. The cartoons originally appeared in the Canadian government's *Weekly Information Bulletin*, circulated to monitoring stations throughout Canada. Other cartoons in the series will appear in this department in future issues of QST.

of the Radio Supply Co. Ltd. to the east side of the McLeod Building, into much more spacious quarters, and has expanded his facilities considerably.

The Edmonton newspapers carried a picture of 4XA, Jack Gillette, of Edmonton, recently, announcing Jack's promotion to a caption in the RCOS.

A letter arrived from 4EO, Bill Savage, of Lethbridge. Bill is kept pretty busy on his new job as chief electrical inspector of the City of Lethbridge. The Lethbridge gang are reorganizing and have had two meetings which showed promise of good support. Their meetings will take place on the first Thursday of every month, and are held in the club rooms of the Lethbridge Revolver and Rifle Club. The club is planning an organized tour of various plants, stations, etc., for each month, so it looks as if you Lethbridge boys are well away again with your club. 4EO says that 4ALI, Roy Hopkins, of Lethbridge, with his supersalesmanship has pushed QST subscriptions practically to the 100 per cent mark in Lethbridge. By the time winter rolls around again the Lethbridge gang will be organized well enough to start some experiments, probably with carrier current, light-beam transmission, and magnetic wire recording.

Edmonton was visited by an unseasonal snow storm on May 11th which broke down trees, shrubs, etc., and in general spoiled much fine garden stock. The next morning I spotted 4EA, Roy Usher, out with his trusty camera photographing the wonders of nature. Yeah, I was out doing the same thing!

4EY, Bill Careless, of Edmonton, has been doing a bit of experimental work with electronic keys and reports very satisfactory progress. However, he says that as it ties up too much of his equipment he has had to dismantle the gadget. 4ABL, Art Shultz, of Edmonton, has an FB amplifier, equipped with about all the frills any amplifier should have, and according to Bill, Art has obtained a degree of fidelity in the unit which he has not heard surpassed by any other amplifier he has seen.

Will be with you next month. 73. 4LQ.

BRITISH COLUMBIA—VE5

From Jack Sibson, VE5BQ:

WITH the help of some of the other hams we have quite a lot of dope, so here goes: Don Murphy, 5EU, who is with TCA, has been transferred from Pat Bay to Winnipeg. Rally Tufnail, 5FM, has joined the ranks of daddy-hood. Congratulations, Rally. Ted Goode, 5ND, is looking forward with excitement to moving into his new home in the very near future. Had a pleasant surprise visit from George Goode, 5EO, who dropped in for a couple of days. Chuck Palmer, who was in Winnipeg, is now back at Toronto studying for TCA. Lots of luck, Chuck. Sid Jones, 5MJ, is now stationed at Grand Prairie, 250 miles from Edmonton. He is in charge of the signals section there. Sid met Doc Ferguson, 5LI, formerly of Vernon, who now is located at Burwash Station, Y. T., about 200 miles north of Whitehorse. He is in charge of a Pan American station and has his XYL with him. He would appreciate some mail, fellows.

Had a very interesting letter from Bill Anderson, 5ADI. In his travels he has met many B. C. hams, and among them are Jack Greaves, 5AGJ, of Victoria, and W. H. Drysdale, 5HO, of Vancouver. For quite some time he was located in an RCN W/T station and while there worked Jim Matthews, 4AFT, who is now overseas; Greaves, 5AGJ; Campbell Watson, of Victoria; Johnny Veres and Gene Wilkinson both VE4s, of Calgary. Bill Anderson is a resident of Alberta now, but before the war operated in Fernie, B. C. Among the hams there were Edge King, 5UK, now a sub-lieutenant in the Navy; Dane Verkirk, 5AD, now in the Air Force; 5MF, Jerry Elkington; Jack Caulfield, 5AHV, now with the RCAF; John Citra, 5MX. In the old days they had a Fernie High School Radio Club which operated under the call of 5ARJ.

Here's hoping we hear from some more of you fellows.

MAILBAG

From Gordon Barber, VE3AAH, who operated at Niagara Falls, Ont., before the war, comes this appeal:

"For nearly two years I have been employed by CKOC as operator and maintenance technician. The transmitter is located on the Queen Elizabeth Highway outside of Hamilton near Fruitland, which makes the job somewhat of a hermit's existence. If you could slip my location into one of your VE columns, perhaps some other hams passing by would drop in and help liven up the atmosphere."

AMATEUR ACTIVITIES

ATLANTIC DIVISION

EASTERN PENNSYLVANIA — SCM, Jerry Mathis. **W3BES** — Quite a bit of DX is being worked in WERS. Easton reports working Somerville, N. J., and can relay through to N.Y.C. with one hop. The Phila. area WERS stations are working into Reading, Allentown and Easton. **3HYX** says his QST "horseshoe" oscillator got through to Reading during one of the tests. Lower Merion WERS is practicing locating hidden transmitters with more than fair success. They have a new rig in the control center. **3DOU** says that the new Red Cross emergency portable headquarters (which contains a WERS station) is ready to operate. **3KT** was home on a furlough from Florida. He is planning to do some remote-control model airplane work. We gather from **3JLE**'s letter that he is in the ATC in the Congo and while there ran into our ORS TLS friend, **3EFH**. **3GYV** is still in Italy. He is trying to make a photo enlarger enlarge. **8UWQ** dropped in to say "hello." He has just returned from the Mediterranean on a merchantman. **3HFD**, **3GGC** and **3BES** heard DX on f.m. recently, Kansas City being the best distance and Nashville the best signal. **9PTK**, now of Phila., built himself a new hi-fi amplifier for his f.m. receiver. **3IRU**, who used to make 10-meter 'phone hum out in Oakmont, is now an instructor in code at Fort McClellan, Ala. We hear that **3QT** is now a major and is stationed in England. Further reports on the State Guard test show that Allentown, Easton and Bethlehem WERS provided the communication and delivered 100 per cent of the traffic. **3JBC** sent in a swell booklet of photos of Camp Atterbury, Ind. **3CJI** is working as flight radio operator with Pan-American Grace Airways in South America and would enjoy corresponding with some of his amateur friends. His address is: Richard E. Brown, Flight Radio Operator, Panagra, Box 51, Limatambo, Lima, Peru, 73. *Jerry*.

MARYLAND-DELAWARE-DISTRICT OF COLUMBIA — SCM, Hermann E. Hobbs, **W3CIZ** — **CDQ** is changing her QTH. She is still in WERS, which gave a good account of itself in the recent blackout. The Md. WERS used radio as its means of communication during the blackout. **JJD-ex-7HXX-ex-6NQB**, has joined the merchant marine and expects assignment as R/O about the middle of May. **CQS** has moved to 734 Silver Spring Ave., Silver Spring, Md., where he will have plenty of room to string his antennas. The B&O R.R. is going to try short-wave radio for emergency communication between its trains. 73, and please send more news.

SOUTHERN NEW JERSEY — SCM, Ray Tomlinson, **W3GCU** — Asst. SCM, **ZI**; Regional EC for So. N. J., technical radio advisor for N. J. State Defense Council, N. J. state radio aide for WERS and radio aide for Hamilton Twp. WERS, ASQ; EC for Somerville and vicinity, including Southbranch, and radio aide for Hillsboro/Branchburg Twps. WERS, ABS. State Radio Aide ASQ, Hamilton Twp., is preparing the necessary papers to petition FCC for amendment for license to cover a total of 30 active units. ITS has joined in the construction and has aided greatly with some completed units. AXU also has aided very materially with technical advice while awaiting arrival of his WERS operator permit to enable him to take active participation in the Hamilton Twp. organization. ABS reports the Bridgewater Twp. organization, **WJMN**, is now on with their control station together with mobile units Nos. 4, 6 and 8. Stan also reports that the Hillsboro/Branchburg Twps. Defense Council is going to turn over an entire meeting to WERS discussion in the near future when final plans will be formulated to enact an "incident" with the fire companies participating. The public will be invited to ride in the mobiles and watch the operation. Plans are about complete to get the five new permittees there into active service with this set-up; two of them have mobile units set to go, while three will be assigned to operate control as well as various mobile units. JAG, who recently obtained his 2nd-class ticket, has signed up with Unk Sam's merchant fleet, and has been assigned as first assistant radio operator on one of our brand-new ships. The first member of our section

to be reported as missing in action is **IKG**. **GEV**, who was reported injured in action, is expecting a transfer from the Marine Hospital in Shoemaker, Calif. Wes was injured in the Solomon Islands action, hospitalized in Auckland, N. Z., and later removed to California for further hospitalization. Reports have it that ex-EM has been inducted and is now located at Red River Army Camp. CCC's son, Blair, recently graduated from Coast Guard Radio School, Atlantic City, and has been transferred to advanced school for aviation radio and has left for duty at San Diego, Calif. **HKO**, now of the Signal Corps Labs, has been reported transferred to duty in England. AYC is still with Public Service Electric at the Burlington sub-station. **GLG** is now chief warrant officer in the Navy. Let's hear from ya, ole-timer. Ex-GFK, who later made quite a rep on "five" while residing at Moorestown under the call **2KWE**, and who also held call **2BCO**, is now hanging his hat at Washington Crossing Park, N. J., and holds the call **3JEU**. SW is now a lieutenant commander. Major VE and W/O Wm. West both report via *DVRA News*. Sam is in England and Bill is in the So. Pacific. Bob Kulp, formerly of Hurley-Tobin Co., Trenton, who has been with Radar Labs., Camp Evans, has been transferred to overseas duty. His address is: Robert L. Kulp, APO 137, c/o Postmaster, N. Y. On Apr. 21st, the Delaware Valley Radio Association held its 12th annual dinner and "open house nite," at which **2OEN/7GLH** was guest speaker and gave a very interesting talk on his experiences while traversing the Alcan Highway. Dave's talk was well illustrated with photos and stereopticon slides which he took while en route. Chairman and toastmaster **CCO**, following the opening address by President **EED**, introduced those present at the occasion. Included was **ITU**, who was home on a 21-day leave from his post as radio operator at Ft. MacArthur. Group photos were taken by **JOL**, after which general rag-chewing took place. Cpl. Steve Czorgo, AAF, Fla., is home on leave. New addresses: M/Sgt. Anthony Constantino, **3IOW**, APO 828, c/o Postmaster, New Orleans, La.; W/O Wm. H. West, **3GHEK**, APO 717, c/o Postmaster, San Francisco, Calif.; Cpl. Arthur G. Hassal, APO 638, c/o Postmaster, New York. *Always look carefully for new changes in these addresses. Very often the only change is in the APO address, which may be the difference in receiving mail and not receiving it. This office is particularly interested in knowing the names and whereabouts (APO addresses) of those of our boys who are doing duty in the Army Airways Communication System. These fellows are doing a wonderful job, so if anyone has information regarding any of these boys, please pass it along to this office. Thanks for this month's reports, and keep 'em coming, 73, Ray.*

WESTERN NEW YORK — SCM, William Bellor, **W8MC** — Lt. **UXD** writes us from the land of the VUs. He tells us that there is quite a considerable number of hams out in that neck of the woods and they are really doing a swell job out there where supplies and equipment are almost never sufficient. Dick asks about **BHI**. Bill had been in the Navy before Pearl Harbor so it was only natural that at the outbreak of the war he went back in the services as radioman. Watch those ships that put in out there, Dick; you might bump into him. We hear **NCM** has been honorably discharged from the Navy after being shot up a bit while in the South Seas. Fran has the Purple Heart and many ribbons, and is back on the job as chief operator at **WHEC**. The Rochester area WERS groups, including **CAP**, State Guard and civilian, are all going strong with increasing activity right along. We could do with a few V-mail letters from you boys away out there so we can pass the dope along. 73, *Bill*.

CENTRAL DIVISION

ILLINOIS — Acting SCM, George Keith, jr., **W9QLZ** — The Chicago Area Radio Club Council held its "Hamboree" in the Hotel Sherman on May 13th. This was the first big ham gathering since Pearl Harbor and some 500 hams and their friends attended. All districts were represented, as well as the Army, Navy, Air Forces, WERS, CAP and war correspondent service. Highlights of the program were the reassuring remarks of Comdr. Jas. E. Parrott, USNR, 7KX, District Comms. Officer, 9th Naval District, and 9AA, Asst. Secretary, ARRL. Three films were shown, giving the gang some idea of the scope of the communications picture at home and on the battle field. Success of the affair was due to the efforts of a large number of manufacturers and jobbers in cooperation with the Council. Officers in charge of the "Hamboree" included **PNV**, chairman; **ALF**, vice-chairman; **YDV**, secretary, and **MAT**, treasurer.

PNV, as MC, occasionally tested the ham sense of humor with well-laudered jokes. S/Sgt. BRD writes from New Guinea that he is "hamming" around with YNY. Rod would like to hear from the old Ill. gang. Address: S/Sgt. R. Newkirk, APO 322, c/o Postmaster, San Francisco. MDZ celebrated his third year in the services recently and hopes if the Central Illinois gang sees his call in print they will let him hear from them. He says, "It is very important to some of the boys overseas to hear, see or read about what is going on back home." Leo still wants to prove to LPR what 1½ watts will do on 160 so he is anxious to get this war over with. His address: Sgt. Leo Webb, APO 252, c/o Postmaster, New York City. Apologies to LLM for the typographical error in May QST. All hams who are in the downtown Chicago area on Mondays may get in on an informal ham session at Hardings on the 7th floor of the Fair Store where a number of the boys have been meeting, eating and talking over the postwar rigs. DSO is an instructor at the U. of Chicago with Navy personnel as students. DQX has been transferred to Fla. as instructor by the Navy. ICS is an inspector of electronic equipment made for the Navy in a Chicago plant. NOU is headed for the Signal Corps. NSA is helping to build test equipment in a Chicago plant. CXK spends his wishful hours with the merchant marine. WKM is employed in the Bell Labs., N. Y. C. IFY, an operator with the power company, expects to see IHN back soon. YBY has taken up motorcycle riding in an effort to stretch the gasoline supply. CBI is a major in the Air Corps stationed at C. Z. BRY sends regards to LQF, GDZ, KTA, KSZ, CFH, WZO, 6RKV and other 10-meter buddies. His address is: Edward O. Holmstrom, Section H, Bks. 513, Naval Air Station, Clinton, Okla. FIJ is at radar school in N. C. His address is: T/5 Carl V. Anderson, Battery H, AAAS, Bldg. 1279, Camp Davis, N. C. Pfc. RCA, in the Army Air Forces, is now in Kansas. His address is: Pfc. Robert Angell, 869 Squadron, Army Air Base, Pratt, Kans. JLK is on the railroad. BPU is in CAP. SXL is turning out the "sweet stuff" for the armed forces. MIN is teaching YLs at Midland Radio in Kansas City, Mo. ODX, who attended Central Radio at Kansas City, is now in Portland, Ore., doing radio work. UQT is operating on one trick at the state police radio at Springfield. MRT is now in the Navy, as is QWM. EAF has been in the Navy since before actual war started and is still operating aboard ship somewhere. For the benefit of those persons wanting to send news, the deadline is the 15th of the month. Let us hear from Chicago, Bloomington, Canton, Peoria, Alton, Joliet and all the other towns having hams in the services or away from home. 73, Geo.

INDIANA — SCM, Herbert S. Brier, W9EGQ — NZZ is working on a radio job in addition to his railroad job. SNF is Class A and is studying small transmitters for the Army. HUV wishes that I had \$1,000,000; he is sure he could sell me at least a \$100,000 "gold brick." NXU has convinced the Army at his air field that a wooden control tower out in the clear will allow better reception of h.f. signals than a metal one next to the machine shop. EBB still makes trips to various manufacturers on Navy business. NLS, a sergeant in New Guinea, got the Nov. issue of the *Bison* on Apr. 5th. He is in a signal arming unit as a radio repairman and does some operating. EHT is now SAD3c and has been in all of the New England states except Maine. WIB hasn't been seasick since he has been married, but does not wish to imply there is any connection between the two. EGV considers SVH's offer to teach him the code as pointless as a dodo offering to teach an eagle to fly. MJW is police radio operator at Mt. Vernon. His wife is also an operator there. The group expects to apply for a WERS license very shortly. Four hams and 20 third-class operators are available. ZHX is in the cavalry in Kans. MLL is Mt. Vernon radio aide and in the radio service business. NDV raises chickens, runs a cream station and sells feed. VQQ is in an Army OCS. IUM sent his report from Auburn by airmail. KBL is temporarily located in Los Angeles. ZYJ is very much alive in England. MBG is chief draftsman in a defense plant. AB built a WERS rig for his car. He uses a ¾-wave car antenna for the radiator. Mishawaka WERS has its first YL operator. YWE is still dreaming about the AARS and the trouble he sometimes had to keep schedules. EBQ is considering building a new superhet receiver if he can get the parts. PBS is studying Spanish industriously. ZFR is a s/sgt. at Camp Van Dorn, Miss. MTL is still experimenting with a 2½-meter a.m./f.m. receiver. W. Austin (LSPH) is home on furlough in Gary after a couple of months across the

Atlantic as an ATC operator. WDV is in the wx service of the Army in India. Radio reception from the States is very fine for the few who have receivers. CTK was recently made RT1c in the Navy. YZB, who works for Minneapolis-Honeywell Reg. Co. Aeronautical Division, wants to hear from some of the fellows he used to know. His address is: Richard G. Caspari, Fact. Rep. Det., Hqs. VIII AFSC, APO 633, New York, N. Y. Drop me a card with your ideas on how to make the Indiana column more interesting. 73, Herb.

KENTUCKY — SCM, Darrell A. Downard, W9ARU — The committee on "YL Observation," ARU, chairman (they say), still functions at the front door of the Canary Cottage after all ARTS meetings. It looks like the gang in Louisville are going to put on a "Field Day" instead of meeting during July and August. Inquire of ARU for particulars. ACD of Bardstown is now a 1st lieutenant in the Signal Corps somewhere in Italy. EDV and ELL are reported out in the So. Pacific. MN is keeping cool up in the Aleutians. OEE is a radioman with the boys who get the stuff over the waves. URG, VBN and RBN are stationed in England. If you guys will drop ARU a line, you will become a member of ARTS for the duration. WJKK was assigned as the call for the Jefferson County WERS. Ashland has four WERS stations working. The State Militia centerplates some new stations. BUE has a temperamental receiver — it works when it wants to. DFW uses a micrometer to adjust his feeders on 114 Mc. CNE, referred to as "Rocking Chair Gates," took the rockers off — too much energy to rock. FKM, of "Mike Oil" fame, seldom misses a meeting. QKA says half of "Thermix" is composed of Louisville hams. AYH is operating on 840 kc. (WHAS, silly) BAZ had a date! — or is that news? SFD calls WJKK-26, who, he says, is never on. AEN is a swell vice-president.

MICHIGAN — SCM, Harold C. Bird, W8DPE — The SCM attended the DARA club meeting a few nights ago and the boys there are carrying on very nicely. They still have the QMN net going around the table with the usual penalties for any talking. They had a nice turn-out. Sam Martin, formerly of Muskegon, writes that he is glad to hear that the gang is carrying on back here so well and hopes that we will continue to do so. He would like to hear from his old buddies. 8DAQ, 8EXJ and 8SOW. Here is his address, gang: S/Sgt. Francis X. Martin, APO 663-S, c/o Postmaster, Miami, Fla. 8NOH writes that he is back in harness again and is feeling much better. He thinks the gang should give quite a bit of consideration to lower power for after-the-emergency operating. Joe Hassett, formerly 8PVV of Flint, pops up again. He has been mustered out of the services and is now working here in Michigan for a radio station and likes it fine. He sends us a nice description of the layout and everything. He says he now sports a first telegraph. 8CSL sends us a nice letter and also renews his QST. Ed is still wondering about WERS up his way. The Pontiac WERS gang is still going at it strong and making regular tests twice a month. Out of the 19 who took their restricted 'phone exams about 11 have received their licenses and are now eligible for their WERS licenses. The school is still being conducted and very good progress is being made in code and theory. We hope to turn out some real engineers before the class breaks up. Constant experimenting has developed some new rigs for WERS and they have proved to be very valuable. They can be constructed with less hard-to-get material and still produce the same results as the more elaborate rigs. Why don't you make it a *must* to report once a month? Sure would be appreciated by all of us. Best of luck and 73. Hal.

OHIO — SCM, D. C. McCoy, W8CBI — Because of the pressure of business it will be necessary for me to retire from the SCM duty at the expiration of my present term of office. May I thank all Ohio amateurs for their cooperation during my tenure and wish the best of luck to my successor. *General*: After discussing the matter of the proposed general meeting with several ECs it was decided to abandon the idea "for the duration." The following ECs have sent in their certificates for renewal: DGU, OXG, EQN, VUS, SUK, RRZ, TAD and LKU. About 15 others have been active enough to warrant renewal of their appointments but haven't sent in their certificates. Any appointments not renewed by July 1st will be canceled. *Toledo*: RRZ has moved to a new QTH. He reports WERS active in spite of the loss of personnel. About 15 applicants for 3rd-class permits will be examined soon. Emphasis is now being placed on mobile equipment since experience has shown it provides a more flexible and versatile system. Excellent coverage is being ob-

tained from main control to Perrysburg, Sylvania, Rossford, Maumee and other outlying points. About 30 "old hams" form the backbone of the system and keep things rolling. Cpl. SIJ, flight radio operator, wants to say "hello" to SVK. His address is: Cpl. Robert E. Cover, APO 627, c/o Postmaster, New York City. **Cleveland:** PZA reports that 75 attended the April CRA meeting to listen to a very fine lecture on ultrahighs by Professor Martin of Case. The SCM attended the May meeting and took part in a discussion on postwar planning. AVH reports WERS going strong. A communications alert was held in April resulting in a turnout of 68 mobile units and 94 operators. QLQ is reported missing in action by his mother, who has received his Purple Heart decoration. EFW was home on furlough recently. FFK is now in England. UCY, an ensign in the Navy Nurse Corps, was home for a few days. GD is living in fox holes and eating "K" rations somewhere in the So. Pacific. Lt. Comdr. PKS, USN, has departed for parts unknown. LZE is still flying overseas. SSV is recovering from an operation and his XYL, TAY, is doing war work and attending night school. **Cincinnati:** MFP and the QCEN publication, *The Listening Post*, report WERS activity up to a good level. A hidden transmitter hunt is planned for July 15th; details will be announced at the June QCEN meeting. The May meeting was devoted to a short business session followed by a buffet supper. Direction finding on 2½ meters was discussed by Roger Robertson. Six new members qualified for QCEN membership during April. Total membership is now 67. The last few issues of *The Listening Post* contained some excellent technical dope for WERS applications. **Bellefontaine:** Radio Aide Prater reports he is still trying to cover six states for the Signal Corps on radio installations. **Piqua:** WKN has been busy modifying the local WERS license from a city to a county basis so that Troy and other surrounding territory can be taken in. Four hams are reported by AMR to be ready for operations as soon as the license is modified. They report excellent signals from several Dayton units. IX is expected home on leave soon after 18 months in the So. Pacific. **Fostoria:** CVZ reports WERS has been on the job constantly with good results. A new Abbott TR4 has been purchased for the headquarters station with OCD funds. Six units have been in use and another will be added when the license is renewed. Cooperation from city and OCD officials has been excellent. The April 5th issue of the *Fostoria Review-Times* carried a fine two-column write-up of WERS operations. **Dayton:** WERS license has been modified and renewed. All fixed stations have been relicensed as portable to make the system more flexible. Several new mobile units have been added replacing men lost to the armed services and out-of-town war work. The new station at Red Cross Volunteer Headquarters is now in operation with a temporary antenna and emergency-powered equipment. Loss of personnel to the armed forces and otherwise has been heavy recently. LJ is in the hospital. Radio Aide CBI has been away on a business trip. Deputy Radio Aide Jones has been to Cleveland and New York on a business trip. RHH has been "running the show." Cpl. Carl Fry, a friend of AGR, writes a very interesting letter from the So. Pacific with details of Jap radio equipment. AGR is suffering enforced inactivity due to painting and repairs at home. MFV passed through town from Godman Field, Ky., bound for "parts unknown." TOZ is a staff sergeant on classification work at Godman Field. His work as personnel officer for Dayton WERS should stand him in good stead on this new assignment. VHJ writes from primary flying school at Decatur, Ala. that he is now ready for basic training. He hopes to become a bomber pilot by Aug. if all goes according to schedule. His father, a major in the Air Corps, is awaiting orders for overseas duty. TPC is the proud papa of a new YL junior operator. TQZ is struggling to get on the air in WERS. QDI is at N.T. School, Princeton, N. J. BI is a captain in the Signal Corps and is assigned to temporary duty in Dayton. A survey of the members of the Miami Valley Emergency Net shows that of the 30 members active on Pearl Harbor Day, 2 have joined the Silent Keys, 10 are in the armed services, 3 serve as civilian Army employees, 16 are, or were until called to the colors, in WERS and all those not in the armed services are, in some manner, employed in industries producing for the war. After the war the Net will be revived on 160 for intercity contacts and 2½ for local work. **Youngstown:** TAD has changed his QTH to 415 Indiana Ave., McDonald, Ohio. He is chairman of the largest selective service board in his county, business agent for the movie operators' local union, radio aide, on the Red Cross disaster committee

and EC. Personnel losses have reduced WERS activities but attempts are being made to add to the personnel. Warren WERS is also losing personnel; 8 local hams with the Astatic Corp., PAL with Signal U. Mfg. Co. 73, *Dan*.

WISCONSIN — SCM, Emil R. Felber, jr., W9RH — The Milwaukee Radio Amateurs' Club closed its season for the summer with the election of the following officers: CDY, pres.; IZO, vice-pres.; HRM, secy.; RH, treas. and GPI, GIL, GVL and LJU, directors. These hams will run the Club for the season starting in Sept. The last meeting on May 25th was held in Gettleman Ratbekeller (brewery basement). Comdr. DTK was present, plus many old-timers. GVL was chairman of the "Jamboree." Ens. Wm. W. Black and Lt. ANA were club visitors and related their travels. AXR was honorably discharged from the Army and is working in Chicago. ZBP is a captain in the Signal Corps overseas. Lt. UHZ also is overseas again. UNY, after five months in the Navy, received an honorable discharge and is back again with Lockheed in Calif. RM1c ZUX is still on the same ship in the Pacific. VIB has been located on Long Island, N. Y. Pfc. Carl Schuppel sends us regular copies of the *Timberwolf*. Cpl. Frank J. Detzek has been transferred from Ky. to Tex. Sgt. James Fisher wrote that he visited Robin Hood's old stamping grounds in England. ACRM JPS's wife is joining him in N. J. Pvt. John Holms is in Illinois. Lt. Jerry M. Lechuk dropped a line from Tex. SYT has been temporarily transferred from N. J. to Chicago. Ens. IZQ is in Tex. GPI, RSA, GIL, HPZ, NVQ and RH attended the Chicago "Hamboree" May 13th and took along WERS unit No. 10 of WMFI and put it on display. The WERS rigs are on the air every Wed. night for tests and a fine system of operation is being worked out. Capt. JWT, USMCR, was home for a two-week leave and visited the club May 4th. Pfc. Gilbert Rink was also a visitor. Pvt. Harvey McDonald is still stationed at Camp Chaffee, Ark. Sgt. OEB is with the U. S. Air Force in England and would like to hear from some of his old buddies. We would like more news from the boys up state. 73, *Emil*.

DAKOTA DIVISION

SOUTH DAKOTA — SCM, P. H. Schultz, W9QVY — Old faithful ZBU sends his report just as regularly as ever. LLG is real busy at Eagle Butte, running the power plant and theater and servicing radios and electrical equipment. IYN and his XYL are in Fresno, Calif., for Western Electric after a stay in Cincinnati and Dayton, Ohio, and are looking forward to coming back to S. D. after the war. OQQ, at Los Angeles, is with Douglas as radio and electrical technician. He writes he is thankful for his ham experience as it is "worth its weight in gold" where he is now located. He is dabbling in WERS. He would like to hear from the old S. D. gang and I know it would be worth while to write to him at 9944 Nat'l Blvd., Los Angeles 34, Calif. 73, *Phil*.

DELTA DIVISION

LOUISIANA — SCM, E. H. Treadaway, W5DKR — LDNW is building a heterodyne audio oscillator. JHM is an aviation cadet. WT is on the lookout for test equipment. HOU is back in New Orleans. BPL, after spending a long time in England, is back in the States with headquarters in Macon, Ga. CQF is 1st lieutenant and is in Africa. ZV, an active YL, is in New Orleans. Lt. Col. EBB is across with the Signal Corps. IKV, with the Coast Guard, is stationed in New Orleans. CJO is in the cigar business. IN is blowing the blues away. AO, of Baton Rouge, was a visitor in New Orleans. BUK is somewhere in the Pacific. KC sends greetings from Plaquemine. LA is spending his time these days with underwater sound equipment. HAW is looking forward to ham activities on the high frequencies. HUT is building planes. IRO was a recent visitor in New Orleans. ADJ says he will be heard on 160-meter 'phone when the gong is sounded. EVS is a busy telephone man. FSX and DKR are studying radio. GDU is shop foreman with Pendleton Shipyards. FMO, the radio technician, is busy with U. S. Engineers. ECO is a radioman at the U. S. Naval station in New Orleans. CXQ is building hi-fidelity amplifiers. AVO is rebuilding tubes. GIA sends 73 from Fort Sill, Okla. IXL sells insurance. AJJ is busy making radio diagrams. FFO moved to the Mississippi Gulf Coast and reports plans for erecting antennas. HOA is standing by and waiting for the day. QJ is building ships. Thanks to CXQ and HHT for the FB reports on the New Orleans gang. We would enjoy hearing from the Monroe Radio Club, Baton Rouge Radio Club, and from all the rest of the gang. 73, *Gene*.

HUDSON DIVISION

EASTERN NEW YORK — Acting SCM, Ernest E. George, W2HZL — It is a pleasure to pass on the news that SCM LU was advanced to the rank of lieutenant commander as of May 3rd. For those who wish to pass on their felicitations, his address is 614 No. Temple St., Cordell, Okla. Schenectady County WERS WKNT expects to follow the regular drill June 18th with a picnic and call it their Field Day. Troy WERS units of WJPD are very active these days. The Schenectady gang held their annual spring dinner this month — the YLs were invited too! HCV is now retired as a police sergeant, address Glen, N. Y. LCB is now a lieutenant in the Signal Corps. NRR holds commercial telegraph and radiotelephone tickets. He was an operator for Pan-American Grace Airways in Lima, Peru, but is back in the States working for the Standard Winding Co. of Newburgh, N. Y., as a radio engineer. Please help me collect interesting news of the E. N. Y. Section by sending it to 2044 Lexington Parkway, Schenectady 8, 73, *Ernie*.

NORTHERN NEW JERSEY — SCM, Winfield G. Beck, W2CQD — Asst. SCM, John J. Vitale, W2IIN, 106 Orchard St., Elizabeth 3. ITD writes that he is in the Navy, stationed at Norfolk, Va.; that JCT will soon be a "medico," and that HZY is keeping the DL&W R.R. running. LFH said "I do" and now has an XYL. Lt. (jg) JKH sent us the following: Lt. BZR is stationed in the Pacific; NUF is radio electrician in the merchant marine; KXD, "King of 160," is engaged to JKH's younger sister; NOK is RM1c at Norfolk, Va.; MIG is a warrant officer in the Army, somewhere on the East Coast; KXD is going to OCS at Ft. Monmouth. EUR's correct address is: A. Kozlowski, APO 635, c/o Postmaster, New York. He writes, "Sure would like to hear from the gang. Mail is sure good stuff out here." BWI is EM2c in the Navy. IIN's jr. operator, Vincent, is in Navy aviation radio stationed at Memphis. OCV and OCH have constructed wired-wireless rigs like the one which appeared in Mar., 1942, *QST*, and are interested in contacting other hams in the locality of Ridgefield and North Bergen. Wake up, N. N. J.! If you send us a little news now and again, we will be able to have something in these pages every month. Don't forget, the mention of your friend's call here is like a letter from home. Won't you please write a line before you forget?

MIDWEST DIVISION

KANSAS — SCM, Alvin B. Unruh, W9AWP — Congratulations to the KNQ family; a jr. operator has been added, male variety. QVB has decided to remain in Wichita and is an AAF inspector for aircraft. RAT spent quite some time in the East, but is back in Kansas City, in airline communications work. John had a visit from PXW, who will take a year in the Pacific for CAA. Sympathy is extended to the family and friends of KAM of Neodesha, who died at Minneapolis after an illness of several months. A graduate of a Kansas City radio school, he had been employed by Northwest Airlines as radio operator for several years. NGQ now has put in a year as radio inspector at North American Aviation in Kansas City and has moved his family from Neodesha to Kansas City. OZN is radio operator with the Signal Corps in the European theater. LFB, who is chief engineer at KGPZ, was forced to evacuate his family during the recent Wichita flood. An orchid to LFB and TBR, who is chief at KANS. They worked for great gobs of hours without sleep in keeping their stations on the air in the emergency. ZKA returned to work at Boeing-Wichita after a siege in the hospital. DJL, a flight service foreman at Boeing-Wichita, returned from Denver, where he spent some time on business. BCY, of the engineering department, returned from New Mexico. Remember, gang, if you want to read Kansas news in *QST*, you hafta mail me the dope. 73, *Abie*.

MISSOURI — SCM, Mrs. Letha A. Dangerfield, W9OUD — OKF and GCL attended the six-week refresher course at the CAA training center in Ft. Worth. OKF is back in St. Louis and GCL is in Cheyenne. Of the 45 men at the center, 18 were hams and made a good showing. GHD has met 20 hams in the Aleutians, including 2DCL, who is an old friend of his. Dave would like some letters from the gang. CDU is with the Navy in Md. FTP is Naval flight engineer attached to the Bureau of Aeronautics. NSU has been engaged in the real estate business for several months and it is doing quite well. TCR has been in the Coast Guard for the past year and is stationed at Washington radio station, Alexandria, Va. HCL is still in civil service and HIC is employed as draftsman unless their statuses have been changed by Uncle

Sam. Ex-JWI is located at Ft. Monmouth. CZU, ex-8QQK, is stationed somewhere south of the border and would appreciate a little snow. ZXX has been assigned to the Navy and is located at the Great Lakes Training Station. OUD has been reelected SCM without opposition. If we don't get any news, we'll make it up and write verses in this column. We suggest you take a look at the length of this report and remember we had our poetic license renewed recently. 73.

NEBRASKA — SCM, Roy E. Olmsted, W9POB — YOP is returning to Alaska for another hitch for CAA, having been promoted to associate engineer. JBK gives out from Camp Carson that he is training in radio with the infantry; he adds that BZR is at Camp Crowder, that IZR is awaiting call to active duty with the Naval Air Corps and that QWU is a staff sergeant in Africa. OHV, who is now doing maintenance for the Grand Island sector of CAA, called at this station (?) last week to fan the breeze. He says that GTG, another Airways mechanic, is now located at Cheyenne. Another FB letter was received from RQW, formerly of Omaha but now at Seattle. He has been working for PAA in Alaska for the past ten months and was stationed at Ketchikan and Juneau, where he was in contact with KPA. Bud winds up by saying that he is on permanent assignment to flight duty now. I have been watching the reports of amateur service records in the columns of *QST* for many months and see very few Nebr. calls listed. May I urge each and every one of you to send that card in if you are either in the armed services or doing full-time war work? 73, *Pop*.

NEW ENGLAND DIVISION

CONNECTICUT — SCM, Edmund R. Fraser, W1KQY — EEM, Waterbury district radio aide, reports 50 operators are now licensed with A-2 emission proposed. WR, operator of WJKA-15, is very active in Torrington WERS. He writes that his son is now a captain in the Air Corps instructing in Texas. WKNQ-4, operated by Jane and Mary Gulielmetti, Schilling, Powers, Betterly and Ackerman are doing a swell job operating in the Middletown warning district, as is DBM, district radio aide, and his XYL. CTI writes that the Stamford WJQA radio aides held a meeting recently in New Canaan. CTI states that he has received a letter from Lt. Comdr. Earl Lockwood, ex-NY1AA and 1BYB, who now is stationed somewhere in England and has charge of 74 tons of radio equipment. Earl writes that he has enough help but could use more hams. Hope he runs into our old friend, GM6RG. The New Haven warning district, WJLH, now is devoting a portion of the test periods to A-2 emission with considerable interest being shown among the new as well as the old operators. The construction of code oscillators is in full swing, with several code classes being conducted. MVH is now working days and is active again in Hamden WERS. At the last Conn. blackout WJLH had a record performance with 40 units and 64 operators participating. At a recent radio aide meeting held at WJLE-1 radio aides JQK, 1GT, SF, AKG, KAT, IJ, KQY and Van Esen were present along with operators Tabor, Spose, Dendas, Harper, Misses Doyle, Domurad, Jackson and Skall, EAO and Cattaneo, state radio aide and communications officer respectively. Movies of WJLH units in operation were shown. 2DOG of Riverhead, L. I., who in the good old days worked our 1KAT in Guilford, writes that he is hearing WERS units WJLH-1, WJQA-66, WKAO-1, WKWG-70 and WKOB-14. At the annual meeting of the Conn. Valley section of the I.R.E., held in New London the first week of May, ham activities were revived by the presence of IJ, KQY, NBP, NEK and 9SAC/2KHA. GB news: Nick Libertino recently visited the club while on furlough from the U. S. Army. HMZ and KUK enlisted in the Army and Navy respectively, bringing the total GB members in the services up to 29. GM, FCC inspector at Boston, dropped in at GB while in New Haven examining 153 candidates at Yale for different licenses. GDC was also a visitor. FMV recently paid former club member Jack Naughton a visit in Syracuse, showing Jack where to purchase a good steak in his own home town. BEM has turned to camera activities for the duration and has been walking off with first prizes in photo exhibits. HBL, Bridgeport, writes that KNM and NNQ were recent visitors at his QTH. APA is in the Signal Corps, stationed at Camp Crowder, Mo. KFN/2OCC and family visited folks in New Haven. Our best wishes to 9WWP, ARRL acting communications manager, and 8VKJ, who were recently united in matrimony. Your SCM had a nice phone QSO with QV, New London, who recently returned from the Pacific area. QRU. 73, *Ed*.

MAINE — Acting SCM, G. C. Brown, W1AQL — MGP, somewhere in Italy, writes that he is getting QST regularly. He says that he has met ZL2IC and some of the boys from the 2nd, 3rd, 5th, 8th and 9th districts. He also goes on to say that QST is the only means he has to keep in touch with what the Maine gang is doing. Give this a little thought, fellows, and think what it must mean to those boys in the war area to be able to read about the home gang. Let's give those chaps a real column to keep up their morale. You send in the news and your SCM will see that it gets in, so they will realize we are behind them all the way. NBK is working in Presque Isle and putting in his spare time with NDV building postwar equipment. NSN is improving his copying by listening in during his spare time. E1Y and AQL attended the Grand Lodge Session of the Knights of Pythias in Augusta; E1Y was reflected to the office of Grand Master of Exchequer. 73.

EASTERN MASSACHUSETTS — SCM, Frank L. Baker, jr., W1ALP — IBF is now EC for Danvers. Sorry to have to report the death of two more hams from this section: DIR, who has been sick for some time, and JQQ, who was killed while in action over in Europe. JXU has a new son, his fourth. HDJ is now a sergeant at Sioux Falls, S. D. DBD and 6NRR are working at M.I.T. 9FFY, an old AARS man, is a 1st lieutenant in the Signal Corps and at present located at M.I.T. Also 7CXO is a lieutenant and at M.I.T. MXG has gone to sea as an operator. GPU is a lieutenant in the Navy and is now living in Cambridge. A few hams working for Sub Signal are: HY, MKT, BWR, 4GKY, 4BST, 5JLO. BBR was home for awhile after spending 17 months on a destroyer in the Pacific. IIM is now working for Wholesale Radio. NPE says that WERS in Boston is going very well. The South Shore Amateur Radio Club held its monthly meeting at the Quincy YMCA with the following present: CT, WK, IB, FWS, IHA, FJN, IYU, KBS, AKY, MD, IS, MMH, CCL, LCK, FVD, EKG, JMY, MMU, CIC, JCX, CPD and ALP. EAU, the radio aide, spoke about the WERS set-up for this district. Lt. GYZ, USN, dropped in unexpectedly and gave a talk on some of his trips out in the Pacific. QW writes from San Francisco, where he is on a brand-new D.E., and sends his regards to all New England hams, especially Essex County. CF's XYL is an operator at BCL station WESX. LYG is on an island in the Pacific. AKS is doing picture enlarging. AGX is busy repairing radio sets. MYO is running a radio store in Lynn. HWE is looking for woodchucks. LN is a corporal in the State Guard and made some 2½-meter rigs for Danvers unit. LZT is now an ensign in the Navy. CTR is on the night shift at Raytheon and sends in some news: JAQ is in England; also JBE, who has a silver star for gallantry in action. KAG is now CRM and still at Winter Harbor, Me. LNC, RT2c, and IVI, RT2c, are both in England. BCL, ART2c, is in Va. JOV is at M.I.T. JUL is working in Somerville. FCZ is still at WBZ and now has two kids. ADB is now a staff sergeant and is at the battlefield. WS is still at Raytheon. NKW has been sick with hay fever. He says he wants to buy some old QST's. HUV sends in his EC certificate and says that his job keeps him very busy. EAU reports that he now has the copies of station licenses and also quite a few operator licenses so that the City of Quincy, WJYM, should be on by the time you read this. Your SCM would like to hear from the following hams: BMO, ASI, JNU, LEU, HUP, MMM, ILR, KXU, AAL, MJY, LRO, and any other old ORS, OPS and ECs from this section. I guarantee to answer all letters. Ex-JUT has gone to sea as an operator. IUQ writes from Bermuda, where he is located with a SeaBee unit, and wants to be remembered to all the gang. KSE is chief aviation radioman located at Squantum. LZL is working in a shipyard in Dorchester. JOM is doing radio service work. BGW is a master sergeant in the Army and is now in New Guinea. KNZ is in the Army and is now in England. WV's address for the summer will be Cataumet. After Sept. 1st his permanent address will be 1200 Arbor Road, Menlo Park, Calif.

WESTERN MASSACHUSETTS — SCM, William J. Barrett, W1JAH — FNY, formerly with RID of FCC, is now at home awaiting call to Navy duty, having passed induction exam. He says ADF, also with FCC, now is stationed somewhere in Alaska. MKR is still somewhere in New Guinea. AZW reports from Pittsfield with some news of the gang, the first to reach here in about a year: FXO is now in the Navy, after leaving FCC. ICW is stationed at Alexandria, Va., playing with "medium power" (50 kw.) transmitters. That power might hit some of our WERS dead spots. BSJ is distributor of CD batteries for Regions 1 and 2.

Prent is still looking for the batteries. Ike, Pittsfield WERS' WKHW, has added three units, bringing their total to 21 stations. LUD is doing a swell job, aided and abetted by AZW, BKG, IZN and JLT. The City of Pittsfield installed new two-way police radio. Fifty-three police officers took the radio course given by AZW and LUD. BKG is teaching code and theory at Pittsfield High School two nights a week. AZW qualifies for the 20-Year Club — Prent's call was issued in Jan. 1924. JAH is teaching pre-induction radio code and theory course two nights a week at Adams High School. With all the radio classes in and out of the services, we should have a bumper crop of hams when the all clear sounds. How about some news from the rest of the gang? It's our only contact now. 73.

NEW HAMPSHIRE — SCM, Mrs. Dorothy W. Evans, W1FTJ — EAL writes that he is now a lieutenant commander. AUY writes us that he is closing out his business in Barnstead and getting transferred from the postmastership there to a radio engineer's post at Grenier Field. Word comes to us that CMR has been doing some *very fast* traveling between continents! BII had a letter from CMB and Mendy says he's still in there pitching. If you fellers would like his QTH, please get in touch with the SCM. It was mighty nice to QSO via land line with CME recently. Stu is due for a hospital check-up and then he's going to "hit the high spots" once more. He has already seen plenty of territory and expects to see much more. HFO writes that May 10th was the beginning of his 12th year with a ticket. FTJ has been QRL planting her victory garden.

VERMONT — SCM, Burtis W. Dean, WINLO — BD has been appointed as 1st lieutenant of Infantry, Vt. S.G., with assignment to the State staff as communications officer. GNF is a private in the Marine Corps and is taking his basic training at Parris Island, S. C. AI is in the hospital at present, waiting for the Marines to decide what to do with a chronic dislocating shoulder he has had since boyhood. His QTH is Pvt. A. H. Battison, USMCR, U. S. Naval Hospital, Ward "O," Parris Island, S. C. BZS is attending the Coast Guard's engineering school at Groton, Conn. His QTH is U. S. Coast Guard Training Sta., REMS, Student Barracks A, Groton, Conn. GAN and NLO have been fishing at the mouth of the Winooski River for wall-eyed pike. Your SCM has yet to catch one. The BARC is planning a hamfette to be held at Bayside, Mallets Bay, Vt., on Sun., Aug. 6th. More details in the next issue of QST. 73 and CUL. Burt.

NORTHWESTERN DIVISION

MONTANA — SCM, Rex Roberts, W7CPY — The Butte Amateur Radio Club is again active. New officers are: C/JN, pres.; Thos. Hood, vice-pres.; James Foster, treas.; Jack Picard, secy. They have 41 members and meet every other week. Several of their members are in the V-12 unit at the School of Mines. EQM and EMF have put on demonstrations at club meetings. HVM has moved to Ellensburg, Wash. Thos. Hood is in Glendive for the summer. FLB is teaching code classes for the CAP. Jack Picard is a shut-in and the BARC built him a swell workbench for Christmas. HRP is working in a radio station. CBY has transferred to Helena and he reports that the Butte Club followed him up and gave him a swell surprise and housewarming. EAI and BIS, of Helena, also got in on the party. FL's XYL has joined the Butte Club as has EQM's mother. FEG reports from Missoula. He is with the Northwest Airlines there. He says he has been a papa since May 5th. FDG is in Hamilton. FGR and FTX (OM and XYL) are now in Washington. FAM still reports from Ronan. DXQ recently visited the SCM in Glendive. The Livic Radio Club of Livingston was affiliated with the ARRL at the Board of Directors meeting in May. Lt.(jg) BMX visited in Great Falls, as did HEM, ART2c. CC, USNR, reports from the So. Pacific that he gets in a little deep sea fishing, but says it's hard to get 'em in ahead of the sharks. FGZ visited AQK at Troy. Thanks for the swell reports this month, gang. 73, Rex.

OREGON — SCM, Carl Austin, W7GNJ — SO is an instructor at Treasure Island, and predicts remarkable things on the amateur frequencies, especially the superhighs, after the war. HLF, with the approval of Radio Aide DBZ, has trained 15 persons for the FCC exam. GUP makes occasional demonstrations with his portable. WR had a nice write-up in the *Oregonian* of Apr. 16th. He taught radio and code in a Portland school for more than 18 months, even though crippled, and has now moved to Seattle, where he

will be a radio operator for ACS. Ken Sawyer, RT1c, of CORK, has been in the So. Pacific, but is returning to the States to take officer's training. Phyllis Coe, also of CORK, is in England, and has met several G hams. AOY spent several months on the Pacific as a fisherman, for his health, and reports that he is practically a new man again. He has returned to his job in the radar shop where OM is a supervisor. AOY is an inspector. Frank mentions that EVR is a chief radioman on a battlegoon. GNJ is giving a short course in radio and electricity at the local high school, and is preparing a class of about 30 for the Eddy Test. Chuck Webb (LSPH) is now in Virginia, and says his ham ticket was very valuable in getting an assignment. HVX, on one of the radio installing crews at Kaiser, is taking a course at OIT. AW passed through Oregon on one of the "detector cars." He is the author of "Let's Use Our Modulators" in July, 1943, QST, 73, Carl.

WASHINGTON — SCM, O. U. Tatro, W7FWD — CMX, state radio officer, reports that WERS license KANR has been issued to Bremerton with Robert Tewell, a W9, as radio aide; they have 4 TR4s with the control station located in the fire station and 4 more units are under construction. This completes a chain covering a line distance of about 150 miles of the northwest portion of the State, with Olympia, KF1Q, on the south; Tacoma, KFNH; Bremerton, KANR; Everett, KFNV, and Mount Vernon, KFEY, on the north. No attempt has been made yet to pass a message along this entire chain but it is believed possible should the state radio officer organize such a venture. EKT, shop man for the City of Spokane, called on IOQ, BG, FWR and others while on the Coast recently and stated that he was going to put a 2 1/4-meter rig together. He says that MV, police radio operator of Spokane, is now heading their WERS. CWY and family stopped at Olympia on their annual trip to Issaquah. IVE is attending CPO and working part time for KMO, Tacoma. BCS is with ACC and located at Seattle. HW is repairing radio and electrical equipment at Yakima. AUP is a weatherman and is teaching radio code and theory at Yakima. A recent meeting at Tacoma with Karl Weingarten, BG, Northwestern Division Director, included IYL, IMB, EHQ, IVK, GZC, DXZ, DSZ, EJS and OS of Tacoma, FWR, EGV, CMX and FWD of Olympia and 6AM of Long Beach, Calif. Don used to be 7MB, 73, Tate.

PACIFIC DIVISION

NEVADA — Acting SCM, Carroll Short, jr., W6BVZ — Hi, gang. How about some of you fellows up state dropping a few lines for this column? Ed Twelker is radio-operating for Western Air Lines at Las Vegas. QNV is in the Glee Club at Great Lakes and broadcasts weekly over a nationwide network. We think the FCC should investigate the broadcasting situation in the State of Nevada. It looks like a monopoly to us; all the broadcasting stations in the State are controlled by the Blue Network. Yes, all both of 'em. KOH in Reno and KENO in Las Vegas are affiliated with the "Blue." GTE, an old pal of mine from So. California days, is now working at Basic Magnesium, Inc., Henderson, Nev. SXD works for the So. Calif. Edison Co. at Boulder Dam. MRT just finished installing a two-way radio system for the U. S. Rangers at Boulder City. He is now doing radio servicing in his spare time.

SANTA CLARA VALLEY — SCM, Earl F. Sanderson, W6IUZ — What with gas rationing and war work, the SCM "don't get around much any more." A nice letter was received from PBV, who is now stationed at Cal-Tech and is busily engaged in study associated with the V-12 program. He reports that Lt. James P. West's new QTH is APO 703, c/o Postmaster, San Francisco. A letter from MOV, now in the So. Pacific, reports very favorably on the good neighbor policy in that area. He has had no trouble in keeping in touch with old friends and mentioned one by the name of Schenley. His new QTH is: Lt. John E. Striker, APO 923, % Postmaster, San Francisco. Your letters are certainly enjoyed and I would appreciate hearing from more of you guys. I'll guarantee to answer all of them. 73, Sandy.

EAST BAY — SCM, Horace R. Greer, W6TI — EC, QDE; EC v.h.f., FKQ; Asst. EC v.h.f., OJU; OO v.h.f., ZM. A card received from OJU/2 says that he has just received his 1st-class commercial 'phone ticket. He also reports 3HIU, ex-6NUJ, is now in the Hawaiian Islands, and that he received television signals from WNBT, New York, on a friend's receiver in Belmar, N. J. EE reports that the regular monthly meeting of WERS was held May 18th. Milt Winsby gave a talk on frequency modulation. The

meeting was held in the Oakland Control Center of OCD, Oakland City Hall. DUB and TT have gone in for bass fishing in a big way. Real fishing is as hard sometimes as fishing for real DX. EY reports that the directors' meeting at Hartford was a big success. LCT has gone on a hush hush job. BUY has a new job as night wire chief for the Pac. Tel. & Tel. QWX is now a full lieutenant in the Navy and was home on a week's furlough. CUG visited Greater Oakland. GEA reports everything under control. Another day closer to victory. 71.

SAN FRANCISCO — SCM, William A. Ladley, W6RBQ — EC, DOT. HLP reports in from the Hawaiian Islands and from the tone of his letter the grand weather and the beautiful girls are his greatest problems these days. Einar Ingobretsen of Eureka advises that he has successfully passed his examinations and is now a ham without a call. He is radio operating for the Army at present and is also participating in local WERS drills. AM was in town last week and tells of the success the Long Beach WERS gang is having with six-element beams and superhet receivers. 9YGS has been transferred from TI as radio instructor to Chicago. KJN and Ralph Abry, members of S. F. WERS, are using home-built superhets with great success. 91LH and 91CN will soon be leaving S. F. as Dale, a sergeant with the USMC, has just about completed his radio studies. Two of RBQ's sons, Bob and Jerry, are in the Navy and doing duty as aviation ordnancemen aboard carriers in the Pacific. CIS can now be addressed: W/O Kenneth B. Hughes, c/o Fleet Post Office, San Francisco. 9FA is now reported at Pago Pago. KB8ILT writes in that all is well. Address: Ens. R. L. Whitten, USN Radio, Navy 41, c/o Fleet Post Office, San Francisco. KZP is spending his vacation at St. Helena. UKO is still active at KGCW, zone control. LES attends WERS drills regularly. Weekly WERS drills are held by all three zone control stations under the direction of Radio Aide Gene Pera. PIV reports from Sacramento that KME is now base communications officer at Minter Field. UER advises that ULR is ready to sign up with our local WERS unit. DAD is still active in WERS. LFZ has put zone No. 3 of KGCW on its feet and draws a good attendance for weekly drills. GAC is now RT2c, instructing at Fleet Service School, Virginia Beach, Va. 9EKY advises that RAH will be back home soon, having suffered a leg injury at an advanced base in the So. Pacific. He got his trouser leg caught in a motor alternator and it tore deep gashes that required 90 stitches to close. Drop a card each month with news of yourself or of the activity of others. Please! 73, Bill.

ROANOKE DIVISION

VIRGINIA — SCM, Walter G. Walker, W3AKN — NE has returned after two years spent in the merchant marine aboard a tanker sailing in Pacific service. He expects to return to sea as radio operator, probably in Atlantic service, within a few weeks. FQP reports that Norfolk efforts have finally resulted in the granting of WERS license WJWB to the Norfolk, Portsmouth, South Norfolk, Princess Anne, Norfolk County and Virginia Beach areas. P. B. White is the radio aide. AKN is instructor in code for the Newport News Civil Air Patrol classes. It is rumored that the Civil Air Patrol has applied for WERS license for the Newport News, Hampton, Phoebus, Fort Monroe, Langley Field and Peninsula areas. The CAP has well over 100 members in the area, many on active flying status. JNH, signalman 2nd-class, USN, was home on leave in March and JHC went up to Richmond to see him. They rounded up an old-time hamfest with JNH, JHJ, JHC and FHS. JHC now has his Class A ticket. HAE graduated from Notre Dame Midshipmen's School in March and is now in pre-radar school. He is rooming with 4A1J of Fla. HAE would like to hear from the Va. boys. His address is: Ens. Elias Etheridge, jr., USNR, 135 — 1903 Hall, USNPTS., Princeton, N. J. IKV is in the Maritime Service. IUV is at Camp Crowder. Letters have been received from former members of the Roanoke Division, namely, II, HJW, EEG and several non-amateurs who are at the various Naval and military training camps in this area. 73, Walt.

ROCKY MOUNTAIN DIVISION

COLORADO — SCM, H. F. Hekel, W9VGG — EHC is on the jump again. After completing a course in cryptographic security he was sent to Victoria, Kans., for a short stay and his last report was from Great Bend, Kans., but he is still on the same job of learning to read the other fellow's

(Continued on page 80)



★ ★ ★

Do you remember the careful workmanship with which receivers were built twenty-five years ago? Do you remember the uncertainty of the results, and the thrill when the set brought in a signal? Those were the days when enthusiasm and patience had to take the place of know how. Radio designers learned the hard way, and they have been doing it ever since.

Experimenters learned quickly enough how to make receivers work. It has taken much longer to learn how to build them so they will keep on working. From our own experience many years ago we recall when National shipped an SW-5 receiver to a customer in Florida. He promptly sent us a letter saying that the regenerative detector did not oscillate, and that he was shipping the whole works back to us. We tested it and it worked fine. Accordingly, we wrote him a polite letter suggesting that he was full of old shoes, and sent it back to Florida again. In return we received what we shall always consider a very temperate letter under the circumstances. It informed us that the detector still did not oscillate, and that the receiver was on its way to Malden. There were also a few comments in the letter which it is not appropriate to repeat here.

We tried the receiver out again in Malden, and performance was dandy. (At about this time a rumor spread in our laboratory that SW-5 stood for five swear words. They are not appropriate to this page, either.)

It was customary to blame everything on the weather at that time, and although we had cynically supposed that anything that could work in the New England climate would work anywhere, we nevertheless tried the SW-5 in a hot, humid atmosphere. The detector promptly stopped oscillating, and the mystery was solved. A few more experiments showed that the trouble was due to leakage through the insulation of the push-back wire used for the grid lead. Rubber-covered wire fixed it.

This was our first real introduction to the special problems presented by high humidity. It has been a continuing study for us ever since. Shortly afterward, we became aware that the detector coupling unit in several of our receivers was as sensitive to the weather as grandpa's rheumatism. This unit was known as the S-101, and "S-101 trouble" became a generic term for ills of this nature by the time we finally licked the problem.

It is really more complicated than it sounds. Putting a coil in a can and pouring it full of moisture repellent compound sounds like an easy solution. It *IS* easy, but it is not a solution. Moisture may still work down inside the insulation of the lead wires. Temperature changes may break connections. We had all kinds of grief, but we have no regrets. We learned so much "know how" that most of our standard units were in use by the armed forces when this war began.

However, keeping up with the specifications of the armed forces is no cinch these days. They believe, and rightly, that nothing less than absolute perfection should be the goal. When radio is fighting all over the world, that goal leads to strange and wonderful techniques. Take mildew, for instance. We always thought that mildew was what happened to the olives that were left over after martinis, but we find it happens to receivers. In certain parts of the world, mildew grows fast enough to make radio equipment inoperative in twenty-four hours. We never expected to have to learn about *Aspergillus Niger*, but if that is what it takes to win this war, we will learn to juggle Petri dishes with the best of them, and we will learn fast.

The New England climate is not so bad, after all.

— GENE SIMMS



THE FIRST IS STILL THE FINEST



SELDOM in the history of radio has a new design received such universal approval as that shown for the Mallory FP Condenser.

Although it was revolutionary in construction, the ease of installation and general efficiency of operation immediately led to acceptance throughout the industry.

Today, as the result of the Mallory program of constant research and refinement, Mallory FP and WP condensers continue to be acknowledged as the finest in the trade.

Mallory also makes

Attenuators	Jacks
Battery Chargers	Plugs
Grid Bias Cells	Single, Multi-gang
Paper Condensers	and Push But-
Noise Filters	ton Switches
Volume Controls	Potentiometers
Dial and Pilot Light	Rectifiers
Assemblies	Battery Chargers
Vibrators and	Resistors
Vibrapacks*	

And many other electronic component parts

*Reg. U. S. Pat. Off. for vibrator power supplies

P. R. MALLORY & CO., Inc.
INDIANAPOLIS 6 INDIANA



Everybody—Every Pay Day—Buy War Bonds!

P. R. MALLORY & CO. Inc.
MALLORY

Amateur Activities

(Continued from page 78)

writing or write so no one can read it. Your guess may be right, too. Always glad to hear from you, Carl. WQO was in Denver visiting his folks and was guest at a meeting of the Electron Club. He also acted as guide for three boys from the RAF while they were in Denver. Pfc. WQO, in the 517 Air Borne Sig. Co., is stationed at Camp Forrest, Tenn. QEC packed up his "go-away" bag and left with his mother to spend the duration in Knoxville, Tenn. where his brother Ed is working. 5JYW, ex-9FCE, sends his best wishes from Washington, D. C., and reports he was able to get in touch with FKK again after three years. You may be able to find a long-lost pal by sending in a report. The other fellow may ask for more dope on you, and if I don't have it handy, I will break an arm, if necessary, trying to get it. So send it in. I have started a scrap-book of V-mail that you may want to see when you get back. I have been able to answer them all, so see if you can swamp me. The gang at KGPX reported in, with DDF and IJU pounding brass. FXQ bought himself a new home at 1900 So Humboldt St. APR is on a soup diet. He got all his teeth yanked out and is starting a new front of his own now. JB got his back all lumped up working in his victory garden, which consists mostly of spuds. He said he had room for only fifteen hundred hills. TFP is a very sick man trying to fight off a bad case of pneumonia. We are pulling for you, Howard. WERS in Denver is now a part of the local CD set-up and some operator permits have been received from Washington, D. C. The control station is licensed under the call KFND. Several of the rigs, after being idle all these years, developed a few bugs. One receiver had a 955 and a dry electrolytic blow their tops. A complete list of operators will be ready for the next issue. WWJ stopped over in Denver on his way back from Rochester, Minn. He had his wife up there for treatment and says she is getting along fine now. His jr. operator is two years old and knows what to do with the telephone. 73, by Heck.

SOUTHEASTERN DIVISION

ALABAMA—SCM, Lawrence J. Smyth, W4GBV—A FYF, a recent visitor of GBV, is being congratulated on the arrival of a daughter. He has been an instructor in radar for the past two years. GKZ is a radio operator somewhere in Australia. He expects a short visit from ECF. CIU is in the radio testing section of a school in Arizona. My apologies for having no report in QST for two months. No dope was sent in and I was too busy to "make up something." GUD is wire chief at Ft. McClellan. GUP is stationed in Italy with Signal Radio Intelligence Co. BDH is maintenance electrician at TCI. I would like a full column for next month, so please let me hear from you. 73, Larry.

WESTERN FLORIDA—SCM, Oscar Cederstrom, W4AXP—Ens. Sally Walker, our WAVE communicator, surprised us when she announced her engagement to Flight Lt. Graham Randall Dawson, of Windsor and Westcliff, England. They were married in Pensacola and spent a week in New Orleans at the Roosevelt Hotel. Sally is having to do double work for a few days because of the death of Evelyn Sherman's sister in Mobile, Ala. Evelyn is another of our radio WAVES. Lt.(jg) GBM is back at Aircraft radio after finishing his course. Lt. Comdr. ABY, formerly of Memphis, made a flying trip to NAS from Washington, D. C. FRS, RM1c, is reported missing in action, according to an article in the Pensacola Journal. Eddie Collins wrote a nice letter from Corpus Christie, where he is in training. Eddie sends his 73 to the gang, whom he hopes to see before long as he is about finished with his training at Corpus Christie. Major Carl Beckham, W. Fla.'s ace of aces, is now officially a prisoner of war in Germany. PE has been promoted to lieutenant commander. Bill Green, former SCM from Abilene, Tex., has also been promoted to lieutenant commander. The OM pays him a visit at times and we always have a pleasant personal rag-chew. BCZ has resigned from the State Guard Signal Corps. His place is being taken over by FVJ, who has been promoted from corporal to technical sergeant. FVJ is also radio engineer at WTAL, Tallahassee. Brundage will be with Phil, too. Lt.(jg) Ludwig is starting to assemble a handbook for communication instructors. His success in compiling the pocket communication manual and the many calls for it makes us willing to bet the instructors' handbook will be as much in demand. Ludwig, ex-6BRF, plans to set up a ham

(Continued on page 82)

Built to take it!

Because they are built to take it
— built to do the job with a wide
margin of safety — Hammarlund
variable condensers are used in
every type of military equip-
ment from planes to battleships.

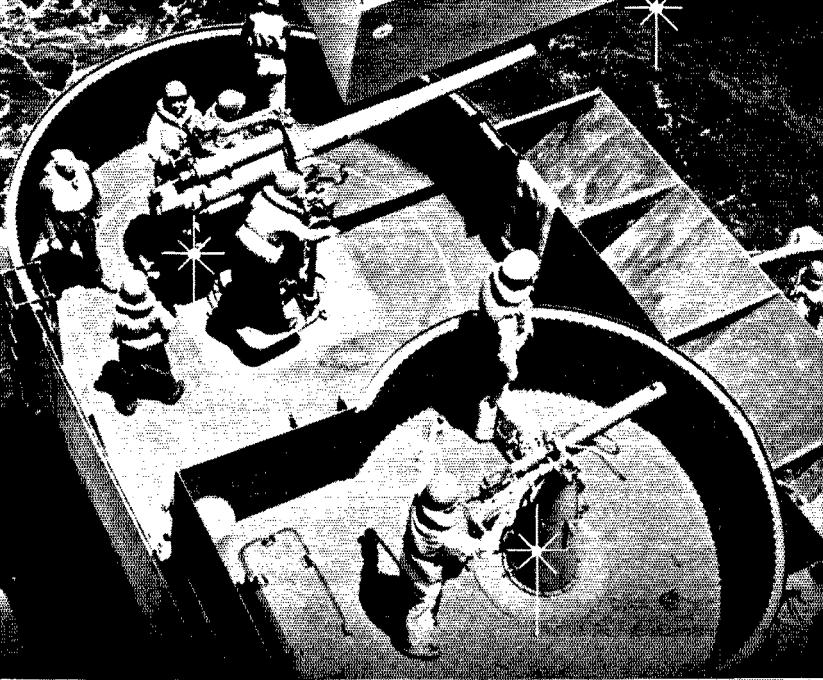
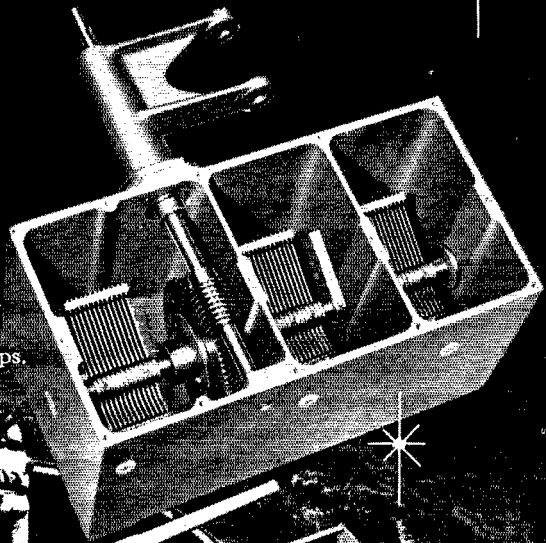

ESTABLISHED 1910

THE HAMMARLUND MFG. CO., INC., 460 W. 34TH ST., N.Y.C.
MANUFACTURERS OF PRECISION COMMUNICATIONS EQUIPMENT

OFFICIAL U.S. NAVY PHOTO

ACCURATE

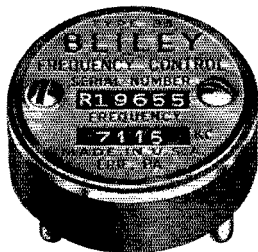

Accuracy and dependability are built into every Bliley Crystal Unit. Specify BLILEY for assured performance.

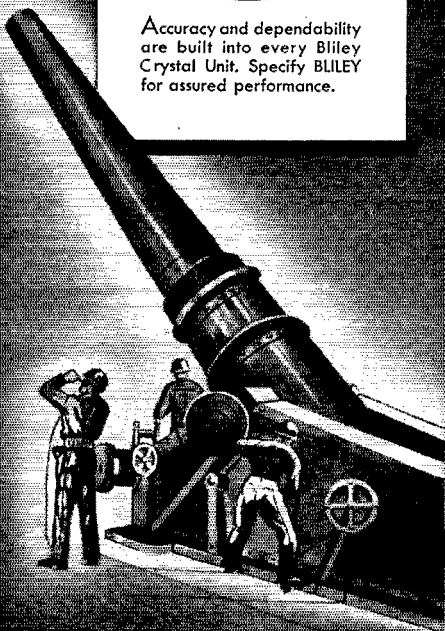

BLILEY ELECTRIC COMPANY · · · ERIE, PA.

Bliley Crystals

(Continued from page 80)

station after the war. A card from ARM1c Rose and ARM1c Swick says that they are in radio school in Mich. They sent regards to all the gang at NAS. The sympathy of the section is extended to EQR in the loss of his mother recently. AXP has been notified that he is to receive the Purple Heart for wounds received in action in World War One. He has also received the German Occupation ribbon. John Blackman, who is one of our radio communication instructors, has invented a code teaching device that is really the berries and as simple as ABC to use. From the looks of the model its use will teach perfect forming of letters and words and proper spacing. The device will be within means of the average boy seeking to learn code. The communication instructors held an informal dinner with Lt.(jg) Ludwig, ex-6BRF; Ens. Reed; RM1c Slattery and Mr. Knight from the Labor Board as guests of honor. Interesting topics were discussed. 73 and many thanks for a real nice report. *The Old Maestro.*

SOUTHWESTERN DIVISION

LOS ANGELES — SCM, H. F. Wood, W6QVV — ON sends in a nice report on the activities of the Los Angeles County Net, KGCL, and advises that the San Dimas net now has 26 units licensed, the Temple City group has 18, the Altadena bunch has 30, the Malibou set-up has 6, and Norwalk 2 that are on the air at present. All of the nets under this main license are putting in considerable time in handling practice messages. Several in their group are working on crystal-controlled jobs and new antenna systems and all are busy getting their equipment improved. Fred Stapp, reporting from Inglewood KGIC, says that the net continues regular weekly drills with more units participating than ever before. They also are doing considerable experimenting with antenna systems, particularly with beam affairs. Several new units have been recently installed and more are under construction. RNS has moved from that group and so is lost to some other city. What is one's loss should be another's gain, so here's hoping you have WERS wherever you are. Long Beach, KGWE, is reported again by "old faithful" AM. Several new additions have been made and others are in the making. They are working regularly with stations up in the Malibou group, a mighty nice hop and tests are still being conducted as far as Santa Barbara. Don says that TCG is now stationed at the Naval Air Station in San Pedro and occasionally drills with the WERS group from unit No. 30. RO now has his crystal-controlled job finished and perking beautifully — no doubt powered from the new power supply mentioned recently. That's a fine report, Don. I, too, hope to have a new job on the air before long, now that I am fairly well settled in the new QTH. Los Angeles finally received its modified license for the entire group of 136 units and the appointed monitor stations are mighty busy at each test period placing each unit "on frequency." New antennas are being rigged up in many spots including main control and by the time this is in print probably most of the units will be energized and taking part in regular drills. Units Nos. 30, 31 and 32 are giving a lot of time and thought to ironing out details of the drill procedure to get as many stations on as possible and working together. RNN, writing for the Inglewood Club, tells me that QVS, an ARM2c, is home on furlough from the Caribbean and was heartily welcomed by the gang at a recent club meeting. PNH is on duty with the Marine Corps somewhere in the Southwest Pacific. SEZ is training at Great Lakes. H. R. Minton has been elected treasurer of the club to replace RNS, who has moved. The club has sent letters of appreciation to those various radio manufacturers who are supporting the hams in the recent advertisements in *QST* as well as other magazines. This is a fine idea, Stu, and one that more clubs, etc. should follow. We need their help and they need our help now and in the future. A letter from UQL, now in Bremerton, reports he has attained his majority and that his XYL, Grace, and son, Spike, are again joining him for the summer months. He entertained SSU while Dick was "north" recently. We also had a note from the latter and he has made a couple of more "western hops" and ran into MQM on the Island recently. He reported our former SCM as being in good health and very busy hopping from here to there. How about a note, Ralph, and give us the low-down. Jimmy Rollins now has a new address. His brother, Tommy, now home from Tulagi, reported having missed Jimmy's boat by just three days while away down there. SCQ was at a recent meeting attended by yours truly and he is bearing up mighty well

(Continued on page 84)

NEVER ALONE



Many thousands of Hammarlund
"Super-Pro" radio receivers
assist the Army Airways Communications System
in providing flight information
for Allied planes
in the skies everywhere...
Below we see a battery of
"Super-Pros" in action
Somewhere in the Pacific.

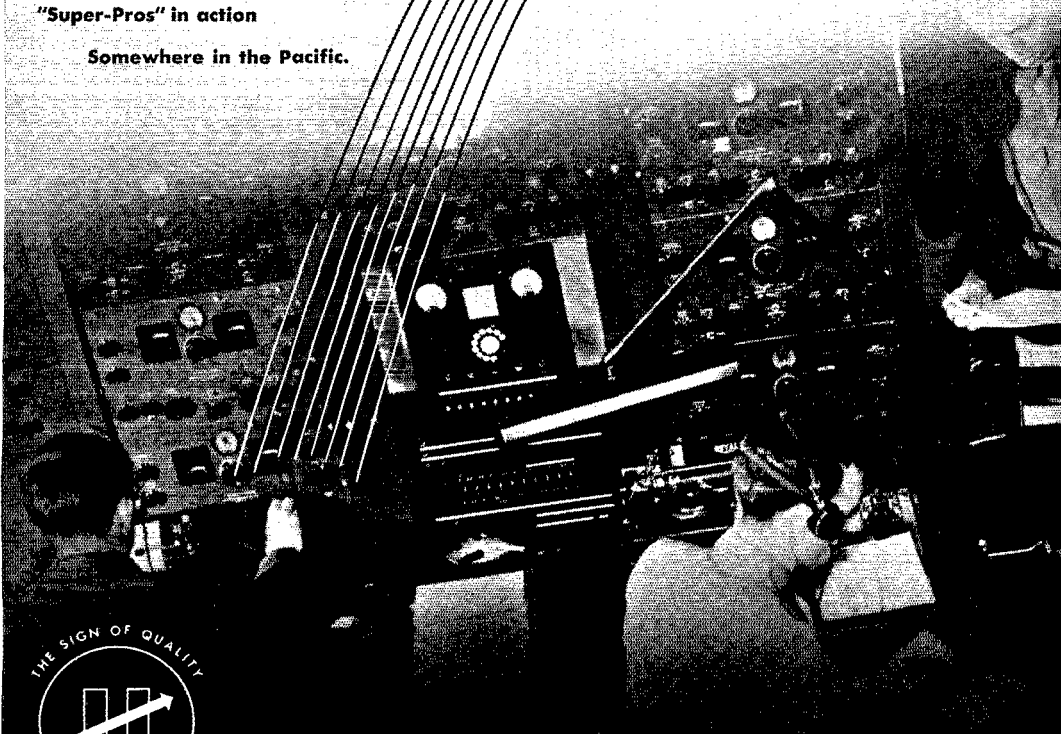
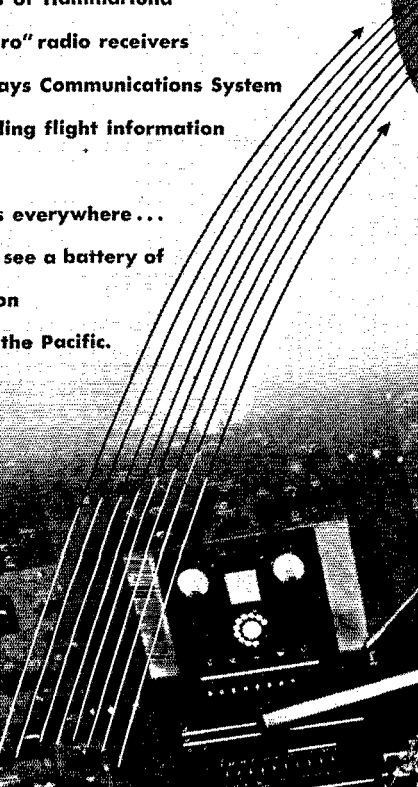

ESTABLISHED 1910

THE HAMMARLUND MFG. CO., INC., 460 W. 34TH ST., N.Y.C.
MANUFACTURERS OF PRECISION COMMUNICATIONS EQUIPMENT



Edison... experimenting with the incandescent lamp in 1883, noted that the hot carbon filament emitted an electric charge. When he put a positively charged electrode in the bulb, negatively charged particles were attracted to it from the filament. Later on, Fleming, intrigued by this mystery, invented the first electronic valve—all of which led to De Forest's invention of the Audion Tube.

Similarly, Stancor Transformer design since its origin, has reflected the refinements of electronic research. This hourly accord with industry's needs and desires is a definite promise always of prime efficiency...

★ SEND FOR NEW COMPLETE CATALOG

STANCOR
Transformers



STANDARD TRANSFORMER CORPORATION
1500 NORTH HALSTED STREET - CHICAGO

Manufacturers of quality transformers, reactors, power packs and allied products for the electronic industries.

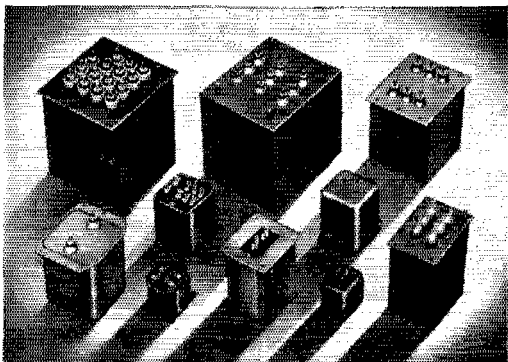

(Continued from page 82)

under his heavy work. SGP, known on 10 meters as "Sweet Grandpa," is now living at 2108 Rose Dr., Whittier, Calif., and is working for U. S. Rubber Co. in Los Angeles. Good luck and health. Write in some news, pulceze, and I'll CUL. 73, Ted.

ARIZONA — SCM, Douglas Aitken, W6RWW — The Tucson Short Wave Assn. deserves a special medal for the work that they have done in training cadets, future hams and others interested in the dit-dahs. Since Pearl Harbor they have maintained classes continuously. At present they have a class of Chinese "lease-land" cadets, in addition to other classes, including WACs. They are really proud of one YL who can take 40 w.p.m. on the mill. GS tries out his 40-watt transmitter on a dummy antenna every once in a while and wishes for the good old days. He is assembling a new rotary beam, to be ready to go when reactivation is permitted. SOB still maintains that the ham rigs beat anything the military has yet put out. OZM swears that his hens cackle "CQ" every time they lay an egg. OJK, who had a letter in May QST, is a former Tucsonite, and the first secretary of the Association there. Now with G. E. Co. RXQ has been back on another leave; he is now RT1c and assigned to destroyer service. UKB has been promoted to ART1c and is on duty somewhere in the Pacific area. QNC dropped by and has many plans for hamming when the shooting is over. Last word from KWI found him wishing he was back again in the land of Desert Rats! Please, fellows, won't a few more of you kick through with a postal card about your doings? 73, Doug.

SAN DIEGO — SCM, Ralph H. Culbertson, W6CHV — Asst. SCM, APG. Gre'tings, gang. Let's try to revive the San Diego Section. How about all of the old gang getting in and digging up some news? BZR has gone East with Raytheon. BKZ, EWU and ATZ are working at Sound Lab., Point Loma. BOS joined the staff at Convair to keep the p.a. systems operating. LFU is still keeping the lights on in Escondido. DAZ, stationed at North Island, is beaming with the new rating of ensign, USN. Lt. Comdr. GWY is somewhere in the So. Pacific. RPJ is taking advance training in the Army Air Corps. EZM, JH, NBJ, NCU, OAT, OOT, QJK, SFO and yours truly are civilian employees at the Naval air station, S. D. LYF is working nights keeping the telephones working. JRW, now a warrant officer, reported that he is married and stationed in Washington, D. C. QEZ, somewhere in the So. Pacific, writes, "Would sure like to hear more from the old gang." How about helping out and sending a note for our column? Ralph.

WEST GULF DIVISION

OKLAHOMA — Acting SCM, Ed Oldfield, W5AYL — AXM is patrolling the air with the FCC in Texas. AOY is keeping KOSO and Highway Patrol Cars operating. IEO is still in the theater business. JPI, ex-secretary of the Oklahoma City Radio Club, is in the Signal Corps, Dodge City, Kans. DTU continues to hunt bacteria and do X-ray work at Wesley Hospital. EIH answered Uncle's call to the Army and when last heard from was in Ft. Sill. FRY, employed at Radio Repair Section, OCASC, enjoyed a nice visit recently from AFX and HFL and their XYLS. HFL is employed in Orange, Tex., and Art is still running the long lines for AT&T. CXE is working for civil service weather bureau here at home. APG returned to Oklahoma City to resume residence here after a three-year stay in Houston, Tex. SL is still fighting crime and fire with radio at the Oklahoma City Fire Dept. FIL is doing a good job educating folks in the diseases of radio equipment at OCASC. QL is OG&E's radio chief. Same old politician and BCL's assistant. IOW is doing a nice job "flight testing" radio equipment at OCASC. GZK continues to mill around at Ada. HJ is looking after CAA radio installations and living in Washington, D. C. We haven't heard from HXI for some time, but understand that the old buzzard is residing at Crescent and still has plenty of oil wells around on which to hang Field Day antennas. JCR, the Oklahoma City gang's treasurer, is keeping the funds in good shape for that time when all the wandering members get back. ERY is engineer for KOMA and has purchased a home in Edmond. "Fire Station Willie," Bus Beaty, has turned to the jewelry business for sustenance. Let's hear from all of you, regardless of where you are. How about it Tulsa, Ponca, Muskogee, Alva, Frederick and Enid? Ed.

(Continued on page 86)

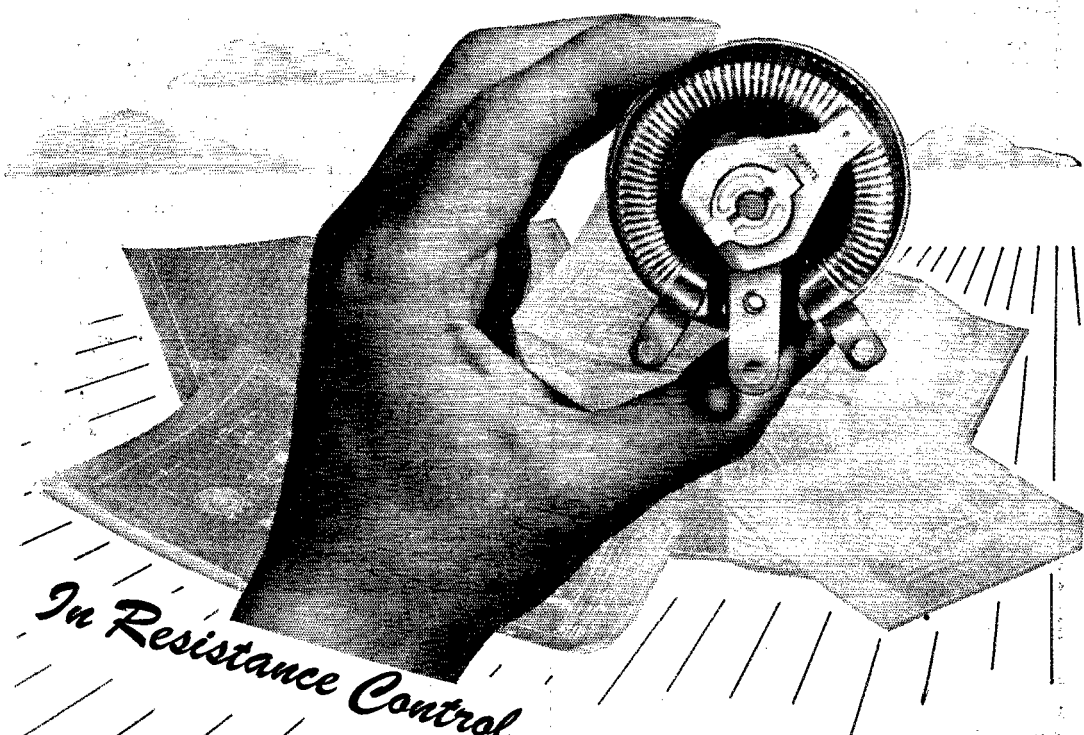

In Resistance Control

OHMITE EXPERIENCE MAKES A DIFFERENCE

You get the benefit of Ohmite experience in meeting the varied requirements of innumerable applications . . . in pioneering new rheostat, resistor and tap switch developments . . . in producing the widest range of types and sizes to answer every control need. Add to this, the long service-record of Ohmite Units—their proved ability to function under the most severe operating conditions. Such experience in resistance control is invaluable to engineers designing new devices to defeat the enemy or planning new products for the postwar era.
Authorized Distributors Everywhere.

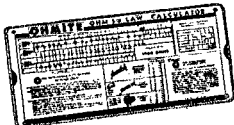
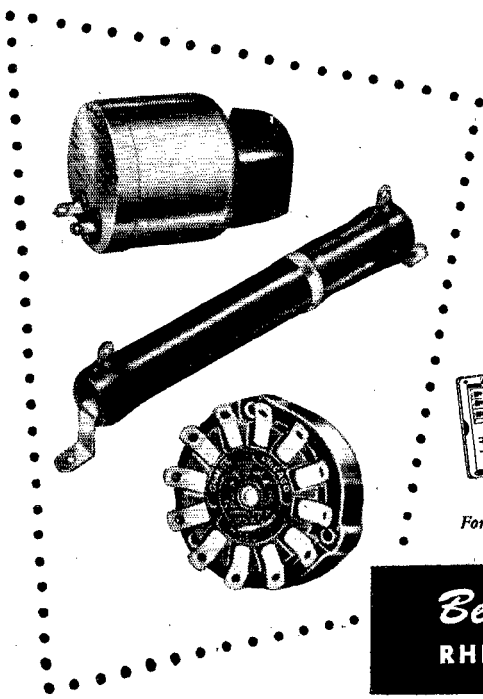

Handy Ohm's Law Calculator
Set the slide once—read the answer!
Solves any Ohm's Law problem—quickly, easily. Send only 10c in coin to cover handling and mailing. (Also available in quantities.)

OHMITE MANUFACTURING COMPANY
Foremost Manufacturers of Power Rheostats, Resistors, Tap Switches
4863 FLOURNOY STREET ★ CHICAGO 44, U. S. A.

Be Right with **OHMITE**
RHEOSTATS • RESISTORS • TAP SWITCHES

NOW — a really high-powered RADIO ENGINEERING LIBRARY

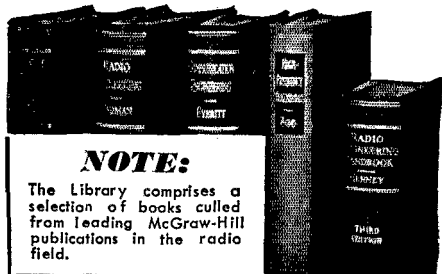

NOTE:

The Library comprises a selection of books culled from leading McGraw-Hill publications in the radio field.

- ➔ especially selected by radio specialists of McGraw-Hill publications
- ➔ to give most complete, dependable coverage of facts needed by all whose fields are grounded on radio fundamentals
- ➔ available at a special price and terms

THESE books cover circuit phenomena, tube theory, networks, measurements, and other subjects—give specialized treatments of all fields of practical design and application. They are books of recognized position in the literature—books you will refer to and be referred to often. If you are a practical designer, researcher or engineer in any field based on radio, you want these books for the help they give in hundreds of problems throughout the whole field of radio engineering.

5 volumes, 3559 pages, 2558 illustrations

Eastman's **FUNDAMENTALS OF VACUUM TUBES**, 2nd edition
 Terman's **RADIO ENGINEERING**, 2nd edition
 Everitt's **COMMUNICATION ENGINEERING**, 2nd edition
 Hund's **HIGH FREQUENCY MEASUREMENTS**
 Henney's **RADIO ENGINEERING HANDBOOK**, 3rd edition

**10 DAYS' FREE EXAMINATION
 SPECIAL LOW PRICE EASY TERMS**

Special price under this offer less than books bought separately. Add these standard works to your library now; pay small monthly installments, while you use the books.

SEND THIS EXAMINATION COUPON

McGraw-Hill Book Co., 330 W. 42 St., N. Y. 18

Send me Radio Engineering Library for 10 days' examination on approval. In 10 days I will send \$3.00 plus few cents postage, and \$3.00 monthly till \$24.00 is paid, or return books postpaid. (We pay postage on orders accompanied by remittance of first installment.)

Name.....
 Address.....
 City and State.....
 Position.....
 Company..... QST7-44

(Continued from page 84)

SOUTHERN TEXAS — SCM, Horace Bidy, W5MN — San Antonio's own LSPH gang have been reported as follows: Les Germer, RM3c in the Navy, is near VK territory and may go to radio school for special training. S/Sgt. Parsons, while on furlough, visited the SCM before reporting back to New River, N. C. Alex Fabris is in Harvard as 2nd lieutenant. S/Sgt. Calvin Graf is finishing his Marine Corps course at Corpus and expects to be a Naval Aviation Cadet soon. Floyd Rowland is in Army motor unit. E. Vradenburg, S1c, is in Boston. Parsons and Fabris met in N. Y. and had an FB QSO. JVF is in the USMC, Tex Perryman, formerly of Houston, now somewhere in the West Indies, expects to get a license soon. M. T/Sgt. ILL spent 9 days of his furlough trying to pacify the home town folks by fixing their radio sets. 73, *Horace*.

NEW MEXICO — SCM, J. G. Hancock, W5HJF — David Erwin (LSPH) has been promoted to chief radio technician in the USNR and has also passed his Class A exam, and is looking forward to his first QSO when this "danged" war is over. Dave's XYL always censors QST before passing it on to him. Harold Wheeler (LSPH) paid the SCM a visit while home on a 3-day pass from Camp Bowie, Tex. HJF is currently trying to exterminate bugs in his over-age Howard 460, but that isn't the reason for such a slim report. Am I going to have to give youse guys another pep talk? That postage raise didn't affect postal cards. 73, *Jake*.

Impedance Bridge

(Continued from page 36)

of sufficient size, the galvanometer, battery and 1000-cycle source can be included in the unit for greater convenience.

The absolute accuracy of measurements made with the bridge naturally will depend upon the accuracy of the fixed resistors and condensers used as standards, as well as the calibration of the variable resistors. Ordinary copper magnet wire may be used in constructing homemade fixed resistance standards of values up to 10,000 ohms. Reference to the wire table in the *Handbook* (see pages 401 and 427 in the 1944 edition) will show the approximate resistance of copper wire of various sizes. For instance, the table shows that No. 28 wire has a resistance of 66.2 ohms per 1000 feet, or 0.0662 ohms per foot. Therefore, a length of about 16 feet will have a resistance of approximately 1 ohm.

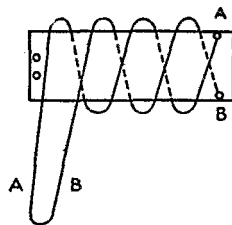
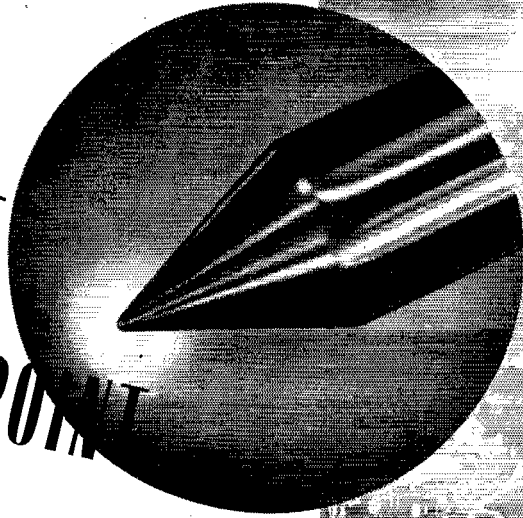

Fig. 3 — Method used for winding noninductive resistance standards from copper magnet wire. See text for details.

The standard resistors (R_1 through R_8) must be of the noninductive type. Fig. 3 shows the method used in winding the lower-value resistors on a thin strip of bakelite. The two ends of the wire first are soldered to the terminals at one end of the strip. The two half-lengths of wire are then wound in opposite directions around the bakelite strip and the loop end fastened to the other end of the strip.

This method was used in making the 1-, 10- and 100-ohm standards. For the 1000- and 10,000-ohm units half-inch bakelite rod was used, grooves being cut in the rod so that the windings

THIS PIVOT PROVES A POINT



THIS unretouched photomicrograph, approximately 50 times actual size, shows pretty clearly what we mean by the value of experience, when it comes to the making of electrical instruments and testing equipment.

Pivots play an important part in determining an instrument's life and accuracy. In the Simpson-made pivot above, you have what is truly a masterpiece of its kind . . . perfect in contour . . . all surfaces brilliantly polished to prevent rusting . . . rounded end properly correlated with radius of jewel to minimize friction and withstand vibration and shock . . . heat-treated for an unusual combination of strength and hardness.

The obvious explanation for this excellence rests in the fact that Simpson employs some processes others do not, and safeguards every step of manufacture by the finest and most complete control modern science can provide. But in the final analysis, it is only Simpson's long experience which makes such a pivot possible.

That experience reaches back more than 30 years. From it has come new shortcuts in manufacture, new refinements in design, which today permit Simpson to make "instruments that stay accurate" in greater volume than ever before. From this long specialization has come too a sound basis for further advance; in your postwar Simpson Instruments you will see still more forcefully the value of this experience.

SIMPSON ELECTRIC COMPANY
5200-5218 Kinzie Street, Chicago 44, Illinois

Simpson

INSTRUMENTS THAT STAY ACCURATE

Buy War Bonds and Stamps for Victory

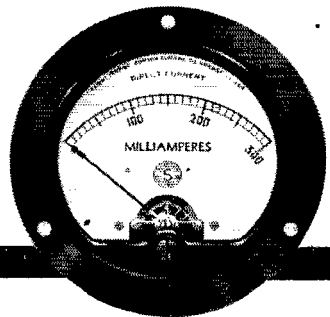
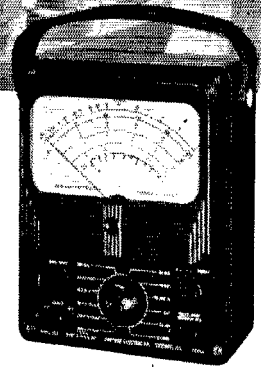

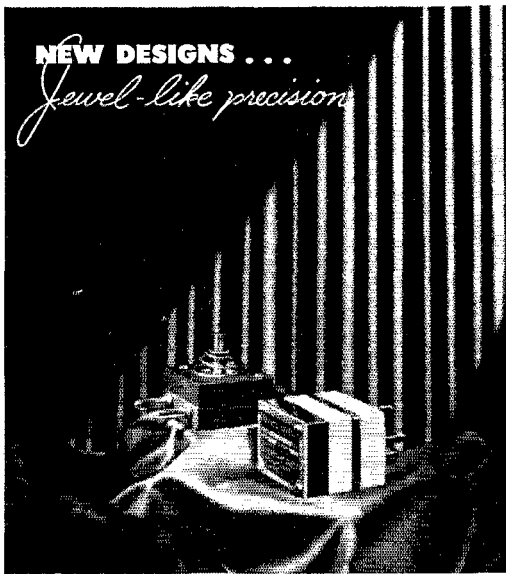

from our
Research Department TWO
Precision Adjustable Crystals

Scientific Radio Products Company proudly presents two newly designed crystal units, adaptable to a multitude of uses. Made with the same careful precision as the thousands we produce for the armed forces, these crystals are now available on priority order.

Type SR1-V, at left, is continuously variable over a range of 12 Kc. at 3 Mc. It may be controlled from the front panel of the transmitter by attaching a flexible shaft to the $\frac{1}{4}$ inch adjusting shaft at top of holder. Available in the frequency range from 1600 to 4000 Kc. 2cy/Mc/deg. C. or less.

Type SR2-V, at right, consists of a precision ground low drift crystal in adjustable ceramic holder designed to fit a five-pin socket. Available for any frequency from 200 Kc. to 8500 Kc. temperature coefficient of 1 cy/Mc/deg. C., or 2 cy/Mc/deg. C.

For prices and full particulars, write.

WRITE FOR NEW BROCHURE

Would you like to read the interesting story of the development of the American crystal industry? Send for your copy of our new brochure. It's as interesting as a tour through our plant. Yours for the asking.

SCIENTIFIC

RADIO PRODUCTS COMPANY

738 W. BDWY. — COUNCIL BLUFFS, IOWA

MANUFACTURERS OF PIEZO ELECTRIC CRYSTALS AND ASSOCIATED EQUIPMENT

(Continued from page 86)

could be made in pies. Each pair of adjacent pies was wound in opposite directions. Resistance wire rated at 80 ohms per foot was used, wound 250 ohms per pie for the 1000-ohm units and 2500 ohms per pie for the 10,000-ohm unit. Two 50,000-ohm meter multipliers, rated at 1 per cent accuracy, were connected in series to provide the 100,000-ohm standard.

Calibration

The most accurate means available should be used in checking the resistance of the standards. A local serviceman or a school laboratory may have a resistance bridge which can be borrowed to make the calibrations. The wire-wound units can be adjusted to exact values by removing the insulation from the loop end and twisting the loop until the correct value is obtained.

An accurate calibration must also be obtained for the R_9R_{10} combination. The curve should be checked at as many points over the range of R_{10} as possible. If a 10,000-ohm resistor with a logarithmic taper is available it may be used to replace the parallel combination. When building this unit a potentiometer of this type could not be obtained locally, and so the combination of R_9 and R_{10} was used to obtain an approach to the desired logarithmic characteristic.

Once the fixed resistance standards and R_{10} are calibrated, it is a relatively simple matter to calibrate R_{11} , R_{12} and R_{13} by simply connecting them to the R terminals of the bridge. These three units preferably should also have a logarithmic taper.

Condensers having capacities as close as possible to the required values of 0.1 μ fd. and 0.01 μ fd. should be used for the capacity standards. Both should be of the mica type, to minimize loss errors. C_1 may be made up of a combination of smaller-capacity units in parallel, if necessary.

The accompanying tables (II and III) show how the dials should be marked to be direct reading.

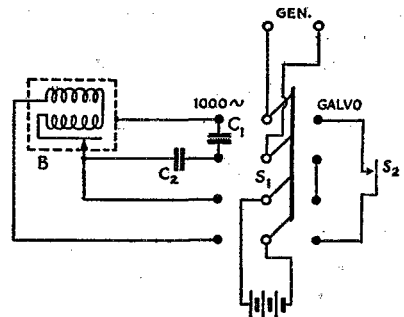
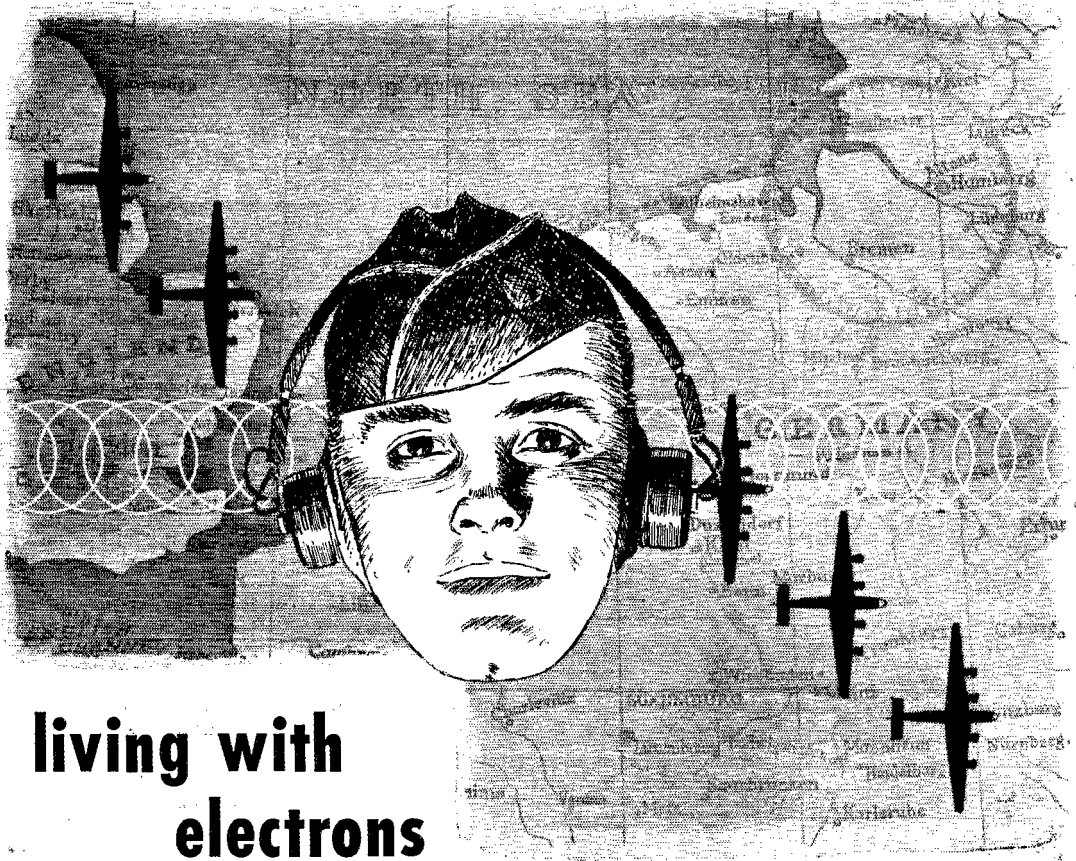

Fig. 4 — Circuit of the 1000-cycle tone source.

- C_1 — 0.5 μ fd.
- C_2 — 0.1 μ fd.
- S_1 — 4-p.d.t. switch.
- S_2 — Push-button switch.
- B — High-frequency buzzer.

Fig. 4 shows the circuit of an inexpensive generator suitable for the 1000-cycle signal source required for measuring capacity and inductance. The frequency can be checked with sufficient accuracy by matching it up with the second B above middle C on a correctly tuned piano. The buzzer should be enclosed in a sound-proof box.



living with electrons

Only a short time ago—when the principles of radio were discovered—men began dimly to realize the versatility of electrons. But it was not until war came, with its deadly challenges, that men really began living with electrons, utilizing them in amazing applications in ships and planes and battle vehicles. Their versatile performances promise future applications that will make electronic devices a part of our daily lives.

Delco Radio has been working in close cooperation with Army and Navy engineers to help make electronics an increasingly effective "weapon" of war. The assignment has called for full utilization of Delco Radio's research laboratories, engineer-

ing background and production facilities, by means of which principles have been explored and exploited, designs evolved to apply these principles, and complete equipment manufactured with speed and skill. To all radio and electronic applications, Delco Radio brings its long experience in volume production of precision radio instruments.

**DO MORE THAN BEFORE—
BUY MORE WAR BONDS**

Delco Radio
DIVISION OF
GENERAL MOTORS

THE ABBOTT



EAGER BEAVERS

In Army slang, the *eager beaver* is the man who is anxious to learn, and shows his desire to advance in the ranks. ABBOTT has *eager beavers*, too. Each of us demonstrates his determination by putting his best into the equipment we build . . . masterpieces of precision that adequately meet the gruelling tests of modern warfare.



Illustrated is a product of ABBOTT peace-time endeavor — the ABBOTT Model TR-4 . . . a standard, compact and efficient ultra-high-frequency transmitter and receiver.

The pint of blood that takes but an hour of your time to donate may give a lifetime to a soldier. Visit your local Red Cross Blood Bank . . . now.

ABBOTT
INSTRUMENT, INC.

8 West 18th St., New York 3, N. Y.

A Lady of Mercy

(Continued from page 55)

By now the sea had become an inferno minus only the flames. Waves forty feet high picked us up, and then threw us down and down until we thought we would never come up again.

The sea had not spent itself when the doctors were called upon to operate. It meant saving a man's life, and blood plasma had to be administered. (Give a pint of blood when you can. I tell you in all honesty that it truly saves men's lives.) It meant operating on a table that was rocking tumultuously, in a room with all its windows knocked out, by doctors and nurses so sick they could barely hold their heads up. Yet the anesthetic was given and the operation successfully performed. . . .

I became acquainted with some of the casualties on the return trip to New York and I found that those who were the most severely wounded were least inclined to brood over their misfortune. Most were quite cheerful and happy beyond words to be going back home. Some who were badly maimed dreaded seeing their families and friends for the first time for fear of a too-sympathetic reaction. Sympathy is the one thing they do not want.

I couldn't help but compare my feelings at returning home to the feelings of those soldiers who were returning as they were. What mental torture they must have gone through on the return trip — wondering what would await them at home, wondering if their sacrifices would be remembered in a world quick to forget. I, for one, won't forget. I'll remember those men to my dying day. . . .

I have said very little about the nurses aboard the *Lady Luck* because I wanted to see how they stacked up at the end of the trip. Believe me, they stacked up all aces. There's very little ballyhoo about nurses. They do a non-spectacular job well and that's that, but if the public could see the sacrifices they make, the backbreaking work they do, the countless odd jobs that keep them on the go at all hours — well, verbal praise is inadequate. I have seen those nurses so seasick they could hardly stand up, but it didn't interfere with their administering to the wants of the wounded. The cheerful smile was still there. The willing hands were still available. Nothing I can say here can do those nurses justice.

The same goes for the doctors and the enlisted men, too. They worked under the most trying conditions sometimes, but always quietly and efficiently. There is no glory in the work they do, only the satisfaction of knowing they are tending to the humane part of war. And if anyone tells you the overseas medical corps is a safe outfit — brother, put them straight for me.

I doubt if there is one person who served on the staff of the *Lady Luck* who isn't more than a little proud of her. She still is carrying on her work of mercy "over there." Yes, ladies and gentlemen, I give you a ship small in size but big in deed — a gallant lady of mercy — the *Lady Luck*.

THE END

LESS THAN 1/2" IN DIAMETER

Silver Mica

CAPACITORS

Capacities from
6 to 2000 MMF

Less than one half inch in diameter . . . capacities from 6 MMF to 2000 MMF . . . ideal for numerous UHF and VHF applications.

Mica discs of the highest grade, individually silvered for maximum stability and stacked to eliminate any book effect. The assembly is vacuum impregnated. Available in a variety of terminals. All units are color coded.

Form 586 is available for additional information on these CENTRALAB Silver Mica Capacitors.

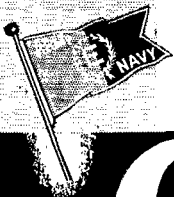

Centralab

Division of GLOBE-UNION INC., Milwaukee

PRODUCERS OF VARIABLE RESISTORS • SELECTOR SWITCHES • CERAMIC CAPACITORS, FIXED AND VARIABLE • STEATITE INSULATORS

Harvey

has last-minute information

Information gained in 17 years of buying and selling experience . . . information gained in tracing special and hard-to-find components has been consolidated by Harvey's for the benefit of purchasing agents. We have last-minute memos on the availability of parts you need, such as . . .

**TUBES RELAYS
RESISTORS
CAPACITORS
TRANSFORMERS
TEST EQUIPMENT**
And other needed
**RADIO AND ELECTRONIC
COMPONENTS**

If what you want cannot be located, we can advise you as to the effectiveness of substitute components. Our service is *fast, competent, complete!*



RAPID DELIVERIES,
too. Within 24 hours, if possible.

**Telephone Orders to
LONGACRE 3-1800**

**HARVEY
RADIO COMPANY
HARVEY**

103 WEST 43rd ST., NEW YORK 18, N. Y.

Electronic Key

(Continued from page 41)

The small chassis and box were made from old phonograph records. The panel is of $\frac{1}{8}$ -inch bakelite. The pictures show more about the construction than any number of words can tell. The "on-off" switch is in the upper left-hand corner of the panel, the keyed-circuit switch in the upper right-hand corner, R_2 in the left center, and R_3 in the right center. R_1 is located at the left rear of the chassis.

The relay shown in the pictures is a sensitive communications type with a 10,000-ohm winding. Before modification it was a 4-pole double-throw affair. However, such a pretentious relay is not required. The first relay used was a 2500-ohm single-pole, single-throw job. An extra single-throw pole was added and it worked quite well. During experimentation the winding was accidentally burned out and another relay had to be obtained. Luckily, the one pictured was found. It has been in use ever since.

The key lever is probably the hardest part of the construction. The sketch of the lever given in Fig. 2, together with the photographs, should make the general scheme clear. The one pictured was built by Capt. B. C. Johnson, W9LMK, from scrap brass, using only a file, two sets of drills and taps and the inevitable hacksaw. According to him the job requires more care and patience than it does actual skill. It looks harder than it really is.

As stated before, one of the objects was to make a key which would take up little or no more room than a conventional bug. Had a smaller condenser and a midget potentiometer been available, the unit could have been made still smaller than it is. However, as it is, the base dimensions are $3\frac{1}{2} \times 6\frac{1}{2}$ inches, which is just the size of a Vibroplex. The key lever is about as simple as it could be and still have both a dot and a dash contact. The action was copied after that of a Vibroplex and it has much the same feel in operation.

The power required to operate the unit may be obtained from a receiver, since the plate current is only about 5 ma.

The 6N7 tube was chosen because it gave a wide variation in plate current for a small change in grid voltage. Only one triode section of the tube is used, but both sections could be connected in parallel to give a greater plate current variation if required. The biasing voltage is 3 volts.

One precaution should be observed. The biasing voltage must not be greater than that required just to cause the relay to open. If the voltage is much greater the condenser will not charge to the full voltage between the characters in a train, and the first character will be longer than those that follow. In actual practice it has proved to be easier to adjust the plate voltage to suit the bias, rather than vice versa. In our case a plate voltage of 110 volts was found to be about right for a biasing voltage of 3 volts. The actual value will depend upon the relay used.

To some the fact that three different adjust-

(Continued on page 94)

SPECIAL OFFER

DURING



- **ARRL MEMBERSHIP**
for one year, including
- **SUBSCRIPTION TO QST**
(new or renewal or extension)
and the
- **RADIO AMATEUR'S HANDBOOK**
Regular or Defense Edition —
be sure to specify which

\$3.00

U. S. A. Only

THIS OFFER AVAILABLE ONLY DIRECT FROM

AMERICAN RADIO RELAY LEAGUE, INC.
WEST HARTFORD, CONNECTICUT

IRC WILL BE READY

with TYPE MP HIGH FREQUENCY
POWER RESISTORS



When the hour of Victory arrives, industry can count on IRC to supply its pent-up needs for all types of resistors. Mass production methods now in operation in these, the world's largest resistor plants, assure ample quantities at favorable prices.



INTERNATIONAL RESISTANCE CO.

401 N. BROAD ST., PHILADELPHIA 8, PA.

IRC makes more types of resistance units, in more shapes, for more applications, than any other manufacturer in the world.



Founded in 1909

RADIO TELEPHONY RADIO TELEGRAPHY PRE-INDUCTION RADIO

Courses ranging in length from 3 to 9 months. Dormitory accommodations on campus for men and women students. Approved by Texas Department of Education with authority to issue a maximum of 60 semester credits for complete training. If interested, write for details.

PORT ARTHUR COLLEGE PORT ARTHUR
TEXAS

(Continued from page 92)

ments are necessary to change keying speed may appear to be a serious disadvantage. This is not so important as it may seem, however, for the average operator usually sets his ordinary-type bug for one speed and then varies his sending speed by altering the amount of space between letters.

Let's not kid ourselves about the length of time it takes to get the hang of operating one of these gadgets. If you happen to be one of those who send perfect code, then it is likely that you will be operating it successfully in about fifteen minutes. If, on the other hand, you are like the writer and the code you send is far from perfect, then it is going to take a few hours to master the proper timing. However, once you have mastered it, sending will become a pleasure and your code will be as nearly perfect as possible.

QST Cruises

(Continued from page 14)

even the auto alarm and the power-input panel — are arranged for maximum accessibility from the main operating position.

The radio room is approximately eight feet wide by twelve long. The operating table extends throughout the length of one side, divided up for the two operating positions with built-in typewriter wells. The transmitters are wall-mounted above the table, the high-frequency unit at the far end and the low-frequency rigs at the center. The auto alarm and the power-input panel are installed on the end wall. Comfortable office-type swivel chairs are provided for the operator. Opposite the operating table there is a comfortable leather-upholstered couch — obviously, a welcome accessory during long-watch vigils.

Aboard the *American Mariner* the radio equipment is RCA throughout. The basic layout is entirely standard, corresponding with that aboard other Liberty ships in actual cargo service. Three transmitters are provided — a 200-watt ET-8010-CA, optionally m.o.p.a. or crystal-controlled, with eight pretuned frequencies in the 355-500 kc. range, an ET-8019-A covering 2 to 22 Mc. in eight bands, also of 200-watt rating, and an auxiliary emergency battery-powered transmitter for the 375- to 500-kc. range.

The dual receiving equipment at each operating position consists of an AR-8503 — a 4-tube t.r.f. receiver covering 15 to 600 kc. in four bands, switch selected — and an AR-8505 for 540 kc. to 30 Mc. — a transformerless 7-tube superheterodyne closely resembling the National NC-44.

Also aboard is an AR-8600 automatic radio alarm. Used when the operator is off watch or listening on another frequency at the alternate operating position, the auto alarm rings a loud bell and lights warning lights notifying whenever an international distress signal is received. Its installation aboard all merchant marine craft is required by FCC regulation. The auto alarm consists essentially of a superheterodyne receiver

ALL EYES ON MT. CARMEL!



On Guard! Symbol of watchfulness at the Meissner plant is this alert, keen-eyed sentinel. All prying eyes are kept at a safe distance, but there's no hiding the fact that great things are in the making here.



Testing: These two men pack a world of electronics knowledge behind youthful faces. They literally "grew up" in the business — thanks to the fact that there are more electronics technicians per thousand population in Mt. Carmel than in any other city.



Meissner's "Precision-El": Long experience, plus "home town" enthusiasm for the job, have so astonished visitors that they refer to Meissner's personnel as "precision-el." And Meissner's "precision-built" products prove the case!



What New Marvels these girls have seen! They're on the inspecting line at the Meissner plant in Mt. Carmel, Illinois, source of numerous major war departments in the electronics field.

ILLINOIS ELECTRONICS CENTER HUMS WITH FUTURE PROMISE

Nearly everywhere you look these days — in America's newspapers or magazines — you're apt to find a glowing reference to Mt. Carmel, or to the Meissner Manufacturing Company. That's because the little Illinois city and its largest industry are both in the forefront of important postwar thinking. Hub of much of this activity is the Meissner laboratory, which occupies an entire floor of the main office building. There are so many closely guarded secrets here, in fact, that no photographer dares set tripod inside!

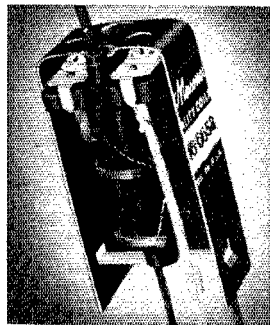

Wide Range, High Gain

Here are the famous "big four" benefits of Meissner "Plastic" I. F. Transformers: (1) wide range; (2) high gain; (3) remarkable stability; (4) double tuning. They're particularly suitable for use in small receivers, where space is at a premium, yet superior performance is required. Only $1\frac{1}{4}$ " square \times $2\frac{1}{2}$ ", yet are not affected by temperature, humidity or vibration. Complete with specially served Litz wire and one-piece molded plastic coil-form and trimmer base. Now ready for delivery, but order promptly.



MEISSNER

MANUFACTURING COMPANY • MT. CARMEL, ILL.
ADVANCED ELECTRONIC RESEARCH AND MANUFACTURE

Get Yourself
a Copy —

"A COURSE IN RADIO FUNDAMENTALS"

By
GEORGE GRAMMER

"A COURSE IN RADIO FUNDAMENTALS" represents an idea unique in the radio educational field. It is not a textbook; instead it contains those elements of a course of classroom study which lie outside the textbook proper—study guide, examination questions and laboratory experiments.

The course is equally valuable for use in connection with home study and as a classroom guide for the teaching profession. For home students it serves to replace the teacher, giving detailed experimental exercises and procedure as well as supplementary explanatory material where needed, in addition to providing an accurate gauge of progress through the probing examination questions accompanying each assignment. For instructors it is a completely synthesized course outline, of particular value to those who find themselves in the new field of radio technician training without the benefit of a planned course or time for thorough preparation.

The material is presented in eight parts, under these major subject headings: (1) Electricity and Magnetism. (2) Ohm's Law for D.C. and A.C. (3) Resonant Circuits. (4) Vacuum-Tube Fundamentals. (5) Radio-Frequency Power Generation. (6) Modulation. (7) Receiver. (8) Antennas. These parts are subdivided into 36 study assignments.

With each assignment there is a group of examination questions carefully designed to test the student's grasp of each of the significant points brought out in the text. Answers to questions involving mathematical problems are given in a separate section at the end of the book. In cases where more than routine methods are required, the complete solution is given.

Accompanying the text assignments are experiments which illustrate the principles being studied. These experiments are described in great detail, including the construction of the necessary apparatus and giving exact procedure and typical results. All apparatus required for the experiments is simple and can be constructed from "junk-box" or replacement parts selected to be most readily available despite shortages.

The text on which the course is based is "The Radio Amateur's Handbook," long recognized as outstanding in the radio training field. Either the 1942 or 1943 standard editions or the widely-used Defense Edition may be used.

To quote the Foreword: "The individual student undertaking the course may be assured that, if he follows its precepts literally and exactly, performs the experiments and examines himself honestly by the test questions, he cannot fail to learn the principles of radio. Instructors who use this material in their work may be confident that their students will receive thorough training in the essential fundamentals of radio."

PRICE 50 CENTS POSTPAID
(No Stamps, Please)

THE AMERICAN
RADIO RELAY LEAGUE
West Hartford 7, Conn.

(Continued from page 24)

with two 1100-kc. wide-band-pass i.f. stages designed to produce uniform response from any 500-mv. or stronger signal of a frequency within plus or minus 12.5 kc. from 500 kc. (the international distress frequency). Associated with this receiver is a timing circuit employing three sequence relay tubes and a stepping selector designed to operate only when a series of dashes of a certain length and interval — the prescribed auto alarm signal, transmitted along with an SOS — is received.

There is, of course, nothing new about the auto alarm; it has been in regular use for more than a decade and has greatly enhanced the cause of safety at sea. But even the auto alarm, effective though it may be, does not equal the effectiveness of an actual operator on watch. In time of war, of course, the need for infallible guarding of distress frequencies is vital — and this emphasizes all the more the need for additional radio operators to sail in the vast fleets of Liberty and Victory ships.

In the first dangerous years of this war more than five thousand merchant seamen gave their lives for their country. Now, of course, sinkings at sea, even in the most active theaters, are comparatively rare. The U. S. Navy's intensive anti-submarine campaign and the present patrolling and convoy operations have vastly reduced the danger from the submarine menace.

Even when unescorted, our merchant ships are far from defenseless. They bristle with stingers calculated to discourage any enemy attacks, whether by sea or by air. Liberty ships literally are speckled with guns. On the *American Mariner* there are gun platforms everywhere, carrying weapons ranging from .50-cal. machine guns to deadly 20-mm. Oerlikon antiaircraft cannon and murderous 3-inch guns which can throw twenty-five 10-lb. shells per minute at ranges of 10,000 to 13,000 yards.

"Abandon Ship!"

A convincing demonstration of the speed and safety of modern "abandon ship" technique was staged during our cruise on the *American Mariner*. It was a part of the regular training given every Maritime Service trainee, at first in school as a simulated exercise, later employing actual lifeboats, and culminating with the surprise lifeboat drill on the shakedown cruise.

The surprise drill we witnessed was entirely unannounced and unrehearsed. At exactly 0912 one morning the ship's whistle blew a series of short blasts followed by a long one — the "Abandon ship!" signal. Promptly all hands came running to the main deck from their usual duties everywhere in the ship and assembled around their assigned lifeboat stations, each man grabbing a fluffy-cushioned orange-colored life vest from an adjacent locker as he arrived topside. Within seconds the main deck was covered with shifting clusters of orange-festooned figures.

While the officer in charge of each contingent checked off his roster, designated men climbed

Vacuum and
Gaseous Discharge
**TUBE ENGINEERS
WANTED**

*for Design • Development
Processing • Testing*

This is the chance you've been waiting for to become associated with a company known in the industry and the armed forces for the top quality of its engineering. You'll be 100% in war work now . . . but there's a peace-time future commensurate with your ability and initiative.

If your education, experience and expected salary fit our specifications, you'll be welcomed by our present staff of engineers who not only know about this advertisement but also urge you to join with them in doing big things *better* with electronics.

Write today to

RAYTHEON MANUFACTURING COMPANY
Waltham, Massachusetts

ATTENTION: CHIEF ENGINEER, POWER TUBE DIVISION

Flash!

The Navy has directed us to greatly expand our Field Engineering Program immediately. See page 103 of March QST. Help us to help the Navy.



THE "C.I." RADIO-ELECTRONIC SUPPLY HOUSE

The promptness and completeness with which we fill priority orders has won us the complimentary nickname, "The C-I Radio-Electronic Supply House," because we've Got It or so quickly Get It. "I" meaning anything in radio and electronics supplies. Giant catalog available to business firms.

TERMINAL RADIO CORP.
 85 BURLINGAME ST., NEW YORK 2, N. Y.
 Phone Worth 2-4415

Communications Control At Finger Tips

★ Outstanding in the field of communications is Astatic's GDN Series Dynamic Microphone equipped with grip-to-talk desk stand for remote control of transmitters and amplifiers. Tilting head. Unaffected by temperature changes. Official Army and Navy finishes.

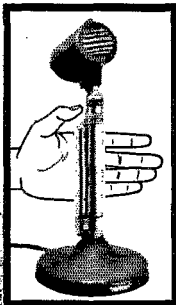

THE ASTATIC CORPORATION
 Youngstown, Ohio

In Canada: Canadian Astatic, Ltd., Toronto, Ont.

ASTATIC

(Continued from page 98)

from the higher boat deck into the lifeboats slung high in their davits. Swiftly they stripped the boats of coverings and lashings. Below, other groups manned the hoists, inserting the large cranks and releasing the brakes holding the cables. Still others unrolled the scramble nets, ready to lower them over the side for the men to swarm down into the waiting boats.

"Lower Away!"

The men above signaled "clear" and the command was given: "Lower away!" Hoists clanking, the bluish-gray boats were swiftly lowered until their keels hung suspended just beyond reach of the lapping waves. Heaving the scramble nets over the rail, the seamen promptly clambered down into the boats.

When all were aboard except the hoist crew and the officer in charge, the boat was lowered down into the water. As the last man scrambled down the net the releasing hooks from the davit falls were cast loose from the shackles.

In this practice drill the first boat was in the water and clear of the ship within less than five minutes after the alarm whistle blew. The remaining crews followed in varying brief intervals after. For inexperienced lads, many of them afloat on salt water for the very first time, it was an excellent performance.

Two types of lifeboats were used in this drill — one the accustomed oar-propelled 35-man surf boat, the other the 70-man manually driven screw-propelled "Lundeen" boat which now is also standard equipment. This boat, which is driven by the backward and forward manipulation of two rows of vertical wooden shafts connected by a ratchet linkage to a central shaft driving a screw propeller, has displaced the older oar-pulled boats. Its prime advantage is that no special rowing skill is required, a desirable feature in choppy seas when inexperienced oarsmen would, by catching crabs or rowing in the air, waste a substantial portion of their energy. After all, no special skill is required to push a lever back and forth. Another advantage is that, depending on the number of men in a boat, from one to four men can operate a single lever.

Also aboard the *American Mariner*, although not used in the drill, was a self-bailing, self-righting power lifeboat larger even than the Lundeen boats, equipped with a 4-cylinder Diesel engine, and the still-larger captain's gig — the latter actually a good-sized power yacht with a 6-cylinder Diesel engine and a speed of better than 15 knots.

In any one of these craft a seaman could abandon ship with full confidence in its seaworthiness and security. He might get cramped and weary and sunburned and seasick, and even hungry and thirsty — but he'd survive.

One minor observation in connection with that lifeboat drill was the surefootedness with which the trainees swarmed down the scramble nets draped down the sides of the ship. They behaved as though they'd lived all their lives in rigging.

(Continued on page 100)

Triple Six S



All-Purpose Pocket Size Volt-Ohm-Milliammeter

Model No. 666S—A.C. and D.C. Volts 0-2.5-10-50-250-1000-5000 (D.C. at 10,000 ohms per volt; A.C. 1000 ohms per volt); 0-.1-1-10-100-1000 D.C. Milliamperes, at 100 millivolts; 0-10 D.C. amperes at 100 millivolts; Resistance 0-400 Ohms (10 ohm center scale); 0-40,000 ohms (500 ohms center scale) 0-4 Megohms (50,000 ohm center scale). Self contained batteries. Selector switch control for all ranges. Completely insulated black molded case and panel, attractive streamlined design.

A new modernistic styled, compact unit provides an answer to all Volt-Ohm-Milliammeter requirements. Incorporates all the testing facilities of larger, more costly equipment. (Leather carrying case also available to hold tester and accessories.)

Triplet

ELECTRICAL
BLUFFTON



INSTRUMENT CO.
OHIO ***

WANTED PRECISION TEST AND LABORATORY APPARATUS

BY COMMUNICATIONS DEVELOPMENT LABORATORY

Give full details and best price for immediate sale. Box 90, QST.

LEARN RADIO

Pre-Military training for beginners. Catalog on request. We teach all technical branches of radio.

MASS. RADIO SCHOOL

18 Boylston Street

Boston, Massachusetts

EASY TO LEARN CODE

It is easy and pleasant to learn or increase speed the modern way — with an **Instructograph Code Teacher**. Excellent for the beginner or advanced student. A quick, practical and dependable method. Available tapes from beginner's alphabet to typical messages on all subjects. Speed range 5 to 40 WPM. Always ready, no QRM, beats having someone send to you.



ENDORSED BY THOUSANDS!

The **Instructograph Code Teacher** literally takes the place of an operator-instructor and enables anyone to learn and master code without further assistance. Thousands of successful operators have "acquired the code" with the **Instructograph System**. Write today for full particulars and convenient rental plans.

INSTRUCTOGRAPH COMPANY

4709 SHERIDAN ROAD, CHICAGO 40, ILLINOIS

Representative for Canada:

Radio College of Canada, 54 Bloor St. West, Toronto

WRITE FOR NEW CATALOG!

A "DIFFERENT" DESIGN... A RADICAL IMPROVEMENT

Meet the Variable Condensers of Tomorrow—B & W CX, heavy duty types! They have perfect design symmetry plus built-in neutralization. They are more durable mechanically. They are designed for built-in mounting of B & W coils, thus reducing lead lengths and resulting lead inductance to an absolute minimum. By any test, by any comparison you care to name, they prove themselves superior to conventional variable condensers. Write for new catalog No. 75-C—just off press.

BARKER & WILLIAMSON

235 Fairfield Avenue, Upper Darby, Pa.

TO OUR READERS
Who are not
A.R.R.L. Members



*Application
 for Membership*

**American
 Radio Relay League**

**Administrative Headquarters:
 West Hartford, Connecticut, U. S. A.**

.....194....

AMERICAN RADIO RELAY LEAGUE,
 West Hartford, Connecticut, U. S. A.

Being genuinely interested in Amateur Radio, I hereby apply for membership in the American Radio Relay League, and enclose \$2.50 (\$3.00 in foreign countries) in payment of one year's dues*, \$1.25 of which is for a subscription to QST for the same period. Please begin my subscription with the.....issue.

The call of my station is.....

The class of my operator's license is.....

I belong to the following radio societies.....

Send my Certificate of Membership or Membership Card (indicate which) to the address below:

Name.....

.....

.....

A bona fide interest in amateur radio is the only essential requirement but full voting membership is granted only to licensed radio amateurs of the United States and Canada. Therefore, if you have a license, please be sure to indicate it above.

*The dues are \$2.50 per year in the United States and Possessions. All other countries \$3.00 per year

(Continued from page 98)

Actually, as we ourselves discovered, that kind of skill is acquired quickly on shipboard. Remember that a ship is equivalent to a seven-story building — with no elevators. (Technically it has no "stairways," either — and that's approximately as true in fact as it is from the standpoint of nautical terminology! To conserve deck space, many of the companionways more nearly resemble wide-stepped ladders than they do stairways.) Consequently, on shipboard you seem to travel as far vertically as you do horizontally in the course of a day's activities. And, even though iron-runged ladders have replaced the traditional rope rigging, their use engenders a high order of agility and surefootedness.

Eat, Sleep and Be Healthy

At the outset, of course, it's a bit rigorous. But that quickly passes as unused muscles harden. It's wonderful body-building exercise — and a wonderful appetite-builder, too!

And when it comes to sleeping . . . well, no one rebels when, at four bells on the evening watch (2200), the loudspeaker blares: "Secure the decks! All hands in your bunks. Lights out!"

The combination of sea air and hard work makes that sack look mighty inviting. And it's even more inviting when you slide between the clean white sheets. The slung mattress is soft and accommodating — more comfortable by far than an Army cot or a hard-drawn hotel bed. By comparison with a Pullman berth, travel on a Liberty ship is rare luxury. Missing are the bumps and jerks, the rattle and vibration of the train; the functioning of the powerful triple-expansion engine is apparent only as a low, pleasantly pitched background hum that reassures rather than disturbs. And even in moderate seas the big ship keeps a steady deck; its rocking, combined with the threnody of the engine, is no more than a lullaby.

The adage about salt air inspiring ravenous appetites is proved whenever chow time comes around. Fortunately, the mess standards in the Maritime Service are more than equal to the occasion. The food is surprisingly diversified and ample. By any standard — at sea or ashore — it is well-prepared, savory and wholesome.

During our explorations aboard the *American Mariner* we invaded the refrigerated meat storage chamber. A large room fully twenty feet square, it contained meat stores in quantities many a large wholesale distributor would covet these days. Sides of beef hung in closely spaced rows — dozens and dozens of them. Lockers were filled with assorted cuts and prepared meats of every variety and description. Vegetable bins and other staple food storage was on a similarly abundant — not to say gourmandish! — scale.

And those desserts! For W9AA and W1CBD, both with an already decided tendency toward fullness of figure, they were as irresistibly insidious concoctions as galley alchemy ever produced. The pastry chef aboard the *American Mariner* was a lad only twenty years old, but he

DX ISOSO-LOOPS

are designed for

**Better
Pick-Up**

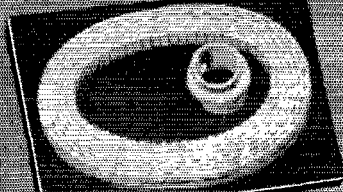

Because every DX Isoso-loop is tailored to fit your circuit and because each design is chosen for its highest "Q"; we'd like to help you with your receiver plans. Our present work concerns new standards of precision in making more and more DX Xtals for our armed forces.

DX CRYSTAL CO.

GENERAL OFFICES: 1200 N. CLAREMONT AVE., CHICAGO 22, ILL., U.S.A.



RF Inductors • RF Chokes • IF Transformers
Condensers • Mica Molded Condensers • Trimmer
Condensers • Miscellaneous Apparatus
The F. W. Sickles Co., Chicopee, Mass.



SICKLES *Electronic Specialties*

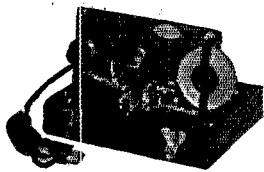

"The Choice of Those Who Know"

MASTER THE CODE

with

Master Teleplex

The ideal way to master the code thoroughly. MASTER TELEPLEX remains the only Code Instructor that will record your own sending and then repeat it back to you.

Booklet CQ explains how you may secure any TELEPLEX for ten days FREE TRIAL

TELEPLEX CO. 107 Hudson St.
Jersey City, N. J.

Here's How You Can Qualify for a BETTER RADIO JOB!

CREI technical training is preparing others for good-paying radio jobs — WHY NOT YOU?

Are you finding yourself in a routine job — a job that any other man can handle just as well as you? Today, radio JOBS are many — but radio CAREERS are few! Now is the opportune time for you to equip yourself with the necessary technical training to qualify for an important engineering position with a sound future.

NOW when industry needs men, is the time for you to investigate radio career training. Your radio experience backed by modern CREI technical training will equip you to share in the good-paying jobs that await trained men . . . and to make good in the important positions that lead to post-war careers with security and happiness!

WRITE TODAY! If you are a professional or amateur radioman and want to make more money — let us prove to you we have something you need to qualify for the better job opportunities that can be yours. To help us intelligently answer your inquiry — please state briefly your education, radio experience and present position.



CAPITOL RADIO ENGINEERING INSTITUTE

Dept. Q-7, 3224 16th St. N.W., Washington 10, D. C.

**A BARGAIN
THAT CAN'T BE BEAT!**



ORDER TODAY DIRECT FROM THIS AD
Sorry—NO CATALOGS for the Duration!

NEWARK'S SUPER-VALUE FILTER CONDENSERS

9 mfd. 2000 v. DC. With porcelain insulators and brackets for mounting. Size 1 3/4" x 3 3/4" x 4 1/2" high.

\$3.25

➔ **NO PRIORITY REQUIRED!**

BARGAIN FILTER CONDENSERS

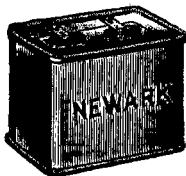

Still have limited stock of the old reliable NEWARK SPECIAL filter condensers. Oil filled and impregnated. Thousands of them have been sold.

Mfd.	Volts. DC.	Size	Price
1	1000	5 x 3 3/4 x 1 1/2	\$.59
2	2000	4 1/4 x 3 3/4 x 1 1/2	1.50
4	3000	5 x 3 3/4 x 3 3/4	3.75

Listen to Newark's Radio Program 7:30 to 7:45 and 8:00 to 8:15 A.M.
Every Saturday; Station WJJD — Chicago

NEWARK Electric Company
323 W. MADISON ST.
Dept. 9 CHICAGO ILL.

CAN YOU FILL ONE OF THESE MOST IMPORTANT WAR JOBS?

If you know theory and practice, you are urgently needed by a non-profit, non-commercial organization assigned to vital war research.

- Electronic Engineers
- Radio Engineers
- Electrical Engineers
- Physicists
- Electrical Designers
- Mechanical Engineers
- Electronic Designers
- Communication Engineers
- Electronic Technicians

If you are in one of the above categories and your highest skill is not being utilized to help save lives and materials, to help shorten the war, please write! ACT NOW!

Salaries based on experience, ability, education and past earnings. In addition, we will pay all expenses of transportation, moving, etc., for you and your family. Living quarters will be made available. If granted an interview, we will compensate you for all expenses incurred in coming to New London. Don't wait! Write, stating background and experience to . . .

PERSONNEL DEPT.

P. O. Box 271, New London, Conn.

(Continued from page 100)

must have lived all his premaritime life in intensive training at his mother's kitchen stove. That time at evening chow we wangled three pieces of chocolate pie . . . !

All in all, the life of a radio operator in the U. S. Maritime Service is a mighty attractive proposition for anyone who knows (or is capable of learning) how to read the code and write up a log and maybe send a little. Travel, adventure, healthful and rewarding living, good companionship — and, above all, a real wartime job of first-line importance.

What to Do

Are you interested — or do you know of someone who would or should be? Here's what to do:

If you've had no previous radio experience, apply at the nearest U. S. Maritime Service enrolling office or U. S. Employment Service office. If your preliminary background includes an operator's license, or if you cannot locate one of the USMS or USES offices in your vicinity, write directly to the War Shipping Administration, Training Organization, National Theater Building, Washington 25, D. C., stating your qualifications and experience. If you are among those who hold an expired or unexpired marine operator's license, you may wire the Recruitment and Manning Organization, War Shipping Administration, Washington 25, D. C., collect. And you can expect immediate action, mate!

Of course, if you're in the lower age bracket from 16 to 17 1/2, you have no draft status. Requests for selective service deferments for men 26 to 35 are made directly to local boards by the Maritime Service for men accepted for training.

Upon acceptance, as fast as quotas can be made up you'll be ordered to school — and your training pay (\$50 a month) will begin. Six weeks will be spent at a Maritime Service apprentice seaman training station where the seagoing knowledge necessary for all shipboard ratings will be learned. Then you will be assigned either to Hoffman Island or Gallups Island for the last twenty-one weeks of the course.

If you can qualify for a temporary limited second-class operator license, you will probably be sent right out to sea. (This temporary second, as previously noted in *QST*,² is the easiest class of commercial license to get. In fact, it is less difficult in some respects than a Class B ham ticket. The code test is the usual sixteen code groups per minute, but only a 50 per cent passing mark on the regular FCC second-class radiotelegraph exam is required. If you've ever before held a first- or second-class radiotelegraph ticket, only the code test without written examination is necessary.)

Base pay starts at \$180 a month, plus a bonus. Considering that living quarters and food are provided, this pay is easily equivalent to a shore job at \$300 a month or more. And don't forget that radio operators are ship's officers and wear uniforms with appropriate insignia.

Bon voyage, OM — and smooth sailing!

² Happenings of the Month, *QST*, June, 1941, p. 25.

**FILTERS
ENGINEERED**
to your Specifications

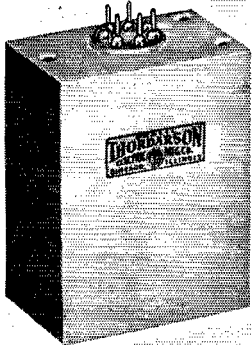

Maximum attenuation of rejection frequencies and minimum insertion loss at pass band frequencies, together with close tolerances and stability, are the usual filter requirements of the audio engineer. * The special design of Thordarson filter coils insures the desired Q at pre-determined frequencies. Time-tested production and inspection methods result in uniform performance to meet your exact needs. Thordarson filters are available with glass seal terminals, as illustrated, for complete hermetic sealing.

WRITE US REGARDING YOUR FILTER PROBLEMS

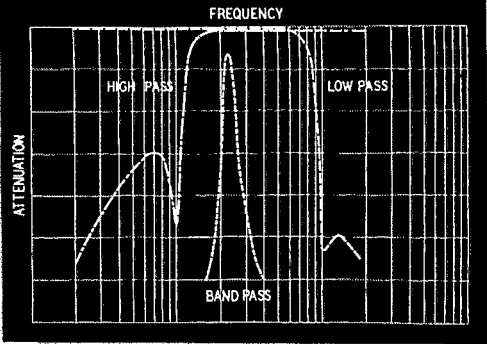

TRANSFORMER DIVISION
THORDARSON ELECTRIC MFG. CO.
500 W. HURON ST., CHICAGO, ILL.

Transformer Specialists Since 1895
... ORIGINATORS OF TRU-FIDELITY AMPLIFIERS

RADIO TECHNOLOGY



RCA Institute offers an intensive two-year course of high standard embracing all phases of Radio and Television. Practical training with modern equipment. Also shorter specialized courses in Commercial Radio Operating, Radio and Television Servicing, and Aviation Communication.

For Free Catalog write Dept. ST-44

RCA INSTITUTES, INC.

A Radio Corporation of America Service

75 Varick Street

New York 13, N. Y.

**SPECIAL
OFFER**

*See
Page 93*

PREMAX

ANTENNAS

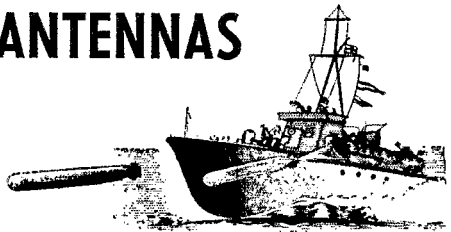

Are Maintaining Communications

- The wide experience and engineering triumphs in creating special antennas for the Armed Forces will be at the disposal of the amateur when Victory comes. In the meantime, Premax is devoting its entire facilities to building equipment for the speeding of V-Day!

Premax Products

Division Chisholm-Ryder Co., Inc.

4419 Highland Avenue

Niagara Falls, N. Y.

TALKING TO TANKS . . .



...is one of the many military jobs for Burgess "Walkie-Talkie" Batteries . . . another reason there are not enough for ordinary uses today.

Burgess Battery Company
FREEPORT, ILLINOIS

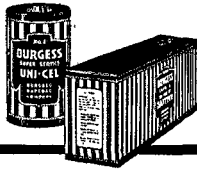

BURGESS BATTERIES

YES . . .
YOU CAN GET
HARD-TO-FIND
RADIO PARTS FROM
LEO —

WRITE FOR
FREE FLYER!

I'VE got hard-to-get parts and equipment for you fellows. Same low prices and square deal as always. WRITE TODAY FOR FREE FLYER that lists unbelievable items. Address Dept. 15.

• HALLICRAFTERS

I've always been a big distributor of Hallicrafter equipment. I'll buy used Hallicrafter rigs, highest prices. Other sets, parts too. Write. I'll quote top price for your used equipment.



GET FREE MAP

Radio reference map, loads of valuable information, standard, shortwave, nets, etc. Yours free. Send 15c to help with mailing and packing.

Wholesale
RADIO LABORATORIES

744 W. Bdwy.

Co. Bluffs, Iowa

Correspondence

(Continued from page 87)

the length of the antenna and counterpoise, I would guess we used a wavelength of approximately 450 meters. (I hadn't heard of "frequency" at that time.)

Later I was promoted to operator on the mine planters that operated in and around Manila Bay. The MP *Hunt* was my favorite. We had ¼-kw. spark rigs on those tubs and real receivers using three vacuum tubes. . . .

I'm getting to be an old man now and both the Army and Navy told me they could do without me very nicely. My only son is in the Navy. I'm working every day in an essential industry and putting 33⅓ per cent of my salary into War Bonds. That seems to be about the best I can do to back up our boys who have been doing such a wonderful job for us. After twenty-five years of military, commercial and ham radio, most of my ambitions have been put behind me.

Good luck to you hams in the services.

— O. C. Crossland, W9IXV

Splatter

(Continued from page 8)

staff of New York's high fidelity station, WQXR, he spends his spare time dreaming of maximum-efficiency low-power rigs on miscellaneous weird frequencies for the postwar period. Meanwhile, as a staff operator at Queens County WERS Boro net control, he operates WNYJ-221 and is conducting a WERS code class. . . . **Frank Heubner** (p. 15) is that *rara avis*—a confirmed wire man converted to radio. His transmutation we are told, was mystically involved with combinations of four cabalistic letters—E, R, S and W. Their first conjunction occurred as WRSE—the call assigned a radio station which he supervises and which the New York Telephone Company calls its "vehicle emergency telephone service." The second materialization was in the form of WERS, of which he has been Manhattan's boro coordinator in the New York City network for the past two years. He's still a transmission staff engineer for the New York Telephone Co., as he has been throughout the twenty-one years that have elapsed since he received his B.S. in ME at McGill University; but he also holds a 2nd class radiotelephone ticket and he testifies right out in open meeting: "I have found WERS a worth-while contribution to the war effort and the amateurs have given nobly both in time and material." And then he adds that he has hopes some day of acquiring a ham ticket himself.

What was that we were saying about *dosiers*? Well, in this one case, at least, our G-2 fell down this month. About **Henry O. Pattison**, W2MYH, we know practically nothing except that he is an advertising man who builds radio gear like an engineer—and who apparently disapproves of personal if not professional advertising. When he built the pretty little WERS job described on p. 19 he was with the J. Walter



◆ HALLICRAFTERS ◆ HALLICRAFTERS ◆
 "I'll Buy Your Used Communications Equipment,
 Especially Hallicrafters

HALLICRAFTERS ◆ HALLICRAFTERS

COMPLETE STOCKS

I have some Hallicrafter and National receivers available for immediate delivery on priority; and the following parts without priority: meter rectifiers \$1.98, transmitting tubes, transformers, resistors, condensers, panels, chassis, etc. Your orders and inquiries invited.

... and pay you *highest cash prices* for it!" It is an easy way for you to get behind the war effort. The equipment you sell will go to the Government who needs communications receivers and test equipment quickly and in large quantities.

Take advantage of this offer so that you may better be in a position to buy the new and better equipment with the improvements the large manufacturers, such as Hallicrafters, will make available after the war.

Write, telephone or telegraph a description of your used communications receivers, test equipment and parts of standard make, Hallicrafters-built or otherwise. You will be paid in cash immediately without bother or red tape.

Remember, I am particularly interested in Hallicrafters.

Bob Henry, W9ARA
HENRY RADIO SHOPS

Butler, Missouri & Los Angeles 25, California

"WORLD'S LARGEST DISTRIBUTOR OF COMMUNICATIONS RECEIVERS"

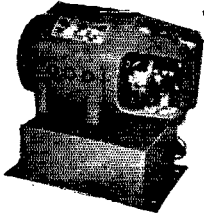

110-VOLTS AC
 from DIRECT CURRENT

with KATO KONVERTERS. Furnish standard 110-v. AC from 32, 110, or 220-v. DC. Good deliveries on sizes 350 through 2500 watts on priority orders. Good deliveries on 5, 7 1/2, 15 and 25 KW AC generators. Mgr's motor generators, frequency changers and high frequency generators.

Katolight, 26 Spring St., Mankato, Minn., U.S.A.

MASTER COURSE
IN RADIO COMMUNICATION



An approved home-study course — prepares you for radio operator's license and job or advancement in Broadcasting, Marine, Aviation, or Police radio. Our graduates can and do hold good radio jobs. Ask for FREE circular 5-Q.

See also our HAM-AD.

NILSON RADIO SCHOOL, 51 E. 42nd St., New York 17, N. Y.

RADIO OPERATORS WANTED



Learn to send and receive Radio Code at home or in camp, or prepare for higher proficiency and rating through same easy, practical system used in training radio-telegraph specialists. Our world famous system teaches you code by developing in you a "knack" of sound sense and sound consciousness that is the secret of speedy sending and receiving. Thousands of operators needed. Good pay, adventure. Learn at home quickly. Big opportunities now and peacetime possibilities appear equally promising.

FREE 52-PAGE BOOK explains complete training method and shows how to become a "crack" operator with sending and receiving speeds of 40-50 wpm — and more. Rush name for it today. It's absolutely FREE.

CANDLER SYSTEM CO.

P.O. Box 928, Dept. 4-G, Denver, Colo., U.S.A.
 and at 121 Kingsway, London, W.C. 2, England

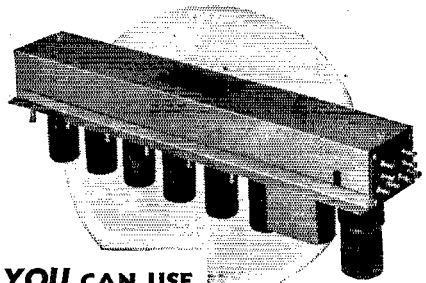

NOW YOU CAN USE
THE HARVEY "AMPLI-STRIP"

This I-F and AUDIO amplifying unit has proved itself on many applications of vital importance. It is now available with electrical characteristics to suit your requirements.

The Harvey Ampli-Strip is representative of Harvey design and production facilities built up over years of specialization in radio and electronics engineering. The electronics knowledge, manufacturing and testing resources responsible for equipment such as this may prove of great practical value to you now or in the future.

Your inquiries will be given prompt and careful attention.



HARVEY RADIO LABORATORIES, INC.
 451 CONCORD AVENUE, CAMBRIDGE 38, MASS.

(Continued from page 104)

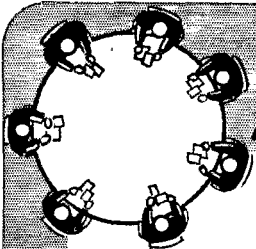



MEMO TO THE FCC

When the restoration of amateur radio bands is next on the hook, we hope you'll remember the magnificent wartime contributions by the men and women, boys and girls, who used those bands in peacetime. No one in this country should ever be allowed to forget that. And we hope that amateurs will remember Browning products, when they are again available for peacetime uses.



BROWNING LABORATORIES

WINCHESTER, MASS.



AMATEURS

Your war duties with the Armed Forces bring you in daily contact with **UNIVERSAL** microphones. The "workouts" the instruments get at your hands will largely determine improvements to be made in microphones after victory is won. Then again **UNIVERSAL** microphones will be ready to serve you constantly in peacetime pursuits.

UNIVERSAL MICROPHONE COMPANY

Inglewood, California

Thompson Co. in New York City, but we understand that subsequently he has joined another agency. Which one it is, we don't know. We'd suggest, though, that research institutions and radio manufacturers in need of an accomplished radio technician might do well to scout a few of the metropolitan New York advertising agencies. . . . Concerning **B. W. Southwell, W6QJW/2**, however, the record is more complete. It discloses that he was first bitten by the radio bug in 1935 and received his ham ticket and present call a year later, followed by a Class A license in 1940. Before the war he worked c.w. on 3.5, 7 and 14 Mc., mixing in a little 'phone — fixed and portable-mobile — on 56 and 112 Mc. For the past two years he has been working as an engineer for the War Department in the Signal Corps Laboratories at Eatontown, N. J., doing research and development work on "specialized electronic equipment." Receiving a 1st-class radiotelephone license earlier this year, in his spare time he has been working as relief operator at WCAP, Asbury Park, N. J. From a usually reliable source we hear that his postwar plans include building a ham television station in collaboration with W6KTI. That rumor receives substantiation on p. 26. . . . Finally, in the form of a personally signed and attested statement: "There really is very little to tell. I was born at Cameron 'mid the hills of 'old Missouri' 9 February 1916. Until joining the Army I spent most of my life there. . . . During 1935-36 I attended a course in Electrical Engineering at the University of Kansas. . . . In the spring of 1936 I took the examination for amateur radio station and operator licenses and much to my surprise was issued the call W9YDA. From that time until 1941 I was more or less active on 80 c.w., mostly rag-chewing. . . . Since leaving school most of my work has been in radio service shops, although I have worked as a power and telephone lineman and have done contract wiring. I was drafted into the Army on 2 July 1941. I had basic training at the Cavalry Replacement Training Center, Fort Riley. On 1 September 1941 I was transferred to the Cavalry School at Fort Riley as an instructor in radio communication, and have been here ever since. I held all of the various enlisted ratings up to and including master sergeant. On 19 April 1943 I was appointed warrant officer after taking a competitive examination. I teach both enlisted and officer classes in radio theory and f.m. My hobbies consist of amateur radio, flying and swimming. While in school I played football and baseball. All in all, a very uncolorful life. Needless to say, I am thrilled to break into print in *QST*. I plan to reënter engineering school when discharged from the Army. Thanking you, I am, respectfully yours, **Lawrence G. Wiley, W9YDA.**"

...

Perennials also with us again are, on p. 46, **Edward M. Noll, ex-W3FWJ** (Splatter, Oct., 1943, p. 8); on p. 56, **Paul J. Palmer, W8UGR** (Splatter, Jan., 1943, p. 16); and, on p. 38, **Sourdough** (Splatter, May, 1943, p. 66).

Here's the Skeleton in your Production Closet

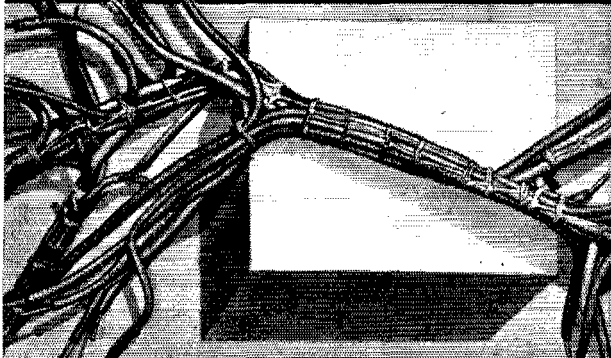

When contracts, new specs, pilot runs and general production troubles pile up—the skeleton in your closet may well become your "harnesses." That's where we shine—because the Wallace Organization is made up of skilled radio craftsmen that take harness and cable jobs in stride. Our wartime work includes crystals, oscillators, cables, harnesses, both radio and radar. We'd like to give you a hand today, when speed means captured enemy territory or tomorrow when it means captured markets. Phone Peru, 151



Wm. T. WALLACE MFG. Co.

General Offices: PERU, INDIANA
Cable Assembly Division: ROCHESTER, INDIANA



▼ WOMEN in Radio ?

Certainly. Making good, too—as radio technicians in broadcast stations, with airline companies, police radio networks, radio laboratories and radio manufacturing plants. Our thorough course prepares for all these fascinating fields. Write for details, stating age and education. No salesman will call.

Dept. S **VALPARAISO TECHNICAL INSTITUTE**
Valparaiso, Ind.

**RADIO'S
BEST
POST-WAR
JOBS**

GO TO THE BEST-TRAINED

PREPARE NOW for your lifetime career in Radio-Communications-Electronics. Day and evening. Send for your FREE copy of the Melville illustrated catalogue. Address Registrar
45 West 45th St., New York 19, N. Y.

**MELVILLE AERONAUTICAL
RADIO SCHOOL, Inc.**

ELECTRICITY FOR ANY JOB—ANYWHERE

Onan Electric Plants furnish dependable electricity on projects remote from commercial power. Gasoline driven . . . single unit, compact design . . . sturdy construction . . . for mobile, stationary or emergency use. ● Over 65 models, ranging in sizes from 350 to 35,000 watts, 50 to 800 cycles, 110 to 660 volts, A.C. . . . 6 to 4000 volts, D.C. . . . Also dual A.C.-D.C. output types.

Descriptive literature sent promptly on request

**D. W. ONAN
& SONS.**
1953 Royalston
Avenue,
Minneapolis 5,
Minn.

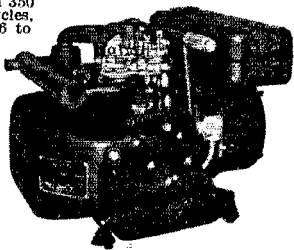

ONAN
ELECTRIC PLANTS

**WE CAN
HELP
YOU
WITH YOUR
PRIORITY
REQUIREMENTS
for
RADIO
PARTS
•
TUBES
•
ELECTRONIC
EQUIPMENT**



- ★ LARGE STOCKS
- ★ RAPID DELIVERY
- ★ INSTANT SERVICE
- ★ 22 YEARS' EXPERIENCE

SEND
for
FREE
800-Page
CATALOG

Write
Box L on
company
letterhead

Telephone BArcley 7-1840

SUN RADIO & ELECTRONICS CO.

212 Fulton Street, New York 7, N. Y.

HAM-ADS

(1) Advertising shall pertain to radio and shall be of nature of interest to radio amateurs or experimenters in their pursuit of the art.

(2) No display of any character will be accepted, nor can any special typographical arrangements, such as all or part capital letters be used which would tend to make one advertisement stand out from the others.

(3) The Ham-Ad rate is 30c per word, except as noted in paragraph (6) below.

(4) Remittance in full must accompany copy. No cash or contract discount or agency commission will be allowed.

(5) Closing date for Ham-Ads is the 25th of the second month preceding publication date.

(6) A special rate of 7c per word will apply to advertising which, in our judgment, is obviously non-commercial in nature and is placed and signed by a member of the American Radio Relay League. Thus, advertising of bona fide surplus equipment owned, used and for sale by an individual or apparatus offered for exchange or advertising inquiring for special equipment, if by a member of the American Radio Relay League takes the 7c rate. An attempt to deal in apparatus in quantity for profit, even if by an individual, is commercial and all advertising by him takes the 30c rate. Provisions of paragraphs (1), (2), (4) and (5) apply to all advertising in this column regardless of which rate may apply.

Having made no investigation of the advertisers in the classified columns, the publishers of QST are unable to vouch for their integrity or for the grade or character of the products advertised

QUARTZ — direct importers from Brazil of best quality pure quartz suitable for making piezo-electric crystals. Diamond Drill Carbon Co., 719 World Bldg., New York City.

COMMERCIAL radio operators examination questions and answers. One dollar per element. G. C. Waller, W5ATV, 6540 Washington Blvd., Tulsa, Okla.

DUAL SPEED phonograph motors needed. Write VAN SICKLE, Box 1583, Indianapolis, Indiana.

WHY NOT turn your unused equipment into ready cash which may be applied towards new and better equipment after the war? Leo, W9GFQ, offers you the best cash prices for communications receivers and test equipment. Write today for large illustrated catalog. Wholesale Radio Laboratories, 744 W. Broadway, Council Bluffs, Iowa.

CRYSTALS available — all types, including 100 kc, 465 kc and 100 kc. Broadcast and Aircraft given prompt attention. Scientific Radio Products, Council Bluffs, Iowa.

PROMPT Repair Service on Meters and Electronic Instruments. Braden Engineering Company, 3317 Kenmore Ave., Dayton 2, Ohio.

USED TELEPLEXES, Instructographs, meters, bought, sold. Ryan's, Hannibal, Mo.

HIGHEST prices paid for used receivers, test equipment, bugs, oscillators. What have you? W9ARA, Butler, Mo.

IMMEDIATE shipment on priority: new NC-200TGs \$174.50; SX-28s \$179.50; SX-25s \$94.50; PM-23s \$15.00. Henry Radio Shop, Butler, Mo.

IN STOCK on priority: New SX-28s and SX-25s, NC-200TGs for immediate shipment. Henry Radio Shop, Butler, Mo.

RADIO TESTS — Pre-examination Tests for Radio Operators. Tests your knowledge before you appear for commercial radio operator license examinations. Avoids failures. Guides your preparation. Saves your time. Worth investigating at once. Also books for home study. Write for free circulars 5Q. NILSON RADIO SCHOOL, 51 E. 42 St., New York 17, N. Y.

PREPARE NOW for tremendous opportunities in new fields of radio after the war. Training for Federal licenses. Write for particulars. Radio code classes, all speeds. AMERICAN RADIO INSTITUTE, 44 East 23rd Street, New York 10, N. Y.

WANTED: Radio Operators for merchant marine. Commercial license. Must join union. Wages, \$310 to \$345 monthly. Radio Officers Union, 265 West 14th Street, New York City.

NEED Dec. 1915 and May 1916 issues QST. Pay any price within reason. ALSO want old call-books and Handbooks. W. L. Holst, W9MD, 2553 Winnemac Avenue, Chicago, Ill.

MISCELLANEOUS equipment slightly used in Signal Corps training program: Utah UAT-4, Collins 4-A, Stancor 60-P, and National transmitters. McElroy keys and tape pullers, \$65. Marine radio compass. RCA television receiver, code keys, Riders Manuals. R. G. Dougherty, 158 Market Street, Newark, N. J.

URGENTLY NEED test equipment. Advise type, condition, price. Warner, W6MRT, 433 Birch St., Boulder City, Nevada

WANTED: Highest cash price for S-29, S-19R, S-20R, EC-4 or small size communications receiver. Lt. Shih Yu-Tien, XU4A, Hq. Sq. AAFTS, Scott Field, Ill.

FOR SALE: Old model SW-3, tubes, 4 sets coils, \$12. P. Goddard, 2273 E. Main St., Rochester, N. Y.

WANTED: Abbott TR-4 transmitter-receivers; Mallory VP-552 or VP-554 Vibrapacks, transformer transformers, midjet Class B input and output transformers and other parts for SG-WERS. F. J. Gornley, 668 Canyon Road, Santa Fe, New Mexico.

WANTED: Hallicrafters S-29 receiver. W9JBK, William R. Luebke, Hq. 2nd Bn., 414 Inf., Camp Carson, Colorado.

WILL PAY top price for 2-VR 105/30 in A-1 condition. Send price, including airmail shipment. C. P. Monod, Fuentes Fluviales, Arecibo, P. R.

WANTED: Will pay cash for 1847 Iconoscope. Lewis M. Edwards, W9BRW, Concordia, Kansas.

CRYSTALS: 100-10,000 kc range. Prompt delivery at reasonable prices on new units, or repair services. Engineers, write us your crystal problems and get catalog L5. "EIDSON'S," Temple, Texas.

WANTED: Complete 20m. unidirectional rotary beam, motor, indicators. Thomas, Proctorville, Ohio.

WANTED: New or good condition original Vibroplex. Pfc. Louis Sollock, 39134048, 754th Tank Bn., AFO 502, San Francisco, Calif.

WANTED: IP501 receiver buzzer. Your price. W1BB.

WILL BUY Baldwin headphones. Write A. Blanchard, c/o Schlumberger Well Surveying Corporation, P. O. Box 2175, Houston 1, Texas, giving information and price wanted.

SELL OR SWAP: Cathode ray 5BPL. Never used and pair RCA 813. Best offer. James Middleton, 25 Hartford Street, Newark, N. J.

RECEIVER: Composite 12 tube super, 540 kc to 20-Mc.; electrical band spread, xtal, air tuned i.f.s, bfo, Lamb silencer; separate power supply, Permag speaker, R meter. Built around Tube Tuner, \$40. ATR vibrator supply, 325 volts, 125 ma output; 6 volt input. \$10. McEntee, W2FHP, 490 Fairfield Avenue, Ridgewood, New Jersey.

WANTED: One new, unused Abbott TR4 transmitter-receiver, mike, tubes, and power supply. J. L. Werner, W8VUS, RD #1, Middleport, Ohio.

SELLING OUT: Complete 450 watt cw transmitter, commercial duty. Extra-heavy relay rack, 40-20 meter coils, Biley crystal; Collins 40-90-watt cw transmitter, complete with coils. Biley crystal. Will trade for high-grade test equipment. Powerful 10-15-watt amplifier complete with microphone-speaker, suitable for stores or any large gatherings, or modulation. George Landry, Lock Box #6, West Somerville, Mass.

WANTED: Volumes 1 and 2 of Riders Manuals in first class condition. W. M. Morgan, 6610 St. Claude Ave., Arabi, Louisiana.

WANTED for church program, RCA Junior velocity mike 74B. Harold Ramsey, Bethesda Hospital, Zanesville, Ohio.

SELL NC-45 AC perfect condition, want Hallicrafters, National, RME or Hammarlund receiver for cash. W5ASG, Widener, Arkansas.

WANTED: Used communications receiver. Give description, price and condition. J. J. Finlon, 1846 W. Grace St., Richmond 20, Va.

WANTED: A 100- to 600-kilocycle receiver. Walter T. Anderson, 85 Calmar St., Brockton, Mass.

WANTED: Utah, Jr., transmitter transformer #2384. W8TWB.

WANTED: Hallicrafters S-29, Sky Traveler. W8SNE, Lt. M. B. Wozniak, 8th Co., 1st STR, JIS, Fort Benning, Ga.

WANTED: Meissner fm chassis, Solar CB analyzer, Carron af oscillator, RCP signal generator, Superior channel-analyzer. Equivalents considered. State price. Soundways, 560 Walnut, Fall River, Mass.

WANTED: Rek-O-Kut or Universal overhead recording drive (outside-in cutting). Also UTC linear standard transformers LS-55, LS-40, LS-22. Thordarson T15A74 interstage. Denzel Murphy, W8WSL, 524 Gaston Ave., Fairmont, West Virginia.

SEVERAL like-new T40s, \$3.50; T55s, \$6.00; T125s, \$13.50; HF100s, \$13.50; HF200s, \$24.50; 211cs, \$10.00. Arthur Dailey W7BL, 343-27 St., Seattle, Washington.

WANTED: Urgently require 10 kw, 110 vac, 60 cycle gas-driven plant; 9 inch oscilloscope, xtals cut for 35,000; 50,000; 75,000; 100,000 c.p.s.; audio generator with range to 75,000 c.p.s.; core for 5 k.w. h.v. xfmr; pr. RCA 833A tubes; four RCA 872A rectifiers; 4000-0-4000 volt 1000 M.A. xfmr; driver xfmr Class-B 100 watts. W6LRL, H.N. Luke, 2113 Somers Place, Oklahoma City, Okla.

NECESSARY parts available for generator construction. WIDMK.

QSTs wanted prior to February 1920. W3BXC, Vinal, Box 213, Fishkill, New York.

FOR SALE: 100 watt ten meter radiotelephone transmitter, Triplet 666 vom, and pair new 807s. Ernest Austin, 1445 Ogden St., N. W., Washington 10, D. C.

PATTERSON PR-16C communications receiver, A-1 condition, 8-550 meters, crystal filter, 12-inch dynamic speaker. Sell at \$75. Lt. David J. Anthony, W9UKF, Escanaba, Michigan

**MIRAGE NOTHING! SHE'S BEEN
FOLLOWING HOGARTH EVER SINCE
SHE FIRST HEARD HIS
ECHOPHONE EC-1**

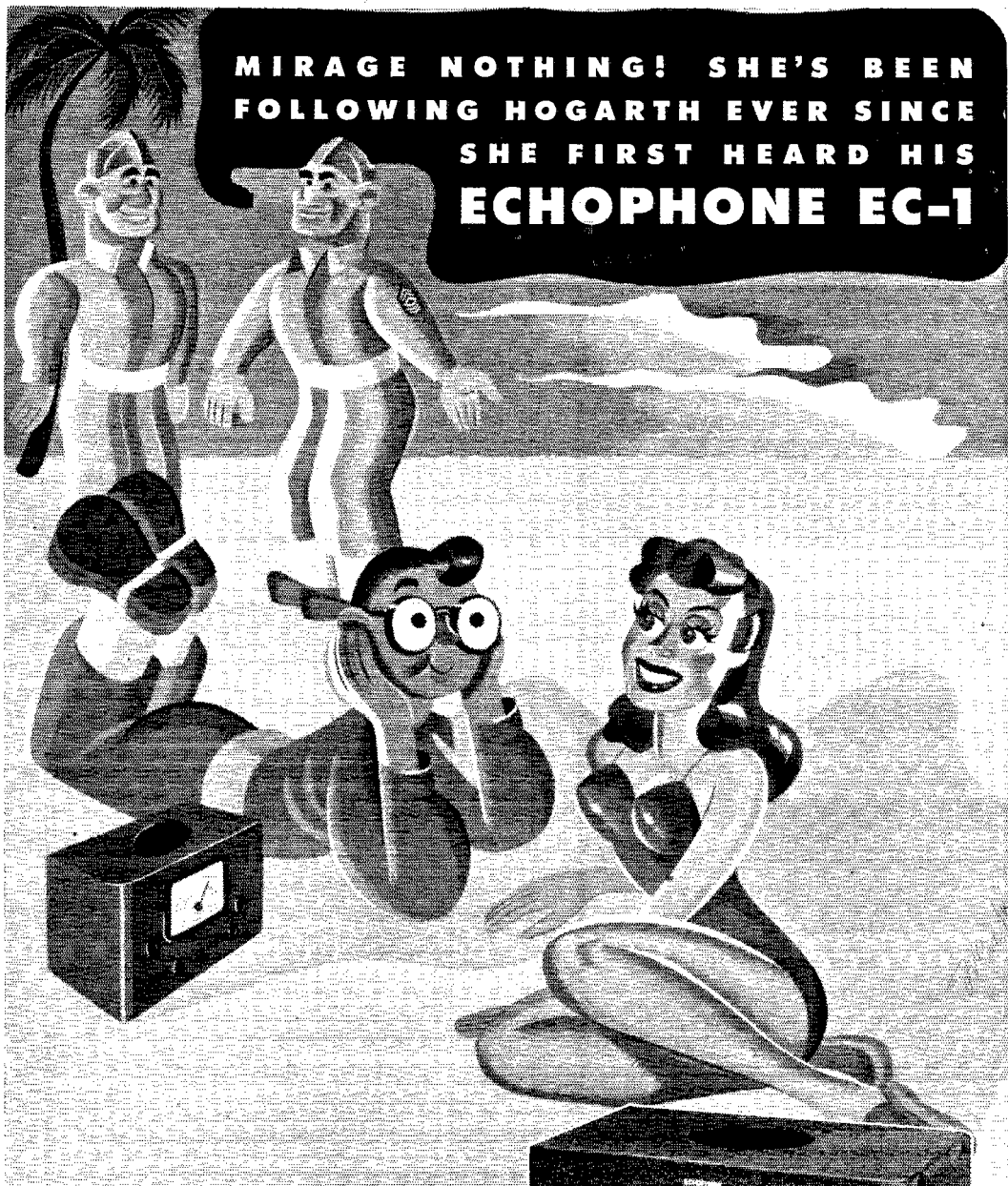

ECHOPHONE MODEL EC-1

(Illustrated) a compact communications receiver with every necessary feature for good reception. Covers from 550 kc. to 30 mc. on 3 bands. Electrical bandspread on all bands. Six tubes. Self-contained speaker. 115-125 volts AC or DC.



ECHOPHONE RADIO CO., 540 NORTH MICHIGAN AVE., CHICAGO 11, ILLINOIS

Designed for

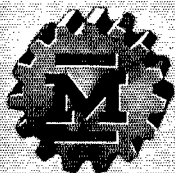

Application

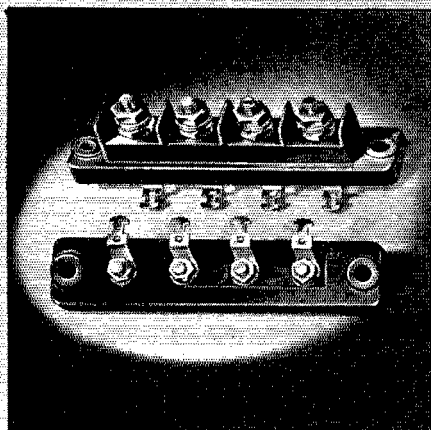

**The No. 37104
Terminal Strip**

is a sturdy four-terminal strip of molded black General Electric Textolite much used on present production Army and Navy equipment. Barriers between contacts. "Non turning" studs, threaded 8/32 each end.

**JAMES MILLEN
MFG. CO., INC.**

MAIN OFFICE AND FACTORY
**MALDEN
MASSACHUSETTS**



Index to Advertisers

	Page
Abbott Instrument, Inc.	90
Aerovox Corporation	**
American Lava Corporation	112
American Radio Institute	**
Amperex Electronic Products, Inc.	**
Astatic Corporation	98
Ayers Automatic Code Machine	**
Barker & Williamsou	99
Billey Electric Company	82
Brach Manufacturing Corp.	**
Browning Laboratories, Inc.	106
Burgess Battery Co.	104
Candler System Company	105
Capitol Radio Engineering Institute	101
Cardwell Manufacturing Corp., Allen D.	**
Centralab	91
Claroostat Manufacturing Co., Inc.	**
Communications Products Co.	**
Crystal Products Co.	**
Delco Radio, Div. Gen. Motors	89
DX Crystal Company	101
Echophone Radio Co.	109
Eitel-McCullough, Inc.	5
Electro-Voice Manufacturing Co.	**
Electronic Laboratories	**
Galvin Manufacturing Corp.	**
Gardner & Company	**
Hallcrafters Company, The	1, 2
Hammarlund Manufacturing Co., The	81, 83
Harrison Radio Corporation	**
Harvey Radio Company	92
Harvey Radio Laboratories, Inc.	105
Harvey-Wells Communications, Inc.	**
Heintz & Kaufman, Ltd.	**
Henry Radio Shop	105
Hudson-American Corp.	**
Hytron Corporation	**
Instructograph Company	99
International Resistance Co.	94
Jensen Radio Manufacturing Co.	**
Kato Engineering Company	105
Ken-Rad Tube & Lamp Corp.	**
Kenyon Transformer Co., Inc.	**
Knights, James, Co.	**
Maedel Publishing House	**
Mallory & Co., Inc. (P. R.)	80
Massachusetts Radio School	99
McElroy Manufacturing Corp.	111
McGraw-Hill Book Co., Inc.	86
Meck, Industries, John	**
Meissner Manufacturing Co.	**
Melville Aeronautical Radio School, Inc.	107
Metropolitan Technical School	**
Millen Manufacturing Co., James	110
Miller, Wayne	79, Cov. 111
National Company, Inc.	102
Newark Electric Company	102
New York Y.M.C.A. Schools	**
Nilson Radio School	105
Ohmite Manufacturing Co.	85
Onan Electric Plants, D. W.	107
Oxford-Tartak Radio Corporation	**
Phileo Corporation	**
Pioneer Gen-F-Motor Co.	**
Port Arthur College	94
Premax Products	103
RCA Institutes, Inc.	103
RCA Manufacturing Co., Inc.	Cov. IV
Radel Corporation	**
Radio Control Headquarters, Inc.	**
Radio Manufacturing Engineers	**
Radio Shack Corporation	**
Raytheon Manufacturing Co.	97
Scientific Radio Products Co.	88
Sire Brothers	**
Sickles Co., F. W.	101
Simpson Electric Co.	87
Sprague Specialties	84
Standard Transformer Corp.	**
Sun Radio & Electronics Co.	107
Taylor Tubes, Inc.	**
Telegraph Apparatus Company	**
Teleplex Company	101
Terminal Radio Corporation	98
Thordarson Electric Mfg. Co.	103
Triplet Electrical Instrument Co., The	99
Turner Company, The	**
United Transformer Company	Cov. II
Universal Microphone Company	106
Valparaiso Technical Institute	107
Vibraplex Co., Inc., The	**
Wallace, William, Co.	107
Westinghouse Electric & Mfg. Co.	**
Wholesale Radio Laboratories	104
Wilcox Electric Company	**
Waxley (Mallory, P. R.)	80
Zenith Radio Co.	**

All of the above advertisers are cooperating with the A.R.R.L. to permit publication of an editorially adequate OST during this period of war rationing of paper. Using less advertising space but at higher rates, they continue their customary support of OST. Some are using smaller space in each issue and some are using space only every second or third issue. Of the latter, those whose advertising does not appear in this particular issue are indicated by the ** above.

A highly RELIABLE, FAST and, when necessary, MOBILE adjunct to radiotelegraph communications!



The new
McELROY WHEATSTONE CODE TAPE PERFORATOR, PFR 443-A

Not only can the PFR-443-A, a proud McElroy achievement, be set up to operate immediately as a stationary unit, but it can be used with equal efficiency in moving vehicles. Requiring little or no maintenance, the PFR-443-A now provides high speed transmission where once it was impossible because of the bulky and complicated equipment required to perforate tape. With this unit, accurate tapes can be prepared for transmission at speeds up to 300 words per minute.

The McElroy PFR-443-A consists of two units. The **Keying Unit**, which is silent in operation, comprises two keys, space bar and punching mechanism. The **Electronic Unit**, which relieves the keying contacts of high current and voltage, is designed so that the tube and relay are separated from the mechanical section. Thus, the delicate electronic components are not subjected to jolts and jars.

Although the transmission of dots and dashes is automatic, the operation is similar to a semi-automatic (bug) key. A light touch actuates the punching mechanism for as long as either the key or space bar is depressed. Experienced operators can maintain, with ease, speeds of between 30 and 40 words per minute in all Morse combinations assigned to the Russian, Turkish, Greek, Arabic and Japanese alphabets and languages. This is a McElroy advantage not found on the keyboards of standard perforators manufactured in the U. S. or Great Britain.

McELROY
 ENGINEERS
 CREATE ...
 DESIGN ...
 BUILD.
 WE
 ARE
 NEVER
 SATISFIED
 WITH
 MEDIOCRITY



SUPPORT THE FIFTH WAR LOAN DRIVE

McElroy MANUFACTURING CORP.
 82 BROOKLINE AVE., BOSTON, MASS.

OUT OF TODAY'S RESEARCH...
TOMORROW IS ENGINEERED

RECORD BREAKING HEAT WAVE

INDUCTION HEATING through powerful high-frequency radio waves is breaking records in speeding up production of bonded plywoods, tin plating and in other industrial applications.

Of prime importance to the efficiency and stability of such high-frequency circuits is insulation whose composition and strength is master of both power and heat.

Permanent in their hardness, strength and rigidity, ALSiMAG Ceramic Insulators are not subject to distortion, warping or shrinking.

ALSiMAG bodies, each with its particular characteristics, are available to meet all insulating requirements. Our engineering and research people will gladly cooperate in today's design — tomorrow's production.

CHARACTERISTICS OF ALSiMAG INSULATORS

- High Mechanical Strength
- Permanent Rigidity
- High Dielectric Strength
- Low-Loss Factor
- Will Not Absorb Moisture
- Chemically Inert

AMERICAN LAVA CORPORATION
CHATTANOOGA 5, TENNESSEE



Army Navy "E"
First Awarded July 27, 1942
Second Award: "Star" February
13, 1943
Third Award: "Star" September
25, 1945

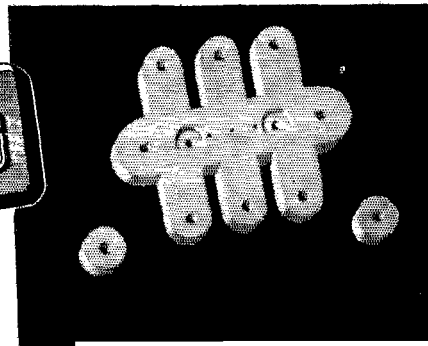

RIGHT, MAJOR, IT WON'T TRANSLATE JAPANESE

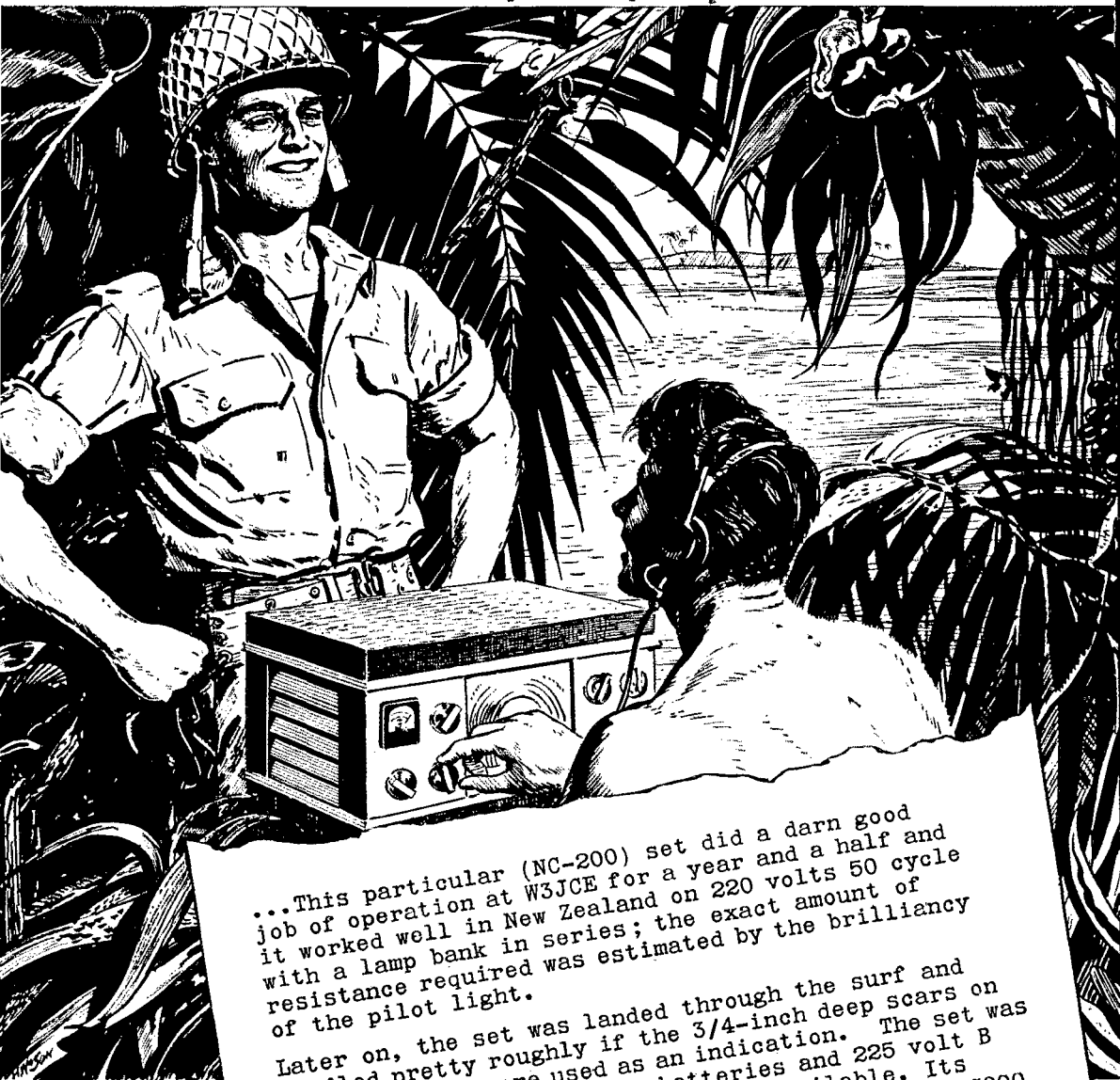

...This particular (NC-200) set did a darn good job of operation at W3JCE for a year and a half and it worked well in New Zealand on 220 volts 50 cycle with a lamp bank in series; the exact amount of resistance required was estimated by the brilliancy of the pilot light.

Later on, the set was landed through the surf and handled pretty roughly if the 3/4-inch deep scars on the packing box are used as an indication. The set was operated on 6 volt storage batteries and 225 volt B for several weeks until AC became available. Its reception of broadcast programs from the States 7000 miles away was excellent. In fact, the only thing it wouldn't do was translate Japanese. The NC-200 was by far the best radio on the island except for one 'RAS' and I guess you know who built that.

When I received my orders to come back to this country, it almost broke my heart to part with 'Baby', but I sold it because a good radio means a lot out there.

(Excerpt from a letter from a Major of Marines in the Pacific)



NATIONAL COMPANY

MALDEN



MASS., U. S. A.

NATIONAL RECEIVERS ARE IN SERVICE THROUGHOUT THE WORLD

